



Cisco Unified Attendant Console Advanced Design Guide

May 1, 2014

Cisco Systems, Inc.

www.cisco.com

Cisco has more than 200 offices worldwide. Addresses, phone numbers, and fax numbers are listed on the Cisco website at www.cisco.com/go/offices.

THE SPECIFICATIONS AND INFORMATION REGARDING THE PRODUCTS IN THIS MANUAL ARE SUBJECT TO CHANGE WITHOUT NOTICE. ALL STATEMENTS, INFORMATION, AND RECOMMENDATIONS IN THIS MANUAL ARE BELIEVED TO BE ACCURATE BUT ARE PRESENTED WITHOUT WARRANTY OF ANY KIND, EXPRESS OR IMPLIED. USERS MUST TAKE FULL RESPONSIBILITY FOR THEIR APPLICATION OF ANY PRODUCTS.

THE SOFTWARE LICENSE AND LIMITED WARRANTY FOR THE ACCOMPANYING PRODUCT ARE SET FORTH IN THE INFORMATION PACKET THAT SHIPPED WITH THE PRODUCT AND ARE INCORPORATED HEREIN BY THIS REFERENCE. IF YOU ARE UNABLE TO LOCATE THE SOFTWARE LICENSE OR LIMITED WARRANTY, CONTACT YOUR CISCO REPRESENTATIVE FOR A COPY.

The Cisco implementation of TCP header compression is an adaptation of a program developed by the University of California, Berkeley (UCB) as part of UCB's public domain version of the UNIX operating system. All rights reserved. Copyright © 1981, Regents of the University of California.

NOTWITHSTANDING ANY OTHER WARRANTY HEREIN, ALL DOCUMENT FILES AND SOFTWARE OF THESE SUPPLIERS ARE PROVIDED "AS IS" WITH ALL FAULTS. CISCO AND THE ABOVE-NAMED SUPPLIERS DISCLAIM ALL WARRANTIES, EXPRESSED OR IMPLIED, INCLUDING, WITHOUT LIMITATION, THOSE OF MERCHANTABILITY, FITNESS FOR A PARTICULAR PURPOSE AND NONINFRINGEMENT OR ARISING FROM A COURSE OF DEALING, USAGE, OR TRADE PRACTICE.

IN NO EVENT SHALL CISCO OR ITS SUPPLIERS BE LIABLE FOR ANY INDIRECT, SPECIAL, CONSEQUENTIAL, OR INCIDENTAL DAMAGES, INCLUDING, WITHOUT LIMITATION, LOST PROFITS OR LOSS OR DAMAGE TO DATA ARISING OUT OF THE USE OR INABILITY TO USE THIS MANUAL, EVEN IF CISCO OR ITS SUPPLIERS HAVE BEEN ADVISED OF THE POSSIBILITY OF SUCH DAMAGES.

CCDE, CCENT, CCSI, Cisco Eos, Cisco HealthPresence, Cisco Ironport, the Cisco logo, Cisco Lumin, Cisco Nexus, Cisco Nurse Connect, Cisco Stackpower, Cisco StadiumVision, Cisco TelePresence, Cisco Unified Computing System, Cisco WebEx, DCE, Flip Channels, Flip for Good, Flip Mino, Flip Video, Flip Video (Design), Flipshare (Design), Flip Ultra, and Welcome to the Human Network are trademarks; Changing the Way We Work, Live, Play, and Learn, Cisco Store, and Flip Gift Card are service marks; and Access Registrar, Aironet, AsyncOS, Bringing the Meeting To You, Catalyst, CCDA, CCDP, CCIE, CCIP, CCNA, CCNP, CCSP, CCVP, Cisco, the Cisco Certified Internetwork Expert logo, Cisco IOS, Cisco Press, Cisco Systems, Cisco Systems Capital, the Cisco Systems logo, Cisco Unity, Collaboration Without Limitation, EtherFast, EtherSwitch, Event Center, Fast Step, Follow Me Browsing, FormShare, GigaDrive, HomeLink, Internet Quotient, IOS, iPhone, iQuick Study, IronPort, the IronPort logo, LightStream, Linksys, MediaTone, MeetingPlace, MeetingPlace Chime Sound, MGX, Networkers, Networking Academy, Network Registrar, PCNow, PIX, PowerPanels, ProConnect, ScriptShare, SenderBase, SMARTnet, Spectrum Expert, StackWise, The Fastest Way to Increase Your Internet Quotient, TransPath, WebEx, and the WebEx logo are registered trademarks of Cisco Systems, Inc. and/or its affiliates in the United States and certain other countries.

All other trademarks mentioned in this document or website are the property of their respective owners. The use of the word partner does not imply a partnership relationship between Cisco and any other company. (0907R)

Any Internet Protocol (IP) addresses and phone numbers used in this document are not intended to be actual addresses and phone numbers. Any examples, command display output, network topology diagrams, and other figures included in the document are shown for illustrative purposes only. Any use of actual IP addresses or phone numbers in illustrative content is unintentional and coincidental.

Cisco Unified Attendant Console Advanced Design Guide
© 2012 Cisco Systems, Inc. All rights reserved.



About This Document **vii**

Audience **vii**

Abbreviations Used In This Document **viii**

Conventions **ix**

Obtaining Documentation and Submitting Service Requests **ix**

CHAPTER 1

Introduction to Cisco Unified Attendant Console Advanced **1-1**

Controlled CTI Devices **1-1**

Controlled CTI Device Provisioning **1-2**

Call Delivery Methods **1-3**

Cisco Unified Attendant Console Advanced User Accounts **1-3**

Cisco Unified Attendant Console Advanced Server **1-5**

Cisco Unified Attendant Console Advanced Server Virtualization **1-5**

VMware Guest Machine Requirements **1-6**

VMware Guest Machine Disk Space **1-6**

Cisco Unified Communications Manager and Cisco Unified Attendant Console Advanced Server Co-residency **1-8**

Server Prerequisites **1-8**

Server Identification **1-8**

Add Web Server Internet Information Services **1-8**

Add IIS to Windows Server 2008 **1-8**

Add IIS to Windows Server 2012 **1-9**

Disable User Account Control **1-10**

Add Firewall Exceptions **1-10**

SQL Database **1-10**

SQL Installation Prerequisites **1-11**

SQL Installation **1-12**

Database Problems **1-12**

Duplicate Server CIDs **1-13**

Model Database Too Small **1-13**

CHAPTER 2

Cisco Unified Attendant Console Advanced Architecture **2-1**

System Architecture Overview **2-1**

Bandwidth and Latency **2-3**

- Cisco TSP Timeouts 2-4
- CTI Architecture 2-4
 - CTI Request Information Flow 2-5
 - Cisco Unified Attendant Console Advanced CTI Setup 2-6
 - CTI Resilience 2-7
- Call Flow Diagrams 2-8
- Centralized Installations and Transcoding 2-12
 - Example Installation Requiring Transcoding 2-13
- Network Bandwidth Consumption 2-17
- Cisco Unified Attendant Console Advanced Ports 2-18
- Sample Topologies 2-20
 - Single Site Topology 2-20
 - Centralized Cisco Unified Attendant Console Advanced Server with Local and Remote Clients 2-21
- AXL Connectivity 2-21
 - AXL Usage During Installation 2-21
 - AXL Usage After Installation 2-22
 - Standalone Installation Scenarios 2-22
 - Resilient Installation Scenarios 2-23

CHAPTER 3

Cisco Unified Communications Manager Compatibility 3-1

- Calling Search Spaces and Partitions 3-1
 - Answering Calls 3-2
 - Consult Transfer 3-3
 - Blind Transfer (Standard Functionality) 3-4
 - Blind Transfer (Direct Transfer) 3-5
 - Night Service /Overflows/ Out of Service 3-5
 - Holding Calls 3-7
 - Parking Calls 3-8
 - Call Flow Example With Partition/CSS 3-9
- Configuring Controlled CTI Devices 3-10
- Configuring CTIManager and Cisco TSP 3-10
- Media Driver Options 3-10
- TSP Silent Install 3-11
- Supported Handsets 3-11
 - Jabber Support 3-17

CHAPTER 4

Cisco Unified Attendant Console Advanced Resilience 4-1

- Full Resilience 4-1

| | |
|--|-----|
| Database Replication | 4-2 |
| System Configuration | 4-5 |
| Failover Scenarios | 4-5 |
| Full Failover | 4-5 |
| Partial Failover | 4-5 |
| Full CTI Failover | 4-6 |
| Providing Additional Resilience | 4-6 |
| CTIManager Service Failure | 4-6 |
| Cisco Unified Communications Manager Failure | 4-7 |
| Client Handset Resets | 4-7 |

CHAPTER 5**Directory Contacts, Devices and Line Status** 5-1

| | |
|--|-----|
| Populating the Directory | 5-1 |
| Searching the Directory | 5-2 |
| Assigning Device Names to DNs (Cisco Unified Communications Manager) | 5-2 |
| Assigning Device Names to DNs (External Sources) | 5-2 |
| BLF Plug-in | 5-3 |
| Amending Device Names | 5-5 |
| Device Selection | 5-5 |
| Shared Line Support | 5-8 |
| Device-based Monitoring | 5-8 |

CHAPTER 6**Presence Integration** 6-1

| | |
|---|-----|
| Cisco Unified Presence Server Integration | 6-2 |
| MOC and Lync Integration | 6-3 |

CHAPTER 7**Cisco Unity Voicemail Integration** 7-1

| | |
|---|-----|
| Configuring Cisco Unified Attendant Console Advanced Voicemail Access | 7-1 |
| Call Arrival Mode | 7-2 |

CHAPTER 8**Antivirus and Remote Access Application Support** 8-1

| | |
|-----------------------------------|-----|
| Remote Access Application Support | 8-1 |
|-----------------------------------|-----|

APPENDIX A**AXL/Database Field Mappings** A-1

| | |
|----------------------------------|-----|
| Phone Mappings | A-1 |
| CTI Route Point Mappings | A-3 |
| Directory Number (Line) Mappings | A-4 |

Devicenumplanmap Mappings A-6

APPENDIX B

Accessing Cisco Unified Attendant Console Advanced Registry Keys on Client PCs B-1



About This Document

This document contains information to help you plan, implement and administer your Cisco Unified Attendant Console Advanced system. It applies to all major releases of Cisco Unified Attendant Console Advanced, and it covers the following major topics:

- [Chapter 1, “Introduction to Cisco Unified Attendant Console Advanced”](#)
- [Chapter 2, “Cisco Unified Attendant Console Advanced Architecture”](#)
- [Chapter 3, “Cisco Unified Communications Manager Compatibility”](#)
- [Chapter 4, “Cisco Unified Attendant Console Advanced Resilience”](#)
- [Chapter 5, “Directory Contacts, Devices and Line Status”](#)
- [Chapter 6, “Presence Integration”](#)
- [Chapter 7, “Cisco Unity Voicemail Integration”](#)
- [Chapter 8, “Antivirus and Remote Access Application Support”](#)
- [Appendix A, “AXL/Database Field Mappings”](#)
- [Appendix B, “Accessing Cisco Unified Attendant Console Advanced Registry Keys on Client PCs”](#)

Audience

This document is for anyone involved with the planning, implementation and administration of a Cisco Unified Attendant Console Advanced system. It assumes basic knowledge of the Cisco Unified Attendant Console Advanced and Cisco Unified Communications Manager.

Use this document in conjunction with the *Cisco Unified Attendant Console Advanced Web Administration and Installation Guide*.

Abbreviations Used In This Document

This document uses the following abbreviations:

| Abbreviation | Name |
|---------------------|---|
| API | Application Programming Interface |
| AXL | AVVID XML Layer |
| BLF | Busy Lamp Field |
| CSS | Calling Search Spaces |
| CT | Computer Telephony |
| CTI | Computer Telephony Integration |
| CUACA | Cisco Unified Attendant Console Advanced |
| CUCM | Cisco Unified Communications Manager |
| CUP | Cisco Unified Presence |
| CUPS | Cisco Unified Presence server |
| DB | Database |
| DDI/DID | Direct Dial In/Direct Inward Dialing |
| DN | Directory Number |
| DND | Do Not Disturb |
| DNS | Domain Name System |
| HTTP | Hypertext Transport Protocol |
| LAN | Local Area Network |
| LDAP | Lightweight Directory Access Protocol |
| MAC | Media Access Control |
| MOC | Microsoft Office Communicator |
| MOH | Music On Hold |
| MSDTC | Microsoft Distributed Transaction Coordinator |
| OCS | Office Communications Server |
| PBX | Private Branch Exchange |
| PCM | Pulse Code Modulation |
| PSTN | Public Switched Telephone Network |
| RID | Resource Identifier |
| RSS | Really Simple Syndication |
| RTT | Round Trip Time |
| SCCP | Skinny Call Control Protocol |
| SIP | Session Initiation Protocol |
| SQL | A language for manipulating databases |
| SRTP | Secure Real-time Transport Protocol |
| SSL | Secure Sockets Layer |

| Abbreviation | Name |
|--------------|--|
| TAPI | Telephony Application Programming Interface |
| TCP/IP | Transmission Control Protocol/Internet Protocol |
| TSP | Telephony Service Provider |
| UC_SRND | Unified Communications Solution Reference Network Design |
| UCST | Unified Communications Sizing Tool |
| WAN | Wide Area Network |
| WMI | Windows Management Instrumentation |
| XML | Extensible Markup Language |

Conventions

This document uses the following typographical conventions:

| Convention | Indication |
|---------------------------|---|
| bold font | Commands and keywords and user-entered text appear in bold font . |
| <i>italic font</i> | Document titles, new or emphasized terms, and arguments for which you supply values are in <i>italic font</i> . |
| [] | Elements in square brackets are optional. |
| { x y z } | Required alternative keywords are grouped in braces and separated by vertical bars. |
| [x y z] | Optional alternative keywords are grouped in brackets and separated by vertical bars. |
| string | A non-quoted set of characters. Do not use quotation marks around the string. |
| <code>courier font</code> | Terminal sessions and information the system displays appear in <code>courier font</code> . |
| < > | Non-printing characters such as passwords are in angle brackets. |
| [] | Default responses to system prompts are in square brackets. |
| !, # | An exclamation point (!) or hash sign (#) at the start of a code line indicates a comment. |



Note

Means *reader take note*.



Tip

Means *the following information will help you solve a problem*.

Obtaining Documentation and Submitting Service Requests

For information on:

- Obtaining documentation
- Obtaining support
- Submitting service requests

- Providing documentation feedback
- Security guidelines
- Recommended aliases
- Gathering additional information
- A list of all new and revised Cisco technical documentation

see the monthly *What's New in Cisco Product Documentation* at:
<http://www.cisco.com/en/US/docs/general/whatsnew/whatsnew.html>

Subscribe to *What's New in Cisco Product Documentation* as a Really Simple Syndication (RSS) feed and set content to be delivered directly to your desktop using a reader application. The RSS feeds are a free service and Cisco currently supports RSS Version 2.0.



Introduction to Cisco Unified Attendant Console Advanced

This chapter provides a brief introduction to Cisco Unified Attendant Console Advanced, including the following:

- [Controlled CTI Devices, page 1-1](#)
- [Cisco Unified Attendant Console Advanced User Accounts, page 1-3](#)
- [Cisco Unified Attendant Console Advanced Server, page 1-5](#)
- [Cisco Unified Attendant Console Advanced Server Virtualization, page 1-5](#)
- [Server Prerequisites, page 1-8](#)
- [SQL Database, page 1-10](#)

Cisco Unified Attendant Console Advanced is a Windows-based operator attendant console application for use exclusively with Cisco Unified Communications Manager. Cisco Unified Attendant Console Advanced emulates the functions of a manual telephone switchboard, and so enables Cisco Unified Attendant Console Advanced operators to quickly accept incoming calls and efficiently dispatch them to recipients within an organization. Cisco Unified Attendant Console Advanced has a Client/server architecture and uses the Cisco TSP to communicate with Cisco Unified Communications Manager for call control.

Controlled CTI Devices

Cisco Unified Communications Manager uses the following types of *Controlled CTI Devices*:

- Computer Telephony Integration (CTI) Ports—virtual phones that can terminate calls. They can be used for queuing calls and can play music on hold to the caller.
- Computer Telephony Integration (CTI) Route Points—virtual devices that can receive multiple, simultaneous calls for application-controlled redirection. They cannot terminate (answer) calls.

Cisco Unified Attendant Console Advanced uses these types of Controlled CTI Devices:

| Cisco Unified Attendant Console Advanced Device | Cisco Unified Communications Manager Device Type | Description/Use |
|---|--|---|
| CT Gateway | CTI Port | When a call reaches a Queue DDI (see below), the Cisco Unified Attendant Console Advanced server informs the Cisco Unified Communications Manager to move the call to a CT Gateway device. The CT Gateway is used for queuing calls in the Cisco Unified Attendant Console Advanced system that have not yet been answered. |
| Queue DDI | CTI Route Point | Each Cisco Unified Attendant Console Advanced queue configured has a DDI. Incoming calls to the Cisco Unified Attendant Console Advanced system must be routed to these DDI devices, either directly or through translation. |
| Service Queues | CTI Port | Service Queues are used by Cisco Unified Attendant Console Advanced to manage calls after they leave the operator's handset. For example, to hold, transfer and call camp on. These devices are only used by Cisco Unified Attendant Console Advanced Clients. |
| Park Devices | CTI Port | Park devices are used by the Cisco Unified Attendant Console Advanced to park calls. Cisco Unified Attendant Console Advanced Call Park functionality is separate from Cisco Unified Communications Manager Call Park functionality. |

Each Cisco Unified Attendant Console Advanced queue has its own resource group—a *Queue Device Group*—with its own audio source for music on hold; calls to the queue DDI number use the devices in a resource group pool. The maximum number of system devices supported by a Cisco Unified Attendant Console Advanced Server is 255. The maximum number supported of each of the following CTI Port types is 100:

- CT Gateway Devices
- Park Devices
- Service Devices

These CTI Port system devices must not collectively total more than 255; they can be distributed among up to 20 Queue Device Groups.

Controlled CTI Device Provisioning

When installing Cisco Unified Attendant Console Advanced you must calculate how many Controlled CTI Devices to configure on the Cisco Unified Communications Manager.

To help you do this you can use the Unified Communications Sizing Tool (UCST) available at <http://tools.cisco.com/cust>.

CTI Ports include CT Gateway device, Service Queues and Park Device. The maximum number of CTI Ports you can configure is 255 per server.

Cisco recommends the following:

- CT Gateway—Configure one CT Gateway for each PSTN line and add 10 ports for other incoming calls, for example, internal calls to the queues.
- Queue DDI—Configure one Queue DDI for each DDI/DID routed into the Cisco Unified Attendant Console Advanced server.
- Service Queues—Configure a minimum of two Service Queues per Cisco Unified Attendant Console Advanced user.

**Note**

If the operators are using the advanced processing option to transfer calls directly to the destination, you can reduce the number of service queue devices.

- Park Devices—Configure at least one Park Device per Cisco Unified Attendant Console Advanced user. The number you configure depends on how often you expect to park calls from the operator.

Call Delivery Methods

The default, broadcast call delivery has the call holding/ringing a CTI Port and being displayed on the attendant console. When the call is answered it is redirected from the CTI Port to the attendant's handset.

Forced delivery makes an enquiry call from the CTI Port to the next attendant handset in a circular, round-robin pattern (determined by the order in which they log in). Attendants receive calls in a specific order, and after the last receives a call, the first receives the next one. Attendants are skipped if they are still busy on a previous call.

Cisco Unified Attendant Console Advanced User Accounts

The Cisco Unified Attendant Console Advanced server must be able to communicate with its assigned Cisco Unified Communications Manager cluster (using Cisco TSP and AXL) to enable Cisco Unified Attendant Console Advanced directory synchronization (if you are using the Cisco Unified Communications Manager directory), busy lamp field (endpoint line state) and call control. To achieve this, Cisco Unified Attendant Console Advanced uses an *Application User*. For more information about Application Users, including how to create them, see the *Cisco Unified Attendant Console Advanced Web Admin and Installation Guide*.

**Note**

If you are upgrading from a previous release of Cisco Unified Attendant Console Advanced that used an End User profile, you must create the Application User with the same roles previously assigned to the End User.

If you are using Cisco Unified Communications Manager Release 8 or earlier you must first create a User Group; if you are using Cisco Unified Communications Manager 9.x you must create an Access Control Group. The User Group or Access Control Group must have the correct roles assigned to it so that it can perform all of the functions required. You must then create the End User/Application User and assign it to the User Group or Access Control Group.

Application Users are not synchronized using Active Directory, so there is no risk of the User being deleted during an LDAP synchronization, which would cause the Cisco Unified Attendant Console Advanced server to shut down.

If you are using Cisco Unified Attendant Console Advanced in resilience mode, you require two Application Users—one for each server—and you must assign the same roles to both.

Assign the following roles to the Application/End User:

- Standard AXL API Access
- Standard CTI Allow Calling Number Modification
- Standard CTI Allow Call Park Monitoring
- Standard CTI Allow Control of All Devices
- Standard CTI Allow Control of Phones supporting Connected Xfer and conf*
- Standard CTI Allow Control of Phones supporting Rollover Mode*
- Standard CTI Allow Reception of SRTP Key Material
- Standard CTI Enabled

**Note**

* are only relevant if using phone models 69xx, 7931, 7965, 89xx and 99xx on Cisco Unified Communications Manager 7.1.2 or greater.

Cisco Unified Attendant Console Advanced Server

The Cisco Unified Attendant Console Advanced server consists of several components, including:

- Cisco Unified Attendant Console Advanced Server, responsible for call control and directory synchronization
- BLF Server, responsible for phone line status information
- CUP Server, responsible for presence information
- Cisco Unified Attendant Console Advanced Administration Server, responsible for administration interface
- LDAP Server, responsible for connecting the Cisco Unified Attendant Console Advanced Server to the Cisco Unified Communications Manager.

Cisco Unified Attendant Console Advanced Clients connect to the Cisco Unified Attendant Console Advanced server over the following ports:

- 1433 for the SQL server
- 1859 for call control
- 1863 for presence information
- 1864 for phone line status

For a full list of IP ports used by Cisco Unified Attendant Console Advanced, see [Cisco Unified Attendant Console Advanced Ports, page 2-18](#).

In small installations with only one or two Cisco Unified Attendant Console Advanced Clients, one of the Console Clients is sometimes run on the machine hosting the Cisco Unified Attendant Console Advanced server. In such a situation, if the system is not resilient, the attendant using that Client must not turn off the machine.

You can install multiple Cisco Unified Attendant Console Advanced servers on a single Cisco Unified Communications Manager cluster; however:

- Each server must use separate TSP User Profile.
- Each Cisco Unified Attendant Console Advanced Client must communicate with just one Cisco Unified Attendant Console Advanced server.
- The total number of CTI devices used by all the Cisco Unified Attendant Console Advanced servers must not exceed the Cisco recommended maximum (see the Cisco UC Solution Reference Network Design for details).
- You must provide sufficient CTI resources for any other CTI applications that may require them.

Cisco Unified Attendant Console Advanced Server Virtualization

In a production environment, Cisco Unified Attendant Console Advanced server release 10.0 runs on either a:

- Physical server
- Virtual environment, compliant with Cisco's Specifications-Based Hardware Support program. This is usually VMware ESXi 4.x or 5.x running on a host machine. For more information, see http://docwiki.cisco.com/wiki/Specification-Based_Hardware_Support).

**Note**

Cisco Unified Attendant Console Advanced server is *not* supported in HyperV or any other virtualization products other than VMware.

For more information about VMware requirements, feature support and services visit:

http://docwiki.cisco.com/wiki/Unified_Communications_VMware_Requirements.

For more information about Unified Communications application and version compatibility with a virtualized hardware support models visit

http://docwiki.cisco.com/wiki/Unified_Communications_Virtualization_Supported_Applications.

VMware Guest Machine Requirements

Cisco Unified Attendant Console Advanced server has the following minimum VMware guest machine (instance) requirements:

- 1x vCPU unrestricted
- 4 GB RAM
- 72 GB of available hard disk space

**Note**

You can download an OVA template configured with the above specifications from the following location:

<http://software.cisco.com/download/release.html?mdfid=284373299&flowid=33202&softwareid=283910832&release=8.x-9.x&relind=AVAILABLE&rellifecycle=&reltype=latest>.

VMware Guest Machine Disk Space

When assigning disk space while creating your guest machine you must consider the following:

- Logging Files
- Database Growth

Logging File Disk Space Requirements

Cisco Unified Attendant Console Advanced generates logging files on the server for use during troubleshooting. You can set different logging levels, although the default is generally sufficient for initial investigations.

For each relevant server process, you can set the number of stored files and the number of lines per file, and for the main server you can specify which processes to log.

The default space requirements are shown in the following table.

| Server Application | Number of Files | Lines Per File | File Size (MB) |
|--------------------|-----------------|----------------|----------------|
| Attendant Server | 10 | 10K | 16.8 |
| Attendant LDAP | 10 | 200K | 53.3 |
| Attendant CUPS | 50 | 10K | 15 |
| Attendant Admin | 50 | 200K | 182 |

| Server Application | Number of Files | Lines Per File | File Size (MB) |
|--------------------|-----------------|----------------|----------------|
| BLF Plug-in | 100 | 100K | 1792 |
| Middleware | 15 | Not applicable | 631 |

Database Disk Space Requirements

Configuration and usage determine the size of the databases. This section describes configuration and logging database requirements based on a system consisting of:

- 10 operators
- 255 configured CTI devices
- 10 queues
- 10,000 imported contacts

Configuration Database

The following table shows the size of the Configuration Database.

| Item | Default Size (KB) | Number of Items | Total Size (KB) |
|---------------------------------|-------------------|-----------------|-----------------|
| Default database Size (MDF+LDF) | 102400 | 1 | 102400 |
| Operator | 1.1 | 10 | 11 |
| CTI Device | 0.468 | 255 | 119.34 |
| Queue | 46.7 | 10 | 467 |
| Queued Message (MBUS) | 69632 | 1 | 69632 |
| Imported Contact | 172 | 10000 | 1720000 |
| Total Database Size | | | 1892629.3 |

Once configured, the configuration database is unlikely to grow, unless more configuration is added. The number of contacts in the system has the largest impact on database size; when fully populated, each contact uses up 172KB of storage.

Logging Database

The following table shows the size of the Logging Database.

| Item | Default Size (KB) | Number of Items | Total Size (KB) |
|---------------------------------|-------------------|-----------------|-----------------|
| Default database size (MDF+LDF) | 378880 | 1 | 378880 |
| Operator | 1.1 | 50 | 55 |
| Devices | 0.468 | 255 | 119.34 |
| Queues | 46.7 | 100 | 4670 |
| Calls | 161 | 100000 | 16100000 |
| Agent (Sessions) | 79.872 | 100000 | 7987200 |
| Total Database Size | | | 24470924.34 |

This database always grows over time as it stores details of all calls and attendant transactions – including logging in/out, answering calls, and making transfers.

Cisco Unified Communications Manager and Cisco Unified Attendant Console Advanced Server Co-residency

Cisco Unified Attendant Console Advanced server can co-reside with Cisco Unified Communications Manager on both B and C series Unified Computing System (UCS) servers. For more information, visit http://docwiki.cisco.com/wiki/Virtualization_for_Cisco_Unified_Attendant_Consoles#IOPS_and_Storage_System_Performance_Requirement

Server Prerequisites

Once an operating system has been installed on a server machine several other things must be installed or configured before installing the Cisco Unified Attendant Console Advanced Server.

- [Server Identification, page 1-8](#)
- [Add Web Server Internet Information Services, page 1-8](#)
- [Disable User Account Control, page 1-10](#)
- [Add Firewall Exceptions, page 1-10.](#)

Server Identification

The server is the engine of the Cisco Unified Attendant Console Advanced system, and as such needs to communicate with all the computers that run the Cisco Unified Attendant Console Advanced Client. Cisco Unified Attendant Console Advanced communicates by machine name, using Dynamic Host Configuration Protocol (DHCP) to allocate IPv4 addresses.

During Client installation you are prompted for the Fully Qualified Domain Name (FQDN) or the machine name of the server, and this is tested to ensure that communication is working. Consequently, you need to ensure that the server has a proper, useful machine name.

Add Web Server Internet Information Services

Internet Information Services (IIS) must be added before installing Cisco Unified Attendant Console Advanced, as it required by the web browser-based Administration interface, which is accessible from any Windows PC with appropriate network access.

To add IIS, do whichever of the following is appropriate:

- [Add IIS to Windows Server 2008, page 1-8](#)
- [Add IIS to Windows Server 2012, page 1-9](#)

Add IIS to Windows Server 2008

To add IIS to an installed Windows Server 2008 operating system, do the following:

-
- Step 1** Run Server Manager, click **Roles**, and then click **Add Roles** to use the Wizard to install Web Server (IIS).
 - Step 2** In the **Before You Begin** page, click **Next**.
 - Step 3** In the **Server Roles** page, select **Web Server (IIS)**.

- Step 4** Add the **Required Features**.
- Step 5** Select and add the following **Role Services**:
- ASP.Net
 - .NET Extensibility
 - ISAPI Extensions
 - ISAPI Filters
 - Server Side Includes
 - Static Content
- Step 6** Click **Install**.
-

Add IIS to Windows Server 2012

To add IIS to an installed Windows Server 2012 operating system, do the following:

- Step 1** Run Server Manager,
- Step 2** Under the Dashboard, click **Add Roles and features**.
The **Add Roles and Features Wizard** appears.
- Step 3** In the **Before You Begin** page, click **Next**.
- Step 4** In the **Installation Type** page, select **Role-based or feature-based installation**, and then click **Next**.
- Step 5** In the **Server Selection** page, select **Select a server from the server pool**, then select the server from the pool, and then click **Next**.
- Step 6** In the **Server Roles** page, select the check box for the **Web Server (IIS)** role.
The **Add features that are required for Web Server (IIS)** dialog box appears.
- Step 7** Select **Add management tools (if applicable)**, and then click **Add Features**.
- Step 8** In the **Select server Roles** page, click **Next**.
- Step 9** In the **Features** page, if they are not already installed, select **.NET Framework 3.5 Features**, and then click **Next**.
- Step 10** In the **Web Server Role (IIS)** page, click **Next**.
- Step 11** In the **Role Services** page, click **Next**.
- Step 12** In the **Confirmation** page, click **Install**.
- Step 13** When installation is complete, click **Close**.
-

Disable User Account Control

Cisco Unified Attendant Console Advanced server and Cisco Unified Attendant Console Advanced Client will neither install nor run correctly under Windows Server 2008, Windows Server 2012, Windows Vista, or Windows 7 when Windows User Account Control (UAC) is enabled. For this reason you must disable UAC on the Client and server computers (in resilient installations, both the Publisher and Subscriber) before installing the software and keep it disabled while the software is running.

To disable UAC:

-
- Step 1** Log into the server machine with local administrator rights.
 - Step 2** In Control Panel, open **User Accounts**.
 - Step 3** Click **User Accounts**.
 - Step 4** Do one of the following:
 - In Windows Server 2008 32-bit, click **Turn User Account Control on or off**.
 - In Windows 7, Windows Server 2008 64-bit and Windows Server 2012, click **Change User Account Control Settings**.
 - Step 5** Do one of the following:
 - In Windows Server 2008 32-bit, de-select **Use User Account Control (UAC) to help protect your computer**.
 - In Windows 7, Windows Server 2008 64-bit and Windows Server 2012, move the **User Account Control Settings** slider to **Never notify**.
 - Step 6** Click **OK**.
 - Step 7** Restart your machine for the change to take effect.
-

Add Firewall Exceptions

If you have a firewall on either the Publisher or Subscriber server, you must add the following ports, services and executable files as firewall exceptions on those machines:

- Windows Management Instrumentation (WMI)
- Distributed Transaction Coordinator (MDDTC) – only required if using SQL replication/resilience
- Message Bus (MBUS) – open inbound and outbound ports 61616 and 61618 (only required if using SQL replication/resilience)
- SQLSERVER.exe – For example:
C:\Program Files\Microsoft SQL Server\MSSQL10.MSSQLSERVER\MSSQL\Binn\sqlservr.exe

SQL Database

Cisco Unified Attendant Console Advanced uses Microsoft SQL Server for all its database storage, including its contact directory, system configuration data, and call activity logging. It uses two databases, which are created on the local machine (both the Publisher and Subscriber Servers) during installation.

In line with its support for both 64-bit and 32-bit Windows (both Windows 2008 and Windows 2012), Cisco Unified Attendant Console Advanced supports both 64-bit and 32-bit SQL Server. SQL 2008 and SQL 2012 are supported. Details of the SQL Server versions supported by each release of Cisco Unified Attendant Console Advanced are listed in the *Administration and Installation Guide* and the *Release Notes*.

SQL Installation Prerequisites

This section describes the SQL Server installation prerequisites, which – if satisfied – will ensure that the Cisco Unified Attendant Console Advanced Resilience installation wizard will run without error.

SQL Prerequisites

If you are installing a replicated/resilient system, you must install SQL Server *exclusively* for use by Cisco Unified Attendant Console Advanced to ensure that the default collation settings are correct.

Before installing SQL Server, do the following:

- Provide a valid SQL user with SysAdmin privileges.
- Ensure that the Windows Hostname and SQL hostname are identical. If Windows gets renamed then SQL needs to be renamed to match.

SQL Server Prerequisites for SQL Replication/Resilience

The following prerequisites are for resilient SQL Server installations only:

- A full version of SQL Server must be installed on the Publisher Server.
- During SQL server installation, ensure **SQL Server Replication** is selected .
- During SQL server installation, on the **Feature Selection** screen ensure the **Collation** settings are the same on both the Publisher and Subscriber machines.
- The network must possess fully functioning Name lookup (DNS). SQL replication can only use hostnames; it cannot use IP addresses.

Windows Prerequisites

Before installing SQL Server, configure the following in your Windows operating system:

- Ensure there is a Windows user account with administrative privileges that can be used for the installation.
- If setting up SQL Server for a standalone Cisco Unified Attendant Console Advanced installation, ensure the following services are running:
 - SQL Server
 - SQL Server Agent
- If setting up SQL Server on the Publisher of a resilient Cisco Unified Attendant Console Advanced installation, ensure the following services are running:
 - SQL Server
 - SQL Server Agent
 - Distributed Transaction Coordinator (MSDTC)
- If setting up SQL Server on the Subscriber of a resilient Cisco Unified Attendant Console Advanced installation, ensure the following services are running:
 - SQL Server

- Distributed Transaction Coordinator (MSDTC)
- If using SQL replication:
 - Ensure that the MSDTC service has firewall rules and authentication requirements set as per the *Technical Guide (Allow inbound/outbound and No Authentication Required)*.
 - Confirm that the TSP instances match across both Publisher and Subscriber servers. The number of TSP instances and the order in which they are listed in Windows must be the same on both servers.
 - Ensure that the CID of the Publisher and Subscriber Servers are unique. To confirm this run regedit and browse to HKEY_CLASSES_ROOT \CID. If any of the listed CIDs match any on the other server then you will need to generate a new CID by reinstalling the MSDTC service, as described in [Duplicate Server CIDs, page 1-13](#).

SQL Installation

If you are creating a standalone Cisco Unified Attendant Console Advanced with fewer than 10 Attendants, the installation wizard will automatically install SQL Server Express. When installing full SQL in preparation for a standalone SQL solution, ensure that the [SQL Prerequisites, page 1-11](#) have been satisfied.

For larger installations, SQL Standard or Enterprise is required, and should be installed using the default settings except for the following:

- **Feature Selection**
 - **Database Engine Services**
 - **Management Tools - Basic**
 - **SQL Server Replication** (only required on resilient installations)
- **Server Configuration - Service Accounts** tab
 - Set the **SQL Server Agent Startup Type** to **Automatic**.
 - Set the **SQL Server Database Engine Startup Type** to **Automatic**.
- **Server Configuration - Collation** tab
 - Set the **Database Engine** to **Latin1_General_CI_AS**.



Note

If you use a different collation settings to the above, make a note of it so that should you want to make your Cisco Unified Attendant Console Advanced installation resilient, you can use it to set up the Subscriber SQL Server, which needs to have the same SQL configuration as the Publisher.

- **Database Engine Configuration - Account Provisioning** tab
 - Set the **Authentication Mode** to **Mixed Mode**.

Database Problems

Cisco Unified Attendant Console Advanced databases must be set up correctly. This section describes common database problems.

Duplicate Server CIDs

Due to the way the database resilience is set up, every Publisher or Subscriber server configuration must have a unique CID, which is used by SQL server to identify machines in the network.

**Note**

To view a machine's CIDs, run **regedit** and browse to HKEY_CLASSES_ROOT\CID.

However, laboratory and production environments often use machine cloning or copying, and this can result in multiple machines (or virtual machines) having the same CID. If several machines do have the same CID, you can generate new, unique ones by reinstalling the Windows MSDTC service on both the Publisher and Subscriber servers.

To reinstall the MSDTC service, on each server do the following:

-
- Step 1** Open a command prompt with administrator rights.
 - Step 2** Enter **MSDTC -uninstall**.
 - Step 3** Enter **MSDTC -install**.
 - Step 4** Reboot the system.
 - Step 5** Re-set the MSDTC service to Automatic start-up.
-

**Note**

This procedure may also stop the MSDTC service on the other server.

Model Database Too Small

Cisco Unified Attendant Console Advanced creates its two databases during installation. The default installation size of each is 3MB, and your model database size must be at least this for Cisco Unified Attendant Console Advanced to be able to create its databases correctly. If your model database is smaller than 3MB the system will not function.

If SQL Server is already installed and has been configured with a different model database size, change the size in the following way:

-
- Step 1** Launch SQL Management Studio.
 - Step 2** Connect to the database.
 - Step 3** Expand **Parent > Databases > System Databases**.
 - Step 4** Right-click **Model**, and then select **Properties**.
 - Step 5** In the left navigation pane, select **Files**.
 - Step 6** Change the **Initial Size** of **modeldev** to **3**.
 - Step 7** Click **OK**.
 - Step 8** Close SQL Management Studio.
 - Step 9** Relaunch the Cisco Unified Attendant Console Advanced installer and proceed with installation.
-



Cisco Unified Attendant Console Advanced Architecture

This chapter describes:

- [System Architecture Overview, page 2-1](#)
- [CTI Architecture, page 2-4](#)— CTI request information flow and CTI setup
- [Call Flow Diagrams, page 2-8](#)—for standard and transferred calls
- [Centralized Installations and Transcoding, page 2-12](#)—networks that require transcoding
- [Network Bandwidth Consumption, page 2-17](#)—system requirements to assist network planning
- [Cisco Unified Attendant Console Advanced Ports, page 2-18](#)—port numbers and their functions.
- [AXL Connectivity, page 2-21](#)—when AXL is used and when the AXL service needs to run.

System Architecture Overview

The Cisco Unified Attendant Console Advanced system comprises several services that run on a single physical or virtual Windows server. Two servers can be run simultaneously to provide a resilient solution, with one server acting as a hot standby for the other. The system requirements are described in *Cisco Unified Attendant Console Advanced Web Admin and Installation Guide*.

The necessary services are:

| Service | Description |
|---|--|
| Cisco Unified Attendant Console Advanced attendant server | This is the engine of the system and it controls the system configuration. It is also the service that the Clients connect to. |
| BLF Plug-in | This handles all communications requests between the Cisco Unified Attendant Console Advanced system and the Cisco Unified Communications Manager system. This includes communication to the Cisco TSP installed on the Cisco Unified Attendant Console Advanced server, all CTI requests, and AXL communication, enabling the system to request information from the correct Cisco Unified Communications Manager. The BLF Plug-in uses information from the main configuration database to control how it functions. |

| Service | Description |
|--------------|---|
| LDAP Plug-in | This handles all directory synchronization requests via LDAP to the Cisco Unified Communications Managers being used. |
| CUPS Plug-in | This provides direct connection to a Cisco CUP server to obtain the relevant presence information for contacts. |

All these services are installed by a single installation script.

Cisco Unified Attendant Console Advanced also uses the Microsoft Active MQ service, which enables the two servers of a resilient installation to communicate with each other. This service is also installed during Cisco Unified Attendant Console Advanced installation.

Also required on the Cisco Unified Attendant Console Advanced server are SQL Server and Cisco TSP. Up to ten instances of Cisco TSP can run simultaneously, each configured with its own Primary and Secondary CTIManager Connections, to enable for system resilience if there is a primary node CTIManager failure. Each instance requires a unique Application User profile, which defines the instance's roles and permissions.

Cisco CTIManager is a service that runs on one or more Cisco Unified Communications Manager subscriber servers operating in primary/secondary mode. It authenticates and authorizes telephony applications to control and/or monitor Cisco IP devices.

For more information about Cisco TSP, see [Configuring CTIManager and Cisco TSP, page 3-10](#). For more information about SQL Server, see [Chapter 5, “Directory Contacts, Devices and Line Status”](#)

The following diagram shows the basic elements of a Cisco Unified Attendant Console Advanced system.

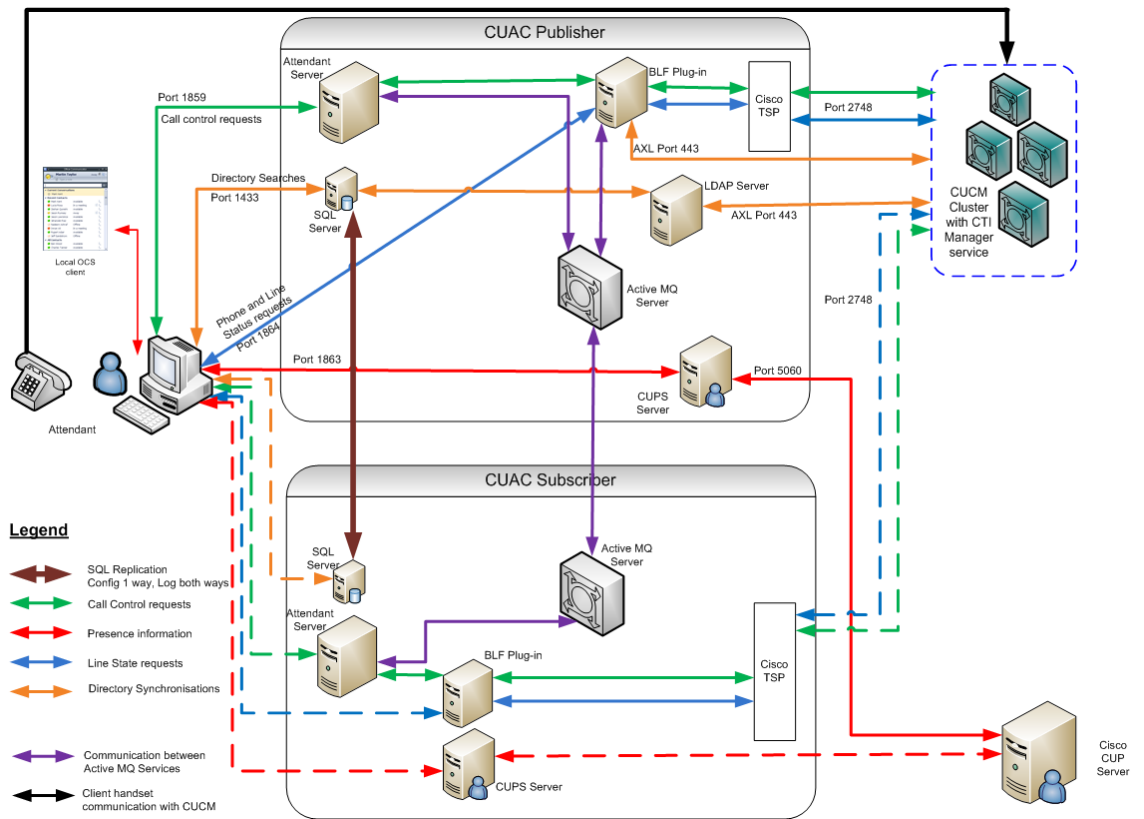

The server components all reside on the machine known as the Cisco Unified Attendant Console Advanced server. The Clients connect to the Cisco Unified Attendant Console Advanced attendant server over port 1859 for all call control communications. Other ports are used for other elements. For a full list of IP ports used by Cisco Unified Attendant Console Advanced, see [Cisco Unified Attendant Console Advanced Ports](#), page 2-18.

Bandwidth and Latency

Communication critical to Cisco Unified Attendant Console Advanced are the messages between the server and the Clients (attendants). Cisco Unified Attendant Console Advanced supports a maximum latency of 150ms Round Trip Time (RTT) between any Client and the server, and you should ensure that this is achievable in your network.

The maximum RTT for communication between the Cisco Unified Attendant Console Advanced Publisher and Subscriber is 150ms. The maximum RTT for TAPI communication between Cisco Unified Attendant Console Advanced and Cisco Unified Communications Manager is 80ms.

For more information, see the Cisco Solution Reference Network Design.

Cisco TSP Timeouts

Cisco recommends that your TSP instances have the **Provider Open Completed Timeout** set to 300 seconds, rather than the default value of 50 seconds. This gives the TSP more time to register the system devices being used for the Cisco Unified Attendant Console Advanced server. If insufficient time is allowed, devices may fail to monitor correctly and this will affect the stability of the system.

To configure the timeout, do the following:

-
- Step 1** Launch Cisco TSP Configuration.
 - Step 2** Select the instance, and then click **Configure**.
 - Step 3** Select the **Advanced** tab.
 - Step 4** In **Provider Open Completed Timeout (secs)**, type 300.
 - Step 5** Click **OK**.
 - Step 6** Restart the server.
-

CTI Architecture

Cisco Unified Attendant Console Advanced provides call control and device monitoring via CTI connections between the Cisco Unified Attendant Console Advanced server and the Cisco Unified Communications Manager cluster. The Cisco Unified Attendant Console Advanced server sends call control requests via this interface, and the Cisco Unified Communications Manager acts upon those requests, returning confirmation messages when the action is complete. This interaction uses Cisco TSP, which is installed on the Cisco Unified Attendant Console Advanced server (as part of the Cisco Unified Attendant Console Advanced server installation), and which communicates with the CTIManager service on the Cisco Unified Communications Manager. To increase CTI resources, you can install up to 10 TSP instances on a single server, but the Cisco Unified Attendant Console Advanced server cannot communicate with any specific instance.

It is important that you include your CTI requirements into the overall Cisco Unified Communications Manager design. At least one Cisco Unified Communications Manager node must have CTIManager service enabled. If you require it, you can request that the CTIManager service is activated on each Cisco Unified Communications Manager node in the cluster.

CTI Request Information Flow

The following diagram illustrates how information flows from the attendant Client through to the Cisco Unified Communications Manager, which actually routes the calls.

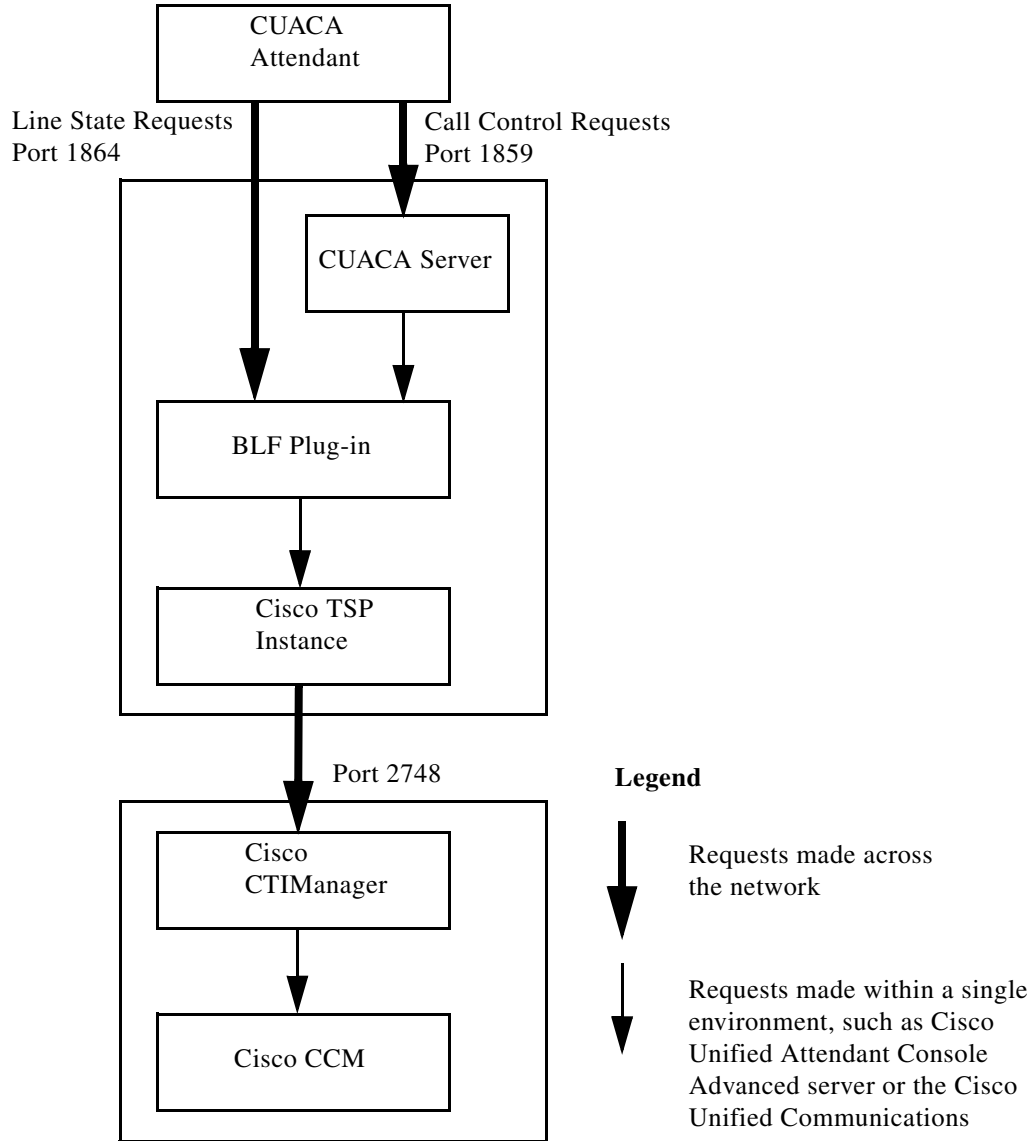

For CTI applications that require redundancy, each TSP instance can be configured with two IP addresses, thereby enabling an alternate CTIManager to be used in the event of a failure.



Note

This redundancy is not stateful: no information is shared or made available between the two CTIManagers, and therefore, after a failover, the CTI application may have to re-initialize, depending on the type of failover.

If a CTIManager fails-over, just the CTI application login process is repeated on the now-active CTIManager.

If the Cisco Unified Communications Manager server itself fails, the re-initialization process is longer due to the re-registration of all the devices from the failed Cisco Unified Communications Manager to the now-active Cisco Unified Communications Manager, followed by the CTI application login process.

Cisco CTI consists of the following components, which interact to enable applications to take advantage of the Cisco Unified Communications Manager telephony feature set:

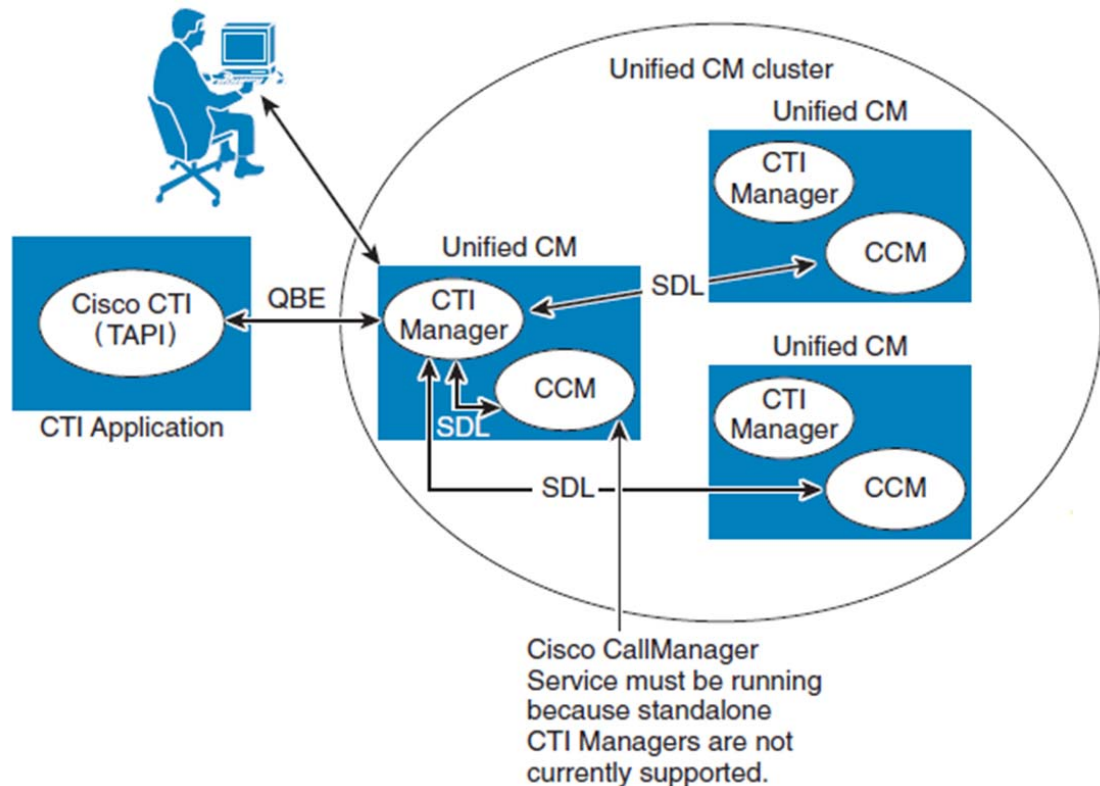

- CTI Application - Cisco or third-party application that provides telephony features and/or functionality. It uses the TAPI interface, which are supported by Cisco CTI. Developers can use either method library when writing applications. The Unified TSP Client converts external messages to Quick Buffer Encoding (QBE) messages used internally by Cisco Unified Communications Manager.
- CCM - Cisco CallManager Service (ccm.exe), the telephony processing engine.
- CTI Manager - A service that runs on one or more Cisco Unified Communications Manager subscriber servers operating in primary/secondary mode, and which authenticates and authorizes telephony applications to control and/or monitor Cisco IP devices.
- Signaling Distribution Layer (SDL) - Cisco Unified Communications Manager internal communication messages.

Cisco Unified Attendant Console Advanced CTI Setup

This section describes how to set up CTI for Cisco Unified Attendant Console Advanced to function correctly.

TSP must be configured and active on each Cisco Unified Attendant Console Advanced server before the server can start.

CTI Resilience

The Cisco Unified Attendant Console Advanced servers can be configured to use multiple TSP instances. This enables the Cisco Unified Attendant Console Advanced servers to use a Backup CTIManager when the Primary fails. This resilience is configured in the TSP itself.

Here are some example configurations.

Standalone Cisco Unified Attendant Console Advanced Server

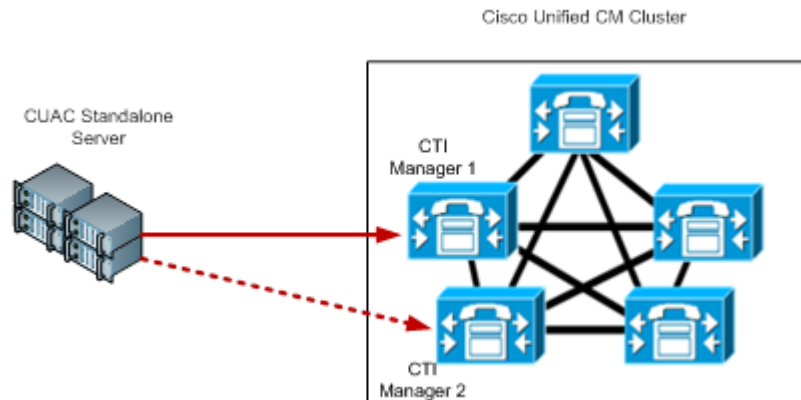

This example has a single Cisco Unified Attendant Console Advanced server, and a five node Cisco Unified Communications Manager cluster with two nodes running the CTIManager service. The Cisco Unified Attendant Console Advanced server is running a single TSP instance with a Primary connection to CTIManager 1 and a Backup connection to CTIManager 2.

Resilient Cisco Unified Attendant Console Advanced Servers On a Small Cisco Unified Communications Manager Cluster

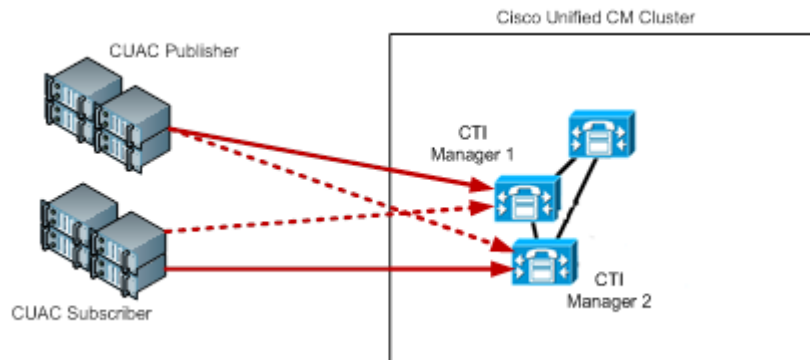

This example has only three nodes in the Cisco Unified Communications Manager cluster, the top node is the Publisher (primary) server and the lower two are Subscriber (secondary) servers. We recommended you do not use the CTIManager on the Publisher node, therefore both Cisco Unified Attendant Console

Advanced servers should use the CTIManagers on the two Cisco Unified Communications Manager subscribers, and should balance the load as best they can. Each server should use a different CTIManager as the primary connection, and then fail over to the other node.

Resilient Cisco Unified Attendant Console Advanced Servers On a Large Cisco Unified Communications Manager Cluster

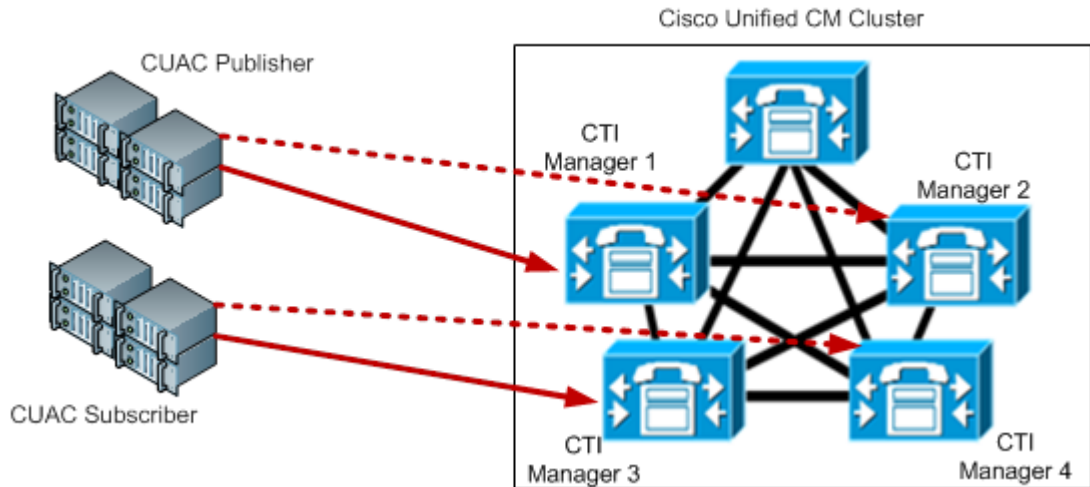

This example provides complete CTI redundancy. Each Cisco Unified Attendant Console Advanced server is configured with a single TSP instance that has primary and backup connections. To spread the load completely four of the CTIManagers in the cluster are used, with each Cisco Unified Attendant Console Advanced server using unique primaries and backups.

Call Flow Diagrams

This section contains the following call flow diagrams:

- [Standard Call Flow Within Cisco Unified Attendant Console Advanced, Figure 2-1](#)
- [Call Flow During Blind Transfer, Figure 2-2 on page 2-10](#)
- [Call Flow During Consultation Transfer, Figure 2-3 on page 2-11](#)

Figure 2-1 Standard Call Flow Within Cisco Unified Attendant Console Advanced

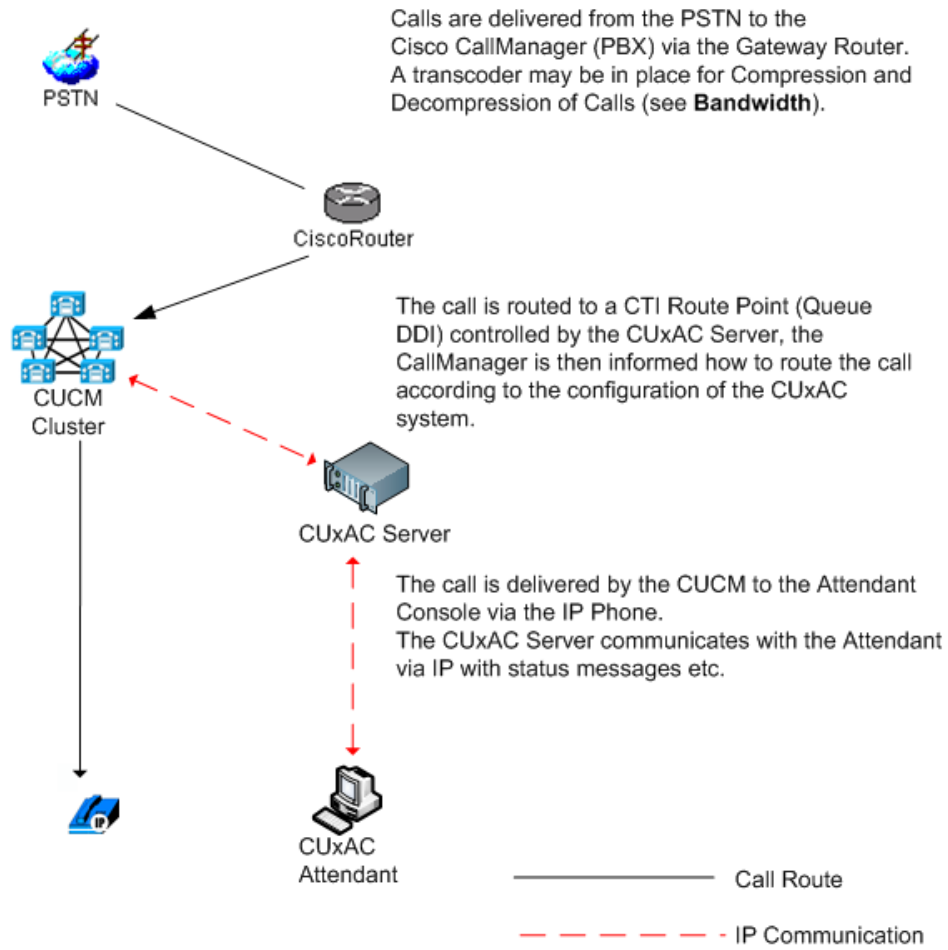

Figure 2-2 Call Flow During Blind Transfer

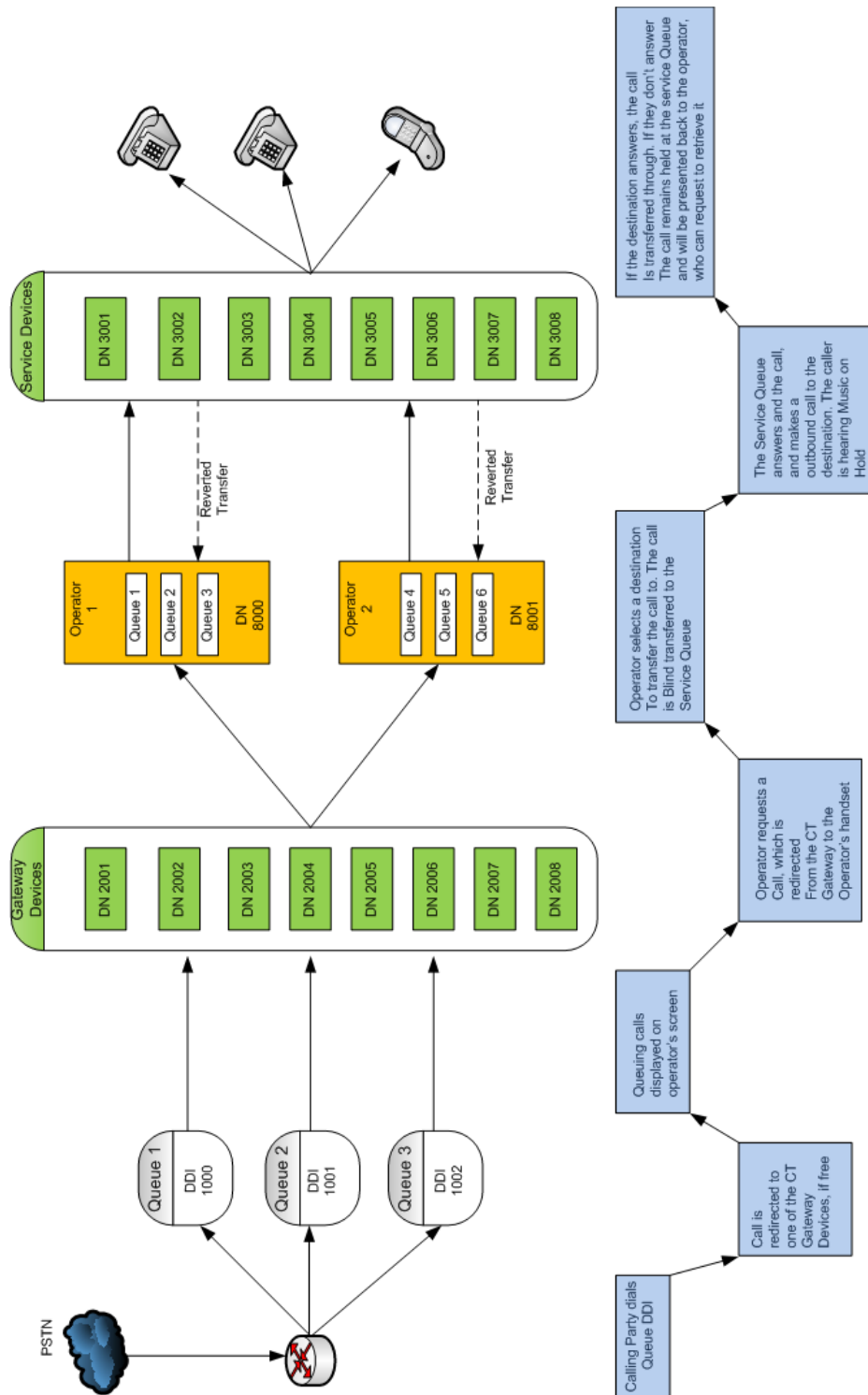
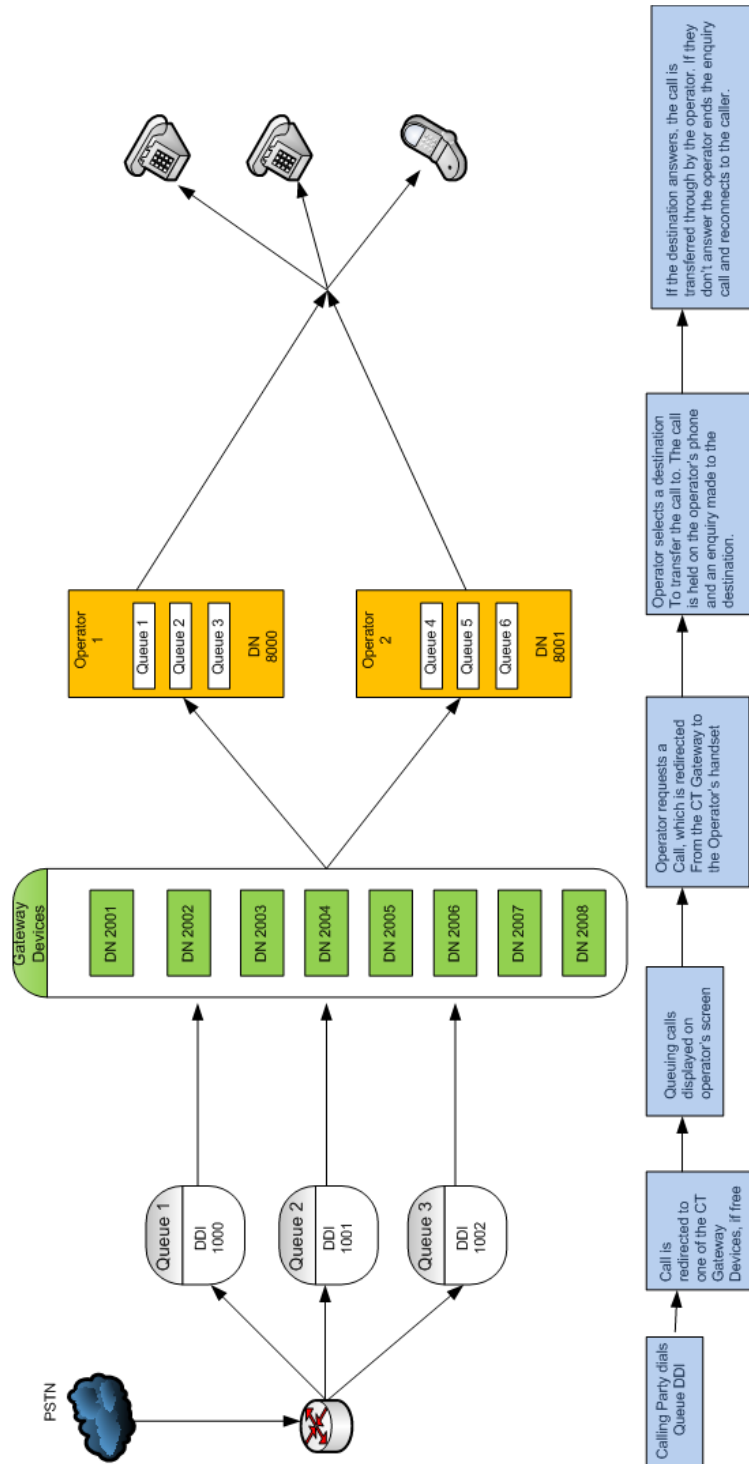

Figure 2-3 Call Flow During Consultation Transfer



Centralized Installations and Transcoding

All Cisco Unified Communications Manager releases support the Cisco TAPI Wave Driver. Cisco Unified Communications Manager Release 8.0 and later also supports the New Media driver, which is the recommended means of enabling CTI ports to be activated because it allows greater scalability and enables G729 to be used as a codec (compression type) without needing transcoding (the conversion of the output stream of one codec into another codec).

In Cisco Unified Communications Manager Release 7.1, TAPI Wave-enabled CTI Ports are needed for the Cisco Unified Attendant Console Advanced system to work correctly. These ports do not support the G729 codec for a connected call. Therefore, in a centralized environment where the G729 codec is being used across WAN links, a transcoder must be installed wherever the Cisco Unified Attendant Console Advanced server is located. This means that when a call crosses the WAN link to an attendant's IP Phone as a G729 call, during any subsequent call transfer, hold or park, Cisco Unified Communications Manager changes the codec to G711 while the call is connected to the Service Queue or Call Park Device CTI Ports.

To support G729 natively with the New Media Driver you need to do the following:

- On the Cisco Unified Attendant Console Advanced server, change the registry key HKEY_USERS/S-1-5-20/Software/Cisco Systems, Inc./RTPLib/G729PassThrough to 1 in either Hex or Dec, and then reboot the server.
- Ensure that the Device Pool and the region in which the CTI Port(s) are assigned is *not* restricted to G729. If it is, calls will not be processed correctly, and will be unable to be redirected to the CTI Port.

For more information on transcoding refer to the Cisco Solution Reference Network Design.

Example Installation Requiring Transcoding

This example describes a call being received by a system with centrally-located Cisco Unified Communications Manager and Cisco Unified Attendant Console Advanced server, and an attendant at a remote location, connected across the WAN. This scenario requires transcoding, as does any other involving the call being transferred, parked, or camped-on.

Figure 2-4 Call Enters System

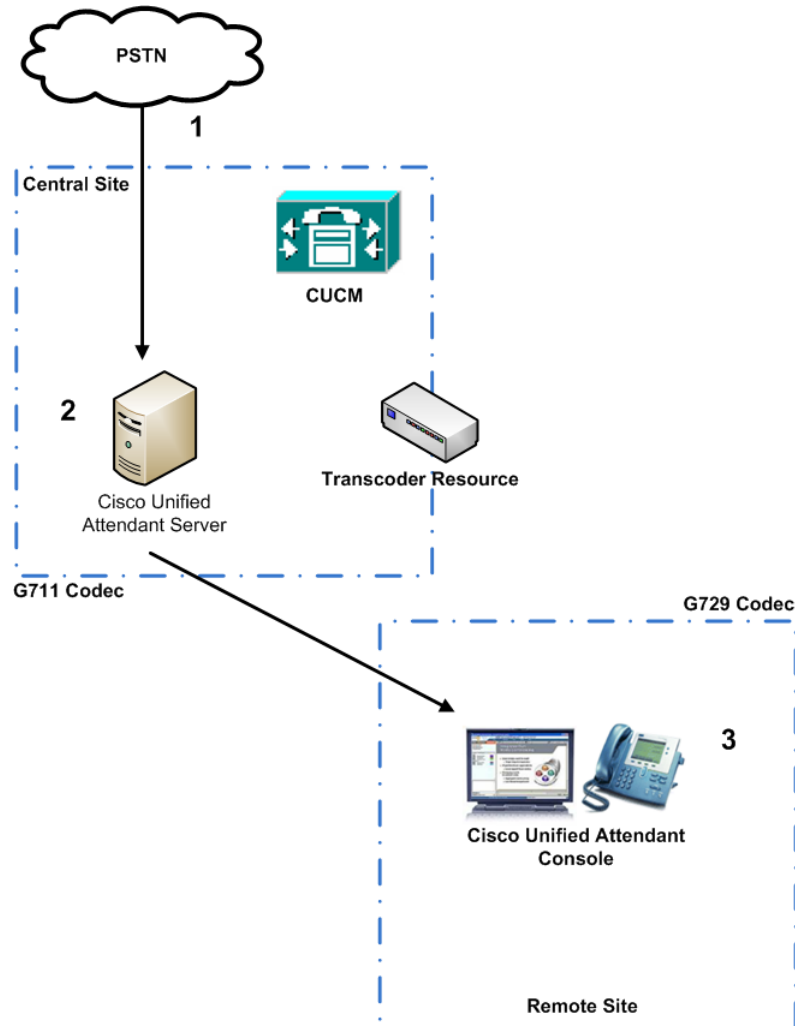

1. The call is received from an external telephone network.
2. The call is routed from the Queue DDI to the CT Gateway CTI Port.
3. The Cisco Unified Attendant Console Advanced Client can now see the call in the queue. The call is ringing on the CT Gateway and is in the queue waiting to be answered. The CT Gateway devices are registered to the Cisco Unified Communications Manager in the central site.

Figure 2-5 Remote Attendant Requests Call

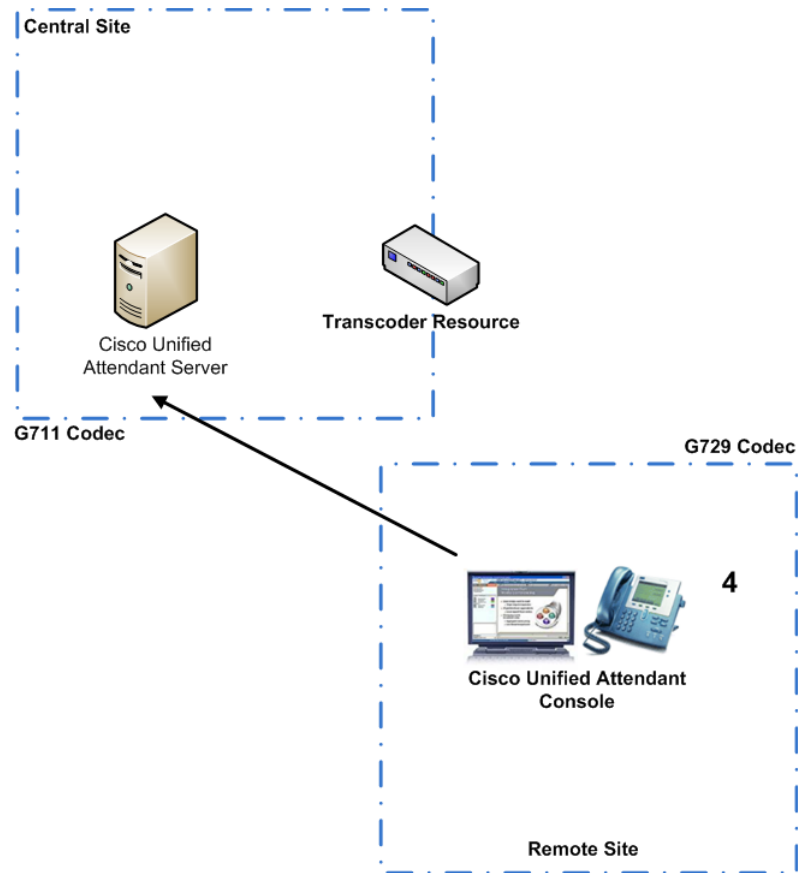

4. The Cisco Unified Attendant Console Advanced requests the call, which is delivered to the attendant extension in the remote site.

Figure 2-6 Cisco Unified Attendant Console Advanced Answers

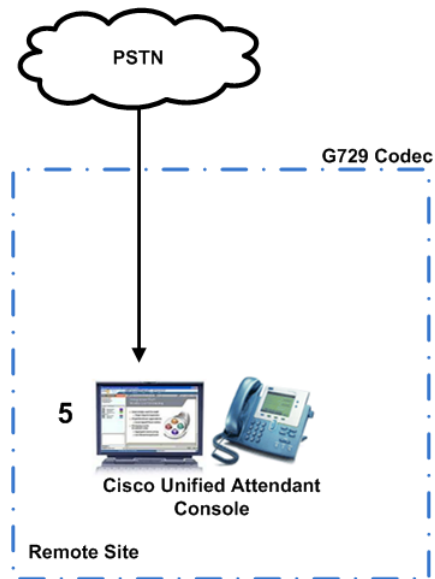

5. The Cisco Unified Attendant Console Advanced is talking to the caller. Because the attendant is on the remote site, the call is established using the G729 codec.

Figure 2-7 Cisco Unified Attendant Console Advanced Puts Call on Hold

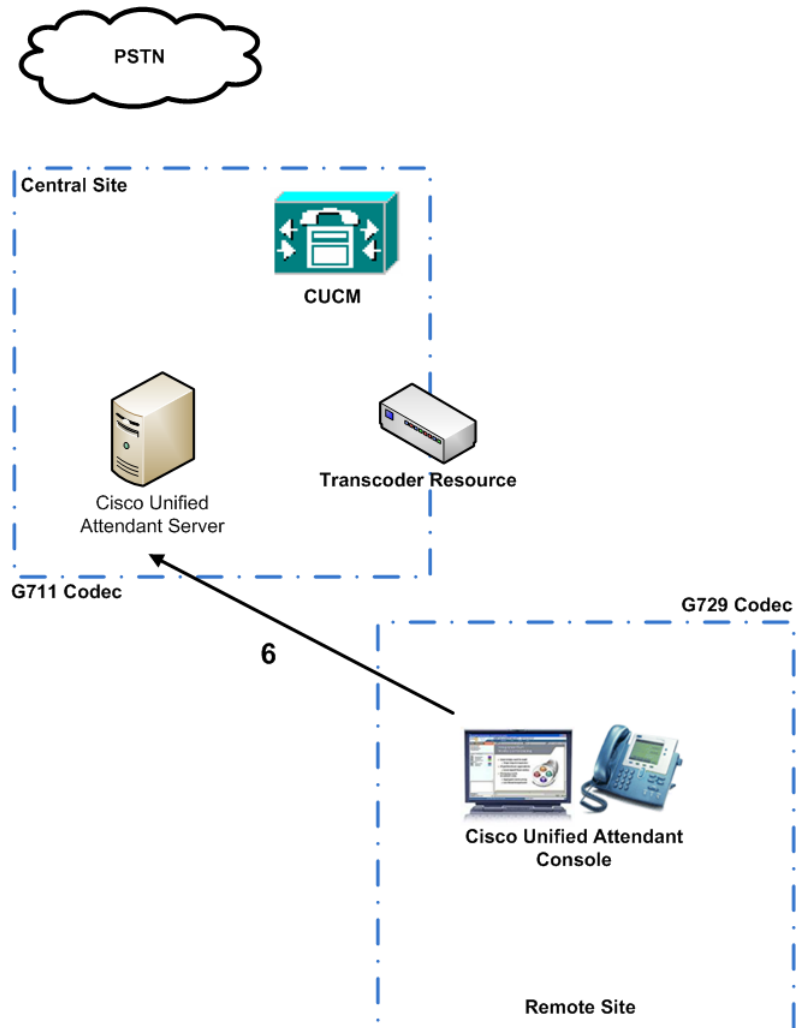

6. The Cisco Unified Attendant Console Advanced requests that the call be put on hold—the call is redirected back to the Cisco Unified Attendant Console Advanced server to be put on hold on a Service Queue Device (CTI Port). The transcoder must now convert the call back to the G711 codec so that the Wave enabled CTI Port can accept the call. If the call is still G729 when it reaches the Service Queue, the Cisco Unified Communications Manager will disconnect the call.

Network Bandwidth Consumption

You can implement location-based Call Admission Control to restrict bandwidth usage across the WAN, with maximum bandwidths set for calls to and from each remote location.

To ensure that devices are not subject to bandwidth restrictions, when you create controlled CTI devices, set their location to None. If you do set locations, bandwidth will be allocated according to the Region settings and the codec used between the endpoints:

- Calls across a LAN typically use the G711 or G722 codec (depending on the phone type), with each call using up to 80Kb/sec of bandwidth.
- Calls across a WAN may use the G729 codec, with each call using 24Kb/sec of bandwidth. If you use other codecs to reduce the bandwidth further, you may need a transcoder, as described in [Centralized Installations and Transcoding, page 2-12](#).

**Note**

Latency - A maximum round trip time (RTT) of 150ms should be ensured to enable provision for optimum network performance. For more information, see [Bandwidth and Latency, page 2-3](#).

The following IP communications between the Cisco Unified Attendant Console Advanced server and the Console Attendant also consume bandwidth:

- Contact Searching—Each search of the Contact Directory returns matches from the SQL database. The bandwidth consumption depends on:
 - Number of contacts returned
 - Amount of data in each contact
 - Number of operators searching simultaneously

Bandwidth consumption varies between 4Kb and 22KB per contact.

- Database Synchronization—The bandwidth consumption depends on:
 - Number of contacts returned
 - Amount of data in each contact

Bandwidth consumption is about 9Kb per contact.

Cisco Unified Attendant Console Advanced Ports

Cisco Unified Attendant Console Advanced applications use TCP/IP and UDP Ports to communicate with each other. In large networks, which often involve a WAN, you may need to prioritize the following ports across the network switches:

| Port Number | Port Type | Relationship * | Function |
|---------------|-----------|--|---|
| 80 | TCP | Pub/Sub Internal and Opr<->Pub/Sub | Used by the Cisco Unified Attendant Console Advanced XML Status Management service, which is hosted on the Internet Information Services (IIS) that runs on the Cisco Unified Attendant Console Advanced server. This service listens for HTTP requests from IP Phones and Web Browsers, and sends requests to IP Phones. |
| 389 | TCP | Pub/Sub Internal or Pub/Sub<->Directory source | Used to communicate with Microsoft Active Directory or iPlanet Netscape Directory when <i>using</i> Secure Sockets Layer (SSL). |
| 443 | TCP | CUCM<->Pub/Sub | Used by the AXL API to communicate with the Cisco Unified Communications Manager, with or without Secure Sockets Layer (SSL). |
| 636 | TCP | Pub/Sub Internal or Pub/Sub<->Directory source | Used to communicate with Microsoft Active Directory or iPlanet Netscape Directory when <i>not using</i> Secure Sockets Layer (SSL). |
| 1433 and 1434 | TCP | Pub<->Sub and Opr<->Pub/Sub | Used for SQL communication between servers and between servers and Clients. |
| 1859 | TCP | Opr<->Pub/Sub | Used by the Cisco Unified Attendant Console Advanced server and the Cisco Unified Attendant Console Advanced Client to communicate across a LAN. |
| 1862 | TCP | Pub/Sub Internal | Used by the Cisco Unified Attendant Console Advanced LDAP Server. |
| 1863 | TCP | Opr<->Pub/Sub | Used for communication between the Cisco Unified Attendant Console Advanced CUP server and the Cisco Unified Attendant Console Advanced Client. |
| 1864 | TCP | Opr<->Pub/Sub | Used for communication between Cisco Unified Attendant Console Advanced Clients and the Cisco Unified Attendant Console Advanced BLF plug-in that provides phone line status. |
| 2748 | TCP | CUCM<->Pub/Sub | Used by the Cisco TSP to communicate between the Cisco Unified Attendant Console Advanced server and the Cisco Unified Communications Manager. |
| 5060 | UDP | CUPS<->Pub/Sub | Used for communication between the Cisco Unified Attendant Console Advanced and the Cisco CUP servers. This is the default when not using Transport Layer Security. |
| 5061 or 5062 | TCP | CUPS<->Pub/Sub | Used for communication between the Cisco Unified Attendant Console Advanced and the Cisco CUP servers. This is the default when using Transport Layer Security. |

| Port Number | Port Type | Relationship * | Function |
|-------------|-----------|------------------|---|
| 11859 | TCP | Pub/Sub Internal | Used by the Cisco Unified Attendant Console Advanced service to communicate with the Cisco Unified Attendant Console Advanced server. |
| 61616 | TCP | Pub<->Sub | Used to enable messages to be passed between Publisher and Subscriber servers in resilient installations. |
| 61618 | TCP | Pub<->Sub | |

* Relationship Key

CUCM = Cisco Unified Communications Manager

CUPS = Cisco Unified Presence server

Opr = Attendant Console Client

Pub = Publisher Server

Sub = Subscriber Server

LDAP uses the following TCP/IP ports to communicate with Cisco Unified Communications Manager:

| TCP/IP Port | Use |
|-------------|---|
| 389 | LDAP server <i>does not use</i> SSL and <i>is not</i> configured as the Global Catalog. |
| 636 | LDAP server <i>uses</i> SSL and <i>is not</i> configured as the Global Catalog. |
| 3268 | LDAP server <i>does not use</i> SSL and <i>is</i> configured as the Global Catalog. |
| 3269 | LDAP server <i>uses</i> SSL and <i>is</i> configured as the Global Catalog. |

Sample Topologies

This section contains diagrams of the following sample topologies:

- [Single Site Topology, page 2-20.](#)
- [Centralized Cisco Unified Attendant Console Advanced Server with Local and Remote Clients, page 2-21.](#)

Single Site Topology

In the example shown below, the Cisco Unified Attendant Console Advanced server and Cisco Unified Attendant Console Advanced Client machines are on the same LAN as the Cisco Unified Communications Manager servers. There are no remote Cisco Unified Attendant Console Advanced Clients, or IP Phones.

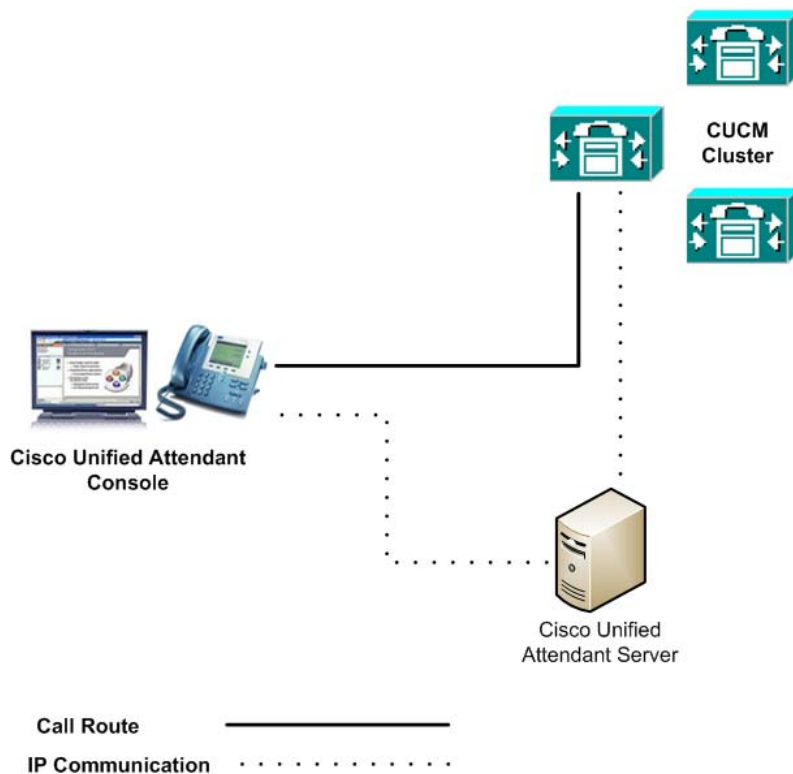

In this scenario resilience is configured using Call Forward No Answer to a Pilot Point Group, IP Phone or other device outside of the Cisco Unified Attendant Console Advanced environment.

Centralized Cisco Unified Attendant Console Advanced Server with Local and Remote Clients

In the example shown below, the Cisco Unified Attendant Console Advanced server and some Cisco Unified Attendant Console Advanced Client machines are on the same LAN as the Cisco Unified Communications Manager servers. Some Client machines are also on a remote site that uses G729.

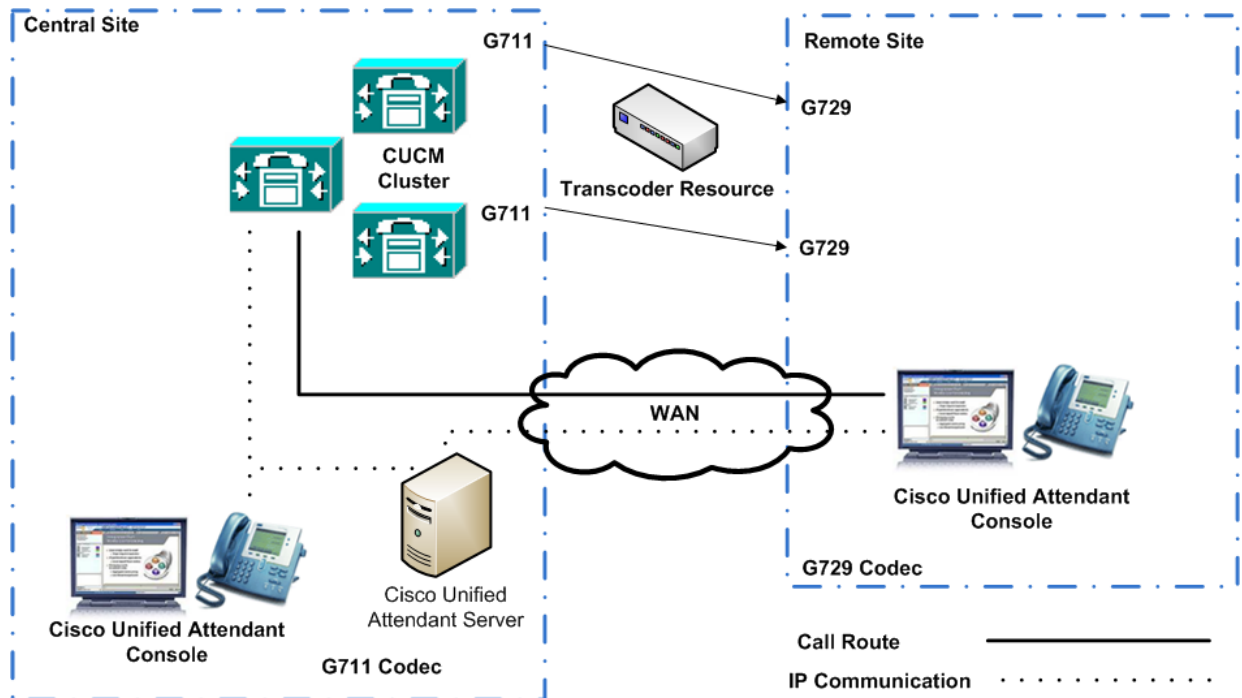

This topology has the following characteristics:

Resilience is configured using Call Forward No Answer to a Pilot Point Group, IP Phone or other device.

Because the TAPI wave method is being used and the G729 codec is being used at the remote site, a transcoder is installed at the central site, where the Cisco Unified Communications Manager is located and the CTI Ports are registered. When a Client at the remote site handles the call, it uses G729, but when the call is routed to the central site, it is changed to G711.

AXL Connectivity

The AVVID XML Layer (AXL) is used both during and after Cisco Unified Attendant Console Advanced installation.

AXL Usage During Installation

During Cisco Unified Attendant Console Advanced server installation (both standalone and resilient) you have to specify the following nodes:

- The Cisco Unified Communications Manager that will use it (see [Step 12](#), in the [Cisco Unified Attendant Console Advanced Server Installation Procedure](#)). In resilient installations the Publisher and Subscriber servers both need this information.
- The Primary and Backup *CTI Manager* that will use it (see [Step 14](#), in the [Cisco Unified Attendant Console Advanced Server Installation Procedure](#)).

CTI Manager is a feature service that runs on one or more Cisco Unified Communications Manager subscribers operating in primary/secondary mode to authenticate and authorize Cisco Unified Attendant Console Advanced. A *CTI Manager node* is a Cisco Unified Communications Manager subscriber that runs only the CTI Manager service.

The Cisco Unified Attendant Console Advanced server installer uses AXL to verify that the specified CTI manager(s) and Cisco Unified Communications Manager versions match, which is essential for successful implementation. After Cisco Unified Attendant Console Advanced is installed, the CTI Manager nodes no longer require the AXL service; so you can disable it. However, if the main Cisco Unified Communications Manager node and the CTI Manager nodes are hosted on the same servers, you need to retain the AXL service on them.

AXL Usage After Installation

Part of the Cisco Unified Attendant Console Advanced BLF Plug-in service known as Device Resolution Manager (DRM) uses AXL to communicate with Cisco Unified Communications Manager. The AXL communications enable DRM to resolve the BLFs of operator and system devices, and to synchronize system devices within the Cisco Unified Communications Manager database.

Standalone Installation Scenarios

This section describes AXL usage in example standalone Cisco Unified Attendant Console Advanced server installations.

Scenario 1

This scenario uses the following node IP addresses:

- Cisco Unified Communications Manager = 172.29.252.111
- Primary CTI Manager = 172.29.252.111
- Backup CTI Manager = 172.29.252.112

DRM uses only the Cisco Unified Communications Manager at 172.29.252.111. Consequently, the AXL service can be disabled on 172.29.252.112 after installing Cisco Unified Attendant Console Advanced.

Scenario 2

This scenario uses the following node IP addresses:

- Cisco Unified Communications Manager = 172.29.252.111
- Primary CTI Manager = 172.29.252.112
- Backup CTI Manager = 172.29.252.113

DRM uses only the Cisco Unified Communications Manager at 172.29.252.111. Consequently, the AXL service can be disabled on 172.29.252.112 and 172.29.252.113 after installing Cisco Unified Attendant Console Advanced.

Resilient Installation Scenarios

This section describes AXL usage in example resilient Cisco Unified Attendant Console Advanced server installations.

Scenario 3

This scenario uses the following node IP addresses:

- Publisher Cisco Unified Communications Manager = 17.29.252.111
- Publisher Primary CTI Manager = 172.29.252.111
- Publisher Backup CTI Manager = 172.29.252.112
- Subscriber Cisco Unified Communications Manager = 17.29.252.111
- Subscriber Primary CTI Manager = 172.29.252.111
- Subscriber Backup CTI Manager = 172.29.252.112

DRM uses the Cisco Unified Communications Manager pointed to by both Publisher and Subscriber Cisco Unified Attendant Console Advanced servers (both 17.29.252.111). Consequently, the AXL service can be disabled on 172.29.252.112 after installing Cisco Unified Attendant Console Advanced.

Scenario 4

This scenario uses the following node IP addresses:

- Publisher Cisco Unified Communications Manager = 17.29.252.111
- Publisher Primary CTI Manager = 172.29.252.111
- Publisher Backup CTI Manager = 172.29.252.112
- Subscriber Cisco Unified Communications Manager = 17.29.252.112
- Subscriber Primary CTI Manager = 172.29.252.111
- Subscriber Backup CTI Manager = 172.29.252.112

DRM uses the Cisco Unified Communications Manager pointed to by both Publisher and Subscriber Cisco Unified Attendant Console Advanced servers (17.29.252.111 and 17.29.252.112). Consequently, we need AXL connectivity to both IP addresses, and cannot disable AXL service on either.

Scenario 5

This scenario uses the following node IP addresses:

- Publisher Cisco Unified Communications Manager = 17.29.252.111
- Publisher Primary CTI Manager = 172.29.252.111
- Publisher Backup CTI Manager = 172.29.252.113
- Subscriber Cisco Unified Communications Manager = 17.29.252.112
- Subscriber Primary CTI Manager = 172.29.252.111
- Subscriber Backup CTI Manager = 172.29.252.113

DRM uses the Cisco Unified Communications Manager pointed to by both Publisher and Subscriber Cisco Unified Attendant Console Advanced servers (17.29.252.111 and 17.29.252.112). Consequently, the AXL service can be disabled on Cisco Unified Communications Manager IP 172.29.252.113 after installing Cisco Unified Attendant Console Advanced.



Cisco Unified Communications Manager Compatibility

Cisco Unified Attendant Console Advanced Releases only support specific Cisco Unified Communications Manager Releases. To check whether your Cisco Unified Attendant Console Advanced and Cisco Unified Communications Manager are compatible, see the appropriate *Cisco Unified Communications Manager Web Admin and Installation Guide* at http://www.cisco.com/en/US/products/ps7282/prod_maintenance_guides_list.html.

This chapter covers the following:

- [Calling Search Spaces and Partitions, page 3-1](#)
- [Configuring Controlled CTI Devices, page 3-10](#)
- [Configuring CTIManager and Cisco TSP, page 3-10](#)
- [Media Driver Options, page 3-10](#)
- [TSP Silent Install, page 3-11](#)
- [Supported Handsets, page 3-11](#)

Calling Search Spaces and Partitions

Calling Search Spaces (CSS) and partitions are used within Cisco Unified Communications Manager to control the calling abilities of the devices in the system. The architecture of the Cisco Unified Attendant Console Advanced system demands that incoming calls can be transferred to all the devices that could possibly be required - not just internal transfers but potential external-to-external transfers as well.

Cisco Unified Attendant Console Advanced moves calls from one device to the next using the `lineBlindTransfer` method, where the CSS of the call changes as it progresses through the system, according to the *transferring* device. Consequently, Cisco Unified Attendant Console Advanced CTI Route Points and CTI Ports need to have all the relevant CSSs and partitions assigned to enable them to receive and then transfer the call. Under the default Cisco Unified Attendant Console Advanced installation, Service Queue Ports must be able to call any destination to which any attendant may wish to transfer a call. If Direct Transfer is being used, it is the attendant's line that needs to be able to call any destination. We recommend that a separate partition and CSS be created for the System Devices.

The attendant Client IP phones do not need to have the same CSS and partition as the controlled CTI devices. However, they must be able to receive incoming calls from the Host PBX Gateways devices and from the Service Queue devices where calls return unanswered. The attendant Client IP phones also need

to be able to dial both the Service Queue and any other destinations to which they may transfer calls. The Service Queue devices must, in turn, be able to dial the attendant's handset and all other destinations for transfers.

The remainder of this section describes some of the most common call routing scenarios, and how CSSs enable Cisco Unified Attendant Console Advanced to function correctly.

Answering Calls

This scenario describes a call being answered.

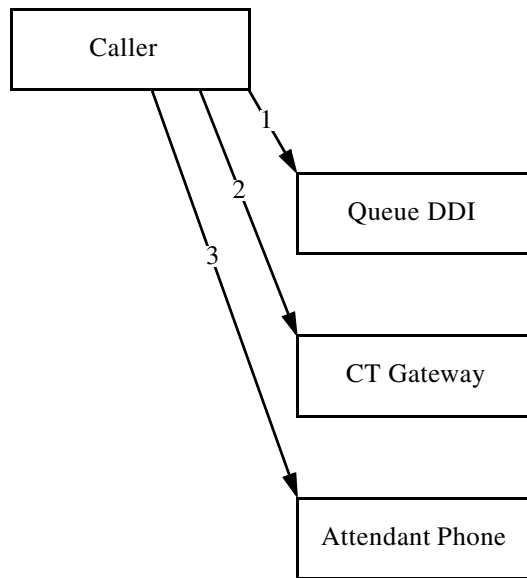

1. Call arrives at the Queue DDI device. This notifies Cisco Unified Attendant Console Advanced that the call has arrived for the specified queue, and allows for CLI filter checking. The CSS of the CTI Route Point (Queue DDI) is now being used.
2. Call is routed to the pool of CT Gateway devices, based on the Queue Device Group of the Pre CT Gateway. The call is now being made from the originating point to the CT Gateway. The CSS changes from that of the originating point to that of the CT Gateway port.
3. The attendant chooses to answer the call or the call is delivered by forced delivery. The call is routed from the CTI Port to the attendant's phone. They are now connected to the original caller.



Tip

If a call is displayed in the attendant console (F8) but does not move the attendant's phone when they try to answer it, check the CSS for the CT Gateway port. Does it contain the attendant phone's partition?

Consult Transfer

This scenario describes a call being answered and then consult transferred to a destination.

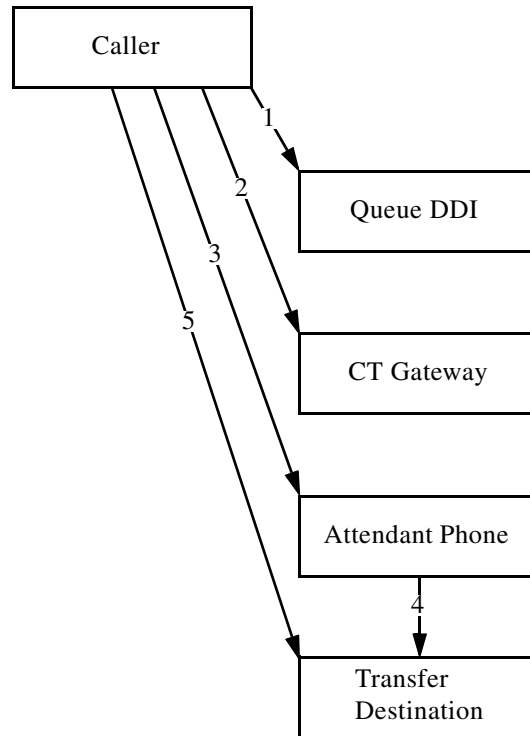

1. Call arrives at the Queue DDI device. This notifies Cisco Unified Attendant Console Advanced that the call has arrived for the specified queue, and allows for CLI filter checking. The CSS of the CTI Route Point (Queue) is now being used.
2. Call is routed to the pool of CT Gateway devices, based on the Queue Device Group of the Pre CT Gateway. The call is now being made from the originating point to the CT Gateway. The CSS changes from that of the originating point to that of the CT Gateway port.
3. The attendant chooses to answer the call or the call is delivered by forced delivery. The call is routed from the CTI Port to the attendant's phone. They are now connected to the original caller. The call now takes the CSS of the attendant's line/phone.
4. The attendant dials the destination for the consult transfer, using the CSS of the attendant's line/phone, as with any other call or transfer made using the IP handset.
5. When the end party answers the call, the transfer connects the original caller with the transfer destination.



Note

If the attendant waits for the transfer destination phone to start ringing before completing the transfer this cancels the consult transfer and initiates a blind transfer to the destination.

Blind Transfer (Standard Functionality)

This scenario describes a call being answered and then blind transferred to a destination, without using the direct transfer feature. When the call is answered, it will appear to be from the Service Queue device.

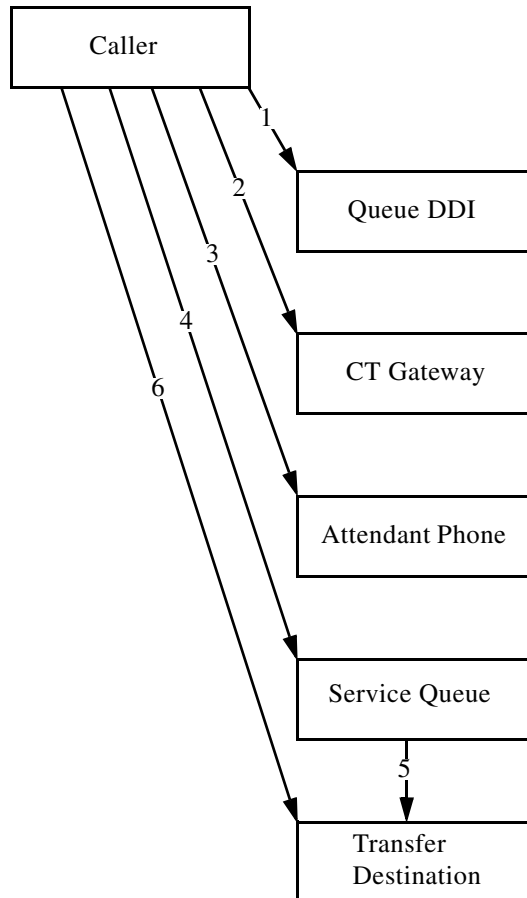

1. Call arrives at the Queue DDI device. This notifies Cisco Unified Attendant Console Advanced that the call has arrived for the specified queue, and allows for CLI filter checking. The CSS of the CTI Route Point (Queue DDI) is now being used.
2. Call is routed to the pool of CT Gateway devices, based on the Queue Device Group of the Pre CT Gateway. The call is now being made from the originating point to the CT Gateway. The CSS changes from that of the originating point to that of the CT Gateway port.
3. The attendant chooses to answer the call or the call is delivered by forced delivery. The call is routed from the CTI Port to the attendant's phone. They are now connected to the original caller. The call now takes the CSS of the attendant's line/phone.
4. The attendant dials the destination for the blind transfer, and the call is transferred to one of the pools of service queue devices, according to the Queue Device group it originally arrived at. The CSS changes from that of the attendant's line to that of the Service Queue port.
5. The Service Queue answers and puts the call on hold and then makes an enquiry call to the end destination.
6. When the call is answered by the destination the call is connected.

Blind Transfer (Direct Transfer)

This scenario describes a call being answered and then blind transferred to a destination, using the direct transfer feature of Arc. This labels the call as being from the original caller, rather than the Arc Service Queue device.

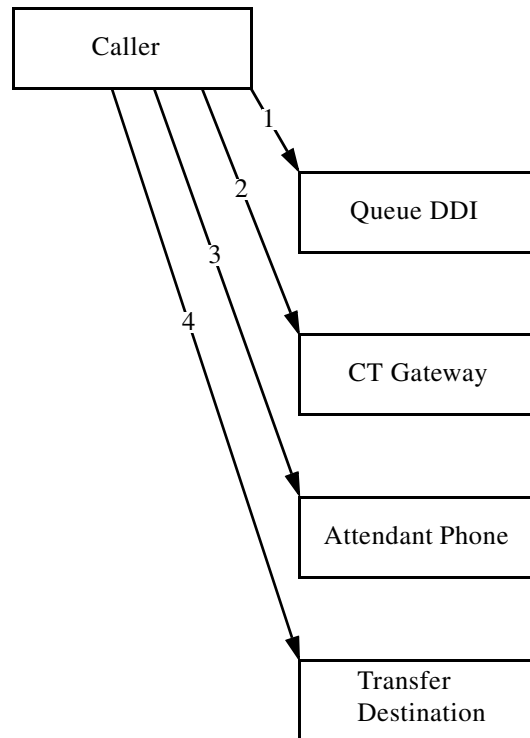

1. Call arrives at the Queue DDI device. This notifies Cisco Unified Attendant Console Advanced that the call has arrived for the specified queue, and allows for CLI filter checking. The CSS of the CTI Route Point (Queue DDI) is now being used.
2. Call is routed to the pool of CT Gateway devices, based on the Queue Device Group of the Pre CT Gateway. The call is now being made from the originating point to the CT Gateway. The CSS changes from that of the originating point to that of the CT Gateway port.
3. The attendant chooses to answer the call or the call is delivered by forced delivery. The call is routed from the CTI Port to the attendant's phone. They are now connected to the original caller. The call now takes the CSS of the attendant's line/phone.
4. The attendant dials the destination for the blind transfer, the call will be transferred from the attendant's extension to the transfer destination, using the attendant's line CSS.

Night Service /Overflows/ Out of Service

This scenario describes calls that:

- End up at night service
- Overflow according to a condition
- Go to an out of service number

and have a destination number that is a DN, rather than an internal queue within Arc.

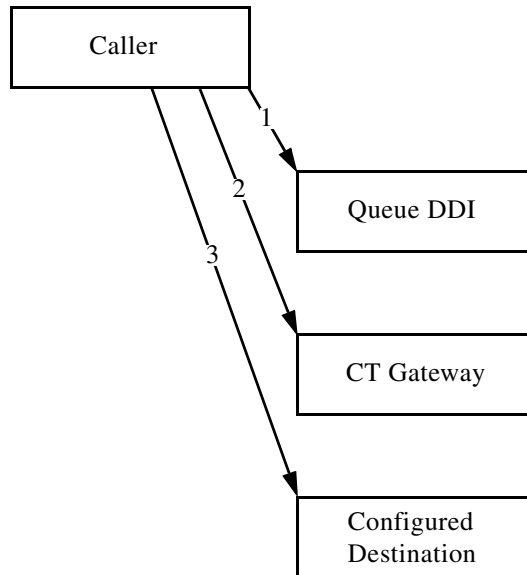

1. Call arrives at the Queue DDI device. This notifies Cisco Unified Attendant Console Advanced that the call has arrived for the specified queue, and allows for CLI filter checking. The CSS of the CTI Route Point (Queue DDI) is now being used.
2. Call is routed to the pool of CT Gateway devices, based on the Queue Device Group of the Pre CT Gateway. The call is now being made from the originating point to the CT Gateway. The CSS changes from that of the originating point to that of the CT Gateway port.
3. Depending on how night service /overflow/ out of service forwarding is configured, the call is forwarded to the destination DN.

Holding Calls

This scenario describes a call being answered, held, and then retrieved.

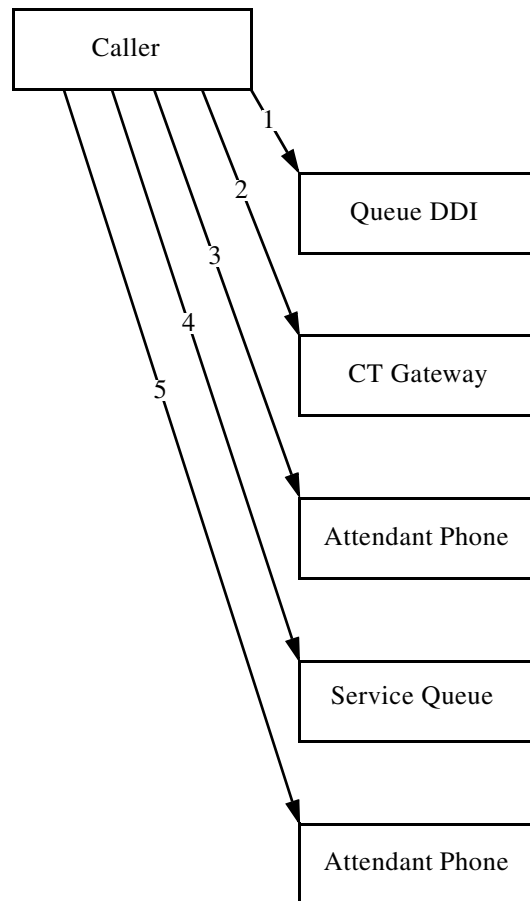

1. Call arrives at the Queue DDI device. This notifies Cisco Unified Attendant Console Advanced that the call has arrived for the specified queue, and allows for CLI filter checking. The CSS of the CTI Route Point (Queue DDI) is now being used.
2. Call is routed to the pool of CT Gateway devices, based on the Queue Device Group of the Pre CT Gateway. The call is now being made from the originating point to the CT Gateway. The CSS changes from that of the originating point to that of the CT Gateway port.
3. The attendant chooses to answer the call or the call is delivered by forced delivery. The call is routed from the CTI Port to the attendant's phone. They are now connected to the original caller. The call now takes the CSS of the attendant's line/phone.
4. The attendant places the call on hold, the call is routed to one of the service queue devices, according to the Queue Device group of the original queue though which the call entered. The call now has the CSS of the Service Queue port.
5. If the attendant retrieves the call, it is redirected back to their phone. The call then reverts back to the CSS of their line/phone.

Parking Calls

The scenario describes a call being parked and then picked up from the park location by the intended recipient.

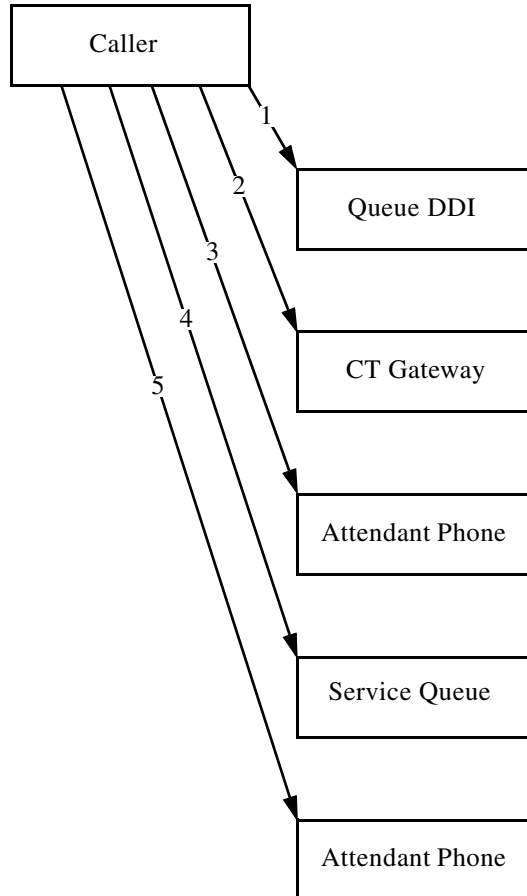

1. Call arrives at the Queue DDI device. This notifies Cisco Unified Attendant Console Advanced that the call has arrived for the specified queue, and allows for CLI filter checking. The CSS of the CTI Route Point (Queue DDI) is now being used.
2. Call is routed to the pool of CT Gateway devices, based on the Queue Device Group of the Pre CT Gateway. The call is now being made from the originating point to the CT Gateway. The CSS changes from that of the originating point to that of the CT Gateway port.
3. The attendant chooses to answer the call or the call is delivered by forced delivery. The call is routed from the CTI Port to the attendant's phone. They are now connected to the original caller. The call now takes the CSS of the attendant's line/phone.
4. The attendant parks the call for a user, the call is routed to one of the call park devices based on the original Queue Device group of the call. The call then takes the CSS of the CTI Port where it is parked.
5. An end user dials to the Call Park device. Their CSS must have access to the Call Park Devices. When that call is connected, it is connected with the call in the Call Park.



Note If the call is retrieved by the attendant, rather than getting picked up by the intended recipient, the call flow is as that of a held call.

Call Flow Example With Partition/CSS

This example explains how the theory above can be used:

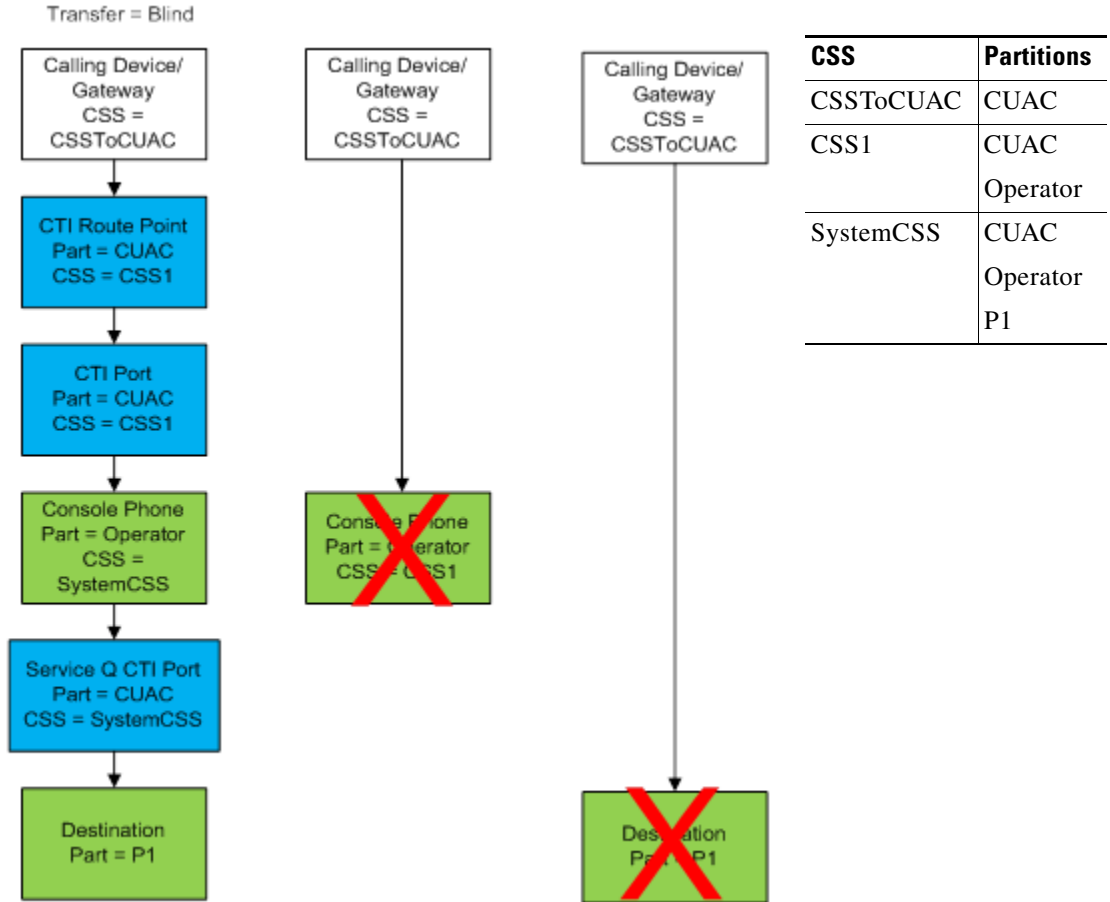

In this example a call is made into the system via a gateway. The Gateway's assigned CSS is CSSToCUAC, which contains just the CUAC partition. The devices in the blue boxes are the Cisco Unified Attendant Console Advanced System Devices, and are in the CUAC partition; so the call on the Gateway can dial any of those devices. However, the console phone is in a different partition, Operator, which is not in the CSS assigned to the Gateway; so a call cannot be routed from the Gateway directly to the attendant. Likewise, the final destination of the call is also in a partition, P1, that cannot be directly reached from the Gateway.

The following occurs:

1. The call is routed from the Gateway to the CTI Route Point (which uses the DDI to determine which queue the call will go into). The CTI Route Point changes the CSS to CSS1, which includes the CUAC partition and the Operator partition.
2. The call is routed to the Host PBX Gateway port (a CTI Port that queues calls), which has the same CSS as the CTI Route Point.
3. The call is routed to the attendant's handset in partition Operator, which is included in CSS1 and also the CSS SystemCSS.
4. Because the destination uses the P1 partition in the SystemCSS CSS, the call can be delivered to it as a blind transfer via a Service Queue CTI Port that also uses SystemCSS.

Configuring Controlled CTI Devices

To maintain the integrity and stability of Controlled CTI Devices, Cisco recommends that you assign them to a dedicated Device Pool. Register your Controlled CTI Devices on the least-used Cisco Unified Communications Managers within the cluster, and register your IP Phones to other Cisco Unified Communications Managers in the cluster.

Configuring CTIManager and Cisco TSP

The CTIManager service provides CTI information to the Cisco TSP Client, both of which run on the Cisco Unified Communications Manager server. In effect, the CTIManager acts as a TAPI server and the Cisco TSP acts as the TAPI Client. CTIManager is disabled by default, but you can enable it on a server-by-server basis.

The CTIManager can view the CTI information for devices registered to any node on the Cisco Unified Communications Manager cluster.

When configuring the Cisco TSP on the Cisco Unified Attendant Console Advanced server, set the Primary and Backup CTIManager to the IP Address of the Cisco Unified Communications Manager(s) for which they will handle communication. This will help balance the load across the cluster and provide stability for the Cisco Unified Attendant Console Advanced devices.



Note

Configure the CTIManager using its IP address, not the DNS name of the server. This prevents TAPI connectivity from being reliant on any DNS servers within the network.

Media Driver Options

Cisco TAPI media drivers are used to activate CTI ports. Cisco Unified Communications Manager Release 8.0 and later supports the following Cisco TAPI media drivers:

- Cisco TAPI Wave Driver
- New Cisco Media Driver

Only one driver at a time can be used by the Cisco Unified Attendant Console Advanced server. The New Cisco Media Driver is recommended because:

- It is simpler to install and configure, as this is done through the Cisco TSP Installation Wizard. All channel and port settings are automatically applied to all configured TSP instances.
- It supports 8KHz, 16-bit PCM, G.711 a-law, G.711 u-law codecs natively. It can also support G.729a when pass-through mode is enabled.
- It runs as an independent process, similar to a Microsoft Windows application. This makes it more reliable, and easier for you to create and debug media applications.

TSP Silent Install

If you are using Cisco Unified Communications Manager Release 8 or later, the TSP and New Cisco Media Driver are automatically installed and activated when you install Cisco Unified Attendant Console Advanced server.

Supported Handsets

The following phone types are supported as attendant console handsets, or as End Points (display line state and can receive transferred calls)













Note











Note the following:

- Shared lines (multiple lines with the same number) are not supported for attendant console handsets.
- Third-party SIP phones cannot be supported as attendant console handsets or for line state.
- Cisco Unified Attendant Console Advanced does not support logging on any device that has a duplicate DN, or that uses Extension Mobility.

● = supported, ○ = unsupported.

| Model | Image | SCCP | SIP | Attendant Console | | End Point |
|-------|---|------|-----|-------------------|------|----------------|
| | | | | SIP | SCCP | |
| 3905 |  | ○ | ● | ○ | ○ | ● ¹ |
| 3911 |  | ○ | ● | ○ | ○ | ● |
| 3951 |  | ○ | ● | ○ | ○ | ● |

| Model | Image | SCCP | SIP | Attendant Console | | End Point |
|-------|---|------|-----|-------------------|------|-----------|
| | | | | SIP | SCCP | |
| 6901 |  | ● | ● | ○ | ○ | ● |
| 6911 |  | ● | ● | ○ | ● | ● |
| 6921 |  | ● | ● | ○ | ● | ● |
| 6941 |  | ● | ● | ● | ● | ● |
| 6945 |  | ● | ● | ○ | ● | ● |
| 6961 |  | ● | ● | ● | ● | ● |
| 7821 |  | ○ | ● | ● | ● | ● |
| 7841 |  | ○ | ● | ● | ● | ● |

| Model | Image | SCCP | SIP | Attendant Console | | End Point |
|----------|---|----------------------------------|----------------------------------|----------------------------------|----------------------------------|---|
| | | | | SIP | SCCP | |
| 7861 |  | <input type="radio"/> | <input checked="" type="radio"/> | <input checked="" type="radio"/> | <input checked="" type="radio"/> | <input checked="" type="radio"/> |
| 7905 |  | <input checked="" type="radio"/> | <input checked="" type="radio"/> | <input checked="" type="radio"/> | <input checked="" type="radio"/> | <input checked="" type="radio"/> |
| 7906 |  | <input checked="" type="radio"/> | <input checked="" type="radio"/> | <input checked="" type="radio"/> | <input checked="" type="radio"/> | <input checked="" type="radio"/> |
| 7910 |  | <input checked="" type="radio"/> | <input type="radio"/> | <input type="radio"/> | <input type="radio"/> | <input checked="" type="radio"/> |
| 7911 |  | <input checked="" type="radio"/> | <input checked="" type="radio"/> | <input checked="" type="radio"/> | <input checked="" type="radio"/> | <input checked="" type="radio"/> |
| 7912 |  | <input checked="" type="radio"/> | <input checked="" type="radio"/> | <input type="radio"/> | <input checked="" type="radio"/> | <input checked="" type="radio"/> ² |
| 7920 |  | <input checked="" type="radio"/> | <input type="radio"/> | <input type="radio"/> | <input type="radio"/> | <input checked="" type="radio"/> |
| 7925 |  | <input checked="" type="radio"/> | <input type="radio"/> | <input type="radio"/> | <input type="radio"/> | <input checked="" type="radio"/> |
| 7925G |  | <input checked="" type="radio"/> | <input type="radio"/> | <input type="radio"/> | <input type="radio"/> | <input checked="" type="radio"/> |
| 7925G-EX |  | <input checked="" type="radio"/> | <input type="radio"/> | <input type="radio"/> | <input type="radio"/> | <input checked="" type="radio"/> |

| Model | Image | SCCP | SIP | Attendant Console | | End Point |
|----------|---|------|-----|-------------------|----------------|----------------|
| | | | | SIP | SCCP | |
| 7926 |  | ● | ○ | ○ | ○ | ● |
| 7931 |  | ● | ● | ● ³ | ● ₃ | ● |
| 7935 |  | ● | ○ | ○ | ○ | ● |
| 7936 |  | ● | ○ | ○ | ○ | ● |
| 7937 |  | ● | ○ | ○ | ○ | ● |
| 7937G |  | ● | ○ | ○ | ○ | ● |
| 7940 |  | ● | ● | ○ | ● | ● ² |
| 7941 |  | ● | ● | ● | ● | ● |
| 7941G-GE |  | ● | ● | ● | ● | ● |
| 7942 |  | ● | ● | ● | ● | ● |
| 7942-G |  | ● | ● | ● | ● | ● |

| Model | Image | SCCP | SIP | Attendant Console | | End Point |
|----------|---|------|-----|-------------------|------|----------------|
| | | | | SIP | SCCP | |
| 7945 |  | ● | ● | ● | ● | ● |
| 7945G |  | ● | ● | ● | ● | ● |
| 7960 |  | ● | ● | ○ | ● | ● ₂ |
| 7961 |  | ● | ● | ● | ● | ● |
| 7961G-GE |  | ● | ● | ● | ● | ● |
| 7962 |  | ● | ● | ● | ● | ● |
| 7965 |  | ● | ● | ● | ● | ● |
| 7965G |  | ● | ● | ● | ● | ● |
| 7970 |  | ● | ● | ● | ● | ● |
| 7971 |  | ● | ● | ● | ● | ● |
| 7975 |  | ● | ● | ● | ● | ● |

| Model | Image | SCCP | SIP | Attendant Console | | End Point |
|-----------------|---|------|-----|-------------------|------|-----------|
| | | | | SIP | SCCP | |
| 7985 |  | ● | ○ | ○ | ● | ● |
| 8941 |  | ● | ● | ● | ● | ● |
| 8945 |  | ● | ● | ● | ● | ● |
| 8961 |  | ○ | ● | ● ³ | ○ | ● |
| 9951 |  | ○ | ● | ● ³ | ○ | ● |
| 9971 |  | ○ | ● | ● ³ | ○ | ● |
| Cius |  | ○ | ● | ○ | ○ | ● |
| DX650 |  | ○ | ● | ● | ● | ● |
| IP Communicator |  | ● | ● | ● | ● | ● |

1. No BLF, but can receive transfer.

2. Supported for SCCP only.
3. Support with disable rollover.

Jabber Support

Both standard installations (locally installed on the operator computer) and VXME installations (installed in a VXME environment) are supported as operator devices and end points.



Cisco Unified Attendant Console Advanced Resilience

Like all software, Cisco Unified Attendant Console Advanced may occasionally fail. This chapter describes the following:

- [Full Resilience, page 4-1](#)
- [Providing Additional Resilience, page 4-6](#)

Full Resilience

Cisco Unified Attendant Console Advanced can be installed in a resilient configuration with two Cisco Unified Attendant Console Advanced servers:

- **Publisher** — the primary server used by the Clients. If this fails all Attendant Operators are switched to the Subscriber server. Once the Publisher is running again, the operators are prompted to reconnect to the Publisher.
- **Subscriber** — used when the Publisher stops.

Each server requires a separate Application User profile to be configured on the Cisco Unified Communications Manager. If possible, each server should be connected to a different CTIManager, otherwise both will be lost if that Cisco Unified Communications Manager node fails or is taken off-line.

On both servers ensure that the machine date, time and time zone are correct, and that they match those on the other machine. Both servers must be in the same time zone to ensure that any daylight-saving time changes occur simultaneously. If the servers do not match, the operator console will be unable to automatically reconnect to the Publisher when it recovers from failure.

If you have a firewall on either server, you must configure firewall exceptions (using **Control Panel > Windows Firewall > Allow a program or feature through Windows Firewall**) for the following:

- Windows Management Instrumentation (WMI)
- Distributed Transaction Coordinator (MSDTC)
- Port 1433 (used by the SQL server)
- Ports 61616 and 61618, to enable messages to pass between the servers.

This section describes the following:

- [Database Replication, page 4-2](#)
- [Failover Scenarios, page 4-5](#)

Figure 4-1 on page 4-2 summarizes server resilience.

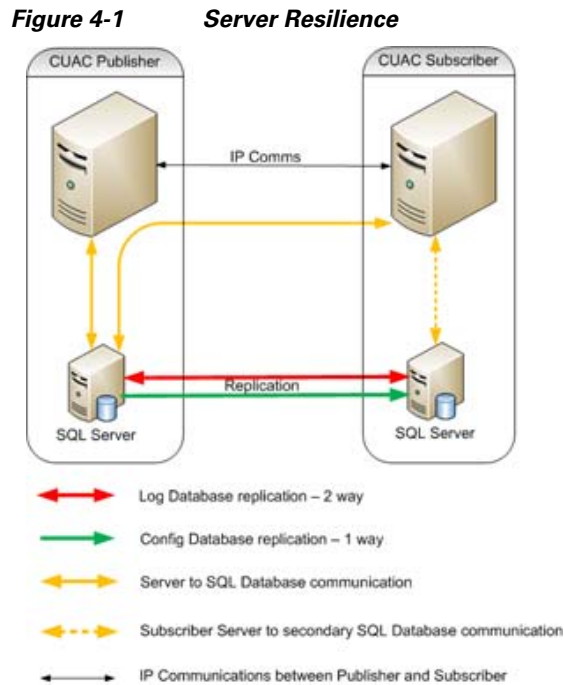

Database Replication

The Cisco Unified Attendant Console Advanced server contains two SQL databases:

- Logging database, contains a copy of the configuration and also holds all call transaction records for queues and operators.
- Configuration database, responsible for all user configurations. For more information, see [System Configuration, page 4-5](#).

SQL replication ensures that the databases in both servers are kept up to date and synchronized.

When running a resilience configuration the Publisher must use SQL 2008 Standard or Enterprise or SQL 2012 Standard or Enterprise. The Subscriber can use SQL 2008 Express or SQL 2012 Express, but because of its limitations you should use SQL Standard or Enterprise if you have more than ten operators. SQL Express only supports 4GB of data; so neither Publisher nor Subscriber database will grow larger than that, and when that limit is reached no new data will be written.

The configuration database is synchronized between the two servers using SQL replication (see below), and Push is used to replicate the data from Publisher to the Subscriber. The log databases are synchronized using Microsoft DTC to ensure that a full set of call transaction data is kept on both servers, thereby enabling you to run call reports from either.

SQL server replication involves:

- Snapshot replication
- Transactional replication

Snapshot replication makes an exact copy (snapshot) of the Publisher and distributes it to the Subscriber. It does not monitor for updates to the data. Snapshot replication is used to provide the initial data set for transactional replication; and it can also be used to completely refresh the data on the subscriber. After the initial snapshot, the Subscriber is kept up to date with the Publisher using transactional replication. Subsequent data transactions (INSERTed, UPDATED, and DELETED data) in the Publisher are captured by the transaction log and then stored in the distribution database, which acts as a data queue. The changes are then propagated and applied to the Subscriber in the order in which they occurred.

SQL server replication uses standalone programs called agents to track changes and distribute data between databases. The agents are:

- SQL server Agent-executes scheduled administrative tasks or jobs consisting of one or more jobsteps. Job information is stored in the SQL server. The other agents run as directed by this agent and it is required for the Publisher and Subscriber to be able to talk to each other.
- Distributor Agent-moves the snapshot and transactions from Publisher to Subscriber.
- Q Reader-a SQL server agent that handles the data queues.
- Snapshot Agent-prepares snapshot files containing schema and data of published tables and database objects, stores the files in the snapshot folder, and records synchronization jobs in the distribution database.
- Log Agent-monitors the transaction log of each database configured for transactional replication, and copies the transactions marked for replication from the transaction log into the distribution database.

Figure 4-2 illustrates the transactional replication used for the logging database.

Figure 4-2 Logging Database Transactional Replication

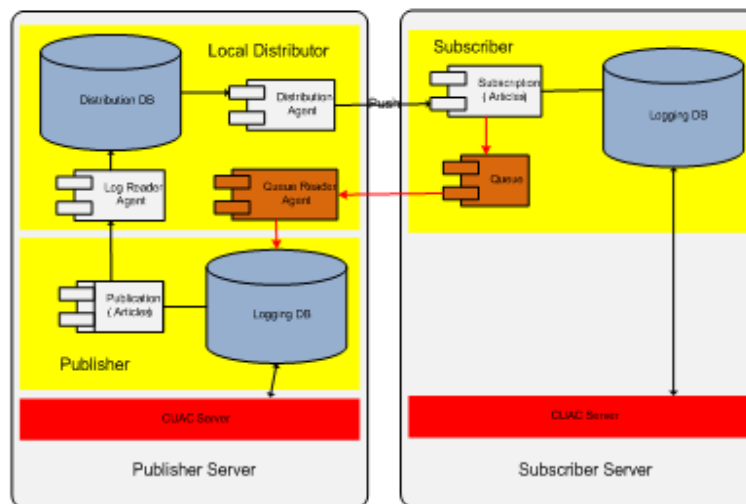
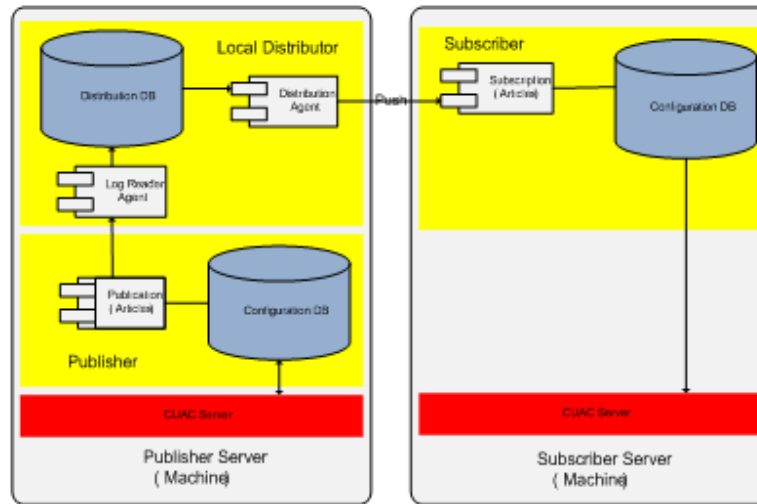

Figure 4-3 on page 4-4 illustrates the transactional replication used for configuration database.

Figure 4-3 Configuration Database Transactional Replication



The Publisher and Subscriber servers are linked using Apache Active MQ, an open-source message broker. When the system is updated with the user configuration on the Publisher, all the changes are sent to the Subscriber in real-time.

**Note**

If the inter-server communication link is down, all online updates will fail.

To check the status of the inter-server communication link:

1. Log in to Cisco Unified Attendant Console Advanced Web Admin and choose **Engineering > Service Management**.
2. View the activity and status of the Cisco Unified Attendant Server.

If the Inter Server Communication Status is **Suspended**, the ActiveMQ service may not be running.

To check and restart the ActiveMQ service:

1. In Control Panel, click **Accessories** and then click **Services**.
2. If the Status of the ActiveMQ service is blank (meaning that it is stopped), select the service and click **Start**.
3. Use Cisco Unified Attendant Console Advanced Web Admin to confirm that the Inter Server Communication Status is **Normal**.

Apache Active MQ is also used for real-time synchronization of operator and queue availability. It also enables the Publisher and Subscriber to detect whether the other has failed.

Cisco Unified Attendant Console Advanced can also be installed as a standalone, with no resilience. When installed in this mode, SQL Express Edition is automatically installed on the server, if no SQL server is detected. To convert a standalone installation to a resilient installation, you must first upgrade SQL Express to either SQL Standard or Enterprise.

For a resilient installation the Publisher server must be installed first, followed by the Subscriber server (the Subscriber installation communicates with the Publisher during its installation). Once installed a Publisher or Subscriber server cannot be converted into the other type. The Publisher requires at least

SQL server Standard to be installed, while the Subscriber can use SQL Express, although there are limitations on its use within the system SQL Express will be installed automatically on a standalone installation if no existing SQL instances are detected on the server

Both servers maintain a link to the Publisher SQL server. There is also a connection from the Subscriber to its local SQL server, which becomes a full connection if communication with the Publisher is lost.

System Configuration

The Cisco Unified Attendant Console Advanced configuration is mirrored on the two servers. However, each server has its own set of Controlled CTI devices. When you configure the Queue DDI DN on the Publisher the system sets *Forward on CTI Failure* and *Forward Unregistered Internal* to point to the Queue DDI of the mirrored queue on the Subscriber. These are used if the Publisher and its Queue DDI go out of service.

A Web Administration service running on both servers enables administrators to configure the system. However, most system configuration—including configuring the Controlled CTI Devices of both servers—can only be done when connected to the Publisher. You can view the configuration when connected to the Subscriber, as well as monitor replication and run reports, but the only things you can change are the Arrival Mode for each queue and the logging levels.

Failover Scenarios

Cisco Unified Attendant Console Advanced can experience the following types of failover scenario:

- Full failover
- Partial failover
- Full CTI failover

Full Failover

Full failovers result from the Publisher shutting down. For example:

- The CTIManager fails or loses connection
- The server machine crashes
- The Cisco Unified Attendant Console Advanced server service is stopped manually

In these situations the server stops and the operators are logged out and prompted to connect to the Subscriber. Initially, incoming calls are routed to the Publisher Queue DDI, but then the Cisco Unified Communications Manager uses Call Forward to route them to the Subscriber Queue DDI. The calls then enter the Subscriber CT Gateway and are routed to an operator logged in to the Subscriber. Any calls that—at the time of the failure—were queuing or held on the Service Queue or Park device, are cut off. Calls that were connected to an operator remain connected.

Partial Failover

Partial failovers occur when all Queue DDI devices go out of service, but the other system devices remain active. This causes the calls to be routed to the Subscriber via the Call Forward, but the operators remain logged in to the Publisher. This results in calls ringing but with no operators able to see or answer them.

Full CTI Failover

Full CTI failover occurs when both the Publisher and Subscriber servers fail at the same time. You can try to prevent this happening by using different CTIManagers as primaries for each server. To mitigate the effects of a full CTI failover you can also set a destination against each queue. This will set *Forward on CTI Failure* and *Forward Unregistered Internal* destinations on the Queue DDI on Cisco Unified Communications Manager. Calls initially route to the Publisher Queue DDI, then forward to the Subscriber Queue DDI, and finally forward to the destination set against that.

Providing Additional Resilience

If the Cisco Unified Attendant Console Advanced server fails, all CTI devices go out of service and any calls ringing into or connected on any of those devices become disconnected.

Any new calls arriving at the system hear the unavailable tone. To ensure that new calls can be answered, access the Cisco Unified Communications Manager and set *Call Forward No Answer* or *Forward Unregistered Internal* on the CTI Route Points used for the Queue DDI numbers. These can be routed to any destination, including a hunt group or VM box. You can also use different destinations for different queues.

For further details, see the following:

- [CTIManager Service Failure, page 4-6](#)
- [Cisco Unified Communications Manager Failure, page 4-7](#)
- [Client Handset Resets, page 4-7](#)

CTIManager Service Failure

When a primary CTIManager fails, the Cisco TSP sends the Cisco Unified Attendant Console Advanced server a message advising that the phone is suspended, followed by a *Line out of service* message for every phone and line device opened by the application. This results in the Controlled CTI devices and monitored phones being seen as *Out of Service*, and the Cisco Unified Attendant Console Advanced server shutting down within about 30 seconds. The Cisco TSP then tries to connect to the configured backup CTIManager. When a connection to a backup CTIManager is established and the device or line is successfully re-opened, the Cisco TSP sends a PHONESTATE_RESUME or LINEDEVSTATE_INSERTSERVICE message to the Cisco Unified Attendant Console Advanced server. At this point, the server is trying to restart itself. Once the CTIManager is connected, the server resumes processing calls. If the Cisco TSP cannot open the device or line for a CTI Port or Route Point, it closes the device or line by sending the appropriate PHONE_CLOSE or LINE_CLOSE message to the Cisco Unified Attendant Console Advanced server.

After the Cisco TSP has connected to the backup CTIManager, it will not reconnect to the primary CTIManager until the connection is lost between the Cisco TSP and the backup CTIManager, or the Cisco Unified Attendant Console Advanced server is restarted.

Once the Cisco Unified Attendant Console Advanced server stops, the operator Clients are logged out, TSP resilience is set up, and calls start being handled by the Backup CTIManager. The server reconnects to the Backup CTIManager and the Clients must log in again to take the calls. Ensure that the CTIManager used by the Subscriber is on a different node to the Publisher. If both servers use the same CTIManager they will fail simultaneously, and you will lose many more calls than otherwise.

Cisco Unified Communications Manager Failure

If the Cisco Unified Communications Manager node in a cluster on which the Cisco Unified Attendant Console Advanced Controlled CTI Devices are registered fails, the CTIManager recovers the affected CTI Ports and Route Points by re-opening these devices on another Cisco Unified Communications Manager node. When the Cisco TSP detects the failure it sends a PHONE_STATE (PHONESTATE_SUSPEND) message to the Cisco Unified Attendant Console Advanced server. During the failure, the CTI Devices controlled by the Cisco Unified Attendant Console Advanced server will be *out of service* and unavailable. Calls cannot enter the Cisco Unified Attendant Console Advanced system during the failure. If the CTIManager is also on the failed Cisco Unified Communications Manager node, the Cisco TSP on the Cisco Unified Attendant Console Advanced server switches to the backup CTIManager.

When the CTI Port/Route Point is successfully re-opened on another Cisco Unified Communications Manager, the Cisco TSP sends a phone PHONE_STATE (PHONESTATE_RESUME) message to the server. If no Cisco Unified Communications Manager is available, the CTIManager waits until one comes back in service and tries again to open the device. The lines on the affected device go out-of-service and in-service in accordance with the events sent by the Cisco TSP to the Cisco Unified Attendant Console Advanced server. If the device or lines cannot be opened, even when all the Cisco Unified Communications Manager nodes come back into service, the devices or lines are closed and Cisco TSP sends a PHONE_CLOSE or LINE_CLOSE message to Cisco Unified Attendant Console Advanced server.

The Cisco Unified Attendant Console Advanced server repeatedly stops and attempt to restart itself until the CTI functionality has returned. This process forces the CTI devices back into service. However, the Client applications lose their connections to the server as soon as it stops itself. Once the server is back on-line, the Client applications can reconnect to it and log in.

When a failed Cisco Unified Communications Manager node comes back in service, the CTIManager re-opens the affected CTI Ports or Route Points to their original Cisco Unified Communications Manager. This re-opening takes place only when calls are no longer being processed and are inactive on the affected device. Consequently, the re-opening may not be made for a long time for Route Points, which can handle many simultaneous calls.

Client Handset Resets

If your Cisco handset reboots, the Client displays the message *Your phone has gone out of service. You will not be able to make or receive calls at this time.* On the Operator Console, the phone icon at the bottom of the window bears a red cross to indicate that the handset is out of service. The message continues to be displayed by the Client until the handset has re-registered and is ready for use. When this happens, the icon in the Operator Console reverts to its original appearance.



Directory Contacts, Devices and Line Status

This chapter covers the following topics:

- [Populating the Directory, page 5-1](#)
- [BLF Plug-in, page 5-3](#)
- [Shared Line Support, page 5-8](#)

Cisco Unified Attendant Console Advanced contacts can be imported directly from the following sources:

- Cisco Unified Attendant Console Advanced Microsoft Active Directory
- iPlanet Netscape Directory

Attendant can also add contact manually.

Populating the Directory

You can populate the Cisco Unified Attendant Console Advanced contact directory from Cisco Unified Communications Manager directory by importing user accounts using LDAP synchronization. The following information is imported:

- User ID
- Last Name
- Middle Name
- First Name
- Telephone Number from User Profile (the main number for the contact). This supplies the DN. If this is blank the contact is not imported.
- Mail ID
- Department

Change notification is not supported on Cisco Unified Communications Manager; so the whole data set is synchronized to the Cisco Unified Attendant Console Advanced server. You can synchronize the data as frequently as once per hour, but this is really only suitable for very small installations. With the larger installations you should only synchronize the data once a day, preferably outside of business hours.

Searching the Directory

The contact directory is used by operators when answering and transferring calls, and is a critical part of the system. To enable rapid database searching, the following fields are indexed so that they can be used as the configurable search fields in the Cisco Unified Attendant Console Advanced Client:

- Extension Number
- Department
- First Name
- Last Name
- Job Title
- Location
- User Field 1

Assigning Device Names to DNs (Cisco Unified Communications Manager)

The imported Device Name (strictly-speaking, the Resource Identifier or RID) is normally the MAC address. DNs are assigned Device Names in the following way:

1. The contact is imported from Cisco Unified Communications Manager.
2. The DN is assigned from the Telephone Number field.
3. A new look-up is performed using AXL, based on the DN and the partition configured using the Directory synchronization web page.
4. All DNs matching the assigned DN are imported.
5. Devices are named in the following way:
 - The top-ranked match has its Device Name inserted into the Cisco Unified Attendant Console Advanced directory, unless an Extension Mobility (EM) profile is in the list, when the Device Name is left blank.
 - Contacts with the same DN are assigned the same Device Name. If shared lines must use different Device Names you can change this manually in the Cisco Unified Attendant Console Advanced Client (Contact Details [F12]). For more information, see [Shared Line Support, page 5-8](#).

Assigning Device Names to DNs (External Sources)

To assign Device Names to DNs when using external directory sources:

1. Map the fields to be imported using Cisco Unified Attendant Console Advanced Web Admin. The telephone number is mandatory. First Name, Last Name and Company are recommended.
2. Import the data using an LDAP synchronization. None of the records are yet resolved against Cisco Unified Communications Manager.
3. When an operator searches for DN for the first time, the BLF plug-in resolves the device on the Cisco Unified Communications Manager.

The DN must be an exact match with the number as presented in the Cisco Unified Communications Manager to allow accurate line state information. In other words, if the number is on E164 in Active Directory, it must be stored in the Cisco Unified Communications Manager in the same format.

BLF Plug-in

Cisco Unified Attendant Console Advanced uses the BLF plug-in to enable you to view device and line state information on any device in the directory. The BLF plug-in monitors devices only when they are required. Using the BLF plug-in requires the *Standard CTI Allow Control of All Devices* role to be associated with the TSP User.

As console attendants search for contacts, the devices in the F3 Directory windows are opened and their device/line status monitored. Once a device is open, its state information remains available to the attendant without the BLF plug-in having to open it again.

The BLF plug-in holds the monitored devices in a cache, with a limit of 2000 simultaneous devices. Consequently, devices are monitored continuously only on small Cisco Unified Attendant Console Advanced systems.

Attendants communicate directly with the BLF plug-in to determine the line state. The following contact information is sent to the plug-in:

- DN
- Device Name (if available)
- Partition details

If a device with matching attributes is already in the cache, its state is immediately returned. If a matching device is not in the cache, the plug-in must open and monitor the device to determine its state.

Figure 5-1 BLF Plug-in Architecture

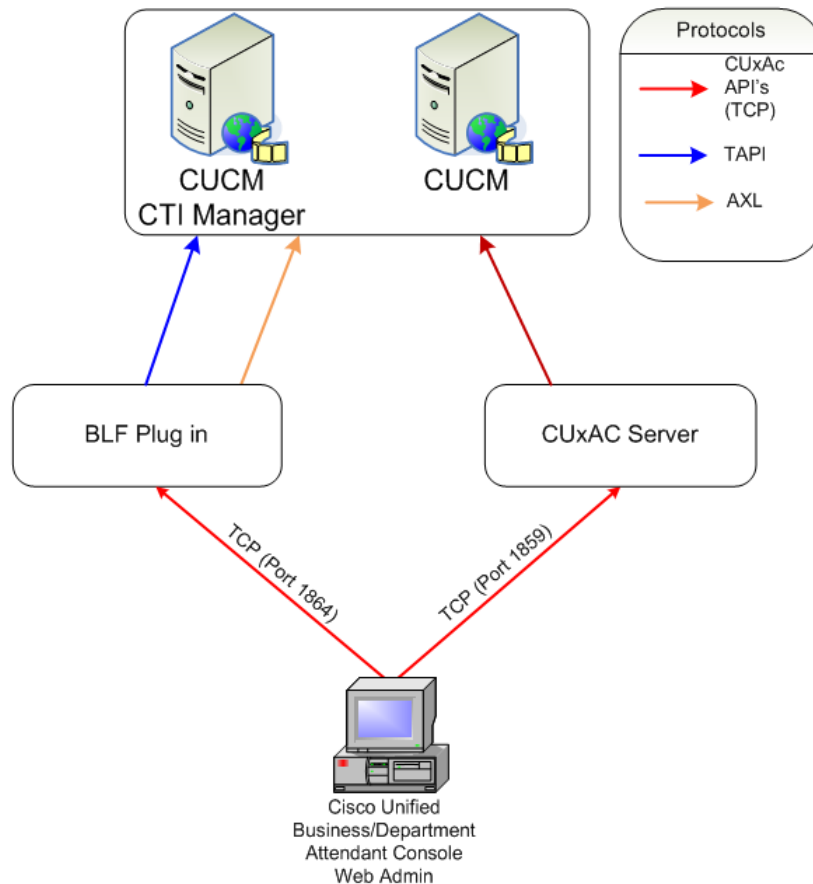
**Note**

Device/line state information is not available across multiple clusters.

If a contact has no Device Name or the *Use device name* option is not set in that contact's details, the BLF plug-in must determine which device to monitor. It does this in the following way:

1. It sends an AXL request that includes the DN and Partition Identifier to the Cisco Unified Communications Manager.
2. All instances of that DN are returned to the BLF plug-in, along with the following additional information, which is used to rank the devices:
 - MAC address
 - Device name
 - Partition
 - Line index
 - Device profile
 - Extension Mobility count.
3. The BLF plug-in requests the state of the top ranked device.

If a device is replaced with one having the same DN, the Device Name of the new device does not get updated during synchronization. Instead, you must manually amend the Device Name, as described below.

When you have amended the Device Name you must then restart the BLF plug-in.

Amending Device Names

To amend a Device Name do the following:

-
- Step 1** Run Cisco Unified Attendant Console Advanced and log in.
- Step 2** In the F3 Directory window select the contact.
- Step 3** Press F12 to display the **Contact Details** dialog box.
- Step 4** In the **Contact Details** dialog box, select **Contact Numbers**.
- Step 5** Edit the **Device Name** as required.
- Step 6** Click **OK**.
- Step 7** Restart the BLF plug-in using either:
- Cisco Unified Attendant Console Advanced Web Admin*
- Run Cisco Unified Attendant Console Advanced Web Admin and log in.
 - Choose **Engineering > Service Management**.
 - For **Cisco Unified Attendant BLF Plug-in**, clicking the red **Stop** button
 - Restart the plug-in by clicking the green button.
- OR
- Control Panel*
- Log in to the Cisco Unified Attendant Console Advanced server
 - In Control Panels, select **Administration Tools > Services**
 - Right-click the BLF plug-in and select **Restart**.
-

Device Selection

The Cisco Unified Attendant Console Advanced system uses the BLF Plug-in to monitor all devices.

The attendant requests data for a device from the BLF Plug-in and displays the busy lamp status that is returned:

- The attendant sends the following information to the CTI server:
 - DN
 - Device Name (if the option is set to use this)
 - Partition
 - Resource Identifier (RID) - This is the MAC address populated in the Contact Directory if this is set to be used

2. The BLF server sends the following information to the Cisco Unified Communications Manager via AXL:
 - DN
 - Partition
 - Resource Identifier
3. The Cisco Unified Communications Manager returns all instances of devices matching the criteria it receives.
4. The BLF server then resolves (filters and sorts) the list of device instances, leaving it with a single device for which it requests the line state.

When resolving devices, the BLF Plug-in gives priority to those using Extension Mobility (EM). EM is supported in the directory but is not supported for any System Devices, such as CTI Ports and Route Points, nor for the devices used by attendants.

1. All matching DNs are sorted by EM Count, which ensures that all Extension Mobility profiles are prioritized. If any returned devices have an EM count, the other instances are deleted from data.
2. Existing lines are sorted by Line Index. A primary line has a Line Index of 0, a secondary line has an Index of 1, and so on. The line with the lowest index is selected.
3. If multiple instances remain, they are sorted by Device Description.
4. If there are still multiple matches, they are parsed by Device name: a unique alphanumeric sort of the MAC addresses of the devices.
5. The device at the top of the list is used and its Resource Identifier returned to the attendant. This device will also be queried by the CTI server via the TAPI TSP to ascertain its Device state and the states of its individual lines.

The following examples show the results that would be generated from various device line configurations.

Example 1

| DN | MAC | Line Index | Partition | EM Count | Device Name | Profile Type | Device Profile |
|------|-----------------|------------|-----------|--------------------------------------|---------------------|---------------|----------------|
| 1000 | SEP222222222222 | 0 | | | Martin Primary | Static device | 0 |
| 1000 | EM_222222222222 | 1 | PartB | 279a22ab-9cb2-42c9-be81-3f26376060cc | Martin Secondary EM | EM Profile | |
| 1000 | EM_111111111111 | 0 | | | Martin Primary EM | EM Profile | 1 |
| 1000 | SEP333333333333 | 1 | PartA | | Martin Secondary | Static Device | 0 |
| 1000 | SEP111111111111 | 1 | | | Martin Softphone | Softphone | 1 |

Depending on the information provided and the configuration settings, the expected resolution results are:

| DN | Partition | Resource Identifier |
|------|-----------|---------------------|
| 1000 | | EM_222222222222 |
| 1000 | PartA | SEP333333333333 |
| 1000 | PartB | EM_222222222222 |

Example 2

| DN | MAC | Line Index | Partition |
|------|------------|------------|-------------|
| 1000 | PHONEMAC_A | 2 | |
| 1000 | PHONEMAC_B | 1 | |
| 1000 | PHONEMAC_C | 1 | PARTITION_X |
| 1000 | PHONEMAC_D | 2 | PARTITION_Y |

1. Resolve => (DN:1000, Partition: <empty>)
Result: [PHONEMAC_B]
2. Resolve => (DN:1000, Partition: PARTITION_X)
Result: [PHONEMAC_C]

Example 3

| DN | MAC | Line Index | Partition |
|------|------------|------------|-------------|
| 1000 | PHONEMAC_C | 2 | PARTITION_X |
| 1000 | PHONEMAC_D | 1 | PARTITION_Y |

1. Resolve => (DN:1000, Partition: <empty>)

Result: [PHONEMAC_D]

2. Resolve => (DN:1000, Partition: PARTITION_X)

Result: [PHONEMAC_C]

Example 4

| DN | MAC | Line Index | Partition |
|------|------------|------------|-------------|
| 1000 | PHONEMAC_A | 2 | |
| 1000 | PHONEMAC_B | 1 | |
| 1000 | PHONEMAC_C | 2 | PARTITION_X |
| 1000 | PHONEMAC_D | 1 | PARTITION_Y |

1. Resolve => (DN:1000, Partition: PARTITION_Z)

Result: not found

2. Resolve => (DN:1000, Partition: PARTITION_X)

Result: [PHONEMAC_C]

Shared Line Support

Cisco Unified Attendant Console Advanced provides full support for shared lines using device-based monitoring logic, which enables the user to view the state of a device, rather than just a single line in the main directory. For more information, see [Device-based Monitoring, page 5-8](#).

If two Cisco Unified Communications Manager End/Application Users have the same Telephone Number, they may both be allocated the same Device Name. This means that when an operator tries to see the state of either contact, the same DN/Device Name combination is requested, and they may not see the correct information.

To fix this issue you must amend the device name as described in [Amending Device Names, page 5-5](#).

Device-based Monitoring





























Cisco Unified Attendant Console Advanced provides the following levels of information:

- Device/phone status
- Line status for individual lines on the selected device.

Phone status information for each contact is shown in the main directory (F3) window. Irrespective of which line on a device is active, the attendant sees the Active  icon for the device. When the attendant presses F2 they are shown the status of each line on that device.

If a line is shared with another device with a different Device Name, that device is not shown as active in the F3 directory view. However, if the attendant uses F2 to view that device's line status, the line is shown as active.

The device and line states are shown in the table below:

| Device State | Device | Directory View | F2 View of shared DN | Notes |
|-------------------|--------|--|--|---|
| Off Hook | Actual |  |  | |
| | Other |  |  | |
| Ringing Out | Actual |  |  | |
| | Other |  |  | |
| Connected | Actual |  |  | |
| | Other |  |  | |
| Hold | Actual |  |  | |
| | Other |  |  | |
| Ringing In | Actual |  |  | |
| | Other |  |  | |
| DND | Actual |  |  | Do Not Disturb shown against each line on the device |
| | Other |  |  | |
| Call Forward All* | Actual |  |  | Call Forward All icon is shown in Directory View only if both lines are primary lines. The icon is shown in F2 against each forwarded line. |
| | Other |  |  | |



Presence Integration

Cisco Unified Attendant Console Advanced can use the following presence sources:

- Cisco Unified Presence (CUP)
- Cisco Unified IM and Presence
- Microsoft Office Communicator (MOC) and Lync.

You can only use one presence source at a time.

This chapter describes the following:

- [Cisco Unified Presence Server Integration, page 6-2](#)
- [MOC and Lync Integration, page 6-3](#)

Cisco Unified Presence Server Integration

Figure 6-1 summarizes Cisco Unified Attendant Console Advanced integration with the CUP server (CUPS).

Figure 6-1 Cisco Unified Attendant Console Advanced Integration with CUPS

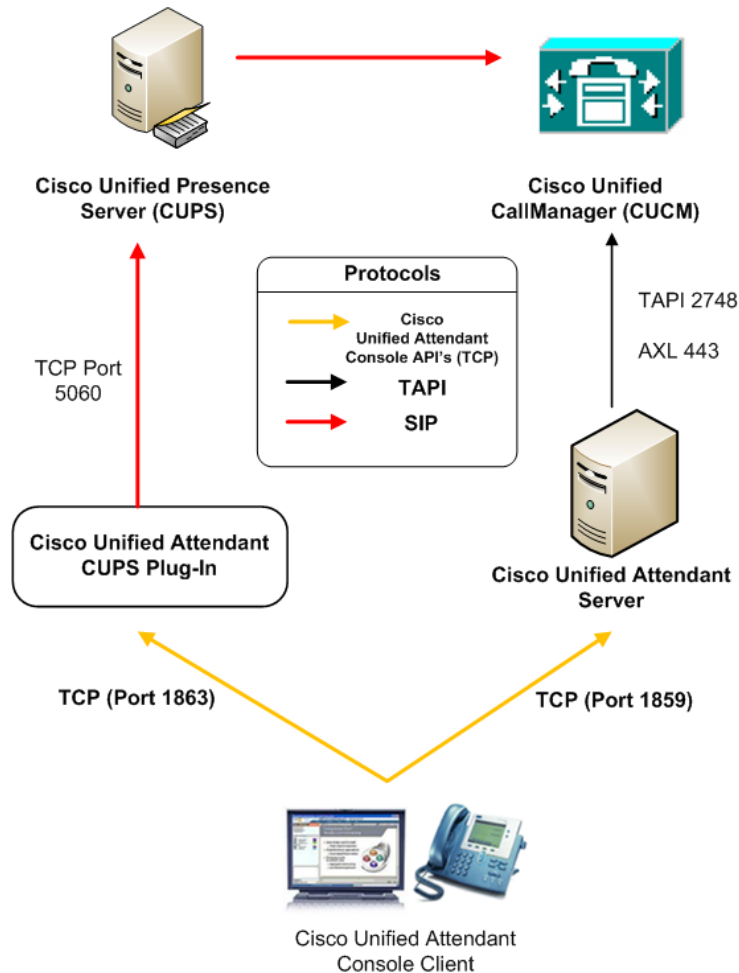

The CUPS plug-in connects to the CUPS using SIP SIMPLE protocol extensions. The Cisco Unified Attendant Console Advanced connects to the CUPS plug-in to manage presence status procurement.



Note

To be able to run the CUPS plug-in you must install the Microsoft .Net framework 2 Service Pack 1 or later. This is done automatically (if not already installed) when you install Cisco Unified Attendant Console Advanced.

For the CUPS plug-in to be able to receive presence information you must create and configure a User Profile on the Cisco Unified Communications Manager. You must then configure the CUPS plug-in using Cisco Unified Attendant Console Advanced Web Admin so that it can communicate with the CUPS and with all the Cisco Unified Attendant Console Advanced Clients. For information on how to do this, see the appropriate *Cisco Unified Attendant Console Advanced Web Admin and Installation Guide*.

The CUPS configuration is stored in an XML file with the same name as the CUPS executable and the .config extension. For example, Cisco Presence server plug-in.exe.config.

MOC and Lync Integration

The Cisco Unified Attendant Console Advanced Clients can be configured to link to Microsoft Office Communicator Server (OCS versions 2007, 2007 R2 and Lync) APIs to display live presence and to exploit MOC functionality, such as instant messaging. The MOC Client must be installed on the same PC as the Cisco Unified Attendant Console Advanced Client.

The Cisco Unified Attendant Console Advanced Client and MOC Client communicate locally to get the status of each contact. If the presence status is available it is updated in the Cisco Unified Attendant Console Advanced as the attendant performs a search.



Note

The link is based on the contact's SIP address which may not be there email address.



Cisco Unity Voicemail Integration

Cisco Unified Communications Manager Release 8.0.3 can integrate with Cisco Unity Voicemail through:

- Voicemail Prefix
- Unified Messaging

It can then transfer data to Cisco Unified Attendant Console Advanced.

Within Cisco Unified Communications Manager you can configure a voicemail prefix which you enter to access the corresponding mailbox. For example, if the prefix is *, you dial *1002 to enter the mailbox of extension 1002. For more details of this functionality read the white paper at http://www.cisco.com/en/US/partner/products/sw/voicesw/ps556/products_tech_note09186a00800dea82.shtml.

Cisco Unified Attendant Console Advanced can use the Cisco Unified Communications Manager voicemail prefix to transfer calls directly to a contact's mailbox. When an attendant is connected to the call, they can right-click a contact to access the **Transfer to Voicemail** option. Clicking this option blind transfers the call to the contact's voice mailbox.

Configuring Cisco Unified Attendant Console Advanced Voicemail Access

To configure voicemail access in Cisco Unified Attendant Console Advanced, do the following:

-
- Step 1** Configure the voicemail prefix on Cisco Unified Communications Manager using the instructions in the Cisco white paper mentioned above.
 - Step 2** In Cisco Unified Attendant Console Advanced, choose **Options > Preferences**
 - Step 3** Select the **Dialling** tab, and set the **Voicemail Prefix** to match what is set on Cisco Unified Communications Manager (typically, this is *).
 - Step 4** Click **OK**.
-

Call Arrival Mode

Cisco Unified Attendant Console Advanced supports the following arrival modes:

- *Alerting* – incoming calls to CTI ports in the CT Gateway ring until they are answered by a console attendant.
- *Held* – calls answered on the CTI port can be put on hold and the caller played Music On Hold (MOH) while they are holding. Held calls are charged from the time they are answered and put on hold. You can also have Unity answer the call and play a welcome message, before using a call handler to transfer the call to the Queue DDI and play the caller music.

**Note**

Cisco Unified Communications Manager 8.0(3) and later enables you to configure a queue with Call Arrival Mode to **Hold Queued Calls when it arrives on the CTI Port**. This function places calls on hold so that Music on Hold can be played to the caller while they wait for an operator to answer. **If you use this mode the call is charged from the time that it is answered and put on hold on the CT Gateway.**



Antivirus and Remote Access Application Support

Cisco Unified Attendant Console Advanced server supports many antivirus products. You can find guidelines on antivirus software at:

http://www.cisco.com/en/US/prod/collateral/voicesw/ps6788/vcallcon/ps556/prod_bulletin0900aecd806f6221.html.

The files in certain folders are constantly being accessed by the Cisco Unified Attendant Console Advanced software. Consequently, your antivirus software will constantly try to scan them for viruses, which will slow down the server. Therefore, your chosen antivirus product must support **exclusions**, which you use to specify the following files and folders that are *not* to be scanned by the antivirus software:

| Default Folder | Contains |
|------------------------|---|
| \\DBData | System configuration databases |
| \\Program Files\Cisco\ | Software and application trace files |
| \\Apache | Active MQ folder |
| \\Temp\Cisco\Trace | This is where the Cisco TSP trace files are located |



Note

Your System Administrator may have set up your Cisco Unified Attendant Console Advanced server to use different folders for these files.

Remote Access Application Support

Cisco customer support staff often require remote access to the Cisco Unified Attendant Console Advanced server

The following remote access applications are supported by the Cisco Unified Attendant Console Advanced server:

- Real VNC
- Symantec pcAnywhere

Install the applications as per the manufacturers' instructions.

Session-based remote access applications such as Remote Desktop and Terminal Services are *not* supported as they can cause problems with the Wave Driver operation.



AXL/Database Field Mappings

This appendix lists the following AXL to Cisco Unified Communications Manager DB field mappings:

- [Phone Mappings, page A-1](#)
- [CTI Route Point Mappings, page A-3](#)
- [Directory Number \(Line\) Mappings, page A-4](#)
- [Devicenumplanmap Mappings, page A-6](#)

Phone Mappings

This table lists the mappings related to *Phone* in the DB *device* table.

| AXL Tag | DB Field/ Default Value | CUCM Property (CTI Port only) |
|--------------------------|--|-------------------------------|
| <name> | name | Device Name |
| <description> | description | Description |
| <product> | tkproduct CTI Port | N/A |
| <model> | tkmodel CTI Port | N/A |
| <class> | tkclass Phone | N/A |
| <protocol> | tkdeviceprotocol SCCP | N/A |
| <protocolSide> | tkprotocolside User | N/A |
| <callingSearchSpaceName> | fkcallingsearchspace | Calling Search Space |
| <devicePoolName> | fkdevicepool As per Cisco recommendations, this is the most used device pool. | Device Pool |
| <networkLocation> | tknetworklocation | N/A |

| AXL Tag | DB Field/ Default Value | CUCM Property (CTI Port only) |
|-------------------------------------|------------------------------------|--|
| <locationName> | fklocation | Location |
| <commonDeviceConfigName> | Fkcommonphoneconfig | Common Device Configuration |
| <mediaResourceListName> | fkmediaresourcelist | Media Resource Group List |
| <networkHoldMOHAudioSourceId> | networkholdmohaudiosourceid | Network Hold MOH Audio Source |
| <userHoldMOHAudioSourceId> | userholdmohaudiosourceid | User Hold MOH Audio Source |
| <automatedAlternateRoutingCSSName> | fkcallingsearchspace_aar | AAR Calling Search Space |
| <aarNeighborhoodName> | fkaarneighborhood | AAR Group |
| <mlppDomainId> | fkmlppdomain | MLPP Domain |
| <cgpnTransformationCSSName> | fkcallingsearchspace_cgpntransform | Calling Party Transformation CSS |
| <geoLocationName> | fkgeolocation | Geo Location |
| <joinAcrossLines> | tkstatus_joinacrosslines | Join Across Lines |
| <useTrustedRelayPoint> | tkstatus_usetrustedrelaypoint | Use Trusted Relay Point |
| <alwaysUsePrimeLine> | tkstatus_alwaysuseprimeline | Always Use Prime Line |
| <alwaysUsePrimeLineforVoiceMessage> | tkstatus_alwaysuseprimelineforvm | Always Use Prime Line for Voice Message |
| <userLocale> | tkuserlocale | User Locale |
| <builtInBridgeStatus> | tkstatus_builtinbridge | N/A |
| <callInfoPrivacyStatus> | tksipprivacy | Privacy |
| <hlogStatus> | Not known | N/A |
| <ownerUserId> | fkenduser | Owner User ID |
| <ignorePresentationIndicators> | ignorepi | Ignore Presentation Indicators (internal calls only) |
| <subscribeCallingSearchSpaceName> | fkcallingsearchspace_restrict | SUBSCRIBE Calling Search Space |
| <unattendedPort> | unattended_port | Unattended Port |
| <phoneSuite> | Not known | N/A |
| <deviceMobilityMode> | tkstatus_devicemobilitymode | Device Mobility Mode |
| <remoteDevice> | remotedevice | N/A |
| <dndOption> | tkdndoption | DND Option |
| <dndRingSetting> | tkdndoption | DND Incoming Call Alert |
| <dndStatus> | dndtimeout | Do Not Disturb |
| <label> | label | Line Text Label |

CTI Route Point Mappings

This table lists the mappings related to *CTI Route Point* in the DB *device* table.

| AXL Tag | DB Field/ Default Value | CUCM Property (CTI Port only) |
|------------------------------------|------------------------------------|---|
| <name> | name | Device Name |
| <description> | description | Description |
| <product> | tkproduct CTI Route Point | N/A |
| <model> | tkmodel CTI Route Point | N/A |
| <class> | tkclass CTI Route Point | N/A |
| <protocol> | tkdeviceprotocol SCCP | N/A |
| <protocolSide> | tkprotocolside User | N/A |
| <callingSearchSpaceName> | kcallingsearchspace | Calling Search Space |
| <devicePoolName> | fkdevicepool | Device Pool As per Cisco recommendations, this is the most used device pool. |
| <networkLocation> | tknetworklocation | N/A |
| <locationName> | fklocation | Location |
| <commonDeviceConfigName> | fkcommonphoneconfig | Common Device Configuration |
| <mediaResourceListName> | fkmediaresourcelist | Media Resource Group List |
| <networkHoldMOHAudioSourceId> | networkholdmohaudiosourceid | Network Hold MOH Audio Source |
| <userHoldMOHAudioSourceId> | userholdmohaudiosourceid | User Hold MOH Audio Source |
| <automatedAlternateRoutingCSSName> | fkcallingsearchspace_aar | AAR Calling Search Space |
| <aarNeighborhoodName> | fkaarneighborhood | AAR Group |
| <cgpnTransformationCSSName> | fkcallingsearchspace_cgpntransform | Calling Party Transformation CSS |
| <geoLocationName> | fkgeolocation | Geo Location |

Directory Number (Line) Mappings

This table lists the mappings related to *Line* or *Directory Number* in the *dnorpattern* DB table.

| AXL Tag | DB Field/ Default Value | CUCM Property (CTI Port only) |
|-------------------------------|--|--|
| <pattern> | dnorpattern Directory number provided | Directory Number |
| <description> | description ASD-<Mac>-<DN> | Description |
| <usage> | tkpatternusage Conference | N/A |
| <routePartition> | fkroutepartition none | Route Partition |
| <aarNeighborhoodName> | fkaarneighborhood | AAR Group |
| <aarDestinationMask> | aardestinationmask | AAR Destination Mask |
| <aarKeepCallHistory> | aarkeepcallhistory | Retain this destination in the call forwarding history |
| <aarVoiceMailEnabled> | aarvoicemailenabled | Voice Mail |
| <presenceGroup> | fkmatrix_presence | Presence Group |
| <callForwardAll> | | Forward All |
| <forwardToVoiceMail> | Cfaptvoicemailenabled | Voice Mail |
| <callingSearchSpace> | fkcallingsearchspace_cfapt | Calling Search Space |
| <secondaryCallingSearchSpace> | Not known | Secondary Calling Search Space for Forward All |
| <destination> | Cfaptdestination | Destination |
| <callForwardBusy> | | Forward Busy External |
| <forwardToVoiceMail> | Cfbintvoicemailenabled | Voice Mail |
| <callingSearchSpace> | fkcallingsearchspace_cfbint | Calling Search Space |
| <destination> | Cfbintdestination | Destination |
| <callForwardBusyInt> | | Forward Busy Internal |
| <forwardToVoiceMail> | cfbintvoicemailenabled | Voice Mail |
| <callingSearchSpace> | fkcallingsearchspace_cfbint | Calling Search Space |
| <destination> | cfbintdestination | Destination |
| <callForwardNoAnswer> | | Forward No Answer External |
| <forwardToVoiceMail> | Cfnavoicemailenabled | Voice Mail |

| AXL Tag | DB Field/ Default Value | CUCM Property (CTI Port only) |
|-------------------------------|------------------------------------|-------------------------------|
| <callingSearchSpace> | fkcallingsearchspace_cfnat | Calling Search Space |
| <destination> | Cfnadestination | Destination |
| <callForwardNoAnswerInt> | | Forward No Answer Internal |
| <forwardToVoiceMail> | Cfnaintvoicemailenabled | Voice Mail |
| <callingSearchSpace> | fkcallingsearchspace_cfnaint | Calling Search Space |
| <destination> | Cfnaintdestination | Destination |
| <callForwardNoCoverage> | | Forward No Coverage External |
| <forwardToVoiceMail> | Pffvoicemailenabled | |
| <callingSearchSpace> | fkcallingsearchspace_pff | |
| <destination> | pffdestination | |
| <callForwardNoCoverageInt> | | Forward No Coverage Internal |
| <forwardToVoiceMail> | pffintvoicemailenabled | |
| <callingSearchSpace> | fkcallingsearchspace_pffint | |
| <destination> | pffintdestination | |
| <callForwardOnFailure> | | Forward on CTI Failure |
| <forwardToVoiceMail> | Cdfvoicemailenabled | |
| <callingSearchSpace> | fkcallingsearchspace_devicefailure | |
| <destination> | Devicefailedn | |
| <callForwardNotRegistered> | | Forward Unregistered External |
| <forwardToVoiceMail> | Cfurvoicemailenabled | |
| <callingSearchSpace> | fkcallingsearchspace_cfur | |
| <destination> | Cfurdestination | |
| <callForwardNotRegisteredInt> | | Forward Unregistered Internal |
| <forwardToVoiceMail> | Cfurintvoicemailenabled | |
| <callingSearchSpace> | fkcallingsearchspace_cfurint | |
| <destination> | Cfurintdestination | |
| <callForwardAlternateParty> | | MLPP Alternate Party Settings |
| <CallingSearchSpace> | fkcallingsearchspace_cfapt | MLPP Calling Search Space |
| <destination> | Cfaptdestination | Target (Destination) |

| AXL Tag | DB Field/ Default Value | CUCM Property (CTI Port only) |
|--|---------------------------------------|--|
| <duration> | cfaptduration | MLPP No Answer Ring Duration (seconds) |
| <callPickupGroup> | Not known | Call Pickup Group |
| <networkHoldMOHAudioSourceId> | networkholdmohaudiosourceid | Network Hold MOH Audio Source |
| <userHoldMOHAudioSourceId> | userholdmohaudiosourceid | User Hold MOH Audio Source |
| <alertingName> | alertingname | Alerting Name |
| <asciiAlertingName> | alertingnameascii | ASCII Alerting Name |
| <shareLineAppearanceCSS> | fkcallingsearchspace_sharedlineappear | N/A |
| <voiceMailProfile> | fkvoicemailprofile | Voice Mail Profile |
| <hrInterval> | hrInterval | Hold Reversion Notification Interval (seconds) |
| <hrDuration> | hrDuration | Hold Reversion Ring Duration (seconds) |
| <ParkMonForwardNoRetrieveDN> | parkmonforwardnoretrievedn | Park Monitoring Forward No Retrieve Destination External |
| <ParkMonForwardNoRetrieveIntDN> | parkmonforwardnoretrieveintdn | Park Monitoring Forward No Retrieve Destination Internal |
| <ParkMonForwardNoRetrieveVMEnabled> | parkmonforwardnoretrievevmenabled | Voice Mail |
| <ParkMonForwardNoRetrieveIntVMEnabled> | parkmonforwardnoretrieveintvmenabled | Voice Mail |
| <ParkMonForwardNoRetrieveCSSName> | fkcallingsearchspace_pkmonfwdnoret | Calling Search Space |
| <ParkMonForwardNoRetrieveIntCSSName> | fkcallingsearchspace_pkmonfwdnoretint | Calling Search Space |
| <ParkMonReversionTimer> | Parkmonreversiontimer | Park Monitoring Reversion Timer |
| <partyEntranceTone> | tkstatus_partyentrancetone | Party Entrance Tone |

Devicenumplanmap Mappings

This table lists the mappings related to the *Device* and *Line* join table (the properties appear on the Directory number GUI).

| AXL Tag | DB Field/ Default Value | CUCM Property (CTI Port only) |
|--------------------|---------------------------------|------------------------------------|
| <label> | label | Line Text Label |
| <display> | Display | Display (Internal Caller ID) |
| <displayASCII> | Displayascii | ASCII Display (Internal Caller ID) |
| <ringSetting> | tkringsetting_activepickupalert | N/A |
| <e164Mask> | e164mask | External Phone Number Mask |
| <dialPlanWizardId> | Dialplanwizardgenid | N/A |

| AXL Tag | DB Field/ Default Value | CUCM Property (CTI Port only) |
|---------------------|--|--|
| <maxNumCalls> | maxnumcalls 2 for CTI Route point, 4 for CTI port | Maximum Number of Calls |
| <busyTrigger> | busytrigger 1 for CTI Route point, 2 for CTI port | Busy Trigger |
| <monitoringCSSName> | fkcallingsearchspace_monitoring | Monitoring Calling Search Space |
| <callInfoDisplay> | Callinfodisplaymask 9 | Forwarded Call Information Display on Device |



Accessing Cisco Unified Attendant Console Advanced Registry Keys on Client PCs

Cisco Unified Attendant Console Advanced applications use the HKEY_Local_Machine Microsoft Windows registry key on the PC on which they run. However, some customer networks may implement domain policies that restrict local access to this registry key, causing Cisco Unified Attendant Console Advanced to malfunction in the following ways:

- An error message is displayed when logging in, stating that a connection to an unnamed server on port 0 cannot be made.
- The Cisco Unified Attendant Console Advanced application interface is displayed incorrectly. The screen display format is stored in the registry.

To grant all users full access to the Cisco Unified Attendant Console Advanced registry keys, thereby preventing this malfunction, do the following:

-
- Step 1** Log into the Cisco Unified Attendant Console Advanced Client PC as a Local Administrator.
 - Step 2** Exit all Cisco Unified Attendant Console Advanced Clients applications.
 - Step 3** Click **Start** and run the Windows Registry Editor, **regedit**.
 - Step 4** In the Registry Editor, locate **HKEY_Local_Machine\Software\Arc Solutions**.
 - Step 5** Right-click **Arc Solutions** and select **Permissions**.
 - Step 6** In the **Permissions for Arc Solutions** dialog box, click **Add**.
The **Select User, Computers, Service accounts, or Groups** dialog box is displayed.
 - Step 7** In **Enter object name to select**, type <DOMAIN NAME>\Everyone, where <DOMAIN NAME> is the domain that attendant operators log into.
 - Step 8** Click **OK** to add the group.
Everyone is now listed in the **Permissions for Arc Solutions** dialog box.
 - Step 9** In the dialog box, select **Everyone** and then check **Allow** in the **Full Control** row to grant full registry access to everyone in the group.
 - Step 10** Click **Apply**.
 - Step 11** Click **OK**.
-

