

Board

BoardPro,
BoardPro
G2

Codec EQ

Codec
Plus

Codec
Pro

Desk,
Desk Pro,
Desk Mini

Room Bar
Pro,
Room Bar

Room Kit,
Room Kit
Mini

Room Kit
EQX

Room 55

Room 55
Dual,
Room 70

Room 70
G2

Room 70
Panorama

Room
Panorama



Administration Guide

for Cisco collaboration devices running RoomOS 11.24

D15503.06

RoomOS
11.24

02-2025



- Board
- BoardPro, BoardPro G2
- Codec EQ
- Codec Plus
- Codec Pro
- Desk, DeskPro, DeskMini
- Room Bar Pro, Room Bar
- Room Kit, Room Kit Mini
- Room Kit EQX
- Room 55
- Room 55 Dual, Room 70
- Room 70 G2
- Room 70 Panorama
- Room Panorama

All entries in the table of contents are hyperlinks that take you to the corresponding chapter. To go between the main sections, you can use the buttons in the top menu bar.

This guide is mainly aimed at administrators working with the setup and configuration of the video conferencing device.

The guide primarily addresses capabilities and configurations for devices registered to an on-premises service (CUCM, VCS), but most capabilities and configurations also apply to devices that are registered to the Webex cloud service.

The following devices are covered:

Board series

- Board (55/55S, 70/70S, and 85S)
- Board Pro (55 and 75)
- Board Pro G2 (55 and 75)

Desk series

- Desk Mini
- Desk
- Desk Pro

Room series

- Codec EQ
(incl. Room Kit EQ and Room Kit EQ PTZ 4K bundles)
- Codec Plus
(incl. Room Kit Plus, Room Kit Plus PTZ 4K, Room Kit Plus Precision 60, and Room Kit Plus PTZ-12 bundles)
- Codec Pro
(incl. Room Kit Pro, Room Kit Pro PTZ 4K, and Room Kit Pro Precision 60 bundles)
- Room Bar
- Room Bar Pro
- Room Kit EQX
- Room Kit
- Room Kit Mini
- Room 55
- Room 55 Dual
- Room 70
- Room 70 G2
- Room 70 Panorama
- Room Panorama

Table of contents

- Introduction..... 5
 - RoomOS software and user documentation 6
 - What’s new 7
 - What’s new 11
 - Product features at a glance 16
 - Room Series at a glance 17
 - Desk Series at a glance 21
 - Board Series at a glance 22
 - How to administer the video conferencing device 23
 - Touch controllers..... 28
- Configuration 29
 - User administration 30
 - Change the device passphrase 31
 - Restrict the access to the Settings menu 32
 - Device configuration 33
 - Add a sign in banner 34
 - Add a welcome banner 35
 - Manage the service certificates of the device 36
 - Manage the lists of trusted certificate authorities - CAs 37
 - Set up secure audit logging 41
 - Delete CUCM trust lists 42
 - Change the persistency mode 43
 - Set up an SMTP email server 44
 - Set up ad hoc multipoint conferences 45
 - Set up and use Cisco Proximity 47
 - Adjust the video quality to call rate ratio 52
 - Select a wallpaper bundle as background image 54
 - Add a custom background image for halfwake mode..... 55
 - Add a custom background for the Home screen 56
 - Add branding to the screen and touch controller 57
 - Add a virtual background 59
 - Choose a ringtone and set the ringtone volume 60
 - Manage the Favorites list 61
 - Set up accessibility features 62
 - Set up the low power behavior 63
 - Provisioning of product specific configurations from CUCM 64

Board

BoardPro,
BoardPro
G2

Codec EQ

Codec
Plus

Codec
Pro

Desk,
DeskPro,
DeskMini

Room Bar
Pro,
Room Bar

Room Kit,
Room Kit
Mini

Room Kit
EQX

Room 55

Room 55
Dual,
Room 70

Room 70
G2

Room 70
Panorama

Room
Panorama

Peripherals	66
Setting up screens and other output devices	67
Connecting input sources	77
Extend the number of input sources	90
Information about displays	91
Information about resolutions	92
Information about HDMI and USB-C cables.....	93
Set up automatic framing features.....	94
Set up a meeting zone	99
Cross-view and extended speaker view.....	100
Set up the PresenterTrack feature.....	101
Presenter and Audience setup.....	107
Briefing room setup.....	121
Classroom setup	131
Using external microphones with Board Pro, Board Pro G2, and Room Bar Pro	141
Test the loudspeaker connections	142
Bluetooth® headset.....	146
Connect the touch controller	147
Maintenance	157
Installing new software	158
Add option keys	160
Device status.....	161
Run diagnostics.....	162
Get system log files.....	163
Get call logs	165
Create a remote support user.....	166
Backup and restore configurations and custom elements.....	167
CUCM provisioning of custom elements.....	168
TMS provisioning of custom elements	169
Revert to the previously used software image.....	170
Factory reset the video conferencing device.....	171
Factory reset Cisco Room Navigator	177
Factory reset Touch 10	178
Factory reset Cisco Natural Audio Module IV	179
Factory reset Table Microphone Pro	180
Capture user interface screenshots.....	181

Device settings	182
Overview of the device settings.....	183
App settings.....	193
Audio settings	193
Bluetooth settings	224
Bookings settings.....	225
BYOD settings	227
CallHistory settings	228
Cameras settings	229
Conference settings.....	243
FacilityService settings	251
Files settings	252
GPIO settings	253
H323 settings.....	253
HttpClient settings	256
HttpFeedback settings.....	257
Logging settings.....	258
Macros settings.....	261
MicrosoftTeams settings	262
Network settings	263
NetworkServices settings	272
Peripherals settings	283
Phonebook settings	286
Provisioning settings	288
Proximity settings.....	291
RemoteAccess settings	292
RoomAnalytics settings	293
RoomCleanup settings.....	296
RoomReset settings	297
RoomScheduler settings.....	297
RTP settings	299
Security settings	301
Sensors settings	305
SerialPort settings.....	305
SIP settings	307
Standby settings	312
SystemUnit settings	317

Board

BoardPro,
BoardPro
G2

Codec EQ

Codec
Plus

Codec
Pro

Desk,
DeskPro,
DeskMini

Room Bar
Pro,
Room Bar

Room Kit,
Room Kit
Mini

Room Kit
EQX

Room 55

Room 55
Dual,
Room 70

Room 70
G2

Room 70
Panorama

Room
Panorama

ThousandEyes settings	319
Time settings.....	320
UserInteraction settings.....	324
UserInterface settings.....	325
UserManagement settings.....	347
Video settings	352
VoiceControl settings.....	376
WebEngine settings	377
Webex settings	380
WebRTC settings	383
Zoom settings	384
Experimental settings.....	385
Physical interfaces	386
Power On/Off and LED behavior	387
Connector panel: Codec EQ	398
Connector panel: Codec Plus	399
Connector panel: Codec Pro and Room Panorama	400
Connector panel: Room Kit	401
Connector panel: Room Kit Mini.....	402
Connector panel: Room Bar	403
Connector panel: Room Bar Pro	404
Connector panel: Room 55	405
Connector panel: Room Kit EQX	406
Connector panel: Room 55 Dual and Room 70.....	407
Connector panel: Room 70 G2 and Room 70 Panorama	408
Connector panel: Desk Mini	409
Connector panel: Desk and Desk Pro	410
Connector panel: Board	411
Connector panel: Board Pro.....	412
Connector panel: Board Pro G2	413
Connector panel: Cisco Natural Audio Module IV amplifier	414
Room Navigator physical interface	415
Touch 10 physical interface	416
Appendices.....	417
Call from laptop using the device as a web camera	418
Panoramic video	422
Set up remote monitoring	423
Access call information and answer a call while using the device web interface.....	424
Place a call using the device web interface.....	425
Share content using the device web interface.....	427

Local layout control.....	428
Control a local camera	429
Control a far end camera	430
Room analytics.....	431
Customize the video conferencing device's user interface	433
Customize the video conferencing device's behavior using macros	435
Show or hide buttons and other elements on the user interface.....	436
Use of a third-party USB input device	437
Sending HTTP(S) requests	438
Digital signage.....	439
Web apps	440
API-driven web views	441
Input source composition.....	442
Presentation source composition	444
Access the device's XML files	446
Execute API commands and configurations from the device web interface	447
Advanced customization of audio	448
About Ethernet ports.....	453
Mini-jack connector pin-out schemes	454
Audio inputs and outputs	455
The GPIO and 3G-SDI connectors.....	457
API access using the COM port.....	458
Serial interface for maintenance	459
The systemtools commands	465
Open TCP ports	466
Ephemeral IP ports.....	467
HTTPFeedback address from TMS	468
Link an on-premises registered device to Cisco Webex Edge for Devices	469
Register a device to the Cisco Webex cloud service.....	470
Supported RFCs.....	471
Calculating minimum bandwidth	472
User documentation on the Cisco web site	473
Cisco contacts	474

Board

BoardPro,
BoardPro
G2

Codec EQ

Codec
Plus

Codec
Pro

Desk,
Desk Pro,
Desk Mini

Room Bar
Pro,
Room Bar

Room Kit,
Room Kit
Mini

Room Kit
EQX

Room 55

Room 55
Dual,
Room 70

Room 70
G2

Room 70
Panorama

Room
Panorama

Chapter 1

Introduction

Board

BoardPro,
BoardPro
G2

Codec EQ

Codec
PlusCodec
ProDesk,
DeskPro,
DeskMiniRoom Bar
Pro,
Room BarRoom Kit,
Room Kit
MiniRoom Kit
EQX

Room 55

Room 55
Dual,
Room 70Room 70
G2Room 70
PanoramaRoom
Panorama

RoomOS software and user documentation

RoomOS is the operating system that powers Cisco collaboration devices, both when the device is registered to an on-premises service (CUCM, VCS) and when it is registered to the Webex cloud service.

How to get software and where to find user documentation depend on where the device is registered.

About the Administration guide

The Administration guide is mainly aimed at administrators working with the setup and configuration of the video conferencing device.

The guide primarily addresses capabilities and configurations for devices registered to an on-premises service (CUCM, VCS), but most capabilities and configurations also apply to devices that are registered to the Webex cloud service.

Webex Workspaces

We recommend you to explore Webex Workspaces to find inspiration and guidelines when preparing an office or meeting room for video conferencing:

► <https://www.webex.com/workspaces.html>

On-premises registered devices

Software

New versions of RoomOS for on-premises registered devices are released 3-4 times a year. You can download the software from the Cisco web site:

► <https://software.cisco.com/download/home>

Release notes

We recommend reading the software release notes (RoomOS 11) before you upgrade your devices.

► https://roomos.cisco.com/doc/WhatsNew/ReleaseNotesRoomOS_11

Other documentation

We also recommend that you visit the Cisco web site regularly to find the most recent version of this Administrator guide, as well as other documentation for your devices.

► <https://www.cisco.com/go/board-docs> (Board series)

► <https://www.cisco.com/go/desk-docs> (Desk series)

► <https://www.cisco.com/go/room-docs> (Room series)

To find the Administration guides, click *Documentation* and look for *Maintain and Operate > Maintain and Operate Guides*.

Refer to the ► [User documentation on the Cisco web site](#) appendix for more information about guides for this product.

Webex registered devices

Software

New versions of RoomOS for Webex cloud registered devices are released monthly. Software is automatically installed on the devices as set up in Control Hub for your organization.

Release notes

To find what's new in the latest version of the Webex deployment, we recommend you to read *What's new in RoomOS devices* on Webex Help Center.

► <https://help.webex.com/article/6ger7db/>

In this article you also find an overview of previously released features, and some details about features that are planned to be released soon.

Other documentation

For more information about devices that are registered to the Webex cloud service, go to the Webex Help Center:

► <https://help.webex.com>

Note that guides that cover both on-premises and Webex registered devices are on the Cisco web site, as described for *On-premises registered devices*.

Board

BoardPro,
BoardPro
G2

Codec EQ

Codec
PlusCodec
ProDesk,
DeskPro,
DeskMiniRoom Bar
Pro,
Room BarRoom Kit,
Room Kit
MiniRoom Kit
EQX

Room 55

Room 55
Dual,
Room 70Room 70
G2Room 70
PanoramaRoom
Panorama

What's new (page 1 of 9)

This chapter provides an overview of new features and improvements, and lists the new, changed, and removed device settings (configurations). For more details, we recommend reading the [software release notes](#) (RoomOS 11).

New features and improvements in RoomOS 11.24

Support for Cisco Ceiling Microphone Pro

RoomOS 11.24.2 has full support for the Cisco Ceiling Microphone Pro together with:

- Cisco Room Bar
- Cisco Room Bar Pro
- Cisco Room Kit EQ
- Cisco Room Kit EQX
- Cisco Room Kit Pro
- Cisco Board Pro
- Cisco Board Pro G2

Support for Cisco Room Bar BYOD

With RoomOS 11.24.2 and later installed on a Cisco Room Bar without a Room Navigator connected, the device boots into Cisco Room Bar BYOD mode.

In BYOD mode, the Room Bar can be connected to a computer through USB-C or USB-A to USB-C, functioning as an advanced web camera that provides audio input and output, video with built-in intelligent framing, and local presentation capabilities when connected to a screen.

Read more about:

- [Administration](#)
- [Use](#)

Support for local ad-hoc bookings ahead of time

The local booking UI for ad-hoc bookings now allow you to book the room ahead of time.

Other updates:

- Microsoft Teams Join Button will now prompt for a Video ID by default instead of the Meeting ID. Meeting ID will still be available but it's promoted as an alternative.
- Share tray on the device's UI now shows a preview of the source that's connected with a cable. This helps you quickly identify the correct source. Note that this do not work for the Extended/Virtual sources feature.
- When AirPlay is connected during a call, an auto-share popup appears, notifying that sharing will begin in 5 seconds and providing a countdown until the content is shared in the call.

- Board
- Board Pro, Board Pro G2
- Codec EQ
- Codec Plus
- Codec Pro
- Desk, Desk Pro, Desk Mini
- Room Bar Pro, Room Bar
- Room Kit, Room Kit Mini
- Room Kit EQX
- Room 55
- Room 55 Dual, Room 70
- Room 70 G2
- Room 70 Panorama
- Room Panorama

What's new (page 2 of 9)

New Configurations

- Apps Whiteboard Url *(All products)*
- Audio Input Ethernet [1..8] EchoControl Mode *(Board Pro G2, Room Bar Pro)*
- Audio Input Ethernet [1..8] EchoControl NoiseReduction *(Board Pro G2, Room Bar Pro)*
- Audio Input Ethernet [1..8] Equalizer ID *(Board Pro G2, Room Bar Pro)*
- Audio Input Ethernet [1..8] Equalizer Mode *(Board Pro G2, Room Bar Pro)*
- Audio Input Ethernet [1..8] Mode *(Board Pro G2, Room Bar Pro)*
- Bookings DeclinableBookingType *(All products)*
- Cameras Camera ExcludedArea *(Desk Mini, Desk Pro, Room 55, Room Bar, Room Kit, Room Kit Mini, Cisco Desk)*
- Cameras Camera Whitebalance Compensation Level *(Room Bar)*
- Cameras Camera [1..7] ExcludedArea *(Codec EQ, Codec Plus, Codec Pro, Room 55 Dual, Room 70, Room 70 G2, Room Kit EQX, Room Panorama, Room 70 Panorama)*
- Cameras Camera [1..7] PtzAutoFraming *(Codec EQ, Codec Plus, Codec Pro, Room 55 Dual, Room 70, Room 70 G2, Room Kit EQX, Room Panorama, Room 70 Panorama)*
- Cameras Camera [1] ExcludedArea *(Board Pro, Board Pro G2, Room Bar Pro)*
- Cameras Camera [1] Whitebalance Compensation Level *(Board Pro, Board Pro G2, Room Bar Pro)*
- Cameras Camera [2] Standby Mode *(Board Pro, Board Pro G2, Room Bar Pro)*
- Cameras Camera [2] VideoFormat *(Board Pro, Board Pro G2, Room Bar Pro)*
- Cameras Camera [3] Standby Mode *(Board Pro, Board Pro G2, Room Bar Pro)*
- Cameras Camera [3] VideoFormat *(Board Pro, Board Pro G2, Room Bar Pro)*
- Cameras Camera [4] Standby Mode *(Board Pro, Board Pro G2, Room Bar Pro)*
- Cameras Camera [4] VideoFormat *(Board Pro, Board Pro G2, Room Bar Pro)*
- Cameras Camera [5] Standby Mode *(Board Pro, Board Pro G2, Room Bar Pro)*
- Cameras Camera [5] VideoFormat *(Board Pro, Board Pro G2, Room Bar Pro)*
- Cameras Camera [6] Standby Mode *(Board Pro, Board Pro G2, Room Bar Pro)*
- Cameras Camera [6] VideoFormat *(Board Pro, Board Pro G2, Room Bar Pro)*
- Cameras Camera [7] Standby Mode *(Board Pro, Board Pro G2, Room Bar Pro)*
- Cameras Camera [7] VideoFormat *(Board Pro, Board Pro G2, Room Bar Pro)*
- Cameras SpeakerTrack GroupAndSpeaker Mode *(Board Pro G2, Codec EQ, Codec Pro, Room 70 G2, Room Bar Pro, Room Kit EQX)*

- Files Services Webex SaveToUser *(All products)*
- Macros Diagnostics ConsoleLogErrors *(All products)*
- NetworkServices Wifi Settings TlsVerify *(All products)*
- RemoteAccess Mode *(All products)*
- RemoteAccess ShowTapIndicator *(All products)*
- Security Enrollment KeySize *(All products)*
- Standby WakeupOnPairing *(All products)*
- UserInterface Bookings AdhocBooking TimeSlotSize *(All products)*
- UserInterface Bookings AdhocBooking UseDefaultTitle *(All products)*
- UserInterface Bookings Visibility AllDayMeetings *(All products)*
- UserInterface Bookings Visibility NonJoinableMeetings *(All products)*
- UserInterface Bookings Visibility Personal NonJoinableMeetings *(All products)*
- UserInterface DecemberThemeBeta *(All products)*
- UserInterface DevicePersonalization QRCodeNotification *(Desk Mini, Desk Pro, Cisco Desk)*
- UserInterface Features Share MTRAutoSelectSource *(All products)*
- Video Input AirPlay PresentationSelection *(Board 55S, Board 70S, Board 85S, Board Pro, Board Pro G2, Codec EQ, Codec Plus, Codec Pro, Desk Mini, Desk Pro, Room 55, Room 55 Dual, Room 70, Room 70 G2, Room Bar, Room Bar Pro, Room Kit, Room Kit EQX, Room Kit Mini, Room Panorama, Room 70 Panorama, Cisco Desk)*
- Video Input Connector [4] CameraControl CameraId *(Board Pro, Board Pro G2, Room Bar Pro, Desk Pro, Room Bar)*
- Video Input Connector [4] CameraControl Mode *(Room Bar Pro, Desk Pro, Room Bar, Board Pro, Board Pro G2)*
- Video Input Connector [4] InputSourceType *(Board Pro, Board Pro G2, Desk Pro, Room Bar, Room Bar Pro)*
- Video Input Connector [4] Name *(Board Pro, Board Pro G2, Desk Pro, Room Bar, Room Bar Pro)*
- Video Input Connector [4] OptimalDefinition Profile *(Board Pro, Board Pro G2, Desk Pro, Room Bar, Room Bar Pro)*
- Video Input Connector [4] OptimalDefinition Threshold60fps *(Board Pro, Board Pro G2, Room Bar, Room Bar Pro, Desk Pro)*
- Video Input Connector [4] PresentationSelection *(Desk Pro, Room Bar, Room Bar Pro, Board Pro, Board Pro G2)*
- Video Input Connector [4] Quality *(Desk Pro, Room Bar, Room Bar Pro, Board Pro, Board Pro G2)*
- Video Input Connector [4] Visibility *(Board Pro, Board Pro G2, Desk Pro, Room Bar, Room Bar Pro)*

D15503.06

RoomOS

11.24

02-2025



Board

Board Pro,
Board Pro G2

Codec EQ

Codec Plus

Codec Pro

Desk,
Desk Pro,
Desk MiniRoom Bar
Pro,
Room BarRoom Kit,
Room Kit
MiniRoom Kit
EQX

Room 55

Room 55
Dual,
Room 70Room 70
G2Room 70
PanoramaRoom
Panorama

What's new (page 3 of 9)

Video Input Connector [5] CameraControl Camerald *(Board Pro, Board Pro G2, Room Bar Pro, Desk Pro, Room Bar, Codec EQ, Room Kit EQX)*

Video Input Connector [5] CameraControl Mode *(Board Pro, Board Pro G2, Room Bar Pro, Desk Pro, Room Bar, Codec EQ, Room Kit EQX)*

Video Input Connector [5] InputSourceType *(Board Pro, Board Pro G2, Room Bar Pro, Desk Pro, Room Bar, Codec EQ, Room Kit EQX)*

Video Input Connector [5] Name *(Board Pro, Board Pro G2, Room Bar Pro, Desk Pro, Room Bar, Codec EQ, Room Kit EQX)*

Video Input Connector [5] OptimalDefinition Profile *(Board Pro, Board Pro G2, Room Bar Pro, Desk Pro, Room Bar, Codec EQ, Room Kit EQX)*

Video Input Connector [5] OptimalDefinition Threshold60fps *(Board Pro, Board Pro G2, Room Bar Pro, Desk Pro, Room Bar, Codec EQ, Room Kit EQX)*

Video Input Connector [5] PresentationSelection *(Board Pro, Board Pro G2, Room Bar Pro, Desk Pro, Room Bar, Codec EQ, Room Kit EQX)*

Video Input Connector [5] Quality *(Board Pro, Board Pro G2, Room Bar Pro, Desk Pro, Room Bar, Codec EQ, Room Kit EQX)*

Video Input Connector [5] Visibility *(Board Pro, Board Pro G2, Room Bar Pro, Desk Pro, Room Bar, Codec EQ, Room Kit EQX)*

Video Input Connector [6] CameraControl Camerald *(Codec EQ, Room Kit EQX)*

Video Input Connector [6] CameraControl Mode *(Codec EQ, Room Kit EQX)*

Video Input Connector [6] InputSourceType *(Codec EQ, Room Kit EQX)*

Video Input Connector [6] Name *(Codec EQ, Room Kit EQX)*

Video Input Connector [6] OptimalDefinition Profile *(Codec EQ, Room Kit EQX)*

Video Input Connector [6] OptimalDefinition Threshold60fps *(Codec EQ, Room Kit EQX)*

Video Input Connector [6] PresentationSelection *(Codec EQ, Room Kit EQX)*

Video Input Connector [6] Quality *(Codec EQ, Room Kit EQX)*

Video Input Connector [6] Visibility *(Codec EQ, Room Kit EQX)*

Video Input Connector [7] CameraControl Camerald *(Codec Pro, Room 70 G2, Room Panorama, Room 70 Panorama)*

Video Input Connector [7] CameraControl Mode *(Codec Pro, Room 70 G2, Room Panorama, Room 70 Panorama)*

Video Input Connector [7] InputSourceType *(Codec Pro, Room 70 G2, Room Panorama, Room 70 Panorama)*

Video Input Connector [7] Name *(Codec Pro, Room 70 G2, Room Panorama, Room 70 Panorama)*

Video Input Connector [7] OptimalDefinition Profile *(Codec Pro, Room 70 G2, Room Panorama, Room 70 Panorama)*

Video Input Connector [7] OptimalDefinition Threshold60fps *(Codec Pro, Room 70 G2, Room 70 Panorama, Room Panorama)*

Video Input Connector [7] PresentationSelection *(Codec Pro, Room 70 G2, Room Panorama, Room 70 Panorama)*

Video Input Connector [7] Quality *(Codec Pro, Room 70 G2, Room Panorama, Room 70 Panorama)*

Video Input Connector [7] Visibility *(Codec Pro, Room 70 G2, Room Panorama, Room 70 Panorama)*

Webex CSATSurveyEnabled *(All products)*

Webex UpgradeChannel *(All products)*

Configurations that are modified

Audio Microphones BeamMix Inputs *(Board Pro G2, Room Bar Pro, Board Pro)*

OLD: Auto/BeamsAndExtMics

NEW: Auto/BeamsAndExtMics/OnlyExtMics

Audio Ultrasound MaxVolume *(Codec EQ, Room Kit EQX)*

OLD: Integer (0..70)

NEW: Integer (0..90)

Cameras SpeakerTrack DefaultBehavior *(Codec EQ, Codec Pro, Room 70 G2, Room Kit EQX, Room Panorama, Room 70 Panorama, Board Pro G2, Room Bar Pro)*

OLD: Auto/BestOverview/Closeup/Current/Frames/Manual

NEW: Auto/BestOverview/Closeup/Current/Frames/GroupAndSpeaker/Manual

Conference Webex CallProtocolIPStack *(All products)*

OLD: PreferIpv4/PreferIpv6

NEW: Dual/PreferIpv4/PreferIpv6

MicrosoftTeams CVI CrossTenant *(All products)*

OLD: Default: Disabled

NEW: Default: Auto

NetworkServices Wifi Settings FrequencyBand *(Board Pro G2, Codec EQ, Room Bar Pro, Room Kit EQX)*

OLD: 2_4Ghz/5Ghz/Auto

NEW: 2_4Ghz/5Ghz/6Ghz/Auto

- Board
- Board Pro, Board Pro G2
- Codec EQ
- Codec Plus
- Codec Pro
- Desk, Desk Pro, Desk Mini
- Room Bar Pro, Room Bar
- Room Kit, Room Kit Mini
- Room Kit EQX
- Room 55
- Room 55 Dual, Room 70
- Room 70 G2
- Room 70 Panorama
- Room Panorama

What's new (page 4 of 9)

UserInterface RoomScheduler Mode *(All products)*

OLD: Auto/RoomInUseOnly

NEW: Auto/CalendarOnly/RoomInUseOnly

Video DefaultMainSource *(Codec Pro, Room 70 G2, Room Panorama, Room 70 Panorama)*

OLD: 1/2/3/4/5/6

NEW: 1/2/3/4/5/6/7

Video DefaultMainSource *(Board Pro, Board Pro G2, Desk Pro, Room Bar, Room Bar Pro)*

OLD: 1/2/3

NEW: 1/2/3/4/5

Video Input Miracast Transport *(All products)*

OLD: Default: Direct

NEW: Default: Auto

Video Presentation DefaultSource *(Codec Pro, Room 70 G2, Room Panorama, Room 70 Panorama)*

OLD: 1/2/3/4/5/6

NEW: 1/2/3/4/5/6/7

Video Presentation DefaultSource *(Board Pro, Board Pro G2, Desk Pro, Room Bar, Room Bar Pro)*

OLD: 1/2/3

NEW: 1/2/3/4/5

Configurations that are removed

Audio Input Ethernet [1..3] Channel [1..8] Gain *(Board Pro G2, Codec EQ, Room Bar Pro, Room Kit EQX)*

Audio Input Ethernet [1..3] Channel [1..8] Level *(Board Pro)*

Audio Input Ethernet [1..3] Channel [1..8] Mode *(Board Pro, Board Pro G2, Codec EQ, Room Bar Pro, Room Kit EQX)*

Audio Input Ethernet [1..3] Channel [1..8] Pan *(Board Pro, Board Pro G2, Codec EQ, Room Bar Pro, Room Kit EQX)*

Audio Input Ethernet [1..3] Channel [1..8] Zone *(Board Pro, Board Pro G2, Codec EQ, Room Bar Pro, Room Kit EQX)*

Audio Input Ethernet [1..3] EchoControl Mode *(Board Pro G2, Room Bar Pro, Board Pro, Codec EQ, Room Kit EQX)*

Audio Input Ethernet [1..3] EchoControl NoiseReduction *(Board Pro G2, Room Bar Pro, Board Pro, Codec EQ, Room Kit EQX)*

Audio Input Ethernet [1..3] Equalizer ID *(Board Pro G2, Room Bar Pro, Board Pro, Codec EQ, Room Kit EQX)*

Audio Input Ethernet [1..3] Equalizer Mode *(Board Pro G2, Room Bar Pro, Board Pro, Codec EQ, Room Kit EQX)*

Audio Input Ethernet [1..3] Mode *(Board Pro G2, Room Bar Pro, Board Pro, Codec EQ, Room Kit EQX)*

UserInterface Bookings Visibility FullDayCalendar *(All products)*

Board

Board Pro,
Board Pro G2

Codec EQ

Codec Plus

Codec Pro

Desk,
Desk Pro,
Desk MiniRoom Bar Pro,
Room BarRoom Kit,
Room Kit Mini

Room Kit EQX

Room 55

Room 55 Dual,
Room 70

Room 70 G2

Room 70 Panorama

Room Panorama

What's new (page 5 of 9)

This chapter provides an overview of new features and improvements, and lists the new, changed, and removed device settings (configurations). For more details, we recommend reading the software release notes (RoomOS 11).

New features and improvements in RoomOS 11.20

Improvements when joining Zoom meetings

In the Join Zoom interface, you now see a list of selectable Zoom CRC domains under the "Advanced Options" for data center location preferences.

The device automatically detects when you're dialing into a Zoom meeting from xCommand Dial or from the normal UI Call interface. If a Zoom meeting is detected, Zoom Call Controls are added to the user interface. If you join a meeting with xCommand Dial using a booking ID, the platform specified in the booking takes priority.

We are now also removing the visual Zoom DTMF menu automatically if we detect a Zoom meeting by adding an option to the dial string. For example, 123456789@zoomcrc.com will become 123456789.504@zoomcrc.com.

Expanded Table Microphone Pro and AES67 support (Board Pro, Board Pro G2, Room Bar)

We've added support for up to 8 Table Microphone Pros for Board Pro and Board Pro G2 (requires AV Integrator Option Key). Board Pro and Board Pro G2 also now supports AES67.

Find more information in the [AES67 interoperability on Room Devices](#) article on Help Center.

Additionally, Room Bar now supports connecting one (1) Cisco Table Microphone Pro.

One additional passive screen with a third-party touchscreen

(Codec EQ, Codec Pro, Room Bar, and Room Bar Pro)

You can connect one third-party touchscreen and one passive screen to a Room Series device.

Allow Microsoft Teams meetings on different tenants through VIMT

Allow existing VIMT (Video Interoperability Meeting Tenant) customers to seamlessly join Microsoft Teams meetings hosted by external tenants while maintaining the familiar Cloud Video Interop (CVI) experience.

This ensures that users can continue to leverage their VIMT setup for enhanced video quality and functionality, even when participating in meetings outside their home tenant, delivering consistent and optimized meeting experiences across different organizations.

You need to enable [Microsoft Teams Cvi CrossTenant](#) and set [UserInterface MeetingJoin CVITenants](#).

Extended reach speaker mode

Adaptive speaker tracking and intelligent framing by the Cisco Quad Camera and the Cisco PTZ 4K pan-tilt-zoom camera, capture the active speaker and other in-room participants, even in the largest spaces.

Cross-view update

(Codec EQ, Codec Pro)

You can now setup cross-view with two Quad Cameras.

Connecting more than one Quad Camera to a Codec is only supported for Cross-view.

Pointing and annotation improvements on live presentations

Previously, a snapshot was taken of the presentation to draw on, but with this update, the presentation continues beneath the drawings.

Additionally, a new tool, disappearing ink, has been introduced. It stays visible for about 5 seconds, helping presenters highlight key elements without interrupting the flow of the presentation.

Frames improvements

The updated framing for groups of 2-4 people ensures that participants are no longer displayed in multiple frames.

For groups of 5-6 participants, the new framing limits the display to two frames, providing a more stable and cohesive viewing experience.

Custom scheduler setups

The Cisco room booking app now supports ad hoc reservations for spaces like quiet or focus rooms without requiring a Webex calendar setup, storing the booking status directly on the device.

If the quiet room is configured with hot-desking, the room booking app also reflects the status of the person who is signed in and the duration of the booking on an outside panel. A user can sign in from the panel outside the room and book the space in addition to being able to do this from the Desk Series device inside.

A third-party calendar provider can also send calendar events and use Cisco's room booking as the user interface. This new capability allows all booking workflows through inside or outside room booking panels.

[Bookings AdhocBooking Enabled](#)

[UserInterface RoomScheduler Mode](#)

[Bookings Book](#)

Board

BoardPro,
BoardPro
G2

Codec EQ

Codec
PlusCodec
ProDesk,
DeskPro,
DeskMiniRoom Bar
Pro,
Room BarRoom Kit,
Room Kit
MiniRoom Kit
EQX

Room 55

Room 55
Dual,
Room 70Room 70
G2Room 70
PanoramaRoom
Panorama

D15503.06

RoomOS
11.24

02-2025



What's new (page 6 of 9)

Configuration changes in RoomOS 11.20

New Configurations

- Audio Input Ethernet [1] Channel [1..4] Level *(Room Bar)*
- Audio Input Ethernet [1] Channel [1..4] Mode *(Room Bar)*
- Audio Input Ethernet [1] Channel [1..4] Pan *(Room Bar)*
- Audio Input Ethernet [1] Channel [1..4] Zone *(Room Bar)*
- Audio Input Ethernet [1] EchoControl Mode *(Room Bar)*
- Audio Input Ethernet [1] EchoControl NoiseReduction *(Room Bar)*
- Audio Input Ethernet [1] Equalizer ID *(Room Bar)*
- Audio Input Ethernet [1] Equalizer Mode *(Room Bar)*
- Audio Input Ethernet [1] Mode *(Room Bar)*
- Bookings AdhocBooking BookAhead Enabled *(All products)*
- Cameras Camera [1..7] Standby Mode *(Codec EQ, Codec Plus, Codec Pro, Room 55 Dual, Room 70, Room 70 G2, Room Kit EQX, Room Panorama, Room 70 Panorama)*
- Conference Diagnostics DegradedQualityNotifications *(All products)*
- Files EndSessionAction *(All products)*
- MicrosoftTeams CVI CrossTenant *(All products)*
- NetworkServices PTP Priority *(Board Pro G2, Codec EQ, Room Bar Pro, Room Kit EQX)*
- NetworkServices SMTP From *(Room Kit EQX)*
- NetworkServices SMTP Mode *(Room Kit EQX)*
- NetworkServices SMTP Password *(Room Kit EQX)*
- NetworkServices SMTP Port *(Room Kit EQX)*
- NetworkServices SMTP Security *(Room Kit EQX)*
- NetworkServices SMTP Server *(Room Kit EQX)*
- NetworkServices SMTP Username *(Room Kit EQX)*
- Standby Signage InteractionMode *(Room Kit EQX)*
- UserInterface Bookings Visibility FullDayCalendar *(All products)*
- UserInterface Bookings Visibility Personal FullDayCalendar *(All products)*

UserInterface DevicePersonalization QRCodeNotification *(Board, Board Pro, Board Pro G2 55, Board Pro G2 75)*

UserInterface Features Files Start *(Room Kit EQX)*

UserInterface Features Share MTRShareExperience *(All products)*

UserInterface Features Whiteboard Start *(Room Kit EQX)*

UserInterface LedControl OutsideOfficeHours *(All products)*

UserInterface LiveAnnotation AvailabilityForPresenter *(All products)*

UserInterface LiveAnnotation EnabledOutOfCall *(All products)*

UserInterface RoomScheduler Mode *(All products)*

UserInterface RoomScheduler OverlayOpacity *(All products)*

Video Output Connector [1] MonitorRole *(Board Pro G2, Board Pro, Desk Pro)*

Video Output TouchInput Mode *(Codec EQ, Codec Pro, Room Bar, Room Kit EQX, Room Kit Mini)*

WebEngine Features LocalWebAppManagement *(Room Kit EQX)*

Webex Privacy AllowUsageDataLogging *(Board Pro, Board Pro G2, Codec EQ, Codec Pro, Desk Pro, Room 70 G2, Room Bar, Room Bar Pro, Room Kit EQX)*

WebRTC Provider MicrosoftTeams DeviceIdentifier *(All products)*

Zoom EnhancedCallControls *(All products)*

Configurations that are removed

RTP MaxPacketSize *(All products)*

Video Output Connector [1..2] TouchInput Mode *(Room Bar)*

Video Output Connector [1..3] TouchInput Mode *(Codec EQ)*

Video Output Connector [1] TouchInput Mode *(Codec Pro, Room Kit Mini)*

Video Output Connector [2] TouchInput Mode *(Codec Pro)*

Video Output Connector [3] TouchInput Mode *(Codec Pro)*

Webex ProvisionalActivationService *(Room Panorama, Room 70 Panorama)*

- Board
- BoardPro, BoardPro G2
- Codec EQ
- Codec Plus
- Codec Pro
- Desk, DeskPro, DeskMini
- Room Bar Pro, Room Bar
- Room Kit, Room Kit Mini
- Room Kit EQX
- Room 55
- Room 55 Dual, Room 70
- Room 70 G2
- Room 70 Panorama
- Room Panorama

What's new (page 7 of 9)

Configurations that are modified

Audio Input Microphone [1] Mode *(Desk Mini, Desk Pro, Cisco Desk)*

OLD: Include_For_Extension:
NEW: Include_For_Extension: mtr

Audio Microphones NearTalkerSector Mode *(Room Bar Pro, Board Pro, Board Pro G2 55, Board Pro G2 75)*

OLD: Include_For_Extension:
NEW: Include_For_Extension: mtr

Audio Microphones VoiceActivityDetector Mode *(All products)*

OLD: Include_For_Extension:
NEW: Include_For_Extension: mtr

Audio Output InternalSpeaker Mode *(Desk Mini, Desk Pro, Cisco Desk)*

OLD: Include_For_Extension:
NEW: Include_For_Extension: mtr

Audio USB VolumeControl Capture Mode *(All products)*

OLD: Include_For_Extension:
NEW: Include_For_Extension: mtr

Audio USB VolumeControl Capture Value *(All products)*

OLD: Include_For_Extension:
NEW: Include_For_Extension: mtr

Audio USB VolumeControl Playback Mode *(All products)*

OLD: Include_For_Extension:
NEW: Include_For_Extension: mtr

Audio USB VolumeControl Playback Value *(All products)*

OLD: Include_For_Extension:
NEW: Include_For_Extension: mtr

Cameras SpeakerTrack MeetingZone Area *(All products)*

OLD: Include_For_Extension:
NEW: Include_For_Extension: mtr

Cameras SpeakerTrack MeetingZone Mode *(All products)*

OLD: Include_For_Extension:
NEW: Include_For_Extension: mtr

Cameras SpeakerTrack ZoomRange MaxZoomFactor *(All products)*

OLD: Include_For_Extension:
NEW: Include_For_Extension: mtr

Conference Diagnostics StreamStatusOverlay *(All products)*

OLD: Include_For_Extension:
NEW: Include_For_Extension: mtr

Conference EndToEndEncryption Identity PreferredDomain *(All products)*

OLD: Include_For_Extension:
NEW: Include_For_Extension: mtr

Conference EndToEndEncryption Mode *(All products)*

OLD: Include_For_Extension:
NEW: Include_For_Extension: mtr

Conference Webex CallProtocolIPStack *(All products)*

OLD: Default: Auto
NEW: Default: PreferIpv4
OLD: Auto/Dual/IPv4/IPv6
NEW: PreferIpv4/PreferIpv6

NetworkServices HTTPS Server MinimumTLSVersion *(All products)*

OLD: Default: TLSv1.1
NEW: Default: TLSv1.2

NetworkServices Wifi Settings A_MPDU *(All products)*

OLD: Include_For_Extension:
NEW: Include_For_Extension: mtr

RTP Audio Ports Range Webex Start *(All products)*

OLD: Include_For_Extension:
NEW: Include_For_Extension: mtr

RTP Audio Ports Range Webex Stop *(All products)*

OLD: Include_For_Extension:
NEW: Include_For_Extension: mtr

RTP Ports Range Start *(All products)*

OLD: Include_For_Extension:
NEW: Include_For_Extension: mtr

Board

BoardPro,
BoardPro
G2

Codec EQ

Codec
PlusCodec
ProDesk,
DeskPro,
DeskMiniRoom Bar
Pro,
Room BarRoom Kit,
Room Kit
MiniRoom Kit
EQX

Room 55

Room 55
Dual,
Room 70Room 70
G2Room 70
PanoramaRoom
Panorama

What's new (page 8 of 9)

RTP Ports Range Stop (All products)

OLD: Include_For_Extension:

NEW: Include_For_Extension: mtr

RTP Video Ports Range Start (All products)

OLD: Include_For_Extension:

NEW: Include_For_Extension: mtr

RTP Video Ports Range Stop (All products)

OLD: Include_For_Extension:

NEW: Include_For_Extension: mtr

RTP Video Ports Range Webex Start (All products)

OLD: Include_For_Extension:

NEW: Include_For_Extension: mtr

RTP Video Ports Range Webex Stop (All products)

OLD: Include_For_Extension:

NEW: Include_For_Extension: mtr

SIP MinimumTLSVersion (All products)

OLD: Default: TLSv1.0

NEW: Default: TLSv1.2

UserInterface Accessibility IncomingCallNotification (All products)

OLD: Include_For_Extension:

NEW: Include_For_Extension: mtr

UserInterface Features Call JoinWebex (All products)

OLD: Include_For_Extension:

NEW: Include_For_Extension: mtr

UserInterface Features Call JoinZoom (All products)

OLD: Include_For_Extension:

NEW: Include_For_Extension: mtr

UserInterface Features Call Start (All products)

OLD: Include_For_Extension:

NEW: Include_For_Extension: mtr

UserInterface LiveAnnotation Enabled (Board Pro, Board Pro G2, Desk Pro)

OLD: Default: False

NEW: Default: True

UserInterface RoomScheduler DevicePersonalization QRCodePairing (All products)

OLD: Default: Off

NEW: Default: On

UserInterface Whiteboard DefaultTheme (All products)

OLD: Include_For_Extension:

NEW: Include_For_Extension: mtr

Video DefaultMainSource (All products)

OLD: User role: Admin, User

NEW: User role: Admin, Integrator, User

Video Output Connector [2] HDCPPolicy (Board Pro G2 55, Board Pro G2 75)

OLD: Default: Off

NEW: Default: On

OLD: Off

NEW: On

Video Output Connector [2] Location HorizontalOffset (Board Pro G2 55, Board Pro G2 75)

OLD: Default: 0

NEW: Default: -1

Video Output Connector [3] Location HorizontalOffset (Board Pro G2 55, Board Pro G2 75)

OLD: Default: 1

NEW: Default: 0

WebEngine MinimumTLSVersion (All products)

OLD: Default: TLSv1.1

NEW: Default: TLSv1.2

Webex CloudUpgrades Mode (All products)

OLD: Include_For_Extension:

NEW: Include_For_Extension: mtr

Webex Meetings JoinProtocol (All products)

OLD: Include_For_Extension:

NEW: Include_For_Extension: mtr

Webex Meetings MeetingChatNotifications Mode (All products)

OLD: Include_For_Extension:

NEW: Include_For_Extension: mtr

D15503.06

RoomOS
11.24

02-2025



Board

What's new (page 9 of 9)

Board Pro,
Board Pro
G2

Webex Meetings MeetingChatPreview *(All products)*

OLD: Include_For_Extension:

NEW: Include_For_Extension: mtr

Codec EQ

Webex ProvisionalActivationService *(Board Pro, Board Pro G2, Codec EQ, Codec Pro, Desk Pro, Room 70 G2, Room Bar, Room Bar Pro, Room Kit EQX)*

OLD: Include_For_Extension:

NEW: Include_For_Extension: mtr

Codec
Plus

Codec
Pro

Desk,
Desk Pro,
Desk Mini

Room Bar
Pro,
Room Bar

Room Kit,
Room Kit
Mini

Room Kit
EQX

Room 55

Room 55
Dual,
Room 70

Room 70
G2

Room 70
Panorama

Room
Panorama

Board

BoardPro,
BoardPro
G2

Codec EQ

Codec
PlusCodec
ProDesk,
DeskPro,
DeskMiniRoom Bar
Pro,
Room BarRoom Kit,
Room Kit
MiniRoom Kit
EQX

Room 55

Room 55
Dual,
Room 70Room 70
G2Room 70
PanoramaRoom
Panorama

Product features at a glance

Combining an unmatched video and audio experience with sophisticated design, every device in the Cisco Webex Room, Desk and Board portfolio creates a powerful collaboration solution. Rich in functionality and easily scalable, there is a Webex device for every room – from huddle spaces to boardrooms – and for personal desktops, too.

Some of the features you can expect across the Cisco Webex device portfolio include:

- Smart meetings: camera best overview, automatic framing and speaker tracking, noise reduction, join meetings easily with OBTP, Wi-Fi support, easy control with a touch controller or the Webex app.
- Smart presentations: single, dual or triple screens, wired or wireless 4k content-sharing, support for dual content sources.
- Smart rooms: automatic wakeup, people count, environmental and peripheral controls.
- Flexible registration: built for both cloud and on-premises deployment. And, you can use *Webex Edge for Devices* to link your on-premises registered devices to the Webex cloud service, and gain access to select cloud features.

The following pages contain additional details about each product, including information about features that vary from device to device.

Board

Board Pro,
Board Pro
G2

Codec EQ

Codec Plus

Codec Pro

Desk,
Desk Pro,
Desk Mini

Room Bar
Pro,
Room Bar

Room Kit,
Room Kit
Mini

Room Kit
EQX

Room 55

Room
55 Dual,
Room 70

Room 70
G2

Room 70
Panorama

Room
Panorama

Room Series at a glance (page 1 of 4)

Room Bar, Room Bar Pro

Cisco Room Bar is a compact yet powerful video collaboration device. It combines a wide (120-degree) field-of-view camera, noise cancelling microphones, dual stereo speakers, and a codec in a single device. It's designed for huddle spaces and small meeting rooms (up to 5 people within 3 meter from the device). In slightly larger mid-sized rooms, you can add an external microphone to ensure the best audio experience.

The larger and more powerful Cisco Room Bar Pro combines a dual camera (112-degree field-of-view lens and a tele-lens working seamlessly together), a three-channel loudspeaker system, a built-in microphone array, and a powerful codec with rich connectivity options. You can connect up to three screens, and choose between analog and digital external microphones to get the best audio experience in larger mid-sized rooms.

Both devices integrate well with flat panel screens through HDMI CEC, and are easy to mount, either on walls or screens.



Room Bar mounted on top of a flat-panel display



Room Bar Pro mounted on top of a flat-panel display

Room Kit, Room Kit Mini

Cisco Room Kit includes camera, codec, speakers, and microphones combined in a single device. Easy to mount, it integrates well with flat panel screens through HDMI CEC. Room Kit is designed for meeting rooms with up to seven people.

On a slightly smaller scale, Cisco Room Kit Mini includes the same equipment and is well-suited to huddle spaces with two to five people, because of its wide 120-degree field of view. When connected to a computer, Room Kit Mini can be used as a USB camera. Room Kit Mini is also available in a bundle with Samsung Flip, thus combining the Room Kit Mini's video conferencing capabilities with the Samsung Flip's whiteboarding and content functions.



Room Kit mounted on top of a flat-panel display

Codec EQ, Codec Plus, Codec Pro

The Cisco codecs are powerful collaboration solutions that integrates well with external displays through HDMI and CEC. Cisco offers Room Kit bundles combining a codec with the Cisco Quad Camera, Precision 60 camera¹, PTZ 4K camera, or PTZ-12 camera², and a Cisco touch controller user interface.

Cisco Codec EQ integrates with up to three screens, 3 analog or 8 digital directional microphones. Just like Codec Pro, it works well for large conference rooms, boardrooms, training rooms, and auditoriums. With the AV integrator package (option key), the full integrator audio API is unlocked.

Cisco Codec Pro integrates with up to three screens, 8 analog or 4 digital directional microphones. It works well also for large conference rooms, boardrooms, training rooms, and auditoriums. The codec is built with AV integrators in mind.

Cisco Codec Plus integrates with up to two displays and 3 analog microphones. It works well for medium to large-sized meeting rooms.



¹ Only Codec Pro and Codec Plus.

² Only Codec Plus.

- Board
- BoardPro, BoardPro G2
- Codec EQ
- Codec Plus
- Codec Pro
- Desk, Desk Pro, DeskMini
- Room Bar Pro, Room Bar
- Room Kit
- Room Kit Mini
- Room 55**
- Room 55 Dual, Room 70**
- Room 70 G2**
- Room 70 Panorama
- Room Panorama

Room Series at a glance (page 2 of 4)

Room 55

Cisco Room 55 includes camera, codec, screen, speakers, and microphones - all integrated in a single device. You can choose to mount the single 55" screen on a floor stand, wheeled base, or on the wall. Perfectly designed for small to medium-sized meeting rooms, Room 55 transforms your work spaces into video collaboration hubs.



Room 55 on a floor stand

Room 70 G2, Room 70, Room 55 Dual

Cisco Room 70 G2 is based on the Codec Pro and comprises a quad-camera, and 70" LED single or dual 4K screen(s) with integrated speakers and microphones*. The single screen setup delivers a people-focused experience, while dual screens create compelling people- and people/content-focused experiences.

With similar functionality, Cisco Room 70 is based on the Codec Plus.

Easily scalable, and offering speaker-tracking and auto-framing capabilities, Room 70/G2 Single or Dual is an ideal all-in-one solution for large meeting rooms seating up to 14 people.

Like the Room 70 Dual only with smaller screens, Cisco Room 55 Dual is based on the Codec Plus, and includes a quad camera, and two 55" 4K screens with integrated speakers and microphones*. Room 55 Dual is best suited to medium or large rooms for up to 12 people.

There are three mounting kit options for each of these products: a free-standing floor stand, a wall-secured floor stand, and a wall mount kit.



Room 70 Single G2 / Room 70 Single on a floor stand



Room 70 Dual G2 / Room 70 Dual on a floor stand

* Integrated microphones for speaker tracking only.

Board

BoardPro,
BoardPro
G2

Codec EQ

Codec
Plus

Codec
Pro

Desk,
Desk Pro,
DeskMini

Room Bar
Pro,
Room Bar

Room Kit,
Room Kit
Mini

Room Kit
EQX

Room 55

Room
55 Dual,
Room 70

Room 70
G2

Room 70
Panorama

Room
Panorama

Room Series at a glance (page 3 of 4)

Room Kit EQX

The Cisco Room Kit EQX is an all-in-one bundle with the Codec EQ and the Quad Camera as core. It gives the flexibility to bring your own external screens and integrate them with the purpose-built kit of room conferencing hardware components.

You can choose between three mounting options: wallmount, wall-stand, and a freestanding floor-stand.

The device supports advanced multi-camera scenarios, and offers speaker tracking, and intelligent presenter and audience views. Integrated microphones support the state of the art speaker tracking solution.

You must connect external microphones for audio pickup, because the integrated microphones are only for speaker tracking. You can choose between analog, USB, or AES67 compatible Ethernet (IP) microphones. You can also install a full external DSP controlled microphone solution. More than one digital microphone requires a PoE compatible switch.

The device's integrated loudspeaker system consists of six main loudspeakers and a bass loudspeaker, driven by a sixteen channel amplifier.



Wall mount



Wall stand



Floor stand

Board

BoardPro,
BoardPro
G2

Codec EQ

Codec
Plus

Codec
Pro

Desk,
Desk Pro,
DeskMini

Room Bar
Pro,
Room Bar

Room Kit

Room Kit
Mini

Room 55

Room
55 Dual,
Room 70

Room 70
G2

Room 70
Panorama

Room
Panorama

Room Series at a glance (page 4 of 4)

Room Panorama, Room 70 Panorama

Built for the modern C-suite, Cisco Room Panorama transforms large meeting spaces and brings teams from around the world, face-to-face.

An all-in-one solution with the Codec Pro and Quad Camera at its core, Room Panorama features two 82-inch 8K video screens and a 65-inch 4K screen for content presentation. The camera provides panorama video, speaker-tracking, and auto-framing capabilities. The specially made integrated loudspeaker system consists of twelve main loudspeakers and four separate bass loudspeakers, driven by a sixteen channel amplifier. You won't miss a word with an integrated microphone array for accurate speaker tracking, and support for up to eight external microphones.

Cisco Room 70 Panorama is a high-end collaboration system, easily scalable for medium to large conference rooms and spaces. Based on the Cisco Room 70 Dual G2, Room 70 Panorama includes a powerful codec, a quad-camera, two 70-inch LED screens, and a 55-inch or 65-inch 4K screen for content presentation. Integrated loudspeakers and microphones ensure accurate speaker-tracking, and the system supports up to eight external microphones. The camera offers panorama video, speaker-tracking, and auto-framing capabilities. There are three mounting kit options: a free-standing floor stand, a wall-secured floor stand, and a wall mount kit.



Room Panorama



Room 70 Panorama,
wall mounted with 65-inch content screen above



Room 70 Panorama,
floor stand with 55-inch content screen below

Board

BoardPro,
BoardPro
G2

Codec EQ

Codec
Plus

Codec
Pro

Desk,
DeskPro,
Desk Mini

Room Bar
Pro,
Room Bar

Room Kit

Room Kit
Mini

Room 55

Room
55 Dual,
Room 70

Room 70
G2

Room 70
Panorama

Room
Panorama

Desk Series at a glance

The Cisco Desk Pro, Cisco Desk, and Cisco Desk Mini devices are designed for personal desk-based collaboration, in an office or focus room that accommodates one or two people. Featuring a high resolution touchscreen, a camera* with wide angle view, and an advanced audio system, the Desk Series provides an exceptional video experience as powerful as Cisco's Room Series but designed for the desktop.

With a USB-C connection for touch-redirect, easy content sharing, and screen extension, a Desk Series device becomes your all-in-one primary monitor and collaboration device.



Desk Pro: shown from the front and side



Desk Mini

Board

BoardPro,
BoardPro
G2

Codec EQ

Codec
PlusCodec
ProDesk,
Desk Pro,
DeskMiniRoom Bar
Pro,
Room Bar

Room Kit

Room Kit
Mini

Room 55

Room
55 Dual,
Room 70Room 70
G2Room 70
PanoramaRoom
Panorama

Board Series at a glance

Cisco Board, Cisco Board Pro, and Cisco Board Pro G2 are all-in-one devices with 4K cameras, built-in microphones and speakers, and a high-resolution 4K touchscreen.

The devices combines premium visual collaboration, video conferencing, and co-creation. They help teams to collaborate in a variety of physical meeting spaces and connect with remote members by joining video meetings, digital whiteboarding, presenting and sharing content.

For Board Pro and Board Pro G2, you can choose between analog, USB, or AES67 compatible Ethernet (IP) microphones.

Board Pro and Board Pro G2

There are three mounting options available for Board Pro and Board Pro G2: floor stand, wheel base, or wall mounted.

These boards are available in two different screen sizes and is designed for small to large sized meeting spaces:

- **Board Pro 55** and **Board Pro 55 G2** with a 55" LED screen.
- **Board Pro 75** and **Board Pro 75 G2** with a 75" LED screen.

Board

There are three mounting options available for Board: floor stand, wall stand, or wall mounted.

Board is available in three different screen sizes:

- **Board 55** and **55S** with a 55" LED screen. Designed for huddle spaces for up to five people.
- **Board 70** and **70S** with a 70" LED screen. Designed for meeting rooms for up to eight people.
- **Board 85S** with a 85" LED screen. Designed for larger collaboration spaces such as auditoriums, training spaces, and classrooms.

The second generation of Board is referred to as the *S Series*, representing some minor optimizations to the hardware platform.



Board Pro on a wheel base



Board Pro on a floor stand



Board Pro, wall mounted

Board

BoardPro,
BoardPro
G2

Codec EQ

Codec
Plus

Codec
Pro

Desk,
DeskPro,
DeskMini

Room Bar
Pro,
Room Bar

Room Kit,
Room Kit
Mini

Room Kit
EQX

Room 55

Room 55
Dual,
Room 70

Room 70
G2

Room 70
Panorama

Room
Panorama

How to administer the video conferencing device (page 1 of 5)

In general, we recommend you to use the device web interface to administer and maintain the device, as described in this administrator guide.

Alternatively, you can access the API of the device by other methods:

- HTTP/HTTPS (also used by the device web interface)
- WebSocket
- SSH
- Serial connection

If you want more information about the different access methods, and how to use the API, refer to the *API guide* for the device.

Tip

If the configuration or status is available in the API, the web interface setting or status translates into an API configuration or status as follows:

Set *X > Y > Z* to *Value* (web)
is the same as
`xConfiguration X Y Z: Value` (API)

Check *X > Y > Z* status (web)
is the same as
`xStatus X Y Z` (API)

For example:

Set *SystemUnit > Name* to *MySystem*
is the same as
`xConfiguration SystemUnit Name: MySystem`

Check *SystemUnit > Software > Version* status
is the same as
`xStatus SystemUnit Software Version`

More settings and statuses are available in the device web interface than in the API.

Access method	Notes	How to enable/disable the methods
HTTP/HTTPS	<ul style="list-style-type: none"> • Used by the device web interface • Non-secure (HTTP) or secure (HTTPS) communication • HTTPS: <i>Enabled</i> by default • HTTP: <i>Enabled</i> by default only for devices that have been upgraded to CE9.4 (or later) from an earlier software version, provided that the device has not been factory reset after the upgrade 	<p>NetworkServices > HTTP > Mode</p> <p>Restart the device for changes to take effect</p>
WebSocket	<ul style="list-style-type: none"> • Tied to HTTP, so that also HTTP or HTTPS must be enabled before you can use WebSocket • Encrypted (wss) or unencrypted (ws) communication • <i>Disabled</i> by default 	<p>NetworkServices > HTTP > Mode</p> <p>NetworkServices > WebSocket</p> <p>Restart the device for changes to take effect</p>
SSH	<ul style="list-style-type: none"> • Secure TCP/IP connection • <i>Enabled</i> by default 	<p>NetworkServices > SSH > Mode</p> <p>You do not need to restart the device. It may take some time for changes to take effect</p>
Serial connection	<ul style="list-style-type: none"> • Connect to the device with a cable. IP-address, DNS, or a network is not required • <i>Enabled</i> by default • We recommend using the default baud rate, because the device may return much feedback (SerialPort > BaudRate) • For security reasons, you are asked to sign in by default (SerialPort > LoginRequired)* 	<p>SerialPort > Mode</p> <p>Restart the device for changes to take effect</p>

* *For Board:* The *SerialPort > LoginRequired* setting is on only available on Board 55S, 70S, and 85S. You always have to sign in on Board 55 and 70.



If all access methods are disabled (set to **Off**), you can no longer configure the device. You are not able to re-enable (set to **On**) any of the access methods, and you must factory reset the device to recover.

- Board
- BoardPro, BoardPro G2
- Codec EQ
- Codec Plus
- Codec Pro
- Desk, DeskPro, Desk Mini
- Room Bar Pro, Room Bar
- Room Kit, Room Kit Mini
- Room Kit EQX
- Room 55
- Room 55 Dual, Room 70
- Room 70 G2
- Room 70 Panorama
- Room Panorama

How to administer the video conferencing device (page 2 of 5)

The device web interface

The device web interface is the administration portal for the device. You can connect from a computer and administer the device remotely. It provides full configuration access and offers tools and mechanisms for maintenance.

Note: The device web interface requires that HTTP or HTTPS is enabled (refer to the [NetworkServices > HTTP > Mode](#) setting).

We recommend that you use the latest release of one of the major web browsers. *

Connect to the device

Open a web browser and enter the IP address of the device in the address bar.

How to find the IP address

1. Swipe in from the right or tap the controls icon  in the upper, right corner to open the control panel. Then select [Device settings](#).
2. Select [About this room device](#).

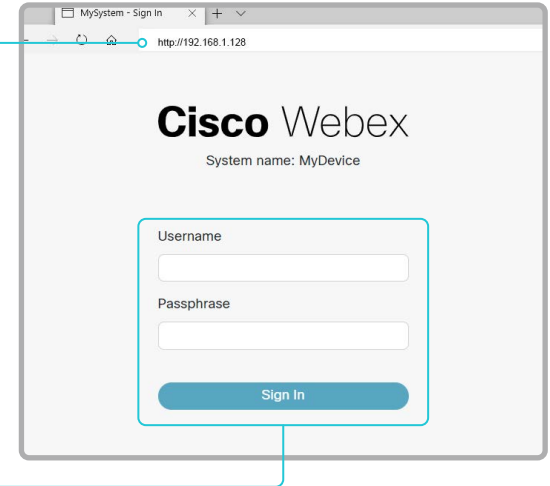

Sign in

Enter user name and passphrase for the device and click [Sign In](#).

 The device is delivered with a default user named *admin* with no passphrase. Leave the *Passphrase* field blank if a passphrase is not set yet.

It is mandatory to set a password for the *admin* user.

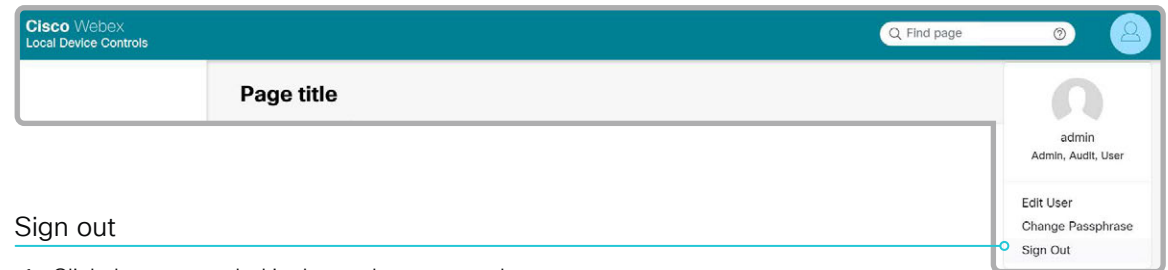

Sign out

1. Click the user symbol in the top bar to open the menu.
2. Click [Sign Out](#).

* Internet Explorer is not supported..

Board

BoardPro,
BoardPro
G2

Codec EQ

Codec
Plus

Codec
Pro

Desk,
Desk Pro,
Desk Mini

Room Bar
Pro,
Room Bar

Room Kit,
Room Kit
Mini

Room Kit
EQX

Room 55

Room 55
Dual,
Room 70

Room 70
G2

Room 70
Panorama

Room
Panorama

How to administer the video conferencing device (page 3 of 5)

How the device web interface is organized

Select pages or topics from the menu at the left side. There is a search field in the top bar to help you find the page you are searching for.

Which pages are present depends on:

- Device type and service registration (Webex, Cisco UCM, VCS, Webex Edge for Devices)
- Connected peripherals and setup
- Roles and access rights of the user that is signed in

This means that some of the menu entries shown in the illustration below may not be present on your device.

Read more about user administration, user roles and access rights in the [User administration](#) chapter.

Device name and type

Main menu

Click an item to open a page.

Cards

The information on a page, tab, or sub-tab, may be further grouped in cards.

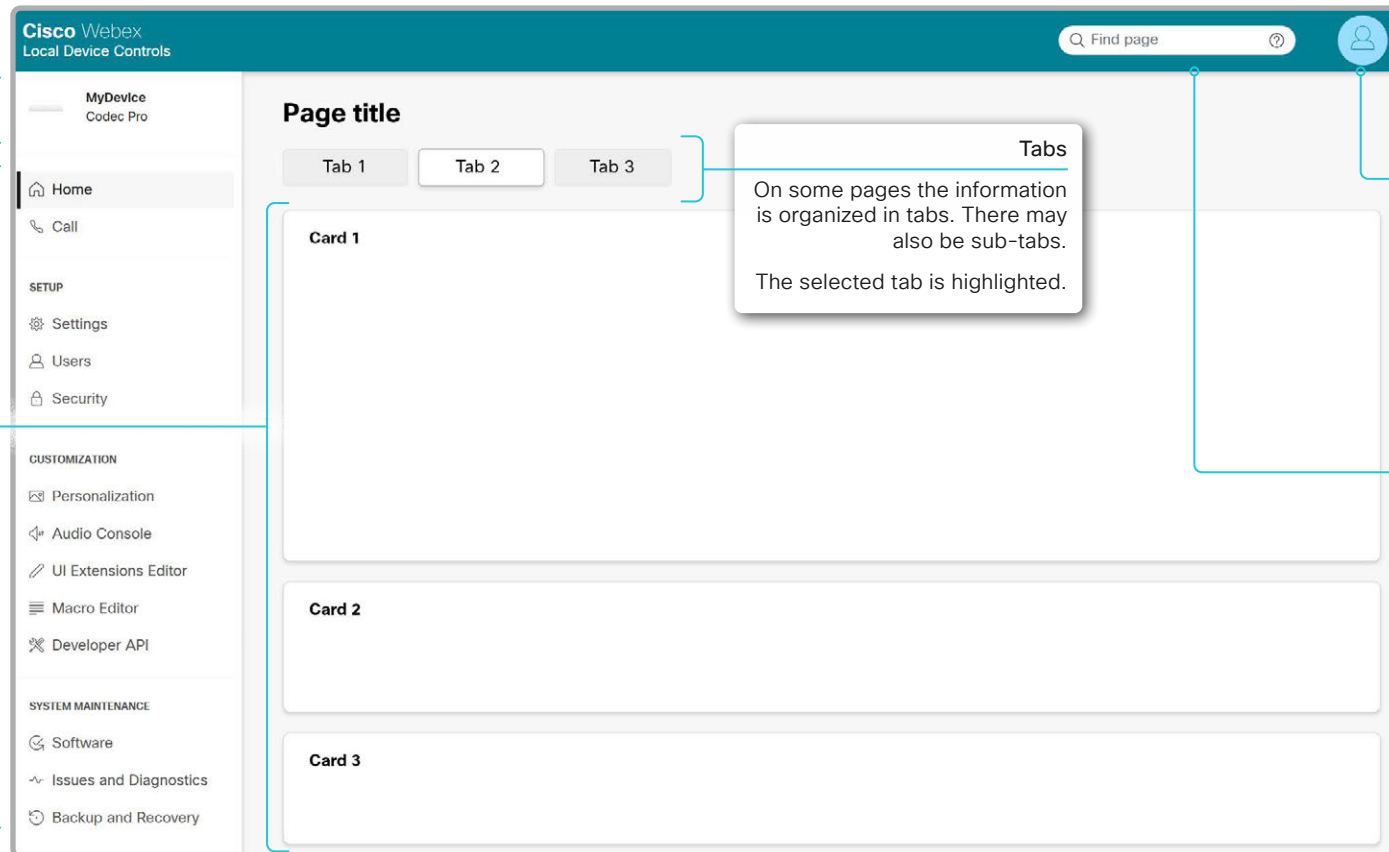

The user menu

Click the symbol to show who is signed in. You can also edit the user settings, change your password, and sign out.

Search field

Use this field to search for a page. Suggestions for relevant pages appear when you start typing. When you click on one of them, the corresponding page opens.

How to administer the video conferencing device (page 4 of 5)

The main menu of the device web interface

- Board
- BoardPro, BoardPro G2
- Codec EQ
- Codec Plus
- Codec Pro
- Desk, DeskPro, DeskMini
- Room Bar Pro, Room Bar
- Room Kit, Room Kit Mini
- Room Kit EQX
- Room 55
- Room 55 Dual, Room 70
- Room 70 G2
- Room 70 Panorama
- Room Panorama

Opens a page where you can set up a call from the device. You can change the camera position, mute the microphones, adjust the volume, change layouts, and check the call details.

Opens a page where you can add, edit, or delete users, or change a users passphrase. You can also create a remote support user from this page.

Opens a page where you can upload and view certificates that are required to communicate with different services and backends. You can also create a sign-in banner, and choose which system components to reset automatically when restarting the device.

Opens the UI Extensions Editor, which allows you to create custom UI panels and action buttons.

Opens a page where you can view the device's XML files, and execute commands and configurations.

Opens a page where you can look at active diagnostics messages, download logs, and create screenshots of the user interface and on-screen messages and indicators.

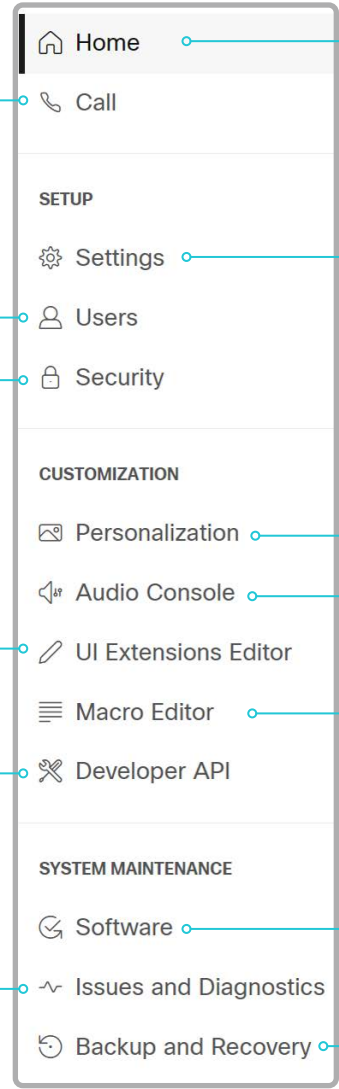

Lists general information such as IP address, MAC address, serial number, active network interface, software version, SIP address, issues, registration status, utilization and environment data, and more.

Opens a page with access to:

- Device configurations and statuses.
- Predefined room type templates. *(Only for Codec EQ, Codec Plus, Codec Pro, Room Kit EQX, Room 55 Dual, Room 70, and Room 70 G2)*
- Details about cameras, screens, microphones, and other inputs, outputs, and peripherals.
- Setting up and enabling presenter tracking if you have a camera that supports the feature. *(Only for Board Pro, Board Pro G2, Codec EQ, Codec Plus, Codec Pro, Room Kit EQX, Room 55 Dual, Room 70, and Room 70 G2)*
- Setting up an SMTP server so that you can send whiteboards and annotations via email. *(Only for Desk, Desk Mini, Desk Pro, Board, Board Pro, Board Pro G2, and Room Kit Mini with Samsung Flip)*

Opens a page where you can personalize the device by adding branding elements or other background images, selecting a ringtone, and creating a local contacts list (favorites).

Opens the Audio Console, which provides a graphical interface that allows advanced customization of audio features. *(Only for Codec EQ with AVIntegrator option, Codec Pro, Room Kit EQX with AVIntegrator option, Room 70 G2, Room Panorama, and Room 70 Panorama)*

Opens the Macro Editor, which allows you to create snippets of code (macros) that automates or customizes the behavior of your device.

Opens a page where you can install new software* and option keys. You can also change the product key; only change the product key if you are directed to do so by a Cisco technical support representative.

Opens a page where you can backup and restore information on your device, such as branding elements, favorites list, UI extensions, macros, the sign in banner, and configurations. You can also swap to the previous software image, factory reset, restart, or shut down the device.

* Not available for cloud registered devices.

Board

BoardPro,
BoardPro
G2

Codec EQ

Codec
PlusCodec
ProDesk,
DeskPro,
DeskMiniRoom Bar
Pro,
Room BarRoom Kit,
Room Kit
MiniRoom Kit
EQX

Room 55

Room 55
Dual,
Room 70Room 70
G2Room 70
PanoramaRoom
Panorama

How to administer the video conferencing device (page 5 of 5)

Settings and device information on the user interface

You have access to device information, and some basic configurations and device tests on the device's user interface.

Device-critical settings and functions, such as network settings, service activation, and factory reset, may be protected by a passphrase, refer to the [Restrict the access to the Settings menu](#) chapter.

Some of the settings and tests are also part of the *Setup assistant* that is launched when the device is powered up for the first time.

Access Settings

1. Swipe in from the right or tap the controls icon  in the upper, right corner to open the control panel. Then select *Device settings*.

A padlock symbol  indicates that a setting is protected (locked down).

2. Select the setting you want to change, or the test you want to run.

If a setting is locked down, an authentication window pops up, and you have to sign in with ADMIN credentials to proceed. If the device is registered to the Webex cloud, the settings must be unlocked from Control Hub.

For Board, Board Pro, and Board Pro G2

If you have connected a touch controller to the board, the two devices operate independently in this context. If you unlock the settings by signing in on one of them, it has no effect on the other.

Board

BoardPro,
BoardPro
G2

Codec EQ

Codec
PlusCodec
ProDesk,
DeskPro,
DeskMiniRoom Bar
Pro,
Room BarRoom Kit,
Room Kit
MiniRoom Kit
EQX

Room 55

Room 55
Dual,
Room 70Room 70
G2Room 70
PanoramaRoom
Panorama

Touch controllers

Controlling a video conferencing device

Touch controllers are Cisco interface units that are used to control the video conferencing devices.

At present there are three such interface units available, all referred to interchangeably as 'touch controllers':

- Cisco Room Navigator
- Cisco Touch 10
- Cisco TelePresence Touch 10

Touch controllers provide instant access to meetings, content, contacts, directories, and more. You can customize the user interface with custom buttons and panels, as described in the Customization Guide. The Room Navigator also offers environmental sensors for monitoring things like air quality and temperature.

Touch controllers can be connected directly to a device, or remotely paired to the device via the network (LAN).

See the [Connect the touch controller](#) chapter about how to connect a touch controller to the video conferencing device.

Video conferencing device compatibility

Room Navigator is supported by:

- Codec EQ, Codec Plus, and Codec Pro
- Room Series
- Board 55S, 70S, 85S
- Board Pro and Board Pro G2

Touch 10 and TelePresence Touch 10 are supported by:

- Codec Plus and Codec Pro
- Room Kit, Room Kit Mini, Room 55, Room 55 Dual, Room 70, Room 70 G2, Room 70 Panorama, and Room Panorama
- Board 55S, 70S, and 85S
- Board 55 and 70

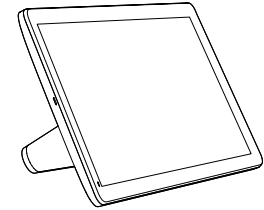

Cisco Room Navigator
(launched early 2021)

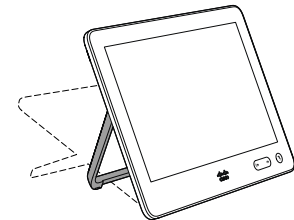

Cisco Touch 10
(second version, launched late 2017)

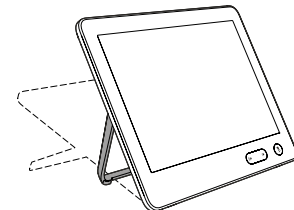

Cisco TelePresence Touch 10
(first version)

Board

BoardPro,
BoardPro
G2

Codec EQ

Codec
Plus

Codec
Pro

Desk,
Desk Pro,
Desk Mini

Room Bar
Pro,
Room Bar

Room Kit,
Room Kit
Mini

Room Kit
EQX

Room 55

Room 55
Dual,
Room 70

Room 70
G2

Room 70
Panorama

Room
Panorama

Chapter 2

Configuration

Board

BoardPro,
BoardPro
G2

Codec EQ

Codec
PlusCodec
ProDesk,
DeskPro,
DeskMiniRoom Bar
Pro,
Room BarRoom Kit,
Room Kit
MiniRoom Kit
EQX

Room 55

Room 55
Dual,
Room 70Room 70
G2Room 70
PanoramaRoom
Panorama

User administration

You must sign in to the device with a local user, for example to access the device web interface or command line interfaces. You can assign different roles to users, to determine what they should have access to.

The default user account

The device comes with a default administrator user account with full access rights. The user name is *admin*, and initially, no passphrase is set.



It is mandatory to set a passphrase for the *admin* user.

On a new or factory reset device, the calling functionality is disabled until you set a passphrase.

Read how to set the passphrase in the [Change the device passphrase](#) chapter.

Create a new user account

1. Sign in to the device web interface and go to [Users](#).
2. Click [Create User](#).
3. Fill in the *Username*, *New passphrase* and *Confirm passphrase* input fields.

As a default, users have to change the passphrase when they sign in for the first time.

Fill in the *Client Certificate DN* (Distinguished Name) field only if you use client certificates for authentication.

4. Check the appropriate *Roles* check boxes.
If you assign the ADMIN role to a user, enter your own passphrase in the *Your passphrase* input field for verification.
5. Set the *Status* to **Active** to activate the user.
6. Click [Create User](#).
Use the [Back](#) button to leave without making any changes.

Edit an existing user account

If you make changes to a user that holds the Admin role, you must always enter your own passphrase in the *Your passphrase* input field for verification.

Change the user privileges

1. Sign in to the device web interface and go to [Users](#).
2. Click the appropriate user in the list.
3. Choose user roles, set the status to **Active** or **Inactive**, and decide if the user has to change the passphrase on the next sign in.

Fill in the *Client Certificate DN* (Distinguished Name) field only if you use certificate login on HTTPS.

4. Click [Save User](#).
Use the [Back](#) button to leave without making any changes.

Change the passphrase

1. Sign in to the device web interface and go to [Users](#).
2. Click the appropriate user in the list.
3. Find the *Passphrase* card and enter the new passphrase in the appropriate input fields.
4. Click [Set New Passphrase](#) to save the change.
Use the [Back](#) button to leave without making any changes.

Delete the user account

1. Sign in to the device web interface and go to [Users](#).
2. Click the appropriate user in the list.
3. Find the *Delete* card, click [Delete User](#) and confirm when prompted.

User roles

A user account may hold one or a combination of *user roles*. A user account with full access rights, like the default *admin* user, should possess the ADMIN, USER and AUDIT roles.

These are the *user roles*:

ADMIN: A user with this role can create new users, change most settings, make calls, and search the contact lists. The user cannot upload audit certificates and change the security audit settings.

USER: A user with this role can make calls and search the contact lists. The user can modify a few settings, for example adjust the ringtone volume and set the time and date format.

AUDIT: A user with this role can change the security audit settings and upload audit certificates.

ROOMCONTROL: A user with this role can create customized UI panels (for example in-room controls). The user has access to the UI Extensions editor and corresponding development tools.

INTEGRATOR: A user with this role has access to settings, commands and status that are required to set up advanced AV scenarios, and to integrate our devices with 3rd party equipment. Such a user can also create customized UI panels.

Board

BoardPro,
BoardPro
G2

Codec EQ

Codec
PlusCodec
ProDesk,
DeskPro,
DeskMiniRoom Bar
Pro,
Room BarRoom Kit,
Room Kit
MiniRoom Kit
EQX

Room 55

Room 55
Dual,
Room 70Room 70
G2Room 70
PanoramaRoom
Panorama

Change the device passphrase

You must sign in to the device with a local user, for example to access the device web interface or command line interfaces.

The default user account

The device comes with a default administrator user account with full access rights. The user name is *admin*, and initially, no passphrase is set.



It is mandatory to set a passphrase for the default *admin* user in order to restrict access to device configuration.

On a new or factory reset device, the calling functionality is disabled until you set a set a passphrase.

A security risk warning, saying that the system passphrase is not set and calling is disabled, is shown on screen until a passphrase is set for the *admin* user.

Other user accounts

You can create many user accounts for the device.

Read more about how to create and manage user accounts in the [User administration](#) chapter.

Passphrase policy

When signing in to the device as a local user, the password must follow the rules set by the [UserManagement > PasswordPolicy](#) settings. These are rules such as minimum length, minimum number of upper case and lower case letters, minimum number of digits and special characters, how long before a password expires, and how soon a password can be reused.

A new password rule will not apply to existing passwords but will take effect on the next password change.

Change your passphrase

1. Sign in to the device web interface, and click the user symbol in the top bar to open the menu.
2. Click [Change Passphrase](#).
3. Enter new and current passphrases in the appropriate input fields, and click [Set New Passphrase](#).



If the passphrase currently is not set, leave the *Current passphrase* field blank.

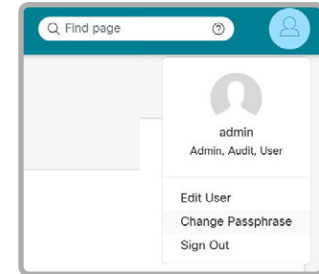

Change another user's passphrase

If you have administrator access rights, you can change the password of any user.

1. Sign in to the device web interface and go to [Users](#).
2. Click the appropriate user in the list.
3. Enter the new passphrase in the *New passphrase* and *Confirm passphrase* input fields.
If the user holds the Admin role, you must enter your own passphrase in the *Your passphrase* input field for verification.
4. Click [Set New Passphrase](#) to save the change.
Use the [Back](#) button to leave without making any changes.

- Board
- BoardPro, BoardPro G2
- Codec EQ
- Codec Plus
- Codec Pro
- Desk, DeskPro, DeskMini
- Room Bar Pro, Room Bar
- Room Kit, Room Kit Mini
- Room Kit EQX
- Room 55
- Room 55 Dual, Room 70
- Room 70 G2
- Room 70 Panorama
- Room Panorama

Restrict the access to the Settings menu

By default, any user has access to the Settings menu on the user interface.

We recommend that you restrict the access to prevent unauthorized users from changing the configuration of the device.

For Board, Board Pro, and Board Pro G2

If you are using a touch controller with the board, you have access to the Settings menu both on the board itself and on the touch controller. In this context, the board and the touch controller operate independently. If you unlock the settings by signing in on one of them, it has no effect on the other.

Lock down the Settings menu

1. Sign in to the device web interface, go to [Settings](#), and select [Configurations](#).
2. Go to [UserInterface > SettingsMenu > Mode](#), and select **Locked**.
3. Click [Save](#) for the change to take effect.

Now a user has to sign in with ADMIN credentials to get access to the device-critical settings on the user interface.

Unlock the Settings menu

1. Sign in to the device web interface, go to [Settings](#), and select [Configurations](#).
2. Go to [UserInterface > SettingsMenu > Mode](#), and select **Unlocked**.
3. Click [Save](#) for the change to take effect.

Now all users have access to the complete Settings menu on the user interface.

The Settings menu on the user interface

If the menu is locked down, you must sign in to access the device-critical settings.

- Swipe in from the right or tap the controls icon (⌵) in the upper, right corner to open the control panel. Then select [Device settings](#).

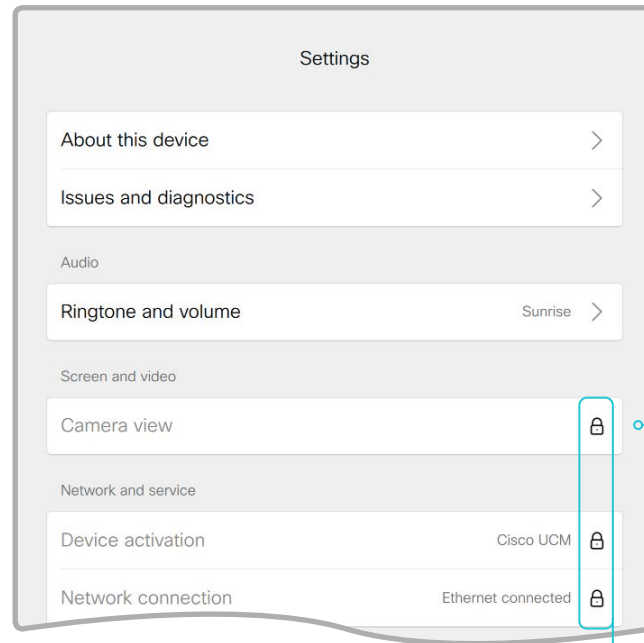

Locked down settings

Locked down settings are marked with a padlock.

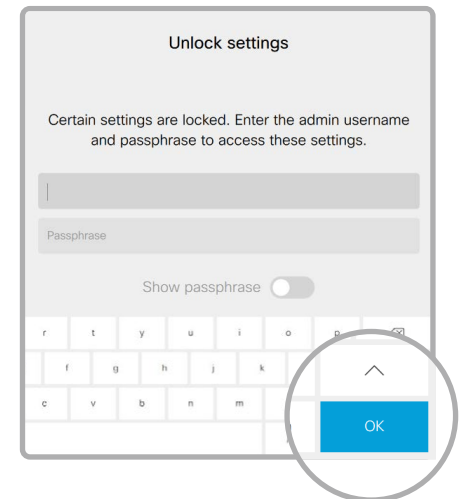

Unlock settings

If you click on the padlock, you are asked to sign in with an ADMIN user. Once signed in, you can access all settings until you close the Settings menu.

If the device is registered to the Webex cloud, the settings must be unlocked from Control Hub.

Board

BoardPro,
BoardPro
G2

Codec EQ

Codec
Plus

Codec
Pro

Desk,
Desk Pro,
Desk Mini

Room Bar
Pro,
Room Bar

Room Kit,
Room Kit
Mini

Room Kit
EQX

Room 55

Room 55
Dual,
Room 70

Room 70
G2

Room 70
Panorama

Room
Panorama

Device configuration

Sign in to the device web interface, go to [Settings](#), and select [Configurations](#).

Find a device setting

Search for settings

Enter as many letters as needed in the search field. All settings that contain these letters are shown in the right pane. Settings that have these letters in their value space are also shown.

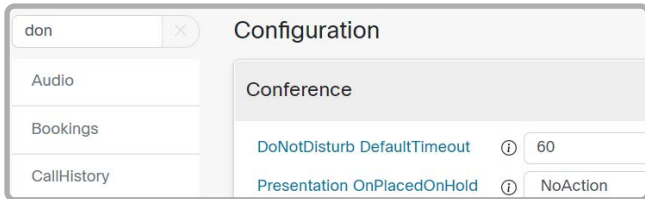

Select a category and navigate to settings

The device settings are grouped in categories. Choose a category in the left pane to show the associated settings.

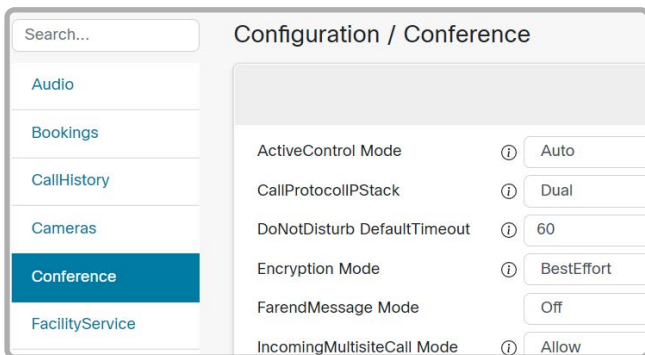

Change a device setting

Check the value space

A settings's value space is specified either by text following the input field or in a drop-down list that opens when you click the arrow.

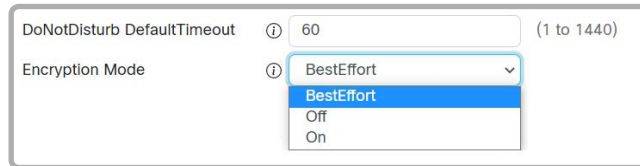

Change a value

1. Choose the preferred value from the drop-down list, or enter new text in the input field.
2. Click [Save](#) for the change to take effect.

Use the [Revert](#) buttons  if you don't want to make any changes.

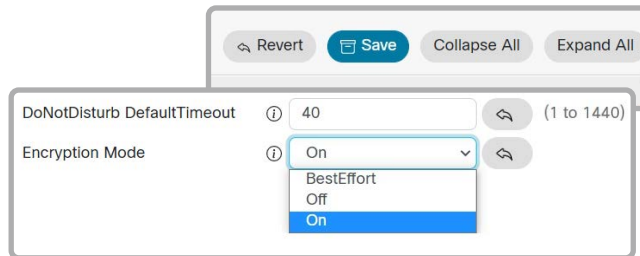

Categories with unsaved changes are marked with an edit symbol ()

About device settings

All device settings can be changed from the device web interface.

Each device setting is described in the [Device settings](#) chapter.

Different settings may require different user credentials. In order to be sure that an administrator is able to change all device settings, an administrator user must possess all user roles.

You can read more about user administration and user roles in the [User administration](#) chapter.

- Board
- BoardPro, BoardPro G2
- Codec EQ
- Codec Plus
- Codec Pro
- Desk, DeskPro, DeskMini
- Room Bar Pro, Room Bar
- Room Kit, Room Kit Mini
- Room Kit EQX
- Room 55
- Room 55 Dual, Room 70
- Room 70 G2
- Room 70 Panorama
- Room Panorama

Add a sign in banner

Sign in to the device web interface, go to *Security*, and select *Sign-in Banner*.

Add a sign in banner

1. Enter the message that you want to present to the user when he signs in.
2. Click *Save* to activate the banner.

Delete a sign in banner

- Click *Clear* to remove a sign in banner.

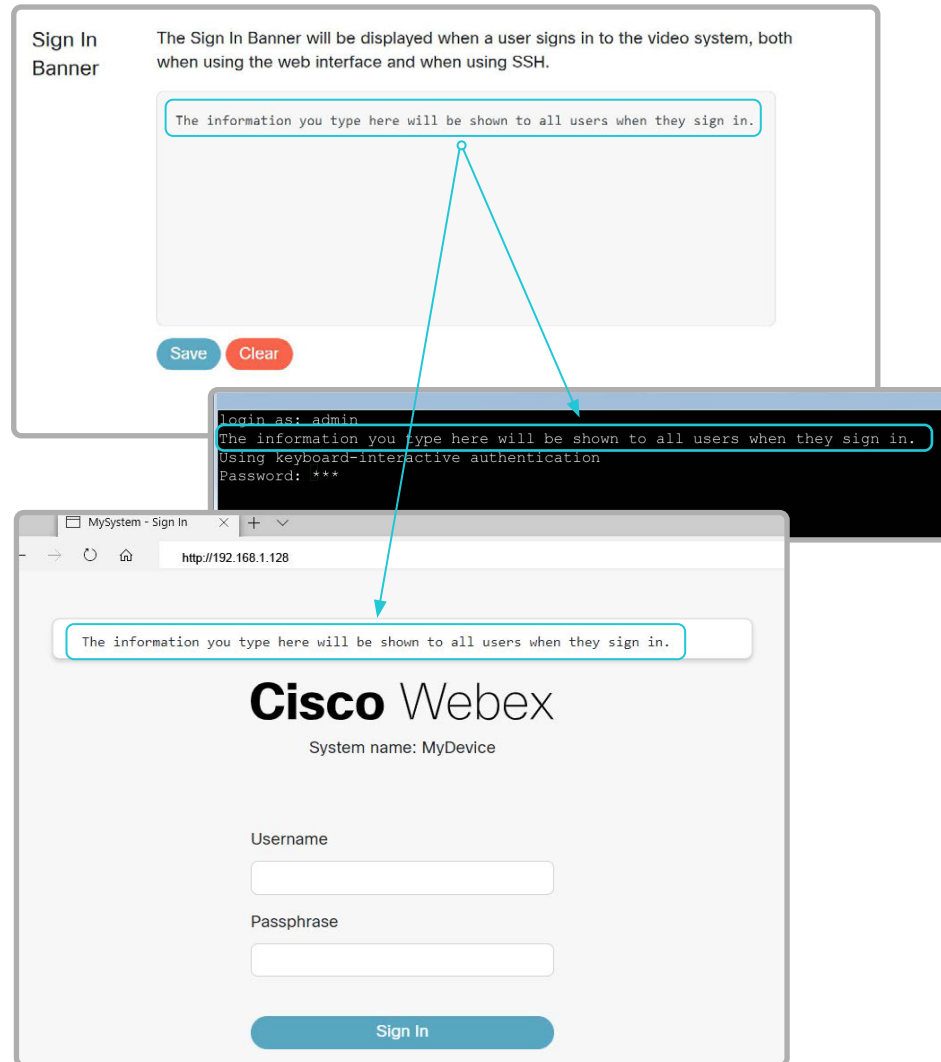

About sign in banner

If a device administrator wants to provide initial information to all users, he can create a sign in banner. The message is shown when the user signs in to the device web interface or the command line interface.

The maximum size is: 4kByte

Welcome banner versus sign in banner

Sign in banner:

- The banner is shown *before* the user signs in to the device web interface or the command line interface.

Welcome banner:

- The banner is shown *after* the user has signed in to the device web interface or the command line interface.

- Board
- BoardPro, BoardPro G2
- Codec EQ
- Codec Plus
- Codec Pro
- Desk, DeskPro, DeskMini
- Room Bar Pro, Room Bar
- Room Kit, Room Kit Mini
- Room Kit EQX
- Room 55
- Room 55 Dual, Room 70
- Room 70 G2
- Room 70 Panorama
- Room Panorama

Add a welcome banner

Adding a Welcome banner is only available using API commands; we don't provide a dedicated user interface for it.

API commands

```
xCommand SystemUnit WelcomeBanner Set
```

This is a multiline command. Anything you input after you issue the command, is input to the command (including line breaks). Finish the input with a separate line containing just a period ending with a line break.

There are also a few more welcome banner commands, refer to the API-guide for more details.

```
xCommand SystemUnit WelcomeBanner Clear
```

```
xCommand SystemUnit WelcomeBanner Get
```

Example

```
xCommand SystemUnit WelcomeBanner Set <enter>
```

```
This is a welcome banner. <enter>
```

```
A welcome banner may have multiple lines. <enter>
```

```
. <enter>
```

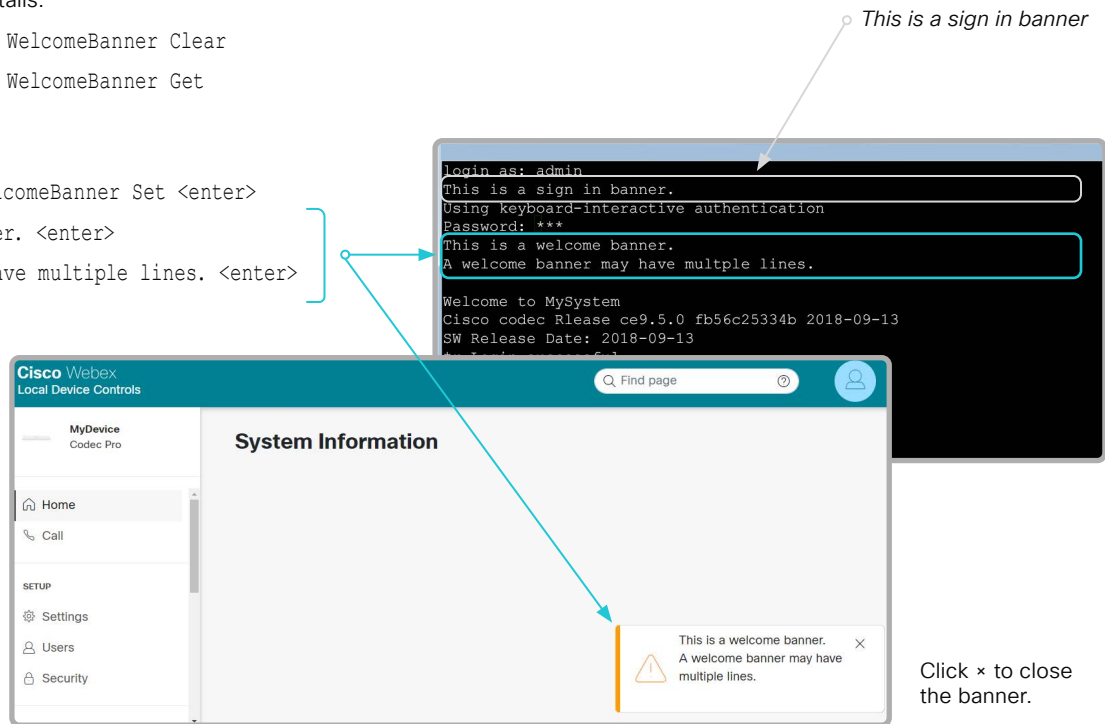

About welcome banner

You can set up a welcome banner that users see after they sign in to the device web interface or command line interface. The banner can have multiple lines.

The banner can for example contain information you need in order to get started, or things you must be aware of when setting up the device.

The maximum size is: 4kByte

Welcome banner versus sign in banner

Sign in banner:

- The banner is shown *before* the user signs in to the device web interface or the command line interface.

Welcome banner:

- The banner is shown *after* the user has signed in to the device web interface or the command line interface.

Board

BoardPro,
BoardPro
G2

Codec EQ

Codec
Plus

Codec
Pro

Desk,
DeskPro,
DeskMini

Room Bar
Pro,
Room Bar

Room Kit,
Room Kit
Mini

Room Kit
EQX

Room 55

Room 55
Dual,
Room 70

Room 70
G2

Room 70
Panorama

Room
Panorama

Manage the service certificates of the device

Sign in to the device web interface and go to [Security](#). Select [Certificates](#), and open the [Services](#) sub-tab.

You need the following files:

- Certificate (file format: .PEM)
- Private key, either as a separate file or included in the same file as the certificate (file format: .PEM format)
- Passphrase (required only if the private key is encrypted)

The certificate and the private key will be stored in the same file on the device.

Add a certificate

1. Browse to find the Certificate file and Private key file (optional) on your computer.
2. Fill in the [Passphrase](#) if required.
3. Click [Upload](#) to store the certificate on the device.
Only certificates with a validity period of up to 10 years are accepted.

Add Certificate

Use the form below to add new certificates.

This system supports PEM formatted certificate files (.pem). The certificate file may contain the certificate and a RSA or DSA encrypted private key with or without a passphrase. Optionally the private key file may be supplied separately.

Certificate No file chosen

Private key (optional) No file chosen

Passphrase (optional)

[Upload](#)

Existing Certificates

Certificate	Issuer	802.1X	Audit	HTTPS	HttpClient	SIP	Pairing	Actions
Certificate_A	Certificatelssuer_A	<input type="checkbox"/>	<input type="checkbox"/>	<input checked="" type="checkbox"/>	<input type="checkbox"/>	<input type="checkbox"/>	<input type="checkbox"/>	Delete View Certificate
Certificate_B	Certificatelssuer_B	<input checked="" type="checkbox"/>	<input type="checkbox"/>	<input type="checkbox"/>	<input type="checkbox"/>	<input checked="" type="checkbox"/>	<input type="checkbox"/>	Delete View Certificate

The certificates and certificate issuers in the illustration are examples. Your device has other certificates.

Enable or disable, view or delete a certificate

Use the toggle buttons to enable or disable a certificate for the different services.

Use the corresponding button to view or delete a certificate.

About the service certificates of the device

Certificate validation may be required when using TLS (Transport Layer Security).

A server or client may require that the device presents a valid certificate to them before communication can be set up.

The device's certificates are text files that verify the authenticity of the device. These certificates may be issued by a certificate authority (CA).

Certificates are used for the following services: HTTPS server, HTTP client, SIP, IEEE 802.1X and audit logging.

You can store many certificates on the device, but only one certificate can be enabled for each service at a time.

If authentication fails, the connection will not be established.

Board

BoardPro,
BoardPro
G2

Codec EQ

Codec
PlusCodec
ProDesk,
DeskPro,
Desk MiniRoom Bar
Pro,
Room BarRoom Kit,
Room Kit
MiniRoom Kit
EQX

Room 55

Room 55
Dual,
Room 70Room 70
G2Room 70
PanoramaRoom
Panorama

Manage the lists of trusted certificate authorities – CAs (page 1 of 4)

Certificate validation may be required when using TLS (Transport Layer Security).

You can configure the device to demand that a server or client presents its certificate before communication is set up. The device uses the certificate to verify the authenticity of the server or client. If authentication fails, the connection will not be established.

The certificate (text file) must be signed by a trusted Certificate Authority (CA). Lists of certificates from trusted CAs reside on the device.

The CA certificate lists

You can check and maintain the lists of trusted CAs from the device web interface:

- Sign in to the device web interface, go to [Security](#), and select [Certificates](#). There is one tab for each CA list.

These are the CA lists:

- **Preinstalled:** Pre-installed CA certificates that are used to validate the certificates of external servers, such as HTTPS, SMTP (*only Board, Board Pro, Board Pro G2, Desk, Desk Mini, Desk Pro, and Room Kit Mini with Samsung Flip*), and syslog, that the device communicates with.
- **Collaboration Edge:** Pre-installed CA certificates that are used to validate the certificates of servers contacted over the Internet when the device is provisioned by Cisco Unified Communications Manager (CUCM) via Expressway (also known as MRA).
- **Custom:** CA certificates that you have uploaded to the device yourself. The list must include all CAs that are needed in order to verify certificates for both logging and other connections, if those certificates are not already included in the pre-installed lists.

Manage the lists of trusted certificate authorities - CAs (page 2 of 4)

Manage pre-installed CA certificates for external servers

Sign in to the device web interface and go to [Security](#). Select [Certificates](#), and open the [Preinstalled](#) sub-tab.

Preinstalled Certificates The Certificate Authorities listed below are used to validate the certificates of external servers that the video system communicates with:

- HTTP servers hosting content used by the web views, the `HttpClient` xAPI, Macros, etc.
- SMTP mail servers (on video systems with touch screens)

Certificate Details

Certificate	Issuer	Details	Enabled
Certificate_01	Issuer_1	View	<input checked="" type="checkbox"/>
Certificate_02	Issuer_2	View	<input checked="" type="checkbox"/>
Certificate_03	Issuer_3	View	<input checked="" type="checkbox"/>
Certificate_04	Issuer_4	View	<input checked="" type="checkbox"/>

The certificates and certificate issuers in the illustration are examples. Your device has other certificates.

View, enable or disable certificates

Use the [View](#) button to see certificate details.

Use the toggle button to enable or disable a certificate.



As an alternative to using the pre-installed certificates, you can append the certificates you need to the custom certificate list manually.

Refer to the [Upload a CA certificate to the device](#) chapter how to update the list of trusted CA certificates.

Pre-installed CA certificates

A list of commonly used CA certificates is pre-installed on the device. The device uses this list when validating certificates from external servers that it communicates with:

- HTTP servers that host content used by the HttpClient API or macros
- Syslog servers (for external logging)
- SMTP mail servers (*only Board, Board Pro, Board Pro G2, Desk, Desk Mini, Desk Pro, and Room Kit Mini with Samsung Flip*)

Factory resetting the device does not delete the list of pre-installed certificates.

- Board
- BoardPro, BoardPro G2
- Codec EQ
- Codec Plus
- Codec Pro
- Desk, DeskPro, DeskMini
- Room Bar Pro, Room Bar
- Room Kit, Room Kit Mini
- Room Kit EQX
- Room 55
- Room 55 Dual, Room 70
- Room 70 G2
- Room 70 Panorama
- Room Panorama

- Board
- Board Pro, Board Pro G2
- Codec EQ
- Codec Plus
- Codec Pro
- Desk, Desk Pro, Desk Mini
- Room Bar Pro, Room Bar
- Room Kit, Room Kit Mini
- Room Kit EQX
- Room 55
- Room 55 Dual, Room 70
- Room 70 G2
- Room 70 Panorama
- Room Panorama

Manage the lists of trusted certificate authorities - CAs (page 3 of 4)

Manage pre-installed CA certificates for CUCM via Expressway provisioning

Sign in to the device web interface and go to [Security](#). Select [Certificates](#), and open the [Collaboration Edge](#) sub-tab.

Collaboration Edge Certificates This CA list is used for Cisco UCM via Expressway (Edge) provisioning only.

[Configure provisioning now.](#)

These certificates are used to validate the servers contacted over the Internet when the endpoint uses Cisco UCM via Expressway provisioning.

You can either enable or disable all Edge certificates on the device by clicking the "Enable All"/"Disable All" button below, or toggle individual certificates on and off in the table.

[Disable All](#)

Certificate Details

Certificate	Issuer	Details	Enabled
Certificate_01	Issuer_1	View	<input checked="" type="checkbox"/>
Certificate_02	Issuer_2	View	<input checked="" type="checkbox"/>
Certificate_03	Issuer_3	View	<input checked="" type="checkbox"/>
Certificate_04	Issuer_4	View	<input checked="" type="checkbox"/>

View, enable or disable certificates

Use the [View](#) button to see certificate details.

Use the toggle button to enable or disable a certificate.

The certificates and certificate issuers in the illustration are examples. Your device has other certificates.



As an alternative to using the pre-installed certificates, you can append the certificates you need to the custom certificate list manually.

Refer to the [Upload a CA certificate to the device](#) chapter how to update the list of trusted CA certificates.

Pre-installed CA certificates for CUCM via Expressway

The pre-installed CA certificates in this list are only used when the device is provisioned by Cisco Unified Communications Manager (CUCM) via Expressway.

Only Cisco Expressway infrastructure certificates are checked against this list.

If the validation of the Cisco Expressway infrastructure certificate fails, the device will not be provisioned and registered.

Factory resetting the device does not delete the list of pre-installed certificates.

- Board
- BoardPro, BoardPro G2
- Codec EQ
- Codec Plus
- Codec Pro
- Desk, Desk Pro, Desk Mini
- Room Bar Pro, Room Bar
- Room Kit, Room Kit Mini
- Room Kit EQX
- Room 55
- Room 55 Dual, Room 70
- Room 70 G2
- Room 70 Panorama
- Room Panorama

Manage the lists of trusted certificate authorities - CAs (page 4 of 4)

Upload a CA certificate to the device

Sign in to the device web interface and go to [Security](#). Select [Certificates](#), and open the [Custom](#) sub-tab.

You need the following file:

- CA certificate list (file format: .PEM).

Upload a list of CA certificates

1. Browse to find the file containing the CA certificates on your computer (file format: .PEM).
2. Click [Upload](#) to store the new CA certificates on the device.

The button appears when you have chosen a file.

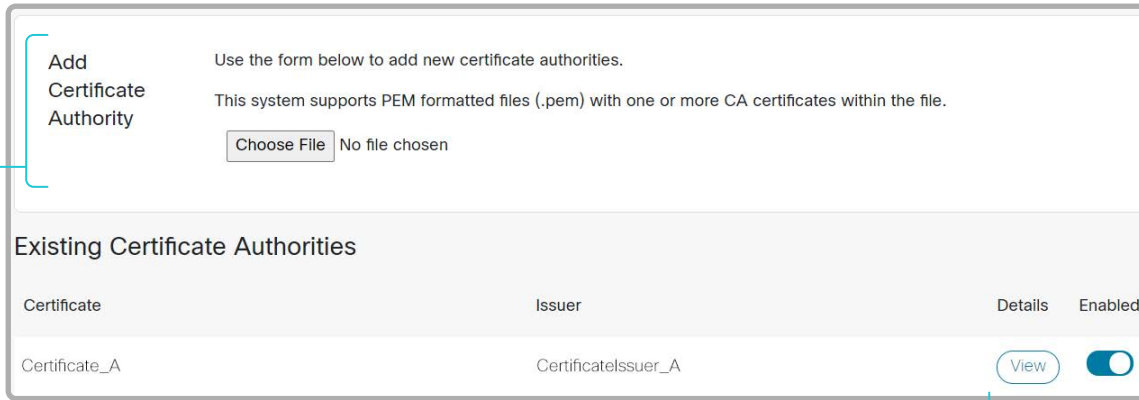

The certificates and certificate issuers in the illustration are examples. Your device has other certificates.

View, enable or disable certificates

Use the [View](#) button to see certificate details.

Use the toggle button to enable or disable a certificate.



Previously stored certificates are not deleted automatically.

The entries in a new file with CA certificates are appended to the existing list.

About the custom list of trusted CA certificates

This list contains the CA certificates that you have uploaded to the device yourself. They can be used to validate client and server certificates for both logging and other connections.

They can be used for:

- HTTP servers that host content used by the HttpClient API or macros
- TMS provisioning and phonebook servers
- SIP servers
- Syslog servers (for external logging)
- SMTP mail servers (*only Board, Board Pro, Board Pro G2, Desk, Desk Mini, and Desk Pro, and Room Kit Mini with Samsung Flip*)
- Cisco Expressway infrastructure

Board

BoardPro,
BoardPro
G2

Codec EQ

Codec
PlusCodec
ProDesk,
DeskPro,
DeskMiniRoom Bar
Pro,
Room BarRoom Kit,
Room Kit
MiniRoom Kit
EQX

Room 55

Room 55
Dual,
Room 70Room 70
G2Room 70
PanoramaRoom
Panorama

Set up secure audit logging

Sign in to the device web interface, go to [Settings](#), and select [Configurations](#).

1. Find the [Security > Audit > Server](#) settings, and enter the [Address](#) of the audit server.

If you set [PortAssignment](#) to [Manual](#), you must also enter a [Port](#) number for the audit server.

2. Set [Security > Audit > Logging > Mode](#) to [ExternalSecure](#).
3. Click [Save](#) for the change to take effect.



The certificate authority (CA) that verifies the certificate of the audit server must be in the device's list of trusted certificate authorities. Otherwise, logs will not be sent to the external server.

Refer to the [Upload a CA certificate to the device](#) chapter how to update the list.

The screenshot shows the 'Configuration / Security' page with the 'Audit' section expanded. The 'Logging Mode' dropdown is set to 'ExternalSecure'. The 'OnError Action' dropdown is also set to 'ExternalSecure'. The 'Server' section contains three fields: 'Address' (empty, with a note '(0 to 255 characters)'), 'Port' (set to '514', with a note '(0 to 65535)'), and 'PortAssignment' (set to 'Auto').

About secure audit logging

When audit logging is enabled, all sign in activity and configuration changes on the device are recorded.

Use the [Security > Audit > Logging > Mode](#) setting to enable audit logging. Audit logging is disabled by default.

In [ExternalSecure](#) audit logging mode the device sends encrypted audit logs to an external audit server (syslog server), which identity must be verified by a signed certificate.

The signature of the audit server is verified using the list of pre-installed CA certificates or the custom CA list.

If the audit server authentication fails, no audit logs are sent to the external server.

Board

BoardPro,
BoardPro
G2

Codec EQ

Codec
PlusCodec
ProDesk,
DeskPro,
Desk MiniRoom Bar
Pro,
Room BarRoom Kit,
Room Kit
MiniRoom Kit
EQX

Room 55

Room 55
Dual,
Room 70Room 70
G2Room 70
PanoramaRoom
Panorama

Delete CUCM trust lists

This chapter is only relevant for devices that are registered to a Cisco Unified Communications Manager (CUCM).

Sign in to the device web interface and go to [Security](#). Select [Certificates](#), and open the [Unified CM](#) sub-tab.

Delete the CUCM trust lists

Click [Delete CTL/ITL](#) to remove the trust lists.

 As a general rule, you should not delete old CTL (Certificate Trust List) and ITL (Initial Trust List) files.

In these cases, you must still delete them:

- When you change the CUCM IP address.
- When you move the endpoint between CUCM clusters.
- When you need to re-generate or change the CUCM certificate.

Overview of trust list fingerprints and certificates

The trust lists' fingerprints and an overview of the certificates in the lists are displayed on the web page.

This information may be useful for troubleshooting.

Board

BoardPro,
BoardPro
G2

Codec EQ

Codec
PlusCodec
ProDesk,
DeskPro,
DeskMiniRoom Bar
Pro,
Room BarRoom Kit,
Room Kit
MiniRoom Kit
EQX

Room 55

Room 55
Dual,
Room 70Room 70
G2Room 70
PanoramaRoom
Panorama

Change the persistency mode

Sign in to the device web interface, go to [Security](#), and select [Persistency Settings](#).

Check the persistency status

The active radio buttons show the current persistency status of the device.

Alternatively, you can navigate to [Settings](#), select [Statuses](#), and check the [Security > Persistency](#) status.

Change the persistency settings

All persistency settings are set to **Persistent** by default. You only have to change these settings if you want to make them **Non-persistent**.

1. Click the radio buttons to set the persistency for configurations, call history, internal logging, local phonebook (local directory and favorites) and IP connectivity (DHCP) information.
2. Click [Apply](#).

The device restarts automatically. After the restart, the behavior changes according to the new persistency settings.



Logs, configurations, and other data that was stored before you switched to Non-persistent mode, are NOT cleared or deleted.

Persistency mode

Configurations, call history, internal logs, local phonebook (local directory and favorites list), and IP connectivity information are stored by default. Because all persistency settings are set to **Persistent**, a device restart does not delete this information.

Generally, we recommend you NOT to change the persistency settings. Only change to **Non-persistent** mode if you have to prevent users from being able to see or traceback to any logged information from the previous session

In Non-persistent mode, the following information is lost or cleared each time the device restarts:

- Device configuration changes
- Information about placed and received calls (call history)
- Internal log files
- Changes to the local contacts or favorites list
- All IP related information (DHCP) from the last session



Information that was stored before changing to Non-persistent mode is not automatically cleared or deleted. You must factory reset the device to delete such information.

There is more information about performing a factory reset in the [▶ Factory reset the video conferencing device](#) chapter.

Board

BoardPro,
BoardPro
G2

Codec EQ

Codec
PlusCodec
ProDesk,
DeskPro,
DeskMiniRoom Bar
Pro,
Room BarRoom Kit,
Room Kit
MiniRoom Kit
EQX

Room 55

Room
55 Dual,
Room 70Room 70
G2Room 70
PanoramaRoom
Panorama

Set up an SMTP email server

By setting up an SMTP server connection, the users of the video conferencing device can share their whiteboards and annotations via email with people inside or outside your organization.

It is possible to set up the server manually, but we strongly recommend you to use the setup wizard. Then you can test the connection while setting it up, and you get guidance how to upload server certificates if needed.

Limitation for Room Kit and Room Kit Mini

This feature is not available for Room Kit Mini in general, only when Room Kit Mini is used with Samsung Flip (Webex on Flip). It's never available for Room Kit.

Enable sharing via email

1. Sign in to the device web interface, go to [Settings](#), and select [Configurations](#).
2. Go to [NetworkServices > SMTP > Mode](#). Sharing via email is only allowed if Mode is On.

Use the wizard to set up the server

Recommended

1. Sign in to the device web interface, go to [Settings](#), and select [Send Whiteboard to Email](#).
2. Click [Start Wizard](#) and enter the server address, encryption method, and port number.
3. Click [Test Connection...](#)

If everything is fine, click [OK](#) to continue the wizard.

If certificates are missing, click [Reconfigure](#) and follow the wizard instructions to upload the required certificates to the device.

4. Enter the email address from where to send whiteboards or annotations.
5. Fill in the username and password fields if the SMTP server requires authentication and the encryption method is TLS or STARTTLS.
6. Select [Verify and Save](#) to finish the server setup wizard.

Provided that [NetworkServices > SMTP > Mode](#) is On, the device is now ready to send whiteboards and annotations by email.

If you choose [Manual Configuration](#) instead of starting the wizard, fill in the same fields as described above and select [Verify and Save](#).

Set up the server from the configurations page

1. Sign in to the device web interface, go to [Settings](#), and select [Configurations](#).
2. Go to [NetworkServices > SMTP](#) and set the [Server](#), [Security](#) (encryption method), [Port](#), [From](#), [Username](#), and [Password](#) settings.
3. If required, upload CA certificates to the device as described in the [Upload a CA certificate to the device](#) chapter.

Encryption methods and certificates

You must choose an encryption method that the email server supports.

Both the TLS and STARTTLS encryption methods require a server certificate. The device doesn't allow connections where the certificate of the SMTP server cannot be validated. Ignoring the certificate check is not an option.

Most often the server certificate can be validated using the CA list that is *pre-installed* on the device. If not, you have to upload the required certificates to the device yourself. Certificates that you upload yourself are added to the list of *Custom* certificates.

Read more about CA lists in the [Manage the lists of trusted certificate authorities - CAs](#) chapter.

Board

BoardPro,
BoardPro
G2

Codec EQ

Codec
Plus

Codec
Pro

Desk,
DeskPro,
DeskMini

Room Bar
Pro,
Room Bar

Room Kit,
Room Kit
Mini

Room Kit
EQX

Room 55

Room 55
Dual,
Room 70

Room 70
G2

Room 70
Panorama

Room
Panorama

Set up ad hoc multipoint conferences (page 1 of 2)

Note: This chapter applies only to regular SIP calls. It does not apply to Webex meetings, even if your device is linked to Webex Edge for Devices and has the Webex optimized experience enabled.

There are several ways to expand a point-to-point video call (a call involving only two parties) into a multipoint conference with more participants.

Centralized conference infrastructure

Most solutions are based on a centralized conference infrastructure, i.e. an MCU (multipoint control unit) ¹.

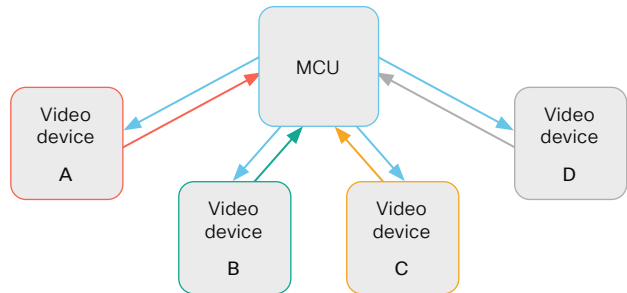

In this setup video devices A, B, C and D participates in a 4-party conference. The MCU receives media streams from all the devices, processes the streams, and sends all media to the other participants.

Local conference resources - MultiSite

In a MultiSite scenario, one of the video devices has MCU functionality.

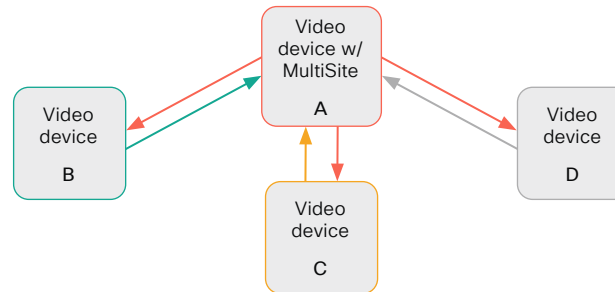

In this setup video devices A, B, C and D participates in a 4-party conference. Device A uses its MultiSite functionality and acts as an MCU. It receives media streams from all the devices, processes the streams, and sends all media to the other participants.

MultiSite is not part of the standard product delivery; you must buy an upgrade option to get the *MultiSite option* key installed on the device.

The maximum number of participants supported by MultiSite depends on the product:

- Four participants, yourself included (*Board, Codec Plus, Room Kit, Room Kit Mini, Room 55, Room 55 Dual, and Room 70*)
- Five participants, yourself included (*Other products*)

Multipoint configuration

Use the *Conference > Multipoint > Mode* setting to decide how to handle multipoint conferences. This setting takes the following values:

- Auto
- CUCMMediaResourceGroupList
- MultiSite
- Off

The table on the next page explains the different conferencing options.

¹ MCU - multipoint control unit, also called video-conferencing gateway or bridge.

Board

BoardPro,
BoardPro
G2

Codec EQ

Codec
Plus

Codec
Pro

Desk,
DeskPro,
DeskMini

Room Bar
Pro,
Room Bar

Room Kit,
Room Kit
Mini

Room Kit
EQX

Room 55

Room 55
Dual,
Room 70

Room 70
G2

Room 70
Panorama

Room
Panorama

Set up ad hoc multipoint conferences (page 2 of 2)

Conference Multipoint Mode setting	MultiSite option key	Remote device type ²	Add participant behavior
Off	N/A	MCU	<ul style="list-style-type: none"> If the MCU supports <i>Add Participant</i>, there is an <i>Add</i> button in the UI and you can call the next participant directly. The new participant is added to the conference as soon as he accepts the call. If the MCU does not support <i>Add Participant</i>, there is no <i>Add</i> button in the UI.
		Video device	<ul style="list-style-type: none"> You can add one extra participant on audio-only. You cannot add more participants on video.
CUCM-MediaResource-GroupList	N/A	Video device	<ul style="list-style-type: none"> Available only to CUCM registered devices, and the <i>SIP > Type</i> setting must be <i>Cisco</i>. The conference is put on hold while calling a new participant. When the new participant accepts the call you can merge the new call with the conference. Only the participant who added the first new participant to the conference can add more participants.
MultiSite ⁴	Yes	N/A	<ul style="list-style-type: none"> There is an <i>Add</i> button in the UI, and you can call the next participant directly. You can keep adding participants until you reach the maximum number for the device.
	No	N/A	<ul style="list-style-type: none"> You can add one extra participant on audio-only. You cannot add more participants on video.
Auto	Yes	MCU	<ul style="list-style-type: none"> If the MCU supports <i>Add Participant</i>, there is an <i>Add</i> button in the UI and you can call the next participant directly. The new participant is added to the conference as soon as he accepts the call. If the MCU does not support <i>Add Participant</i>, there is no <i>Add</i> button in the UI.
		Video device	<ul style="list-style-type: none"> There is an <i>Add</i> button in the UI, and you can call the next participant directly. You can keep adding participants until you reach the maximum number for the device. Only the MultiSite host (which is now acting as an MCU) can add participants. This prevents cascaded conferences.
	No	MCU	<ul style="list-style-type: none"> If the MCU supports <i>Add Participant</i>, there is an <i>Add</i> button in the UI and you can call the next participant directly. The new participant is added to the conference as soon as he accepts the call. If the MCU does not support <i>Add Participant</i>, there is no <i>Add</i> button in the UI.
		Video device	<ul style="list-style-type: none"> You can add one extra participant on audio-only. You cannot add more participants on video.

² The remote device type is shown in the *Call [n] > DeviceType* status.

³ Supported by the following products: Board, Codec Plus, Codec Pro, Desk Pro, Room Kit, Room Kit Mini, Room 55, Room 55 Dual, Room 70, and Room 70 G2.

⁴ MultiSite is disabled automatically in a conference that is using multi stream. This means that you cannot add any new participants to the conference using the *Add* button in the UI (neither video nor audio-only participants).

⁵ We recommend setting *Conference > Multipoint > Mode* to *Auto* rather than to *MultiSite* in order to avoid cascaded conferences.

Board

BoardPro,
BoardPro
G2

Codec EQ

Codec
Plus

Codec
Pro

Desk,
DeskPro,
DeskMini

Room Bar
Pro,
Room Bar

Room Kit,
Room Kit
Mini

Room Kit
EQX

Room 55

Room 55
Dual,
Room 70

Room 70
G2

Room 70
Panorama

Room
Panorama

Set up and use Cisco Proximity (page 1 of 5)

Cisco Proximity allows users to share content wirelessly, place calls, and control video conferencing devices from their laptop, when they are close to a video conferencing device.

When Cisco Proximity is enabled, the video conferencing device transmits ultrasound pairing messages. These messages are received by nearby devices with the Cisco Proximity client, which can then pair automatically with the video conferencing device.

Cisco recommends deploying the Webex app for wireless sharing, device control, and easy meeting join. But where that's not possible, Cisco Proximity provides a lightweight and device-centric alternative without infrastructure dependencies.

This guide is about Cisco Proximity for video conferencing devices registered on-premises. If your on-premises device is linked to Webex Edge for Devices, you should refer to [▶ Webex Help Center \(https://help.webex.com/n1v31g9/\)](https://help.webex.com/n1v31g9/) for information about Cisco Proximity for cloud-pairing.



Number of Proximity connections

The maximum number of simultaneous Proximity connections is:

- 30

The client warns new users if the maximum number of connections has been reached.

Proximity services

Place calls and control the video conferencing device:

- Dial, mute, adjust volume, hang up
- Available on laptops (OS X and Windows)

Wireless share from a laptop:

- Share content without connecting a presentation cable
- Available on laptops (OS X and Windows)

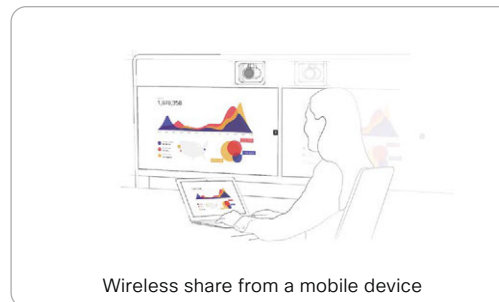
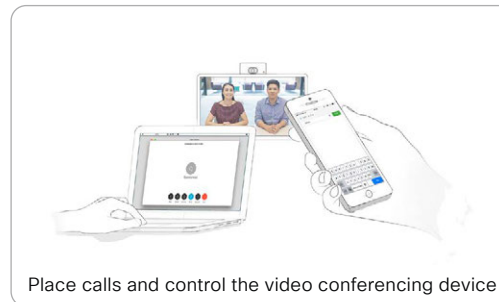

Install a Cisco Proximity client

Where to find the client

You can download the Cisco Proximity client for laptops (Windows and OS X) free of charge from [▶ https://proximity.cisco.com](https://proximity.cisco.com)

End-user license agreement

Read the end-user license agreement carefully, [▶ https://www.cisco.com/c/en/us/td/docs/general/warranty/English/EU1KEN_.html](https://www.cisco.com/c/en/us/td/docs/general/warranty/English/EU1KEN_.html)

Supported operating systems

- Mac OS X 10.9 and above
 - Windows 7 and above
- The tile based interface introduced with Windows 8 is not supported.

Board

BoardPro,
BoardPro
G2

Codec EQ

Codec
PlusCodec
ProDesk,
DeskPro,
Desk MiniRoom Bar
Pro,
Room BarRoom Kit,
Room Kit
MiniRoom Kit
EQX

Room 55

Room 55
Dual,
Room 70Room 70
G2Room 70
PanoramaRoom
Panorama

Set up and use Cisco Proximity (page 2 of 5)

Ultrasound emission

Cisco video conferencing devices emit ultrasound pairing messages as part of the Proximity feature.

Most people are exposed to ultrasound more or less daily in many environments, including industry, commercial applications and home appliances.

Even if airborne ultrasound may cause subjective effects for some individuals, it is very unlikely that any effects will occur for levels below 75 dB.

Room 70, Room 70 G2, Room Panorama, Room 70 Panorama, Room 55, Room 55 Dual, Room Bar, Room Bar Pro, Room Kit, Room Kit Mini, Room Kit EQX, Room Kit EQ, Room Kit Plus*, and Room Kit Pro**:

- The ultrasound sound pressure level is below 75 dB at a distance of 50 cm or more from the loudspeaker.

Desk, Desk Mini, and Desk Pro:

- The ultrasound sound pressure level is below 75 dB at a distance of 20 cm or more from the loudspeaker.

Board, Board Pro, and Board Pro G2:

- The ultrasound sound pressure level is below 75 dB at a distance of 20 cm or more from the screen.

For Board 55 and 70 (not *S Series*) the level can be slightly higher right below the screen due to downward-facing loudspeakers.

Codec EQ, Codec Plus, and Codec Pro:

- We cannot foresee the ultrasound sound pressure level on these video conferencing devices, because they emit ultrasound on third-party loudspeakers.

The volume control on the loudspeaker itself, and the [Audio > Ultrasound > MaxVolume](#) setting affect the ultrasound sound pressure level; the volume control on the remote control or touch controller does not have any effect.

How to turn off ultrasound

The devices rely on ultrasound for these features:

- Proximity pairing
- Motion detection

If you turn off ultrasound for a feature, you cannot use that feature.

To turn off ultrasound emission for proximity pairing, you must set the following:

- [Proximity > Mode](#): Off
- [Audio > Ultrasound > MaxVolume](#): 0

To turn off ultrasound emission for motion detection, you must set the following:

- [RoomAnalytics > PeoplePresenceDetector](#): Off
- [Standby > WakeupOnMotionDetection > Mode](#): Off

To fully turn off ultrasound emission all the settings above must be set to Off.

* This applies if using only the Quad Camera's internal loudspeakers. If using external third-party loudspeakers, refer to the information for Codec EQ, Codec Plus, and Codec Pro.

Board

BoardPro,
BoardPro
G2

Codec EQ

Codec
PlusCodec
ProDesk,
DeskPro,
DeskMiniRoom Bar
Pro,
Room BarRoom Kit,
Room Kit
MiniRoom Kit
EQX

Room 55

Room 55
Dual,
Room 70Room 70
G2Room 70
PanoramaRoom
Panorama

Set up and use Cisco Proximity (page 3 of 5)

Headsets

Headsets or headphones can be connected to several output types, depending on the product.

NOTE: You should never connect a headset to an output that emits ultrasound.

Dedicated headset outputs (*analog*), mini-jack

Desk Pro:

- The device doesn't emit ultrasound on dedicated headset outputs. Hence, you can always connect a headset.

Audio line outputs (*analog*), mini-jack or Euroblock

Codec EQ, Codec Plus, and Codec Pro:

- The device emits ultrasound on audio line outputs, and we will not be able to control the sound pressure level from a connected headset.
- We strongly recommend you to switch off ultrasound emission* if you connect a headset to an analog line output.

Board, Board Pro, Board Pro G2, Room Bar Pro, Room Kit, Room Kit EQX, Room 55, Room 55 Dual, Room 70, Room 70 G2, Room 70 Panorama, and Room Panorama:

- The device doesn't emit ultrasound on the audio line outputs.

USB outputs

Board Pro, Board Pro G2, Desk series, Room Bar, Room Bar Pro, Room Kit, Room Kit Mini, and Room 55:

- The device doesn't emit ultrasound on the USB outputs. Hence, you can always connect a headset.

Codec EQ, Codec Plus, and Codec Pro:

- Per default, the device emits ultrasound on the USB outputs. These outputs are mainly intended for USB audio interfaces.
- If you connect a headset - directly or via a USB audio interface - we strongly recommend you to switch off the ultrasound emission*, or otherwise take care to configure the audio system to not emit ultrasound on these outputs.

Room 55 Dual, Room 70, Room 70 G2, Room 70 Panorama, Room Panorama:

- The device doesn't emit ultrasound on the USB outputs.

Board:

- There is no audio on the USB output.

* As a side effect, you *cannot* use the Proximity or Motion detection features.

Board

BoardPro,
BoardPro
G2

Codec EQ

Codec
PlusCodec
ProDesk,
DeskPro,
DeskMiniRoom Bar
Pro,
Room BarRoom Kit,
Room Kit
MiniRoom Kit
EQX

Room 55

Room 55
Dual,
Room 70Room 70
G2Room 70
PanoramaRoom
Panorama

Set up and use Cisco Proximity (page 4 of 5)

Enable Proximity services

1. Sign in to the device web interface, go to [Settings](#), and select [Configurations](#).
2. Go to [Proximity > Mode](#) to switch Proximity On.

When Proximity is On, the video conferencing device transmits ultrasound pairing messages.

The ultrasound pairing messages are received by nearby devices with Proximity clients, and triggers the authentication and authorization of the device.

Whether Proximity is On or Off by default depends on the product.

3. Enable the services you want to allow. *Wireless share from a desktop client* is enabled by default.

In order to fully utilise the Proximity functionality, we recommend that you enable both services.

Place calls and control the video conferencing device:

- Go to [Proximity > Services > CallControl](#) and choose **Enabled**.

Wireless share from a desktop client:

- Go to [Proximity > Services > ContentShare > FromClients](#) and choose **Enabled**.

Default behavior

Room Bar Pro, Room Kit EQX, Codec EQ, Codec Plus, and Codec Pro:

- The Proximity feature is switched **Off** by default, because the use of third-party speakers may need additional testing for Proximity to work as expected. In rare cases the ultrasound may cause audio artifacts. If so, consider to decrease the maximum ultrasound volume with the [Audio > Ultrasound > MaxVolume](#) setting.

Desk, Desk Mini, and Desk Pro:

- The Proximity feature is switched **Off** by default, because the Desk products are often deployed in open offices with several devices close to each other. In such environments, pairing could be unstable. In general, Proximity should be switched **On** only on one device per room.

Other products:

- The Proximity feature is switched **On** by default.

Recommendation

In general, Cisco recommends – for the best user experience – that Proximity always is switched **On**.

However, for the products where Proximity is switched **Off** by default, it is important that you verify that Proximity is suitable in your environment and setup before you switch it on.

In order to get full access to Proximity, the Proximity services ([Proximity > Services > ...](#)) must be **Enabled** as well.

Board

BoardPro,
BoardPro
G2

Codec EQ

Codec
PlusCodec
ProDesk,
DeskPro,
DeskMiniRoom Bar
Pro,
Room BarRoom Kit,
Room Kit
MiniRoom Kit
EQX

Room 55

Room 55
Dual,
Room 70Room 70
G2Room 70
PanoramaRoom
Panorama

Set up and use Cisco Proximity (page 5 of 5)

Room considerations

Room acoustics

- Rooms with hard surfaces may cause challenges due to severe audio reflections. Acoustical treatment of meeting rooms is always highly recommended for the best meeting experience as well as Proximity performance.
- Cisco recommends only one video conferencing device with Proximity enabled in a room. Otherwise, interference is likely to occur, which may lead to problems with device discovery and session maintenance.

About privacy

In the Cisco Privacy statement and the Cisco Proximity Supplement you find information about data collection in the clients and privacy concerns that needs to be considered when deploying this feature in the organization. Refer to: [▶ https://www.cisco.com/web/siteassets/legal/privacy.html](https://www.cisco.com/web/siteassets/legal/privacy.html)

Basic troubleshooting

Cannot detect devices with Webex clients

- Check if the video conferencing device is in standby mode. Ultrasound is not transmitted if the speakers (for example a TV in standby mode) are turned off. *(only Codec EQ, Codec Plus, and Codec Pro)*
- Check the speaker volume. The volume control on a speaker itself (not the volume controlled with the remote control or touch controller) affects the ultrasound volume. If the volume is too low, the listening devices cannot detect the ultrasound pairing messages. *(only Codec EQ, Codec Plus, and Codec Pro)*
- Some Windows laptops are not able to record sound in the ultrasound frequency range (20kHz-22kHz). This can be due to frequency limitations with the sound card, sound driver or the internal microphone of the particular device. Refer to the Support forum for more information.
- Check [Device settings > Issues and diagnostics](#) on the user interface (control panel), or [Issues and Diagnostics](#) on the device web interface. If there are no ultrasound related issues listed ("Unable to verify the ultrasound signal"), ultrasound pairing messages are emitted by the video conferencing device as they should. Refer to the Proximity *Support forum* for further assistance with the client detection issues.

Audio artifacts

- If you can hear audio artifacts, like humming or clipping noise, decrease the maximum ultrasound volume ([Audio > Ultrasound > MaxVolume](#)).

Cannot share content from a laptop

- For content sharing to work, the video conferencing device and the laptop must be on the same network. For this reason Proximity sharing might fail if your video conferencing device is connected to your company network via Expressway, and your laptop is connected via VPN (VPN client dependent).

Additional resources

Cisco Proximity site:

▶ <https://proximity.cisco.com>

Support forum:

▶ <https://www.cisco.com/go/proximity-support>

Board

BoardPro,
BoardPro
G2

Codec EQ

Codec
PlusCodec
ProDesk,
DeskPro,
DeskMiniRoom Bar
Pro,
Room BarRoom Kit,
Room Kit
MiniRoom Kit
EQX

Room 55

Room 55
Dual,
Room 70Room 70
G2Room 70
PanoramaRoom
Panorama

Adjust the video quality to call rate ratio (page 1 of 2)

Video input quality settings

When encoding and transmitting video there is a trade-off between high resolution and high frame rate.

Use the *Video > Input > Connector n > Quality* setting to decide whether to give priority to high frame rate (**Motion**) or high resolution (**Sharpness**).

The tables on the next page are for the main video channel, hence with *Quality* is set to **Motion**.

Optimal definition profile

The optimal definition profile should reflect the lighting conditions in the video conferencing room and the quality of the camera (video input source). The better the lighting conditions and the better the quality of the camera, the higher the optimal definition profile should be used.

Generally, the Medium profile is recommended. However, if the lighting conditions are very good, we recommend that you test the endpoint on the various Optimal Definition Profile settings before deciding on a profile. The High profile may be set in order to increase the resolution for a given call rate.

Some typical resolutions used for different optimal definition profiles, call rates and transmit frame rates are shown in the tables on the next page. The resolution and frame rate must be supported by both the calling and called devices.

Threshold for sending video at 60 fps

Use the *Video > Input > Connector n > OptimalDefinition > Threshold60fps* setting to decide when to allow sending video at 60 fps.

For all resolutions lower than this threshold, the maximum transmitted frame rate will be 30 fps; for higher resolutions, 60 fps is possible if the available bandwidth is adequate.

Allowing video at 60 fps

(Applies to: Room Kit, Room Kit Mini, and Room 55)

As default, the camera outputs 30 frames per second (fps). This allows for good quality both in close-ups and overview pictures for normal bandwidths and lighting conditions. If the conditions are better, a 60 fps output from the camera may give a better overall quality.

Use the *Cameras > Camera > Framerate* setting to set the camera output framerate.

Sign in to the device web interface, go to *Settings*, and select *Configurations*.

1. *Applies to all products and connectors except Connector 1 (integrated camera) of Board, Board Pro, Board Pro G2, Desk, Desk Mini, Desk Pro, Room Bar, Room Bar Pro, Room Kit, Room Kit Mini, and Room 55.*

Go to *Video > Input > Connector n > Quality* and choose whether to give priority to high frame rate or high resolution.

2. Go to *Video > Input > Connector n > OptimalDefinition > Profile* and choose the preferred optimal definition profile.
3. Go to *Video > Input > Connector n > OptimalDefinition > Threshold60fps* to set the threshold below which the maximum transmitted frame rate will be 30 fps.
4. *Applies to Room Kit, Room Kit Mini, and Room 55.*

Go to *Cameras > Camera > Framerate* and choose whether or not to allow video at 60 fps.

Board

BoardPro,
BoardPro
G2

Codec EQ

Codec
Plus

Codec
Pro

Desk,
Desk Pro,
Desk Mini

Room Bar
Pro,
Room Bar

Room Kit,
Room Kit
Mini

Room Kit
EQX

Room 55

Room 55
Dual,
Room 70

Room 70
G2

Room 70
Panorama

Room
Panorama

Adjust the video quality to call rate ratio (page 2 of 2)

Products that support H.264:

- All products *

H.264: Resolutions and frame rate [w×h@fps] obtained for different optimal definition profiles and call rates						
Call rate [kbps]	maximum 30fps and maximum 128kbps audio bit rate			maximum 60fps and maximum 128kbps audio bit rate		
	Normal	Medium	High	Normal	Medium	High
128	320×180@30	320×180@30	512×288@30	320×180@30	512×288@20	512×288@30
256	512×288@30	640×360@30	768×448@30	512×288@30	640×360@30	512×288@60
384	640×360@30	768×448@30	768×448@30	640×360@30	512×288@60	640×360@30
512	768×448@30	1024×576@30	1024×576@30	512×288@60	640×360@60	768×448@60
768	1024×576@30	1280×720@30	1280×720@30	640×360@60	768×448@60	1024×576@60
1152	1280×720@30	1280×720@30	1280×720@30	768×448@60	1024×576@60	1280×720@60
1472	1280×720@30	1280×720@30	1920×1080@30	1024×576@60	1024×576@60	1280×720@60
1920	1280×720@30	1920×1080@30	1920×1080@30	1024×576@60	1280×720@60	1280×720@60
2560	1920×1080@30	1920×1080@30	1920×1080@30	1280×720@60	1280×720@60	1920×1080@60
3072	1920×1080@30	1920×1080@30	1920×1080@30	1280×720@60	1280×720@60	1920×1080@60
4000	1920×1080@30	1920×1080@30	1920×1080@30	1280×720@60	1920×1080@60	1920×1080@60
6000	1920×1080@30	1920×1080@30	1920×1080@30	1920×1080@60	1920×1080@60	1920×1080@60

Products that support H.265:

- Board Pro
- Board Pro G2
- Codec EQ
- Codec Pro
- Codec Plus
- Room Bar Pro
- Room Kit
- Room Kit EQX
- Room 55
- Room 55 Dual
- Room 70
- Room 70 G2
- Room 70 Panorama *
- Room Panorama *

H.265: Resolutions and frame rate [w×h@fps] obtained for different optimal definition profiles and call rates						
Call rate [kbps]	maximum 30fps and maximum 128kbps audio bit rate			maximum 60fps and maximum 128kbps audio bit rate		
	Normal	Medium	High	Normal	Medium	High
128	512×288@30	512×288@30	640×360@30	512×288@30	512×288@30	512×288@60
256	640×360@30	768×448@30	768×448@30	640×360@30	512×288@60	640×360@60
384	768×448@30	1024×576@30	1280×720@30	640×360@60	768×448@60	768×448@60
512	1024×576@30	1280×720@30	1280×720@30	640×360@60	768×448@60	1024×576@60
768	1280×720@30	1280×720@30	1920×1080@30	768×448@60	1024×576@60	1280×720@60
1152	1280×720@30	1920×1080@30	1920×1080@30	1024×576@60	1280×720@60	1280×720@60
1472	1280×720@30	1920×1080@30	1920×1080@30	1280×720@60	1280×720@60	1280×720@60
1920	1920×1080@30	1920×1080@30	1920×1080@30	1280×720@60	1280×720@60	1920×1080@60
2560	1920×1080@30	1920×1080@30	1920×1080@30	1280×720@60	1920×1080@60	1920×1080@60
3072	1920×1080@30	1920×1080@30	1920×1080@30	1920×1080@60	1920×1080@60	1920×1080@60
4000	1920×1080@30	1920×1080@30	1920×1080@30	1920×1080@60	1920×1080@60	1920×1080@60
6000	1920×1080@30	1920×1080@30	1920×1080@30	1920×1080@60	1920×1080@60	1920×1080@60

* For Room Panorama and Room 70 Panorama the data applies in non-panoramic mode.

Board

BoardPro,
BoardPro
G2

Codec EQ

Codec
PlusCodec
ProDesk,
DeskPro,
Desk MiniRoom Bar
Pro,
Room BarRoom Kit,
Room Kit
MiniRoom Kit
EQX

Room 55

Room 55
Dual,
Room 70Room 70
G2Room 70
PanoramaRoom
Panorama

Select a wallpaper bundle as background image

You can choose between a set of pre-installed wallpaper bundles for the device. The wallpaper bundle is shown when the system is in the awake state. You cannot upload your own custom bundles.

A wallpaper bundle may include wallpapers for several setup types. Some bundles are prepared for multi-screen setups, by providing an image that spans several screens; and some bundles include a wallpaper for the touch controller.

Examples of setup types are:

- *single*: Single-screen background image
- *dual*: Background image spanning two screens (side-by-side)
- *dualAbove*: Background image spanning two screens (one screen above the other)
- *triple*: Background image spanning three screens (side-by-side)
- *tripleAbove/tripleBelow*: Background image spanning three screens, designed for Room Panorama and Room 70 Panorama, where the third screen is either above or below the two main screens
- *controller*: Background image for the touch controller



You must use the *UserInterface WallpaperBundle* API commands if you want to apply a wallpaper bundle or change to a different bundle. You cannot do this from the touch controller or the device web interface.

Using Wallpaper bundles requires that *UserInterface > Wallpaper* is set to *Auto*.

Check which wallpaper bundles you can choose from

```
xCommand UserInterface WallpaperBundle List
```

Both the name and setup types of the bundle are returned.

Change to another wallpaper bundle:

You must choose a bundle that offers the setup type that match your screen setup.*

```
xCommand UserInterface WallpaperBundle Set  
Name: "Name"
```

Remove the wallpaper bundle and return to the default background appearance.

```
xCommand UserInterface WallpaperBundle Clear
```

* Exception: The "beige", "blue", "carbon", and "forestgreen" bundles are reserved for the limited edition color Desk and Desk Mini devices.

- Board
- BoardPro, BoardPro G2
- Codec EQ
- Codec Plus
- Codec Pro
- Desk, DeskPro, Desk Mini
- Room Bar Pro, Room Bar
- Room Kit, Room Kit Mini
- Room Kit EQX
- Room 55
- Room 55 Dual, Room 70
- Room 70 G2
- Room 70 Panorama
- Room Panorama

Add a custom background image for halfwake mode

Sign in to the device web interface, go to *Personalization*, and select *Wallpaper and Halfwake*.

You can apply a custom background image that will show on both the main screen(s) and the touch controller when the device is in halfwake mode.

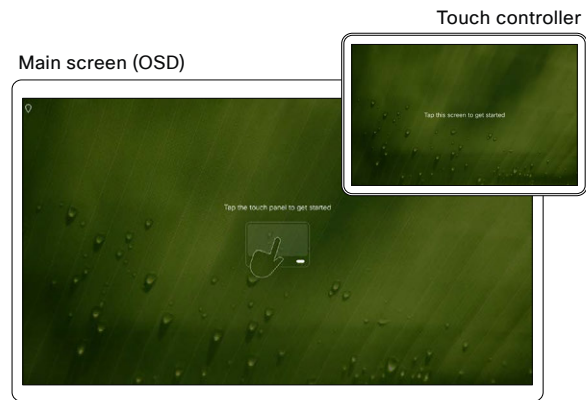

Upload or replace a halfwake image

Click *Upload image* or *Replace image* and browse to find the image file.

Supported file formats:

- JPEG, PNG

Recommended size:

- 1920 × 1080 pixel (*Desk, Desk Mini*)
- 3840 × 2160 pixel (*other products*)

The custom halfwake background is automatically saved on the device, and activated once uploaded.

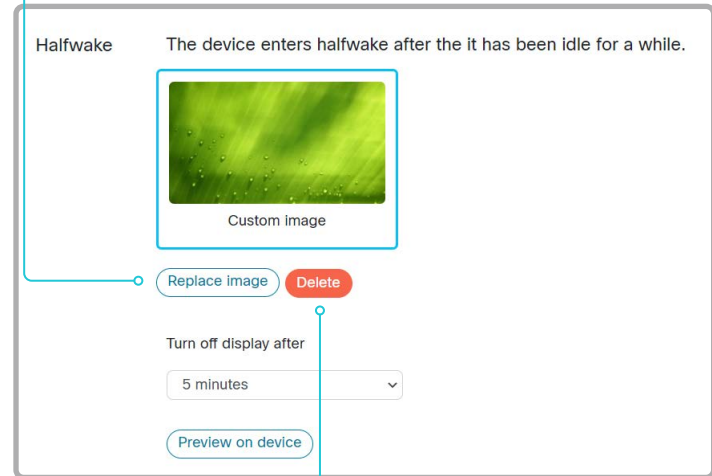
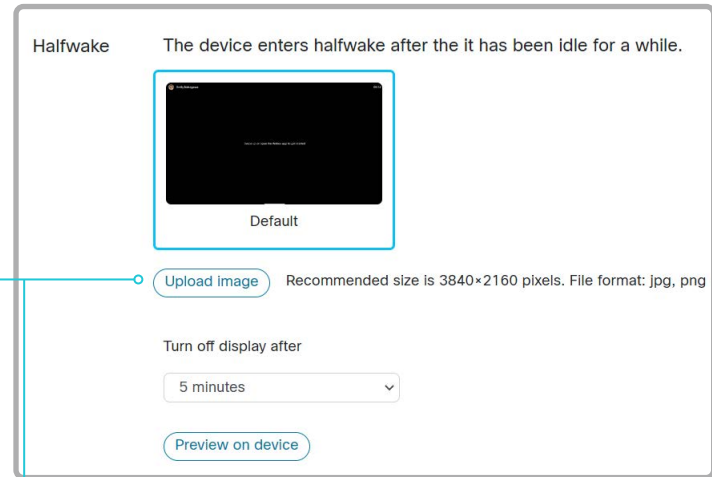

Delete the halfwake image

Delete removes the image from the device. You must upload it anew if you want use it again.

- Board
- BoardPro, BoardPro G2
- Codec EQ
- Codec Plus
- Codec Pro
- Desk, Desk Pro, Desk Mini
- Room Bar Pro, Room Bar
- Room Kit, Room Kit Mini
- Room Kit EQX
- Room 55
- Room 55 Dual, Room 70
- Room 70 G2
- Room 70 Panorama
- Room Panorama

Add a custom background for the Home screen

Sign in to the device web interface, go to [Personalization](#), and select [Wallpaper and Halfwake](#).

You can apply a custom background (also known as a wallpaper) for the Home screen. The custom background will show only on the main screen(s); the touch controller has the default background.

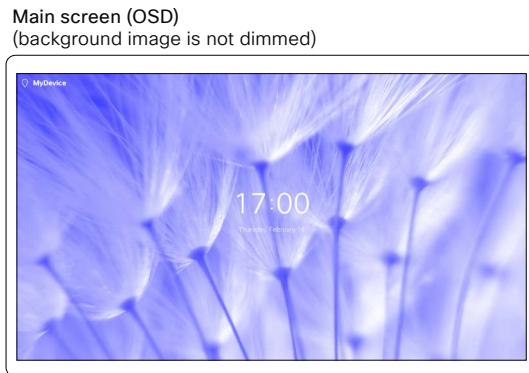
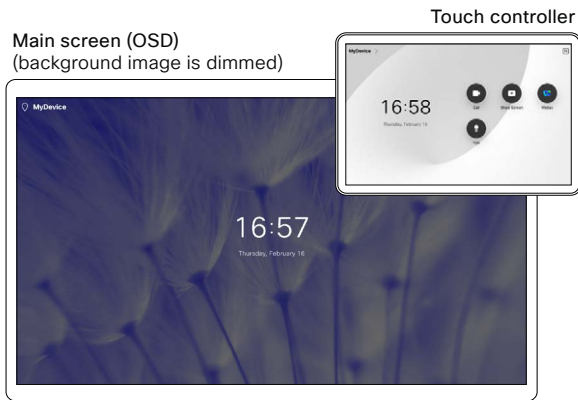

Upload or replace the Home screen wallpaper

Click [Upload image](#) or [Replace image](#) and browse to find the image file.

Supported file formats:

- JPEG, PNG

Recommended size:

- 1920 × 1080 pixel (*Desk, Desk Mini*)
- 3840 × 2160 pixel (*other products*)

The custom wallpaper is automatically saved on the device, and activated once uploaded.

Choose a wallpaper

Click the wallpaper you want to use. Choose between the preinstalled background images and the custom wallpaper.

Dim the background image

We recommend you to dim the background image to increase the contrast between the background and the text.

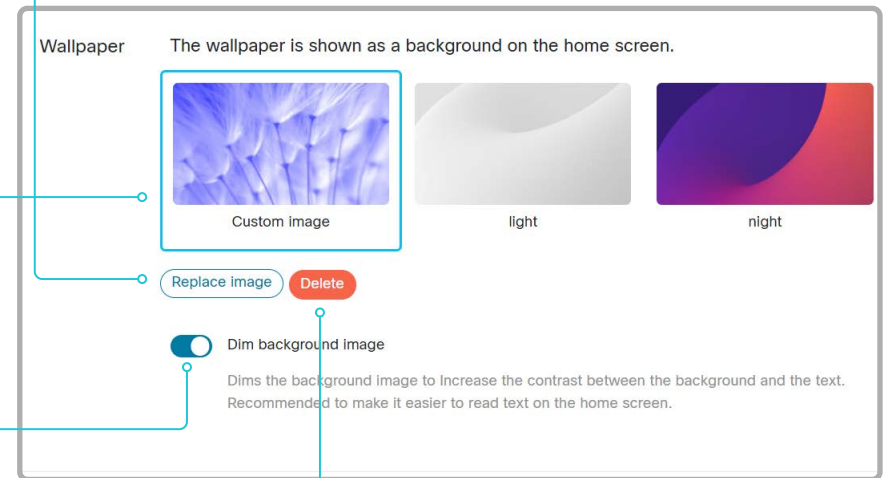
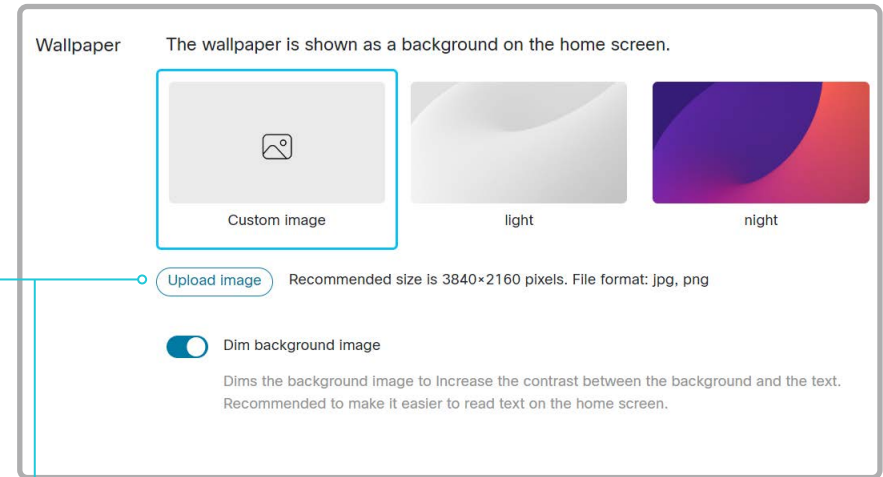

Delete the custom wallpaper

Delete removes the image from the device. You must upload it anew if you want use it again.

- Board
- BoardPro, BoardPro G2
- Codec EQ
- Codec Plus
- Codec Pro
- Desk, Desk Pro, Desk Mini
- Room Bar Pro, Room Bar
- Room Kit, Room Kit Mini
- Room Kit EQX
- Room 55
- Room 55 Dual, Room 70
- Room 70 G2
- Room 70 Panorama
- Room Panorama

Add branding to the screen and touch controller (page 1 of 2)

Sign in to the device web interface, go to *Personalization*, and select *Branding*.

You can add a company logo and custom text that will show on the Home screen (awake mode) and when the device is in halfwake mode.

Branding on the Home screen

In the awake state the logo and custom text shows only on the main screen; the logo is lower right, the custom text is lower left. These branding elements has no effect on the touch controller.

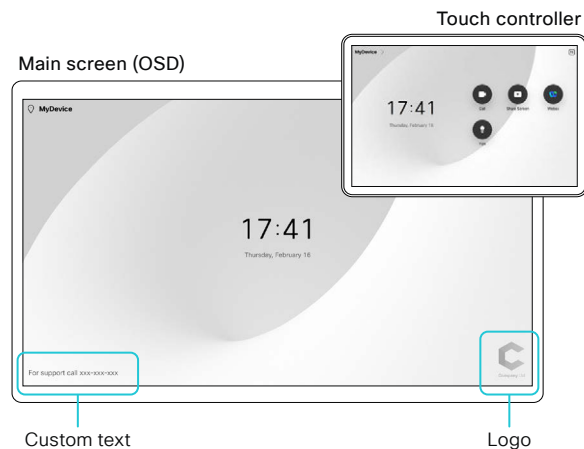

Upload a Home screen logo

Click *Upload image* or *Replace image* and browse to find the image file.

Supported file format: PNG

Recommended size: 272 × 272 pixel

The logo is automatically saved on the device, and activated once uploaded.

Brand Logo

Halfwake logo
Shows brand logo in halfwake

Recommended size is 272×272 pixels. File format: png

Home screen logo
Show brand logo on home screen

Recommended size is 272×272 pixels. File format: png

Custom Text

Custom text displays in the bottom left corner of the main screen.
Example: A help desk number your end users can call for assistance.

Add custom text

Enter text in the input field and click *Apply*.

Home screen logo
Show brand logo on home screen

Apply transparency to this logo
Allows logos to be blended in with the background image. Only recommended for monochrome logos.

Delete the halfwake image

Delete removes the logo from the device. You must upload it anew if you want use it again.

Apply transparency to the logo on the Home screen

You can apply transparency to the logo to better blend in with the Home screen background. We recommend it only for monochrome logos.

Board

BoardPro,
BoardPro
G2

Codec EQ

Codec
Plus

Codec
Pro

Desk,
Desk Pro,
Desk Mini

Room Bar
Pro,
Room Bar

Room Kit,
Room Kit
Mini

Room Kit
EQX

Room 55

Room 55
Dual,
Room 70

Room 70
G2

Room 70
Panorama

Room
Panorama

Add branding to the screen and touch controller (page 2 of 2)

Branding in halfwake mode

In the halfwake mode the logo shows lower right on both the main screen and the touch controller. The custom text applied to the Home screen doesn't show in halfwake mode.

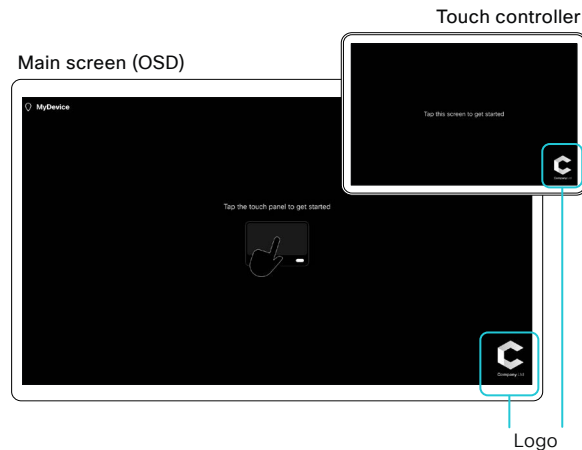

Instructions how to start using the device

Use the [UserInterface > OSD > HalfwakeMessage](#) setting if you want to customize or remove the message at the center of the screen (only on screen, not on touch controller). This is the message that informs the user how to start using the device.

In general, we recommend that you keep the standard message. Change the message only if you have to adapt it to a different scenario, for example if you have a third-party user interface.

Upload a logo for halfwake mode

Click [Upload image](#) or [Replace image](#) and browse to find the image file.

- Supported file format: PNG
- Recommended size: 272 × 272 pixel

We recommend a light logo, so that it blends well with the dark halfwake background image.

The logo is automatically saved on the device, and activated once uploaded.

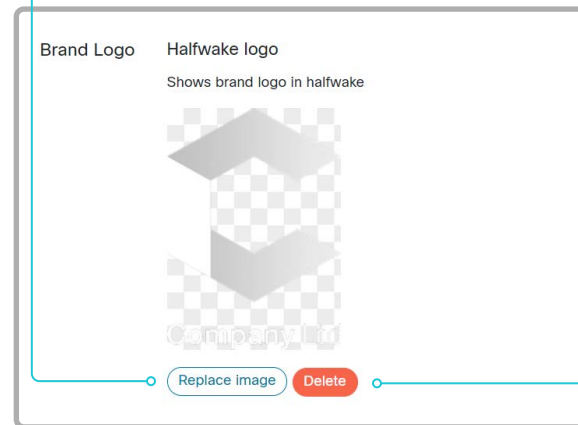
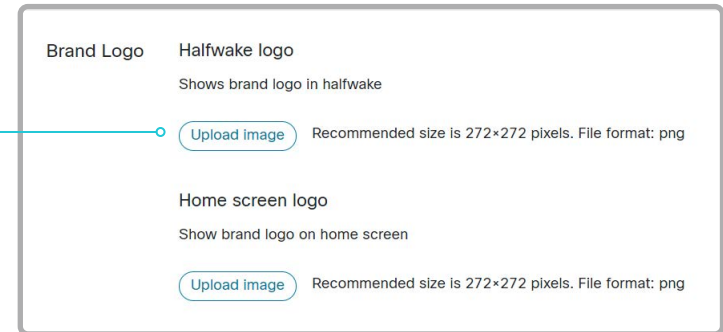

Delete the halfwake image

Delete removes the logo from the device. You must upload it anew if you want use it again.

- Board
- Board Pro, Board Pro G2
- Codec EQ
- Codec Plus
- Codec Pro
- Desk, Desk Pro, Desk Mini
- Room Bar Pro, Room Bar
- Room Kit, Room Kit Mini
- Room Kit EQX
- Room 55
- Room 55 Dual, Room 70
- Room 70 G2
- Room 70 Panorama
- Room Panorama

Add a virtual background

Sign in to the device web interface, go to [Personalization](#), and select [Virtual Backgrounds](#).

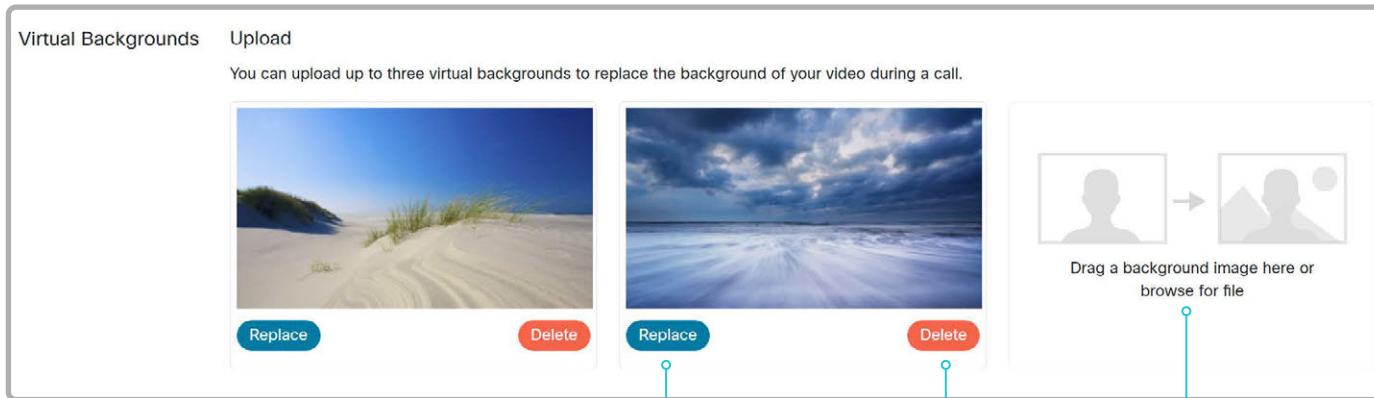

Replace the background image

[Replace](#) allows you to replace the virtual background with a new file.

Delete the background image

[Delete](#) fully removes the virtual background from the device.

You have to upload it again if you want use it again.

Upload a background image

Browse to select a new virtual background or select the file from your file system and drag it into the device web interface.

Supported file formats: BMP, GIF (no animation), JPEG, PNG

Maximum file size*: 8 MB

* The image file must be slightly smaller, since this maximum number includes Base64 encoding overhead.

About virtual backgrounds

If you want to use a custom image as the background while you are in a call, you may upload and use up to three *virtual backgrounds*.

Virtual backgrounds can be selected from the user interface. Tap the **selfview** or open the control panel and select **Background** to find the background options. See the user guide for more details.

- Board
- BoardPro, BoardPro G2
- Codec EQ
- Codec Plus
- Codec Pro
- Desk, DeskPro, DeskMini
- Room Bar Pro, Room Bar
- Room Kit, Room Kit Mini
- Room Kit EQX
- Room 55
- Room 55 Dual, Room 70
- Room 70 G2
- Room 70 Panorama
- Room Panorama

Choose a ringtone and set the ringtone volume

Sign in to the device web interface, go to [Personalization](#), and select [Ringtones](#).

Change the ringtone

1. Choose a ringtone from the drop-down list.
2. Click *Save* to make it the active ringtone.

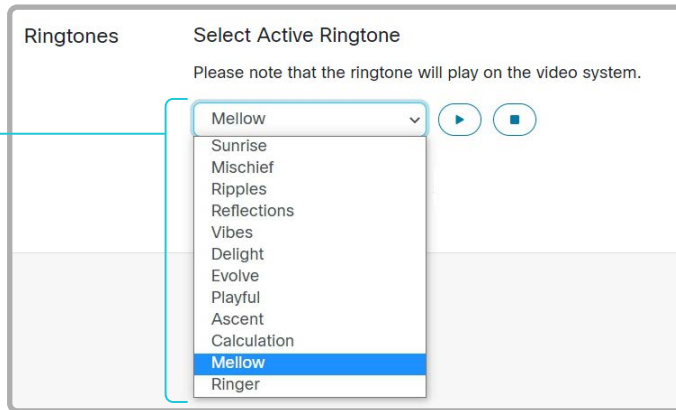

Set the ringtone volume

Use the slide bar to adjust the ringtone volume.

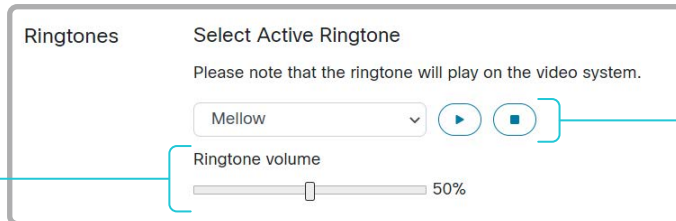

Play back the ringtone

Click the play button (▶) to play back the ringtone.

Use the stop button (■) to end the playback.

About ringtones

A set of ringtones is installed on the device. Use the device web interface to choose a ringtone, and set the ringtone volume.

You can play back the chosen ringtone from the device web interface. Note that the ringtone will be played back on the device itself, and not on the computer running the web interface.

- Board
- BoardPro, BoardPro G2
- Codec EQ
- Codec Plus
- Codec Pro
- Desk, DeskPro, DeskMini
- Room Bar Pro, Room Bar
- Room Kit, Room Kit Mini
- Room Kit EQX
- Room 55
- Room 55 Dual, Room 70
- Room 70 G2
- Room 70 Panorama
- Room Panorama

Manage the Favorites list

Sign in to the device web interface, go to [Personalization](#), and select [Contacts](#).

Import or export contacts from file

Click [Export](#) to save the local contacts in a file; and click [Import](#) to bring in contacts from a file.

The current local contacts are discarded when you import new contacts from a file.

Add or edit a contact

1. Click [Add Contact](#) to make a new local contact, or click a contact's name followed by [Edit Contact](#).

2. Fill in or update the form that pops up.

Choose a folder in the folder drop down list in order to store the contact in a sub-folder.

Click [Add Contact Method](#) and fill in the new input fields if you want to store more than one contact method for the contact (for example video address, telephone and mobile number).

3. Click [Save](#) to store the local contact.

Delete a contact

1. Click a contacts name followed by [Edit Contact](#).
2. Click [Delete](#) to remove the local contact. Confirm your choice in the dialog that pops up.

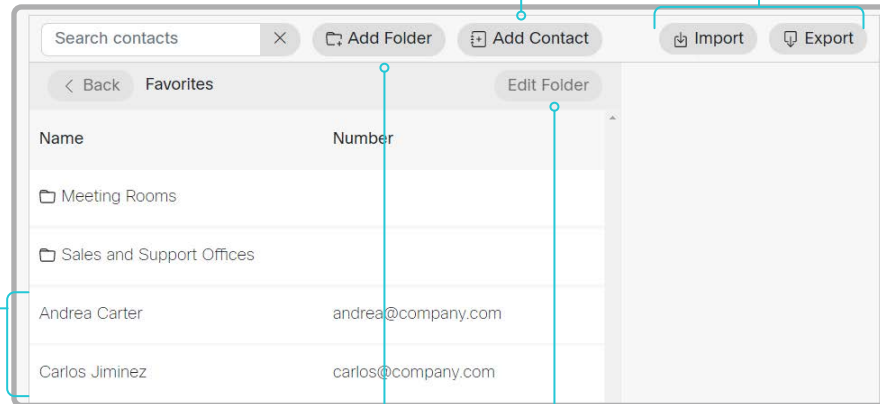

Add or edit a sub-folder

1. Click [Add Folder](#) to make a new sub-folder, or click one of the listed sub-folders followed by [Edit Folder](#) to change an existing sub-folder.
2. Fill in or update the form that pops up.
3. Click [Save](#) to create or update the folder.

Delete a sub-folder

1. Click a folder's name followed by [Edit Folder](#).
2. Click [Delete](#) to remove the folder and all its contacts and sub-folders. Confirm your choice in the dialog that pops up.

Manage Favorites using the device's user interface

Add a contact to the Favorites list

1. Select [Call](#) on the home screen.
2. Select the contact you want to add.
3. Tap the star symbol next to the [Call](#) button on the contact card. Then the color of the star symbol changes from black to white.

The contact you add will be placed in the top folder. You cannot select or create a sub-folder.

Remove a contact from the Favorites list

1. Select [Call](#) on the home screen.
2. Select the [Favorites](#) tab.
3. Select the contact you want to remove.
4. Tap the star symbol next to the [Call](#) button on the contact card. Then the color of the star symbol changes from white to black.

Board

BoardPro,
BoardPro
G2

Codec EQ

Codec
Plus

Codec
Pro

Desk,
Desk Pro,
Desk Mini

Room Bar
Pro,
Room Bar

Room Kit,
Room Kit
Mini

Room Kit
EQX

Room 55

Room 55
Dual,
Room 70

Room 70
G2

Room 70
Panorama

Room
Panorama

Set up accessibility features

Flashing screen for incoming calls

To make it easier for the hearing impaired users to notice when someone is calling, the screen can be setup to flash on incoming calls.

1. Sign in to the device web interface, go to [Settings](#), and select [Configurations](#).
2. Go to [UserInterface > Accessibility > IncomingCallNotification](#) and select **AmplifiedVisuals**.
3. Click [Save](#).

- Board
- Board Pro, Board Pro G2
- Codec EQ
- Codec Plus
- Codec Pro
- Desk, Desk Pro, Desk Mini
- Room Bar Pro, Room Bar
- Room Kit, Room Kit Mini
- Room Kit EQX
- Room 55
- Room 55 Dual, Room 70
- Room 70 G2
- Room 70 Panorama
- Room Panorama

Set up the low power behavior

By default, a device will enter display off mode after *y* minutes. The default delay depends on the product.

You can set the preferred delay or switch off this mode with these settings:

- **Standby Control:** Off/On
- **Standby Delay:** Integer (1..480)

The device will not enter display off mode automatically if the *Standby Control* is Off. If the *Standby Control* is On, the device will enter display off mode when the *Standby Delay* has timed out.

Note that the *Standby Delay* also includes the halfwake period.

By default, a device will enter networked standby 2 minutes after it enters display off mode.*

You can set the preferred delay or switch off the automatic transition to networked standby with these settings:

- **Standby Level Networked Mode:** Off/On
- **Standby Level Networked Delay:** Integer (0..1440)

The device will not enter networked standby level if the *Standby Level Networked Control* is Off. If the *Standby Level Networked Control* is On, the device will enter networked standby when the *Standby Level Networked Delay* has timed out.

If the delay is set to 0, the device will go directly to networked standby, skipping the display off stage.

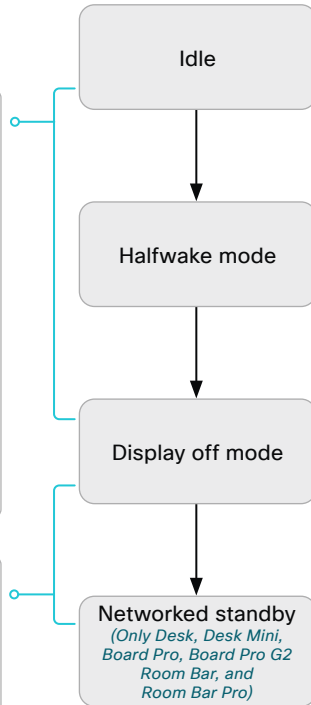

By default, a device will enter halfwake mode after 2 minutes (not configurable) when there is no activity, no active web apps or sessions. Halfwake mode will be displayed for *x* minutes, where $x = \text{Standby Delay} - 2$.

Example: **Standby Delay: 5**

The halfwake screen will be displayed for 3 minutes, and then the device will go into display off mode.

In order to skip the halfwake stage, use this setting:

- **Standby Halfwake Mode:** Manual

* The device will stay in Display off mode and not enter Networked standby if presence of people are detected, or if audio is streamed to the device via Bluetooth.

Halfwake mode

The halfwake mode is a stage between idle and display off mode. A device remains in halfwake mode until activity is detected or until it goes into display off mode.

The halfwake mode may show a darkened screen with text or it may be configured to show branding information, including web pages or digital signage.

Low power modes

There are several low power modes, each providing different power consumption profiles.

Display off mode

This is the first low power stage. The display is turned off.

Networked standby

(Only Desk, Desk Mini, Board Pro, Board Pro G2, Room Bar, and Room Bar Pro)

This is the second low power stage, which reduces power consumption further than the display off mode.

In addition to turning off the display, we will clock down the CPU/GPU and power down some modules on lower level.

The device is still accessible through the network, and it will wake up when receiving a call.

Board

BoardPro,
BoardPro
G2

Codec EQ

Codec
PlusCodec
ProDesk,
Desk Pro,
Desk MiniRoom Bar
Pro,
Room BarRoom Kit,
Room Kit
MiniRoom Kit
EQX

Room 55

Room 55
Dual,
Room 70Room 70
G2Room 70
PanoramaRoom
Panorama

Provisioning of product specific configurations from CUCM (page 1 of 2)

This chapter describes how to provision settings or parameters to a device (endpoint) using the method that was introduced in Cisco UCM Release 12.5(1)SU1.

Prior to Cisco UCM release 12.5(1)SU1, only a limited set of product-specific configurations were pushed from UCM to the device. The administrator had to rely on Cisco TMS or the device web interface to configure all the other settings.

From CUCM release 12.5(1)SU1 more settings or parameters can be provisioned from CUCM. The list of settings matches what users see on their device (public xConfigurations), with the exception of Network, Provisioning, SIP and H.323 settings.

For more information about CUCM refer to the *Video Endpoints Management* chapter of the [► Feature Configuration Guide for Cisco Unified Communications Manager, Release 12.5\(1\)SU1](#).

Configuration control modes

Based on the deployment needs, administrators can configure various configuration control modes in the CUCM administration interface. You can decide whether you want to control the configuration settings from CUCM, the device, or both of them together.

These are the various configuration control modes:

- **Unified CM and Endpoint** (default): Use this mode if you want the CUCM and the device to operate as the multi-master source for provisioning device data. CUCM reads the xConfiguration data automatically from the device, and any updates made locally on the device is synchronised with the CUCM server instantly.
- **Unified CM**: CUCM operates as the centralized master source for provisioning device data. CUCM ignores any changes that are done locally on the device, and therefore such changes will be overridden the next time CUCM applies a new configuration to the device.
- **Endpoint**: The endpoint operates as the centralized master source of configuration data. In this mode, the endpoint ignores any configuration data from the CUCM and doesn't synchronize back the changes done locally.

This mode is typically used when an integrator is installing the devices and wants to control the configuration locally from the device.

Pull configurations from the device on-demand

Administrators can use the *Pull xConfig. from Device* option in CUCM to pull configuration changes from the devices on-demand at any time.

This option is enabled only if the device is registered.

Supported CE software versions

Any device that supports CE9.8 or higher can use this new provisioning layout in CUCM.

If the device has a software version prior to CE9.8, you will be able to view the complete set of parameters in the CUCM user interface; but you can only configure the subset that is marked with a "#". The "#" is to the right of each parameter value.

The full set of parameters functions only if you upgrade the device to CE9.8 or higher.

- Board
- BoardPro, BoardPro G2
- Codec EQ
- Codec Plus
- Codec Pro
- Desk, DeskPro, DeskMini
- Room Bar Pro, Room Bar
- Room Kit, Room Kit Mini
- Room Kit EQX
- Room 55
- Room 55 Dual, Room 70
- Room 70 G2
- Room 70 Panorama
- Room Panorama

Provisioning of product specific configurations from CUCM (page 2 of 2)

Set up provisioning from CUCM

1. Sign in to CUCM, navigate to [Device > Phone](#), and find your device.
2. Find the *Product Specific Configuration Layout* section (see illustration).
3. Click the *Miscellaneous* category and find the *Configuration Control Mode* setting.
Choose your preferred mode: Unified CM, Endpoint, or Unified CM and Endpoint (see the description on the previous page).
4. Click the [Pull xConfig. from Device](#) button if you want to load the current configuration from the device.
5. Select a category and set a value for the configurations you want to change.
6. Finally, click [Save](#) and [Apply Config](#), just like you do in earlier CUCM versions.

Note: If you want to update the device's admin password from CUCM, you must enable the *TFTP Encrypted config* option on the Phone Security Profile configuration for the device.

Pull configurations from the device on-demand

Click this button to pull any data configuration from the device on-demand.

Settings marked with a hash, #

Settings that also were available in Cisco UCM releases prior to 12.5(1) SU1.

Settings or parameters

The settings that belong to the selected category.

Categories

The device settings are grouped in categories. These are the same categories that you find in the device web interface. They also correspond to the API command path.

Miscellaneous is an exception to this rule. In this category you find settings that only can be set by CUCM. They don't correspond to a local setting on the device.

Board

BoardPro,
BoardPro
G2

Codec EQ

Codec
Plus

Codec
Pro

Desk,
Desk Pro,
Desk Mini

Room Bar
Pro,
Room Bar

Room Kit,
Room Kit
Mini

Room Kit
EQX

Room 55

Room 55
Dual,
Room 70

Room 70
G2

Room 70
Panorama

Room
Panorama

Chapter 3

Peripherals

Board

BoardPro,
BoardPro
G2

Codec EQ

Codec
Plus

Codec
Pro

Desk,
DeskPro,
DeskMini

Room Bar
Pro,
Room Bar

Room Kit,
Room Kit
Mini

Room Kit
EQX

Room 55

Room 55
Dual,
Room 70

Room 70
G2

Room 70
Panorama

Room
Panorama

Setting up screens and other output devices (page 1 of 10)

The *number of video outputs* depends on the product. Typically, the outputs are used for screens or other types of displays. Some products also support connecting a recorder.

Some devices has one or more *internal screens* in addition to connectors that are available for *external screens*.

The device distributes the layout (people and content) on all available monitors. Refer to the article [▶ Screen layouts for Cisco devices \(https://help.webex.com/zp1dhab/\)](https://help.webex.com/zp1dhab/) on Webex Help Center for information about how layouts appear depending on your device and the number of screens in your setup.

Logical connectors

A logical output is assigned to each output connector, and also to internal screens that are not connected to a physical connector on the connector panel of the device.

The logical outputs are added in parentheses in the table below: Connector 1, Connector 2, etc.

These are the names that are used in the configuration and status paths, and also in API commands.

4K resolution

Note that you need Premium HDMI cables to support high resolutions and frame rates.

USB-C cables must support USB 3.1 Gen 1 / USB 3.2 Gen 1x1 (DisplayPort Alternate Mode).

Audio support

Note that audio is not supported on all outputs.

Product	Number of video outputs	In use for internal screens	Available for external screens and other output devices		
			Connectors	Maximum resolution	Audio support
Board	1	Internal (Connector 1)	None		
Board Pro	2	Internal (Connector 1)	HDMI (Connector 2)	3840 × 2160 at 60 fps	No audio on the HDMI output.
Board Pro G2	3	Internal (Connector 1)	HDMI 2 (Connector 2) HDMI 3 (Connector 3)	3840 × 2160 at 60 fps 3840 × 2160 at 60 fps	No audio on the HDMI output.
Codec EQ	3	None	HDMI 1 (Connector 1) HDMI 2 (Connector 2) HDMI 3 (Connector 3)	3840 × 2160 at 60 fps 3840 × 2160 at 60 fps 3840 × 2160 at 60 fps	If the connected camera has loudspeakers (Quad Camera) there is no audio on the HDMI outputs. If all connectors are set to Auto and no Quad Camera is connected, the device will try HDMI 1, then HDMI 2, and finally HDMI 3 and play the audio on the first available screen. See full description of the Audio Output HDMI [n] Mode in the Device Settings section.
Codec Plus	2	None	HDMI 1 (Connector 1) HDMI 2 (Connector 2)	3840 × 2160 at 60 fps 3840 × 2160 at 60 fps	If the connected camera has loudspeakers (Quad Camera) there is no audio on the HDMI outputs. Otherwise there is audio on HDMI 1.
Codec Pro	3	None	HDMI 1 (Connector 1) HDMI 2 (Connector 2) HDMI 3 (Connector 3)	3840 × 2160 at 60 fps 3840 × 2160 at 60 fps 3840 × 2160 at 30 fps	If the connected camera has loudspeakers (Quad Camera) there is no audio on the HDMI outputs. If all connectors are set to Auto and no Quad Camera is connected, the device will try HDMI 1, then HDMI 2, and finally HDMI 3 and play the audio on the first available screen. See full description of the Audio Output HDMI [n] Mode in the Device Settings section.

Setting up screens and other output devices (page 2 of 10)

Product	Number of video outputs	In use for internal screens	Available for external screens and other output devices		
			Connectors	Maximum resolution	Audio support
Desk	1	Internal (Connector 1)	None		
Desk Mini	1	Internal (Connector 1)	None		
Desk Pro	2	Internal (Connector 1)	HDMI (Connector 2)	3840 × 2160 at 60 fps	No audio on the HDMI output.
Room Bar	2	None	HDMI 1 (Connector 1) HDMI 2 (Connector 2)	3840 × 2160 at 60 fps	No audio on the HDMI outputs.
Room Bar Pro	3	None	HDMI 1 (Connector 1) HDMI 2 (Connector 2) HDMI 3 (Connector 3)	3840 × 2160 at 60 fps 3840 × 2160 at 60 fps 3840 × 2160 at 60 fps	No audio on the HDMI outputs.
Room Kit	2	None	HDMI 1 (Connector 1) HDMI 2 (Connector 2)	3840 × 2160 at 60 fps	No audio on the HDMI outputs.
Room Kit Mini	1	None	HDMI (Connector 1)	3840 × 2160 at 60 fps	No audio on the HDMI output.
Room 55	2	Internal (Connector 1)	HDMI (Connector 2)	3840 × 2160 at 60 fps	No audio on the HDMI output.
Room 55 Dual / Room 70 Dual	2	HDMI 1 (Connector 1) HDMI 2 (Connector 2)	None		Audio only on the integrated screens.
Room 70 Single	2	HDMI 1 (Connector 1)	HDMI 2 (Connector 2)	3840 × 2160 at 60 fps	Audio only on the integrated screens. If required, an external speaker can be connected to the audio line output connector.
Room 70 Dual G2	3	HDMI 1 (Connector 1) HDMI 2 (Connector 2)	HDMI 3 (Connector 3)	3840 × 2160 at 30 fps	As default, audio only on the integrated screens.
Room 70 Single G2	3	HDMI 1 (Connector 1)	HDMI 2 (Connector 2) HDMI 3 (Connector 3)	3840 × 2160 at 60 fps 3840 × 2160 at 30 fps	As default, audio only on the integrated screen.
Room Kit EQX ¹	3	HDMI 1 (Connector 1) HDMI 2 (Connector 2)	HDMI 3 (Connector 3)	3840 × 2160 at 60 fps	As default, no audio on the HDMI outputs. See full description of the Audio Output HDMI [n] Mode in the Device Settings section.

¹ HDMI 1 and HDMI 2 are reserved for the two default screens. The connectors maximum resolution is 3840 × 2160 at 60 fps. Refer to the *Room Kit EQX Room preparation guidelines* at <https://www.cisco.com/go/room-kit-eqx-installation> for more information about default screen requirements.

- Board
- BoardPro, BoardPro G2
- Codec EQ
- Codec Plus
- Codec Pro
- Desk, Desk Pro, Desk Mini
- Room Bar Pro, Room Bar
- Room Kit, Room Kit Mini
- Room Kit EQX
- Room 55
- Room 55 Dual, Room 70
- Room 70 G2
- Room 70 Panorama
- Room Panorama

Board

BoardPro,
BoardPro
G2

Codec EQ

Codec
Plus

Codec
Pro

Desk,
Desk Pro,
Desk Mini

Room Bar
Pro,
Room Bar

Room Kit,
Room Kit
Mini

Room Kit
EQX

Room 55

Room 55
Dual,
Room 70

Room 70
G2

Room 70
Panorama

Room
Panorama

Setting up screens and other output devices (page 3 of 10)

Product	Number of video outputs	In use for internal screens	Available for external screens and other output devices		
			Connectors	Maximum resolution	Audio support
Room 70 Panorama ²	3	HDMI 1 (Connector 1) HDMI 2 (Connector 2) HDMI 3 (Connector 3)	None		
Room Panorama ²	3	HDMI 1 (Connector 1) HDMI 2 (Connector 2) HDMI 3 (Connector 3)	None		

D15503.06

RoomOS
11.24
02-2025

² Screen calibration is a mandatory part of the Room Panorama installation. It's described in the *Room Panorama Getting Started Guide*. Also, you may have to manually update the firmware of all Room Panorama screens (HDMI 1,2,3) and the Room 70 Panorama content screen (HDMI 3). The *Room Panorama and Room 70 Panorama Display Firmware Update Guide* explains how to find out if a firmware update is needed, and how to do it. You'll find both guides here: <https://www.cisco.com/go/panorama-installation>

Board

BoardPro,
BoardPro
G2

Codec EQ

Codec
PlusCodec
ProDesk,
DeskPro,
DeskMiniRoom Bar
Pro,
Room BarRoom Kit,
Room Kit
MiniRoom Kit
EQX

Room 55

Room 55
Dual,
Room 70Room 70
G2Room 70
PanoramaRoom
Panorama

Setting up screens and other output devices (page 4 of 10)

Automatic setup

(Not relevant for Board, Desk, and Desk Mini, which have only one video output; and not relevant for Room 70 Panorama and Room Panorama which have a pre-defined behavior of all screens)

By default the number of screens is auto-detected, and the role of each screen – whether it is intended to be the first, second, or third screen – is automatically set according to the physical connections.

Sign in to the device web interface, go to [Settings](#), and select [Configurations](#), to find the settings referred below.

Examples

If the total number of screens are three, the following settings will be assumed when set to **Auto**:

- [Video > Monitors](#): **Triple**
- [Video > Output > Connector 1 > MonitorRole](#): **First**
- [Video > Output > Connector 2 > MonitorRole](#): **Second**
- [Video > Output > Connector 3 > MonitorRole](#): **Third**

If the total number of screens are two, the following settings will be assumed when set to **Auto**:

- [Video > Monitors](#): **Dual**
- [Video > Output > Connector 1 > MonitorRole](#): **First**³
- [Video > Output > Connector 2 > MonitorRole](#): **Second**

When do you need manual setup

You can override the default behavior by setting one or more settings manually. You need manual setup when you want to:

- Dedicate a screen to only show presentations
- Use one of the outputs for a recorder *(available for Codec EQ, Codec Pro, Room Kit EQX, Room 70 G2, Room Bar Pro, and Board Pro G2)*
- Replicate the same layout on more than one screen
- Show the on-screen messages and indicators (OSD) on another screen than the video output with the lowest number *(not available for Room 55, Desk Pro, Board Pro, and Board Pro G2)*
- Set the resolution manually, e.g. if the device fails to detect the native resolution and refresh rate of a screen

³ Room 55, Desk Pro, Board Pro, and Board Pro G2 doesn't have explicit MonitorRole settings for Connector 1 (the internal screen). This connector always assumes the monitor role **First** on these devices.

Board

Board Pro,
Board Pro
G2

Codec EQ

Codec
PlusCodec
ProDesk,
Desk Pro,
Desk MiniRoom Bar
Pro,
Room BarRoom Kit,
Room Kit
MiniRoom Kit
EQX

Room 55

Room 55
Dual,
Room 70Room 70
G2Room 70
PanoramaRoom
Panorama

Setting up screens and other output devices (page 5 of 10)

Manual setup

(Not relevant for Board, Desk, and Desk Mini, which have only one video output; and not relevant for Room 70 Panorama and Room Panorama which have a pre-defined behavior of all screens)

The automatic setup works well for common scenarios with one or multiple screens. For more complex scenarios, you may need manual configuration.

Sign in to the device web interface, go to [Settings](#), and select [Configurations](#), to find the settings referred below

Set a role for each screen

Define a role for each screen with the [Video > Output > Connector n > MonitorRole](#) setting. ¹

The monitor role decides which layout (people and content) will appear on the screen that is connected to this output.

Screens with the same monitor role get the same layout; screens with different monitor roles get different layouts.

You must choose monitor roles that match your screen setup.

Set the number of screens

Set the number of screens with *different* layouts in your setup with the [Video > Monitors](#) setting.

Most often the number of different layouts are the same as the number of physical screens, but not always. If exactly the same layout shall be repeated on more than one screen, the number of different layouts is less.

When set to **Auto**, the device automatically detects if a screen is connected to a connector, and thereby also determines the number of screens in the setup.

The other options allow you to fix a single, dual, or triple screen setup; and to reserve one screen for content.

Choose on which screen to display messages and indicators

Define on which screen to display the messages and indicators on-screen with the [UserInterface > OSD > Output](#) setting.

When set to **Auto**, the device determines which screen to use based on the number of the connector.

Set the screen resolution and refresh rate

The device reads the native resolution of a screen and outputs this if possible. Typically, this gives the best possible picture on the screen.

If auto-detection of resolution and refresh rate fails, you must set the resolution manually with the [Video > Output > Connector n > Resolution](#) setting.

Examples

Two screens in total, and the second screen is dedicated to only show presentations:

- [Video > Monitors: DualPresentationOnly](#)
- [Video > Output > Connector 1 > MonitorRole: Auto](#) ⁴
- [Video > Output > Connector 2 > MonitorRole: Auto](#)
- [UserInterface > OSD > Output: 1 or Auto](#) ⁵

Three screens in total⁶, and the third screen is dedicated to only show presentations:

- [Video > Monitors: TriplePresentationOnly](#)
- [Video > Output > Connector 1 > MonitorRole: Auto](#)
- [Video > Output > Connector 2 > MonitorRole: Auto](#)
- [Video > Output > Connector 3 > MonitorRole: Auto](#)
- [UserInterface > OSD > Output: 1](#)

Two screens in total, and a recording device is attached to Connector 3 (HDMI). OSD is on the screen on Connector 2:

- [Video > Monitors: Auto](#)
- [Video > Output > Connector 1 > MonitorRole: Auto](#)
- [Video > Output > Connector 2 > MonitorRole: Auto](#)
- [Video > Output > Connector 3 > MonitorRole: Recorder](#)
- [UserInterface > OSD > Output: 2](#)

⁴ Room 55, Desk Pro, and Board Pro G2 doesn't have explicit MonitorRole settings for Connector 1 (the internal screen). This connector always assumes the monitor role **First on these devices**.

⁵ Set to 1 for Room 55, Desk Pro, Board Pro and Board Pro G2; **Auto** for other devices.

⁶ Only Codec Pro, Codec EQ, Room 70 G2, Room Kit EQX, Room Bar Pro, and Board Pro G2 support three screens in total.

Board

BoardPro,
BoardPro
G2

Codec EQ

Codec
PlusCodec
ProDesk,
Desk Pro,
DeskMiniRoom Bar
Pro,
Room BarRoom Kit,
Room Kit
MiniRoom Kit
EQX

Room 55

Room
55 Dual,
Room 70Room 70
G2Room 70
PanoramaRoom
Panorama

Setting up screens and other output devices (page 6 of 10)

Third-party touchscreen

By connecting a display supporting touch inputs to your Room Bar, Room Bar Pro, Codec EQ, or Codec Pro, the device automatically gets the same UI as a Cisco Board and accepts touch inputs.

Using a Room Series device with a touchscreen lets you use the same functionality that a Cisco Board offers, such as whiteboarding and annotation. You can control the device from the touchscreen or a Room Navigator.

Supported Room Series devices

- Room Bar
- Room Bar Pro
- Codec EQ
- Codec Pro

NOTE: Room Bar Pro, Codec EQ, and Codec Pro require a Room Navigator and you can use both UIs to use the device. For Room Bar, the Room Navigator is optional.

Supported screens

For a list of certified screens, see details on [Cisco collaboration devices certification program](#).

The feature has also been tested with the following non-certified screens:

- Dell C Series Large Format
- Dell P Series Large Format
- Samsung QMR-T Digital Signage series

Limitations

- Touch redirect is not supported.
- Active styluses are not supported. Passive styluses may work.

Connect a touchscreen

When you connect the Room Series device to a touchscreen, you need to use both an HDMI cable and a USB cable.

On the Room Series device:

1. Connect the HDMI cable from the touchscreen to connector 1.
2. Connect the USB cable to the USB-A port for the device to recognize the touch inputs.

Connect a touchscreen and a passive screen

You can connect one touchscreen and one passive screen to the Room Series device. You can set up this combination in two different ways.

1: Screen 1 (left) as interactive/touch screen and screen 2 (right) as passive screen

In this scenario, interactive content moves from screen 2 to screen 1, for example, when starting to annotate on an incoming presentation.

1. Connect the HDMI cable from screen 1 to connector 1.
2. Connect the USB cable from screen 1 to the USB-A port for the device to recognize the touch inputs.
3. Connect the HDMI cable from screen 2 to connector 2.

2: Screen 1 (left) as passive screen and screen 2 (right) as interactive/touch screen

In this scenario, content in a call is always shown on screen 2, whether it is interactive or not. Out of call, interactive apps and elements are shown on screen 2.

1. Connect the display cable from screen 1 to connector 1.
2. Connect the display cable from screen 2 to connector 2.

Connect the USB cable from screen 2 to the USB-A port for the device to recognize the touch inputs.

3. Set the configuration:
[UserInterface > OSD > Output: 2](#)

Board

Board Pro,
Board Pro
G2

Codec EQ

Codec
Plus

Codec
Pro

Desk,
Desk Pro,
DeskMini

Room Bar
Pro,
Room Bar

Room Kit

Room Kit
Mini

Room 55

Room 55
Dual,
Room 70

Room 70
G2

Room 70
Panorama

Room
Panorama

Setting up screens and other output devices (page 7 of 10)

Output connectors

 Always switch off power when you connect and disconnect screens and peripherals.

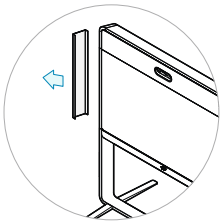

Remove the left side cover to get access to the connector panel and power switch for these devices. The cover is fastened with magnets.

Room 70 Single

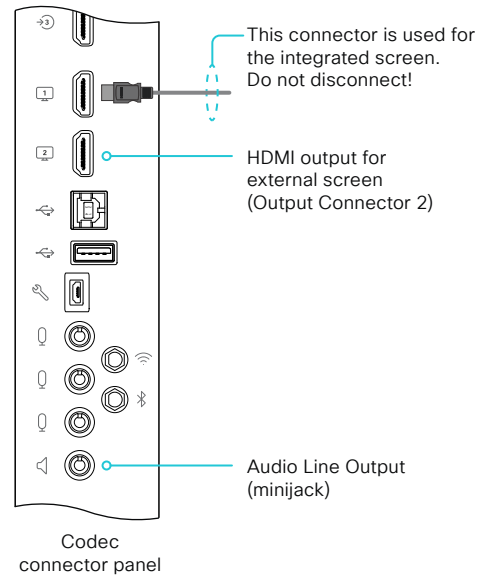

Room 55 Dual and Room 70 Dual

Both HDMI outputs (Output Connector 1 and 2) is used for the integrated screens. Do not disconnect!

 Do not disconnect the integrated screens for Room 55 Dual, Room 70 and Room 70 G2. The integrated screen connections make use of multichannel audio, which drives the speaker system of the devices. Inserting third party equipment is likely to break the audio chain, causing the device to fail from an audio perspective.

Room 70 Dual G2

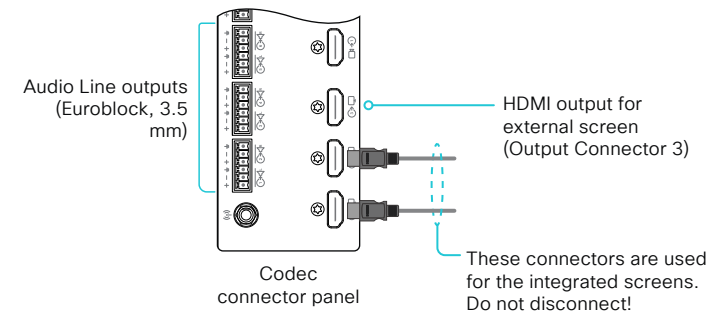

Room 70 Single G2

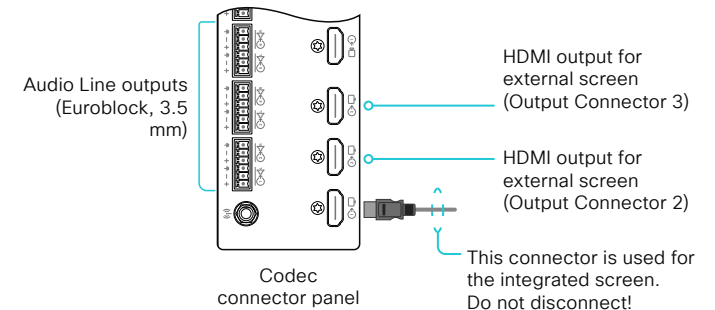

Setting up screens and other output devices (page 8 of 10)

Output connectors

 Always switch off power when you connect and disconnect screens and peripherals.

Room Bar

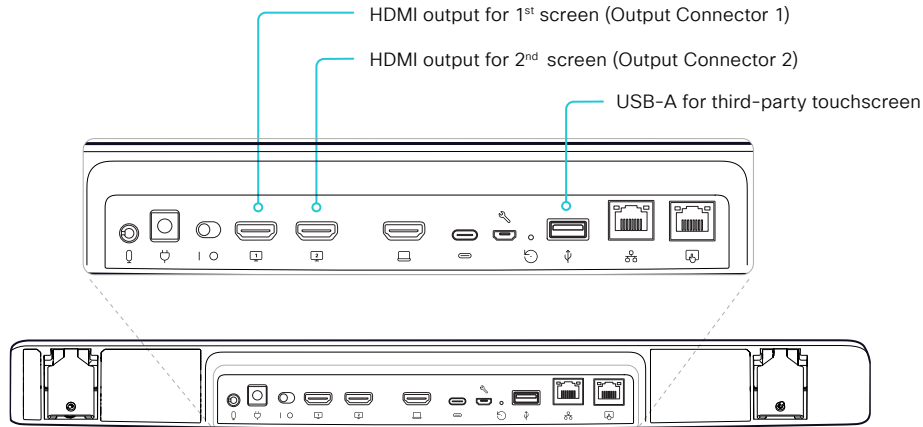

Room Kit

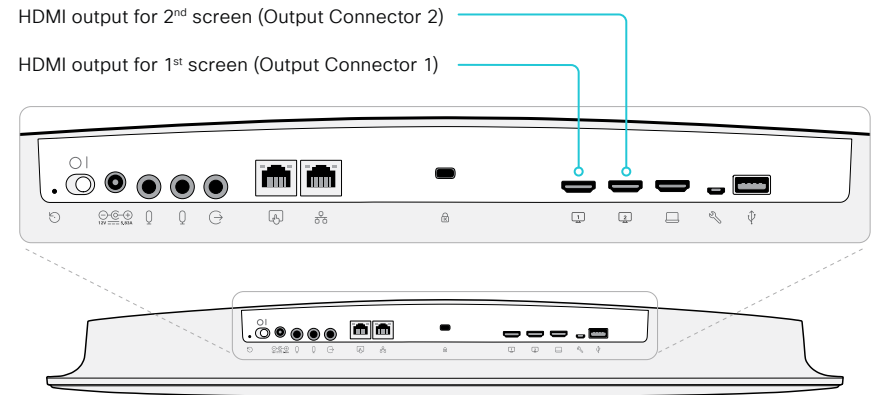

Room Bar Pro

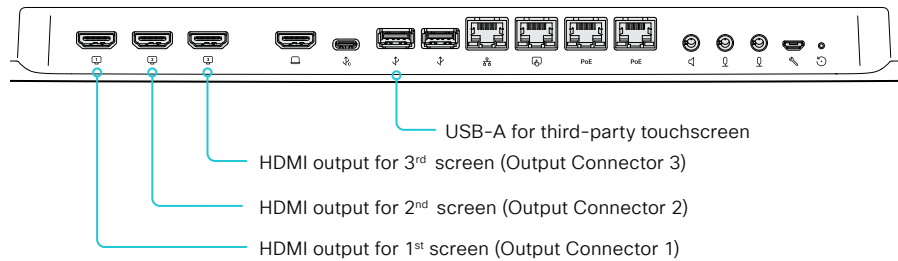

Room Kit Mini

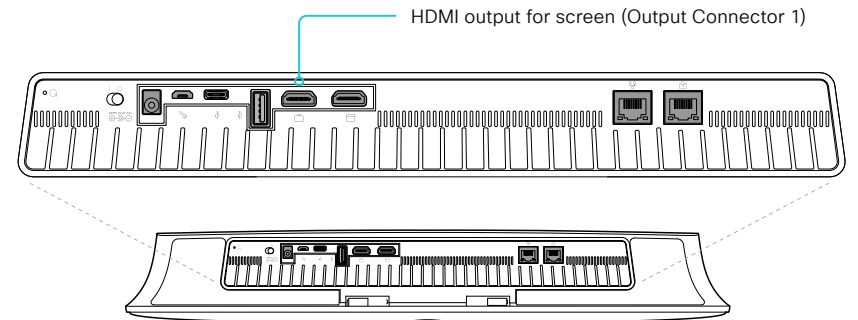

Board

Board Pro,
Board Pro
G2

Codec EQ

Codec
Plus

Codec
Pro

Desk,
Desk Pro,
Desk Mini

Room Bar
Pro,
Room Bar

Room Kit,
Room Kit
Mini

Room Kit
EQX

Room 55

Room
55 Dual,
Room 70

Room 70
G2

Room 70
Panorama

Room
Panorama

D15503.06

RoomOS

11.24

02-2025



Setting up screens and other output devices (page 9 of 10)

Output connectors

 Always switch off power when you connect and disconnect screens and peripherals.

Codec Pro

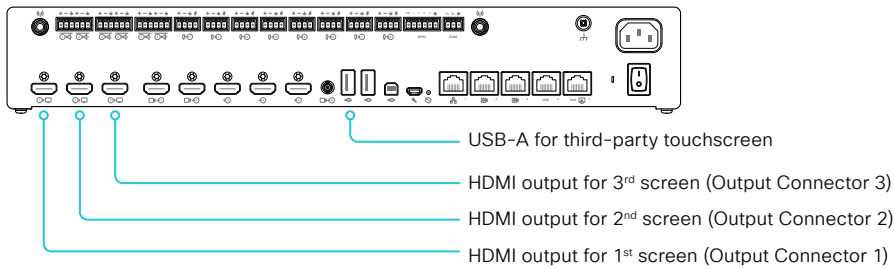

Codec EQ

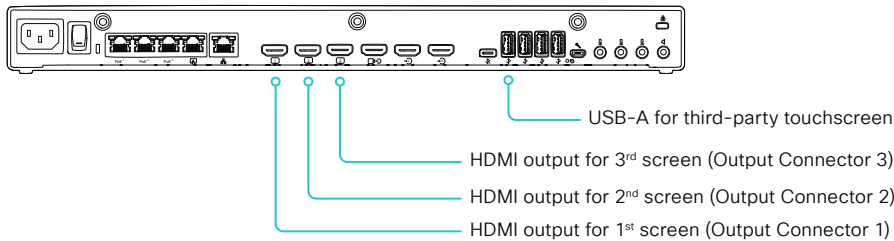

Room Kit EQX

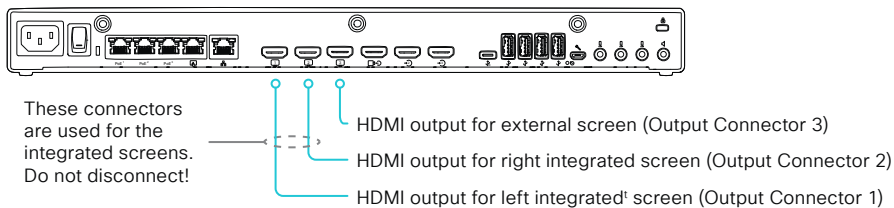

Codec Plus

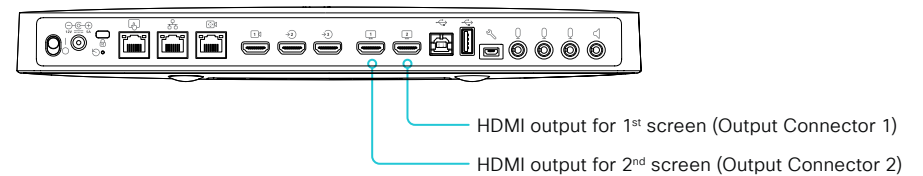

Room 55

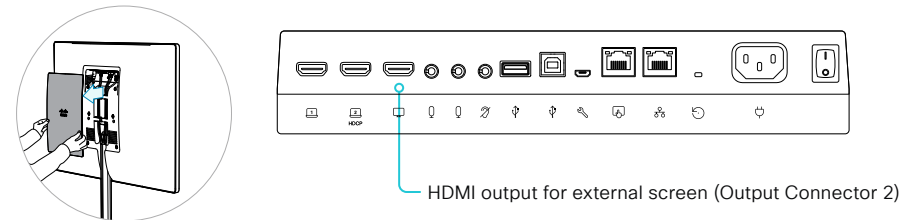

Remove the rear cover to get access to the connector panel and power switch.

Board

Board Pro,
Board Pro
G2

Codec EQ

Codec
Plus

Codec
Pro

Desk,
Desk Pro,
DeskMini

Room Bar
Pro,
Room Bar

Room Kit,
Room Kit
Mini

Room Kit
EQX

Room 55

Room
55 Dual,
Room 70

Room 70
G2

Room 70
Panorama

Room
Panorama

D15503.06

RoomOS
11.24

02-2025



- Board
- Board Pro, Board Pro G2
- Codec EQ
- Codec Plus
- Codec Pro
- Desk, Desk Pro, Desk Mini
- Room Bar Pro, Room Bar
- Room Kit, Room Kit Mini
- Room Kit EQX
- Room 55
- Room 55 Dual, Room 70
- Room 70 G2
- Room 70 Panorama
- Room Panorama

Setting up screens and other output devices (page 10 of 10)

Output connectors

 Always switch off power when you connect and disconnect screens and peripherals.

Board Pro

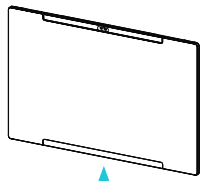

The connector panel is at the bottom

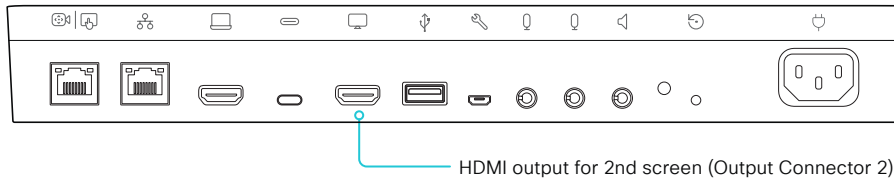

Desk Pro

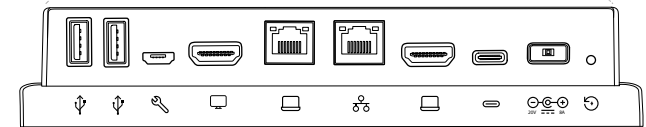
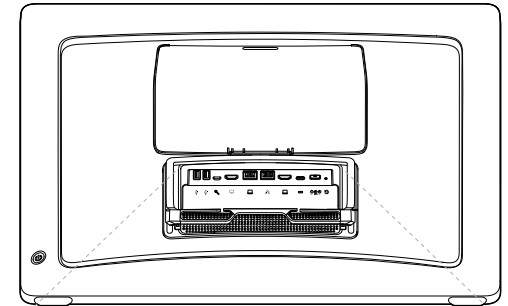

Board Pro G2

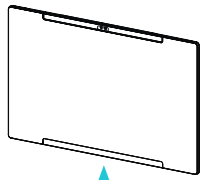

The connector panel is at the bottom

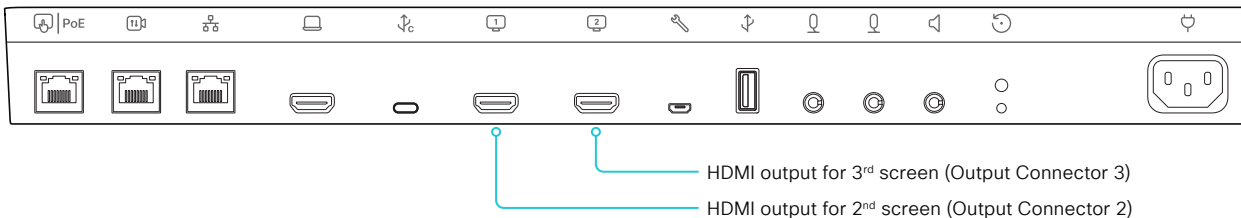

Board

BoardPro,
BoardPro
G2

Codec EQ

Codec
Plus

Codec
Pro

Desk,
DeskPro,
DeskMini

Room Bar
Pro,
Room Bar

Room Kit,
Room Kit
Mini

Room Kit
EQX

Room 55

Room 55
Dual,
Room 70

Room 70
G2

Room 70
Panorama

Room
Panorama

Connecting input sources (page 1 of 13)

Sign in to the device web interface, go to [Settings](#), and select [Configurations](#), to find the settings referred in this chapter.

The *number of video inputs* depends on the product. Typically, the video inputs are used for cameras and computers, and other content sources, but you can also connect other types of video and content sources.

When you connect a computer or content source to an input, you can share content locally or with conference participants.

The integrated devices has *internal cameras* in addition to connectors that are available for *external* content sources. The kits and codecs have connectors only for *external* cameras and other content sources.

Logical connectors

A logical input is assigned to each input connector, and also to internal cameras that are not connected to a physical connector on the connector panel of the device.

The logical inputs are added in parentheses in the table on the next pages: Connector 1, Connector 2, etc.

These are the names that are used in the configuration and status paths, and also in API commands.

About video and content quality

When encoding and transmitting video there is a trade-off between high resolution and high frame rate. For some video sources it is more important to transmit a high frame rate than high resolution and vice versa.

Use the [Video > Input > Connector n > Quality](#) setting to optimize quality with respect to motion (high frame rate) or sharpness (high resolution).

Typically, you should choose **Motion** for regular video inputs and when there is a lot of motion in the picture. Choose **Auto** or **Sharpness** when you want the highest quality of detailed images and graphics.



If a Quad Camera, SpeakerTrack 60 camera, or Precision 60 camera is detected by the device this setting is automatically set to **Motion**. If a user changes this setting manually, it will be set back to **Motion** after a restart or a camera reconnect.

When set to **Auto**, the device will continuously analyze the incoming video stream. As a starting point Auto leads to the highest possible resolution (sharpness). If motion is detected the encoding will automatically change to give the highest possible frame rate (motion).

The default value is **Motion** for connectors that are most often used for cameras, and **Auto** for connectors that are most often used for presentation sources. Refer to the table.

Set type and name for an input source

We recommend that you set type and name for an input source:

- [Video > Input > Connector n > InputSourceType](#)
- [Video > Input > Connector n > Name](#)

These settings determine the names and icons that are shown on the user interfaces. Intuitive names and icons make source selection easier.

Product	Quality default setting
Board	Connector 2: Auto
Board Pro / Board Pro G2	Connector 2, 3: Auto
Codec EQ / Room Kit EQX	Connector 1, 2: Motion Connector 3, 4: Auto
Codec Plus / Room 55 Dual / Room 70	Connector 1: Motion Connector 2, 3: Auto
Codec Pro / Room 70 G2 / Room Panorama / Room 70 Panorama	Connector 1, 2: Motion Connector 3, 4, 5: Auto Connector 6: Motion
Desk / Desk Pro	Connector 2, 3: Auto
Desk Mini	Connector 2: Auto
Room Bar / Room 55	Connector 2, 3: Auto
Room Bar Pro	Connector 2: Motion Connector 3: Auto
Room Kit / Room Kit Mini	Connector 2: Auto

Board

BoardPro,
BoardPro
G2

Codec EQ

Codec
PlusCodec
ProDesk,
DeskPro,
DeskMiniRoom Bar
Pro,
Room BarRoom Kit,
Room Kit
MiniRoom Kit
EQX

Room 55

Room 55
Dual,
Room 70Room 70
G2Room 70
PanoramaRoom
Panorama

Connecting input sources (page 2 of 13)

HDCP support

(Applies to: Board Pro, Board Pro G2, Codec EQ, Codec Plus, Codec Pro, Room Kit EQX, Room 55, Room 55 Dual, Room 70, Room 70 G2, Room 70 Panorama, and Room Panorama)

You can configure one of the input connectors to support HDCP (High-bandwidth Digital Content Protection), which means that the device is authorized to display HDCP protected content.

 This only applies to specific connectors, refer to the following table.

Use this setting to enable HDCP on this input:

- [Video > Input > Connector n > HDCP > Mode](#)

When this setting is On, the content from the source that is connected to the specified connector can only be played locally; you cannot share it with other conference participants while in a call. This applies whether the content is HDCP protected or not.

Connecting the Quad Camera

(Applies to: Codec EQ, Codec Plus, and Codec Pro)

Always use Connector 1 when you connect the Quad Camera to the device. This is required for correct playback of audio through the loudspeakers in the camera.

For details about connecting cameras, refer to the installation guides for the Room Series products online.

Connecting a computer or other content source

You can connect one or more content sources, for example computers, to a device in order to share content locally or with conference participants. The number of external input sources and the maximum resolution they support is in the table below.

Note that you need a High Speed HDMI 1.4b cable to support the higher resolutions and frame rates.

USB-C cables must support USB 3.1 Gen 1 / USB 3.2 Gen 1x1 (DisplayPort Alternate Mode).

External analog microphones on devices that also have a built-in microphone

(Applies to: Board Pro, Board Pro G2, Room Bar, Room Bar Pro, Room Kit, and Room 55)

These devices support one or two external microphones in addition to their built-in microphone. We recommend the Cisco Table Microphone or the Cisco Ceiling Microphone Pro.

Note that Microphone 1 is the integrated microphone.

For Board Pro, Board Pro G2, and Room Bar Pro, refer to the [▶ Using external microphones with Board Pro, Board Pro G2, and Room Bar Pro](#) chapter for more information.

Board

BoardPro,
BoardPro
G2

Codec EQ

Codec
Plus

Codec
Pro

Desk,
Desk Pro,
Desk Mini

Room Bar
Pro,
Room Bar

Room Kit,
Room Kit
Mini

Room Kit
EQX

Room 55

Room 55
Dual,
Room 70

Room 70
G2

Room 70
Panorama

Room
Panorama

Connecting input sources (page 3 of 13)

Input connector overview

Product	Number of video inputs	Reserved for internal camera	External input sources	Maximum resolution	HDCP support	Comments
Board	2	Internal (Connector 1)	HDMI 2 (Connector 2)	Connector 2: 3840 × 2160 at 30 fps or 1080p at 60 fps	Not available	
Board Pro	3	Internal (Connector 1)	USB-C (Connector 2) HDMI (Connector 3)	Connector 2: 3840 × 2160 at 60 fps Connector 3: 3840 × 2160 at 30 fps	HDMI (Connector 3)	<p>USB-C:</p> <ul style="list-style-type: none"> For content sharing, screen extension (external screen for computer), and touch forwarding capabilities on supported operating systems. The USB-C also allows the use of camera, microphone, and speakers with any software client (USB-camera mode); as well as, providing laptop charging (60W maximum). <p>HDMI:</p> <ul style="list-style-type: none"> For content sharing and screen extension (external screen for computer).
Board Pro G2	3	Internal (Connector 1)	USB-C (Connector 2) HDMI (Connector 3)	Connector 2: 3840 × 2160 at 60 fps Connector 3: 3840 × 2160 at 60 fps	HDMI (Connector 3)	<p>USB-C:</p> <ul style="list-style-type: none"> For content sharing, screen extension (external screen for computer), and touch forwarding capabilities on supported operating systems. The USB-C also allows the use of camera, microphone, and speakers with any software client (USB-camera mode); as well as, providing laptop charging (60W maximum). <p>HDMI:</p> <ul style="list-style-type: none"> For content sharing and screen extension (external screen for computer).

- Board
- BoardPro, BoardPro G2
- Codec EQ
- Codec Plus
- Codec Pro
- Desk, DeskPro, Desk Mini
- Room Bar Pro, Room Bar
- Room Kit, Room Kit Mini
- Room Kit EQX
- Room 55
- Room 55 Dual, Room 70
- Room 70 G2
- Room 70 Panorama
- Room Panorama

Connecting input sources (page 4 of 13)

Product	Number of video inputs	Reserved for internal camera	External input sources	Maximum resolution	HDCP support	Comments
Codec EQ	4	N/A	HDMI 1 (Connector 1) HDMI 2 (Connector 2) HDMI 3 (Connector 3) USB-C (Connector 4)	Connector 1: 1920 × 1080 at 60 fps Connector 2: 3840 × 2160 at 30 fps Connector 3: 3840 × 2160 at 30 fps Connector 4: 3840 × 2160 at 30 fps	HDMI 3 (Connector 3)	<p>Quad Camera:</p> <ul style="list-style-type: none"> Always use Connector 1 <p>Camera Control:</p> <ul style="list-style-type: none"> Through one of the auxiliary Ethernet ports If you run out of Ethernet ports, you can connect an Ethernet switch to allow for camera control on all cameras. <p>HDMI:</p> <ul style="list-style-type: none"> For content sharing. <p>USB-C:</p> <ul style="list-style-type: none"> For content sharing. The USB-C also allows the use of camera, microphone, and speakers with any software client (USB-camera mode / USB-C passthrough).
Codec Plus	3	N/A	HDMI 1 (Connector 1) HDMI 2 (Connector 2) HDMI 3 (Connector 3)		HDMI 2 (Connector 2)	<p>Quad Camera:</p> <ul style="list-style-type: none"> Always use Connector 1 <p>SpeakerTrack 60:</p> <ul style="list-style-type: none"> Use Connector 1 and Connector 2 <p>Camera Control:</p> <ul style="list-style-type: none"> Through the auxiliary Ethernet port If you connect more than one camera you can connect an Ethernet switch to allow for camera control on all cameras.
Codec Pro	6	N/A	HDMI 1 (Connector 1) HDMI 2 (Connector 2) HDMI 3 (Connector 3) HDMI 4 (Connector 4) HDMI 5 (Connector 5) SDI (Connector 6)	Connector 1: 1920 × 1080 at 60 fps Connector 2: 1920 × 1080 at 60 fps Connector 3: 3840 × 2160 at 30 fps Connector 4: 3840 × 2160 at 30 fps Connector 5: 3840 × 2160 at 30 fps	HDMI 5 (Connector 5)	<p>Quad Camera:</p> <ul style="list-style-type: none"> Always use Connector 1 <p>SpeakerTrack 60:</p> <ul style="list-style-type: none"> Use Connector 1 and Connector 2 <p>Camera Control:</p> <ul style="list-style-type: none"> Through the auxiliary Ethernet ports If you have more cameras than available auxiliary Ethernet ports you need an Ethernet switch to allow for camera control of all cameras.

- Board
- BoardPro, BoardPro G2
- Codec EQ
- Codec Plus
- Codec Pro
- Desk, Desk Pro, Desk Mini
- Room Bar Pro, Room Bar
- Room Kit, Room Kit Mini
- Room Kit EQX
- Room 55
- Room 55 Dual, Room 70
- Room 70 G2
- Room 70 Panorama
- Room Panorama

Connecting input sources (page 5 of 13)

Product	Number of video inputs	Reserved for internal camera	External input sources	Maximum resolution	HDCP support	Comments
Desk Pro	3	Internal (Connector 1)	USB-C (Connector 2) HDMI (Connector 3)	Connector 2: 3840 × 2160 at 60 fps Connector 3: 3840 × 2160 at 60 fps	Not available	<p>USB-C:</p> <ul style="list-style-type: none"> For content sharing, screen extension (external screen for computer), and touch forwarding capabilities on supported operating systems. The USB-C also allows the use of camera, microphone, and speakers with any software client (USB-camera mode / USB-C passthrough); as well as, providing laptop charging (60W maximum). <p>HDMI:</p> <ul style="list-style-type: none"> For content sharing and screen extension (external screen for computer).
Desk	3	Internal (Connector 1)	USB-C (Connector 2) HDMI (Connector 3)	Connector 2: 1920 × 1080 at 60 fps Connector 3: 1920 × 1080 at 60 fps	Not available	<p>USB-C:</p> <ul style="list-style-type: none"> For content sharing, screen extension (external screen for computer), and touch forwarding capabilities on supported operating systems The USB-C also allows the use of camera, microphone, and speakers with any software client (USB-camera mode / USB-C passthrough). <p>HDMI:</p> <ul style="list-style-type: none"> For screen extension and content sharing.
Desk Mini	2	Internal (Connector 1)	USB-C (Connector 2)	Connector 2: 1920 × 1080 at 60 fps	Not available	<p>For content sharing, screen extension (external screen for computer), and touch forwarding capabilities on supported operating systems.</p> <p>The USB-C also allows the use of camera, microphone, and speakers with any software client (USB-camera mode / USB-C passthrough).</p>
Room Bar	3	Internal (Connector 1)	USB-C (Connector 2) HDMI (Connector 3)	Connector 2: 3840 × 2160 at 30 fps or 1920 × 1080 at 60 fps Connector 3: 3840 × 2160 at 30 fps or 1920 × 1080 at 60 fps	Not available	<p>USB-C:</p> <ul style="list-style-type: none"> For content sharing and screen extension (external screen for computer). The USB-C also allows the use of camera, microphone, and speakers with any software client (USB-camera mode / USB-C passthrough). <p>HDMI:</p> <ul style="list-style-type: none"> For screen extension and content sharing.

- Board
- BoardPro, BoardPro G2
- Codec EQ
- Codec Plus
- Codec Pro
- Desk, Desk Pro, Desk Mini
- Room Bar Pro, Room Bar
- Room Kit, Room Kit Mini
- Room Kit EQX
- Room 55
- Room 55 Dual, Room 70
- Room 70 G2
- Room 70 Panorama
- Room Panorama

Connecting input sources (page 6 of 13)

Product	Number of video inputs	Reserved for internal camera	External input sources	Maximum resolution	HDCP support	Comments
Room Bar Pro	2	Internal (Connector 1)	HDMI (Connector 2) USB-C (Connector 3)	Connector 2: 3840 × 2160 at 30fps or 1920 × 1080 at 60fps Connector 3: 3840 × 2160 at 30fps or 1920 × 1080 at 60fps	Not available	USB-C: <ul style="list-style-type: none"> • For content sharing and screen extension (external screen for computer). • The USB-C also allows the use of camera, microphone, and speakers with any software client (USB-camera mode / USB-C passthrough). HDMI: <ul style="list-style-type: none"> • For screen extension and content sharing.
Room Kit	2	Internal (Connector 1)	HDMI 2 (Connector 2)	Connector 2: 3840 × 2160 at 30fps	Not available	
Room Kit Mini	2	Internal (Connector 1)	HDMI 2 (Connector 2)	Connector 2: 3840 × 2160 at 30fps	Not available	
Room 55	3	Internal (Connector 1)	HDMI 1 (Connector 2) HDMI 2 (Connector 3)	Connector 2: 3840 × 2160 at 30fps Connector 3: 3840 × 2160 at 30fps	HDMI 2 (Connector 3)	
Room 55 Dual / Room 70	3	HDMI 1 (Connector 1)	HDMI 2 (Connector 2) HDMI 3 (Connector 3)		HDMI 2 (Connector 2)	Camera Control: Through the auxiliary Ethernet port If you connect extra cameras you need an Ethernet switch to allow for camera control on all cameras.
Room 70 G2	6	HDMI 1 (Connector 1)	HDMI 2 (Connector 2) HDMI 3 (Connector 3) HDMI 4 (Connector 4) HDMI 5 (Connector 5) SDI (Connector 6)	Connector 1: 1920 × 1080 at 60fps Connector 2: 1920 × 1080 at 60fps Connector 3: 3840 × 2160 at 30fps Connector 4: 3840 × 2160 at 30fps Connector 5: 3840 × 2160 at 30fps	HDMI 5 (Connector 5)	Camera Control: Through the auxiliary Ethernet ports If you have more cameras than available auxiliary Ethernet ports you need an Ethernet switch to allow for camera control of all cameras.

- Board
- BoardPro, BoardPro G2
- Codec EQ
- Codec Plus
- Codec Pro
- Desk, Desk Pro, Desk Mini
- Room Bar Pro, Room Bar
- Room Kit, Room Kit Mini
- Room Kit EQX
- Room 55
- Room 55 Dual, Room 70
- Room 70 G2
- Room 70 Panorama
- Room Panorama

Connecting input sources (page 7 of 13)

Product	Number of video inputs	Reserved for internal camera	External input sources	Maximum resolution	HDCP support	Comments
Room Kit EQX	4	HDMI 1 (Connector 1)	HDMI 2 (Connector 2) HDMI 3 (Connector 3) USB-C (Connector 4)	Connector 1: 1920 × 1080 at 60 fps Connector 2: 3840 × 2160 at 30 fps Connector 3: 3840 × 2160 at 30 fps Connector 4: 3840 × 2160 at 30 fps	HDMI 3 (Connector 3)	<p>Camera Control:</p> <ul style="list-style-type: none"> Through auxiliary Ethernet port 1 (the others are used by other EQX components) If you run out of auxiliary Ethernet ports, you can connect an Ethernet switch to allow for camera control on all cameras. <p>HDMI:</p> <ul style="list-style-type: none"> For content sharing. <p>USB-C:</p> <ul style="list-style-type: none"> For content sharing. The USB-C also allows the use of camera, microphone, and speakers with any software client (USB-camera mode / USB-C passthrough).
Room 70 Panorama	6	HDMI 1 (Connector 1) HDMI 2 (Connector 2)	HDMI 3 (Connector 3) HDMI 4 (Connector 4) HDMI 5 (Connector 5) SDI (Connector 6)	Connector 1: 1920 × 1080 at 60 fps Connector 2: 1920 × 1080 at 60 fps Connector 3: 3840 × 2160 at 30 fps Connector 4: 3840 × 2160 at 30 fps Connector 5: 3840 × 2160 at 30 fps	HDMI 5 (Connector 5)	Camera control is through Ethernet port 2.
Room Panorama	6	HDMI 1 (Connector 1) HDMI 2 (Connector 2)	HDMI 3 (Connector 3) HDMI 4 (Connector 4) HDMI 5 (Connector 5) SDI (Connector 6)	Connector 1: 1920 × 1080 at 60 fps Connector 2: 1920 × 1080 at 60 fps Connector 3: 3840 × 2160 at 30 fps Connector 4: 3840 × 2160 at 30 fps Connector 5: 3840 × 2160 at 30 fps	HDMI 5 (Connector 5)	Camera control is through Ethernet port 2.

Board

Board Pro,
Board Pro
G2

Codec EQ

Codec
Plus

Codec
Pro

Desk,
Desk Pro,
DeskMini

Room Bar
Pro,
Room Bar

Room Kit,
Room Kit
Mini

Room Kit
EQX

Room 55

Room 55
Dual,
Room 70

Room 70
G2

Room 70
Panorama

Room
Panorama

Connecting input sources (page 8 of 13)

Input connectors

 In general, it's good practice to turn off power when you connect or disconnect peripherals. Nevertheless, you can always connect a laptop and share content locally or in a call without powering down the device.

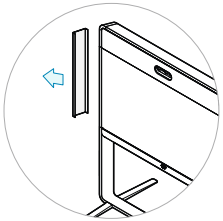

Remove the left side cover to get access to the connector panel and power switch for these devices. The cover is fastened with magnets.

Room 55 Dual and Room 70

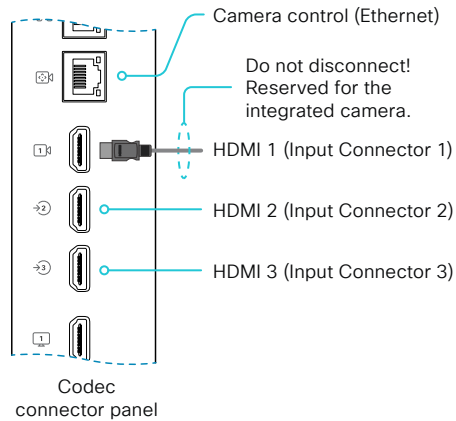

Room 70 G2

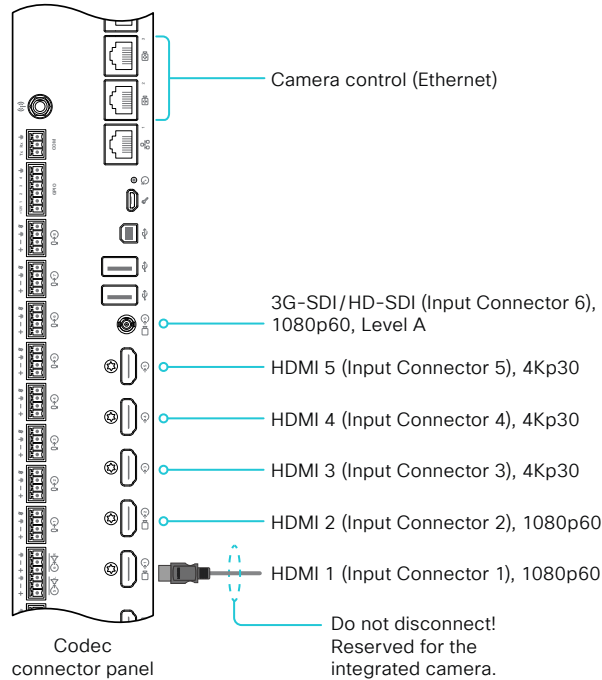

Room 70 Panorama

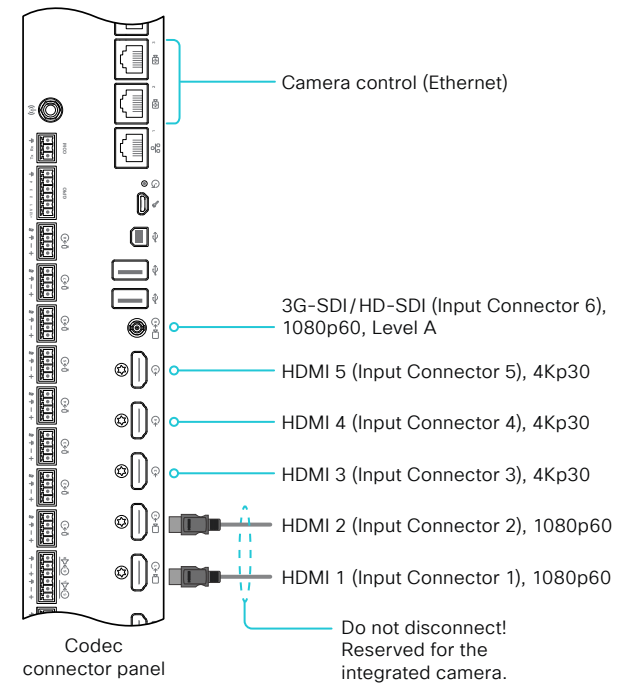

Connecting input sources (page 9 of 13)

Input connectors

 In general, it's good practice to turn off power when you connect or disconnect peripherals. Nevertheless, you can always connect a laptop and share content locally or in a call without powering down the device.

Codec Plus

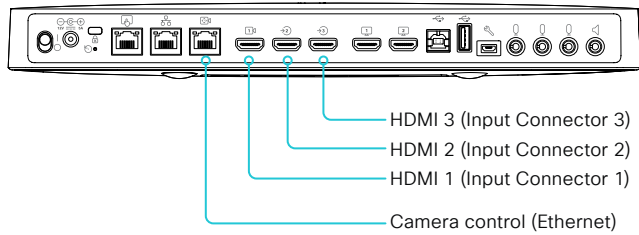

Codec EQ

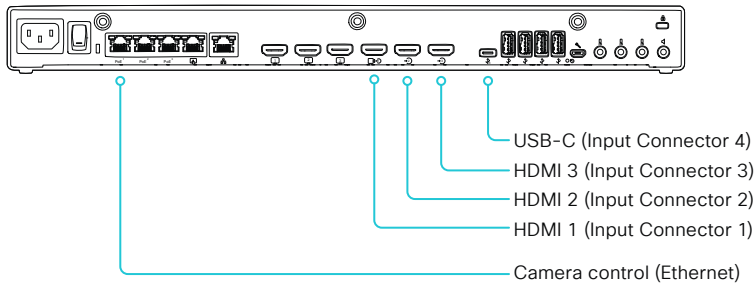

Room Kit EQX

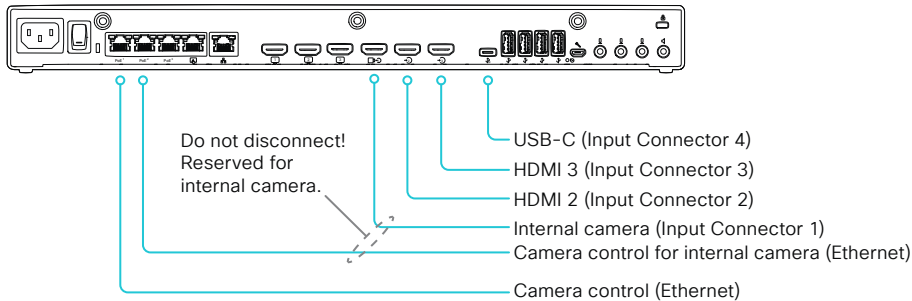

Codec Pro and Room Panorama

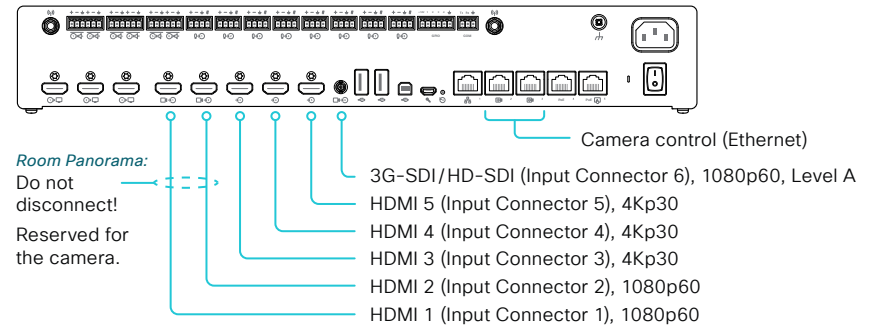

Room 55

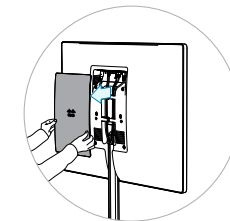

Remove the rear cover to get access to the connector panel and power switch.

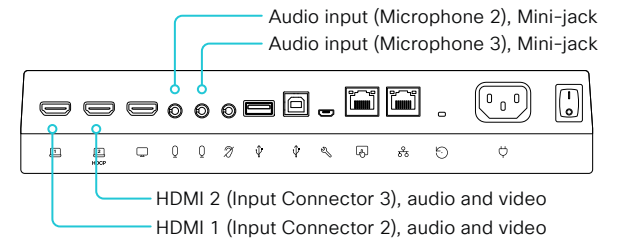

Board

Board Pro,
Board Pro
G2

Codec EQ

Codec
Plus

Codec
Pro

Desk,
Desk Pro,
Desk Mini

Room Bar
Pro,
Room Bar

Room Kit,
Room Kit
Mini

Room Kit
EQX

Room 55

Room
55 Dual,
Room 70

Room 70
G2

Room 70
Panorama

Room
Panorama

D15503.06

RoomOS
11.24

02-2025



Connecting input sources (page 10 of 13)

Input connectors

 In general, it's good practice to turn off power when you connect or disconnect peripherals. Nevertheless, you can always connect a laptop and share content locally or in a call without powering down the device.

Room Bar

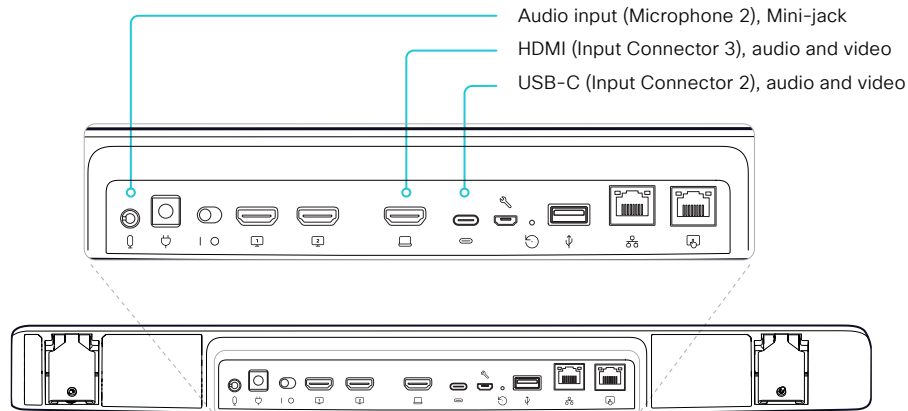

Room Kit

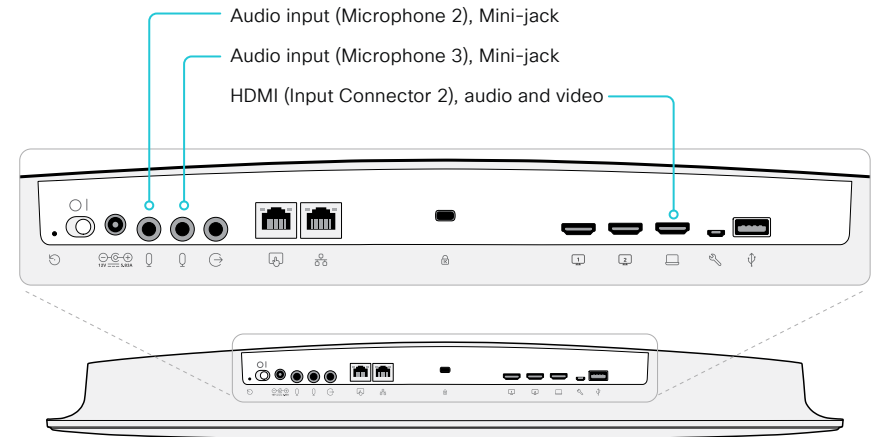

Room Bar Pro

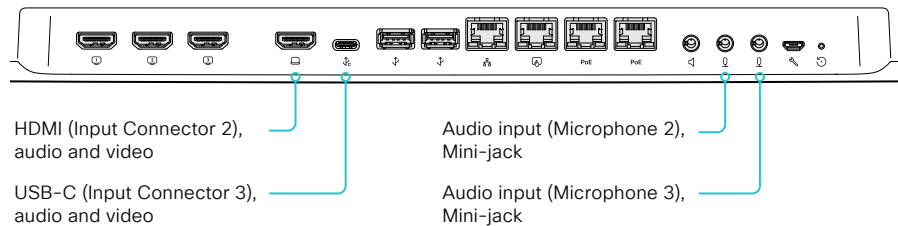

Room Kit Mini

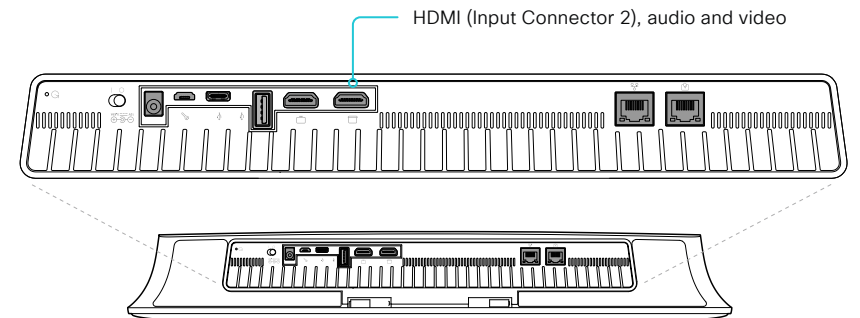

Board

Board Pro,
Board Pro
G2

Codec EQ

Codec
Plus

Codec
Pro

Desk,
Desk Pro,
Desk Mini

Room Bar
Pro,
Room Bar

Room Kit,
Room Kit
Mini

Room Kit
EQX

Room 55

Room
55 Dual,
Room 70

Room 70
G2

Room 70
Panorama

Room
Panorama

D15503.06

RoomOS

11.24

02-2025



Board

Board Pro,
Board Pro
G2

Codec EQ

Codec
Plus

Codec
Pro

Desk,
Desk Pro,
Desk Mini

Room Bar
Pro,
Room Bar

Room Kit,
Room Kit
Mini

Room Kit
EQX

Room 55

Room
55 Dual,
Room 70

Room 70
G2

Room 70
Panorama

Room
Panorama

D15503.06

RoomOS
11.24

02-2025



Connecting input sources (page 11 of 13)

Input connectors

 In general, it's good practice to turn off power when you connect or disconnect peripherals. Nevertheless, you can always connect a laptop and share content locally or in a call without powering down the device.

Desk and Desk Pro

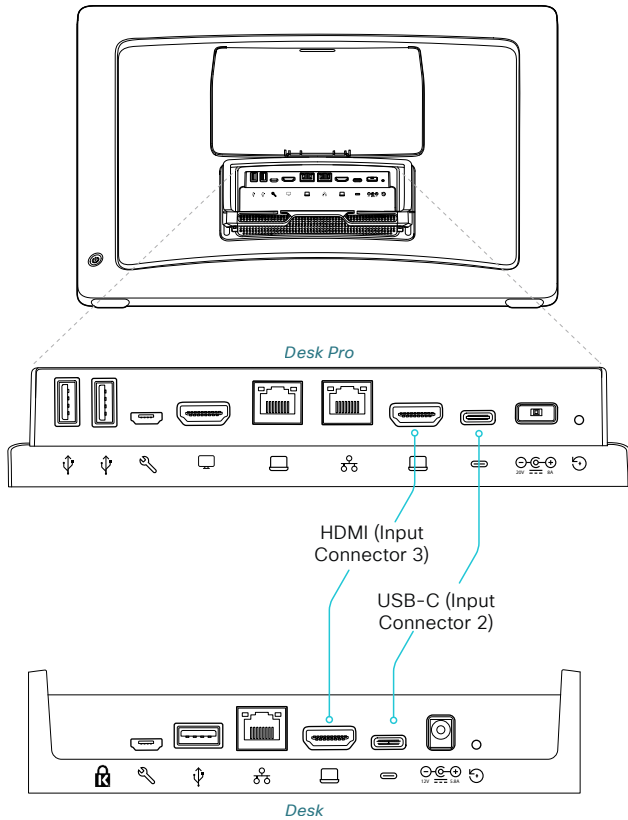

Desk Mini

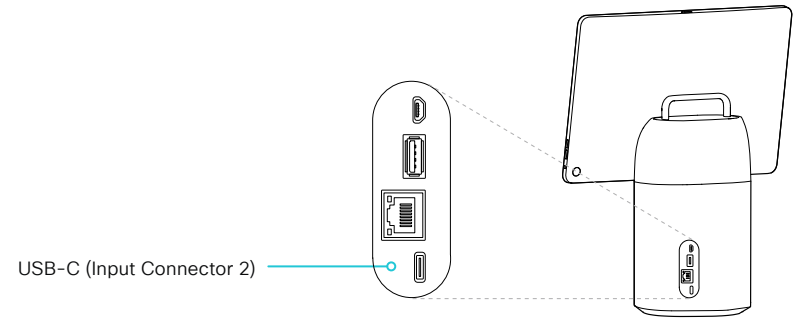

Board

BoardPro,
BoardPro
G2

Codec EQ

Codec
Plus

Codec
Pro

Desk,
Desk Pro,
DeskMini

Room Bar
Pro,
Room Bar

Room Kit,
Room Kit
Mini

Room Kit
EQX

Room 55

Room
55 Dual,
Room 70

Room 70
G2

Room 70
Panorama

Room
Panorama

Connecting input sources (page 12 of 13)

Input connectors

 In general, it's good practice to turn off power when you connect or disconnect peripherals. Nevertheless, you can always connect a laptop and share content locally or in a call without powering down the device.

Board

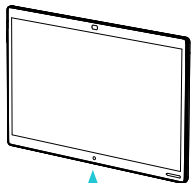

The connector panel is at the bottom

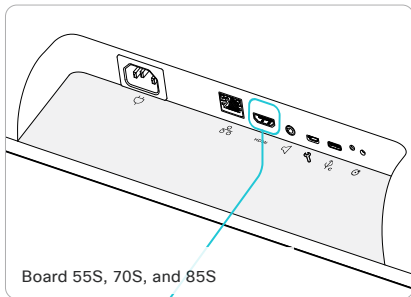

Board 55S, 70S, and 85S

HDMI (Input Connector 2), audio and video

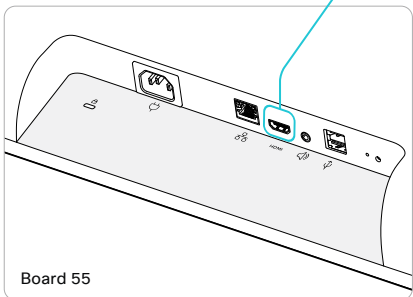

Board 55

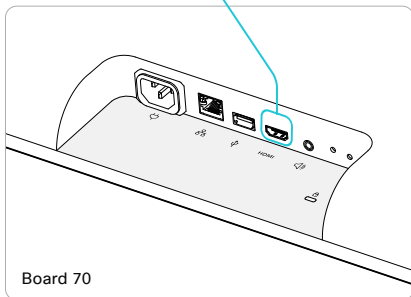

Board 70

Board Pro

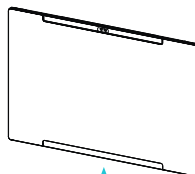

The connector panel is at the bottom

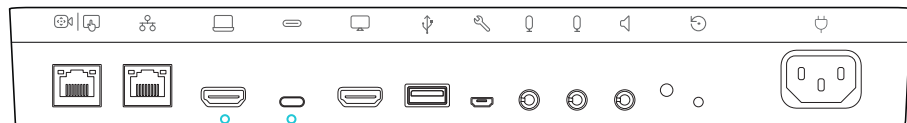

Audio input (Microphone 3),
Mini-jack

Audio input (Microphone 2),
Mini-jack

USB-C (Input Connector 2), audio and video

HDMI (Input Connector 3), audio and video

Board

BoardPro,
BoardPro
G2

Codec EQ

Codec
Plus

Codec
Pro

Desk,
Desk Pro,
Desk Mini

Room Bar
Pro,
Room Bar

Room Kit,
Room Kit
Mini

Room Kit
EQX

Room 55

Room 55
Dual,
Room 70

Room 70
G2

Room 70
Panorama

Room
Panorama

Connecting input sources (page 13 of 13)

Input connectors

 In general, it's good practice to turn off power when you connect or disconnect peripherals. Nevertheless, you can always connect a laptop and share content locally or in a call without powering down the device.

Board Pro

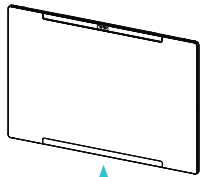

The connector panel is at the bottom

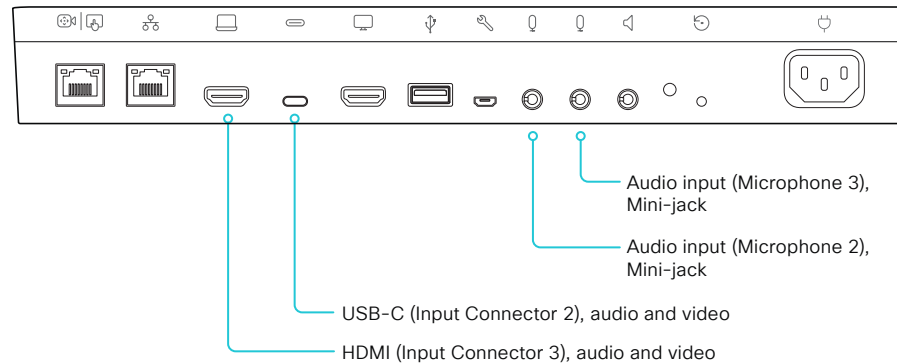

Board Pro G2

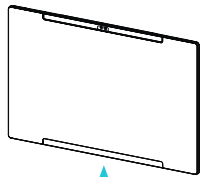

The connector panel is at the bottom

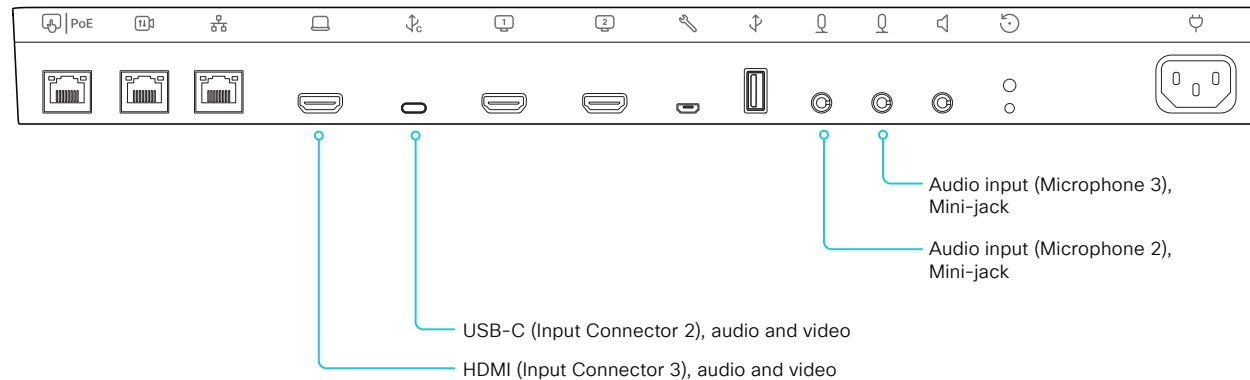

- Board
- BoardPro, BoardPro G2
- Codec EQ
- Codec Plus
- Codec Pro
- Desk, DeskPro, DeskMini
- Room Bar Pro, Room Bar
- Room Kit, Room Kit Mini
- Room Kit EQX
- Room 55
- Room 55 Dual, Room 70
- Room 70 G2
- Room 70 Panorama
- Room Panorama

Extend the number of input sources

You can customize our touch user interfaces to include input sources that are connected to a third-party external video switch.

The sources will appear and behave as any other video source that is connected directly to the video conferencing device.

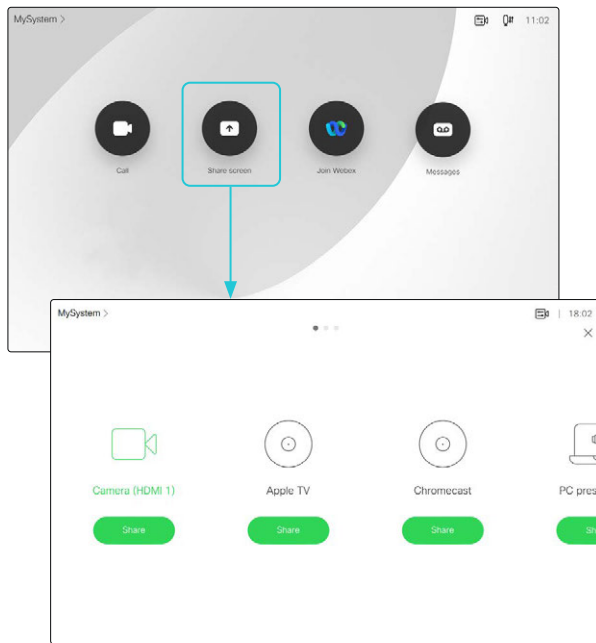

User interface with multiple external input sources (example)

Consult the *Customization guide* for full details about how to extend the user interface, and how to use the device's API to set it up. Go to:

<https://www.cisco.com/go/in-room-control-docs>

Architecture

You need a Cisco video conferencing device with a touch interface, a third-party control system, for example Lightware, Crestron, or AMX, and a third-party video switch. It is the control system, not the video conferencing device, that controls the video switch.

When you program the control system you must use the video conferencing device's API (events and commands)* in order to connect with the video switch and the controls on the touch interface. This way you can synchronize what is shown and done on the user interface with the actual state of the input sources.

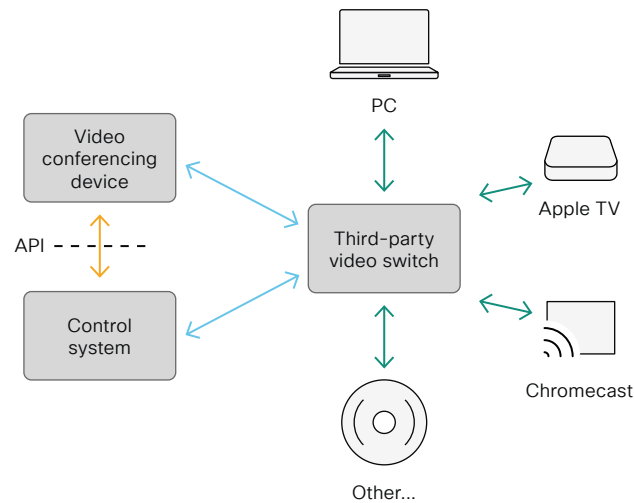

* You need a user that holds the ROOMCONTROL, INTEGRATOR, or ADMIN user roles in order to access the API commands that you need when programming the control system.

Board

BoardPro,
BoardPro
G2

Codec EQ

Codec
PlusCodec
ProDesk,
DeskPro,
DeskMiniRoom Bar
Pro,
Room BarRoom Kit,
Room Kit
MiniRoom Kit
EQX

Room 55

Room 55
Dual,
Room 70Room 70
G2Room 70
PanoramaRoom
Panorama

Information about displays

Display recommendations

As a technology leader in video conferencing, Cisco has created a certification program to further ensure premium meeting experiences with third party displays.

Cisco certifications are done using rigorous analysis and test specifications. These define a standard point of reference for performance that faithfully reproduces the engineering intent.

The Cisco collaboration devices are designed to optimize picture quality, minimize the camera-to-screen delay, implement robust standby handling, and implement other measures for an optimal experience.

Cisco certified or compatible displays

We recommend using Cisco certified or compatible displays. Compatibility is verified, and they give the best experience when connected to a Cisco device.

You can find information about the certification program and a list of supported third-party displays here:

► <https://cs.co/certifiedvendors>

Other displays

If not using a certified display, it is important that you configure the display is to give the best possible experience.

In the default display configuration, the delay through most displays is often very high (>100 ms). This can be detrimental to real-time communication quality.

The following display settings may reduce the delay:

- Activate *Game* mode, *PC* mode, or similar modes that are designed to reduce the response time and normally also the delay.
- Deactivate motion smoothing, such as *Motion Flow*, *Natural Motion*, or any other video processing that introduces delay.
- Deactivate advanced audio processing, such as *Virtual Surround* effects and *Dynamic Compression*, which will cause malfunctions in acoustic echo cancellation.

In order to achieve automatic input switching and standby control, the Consumer Electronics Control (CEC) function of the display may need to be enabled manually.

This function is then utilized as follows:

- The active video input on a display may be changed by the user through the manufacturer's user interface. Therefore, when a call is placed, the video conferencing device queries the active video input source and switches this source back to itself, if necessary.
- If the video conferencing device goes into standby without being the active input source, the display will not be set to standby.

Board

BoardPro,
BoardPro
G2

Codec EQ

Codec
PlusCodec
ProDesk,
DeskPro,
DeskMiniRoom Bar
Pro,
Room BarRoom Kit,
Room Kit
MiniRoom Kit
EQX

Room 55

Room 55
Dual,
Room 70Room 70
G2Room 70
PanoramaRoom
Panorama

Information about resolutions

Connecting a computer

It is the connected computer, or other input source, that finally decides which resolution to send to the video device.

The video device signals which resolutions it supports, and also its preferred resolution. The default preferred resolution depends on the video device. Also, different connectors on the same device may support and prefer different resolutions.

You can change the default preferred resolution as follows:

1. Sign in to the device web interface, go to [Settings](#), and select [Configurations](#).
2. Go to [Video > Input > Connector n > PreferredResolution](#), and adjust the value.
3. Click [Save](#).

If an error occurs when you connect a computer, a message will show on the screen or touch controller.

Connecting an external display

(Applies to: All products except Board, Desk, Desk Mini, Room 70 Panorama, and Room Panorama)

When you start the device for the first time, the setup assistant starts automatically. This is where you test the external display and adjust the settings. Follow the on-screen instructions.

If you need to adjust the settings for the external display at a later stage, sign in to the device web interface, go to [Settings](#), and select [Configurations](#). Go to [Video > Output > Connector n > Resolution](#), and adjust the screen resolution. Set the resolution according to what your display supports.

If your screen is black or flickering, you can set the resolution to a lower setting. If there still are problems, check that the cable is connected to a port on your display that supports Ultra HD. Check also that the Ultra HD settings are set to On on your display.

Cisco provides lists of Webex Room certified and compatible displays. Refer to the [Information about displays](#) chapter.

Checklist

For guaranteed operation, use cables from Cisco, or other certified cables. Refer to the [Information about HDMI and USB-C cables](#) chapter.

Check that the video conferencing device's connectors (input and/or output) are configured correctly.

Check that the connected external device has support for 4K and that it is configured correctly.

The need for high quality cables increases with 4K usage:

- 4kp30 uses about twice the data rate of 1080p60
- 4kp60 uses about four times the data rate of 1080p60

Board

BoardPro,
BoardPro
G2

Codec EQ

Codec
PlusCodec
ProDesk,
DeskPro,
DeskMiniRoom Bar
Pro,
Room BarRoom Kit,
Room Kit
MiniRoom Kit
EQX

Room 55

Room 55
Dual,
Room 70Room 70
G2Room 70
PanoramaRoom
Panorama

Information about HDMI and USB-C cables

You need HDMI or USB-C cables for:

- Presentation sources
- External cameras (*not supported by Board, Desk, Desk Mini, and Desk Pro*)
- External displays (*not supported by Board, Desk, and Desk Mini.*)

Some devices have HDMI inputs/outputs, some have USB-C inputs/outputs, and some have a combination of HDMI and USB-C inputs/outputs. Refer to the [Physical interfaces](#) chapter to find details of each device's connector panel.



For guaranteed operation we recommend that you order cables from Cisco^{1,2}, or use certified cables.

HDMI cables for presentation sources

A presentation source can be a PC/laptop, document camera, media player, whiteboard, or other device.

The resolution formats larger than 1920×1080@60fps require use of high speed HDMI cables. For guaranteed operation, use a HDMI cable from Cisco, or use a cable that complies with the high speed HDMI 1.4b Category 2 specification.

We recommend that you order the HDMI presentation cable from Cisco (HDMI 1.4b Category 2).

HDMI cables for external cameras and displays

The resolution formats larger than 1920×1200@60fps require use of high speed HDMI cables. For guaranteed operation, use HDMI cables that are pre-qualified from Cisco³ for use at 3840×2160@60fps, or use a cable that has passed the Premium HDMI Cable Certification Programme.

Extending the HDMI cable reach

In general, for formats larger than 1920×1200@60fps, we recommend connecting the source directly to the device with a good quality high speed HDMI cable.

To extend the cable reach beyond what is supported by a single cable, you need an extender or repeater that can maintain the signal quality over the required distance. Do not use a passive adapter.

USB-C cables

In general, you need USB-C cables that support USB 3.1 Gen 1 / USB 3.2 Gen 1x1:

- Length up to 2 meters for passive cables ²
- Power delivery 3A or 5A (60W or 100W) ⁴
- Support for DisplayPort Alternate Mode

More information

HDMI

You can find more information about HDMI cables at <http://www.hdmi.org>

Connecting input sources and displays to the video devices

You will find more details about how to connect displays, cameras, and computers to the different video devices in these sections:

[▶ Connecting input sources](#)

[▶ Setting up screens and other output devices](#)

¹ Our 4K multihead cables (CAB-HDMI-MUL4K-9M and CAB-HDMI-MUL4K-2M) support up to 4Kp30 resolutions, and are compatible with devices in the Board and Room series. The cables have connectors HDMI type A ↔ USB-C, Mini display port, and HDMI type A.

Our 1080p multihead cable (CAB-HDMI-MULT-9M) is not compatible with these devices.

² Our 9m *active*, optical USB-C cable (CAB-USBC-AC-9M) complies with USB 3.1 Gen 1 / USB 3.2 Gen 1x1 and provides charging (60W). The cable supports up to 4Kp60 resolutions, and can be used with all our devices that have USB-C connectors except Desk and Desk Pro (the exception is due to the physical size of the connector).

³ Our 8m *active* HDMI cable (CAB-PRES-2HDMI-GR) supports up to 4Kp30 resolutions. It is only for presentation sources; don't use it for a camera that requires ARC (Quad Camera).

⁴ Required only for inputs that offer power charging over USB-C.

- Board
- Board Pro, Board Pro G2
- Codec EQ
- Codec Plus
- Codec Pro
- Desk, Desk Pro, Desk Mini
- Room Bar Pro, Room Bar
- Room Kit, Room Kit Mini
- Room Kit EQX
- Room 55
- Room 55 Dual, Room 70
- Room 70 G2
- Room 70 Panorama
- Room Panorama

Set up automatic framing features (page 1 of 5)

The device's automatic framing capabilities depend on the camera. The major framing features are:

- Best overview - the smallest frame that still covers all people in the room
- Speaker tracking - zoom in on the active speaker (closeup) or a group of people close to the speaker (group framing)
- Frames - composition of closeups of all individuals, excess background removed

	Best overview	Closeup and group framing	Frames
Board Pro G2, Board Pro, Board	x	x	x
Desk Pro, Desk, Desk Mini	x		
Codec EQ ¹ , Codec Plus ² , Codec Pro ²	x	x	x
Room Bar, Room Bar Pro	x	x	x
Room Kit Mini,	x		x
Room Kit, Room 55	x	x	x
Room Kit EQX	x	x	x
Room 55 Dual, Room 70, Room 70 G2	x	x	x
Room 70 Panorama ³ , Room Panorama ³	x	x	

Best overview

Head detection⁴ and automatic camera framing are used to assess the situation and compose the *best overview* containing all the people in the room. If people are moving around in the room or additional participants enter the room, the system will adapt and automatically adjust to include all persons in the frame.

Limit the maximum view (room overview)

Not supported by the SpeakerTrack 60 camera, Desk series devices, or the Room Panorama / Room 70 Panorama in panoramic video scenarios.

By default, the maximum view for best overview / speaker tracking (room overview) is the fully zoomed-out camera view.

The user can define a less zoomed-out view as maximum from the user interface⁵.

Limit the view by using a meeting zone

Not supported by the SpeakerTrack 60 camera.

The meeting zone feature allows you to limit the area that the speaker track and video framing logic uses when deciding what to include in the video frames. This feature may be useful in open offices, meeting rooms with glass walls, or the like. People outside the defined meeting zone, don't influence the choice of the most suitable video framing.

Read the [Set up a meeting zone](#) chapter to learn how to set up a meeting zone.

¹ Requires Quad Camera.

² Requires Quad Camera or SpeakerTrack 60 camera.

³ In panoramic video scenarios, the 2-camera panoramic view cannot be switched off. In all other scenarios, the automatic framing features works and can be configured as described in this chapter.

⁴ Exception: The SpeakerTrack 60 camera is using a face detection algorithm instead of a head detection algorithm. Therefore speaker tracking / best overview doesn't work well when people are wearing masks.

⁵ For Board series: You can only define the new view limits from a connected touch controller; not from the Board itself.

Closeup and group framing

Not supported by Desk, Desk Mini, Desk Pro, or Room Kit Mini.

When closeup is enabled (*Cameras > SpeakerTrack > Closeup*), audio tracking is used to locate the active speaker in a room.

Once the active speaker is located, the device decides whether to focus and zoom in solely on the active speaker (closeup) or to create frames that include, not only the active speaker, but also the participants in close proximity to him/her (group framing). Other participants will be excluded from the frame.

If you want to ensure that everyone in the room is always in the camera frame, turn off the closeup functionality.

For cameras and devices that support group framing, finding a good group framing is prioritized over making a closeup of only the active speaker. This has the positive effect of reducing the total number of switches and thereby creating a more natural user experience. For example, if another person within the frame starts to speak, the camera will most likely not need to reframe.

Also, depending on the maximum zoom factor of the camera and the distance at which the speaker is located away from the camera, it might not be possible to create a framing for the speaker alone.

- Board
- BoardPro, BoardPro G2
- Codec EQ
- Codec Plus
- Codec Pro
- Desk, Desk Pro, DeskMini
- Room Bar Pro, Room Bar
- Room Kit, Room Kit Mini
- Room Kit EQX
- Room 55
- Room 55 Dual, Room 70
- Room 70 G2
- Room 70 Panorama
- Room Panorama

Set up automatic framing features (page 2 of 5)

Frames

When Frames is enabled (*Cameras > SpeakerTrack > Frames > Mode*), the camera will zoom and show people individually or in smaller groups. These individual and group frames are further composed into one outgoing video stream. In this stream excess background is removed, the people are shown closer to each other, uniform in size, and at the same eye level.

The camera supports up to four frames. All the image processing is done on the sender side, so the receiving device doesn't have to support Frames.

Frames mode depends on the speaker tracking technology; hence the *Cameras > SpeakerTrack > Mode* must be set to *Auto* for Frames to work.



Video stream *without* Frames enabled



Video stream *with* Frames enabled

Board

Board Pro,
Board Pro
G2

Codec EQ

Codec
PlusCodec
ProDesk,
Desk Pro,
Desk MiniRoom Bar
Pro,
Room BarRoom Kit,
Room Kit
MiniRoom Kit
EQX

Room 55

Room
55 Dual,
Room 70Room 70
G2Room 70
PanoramaRoom
Panorama

Set up automatic framing features (page 3 of 5)

Camera specifics

Cisco Quad Camera

(an option for Codec EQ, Codec Plus, and Codec Pro)

- The camera supports best overview, closeup and group framing, and frames.
- Finding a good group framing is prioritized over making a closeup of only the active speaker.
- The camera has a lower maximum zoom factor than the SpeakerTrack 60 camera and therefore cannot zoom in so closely on speakers far away from the camera.
- The maximum zoom level that can be saved on a preset camera position is 95%. Any zoom level beyond this maximum will be saved at 95%.
- Certain room conditions such as lighting and acoustics, can significantly impact the Quad camera's ability to detect every person present. Speaker tracking functionality works best under optimal room conditions in combination with a seating area that is a maximum of 8m/26ft deep and up to 5m/16ft wide, in relation to the camera's position. Sub-optimal room conditions or a camera distance greater than 8m/26ft will cause performance to degrade.
- Participants seated outside the horizontal field of view (83°) will not be detected.

Cisco TelePresence SpeakerTrack 60 Camera

(an option for Codec Plus and Codec Pro)

- The dual camera assembly consists of two cameras that support best overview and closeup.
- Group framing is not supported. When a change of speaker is detected, the video conferencing device will switch automatically between the two cameras to always show the optimal camera frame.
- SpeakerTrack 60 works best when the room's seating area is a maximum of 9m/30ft deep and 5m/16ft wide, in relation to the camera's position.
- Participants seated outside the horizontal field of view (80°) will not be detected. Room conditions such as lighting, also impact the camera's ability to detect people.

Board

BoardPro,
BoardPro
G2

Codec EQ

Codec
PlusCodec
ProDesk,
DeskPro,
DeskMiniRoom Bar
Pro,
Room BarRoom Kit,
Room Kit
MiniRoom Kit
EQX

Room 55

Room 55
Dual,
Room 70Room 70
G2Room 70
PanoramaRoom
Panorama

Set up automatic framing features (page 4 of 5)

Sign in to the device web interface, go to [Settings](#), and select [Configurations](#), to find the settings referred.

Configure the automatic framing features

Best overview / Speaker tracking

[Cameras > SpeakerTrack > Mode](#)

Enable or disable Best overview / Speaker tracking.

Auto: Best overview / Speaker tracking is enabled by default. Users can switch the mode on or off instantly from the camera control panel in the user interface.

Off: Best overview / Speaker tracking is switched off and it is not possible to switch it on from the user interface.

Closeup and group framing

Not supported by Desk, Desk Mini, Desk Pro, and Room Kit Mini.

[Cameras > SpeakerTrack > Closeup](#)

This setting only applies when the [Cameras > SpeakerTrack > Mode](#) is set to **Auto**.

Turn on/off the closeup and group framing feature.

Auto: The behavior depends on the device type. **Board** will strive to keep everyone in the room in the camera frame at all times. The other devices will zoom in either solely on the active speaker or the active speaker and the participants in close proximity to him/her (group frame).

Off: The device will keep everyone in the room in the camera frame at all times.

On: The device will zoom in either solely on the active speaker or the active speaker and the participants in close proximity to him/her (group frame).

Frames

Not supported by Desk, Desk Mini, Desk Pro, Room 70 Panorama, and Room Panorama.

[Cameras > SpeakerTrack > Frames > Mode](#)

This setting only applies when the [Cameras > SpeakerTrack > Mode](#) is set to **Auto**.

Turn on/off support for the Frames camera mode (removal of excess background).

Auto: The user can switch Frames on and off using the camera controls on the device's user interface.

Off: Frames are not available.

Board

BoardPro,
BoardPro
G2

Codec EQ

Codec
PlusCodec
ProDesk,
Desk Pro,
DeskMiniRoom Bar
Pro,
Room BarRoom Kit,
Room Kit
MiniRoom Kit
EQX

Room 55

Room
55 Dual,
Room 70Room 70
G2Room 70
PanoramaRoom
Panorama

Set up automatic framing features (page 5 of 5)

Tracking mode

Applies to Codec Plus and Codec Pro, when these devices are using a SpeakerTrack 60 camera.

The tracking mode defines how fast the camera view will switch to a new speaker when the tracking algorithm detects a change.

[Cameras > SpeakerTrack > TrackingMode](#)

Auto: This is the default setting.

Conservative: The device reacts slower to detected changes and delays switching the camera view.

Speaker track connector detection

Applies to Codec Plus and Codec Pro, when these devices are using a SpeakerTrack 60 camera.

In most cases the device detects automatically which inputs the left and right camera of the Speaker Track 60 are connected to. You should only set the connector detection mode to Manual if that's not the case.

[Cameras > SpeakerTrack > ConnectorDetection > Mode](#)

Auto: The device will automatically detect the video input.

Manual: Manually configure the video input for each individual camera. You should choose manual configuration in situations where the video conferencing device does not receive Extended Display Identification Data (EDID) information from the cameras.

If the connector detection mode is set to Manual, you must specify which video input connectors the left and right cameras are connected to.

[Cameras > SpeakerTrack > ConnectorDetection > CameraRight](#)

[Cameras > SpeakerTrack > ConnectorDetection > CameraLeft](#)

Set the number of the video input connectors that the left and right camera of the SpeakerTrack 60 are connected to.

Settings that are overridden by the speaker track functionality

Applies to Codec Plus and Codec Pro, when these devices are using a SpeakerTrack 60 camera.

These settings are changed automatically when speaker tracking is on:

- [Video > Input > Connector n > Quality](#)

These settings are always forced to **Motion** for the connectors where the dual cameras are connected. If both settings are already set to **Motion**, there is no change.

- [Video > Input > Connector n > OptimalDefinition > Threshold60fps](#)

These settings will stay untouched if they are already equal for the connectors where the dual cameras are connected. If they are not equal, the lowest threshold among the two is preferred.

- [Video > Input > Connector n > OptimalDefinition > Profile](#)

These settings will stay untouched if they are already equal for the connectors where the dual cameras are connected. If they are not equal, the preferred setting is the first value in the list, (**Normal**, **Medium**, **High**) that one of the two settings has.

The settings above are restored to their previous values when speaker tracking is turned off. This is regardless of whether you have used the user interface or the [Cameras > SpeakerTrack > Mode](#) setting to turn off speaker tracking.

- Board
- BoardPro, BoardPro G2
- Codec EQ
- Codec Plus
- Codec Pro
- Desk, DeskPro, DeskMini
- Room Bar Pro, Room Bar
- Room Kit, Room Kit Mini
- Room Kit EQX
- Room 55
- Room 55 Dual, Room 70
- Room 70 G2
- Room 70 Panorama
- Room Panorama

Set up a meeting zone

Not supported by the SpeakerTrack 60 camera.

The meeting zone feature allows you to limit the area that the speaker track and video framing logic uses when deciding what to include in the video frames. This feature may be useful in open offices, meeting rooms with glass walls, or the like. People outside the defined meeting zone, don't influence the choice of the most suitable video framing.

Note that setting up a meeting zone is no guarantee for areas outside the zone never being captured by the camera and sent to the far end.

Define the meeting zone

The easiest way to define a meeting zone is to use the graphical tool on the device's user interface.

1. Swipe in from the right or tap the controls icon  in the upper, right corner to open the control panel. Then select *Device settings*.
2. Select *Meeting Zone* and choose between the two standard meeting zones layout: rectangular zone or round zone.

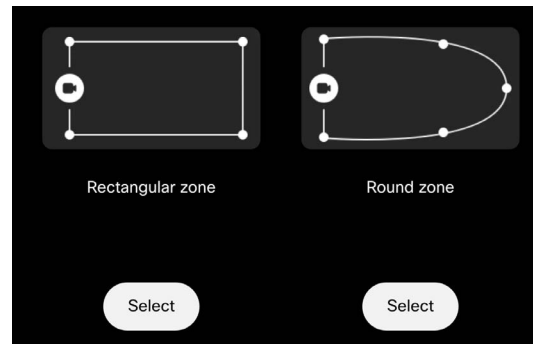

3. Drag the anchor points to the desired position to change the shape of the zone.

Long press a point to delete it or long press anywhere on the grid to add a new anchor point.

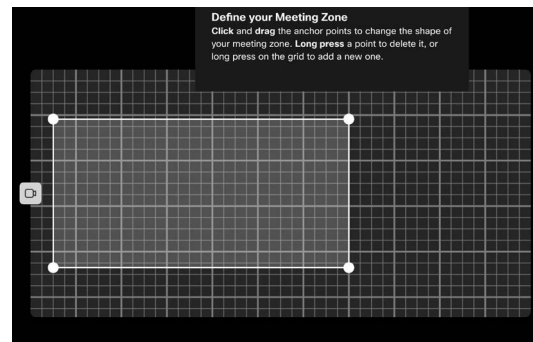

Blue dots represent the position of the people currently in the room. These dots are useful when checking that the size and shape of the meeting zone is as planned. It's easier if you are more than one person in the room.

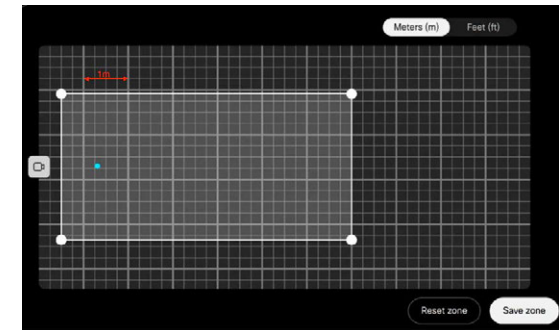

4. Once you are done, tap *Save zone*.

Alternatively, you can use the following setting (from the web UI or using the API) to define the shape of the meeting zone:

[Cameras > SpeakerTrack > MeetingZone > Area](#)

Enable the meeting zone feature

Use the following setting to enable (Auto) or disable (Off) the meeting zone feature:

[Cameras > SpeakerTrack > MeetingZone > Mode](#)

If a meeting zone is defined and enabled, the user can toggle the feature on and off with the *Meeting Zone Active* button on the user interface.

Board

BoardPro,
BoardPro
G2

Codec EQ

Codec EQ

Codec
ProDesk,
Desk Pro,
DeskMiniRoom Bar
Pro,
Room BarRoom Kit,
Room Kit
MiniRoom Kit
EQX

Room 55

Room
55 Dual,
Room 70Room 70
G2Room 70
PanoramaRoom
Panorama

Cross-view and extended speaker view

Cross-view is an AI-driven feature that brings a cinematic view to your meetings, using two side PTZ 4K or Quad cameras, one Quad camera above the screen, Codec EQ/Room Kit EQX or Codec Pro, and Table Microphone Pros or Ceiling Microphone Pros. By analyzing room activity, recognizing speakers, and tracking where people are facing, the system automatically picks the best camera angle to get the best view.

The Extended speaker view feature enhances video conferencing by providing high-quality close-ups of all participants, including those seated at the far end of a long table. This is achieved using a PTZ 4K camera mounted above a Quad camera, a Codec EQ/Room Kit EQX or Codec Pro, and Table Microphones Pros or Ceiling Microphone Pros.

NOTE: Improvements in experience and quality can be expected with future releases. A reconfiguration of the room will be necessary once improvements become available in the future.

References

Read the Room preparation guidelines for a successful installation and use of Cross-view and Extended speaker view.

► https://www.cisco.com/c/dam/en/us/td/docs/telepresence/endpoint/camera/cross-view_guidelines.pdf

These guidelines cover aspects related to room dimensions, camera positionings, and other factors such as table size, seating arrangements, microphones, acoustic considerations, and lighting.

Check the Multi camera director setup to read about each step of the Multi camera director setup wizard.

► https://www.cisco.com/c/dam/en/us/td/docs/telepresence/endpoint/camera/Multi_camera_director_setup.pdf

Download and print the Calibration board. You will need it during the Multi camera director setup wizard.

► <https://help.webex.com/ikp5ys/>

Check the SpeakerTrack using external microphones and follow each step of the wizard to use the Table Microphones Pro for tracking the speaker's position. This enables better video framing.

► https://www.cisco.com/c/dam/en/us/td/docs/telepresence/endpoint/camera/SpeakerTrack_using_external_microphones.pdf

- Board
- Board Pro, Board Pro G2
- Codec EQ
- Codec Plus
- Codec Pro
- Desk, Desk Pro, Desk Mini
- Room Bar Pro, Room Bar
- Room Kit, Room Kit Mini
- Room Kit EQX
- Room 55
- Room 55 Dual, Room 70
- Room 70 G2
- Room 70 Panorama
- Room Panorama

Set up the PresenterTrack feature (page 1 of 6)

The PresenterTrack feature enables the camera to follow a presenter that is moving about on stage. The tracking stops when the presenter leaves the stage.

PresenterTrack support depends on both the video device and the camera. The table lists the devices that support presenter tracking, and it shows which camera they require to do so.

Capabilities and limitations

- Once set up, the user can activate and deactivate PresenterTrack from the camera panel on the touch controller.
- The camera uses digital pan, tilt, and zoom, so it doesn't move physically while tracking the presenter.
- PresenterTrack supports the tracking of one or more persons on stage. If they stand too far apart to fit within a zoomed view, the camera zooms out to show the full stage.
- You can use PresenterTrack as a standalone feature, or as part of the Presenter and Audience, Briefing room, and Classroom scenarios.
- You cannot use PresenterTrack and SpeakerTrack simultaneously.
 - When you activate PresenterTrack, SpeakerTrack is disabled automatically.
 - When you activate SpeakerTrack, PresenterTrack is disabled automatically.

There is one exception to this: In the Presenter and Audience, Briefing room, and Classroom scenarios both features are active simultaneously in the Q&A mode (when someone in the local audience asks a question, while the device is in *Local Presenter* mode).

Devices and cameras with PresenterTrack support

	PTZ 4K camera	Precision 60 camera
Board Pro G2	✓	
Board Pro	✓	
Codec EQ	✓	✓
Codec Plus*	✓	✓
Codec Pro*	✓	✓
Room Bar Pro	✓	
Room Kit EQX	✓	✓
Room 55 Dual, Room 70	✓	✓
Room 70 G2	✓	✓

* You may connect a SpeakerTrack 60 camera assembly, and set up the device to use one of the cameras in the assembly for PresenterTrack.

Board

BoardPro,
BoardPro
G2

Codec EQ

Codec
PlusCodec
ProDesk,
Desk Pro,
DeskMiniRoom Bar
Pro,
Room BarRoom Kit,
Room Kit
MiniRoom Kit
EQX

Room 55

Room 55
Dual,
Room 70Room 70
G2Room 70
PanoramaRoom
Panorama

Set up the PresenterTrack feature (page 2 of 6)

Considerations before placing the camera

When you set up PresenterTrack, you must define a stage area and a trigger zone. Consider the location and use of these areas when placing the camera that is tracking the presenter on stage.

We recommend you to be in the same room as the video conferencing device and camera while setting up PresenterTrack.

Stage area

The stage area is the zoomed-out overview image.

- Make it large enough so that the presenter can move about on stage. The tracking stops when the presenter leaves the stage area.
- Allow the audience or meeting participants to move naturally in the room without triggering the tracking.

Trigger zone

Presenter tracking doesn't start before the camera detects a head in the trigger zone.

- Choose a location where the presenter naturally enters the stage, for example by a presenter table or podium.
- Make it large enough for the camera to detect the head of the presenter.
- To avoid a false head detection, make sure that the background of the trigger zone is neutral. Avoid having the trigger zone in front of a screen.

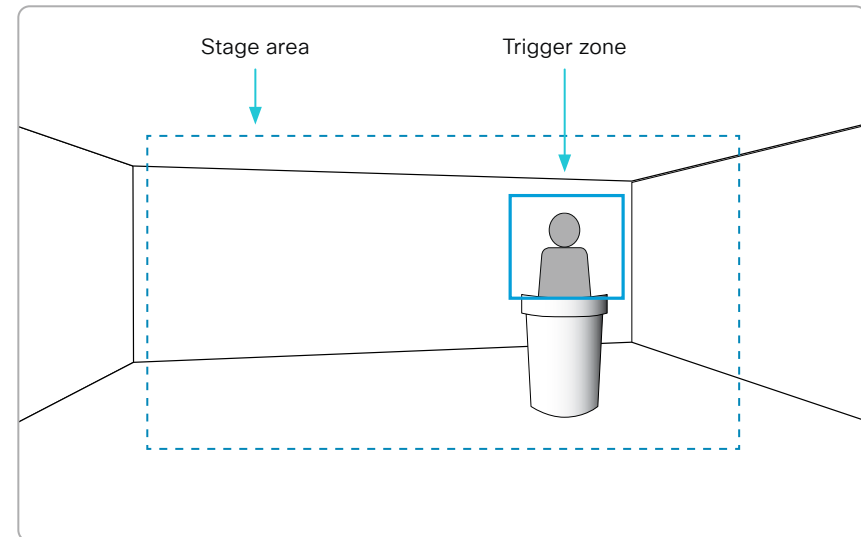

Board

BoardPro,
BoardPro
G2

Codec EQ

Codec
Plus

Codec
Pro

Desk,
Desk Pro,
DeskMini

Room Bar
Pro,
Room Bar

Room Kit,
Room Kit
Mini

Room Kit
EQX

Room 55

Room 55
Dual,
Room 70

Room 70
G2

Room 70
Panorama

Room
Panorama

Set up the PresenterTrack feature (page 3 of 6)

Set up and test PresenterTrack

We recommend you to be in the same room as the video conferencing device and camera while setting up PresenterTrack.

1. Sign in to the device web interface, go to [Settings](#) and open the [Configurations](#) tab.

For the connector (n) that the camera is connected to, set:
 - [Video > Connector n > InputSourceType](#): camera
 - [Video > Connector n > CameraControl > Mode](#): On

2. If using a PTZ4K camera, enable 4K resolution with [Cameras > Camera n > VideoFormat](#): 3840_2160_30

Note that the codec needs to go into standby for this to take effect.

3. Go to [Settings](#), open the [Audio and Video](#) tab, and open the [Presenter Track](#) sub-tab.

4. Toggle on [Enable PresenterTrack](#) and click [Configure](#) to open the configuration page.

Opening this page deactivates standby and presenter tracking, enables the self-view in full screen, and shows the trigger zone rectangle on the screen of the device.



Don't leave this web page without clicking [Done](#), otherwise the trigger zone rectangle stays visible on the screen of the device.

Alternatively, you can remove the rectangle by opening the control panel on the device's user interface, tap [Camera](#), and select a new camera mode or preset.

5. On the device's user interface, open the control panel and select [Camera](#) followed by [Manual](#). Choose the correct camera from the drop down list (if your device has more than one camera) and use the camera controls (zoom, pan, tilt) on the touch controller to define the stage area.

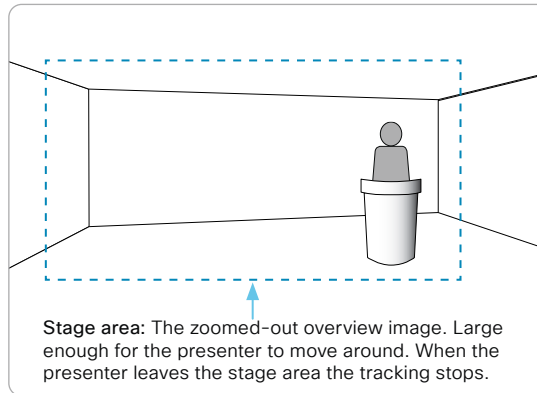

Stage area: The zoomed-out overview image. Large enough for the presenter to move around. When the presenter leaves the stage area the tracking stops.

You see a notification if the camera does not support the PresenterTrack feature.

6. A blue dashed rectangle, which represents the trigger zone, is shown on the device web interface. Move and resize the rectangle while watching the screen of the device. You see the same rectangle overlaying the camera self-view. Place the rectangle where you want the trigger zone to be.

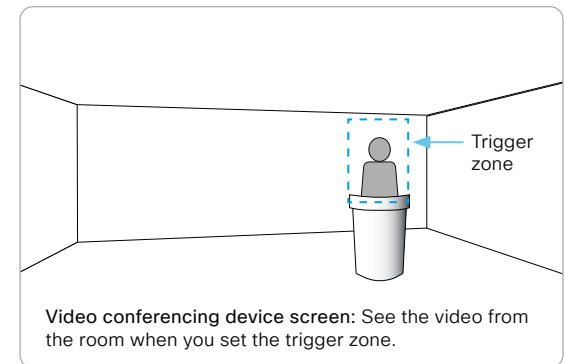
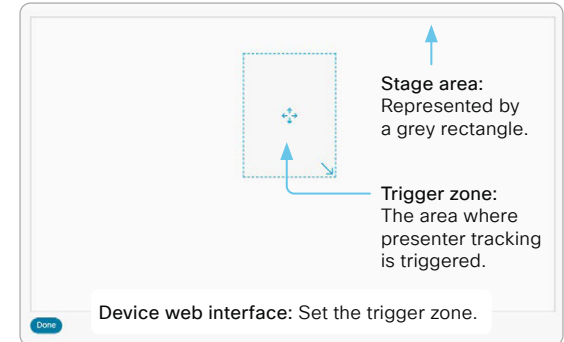

If you want to set up a more advanced polygonal trigger zone, see the [Set up a polygonal trigger zone](#) chapter.

7. Click [Done](#).

- Board
- BoardPro, BoardPro G2
- Codec EQ
- Codec Plus
- Codec Pro
- Desk, Desk Pro, DeskMini
- Room Bar Pro, Room Bar
- Room Kit, Room Kit Mini
- Room Kit EQX
- Room 55
- Room 55 Dual, Room 70
- Room 70 G2
- Room 70 Panorama
- Room Panorama

Set up the PresenterTrack feature (page 4 of 6)

8. On the device's user interface, open the control panel and select *Camera* followed by *Presenter*.

This activates presenter tracking.

9. Position yourself in the trigger zone and see that the camera zooms in on you.

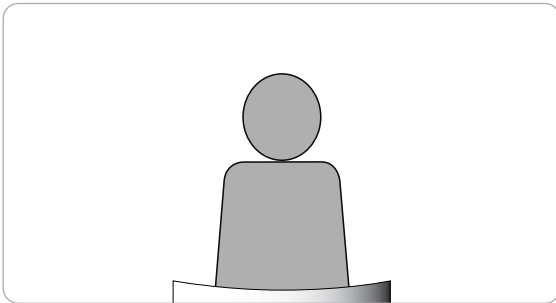
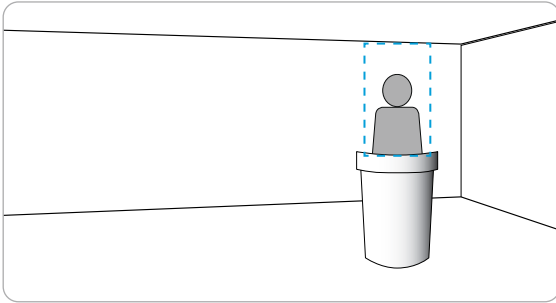

10. Walk about on the stage and check that the camera follows you.

11. Check that presenter tracking stops when you leave the stage.

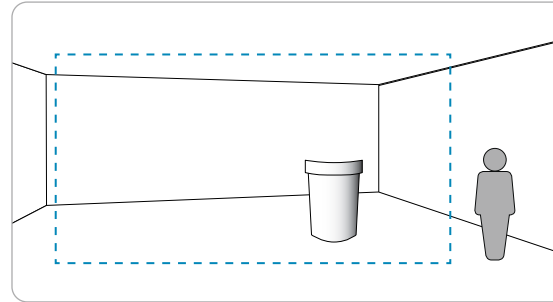

If something fails, go back to step 3, 4 and 5 to adjust the size and location of the stage area and the trigger zone.

For more troubleshooting help, you can switch on PresenterTrack *Diagnostics Mode*, as described on the next page.

Temporarily activate or deactivate PresenterTrack

During a meeting, you can use the touch controller to temporarily activate or deactivate presenter tracking.

1. On the device's user interface, open the control panel and select *Camera*.
2. Select *Presenter* in the list of camera modes and presets to activate presenter tracking.

Select something other than *Presenter* in the list of camera modes and presets to deactivate presenter tracking.

If presenter tracking has been deactivated, the presenter must enter the trigger zone again in order for tracking to start.

Board

BoardPro,
BoardPro
G2

Codec EQ

Codec
PlusCodec
ProDesk,
Desk Pro,
DeskMiniRoom Bar
Pro,
Room BarRoom Kit,
Room Kit
MiniRoom Kit
EQX

Room 55

Room 55
Dual,
Room 70Room 70
G2Room 70
PanoramaRoom
Panorama

Set up the PresenterTrack feature (page 5 of 6)

Set up a polygonal trigger zone

You can set up only rectangular trigger zones from the [Presenter Track](#) web page.

If you want to define a more advanced polygonal trigger zone, you must go to [Settings](#), select [Configurations](#), and find the [Cameras > PresenterTrack > TriggerZone](#) setting.

The value of this setting is a string that contains the coordinate pairs of all the vertices of the polygon.

Example:

Define the following trigger zone, which has 12 vertices. Such a trigger zone may be convenient if there is a screen, which you want to avoid, behind the presenter.

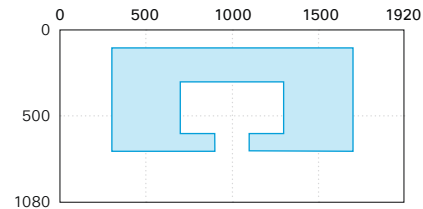

The coordinates of the vertices are:

(300,100)
(1700,100)
(1700,700)
(1100,700)
(1100,600)
(1300,600)
(1300,300)
(700,300)
(700,600)
(900,600)
(900,700)
(300,700)

The corresponding setting value is:

[Cameras > PresenterTrack > TriggerZone](#): 300,100,1700,100,1700,700,1100,700,1100,600,1300,600,1300,300,700,300,700,600,900,600,900,700,300,700

- Board
- BoardPro, BoardPro G2
- Codec EQ
- Codec Plus
- Codec Pro
- Desk, Desk Pro, DeskMini
- Room Bar Pro, Room Bar
- Room Kit, Room Kit Mini
- Room Kit EQX
- Room 55
- Room 55 Dual, Room 70
- Room 70 G2
- Room 70 Panorama
- Room Panorama

Set up the PresenterTrack feature (page 6 of 6)

Diagnostics mode

The PresenterTrack diagnostics mode may be a helpful tool when troubleshooting an issue. In order to set the device in diagnostics mode, you have to use the xAPI of the device.

Sign in to the xAPI and run the following command:

- xCommand Cameras PresenterTrack Set Mode: Diagnostic

In this mode, you see the stage area (the zoomed-out overview image) on the screen, and an overlay with the following indicators:

- RED frame: The trigger zone.
- LIGHT BLUE frame: The zoomed-in view of the presenter.
- GREEN frame: A head that is detected and tracked.
- GREEN or RED blinking filled frame: Head detections. Green color indicates a high confidence, red color indicates a low confidence.
- BLUE: A head is detected but the head is not tracked.

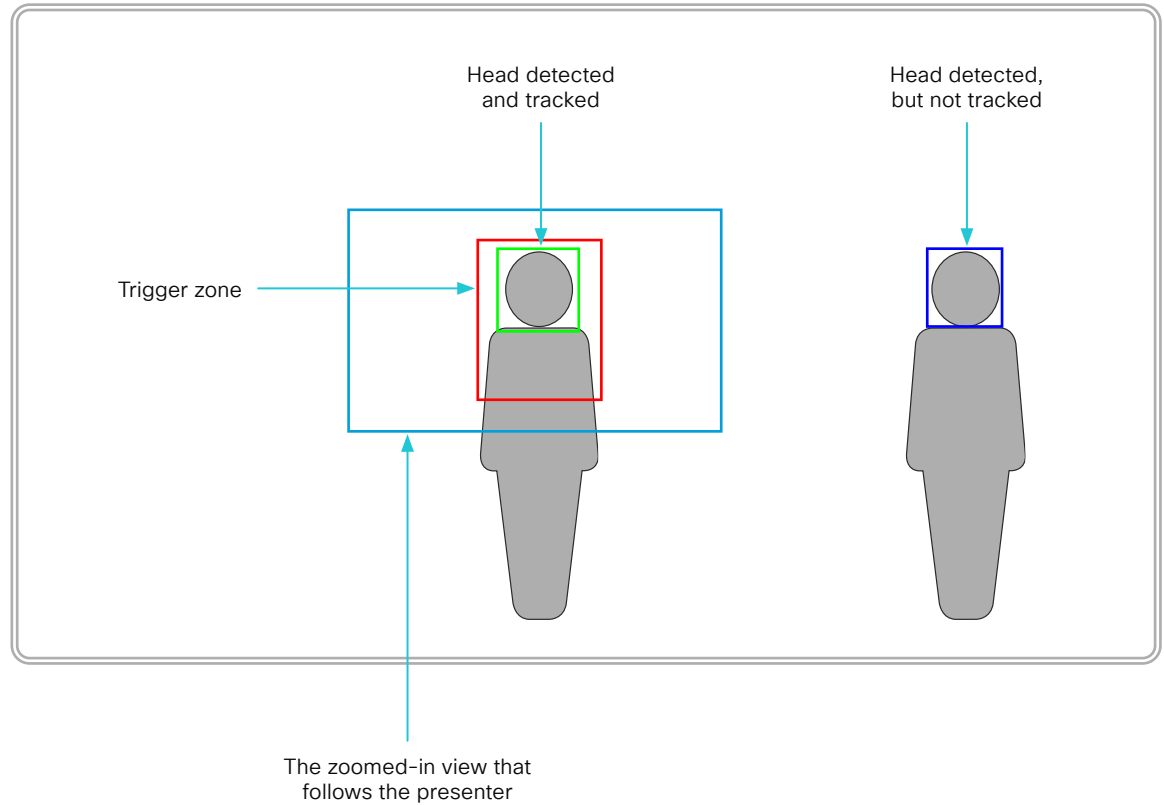

Board

BoardPro,
BoardPro
G2

Codec EQ

Codec
PlusCodec
ProDesk,
Desk Pro,
DeskMiniRoom Bar
Pro,
Room BarRoom Kit,
Room Kit
MiniRoom Kit
EQX

Room 55

Room 55
Dual,
Room 70Room 70
G2Room 70
PanoramaRoom
Panorama

Presenter and Audience setup (page 1 of 14)

The *Presenter and Audience* setup is tailored for using a room to deliver hybrid events, such as training sessions or town halls. The setup is built around three modes:

- The presenter is in the room (local presenter)
- The presenter is on video (remote presenter)
- There are presenters both in the room and on video (hybrid presenter)

The device automatically detects where the presenter is and selects a mode based on that. Alternatively, the user can override the automatic behavior and select the mode manually from the user interface.

The *Presenter and Audience* setup is available as a room type template. When you set up a room using a template, a set of configurations is pushed automatically to the device. It is important that the room is set up correctly, and that the cameras and screens are connected exactly as specified. Otherwise the configurations will not match the room.

Required equipment

- One of the following devices:
 - Codec EQ, Codec Plus, Codec Pro
 - Room Kit EQX, Room 55 Dual, Room 70, Room 70 G2
 - Room Bar Pro
- Two or three screens
- Two cameras (*Audience camera* and *Presenter camera*)
- Microphones
- Loudspeakers
- Touch controller

More details on the following page.

Limitations

- The setup works only for Webex meetings and SIP calls.
- All microphones support automatic switching of room modes (local, remote, or hybrid presenter). Currently, only analog microphones support the most advanced automatic behavior.

Comparing the room type setups

Presenter and Audience: This is the next generation *Briefing room* and *Classroom* setup. Updates and improvements will only be for *Presenter and Audience*.^{*}

Compared to the older setups, you get:

- Easier manual layout selection options.
- Improved camera switching based on voice activity detection.
- Improved diagnostics tools, such as the diagnostics page that is available on the touch controller.

Supported products: Codec EQ, Codec Plus, Codec Pro, Room Kit EQX, Room 55 Dual, Room 70, Room 70 G2, and Room Bar Pro

Briefing room:

Supported products: Codec EQ, Codec Pro, Room Kit EQX, Room 70 G2, and Room Bar Pro

The setup requires three screens, and the layouts on the screens are preconfigured (and fixed) to match that particular scenario.

Classroom: More flexible than the *Briefing room* setup regarding the number of screens and how the layout is distributed on the screens.

Supported products: Codec EQ, Codec Plus, Codec Pro, Room Kit EQX, Room 55 Dual, Room 70, Room 70 G2, and Room Bar Pro

You can use any number of screens that the device supports, typically two or three. Use the video monitor settings to configure the distribution of layouts on the screens, if the default behavior does not fulfill your requirements.

^{*} *Briefing room* and *Classroom* may be deprecated in a later software release.

- Board
- Board Pro, Board Pro G2
- Codec EQ
- Codec Plus
- Codec Pro
- Desk, Desk Pro, Desk Mini
- Room Bar Pro, Room Bar
- Room Kit, Room Kit Mini
- Room Kit EQX
- Room 55
- Room 55 Dual, Room 70
- Room 70 G2
- Room 70 Panorama
- Room Panorama

Presenter and Audience setup (page 2 of 14)

Definitions and room recommendations

Audience camera

Use the integrated camera for video devices that have that. For other devices, we recommend a camera that supports speakertracking, such as the Quad Camera. It is also possible to use a camera without speaker tracking capabilities.

Presenter camera

A PTZ 4K or Precision 60 camera with presenter tracking enabled.

Screens

You can use two or three screens (the maximum number depends on your type of device).

- *Screen 1*: Placed at the front. For integrated devices with two screens, it's the left screen.
- *Screen 2*: Placed next to *screen 1* at the front. For devices with two integrated screens, *screen 2* is the right screen.
- *Screen 3*: Placed on the side or at the back, so that a local presenter can see the remote audience.

Microphones

You need microphones for good coverage of the stage, and microphones for good coverage of the room with the audience.

Loudspeakers

Use the integrated loudspeakers for video devices that have that. For other devices, we recommend good quality stereo loudspeakers placed next to *screen 1* or *screen 2* at the front of the room.

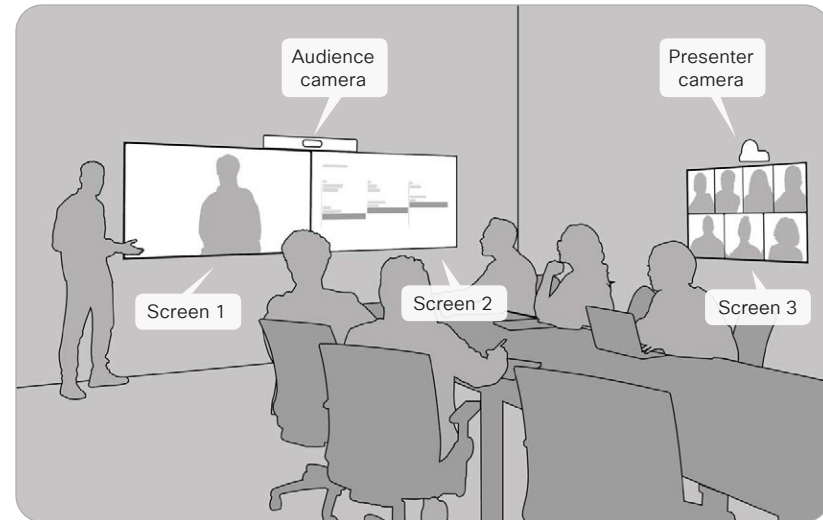

Presenter and Audience setup with three screens

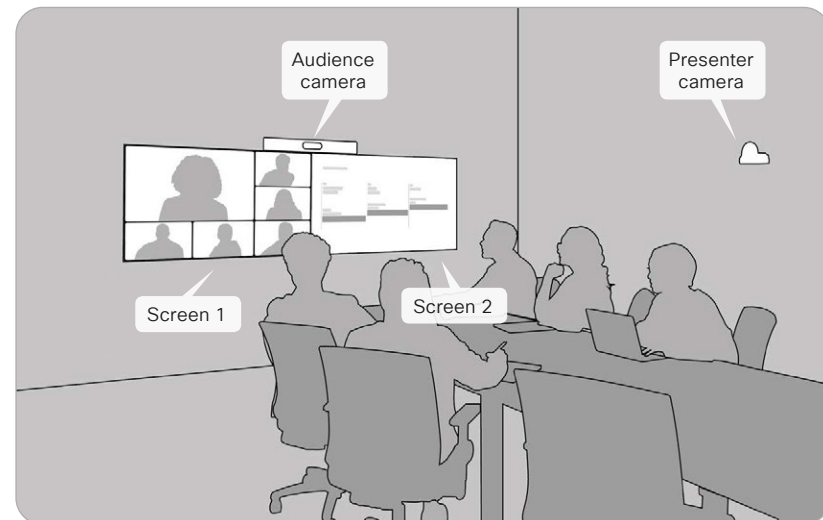

Presenter and Audience setup with two screens

Board

Board Pro,
Board Pro
G2

Codec EQ

Codec Plus

Codec Pro

Desk,
Desk Pro,
Desk Mini

Room Bar Pro,
Room Bar

Room Kit,
Room Kit Mini

Room Kit EQX

Room 55

Room 55 Dual,
Room 70

Room 70 G2

Room 70 Panorama

Room Panorama

Presenter and Audience setup (page 3 of 14)

Room modes

Local Presenter mode

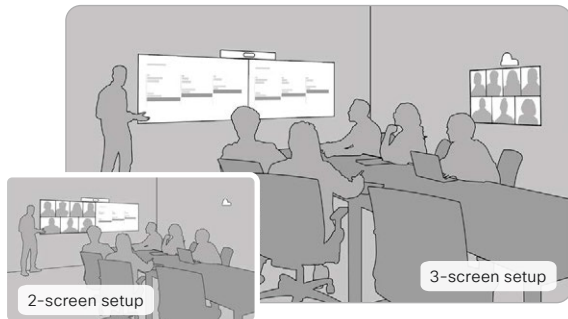

The presenter is on the stage, and is continuously tracked by the *Presenter camera*.

This mode also covers the case when someone in the local audience asks a question (Q&A).

Remote Presenter mode

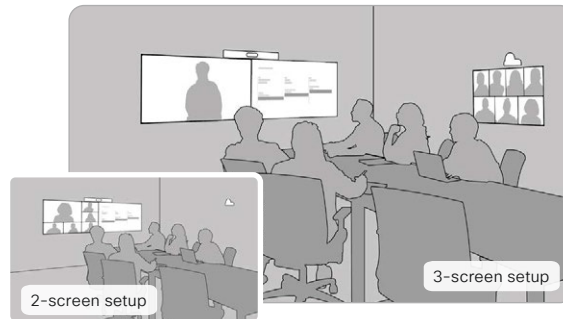

The presenter is calling in, and takes a virtual presence on the stage.

Hybrid Presenter mode

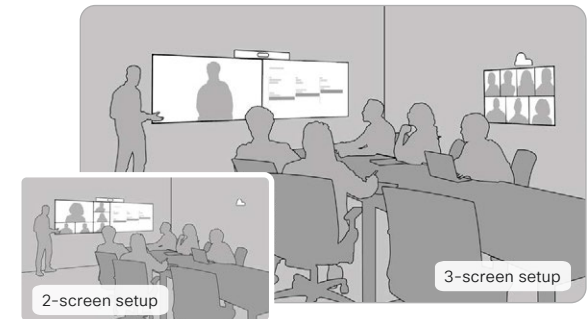

Both a local presenter and a remote presenter are on the stage simultaneously - one physically and one on-screen.

This mode also covers the case when someone in the local audience asks a question (Q&A).

		Local Presenter mode	Remote Presenter mode	Hybrid Presenter mode	
Number of screens in the setup	Three	Screen 1	Shows the presentation ¹	Shows the presenter that is calling in (in fullscreen)	
		Screen 2	Shows the presentation ¹	Shows the presentation ¹	
		Screen 3	Shows the remote participants that are calling in	Shows the remote participants that are calling in	
	Two	Screen 1	Shows the remote participants (grid layout)	Shows the presenter and the remote participants that are calling in (prominent layout with active speaker)	Shows the presenter and the remote participants that are calling in (prominent layout with active speaker)
		Screen 2	Shows the presentation ¹	Shows the presentation ¹	Shows the presentation ¹
	Video sent to the far end ²		Sends video from the <i>Presenter camera</i> Q&A: Sends split-screen video from the <i>Presenter camera</i> and the <i>Audience camera</i> with speaker tracking (that is, the local presenter and the person asking the question) ³	Sends video from the <i>Audience camera</i>	Sends video from the <i>Presenter camera</i> Q&A: Sends split-screen video from the <i>Presenter camera</i> and the <i>Audience camera</i> with speaker tracking (that is, the local presenter and the person asking the question) ³

¹ If there is no presentation, this screen is empty.

² Additionally, if present, a presentation is sent to far end in the presentation channel as usual.

³ In automatic switching mode, split-screen video is sent to far end when the device detects that someone in the audience speaks while there is a local presenter on stage. If the mode is selected manually from the user interface, split-screen video is sent to far end when *Show audience camera* is toggled on from the user interface.

Board

Board Pro,
Board Pro
G2

Codec EQ

Codec Plus

Codec Pro

Desk,
Desk Pro,
Desk Mini

Room Bar
Pro,
Room Bar

Room Kit,
Room Kit
Mini

Room Kit
EQX

Room 55

Room 55
Dual,
Room 70

Room 70
G2

Room 70
Panorama

Room
Panorama

Presenter and Audience setup (page 4 of 14)

Switching between room modes

Switching between room modes (*Local Presenter*, *Remote Presenter*, *Hybrid Presenter*), which implies that camera input sources, and remote and local screen layouts are changed, can be done in two ways:

- **Automatically**, based on who is speaking and whether a local presenter is present on stage.

Automatic switching is supported only when the PresenterTrack feature is enabled (*Cameras > PresenterTrack > Enabled* set to **True**).

- **Manually**, using the buttons on the touch controller.

Automatic switching implies:

- The device switches to the *Local Presenter* mode when a person is detected in the PresenterTrack trigger zone.
- The device switches to the *Remote Presenter* mode when the local presenter, who is tracked, leaves the stage.
- The device switches to the *Hybrid Presenter* mode when a person from far end is speaking while the local presenter, who is tracked, is still on the stage.
- If someone in the local audience asks a question when the device is in the *Local Presenter* or *Hybrid Presenter* mode, the device sends split-screen video showing both the presenter and the person asking the question. This requires that speaker tracking is switched on on the *Audience camera*.

Switch between room modes manually

You can switch to another mode during a meeting.

1. Tap *Presenter & Audience* on the touch controller.
2. Tap the mode you want to change to: *Local Presenter*, *Remote Presenter*, or *Hybrid Presenter*. The current mode is highlighted.

The device remains in the selected mode for the duration of the meeting, or until you choose another mode.

When the meeting is over, the system will revert back to automatic switching (**Auto**).

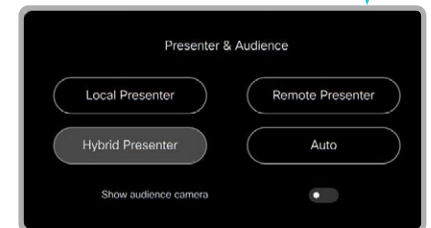
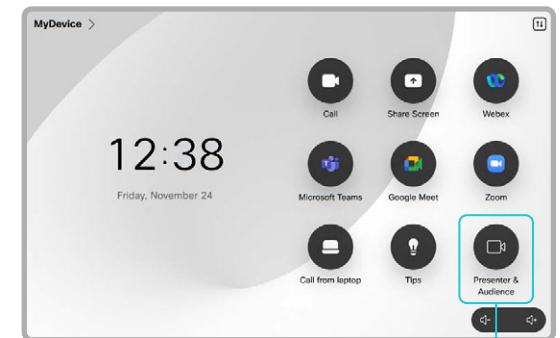

Board

Board Pro,
Board Pro
G2

Codec EQ

Codec
Plus

Codec
Pro

Desk,
Desk Pro,
Desk Mini

Room Bar
Pro,
Room Bar

Room Kit,
Room Kit
Mini

Room Kit
EQX

Room 55

Room
55 Dual,
Room 70

Room 70
G2

Room 70
Panorama

Room
Panorama

Presenter and Audience setup (page 5 of 14)

Codec EQ: Connect cables

 Connect the cameras and screens to the device as shown in the illustrations. Following the illustration ensures that the configurations that are automatically pushed to the device when selecting the *Presenter and Audience* room type template, match your actual setup.

Skip *Screen 3* if your room setup only requires two screens.

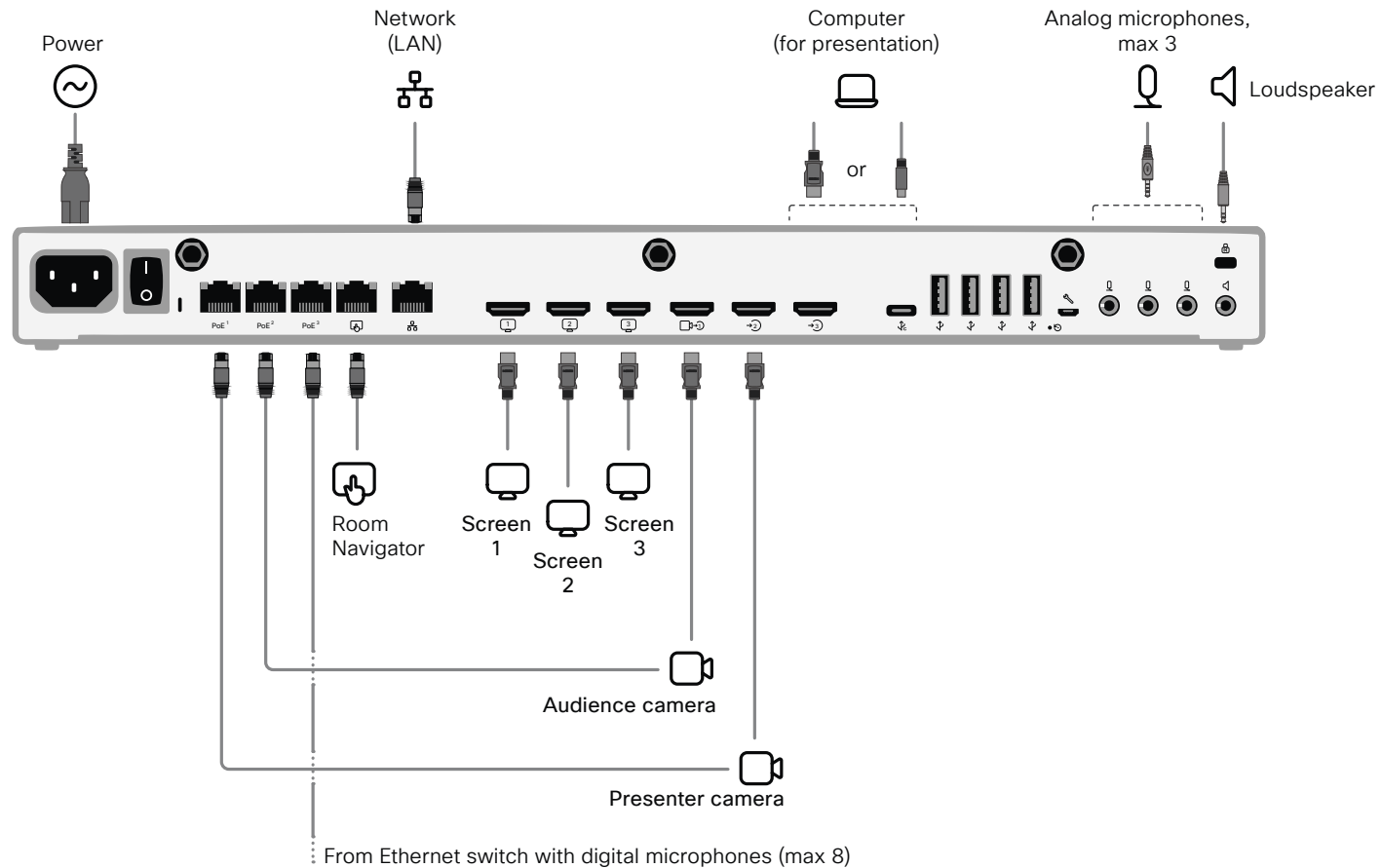

- Board
- Board Pro, Board Pro G2
- Codec EQ
- Codec Plus**
- Codec Pro
- Desk, Desk Pro, Desk Mini
- Room Bar Pro, Room Bar
- Room Kit, Room Kit Mini
- Room Kit EQX
- Room 55
- Room 55 Dual, Room 70
- Room 70 G2
- Room 70 Panorama
- Room Panorama

Presenter and Audience setup (page 6 of 14)

Codec Plus: Connect cables

 Connect the cameras and screens to the device as shown in the illustrations. Following the illustration ensures that the configurations that are automatically pushed to the device when selecting the *Presenter and Audience* room type template, match your actual setup.

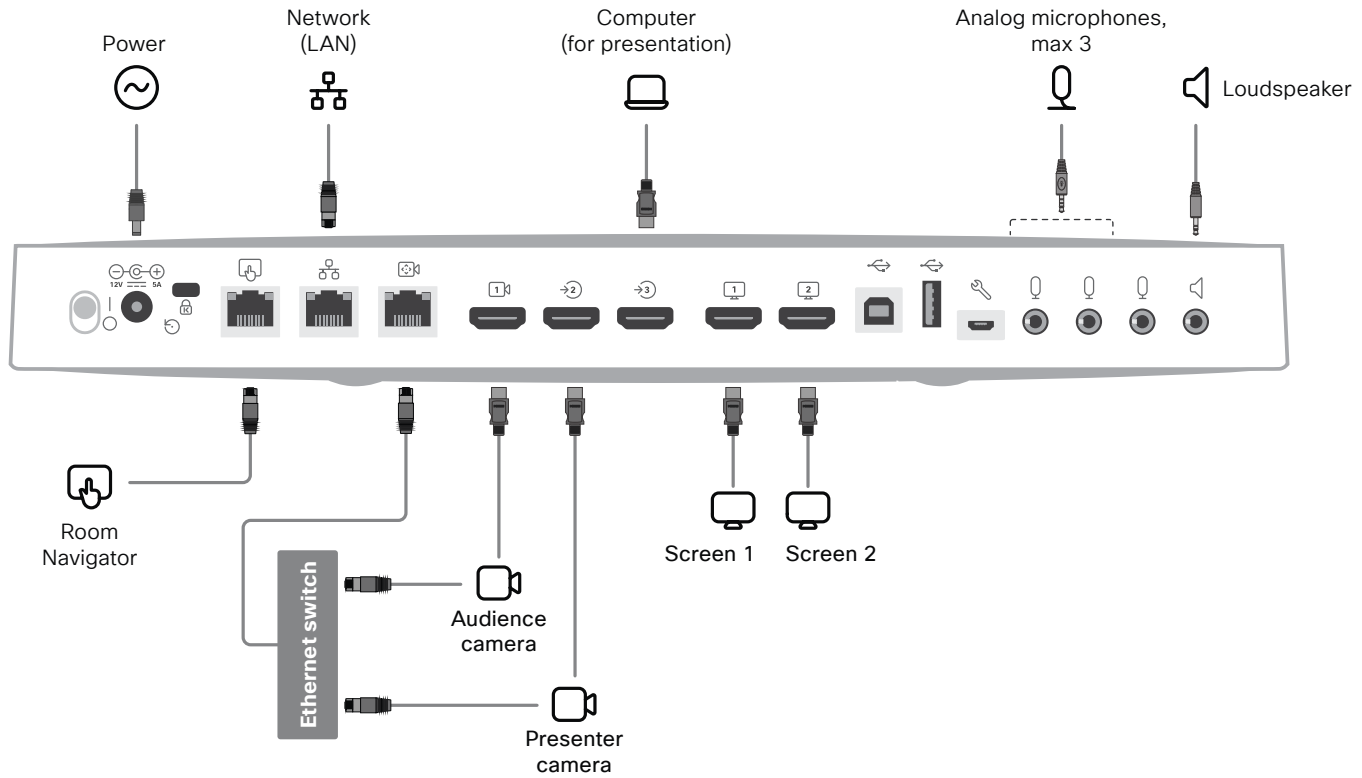

- Board
- Board Pro, Board Pro G2
- Codec EQ
- Codec Plus
- Codec Pro**
- Desk, Desk Pro, Desk Mini
- Room Bar Pro, Room Bar
- Room Kit, Room Kit Mini
- Room Kit EQX
- Room 55
- Room 55 Dual, Room 70
- Room 70 G2
- Room 70 Panorama
- Room Panorama

Presenter and Audience setup (page 7 of 14)

Codec Pro: Connect cables

 Connect the cameras and screens to the device as shown in the illustrations. Following the illustration ensures that the configurations that are automatically pushed to the device when selecting the *Presenter and Audience* room type template, match your actual setup.

Skip *Screen 3* if your room setup only requires two screens.

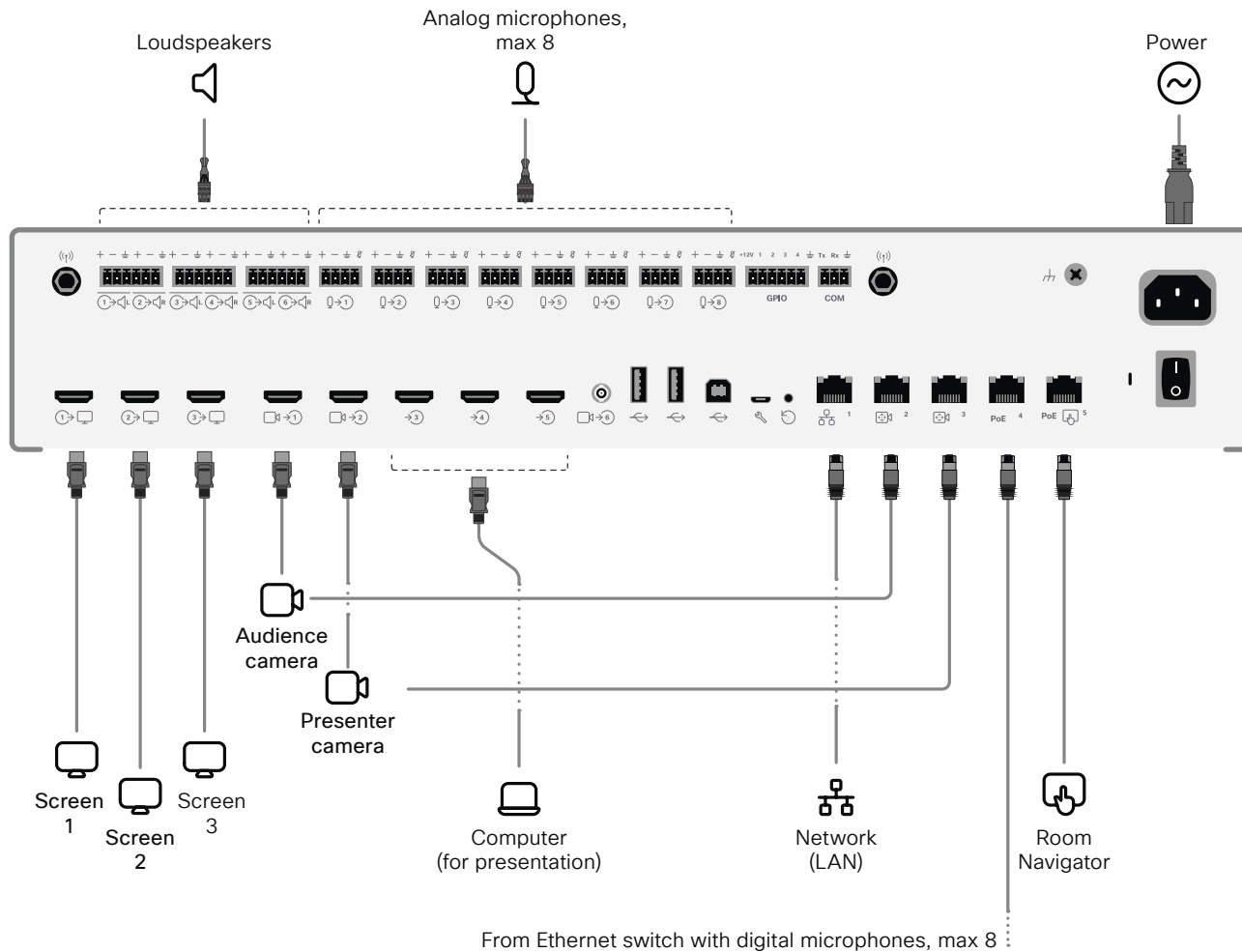

Presenter and Audience setup (page 8 of 14)

Room Kit EQX: Connect cables

 Connect the cameras and screens to the device as shown in the illustration. Following the illustration ensures that the configurations that are automatically pushed to the device when selecting the *Presenter and Audience* room type template, match your actual setup.

Keep all cables connected as described in the Room Kit EQX installation guide. This includes the cables for the integrated camera and screens.

You only have to connect external screens and cameras:

- *Presenter camera*
- *Screen 3* (only if your room setup requires three screens)

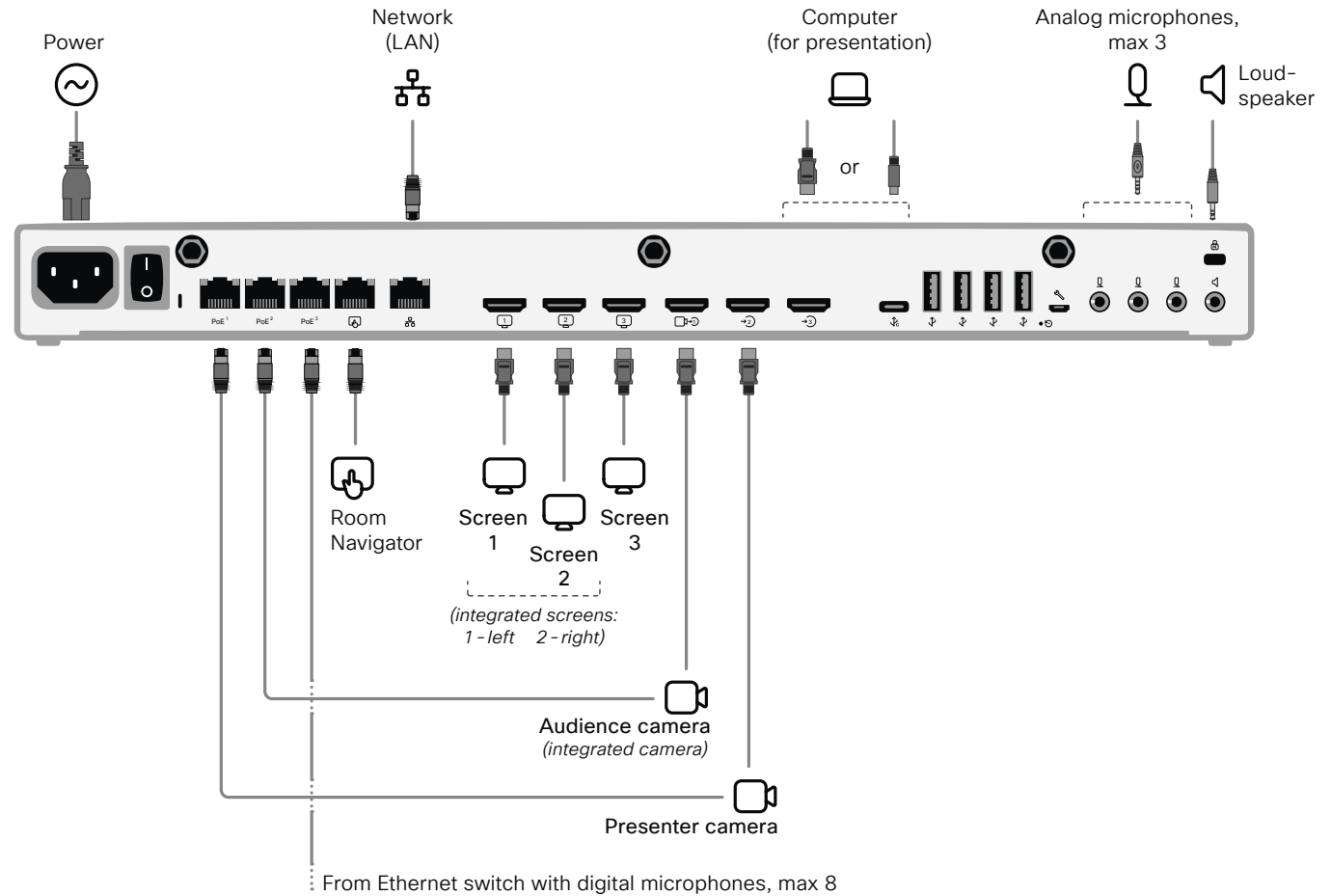

- Board
- Board Pro, Board Pro G2
- Codec EQ
- Codec Plus
- Codec Pro
- Desk, Desk Pro, DeskMini
- Room Bar Pro, Room Bar
- Room Kit, Room Kit Mini
- Room Kit EQX**
- Room 55
- Room 55 Dual, Room 70
- Room 70 G2
- Room 70 Panorama
- Room Panorama

Board

Board Pro,
Board Pro
G2

Codec EQ

Codec
Plus

Codec
Pro

Desk,
Desk Pro,
Desk Mini

Room Bar
Pro,
Room Bar

Room Kit,
Room Kit
Mini

Room Kit
EQX

Room 55

Room 55
Dual,
Room 70

Room 70
G2

Room 70
Panorama

Room
Panorama

Presenter and Audience setup (page 9 of 14)

Room 55 Dual and Room 70: Connect cables

⚠ Connect the cameras and screens to the device as shown in the illustration. Following the illustration ensures that the configurations that are automatically pushed to the device when selecting the *Presenter and Audience* room type template, match your actual setup.

Keep all preconnected cables, including the cables for the integrated camera and screens, as delivered from the factory.

You only have to connect the external screens and cameras:

- *Presenter camera*
- *Screen 2 (only for Room 70 Single)*

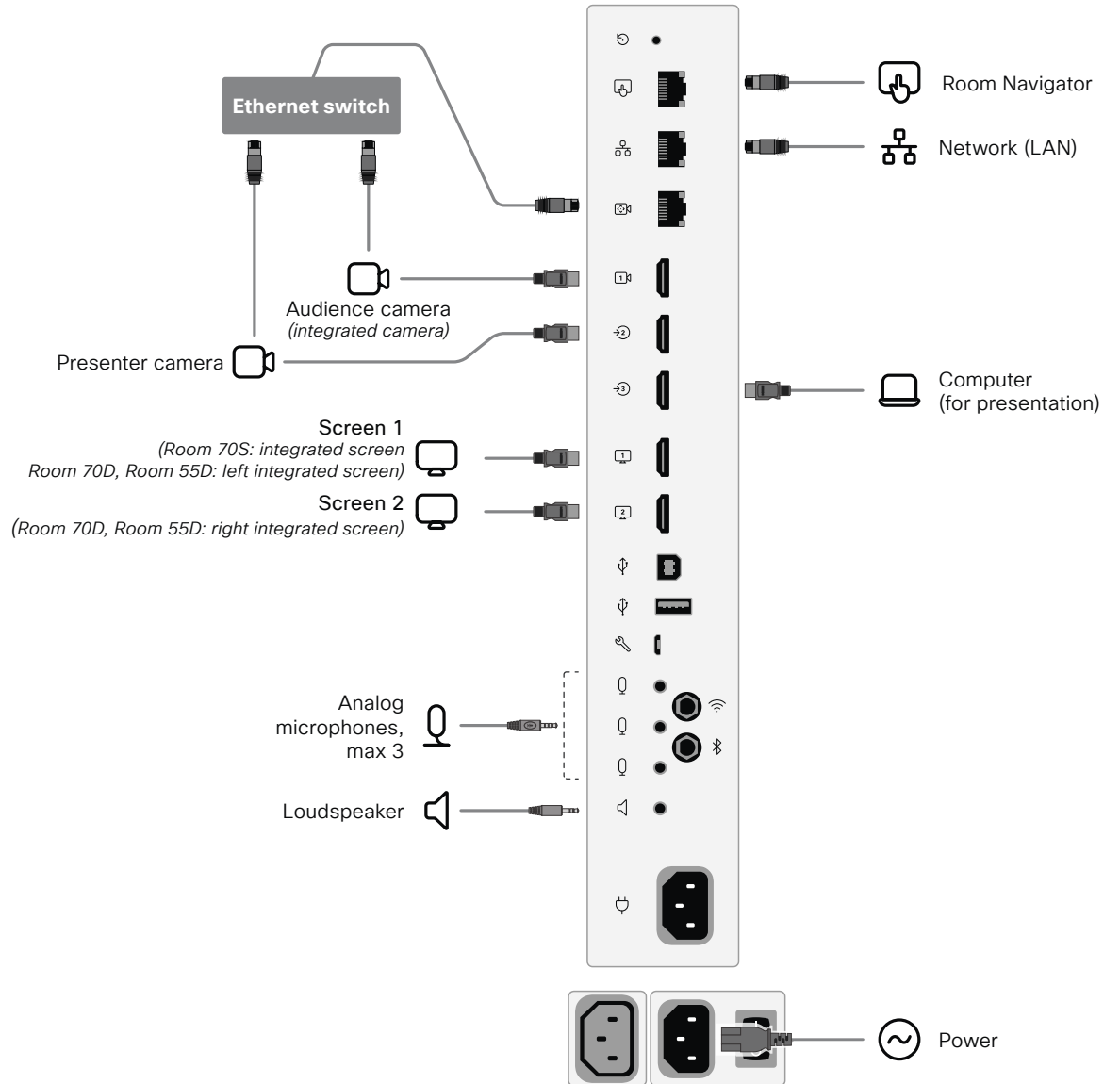

Board

Board Pro,
Board Pro
G2

Codec EQ

Codec
Plus

Codec
Pro

Desk,
Desk Pro,
DeskMini

Room Bar
Pro,
Room Bar

Room Kit,
Room Kit
Mini

Room Kit
EQX

Room 55

Room
55 Dual,
Room 70

**Room 70
G2**

Room 70
Panorama

Room
Panorama

Presenter and Audience setup (page 10 of 14)

Room 70 G2: Connect cables

 Connect the cameras and screens to the device as shown in the illustration. Following the illustration ensures that the configurations that are automatically pushed to the device when selecting the *Presenter and Audience* room type template, match your actual setup.

Keep all preconnected cables, including the cables for the integrated camera and screens, as delivered from the factory.

You only have to connect the external screens and cameras:

- *Presenter camera*
- *Screen 2 (only for Room 70 Single G2)*
- *Screen 3 (only if your room setup requires three screens)*

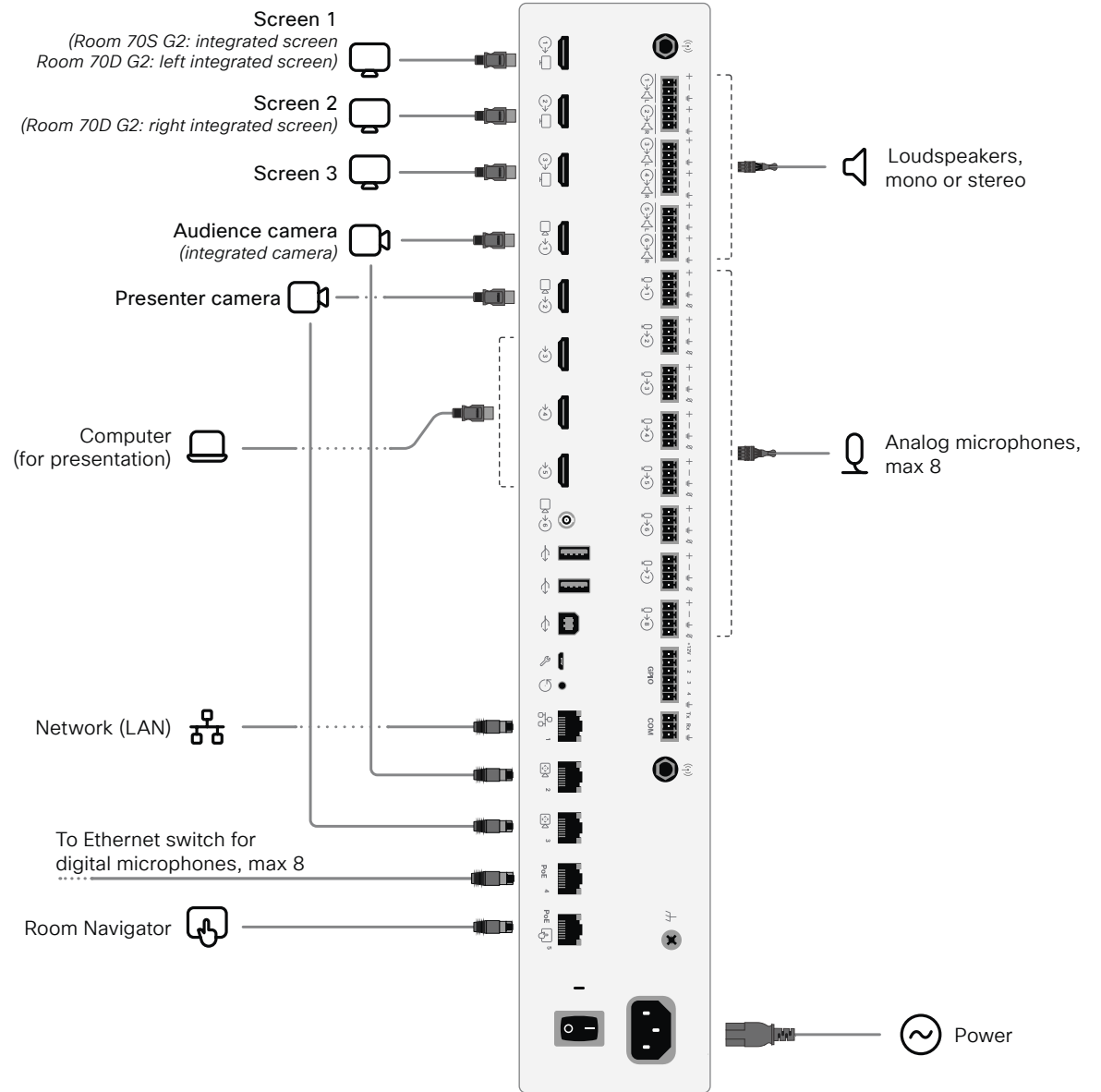

Board

Board Pro,
Board Pro
G2

Codec EQ

Codec
Plus

Codec
Pro

Desk,
Desk Pro,
DeskMini

Room Bar
Pro,
Room Bar

Room Kit,
Room Kit
Mini

Room Kit
EQX

Room 55

Room
55 Dual,
Room 70

Room 70
G2

Room 70
Panorama

Room
Panorama

Presenter and Audience setup (page 11 of 14)

Room Bar Pro: Connect cables

 Connect the cameras and screens to the device as shown in the illustrations. Following the illustration ensures that the configurations that are automatically pushed to the device when selecting the *Presenter and Audience* room type template, match your actual setup.

Skip *Screen 3* if your room setup only requires two screens.

The device's integrated camera is the *Audience camera*.

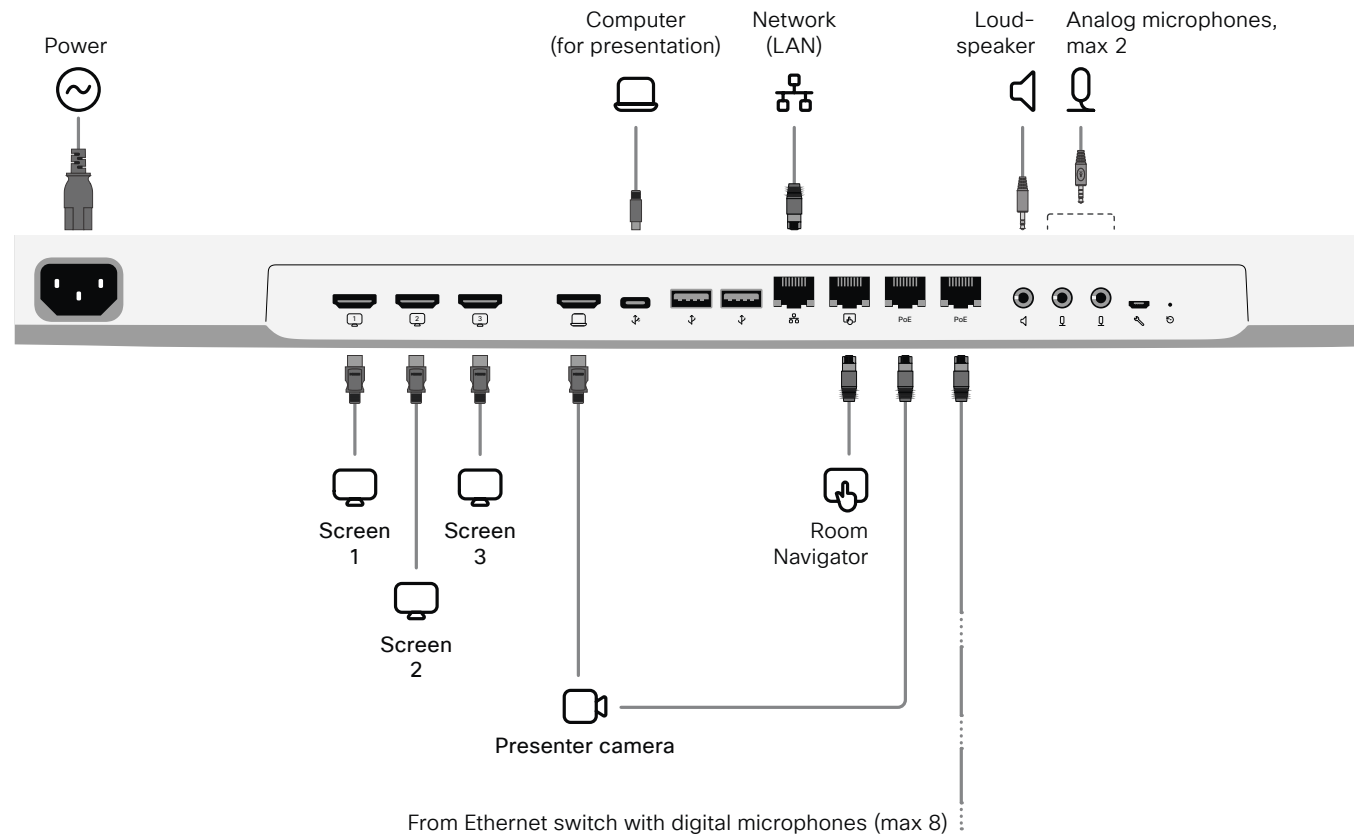

Board

Board Pro,
Board Pro
G2

Codec EQ

Codec Plus

Codec Pro

Desk,
Desk Pro,
Desk Mini

Room Bar
Pro,
Room Bar

Room Kit,
Room Kit
Mini

Room Kit
EQX

Room 55

Room
55 Dual,
Room 70

Room 70
G2

Room 70
Panorama

Room
Panorama

Presenter and Audience setup (page 12 of 14)

Board Pro G2: Connect cables

 Connect the cameras and screens to the device as shown in the illustration. Following the illustration ensures that the configurations that are automatically pushed to the device when selecting the *Presenter* and *Audience* room type template, match your actual setup.

Keep all cables connected as described in the Board Pro G2 installation guide.

You only have to connect the external screens and cameras:

- *Presenter camera*
- *Screen 2*
- *Screen 3 (only if your room setup requires three screens)*

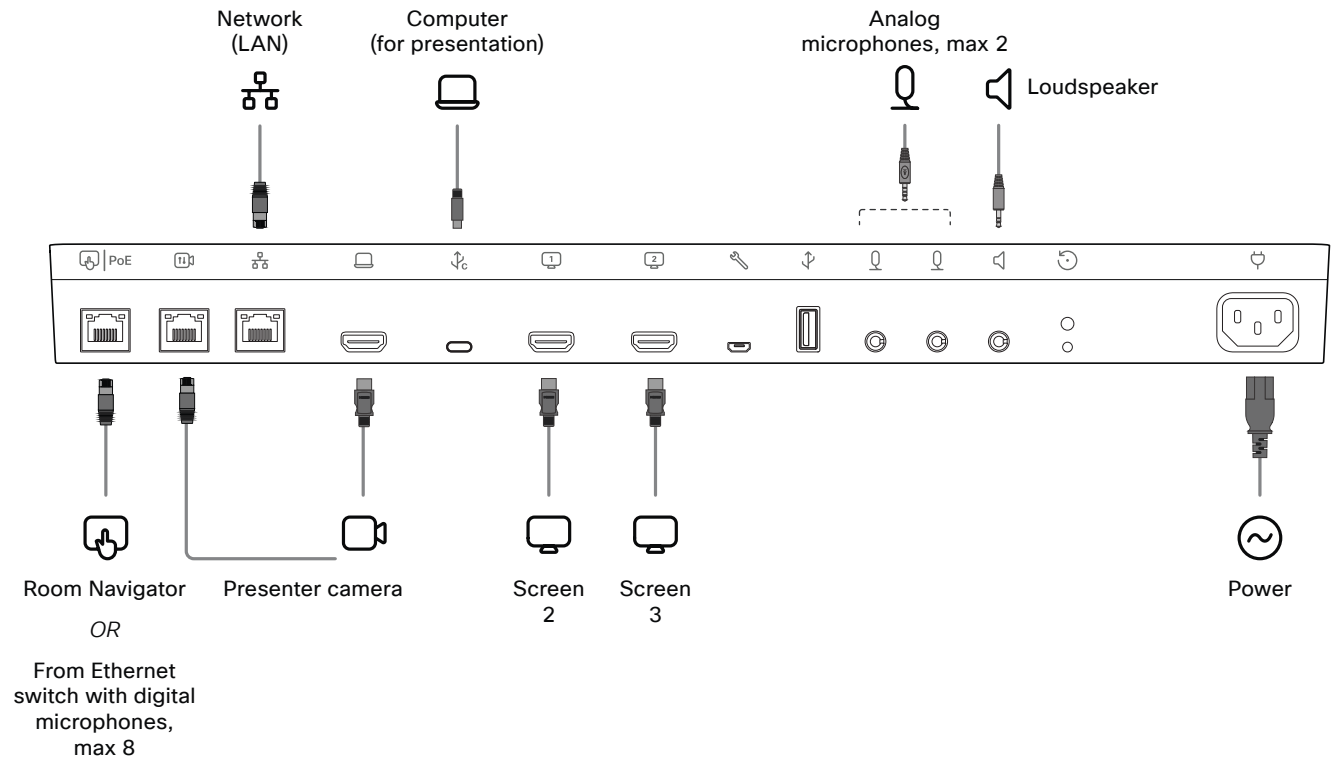

Board

Board Pro,
Board Pro
G2

Codec EQ

Codec
PlusCodec
ProDesk,
Desk Pro,
Desk MiniRoom Bar
Pro,
Room BarRoom Kit,
Room Kit
MiniRoom Kit
EQX

Room 55

Room 55
Dual,
Room 70Room 70
G2Room 70
PanoramaRoom
Panorama

Presenter and Audience setup (page 13 of 14)

Configure the device

We recommend you to be in the room when setting up Presenter and Audience. Otherwise, it's difficult to set up PresenterTrack properly.

1. Connect cameras and screens as described on the previous pages.
2. Use the touch controller to stop sharing the video from the *Presenter camera*. It's important that video from the *Presenter camera* isn't displayed on any screen while setting up Presenter and Audience.
3. Sign in to the device web interface, go to [Settings](#), and select [Configurations](#).
4. Go to [Video > Input > Connector 2](#)¹, and set the following:
 - **InputSourceType:** camera
 - **PresentationSelection:** Manual
 - **Quality:** Motion
 - **Visibility:** Never
 - **CameraControl Mode:** On
 Click [Save](#) for the changes to take effect.
5. Set up PresenterTrack for the *Presenter camera*, see the [► Set up the PresenterTrack feature](#) chapter.

This feature enables the camera to follow a presenter that is moving about on stage.
6. Go to [Settings](#), and select [Room Types](#). Click the [Presenter and Audience](#) thumbnail to push the corresponding configuration to the device.

As a result, there's a *Presenter & Audience* button on the device's home screen and a *Presenter & Audience diagnostics* page in its control panel.

If your room has more than one microphone, we recommend you specify which ones are covering the stage and which ones are covering the audience.

This allows for more accurate automatic switching between room modes (local, remote, or hybrid presenter)².

7. On the device's user interface (Room Navigator), swipe in from the right or tap the controls icon  in the upper, right corner to open the control panel. Then select [Device settings](#).
8. Select [Issues and diagnostics > Presenter & Audience diagnostics > Microphone orientation configuration](#).

For each microphone, tap [Stage](#) or [Audience](#) depending on its orientation³.

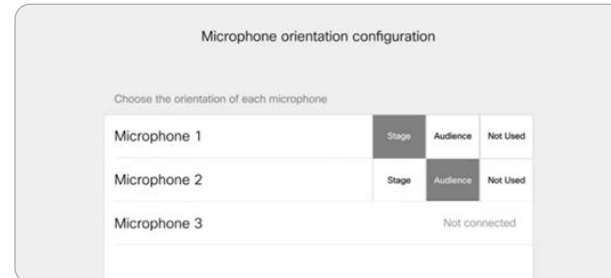

The change is pushed to the device immediately

¹ [Connector 2](#) is the connector where the *Presenter camera* is connected.

² All microphones support automatic switching between room modes. Currently, only analog microphones support the most advanced behavior, which is based on a comparison of the audio signals from the stage and the audience.

³ **Not used** means that the microphone orientation has no impact on the mode selection logic in **Auto** mode. It doesn't mean that the microphone itself is disabled.

Board

Board Pro,
Board Pro
G2

Codec EQ

Codec
Plus

Codec
Pro

Desk,
Desk Pro,
Desk Mini

Room Bar
Pro,
Room Bar

Room Kit,
Room Kit
Mini

Room Kit
EQX

Room 55

Room 55
Dual,
Room 70

Room 70
G2

Room 70
Panorama

Room
Panorama

Presenter and Audience setup (page 14 of 14)

Diagnostics are available on the user interface

You can open a diagnostics page for the Presenter and Audience set up from the device user interface. Just open the control panel, select *Device settings > Issues and diagnostics > Presenter & Audience diagnostics*.

This page gives information about the microphone setup, audio levels, and presenter diagnostics. These are useful tools when troubleshooting issues.

Microphone orientation configuration

During set up we recommend you to add information whether a microphone is facing the stage (presenter) or the audience. This information allows for more accurate automatic switching between the local, remote, and hybrid presenter modes.

The *Microphone orientation configuration* page shows the current setup, and allows you to change it if it's not correct*.

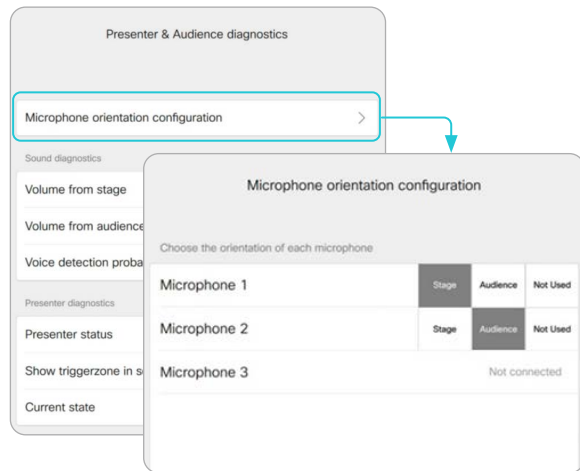

Sound diagnostics

If you've configured at least one microphone to face the stage and at least one to face the audience, VU meters show the current audio volume from the stage and the audience. Otherwise, you get a notification that the microphone orientation is invalid.

The last indicator, *Voice detection probability*, shows the probability that the picked-up audio signal is a voice and not just background noise.



Example:

- When the person on stage speaks, you observe a high signal level in the *Volume from stage* meter and a high *Voice detection probability*.
- If the audience applauds, you see the *Volume from audience* showing high levels. However, the *Voice detection probability* is low, indicating that it doesn't recognize this as someone in the audience speaking.
- If someone in the audience starts speaking, both the *Volume from audience* meter and the *Voice detection probability* rise.

In **Auto** mode, the combination of high audience volume and high voice probability triggers the Q&A mode. In this mode, the audience camera is on and uses speaker tracking to focus on the speaker in the audience.

Presenter diagnostics



Presenter status:

- Shows if the device detects a presenter on stage (**Detected**) or not (**Gone**).

Show trigger zone in selfview:

- If you toggle on this switch, you see the location of the presenter track trigger zone in the selfview image.

This may be useful when troubleshooting issues with local presenter detection.

The trigger zone overlay isn't sent to the far end, it's only shown in the selfview.

Current state:

- This field shows the current state that the room is in, the main states being Local Presenter, Remote Presenter, or Hybrid Presenter. Other valid states are Local Q and A and Hybrid Q and A, which occur when someone in the audience speaks (asks a question); Noise – No Q and A, which occur when microphones pick up noise from the audience without detecting it as a voice; and Discussion

* **Not used** means that the microphone orientation has no impact on the mode selection logic in **Auto** mode. It doesn't mean that the microphone itself is disabled.

Board

Board Pro,
Board Pro
G2

Codec EQ

Codec
PlusCodec
ProDesk,
Desk Pro,
Desk MiniRoom Bar
Pro,
Room BarRoom Kit,
Room Kit
MiniRoom Kit
EQX

Room 55

Room
55 Dual,
Room 70Room 70
G2Room 70
PanoramaRoom
Panorama

Briefing room setup (page 1 of 10)

The *Briefing room* setup makes it easy to set up, manage, and use a room to deliver training and education sessions to groups of people.

The *Briefing room* setup has the following predefined room modes that accommodate different scenarios:

- *Local Presenter* (the presenter is in the room)
- *Remote Presenter* (the presenter is calling in)
- *Discussions* (for discussions between different sites, and with a local presenter in the room)

The *Briefing room* setup is available as a room type template. When you set up a room using a template, a set of configurations is pushed automatically to the device. It is important that the room is set up correctly, and that the cameras and screens are connected exactly as specified. Otherwise the configurations will not match the room.

Required equipment

- One of the following devices:
 - Codec Pro
 - Room 70 G2
 - Room Bar Pro
- Three displays (Presentation display, Remote presenter display, and Remote audience display)
- Two cameras (Audience camera and Presenter camera)
- Microphones
- Speakers
- Touch controller



Briefing room setup *

Comparing the room type setups

Presenter and Audience: This is the next generation *Briefing room* and *Classroom* setup. Updates and improvements will only be for *Presenter and Audience*.*

Compared to the older setups, you get:

- Easier manual layout selection options.
- Improved camera switching based on voice activity detection.
- Improved diagnostics tools, such as the diagnostics page that is available on the touch controller.

Supported products: Codec EQ, Codec Plus, Codec Pro, Room Kit EQX, Room 55 Dual, Room 70, Room 70 G2, and Room Bar Pro

Briefing room:

Supported products: Codec EQ, Codec Pro, Room Kit EQX, Room 70 G2, and Room Bar Pro

The setup requires three screens, and the layouts on the screens are preconfigured (and fixed) to match that particular scenario.

Classroom: More flexible than the *Briefing room* setup regarding the number of screens and how the layout is distributed on the screens.

Supported products: Codec EQ, Codec Plus, Codec Pro, Room Kit EQX, Room 55 Dual, Room 70, Room 70 G2, and Room Bar Pro

You can use any number of screens that the device supports, typically two or three. Use the video monitor settings to configure the distribution of layouts on the screens, if the default behavior does not fulfill your requirements.

* *Briefing room* and *Classroom* may be deprecated in a later software release.

* The illustration shows a codec with Speaker Track 60 camera as audience camera. The same principle applies also to the supported integrated devices, and other supported codec and camera combinations.

Board

Board Pro,
Board Pro
G2

Codec EQ

Codec
Plus

Codec
Pro

Desk,
Desk Pro,
DeskMini

Room Bar
Pro,
Room Bar

Room Kit,
Room Kit
Mini

Room Kit
EQX

Room 55

Room
55 Dual,
Room 70

Room 70
G2

Room 70
Panorama

Room
Panorama

Briefing room setup (page 2 of 10)

Room modes*

Local Presenter mode



The presenter is in the room. This mode also covers the case when someone in the local audience asks a question (Q&A).

If automatic switching is enabled (default), the device switches to this mode when the *Presenter camera* detects a presenter in the room.

Remote Presenter mode



The presenter is calling in.

If automatic switching is enabled (default), the device switches to this mode when the *Presenter camera* doesn't detect a presenter in the room.

Discussion mode



For discussions between different sites. A local presenter is in the room.

Always use the touch controller to activate this mode.

	Local Presenter mode	Remote Presenter mode	Discussion mode
Video sent to the far end	Sends video from the <i>Presenter camera</i> Q&A: Sends split-screen video from the <i>Presenter camera</i> and the person asking the question (<i>Audience camera</i>)	Sends video from the <i>Audience camera</i>	Sends video from the <i>Audience camera</i>
Remote presenter display	Shows the presentation	Shows the presenter that is calling in, and other remote sites (you can decide the layout locally)	Shows the remote sites that are part of the discussion (you can decide the layout locally)
Presentation display	Shows the presentation	Shows the presentation	Shows the presentation
Remote audience display	Shows the remote participants that are calling in from different sites	Shows the presentation	Shows the presentation

If there is no presentation, nothing will be shown on the corresponding screens (gray).

* The illustrations show a codec with SpeakerTrack 60 camera as audience camera. The same principle applies also to the supported integrated devices, and other supported codec and camera combinations.

Board

BoardPro,
BoardPro
G2

Codec EQ

Codec
Plus

Codec
Pro

Desk,
Desk Pro,
DeskMini

Room Bar
Pro,
Room Bar

Room Kit,
Room Kit
Mini

Room Kit
EQX

Room 55

Room
55 Dual,
Room 70

Room 70
G2

Room 70
Panorama

Room
Panorama

Briefing room setup (page 3 of 10)

Room arrangement examples

These illustrations show examples of how to arrange screens, cameras and microphones, and where to place people for the best experience.

Recommendation

- **Remote presenter display:** 1st screen, placed at front. For integrated devices, this is its (left) screen.
- **Presentation display:** 2nd screen, placed at front. For integrated devices with two screens, this is its right screen.
- **Remote audience display:** 3rd screen, placed on the side or at the back, so that the local presenter can see the remote audience.
- **Audience camera:** Use the integrated camera for video conferencing devices that have that. For other devices, we recommend the Quad Camera or SpeakerTrack 60 camera. We recommend a camera with speaker tracking, but it is also possible to use a camera without speaker tracking capabilities.
- **Presenter camera:** PTZ 4K or Precision 60 camera with presenter tracking enabled.
- **Microphones:** We recommend the Cisco Ceiling Microphone for good coverage of the room. Also other microphone solutions can be used.
- **Speakers:** Use the integrated speakers for video conferencing devices that have that. For other devices, we recommend good quality stereo speakers placed next to the *Presentation display* at the front of the room.

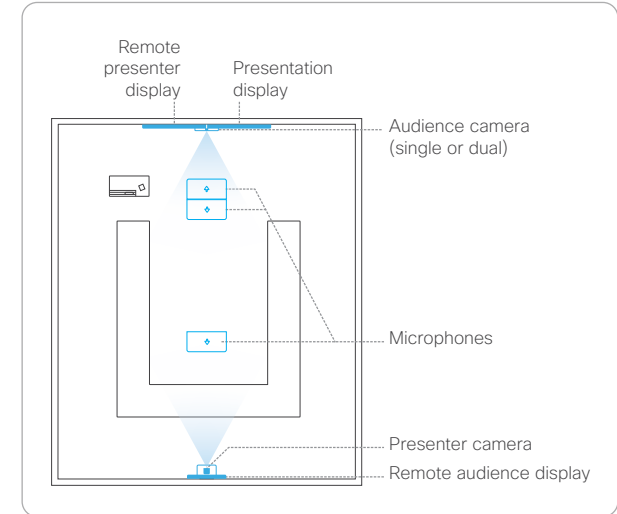
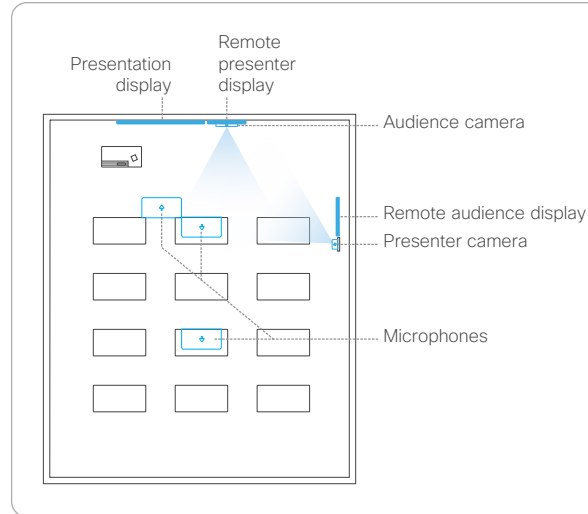

Briefing room setup (page 4 of 10)

Codec Pro: Connect cables

! Connect the cameras and screens to the device as shown in the illustrations. Following the illustration ensures that the configurations that are automatically pushed to the device when selecting the *Briefing* room type template, match your actual setup.

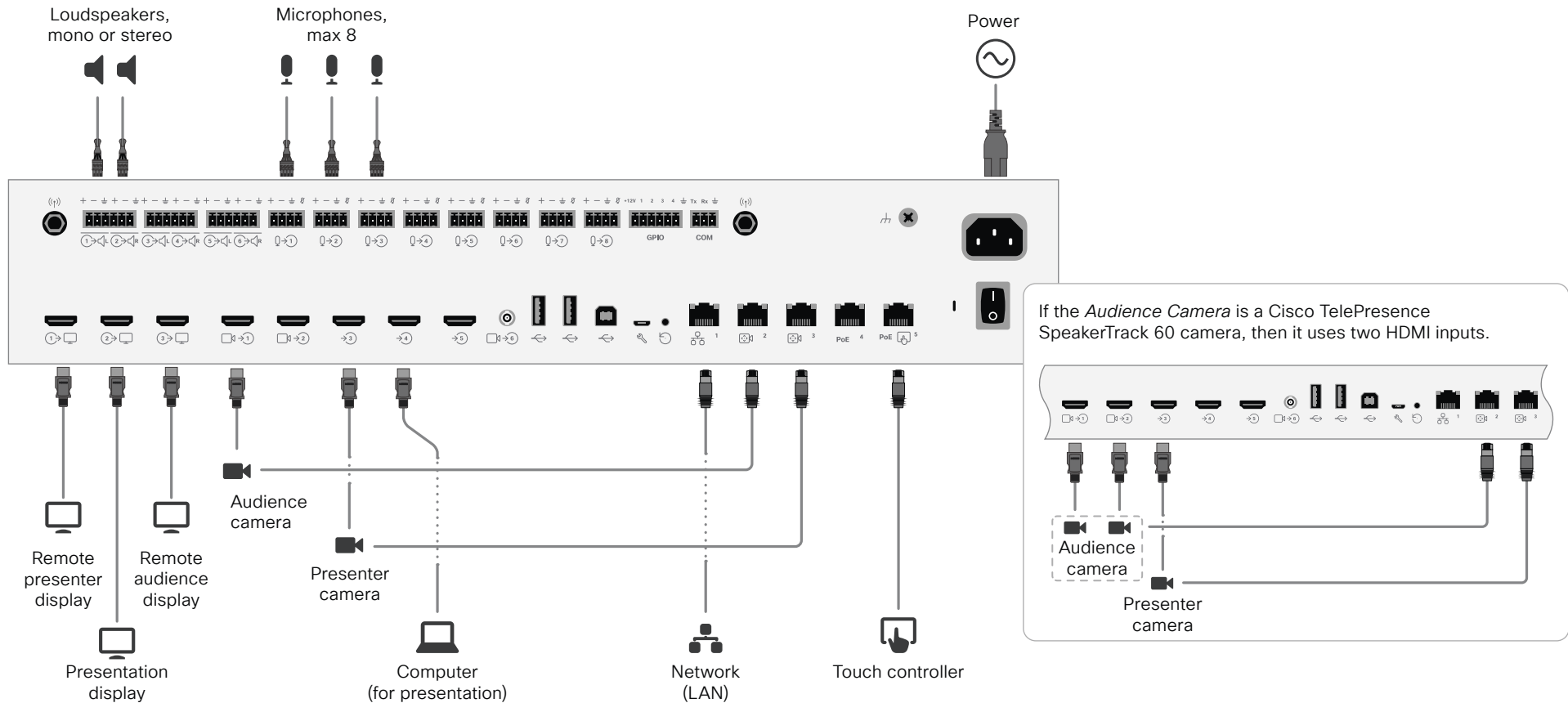

- Board
- Board Pro, Board Pro G2 Pro
- Codec EQ
- Codec Plus
- Codec Pro**
- Desk, Desk Pro, Desk Mini
- Room Bar Pro, Room Bar
- Room Kit, Room Kit Mini
- Room Kit EQX
- Room 55
- Room 55 Dual, Room 70
- Room 70 G2
- Room 70 Panorama
- Room Panorama

Board

Board Pro,
Board Pro
G2

Codec EQ

Codec
Plus

Codec
Pro

Desk,
Desk Pro,
Desk Mini

Room Bar
Pro,
Room Bar

Room Kit,
Room Kit
Mini

Room Kit
EQX

Room 55

Room
55 Dual,
Room 70

**Room 70
G2**

Room 70
Panorama

Room
Panorama

Briefing room setup (page 5 of 10)

Room 70 G2: Connect cables

 Connect the cameras and screens to the device as shown in the illustration. Following the illustration ensures that the configurations that are automatically pushed to the device when selecting the *Briefing* room type template, match your actual setup.

Keep all preconnected cables, including the cables for the integrated camera and screens, as delivered from the factory. You only have to connect the external screens and cameras.

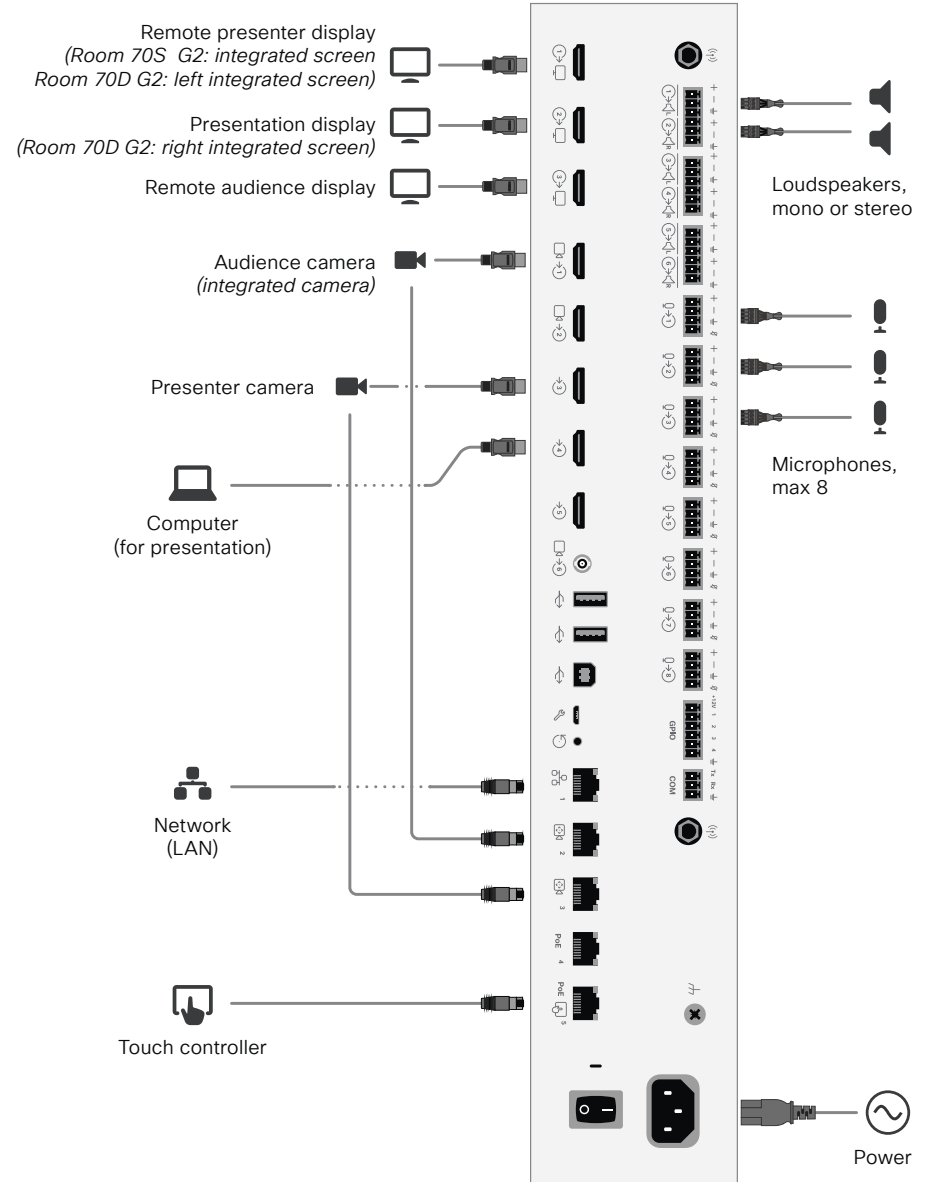

- Board
- BoardPro, BoardPro G2
- Codec EQ
- Codec Plus
- Codec Pro
- Desk, Desk Pro, Desk Mini
- Room Bar Pro, Room Bar
- Room Kit, Room Kit Mini
- Room Kit EQX
- Room 55
- Room 55 Dual, Room 70
- Room 70 G2
- Room 70 Panorama
- Room Panorama

Briefing room setup (page 6 of 10)

Codec EQ: Connect cables

 Connect the cameras and screens to the device as shown in the illustrations. Following the illustration ensures that the configurations that are automatically pushed to the device when selecting the *Briefing* room type template, match your actual setup.

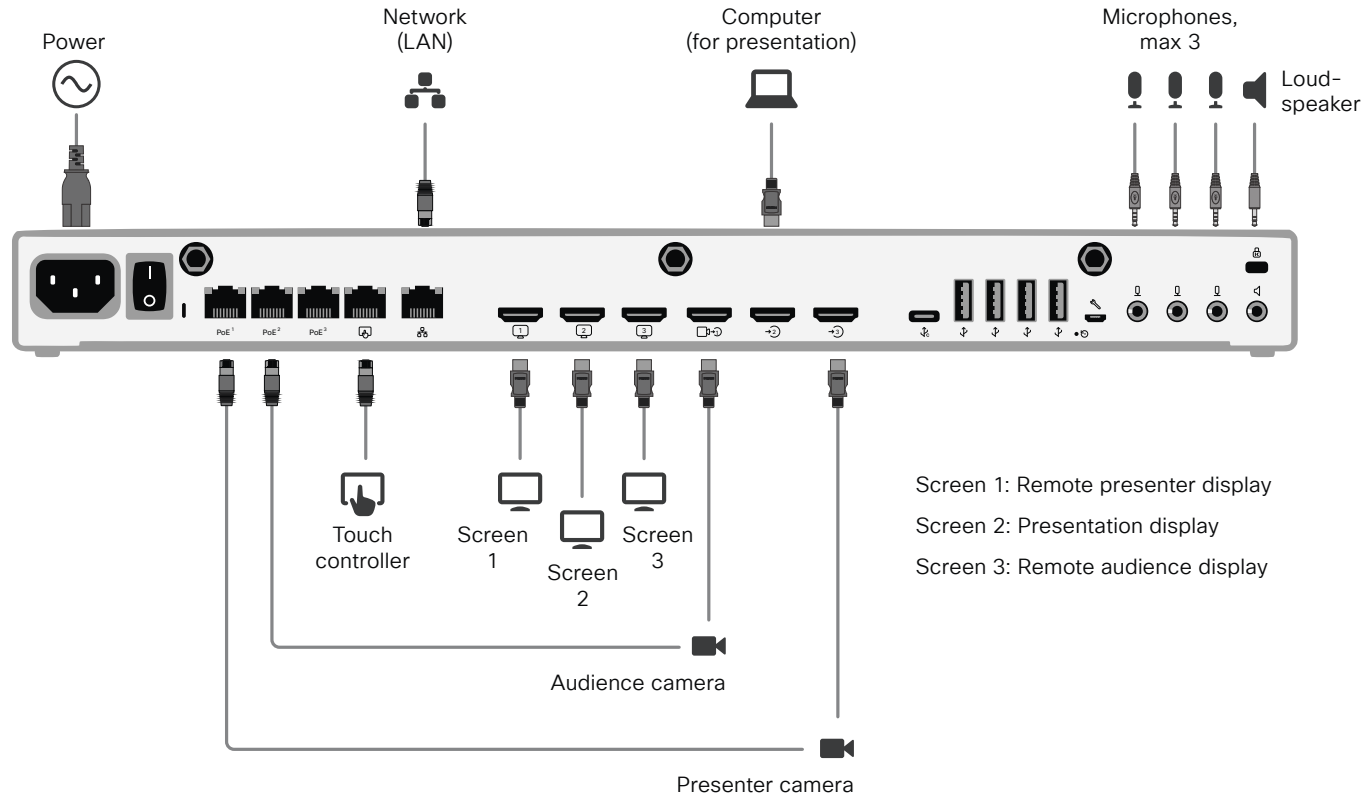

- Board
- BoardPro, BoardPro G2
- Codec EQ
- Codec Plus
- Codec Pro
- Desk, Desk Pro, Desk Mini
- Room Bar Pro, Room Bar
- Room Kit, Room Kit Mini
- Room Kit EQX
- Room 55
- Room 55 Dual, Room 70
- Room 70 G2
- Room 70 Panorama
- Room Panorama

Briefing room setup (page 7 of 10)

Room Kit EQX: Connect cables

 Connect the cameras and screens to the device as shown in the illustration. Following the illustration ensures that the configurations that are automatically pushed to the device when selecting the *Briefing* room type template, match your actual setup.

Keep all preconnected cables, including the cables for the integrated camera and screens, as delivered from the factory. You only have to connect the external screens and cameras.

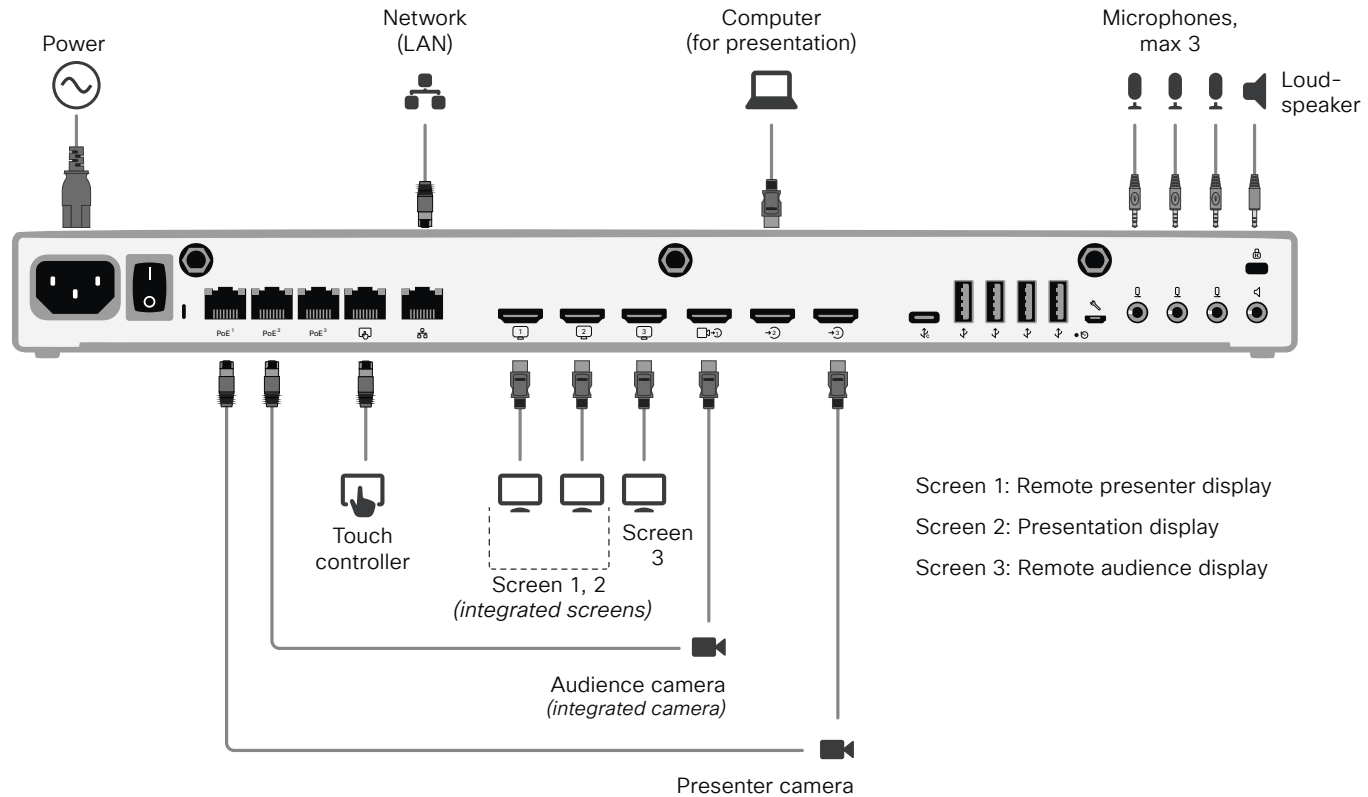

Screen 1: Remote presenter display
Screen 2: Presentation display
Screen 3: Remote audience display

Board

Board Pro,
Board Pro
G2

Codec EQ

Codec
Plus

Codec
Pro

Desk,
Desk Pro,
Desk Mini

Room Bar
Pro,
Room Bar

Room Kit,
Room Kit
Mini

Room Kit
EQX

Room 55

Room
55 Dual,
Room 70

Room 70
G2

Room 70
Panorama

Room
Panorama

Briefing room setup (page 8 of 10)

Room Bar Pro: Connect cables

 Connect the cameras and screens to the device as shown in the illustrations. Following the illustration ensures that the configurations that are automatically pushed to the device when selecting the *Briefing* room type template, match your actual setup.

The device's integrated camera is the *Audience camera*.

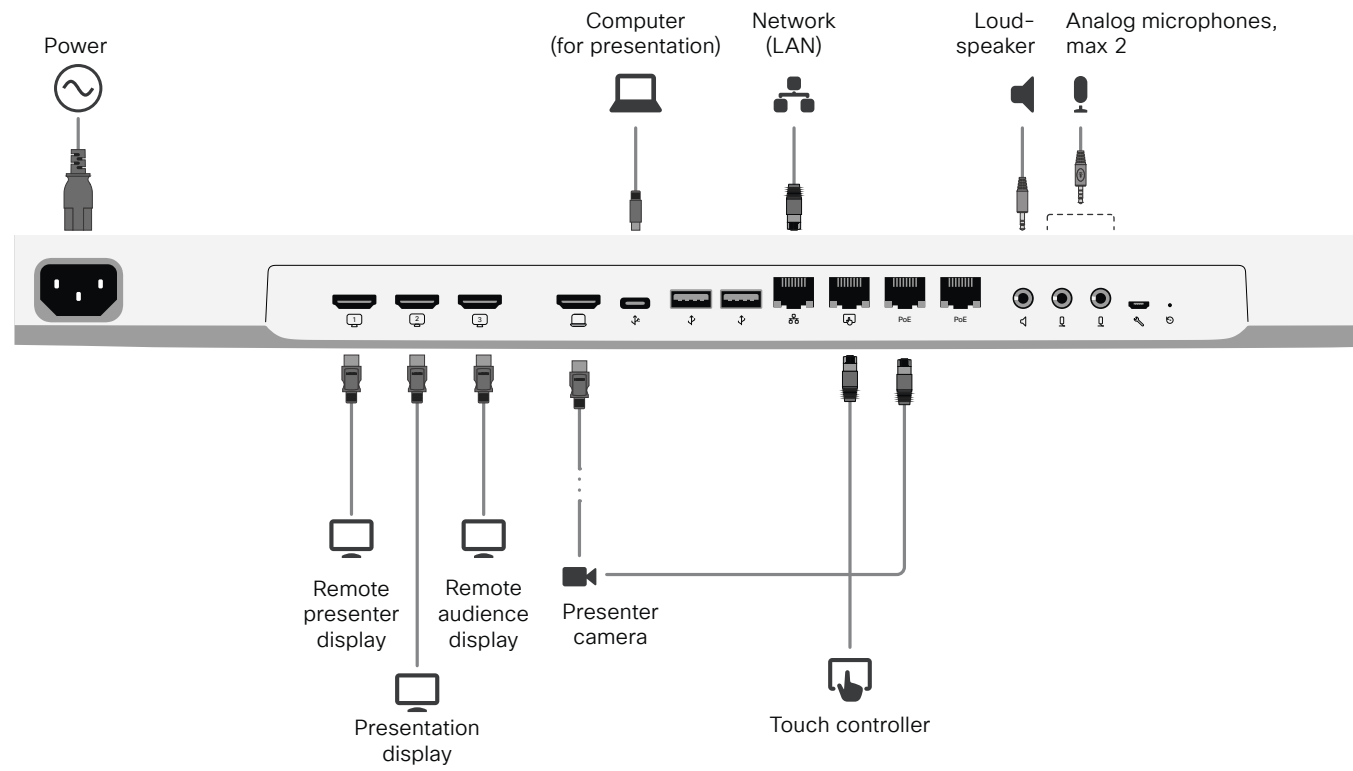

Board

Board Pro,
Board Pro
G2

Codec EQ

Codec
PlusCodec
ProDesk,
Desk Pro,
DeskMiniRoom Bar
Pro,
Room BarRoom Kit,
Room Kit
MiniRoom Kit
EQX

Room 55

Room
55 Dual,
Room 70Room 70
G2Room 70
PanoramaRoom
Panorama

Briefing room setup (page 9 of 10)

Configure the device

We recommend you to be in the same room when setting up the Briefing room. Otherwise you are not able to set up PresenterTrack properly.

1. Connect cameras and screens as described on the previous pages.
2. Use the touch controller to stop sharing the video from the *Presenter camera*. It is important that video from the *Presenter camera* is not displayed on any screen while setting up Briefing room.
3. Sign in to the device web interface, go to [Settings](#), and select [Configurations](#).
4. Go to [Video > Input > Connector 3](#), and set the following:
 - [InputSourceType](#): camera
 - [PresentationSelection](#): Manual
 - [Quality](#): Motion
 - [Visibility](#): Never
 - [CameraControl Mode](#): On

Click [Save](#) for the changes to take effect.
5. Set up PresenterTrack for the *Presenter camera*, see the [▶ Set up the PresenterTrack feature](#) chapter. This feature enables the camera to follow a presenter that is moving about on stage.
6. Go to [Settings](#), and select [Configurations](#). Find [Cameras > PresenterTrack > PresenterDetectedStatus](#) and choose whether to enable (default) or disable automatic switching between *Local Presenter* and *Remote Presenter* modes.

Click [Save](#) for the changes to take effect.
7. Go to [Settings](#), and select [Room Types](#). Click the [Briefing](#) thumbnail to push the corresponding configuration to the device.

Switching between room modes

Switching between room modes (*Local Presenter*, *Remote Presenter*, *Discussions*), which implies that camera input sources, and remote and local screen layouts, are changed, can be done in two ways:

- Automatically, based on who is speaking and whether a local presenter is present on stage.

Automatic switching is only between the *Local Presenter* and *Remote Presenter* modes. The room mode doesn't change automatically if the current mode is *Discussion*.

You can disable all automatic switching by setting [Cameras > PresenterTrack > PresenterDetectedStatus](#) to **Disabled**.

Automatic switching is supported only when the PresenterTrack feature enabled ([Cameras > PresenterTrack > Enabled](#) set to **True**).

- Manually, using the buttons on the touch controller.

Automatic switching implies:

- The device switches to the *Local Presenter* mode when a person is detected in the PresenterTrack trigger zone.
- The device switches to the *Remote Presenter* mode when the local presenter, who is tracked, leaves the stage.
- If someone in the local audience asks a question when the device is in *Local Presenter* mode, the device sends split-screen video showing both the presenter and the person asking the question. This requires a SpeakerTrack 60 or Quad Camera as *Audience camera*, and that speaker tracking is switched on.

Switch between room modes manually

While in a conference, you can switch to another mode using the touch controller.

1. Tap [Briefing Room](#) on the touch controller.
2. Tap the mode you want to change to: *Local Presenter*, *Remote Presenter*, or *Discussion*. The current mode is highlighted.

If automatic switching isn't disabled, the room mode will continue to change according to the automatic switching rules.



Board

BoardPro,
BoardPro
G2

Codec EQ

Codec
Plus

Codec
Pro

Desk,
Desk Pro,
DeskMini

Room Bar
Pro,
Room Bar

Room Kit,
Room Kit
Mini

Room Kit
EQX

Room 55

Room
55 Dual,
Room 70

Room 70
G2

Room 70
Panorama

Room
Panorama

Briefing room setup (page 10 of 10)

Limitations

Not supported functionality when using *Briefing Room*:

- MultiSite (embedded multipoint switch)
- Directional audio
- Active control (selection of layouts from CMS)

Board

Board Pro,
Board Pro
G2

Codec EQ

Codec
PlusCodec
ProDesk,
Desk Pro,
Desk MiniRoom Bar
Pro,
Room BarRoom Kit,
Room Kit
MiniRoom Kit
EQX

Room 55

Room 55
Dual,
Room 70Room 70
G2Room 70
PanoramaRoom
Panorama

Classroom setup (page 1 of 10)

The *Classroom* setup makes it easy to set up, manage, and use a room to deliver training and education sessions to groups of people.

The *Classroom* setup is available as a room type template. When you set up a room using a template, a set of configurations is pushed automatically to the device. It is important that the room is set up correctly, and that the cameras are connected exactly as specified. Otherwise the configurations will not match the room.

Required equipment

- One of the following devices:
 - Codec EQ
 - Codec Plus
 - Codec Pro
 - Room Kit EQX
 - Room 55 Dual
 - Room 70
 - Room 70 G2
 - Room Bar Pro
- One or more screens (configurable)
- Two cameras (Audience camera and Presenter camera)
- Microphones
- Speakers
- Touch controller

Limitations

Not supported functionality when using Classroom:

- MultiSite (embedded multipoint switch)
- Directional audio
- Active control (selection of layouts from CMS)

Room modes

The *Classroom* setup has the following predefined room modes that accommodate different scenarios: Local Presenter, Remote Presenter, and Discussion.

Local Presenter mode

- The presenter is in the room. This mode also covers the case when someone in the local audience asks a question (Q&A).
- If automatic switching is enabled (default), the device switches to this mode when the *Presenter camera* detects a presenter in the room.
- Sends video from the *Presenter camera* to the far end. In the Q&A case: Sends split-screen video from the *Presenter camera* and the person asking the question (*Audience camera*) to the far end.

Remote Presenter mode

- The presenter is calling in.
- If automatic switching is enabled (default), the device switches to this mode when the *Presenter camera* doesn't detect a presenter in the room.
- Sends video from the *Audience camera* to the far end.

Discussion mode

- For discussions between different sites. A local presenter is in the room.
- Always use the touch controller to activate this mode.
- Sends video from the *Audience camera* to the far end.

Comparing the room type setups

Presenter and Audience: This is the next generation *Briefing room* and *Classroom* setup. Updates and improvements will only be for *Presenter and Audience*.*

Compared to the older setups, you get:

- Easier manual layout selection options.
- Improved camera switching based on voice activity detection.
- Improved diagnostics tools, such as the diagnostics page that is available on the touch controller.

Supported products: Codec EQ, Codec Plus, Codec Pro, Room Kit EQX, Room 55 Dual, Room 70, Room 70 G2, and Room Bar Pro

Briefing room:

Supported products: Codec EQ, Codec Pro, Room Kit EQX, Room 70 G2, and Room Bar Pro

The setup requires three screens, and the layouts on the screens are preconfigured (and fixed) to match that particular scenario.

Classroom: More flexible than the *Briefing room* setup regarding the number of screens and how the layout is distributed on the screens.

Supported products: Codec EQ, Codec Plus, Codec Pro, Room Kit EQX, Room 55 Dual, Room 70, Room 70 G2, and Room Bar Pro

You can use any number of screens that the device supports, typically two or three. Use the video monitor settings to configure the distribution of layouts on the screens, if the default behavior does not fulfill your requirements.

* *Briefing room* and *Classroom* may be deprecated in a later software release.

Board

Board Pro,
Board Pro
G2

Codec EQ

Codec
Plus

Codec
Pro

Desk,
Desk Pro,
Desk Mini

Room Bar
Pro,
Room Bar

Room Kit,
Room Kit
Mini

Room Kit
EQX

Room 55

Room 55
Dual,
Room 70

Room 70
G2

Room 70
Panorama

Room
Panorama

Classroom setup (page 2 of 10)

Room arrangement examples

These illustrations show examples of how to arrange screens, cameras and microphones, and where to place people for the best experience.

Recommendation

Audience camera:

- Use the integrated camera for video conferencing devices that have that. For other devices, we recommend the Quad Camera or SpeakerTrack 60 camera. We recommend a camera with speaker tracking, but it is also possible to use a camera without speaker tracking capabilities.

Presenter camera:

- PTZ 4K or Precision 60 camera with presenter tracking enabled.

Microphones:

- We recommend the Cisco Ceiling Microphone for good coverage of the room. Also other microphone solutions can be used.

Speakers:

- Use the integrated speakers for video conferencing devices that have that. For other devices, we recommend good quality stereo speakers placed next to the main screen at the front of the room.

Screens:

- You can use one or more screens (the maximum number of screens depends on your type of device).
- For most setups, we recommend that you use two screens or more. Place the main screen at the front of the room. Place a second screen on the side or at the back, so that the local presenter can see the remote audience.

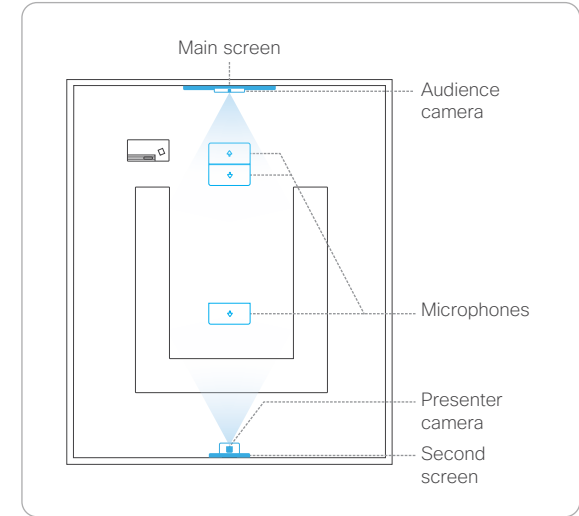
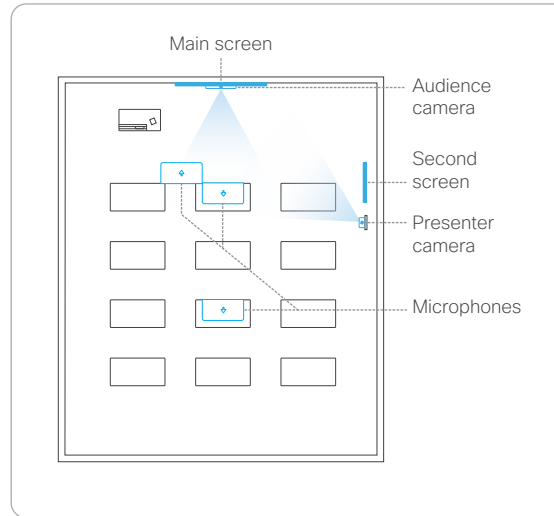

Board

Board Pro,
Board Pro
G2

Codec EQ

Codec
Plus

Codec
Pro

Desk,
Desk Pro,
Desk Mini

Room Bar
Pro,
Room Bar

Room Kit,
Room Kit
Mini

Room Kit
EQX

Room 55

Room
55 Dual,
Room 70

Room 70
G2

Room 70
Panorama

Room
Panorama

Classroom setup (page 3 of 10)

Codec EQ and Room Kit EQX: Connect cables

! Connect the cameras and screens to the device as shown in the illustration. Following the illustration ensures that the configurations that are automatically pushed to the device when selecting the *Classroom* room type template, match your actual setup.

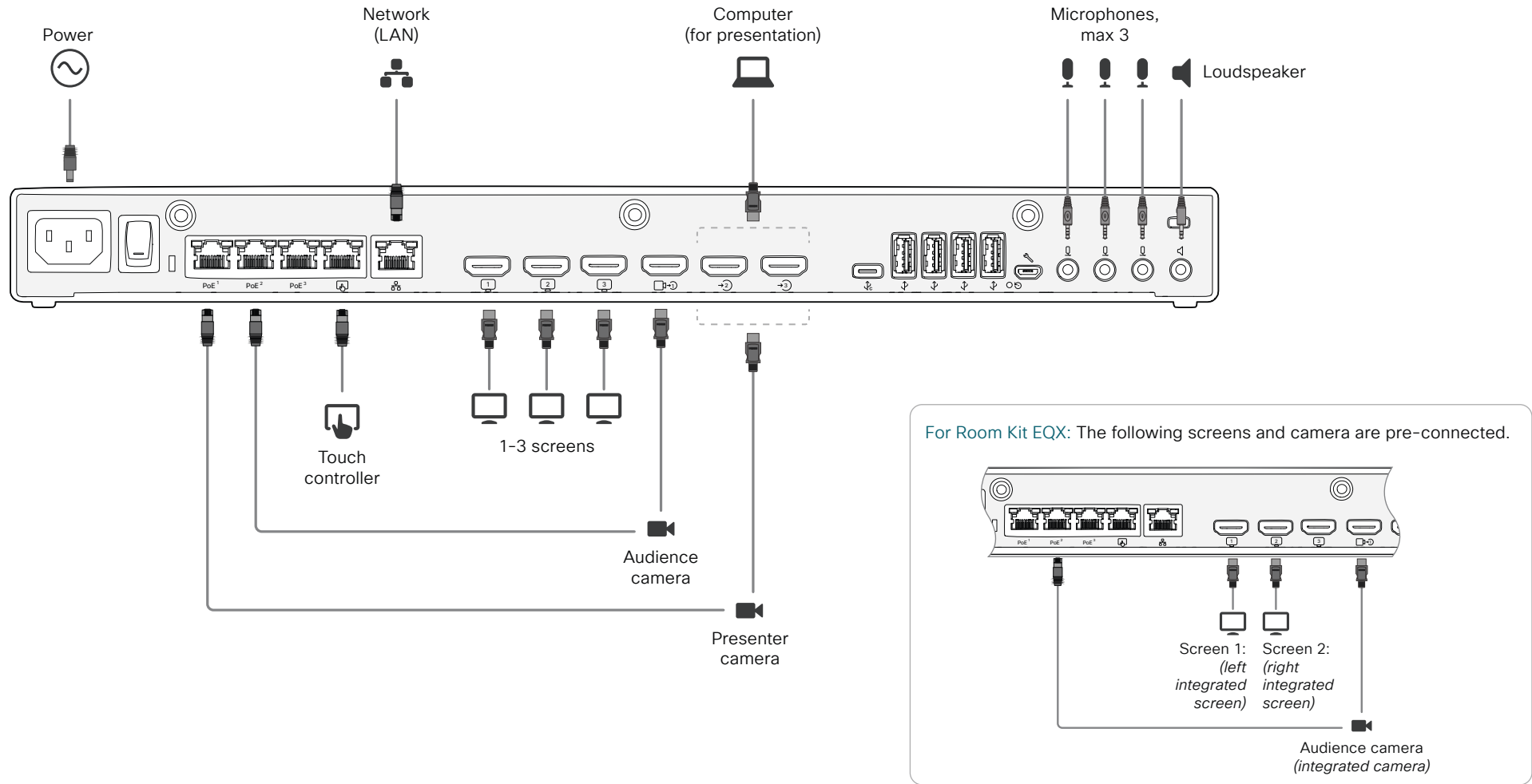

Board

Board Pro,
Board Pro
G2

Codec EQ

Codec
Plus

Codec
Pro

Desk,
Desk Pro,
Desk Mini

Room Bar
Pro,
Room Bar

Room Kit,
Room Kit
Mini

Room Kit
EQX

Room 55

Room
55 Dual,
Room 70

Room 70
G2

Room 70
Panorama

Room
Panorama

Classroom setup (page 4 of 10)

Codec Plus: Connect cables

 Connect the cameras and screens to the device as shown in the illustration. Following the illustration ensures that the configurations that are automatically pushed to the device when selecting the *Classroom* room type template, match your actual setup.

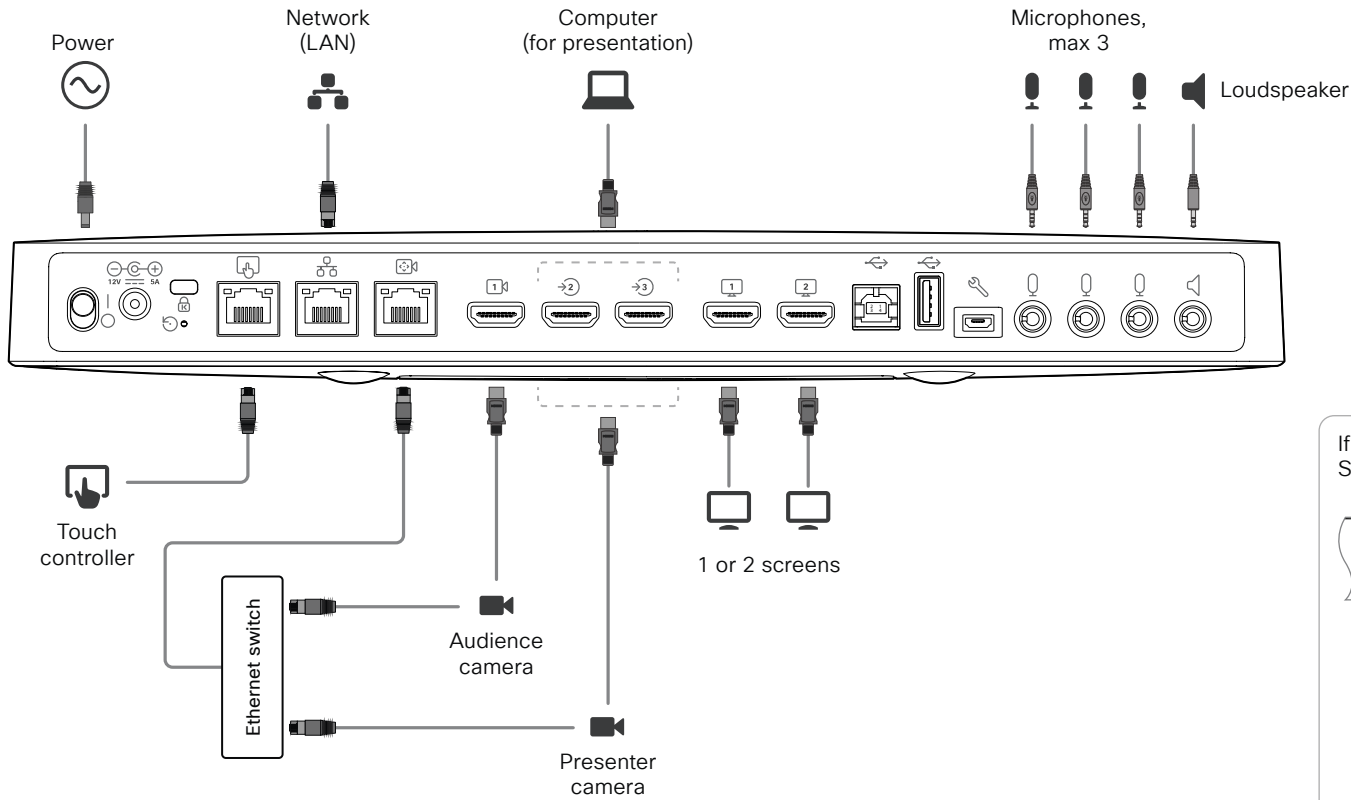

If the *Audience Camera* is a Cisco TelePresence SpeakerTrack 60 camera, then it uses two HDMI inputs.

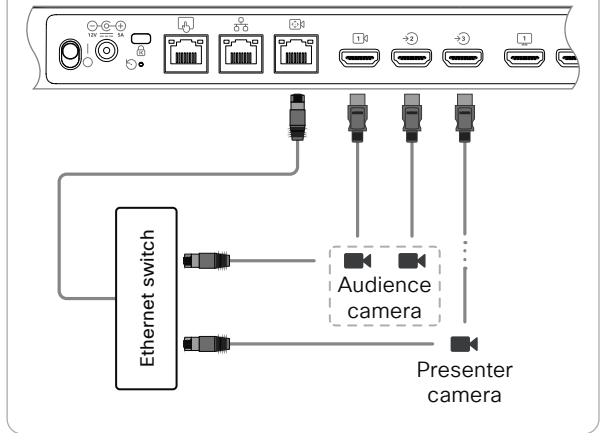

Board

BoardPro,
BoardPro
G2

Codec EQ

Codec
Plus

Codec
Pro

Desk,
Desk Pro,
DeskMini

Room Bar
Pro,
Room Bar

Room Kit,
Room Kit
Mini

Room Kit
EQX

Room 55

Room
55 Dual,
Room 70

Room 70
G2

Room 70
Panorama

Room
Panorama

Classroom setup (page 5 of 10)

Codec Pro: Connect cables

 Connect the cameras and screens to the device as shown in the illustration. Following the illustration ensures that the configurations that are automatically pushed to the device when selecting the *Classroom* room type template, match your actual setup.

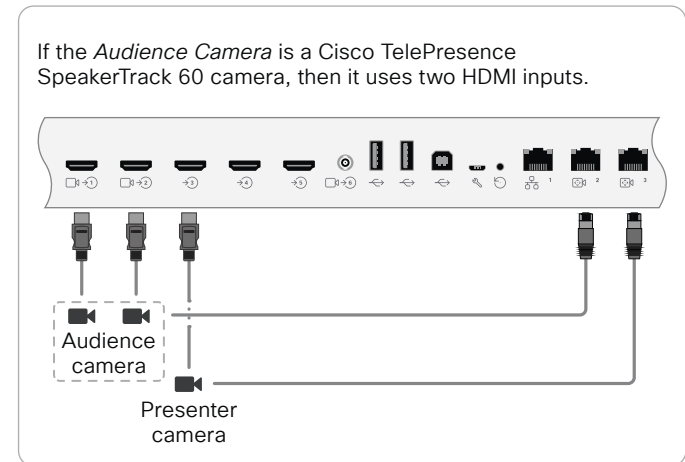
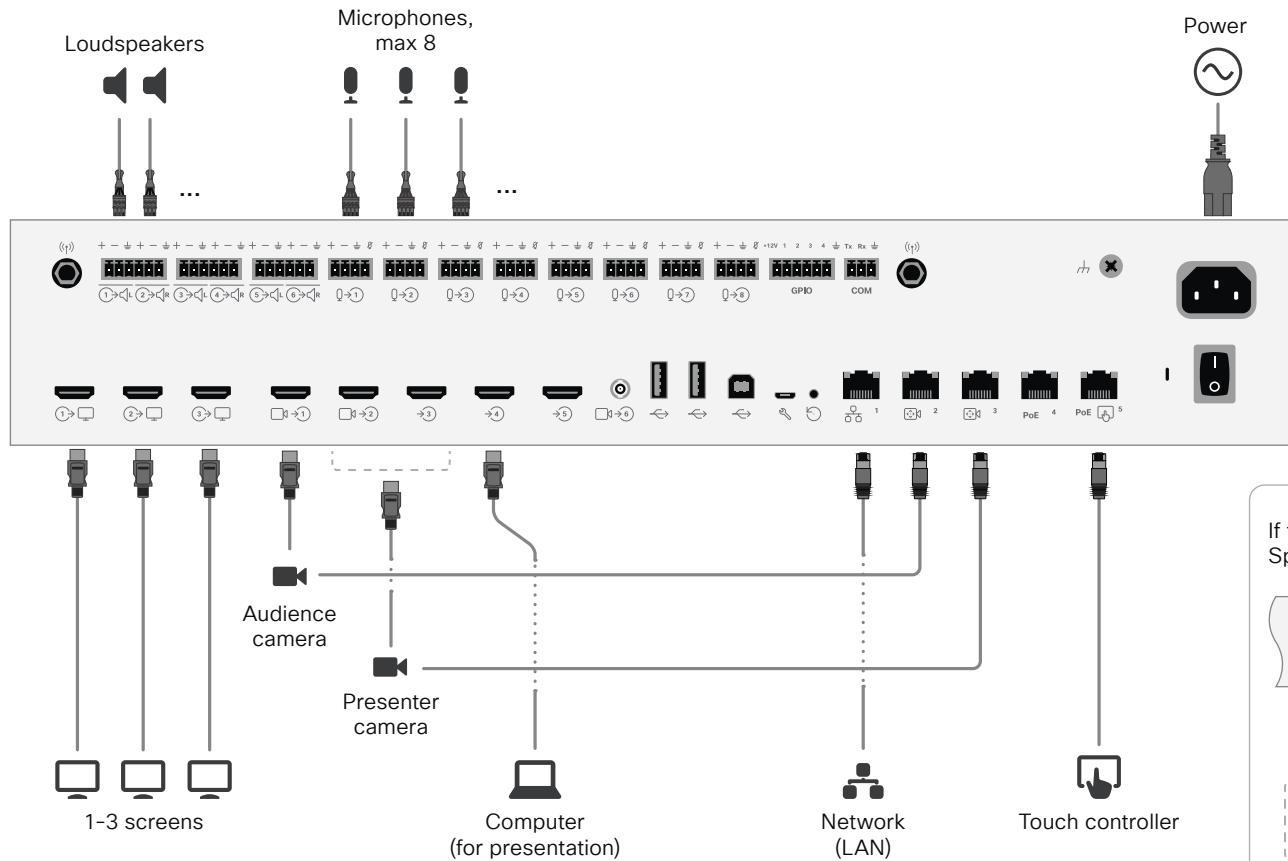

Board

Board Pro,
Board Pro
G2

Codec EQ

Codec
Plus

Codec
Pro

Desk,
Desk Pro,
Desk Mini

Room Bar
Pro,
Room Bar

Room Kit,
Room Kit
Mini

Room Kit
EQX

Room 55

Room 55
Dual,
Room 70

Room 70
G2

Room 70
Panorama

Room
Panorama

Classroom setup (page 6 of 10)

Room 55 Dual and Room 70: Connect cables



Connect the cameras and screens to the device as shown in the illustration. Following the illustration ensures that the configurations that are automatically pushed to the device when selecting the *Classroom* room type template, match your actual setup.

Keep all preconnected cables, including the cables for the integrated camera and screens, as delivered from the factory. **You only have to connect the external screens and cameras.**

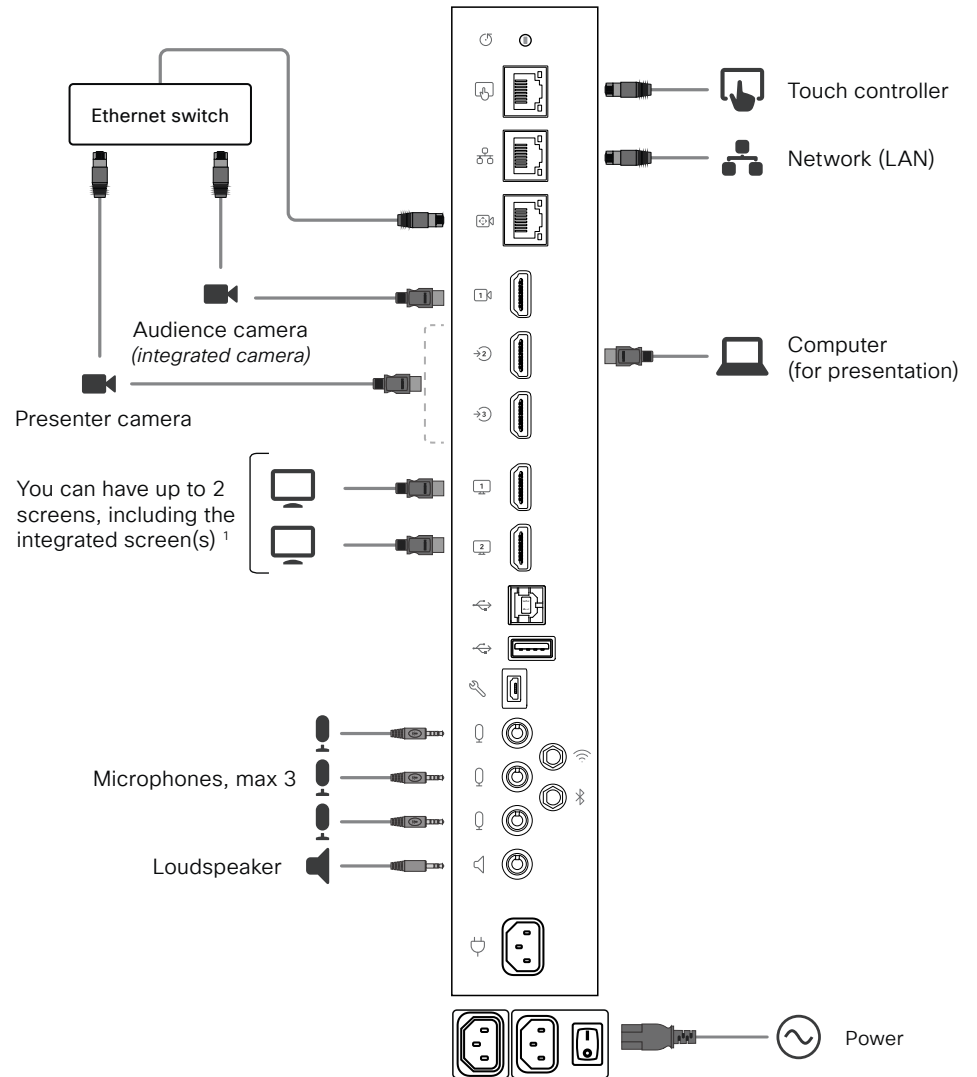

¹ Room 55 Dual and Room 70 Dual: HDMI outputs 1 and 2 are for the integrated screens of the device. External screens are not supported. Room 70 Single: HDMI output 1 is for the integrated screen of the device. An external screen may be connected to HDMI output 2.

Classroom setup (page 7 of 10)

Room 70 G2: Connect cables



Connect the cameras and screens to the device as shown in the illustration. Following the illustration ensures that the configurations that are automatically pushed to the device when selecting the *Classroom* room type template, match your actual setup.

Keep all preconnected cables, including the cables for the integrated camera and screens, as delivered from the factory. You only have to connect the external screens and cameras.

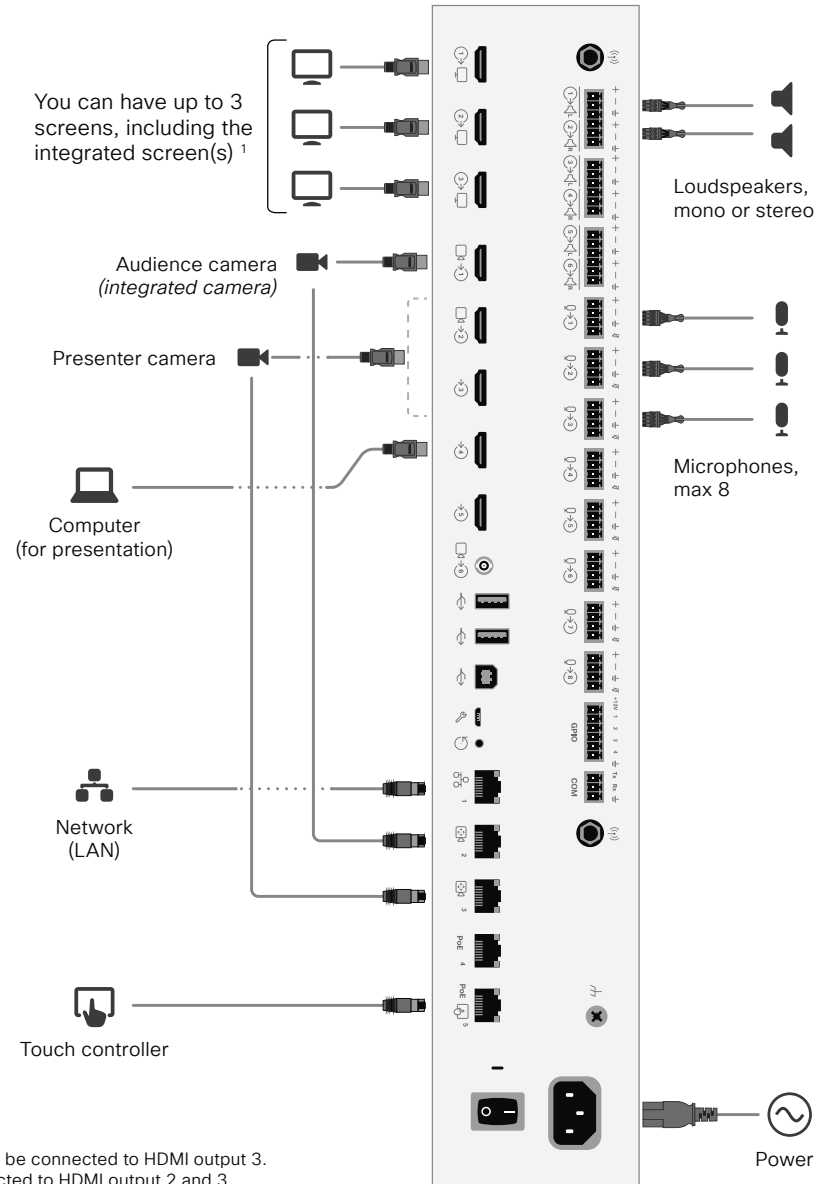

¹ Room 70 Dual G2: HDMI outputs 1 and 2 are for the integrated screens of the device. An external screen may be connected to HDMI output 3. Room 70 Single G2: HDMI output 1 is for the integrated screen of the device. External screens may be connected to HDMI output 2 and 3.

- Board
- Board Pro, Board Pro G2
- Codec EQ
- Codec Plus
- Codec Pro
- Desk, Desk Pro, Desk Mini
- Room Bar Pro, Room Bar
- Room Kit, Room Kit Mini
- Room Kit EQX
- Room 55
- Room 55 Dual, Room 70
- Room 70 G2**
- Room 70 Panorama
- Room Panorama

Board

BoardPro,
BoardPro
G2

Codec EQ

Codec
Plus

Codec
Pro

Desk,
Desk Pro,
Desk Mini

Room Bar
Pro,
Room Bar

Room Kit,
Room Kit
Mini

Room Kit
EQX

Room 55

Room 55
Dual,
Room 70

Room 70
G2

Room 70
Panorama

Room
Panorama

Classroom setup (page 8 of 10)

Room Kit Pro: Connect cables

 Connect the cameras and screens to the device as shown in the illustration. Following the illustration ensures that the configurations that are automatically pushed to the device when selecting the *Classroom* room type template, match your actual setup.

The device's integrated camera is the *Audience camera*.

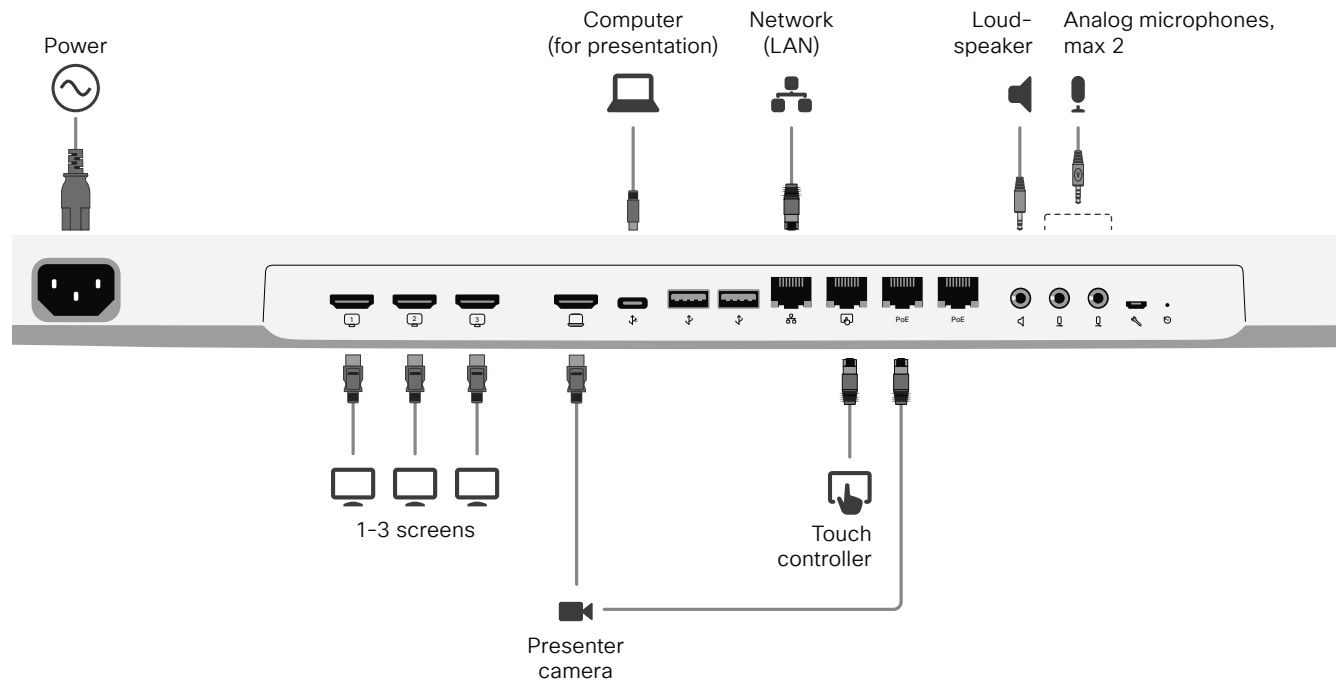

Board

Board Pro,
Board Pro
G2

Codec EQ

Codec
PlusCodec
ProDesk,
Desk Pro,
Desk MiniRoom Bar
Pro,
Room BarRoom Kit,
Room Kit
MiniRoom Kit
EQX

Room 55

Room 55
Dual,
Room 70Room 70
G2Room 70
PanoramaRoom
Panorama

Classroom setup (page 9 of 10)

Configure the device

We recommend you to be in the same room when setting up the Classroom. Otherwise you are not able to set up PresenterTrack properly.

1. Connect cameras and screens as described on the previous pages.
2. Use the touch controller to stop sharing the video from the *Presenter camera*. It is important that video from the *Presenter camera* is not displayed on any screen while setting up Classroom.
3. Sign in to the device web interface, go to [Settings](#), and select [Configurations](#).
4. Go to [Video > Input > Connector n](#), and set the following (*n* is the number of the Connector where the *Presenter Camera* is connected):
 - [InputSourceType](#): camera
 - [PresentationSelection](#): Manual
 - [Quality](#): Motion
 - [Visibility](#): Never
 - [CameraControl Mode](#): OnClick [Save](#) for the changes to take effect.
5. Set up PresenterTrack for the *Presenter camera*, see the [Set up the PresenterTrack feature](#) chapter.

This feature enables the camera to follow a presenter that is moving about on stage.
6. Go to [Settings](#), and select [Configurations](#). Find [Cameras > PresenterTrack > PresenterDetectedStatus](#) and choose whether to enable (default) or disable automatic switching between *Local Presenter* and *Remote Presenter* modes.

Click [Save](#) for the changes to take effect.

Read more about switching between modes on the next page.
7. If the default screen and layout behavior doesn't suit your setup, you must configure the screens and layouts using the following settings:
 - [Video > Monitors](#): Defines the number of different layouts in your room setup.
 - [Video > Output > Connector n > MonitorRole](#): Defines which layout each screen gets. Screens with different monitor roles get different layouts.Refer to the [Setting up screens and other output devices](#) chapter for more details.
8. Go to [Settings](#), and select [Room Types](#). Click the [Classroom](#) thumbnail to push the corresponding configuration to the device.

- Board
- Board Pro, Board Pro G2
- Codec EQ
- Codec Plus
- Codec Pro
- Desk, Desk Pro, Desk Mini
- Room Bar Pro, Room Bar
- Room Kit, Room Kit Mini
- Room Kit EQX
- Room 55
- Room 55 Dual, Room 70
- Room 70 G2
- Room 70 Panorama
- Room Panorama

Classroom setup (page 10 of 10)

Switching between room modes

Switching between room modes (*Local Presenter*, *Remote Presenter*, *Discussions*), which implies that camera input sources, and remote and local screen layouts, are changed, can be done in two ways:

- Automatically, based on who is speaking and whether a local presenter is present on stage.

Automatic switching is only between the *Local Presenter* and *Remote Presenter* modes. The room mode doesn't change automatically if the current mode is *Discussion*.

You can disable all automatic switching by setting [Cameras > PresenterTrack > PresenterDetectedStatus](#) to **Disabled**.

Automatic switching is supported only when the PresenterTrack feature enabled ([Cameras > PresenterTrack > Enabled](#) set to **True**).

- Manually, using the buttons on the touch controller.

Automatic switching implies:

- The device switches to the *Local Presenter* mode when a person is detected in the PresenterTrack trigger zone.
- The device switches to the *Remote Presenter* mode when the local presenter, who is tracked, leaves the stage.
- If someone in the local audience asks a question when the device is in *Local Presenter* mode, the device sends split-screen video showing both the presenter and the person asking the question. This behavior requires a SpeakerTrack 60 or Quad Camera as *Audience camera*, and that speaker tracking is switched on.

Switch between room modes manually

While in a conference, you can switch to another mode using the touch controller.

1. Tap *Classroom* on the touch controller.
2. Tap the mode you want to change to: *Local Presenter*, *Remote Presenter*, or *Discussion*. The current mode is highlighted.

If automatic switching isn't disabled, the room mode will continue to change according to the automatic switching rules.



Using external microphones with Board Pro, Board Pro G2, and Room Bar Pro

These devices have an internal microphone array that is optimized for distances up to 4 m/13 ft. This is sufficient in most small and mid-sized meeting rooms and collaboration spaces. In larger rooms, we recommend to extend audio pickup by adding external table or ceiling microphones to ensure the best audio experience.

Please note that room acoustics and background noise level also impact the speech pickup distance and quality in the meeting space. Consult Webex Workspaces for guidance on best practices:

► <https://www.webex.com/workspaces.html>

¹ *Board Pro, Board Pro G2:* Maximum 8 digital microphones.
Room Bar Pro: Maximum 8 digital microphones.

Internal microphone array

The device's internal microphone array consists of two major parts:

1. A near talker sector, covering up to about 1.5m/5ft from the device. This picks up audio from people standing by the device, presenting or drawing.
2. Three beams that together cover about the same 120° sector as the wide camera lens. They pick up audio from people in the room, up to about 4 m/13ft from the device.

External microphones

If the room requires a pickup range beyond 4 m/13ft from the device, we recommend you to add external microphones. The devices support up to two analog microphones (mini-jack); or multiple digital microphones (Ethernet)¹. Digital USB microphones are also supported.

When connecting an analog or digital (Ethernet) microphone to the device, the internal microphone array's

three beams are automatically disabled. Whether the near talker zone is enabled depends on the product:

- *Board Pro, Board Pro G2:* The near talker zone is activated when someone is inside this zone; hence it picks up audio from people standing by the device.
- *Room Bar Pro:* The near talker zone is disabled.

If you want to enable the three beams when using external microphones, you must set the following:

Audio > Microphones > BeamMix > Inputs: BeamsAndExtMics

NOTE: When using Ceiling Microphone Pro, we recommend using the **Auto** setting as it provides a smarter audio mixer, taking into account the placement of the Ceiling Microphone Pro.

When connecting a USB microphone, all internal microphones and all external analog or digital (Ethernet) microphones are disabled.

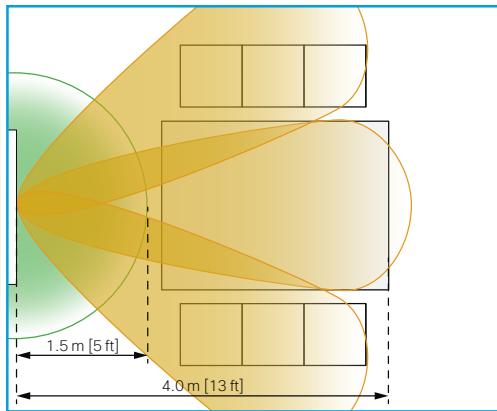

Set-up without external microphones:
The internal microphone array with a near talker zone (green) and three beams (yellow).

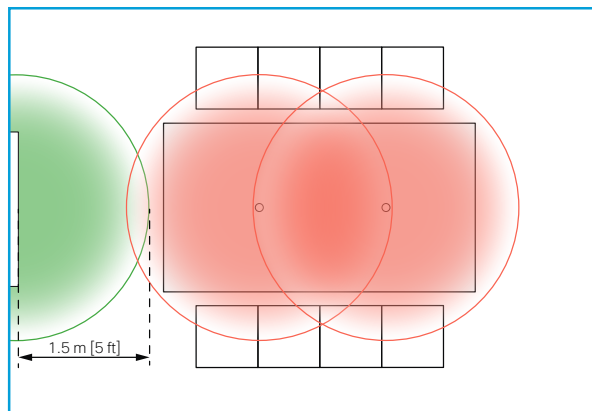

Set-up with external microphones (auto behavior):
Two external microphones (red) and the internal microphone array's near talker zone (green).

Default experience with Table Microphone Pro.
For Ceiling Microphone Pro, this is the experience without using the setup wizard.

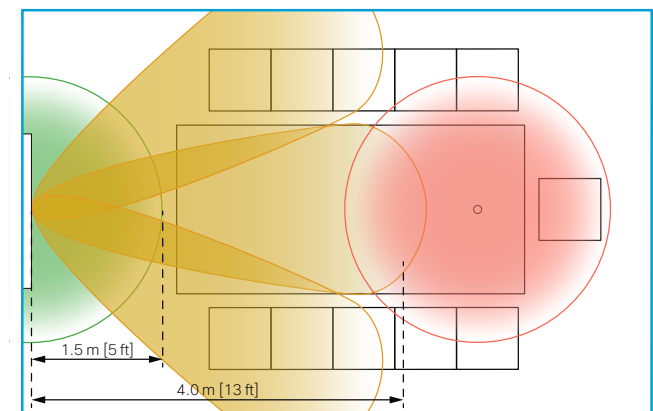

Set-up with external microphones and beams enabled:
One external microphone (red), the internal microphone array's near talker zone (green), and the three beams (yellow).

With Ceiling Microphone Pro, you must use the setup wizard and set beam mixing to **Auto**.

Board

Board Pro,
Board Pro G2

Codec EQ

Codec Plus

Codec Pro

Desk,
Desk Pro,
Desk Mini

Room Bar Pro,
Room Bar

Room Kit,
Room Kit Mini

Room Kit EQX

Room 55

Room 55 Dual,
Room 70

Room 70 G2

Room 70 Panorama

Room Panorama

D15503.06

RoomOS 11.24

02-2025



Board

Board Pro,
Board Pro
G2

Codec EQ

Codec
PlusCodec
ProDesk,
Desk Pro,
DeskMiniRoom Bar
Pro,
Room BarRoom Kit,
Room Kit
MiniRoom Kit
EQX

Room 55

Room 55
Dual,
Room 70Room 70
G2Room 70
PanoramaRoom
Panorama

Test the loudspeaker connections (page 1 of 4)

It is crucial for the conferencing experience that the device's loudspeakers are correctly connected to the codec.

Correct cabling ensures that sound meant to be coming from the right loudspeakers actually comes from the right speakers, and the sound meant to be coming from the left loudspeakers comes from the left speakers. If the speaker cables are incorrectly connected this will not happen.

You must be in the same room as the video conferencing device when you test the loudspeaker connections. If the speaker test reveals any issues, you must reconnect the cables.

Room Kit EQX, Room 55 Dual, Room 70, Room 70 G2, and Room 70 Panorama

We have provided a speaker check tool that you can run to verify that the loudspeakers are correctly connected. The speaker in the camera module is also included in the test.

Room Panorama: You can use this method also for Room Panorama, but we recommend you use the loudspeaker test that is included in the Room Panorama setup assistant. This is described later in this chapter.

Sign in to the device web interface and go to [Developer API](#).

Run the loudspeaker check

1. Enter the following command in the *Execute Commands and Configurations* text area: *

```
xCommand Audio SpeakerCheck  
  MeasurementLength: <number of  
seconds>  
  Volume: <test-signal volume>
```

If you leave out the `MeasurementLength` and `Volume` parameters, the test signal is emitted for 1 second from each speaker, and the volume is 1.

2. Click *Execute*.

The speaker check will now run, and a test signal will be emitted from each speaker.

Room Kit EQX, Room Panorama: The sequence is from left to right, but with the speaker in the camera (at center) playing last.

Other products: The sequence is strictly from left to right, including the speaker in the camera.

3. Listen for the test signals.

If one or more speakers do not make a sound, or the sequence is not correct, you must reconnect the loudspeaker cables and run the speaker check again.

In the field below you can enter API commands (xCommand and xConfiguration) directly.

Example command:

```
xCommand Dial Number: "person@example.com" Protocol: Sip
```

```
xCommand Audio SpeakerCheck
```

[Execute](#)

* Syntax and semantics are explained in the API guide for the device.

Board

BoardPro,
BoardPro
G2

Codec EQ

Codec
Plus

Codec
Pro

Desk,
Desk Pro,
DeskMini

Room Bar
Pro,
Room Bar

Room Kit,
Room Kit
Mini

Room Kit
EQX

Room 55

Room 55
Dual,
Room 70

Room 70
G2

Room 70
Panorama

Room
Panorama

Test the loudspeaker connections (page 2 of 4)

How to reconnect cables

Check the *Installation Guide* for the product for all details.

1. Remove the device's upper textile grille. It snaps to magnets.
2. Unscrew the screw(s) that fastens the loudspeaker (Torx T20). Then, release the speaker gently from its peg.
3. Disconnect the cable that is connected incorrectly, and connect the correct cable.

The cables are marked with a number. Check the illustrations to see which cable should be connected to which loudspeaker.

Room 55 Dual

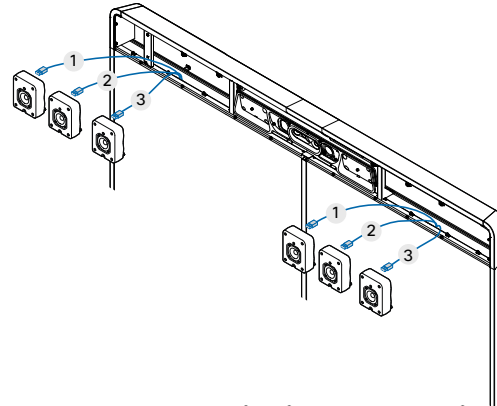

Room 70 Single and Room 70 Single G2

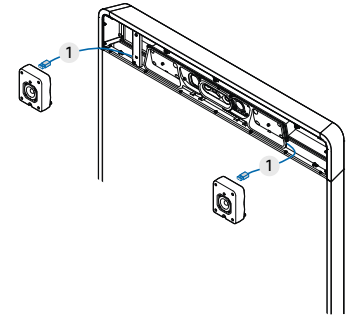

Room 70 Dual, Room 70 Dual G2, Room 70 Panorama

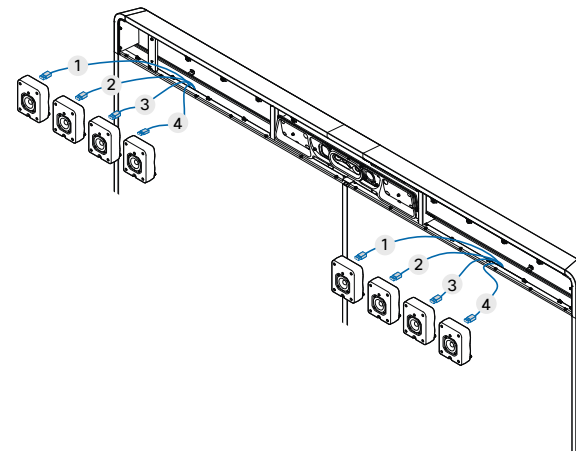

Test the loudspeaker connections (page 3 of 4)

How to reconnect cables

Check the *Installation Guide* for the product for all details.

1. Pop out the screens by pushing them gently.
2. Remove the side panels. They are fastened with two screws each.
3. Remove the upper textile grille. It is fastened with four screws.
4. Unscrew the screws that fastens the loudspeaker (Torx T20). Then, release the speaker gently from its pegs.
5. Disconnect the cable that is connected incorrectly, and connect the correct cable.

The cables are marked with a number. Check the illustrations to see which cable should be connected to which loudspeaker.

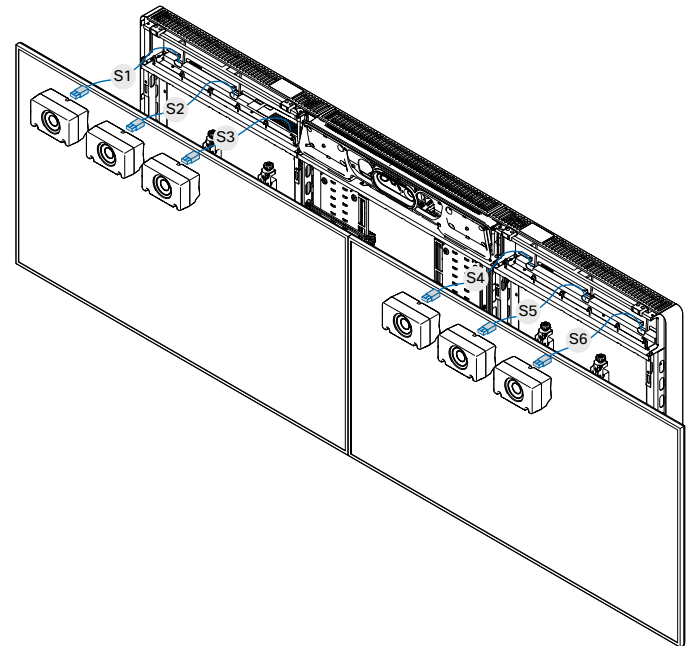
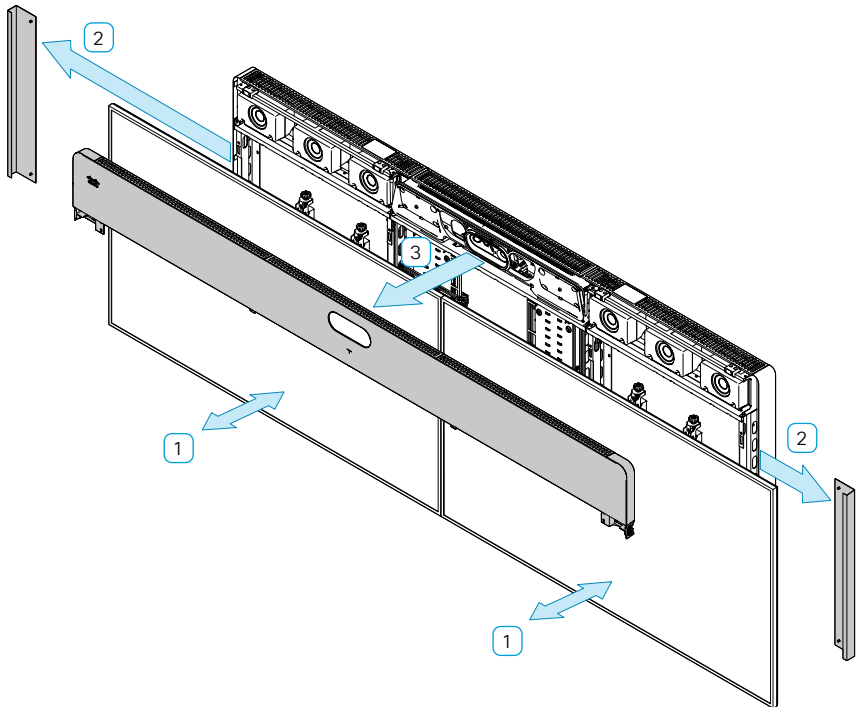

Board

Board Pro,
Board Pro
G2

Codec EQ

Codec
Plus

Codec
Pro

Desk,
Desk Pro,
Desk Mini

Room Bar
Pro,
Room Bar

Room Kit,
Room Kit
Mini

Room Kit
EQX

Room 55

Room
55 Dual,
Room 70

Room 70
G2

Room 70
Panorama

Room
Panorama

D15503.06

RoomOS
11.24

02-2025



Board

Board Pro,
Board Pro
G2

Codec EQ

Codec
PlusCodec
ProDesk,
Desk Pro,
DeskMiniRoom Bar
Pro,
Room Bar

Room Kit

Room Kit
Mini

Room 55

Room
55 Dual,
Room 70Room 70
G2Room 70
PanoramaRoom
Panorama

Test the loudspeaker connections (page 4 of 4)

Room Panorama

The loudspeaker test is included in the Room Panorama setup assistant. This is described in the Getting Started guide for the product.

You can also start the test manually from the touch controller.

When you perform the loudspeaker test, a sound plays from each loudspeaker in sequence.

1. Tap [Settings > Issues and diagnostics > Manual speaker check > Play Sound](#) to start the test.

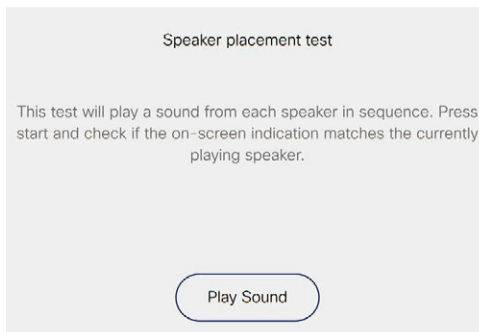

2. Tap [Next](#) to listen to the next loudspeaker, or [Previous](#) to go back and listen to the previous loudspeaker again.

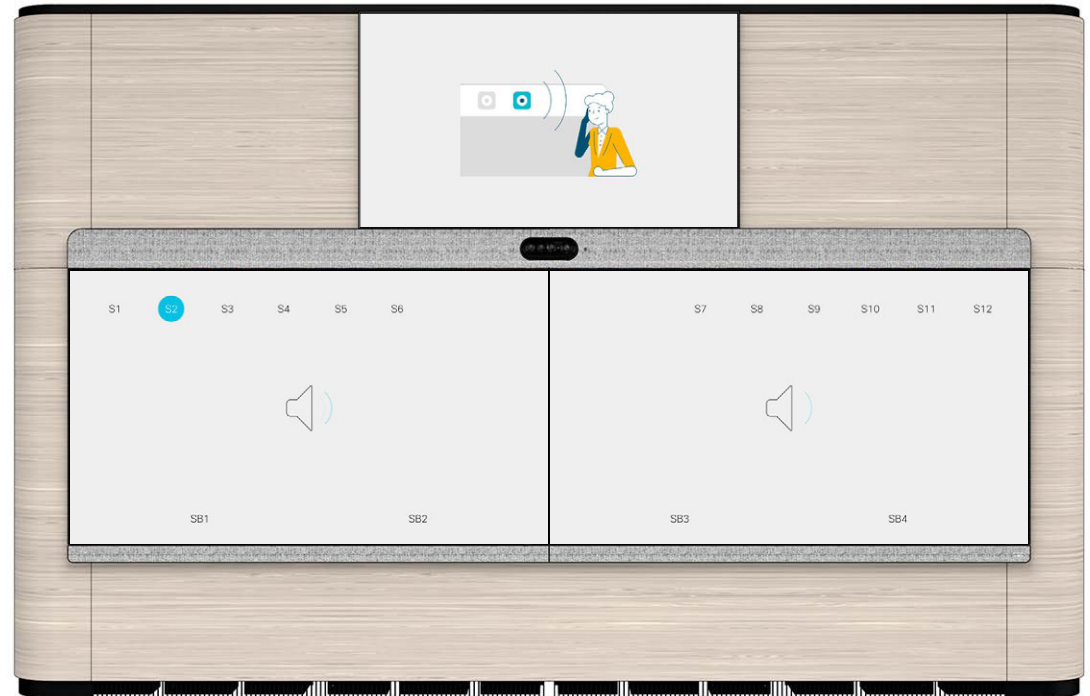

While running the test the graphics on the screens show a number close to the position of each loudspeaker. The number close to the loudspeaker that is supposed to play is marked with blue color.

- **S1-S12:** The loudspeakers above the screens (behind the speaker grille)
- **SB1-SB4:** The subwoofers below the screens (behind the cosmetic panels)

If the loudspeakers and subwoofers are connected correctly, you will hear that the sound is played from the speaker in the position that is marked with blue.

If the loudspeakers play out of order, or a loudspeaker doesn't play at all, you must check the cabling. Read the Getting Started guide to find how to fix the problem.

Board

Board Pro,
Board Pro G2

Codec EQ

Codec Plus

Codec Pro

Desk,
Desk Pro,
Desk MiniRoom Bar Pro,
Room BarRoom Kit,
Room Kit Mini

Room Kit EQX

Room 55

Room 55 Dual,
Room 70

Room 70 G2

Room 70 Panorama

Room Panorama

Bluetooth® headset

The following Bluetooth profiles are supported:

- HFP (Hands-Free Profile)
- A2DP (Advanced Audio Distribution Profile)
- The headset must support both HFP and A2DP or HFP-only. Headsets with A2DP-only is not supported.

A Bluetooth headset is supported directly with the embedded Bluetooth radio or using a USB Bluetooth dongle. Multiple headsets can be paired to the video conferencing device, but only one can be connected at a time.

The range is up to 10m (30ft). If you move outside the range when in a call, the audio will switch to the speakers on the video conferencing device.

Most headsets have built in volume controls. When in a call, the volume of the headset and video conferencing device is synchronized. When not in a call, the volume buttons on the headset and video conferencing device operates independently.

Supported Bluetooth features:

- Answer an incoming call
- Hold and Resume a call
- Reject an incoming call
- Hang up a call
- Volume up and down
- Some headsets have mute control. When using a Cisco headset the mute controls on the headset and video conferencing device are synchronised. For other headsets, mute control on the headset operates independently from the mute control on the video conferencing device.

USB Bluetooth dongle





- When using a USB Bluetooth dongle the headset is detected as a USB headset.
- There will be no synchronization of headset volume and video conferencing device volume when using a dongle.
- We have tested Cisco 700 USB Adapter, Jabra Link 360, Jabra Link 370, Plantronics BT300 and Plantronics BT600; though others might work as well.

Pairing a Bluetooth headset

1. Activate Bluetooth pairing on the headset. Refer to the instruction manual for the headset if in doubt.
2. Swipe in from the right or tap the controls icon  in the upper, right corner to open the control panel. Then select *Device settings*.
3. Select *Bluetooth*. If Bluetooth is disabled, turn it on.
4. The video conferencing device will scan for Bluetooth devices. Upon successful discovery the Bluetooth headset should be displayed in the device list.
5. Select the device and pairing begins. It may take a few seconds for the pairing to complete.
6. If the pairing is successful the video conferencing device will now list the headset as connected. The pairing is now completed.

Switch between devices

You can switch between the built-in speakers on the video conferencing device and the audio devices that are connected via analog, Bluetooth or USB:

-  Built in audio (speakers)
-  Headset/Headphones (analog)
-  Headset USB
-  Handset
-  Bluetooth device

How to choose which audio device to use from the user interface:

1. Swipe in from the right or tap the controls icon  in the upper, right corner to open the control panel.
2. Select an audio device from the corresponding drop down menu. (*Board Pro, Board Pro G2, Desk, Desk Pro, and Desk Mini*)
Tap *Audio* and select an audio device from the corresponding drop down menu. (*Room Bar, Room Bar Pro, and Room Navigator*)

Board

BoardPro,
BoardPro
G2

Codec EQ

Codec
PlusCodec
ProDesk,
Desk Pro,
Desk MiniRoom Bar
Pro,
Room BarRoom Kit,
Room Kit
MiniRoom Kit
EQX

Room 55

Room 55
Dual,
Room 70Room 70
G2Room 70
PanoramaRoom
Panorama

Connect the touch controller (page 1 of 10)

Depending on the type of video conferencing device, the touch controller* can be connected in the following ways:

- Directly to the video conferencing device *(not supported by Board)*
- Paired to the device via the network (LAN). The is referred to as remote pairing.

Connecting the touch controller directly to the video conferencing device

Applies to: All products except Board

Room Panorama: The Room Panorama installation has an Ethernet switch that is mounted under the table, or close to the table. Connect the touch controller to this switch, and not directly to the codec.

Room Panorama supports up to two touch controllers.

Other products: Connect the touch controller to the video conferencing device's dedicated touch controller port (RJ45) as illustrated on the next pages.

Note that the Room Kit doesn't provide Power over Ethernet (PoE), so you need a mid-span PoE injector to power the touch controller.

Touch controller setup

The touch controller is powered over Ethernet (PoE). Once connected, the setup procedure begins. Follow the instructions on screen.

If the touch controller needs software upgrade, new software will be downloaded from the video conferencing device and installed on the unit automatically as part of the setup procedure. The touch controller restarts after the upgrade.

You can then complete the setup by following the instructions on the touch controller.

* Supported touch controllers: Room Navigator (shown in illustrations) and Touch 10. See the [Touch controllers](#) chapter to find which device supports which type of controller.

Board

Board Pro,
Board Pro
G2

Codec EQ

Codec Plus

Codec Pro

Desk,
Desk Pro,
Desk Mini

Room Bar
Pro,
Room Bar

Room Kit,
Room Kit
Mini

Room Kit
EQX

Room 55

Room 55
Dual,
Room 70

Room 70
G2

Room 70
Panorama

Room
Panorama

Connect the touch controller (page 2 of 10)

Connecting the touch controller directly to the video conferencing device

Codec Plus

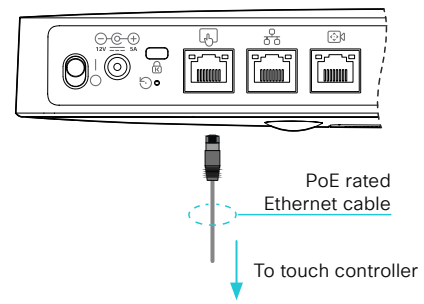

Room 55 Dual and Room 70

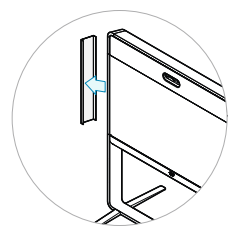

Remove the side cover to get access to the connector panel.

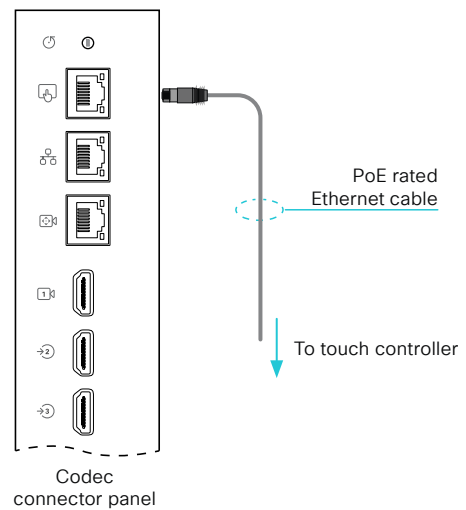

Codec Pro

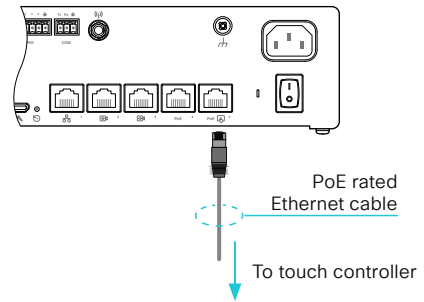

Room 70 G2 and Room 70 Panorama

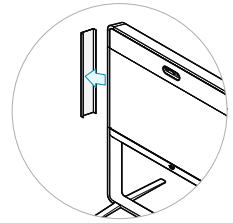

Remove the side cover to get access to the connector panel.

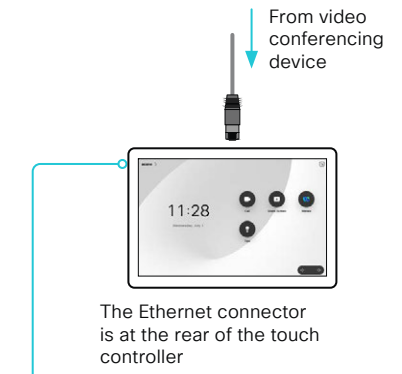
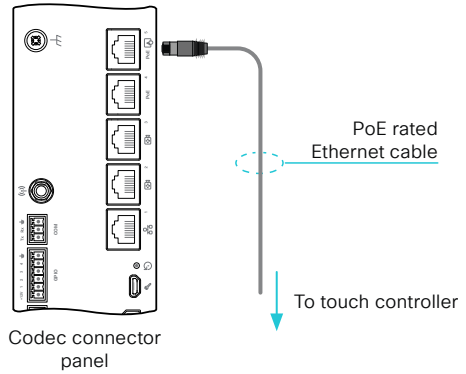

Contact information

The video conferencing device's name or address is displayed in the upper left corner when the touch controller is successfully connected to the device.

Connect the touch controller (page 3 of 10)

Connecting the touch controller directly to the video conferencing device

Room Kit

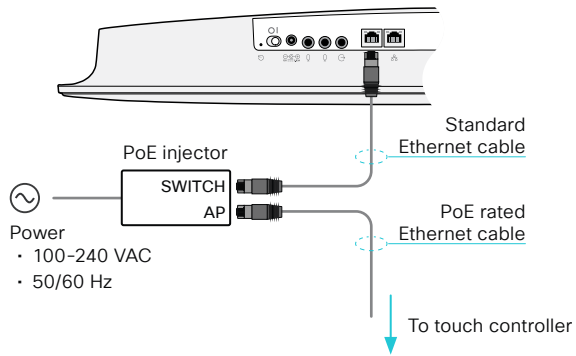

Room Kit Mini

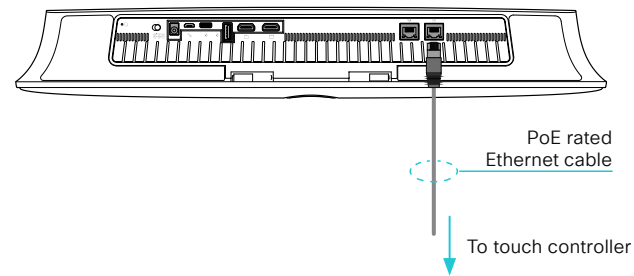

Room Bar

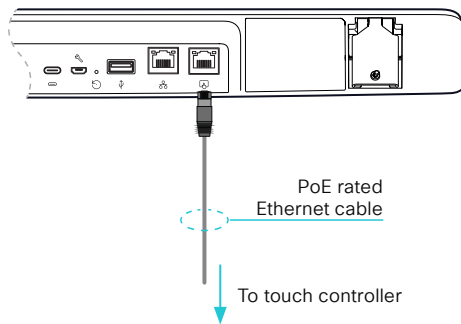

Room Bar Pro

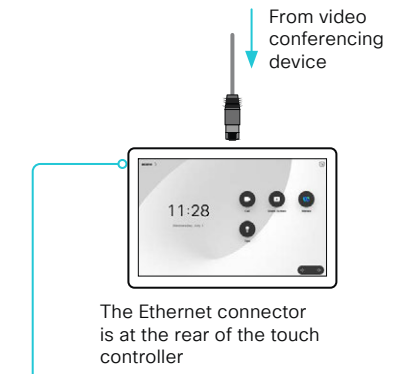
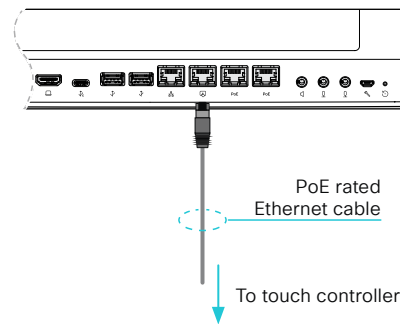

Contact information

The video conferencing device's name or address is displayed in the upper left corner when the touch controller is successfully connected to the device.

Board

Board Pro,
Board Pro
G2

Codec EQ

Codec
Plus

Codec
Pro

Desk,
Desk Pro,
Desk Mini

Room Bar
Pro,
Room Bar

Room Kit,
Room Kit
Mini

Room Kit
EQX

Room 55

Room
55 Dual,
Room 70

Room 70
G2

Room 70
Panorama

Room
Panorama

Connect the touch controller (page 4 of 10)

Connecting the touch controller directly to the video conferencing device

Room 55

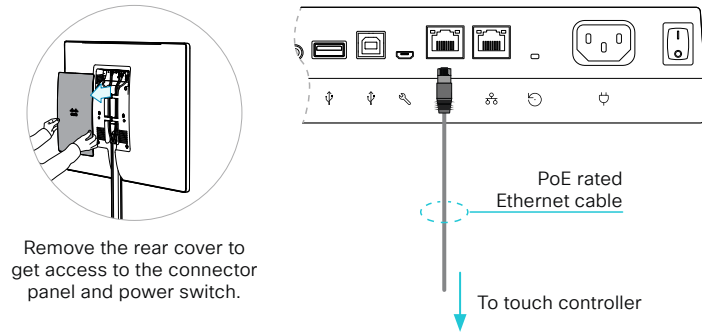

Codec EQ and Room Kit EQX

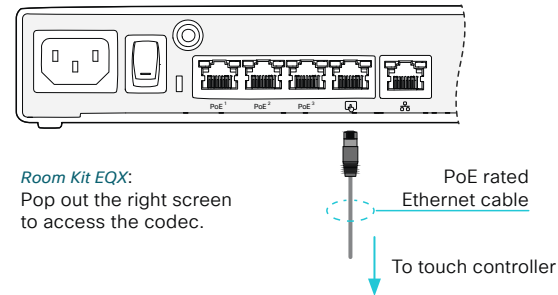

Room Panorama

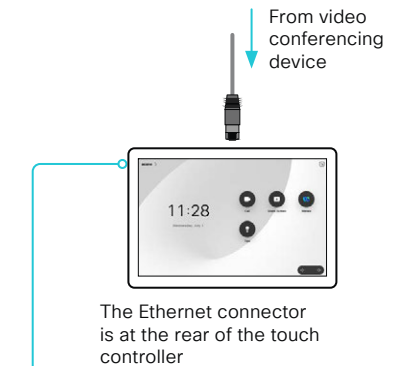
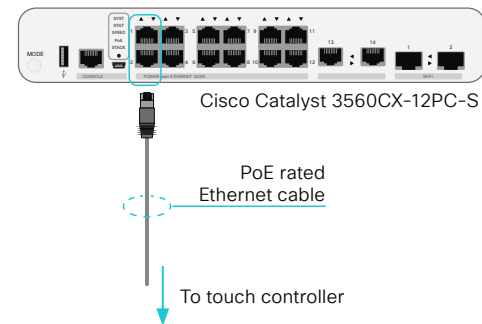

Contact information

The video conferencing device's name or address is displayed in the upper left corner when the touch controller is successfully connected to the device.

Board

Board Pro,
Board Pro
G2

Codec EQ

Codec
Plus

Codec
Pro

Desk,
Desk Pro,
Desk Mini

Room Bar
Pro,
Room Bar

Room Kit,
Room Kit
Mini

Room Kit
EQX

Room 55

Room
55 Dual,
Room 70

Room 70
G2

Room 70
Panorama

Room
Panorama

Board

Board Pro,
Board Pro
G2

Codec EQ

Codec
Plus

Codec
Pro

Desk,
Desk Pro,
Desk Mini

Room Bar
Pro,
Room Bar

Room Kit,
Room Kit
Mini

Room Kit
EQX

Room 55

Room
55 Dual,
Room 70

Room 70
G2

Room 70
Panorama

Room
Panorama

Connect the touch controller (page 5 of 10)

Connecting the touch controller directly to the video conferencing device

Board Pro

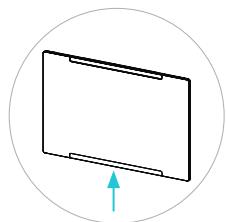

The connector panel is at the bottom.

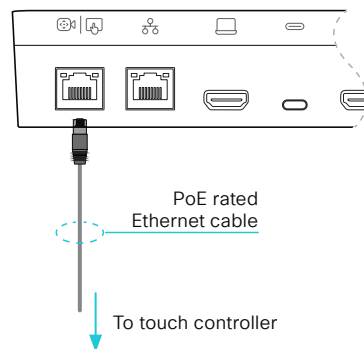

Board Pro G2

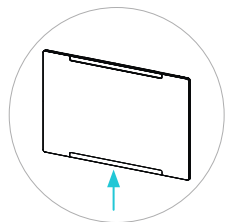

The connector panel is at the bottom.

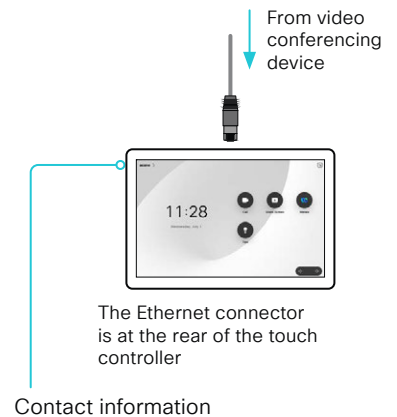
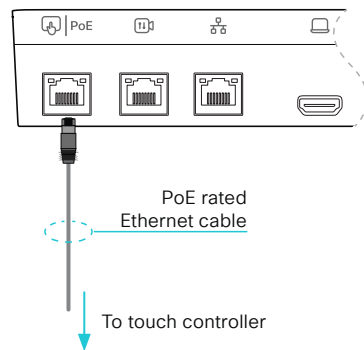

The video conferencing device's name or address is displayed in the upper left corner when the touch controller is successfully connected to the device.

Board

BoardPro,
BoardPro
G2

Codec EQ

Codec
PlusCodec
ProDesk,
Desk Pro,
DeskMiniRoom Bar
Pro,
Room BarRoom Kit,
Room Kit
MiniRoom Kit
EQX

Room 55

Room 55
Dual,
Room 70Room 70
G2Room 70
PanoramaRoom
Panorama

Connect the touch controller (page 6 of 10)

Connecting the touch controller to the video conferencing device via the network (LAN)

Connect the touch controller and the video conferencing device to network wall sockets or to a network switch, as illustrated on the next pages.

Touch controller setup

Once the touch controller is connected to power, the setup procedure begins. Follow the instructions on screen.

When the [Select a room device](#) screen appears, select the video device that you want to connect to.

- A list of devices signalling that they are available for pairing will show up on the screen. Tap the name of the device you want to pair with.

Note that the following must be fulfilled for a device to show up in the list:

- The device and touch controller must be on the same subnet.
- The device must have been restarted within the last 10 minutes. If the device does not appear in the list, try restarting it.
- If the device does not appear in the list of available devices, enter its IP address or hostname in the input field. Tap [Connect](#).

If the touch controller needs software upgrade, new software will be downloaded from the device and installed on the unit automatically as part of the setup procedure. The touch controller restarts after the upgrade.

When the [Pair to device](#) screen appears, select how to pair from these options:

- **Username/Passphrase** - Sign-in with username and passphrase. Tap the right arrow to proceed.
A user with the USER role is sufficient; you do not need the ADMIN role to perform this task.
Read more about how to create a user account and assign a role to it in the [User administration](#) chapter.
- **PIN pairing** - Generate the PIN through the xAPI.

To initiate PIN pairing and create a PIN:

```
xCommand Peripherals Pairing PinPairing Start
```

You can specify the following parameters:

- **Duration** - How long the pairing process will be active (minutes).
- **PinVisibleOnScreen** - Whether the PIN will be visible on the main screen connected to the video device. If this is false, the administrator must provide the PIN to the person at the touch controller screen.
- **Retries** - How many invalid attempts will be allowed before a new PIN must be generated.

Unpairing a touch controller that is connected via the network

To unpair a touch controller that is connected to the device via the network (remotely paired), go to the [Settings](#) menu on the touch controller. Select [Unpair touch controller](#) and confirm by tapping [Unpair](#).

Board

BoardPro,
BoardPro
G2

Codec EQ

Codec
Plus

Codec
Pro

Desk,
Desk Pro,
DeskMini

Room Bar
Pro,
Room Bar

Room Kit,
Room Kit
Mini

Room Kit
EQX

Room 55

Room 55
Dual,
Room 70

Room 70
G2

Room 70
Panorama

Room
Panorama

Connect the touch controller (page 7 of 10)

Connecting the touch controller to the video conferencing device via the network (LAN)

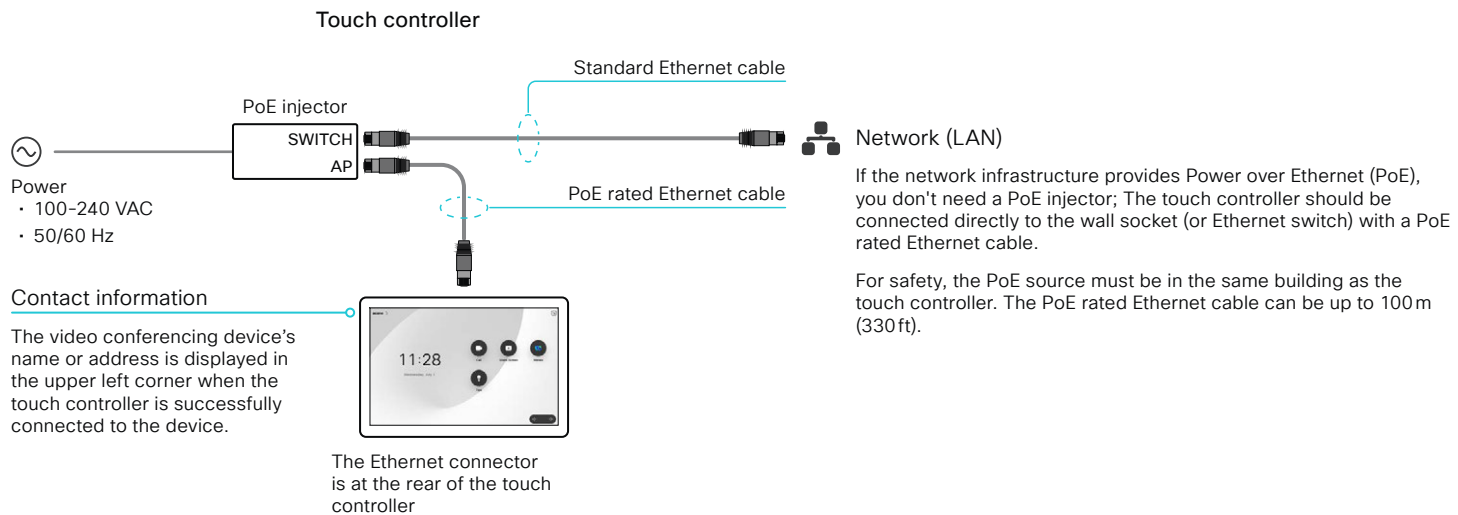

Board

Board Pro,
Board Pro
G2

Codec EQ

Codec
Plus

Codec
Pro

Desk,
Desk Pro,
Desk Mini

Room Bar
Pro,
Room Bar

Room Kit,
Room Kit
Mini

Room Kit
EQX

Room 55

Room 55
Dual,
Room 70

Room 70
G2

Room 70
Panorama

Room
Panorama

D15503.06

RoomOS
11.24

02-2025



Connect the touch controller (page 8 of 10)

Connecting the touch controller to the video conferencing device via the network (LAN)

Codec Plus

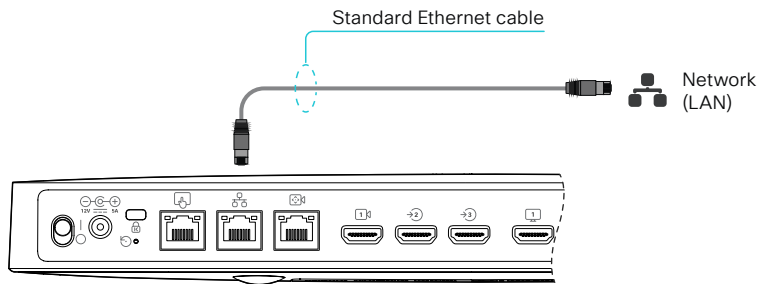

Room 55 Dual and Room 70

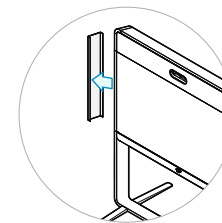

Remove the side cover to get access to the connector panel.

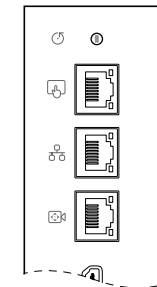

Codec connector panel

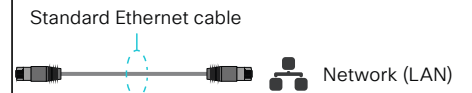

Codec Pro and Room Panorama

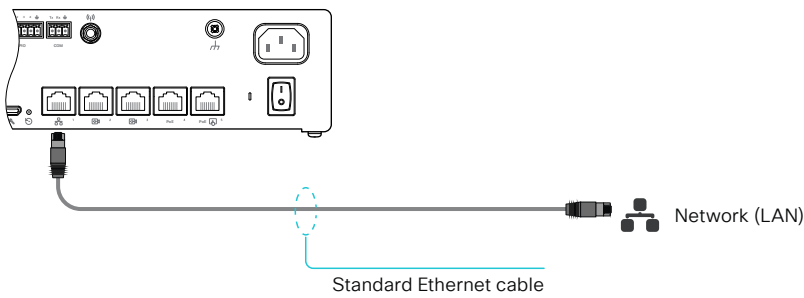

Room 70 G2 and Room 70 Panorama

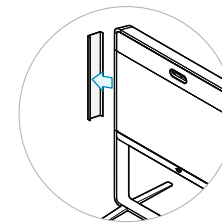

Remove the side cover to get access to the connector panel.

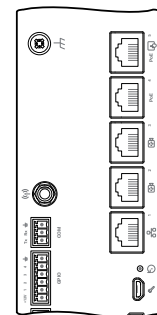

Codec connector panel

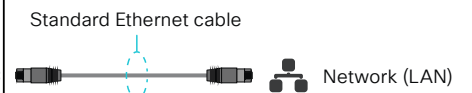

Connect the touch controller (page 9 of 10)

Connecting the touch controller to the video conferencing device via the network (LAN)

Room Kit

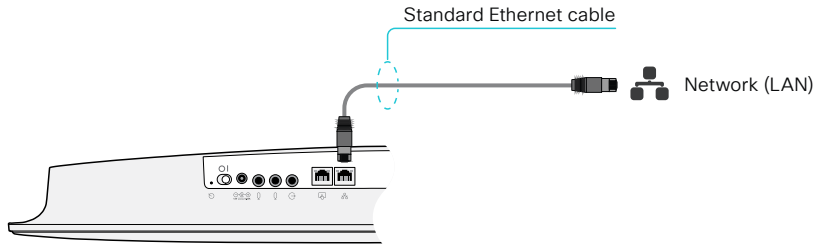

Room Kit Mini

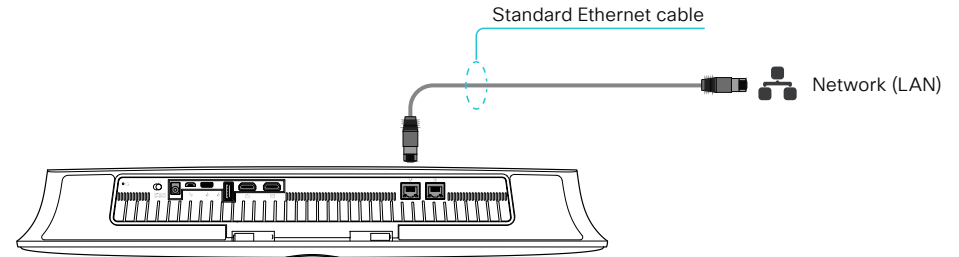

Room Bar Pro

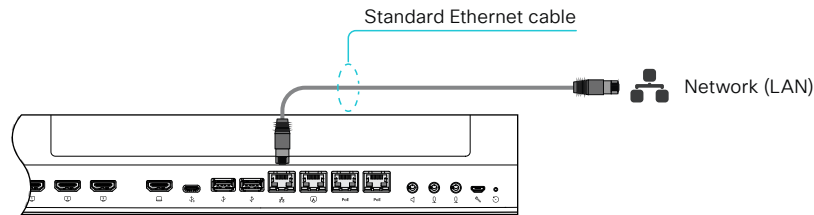

Room Bar

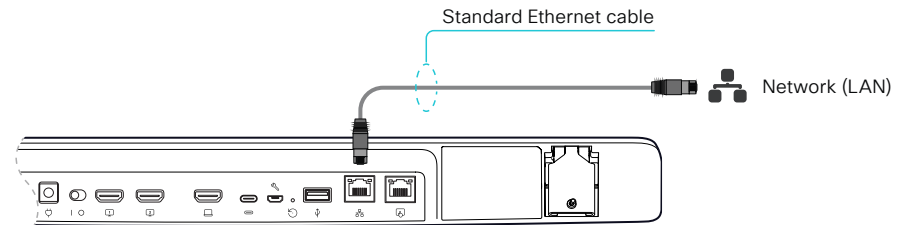

Board

Board Pro,
Board Pro
G2

Codec EQ

Codec
Plus

Codec
Pro

Desk,
Desk Pro,
Desk Mini

Room Bar
Pro,
Room Bar

Room Kit,
Room Kit
Mini

Room Kit
EQX

Room 55

Room
55 Dual,
Room 70

Room 70
G2

Room 70
Panorama

Room
Panorama

- Board
- Board Pro, Board Pro G2
- Codec EQ
- Codec Plus
- Codec Pro
- Desk, Desk Pro, Desk Mini
- Room Bar Pro, Room Bar
- Room Kit, Room Kit Mini
- Room Kit EQX
- Room 55
- Room 55 Dual, Room 70
- Room 70 G2
- Room 70 Panorama
- Room Panorama

Connect the touch controller (page 10 of 10)

Connecting the touch controller to the video conferencing device via the network (LAN)

Room 55

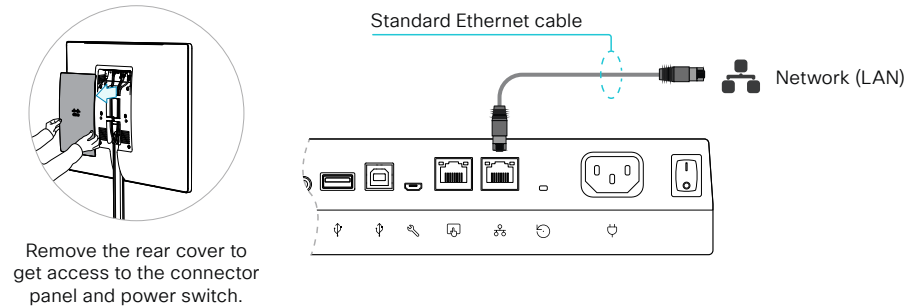

Board

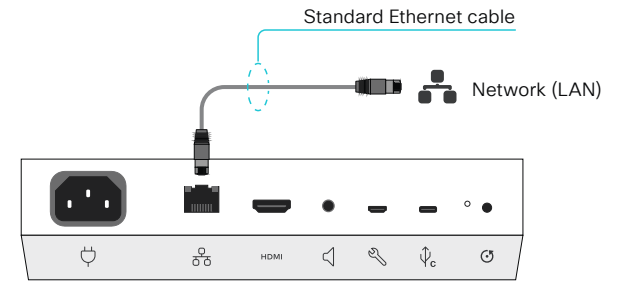
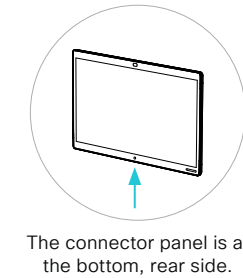

Codec EQ and Room Kit EQX

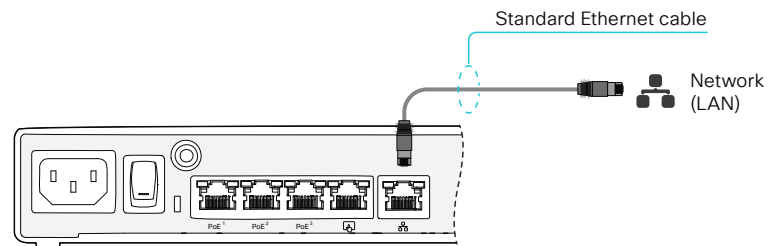

Room Kit EQX:
Pop out the right screen to access the codec.

Board Pro

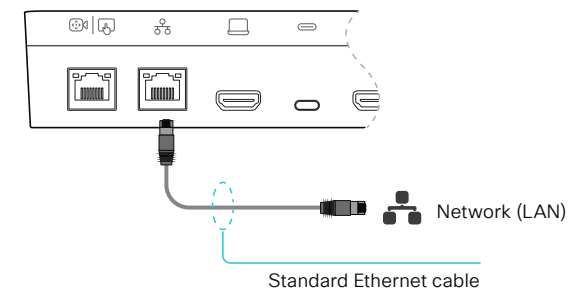
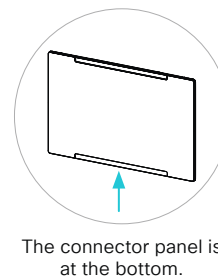

Board Pro G2

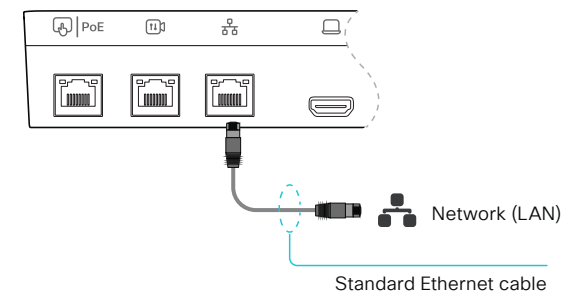
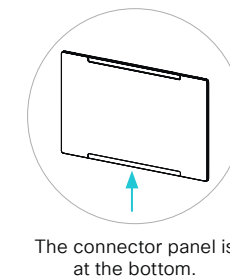

Board

BoardPro,
BoardPro
G2

Codec EQ

Codec
Plus

Codec
Pro

Desk,
Desk Pro,
Desk Mini

Room Bar
Pro,
Room Bar

Room Kit,
Room Kit
Mini

Room Kit
EQX

Room 55

Room 55
Dual,
Room 70

Room 70
G2

Room 70
Panorama

Room
Panorama

Chapter 4

Maintenance

Board

BoardPro,
BoardPro
G2

Codec EQ

Codec
PlusCodec
ProDesk,
DeskPro,
DeskMiniRoom Bar
Pro,
Room BarRoom Kit,
Room Kit
MiniRoom Kit
EQX

Room 55

Room 55
Dual,
Room 70Room 70
G2Room 70
PanoramaRoom
Panorama

Installing new software (page 1 of 2)

Download new software

Each software version has a unique file name. Go to the Cisco Download Software web page, and select your product:

► <https://software.cisco.com/download/home>

The format of the file name is: *

- “cmterm-s53200ce11_x_y_z.k4.cop.sha512”
(for Board, Codec Plus, Room Kit, Room Kit Mini, Room 55, Room 55 Dual, and Room 70)
- “cmterm-s53300ce11_x_y_z.k4.cop.sha512”
(for Board Pro, Board Pro G2, Desk Pro, Desk, Desk Mini, Codec EQ, Codec Pro, Room Bar, Room Bar Pro, Room Kit EQX, Room 70 G2, Room 70 Panorama, and Room Panorama)

where "x" is the minor release number, "y" is the patch number and "z" is the build number.

Software upgrade and downgrade

Carefully read the software release notes (link in side bar) to find software upgrade and downgrade requirements. This applies both when installing software using Cisco UCM, TMS, the device web interface, or other.

When upgrading or downgrading, any settings not appearing in the version you are installing will be deleted. If you later try to go back to the previous software version, those removed settings will be assigned default values.

Cloud-managed software upgrade

If your device is linked to Webex Edge for Devices, you can choose to upgrade the software from the Webex cloud service. Then the device is upgraded automatically as soon as a new RoomOS software version is available from the cloud.

Find more details about *Cloud-managed software upgrade for Webex Edge for Devices* in the ► [Webex Edge for Devices](https://help.webex.com/cy2l2z/) (https://help.webex.com/cy2l2z/) article on Webex Help Center.

About PKG files and COP files

The software images for the video device and the peripherals are in separate PKG files.

Therefore, you must use the COP file when upgrading these devices. The COP file contains the required PKG files for the video device and the peripherals, and a *loads* file that lists the content of the COP file.

Software release notes

For a complete overview of the news and changes in this release, we recommend reading the Software Release Notes (RoomOS 11). It's one set of release notes that covers all products. Go to one of these pages:

► <https://www.cisco.com/c/en/us/support/collaboration-endpoints/desktop-collaboration-experience-dx600-series/products-release-notes-list.html>

► <https://www.cisco.com/c/en/us/support/collaboration-endpoints/spark-room-kit-series/products-release-notes-list.html>

► <https://www.cisco.com/c/en/us/support/collaboration-endpoints/spark-board/products-release-notes-list.html>

Board

BoardPro,
BoardPro
G2

Codec EQ

Codec
Plus

Codec
Pro

Desk,
DeskPro,
Desk Mini

Room Bar
Pro,
Room Bar

Room Kit,
Room Kit
Mini

Room Kit
EQX

Room 55

Room 55
Dual,
Room 70

Room 70
G2

Room 70
Panorama

Room
Panorama

Installing new software (page 2 of 2)

If you want to install software from the device web interface, sign in the interface, go to [Software](#), and select [Software Upgrade](#).

Install new software

Download the appropriate software package and store it on your computer. This is a .cop.sgn file. Don't change the file name.

1. Click [Choose File](#) and find the .cop.sgn file that contains the new software.
The software version will be detected and shown.
2. Click [Install](#) to start the installation process.

The complete installation normally take no longer than 15 minutes. You can follow the progress on the web page. The device restarts automatically after the installation.

You must sign in anew in order to continue working with the device web interface after the restart.

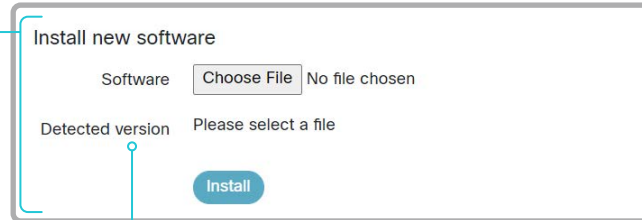

Check new software version

When you have selected a file, the software version is shown here

- Board
- BoardPro, BoardPro G2
- Codec EQ
- Codec Plus
- Codec Pro
- Desk, DeskPro, Desk Mini
- Room Bar Pro, Room Bar
- Room Kit, Room Kit Mini
- Room Kit EQX
- Room 55
- Room 55 Dual, Room 70
- Room 70 G2
- Room 70 Panorama
- Room Panorama

Add option keys

Sign in to the device web interface, go to [Software](#), and select [Option Keys](#).

You see a list of all option keys, also the ones that are not installed on your device.

Contact your Cisco representative for information about how to get option keys for the uninstalled options.

Type	Description	Key	Status	
RemoteMonitoring	Enables snapshots of local and remote video sources in the web interface	Active	
DeveloperPreview	Enables previewing new APIs and features		Not installed	

Uninstall an option key

Click the delete button to uninstall an option key.

The device's serial number

You need the device's serial number when ordering an option key.

Add an option key

1. Enter an *Option key* in the text input field.
2. Click *Apply* to add the option key.

If you want to add more than one option key, repeat these steps for all keys.

Add key

Serial number

Option key

Contact your Cisco representative to obtain option keys. You need to provide the serial number to get option keys.

[Apply](#)

About option keys

Your device may or may not have one or more software options installed. In order to activate the optional functionality the corresponding *option key* must be present on the device.

Each device has unique option keys.

Option keys are not deleted when performing a software upgrade or factory reset, so they need to be added only once.

- Board
- BoardPro, BoardPro G2
- Codec EQ
- Codec Plus
- Codec Pro
- Desk, DeskPro, Desk Mini
- Room Bar Pro, Room Bar
- Room Kit, Room Kit Mini
- Room Kit EQX
- Room 55
- Room 55 Dual, Room 70
- Room 70 G2
- Room 70 Panorama
- Room Panorama

Device status

Device information overview

Sign in to the device web interface and select [Home](#).

This is the *System Information* page, which shows general information such as IP address, MAC address, serial number, active network interface, software version, SIP address, issues, registration status, utilization and environment data, and more.

Detailed device status

Sign in to the device web interface, go to [Settings](#), and select [Statuses](#), in order to find more detailed status information*.

Search for a status entry

Enter as many letters as needed in the search field. All entries that contain these letters are shown in the right pane. Entries that have these letters in their value space are also shown.

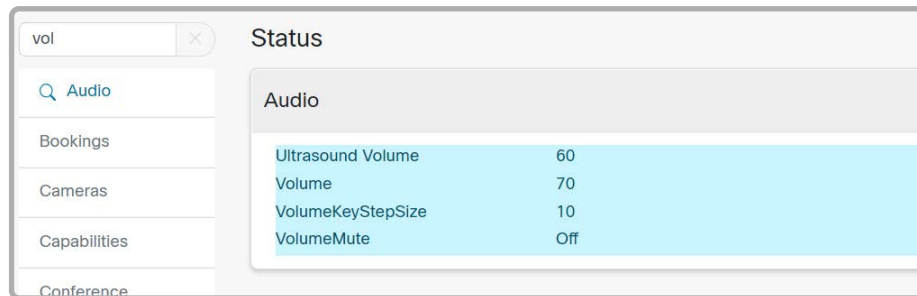

Select a category and navigate to the correct status

The device status is grouped in categories. Choose a category in the left pane to show the related status to the right.

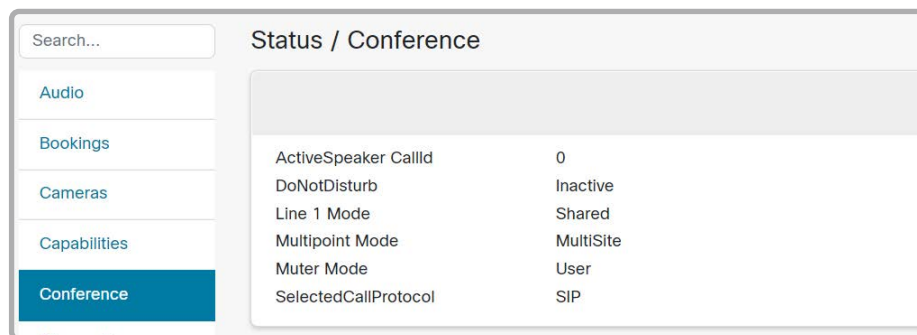

* The status shown in the illustration serve as an example. The status of your device may be different.

- Board
- BoardPro, BoardPro G2
- Codec EQ
- Codec Plus
- Codec Pro
- Desk, DeskPro, Desk Mini
- Room Bar Pro, Room Bar
- Room Kit, Room Kit Mini
- Room Kit EQX
- Room 55
- Room 55 Dual, Room 70
- Room 70 G2
- Room 70 Panorama
- Room Panorama

Run diagnostics

Sign in to the device web interface, go to *Issues and Diagnostics*, and select *Issues*.

A list of active issues* are shown. Errors and critical issues are clearly marked in red color; warnings are yellow.

Run diagnostics

Click *Rerun* to ensure that the list is up to date.

Leave standby mode

Click *System Wakeup* to wake up a device that is in standby mode.

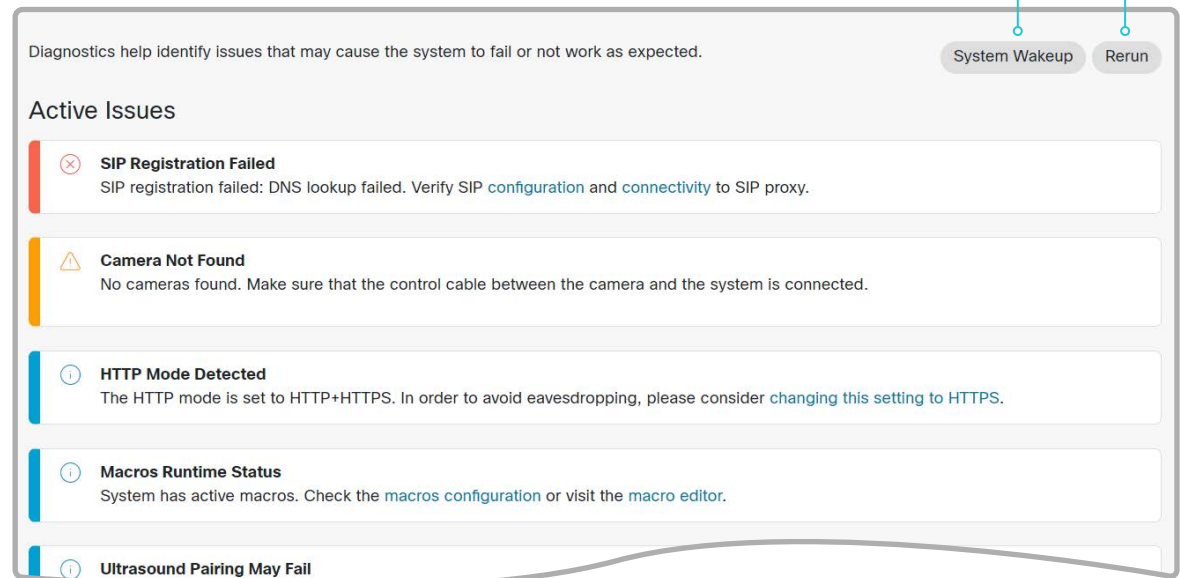

* The issues shown in the illustration serve as examples. Your device will show other information.

Board

BoardPro,
BoardPro
G2

Codec EQ

Codec
PlusCodec
ProDesk,
DeskPro,
DeskMiniRoom Bar
Pro,
Room BarRoom Kit,
Room Kit
MiniRoom Kit
EQX

Room 55

Room 55
Dual,
Room 70Room 70
G2Room 70
PanoramaRoom
Panorama

Get system log files (page 1 of 2)

The system log files are Cisco specific debug files which may be requested by the Cisco support organization if you need technical support.

Current logs and historical logs

The *current log files* are time stamped event log files.

All current log files are archived in a time stamped *historical log file* each time the device restarts. If the maximum number of historical log files is reached, the oldest one will be overwritten.

Extended logging mode

Extended logging mode may be switched on to help diagnose network issues and problems during call setup. While in this mode more information is stored in the log files. Network traffic may also be captured in this mode.

Extended logging uses more of the device's resources, and may cause the device to under-perform. Only use extended logging mode when you are troubleshooting an issue.

Extended logging lasts for 3 or 10 minutes, depending on whether full capture of network traffic is included or not.

Personal identifiable information (PII) in logs

You can choose whether to include PII in the logs or not. In some cases PII is replaced by a *Removed for privacy* note rather than the full entry being removed.

Set up logs from the user interface

You have a few options to set up logs from the device's user interface.

1. Swipe in from the right or tap the controls icon  in the upper, right corner to open the control panel. Then select *Device settings*.
2. Open *Issues and diagnostics* and find these toggle buttons:
 - *Extended logging*: If toggled on, a full capture of network traffic will be included in the logs. PII information will also be included.
 - *PII logging*: If toggled on, PII will be included in the logs, even if Extended logging is not turned on.

Sending logs to the Webex cloud

If your device is registered to the Webex cloud service or linked to Webex Edge for Devices, you can also upload the logs to the cloud.

1. Swipe in from the right or tap the controls icon  in the upper, right corner to open the control panel. Then select *Device settings*.
2. Open *Issues and diagnostics* and tap *Send logs*.

Board

BoardPro,
BoardPro
G2

Codec EQ

Codec
Plus

Codec
Pro

Desk,
DeskPro,
DeskMini

Room Bar
Pro,
Room Bar

Room Kit,
Room Kit
Mini

Room Kit
EQX

Room 55

Room 55
Dual,
Room 70

Room 70
G2

Room 70
Panorama

Room
Panorama

Get system log files (page 2 of 2)

Set up and download logs from the device web interface

Sign in to the device web interface, go to *Issues and Diagnostics*, and select *System Logs*.

Download all log files

Find the *System Logs* card, and click *Download logs...*

Choose whether to download *Full logs* or *Anonymized logs*.

Follow the instructions to save the file.

Personal identifiable information (PII) are replaced by a *Removed for privacy* note in the anonymized logs. Attaching anonymized logs to support cases may increase the time needed to resolve your issue.

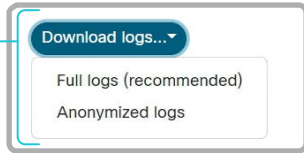

Start extended logging

Find the *Extended Logging* card, and click *Start*.

Extended logging lasts for 3 or 10 minutes, depending on whether full capture of network traffic is included or not.

Click *Stop* if you want to stop the extended logging before it times out.

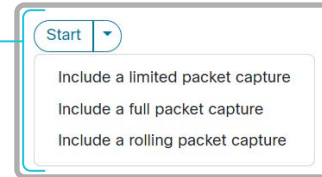

As default, the network traffic is not captured. Use the drop down menu if you want to include partial or full capture of network traffic. A rolling, full capture mode is also available.

Download all log files (legacy format) *Not recommended*

Find the *System Logs* card, and click *Download logs in legacy format...*

Choose whether to include the full call history (non-anonymous caller/callee), an anonymized call history, or no call history at all, in the log files.

Follow the instructions to save the file.

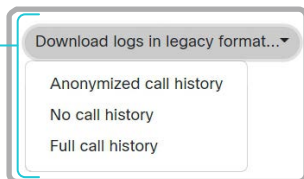

Open or save a log file

Click a *current log file* to open the log file in the web browser; right click to save the file on the computer.

Click a *historical log file* and follow the instructions to save the file on your computer.

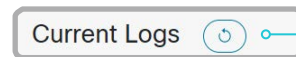

Refresh a log file list

Click the refresh button for *Current logs* or *Historical logs* to update the corresponding lists.

Log file format

We introduced a new log file format for on-premises registered devices in CE9.15. The new format aligns with the format used for cloud registered devices.

We recommend you to download logs using the newer file format, rather than using the legacy format.

Board

BoardPro,
BoardPro
G2

Codec EQ

Codec
PlusCodec
ProDesk,
DeskPro,
DeskMiniRoom Bar
Pro,
Room BarRoom Kit,
Room Kit
MiniRoom Kit
EQX

Room 55

Room 55
Dual,
Room 70Room 70
G2Room 70
PanoramaRoom
Panorama

Get call logs

Sign in to the device web interface, go to *Issues and Diagnostics*, and select *Call Logs*. From the list that appears, select a call to see its details.

The details include information about the remote number, direction of the originating call, protocol, call rate, encryption type, and duration; as well as, information relating to the disconnection of a call.

The **Disconnect cause type** field is used to describe why the call was disconnected. There are many possible values, and these can be changed downstream. Some examples include: OtherLocal, LocalDisconnect, UnknownRemoteSite, LocalBusy, LocalReject, InsufficientSecurity, OtherRemote, RemoteDisconnect, RemoteBusy, RemoteRejected, RemoteNoAnswer, CallForwarded, and NetworkRejected.

The **disconnection cause** field can provide additional information as a supplement to the **disconnect cause type**.

The **disconnect cause code** is defined by SIP and Q.850.

Occurrence type provides further information relating to whether the call was placed, received, missed, rejected, if the remote end never answered the call, or if the call answered on another device.

The **Is acknowledged** field shows whether or not a missed call has been acknowledged by a user.

- Board
- BoardPro, BoardPro G2
- Codec EQ
- Codec Plus
- Codec Pro
- Desk, DeskPro, DeskMini
- Room Bar Pro, Room Bar
- Room Kit, Room Kit Mini
- Room Kit EQX
- Room 55
- Room 55 Dual, Room 70
- Room 70 G2
- Room 70 Panorama
- Room Panorama

Create a remote support user

Sign in to the device web interface and, go to [Users](#).

 The remote support user should only be enabled for troubleshooting reasons when instructed by Cisco TAC.

Create remote support user

1. Find the *Remote Support User* card, and click [Create User](#).
2. Open a case with Cisco TAC.
3. Copy the text in the *Token* field and send it to Cisco TAC.
4. Cisco TAC will generate a *password*.

The remote support user is valid for seven days, or until it is deleted.

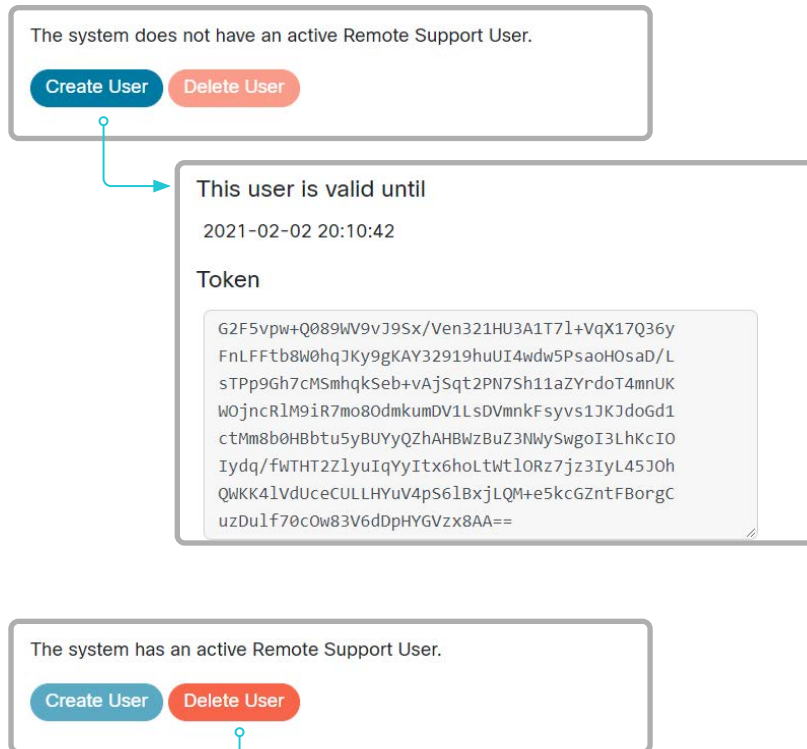

Delete remote support user

Click [Delete User](#).

About the remote support user

In cases where you need to diagnose problems on the device you can create a remote support user.

The remote support user is granted read access to the device and has access to a limited set of commands that can aid troubleshooting.

You will need assistance from Cisco Technical Assistance Center (TAC) to acquire the password for the remote support user.

Board

BoardPro,
BoardPro
G2

Codec EQ

Codec
PlusCodec
ProDesk,
DeskPro,
Desk MiniRoom Bar
Pro,
Room BarRoom Kit,
Room Kit
MiniRoom Kit
EQX

Room 55

Room 55
Dual,
Room 70Room 70
G2Room 70
PanoramaRoom
Panorama

Backup and restore configurations and custom elements

Sign in to the device web interface and go to [Backup and Recovery](#).

You can include custom elements as well as configurations in a backup file (zip-format). You can choose which of the following elements to include in the bundle:

- Branding images
- Macros
- Favorites
- Sign-in banner
- UI extensions
- Configurations/settings (all or a sub-set)

The backup file can either be restored manually from the device web interface, or you can generalize the backup bundle so that it can be provisioned across multiple devices, for example using Cisco UCM or TMS (see the next chapters).

Create a backup file

1. Select [Backup](#).
2. Select the elements you want to include in the backup file.
3. Select which settings – if any – you want to include in the backup file. Note the following:
 - As default, all settings are included in the backup file.
 - You can remove one or more settings manually by deleting them from the list on the web page.
 - If you want to remove all settings that are specific to one device, click [Remove system-specific configurations](#).
This is useful if you are going to restore the backup bundle on other devices.
4. Click [Download](#) to store the elements in a zip-file on your computer.

Restore a backup file

1. Select [Restore](#).
2. Click [Choose File](#) and find the backup file you want to restore.
All settings and elements in the backup file will be applied.
3. Click [Upload](#) to apply the backup.
Some settings may require that you restart the device before they take effect.

Additional information

Restoring macros

If a backup file that contains macros is restored on a device the following applies:

- The macro runtime is started or restarted.
- The macros are automatically activated (started).

Restoring branding images

If a backup bundle contains branding images, the *UserInterface Wallpaper* setting is automatically set to **Auto**.

This means that the branding images will automatically be displayed.

The backup file

The backup file is a zip-file that contains several files. It is important that the files are at the top level within the zip-file, and not include in a folder.

Board

BoardPro,
BoardPro
G2

Codec EQ

Codec
PlusCodec
ProDesk,
DeskPro,
DeskMiniRoom Bar
Pro,
Room BarRoom Kit,
Room Kit
MiniRoom Kit
EQX

Room 55

Room 55
Dual,
Room 70Room 70
G2Room 70
PanoramaRoom
Panorama

CUCM provisioning of custom elements

A backup file, as described in the [► Backup and restore configurations and custom elements](#) chapter, can be used as a *customization template* for multiple devices.

The customization template (backup file) may be hosted on either:

- the CUCM TFTP file service, or
- a custom web server that can be reached by the devices on HTTP or HTTPS.

When a device get information from CUCM (Cisco Unified Communications Manager) about the name and location of a customization template, the device will contact the server, download the file, and restore the custom elements.



Configurations will not be restored on the device, even if they are part of the backup file that you use as a customization template.

Upload a customization template to the TFTP file server

1. Sign in to *Cisco Unified OS Administration*.
2. Navigate to *Software Upgrades > TFTP File Management*.
3. Click *Upload File*. Enter the name and path of the customization template in the input field.
4. Click *Upload File*.

Restart the TFTP service after the file has been uploaded.

Add customization provisioning information for each device

1. Sign in to *Cisco Unified CM Administration*.
2. Navigate to *Device > Phone*.
3. Fill in the **Customization Provisioning** fields in the product specific configuration section of the relevant devices:
 - *Customization File*: The customization template file name (for example: backup.zip) *
 - *Customization Hash Type*: **SHA512**
 - *Customization Hash*: The SHA512 checksum for the customization template.

If these fields are not present, you must install a newer Device Package on CUCM.

4. Click *Save* and *Apply Config* to push the configuration to the devices.

SHA512 checksum

Tip! You can find the SHA512 checksum of a file by restoring it to a device using its web interface.

1. Sign in to the device web interface, go to *Backup and Recovery*, and select *Restore*.
2. Click *Choose File* and find the file you want to calculate the checksum for.

Then you can see the SHA512 checksum at the bottom of the page.

CUCM documentation

► <https://www.cisco.com/c/en/us/support/unified-communications/unified-communications-manager-callmanager/tsd-products-support-series-home.html>

* If not using the TFTP Service, you must enter the complete URI for the customization template: <hostname>:<portnumber>/<path-and-filename>

For example:

- <http://host:6970/backup.zip>, or
- <https://host:6971/backup.zip>

Board

BoardPro,
BoardPro
G2

Codec EQ

Codec
PlusCodec
ProDesk,
Desk Pro,
Desk MiniRoom Bar
Pro,
Room BarRoom Kit,
Room Kit
MiniRoom Kit
EQX

Room 55

Room 55
Dual,
Room 70Room 70
G2Room 70
PanoramaRoom
Panorama

TMS provisioning of custom elements

A backup file, as described in the [Backup and restore configurations and custom elements](#) chapter, can be used as a *customization template* for multiple devices.

The backup file must be hosted on a custom web server that can be reached by the devices on HTTP or HTTPS.

When a device get information from TMS (TelePresence Management Suite) about the name and location of the backup file, the device will contact the server, download the file, and restore the custom elements.

Create and apply a configuration template

1. Create a configurations template.
2. Add a custom command containing the following XML string in the configuration template:

```
<Command>
  <Provisioning>
    <Service>
      <Fetch>
        <URL>web-server-address</URL>
        <Checksum>checksum</Checksum>
        <Origin>origin</Origin>
      </Fetch>
    </Service>
  </Provisioning>
</Command>
```

where

web-server-address: The URI to the backup file (for example, `http://host/backup.zip`).

checksum: The SHA512 checksum of the backup file.

origin: **Provisioning** *

3. Select the devices you want to push the configuration template to, and click [Set on systems](#).

Read the [Cisco TMS administrator guide](#) for details how to create TMS configurations templates and make custom commands.

SHA512 checksum

Tip! You can find the SHA512 checksum of a file by restoring it to a device using its web interface.

1. Sign in to the device web interface, go to [Backup and Recovery](#), and select [Restore](#).
2. Click [Choose File](#) and find the file you want to calculate the checksum for.

Then you can see the SHA512 checksum at the bottom of the page.

* If not setting this parameter to **Provisioning**, also configurations that are part of the backup file will be pushed to the device. If the backup file contains configurations that are specific to one device, for example static IP addresses, device name, and contact information, you may end up with devices that you cannot reach.

Board

BoardPro,
BoardPro
G2

Codec EQ

Codec
PlusCodec
ProDesk,
DeskPro,
Desk MiniRoom Bar
Pro,
Room BarRoom Kit,
Room Kit
MiniRoom Kit
EQX

Room 55

Room 55
Dual,
Room 70Room 70
G2Room 70
PanoramaRoom
Panorama

Revert to the previously used software image

Sign in to the device web interface, go to [Backup and Recovery](#), and select [System Recovery](#).

We recommend you to back up the log files, configurations, and custom elements of the device before you swap to the previously used software image.

Back up log files

1. Go to [Issues and Diagnostics](#) and select [System Logs](#).
2. Click [Download logs](#) and follow the instructions to save the log files on your computer.

Back up configurations and custom elements

1. Go to [Backup and Recovery](#) and select [Backup](#).
2. Click [Download](#) and follow the instructions to save the backup bundle on your computer.

Revert to the previously used software image

Only administrators, or people in contact with Cisco technical support, should perform this procedure.

1. Select [System Recovery](#).
2. Find the [Software Recovery Swap](#) card and click [Swap software](#).
3. Click [Confirm](#) to continue, or [Cancel](#) if you have changed your mind.

Wait while the device resets. The device restarts automatically when finished. This procedure may take a few minutes.

About the previously used software image

If there is a severe problem with the device, switching to the previously used software image may help solving the problem.

If the device has not been factory reset since the last software upgrade, the previously used software image still resides on the device. You do not have to download the software again.

Board

BoardPro,
BoardPro
G2

Codec EQ

Codec
PlusCodec
ProDesk,
DeskPro,
DeskMiniRoom Bar
Pro,
Room BarRoom Kit,
Room Kit
MiniRoom Kit
EQX

Room 55

Room 55
Dual,
Room 70Room 70
G2Room 70
PanoramaRoom
Panorama

Factory reset the video conferencing device (page 1 of 6)

If there is a severe problem with the device, the last resort may be to reset it to its default factory settings.



It is not possible to undo a factory reset.

Always consider reverting to the previously used software image before performing a factory reset. In many situations, this will recover the device. Read about software swapping in the [► Revert to the previously used software image](#) chapter.

We recommend that you use the device web interface or user interface to factory reset the device. If these interfaces are not available, you can use the reset button through the pinhole.

A factory reset implies:

- Call logs are deleted.
- Passphrases are reset to default.
- All device parameters are reset to default values.
- All files that have been uploaded to the device are deleted. This includes, but is not limited to, custom wallpaper, branding elements, certificates, and favorites lists.
- The previous (inactive) software image is deleted.
- Option keys are not affected.

The device restarts automatically after the factory reset. It is using the same software image as it used before the reset.

We recommend that you back up the log files, configurations, and custom elements of the device before performing a factory reset; otherwise this data will be lost.

Factory reset using the web interface

We recommend that you back up the log files and configuration of the device before you continue with the factory reset.

Sign in to the device web interface, go to [Backup and Recovery](#), and select [System Recovery](#).

1. Find the *Factory Reset* card, and read the provided information carefully.
2. Click [Reset to Factory Defaults](#).
3. Click [Factory Reset](#) to confirm your choice, or [Cancel](#) if you have changed your mind.
4. Wait while the device reverts to the default factory settings. When finished, the device restarts automatically. This may take a few minutes.

When the device has been successfully reset to factory settings, the *Setup assistant* starts with the *Welcome* screen.

Back up log files

1. Go to [Issues and Diagnostics](#) and select [System Logs](#).
2. Click [Download logs](#) and follow the instructions to save the log files on your computer.

Back up configurations and custom elements

1. Go to [Backup and Recovery](#) and select [Backup](#).
2. Click [Download](#) and follow the instructions to save the backup bundle on your computer.

Factory reset from the user interface

We recommend that you back up the log files and configuration of the device before you continue with the factory reset.

1. Swipe in from the right or tap the controls icon  in the upper, right corner to open the control panel. Then select [Device settings](#).
2. Select [Factory reset](#).
3. Select [Reset](#) to confirm your choice, or [Cancel](#) if you have changed your mind.
4. Wait while the device reverts to the default factory settings. When finished, the device restarts automatically. This may take a few minutes.

When the device has been successfully reset to factory settings, the *Setup assistant* starts with the *Welcome* screen.

Board

BoardPro,
BoardPro
G2

Codec EQ

Codec
Plus

Codec
Pro

Desk,
DeskPro,
DeskMini

Room Bar
Pro,
Room Bar

Room Kit,
Room Kit
Mini

Room Kit
EQX

Room 55

Room 55
Dual,
Room 70

Room 70
G2

Room 70
Panorama

Room
Panorama

Factory reset the video conferencing device (page 2 of 6)

Factory reset using the reset button through the pinhole

We recommend that you back up the log files and configuration of the device before you continue with the factory reset.

1. Insert a paper clip (or similar) into the pinhole. Press and hold the recessed reset button until the screen turns black (approximately 10 seconds). Then, release the button.
2. Wait while the device reverts to the default factory settings. When finished, the device restarts automatically. This may take a few minutes.

When the device has been successfully reset to factory settings, the Setup assistant starts with the *Welcome* screen.

i See the illustrations to find the recessed reset button for the different products.

The button can be quite difficult to use. You should feel the button go down when pushed.

Room 55 Dual and Room 70

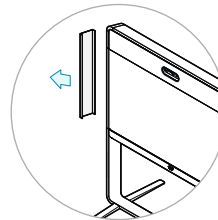

Remove the left side cover of the device to get access to the codec connector panel. The cover snaps to magnets.

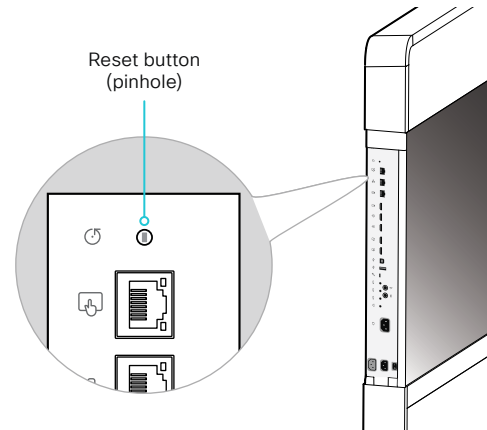

Room 70 G2 and Room 70 Panorama

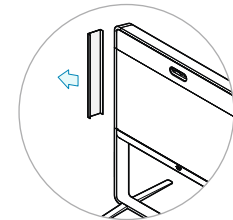

Remove the left side cover of the device to get access to the codec connector panel. The cover snaps to magnets.

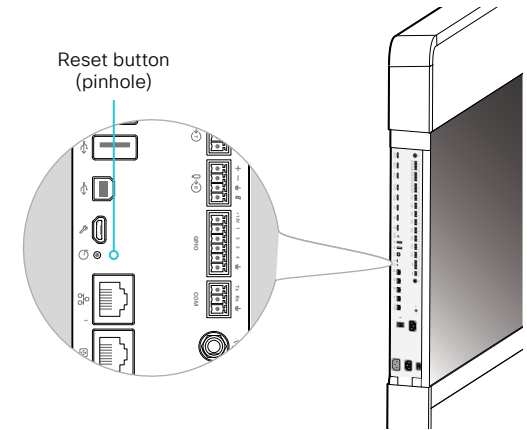

Board

Board Pro,
Board Pro
G2

Codec EQ

Codec
Plus

Codec
Pro

Desk,
Desk Pro,
Desk Mini

Room Bar
Pro,
Room Bar

Room Kit,
Room Kit
Mini

Room Kit
EQX

Room 55

Room
55 Dual,
Room 70

Room 70
G2

Room 70
Panorama

Room
Panorama

Factory reset the video conferencing device (page 3 of 6)

Codec EQ and Room Kit EQX

Room Kit EQX:

Pop out the right handle to access the codec.

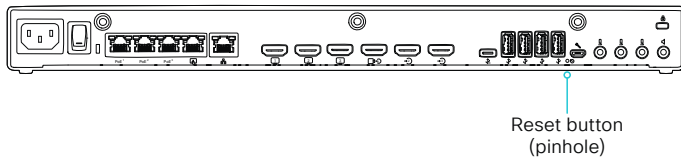

Codec Plus

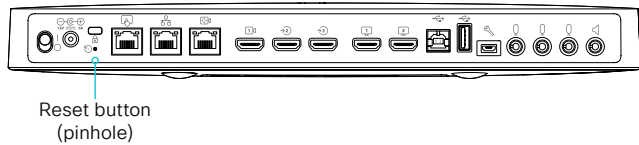

Codec Pro and Room Panorama

Room Panorama:

Use the handle at the bottom of the deco grille, and pull down the left screen to get access to the codec.

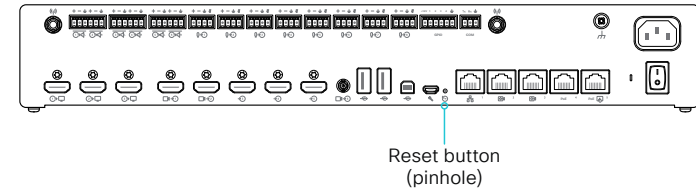

Room 55

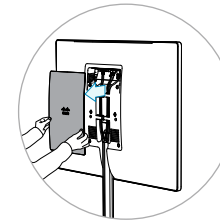

Remove the rear cover to get access to the connector panel.

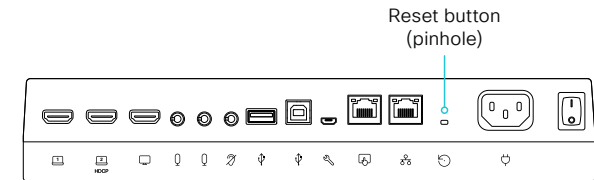

Board

Board Pro,
Board Pro
G2

Codec EQ

Codec
Plus

Codec
Pro

Desk,
Desk Pro,
Desk Mini

Room Bar
Pro,
Room Bar

Room Kit,
Room Kit
Mini

Room Kit
EQX

Room 55

Room
55 Dual,
Room 70

Room 70
G2

Room 70
Panorama

Room
Panorama

Factory reset the video conferencing device (page 4 of 6)

Room Bar

Tilt the unit forward to get access to the connector panel.

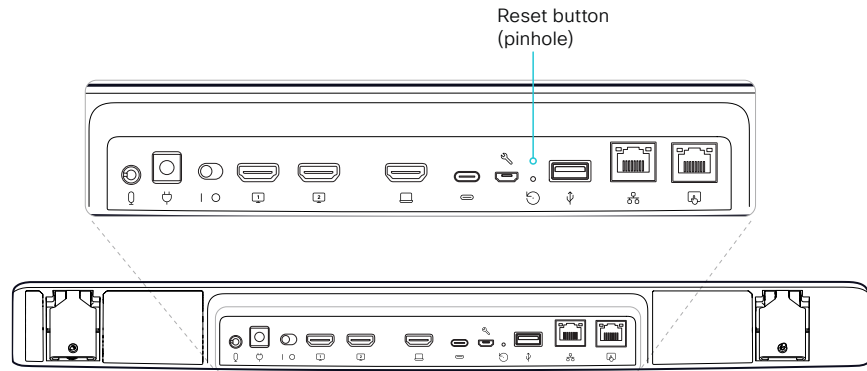

Room Bar Pro

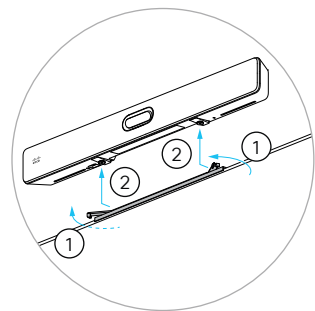

First, unlock the device by pulling the locking handles on each side of the mounting bar (1). Then, pull the device gently towards you and lift it off the mounting bar (2) to get access to the connector panel.

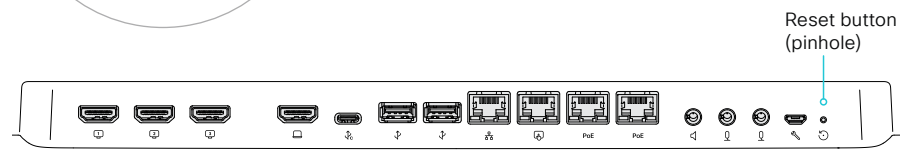

Room Kit

Tilt the unit forward to get access to the connector panel.

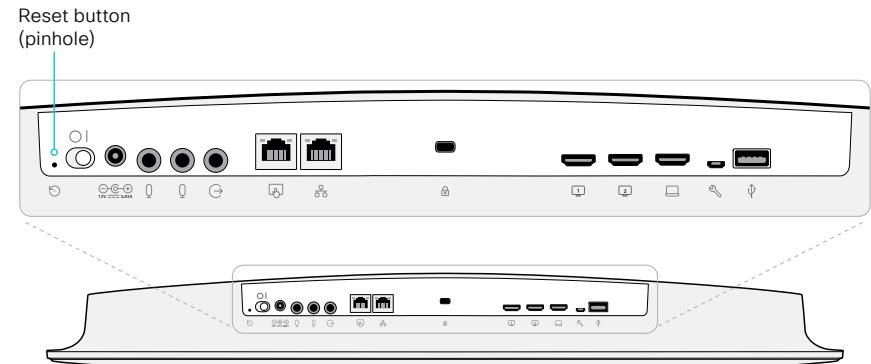

Room Kit Mini

Tilt the unit forward to get access to the connector panel.

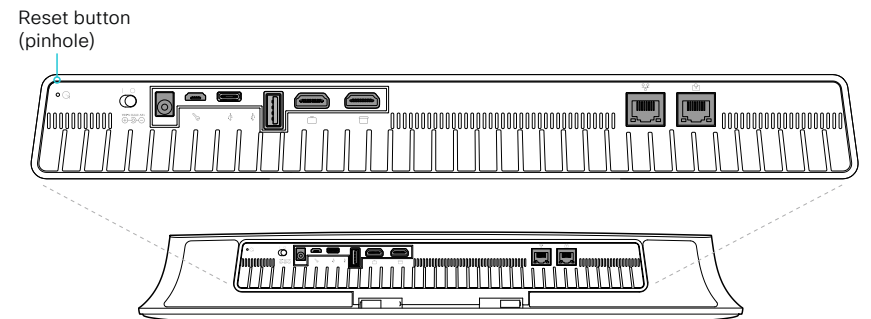

Board

Board Pro,
Board Pro
G2

Codec EQ

Codec
Plus

Codec
Pro

Desk,
Desk Pro,
Desk Mini

Room Bar
Pro,
Room Bar

Room Kit,
Room Kit
Mini

Room Kit
EQX

Room 55

Room
55 Dual,
Room 70

Room 70
G2

Room 70
Panorama

Room
Panorama

Factory reset the video conferencing device (page 5 of 6)

Desk and Desk Pro

Flip the cover on the back of the device to get access to the connector panel.

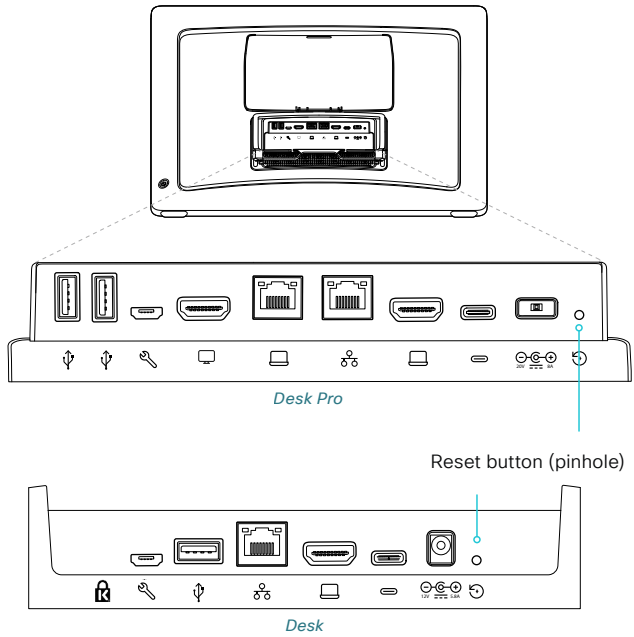

Desk Mini

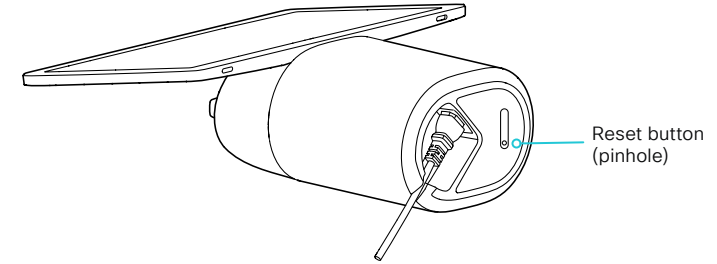

Board

Board Pro,
Board Pro
G2

Codec EQ

Codec
Plus

Codec
Pro

Desk,
Desk Pro,
DeskMini

Room Bar
Pro,
Room Bar

Room Kit,
Room Kit
Mini

Room Kit
EQX

Room 55

Room
55 Dual,
Room 70

Room 70
G2

Room 70
Panorama

Room
Panorama

Factory reset the video conferencing device (page 6 of 6)

Board

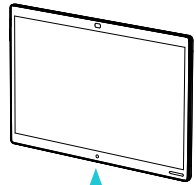

The connector panel is at the bottom

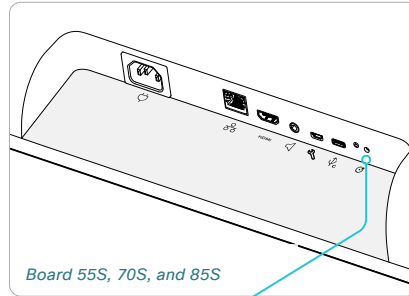

Board 55S, 70S, and 85S

Reset button (pinhole)

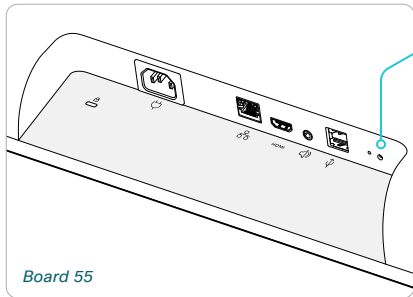

Board 55

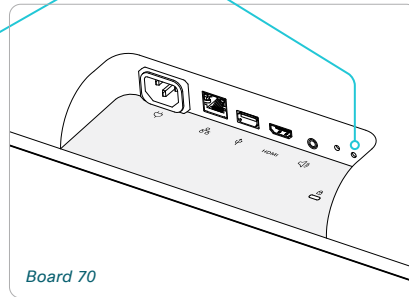

Board 70

Board Pro

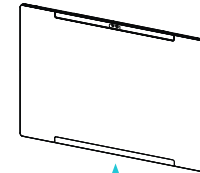

The connector panel is at the bottom

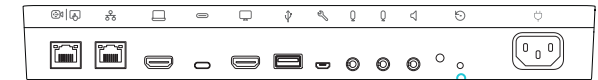

Reset button (pinhole)

Board Pro G2

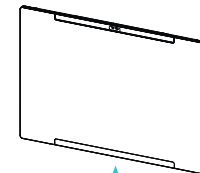

The connector panel is at the bottom



Reset button (pinhole)

Board

BoardPro,
BoardPro
G2

Codec EQ

Codec
PlusCodec
ProDesk,
Desk Pro,
DeskMiniRoom Bar
Pro,
Room BarRoom Kit,
Room Kit
MiniRoom Kit
EQX

Room 55

Room 55
Dual,
Room 70Room 70
G2Room 70
PanoramaRoom
Panorama

Factory reset Cisco Room Navigator

In an error situation it may be required to factory reset the touch controller to recover connectivity.

When factory resetting the touch controller the pairing information is lost, and the touch controller itself (not the video conferencing device) is reverted to factory defaults.



It is not possible to undo a factory reset.

1. Remove the foot to find the reset button (pinhole) on the connector panel.
2. Use a paper clip (or similar) to press and hold the recessed reset button until the screen turns black (approximately 10 seconds). Then release the button.
3. Wait while the Room Navigator reverts to the default factory settings. When finished, the Room Navigator restarts automatically. This may take a few minutes.

If the Room Navigator is directly connected to the video conferencing device, it receives a new configuration automatically from the device.

If the Room Navigator is connected via LAN, it must be paired to the video conferencing device anew. When successfully paired it receives a new configuration automatically from the device.

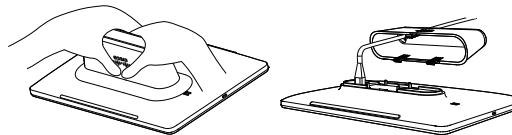

Press firmly and pivot to remove the table stand.

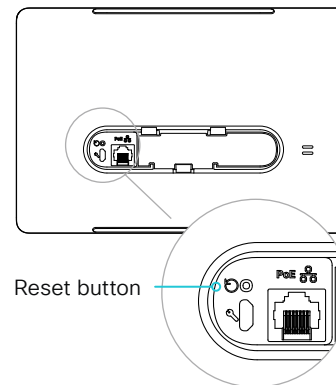

- Board
- Board Pro, Board Pro G2
- Codec EQ
- Codec Plus
- Codec Pro
- Desk, Desk Pro, Desk Mini
- Room Bar Pro, Room Bar
- Room Kit, Room Kit Mini
- Room Kit EQX
- Room 55
- Room 55 Dual, Room 70
- Room 70 G2
- Room 70 Panorama
- Room Panorama

Factory reset Touch 10

In an error situation it may be required to factory reset the touch controller to recover connectivity.

Cisco Touch 10

1. Open the small cover at the rear to find the reset button.
2. Press and hold the reset button until the mute button at the front starts blinking (approximately 5 seconds). Then release the button.

Touch 10 automatically reverts to the default factory settings and restarts.

If Touch 10 is directly connected to the video conferencing device, it receives a new configuration automatically from the device.

If Touch 10 is connected via LAN, it must be paired to the video conferencing device anew. When successfully paired it receives a new configuration automatically from the device.

When factory resetting the touch controller the pairing information is lost, and the touch controller itself (not the video conferencing device) is reverted to factory defaults.

 It is not possible to undo a factory reset.

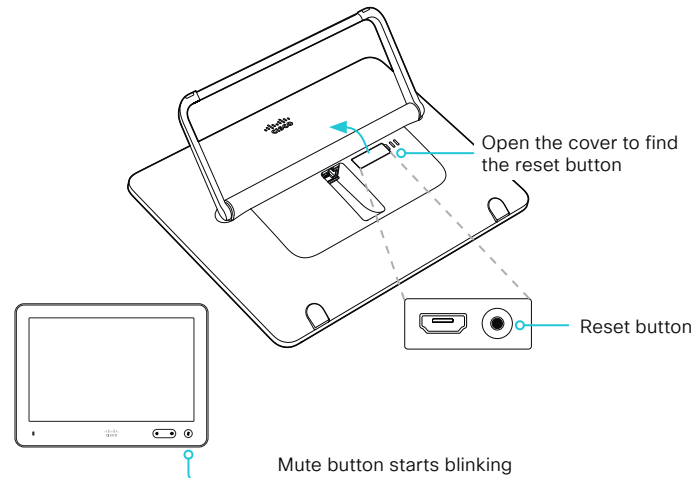

Cisco TelePresence Touch 10

1. Locate the *Mute* and *Volume down* buttons.
2. Press and hold the *Mute* button until it starts blinking (red and green). It takes approximately 10 seconds.
3. Press the *Volume down* button twice.

Touch 10 automatically reverts to the default factory settings and restarts.

If Touch 10 is directly connected to the video conferencing device, it receives a new configuration automatically from the device.

If Touch 10 is connected via LAN, it must be paired to the video conferencing device anew. When successfully paired it receives a new configuration automatically from the device.

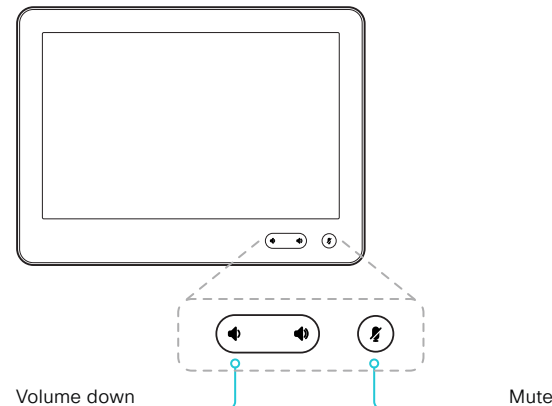

Two Touch 10 versions

There are two versions of the Touch 10. They look almost the same and has the same functionality.

- *Cisco TelePresence Touch 10*: This is the first version. It has no logo on front.
- *Cisco Touch 10*: This version was launched late 2017. It is identified by the logo on front, and fewer connectors at the back.

Board

Board Pro,
Board Pro
G2

Codec EQ

Codec
PlusCodec
ProDesk,
Desk Pro,
Desk MiniRoom Bar
Pro,
Room BarRoom Kit,
Room Kit
MiniRoom Kit
EQX

Room 55

Room
55 Dual,
Room 70Room 70
G2Room 70
PanoramaRoom
Panorama

Factory reset Cisco Natural Audio Module IV

In an error situation it may be required to factory reset the amplifier.



It is not possible to undo a factory reset.

We recommend that you back up the log files and configuration of the device before you continue with the factory reset.

1. Insert a paper clip (or similar) into the pinhole. Press and hold the recessed reset button until the screen turns black (approximately 10 seconds). Then, release the button.
2. Wait while the device reverts to the default factory settings. When finished, the device restarts automatically. This may take a few minutes.

When the device has been successfully reset to factory settings, the Setup assistant starts with the *Welcome* screen.



The button can be quite difficult to use. You should feel the button move when pressed.

Amplifier: Cisco Natural Audio Module IV

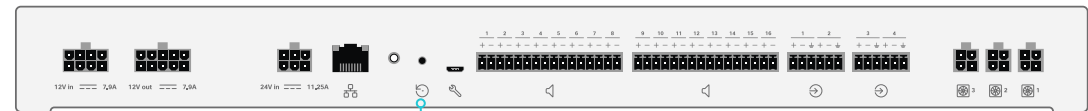

Reset button (pinhole)

- Board
- Board Pro, Board Pro G2
- Codec EQ
- Codec Plus
- Codec Pro
- Desk, Desk Pro, Desk Mini
- Room Bar Pro, Room Bar
- Room Kit, Room Kit Mini
- Room Kit EQX
- Room 55
- Room 55 Dual, Room 70
- Room 70 G2
- Room 70 Panorama
- Room Panorama

Factory reset Table Microphone Pro

Note: The same as Cisco Microphone Array.

In an error situation it may be required to factory reset the microphone.



It is not possible to undo a factory reset.

We recommend that you back up the log files and configuration of the device before you continue with the factory reset.

1. Insert a paper clip (or similar) into the pinhole. Press and hold the recessed reset button until the screen turns black (approximately 10 seconds). Then, release the button.
2. Wait while the device reverts to the default factory settings. When finished, the device restarts automatically. This may take a few minutes.

When the device has been successfully reset to factory settings, the Setup assistant starts with the *Welcome* screen.



The button can be quite difficult to use. You should feel the button move when pressed.

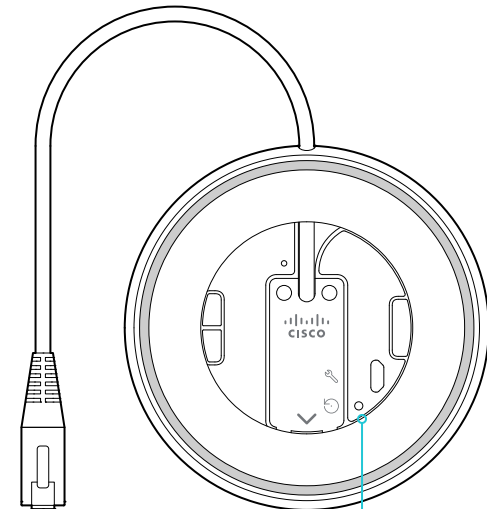

Reset button (pinhole)

- Board
- BoardPro, BoardPro G2
- Codec EQ
- Codec Plus
- Codec Pro
- Desk, Desk Pro, Desk Mini
- Room Bar Pro, Room Bar
- Room Kit, Room Kit Mini
- Room Kit EQX
- Room 55
- Room 55 Dual, Room 70
- Room 70 G2
- Room 70 Panorama
- Room Panorama

Capture user interface screenshots

Sign in to the device web interface, go to *Issues and Diagnostics*, and select *User Interface Screenshots*.

Capture a screenshot

Click *Touch Panel Screenshot* to capture a screenshot of the touch controller, or click *OSD screenshot* to capture a screenshot of the main screen (on screen display).

The screenshot appears below the *Current Screenshots* card. It may take up to 30 seconds before the screenshot is ready.

All captured screenshots are listed in the *Current Screenshots* card. Click the screenshot ID to display the image.

Wake up the device

Use these buttons to wake up the device from standby.

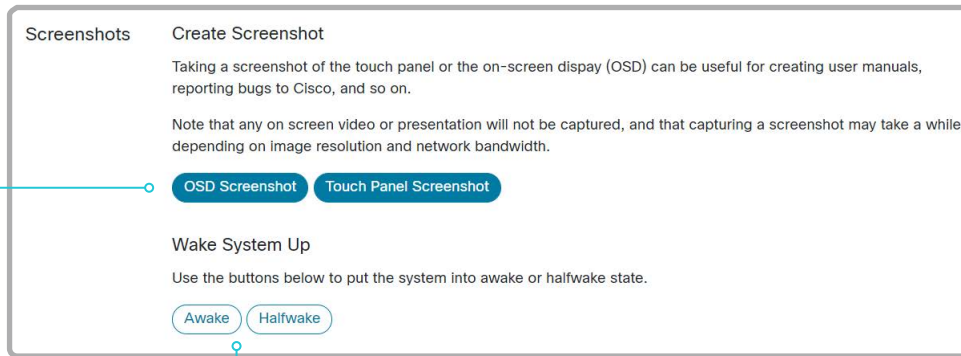

Current Screenshots	Screenshot ID	Type	Annotation
	Web_2020-10-07 T12:55:55.648Z	Touchpanel	
	Web_2020-10-07 T12:58:04.744Z	OSD	

[Remove All](#)

Delete screenshots

If you want to delete all screenshots, click *Remove All*.

To delete just one screenshot, click the button for that screenshot.

About user interface screenshots

You can capture screenshots both of a touch controller that is connected to a video conferencing device, and of the main screen with menus, indicators and messages (also know as *on-screen display or OSD*).

For Desk, Desk Mini, and Desk Pro:

- Only OSD screenshots are available.

Board

BoardPro,
BoardPro
G2

Codec EQ

Codec
Plus

Codec
Pro

Desk,
Desk Pro,
Desk Mini

Room Bar
Pro,
Room Bar

Room Kit,
Room Kit
Mini

Room Kit
EQX

Room 55

Room 55
Dual,
Room 70

Room 70
G2

Room 70
Panorama

Room
Panorama

Chapter 5

Device settings

Board

BoardPro,
BoardPro
G2

Codec EQ

Codec
Plus

Codec
Pro

Desk,
DeskPro,
DeskMini

Room Bar
Pro,
Room Bar

Room Kit,
Room Kit
Mini

Room Kit
EQX

Room 55

Room 55
Dual,
Room 70

Room 70
G2

Room 70
Panorama

Room
Panorama

Overview of the device settings

In the following pages you find a complete list of the device settings. They can be configured from the device web interface.

Open a web browser, enter the IP address of the device, and sign in. Go to [Settings](#), and select [Configurations](#).



How to find the IP address

1. Swipe in from the right or tap the controls icon  in the upper, right corner to open the control panel. Then select [Device settings](#).
2. Select [About this room device](#).

App settings	193
Apps WallpaperBundles HalfwakelImage	193
Audio settings.....	193
Audio ConnectorSetup.....	193
Audio DefaultVolume.....	194
Audio Ethernet Encryption.....	194
Audio Ethernet SAPDiscovery Address.....	194
Audio Ethernet SAPDiscovery Mode.....	195
Audio Input ARC [n] Mode.....	195
Audio Input Ethernet[1] Channel[1..4] Zone	197
Audio Input Ethernet[n] Channel[1..4] Level.....	195
Audio Input Ethernet[n] Channel[1..4] Mode	196
Audio Input Ethernet[n] Channel[1..4] Pan	196
Audio Input Ethernet [n] Channel [1..8] Gain.....	195
Audio Input Ethernet [n] Channel [1..8] Level.....	196
Audio Input Ethernet [n] Channel [1..8] Mode	196
Audio Input Ethernet [n] Channel [1..8] Pan	197
Audio Input Ethernet [n] Channel [1..8] Zone	197
Audio Input Ethernet [n] EchoControl Mode	197
Audio Input Ethernet [n] EchoControl NoiseReduction	198
Audio Input Ethernet [n] Equalizer ID	198
Audio Input Ethernet [n] Equalizer Mode	198
Audio Input Ethernet [n] Mode.....	198
Audio Input HDMI [n] Gain	199
Audio Input HDMI [n] Level	199
Audio Input HDMI [n] Mode	199
Audio Input HDMI [n] VideoAssociation MuteOnInactiveVideo	200
Audio Input MicrophoneMode.....	205
Audio Input Microphone [n] Channel.....	200
Audio Input Microphone [n] EchoControl Dereverberation.....	201
Audio Input Microphone [n] EchoControl Mode	200
Audio Input Microphone [n] EchoControl NoiseReduction	201
Audio Input Microphone [n] Equalizer ID	201
Audio Input Microphone [n] Equalizer Mode.....	201
Audio Input Microphone [n] Gain	202
Audio Input Microphone [n] Level.....	202
Audio Input Microphone [n] Mode.....	203
Audio Input Microphone [n] MuteOverride	203
Audio Input Microphone [n] Pan	204
Audio Input Microphone [n] PhantomPower	204
Audio Input Microphone [n] VideoAssociation MuteOnInactiveVideo	204

Board

BoardPro,
BoardPro
G2

Codec EQ

Codec
Plus

Codec
Pro

Desk,
DeskPro,
DeskMini

Room Bar
Pro,
Room Bar

Room Kit,
Room Kit
Mini

Room Kit
EQX

Room 55

Room 55
Dual,
Room 70

Room 70
G2

Room 70
Panorama

Room
Panorama

Audio Input Microphone [n] VideoAssociation VideInputSource.....	204
Audio Input Microphone [n] Zone	205
Audio Input USBC [n] Gain	206
Audio Input USBC [n] Level	206
Audio Input USBC [n] Mode	206
Audio Input USBC [n] VideoAssociation MuteOnInactiveVideo.....	207
Audio Input USBInterface [n] EchoControl Mode	207
Audio Input USBInterface [n] Gain.....	208
Audio Input USBInterface [n] Level.....	207
Audio Input USBInterface [n] Mode.....	208
Audio Input USBInterface [n] Zone.....	208
Audio Input USBMicrophone [n] EchoControl Mode	209
Audio Input USBMicrophone [n] Gain.....	209
Audio Input USBMicrophone [n] Level.....	209
Audio Input USBMicrophone [n] Zone.....	209
Audio Input WebView [n] Mode.....	210
Audio Microphones AGC.....	210
Audio Microphones BeamMix Inputs	206
Audio Microphones HdmiPassthrough MuteButton	210
Audio Microphones Mute Enabled	211
Audio Microphones NearTalkerSector Mode	211
Audio Microphones NoiseRemoval Mode	211
Audio Microphones PhantomPower	212
Audio Microphones UsbPassthrough MuteButton	212
Audio Microphones VoiceActivityDetector Mode	212
Audio Output ARC [n] Delay DelayMs	212
Audio Output ARC [n] Delay Mode.....	213
Audio Output ARC [n] Mode.....	213
Audio Output ConnectorSetup.....	213
Audio Output Ethernet[n] Delay DelayMs	214
Audio Output Ethernet[n] Delay Mode.....	214
Audio Output Ethernet [n] Mode.....	215
Audio Output HDMI [n] Delay DelayMs.....	215
Audio Output HDMI [n] Delay Mode	215
Audio Output HDMI [n] Gain	216
Audio Output HDMI [n] Level.....	216
Audio Output HDMI [n] Mode	216
Audio Output InternalSpeaker Mode.....	217
Audio Output Line [n] Channel	217
Audio Output Line [n] Delay DelayMs	217

Audio Output Line [n] Delay Mode.....	217
Audio Output Line [n] Equalizer ID.....	218
Audio Output Line [n] Equalizer Mode	218
Audio Output Line [n] Gain	218
Audio Output Line [n] Level.....	218
Audio Output Line [n] Mode	219
Audio Output Line [n] OutputType.....	219
Audio Output USBC [n] Mode.....	220
Audio Output USBInterface [n] Mode.....	220
Audio Panning HeadsetAnalog BinauralProcessing.....	220
Audio Panning HeadsetAnalog Mode	221
Audio Panning HeadsetUSB BinauralProcessing	221
Audio Panning HeadsetUSB Mode.....	221
Audio Panning Mode	220
Audio Placement	221
Audio SoundsAndAlerts RingTone	222
Audio SoundsAndAlerts RingVolume.....	222
Audio Ultrasound MaxVolume	222
Audio USB Mode.....	223
Audio USB VolumeControl Capture Mode	223
Audio USB VolumeControl Capture Value.....	223
Audio USB VolumeControl Playback Mode.....	224
Audio USB VolumeControl Playback Value	224
Bluetooth settings.....	224
Bluetooth Allowed	224
Bluetooth Enabled	224
Bookings settings	225
Bookings AdHocBooking BookAhead Enabled	225
Bookings AdhocBooking BookingTimeout	225
Bookings AdhocBooking Enabled	225
Bookings AllowDecline.....	225
Bookings CheckIn Enabled	226
Bookings CheckIn WindowDuration.....	226
Bookings DeclinableBookingType	226
Bookings MaxDuration	226
Bookings ProtocolPriority.....	227
BYOD settings.....	227
BYOD HidForwarding Enabled.....	227
BYOD QRCodePairing	227

Board

Board Pro,
Board Pro
G2

Codec EQ

Codec
Plus

Codec
Pro

Desk,
Desk Pro,
Desk Mini

Room Bar
Pro,
Room Bar

Room Kit,
Room Kit
Mini

Room Kit
EQX

Room 55

Room 55
Dual,
Room 70

Room 70
G2

Room 70
Panorama

Room
Panorama

BYOD TouchForwarding Enabled	228
BYOD USB CXapi	228
CallHistory settings	228
CallHistory Mode	228
CallHistory Recents DisplayName	228
Cameras settings	229
Cameras Background Enabled	229
Cameras Background UserImagesAllowed	229
Cameras Camera ColorSaturation Level	236
Cameras Camera ExposureCompensation Level	236
Cameras Camera Framerate	237
Cameras Camera [n] AssignedSerialNumber	229
Cameras Camera [n] Backlight DefaultMode	230
Cameras Camera [n] Brightness Algorithm	230
Cameras Camera [n] Brightness DefaultLevel	230
Cameras Camera [n] Brightness Mode	231
Cameras Camera [n] ExcludedArea	231
Cameras Camera [n] Flip	232
Cameras Camera [n] Focus Mode	232
Cameras Camera [n] Gamma Level	233
Cameras Camera [n] Gamma Mode	233
Cameras Camera [n] IrCutFilter Mode	234
Cameras Camera [n] IrCutFilter Threshold	234
Cameras Camera [n] Mirror	234
Cameras Camera [n] PtzAutoFraming	235
Cameras Camera [n] Standby Mode	235
Cameras Camera [n] VideoFormat	235
Cameras Camera [n] Whitebalance Compensation Level	235
Cameras Camera [n] Whitebalance Level	236
Cameras Camera [n] Whitebalance Mode	236
Cameras PowerLine Frequency	237
Cameras PresenterTrack CameraPosition Pan	237
Cameras PresenterTrack CameraPosition Tilt	237
Cameras PresenterTrack CameraPosition Zoom	237
Cameras PresenterTrack Connector	238
Cameras PresenterTrack Enabled	238
Cameras PresenterTrack PresenterDetectedStatus	238
Cameras PresenterTrack TriggerZone	238
Cameras SpeakerTrack Closeup	242
Cameras SpeakerTrack ConnectorDetection CameraLeft	242

Cameras SpeakerTrack ConnectorDetection CameraRight	243
Cameras SpeakerTrack ConnectorDetection Mode	242
Cameras SpeakerTrack DefaultBehavior	239
Cameras SpeakerTrack Frames Mode	239
Cameras SpeakerTrack GroupAndSpeaker Mode	239
Cameras SpeakerTrack HeadDetectorRange	240
Cameras SpeakerTrack MeetingZone Area	240
Cameras SpeakerTrack MeetingZone Mode	240
Cameras SpeakerTrack Mode	241
Cameras SpeakerTrack TrackingMode	242
Cameras SpeakerTrack Whiteboard Mode	243
Cameras SpeakerTrack ZoomRange MaxZoomFactor	241
Conference settings	243
Conference ActiveControl Mode	243
Conference AutoAnswer Delay	244
Conference AutoAnswer Mode	243
Conference AutoAnswer Mute	244
Conference CallProtocolIPStack	244
Conference CapsetFilter	244
Conference DefaultCall Protocol	244
Conference DefaultCall Rate	245
Conference DefaultCall Webex Rate	245
Conference Diagnostics DegradedQualityNotifications	245
Conference Diagnostics StreamStatusOverlay	245
Conference DoNotDisturb DefaultTimeout	245
Conference EmbeddedApp NotificationsOnly	246
Conference Encryption Mode	246
Conference EndToEndEncryption Identity PreferredDomain	246
Conference FarEndControl Mode	246
Conference FarEndControl SignalCapability	247
Conference FarendMessage Mode	247
Conference HideNonVideo OnCall Mode	247
Conference IncomingMultisiteCall Mode	250
Conference JoinLeaveNotifications	247
Conference MaxMultisiteReceiveRate	248
Conference MaxMultisiteTransmitRate	249
Conference MaxReceiveCallRate	248
Conference MaxTransmitCallRate	248
Conference MicUnmuteOnDisconnect Mode	249
Conference Multipoint Mode	249
Conference MultiStream Mode	250

Board

BoardPro,
BoardPro
G2

Codec EQ

Codec
Plus

Codec
Pro

Desk,
DeskPro,
DeskMini

Room Bar
Pro,
Room Bar

Room Kit,
Room Kit
Mini

Room Kit
EQX

Room 55

Room 55
Dual,
Room 70

Room 70
G2

Room 70
Panorama

Room
Panorama

Conference PeopleFocus OnCall Mode.....	250
Conference Presentation OnPlacedOnHold.....	250
Conference Presentation RelayQuality	251
Conference Webex CallProtocolIPStack.....	251
FacilityService settings.....	251
FacilityService Service [n] CallType	251
FacilityService Service [n] Name	251
FacilityService Service [n] Number	252
FacilityService Service [n] Type	252
Files settings.....	252
Files Services OneDrive TemporaryPersonalSignIn.....	252
Files Services Webex SaveToUser.....	252
GPIO settings.....	253
GPIO Pin [n] Mode	253
H323 settings.....	253
H323 Authentication LoginName	253
H323 Authentication Mode	253
H323 Authentication Password.....	254
H323 CallSetup Mode.....	254
H323 Encryption AES256Support.....	254
H323 Encryption KeySize.....	254
H323 Gatekeeper Address.....	254
H323 H323Alias E164	255
H323 H323Alias ID.....	255
H323 NAT Address	256
H323 NAT Mode.....	255
H323 PortAllocation	256
HttpClient settings.....	256
HttpClient AllowHTTP	256
HttpClient AllowInsecureHTTPS	257
HttpClient Mode	256
HttpClient UseHttpProxy.....	257
HttpFeedback settings.....	257
HttpFeedback TlsVerify	257
HttpFeedback UseHttpProxy	258
Logging settings.....	258
Logging CloudUpload Mode	258
Logging Debug Bluetooth	258

Logging Debug Wifi.....	259
Logging External Mode	259
Logging External Protocol.....	259
Logging External Server Address	259
Logging External Server Port.....	259
Logging External TlsVerify.....	260
Logging Internal Mode	260
Logging Mode.....	260
Macros settings	261
Macros AutoStart	261
Macros Diagnostics JavascriptErrors.....	262
Macros EvaluateTranspiled.....	261
Macros Mode	261
Macros QuickJSEngine	262
Macros UnresponsiveTimeout.....	262
MicrosoftTeams settings.....	262
MicrosoftTeams CVI CrossTenant	262
MicrosoftTeams Diagnostics ShowUnsupportedConsoleNotification.....	262
Network settings.....	263
Network [n] DNS DNSSEC Mode	263
Network [n] DNS Domain Name	263
Network [n] DNS Server [m] Address.....	263
Network [n] IEEEE8021X AnonymousIdentity	265
Network [n] IEEEE8021X Eap Md5.....	265
Network [n] IEEEE8021X Eap Peap.....	266
Network [n] IEEEE8021X Eap Tls	265
Network [n] IEEEE8021X Eap Ttls	265
Network [n] IEEEE8021X Identity	264
Network [n] IEEEE8021X Mode.....	263
Network [n] IEEEE8021X Password	264
Network [n] IEEEE8021X TlsVerify	264
Network [n] IEEEE8021X UseClientCertificate.....	264
Network [n] IPStack.....	266
Network [n] IPv4 Address.....	266
Network [n] IPv4 Assignment	266
Network [n] IPv4 Gateway	267
Network [n] IPv4 InterfacelIdentifier.....	267
Network [n] IPv4 SubnetMask	267
Network [n] IPv6 Address.....	268
Network [n] IPv6 Assignment.....	267

Board

BoardPro,
BoardPro
G2

Codec EQ

Codec
Plus

Codec
Pro

Desk,
DeskPro,
DeskMini

Room Bar
Pro,
Room Bar

Room Kit,
Room Kit
Mini

Room Kit
EQX

Room 55

Room 55
Dual,
Room 70

Room 70
G2

Room 70
Panorama

Room
Panorama

Network [n] IPv6 DHCPOptions.....	268
Network [n] IPv6 Gateway.....	268
Network [n] IPv6 InterfacelIdentifier.....	268
Network [n] MTU.....	269
Network [n] QoS Diffserv Audio.....	269
Network [n] QoS Diffserv Data.....	270
Network [n] QoS Diffserv ICMPv6.....	270
Network [n] QoS Diffserv NTP.....	270
Network [n] QoS Diffserv Signalling.....	270
Network [n] QoS Diffserv Video.....	269
Network [n] QoS Mode.....	269
Network [n] RemoteAccess Allow.....	271
Network [n] Speed.....	271
Network [n] TrafficControl Mode.....	271
Network [n] VLAN Voice Mode.....	271
Network [n] VLAN Voice VlanId.....	272
NetworkServices settings.....	272
NetworkServices CDP Mode.....	272
NetworkServices CommonProxy.....	272
NetworkServices H323 Mode.....	273
NetworkServices HTTP Mode.....	273
NetworkServices HTTP Proxy Authentication Method.....	273
NetworkServices HTTP Proxy LoginName.....	273
NetworkServices HTTP Proxy Mode.....	274
NetworkServices HTTP Proxy PACUrl.....	274
NetworkServices HTTP Proxy Password.....	274
NetworkServices HTTP Proxy Url.....	274
NetworkServices HTTPS OCSP Mode.....	275
NetworkServices HTTPS OCSP URL.....	275
NetworkServices HTTPS Server MinimumTLSVersion.....	275
NetworkServices HTTPS StrictTransportSecurity.....	275
NetworkServices HTTPS VerifyClientCertificate.....	275
NetworkServices NTP Mode.....	276
NetworkServices NTP Server [n] Address.....	276
NetworkServices NTP Server [n] Key.....	276
NetworkServices NTP Server [n] KeyAlgorithm.....	277
NetworkServices NTP Server [n] KeyId.....	276
NetworkServices PTP Priority.....	277
NetworkServices SIP Mode.....	277
NetworkServices SMTP From.....	279

NetworkServices SMTP Mode.....	277
NetworkServices SMTP Password.....	278
NetworkServices SMTP Port.....	278
NetworkServices SMTP Security.....	279
NetworkServices SMTP Server.....	278
NetworkServices SMTP Username.....	278
NetworkServices SNMP CommunityName.....	279
NetworkServices SNMP Mode.....	279
NetworkServices SNMP SystemContact.....	280
NetworkServices SNMP SystemLocation.....	280
NetworkServices SSH HostKeyAlgorithm.....	280
NetworkServices SSH KeyExchangeAlgorithms AllowLegacy.....	280
NetworkServices SSH Mode.....	280
NetworkServices UPnP Mode.....	281
NetworkServices UPnP Timeout.....	281
NetworkServices Websocket.....	281
NetworkServices WelcomeText.....	281
NetworkServices Wifi Allowed.....	282
NetworkServices Wifi Enabled.....	282
NetworkServices Wifi Settings FrequencyBand.....	282
NetworkServices XMLAPI Mode.....	282
Peripherals settings.....	283
Peripherals ActivePen Enabled.....	283
Peripherals InputDevice Mode.....	283
Peripherals Pairing CiscoTouchPanels EmcResilience.....	283
Peripherals Pairing CiscoTouchPanels HttpProxy.....	283
Peripherals Pairing CiscoTouchPanels RemotePairing.....	284
Peripherals Profile Cameras.....	284
Peripherals Profile Cameras.....	284
Peripherals Profile ControlSystems.....	284
Peripherals Profile NetworkSwitches.....	285
Peripherals Profile TouchPanels.....	285
Peripherals Security Certificates SyncToPeripherals Enabled.....	286
Phonebook settings.....	286
Phonebook Server [n] ID.....	286
Phonebook Server [n] Pagination.....	286
Phonebook Server [n] TlsVerify.....	287
Phonebook Server [n] Type.....	287
Phonebook Server [n] URL.....	287

Board

BoardPro,
BoardPro
G2

Codec EQ

Codec
Plus

Codec
Pro

Desk,
DeskPro,
DeskMini

Room Bar
Pro,
Room Bar

Room Kit,
Room Kit
Mini

Room Kit
EQX

Room 55

Room 55
Dual,
Room 70

Room 70
G2

Room 70
Panorama

Room
Panorama

Provisioning settings	288
Provisioning Connectivity.....	288
Provisioning CUCM CallManagementRecords CallDiagnostics	288
Provisioning ExternalManager Address	288
Provisioning ExternalManager AlternateAddress.....	288
Provisioning ExternalManager Domain.....	289
Provisioning ExternalManager Path.....	289
Provisioning ExternalManager Protocol	289
Provisioning LoginName.....	289
Provisioning Mode.....	289
Provisioning Password	290
Provisioning TlsVerify	290
Provisioning WebexEdge	290
Proximity settings	291
Proximity AlternatePort Enabled	291
Proximity Mode	291
Proximity Services CallControl.....	291
Proximity Services ContentShare FromClients	292
Proximity Services ContentShare ToClients	292
RemoteAccess settings	292
RemoteAccess Mode.....	292
RemoteAccess ShowTapIndicator.....	292
RoomAnalytics settings	293
RoomAnalytics AmbientNoiseEstimation Interval	293
RoomAnalytics AmbientNoiseEstimation Mode	293
RoomAnalytics PeopleCountOutOfCall.....	293
RoomAnalytics PeoplePresenceDetector	293
RoomAnalytics PeoplePresence Input HeadDetector.....	294
RoomAnalytics PeoplePresence Input Ultrasound.....	294
RoomAnalytics ReverberationTime Interval	294
RoomAnalytics ReverberationTime Mode	294
RoomAnalytics RoomInUse InCall.....	295
RoomAnalytics RoomInUse LocalUsage.....	295
RoomAnalytics T3AlarmDetection Mode	295
RoomAnalytics T3AlarmDetection Timeout	295
RoomCleanup settings	296
RoomCleanup AutoRun ContentType TemporaryAccounts	296
RoomCleanup AutoRun ContentType WebData	296
RoomCleanup AutoRun ContentType Whiteboards	296

RoomCleanup AutoRun HourOfDay	296
RoomReset settings	297
RoomReset Control.....	297
RoomScheduler settings	297
RoomScheduler BookingTimeout.....	297
RoomScheduler Enabled.....	297
UserInterface RoomScheduler OverlayOpacity	298
UserInterface RoomScheduler State Available Color	298
UserInterface RoomScheduler State Busy Color	298
UserInterface RoomScheduler State Pending Color.....	298
RTP settings	299
RTP Audio Ports Range Webex Start.....	299
RTP Audio Ports Range Webex Stop	300
RTP Ports Range Start	299
RTP Ports Range Stop.....	299
RTP Video Ports Range Start	300
RTP Video Ports Range Stop	300
RTP Video Ports Range Webex Start.....	300
RTP Video Ports Range Webex Stop	301
Security settings	301
Security Audit Logging Mode.....	301
Security Audit OnError Action	302
Security Audit Server Address.....	302
Security Audit Server Port	302
Security Audit Server PortAssignment	302
Security Enrollment KeySize.....	303
Security Fips Mode	303
Security Session FailedLoginsLockoutTime.....	303
Security Session InactivityTimeout	303
Security Session MaxFailedLogins	303
Security Session MaxSessionsPerUser	304
Security Session MaxTotalSessions.....	304
Security Session ShowLastLogon	304
Security Xapi WebSocket ApiKey Allowed.....	304
Sensors settings	305
Sensors Radar Mode.....	305
Sensors Ultrasound Mode	305
SerialPort settings	305

Board

BoardPro,
BoardPro
G2

Codec EQ

Codec
Plus

Codec
Pro

Desk,
DeskPro,
DeskMini

Room Bar
Pro,
Room Bar

Room Kit,
Room Kit
Mini

Room Kit
EQX

Room 55

Room 55
Dual,
Room 70

Room 70
G2

Room 70
Panorama

Room
Panorama

SerialPort BaudRate	305
SerialPort LoginRequired	306
SerialPort Mode	305
SerialPort Outbound Mode	306
SerialPort Outbound Port [1] BaudRate	306
SerialPort Outbound Port [1] Description	306
SerialPort Outbound Port [1] Parity	307
SIP settings.....	307
SIP ANAT.....	307
SIP Authentication Password.....	307
SIP Authentication UserName.....	307
SIP DefaultTransport	308
SIP DisplayName.....	308
SIP Ice DefaultCandidate	308
SIP Ice Mode.....	308
SIP Line	309
SIP ListenPort.....	309
SIP Mailbox	309
SIP MinimumTLSVersion	309
SIP PreferredIPSignaling	310
SIP Proxy [n] Address.....	310
SIP TlsVerify	310
SIP TransportSecurity CertificateVerificationMode.....	311
SIP Turn Password	311
SIP Turn Server	311
SIP Turn UserName.....	311
SIP Type	312
SIP URI	312
Standby settings.....	312
Standby BootAction	312
Standby BrightnessDelay	312
Standby Control	313
Standby Delay	313
Standby Halfwake Mode	314
Standby Halfwake Screensaver	313
Standby Level Networked Delay	313
Standby Level Networked Mode	314
Standby Signage Audio.....	314
Standby Signage InteractionMode.....	314
Standby Signage Mode.....	315

Standby Signage RefreshInterval.....	315
Standby Signage Url	315
Standby StandbyAction.....	315
Standby WakeupAction.....	316
Standby WakeupAtMeetingStart.....	316
Standby WakeupOnMotionDetection	316
Standby WakeupOnPairing	316
SystemUnit settings.....	317
SystemUnit BroadcastName	317
SystemUnit CrashReporting Advanced.....	317
SystemUnit CrashReporting Mode.....	317
SystemUnit CrashReporting URL	318
SystemUnit CustomDeviceId.....	318
SystemUnit Extension MouseSupport.....	318
SystemUnit Hardware USBC[1] Mode	318
SystemUnit Name	317
SystemUnit SoftwareUpgrade Provider	318
SystemUnit SoftwareUpgrade WebCache Mode.....	319
SystemUnit SoftwareUpgrade WebCache Url	319
ThousandEyes settings	319
ThousandEyes ConnectionString.....	319
Time settings	320
Time DateFormat.....	320
Time OfficeHours Enabled	322
Time OfficeHours OutsideOfficeHours Standby AutoWakeup.....	322
Time OfficeHours OutsideOfficeHours Standby Delay	322
Time OfficeHours WorkDay End.....	322
Time OfficeHours WorkDay Start.....	322
Time OfficeHours WorkWeek Friday	323
Time OfficeHours WorkWeek Monday.....	323
Time OfficeHours WorkWeek Saturday	323
Time OfficeHours WorkWeek Sunday.....	324
Time OfficeHours WorkWeek Thursday.....	323
Time OfficeHours WorkWeek Tuesday	323
Time OfficeHours WorkWeek Wednesday.....	323
Time TimeFormat	320
Time Zone	320
UserInteraction settings.....	324
UserInteraction RaiseHand CMS.....	324

Board

Board Pro,
Board Pro
G2

Codec EQ

Codec
Plus

Codec
Pro

Desk,
Desk Pro,
Desk Mini

Room Bar
Pro,
Room Bar

Room Kit,
Room Kit
Mini

Room Kit
EQX

Room 55

Room 55
Dual,
Room 70

Room 70
G2

Room 70
Panorama

Room
Panorama

UserInterface settings	325	UserInterface Features Call ParticipantList.....	333
UserInterface Accessibility IncomingCallNotification.....	325	UserInterface Features Call SelfviewControls	333
UserInterface Accessibility ScreenReader Default Mode.....	325	UserInterface Features Call Start.....	334
UserInterface Accessibility ScreenReader Gesture.....	325	UserInterface Features Call VideoMute	334
UserInterface Assistant Mode.....	325	UserInterface Features Call Webcam	334
UserInterface Assistant ProactiveMeetingJoin	326	UserInterface Features Files Start	334
UserInterface Bookings AdhocBooking DefaultTitle	326	UserInterface Features HideAll	334
UserInterface Bookings AdhocBooking TimeSlotSize	326	UserInterface Features Share MTRAutoSelectSource.....	329
UserInterface Bookings AdhocBooking UseDefaultTitle.....	326	UserInterface Features Share MTRShareExperience.....	335
UserInterface Bookings Visibility AllDayMeetings.....	326	UserInterface Features Share Start	335
UserInterface Bookings Visibility EarlyJoin	327	UserInterface Features Whiteboard Start	335
UserInterface Bookings Visibility JoinedParticipants Avatars.....	327	UserInterface Help Tips	335
UserInterface Bookings Visibility MeetingReminder	327	UserInterface HomeScreen Dashboard	336
UserInterface Bookings Visibility NonJoinableMeetings.....	327	UserInterface HomeScreen Peripherals WebApp URL	336
UserInterface Bookings Visibility Organizer	327	UserInterface InstantMeeting Invite	330
UserInterface Bookings Visibility Personal FullDayCalendar.....	327	UserInterface KeyTones Mode	336
UserInterface Bookings Visibility Personal NonJoinableMeetings.....	328	UserInterface Kiosk Mode.....	336
UserInterface Bookings Visibility TentativeMeetings	328	UserInterface Kiosk URL	337
UserInterface Bookings Visibility Title.....	328	UserInterface Language.....	337
UserInterface Branding AwakeBranding Colors.....	328	UserInterface LedControl Mode.....	337
UserInterface CameraControl Presets Mode	328	UserInterface LedControl OutsideOfficeHours.....	337
UserInterface ContactInfo Type	329	UserInterface LiveAnnotation AvailabilityForPresenter	338
UserInterface CustomMessage	329	UserInterface LiveAnnotation Enabled.....	338
UserInterface CustomWallpaperOverlay.....	330	UserInterface LiveAnnotation EnabledOutOfCall	338
UserInterface DecemberThemeBeta.....	329	UserInterface MeetingJoin CVITenants.....	338
UserInterface DevicePersonalization QRCodeNotification	329	UserInterface MuteWarning	339
UserInterface Diagnostics Notifications.....	330	UserInterface NameAndSiteLabels Mode.....	339
UserInterface Features Calendar Start	330	UserInterface OSD EncryptionIndicator	339
UserInterface Features Call AudioMute	331	UserInterface OSD HalfwakeMessage.....	339
UserInterface Features Call CameraControls	331	UserInterface OSD Mode.....	340
UserInterface Features Call End.....	331	UserInterface OSD Output	340
UserInterface Features Call HdmiPassthrough	331	UserInterface Phonebook DefaultSearchFilter.....	341
UserInterface Features Call JoinGoogleMeet	331	UserInterface Phonebook Mode	341
UserInterface Features Call JoinMicrosoftTeamsCVI.....	332	UserInterface Proximity Notifications.....	341
UserInterface Features Call JoinMicrosoftTeamsDirectGuestJoin.....	332	UserInterface RoomScheduler AmbientTemperature Show	341
UserInterface Features Call JoinWebex.....	332	UserInterface RoomScheduler DevicePersonalization QRCodePairing	342
UserInterface Features Call JoinZoom.....	332	UserInterface RoomScheduler Mode.....	342
UserInterface Features Call Keypad.....	333	UserInterface RoomScheduler PeopleCount Current	342
UserInterface Features Call LayoutControls	333	UserInterface RoomScheduler StatusWhenInUse	342
UserInterface Features Call MidCallControls	333	UserInterface RoomStatusMenu Visibility.....	343
UserInterface Features Call MusicMode.....	333	UserInterface ScreenLock Policy.....	343

D15503.06
RoomOS
11.24
02-2025



Board

Board Pro,
Board Pro
G2

Codec EQ

Codec
Plus

Codec
Pro

Desk,
Desk Pro,
Desk Mini

Room Bar
Pro,
Room Bar

Room Kit,
Room Kit
Mini

Room Kit
EQX

Room 55

Room 55
Dual,
Room 70

Room 70
G2

Room 70
Panorama

Room
Panorama

UserInterface ScreenLock Workspace Allowed.....	343
UserInterface Security Mode	343
UserInterface SettingsMenu Mode	344
UserInterface SettingsMenu Visibility	344
UserInterface SoundEffects Mode	344
UserInterface Theme Name	344
UserInterface UsbPromotion.....	345
UserInterface Wallpaper	345
UserInterface WallpaperFillMode.....	330
UserInterface WebcamOnlyMode.....	345
UserInterface Whiteboard ActivityIndicators	345
UserInterface Whiteboard Deletion.....	345
UserInterface Whiteboard ShareInCall.....	346
UserManagement settings.....	347
UserManagement LDAP Admin Filter.....	347
UserManagement LDAP Admin Group.....	347
UserManagement LDAP Attribute	347
UserManagement LDAP BaseDN	347
UserManagement LDAP BindDN.....	347
UserManagement LDAP BindPassword	348
UserManagement LDAP Encryption.....	348
UserManagement LDAP MemberAttribute.....	348
UserManagement LDAP MinimumTLSVersion	348
UserManagement LDAP Mode.....	349
UserManagement LDAP Server Address.....	349
UserManagement LDAP Server Port.....	349
UserManagement LDAP VerifyServerCertificate	349
UserManagement PasswordPolicy Complexity MinimumDigits.....	350
UserManagement PasswordPolicy Complexity MinimumLength.....	350
UserManagement PasswordPolicy Complexity MinimumLowercase	350
UserManagement PasswordPolicy Complexity MinimumSpecial	350
UserManagement PasswordPolicy Complexity MinimumUppercase	351
UserManagement PasswordPolicy MaxLifetime	351
UserManagement PasswordPolicy ReuseLimit.....	351
Video settings.....	352
Video ActiveSpeaker DefaultPIPPosition	352
Video DefaultLayoutFamily Local	352
Video DefaultLayoutFamily LocalContent.....	352
Video DefaultLayoutFamily Remote	353
Video DefaultMainSource.....	353

Video Input AirPlay Beacon.....	353
Video Input AirPlay DiscoveryInstructions NetworkName	353
Video Input AirPlay DiscoveryInstructions ShowNetworkInfo	354
Video Input AirPlay Mode.....	354
Video Input AirPlay Password	354
Video Input AirPlay PresentationSelection.....	354
Video Input AirPlay SecurityMode.....	355
Video Input CameraConfigMode.....	355
Video Input Connector [n] CameraControl Camerald	356
Video Input Connector [n] CameraControl Mode.....	356
Video Input Connector [n] CEC Mode	357
Video Input Connector [n] HDCP Mode.....	357
Video Input Connector [n] InputSourceType	358
Video Input Connector [n] MaxResolution.....	358
Video Input Connector [n] Name	359
Video Input Connector [n] OptimalDefinition Profile.....	359
Video Input Connector [n] OptimalDefinition Threshold60fps.....	360
Video Input Connector [n] PreferredResolution	360
Video Input Connector [n] PresentationSelection	361
Video Input Connector [n] Quality	362
Video Input Connector [n] RGBQuantizationRange	362
Video Input Connector [n] Visibility	363
Video Input Miracast MaxBitrate	364
Video Input Miracast Mode	363
Video Input Miracast Pin Length	364
Video Input Miracast PresentationSelection	364
Video Input Miracast Quality	364
Video Input Miracast Transport.....	365
Video Monitors	365
Video Output Connector [n] Brightness	366
Video Output Connector [n] BrightnessMode	366
Video Output Connector [n] CEC Mode	366
Video Output Connector[n] ContentType	367
Video Output Connector [n] HDCPPolicy	367
Video Output Connector [n] Location HorizontalOffset.....	368
Video Output Connector [n] Location VerticalOffset.....	369
Video Output Connector [n] MonitorRole	369
Video Output Connector [n] Resolution.....	370
Video Output Connector [n] RGBQuantizationRange	371
Video Output Connector [n] Whitebalance Level	373
Video Output HDMI Passthrough Allowed	371

Board

Board Pro,
Board Pro
G2

Codec EQ

Codec
Plus

Codec
Pro

Desk,
Desk Pro,
Desk Mini

Room Bar
Pro,
Room Bar

Room Kit,
Room Kit
Mini

Room Kit
EQX

Room 55

Room 55
Dual,
Room 70

Room 70
G2

Room 70
Panorama

Room
Panorama

Video Output HDMI Passthrough AutoDisconnect Delay	373
Video Output HDMI Passthrough AutoDisconnect Enabled	372
Video Output HDMI Passthrough HdmiUsbConverter Mode	372
Video Output HDMI Passthrough HdmiUsbConverter Name	372
Video Output HDMI Passthrough OutputConnector	372
Video Output MirroringType	373
Video Output Webcam USBMode	373
Video Presentation DefaultPIPPosition	374
Video Presentation DefaultSource	374
Video Presentation Priority	374
Video Selfview Default FullscreenMode	374
Video Selfview Default Mode	375
Video Selfview Default OnMonitorRole	375
Video Selfview Default PIPPosition	375
Video Selfview OnCall Duration	376
Video Selfview OnCall Mode	376
VoiceControl settings	376
VoiceControl Wakeword Mode	376
WebEngine settings	377
WebEngine Certificates RevocationChecks NetworkAccess	377
WebEngine Features AllowDeviceCertificate	377
WebEngine Features GpuRasterization	377
WebEngine Features LocalWebAppManagement	377
WebEngine Features Peripherals AudioOutput	378
WebEngine Features Peripherals WebGL	378
WebEngine Features SipUrlHandler	378
WebEngine Features WebGL	378
WebEngine Features Xapi Peripherals AllowedHosts Hosts	378
WebEngine FpsCounter	379
WebEngine MinimumTLSVersion	379
WebEngine Mode	379
WebEngine RemoteDebugging	379
WebEngine UseHttpProxy	379
Webex settings	380
Webex CloudProximity GuestShare	380
Webex CloudProximity ManualPairing	380
Webex CloudUpgrades Mode	380
Webex DevicePersonalization Features Whiteboard SignInRequired	380
Webex Hotdesking DefaultBookingEndTime	381
Webex Meetings HttpProxyForMedia Mode	381

Webex Meetings JoinProtocol	381
Webex Meetings MeetingChatNotifications Mode	382
Webex Meetings MeetingChatPreview	382
Webex Privacy AllowUsageDataLogging	382
Webex ProvisionalActivationService	383
Webex UpgradeChannel	383
WebRTC settings	383
WebRTC EndCallTimeout	383
WebRTC InteractionMode	383
WebRTC Provider MicrosoftTeams CompatibilityMode	384
Zoom settings	384
Zoom DefaultDomain	384
Zoom DialStringOptions	384
Zoom EnhancedCallControls	385
Experimental settings	385

Board

BoardPro,
BoardPro
G2

Codec EQ

Codec
PlusCodec
ProDesk,
DeskPro,
DeskMiniRoom Bar
Pro,
Room BarRoom Kit,
Room Kit
MiniRoom Kit
EQX

Room 55

Room 55
Dual,
Room 70Room 70
G2Room 70
PanoramaRoom
Panorama

App settings

Apps WallpaperBundles Halfwakelmage

Applies to: All products

Requires user role: ADMIN

In some scenarios, for example when UserInterface Theme Name is set to Night, a colored background will show in half-wake mode. You can turn it off with this setting, to always use a black background.

Default value:

Auto

Value space:

Auto/Off

Auto: The background is colored in half-wake mode in some scenarios.

Off: The background is black in half-wake mode.

Audio settings

Audio ConnectorSetup

Applies to: RoomKitEQX CodecEQ

Requires user role: ADMIN, INTEGRATOR

You can choose whether to set up the audio inputs and outputs manually, or to let the video device do it automatically based on the type of camera you have and which screens are connected.

In Auto mode, you cannot add, update, delete or connect audio inputs and outputs manually. Therefore the following API commands do not have any effect: xCommand Audio Setup *, xCommand Audio LocalInput *, and xCommand Audio LocalOutput *.

When going from Manual to Auto mode: The existing Audio setup is cleared (xCommand Audio Setup Clear), and the input and output groups are set up according to product defaults. The Audio Output HDMI [n] Mode and Audio Output ARC [1] Mode settings are set to their default value.

When going from Auto to Manual mode: The HDMI and ARC output connectors are connected to the main output group. The Audio Output HDMI [n] Mode and Audio Output ARC [1] Mode settings are not changed.

AVIntegrator option required.

Default value:

Auto

Value space:

Auto/Manual

Auto: For Codec EQ, the video device will play audio either through the camera, or through a screen that is connected to one of the HDMI outputs. The video device chooses to play the audio on the first available device in the following list:

1. A Quad Camera that has camera control connected to one of the camera control connectors of the video device, and HDMI connected to the camera input of the video device (HDMI 1 input). Additionally, the Audio Output ARC [1] Mode and Video Input Connector [1] CEC Mode settings must be On. The audio return channel (ARC) on the HDMI 1 input is used to play audio through the camera.
2. A screen that is connected to the HDMI 1 output, provided that the Audio Output HDMI [1] Mode setting is On.
3. A screen that is connected to the HDMI 2 output, provided that the Audio Output HDMI [2] Mode setting is On.
4. A screen that is connected to the HDMI 3 output, provided that the Audio Output HDMI [3] Mode setting is On.

When audio is played out through the Quad Camera, the video device will check the delay between a screen and the camera, so that it can synchronize the audio on the camera with the video on screen (lip-synchronization). In order to check the delay, the video device communicates with the screen via CEC (Consumer Electronics Control). The first screen in the list above that supports CEC and has the Video

Board

Output Connector [n] CEC Mode set to On, is used for the delay assessment.

When audio is played out through a screen, additional lip-synchronization delay is the responsibility of the screen. The video device will not add any delay.

For Room Kit EQX, the video device will play audio through its integrated loudspeaker system, provided that Audio Output ARC [1] Mode and Audio Output InternalSpeaker Mode is On, and Audio Output Ethernet [2] Mode is On.

Manual: You must set up the audio inputs and outputs manually using the Audio Console application or the API (xCommand Audio LocalInput *, and xCommand Audio LocalOutput *).

For Room Kit EQX, connected screens may be used for audio output if the connectors are explicitly added using the Audio Console application or the API (xCommand Audio LocalOutput *). In that case, the screens will play a stereo down mix of the audio that is played on the built-in loudspeaker system. Ultrasound signals will not play through the screens or line outputs; only through the integrated loudspeaker system.

BoardPro,
BoardPro
G2

Codec EQ

Codec
PlusCodec
ProDesk,
DeskPro,
DeskMiniRoom Bar
Pro,
Room BarRoom Kit,
Room Kit
MiniRoom Kit
EQX

Room 55

Room 55
Dual,
Room 70Room 70
G2Room 70
PanoramaRoom
Panorama

Audio DefaultVolume

Applies to: All products

Requires user role: ADMIN, INTEGRATOR, USER

Define the default volume for the speakers. For all devices except the Desk series, the volume is set to this level when you switch on the device or restart it. Desk devices remember the last audio level set by the user also after a restart.

You can use the controls on the user interface or the Audio Volume commands to change the volume both in call and out of call. The Audio Volume SetToDefault command resets the volume to the default value.

Default value:

50 [RoomKit RoomKitMini RoomBar RoomBarPro RoomKitEQX CodecEQ CodecPlus CodecPro Room55 Room70/Room55D Room70G2 RoomPanorama/Room70Panorama DeskMini Desk DeskPro]

70 [Board BoardPro BoardProG2]

Value space:

Integer (0..100)

Range: Select a value between 1 and 100. This corresponds to the dB range from -34.5 dB to 15 dB, in steps of 0.5 dB. If set to 0 the audio is switched off.

Audio Ethernet Encryption

Applies to: RoomBarPro RoomKitEQX CodecEQ CodecPro Room70G2 RoomPanorama/Room70Panorama

Requires user role: ADMIN

Decide whether to allow unencrypted audio streams on the video device's internal network.

Note that the AES67 standard doesn't support encrypted media streams. Therefore, this setting must be set to Optional to allow AES67 audio.

Codec EQ, Codec EQX, Room Bar Pro: AVIntegrator option required.

Default value:

Required

Value space:

Optional/Required

Optional: Allow both encrypted and unencrypted media streams.

Required: Only allow encrypted media streams.

Audio Ethernet SAPDiscovery Address

Applies to: RoomBarPro RoomKitEQX CodecEQ CodecPro Room70G2 RoomPanorama/Room70Panorama

Requires user role: ADMIN

Set the multicast address that the video device will both listen for stream announcements on and announce its own streams on. Only change this setting if required by your peripherals.

Codec EQ, Codec EQX, Room Bar Pro: AVIntegrator option required.

Default value:

239.255.255.255

Value space:

String (0, 64)

A valid multicast address for stream announcements.

Board

BoardPro,
BoardPro
G2

Codec EQ

Codec
PlusCodec
ProDesk,
DeskPro,
DeskMiniRoom Bar
Pro,
Room BarRoom Kit,
Room Kit
MiniRoom Kit
EQX

Room 55

Room 55
Dual,
Room 70Room 70
G2Room 70
PanoramaRoom
Panorama

Audio Ethernet SAPDiscovery Mode

Applies to: RoomBarPro RoomKitEQX CodecEQ CodecPro Room70G2 RoomPanorama/Room70Panorama

Requires user role: ADMIN

The video device supports discovery using SAP (Service Announcement Protocol). Therefore, when enabled, the video device can both discover streams that are announced by peripherals and announce its own streams. Which IP address to listen for and send announcements on, are decided in the Audio Ethernet SAPDiscovery Address setting.

Codec EQ, Codec EQX, Room Bar Pro: AVIntegrator option required.

Default value:

Off

Value space:

Off/On

Off: The device will not listen for or send stream announcements.

On: The device can both discover streams announced by peripherals and announce its own streams.

Audio Input ARC [n] Mode

Applies to: CodecPlus CodecPro Room70G2 RoomPanorama/Room70Panorama

Requires user role: ADMIN, INTEGRATOR

Each HDMI output has an associated audio return channel (ARC). You can use the ARC to send audio from a screen or TV, which is connected to the HDMI output, to the video device. You can decide for each HDMI output connector (n) separately, whether or not to allow audio transmission.

Default value:

On

Value space:

Off/On

Off: Disable the ARC channel of HDMI output n (audio is not sent to the video device).

On: Enable the ARC channel of HDMI output n (audio is sent to the video device).

n: Unique ID that identifies the ARC input.

Range: 1..2 [[CodecPlus](#)]

Range: 1..3 [[CodecPro](#)]

Range: 3..3 for Room 70 Dual G2; 2..3 for Room 70 Single G2 [[Room70G2](#)]

Range: 3..3 [[RoomPanorama/Room70Panorama](#)]

Audio Input Ethernet [n] Channel [1..8] Gain

Applies to: RoomBarPro RoomKitEQX CodecEQ BoardProG2

Requires user role: ADMIN, INTEGRATOR

Set the gain for the specified channel of an Ethernet input, e.g. a microphone or audio interface. We allow up to 8 channels per input, and the gain is set separately for each channel.

The gain should be adjusted to suit the output level of the connected audio source. The gain can be tuned in steps of 1 dB. If the gain is set too high, the audio signal will be clipped. If the gain is set too low, the audio signal-to-noise ratio will be degraded; however, this is usually preferable to clipping. Note that unprocessed speech signals typically contain significant level variations, making it very important to allow for sufficient signal headroom.

Default value:

45

Value space:

Integer (0..70)

Range: Select the gain in decibel (dB).

n: Unique ID that identifies the logical Ethernet input.

Range: 1..8 [[RoomBarPro RoomKitEQX CodecEQ BoardProG2](#)]

Audio Input Ethernet[n] Channel[1..4] Level

Applies to: RoomBar

Requires user role: ADMIN, INTEGRATOR

>Sets the gain for the specified channel of an Ethernet input, e.g. a microphone or audio interface. We allow up to 4 channels per input, and the gain is set separately for each channel.

The gain should be adjusted to suit the output level of the connected audio source. The gain can be tuned in steps of 1 dB. If the gain is set too high, the audio signal will be clipped. If the gain is set too low, the audio signal-to-noise ratio will be degraded; however, this is usually preferable to clipping. Note that unprocessed speech signals typically contain significant level variations, making it very important to allow for sufficient signal headroom.

Default value:

45

Value space:

Integer (0..70)

Range: Select the gain in decibel (dB).

n: Unique ID that identifies the logical Ethernet input.

Range: 1 [[RoomBar](#)]

Board

BoardPro,
BoardPro
G2

Codec EQ

Codec
PlusCodec
ProDesk,
DeskPro,
Desk MiniRoom Bar
Pro,
Room BarRoom Kit,
Room Kit
MiniRoom Kit
EQX

Room 55

Room 55
Dual,
Room 70Room 70
G2Room 70
PanoramaRoom
Panorama

Audio Input Ethernet [n] Channel [1..8] Level

Applies to: CodecPro Room70G2 RoomPanorama/Room70Panorama BoardPro

Requires user role: ADMIN, INTEGRATOR

Set the gain for the specified channel of an Ethernet input, e.g. a microphone or audio interface. We allow up to 8 channels per input, and the gain is set separately for each channel.

The gain should be adjusted to suit the output level of the connected audio source. The gain can be tuned in steps of 1 dB. If the gain is set too high, the audio signal will be clipped. If the gain is set too low, the audio signal-to-noise ratio will be degraded; however, this is usually preferable to clipping. Note that unprocessed speech signals typically contain significant level variations, making it very important to allow for sufficient signal headroom.

Default value:

45

Value space:

Integer (0..70)

Range: Select the gain in decibel (dB).

n: Unique ID that identifies the logical Ethernet input.

Range: 1..8 [[CodecPro](#) [Room70G2](#) [BoardPro](#)]

Range: 1..6 [[RoomPanorama/Room70Panorama](#)]

Audio Input Ethernet[n] Channel[1..4] Mode

Applies to: RoomBar

Requires user role: ADMIN, INTEGRATOR

Disables or enables audio on the specified channel of an Ethernet input. We allow up to 4 channels per input, and the mode is set separately for each channel.

Setting Audio Input Ethernet [n] Mode to Off will override the effect of the individual channel mode settings.

Default value:

On

Value space:

Off/On

Off: Disable audio from this channel.

On: Enable audio from this channel.

n: Unique ID that identifies the logical Ethernet input.

Range: 1 [[RoomBar](#)]

Audio Input Ethernet [n] Channel [1..8] Mode

Applies to: RoomBarPro RoomKitEQX CodecEQ CodecPro Room70G2 RoomPanorama/Room70Panorama BoardPro BoardProG2

Requires user role: ADMIN, INTEGRATOR

Disable or enable audio on the specified channel of an Ethernet input. We allow up to 8 channels per input, and the mode is set separately for each channel.

Setting Audio Input Ethernet [n] Mode to Off will override the effect of the individual channel mode settings.

Default value:

On

Value space:

Off/On

Off: Disable audio from this channel.

On: Enable audio from this channel.

n: Unique ID that identifies the logical Ethernet input.

Range: 1..8 [[RoomBarPro](#) [RoomKitEQX](#) [CodecEQ](#) [CodecPro](#) [Room70G2](#) [BoardPro](#) [BoardProG2](#)]

Range: 1..6 [[RoomPanorama/Room70Panorama](#)]

Audio Input Ethernet[n] Channel[1..4] Pan

Applies to: RoomBar

Requires user role: ADMIN, INTEGRATOR

Set which mix channel (left or right) this input channel is mixed to. For a single channel mix this setting has no effect.

Default value:

Mono

Value space:

Left/Mono/Right

Left: Pan to the left mix channel.

Right: Pan to the right mix channel

Mono: Pan equally to both the left and right channel.

n: Unique ID that identifies the logical Ethernet input.

Range: 1 [[RoomBar](#)]

Board

BoardPro,
BoardPro
G2

Codec EQ

Codec
PlusCodec
ProDesk,
DeskPro,
DeskMiniRoom Bar
Pro,
Room BarRoom Kit,
Room Kit
MiniRoom Kit
EQX

Room 55

Room 55
Dual,
Room 70Room 70
G2Room 70
PanoramaRoom
Panorama

D15503.06

RoomOS
11.24

02-2025



Audio Input Ethernet [n] Channel [1..8] Pan

Applies to: RoomBarPro RoomKitEQX CodecEQ CodecPro Room70G2 RoomPanorama/Room70Panorama BoardPro BoardProG2

Requires user role: ADMIN, INTEGRATOR

Set which mix channel (left or right) this input channel is mixed to. For a single channel mix this setting has no effect.

Default value:

Mono

Value space:

Left/Right/Mono

Left: Pan to the left mix channel.

Right: Pan to the right mix channel

Mono: Pan equally to both the left and right channel.

n: Unique ID that identifies the logical Ethernet input.

Range: 1..8 [RoomBarPro RoomKitEQX CodecEQ CodecPro Room70G2 BoardPro BoardProG2]

Range: 1..6 [RoomPanorama/Room70Panorama]

Audio Input Ethernet[1] Channel[1..4] Zone

Applies to: RoomBar

Requires user role: ADMIN, INTEGRATOR

This command is mainly used for Presenter and Audience room setup. It's mainly used from Control Hub when setting up the feature. During setup we recommend you add information whether the microphone is facing the stage (presenter) or the audience. This information allows for more accurate automatic switching between the local, remote, and hybrid presenter modes.

Default value:

1

Value space:

Integer (1..3)

1: Use this value, when the direction of the microphone is not used.

2: Use this value when the microphone is set up to face the stage area

3: Use this value when the microphone is set up to face the audience.

n: Unique ID that identifies the logical Ethernet input.

Range: 1 [RoomBar]

Audio Input Ethernet [n] Channel [1..8] Zone

Applies to: RoomBarPro RoomKitEQX CodecEQ CodecPro Room70G2 RoomPanorama/Room70Panorama BoardPro BoardProG2

Requires user role: ADMIN, INTEGRATOR

This command is mainly used for Presenter and Audience room setup. It's mainly used from Control Hub when setting up the feature. During setup we recommend you add information whether the microphone is facing the stage (presenter) or the audience. This information allows for more accurate automatic switching between the local, remote, and hybrid presenter modes.

Default value:

1

Value space:

Integer (1..3)

1: Use this value, when the direction of the microphone is not used.

2: Use this value when the microphone is set up to face the stage area

3: Use this value when the microphone is set up to face the audience.

n: Unique ID that identifies the logical Ethernet input.

Range: 1..8 [RoomBarPro RoomKitEQX CodecEQ CodecPro Room70G2 BoardPro BoardProG2]

Range: 1..6 [RoomPanorama/Room70Panorama]

Audio Input Ethernet [n] EchoControl Mode

Applies to: RoomBar RoomBarPro RoomKitEQX CodecEQ CodecPro Room70G2 RoomPanorama/Room70Panorama BoardPro BoardProG2

Requires user role: ADMIN, INTEGRATOR

The echo canceller continuously adjusts itself to the audio characteristics of the room, and compensates for any changes it detects in the audio environment. If the changes in the audio conditions are significant, the echo canceller may take a second or two to re-adjust.

Default value:

On

Value space:

Off/On

Off: Turn off the echo control. Recommended if echo cancellation is performed by external equipment.

On: Turn on the echo control. Recommended, in general, to prevent the far end from hearing their own audio. Once selected, echo cancellation is active at all times.

n: Unique ID that identifies the logical Ethernet input.

Range: 1..8 [RoomBarPro RoomKitEQX CodecEQ CodecPro Room70G2 BoardPro BoardProG2]

Range: 1..6 [RoomPanorama/Room70Panorama]

Range: 1 [RoomBar]

Board

BoardPro,
BoardPro
G2

Codec EQ

Codec
PlusCodec
ProDesk,
DeskPro,
DeskMiniRoom Bar
Pro,
Room BarRoom Kit,
Room Kit
MiniRoom Kit
EQX

Room 55

Room 55
Dual,
Room 70Room 70
G2Room 70
PanoramaRoom
Panorama

Audio Input Ethernet [n] EchoControl NoiseReduction

Applies to: RoomBar RoomBarPro RoomKitEQX CodecEQ CodecPro Room70G2 RoomPanorama/Room70Panorama BoardPro BoardProG2

Requires user role: ADMIN, INTEGRATOR

The video device has built-in noise reduction, which reduces stationary background noise, for example noise from air-conditioning systems, cooling fans etc. In addition, a high pass filter (Humfilter) reduces very low frequency noise. Noise reduction requires that Audio Input Ethernet [n] EchoControl Mode is enabled.

Default value:

On

Value space:

Off/On

Off: Turn off the noise reduction.

On: Turn on the noise reduction. Recommended in the presence of low frequency noise.

n: Unique ID that identifies the logical Ethernet input.

Range: 1..8 [RoomBarPro RoomKitEQX CodecEQ CodecPro Room70G2 BoardPro BoardProG2]

Range: 1..6 [RoomPanorama/Room70Panorama]

Range: 1 [RoomBar]

Audio Input Ethernet [n] Equalizer ID

Applies to: RoomBar RoomBarPro RoomKitEQX CodecEQ CodecPro Room70G2 RoomPanorama/Room70Panorama BoardPro BoardProG2

Requires user role: ADMIN, INTEGRATOR

Select which equalizer preset to apply to this input. If this input has more than one channel, the processing will apply equally to all of them.

Default value:

1

Value space:

Integer (1..8)

The equalizer preset number.

n: Unique ID that identifies the logical Ethernet input.

Range: 1..8 [RoomBarPro RoomKitEQX CodecEQ CodecPro Room70G2 BoardPro BoardProG2]

Range: 1..6 [RoomPanorama/Room70Panorama]

Range: 1 [RoomBar]

Audio Input Ethernet [n] Equalizer Mode

Applies to: RoomBar RoomBarPro RoomKitEQX CodecEQ CodecPro Room70G2 RoomPanorama/Room70Panorama BoardPro BoardProG2

Requires user role: ADMIN, INTEGRATOR

Enable or disable the equalization processing for this input.

Default value:

Off

Value space:

Off/On

Off: Do not apply equalization processing.

On: Apply equalization processing.

n: Unique ID that identifies the logical Ethernet input.

Range: 1..8 [RoomBarPro RoomKitEQX CodecEQ CodecPro Room70G2 BoardPro BoardProG2]

Range: 1..6 [RoomPanorama/Room70Panorama]

Range: 1 [RoomBar]

Audio Input Ethernet [n] Mode

Applies to: RoomBar RoomBarPro RoomKitEQX CodecEQ CodecPro Room70G2 RoomPanorama/Room70Panorama BoardPro BoardProG2

Requires user role: ADMIN, INTEGRATOR

Disable or enable audio from this Ethernet input.

If this input has more than one channel, see also the Audio Input Ethernet [n] Channel [1..8] Mode setting.

Default value:

On

Value space:

Off/On

Off: Disable all audio from this input.

On: Enable audio from active channels.

n: Unique ID that identifies the logical Ethernet input.

Range: 1..8 [RoomBarPro RoomKitEQX CodecEQ CodecPro Room70G2 BoardPro BoardProG2]

Range: 1..6 [RoomPanorama/Room70Panorama]

Range: 1 [RoomBar]

Board

Audio Input HDMI [n] Level

Applies to: RoomKit RoomKitMini RoomBar CodecPlus CodecPro Room55 Room70/Room55D Room70G2 RoomPanorama/Room70Panorama Desk DeskPro Board BoardPro

Requires user role: ADMIN, INTEGRATOR

Set the gain on the HDMI input connector. The gain can be tuned in steps of 1 dB.

Default value:

-5

Value space:

Integer (-24..0)

Range: Select the gain in decibel (dB).

n: Unique ID that identifies the HDMI input.

Range: 2..3 [CodecPlus Room70/Room55D]

Range: 1..5 [CodecPro]

Range: 1..1 [RoomKit RoomKitMini RoomBar Desk DeskPro Board BoardPro BoardProG2]

Range: 1..2 [Room55]

Range: 2..5 [Room70G2 RoomPanorama/Room70Panorama]

Audio Input HDMI [n] Gain

Applies to: RoomBarPro RoomKitEQX CodecEQ BoardProG2

Requires user role: ADMIN, INTEGRATOR

Set the gain on the HDMI input connector. The gain can be tuned in steps of 1 dB.

Default value:

-5

Value space:

Integer (-24..0)

Range: Select the gain in decibel (dB).

n: Unique ID that identifies the HDMI input.

Range: 1..3 [RoomKitEQX CodecEQ]

Range: 1..1 [RoomBarPro BoardProG2]

Audio Input HDMI [n] Mode

Applies to: RoomKit RoomKitMini RoomBar RoomBarPro RoomKitEQX CodecEQ CodecPlus CodecPro Room55 Room70/Room55D Room70G2 RoomPanorama/Room70Panorama Desk DeskPro Board BoardPro BoardProG2

Requires user role: ADMIN, INTEGRATOR

Define if the audio on the HDMI input connector shall be enabled.

Default value:

On

Value space:

Off/On

Off: Disable audio on the HDMI input.

On: Enable audio on the HDMI input.

n: Unique ID that identifies the HDMI input.

Range: 2..3 [CodecPlus Room70/Room55D]

Range: 1..3 [RoomKitEQX CodecEQ]

Range: 1..5 [CodecPro]

Range: 1..1 [RoomKit RoomKitMini RoomBar RoomBarPro Desk DeskPro Board BoardPro BoardProG2]

Range: 1..2 [Room55]

Range: 2..5 [Room70G2 RoomPanorama/Room70Panorama]

Board

BoardPro,
BoardPro
G2

Codec EQ

Codec
PlusCodec
ProDesk,
DeskPro,
DeskMiniRoom Bar
Pro,
Room BarRoom Kit,
Room Kit
MiniRoom Kit
EQX

Room 55

Room 55
Dual,
Room 70Room 70
G2Room 70
PanoramaRoom
Panorama

Audio Input HDMI [n] VideoAssociation MuteOnInactiveVideo

Applies to: RoomKit RoomKitMini RoomBar RoomBarPro RoomKitEQX CodecEQ CodecPlus CodecPro Room55 Room70/Room55D Room70G2 RoomPanorama/Room70Panorama Desk DeskPro Board BoardPro BoardProG2

Requires user role: ADMIN, INTEGRATOR

Use this setting to decide if audio from a presentation source that is connected to this HDMI connector shall be shared with far end, regardless of whether video from the same source is shared with far end.

Default value:

On [RoomKit RoomKitMini RoomBar RoomBarPro CodecPlus Room55 Room70/Room55D Desk DeskPro Board BoardPro BoardProG2]

HDMI 1: Off HDMI 2,3]: On [RoomKitEQX CodecEQ]

HDMI 1,2: Off HDMI 3,4,5: On [CodecPro]

HDMI 2: Off HDMI 3,4,5: On [Room70G2 RoomPanorama/Room70Panorama]

Value space:

Off/On

Off: Audio is always played back, both locally and to far end, when a presentation source is connected. That is, audio is sent to the far end even if you only share the video locally, or if you don't share any video at all.

On: Audio will always follow the video share of the input connector. If only sharing locally, audio is played back only locally; if video is shared with the far end, audio is also shared with the far end.

n: Unique ID that identifies the HDMI input.

Range: 2..3 [CodecPlus Room70/Room55D]

Range: 1..3 [RoomKitEQX CodecEQ]

Range: 1..5 [CodecPro]

Range: 1..2 [Room55]

Range: 2..5 [Room70G2 RoomPanorama/Room70Panorama]

Range: 1..1 [RoomKit RoomKitMini RoomBar RoomBarPro Desk DeskPro Board BoardPro BoardProG2]

Audio Input Microphone [n] Channel

Applies to: CodecPro Room70G2 RoomPanorama/Room70Panorama

Requires user role: ADMIN, INTEGRATOR

Define how to mix the input signal when generating a multichannel mix. For a single channel mix this setting has no effect.

For other products that support this feature, refer to the Audio Input Microphone [n] Pan setting.

Default value:

Mono

Value space:

Left/Mono/Right

Left: Mixed to the left channel when generating a stereo mix.

Mono: Mixed to both channels when generating a stereo mix.

Right: Mixed to the right channel when generating a stereo mix.

n: Unique ID that identifies the microphone input.

Range: 1..8

Audio Input Microphone [n] EchoControl Mode

Applies to: RoomKit RoomBar RoomBarPro RoomKitEQX CodecEQ CodecPlus CodecPro Room55 Room70/Room55D Room70G2 RoomPanorama/Room70Panorama BoardPro BoardProG2

Requires user role: ADMIN, INTEGRATOR

The echo canceller continuously adjusts itself to the audio characteristics of the room, and compensates for any changes it detects in the audio environment. If the changes in the audio conditions are significant, the echo canceller may take a second or two to re-adjust.

Default value:

On

Value space:

Off/On

Off: Turn off the echo control. Recommended if echo cancellation is performed by external equipment.

On: Turn on the echo control. Recommended, in general, to prevent the far end from hearing their own audio. Once selected, echo cancellation is active at all times.

n: Unique ID that identifies the microphone input.

Range: 1..8 [CodecPro Room70G2 RoomPanorama/Room70Panorama]

Range: 1..3 [RoomKitEQX CodecEQ CodecPlus Room70/Room55D]

Range: 2..3 [RoomKit RoomBarPro Room55 BoardPro BoardProG2]

Range: 2..2 [RoomBar]

Board

BoardPro,
BoardPro
G2

Codec EQ

Codec
PlusCodec
ProDesk,
DeskPro,
DeskMiniRoom Bar
Pro,
Room BarRoom Kit,
Room Kit
MiniRoom Kit
EQX

Room 55

Room 55
Dual,
Room 70Room 70
G2Room 70
PanoramaRoom
Panorama

Audio Input Microphone [n] EchoControl Dereverberation

Applies to: RoomKit RoomBar RoomKitEQX CodecEQ CodecPlus CodecPro Room55 Room70/Room55D Room70G2 RoomPanorama/Room70Panorama

Requires user role: ADMIN, INTEGRATOR

The video device has built-in signal processing to reduce the effect of room reverberation. Dereverberation requires that Audio Input Microphone [n] EchoControl Mode is enabled.

Default value:

Off

Value space:

Off/On

Off: Turn off the dereverberation.

On: Turn on the dereverberation.

n: Unique ID that identifies the microphone input.

Range: 1..8 [[CodecPro](#) [Room70G2](#) [RoomPanorama/Room70Panorama](#)]

Range: 1..3 [[RoomKitEQX](#) [CodecEQ](#) [CodecPlus](#) [Room70/Room55D](#)]

Range: 2..3 [[RoomKit](#) [Room55](#)]

Range: 2..2 [[RoomBar](#)]

Audio Input Microphone [n] EchoControl NoiseReduction

Applies to: RoomKit RoomBar RoomBarPro RoomKitEQX CodecEQ CodecPlus CodecPro Room55 Room70/Room55D Room70G2 RoomPanorama/Room70Panorama BoardPro BoardProG2

Requires user role: ADMIN, INTEGRATOR

The video device has built-in noise reduction, which reduces stationary background noise, for example noise from air-conditioning systems, cooling fans etc. In addition, a high pass filter (Humfilter) reduces very low frequency noise. Noise reduction requires that Audio Input Microphone [n] EchoControl Mode is enabled.

Default value:

On

Value space:

Off/On

Off: Turn off the noise reduction.

On: Turn on the noise reduction. Recommended in the presence of low frequency noise.

n: Unique ID that identifies the microphone input.

Range: 1..8 [[CodecPro](#) [Room70G2](#) [RoomPanorama/Room70Panorama](#)]

Range: 1..3 [[RoomKitEQX](#) [CodecEQ](#) [CodecPlus](#) [Room70/Room55D](#)]

Range: 2..3 [[RoomKit](#) [RoomBarPro](#) [Room55](#) [BoardPro](#) [BoardProG2](#)]

Range: 2..2 [[RoomBar](#)]

Audio Input Microphone [n] Equalizer ID

Applies to: RoomKitEQX CodecEQ CodecPro Room70G2 RoomPanorama/Room70Panorama

Requires user role: ADMIN, INTEGRATOR

Select which equalizer preset to apply to this microphone.

Default value:

1

Value space:

Integer (1..8)

The equalizer preset number.

n: Unique ID that identifies the microphone input.

Range: 1..8 [[CodecPro](#) [Room70G2](#) [RoomPanorama/Room70Panorama](#)]

Range: 1..3 [[RoomKitEQX](#) [CodecEQ](#)]

Audio Input Microphone [n] Equalizer Mode

Applies to: RoomKitEQX CodecEQ CodecPro Room70G2 RoomPanorama/Room70Panorama

Requires user role: ADMIN, INTEGRATOR

Enable or disable the equalizer processing for this microphone input.

Default value:

Off

Value space:

Off/On

Off: Do not apply equalization processing.

On: Apply equalization processing.

n: Unique ID that identifies the microphone input.

Range: 1..8 [[CodecPro](#) [Room70G2](#) [RoomPanorama/Room70Panorama](#)]

Range: 1..3 [[RoomKitEQX](#) [CodecEQ](#)]

Board

BoardPro,
BoardPro
G2

Codec EQ

Codec
PlusCodec
ProDesk,
DeskPro,
DeskMiniRoom Bar
Pro,
Room BarRoom Kit,
Room Kit
MiniRoom Kit
EQX

Room 55

Room 55
Dual,
Room 70Room 70
G2Room 70
PanoramaRoom
Panorama

Audio Input Microphone [n] Level

Applies to: RoomKit RoomBar CodecPlus Room55 Room70/Room55D Room70G2 RoomPanorama/Room70Panorama BoardPro

Requires user role: ADMIN, INTEGRATOR

Set the gain on the Microphone input connector. The gain should be adjusted to suit the output level of the connected audio source. The gain can be tuned in steps of 1 dB.

If the gain is set too high, the audio signal will be clipped. If the gain is set too low, the audio signal-to-noise ratio will be degraded; however, this is usually preferable to clipping.

Note that unprocessed speech signals typically contain significant level variations, making it very important to allow for sufficient signal headroom.

The maximum input level with 0 dB gain depends on the product: -18 dBu (Room Bar, Room Kit, Codec Plus, Room 55, Room 70, Room 55 Dual), 24 dBu (Codec Pro, Room 70 G2).

Example: If your microphone has a maximum output level of -44 dBu, and it is connected to a Codec Pro, then you should set the gain to 24 dBu - (-44 dBu) = 68 dB.

Default value:

14 [RoomKit RoomBar CodecPlus Room55 Room70/Room55D BoardPro]

58 [CodecPro Room70G2 RoomPanorama/Room70Panorama]

Value space:

Integer (0..24) [RoomKit RoomBar CodecPlus Room55 Room70/Room55D BoardPro]

Integer (0..70) [CodecPro Room70G2 RoomPanorama/Room70Panorama]

Range: Select the gain in decibel (dB).

n: Unique ID that identifies the microphone input.

Range: 1..8 [CodecPro Room70G2 RoomPanorama/Room70Panorama]

Range: 1..3 [CodecPlus Room70/Room55D]

Range: 2..3 [RoomKit Room55 BoardPro]

Range: 2..2 [RoomBar]

Audio Input Microphone [n] Gain

Applies to: RoomBarPro RoomKitEQX CodecEQ BoardProG2

Requires user role: ADMIN, INTEGRATOR

Set the gain on the Microphone input connector. The gain should be adjusted to suit the output level of the connected audio source. The gain can be tuned in steps of 1 dB.

If the gain is set too high, the audio signal will be clipped. If the gain is set too low, the audio signal-to-noise ratio will be degraded; however, this is usually preferable to clipping.

Note that unprocessed speech signals typically contain significant level variations, making it very important to allow for sufficient signal headroom.

The maximum input level with 0 dB gain is -18 dBu.

Example: If your microphone has a maximum output level of -40 dBu, then you should set the gain to -18 dBu - (-40 dBu) = 22 dB.

Default value:

20 [RoomBarPro RoomKitEQX CodecEQ]

14 [BoardProG2]

Value space:

Integer (0..24)

Range: Select the gain in decibel (dB).

n: Unique ID that identifies the microphone input.

Range: 1..3 [RoomKitEQX CodecEQ]

Range: 2..3 [RoomBarPro BoardProG2]

Board

Board Pro,
Board Pro
G2

Codec EQ

Codec
PlusCodec
ProDesk,
Desk Pro,
Desk MiniRoom Bar
Pro,
Room BarRoom Kit,
Room Kit
MiniRoom Kit
EQX

Room 55

Room 55
Dual,
Room 70Room 70
G2Room 70
PanoramaRoom
Panorama

Audio Input Microphone [n] Mode

Applies to: RoomKit RoomBar RoomBarPro RoomKitEQX CodecEQ CodecPlus CodecPro Room55 Room70/Room55D Room70G2 RoomPanorama/Room70Panorama DeskMini Desk DeskPro BoardPro BoardProG2

Requires user role: ADMIN, INTEGRATOR

Disable or enable audio on the microphone connector.

Board Pro, Board Pro G2, Desk Mini, Desk, Desk Pro, Room Bar, Room Bar Pro, Room Kit, Room 55: Microphone [1] is the device's internal microphone.

Default value:

On

Value space:

Off/On

Off: Disable the audio input microphone connector.

On: Enable the audio input microphone connector.

n: Unique ID that identifies the microphone input.

Range: 1..8 [CodecPro Room70G2 RoomPanorama/Room70Panorama]

Range: 1..3 [RoomKit RoomBarPro RoomKitEQX CodecEQ CodecPlus Room55 Room70/Room55D BoardPro BoardProG2]

Range: 1..2 [RoomBar]

Range: 1..1 [DeskMini Desk DeskPro]

Audio Input Microphone [n] MuteOverride

Applies to: CodecPro Room70G2 RoomPanorama/Room70Panorama

Requires user role: ADMIN, INTEGRATOR

This setting is only for the analog microphone inputs on Codec Pro.

Configure the microphone input to override the main mute state of the system (that is, the mute state controlled with the ordinary mute button(s)).

This allows for the microphone input to be unmuted and used as a line input for transmitting presentation sounds, etc. during active video input.

Note that the microphone may still be muted if it is associated with an inactive video input and is set to mute on inactive video input.

As an example, if one needs to present audio from an analog source, some of the microphone inputs need to be repurposed as line inputs.

Without MuteOverride, the sound from these presentation sources will go silent if the presenter mutes the microphone(s) during playback of the presentation.

Default value:

Off

Value space:

Off/On

Off: Do not override the mute setting.

On: Override the mute setting.

n: Unique ID that identifies the microphone input.

Range: 1..8

Board

Audio Input Microphone [n] Pan

Applies to: RoomKitEQX CodecEQ

Requires user role: ADMIN, INTEGRATOR

Define how to mix the input signal when generating a multichannel mix. For a single channel mix this setting has no effect.

For other products that support this feature, refer to the Audio Input Microphone [n] Channel setting.

Default value:

Mono

Value space:

Left/Mono/Right

Left: Mixed to the left channel when generating a stereo mix.

Mono: Mixed to both channels when generating a stereo mix.

Right: Mixed to the right channel when generating a stereo mix.

n: Unique ID that identifies the microphone input.

Range: 1..3

BoardPro,
BoardPro
G2

Codec EQ

Codec
PlusCodec
ProDesk,
DeskPro,
DeskMiniRoom Bar
Pro,
Room BarRoom Kit,
Room Kit
MiniRoom Kit
EQX

Room 55

Room 55
Dual,
Room 70Room 70
G2Room 70
PanoramaRoom
Panorama

Audio Input Microphone [n] PhantomPower

Applies to: CodecPro Room70G2 RoomPanorama/Room70Panorama

Requires user role: ADMIN, INTEGRATOR

Define whether or not to have phantom power (48 V +/- 1 V) on the microphone input.

Default value:

On

Value space:

Off/On

Off: Disable the phantom power on the microphone input. Use this when connecting to equipment that do not need phantom power, such as external mixers.

On: Enable the phantom power on the microphone input. Use this when connecting directly to microphones that require phantom power, including the Cisco Table Microphone and Cisco Ceiling Microphone.

n: Unique ID that identifies the microphone input.

Range: 1..8

Audio Input Microphone [n] VideoAssociation MuteOnInactiveVideo

Applies to: RoomKitEQX CodecEQ CodecPro Room70G2 RoomPanorama/Room70Panorama

Requires user role: ADMIN, INTEGRATOR

You can associate a microphone with a video input connector, so that the microphone is automatically muted when there is no video stream or content on that video input. Use the Audio Input Microphone [n] VideoAssociation VideoInputSource setting to choose which video input connector to associate the microphone with.

Default value:

Off

Value space:

Off/On

Off: The microphone mute state is independent of the state of the video inputs.

On: The microphone will be automatically muted when there is no video stream or content on the associated video input.

n: Unique ID that identifies the microphone input.

Range: 1..8 [[CodecPro](#) [Room70G2](#) [RoomPanorama/Room70Panorama](#)]

Range: 1..3 [[RoomKitEQX](#) [CodecEQ](#)]

Audio Input Microphone [n] VideoAssociation VideoInputSource

Applies to: RoomKitEQX CodecEQ CodecPro Room70G2 RoomPanorama/Room70Panorama

Requires user role: ADMIN, INTEGRATOR

Select the video input connector to associate the microphone with.

Default value:

1

Value space:

1/2/3/4/5/6 [[CodecPro](#) [Room70G2](#) [RoomPanorama/Room70Panorama](#)]

1/2/3/4 [[RoomKitEQX](#) [CodecEQ](#)]

The video input connector that the microphone is associated with.

n: Unique ID that identifies the microphone input.

Range: 1..8 [[CodecPro](#) [Room70G2](#) [RoomPanorama/Room70Panorama](#)]

Range: 1..3 [[RoomKitEQX](#) [CodecEQ](#)]

Board

BoardPro,
BoardPro
G2

Codec EQ

Codec
PlusCodec
ProDesk,
DeskPro,
DeskMiniRoom Bar
Pro,
Room BarRoom Kit,
Room Kit
MiniRoom Kit
EQX

Room 55

Room 55
Dual,
Room 70Room 70
G2Room 70
PanoramaRoom
Panorama

Audio Input Microphone [n] Zone

Applies to: RoomKit RoomBar RoomBarPro RoomKitEQX CodecEQ CodecPlus CodecPro Room55 Room70/Room55D Room70G2 RoomPanorama/Room70Panorama BoardPro BoardProG2

Requires user role: ADMIN, INTEGRATOR

This command is mainly used for the Presenter and Audience room setup. It's mainly used from Control Hub when setting up the feature. During setup we recommend you add information whether the microphone is facing the stage (presenter) or the audience. This information allows for more accurate automatic switching between the local, remote, and hybrid presenter modes.

Default value:

1

Value space:

Integer (1..3)

- 1: Use this value, when the direction of the microphone is not used.
- 2: Use this value when the microphone is set up to face the stage area
- 3: Use this value when the microphone is set up to face the audience.

n: Unique ID that identifies the microphone input.

Range: 1..8 [CodecPro Room70G2 RoomPanorama/Room70Panorama]

Range: 1..3 [RoomKit RoomBarPro RoomKitEQX CodecEQ CodecPlus Room55 Room70/Room55D BoardPro BoardProG2]

Range: 1..2 [RoomBar]

Audio Input MicrophoneMode

Applies to: DeskMini Desk DeskPro

Requires user role: ADMIN, INTEGRATOR

If the microphone mode is Focused, the microphones can be combined to focus sound sensitivity. As a result, the noise in the room is suppressed, and you can be heard better when sitting right in front of the device. The voice of people not sitting right in front of the device will be suppressed.

If the microphone mode is Wide, the device behaves like any other device. The voice of people sitting beside you will be heard, and also more noise from the room.

We recommend that you use Focused mode when you are the only speaker. Use Wide mode when several speakers are in front of the device.

Default value:

Focused

Value space:

Focused/Wide

Focused: Focused sound sensitivity, suppressing sound from sources that are not right in front of the device.

Wide: Default microphone operation with normal sound sensitivity.

Board

BoardPro,
BoardPro
G2

Codec EQ

Codec
PlusCodec
ProDesk,
DeskPro,
DeskMiniRoom Bar
Pro,
Room BarRoom Kit,
Room Kit
MiniRoom Kit
EQX

Room 55

Room 55
Dual,
Room 70Room 70
G2Room 70
PanoramaRoom
Panorama

Audio Microphones BeamMix Inputs

Applies to: RoomBarPro BoardPro BoardProG2

Requires user role: ADMIN, INTEGRATOR

The device's internal microphone array consists of two major parts: A near talker sector, covering up to about 1.5 m from the device; and three beams that cover up to about 4 m from the device. The device also supports external analog or digital microphones. This setting is about using the beams and external microphones (analog or digital (Ethernet)) at the same time.

In general, we recommend you not to allow the beams and external microphones at the same time, that is, we recommend keeping this setting at Auto.

If you choose to allow the beams and external microphones at the same time, be aware that you might get more reverberation.

Default value:

Auto

Value space:

Auto/BeamsAndExtMics/OnlyExtMics

Auto: If a Ceiling Microphone Pro is connected and the Ceiling Microphone Pro voice tracking wizard has been run, the new smart audio mixer uses both internal beams and the Ceiling Microphone Pro. For other external microphones, the internal beams are disabled.

BeamsAndExtMics: The audio mixer uses internal beams and external microphones for voice pickup at all times. When using Ceiling Microphone Pro, we recommend using the Auto setting as it provides a smarter audio mixer, taking into account the placement of the Ceiling Microphone Pro.

OnlyExtMics: Uses only external microphones for voice pickup and falls back to internal beams if no external microphones are connected.

Audio Input USBC [n] Level

Applies to: RoomBar DeskMini Desk DeskPro BoardPro

Requires user role: ADMIN, INTEGRATOR

Set the gain on the USB-C input connector. The gain can be tuned in steps of 1 dB.

Default value:

-5

Value space:

Integer (-24..0)

Select the gain in decibel (dB).

n: Unique ID that identifies the USB-C input.

Range: 1..1

Audio Input USBC [n] Gain

Applies to: RoomBarPro RoomKitEQX CodecEQ BoardProG2

Requires user role: ADMIN, INTEGRATOR

Set the gain on the USB-C input connector. The gain can be tuned in steps of 1 dB.

Default value:

-5

Value space:

Integer (-24..0)

Select the gain in decibel (dB).

n: Unique ID that identifies the USB-C input.

Range: 1..1

Audio Input USBC [n] Mode

Applies to: RoomBar RoomBarPro RoomKitEQX CodecEQ DeskMini Desk DeskPro BoardPro BoardProG2

Requires user role: ADMIN, INTEGRATOR

Set the USB-C audio mode.

Default value:

On

Value space:

Off/On

On: Allow audio from the USB-C.

Off: Do not allow any audio from the USB-C.

n: Unique ID that identifies the USBC input.

Range: 1..1

Board

BoardPro,
BoardPro
G2

Codec EQ

Codec
PlusCodec
ProDesk,
DeskPro,
DeskMiniRoom Bar
Pro,
Room BarRoom Kit,
Room Kit
MiniRoom Kit
EQX

Room 55

Room 55
Dual,
Room 70Room 70
G2Room 70
PanoramaRoom
Panorama

Audio Input USBC [n] VideoAssociation MuteOnInactiveVideo

Applies to: RoomBar RoomBarPro RoomKitEQX CodecEQ DeskMini Desk DeskPro BoardPro BoardProG2

Requires user role: ADMIN

Use this setting to decide if audio from a presentation source that is connected to this USB-C connector shall be shared with far end, regardless of whether video from the same source is shared with the far end.

Default value:

On

Value space:

Off/On

Off: Audio is always played back, both locally and to far end, when a presentation source is connected. That is, audio is sent to the far end even if you only share the video locally, or if you don't share any video at all.

On: Audio will always follow the video share of the input connector. If only sharing locally, audio is played back only locally; if video is shared with the far end, audio is also shared with far end.

n: Unique ID that identifies the USBC input.

Range: 1..1

Audio Input USBInterface [n] EchoControl Mode

Applies to: RoomKitEQX CodecEQ CodecPlus CodecPro Room70/Room55D Room70G2 RoomPanorama/Room70Panorama

Requires user role: ADMIN, INTEGRATOR

The device's echo canceller continuously adjusts itself to the audio characteristics of the room and compensates for any changes it detects in the audio environment. If the changes in the audio conditions are significant, the echo canceller may take a second or two to re-adjust.

If performing echo cancellation in external equipment, directional audio should be switched off using the Audio Panning Mode setting.

Default value:

On

Value space:

Off/On

Off: Turn off echo cancellation in the device. Recommended if echo cancellation is performed by external equipment.

On: Turn on echo cancellation in the device. Recommended, in general, to prevent the far end from hearing their own audio. Once selected, echo cancellation is always active.

n: Unique ID that identifies the USB interface.

Range: 1..1

Audio Input USBInterface [n] Level

Applies to: CodecPlus CodecPro Room70/Room55D Room70G2 RoomPanorama/Room70Panorama

Requires user role: ADMIN, INTEGRATOR

Set the gain on the USB connector to fit the output level of the specific USB device that is connected. The output levels of USB devices may vary.

The gain can be tuned in steps of 1 dB.

Default value:

5

Value space:

Integer (0..24)

Set the gain in decibel (dB).

n: Unique ID that identifies the USB interface.

Range: 1..1

Board

BoardPro,
BoardPro
G2

Codec EQ

Codec
PlusCodec
ProDesk,
DeskPro,
DeskMiniRoom Bar
Pro,
Room BarRoom Kit,
Room Kit
MiniRoom Kit
EQX

Room 55

Room 55
Dual,
Room 70Room 70
G2Room 70
PanoramaRoom
Panorama

Audio Input USBInterface [n] Gain

Applies to: RoomKitEQX CodecEQ

Requires user role: ADMIN, INTEGRATOR

Set the gain on the USB connector to fit the output level of the specific USB device that is connected. The output levels of USB devices may vary.

The gain can be tuned in steps of 1 dB.

Default value:

5

Value space:

Integer (0..24)

Set the gain in decibel (dB).

n: Unique ID that identifies the USB interface.

Range: 1..1

Audio Input USBInterface [n] Mode

Applies to: RoomKitEQX CodecEQ CodecPlus CodecPro Room70/Room55D Room70G2 RoomPanorama/Room70Panorama

Requires user role: ADMIN, INTEGRATOR

Disable or enable audio input on the USB connector.

Default value:

On

Value space:

Off/On

Off: Disable audio input on the USB connector.

On: Enable audio input on the USB connector.

n: Unique ID that identifies the USB interface.

Range: 1..1

Audio Input USBInterface [n] Zone

Applies to: RoomKitEQX CodecEQ CodecPlus CodecPro Room70/Room55D Room70G2 RoomPanorama/Room70Panorama

Requires user role: ADMIN, INTEGRATOR

This command is mainly used for the Presenter and Audience room setup. It's mainly used from Control Hub when setting up the feature. During setup we recommend you add information whether the microphone is facing the stage (presenter) or the audience. This information allows for more accurate automatic switching between the local, remote, and hybrid presenter modes.

Default value:

1

Value space:

Integer (1..3)

1: Use this value, when the direction of the microphone is not used.

2: Use this value when the microphone is set up to face the stage area

3: Use this value when the microphone is set up to face the audience.

n: Unique ID that identifies the USB interface.

Range: 1..1

Board

Audio Input USBMicrophone [n] EchoControl Mode

Applies to: RoomKit RoomKitMini RoomBar RoomBarPro Room55 DeskMini Desk DeskPro BoardPro BoardProG2

Requires user role: ADMIN, INTEGRATOR

The device's echo canceller continuously adjusts itself to the audio characteristics of the room and compensates for any changes it detects in the audio environment. If the changes in the audio conditions are significant, the echo canceller may take a second or two to re-adjust.

The AEC reference signal is always sent from the device to the USB microphone. Whether echo cancellation is performed in the device or in external equipment doesn't matter.

If performing echo cancellation in external equipment, directional audio should be switched off using the Audio Panning Mode setting.

Default value:

On

Value space:

Off/On

Off: Turn off echo cancellation in the device. Recommended if echo cancellation is performed by external equipment.

On: Turn on echo cancellation in the device. Recommended, in general, to prevent the far end from hearing their own audio. Once selected, echo cancellation is always active.

n: Unique ID that identifies the USB microphone.

Range: 1..1

Audio Input USBMicrophone [n] Gain

Applies to: RoomBarPro BoardProG2

Requires user role: ADMIN, INTEGRATOR

Set the gain on the USB connector to fit the output level of the specific USB microphone that is connected. The output levels of USB microphones may vary.

The gain can be tuned in steps of 1 dB.

Default value:

5

Value space:

Integer (0..24)

Set the gain in decibel (dB).

n: Unique ID that identifies the USB microphone.

Range: 1..1

Audio Input USBMicrophone [n] Level

Applies to: RoomKit RoomKitMini RoomBar Room55 DeskMini Desk DeskPro BoardPro

Requires user role: ADMIN, INTEGRATOR

Set the gain on the USB connector to fit the output level of the specific USB microphone that is connected. The output levels of USB microphones may vary.

The gain can be tuned in steps of 1 dB.

Default value:

5

Value space:

Integer (0..24)

Set the gain in decibel (dB).

n: Unique ID that identifies the USB microphone.

Range: 1..1

Audio Input USBMicrophone [n] Zone

Applies to: RoomKit RoomKitMini RoomBar RoomBarPro Room55 DeskMini Desk DeskPro BoardPro BoardProG2

Requires user role: ADMIN, INTEGRATOR

This command is mainly used for the Presenter and Audience room setup. It's mainly used from Control Hub when setting up the feature. During setup we recommend you add information whether the microphone is facing the stage (presenter) or the audience. This information allows for more accurate automatic switching between the local, remote, and hybrid presenter modes.

Default value:

1

Value space:

Integer (1..3)

- 1: Use this value, when the direction of the microphone is not used.
- 2: Use this value when the microphone is set up to face the stage area
- 3: Use this value when the microphone is set up to face the audience.

n: Unique ID that identifies the USB microphone.

Range: 1..1

Board

BoardPro,
BoardPro
G2

Codec EQ

Codec
PlusCodec
ProDesk,
DeskPro,
DeskMiniRoom Bar
Pro,
Room BarRoom Kit,
Room Kit
MiniRoom Kit
EQX

Room 55

Room 55
Dual,
Room 70Room 70
G2Room 70
PanoramaRoom
Panorama

Audio Input WebView [n] Mode

Applies to: RoomKitEQX CodecEQ CodecPro Room70G2 RoomPanorama/Room70Panorama

Requires user role: ADMIN, INTEGRATOR

Set whether to allow audio playback from the embedded web browser (WebView).

Default value:

On

Value space:

Off/On

On: Allow audio from the web browser.

Off: Do not allow any audio to be played from the web browser.

n: Unique ID that identifies the WebView input.

Range: 1..1

Audio Microphones AGC

Applies to: RoomKit RoomBar RoomBarPro RoomKitEQX CodecEQ CodecPlus

Requires user role: ADMIN, INTEGRATOR

Enable or disable Automatic Gain Control (AGC) on the microphones.

Codec EQ and Room Kit EQX with AVIntegrator option: Not applicable.

Default value:

On

Value space:

Off/On

Off: Disable AGC. Use this when connecting to equipment where AGC is already applied to the microphone signal, like external mixers or DSPs.

On: Enable AGC.

Audio Microphones HdmiPassthrough MuteButton

Applies to: RoomKit CodecPlus CodecPro Room55 Room70/Room55D Room70G2

Requires user role: ADMIN, INTEGRATOR

When using the Call from laptop feature (requires that Video Output HDMI Passthrough Allowed is set to True), people can always mute their audio from the meeting app. Use this setting to configure whether to allow muting from the touch controller and external microphones as well. The meeting app must be set up to use the HDMI-to-USB converter (capturing device) as microphone instead of the laptop microphone.

Be aware that the touch controller / microphones are not synchronized with the meeting app regarding mute. Therefore, the mute indicators in the room and in the meeting app don't always reflect the true mute state.

This setting is not available for Room 55 Dual and Room 70 Dual because they don't have an HDMI output available for the converter.

Default value:

Active

Value space:

Active/Inactive

Active: People can mute using the buttons on the touch controller or microphones.

Inactive: People can't mute from the touch controller or microphones. Physical buttons are disabled, and there is no mute button on the user interface.

Board

BoardPro,
BoardPro
G2

Codec EQ

Codec
PlusCodec
ProDesk,
DeskPro,
DeskMiniRoom Bar
Pro,
Room BarRoom Kit,
Room Kit
MiniRoom Kit
EQX

Room 55

Room 55
Dual,
Room 70Room 70
G2Room 70
PanoramaRoom
Panorama

Audio Microphones NoiseRemoval Mode

Applies to: All products

Requires user role: ADMIN, INTEGRATOR

Use this setting to enable or disable the noise removal function on a device, as well as to define the default behavior when the function is enabled. If enabled (Enabled or Manual), there will be buttons on the user interface that allow users to turn background noise removal on and off, and it will also be possible to turn it on and off using API commands.

Default value:

Enabled

Value space:

Disabled/Enabled/Manual

Disabled: The noise removal function is turned off and can't be turned on via the user interface or by sending API commands.

Enabled: You can turn noise removal on and off using buttons on the user interface or by sending API commands. Noise removal is turned on by default. For personal mode devices that are registered to the Webex cloud, the noise removal state is not affected when a call is ended, or you restart the device. If noise removal was turned on, it stays on; if it was turned off, it stays off. For other devices, the noise removal state returns to the default state (on) when a call is ended, or you restart the device.

Manual: You can turn noise removal on and off using buttons on the user interface or by sending API commands. Noise removal is turned off by default. For personal mode devices that are registered to the Webex cloud, the noise removal state is not affected when a call is ended, or you restart the device. If noise removal was turned on, it stays on; if it was turned off, it stays off. For other devices, the noise removal state returns to the default state (off) when a call is ended, or you restart the device.

Audio Microphones Mute Enabled

Applies to: RoomKit RoomKitMini RoomBar RoomBarPro RoomKitEQX CodecEQ CodecPlus CodecPro Room55 Room70/Room55D Room70G2 RoomPanorama/Room70Panorama DeskMini Desk DeskPro BoardPro BoardProG2

Requires user role: ADMIN, INTEGRATOR

Define the microphone mute behavior on the device.

Default value:

True

Value space:

True/InCallOnly

True: Muting of audio is always available. In general, the microphone mute LED will not be lit outside of call, but you can still mute using the API commands.

InCallOnly: Muting of audio is only available when the device is in a call. When Idle, it is not possible to mute the microphone. This is useful when an external telephone service/audio system is connected via the device and is to be available when the device is not in a call. When set to InCallOnly this will prevent the audio-system from being muted by mistake.

Audio Microphones NearTalkerSector Mode

Applies to: RoomBarPro BoardPro BoardProG2

Requires user role: ADMIN, INTEGRATOR

The device's internal microphone array consists of two major parts: A near talker sector, covering up to about 1.5 m from the device; and three beams that cover up to about 4 m from the device.

This setting is about activating and using the near talker sector.

Default value:

Off [RoomBarPro]

On [BoardPro BoardProG2]

Value space:

Off/On

Off: The near talker sector microphone is deactivated; hence audio from this microphone will not be included when making the final audio mix from the room.

On: The near talker sector microphone is available; which means that audio picked up from this microphone may be included when making the final audio mix from the room, provided that the following requirement is met: People are detected speaking in the near talker sector.

Board

Audio Microphones PhantomPower

Applies to: RoomKit RoomBarPro RoomKitEQX CodecEQ CodecPlus Room55 Room70/Room55D BoardPro BoardProG2

Requires user role: ADMIN

Define whether or not to have phantom power (11 V +/- 1 V) on the microphone inputs.

Default value:

On

Value space:

Off/On

Off: Disable the phantom power on the microphone inputs. Use this when connecting to equipment that do not need phantom power, such as external mixers.

On: Enable the phantom power on the microphone inputs. Use this when connecting directly to microphones that require phantom power, including the Cisco Table Microphone and Cisco Ceiling Microphone.

Audio Microphones UsbPassthrough MuteButton

Applies to: RoomKitMini RoomBar RoomBarPro RoomKitEQX CodecEQ DeskMini Desk DeskPro BoardPro BoardProG2

Requires user role: ADMIN, INTEGRATOR

When using the Call from laptop feature (that is, a laptop meeting app is using the device's camera, microphones, or loudspeakers), people can always mute their sound from the meeting app. Use this setting to configure whether to also allow muting from external microphones and the device itself as well. It is of course a prerequisite that people set up their meeting app to use the device's microphones instead of the laptop microphone.

Be aware that the device and microphones are not synchronized with the meeting app regarding mute. Therefore, the mute indicators in the room and in the meeting app don't always reflect the true mute state.

Default value:

Active [RoomKitMini RoomBar RoomBarPro RoomKitEQX CodecEQ BoardPro BoardProG2]

Inactive [DeskMini Desk DeskPro]

Value space:

Active/Inactive

Active: People can mute their audio using the buttons on the device and microphones.

Inactive: People can't mute from the device and microphones. Physical buttons are disabled, and there is no mute button on the user interface.

Audio Microphones VoiceActivityDetector Mode

Applies to: All products

Requires user role: ADMIN, INTEGRATOR

The device can detect whether the picked-up audio signal is voice or just background noise or other sounds.

Whether voice is picked up or not is reported in the Audio Microphones VoiceActivityDetector Activity status. This may be useful for example if you want to make a macro that reports if voice is detected in a meeting area.

Default value:

Off

Value space:

Off/On

Off: Don't check whether the picked up audio signal is voices.

On: Check if the picked up audio signal is voices, and report it in the corresponding status

Audio Output ARC [n] Delay DelayMs

Applies to: RoomKitEQX CodecEQ CodecPro Room70G2 RoomPanorama/Room70Panorama

Requires user role: ADMIN, INTEGRATOR

To obtain lip-synchronization, you can configure each ARC output with an extra delay that compensates for delay in other connected devices, for example TVs and external loudspeakers. The delay that you set here is either fixed or relative to the delay measured on or reported by an external monitor, as defined in the Audio Output ARC [n] Delay Mode setting.

Default value:

0

Value space:

Integer (0..290)

The delay in milliseconds.

n: Unique ID that identifies the audio ARC output.

Range: 1..1

Board

BoardPro,
BoardPro
G2

Codec EQ

Codec
PlusCodec
ProDesk,
DeskPro,
DeskMiniRoom Bar
Pro,
Room BarRoom Kit,
Room Kit
MiniRoom Kit
EQX

Room 55

Room 55
Dual,
Room 70Room 70
G2Room 70
PanoramaRoom
Panorama

Audio Output ARC [n] Delay Mode

Applies to: RoomKitEQX CodecEQ CodecPro Room70G2 RoomPanorama/Room70Panorama

Requires user role: ADMIN, INTEGRATOR

You may add extra delay to an audio ARC output with the Audio Output ARC [n] Delay DelayMs setting. The extra delay added is either a fixed number of milliseconds, or a number of milliseconds relative to the detected delay on or reported by an external monitor.

Default value:

RelativeToHDMI [RoomKitEQX CodecEQ CodecPro]

Fixed [Room70G2 RoomPanorama/Room70Panorama]

Value space:

Fixed/RelativeToHDMI

Fixed: Any extra delay (DelayMs) added to the output, will be a fixed number of millisecond.

RelativeToHDMI: Any extra delay (DelayMs) added to the output, will be relative to the detected delay on or reported by an external monitor. The actual delay is detected-delay + DelayMs. The Audio Output Connectors ARC [n] DelayMs status reports the actual delay.

n: Unique ID that identifies the audio ARC output.

Range: 1..1

Audio Output ARC [n] Mode

Applies to: RoomKitEQX CodecEQ CodecPro Room70G2 RoomPanorama/Room70Panorama

Requires user role: ADMIN, INTEGRATOR

Choose whether or not to enable the audio return channel (ARC) on the HDMI [n] input connector. The ARC output must be enabled if you want audio playback through the Quad Camera.

On Room 70 G2, the Quad Camera is a part of the integrated loudspeaker system. We recommend to leave the ARC output enabled. If you want to disable the complete integrated loudspeaker system, use the Audio Output InternalSpeaker Mode setting.

Default value:

On

Value space:

Off/On

Off: Disable the ARC output on the HDMI input.

On: Enable the ARC output on the HDMI input.

n: Unique ID that identifies the audio ARC output.

Range: 1..1

Audio Output ConnectorSetup

Applies to: CodecPro Room70G2 RoomPanorama/Room70Panorama

Requires user role: ADMIN, INTEGRATOR

You can choose whether to set up the audio inputs and outputs manually, or to let the video device do it automatically based on the type of camera you have and which screens are connected.

In Auto mode, you cannot add, update, delete or connect audio inputs and outputs manually. Therefore the following API commands do not have any effect: xCommand Audio Setup *, xCommand Audio LocalInput *, and xCommand Audio LocalOutput *.

When going from Manual to Auto mode: The existing Audio setup is cleared (xCommand Audio Setup Clear), and the input and output groups are set up according to product defaults. The Audio Output HDMI [n] Mode and Audio Output ARC [1] Mode settings are set to their default value. For Codec Pro automatic delay measurement is enabled.

When going from Auto to Manual mode: The HDMI and ARC output connectors are connected to the main output group. The Audio Output HDMI [n] Mode and Audio Output ARC [1] Mode settings are not changed. If microphone passthrough is enabled for Codec Pro or Room 70 G2, it will be disconnected. For Codec Pro delay measurement is stopped.

Default value:

Auto

Value space:

Auto/Manual

Auto: For Codec Pro, the video device will play audio either through the camera, or through a screen that is connected to one of the HDMI outputs. The video device chooses to play the audio on the first available device in the following list:

1. A Quad Camera that has camera control connected to one of the camera control connectors of the video device, and HDMI connected to the camera input of the video device (HDMI 1 input). Additionally, the Audio Output ARC [1] Mode and Video Input Connector [1] CEC Mode settings must be On. The audio return channel (ARC) on the HDMI 1 input is used to play audio through the camera.
2. A screen that is connected to the HDMI 1 output, provided that the Audio Output HDMI [1] Mode setting is On.
3. A screen that is connected to the HDMI 2 output, provided that the Audio Output HDMI [2] Mode setting is On.
4. A screen that is connected to the HDMI 3 output, provided that the Audio Output HDMI [3] Mode setting is On.

When audio is played out through the Quad Camera, the video device will measure the delay between a screen and the camera, so that it can synchronize the audio on the camera with the video on screen (lip-synchronization). In order to measure the delay, the video device sends a signal to the screen, and the screen sends the signal back to the video device using the audio return channel. The first screen in the list above that supports CEC (Consumer Electronics Control), and has the Video Output Connector [n] CEC Mode set to On, is used for the delay measurements.

When audio is played out through a screen, additional lip-synchronization delay is the responsibility of the screen. The video device will not add any delay.

D15503.06

RoomOS

11.24

02-2025



Board

BoardPro,
BoardPro
G2

Codec EQ

Codec
PlusCodec
ProDesk,
DeskPro,
DeskMiniRoom Bar
Pro,
Room BarRoom Kit,
Room Kit
MiniRoom Kit
EQX

Room 55

Room 55
Dual,
Room 70Room 70
G2Room 70
PanoramaRoom
Panorama

For Room 70 G2, the video device will play audio through its integrated loudspeaker system, provided that Audio Output ARC [1] Mode and Audio Output InternalSpeaker Mode is On, and Audio Output HDMI [n] Mode is On for the integrated screen(s). Automatic delay measurement is not necessary, because the relationship between the integrated loudspeaker system and screen(s) is known.

Manual: You must set up the audio inputs and outputs manually using the Audio Console application or the API (xCommand Audio LocalInput *, and xCommand Audio LocalOutput *).

For Room 70 G2, external screen(s) may be used for audio output if the connectors are explicitly added using the Audio Console application or the API (xCommand Audio LocalOutput *). In that case, the external screens will play a stereo down mix of the audio that is played on the built-in loudspeaker system. Ultrasound signals will not play through external screens or line outputs; only through the integrated loudspeaker system.

Audio Output Ethernet[n] Delay DelayMs

Applies to: RoomKitEQX CodecEQ CodecPro Room70G2 RoomPanorama/Room70Panorama

Requires user role: ADMIN, INTEGRATOR

To obtain lip-synchronization, you can configure each Ethernet output with an extra delay that compensates for delay in other connected devices, for example TVs and external loudspeakers. The delay that you set here is either fixed or relative to the delay measured on or reported by an external monitor, as defined in the Audio Output Ethernet [n] Delay Mode setting.

Default value:

0

Value space:

Integer (0..290)

The delay in milliseconds.

n: Unique ID that identifies the Ethernet connection.

Range: 1..4 [CodecPro Room70G2 RoomPanorama/Room70Panorama]

Range: Without AVIntegrator option: 1..2 With AVIntegrator option: 1..4 [RoomKitEQX]

Range: Without AVIntegrator option: 1..1 With AVIntegrator option: 1..4 [CodecEQ]

Audio Output Ethernet[n] Delay Mode

Applies to: RoomKitEQX CodecEQ CodecPro Room70G2 RoomPanorama/Room70Panorama

Requires user role: ADMIN, INTEGRATOR

You may add extra delay to an audio Ethernet output with the Audio Output Ethernet [n] Delay DelayMs setting. The extra delay added is either a fixed number of milliseconds, or a number of milliseconds relative to the detected delay on the HDMI output (typically introduced by the connected TV).

Default value:

RelativeToHDMI

Value space:

Fixed/RelativeToHDMI

Fixed: Any extra delay (DelayMs) added to the output, will be a fixed number of millisecond.

RelativeToHDMI: Any extra delay (DelayMs) added to the output, will be relative to the detected delay on the HDMI output. The actual delay is detected-delay + DelayMs. The Audio Output Connectors Ethernet [n] DelayMs status reports the actual delay.

n: Unique ID that identifies the Ethernet connection.

Range: 1..4 [CodecPro Room70G2 RoomPanorama/Room70Panorama]

Range: Without AVIntegrator option: 1..2 With AVIntegrator option: 1..4 [RoomKitEQX]

Range: Without AVIntegrator option: 1..1 With AVIntegrator option: 1..4 [CodecEQ]

Board

BoardPro,
BoardPro
G2

Codec EQ

Codec
PlusCodec
ProDesk,
DeskPro,
DeskMiniRoom Bar
Pro,
Room BarRoom Kit,
Room Kit
MiniRoom Kit
EQX

Room 55

Room 55
Dual,
Room 70Room 70
G2Room 70
PanoramaRoom
Panorama

Audio Output Ethernet [n] Mode

Applies to: RoomBarPro RoomKitEQX CodecEQ CodecPro Room70G2 RoomPanorama/Room70Panorama BoardPro BoardProG2

Requires user role: ADMIN, INTEGRATOR

Ethernet [1]: The reference signal, which is required for acoustic echo cancelling (AEC), is sent from the codec to all connected digital microphones (Cisco Table Microphone Pro / Cisco Microphone Array) on this connection. If disabled, AEC will not work.

Ethernet [2]: This connection is used by Room Kit EQX and Room Panorama for the audio output from the codec to the DNAM IV amplifier.

Other Ethernet [n]: The connection is used for audio output from the codec to third-party audio peripherals, such as loudspeakers, that support the AES67 standard.

We recommend you use the embedded Room Kit EQX and Room Panorama audio systems, which requires this setting to be On. If you switch it Off, the internal loudspeakers will not be used, and you need to connect external loudspeakers to the codec.

Default value:

On

Value space:

Off/On

Off: The Ethernet connection is disabled.

On: The Ethernet connection is enabled.

n: Unique ID that identifies the Ethernet connection.

Range: 1..4 [[CodecPro](#) [Room70G2](#) [RoomPanorama/Room70Panorama](#)]

Range: Without AVIntegrator option: 1..2 With AVIntegrator option: 1..4 [[RoomKitEQX](#)]

Range: Without AVIntegrator option: 1..1 With AVIntegrator option: 1..4 [[RoomBarPro](#) [CodecEQ](#)]

Range: 1..1 [[BoardPro](#) [BoardProG2](#)]

Audio Output HDMI [n] Delay DelayMs

Applies to: RoomKitEQX CodecEQ CodecPro

Requires user role: ADMIN, INTEGRATOR

To obtain lip-synchronization, you can configure each HDMI output with an extra delay that compensates for delay in other connected devices, for example TVs and external loudspeakers. The delay that you set here is either fixed or relative to the delay measured on or reported by an external monitor, as defined in the Audio Output HDMI [n] Delay Mode setting.

Default value:

0

Value space:

Integer (0..290)

The delay in milliseconds.

n: Unique ID that identifies the audio line output.

Range: 1..3

Audio Output HDMI [n] Delay Mode

Applies to: RoomKitEQX CodecEQ CodecPro

Requires user role: ADMIN, INTEGRATOR

You may add extra delay to an audio HDMI output with the Audio Output HDMI [n] Delay DelayMs setting. The extra delay added is either a fixed number of milliseconds, or a number of milliseconds relative to the detected delay on the HDMI output (typically introduced by the connected TV).

Default value:

Fixed

Value space:

Fixed/RelativeToHDMI

Fixed: Any extra delay (DelayMs) added to the output, will be a fixed number of millisecond.

RelativeToHDMI: Any extra delay (DelayMs) added to the output, will be relative to the detected delay on the HDMI output. The actual delay is detected-delay + DelayMs. The Audio Output Connectors HDMI [n] DelayMs status reports the actual delay.

n: Unique ID that identifies the audio line output.

Range: 1..3

Board

Audio Output HDMI [n] Level

Applies to: Room70G2 RoomPanorama/Room70Panorama

Requires user role: ADMIN, INTEGRATOR

Set the gain on the HDMI input connector. The gain can be tuned in steps of 1 dB.

Default value:

0

Value space:

Integer (-24..0)

Range: Select the gain in decibel (dB).

n: Unique ID that identifies the HDMI output.

Range: 1..3 [Room70G2]

Range: For Room Panorama: 3..3; For Room 70 Panorama: 1..3 [RoomPanorama/Room70Panorama]

Audio Output HDMI [n] Gain

Applies to: RoomKitEQX CodecEQ

Requires user role: ADMIN, INTEGRATOR

Set the gain on the HDMI input connector. The gain can be tuned in steps of 1 dB.

Default value:

0

Value space:

Integer (-24..0)

Range: Select the gain in decibel (dB).

n: Unique ID that identifies the HDMI output.

Range: 1..3

Audio Output HDMI [n] Mode

Applies to: RoomKitEQX CodecEQ CodecPlus CodecPro Room70G2 RoomPanorama/Room70Panorama

Requires user role: ADMIN, INTEGRATOR

Define if the audio channel on this HDMI output connector shall be enabled.

Default value:

Room 70 Dual G2: HDMI 1,2: On HDMI 3: Off

Room 70 Single G2: HDMI 1: On HDMI 2,3: Off [Room70G2]

Room 70 Panorama: HDMI 1,2: On HDMI 3: Off

Room Panorama: Off [RoomPanorama/Room70Panorama]

On [CodecEQ CodecPlus CodecPro]

Off [RoomKitEQX]

Value space:

Off/On

Off: The connector will not be used for audio out.

On: The connector can be used for audio out. For Codec Pro and Room 70 G2 it depends on the Audio Output ConnectorSetup setting, and for Codec EQ and Room Kit EQX it depends on the Audio ConnectorSetup setting.

n: Unique ID that identifies the HDMI output.

Range: 1..1 [CodecPlus]

Range: 1..3 [RoomKitEQX CodecEQ CodecPro Room70G2]

Range: For Room Panorama: 3..3; For Room 70 Panorama: 1..3 [RoomPanorama/Room70Panorama]

BoardPro,
BoardPro
G2

Codec EQ

Codec
PlusCodec
ProDesk,
DeskPro,
DeskMiniRoom Bar
Pro,
Room BarRoom Kit,
Room Kit
MiniRoom Kit
EQX

Room 55

Room 55
Dual,
Room 70Room 70
G2Room 70
PanoramaRoom
Panorama

Board

BoardPro,
BoardPro
G2

Codec EQ

Codec
PlusCodec
ProDesk,
DeskPro,
DeskMiniRoom Bar
Pro,
Room BarRoom Kit,
Room Kit
MiniRoom Kit
EQX

Room 55

Room 55
Dual,
Room 70Room 70
G2Room 70
PanoramaRoom
Panorama

Audio Output InternalSpeaker Mode

Applies to: RoomKit RoomBarPro RoomKitEQX CodecPlus Room55 Room70/Room55D Room70G2 RoomPanorama/Room70Panorama DeskMini Desk DeskPro BoardPro BoardProG2

Requires user role: ADMIN, INTEGRATOR

Define whether or not to use the device's integrated speakers.

Codec Plus must be connected to a Quad Camera for this setting to apply.

For Room Kit EQX, Room 70 G2, Room 70 Panorama, and Room Panorama, the Audio Output HDMI [n] Mode settings for the integrated screens(s) must be set to On in order to play any audio on the integrated speakers. Also, the Audio Output ARC 1 Mode setting must be On.

For all products except Codec Plus, you can limit the use of the integrated speakers to play only ultrasound.

Default value:

On

Value space:

Off/On/UltrasoundOnly [RoomKit RoomBarPro RoomKitEQX Room55 Room70/Room55D Room70G2 RoomPanorama/Room70Panorama DeskMini Desk DeskPro BoardPro BoardProG2]

Off/On [CodecPlus]

Off: Disable the device's integrated speakers.

On: Enable the device's integrated speakers.

UltrasoundOnly: Enable the device's integrated speakers only for ultrasound.

Audio Output Line [n] Channel

Applies to: CodecPro Room70G2 RoomPanorama/Room70Panorama

Requires user role: ADMIN, INTEGRATOR

Define whether the Audio Line output is a mono signal or part of a multichannel signal.

Default value:

Line 1,3,5: Left Line 2,4,6: Right [CodecPro Room70G2]

Room Panorama: Line 1,3,5: Left Line 2,4,6: Right

Room 70 Panorama: Line 1,2: Mono Line 3,5: Left Line 4,6: Right [RoomPanorama/Room70Panorama]

Value space:

Left/Mono/Right

Left: The Audio Line output signal is the left channel of a stereo signal.

Mono: The Audio Line output signal is a mono signal.

Right: The Audio Line output signal is the right channel of a stereo signal.

n: Unique ID that identifies the audio line output.

Range: 1..6

Audio Output Line [n] Delay DelayMs

Applies to: RoomKitEQX CodecEQ CodecPro Room70G2 RoomPanorama/Room70Panorama

Requires user role: ADMIN, INTEGRATOR

To obtain lip-synchronization, you can configure each audio line output with an extra delay that compensates for delay in other connected devices, for example TVs and external loudspeakers. The delay that you set here is either fixed or relative to the delay on the HDMI output, as defined in the Audio Output Line [n] Delay Mode setting.

Default value:

0

Value space:

Integer (0..290)

The delay in milliseconds.

n: Unique ID that identifies the audio line output.

Range: 1..6 [CodecPro Room70G2 RoomPanorama/Room70Panorama]

Range: 1..1 [RoomKitEQX CodecEQ]

Audio Output Line [n] Delay Mode

Applies to: RoomKitEQX CodecEQ CodecPro Room70G2 RoomPanorama/Room70Panorama

Requires user role: ADMIN, INTEGRATOR

You may add extra delay to an audio line output with the Audio Output Line [n] Delay DelayMs setting. The extra delay added is either a fixed number of milliseconds, or a number of milliseconds relative to the detected delay on the HDMI output (typically introduced by the connected TV).

Default value:

Fixed [Room70G2 RoomPanorama/Room70Panorama]

RelativeToHDMI [RoomKitEQX CodecEQ CodecPro]

Value space:

Fixed/RelativeToHDMI

Fixed: Any extra delay (DelayMs) added to the output, will be a fixed number of millisecond.

RelativeToHDMI: Any extra delay (DelayMs) added to the output, will be relative to the detected delay on the HDMI output. The actual delay is HDMI-delay + DelayMs. The Audio Output Connectors Line [n] DelayMs status reports the actual delay.

n: Unique ID that identifies the audio line output.

Range: 1..6 [CodecPro Room70G2 RoomPanorama/Room70Panorama]

Range: 1..1 [RoomKitEQX CodecEQ]

Board

BoardPro,
BoardPro
G2

Codec EQ

Codec
PlusCodec
ProDesk,
DeskPro,
DeskMiniRoom Bar
Pro,
Room BarRoom Kit,
Room Kit
MiniRoom Kit
EQX

Room 55

Room 55
Dual,
Room 70Room 70
G2Room 70
PanoramaRoom
Panorama

Audio Output Line [n] Equalizer ID

Applies to: RoomKitEQX CodecEQ CodecPro Room70G2 RoomPanorama/Room70Panorama

Requires user role: ADMIN, INTEGRATOR

Select which equalizer preset to apply to this output.
Codec EQ, Room Kit EQX: AVIntegrator option required.

Default value:

1

Value space:

Integer (1..8)

The equalizer preset number.

n: Unique ID that identifies the audio line output.

Range: 1..6 [*CodecPro Room70G2 RoomPanorama/Room70Panorama*]

Range: 1..1 [*RoomKitEQX CodecEQ*]

Audio Output Line [n] Equalizer Mode

Applies to: RoomKitEQX CodecEQ CodecPro Room70G2 RoomPanorama/Room70Panorama

Requires user role: ADMIN, INTEGRATOR

Enable or disable the equalizer processing for this output.
Codec EQ, Room Kit EQX: AVIntegrator option required.

Default value:

Off

Value space:

Off/On

Off: Do not apply equalization processing.

On: Apply equalization processing.

n: Unique ID that identifies the audio line output.

Range: 1..6 [*CodecPro Room70G2 RoomPanorama/Room70Panorama*]

Range: 1..1 [*RoomKitEQX CodecEQ*]

Audio Output Line [n] Level

Applies to: CodecPro Room70/Room55D Room70G2 RoomPanorama/Room70Panorama

Requires user role: ADMIN, INTEGRATOR

Set the gain on the Line output connector. The gain should be adjusted to fit the audio input level of the connected device. The gain can be tuned in steps of 1 dB.

The maximum output level with 0 dB gain differs depending on the product: 8 dBu (Room 70, Room 55 Dual), 18 dBu (Codec Pro, Room 70 G2).

Example: If the audio device that is connected to a Codec Pro has max input level 10 dBu, then you should set the gain to 10 dBu - 18 dBu = -8 dB.

Default value:

-4 [*CodecPro Room70G2 RoomPanorama/Room70Panorama*]

0 [*Room70/Room55D*]

Value space:

Integer (-24..0)

Range: Select the gain in decibel (dB).

n: Unique ID that identifies the audio line output.

Range: 1..6 [*CodecPro Room70G2 RoomPanorama/Room70Panorama*]

Range: 1..1 [*Room70/Room55D*]

Audio Output Line [n] Gain

Applies to: RoomKitEQX CodecEQ

Requires user role: ADMIN, INTEGRATOR

Set the gain on the Line output connector. The gain should be adjusted to fit the audio input level of the connected device. The gain can be tuned in steps of 1 dB.

The maximum output level with 0 dB gain is 8 dBu.

Example: If the connected audio device has max input level 4 dBu, then you should set the gain to 4 dBu - 8 dBu = -4 dB.

Default value:

0

Value space:

Integer (-24..0)

Range: Select the gain in decibel (dB).

n: Unique ID that identifies the audio line output.

Range: 1..1

Board

Audio Output Line [n] Mode

Applies to: [RoomKit](#) [RoomBarPro](#) [RoomKitEQX](#) [CodecEQ](#) [CodecPlus](#) [CodecPro](#) [Room55](#) [Room70/Room55D](#) [Room70G2](#) [RoomPanorama/Room70Panorama](#) [BoardPro](#) [BoardProG2](#)

Requires user role: ADMIN, INTEGRATOR

Define the mode for the audio line output.

Default value:

On

Value space:

Off/On

Off: Disable the audio line output.

On: Enable the audio line output.

n: Unique ID that identifies the audio line output.

Range: 1..6 [[CodecPro](#) [Room70G2](#) [RoomPanorama/Room70Panorama](#)]

Range: 1..1 [[RoomKit](#) [RoomBarPro](#) [RoomKitEQX](#) [CodecEQ](#) [CodecPlus](#) [Room55](#) [Room70/Room55D](#) [BoardPro](#) [BoardProG2](#)]

BoardPro,
BoardPro
G2

Codec EQ

Codec
PlusCodec
ProDesk,
DeskPro,
DeskMiniRoom Bar
Pro,
Room BarRoom Kit,
Room Kit
MiniRoom Kit
EQX

Room 55

Room 55
Dual,
Room 70Room 70
G2Room 70
PanoramaRoom
Panorama

Audio Output Line [n] OutputType

Applies to: [RoomKit](#) [RoomBarPro](#) [RoomKitEQX](#) [CodecEQ](#) [CodecPlus](#) [Room55](#) [Room70/Room55D](#) [BoardPro](#) [BoardProG2](#)

Requires user role: ADMIN, INTEGRATOR

The output type should be set to match the connected device.

Codec EQ and Room Kit EQX with AVIntegrator option: Not applicable.

Default value:

Loudspeaker [[RoomKit](#) [RoomBarPro](#) [RoomKitEQX](#) [CodecEQ](#) [CodecPlus](#) [Room55](#) [BoardPro](#) [BoardProG2](#)]

LineOut [[Room70/Room55D](#)]

Value space:

LineOut/Loudspeaker/Microphone/Recorder/Subwoofer [[RoomKit](#)]

LineOut/Loudspeaker/Microphone/Recorder [[RoomBarPro](#) [RoomKitEQX](#) [CodecEQ](#) [CodecPlus](#) [Room55](#) [Room70/Room55D](#) [BoardPro](#) [BoardProG2](#)]

Loudspeaker: Use Loudspeaker if a loudspeaker is connected to the line output. In this mode, the output level on that connector follows the master volume control and the output signal includes all system sounds (ringtones, Webex assistant, etc.).

Microphone: In this mode, the sound picked up by the connected microphones will be sent to the line output. System sounds and sounds from far-end sources are not included.

Recorder: Use Recorder if a recorder is connected to the line output. In this mode, the output level is fixed and system sounds are not included. The sound from local presentation sources, the local microphones, and any far end sources are included.

Subwoofer: Use Subwoofer if a subwoofer is connected to the line output. In this mode, the bass is sent to line output and the rest of the audio range is played on the internal speaker.

LineOut: Use LineOut for other devices. In this mode, the output level is fixed and system sounds are not included. The sound from local presentation sources and far end sources are included.

n: Unique ID that identifies the audio line output.

Range: 1..1

Board

Audio Output USBC [n] Mode

Applies to: RoomKitEQX CodecEQ

Requires user role: ADMIN, INTEGRATOR

Disable or enable audio output from the USB-C connector.

Default value:

On

Value space:

Off/On

Off: Disable audio output from the USB-C connector.

On: Enable audio output from the USB-C connector.

n: Unique ID that identifies the USB-C connector.

Range: 1..1

Board Pro,
Board Pro
G2

Codec EQ

Codec
PlusCodec
ProDesk,
Desk Pro,
Desk MiniRoom Bar
Pro,
Room BarRoom Kit,
Room Kit
MiniRoom Kit
EQX

Room 55

Room 55
Dual,
Room 70Room 70
G2Room 70
PanoramaRoom
Panorama

Audio Output USBInterface [n] Mode

Applies to: RoomKitEQX CodecEQ CodecPlus CodecPro Room70/Room55D Room70G2 RoomPanorama/Room70Panorama

Requires user role: ADMIN, INTEGRATOR

Disable or enable audio output from the USB connector.

Default value:

On

Value space:

Off/On

Off: Disable audio output from the USB connector.

On: Enable audio output from the USB connector.

n: Unique ID that identifies the USB interface.

Range: 1..1

Audio Panning Mode

Applies to: RoomBar RoomBarPro Room55 Room70/Room55D Room70G2 RoomPanorama/Room70Panorama DeskMini Desk DeskPro Board BoardPro BoardProG2

Requires user role: ADMIN

In scenarios where the device knows where in the video stream layout the person speaking is located, the device can playback audio on the loudspeakers closest to that location. You will also get a similar effect when using a headset. This is referred to as directional audio. For example, if the person speaking is placed to the left in the layout, audio will come from the left loudspeaker.

Headsets are further addressed in the Audio Panning HeadsetAnalog (only Desk Pro) and Audio Panning HeadsetUSB (only Board Pro, Board Pro G2, and Desk Series devices) settings.

This setting is not available for the first generation of Board (non S-series).

Default value:

Auto

Value space:

Auto/Off

Auto: Use directional audio when it is available.

Off: Disable directional audio for loudspeakers and headsets.

Audio Panning HeadsetAnalog BinauralProcessing

Applies to: DeskPro

Requires user role: ADMIN

Disable or enable binaural processing of audio for an analog headset. This is the audio processing technique that achieves natural sounding directional audio.

Default value:

True

Value space:

False/True

False: Do not perform binaural processing, but normal panning, with simple volume difference on left and right ear.

True: Perform binaural processing on the audio.

Board

BoardPro,
BoardPro
G2

Codec EQ

Codec
PlusCodec
ProDesk,
DeskPro,
DeskMiniRoom Bar
Pro,
Room BarRoom Kit,
Room Kit
MiniRoom Kit
EQX

Room 55

Room 55
Dual,
Room 70Room 70
G2Room 70
PanoramaRoom
Panorama

Audio Panning HeadsetAnalog Mode

Applies to: DeskPro

Requires user role: ADMIN

Disable or enable audio panning to provide directional audio for an analog headset. If directional audio is turned off overall with the Audio Panning Mode setting, you will never get directional audio for the headset even if Audio Panning HeadsetAnalog Mode is set to Auto.

Default value:

Auto

Value space:

Auto/Off

Auto: Use directional audio when it is available.

Off: Disable directional audio for analog headsets.

Audio Panning HeadsetUSB BinauralProcessing

Applies to: DeskMini Desk DeskPro

Requires user role: ADMIN

Disable or enable binaural processing of audio for a USB headset. This is the audio processing technique that achieves natural sounding directional audio.

Default value:

False

Value space:

False/True

False: Do not perform binaural processing, but normal panning, with simple volume difference on left and right ear.

True: Perform binaural processing on the audio.

Audio Panning HeadsetUSB Mode

Applies to: DeskMini Desk DeskPro

Requires user role: ADMIN

Disable or enable audio panning to provide directional audio for a USB headset. If directional audio is turned off overall with the Audio Panning Mode setting, you will never get directional audio for the headset even if Audio Panning HeadsetUSB Mode is set to Auto.

Default value:

Auto

Value space:

Auto/Off

Auto: Use directional audio when it is available.

Off: Disable directional audio for USB headsets.

Audio Placement

Applies to: RoomBarPro BoardPro BoardProG2

Requires user role: ADMIN

Define the mounting configuration of the device. Based on this setting, the loudspeaker system is configured to optimize sound quality.

Default value:

Freestanding

Value space:

Freestanding/Wallmount

Freestanding: The device is mounted with free space behind it. For Board Pro and Board Pro G2, this means that the device is mounted using its floor stand or wheelbase kits.

Wallmount: The device is mounted close to a wall. For Board Pro and Board Pro G2, this means that the device is mounted using its wall mount kit.

Board

Audio SoundsAndAlerts RingTone

Applies to: All products

Requires user role: ADMIN, INTEGRATOR, USER

Define which ringtone to use for incoming calls.

Default value:

Sunrise BoardPro BoardProG2

Value space:

Sunrise/Mischief/Ripples/Reflections/Vibes/Delight/Evolve/Playful/Ascent/Calculation/
Mellow/Ringer

Select a ringtone from the list.

BoardPro,
BoardPro
G2

Codec EQ

Codec
PlusCodec
ProDesk,
DeskPro,
DeskMiniRoom Bar
Pro,
Room BarRoom Kit,
Room Kit
MiniRoom Kit
EQX

Room 55

Room 55
Dual,
Room 70Room 70
G2Room 70
PanoramaRoom
Panorama

Audio SoundsAndAlerts RingVolume

Applies to: All products

Requires user role: ADMIN, INTEGRATOR, USER

Define the ring volume for incoming calls.

Default value:

50

Value space:

Integer (0..100)

Range: The value goes in steps of 5 from 0 to 100 (from -34.5 dB to 15 dB). Volume
0 = Off.

Audio Ultrasound MaxVolume

Applies to: All products

Requires user role: ADMIN, INTEGRATOR

This setting applies to the Proximity feature. Set the maximum volume of the ultrasound pairing messages.

The Audio Ultrasound MaxVolume and Proximity Mode settings only affect ultrasound pairing messages. See the RoomAnalytics PeoplePresenceDetector and Standby WakeupOnMotionDetection settings for information about the use of ultrasound in presence and motion detection.

Default value:

70

Value space:

Integer (0..90) [RoomKitEQX CodecEQ CodecPlus CodecPro]

Integer (0..70) [RoomKit RoomKitMini RoomBar RoomBarPro Room55 Room70/Room55D Room70G2
RoomPanorama/Room70Panorama DeskMini Desk DeskPro Board BoardPro BoardProG2]

Select a value in the specified range. If set to 0, ultrasound pairing messages are not emitted.

Board

BoardPro,
BoardPro
G2

Codec EQ

Codec
PlusCodec
ProDesk,
Desk Pro,
Desk MiniRoom Bar
Pro,
Room BarRoom Kit,
Room Kit
MiniRoom Kit
EQX

Room 55

Room 55
Dual,
Room 70Room 70
G2Room 70
PanoramaRoom
Panorama

Audio USB Mode

Applies to: RoomKit RoomKitMini RoomBar RoomBarPro Room55 DeskMini Desk DeskPro BoardPro BoardProG2

Requires user role: ADMIN, INTEGRATOR

Enable or disable the audio channels on the USB connector.

Default value:

SpeakerAndMicrophone

Value space:

AdditionalSpeaker/Microphone/Off/Speaker/SpeakerAndMicrophone [*RoomKit RoomBarPro Room55 DeskMini Desk DeskPro BoardPro BoardProG2*]

AdditionalMicrophone/AdditionalSpeaker/Microphone/Off/Speaker/
SpeakerAndMicrophone [*RoomKitMini RoomBar*]

AdditionalMicrophone: Both the video device's built-in microphone and an external audio input device (USB microphone) will be used. The USB audio output channel is disabled.

AdditionalSpeaker: Both the video device's built-in loudspeakers and the USB audio output device will be used. The USB audio input channel is disabled.

A loudspeaker that is connected to USB may have higher latency than the internal loudspeaker of the device. This can cause strange audio artefacts if you use both loudspeakers simultaneously.

A typical use case for AdditionalSpeaker is to support hearing aids/assisted listening devices (ALD) on video devices without an analog audio output. The difference in latency is less likely to cause issues in such set-ups.

Microphone: Only the external USB microphone will be used; other microphones are disabled. The USB audio output channel is also disabled.

Off: No audio will flow over USB but signaling is still enabled. This allows for using a USB device as a mute or volume controller.

Speaker: The USB audio output channel will be connected (speaker). Other speakers are disabled. The USB audio input channel is also disabled.

SpeakerAndMicrophone: Both the input (microphone) and output (speaker) channels of a USB audio device will be connected. Other microphones and speakers are disabled.

Audio USB VolumeControl Capture Mode

Applies to: All products

Requires user role: ADMIN, USER

This setting applies when a USB capture device (e.g. a USB microphone) is connected to the video device.

If the USB device has an internal trim setting, you can request the USB device to trim the audio signal level before sending it to the video device. Use the Audio USB VolumeControl Capture Value setting to set how much gain/attenuation to apply.

Default value:

Bypass

Value space:

Active/Bypass

Active: Allow the video device to request the USB device to trim its output level before sending the audio signal.

Bypass: Don't adjust the volume output from the USB device before sending it to the video device.

Audio USB VolumeControl Capture Value

Applies to: All products

Requires user role: ADMIN, USER

This setting applies if the Audio USB VolumeControl Capture Mode is set to Active.

This is the gain that the video device requests the USB capture device to apply before sending the audio signal to the video device.

The actual range that the USB device offers can be found in the Audio USB VolumeControl Capture Max and Audio USB VolumeControl Capture Min statuses. If the requested volume value is outside this range, the closest allowed value will be used. The Audio USB VolumeControl Capture Value status always returns the actual gain applied.

Note that the USB device may apply a gain as default. Since the Audio USB VolumeControl Capture Value status always returns the actual gain applied, you may want to check this status before you decide on which gain to request. Example: If you want to request a 6 dB increase to the current level, and the default gain already applied by the USB device is 42 dB, you must set the Audio USB VolumeControl Capture Value setting to 48, that is 42+6 dB.

Default value:

0

Value space:

Integer (-100..100)

The gain to request in dB.

Board

BoardPro,
BoardPro
G2

Codec EQ

Codec
PlusCodec
ProDesk,
DeskPro,
DeskMiniRoom Bar
Pro,
Room BarRoom Kit,
Room Kit
MiniRoom Kit
EQX

Room 55

Room 55
Dual,
Room 70Room 70
G2Room 70
PanoramaRoom
Panorama

Audio USB VolumeControl Playback Mode

Applies to: All products

Requires user role: ADMIN, USER

This setting applies when a USB playback device (e.g. a USB loudspeaker) is connected to the video device.

If the USB device has an internal trim setting, you can request the USB device to trim the audio signal level it receives from the video device before any further processing. Use the Audio USB VolumeControl Playback Value setting to set how much gain/attenuation to apply.

Default value:

Bypass

Value space:

Active/Bypass

Active: Allow the video device to request the USB device to trim the input level before further processing.

Bypass: Don't adjust the volume input to the USB device before further processing.

Audio USB VolumeControl Playback Value

Applies to: All products

Requires user role: ADMIN, USER

This setting applies if the Audio USB VolumeControl Playback Mode is set to Active.

This is the gain that the video device requests the USB capture device to apply after receiving the audio signal from the video device.

The actual range that the USB device offers can be found in the Audio USB VolumeControl Playback Max and Audio USB VolumeControl Playback Min statuses. If the requested volume value is outside this range, the closest allowed value will be used. The Audio USB VolumeControl Playback Value status always returns the actual gain applied.

Note that the USB device may apply a gain as default. Since the Audio USB VolumeControl Playback Value status always returns the actual gain applied, you may want to check this status before you decide on which gain to request. Example: If you want to request a 6 dB increase to the current level, and the default gain already applied by the USB device is 42 dB, you must set the Audio USB VolumeControl Playback Value setting to 48, that is 42+6 dB.

Default value:

0

Value space:

Integer (-100..100)

The gain to request in dB.

Bluetooth settings

Bluetooth Allowed

Applies to: RoomBar RoomBarPro DeskMini Desk DeskPro BoardPro BoardProG2

Requires user role: ADMIN

The device has a built-in Bluetooth® module. As a default, the user can turn it on or off using the user interface. With this setting, the administrator can disable Bluetooth configuration, so that it cannot be set up from the user interface.

Default value:

True

Value space:

False/True

False: Bluetooth is switched off by the administrator, and the user cannot turn it on from the user interface.

True: Bluetooth is allowed. The user can turn it on or off from the user interface.

Bluetooth Enabled

Applies to: RoomBar RoomBarPro DeskMini Desk DeskPro BoardPro BoardProG2

Requires user role: ADMIN

Provided that Bluetooth® connections are allowed (see the Bluetooth Allowed setting), you can use this setting to enable and disable Bluetooth. The video device supports the HFP (Hands-Free Profile) and A2DP (Advanced Audio Distribution Profile) profiles. Headsets that only supports A2DP cannot be used.

Default value:

False

Value space:

False/True

False: Bluetooth is disabled, and no Bluetooth devices can pair with the video device.

True: Bluetooth is enabled, and you can pair and use a Bluetooth headset.

Board

BoardPro,
BoardPro
G2

Codec EQ

Codec
PlusCodec
ProDesk,
DeskPro,
DeskMiniRoom Bar
Pro,
Room BarRoom Kit,
Room Kit
MiniRoom Kit
EQX

Room 55

Room 55
Dual,
Room 70Room 70
G2Room 70
PanoramaRoom
Panorama

Bookings settings

Bookings AdHocBooking BookAhead Enabled

Applies to: All products

Requires user role: ADMIN

Book Ahead allows users to schedule shared spaces for future times. With Book Ahead enabled, users can book rooms for times later in the day, even if the space is currently booked, through a controller, board, or scheduler.

Default value:

False

Value space:

False/True

False: Book ahead is not available.

True: Book ahead is available.

Bookings AdhocBooking BookingTimeout

Applies to: All products

Requires user role: ADMIN

For ad hoc bookings, we need to wait a certain time to make sure it has been confirmed from the backend. This setting is useful for hybrid calendar situations where it might take a long time to get such confirmation of the booking. The booking shows up when you book ad hoc, but it might get removed if the backend (exchange, google calendar, etc.) does not confirm it in time. This setting determines how long we wait before removing it.

Default value:

60

Value space:

Integer (60..300)

The number of seconds to wait before removing an ad hoc booking, if not confirmed from the backend.

Bookings AdhocBooking Enabled

Applies to: All products

Requires user role: ADMIN

The ad hoc booking feature allows you to book a room directly from the navigator that is in or by the meeting room. You can also extend an ongoing meeting if the room is still available. You can also use the Webex Assistant (voice-driven virtual assistant) to book or extend a meeting.

Ad-hoc booking is provided by the on-device calendar or the selected calendar provider in Control Hub.

Default value:

False

Value space:

False/True

False: The ad hoc booking feature is not available.

True: The ad hoc booking feature is available

Bookings AllowDecline

Applies to: All products

Requires user role: ADMIN

Configures if you can decline a meeting and where you can decline it from; either using the dropdown in calendar list to remove it, or from the checkout button. Example: From controller inside the room, or from the scheduler on the wall outside the room, or no ability.

Default value:

All

Value space:

All/InsideOnly/None

All: You can decline a meeting from navigators both inside and outside the room.

InsideOnly: You can decline a meeting from navigators inside the room.

None: You cannot decline a meeting from a navigator (neither controllers nor schedulers).

Board

Bookings CheckIn Enabled

Applies to: All products

Requires user role: ADMIN

In a significant percentage of meetings no one shows up and the meeting resources are wasted during the booking. Enabling the check in option helps alleviate this problem. The users can check in to their booking when they arrive to the meeting room which confirms the booking. If no one arrives for the booking, the meeting room can be released, and others can book the free meeting room.

The check in option is available on shared bookable devices and standalone Room Navigator.

Default value:

False

Value space:

False/True

False: The check in option is not available.

True: The check in option is available.

Bookings CheckIn WindowDuration

Applies to: All products

Requires user role: ADMIN

This setting is relevant only if the check in option is enabled (see the Bookings CheckIn Enabled setting).

A check in button appears on the touch panels some minutes before a booking starts. Use this setting to define for how long after the booking start the user can check in. If no one checks in during this period, manually or automatically, the room is automatically released, and the organizer gets an email informing about the cancellation.

The room device will automatically check in for: ad hoc bookings, when joining a call, when a sharing session has started (wired or wireless), or people count is 1 or more.

Default value:

10

Value space:

5/10/15/20/30/60

The time the check in option is available (in minutes) before the room booking is released

Bookings DeclinableBookingType

Applies to: All products

Requires user role: ADMIN

This configuration allows you to control the type of meetings that can be declined on the device. Options include restricting declines to all meetings or only ad-hoc meetings. This is used with the AllowDecline configuration.

This setting does not affect the CheckIn feature.

Default value:

AdhocOnly

Value space:

AdhocOnly/All

All: All types of meetings can be declined.

Adhoc: Only ad-hoc meetings can be declined.

Bookings MaxDuration

Applies to: All products

Requires user role: ADMIN

You can set the maximum duration allowed for ad hoc room booking and hot desking. For example, if set to 2 (hours), the time selector will only give you the next two hours for a max duration of your booking.

Default value:

0

Value space:

Integer (0..24)

Maximum booking duration (in hours)

Board

Bookings ProtocolPriority

Applies to: All products

Requires user role: ADMIN

Video devices can join Microsoft Teams meetings either using SIP via a Cloud Video Interop (CVI) gateway, which is a service that is provided in the Webex cloud, or by running the Microsoft Teams meeting web app (WebRTC).

Joining Microsoft Teams meetings relies on a calendar service and is available for devices that are registered to an on-premises service and linked to Webex Edge for Devices, and for devices that are registered to the Webex cloud service.

Default value:

Auto

Value space:

Auto/WebRTC

Auto: The device will join the Microsoft Teams meeting via SIP/CVI if there is a CVI address in the meeting invite. Otherwise it will use WebRTC.

WebRTC: The device will always use WebRTC for Microsoft Teams meetings.

BoardPro,
BoardPro
G2

Codec EQ

Codec
PlusCodec
ProDesk,
DeskPro,
DeskMiniRoom Bar
Pro,
Room BarRoom Kit,
Room Kit
MiniRoom Kit
EQX

Room 55

Room 55
Dual,
Room 70Room 70
G2Room 70
PanoramaRoom
Panorama

BYOD settings

BYOD HidForwarding Enabled

Applies to: DeskPro

Requires user role: ADMIN, INTEGRATOR

If you use an external mouse or keyboard for your laptop (wired USB or USB dongle), you can connect them to the video device's USB port instead of directly to the laptop.

Default value:

False

Value space:

False/True

False: You must connect the external mouse or keyboard directly to your laptop.

True: You can connect the external mouse or keyboard for your laptop to the video device.

BYOD QRCodePairing

Applies to: DeskMini Desk DeskPro Board BoardPro BoardProG2

Requires user role: ADMIN

Controls if users can use a QR code to pair their mobile phone and the video device through the Webex app. When enabled, the user just scans the QR code that is displayed on the device's screen and waits for the pairing process to complete.

This setting applies only to devices that are set up for Hot desking, which implies that they must be in shared mode and registered to the Webex cloud service or linked to Webex Edge for Devices.

Default value:

Enabled

Value space:

Disabled/Enabled

Enabled: There is a QR code on the device's screen, and users can scan it to sign in on the device.

Disabled: There is no QR code on the device. Users must sign in another way (USB-C).

Board

BYOD TouchForwarding Enabled

Applies to: DeskPro Board

Requires user role: ADMIN, INTEGRATOR

Use this setting to enable or disable the touch redirect feature. Touch redirect enables you to control your laptop from the touch screen of the board or video device. You must connect the laptop to the device with an HDMI cable (wired sharing) and a USB-C cable. You can use either a USB-C to USB-C cable or a USB-C to USB-A cable from the device to the laptop.

This feature is not available on the first generation of boards (Board 55 and 70).

Default value:

True

Value space:

False/True

False: Touch redirect is disabled.

True: Touch redirect is enabled.

BoardPro,
BoardPro
G2

Codec EQ

Codec
PlusCodec
ProDesk,
DeskPro,
DeskMiniRoom Bar
Pro,
Room BarRoom Kit,
Room Kit
MiniRoom Kit
EQX

Room 55

Room 55
Dual,
Room 70Room 70
G2Room 70
PanoramaRoom
Panorama

CallHistory settings

CallHistory Mode

Applies to: All products

Requires user role: ADMIN, INTEGRATOR

Specify whether or not information about calls that are placed or received are stored, including missed calls and calls that are not answered (call history). This determines whether or not the calls appear in the Recents list on the user interfaces.

Default value:

On

Value space:

Off/On

Off: New entries are not added to the call history.

On: New entries are stored in the call history list.

CallHistory Recents DisplayName

Applies to: All products

Requires user role: ADMIN

You can choose to hide meeting titles from the Recents list. This list is available when tapping the Call button on the UI, and in the Call page on the device web interface. This setting is neither supported on shared mode devices where hotdesking is enabled nor on personal mode devices.

Default value:

Auto

Value space:

Auto/Hidden

Auto: Keep meeting titles in the Recents list.

Hidden: Don't show meeting titles in the Recents list.

Board

BoardPro,
BoardPro
G2

Codec EQ

Codec
PlusCodec
ProDesk,
DeskPro,
DeskMiniRoom Bar
Pro,
Room BarRoom Kit,
Room Kit
MiniRoom Kit
EQX

Room 55

Room 55
Dual,
Room 70Room 70
G2Room 70
PanoramaRoom
Panorama

Cameras settings

Cameras Background Enabled

Applies to: DeskMini Desk DeskPro

Requires user role: ADMIN, USER

Enable or disable the Camera Background feature.

The Camera Background feature allows for a virtual background (images or effects) to be shown as the background in the camera view, instead of the real surroundings. This configuration must be enabled to allow the Cameras Background Set command to take effect.

Default value:

True

Value space:

False/True

True: Enable the Camera Background feature.

False: Disable the Camera Background feature.

Cameras Background UserImagesAllowed

Applies to: DeskMini Desk DeskPro

Requires user role: ADMIN

Enable or disable the ability for users to use custom images as virtual background during meetings or calls.

The Cameras Background Enabled setting must also be enabled for this feature to be accessible.

Default value:

False

Value space:

False/True

True: Enable the use of custom images as virtual backgrounds.

False: Disable the use of custom images as virtual backgrounds.

Cameras Camera [n] AssignedSerialNumber

Applies to: RoomBarPro RoomKitEQX CodecEQ CodecPlus CodecPro Room70/Room55D Room70G2 RoomPanorama/Room70Panorama BoardPro BoardProG2

Requires user role: ADMIN, INTEGRATOR

The camera ID is the number n in Camera [n]. By default, the camera ID is assigned automatically to a camera. If EDID information is not passed on from the camera to the video device, the camera ID is not persistent after a reboot. This means that a camera may get a new camera ID when the video device is restarted.

You should use the Cameras Camera AssignedSerialNumber setting to cater for configurations where the video device does not receive EDID information from multiple cameras. This setting allows you to manually assign a camera ID to a camera by associating the camera ID with the camera's serial number. The setting is persistent until the video device is factory reset.

A typical situation where the video device doesn't receive EDID information is when using an HDMI repeater that doesn't pass on such information.

Default value:

""

Value space:

String (0, 20)

The camera's serial number.

n: Unique ID that identifies the camera.

Range: 1..7 [RoomBarPro RoomKitEQX CodecEQ CodecPlus CodecPro Room70/Room55D Room70G2 RoomPanorama/Room70Panorama]

Range: 2..7 [BoardPro BoardProG2]

Board

Cameras Camera [n] Backlight DefaultMode

Applies to: RoomBarPro RoomKitEQX CodecEQ CodecPlus CodecPro Room70/Room55D Room70G2 RoomPanorama/Room70Panorama BoardPro BoardProG2

Requires user role: ADMIN, INTEGRATOR

Turn backlight compensation on or off. Backlight compensation is useful when there is much light behind the persons in the room. Without compensation the persons may appear very dark to the far end.

This setting is not applicable for the integrated camera of Bar Pro, Board Pro, and Board Pro G2. If the Cameras Camera Brightness Algorithm is not set to Average, neither is it applicable to the Quad camera and the integrated camera of Room 55 Dual, Room 70, Room 70 G2, Room 70 Panorama, or Room Panorama. These cameras automatically adjust themselves based on the room lighting conditions.

Default value:

Off

Value space:

Off/On

Off: Turn off the camera backlight compensation.

On: Turn on the camera backlight compensation.

n: Unique ID that identifies the camera.

Range: 1..7 [RoomBarPro RoomKitEQX CodecEQ CodecPlus CodecPro Room70/Room55D Room70G2 RoomPanorama/Room70Panorama]

Range: 2..7 [BoardPro BoardProG2]

BoardPro
BoardPro
G2

Codec EQ

Codec
PlusCodec
ProDesk,
DeskPro,
DeskMiniRoom Bar
Pro,
Room BarRoom Kit,
Room Kit
MiniRoom Kit
EQX

Room 55

Room 55
Dual,
Room 70Room 70
G2Room 70
PanoramaRoom
Panorama

Cameras Camera [n] Brightness Algorithm

Applies to: RoomBarPro RoomKitEQX CodecEQ CodecPlus CodecPro Room70/Room55D Room70G2 RoomPanorama/Room70Panorama BoardPro BoardProG2

Requires user role: ADMIN, INTEGRATOR

Specify the camera brightness algorithm.

Default value:

Auto

Value space:

Auto/Average/FaceOptimized

Auto: The camera brightness algorithm is automatically set by the device.

Average: The traditional brightness algorithm is applied. This uses the entire image area to calculate brightness.

FaceOptimized: Brightness is calculated by weighing the areas where people are detected. This includes automatic backlight compensation.

n: Unique ID that identifies the camera.

Range: 1..7 [RoomBarPro RoomKitEQX CodecEQ CodecPlus CodecPro Room70/Room55D Room70G2 RoomPanorama/Room70Panorama]

Range: 2..7 [BoardPro BoardProG2]

Cameras Camera [n] Brightness DefaultLevel

Applies to: RoomKit RoomKitMini RoomBar RoomBarPro RoomKitEQX CodecEQ CodecPlus CodecPro Room55 Room70/Room55D Room70G2 RoomPanorama/Room70Panorama DeskMini Desk DeskPro BoardPro BoardProG2

Requires user role: ADMIN, INTEGRATOR

Set the brightness level. Requires the Cameras Camera Brightness Mode to be Manual.

Default value:

20

Value space:

Integer (1..31)

The brightness level. The higher the number, the brighter the image.

n: Unique ID that identifies the camera.

Range: 1..1 [RoomKit RoomKitMini RoomBar Room55 DeskMini Desk DeskPro]

Range: 1..7 [RoomBarPro RoomKitEQX CodecEQ CodecPlus CodecPro Room70/Room55D Room70G2 RoomPanorama/Room70Panorama BoardPro BoardProG2]

Board

BoardPro,
BoardPro
G2

Codec EQ

Codec
PlusCodec
ProDesk,
DeskPro,
DeskMiniRoom Bar
Pro,
Room BarRoom Kit,
Room Kit
MiniRoom Kit
EQX

Room 55

Room 55
Dual,
Room 70Room 70
G2Room 70
PanoramaRoom
Panorama

Cameras Camera [n] Brightness Mode

Applies to: RoomKit RoomKitMini RoomBar RoomBarPro RoomKitEQX CodecEQ CodecPlus CodecPro Room55 Room70/Room55D Room70G2 RoomPanorama/Room70Panorama DeskMini Desk DeskPro BoardPro BoardProG2

Requires user role: ADMIN, INTEGRATOR

When the Brightness Mode is set to Auto the brightness is set and continuously adjusted by the device based on the current lighting conditions. There is no auto-adjustment in Manual mode, and the brightness level is manually set using the Cameras Camera Brightness DefaultLevel setting.

Default value:

Auto

Value space:

Auto/Manual

Auto: The camera brightness is automatically adjusted by the device. The Cameras Camera Brightness DefaultLevel setting has no effect.

Manual: Enable manual control of the camera brightness level. The brightness level is set using the Cameras Camera Brightness DefaultLevel setting.

n: Unique ID that identifies the camera.

Range: 1..1 [RoomKit RoomKitMini RoomBar Room55 DeskMini Desk DeskPro]

Range: 1..7 [RoomBarPro RoomKitEQX CodecEQ CodecPlus CodecPro Room70/Room55D Room70G2 RoomPanorama/Room70Panorama BoardPro BoardProG2]

Cameras Camera [n] ExcludedArea

Applies to: RoomKit RoomKitMini RoomBar RoomBarPro RoomKitEQX CodecEQ CodecPlus CodecPro Room55 Room70/Room55D Room70G2 RoomPanorama/Room70Panorama DeskMini Desk DeskPro BoardPro BoardProG2

Requires user role: ADMIN, INTEGRATOR

When set, this configuration instructs the Multi Camera Director to ignore faces that appear in selected areas of a camera's field of view.

The format is a list of polygons separated by semicolons. Each polygon is defined by 3 or more coordinate pairs, separated by commas.

The coordinates are spherical and expressed in hundredths of degrees. For example, "0,0" would indicate a ray pointing straight out of the camera.

"100,100" would indicate a ray pointing one degree to the left and one degree up from the camera. For a motorized camera, the coordinate system

is relative to the neutral position of the camera, and does not change when the camera moves.

For multi camera setups it is useful to note that the exclusion zones are defined per camera.

Example:

"1000,500, 500,500, 500,-500, 1000,500; -2000,-1000, -2500,-1000, -2500,-1500, -2000,-1500"

This defines two exclusion zones:

- The first is from (10°,5°) to (5°,-5°).
- The second is from (-20°,-10°) to (-25°,-15°)

Default value:

""

Value space:

String (0, 255)

n: Unique ID that identifies the camera.

Range: 1..1 [RoomKit RoomKitMini RoomBar Room55 DeskMini Desk DeskPro]

Range: 1..7 [RoomBarPro RoomKitEQX CodecEQ CodecPlus CodecPro Room70/Room55D Room70G2 RoomPanorama/Room70Panorama BoardPro BoardProG2]

Board

Cameras Camera [n] Flip

Applies to: RoomBarPro RoomKitEQX CodecEQ CodecPlus CodecPro Room70/Room55D Room70G2 RoomPanorama/Room70Panorama BoardPro BoardProG2

Requires user role: ADMIN, INTEGRATOR

With Flip mode (vertical flip), you can flip the image upside down. Flipping applies both to the self-view and the video that is transmitted to the far end.

This setting is not supported by the Quad Camera, the PTZ-12 camera, or the integrated camera of Board Pro, Board Pro G2, Room 55 Dual, Room 70, Room 70 G2, Room 70 Panorama, or Room Panorama.

Default value:

Auto

Value space:

Auto/Off/On

Auto: If the camera detects that it is mounted upside down, the image is automatically flipped. If the camera cannot auto-detect whether it is mounted upside down or not, the image is not changed. As an example, the Sony PTZ 4K camera cannot auto-detect that it's upside down. If you mount it upside down, you must set this parameter to On.

Off: Display the image on screen the normal way.

On: Display the image flipped upside down. This setting is used when a camera is mounted upside down, but cannot automatically detect which way it is mounted.

n: Unique ID that identifies the camera.

Range: 1..7 [*RoomBarPro RoomKitEQX CodecEQ CodecPlus CodecPro Room70/Room55D Room70G2 RoomPanorama/Room70Panorama*]

Range: 2..7 [*BoardPro BoardProG2*]

Cameras Camera [n] Focus Mode

Applies to: RoomBarPro RoomKitEQX CodecEQ CodecPlus CodecPro Room70/Room55D Room70G2 RoomPanorama/Room70Panorama BoardPro BoardProG2

Requires user role: ADMIN, INTEGRATOR

Define the camera focus mode.

Default value:

Auto

Value space:

Auto/AutoLimited/Manual [*CodecPlus CodecPro*]

Auto/Manual [*RoomBarPro RoomKitEQX CodecEQ Room70/Room55D Room70G2 RoomPanorama/Room70Panorama BoardPro BoardProG2*]

Auto: The auto focus works differently for different products. For the integrated cameras of Bar Pro, Board Pro, Board Pro G2, Room 55 Dual, Room 70, Room 70 G2, Room 70 Panorama, Room Panorama, and when using the Quad Camera with a codec (Codec EQ, Codec Plus, or Codec Pro), the camera will do single shot auto focusing once a call is connected, and when the view has changed.

When using a Precision 60 or PTZ 4K camera, the camera will do continuous auto focusing. It will run auto focus once a call is connected, after pan, tilt, or zoom, and generally when the camera identifies a change in the scene.

AutoLimited: This mode only applies when using a Precision 60 camera with a Codec Plus or Codec Pro. In most cases this mode will operate the same way as auto focus. In some cases, auto-limited will reduce the focus hunting that may occur.

Problematic scenes have large areas with no or low contrast (for example, a painted wall with no details or a partly empty whiteboard). There's a slightly higher chance of background focus with this mode, compared to auto focus.

Manual: Turn the auto focus off and adjust the camera focus manually.

n: Unique ID that identifies the camera.

Range: 1..7 [*RoomBarPro RoomKitEQX CodecEQ CodecPlus CodecPro Room70/Room55D Room70G2 RoomPanorama/Room70Panorama*]

Range: 2..7 [*BoardPro BoardProG2*]

Board Pro,
Board Pro
G2

Codec EQ

Codec
PlusCodec
ProDesk,
Desk Pro,
Desk MiniRoom Bar
Pro,
Room BarRoom Kit,
Room Kit
MiniRoom Kit
EQX

Room 55

Room 55
Dual,
Room 70Room 70
G2Room 70
PanoramaRoom
Panorama

Board

Cameras Camera [n] Gamma Level

Applies to: RoomBarPro RoomKitEQX CodecEQ CodecPlus CodecPro Room70/Room55D Room70G2 RoomPanorama/Room70Panorama BoardPro BoardProG2

Requires user role: ADMIN, INTEGRATOR

By setting the Gamma Level you can select which gamma correction table to use. This setting may be useful in difficult lighting conditions, where changes to the brightness setting does not provide satisfactory results. Requires the Cameras Camera [n] Gamma Mode to be set to Manual.

This setting is not applicable for the Quad Camera or the integrated cameras of Bar Pro, Board Pro, Board Pro G2, Room 55 Dual, Room 70, Room 70 G2, Room 70 Panorama, and Room Panorama. These cameras automatically adjust themselves based on the room lighting conditions. Also, this feature is not supported by the PTZ 4K camera or the PTZ-12 camera.

Default value:

0

Value space:

Integer (0..7) [*BoardPro BoardProG2*]

Integer (0..14) [*RoomBarPro RoomKitEQX CodecEQ CodecPlus CodecPro Room70/Room55D Room70G2 RoomPanorama/Room70Panorama*]

Define the gamma level.

n: Unique ID that identifies the camera.

Range: 1..7 [*RoomBarPro RoomKitEQX CodecEQ CodecPlus CodecPro Room70/Room55D Room70G2 RoomPanorama/Room70Panorama*]

Range: 2..7 [*BoardPro BoardProG2*]

BoardPro
BoardPro
G2

Codec EQ

Codec
PlusCodec
ProDesk,
DeskPro,
DeskMiniRoom Bar
Pro,
Room BarRoom Kit,
Room Kit
MiniRoom Kit
EQX

Room 55

Room 55
Dual,
Room 70Room 70
G2Room 70
PanoramaRoom
Panorama

Cameras Camera [n] Gamma Mode

Applies to: RoomBarPro RoomKitEQX CodecEQ CodecPlus CodecPro Room70/Room55D Room70G2 RoomPanorama/Room70Panorama BoardPro BoardProG2

Requires user role: ADMIN, INTEGRATOR

This setting enables gamma corrections. Gamma describes the nonlinear relationship between image pixels and monitor brightness.

This setting is not applicable for the Quad Camera or the integrated cameras of Bar Pro, Board Pro, Board Pro G2, Room 55 Dual, Room 70, Room 70 G2, Room 70 Panorama, and Room Panorama. These cameras automatically adjust themselves based on the room lighting conditions. Also, this feature is not supported by the PTZ 4K camera or the PTZ-12 camera.

Default value:

Auto

Value space:

Auto/Manual

Auto: Auto is the default and the recommended setting.

Manual: In manual mode the gamma value is changed with the gamma level setting, ref. Cameras Camera [n] Gamma Level.

n: Unique ID that identifies the camera.

Range: 1..7 [*RoomBarPro RoomKitEQX CodecEQ CodecPlus CodecPro Room70/Room55D Room70G2 RoomPanorama/Room70Panorama*]

Range: 2..7 [*BoardPro BoardProG2*]

Board

BoardPro,
BoardPro
G2

Codec EQ

Codec
PlusCodec
ProDesk,
DeskPro,
DeskMiniRoom Bar
Pro,
Room BarRoom Kit,
Room Kit
MiniRoom Kit
EQX

Room 55

Room 55
Dual,
Room 70Room 70
G2Room 70
PanoramaRoom
Panorama

Cameras Camera [n] IrCutFilter Mode

Applies to: RoomBarPro RoomKitEQX CodecEQ CodecPlus CodecPro Room70/Room55D Room70G2 RoomPanorama/Room70Panorama BoardPro BoardProG2

Requires user role: ADMIN, INTEGRATOR

This setting applies only to the PTZ 4K camera and will not have any effect on other cameras.

The IR cut filter (infrared cut-off filter) blocks near-infrared wavelengths while passing visible light. In regular lighting conditions, the filter should be on (Day mode) to avoid unwanted side-effects caused by infrared light. However, if you want the camera to capture images in the dark, the filter should be off (Night mode) so that infrared light can be utilized.

Default value:

Day

Value space:

Auto/Day/Night

Auto: The device switches between Day and Night mode automatically based on changes in brightness. Refer to the IrCutFilter Threshold setting how to control when to switch between the two modes.

Day: The IR cut filter is on.

Night: The IR cut filter is off.

n: Unique ID that identifies the camera.

Range: 1..7 [RoomBarPro RoomKitEQX CodecEQ CodecPlus CodecPro Room70/Room55D Room70G2 RoomPanorama/Room70Panorama]

Range: 2..7 [BoardPro BoardProG2]

Cameras Camera [n] IrCutFilter Threshold

Applies to: RoomBarPro RoomKitEQX CodecEQ CodecPlus CodecPro Room70/Room55D Room70G2 RoomPanorama/Room70Panorama BoardPro BoardProG2

Requires user role: ADMIN, INTEGRATOR

This setting has an effect only when Cameras Camera [n] IrCutFilter Mode is set to Auto, that is, when the camera is set to switch between Day and Night mode automatically. The higher the threshold value, the more light is required to trigger a switch to Day mode.

Default value:

14

Value space:

Integer (0..255)

The higher the number, the more ambient light is required to switch to Day mode.

n: Unique ID that identifies the camera.

Range: 1..7 [RoomBarPro RoomKitEQX CodecEQ CodecPlus CodecPro Room70/Room55D Room70G2 RoomPanorama/Room70Panorama]

Range: 2..7 [BoardPro BoardProG2]

Cameras Camera [n] Mirror

Applies to: RoomBarPro RoomKitEQX CodecEQ CodecPlus CodecPro Room70/Room55D Room70G2 RoomPanorama/Room70Panorama BoardPro BoardProG2

Requires user role: ADMIN, INTEGRATOR

With Mirror mode (horizontal flip) you can mirror the image on screen. Mirroring applies both to the self-view and the video that is transmitted to the far end. Mirroring is automatically disabled when speaker tracking is on.

This setting is only applicable when using a Precision 60 camera. However, the PTZ 4K camera automatically mirrors the image when the Cameras Camera [n] Flip setting is On.

Default value:

Auto

Value space:

Auto/Off/On

Auto: If the camera detects that it is mounted upside down, the image is automatically mirrored. If the camera cannot auto-detect whether it is mounted upside down or not, the image is not changed.

Off: Display the image as other people see you.

On: Display the image as you see yourself in a mirror.

n: Unique ID that identifies the camera.

Range: 1..7 [RoomBarPro RoomKitEQX CodecEQ CodecPlus CodecPro Room70/Room55D Room70G2 RoomPanorama/Room70Panorama]

Range: 2..7 [BoardPro BoardProG2]

Board

Cameras Camera [n] PtzAutoFraming

Applies to: RoomKitEQX CodecEQ CodecPlus CodecPro Room70/Room55D Room70G2 RoomPanorama/Room70Panorama

Requires user role: ADMIN, USER

Enables the PTZ AutoFraming feature of the Sony SRG-A40 and SRG-A12.

Default value:

On

Value space:

Off/On

Off: Disables the AutoFraming feature.

On: Enables the AutoFraming feature.

n: Unique ID that identifies the camera.

Range: 1..7

BoardPro,
BoardPro
G2

Codec EQ

Codec
PlusCodec
ProDesk,
DeskPro,
DeskMiniRoom Bar
Pro,
Room BarRoom Kit,
Room Kit
MiniRoom Kit
EQX

Room 55

Room 55
Dual,
Room 70Room 70
G2Room 70
PanoramaRoom
Panorama

Cameras Camera [n] VideoFormat

Applies to: RoomBarPro RoomKitEQX CodecEQ CodecPlus CodecPro Room70/Room55D Room70G2 RoomPanorama/Room70Panorama BoardPro BoardProG2

Requires user role: ADMIN, INTEGRATOR

Sets the camera's output video resolution and framerate.

Default value:

1920_1080_60

Value space:

1920_1080_30/1920_1080_60/3840_2160_30

1920_1080_30: The camera output is 1920x1080 resolution at 30 frames per second.

1920_1080_60: The camera output is 1920x1080 resolution at 60 frames per second.

3840_2160_30: The camera output is 3840x2160 resolution at 30 frames per second (supported only by the PTZ 4K camera).

n: Unique ID that identifies the camera.

Range: 1..7

Cameras Camera [n] Whitebalance Compensation Level

Applies to: RoomBar RoomBarPro BoardPro BoardProG2

Requires user role: ADMIN, INTEGRATOR

Shows the white balance compensation level of the specified camera.

Default value:

0

Value space:

Integer (-3..3)

The white balance compensation level of the camera.

n: Unique ID that identifies the camera.

Range: 1..1

Cameras Camera [n] Standby Mode

Applies to: RoomBarPro RoomKitEQX CodecEQ CodecPlus CodecPro Room70/Room55D Room70G2 RoomPanorama/Room70Panorama BoardPro BoardProG2

Requires user role: ADMIN, INTEGRATOR

Configures the standby mode for the specified camera [n].

Default value:

Enabled

Value space:

Disabled/Enabled

Disabled: When the device enters standby mode, no power-off command is sent to the camera. Upon exiting standby, the camera remains in its previous state without any additional movement, making it immediately available for use.

Enabled: When the device enters standby mode, power-off is sent to the camera. Upon exiting standby, power-on is issued, causing the camera to perform a calibration process. During calibration, the camera pans to its maximum position and then returns to the center, which takes approximately 12 seconds.

n: Unique ID that identifies the camera.

Range: 1..7

Board

BoardPro,
BoardPro
G2

Codec EQ

Codec
PlusCodec
ProDesk,
DeskPro,
DeskMiniRoom Bar
Pro,
Room BarRoom Kit,
Room Kit
MiniRoom Kit
EQX

Room 55

Room 55
Dual,
Room 70Room 70
G2Room 70
PanoramaRoom
Panorama

Cameras Camera [n] Whitebalance Mode

Applies to: RoomBarPro RoomKitEQX CodecEQ CodecPlus CodecPro Room70/Room55D Room70G2 RoomPanorama/Room70Panorama BoardPro BoardProG2

Requires user role: ADMIN, INTEGRATOR

Define the camera white balance mode.

This setting is not applicable for the integrated camera of Bar Pro, Board Pro, and Board Pro G2, which automatically adjusts itself based on the room lighting conditions.

Default value:

Auto

Value space:

Auto/Manual

Auto: The camera will continuously adjust the white balance depending on the camera view.

Manual: Enables manual control of the camera white balance. The white balance level is set using the Cameras Camera Whitebalance Level setting.

n: Unique ID that identifies the camera.

Range: 1..7 [RoomBarPro RoomKitEQX CodecEQ CodecPlus CodecPro Room70/Room55D Room70G2 RoomPanorama/Room70Panorama]

Range: 2..7 [BoardPro BoardProG2]

Cameras Camera [n] Whitebalance Level

Applies to: RoomBarPro RoomKitEQX CodecEQ CodecPlus CodecPro Room70/Room55D Room70G2 RoomPanorama/Room70Panorama BoardPro BoardProG2

Requires user role: ADMIN, INTEGRATOR

Define the white balance level. Requires the Cameras Camera [n] Whitebalance Mode to be set to Manual.

This setting is not applicable for the integrated camera of Bar Pro, Board Pro, and Board Pro G2, which automatically adjusts itself based on the room lighting conditions. Also, this setting has no effect for the PTZ 4K and PTZ-12 cameras, which are using Sony's One Push mode when the Whitebalance Mode is set to manual.

Default value:

1

Value space:

Integer (1..16)

The white balance level.

n: Unique ID that identifies the camera.

Range: 1..7 [RoomBarPro RoomKitEQX CodecEQ CodecPlus CodecPro Room70/Room55D Room70G2 RoomPanorama/Room70Panorama]

Range: 2..7 [BoardPro BoardProG2]

Cameras Camera ColorSaturation Level

Applies to: DeskMini Desk DeskPro

Requires user role: ADMIN, INTEGRATOR

You can change the color saturation in the video sent from the camera. The higher the number the more saturated (intense) are the colors.

Default value:

0

Value space:

Integer (-20..20)

Range: The higher the number the more saturated (intense) are the colors. A value of 0 gives a neutral color saturation level. The most negative value removes all color and leaves you with a greyscale image.

Cameras Camera ExposureCompensation Level

Applies to: DeskMini Desk DeskPro

Requires user role: ADMIN, INTEGRATOR

If you find the camera image always to be too dark (under-exposed) or too bright (over-exposed), you can use this setting to offset the target brightness. The brightness/exposure will continue to be adjusted automatically. This setting has an effect only when the Cameras Camera Brightness Mode is set to Auto.

Default value:

0

Value space:

Integer (-3..3)

A positive number increases brightness in the captured image; a negative number darkens it.

Board

Cameras Camera Framerate

Applies to: RoomKit RoomKitMini Room55

Requires user role: ADMIN

As default, the camera outputs 30 frames per second. This allows for good quality both in close-ups and overview pictures for normal bandwidths and lighting conditions. If the conditions are better, a 60 frames per second output from the camera may give a better overall quality.

Default value:

30

Value space:

30/60

30: The camera outputs 30 frames per second.

60: The camera outputs 60 frames per second.

BoardPro,
BoardPro
G2

Codec EQ

Codec
PlusCodec
ProDesk,
DeskPro,
DeskMiniRoom Bar
Pro,
Room BarRoom Kit,
Room Kit
MiniRoom Kit
EQX

Room 55

Room 55
Dual,
Room 70Room 70
G2Room 70
PanoramaRoom
Panorama

Cameras PowerLine Frequency

Applies to: RoomKit RoomKitMini RoomBar RoomBarPro RoomKitEQX CodecEQ CodecPlus CodecPro Room55 Room70/Room55D Room70G2 RoomPanorama/Room70Panorama DeskMini Desk DeskPro BoardPro BoardProG2

Requires user role: ADMIN, INTEGRATOR

If your camera supports power line frequency anti-flickering, the camera is able to compensate for any flicker noise from the electrical power supply. You should set this camera configuration based on your power line frequency. If your camera supports auto detection of line frequency, you can select the Auto option in the configuration.

The Cisco cameras support both anti-flickering and auto detection of line frequency. Auto is the default value, so you should change this setting if you have a camera that does not support auto detection.

Default value:

Auto

Value space:

50Hz/60Hz/Auto

50Hz: Use this value when the power line frequency is 50 Hz.

60Hz: Use this value when the power line frequency is 60 Hz.

Auto: Allow the camera to detect the power frequency automatically.

Cameras PresenterTrack CameraPosition Pan

Applies to: RoomBarPro RoomKitEQX CodecEQ CodecPlus CodecPro Room70/Room55D Room70G2 BoardPro BoardProG2

Requires user role: ADMIN, INTEGRATOR

Define the pan position that the presenter tracking camera (PTZ 4K or Precision 60 camera) will move to when the feature is activated.

Default value:

0

Value space:

Integer (-65535..65535)

The pan position.

Cameras PresenterTrack CameraPosition Tilt

Applies to: RoomBarPro RoomKitEQX CodecEQ CodecPlus CodecPro Room70/Room55D Room70G2 BoardPro BoardProG2

Requires user role: ADMIN, INTEGRATOR

Define the tilt position that the presenter tracking camera (PTZ 4K or Precision 60 camera) will move to when the feature is activated.

Default value:

0

Value space:

Integer (-65535..65535)

The tilt position.

Cameras PresenterTrack CameraPosition Zoom

Applies to: RoomBarPro RoomKitEQX CodecEQ CodecPlus CodecPro Room70/Room55D Room70G2 BoardPro BoardProG2

Requires user role: ADMIN, INTEGRATOR

Define the zoom position that the presenter tracking camera (PTZ 4K or Precision 60 camera) will move to when the feature is activated.

Default value:

0

Value space:

Integer (-65535..65535)

The zoom position.

Board

Cameras PresenterTrack Connector

Applies to: RoomBarPro RoomKitEQX CodecEQ CodecPlus CodecPro Room70/Room55D Room70G2 BoardPro BoardProG2

Requires user role: ADMIN, INTEGRATOR

Define which video input connector the presenter tracking camera (PTZ 4K or Precision 60 camera) is connected to.

Default value:

- 1 [RoomKitEQX CodecEQ CodecPlus CodecPro Room70/Room55D Room70G2]
- 3 [BoardPro BoardProG2]
- 2 [RoomBarPro]

Value space:

- Integer (1..6) [RoomKitEQX CodecEQ CodecPro Room70G2]
 - Integer (1..3) [CodecPlus Room70/Room55D]
 - Integer (3..3) [BoardPro BoardProG2]
 - Integer (2..2) [RoomBarPro]
- The video input connector.

Cameras PresenterTrack Enabled

Applies to: RoomBarPro RoomKitEQX CodecEQ CodecPlus CodecPro Room70/Room55D Room70G2 BoardPro BoardProG2

Requires user role: ADMIN, INTEGRATOR

Define whether or not the PresenterTrack feature is available for use. The feature requires a PTZ 4K or Precision 60 camera as presenter tracking camera.

Default value:

False

Value space:

- False/True
- False: The PresenterTrack feature is disabled.
- True: The PresenterTrack feature is available for use.

Cameras PresenterTrack PresenterDetectedStatus

Applies to: RoomBarPro RoomKitEQX CodecEQ CodecPlus CodecPro Room70/Room55D Room70G2 BoardPro BoardProG2

Requires user role: ADMIN, INTEGRATOR

Define whether to enable or disable automatic switching between the Remote Presenter and Local Presenter modes in the Briefing room and Classroom scenarios (Room Type templates). Automatic switching implies that the device switches to Local Presenter mode when a person is detected in the PresenterTrack trigger zone, and that the device switches back to the Remote Presenter mode when the local presenter leaves the stage.

If this setting is enabled, the Cameras PresenterTrack PresenterDetected status will be updated when a new person enters the trigger zone.

Only the Precision 60 and PTZ 4K cameras support presenter tracking. Briefing room is not supported by Codec Plus, Room 70, and Room 55 Dual. This setting is not applicable to Board Pro and Board Pro G2, since neither Briefing room nor Classroom is supported.

Default value:

Enabled

Value space:

- Disabled/Enabled
- Disabled: No automatic switching between modes.
- Enabled: Automatic switching between the Local Presenter and Remote Presenter modes.

Cameras PresenterTrack TriggerZone

Applies to: RoomBarPro RoomKitEQX CodecEQ CodecPlus CodecPro Room70/Room55D Room70G2 BoardPro BoardProG2

Requires user role: ADMIN, INTEGRATOR

Define the trigger zone, which corresponds to the area where a person's head must be detected for presenter tracking to start.

The format is a string of x and y coordinate pairs: "x1,y1,...xn,yn", where the range of x is (0,1920) and y is (0,1080). Two coordinate pairs define the upper left and lower right corner of a rectangular trigger zone. More than two coordinate pairs define the vertices of a polygonal trigger zone.

The feature requires a PTZ 4K or Precision 60 camera as presenter tracking camera.

Default value:

""

Value space:

- String (0, 255)
- The coordinates for the trigger zone.

D15503.06

RoomOS
11.24

02-2025



Board

Cameras SpeakerTrack DefaultBehavior

Applies to: All products

Requires user role: ADMIN, USER

The device's automatic framing capabilities depend on the camera. The major framing features are Best overview (the smallest frame that still covers all people in the room); Closeup (zoom in on the active speaker or a group of people close to the speaker); and Frames (composition of closeups of all individuals in the room, and with excess background removed).

Select the cameras default framing mode, which the camera will return to after a call. You can change to another mode from the user interface both in call and out of call.

Default value:

Auto

Value space:

Auto/BestOverview/Closeup/Current/Frames/Manual [[RoomKit](#) [RoomBar](#) [CodecPlus](#) [Room55](#) [Room70/Room55D](#) [Board](#) [BoardPro](#)]

Auto/BestOverview/Closeup/Current/Frames/GroupAndSpeaker/Manual [[RoomBarPro](#) [RoomKitEQX](#) [CodecEQ](#) [CodecPro](#) [Room70G2](#) [RoomPanorama/Room70Panorama](#) [BoardProG2](#)]

Auto/BestOverview/Current/Manual [[DeskMini](#) [Desk](#) [DeskPro](#)]

Auto/BestOverview/Current/Frames/Manual [[RoomKitMini](#)]

BoardPro,
BoardPro
G2

Codec EQ

Codec
PlusCodec
ProDesk,
DeskPro,
DeskMiniRoom Bar
Pro,
Room BarRoom Kit,
Room Kit
MiniRoom Kit
EQX

Room 55

Room 55
Dual,
Room 70Room 70
G2Room 70
PanoramaRoom
Panorama

Cameras SpeakerTrack Frames Mode

Applies to: RoomKit RoomKitMini RoomBar RoomBarPro RoomKitEQX CodecEQ CodecPlus CodecPro Room55 Room70/Room55D Room70G2 RoomPanorama/Room70Panorama Board BoardPro BoardProG2

Requires user role: ADMIN, USER

In Frames camera mode the camera will zoom and show people individually or in smaller groups. These individual and group frames are further composed into one outgoing video stream. In this stream excess background is removed, the people are shown closer to each other, uniform in size, and at the same eye level. The camera supports up to four frames. All the image processing is done on the sender side, so the receiving device doesn't have to support Frames.

Frames mode depends on the speaker tracking functionality; hence also the Cameras SpeakerTrack Mode must be set to Auto for Frames to work.

This feature is not available for Room 70 Panorama and Room Panorama in this software version.

Default value:

Auto

Value space:

Auto/Off

Auto: The user can switch Frames on and off using the camera controls on the device's user interface.

Off: Frames are not available.

Cameras SpeakerTrack GroupAndSpeaker Mode

Applies to: RoomBarPro RoomKitEQX CodecEQ CodecPro Room70G2 BoardProG2

Requires user role: ADMIN, USER

Group and Speaker camera mode sends two views of the meeting room simultaneously to remote meeting participants: a group overview and a close-up of the active speaker. There need to be at least three people in the room for Group and Speaker mode.

Default value:

Auto

Value space:

Auto/Off

Auto: Group and Speaker mode is enabled.

Off: Group and Speaker mode is disabled.

Board

BoardPro,
BoardPro
G2

Codec EQ

Codec
PlusCodec
ProDesk,
DeskPro,
DeskMiniRoom Bar
Pro,
Room BarRoom Kit,
Room Kit
MiniRoom Kit
EQX

Room 55

Room 55
Dual,
Room 70Room 70
G2Room 70
PanoramaRoom
Panorama

Cameras SpeakerTrack HeadDetectorRange

Applies to: RoomKitEQX CodecEQ CodecPlus CodecPro Room70/Room55D Room70G2 RoomPanorama/Room70Panorama

Requires user role: ADMIN, USER

There is a limit how far the head detection algorithm works optimally. In good conditions we recommend keeping the default value. If you experience issues tracking people that are close and toward the sides of the room, consider setting the head detector range to Standard. One side effect of this is that people at far distance, even if centered in the view, may not be detected.

For Codec EQ, Codec Pro, and Codec Plus, this setting applies only when you are using the Quad Camera.

Default value:

Extended

Value space:

Extended/Standard

Extended: The longest range. This applies to a rectangle centered in the camera field-of-view. This rectangle is visualized in the Speakertrack diagnostics view.

Standard: The shortest range.

Cameras SpeakerTrack MeetingZone Area

Applies to: All products

Requires user role: ADMIN, USER

Defines a meeting zone. This is the area that the speaker track and video framing logic use when deciding what to include in the video frame when the Cameras SpeakerTrack MeetingZone Mode setting is set to Auto.

A meeting zone is polygonal, and it is defined by a string of (x,z) coordinate pairs: "x1,z1, x2,z2, ..., xn,zn", where the coordinate pairs define the vertices of the polygon.

When viewing the room from above, the coordinate pair (0,0) represents the position of the camera; (0,z) represents a point z cm from the camera along the center line of its view; and (x,0) represents a point x cm to the side of the camera. Viewed from the room facing the camera, a positive x-value is to the right and a negative x-value is to the left of the camera. Negative z-values are not used; they would be behind the camera.

The easiest way to define a meeting zone may be to use the graphical tool available under Device settings on the touch user interface.

Default value:

""

Value space:

String (0, 255)

The string of coordinate pairs that defines the meeting zone.

Cameras SpeakerTrack MeetingZone Mode

Applies to: All products

Requires user role: ADMIN, USER

The meeting zone feature allows you to limit the area that the speaker track and video framing logic uses when deciding what to include in the video frames. This feature may be useful in open offices, meeting rooms with glass walls, or the like. People outside the defined meeting zone, don't influence the choice of the most suitable video framing.

You can easily define a meeting zone using the touch user interface. Alternatively, you can use the Cameras SpeakerTrack MeetingZone Area setting.

For Codec Plus, Codec Pro, and Codec EQ: The device needs a camera that supports speaker tracking.

Default value:

Off

Value space:

Auto/Off

Auto: As long as a meeting zone is defined, it will be used. If a meeting zone is not defined, the behavior is the same as Off.

Off: The meeting zone feature is not used, regardless of whether a meeting zone is defined or not.

Board

Cameras SpeakerTrack ZoomRange MaxZoomFactor

Applies to: RoomKit RoomKitMini RoomBar RoomBarPro RoomKitEQX CodecEQ CodecPlus CodecPro Room55 Room70/Room55D Room70G2 RoomPanorama/Room70Panorama BoardPro BoardProG2

Requires user role: ADMIN, USER

There is a trade-off between the zoom range and the quality of a maximum zoomed in picture. The longer the range, the lower the quality.

This setting lets you configure the maximum zoom level for the automatic framing features. The setting has no effect on the manual camera control zoom range.

This setting applies for Cisco cameras (external or internal) that support automatic framing features (not supported with SpeakerTrack 60, PTZ 4K, and PTZ-12).

Default value:

Auto

Value space:

2x/3x/4x/5x/Auto [RoomKitMini]

3x/4x/Auto [RoomKitEQX CodecEQ CodecPlus CodecPro Room70/Room55D Room70G2 RoomPanorama/Room70Panorama]

3x/4x/5x/Auto [RoomKit RoomBar RoomBarPro Room55 BoardPro BoardProG2]

2x: Maximum zoom factor for automatic framing features is 2x.

3x: Maximum zoom factor for automatic framing features is 3x.

4x: Maximum zoom factor for automatic framing features is 4x.

5x: Maximum zoom factor for automatic framing features is 5x.

Auto: Our recommended zoom range.

BoardPro,
BoardPro
G2

Codec EQ

Codec
PlusCodec
ProDesk,
DeskPro,
DeskMiniRoom Bar
Pro,
Room BarRoom Kit,
Room Kit
MiniRoom Kit
EQX

Room 55

Room 55
Dual,
Room 70Room 70
G2Room 70
PanoramaRoom
Panorama

Cameras SpeakerTrack Mode

Applies to: All products

Requires user role: ADMIN, INTEGRATOR

This setting applies only when using a camera with support for speaker tracking or best overview.

Quad Camera: Speaker tracking uses automatic camera framing to select the best camera view based on where people are in the room. The Quad Camera uses an audio tracking technique that finds and captures a close-up of the active speaker.

SpeakerTrack 60 Camera: The dual camera assembly consists of two cameras and uses an audio tracking technique that finds and captures a close-up of the active speaker. When a change of speaker is detected, the video device can switch automatically between the two cameras to always show the best camera view. Refer to the Cameras SpeakerTrack TrackingMode setting for different switching modes.

Video devices with a built-in speakertrack camera (Room Kit, Room 55, Room 55 Dual, Room 70, Room 70 G2, Room 70 Panorama, Room Panorama, Board, Board Pro, and Board Pro G2): Speaker tracking uses automatic camera framing to select the best camera view based on where people are in the room. The camera uses an audio tracking technique that finds and captures a close-up of the active speaker.

Video devices with a camera that supports Best overview, but not speaker tracking (Room Kit Mini and Desk series products): Best overview uses automatic camera framing to select the best camera view based on where people are in the room.

Default value:

Auto

Value space:

Auto/Off

Auto: Speaker tracking (not supported on Room Kit Mini or Desk series products) and best overview is switched on. The device will detect people in the room and automatically select the best camera framing. Users can switch the feature on or off instantly in the camera control panel on the touch controller, but the feature is switched back on after each call so that the device is ready for the next user.

Off: Speaker tracking (not supported on Room Kit Mini or Desk series products) and best overview is switched off. If you have a SpeakerTrack 60 Camera assembly the two cameras will operate as individual cameras.

Board

BoardPro,
BoardPro
G2

Codec EQ

Codec
PlusCodec
ProDesk,
DeskPro,
DeskMiniRoom Bar
Pro,
Room BarRoom Kit,
Room Kit
MiniRoom Kit
EQX

Room 55

Room 55
Dual,
Room 70Room 70
G2Room 70
PanoramaRoom
Panorama

Cameras SpeakerTrack Closeup

Applies to: RoomKit RoomBar RoomBarPro RoomKitEQX CodecEQ CodecPlus CodecPro Room55 Room70/Room55D Room70G2 RoomPanorama/Room70Panorama Board BoardPro BoardProG2

Requires user role: ADMIN, INTEGRATOR, USER

Turn on/off the closeup and group framing feature.

This setting applies only when the Cameras SpeakerTrack Mode is set to Auto. When the closeup functionality is turned on, the device will detect that a person is speaking and select the best framing to cover that person. This is called a closeup and may not include all the persons in the room. If you want all the persons in the room to be in the picture at all times you can turn off the closeup functionality.

Default value:

Auto

Value space:

Auto/Off/On

Auto: The behavior depends on the device type. Board 55/55S/70/70S/85S strive to keep everyone in the room in the camera frame at all times, while other devices will zoom in either solely on the active speaker or the active speaker and the participants in close proximity to him/her (group frame).

Off: The device will keep all the persons in the room in the camera framing at all times.

On: The device will zoom in on the active speaker or the group frame.

Cameras SpeakerTrack TrackingMode

Applies to: RoomKitEQX CodecEQ CodecPlus CodecPro

Requires user role: ADMIN, INTEGRATOR

This setting applies only when using a SpeakerTrack 60 camera, and when Cameras SpeakerTrack Mode is set to Auto.

The speaker tracking algorithm can react to changes in two modes, one faster than the other. The mode determines when the camera view will change to a new speaker.

Default value:

Auto

Value space:

Auto/Conservative

Auto: This is the normal tracking mode.

Conservative: The camera view will change to a new speaker later than in normal tracking mode.

Cameras SpeakerTrack ConnectorDetection Mode

Applies to: RoomKitEQX CodecEQ CodecPlus CodecPro

Requires user role: ADMIN, INTEGRATOR

This setting applies only when a SpeakerTrack 60 camera is connected to the video device. Define whether to automatically detect or manually configure which video input each individual camera is connected to. You should choose manual configuration in situations where the video device does not receive EDID information from the cameras. Typically, this will be when you use HDMI repeaters that do not pass on EDID information.

Default value:

Auto

Value space:

Auto/Manual

Auto: Automatically detect which video inputs the cameras are connected to.

Manual: Manually define which video inputs the cameras are connected to. Use the Cameras SpeakerTrack ConnectorDetection CameraLeft and Cameras SpeakerTrack ConnectorDetection CameraRight settings.

Cameras SpeakerTrack ConnectorDetection CameraLeft

Applies to: RoomKitEQX CodecEQ CodecPlus CodecPro

Requires user role: ADMIN, INTEGRATOR

Define the number of the video input that SpeakerTrack 60's left camera is connected to.

This setting applies only when a SpeakerTrack 60 camera is connected to the video device. Furthermore, Cameras SpeakerTrack ConnectorDetection Mode must be set to Manual.

Codec EQ doesn't support the SpeakerTrack 60 camera.

Default value:

1

Value space:

Integer (1..5) [*CodecPro*]

Integer (1..3) [*CodecPlus*]

Set a valid video input number. For example, set to 1 if the left camera is connected to video input 1.

Board

BoardPro,
BoardPro
G2

Codec EQ

Codec
PlusCodec
ProDesk,
DeskPro,
DeskMiniRoom Bar
Pro,
Room BarRoom Kit,
Room Kit
MiniRoom Kit
EQX

Room 55

Room 55
Dual,
Room 70Room 70
G2Room 70
PanoramaRoom
Panorama

Cameras SpeakerTrack ConnectorDetection CameraRight

Applies to: RoomKitEQX CodecEQ CodecPlus CodecPro

Requires user role: ADMIN, INTEGRATOR

Define the number of the video input that SpeakerTrack 60's right camera is connected to. This setting applies only when a SpeakerTrack 60 camera is connected to the video device. Furthermore, Cameras SpeakerTrack ConnectorDetection Mode must be set to Manual.

Codec EQ doesn't support the SpeakerTrack 60 camera.

Default value:

2

Value space:

Integer (1..5) [*CodecPro*]

Integer (1..3) [*CodecPlus*]

Set a valid video input number. For example, set to 2 if the right camera is connected to video input 2.

Cameras SpeakerTrack Whiteboard Mode

Applies to: RoomKit RoomBarPro RoomKitEQX CodecEQ CodecPlus CodecPro Room55 Room70/Room55D Room70G2 RoomPanorama/Room70Panorama

Requires user role: ADMIN, INTEGRATOR, USER

This setting belongs to the Snap to whiteboard feature, which is not supported in this software version.

Conference settings

Conference ActiveControl Mode

Applies to: All products

Requires user role: ADMIN

Active control is a feature that allows conference participants to administer a conference on Cisco TelePresence Server or Cisco Meeting Server using the video device's interfaces. Each user can see the participant list, change video layout, disconnect participants, etc. from the interface. The active control feature is enabled by default, provided that it is supported by the infrastructure (Cisco Unified Communications Manager (CUCM) version 9.1.2 or newer, Cisco TelePresence Video Communication Server (VCS) version X8.1 or newer, Cisco Media Server (CMS) version 2.1 or newer). Change this setting if you want to disable the active control features.

Default value:

Auto

Value space:

Auto/Off

Auto: Active control is enabled when supported by the infrastructure.

Off: Active control is disabled.

Conference AutoAnswer Mode

Applies to: All products

Requires user role: ADMIN

Define the auto answer mode. Use the Conference AutoAnswer Delay setting if you want the device to wait a number of seconds before answering the call, and use the Conference AutoAnswer Mute setting if you want your microphone to be muted when the call is answered.

Default value:

Off

Value space:

Off/On

Off: You can answer incoming calls manually by tapping Answer on the touch controller.

On: The device automatically answers incoming calls, except if you are already in a call. You can answer or decline incoming calls manually when you are already engaged in a call.

Board

Conference AutoAnswer Mute

Applies to: All products

Requires user role: ADMIN

Define if the microphone shall be muted when an incoming call is automatically answered. Requires that AutoAnswer Mode is switched on.

Default value:

Off

Value space:

Off/On

Off: The incoming call will not be muted.

On: The incoming call will be muted when automatically answered.

Conference AutoAnswer Delay

Applies to: All products

Requires user role: ADMIN

Define how long (in seconds) an incoming call has to wait before it is answered automatically by the device. Requires that AutoAnswer Mode is switched on.

Default value:

0

Value space:

Integer (0..50)

The auto answer delay (seconds).

Conference CallProtocolIPStack

Applies to: All products

Requires user role: ADMIN

Select whether the device should enable IPv4, IPv6, or dual IP stack for the call protocol (SIP, H323). For Webex, refer to the Conference Webex CallProtocolIPStack setting.

Default value:

Dual

Value space:

Dual/IPv4/IPv6

Dual: Enables both IPv4 and IPv6 for the call protocol.

IPv4: The call protocol will use IPv4.

IPv6: The call protocol will use IPv6.

Conference CapsetFilter

Applies to: All products

Requires user role: ADMIN

This setting lets you specify what media codecs should be filtered in media negotiation in H.323 and SIP calls. It should only be used for debug purposes and in agreement with Cisco.

Default value:

""

Value space:

String (0, 200)

The filter definition.

Conference DefaultCall Protocol

Applies to: All products

Requires user role: ADMIN

Define the Default Call Protocol to be used when placing calls from the device.

Default value:

Auto

Value space:

Auto/H323/Sip/Spark

Auto: Enables auto-selection of the call protocol based on which protocols are available. If multiple protocols are available, the order of priority is: 1) SIP; 2) H323. If the device cannot register, the auto-selection chooses H323.

H323: All calls are set up as H.323 calls.

Sip: All calls are set up as SIP calls.

Spark: All calls are set up via the Webex infrastructure.

BoardPro,
BoardPro
G2

Codec EQ

Codec
PlusCodec
ProDesk,
DeskPro,
DeskMiniRoom Bar
Pro,
Room BarRoom Kit,
Room Kit
MiniRoom Kit
EQX

Room 55

Room 55
Dual,
Room 70Room 70
G2Room 70
PanoramaRoom
Panorama

Board

BoardPro,
BoardPro
G2

Codec EQ

Codec
PlusCodec
ProDesk,
DeskPro,
DeskMiniRoom Bar
Pro,
Room BarRoom Kit,
Room Kit
MiniRoom Kit
EQX

Room 55

Room 55
Dual,
Room 70Room 70
G2Room 70
PanoramaRoom
Panorama

Conference DefaultCall Rate

Applies to: All products

Requires user role: ADMIN, INTEGRATOR

Define the default call rate to be used when placing a call. For Webex meetings, this default may be overridden by the Conference DefaultCall Webex Rate setting.

The call rate will always be limited by the Conference MaxReceiveCallRate and Conference MaxTransmitCallRate settings. If applicable, it is also limited by the Conference MaxMultisiteReceiveRate, and Conference MaxMultiSiteTransmitRate.

Default value:

6000 [RoomKit RoomKitMini RoomBar RoomBarPro RoomKitEQX CodecEQ CodecPlus CodecPro Room55 Room70/Room55D Room70G2 DeskMini Desk DeskPro BoardPro BoardProG2]
10000 [Board]
16000 [RoomPanorama/Room70Panorama]

Value space:

Integer (64..6000) [RoomKit RoomKitMini RoomBar RoomBarPro RoomKitEQX CodecEQ CodecPlus CodecPro Room55 Room70/Room55D Room70G2 DeskMini Desk DeskPro BoardPro BoardProG2]
Integer (64..10000) [Board]
Integer (64..20000) [RoomPanorama/Room70Panorama]

The default call rate (kbps).

Conference DefaultCall Webex Rate

Applies to: All products

Requires user role: ADMIN, INTEGRATOR

Define the default call rate to be used in Webex meetings. The setting applies only to devices that get software from the Webex cloud service.

The call rate will always be limited by the Conference MaxReceiveCallRate and Conference MaxTransmitCallRate settings.

Default value:

0 [RoomKit RoomKitMini RoomBar CodecPlus CodecPro Room55 Room70/Room55D Room70G2 RoomPanorama/Room70Panorama DeskMini Desk DeskPro BoardPro BoardProG2]
20000 [RoomBarPro RoomKitEQX CodecEQ]
10000 [Board]

Value space:

Integer (0..20000) [RoomBar RoomBarPro RoomKitEQX CodecEQ CodecPro Room70G2 RoomPanorama/Room70Panorama DeskMini Desk DeskPro BoardPro BoardProG2]
Integer (0..10000) [Board]
Integer (0..6000) [RoomKit RoomKitMini CodecPlus Room55 Room70/Room55D]

The default call rate (kbps). If set to 0, the default call rate is given by the Conference DefaultCall Rate setting.

Conference Diagnostics DegradedQualityNotifications

Applies to: All products

Requires user role: ADMIN

Controls whether users are shown in-call notifications about network issues and degraded call quality, or not.

Default value:

On

Value space:

Off/On

Off: notifications about network issues and degraded call quality will not be shown.

On: notifications about network issues and degraded call quality will be shown.

Conference DoNotDisturb DefaultTimeout

Applies to: All products

Requires user role: ADMIN, INTEGRATOR

This setting determines the default duration of a Do Not Disturb session, that is, the period when incoming calls are rejected and registered as missed calls. The session can be terminated earlier by using the user interface.

Default value:

60

Value space:

Integer (1..1440)

The number of minutes (maximum 1440 minutes = 24 hours) before the Do Not Disturb session times out automatically.

Conference Diagnostics StreamStatusOverlay

Applies to: All products

Requires user role: ADMIN

Decide whether to show information, for example bitrates and framerates, about each video stream on-screen. The information will be shown in a transparent layer on top of each video frame. It's intended for debugging purposes, so in general, it should be Off. The actual data shown may change without further notice.

Default value:

Off

Value space:

Off/On

Off: Show only the video streams; no information overlay.

On: Show the transparent data layer on top of the video streams.

D15503.06

RoomOS
11.24
02-2025

Board

BoardPro,
BoardPro
G2

Codec EQ

Codec
PlusCodec
ProDesk,
DeskPro,
DeskMiniRoom Bar
Pro,
Room BarRoom Kit,
Room Kit
MiniRoom Kit
EQX

Room 55

Room 55
Dual,
Room 70Room 70
G2Room 70
PanoramaRoom
Panorama

Conference EmbeddedApp NotificationsOnly

Applies to: DeskMini Desk DeskPro Board BoardPro BoardProG2

Requires user role: ADMIN, INTEGRATOR

With Embedded App support, you can use the device to see and interact with apps that have been initiated by a meeting participant that is using a Webex client.

As an administrator, you can set whether to show the actual app on the device or just a notification that an app is being shared. In the latter case, people must open their meeting client to see and interact with the app.

Embedded apps are using the device's web engine, so the WebEngine Mode setting must be On.

Default value:

False

Value space:

False/True

False: People can see and interact with embedded apps on the device.

True: People will see a notification when an embedded app is shared. They can't see or interact with the app on the device; they must use a meeting client.

Conference Encryption Mode

Applies to: All products

Requires user role: ADMIN

Define the conference encryption mode. A padlock with the text "Encryption On" or "Encryption Off" displays on screen for a few seconds when the conference starts.

NOTE: If the Encryption Option Key is not installed on the device, the encryption mode is always Off.

Default value:

BestEffort

Value space:

Off/On/BestEffort

Off: The device will not use encryption.

On: The device will only allow calls that are encrypted.

BestEffort: The device will use encryption whenever possible.

> In Point to point calls: If the far end device supports encryption (AES-128), the call will be encrypted. If not, the call will proceed without encryption.

> In MultiSite calls: In order to have encrypted MultiSite conferences, all sites must support encryption. If not, the conference will be unencrypted.

Conference EndToEndEncryption Identity PreferredDomain

Applies to: All products

Requires user role: ADMIN

This is only available on devices registered to the Webex cloud service or linked to Webex Edge for devices.

This configuration is made when the admin sets the device's preferred domain from Control Hub. It is only necessary if the organization has more than one domain.

The device uses this domain when it requests a certificate from the Webex CA. The domain then identifies the device.

This configuration is not applicable when the device has an active, externally-issued certificate to identify itself.

Default value:

""

Value space:

String (0, 255)

Conference FarEndControl Mode

Applies to: All products

Requires user role: ADMIN

Decide if the remote side (far end) is allowed to select video sources and control the camera (pan, tilt, zoom) of the device. It is still possible to control the camera and select your video sources locally.

Default value:

Auto

Value space:

Auto/Off/On

Auto: The far end is allowed to select video sources or control the camera only when speaker tracking is disabled. Far end control is not allowed on personal mode devices.

Off: The far end can't select video sources or control the camera.

On: The far end is allowed to select video sources and control the camera on all devices (both personal and shared). Speaker tracking will be disabled when the device receives the first FarEndControl Camera Move command, and then re-enabled when the call ends.

Board

Conference FarEndControl SignalCapability

Applies to: All products

Requires user role: ADMIN

Define the far end control (H.224) signal capability mode.

Default value:

On

Value space:

Off/On

Off: Disable the far end control signal capability.

On: Enable the far end control signal capability.

BoardPro,
BoardPro
G2

Codec EQ

Codec
PlusCodec
ProDesk,
DeskPro,
DeskMiniRoom Bar
Pro,
Room BarRoom Kit,
Room Kit
MiniRoom Kit
EQX

Room 55

Room 55
Dual,
Room 70Room 70
G2Room 70
PanoramaRoom
Panorama

Conference FarendMessage Mode

Applies to: All products

Requires user role: ADMIN

Toggle whether it is allowed to send data between two devices in a point-to-point call, for use with control systems or macros. Works with SIP calls only. This setting will enable/disable the use of the xCommand Call FarEndMessage Send command.

Default value:

Off

Value space:

Off/On

Off: It is not possible to send messages between two devices.

On: It is possible to send messages between two devices in a point-to-point call.

Conference HideNonVideo OnCall Mode

Applies to: All products

Requires user role: ADMIN

Specify in which mode you want to display participants who have their video turned off during meetings.

This feature is only available on devices that are registered to the Webex cloud service or linked to Webex Edge for devices with the Webex optimized experience enabled.

Default value:

Inactive

Value space:

Active/Auto/Inactive/Previous

Active: Hide participants whose video is off during meetings, regardless of the usage in the previous call.

Auto: Auto will resolve to "Active" at the beginning of calls for shared devices, and to "Previous" for personal devices.

Inactive: Show participants whose video is off during meetings, regardless of the usage in previous call.

Previous: Previous will set the same state as the last call.

Conference JoinLeaveNotifications

Applies to: All products

Requires user role: ADMIN

Specify when to show notifications of people entering or exiting meetings.

Default value:

Auto

Value space:

Always/Auto/Never

Always: Always show all notifications.

Auto: Show notifications only for the first 25 joining participants.

Never: Never show notifications.

Board

Conference MaxReceiveCallRate

Applies to: All products

Requires user role: ADMIN

Define the maximum receive bit rate to be used when placing or receiving calls. In general, this is the maximum receive bit rate for an individual call.

For on-premises registered devices, the maximum receive bit rate for an individual call is the lowest of the Conference MaxReceiveCallRate and Conference MaxMultisiteReceiveRate settings. In a MultiSite conference, Conference MaxMultisiteReceiveRate is the aggregated maximum for all simultaneous active calls.

Default value:

6000 [RoomKit RoomKitMini RoomBar CodecPlus CodecPro Room55 Room70/Room55D Room70G2 DeskMini Desk DeskPro BoardPro BoardProG2]
20000 [RoomBarPro RoomKitEQX CodecEQ RoomPanorama/Room70Panorama]
10000 [Board]

Value space:

Integer (64..6000) [RoomKit RoomKitMini CodecPlus Room55 Room70/Room55D]
Integer (64..20000) [RoomBar RoomBarPro RoomKitEQX CodecEQ CodecPro Room70G2 RoomPanorama/Room70Panorama DeskMini Desk DeskPro BoardPro BoardProG2]
Integer (64..10000) [Board]

The maximum receive call rate (kbps).

Conference MaxTransmitCallRate

Applies to: All products

Requires user role: ADMIN

Define the maximum transmit bit rate to be used when placing or receiving calls. In general, this is the maximum transmit bit rate for an individual call.

For on-premises registered devices, the maximum transmit bit rate for an individual call is the lowest of the Conference MaxTransmitCallRate and Conference MaxMultisiteTransmitRate settings. In a MultiSite conference, Conference MaxMultisiteTransmitRate is the aggregated maximum for all simultaneous active calls.

Default value:

6000 [RoomKit RoomKitMini RoomBar CodecPlus CodecPro Room55 Room70/Room55D Room70G2 DeskMini Desk DeskPro Board BoardPro BoardProG2]
20000 [RoomBarPro RoomKitEQX CodecEQ RoomPanorama/Room70Panorama]

Value space:

Integer (64..6000) [RoomKit RoomKitMini CodecPlus Room55 Room70/Room55D]
Integer (64..20000) [RoomBar RoomBarPro RoomKitEQX CodecEQ CodecPro Room70G2 RoomPanorama/Room70Panorama DeskMini Desk DeskPro Board BoardPro BoardProG2]

The maximum transmit call rate (kbps).

Conference MaxMultisiteReceiveRate

Applies to: All products

Requires user role: ADMIN

This configuration applies when using a device's built-in MultiSite feature (optional) to host a multipoint video conference.

Define the maximum aggregated receive bit rate allowed. The bit rate will be divided fairly among all active calls at any time. This means that the individual calls will be up-speeded or down-speeded as appropriate when someone leaves or enters a MultiSite conference, or when a call is put on hold (suspended) or resumed.

The maximum receive bit rate for each individual call is defined in the Conference MaxReceiveCallRate setting.

Default value:

6000 [RoomKit RoomKitMini CodecPlus Room55 Room70/Room55D Board]
15000 [RoomBar RoomBarPro RoomKitEQX CodecEQ CodecPro Room70G2 RoomPanorama/Room70Panorama DeskMini Desk DeskPro BoardPro BoardProG2]

Value space:

Integer (64..6000) [RoomKit RoomKitMini CodecPlus Room55 Room70/Room55D Board]
Integer (64..15000) [RoomBar RoomBarPro RoomKitEQX CodecEQ CodecPro Room70G2 RoomPanorama/Room70Panorama DeskMini Desk DeskPro BoardPro BoardProG2]

The maximum aggregated receive call rate (kbps) in a MultiSite conference.

Board

Conference MaxMultisiteTransmitRate

Applies to: All products

Requires user role: ADMIN

This configuration applies when using a device's built-in MultiSite feature (optional) to host a multipoint video conference.

Define the maximum aggregated transmit bit rate allowed. The bit rate will be divided fairly among all active calls at any time. This means that the individual calls will be up-speeded or down-speeded as appropriate when someone leaves or enters a MultiSite conference, or when a call is put on hold (suspended) or resumed.

The maximum transmit bit rate for each individual call is defined in the Conference MaxTransmitCallRate setting.

Default value:

6000 [RoomKit RoomKitMini CodecPlus Room55 Room70/Room55D Board]

15000 [RoomBar RoomBarPro RoomKitEQX CodecEQ CodecPro Room70G2 RoomPanorama/Room70Panorama DeskMini Desk DeskPro BoardPro BoardProG2]

Value space:

Integer (64..6000) [RoomKit RoomKitMini CodecPlus Room55 Room70/Room55D Board]

Integer (64..15000) [RoomBar RoomBarPro RoomKitEQX CodecEQ CodecPro Room70G2 RoomPanorama/Room70Panorama DeskMini Desk DeskPro BoardPro BoardProG2]

The maximum aggregated transmit call rate (kbps) in a MultiSite conference.

BoardPro,
BoardPro
G2

Codec EQ

Codec
PlusCodec
ProDesk,
DeskPro,
DeskMiniRoom Bar
Pro,
Room BarRoom Kit,
Room Kit
MiniRoom Kit
EQX

Room 55

Room 55
Dual,
Room 70Room 70
G2Room 70
PanoramaRoom
Panorama

Conference Multipoint Mode

Applies to: All products

Requires user role: ADMIN

Define how to expand a point-to-point video call (a call involving only two parties) into a multipoint conference with more participants (ad hoc conferences). Both the built-in MultiSite feature, which relies only on local resources, and different solutions based on centralized infrastructure (multipoint control units – MCUs) are available.

The MultiSite feature is an upgrade option and is only available on devices where the MultiSite option key is installed. If registered to a Cisco TelePresence Video Communication Server (VCS), the device can use MultiSite when calling other video devices. If registered to a Cisco Unified Communications Manager (CUCM), the device can use either a CUCM conference bridge or the device's own built-in MultiSite feature. Which option to use, is set up by CUCM.

In either case, multiparty conferences may be set up via an MCU if you call an MCU that allows devices to add participants to a conference (Direct Remote Add).

Default value:

Auto

Value space:

Auto/CUCMMediaResourceGroupList/MultiSite/Off

Auto: The multipoint method is selected automatically. Multiparty conferences are set up using the built-in MultiSite feature, provided that the MultiSite option key is installed on the device, and that you are calling another device (not an MCU). Only the MultiSite host can add participants. This prevents cascaded conferences. If the device doesn't have the MultiSite option key, you cannot call more than one device on video. When calling another video device (not an MCU), some devices support adding one extra participant on audio-only.

Regardless of the MultiSite option key, multiparty conferences may be set up via an MCU if you call an MCU that allows devices to add participants to a conference (Direct Remote Add).

CUCMMediaResourceGroupList: Multiparty conferences are hosted by the CUCM configured conference bridge. This setting is provisioned by CUCM in a CUCM environment and should never be set manually by the user.

MultiSite: Multiparty conferences are set up using the built-in MultiSite feature, provided that the MultiSite option key is installed on the device. If the device doesn't have the MultiSite option key, you cannot call more than one device on video. Some devices support adding one extra participant on audio-only.

Off: You cannot call more than one device on video. Multiparty conferences may be set up via an MCU if you call an MCU that allows devices to add participants to a conference (Direct Remote Add). When calling another video device (not an MCU), some devices support adding one extra participant on audio-only.

Conference MicUnmuteOnDisconnect Mode

Applies to: All products

Requires user role: ADMIN

Define if the microphones shall be unmuted automatically when all calls are disconnected. In a meeting room or other shared resources this may be done to prepare the device for the next user.

Default value:

On

Value space:

Off/On

Off: If muted during a call, let the microphones remain muted after the call is disconnected.

On: Unmute the microphones after the call is disconnected.

Board

BoardPro,
BoardPro
G2

Codec EQ

Codec
PlusCodec
ProDesk,
DeskPro,
DeskMiniRoom Bar
Pro,
Room BarRoom Kit,
Room Kit
MiniRoom Kit
EQX

Room 55

Room 55
Dual,
Room 70Room 70
G2Room 70
PanoramaRoom
Panorama

Conference MultiStream Mode

Applies to: RoomKit RoomKitMini RoomBar RoomKitEQX CodecEQ CodecPlus CodecPro Room55 Room70/Room55D Room70G2 RoomPanorama/Room70Panorama

Requires user role: ADMIN

In supported devices, Conference MultiStream Mode provides the option to turn on/off multistream.

Default value:

Auto

Value space:

Auto/Off

Auto: Multistream will be used when the conference infrastructure supports the feature. Minimum versions required: CMS 2.2, CUCM 11.5, VCS X8.7.

Off: Multistream is disabled. This does not have any effect for devices registered to the Webex cloud service, because these always use multistream. The same applies if your device is linked to Webex Edge for devices and the Webex optimized experience is enabled (that is, joining meetings through the Webex calling infrastructure).

Conference IncomingMultisiteCall Mode

Applies to: All products

Requires user role: ADMIN

Select whether or not to allow incoming calls when already in a call/conference.

Default value:

Allow

Value space:

Allow/Deny

Allow: You will be notified when someone calls you while you are already in a call. You can accept the incoming call or not. The ongoing call may be put on hold while answering the incoming call; or you may merge the calls (requires support for multiparty video conferences).

Deny: An incoming call will be rejected if you are already in a call. You will not be notified about the incoming call. However, the call will appear as a missed call in the call history list.

Conference PeopleFocus OnCall Mode

Applies to: All products

Requires user role: ADMIN

When you enable people focus, your local layout change dynamically to crop away empty background and optimize each participant's space on your screen. This setting determines whether people focus is initially on or off when joining a meeting.

Regardless of this setting, the user can toggle people focus on and off from the UI (Layout button) during the meeting. Also, the Conference PeopleFocus Activate and Conference PeopleFocus Deactivate commands can be used.

People focus is only available on devices that are registered to the Webex cloud service or linked to Webex Edge for devices with the Webex optimized experience enabled.

Default value:

Auto

Value space:

Auto/Active/Inactive/Previous

Auto: Like Active on shared mode devices; like Previous for personal mode devices.

Active: People focus is on when you join a meeting.

Inactive: People focus is off when you join a meeting.

Previous: When joining a new meeting, the initial people focus state (on or off) is the same as when you left the previous meeting.

Conference Presentation OnPlacedOnHold

Applies to: All products

Requires user role: ADMIN

Define whether or not to continue sharing a presentation after the remote site has put you on hold.

Default value:

NoAction

Value space:

NoAction/Stop

NoAction: The device will not stop the presentation sharing when put on hold. The presentation will not be shared while you are on hold, but it will continue automatically when the call is resumed.

Stop: The device stops the presentation sharing when the remote site puts you on hold. The presentation will not continue when the call is resumed.

Board

Conference Presentation RelayQuality

Applies to: All products

Requires user role: ADMIN

This configuration applies to devices that are using the built-in MultiSite feature (optional) to host a multipoint video conference. When a remote user shares a presentation, the device will transcode the presentation and send it to the other participants in the multipoint conference. The RelayQuality setting specifies whether to give priority to high frame rate or to high resolution for the presentation source.

Default value:

Sharpness

Value space:

Motion/Sharpness

Motion: Gives the highest possible frame rate. Used when there is a need for higher frame rates, typically when there is a lot of motion in the picture.

Sharpness: Gives the highest possible resolution. Used when you want the highest quality of detailed images and graphics.

Conference Webex CallProtocollPStack

Applies to: All products

Requires user role: ADMIN

This configuration applies to devices that are registered to the Webex cloud service or linked to Webex Edge for devices with the Webex optimized experience enabled.

Select whether the device should enable the IPv4 or IPv6 stack for the call protocol (Webex). For SIP and H.323, refer to the Conference CallProtocollPStack setting.

Default value:

PreferIpv4

Value space:

Dual/PreferIpv4/PreferIpv6

Dual: Enables both IPv4 and IPv6 for the call protocol.

PreferIpv4: The call protocol will use IPv4.

PreferIpv6: The call protocol will use IPv6. This value requires NAT64 and DNS64 in the customer's network.

FacilityService settings

FacilityService Service [n] CallType

Applies to: RoomKit RoomKitMini RoomBar RoomBarPro RoomKitEQX CodecEQ CodecPlus CodecPro Room55 Room70/Room55D Room70G2 RoomPanorama/Room70Panorama Desk DeskPro Board

Requires user role: ADMIN, INTEGRATOR

Facility services are no longer supported in RoomOS. Quick dial functionality can be created using UI Extensions and macros instead.

Default value:

Video

Value space:

Audio/Video

n: Unique ID that identifies the service.

Range: 1..5

FacilityService Service [n] Name

Applies to: RoomKit RoomKitMini RoomBar RoomBarPro RoomKitEQX CodecEQ CodecPlus CodecPro Room55 Room70/Room55D Room70G2 RoomPanorama/Room70Panorama Desk DeskPro Board

Requires user role: ADMIN, INTEGRATOR

Facility services are no longer supported in RoomOS. Quick dial functionality can be created using UI Extensions and macros instead.

Default value:

Service 1: "Live Support" Other services: ""

Value space:

String (0, 1024)

n: Unique ID that identifies the service.

Range: 1..5

BoardPro,
BoardPro
G2

Codec EQ

Codec
PlusCodec
ProDesk,
DeskPro,
DeskMiniRoom Bar
Pro,
Room BarRoom Kit,
Room Kit
MiniRoom Kit
EQX

Room 55

Room 55
Dual,
Room 70Room 70
G2Room 70
PanoramaRoom
Panorama

Board

FacilityService Service [n] Number

Applies to: RoomKit RoomKitMini RoomBar RoomBarPro RoomKitEQX CodecEQ CodecPlus CodecPro Room55 Room70/Room55D Room70G2 RoomPanorama/Room70Panorama Desk DeskPro Board

Requires user role: ADMIN, INTEGRATOR

Facility services are no longer supported in RoomOS. Quick dial functionality can be created using UI Extensions and macros instead.

Default value:

""

Value space:

String (0, 1024)

n: Unique ID that identifies the service.

Range: 1..5

Codec Plus

Codec Pro

Desk,
DeskPro,
DeskMiniRoom Bar
Pro,
Room BarRoom Kit,
Room Kit
MiniRoom Kit
EQX

Room 55

Room 55
Dual,
Room 70Room 70
G2Room 70
PanoramaRoom
Panorama

FacilityService Service [n] Type

Applies to: RoomKit RoomKitMini RoomBar RoomBarPro RoomKitEQX CodecEQ CodecPlus CodecPro Room55 Room70/Room55D Room70G2 RoomPanorama/Room70Panorama Desk DeskPro Board

Requires user role: ADMIN, INTEGRATOR

Facility services are no longer supported in RoomOS. Quick dial functionality can be created using UI Extensions and macros instead.

Default value:

Helpdesk

Value space:

Catering/Concierge/Emergency/Helpdesk/Security/Transportation/Other

n: Unique ID that identifies the service.

Range: 1..5

Files settings

Files Services OneDrive TemporaryPersonalSignIn

Applies to: All products

Requires user role: ADMIN, INTEGRATOR

When enabled, users can sign into their Microsoft OneDrive account and access their OneDrive files from the device. Also, whiteboards can be accessed, edited, and saved to OneDrive. The user is automatically signed out when the device goes to standby.

This feature is not available for Room 70 Panorama and Room Panorama in this software version.

Default value:

Disabled

Value space:

Disabled/Enabled

Disabled: Users don't have access to their OneDrive files and whiteboards from the device.

Enabled: Users can sign in and access their OneDrive files and store whiteboards.

Files Services Webex SaveToUser

Applies to: All products

Requires user role: ADMIN, INTEGRATOR

Allows enabling or disabling the option to save whiteboards to a user's account during the 'Save Your Work' wizard on the whiteboard.

Default value:

Disabled

Value space:

Disabled/Enabled

Disabled: the option is not available.

Enabled: the option to save whiteboards to a user's account is available.

Board

BoardPro,
BoardPro
G2

Codec EQ

Codec
PlusCodec
ProDesk,
DeskPro,
DeskMiniRoom Bar
Pro,
Room BarRoom Kit,
Room Kit
MiniRoom Kit
EQX

Room 55

Room 55
Dual,
Room 70Room 70
G2Room 70
PanoramaRoom
Panorama

GPIO settings

GPIO Pin [n] Mode

Applies to: CodecPro Room70G2 RoomPanorama/Room70Panorama

Requires user role: ADMIN, INTEGRATOR

The four GPIO pins are configured individually. The actual measured pin state (Low/High) can be retrieved by the GPIO Pin [1..4] State status.

The default state for a pin in output mode is High (+12 V).

NOTE: A pin defined to output mode can be set to force line Low actively. If set to High, the line will be high only when it is not connected to an external device that pulls the line low.

Default value:

InputNoAction

Value space:

InputAcceptAllCalls/InputDisconnectAllCalls/InputMuteMicrophones/InputNoAction/OutputAllCallsEncrypted/OutputInCall/OutputManualState/OutputMicrophonesMuted/OutputPresentationOn/OutputStandbyActive

InputAcceptAllCalls: When the pin transitions from High to Low on an incoming call, the call will be accepted (the Call Accept command is issued automatically).

InputDisconnectAllCalls: When the pin transitions from High to Low during a call, call(s) will be disconnected (the Call Disconnect command is issued automatically).

InputMuteMicrophones: When the pin transitions from High to Low during a call, the microphones will be muted. When the pin transitions from Low to High during a call, the microphones will be unmuted (the Audio Mute and Audio Unmute commands are issued automatically).

InputNoAction: The pin state does not trigger any action. The pin state can be read with the GPIO Pin [1..4] State status.

OutputAllCallsEncrypted: The pin is set Low when all calls are encrypted, and High when one or more calls are not encrypted.

OutputInCall: The pin is set Low when in call, and High when not in call.

OutputManualState: The pin state can be set to High or Low by the GPIO ManualState Set PinX command. It is set to +12 V or 0 V, respectively.

OutputMicrophonesMuted: The pin is set Low when the microphones are muted, and High when they are not muted.

OutputPresentationOn: The pin is set Low when a presentation is active, and High when a presentation is not active.

OutputStandbyActive: The pin is set Low when the device is in standby mode, and High when the device is not in standby mode.

n: GPIO pin number.

Range: 1..4

H323 settings

H323 Authentication Mode

Applies to: All products

Requires user role: ADMIN

Defines the authentication mode for the H.323 profile.

Default value:

Off

Value space:

Off/On

Off: The device will not try to authenticate itself to a H.323 Gatekeeper, but will still try a normal registration.

On: If an H.323 Gatekeeper indicates that it requires authentication, the device will try to authenticate itself to the gatekeeper. Requires the H323 Authentication LoginName and H323 Authentication Password settings to be defined on both the device and the Gatekeeper.

H323 Authentication LoginName

Applies to: All products

Requires user role: ADMIN

The device sends the H323 Authentication Login Name and the H323 Authentication Password to an H.323 Gatekeeper for authentication. The authentication is a one way authentication from the device to the H.323 Gatekeeper, that is, the device is authenticated to the gatekeeper. If the H.323 Gatekeeper indicates that no authentication is required, the device will still try to register. Requires the H.323 Authentication Mode to be enabled.

Default value:

""

Value space:

String (0, 50)

The authentication login name.

Board

BoardPro,
BoardPro
G2

Codec EQ

Codec
PlusCodec
ProDesk,
DeskPro,
DeskMiniRoom Bar
Pro,
Room BarRoom Kit,
Room Kit
MiniRoom Kit
EQX

Room 55

Room 55
Dual,
Room 70Room 70
G2Room 70
PanoramaRoom
Panorama

H323 Authentication Password

Applies to: All products

Requires user role: ADMIN

The device sends the H323 Authentication Login Name and the H323 Authentication Password to an H.323 Gatekeeper for authentication. The authentication is a one way authentication from the device to the H.323 Gatekeeper, that is, the device is authenticated to the gatekeeper. If the H.323 Gatekeeper indicates that no authentication is required, the device will still try to register. Requires the H.323 Authentication Mode to be enabled.

Default value:

""

Value space:

String (0, 50)

The authentication password.

H323 CallSetup Mode

Applies to: All products

Requires user role: ADMIN

Defines whether to use a Gatekeeper or Direct calling when establishing H.323 calls. Direct H.323 calls can be made also when H323 CallSetup Mode is set to Gatekeeper.

Default value:

Gatekeeper

Value space:

Direct/Gatekeeper

Direct: You can only make an H.323 call by dialing an IP address directly.

Gatekeeper: The device uses a Gatekeeper to make an H.323 call. When choosing this option, the H323 Gatekeeper Address must also be configured.

H323 Encryption AES256Support

Applies to: All products

Requires user role: ADMIN

The device always supports 128-bit AES encryption keys for the media transport. You can configure the device to also support 256-bit keys. When using 256-bit keys the minimum key size for the Diffie-Hellman key exchange method should be 2048 bit (refer to the H323 Encryption KeySize setting).

Default value:

Off

Value space:

Off/On

Off: The device only supports 128-bit AES encryption keys.

On: The device supports both 128-bit and 256-bit AES encryption keys.

H323 Encryption KeySize

Applies to: All products

Requires user role: ADMIN

Define the minimum or maximum key size for the Diffie-Hellman key exchange method, which is used when establishing the Advanced Encryption Standard (AES) encryption key.

Default value:

Min1024bit

Value space:

Max1024bit/Min1024bit/Min2048bit

Max1024bit: The maximum size is 1024 bit.

Min1024bit: The minimum size is 1024 bit.

Min2048bit: The minimum size is 2048 bit.

H323 Gatekeeper Address

Applies to: All products

Requires user role: ADMIN

Define the IP address of the Gatekeeper. Requires H323 CallSetup Mode to be set to Gatekeeper.

Default value:

""

Value space:

String (0, 255)

A valid IPv4 address, IPv6 address or DNS name.

Board

H323 H323Alias E164

Applies to: All products

Requires user role: ADMIN

The H.323 Alias E.164 defines the address of the device, according to the numbering plan implemented in the H.323 Gatekeeper. The E.164 alias is equivalent to a telephone number, sometimes combined with access codes.

Default value:

""

Value space:

String (0, 30)

The H.323 Alias E.164 address. Valid characters are 0-9, * and #.

H323 H323Alias ID

Applies to: All products

Requires user role: ADMIN

Define the H.323 Alias ID, which is used to address the device on a H.323 Gatekeeper and will be displayed in the call lists.

Default value:

""

Value space:

String (0, 49)

The H.323 Alias ID. Example: "firstname.lastname@company.com", "My H.323 Alias ID"

H323 NAT Mode

Applies to: All products

Requires user role: ADMIN

The H323 NAT Mode is intended to be used if your device is on a private network and is not registered to a gatekeeper. H323 NAT Mode can then be used to reach devices on a public network.

NAT is not supported for IPv6.

NOTE: The H323 NAT Mode and H323 NAT Address settings will be ignored if the video devices is registered to a gatekeeper. We recommend the use of a gatekeeper with firewall traversal capabilities, rather than using the H323 NAT Mode.

Default value:

Off

Value space:

Auto/Off/On

Auto: Auto mode works only if you have specified the NAT address in the H323 NAT Address setting.

NAT is turned On if the device is not registered to a gatekeeper, the local address of the device is private, the address you are calling (remote) is public, and both the local and remote addresses are IPv4. Otherwise, NAT is turned Off.

This means that you can place calls to devices on your private network as well as to external devices (outside your private network). For calls on your private network, the H323 NAT Address is not used (but must be present). For calls to the public network, the H323 NAT Address is used.

Off: NAT is turned off, and the H323 NAT Address setting will be ignored. In this case you will not be able to set up a call to a device that is outside of your private network unless you use a gatekeeper.

On: NAT is always turned on. You must specify the NAT address in the H323 NAT Address setting. The device will always signal the H323 NAT Address instead of its private IP address in Q.931 and H.245. If the H323 NAT Address is wrong or not set, H.323 calls cannot be set up.

BoardPro,
BoardPro
G2

Codec EQ

Codec
PlusCodec
ProDesk,
DeskPro,
DeskMiniRoom Bar
Pro,
Room BarRoom Kit,
Room Kit
MiniRoom Kit
EQX

Room 55

Room 55
Dual,
Room 70Room 70
G2Room 70
PanoramaRoom
Panorama

Board

BoardPro,
BoardPro
G2

Codec EQ

Codec
PlusCodec
ProDesk,
DeskPro,
DeskMiniRoom Bar
Pro,
Room BarRoom Kit,
Room Kit
MiniRoom Kit
EQX

Room 55

Room 55
Dual,
Room 70Room 70
G2Room 70
PanoramaRoom
Panorama

H323 NAT Address

Applies to: All products

Requires user role: ADMIN

Define the external/global IP address of the router with NAT support. This address will be exposed when setting up a call to devices outside your private network. Refer to the H323 NAT Mode setting for details when the NAT Address is used.

In the router, the following ports must be routed to the video device's IP address:

- * Port 1720
- * Port 5555-6555
- * Port 2326-2487

Default value:

""

Value space:

String (0, 64)

An IPv4 address. It's most often a public IP address, refer to RFC 1918, but it could also be another private address (for example in a larger company network).

H323 PortAllocation

Applies to: All products

Requires user role: ADMIN

This setting affects the H.245 port numbers used for H.323 call signaling.

Default value:

Dynamic

Value space:

Dynamic/Static

Dynamic: The system will allocate which ports to use when opening a TCP connection. The reason for doing this is to avoid using the same ports for subsequent calls, as some firewalls consider this as a sign of attack. When Dynamic is selected, the H.323 ports used are from 11000 to 20999. Once 20999 is reached they restart again at 11000. The ports are automatically selected by the system within the given range. Firewall administrators should not try to deduce which ports are used when, as the allocation schema within the mentioned range may change without any further notice.

Static: When set to Static the ports are given within a static predefined range [5555-6555].

HttpClient settings

HttpClient Mode

Applies to: All products

Requires user role: ADMIN

Allow or prohibit communication with an external HTTP(S) server using HTTP(S) requests and responses.

Default value:

Off

Value space:

Off/On

Off: The video device cannot communicate with an external HTTP(S) server.

On: The video device is allowed to communicate with an external HTTP(S) server.

HttpClient AllowHTTP

Applies to: All products

Requires user role: ADMIN

The HttpClient Mode setting is used to allow or prohibit communication with an external HTTP(S) server. The Mode setting does not distinguish between HTTP and HTTPS. You must use the HttpClient AllowHTTP setting to further allow or prohibit the use of HTTP.

Default value:

True

Value space:

False/True

False: The video device can communicate only over HTTPS.

True: The video device can communicate over both HTTPS and HTTP.

Board

BoardPro,
BoardPro
G2

Codec EQ

Codec
PlusCodec
ProDesk,
DeskPro,
DeskMiniRoom Bar
Pro,
Room BarRoom Kit,
Room Kit
MiniRoom Kit
EQX

Room 55

Room 55
Dual,
Room 70Room 70
G2Room 70
PanoramaRoom
Panorama

HttpClient AllowInsecureHTTPS

Applies to: All products

Requires user role: ADMIN

You can choose whether or not to allow the video device to communicate with a server over HTTPS without checking the server's certificate first.

Even if the device is allowed to skip the certificate validation process, it doesn't automatically do it. You must specifically set the AllowInsecureHTTPS parameter in each xCommand HttpClient command for data to be exchanged with the server without certificate validation.

Default value:

False

Value space:

False/True

False: The device always checks that the HTTPS server has a valid certificate. No communication with the server takes place if the certificate validation fails.

True: The device is allowed to skip the certificate validation process before communicating with the server.

HttpClient UseHttpProxy

Applies to: All products

Requires user role: ADMIN

There are several UseHttpProxy settings that specify if a service shall communicate via an HTTP proxy or not. The HttpClient UseHttpProxy setting applies to macros and arbitrary HTTP(S) requests using the HttpClient commands.

For this setting to have any effect, a proxy server for HTTP, HTTPS, and WebSocket traffic must be set up using the NetworkServices HTTP Proxy settings.

Default value:

On

Value space:

Off/On

Off: Set up communication directly with the server (not using a proxy).

On: Set up communication via proxy.

HttpFeedback settings

HttpFeedback TlsVerify

Applies to: All products

Requires user role: ADMIN

This setting applies when a video device connects to an HTTPS server for arbitrary HTTPS communication (refer to the HttpClient Post/Put/Patch/Get/Delete commands). For phone book, provisioning, and external logging servers, see the Phonebook Server 1 TlsVerify, Provisioning TlsVerify, and Logging External TlsVerify settings.

Before establishing a connection between the device and the HTTPS server, the device checks if the certificate of the server is signed by a trusted Certificate Authority (CA). The CA certificate must be included in the CA list on the device, manually uploaded using the web interface or API.

In general, the minimum TLS (Transport Layer Security) version for the HTTPS connection is 1.1. There are two exceptions to this rule: 1) For compatibility reasons, the minimum TLS version is 1.0 for devices that are registered to CUCM. 2) Devices registered to the Webex cloud service always use version 1.2.

Note: The value is set to Off for a device that has been upgraded to CE9.9 (or later) from CE9.8 or earlier software versions, provided that the device has not been factory reset after the upgrade, and that the old NetworkServices HTTPS VerifyServerCertificate setting was not explicitly set to On.

Default value:

On

Value space:

Off/On

Off: The device doesn't check the certificate of the HTTPS server.

On: The device checks if the certificate of the HTTPS server can be trusted. If not, the connection between the device and the server is not established.

Board

BoardPro,
BoardPro
G2

Codec EQ

Codec
PlusCodec
ProDesk,
DeskPro,
DeskMiniRoom Bar
Pro,
Room BarRoom Kit,
Room Kit
MiniRoom Kit
EQX

Room 55

Room 55
Dual,
Room 70Room 70
G2Room 70
PanoramaRoom
Panorama

HttpFeedback UseHttpProxy

Applies to: All products

Requires user role: ADMIN

There are several UseHttpProxy settings that specify if a service shall communicate via an HTTP proxy or not. The HttpFeedback UseHttpProxy setting applies to feedback sent from the video device.

For this setting to have any effect, a proxy server for HTTP, HTTPS, and WebSocket traffic must be set up using the NetworkServices HTTP Proxy settings.

Default value:

On

Value space:

Off/On

Off: Set up communication directly with the server (not using a proxy).

On: Set up communication via proxy.

Logging settings

Logging CloudUpload Mode

Applies to: All products

Requires user role: ADMIN

Specify whether or not logs from the device can be uploaded to the Webex cloud service. The device logs will be filtered for personally-identifiable information before they are sent to the cloud.

When enabled, the log upload can be initiated from the device itself or from Control Hub. The device will display a "Send logs" button on the user interface, and there will be a "Manage Logs" section on the Devices page in Control Hub.

The device must either be registered to the Webex cloud service or registered to an on-premises service and linked to Webex Edge for Devices.

Default value:

Off

Value space:

Off/On

Off: Logs from the device can not be uploaded to the Webex cloud.

On: Logs from the device can be uploaded to the Webex cloud.

Logging Debug Bluetooth

Applies to: All products

Requires user role: ADMIN

When this option is enabled, the video device logs more information about the set-up and maintenance of a Bluetooth connection. This may be useful when you are troubleshooting Bluetooth connection issues.

Default value:

On

Value space:

Off/On

Off: Logging only basic Bluetooth information.

On: Logging a large amount of information about the Bluetooth connection.

Board

Logging Debug Wifi

Applies to: All products

Requires user role: ADMIN

When this option is enabled, the device logs more information about the set-up and maintenance of the Wi-Fi connection between the device and the access point. This may be useful when you are troubleshooting Wi-Fi connection issues.

Default value:

On

Value space:

Off/On

Off: Logging only basic Wi-Fi information.

On: Logging a large amount of information about the Wi-Fi connection.

Codec EQ

Codec Plus

Codec Pro

Desk, Desk Pro, Desk Mini

Room Bar Pro, Room Bar

Room Kit, Room Kit Mini

Room Kit EQX

Room 55

Room 55 Dual, Room 70

Room 70 G2

Room 70 Panorama

Room Panorama

Logging External Protocol

Applies to: All products

Requires user role: ADMIN

Specify which protocol to use toward the remote logging server. You can use either the syslog protocol over TLS (Transport Layer Security), or the syslog protocol in plaintext. For details about the syslog protocol, see RFC 5424.

Default value:

SyslogTLS

Value space:

Syslog/SyslogTLS

Syslog: Syslog protocol in plain text.

SyslogTLS: Syslog protocol over TLS.

Logging External Server Address

Applies to: All products

Requires user role: ADMIN

Specify the address of the remote syslog server.

Default value:

""

Value space:

String (0, 255)

A valid IPv4 address, IPv6 address or DNS name.

Logging External Server Port

Applies to: All products

Requires user role: ADMIN

The port that the remote syslog server listens for messages on. If set to 0, the device will use the standard syslog port. The standard syslog port is 514 for syslog, and 6514 for syslog over TLS.

Default value:

514

Value space:

Integer (0..65535)

The number of the port that the remote syslog server is using. 0 means that the device uses the standard syslog port.

Board

BoardPro,
BoardPro
G2

Codec EQ

Codec
PlusCodec
ProDesk,
DeskPro,
DeskMiniRoom Bar
Pro,
Room BarRoom Kit,
Room Kit
MiniRoom Kit
EQX

Room 55

Room 55
Dual,
Room 70Room 70
G2Room 70
PanoramaRoom
Panorama

Logging External TlsVerify

Applies to: All products

Requires user role: ADMIN

This setting applies when a video device connects to a remote syslog server. It applies to both regular logging (refer to the Logging External Mode setting) and audit logging (refer to the Security Audit Logging Mode setting).

Before establishing a connection between the device and the syslog server, the device checks if the certificate of the server is signed by a trusted Certificate Authority (CA). The CA certificate must be included in the CA list on the device, either pre-installed or manually uploaded using the web interface or API.

The minimum TLS (Transport Layer Security) version for the syslog connection is 1.1.

Default value:

On

Value space:

Off/On

Off: The device doesn't check the certificate of the syslog server.

On: The device checks if the certificate of the syslog server can be trusted. If not, the connection between the device and the server is not established.

Logging Internal Mode

Applies to: All products

Requires user role: ADMIN

Specify whether or not to store the system logs on the device (local files). These are the files that you get when you download the log bundles from the device. This setting has no effect if the Logging Mode setting is set to Off.

Default value:

On

Value space:

Off/On

Off: System logs will not be stored on the device.

On: System logs will be stored on the device.

Logging Mode

Applies to: All products

Requires user role: ADMIN

Define the logging mode for the device (syslog service). When disabled, the syslog service does not start, and most of the system and audit logs are not generated. The Historical Logs and Call Logs are not affected.

Default value:

On

Value space:

Off/On

Off: Disable the system logging service.

On: Enable the system logging service.

Board

BoardPro,
BoardPro
G2

Codec EQ

Codec
PlusCodec
ProDesk,
DeskPro,
DeskMiniRoom Bar
Pro,
Room BarRoom Kit,
Room Kit
MiniRoom Kit
EQX

Room 55

Room 55
Dual,
Room 70Room 70
G2Room 70
PanoramaRoom
Panorama

Macros settings

Macros EvaluateTranspiled

Applies to: All products

Requires user role: ADMIN

This setting is part of the graceful deprecation strategy of decommissioning the old macro runtime environment that was using Duktape as runtime engine. This runtime engine was also supporting ECMA Script 2009 style Javascript code standard and was under the hood using a transpiler library called Bable.

The runtime engine going forward is QuickJS and supports only ECMA Script 2015/2020 coding standard. QuickJS is the default runtime engine in this software release (use the Macros QuickJS setting to change runtime engine if needed). However, the Bable transpiler is still being used.

There are substantial benefits of QuickJS both regarding speed and features that will be fully unlocked when also the Bable transpiler is disabled. However, as there are some older style Javascript syntax differences between the old and a pure QuickJS environment, Cisco has put in place mechanisms to avoid existing macro deployments suddenly stop working.

The Macros EvaluateTranspiled setting controls whether the macro engine will continue to support the old style "require" format for importing javascript libraries, e.g. `const xapi = require("xapi")`.

As older macros used to have this syntax, the Cisco devices have been graceful in allowing this, by using the Bable library to provide this backwards compatibility.

For macros that are already using the more modern import syntax for libraries, e.g. `import xapi from "xapi"`, Macros EvaluateTranspiled should be set to False.

If you set Macros EvaluateTranspiled to False and Macros QuickJSEngine to On, and your macros are working as intended on the device, then your macro runtime environment is in the state all devices should be in going forward. We will enforce this behavior in a later release.

Note that Macros EvaluateTranspiled is a temporary setting that will be removed once Cisco is content that all customers no longer have macros that are using the old Javascript style for importing libraries.

Default value:

True

Value space:

False/True

True: Babel transpiling is enabled. The macro runtime engine accepts old style "require", e.g. `const xapi = require("xapi")`

False: Babel transpiling is disabled. Macros containing old style "require", e.g. `const xapi = require("xapi")` will fail. Only e.g. `import xapi from "xapi"` will work.

Macros Mode

Applies to: All products

Requires user role: ADMIN

Macros allow you to write snippets of JavaScript code that can automate parts of your video device, thus creating custom behavior. Use of macros is disabled by default, but the first time you open the Macro Editor you will be asked whether to enable use of macros on the device. Use this setting when you want to manually enable, or to permanently disable the use of macros on the device. You can disable the use of macros within the Macro Editor. But this will not permanently disable macros from running, because every time the device is reset the macros will be re-enabled automatically.

Default value:

Off

Value space:

Off/On

Off: Permanently disable the use of macros on this device.

On: Enable the use of macros on this device.

Macros AutoStart

Applies to: All products

Requires user role: ADMIN

All the macros run in a single process on the video device, called the macro runtime. It should be running by default, but you can choose to stop and start it manually. If you restart the device, the runtime will automatically start again if auto start is enabled.

Default value:

On

Value space:

Off/On

Off: The macro runtime will not start automatically after a restart of the device.

On: The macro runtime will start automatically after a restart of the device.

Board

Macros Diagnostics JavascriptErrors

Applies to: All products

Requires user role: ADMIN

Choose whether to issue diagnostics messages for errors in, or related to, macros.

Default value:

Off

Value space:

Off/On

Off: Don't expose macro logged errors as diagnostics.

On: Expose macro logged errors as diagnostics.

Codec EQ

Codec Plus

Codec Pro

Desk,
DeskPro,
DeskMiniRoom Bar
Pro,
Room BarRoom Kit,
Room Kit
MiniRoom Kit
EQX

Room 55

Room 55
Dual,
Room 70Room 70
G2Room 70
PanoramaRoom
Panorama

Macros QuickJSEngine

Applies to: All products

Requires user role: ADMIN

Changes which javascript engine type to use for running macro code. It is not recommended to change this configuration.

Default value:

On

Value space:

Off/On

On: Use QuickJS as the macro javascript engine.

Off: Use Duktape as the macro javascript engine.

Macros UnresponsiveTimeout

Applies to: All products

Requires user role: ADMIN

Macros are continuously monitored to detect unresponsive code. Unresponsive macros are typically a sign of a programming error, but occasionally it might be due to limited system resources. Increasing the value allows macros to run for longer without being terminated, while decreasing the value ensures that faulty macros do not consume system resources.

Default value:

5

Value space:

Integer (0..65535)

Set the number of seconds before terminating an unresponsive macro. The value 0 disables the check altogether.

MicrosoftTeams settings

MicrosoftTeams Diagnostics ShowUnsupportedConsoleNotification

Applies to: RoomBar RoomBarPro RoomKitEQX CodecEQ CodecPro Room70G2 DeskPro BoardPro BoardProG2

Requires user role: ADMIN

Room Navigators with 2 GB memory are not supported when the video device is configured to run Microsoft Teams. If you are using a 2 GB Room Navigator in this configuration, we provide a notification (unsupported touch device) both on the main screen and in the Issue and diagnostics pages on the device UI and device web interface. If you are using an unsupported Room Navigator, you should work with your Cisco support to replace it.

Default value:

True

Value space:

False/True

False: Hide the notification from the main screen. You get notifications in the Issues and diagnostics pages regardless.

True: Show the notification on the main screen.

MicrosoftTeams CVI CrossTenant

Applies to: RoomBar RoomBarPro RoomKitEQX CodecEQ CodecPro Room70G2 DeskPro BoardPro BoardProG2

Requires user role: ADMIN

Configures the Cross-Tenant Join feature for Microsoft Teams meetings. This feature allows devices using Video Integration for Microsoft Teams (VIMT) to join Teams meetings hosted by a different business or tenant directly from the device using the Microsoft Teams button. This method provides the VIMT meeting experience instead of using WebRTC Direct Guest Join.

Default value:

Auto

Value space:

Auto/Disabled/Enabled

Auto: Automatically enables Cross-Tenant Join based on the meeting invitation and device configuration.

Disabled: Disables the Cross-Tenant Join feature.

Enabled: Enables Cross-Tenant Join feature.

Board

BoardPro,
BoardPro
G2

Codec EQ

Codec
PlusCodec
ProDesk,
DeskPro,
DeskMiniRoom Bar
Pro,
Room BarRoom Kit,
Room Kit
MiniRoom Kit
EQX

Room 55

Room 55
Dual,
Room 70Room 70
G2Room 70
PanoramaRoom
Panorama

Network settings

Network [n] DNS DNSSEC Mode

Applies to: All products

Requires user role: ADMIN

Domain Name System Security extensions (DNSSEC) is a set of extensions to DNS. It is used to authenticate DNS replies for zones that are signed. It will still allow unsigned zones.

Default value:

Off

Value space:

Off/On

Off: Disable Domain Name System Security Extensions.

On: Enable Domain Name System Security Extensions.

n: Index that identifies the network.

Range: 1..1

Network [n] DNS Domain Name

Applies to: All products

Requires user role: ADMIN

The DNS Domain Name is the default domain name suffix which is added to unqualified names.

Example: If the DNS Domain Name is "company.com" and the name to lookup is "MyDevice", this will result in the DNS lookup "MyDevice.company.com".

Default value:

""

Value space:

String (0, 64)

The DNS domain name.

n: Index that identifies the network.

Range: 1..1

Network [n] DNS Server [m] Address

Applies to: All products

Requires user role: ADMIN

Define the network addresses for DNS servers. Up to three addresses may be specified. If the network addresses are unknown, contact your administrator or Internet Service Provider.

Default value:

""

Value space:

String (0, 64)

A valid IPv4 address or IPv6 address.

n: Index that identifies the network.

Range: 1..1

m: Index that identifies the DNS server. **Maximum three DNS servers are allowed.**

Range: 1..3

Network [n] IEEE8021X Mode

Applies to: All products

Requires user role: ADMIN

The device can be connected to an IEEE 802.1X LAN network, with a port-based network access control that is used to provide authenticated network access for Ethernet networks.

Default value:

Off

Value space:

Off/On

Off: The 802.1X authentication is disabled.

On: The 802.1X authentication is enabled.

n: Index that identifies the network.

Range: 1..1

Board

BoardPro,
BoardPro
G2

Codec EQ

Codec
PlusCodec
ProDesk,
DeskPro,
DeskMiniRoom Bar
Pro,
Room BarRoom Kit,
Room Kit
MiniRoom Kit
EQX

Room 55

Room 55
Dual,
Room 70Room 70
G2Room 70
PanoramaRoom
Panorama

Network [n] IEEE8021X TlsVerify

Applies to: All products

Requires user role: ADMIN

Verification of the server-side certificate of an IEEE802.1x connection against the certificates in the local CA-list when TLS is used. The CA-list must be uploaded to the video device. This can be done from the device web interface.

This setting takes effect only when Network [1] IEEE8021X Eap Tls is enabled (On).

Default value:

Off

Value space:

Off/On

Off: When set to Off, TLS connections are allowed without verifying the server-side X.509 certificate against the local CA-list. This should typically be selected if no CA-list has been uploaded to the device.

On: When set to On, the server-side X.509 certificate will be validated against the local CA-list for all TLS connections. Only servers with a valid certificate will be allowed.

n: Index that identifies the network.

Range: 1..1

Network [n] IEEE8021X UseClientCertificate

Applies to: All products

Requires user role: ADMIN

Authentication using a private key/certificate pair during an IEEE802.1x connection. The authentication X.509 certificate must be uploaded to the video device. This can be done from the device web interface.

Default value:

Off

Value space:

Off/On

Off: When set to Off client-side authentication is not used (only server-side).

On: When set to On the client (video device) will perform a mutual authentication TLS handshake with the server.

n: Index that identifies the network.

Range: 1..1

Network [n] IEEE8021X Identity

Applies to: All products

Requires user role: ADMIN

Define the username for 802.1X authentication.

Default value:

""

Value space:

String (0, 64)

The username for 802.1X authentication.

n: Index that identifies the network.

Range: 1..1

Network [n] IEEE8021X Password

Applies to: All products

Requires user role: ADMIN

Define the password for 802.1X authentication.

Default value:

""

Value space:

String (0, 50)

The password for 802.1X authentication.

n: Index that identifies the network.

Range: 1..1

Board

Network [n] IEEE8021X AnonymousIdentity

Applies to: All products

Requires user role: ADMIN

The 802.1X Anonymous ID string is to be used as unencrypted identity with EAP (Extensible Authentication Protocol) types that support different tunneled identity, like EAP-PEAP and EAP-TTLS. If set, the anonymous ID will be used for the initial (unencrypted) EAP Identity Request.

Default value:

""

Value space:

String (0, 64)

The 802.1X Anonymous ID string.

n: Index that identifies the network.

Range: 1..1

BoardPro,
BoardPro
G2

Codec EQ

Codec
PlusCodec
ProDesk,
DeskPro,
DeskMiniRoom Bar
Pro,
Room BarRoom Kit,
Room Kit
MiniRoom Kit
EQX

Room 55

Room 55
Dual,
Room 70Room 70
G2Room 70
PanoramaRoom
Panorama

Network [n] IEEE8021X Eap Ttls

Applies to: All products

Requires user role: ADMIN

Define the TTLS (Tunneled Transport Layer Security) mode. Authenticates LAN clients without the need for client certificates. Developed by Funk Software and Certicom. Usually supported by Agere Systems, Proxim and Avaya.

Default value:

On

Value space:

Off/On

Off: The EAP-TTLS protocol is disabled.

On: The EAP-TTLS protocol is enabled.

n: Index that identifies the network.

Range: 1..1

Network [n] IEEE8021X Eap Tls

Applies to: All products

Requires user role: ADMIN

Enable or disable the use of EAP-TLS (Transport Layer Security) for IEEE802.1x connections. The EAP-TLS protocol, defined in RFC 5216, is considered one of the most secure EAP standards. LAN clients are authenticated using client certificates.

Default value:

On

Value space:

Off/On

Off: The EAP-TLS protocol is disabled.

On: The EAP-TLS protocol is enabled.

n: Index that identifies the network.

Range: 1..1

Board

Network [n] IEEE8021X Eap Peap

Applies to: All products

Requires user role: ADMIN

Define the Peap (Protected Extensible Authentication Protocol) mode. Authenticates LAN clients without the need for client certificates. Developed by Microsoft, Cisco and RSA Security.

Default value:

On

Value space:

Off/On

Off: The EAP-PEAP protocol is disabled.

On: The EAP-PEAP protocol is enabled.

n: Index that identifies the network.

Range: 1..1

Network [n] IPStack

Applies to: All products

Requires user role: ADMIN

Select if the device should use IPv4, IPv6, or dual IP stack, on the network interface. It may take up to 30 seconds before a change to this setting takes effect.

Default value:

Dual

Value space:

Dual/IPv4/IPv6

Dual: When set to Dual, the network interface can operate on both IP versions at the same time, and can have both an IPv4 and an IPv6 address at the same time.

IPv4: When set to IPv4, the device will use IPv4 on the network interface.

IPv6: When set to IPv6, the device will use IPv6 on the network interface.

n: Index that identifies the network.

Range: 1..1

Network [n] IPv4 Assignment

Applies to: All products

Requires user role: ADMIN

Define how the device will obtain its IPv4 address, subnet mask and gateway address.

The client identifier, which is used in the DHCP requests, is different for different products: MAC address (Touch 10), "01" followed by the MAC address (Room Kit, Room Kit Mini, Room 55, Room 70, Room 70 G2, Room 70 Panorama, Room Panorama, Board, Codec Plus, and Codec Pro), and DHCP Unique Identifier (DUID) as specified in RFC 4361 (other products, including Room Navigator).

Default value:

DHCP

Value space:

Static/DHCP

Static: The addresses must be configured manually using the Network IPv4 Address, Network IPv4 Gateway and Network IPv4 SubnetMask settings (static addresses).

DHCP: The device addresses are automatically assigned by the DHCP server.

n: Index that identifies the network.

Range: 1..1

Network [n] IPv4 Address

Applies to: All products

Requires user role: ADMIN

Define the static IPv4 network address for the device. Applicable only when Network IPv4 Assignment is set to Static.

Default value:

""

Value space:

String (0, 64)

A valid IPv4 address.

n: Index that identifies the network.

Range: 1..1

Board

Network [n] IPv4 Gateway

Applies to: All products

Requires user role: ADMIN

Define the IPv4 network gateway address. Applicable only when the Network IPv4 Assignment is set to Static.

Default value:

""

Value space:

String (0, 64)

A valid IPv4 address.

n: Index that identifies the network.

Range: 1..1

BoardPro,
BoardPro
G2

Codec EQ

Codec
PlusCodec
ProDesk,
DeskPro,
DeskMiniRoom Bar
Pro,
Room BarRoom Kit,
Room Kit
MiniRoom Kit
EQX

Room 55

Room 55
Dual,
Room 70Room 70
G2Room 70
PanoramaRoom
Panorama

Network [n] IPv4 InterfacelIdentifier

Applies to: All products

Requires user role: ADMIN

Select which identifier to use for IPv4 DHCP.

Default value:

Auto

Value space:

Auto/MAC/Opaque

MAC: The device will send "01" followed by the MAC address of the device as identifier.

Opaque: The device will use an RFC4361-based DHCP Unique Identifier (DUID); DUID-LL, based on the link-layer address with no timestamp.

Auto: The use of MAC or Opaque as identifier depends on the product. MAC address (Touch 10), "01" followed by the MAC address (Room Kit, Room Kit Mini, Room 55, Room 70, Room 70 G2, Room 70 Panorama, Room Panorama, Board, Codec Plus, and Codec Pro), and DHCP Unique Identifier (DUID) as specified in RFC 4361 (other products, including Room Navigator).

n: Index that identifies the network.

Range: 1..1

Network [n] IPv4 SubnetMask

Applies to: All products

Requires user role: ADMIN

Define the IPv4 network subnet mask. Applicable only when the Network IPv4 Assignment is set to Static.

Default value:

""

Value space:

String (0, 64)

A valid IPv4 address.

n: Index that identifies the network.

Range: 1..1

Network [n] IPv6 Assignment

Applies to: All products

Requires user role: ADMIN

Define how the device will obtain its IPv6 address, subnet mask and gateway address.

The client identifier, which is used in the DHCP requests, is different for different products: MAC address (Touch 10), "01" followed by the MAC address (Room Kit, Room Kit Mini, Room 55, Room 70, Room 70 G2, Room 70 Panorama, Room Panorama, Board, Codec Plus, and Codec Pro), and DHCP Unique Identifier (DUID) as specified in RFC 4361 (other products, including Room Navigator).

Default value:

Autoconf

Value space:

Static/DHCPv6/Autoconf

Static: The device and gateway IP addresses must be configured manually using the Network IPv6 Address and Network IPv6 Gateway settings. The options, for example NTP and DNS server addresses, must either be set manually or obtained from a DHCPv6 server. The Network IPv6 DHCPOptions setting determines which method to use.

DHCPv6: All IPv6 addresses, including options, will be obtained from a DHCPv6 server. See RFC 3315 for a detailed description. The Network IPv6 DHCPOptions setting will be ignored.

Autoconf: Enable IPv6 stateless autoconfiguration of the IPv6 network interface. See RFC 4862 for a detailed description. The options, for example NTP and DNS server addresses, must either be set manually or obtained from a DHCPv6 server. The Network IPv6 DHCPOptions setting determines which method to use.

n: Index that identifies the network.

Range: 1..1

Board

Network [n] IPv6 Address

Applies to: All products

Requires user role: ADMIN

Define the static IPv6 network address for the device. Applicable only when the Network IPv6 Assignment is set to Static.

Default value:

""

Value space:

String (0, 64)

A valid IPv6 address including a network mask. Example: 2001:DB8::/48

n: Index that identifies the network.

Range: 1..1

BoardPro,
BoardPro
G2

Codec EQ

Codec
PlusCodec
ProDesk,
DeskPro,
DeskMiniRoom Bar
Pro,
Room BarRoom Kit,
Room Kit
MiniRoom Kit
EQX

Room 55

Room 55
Dual,
Room 70Room 70
G2Room 70
PanoramaRoom
Panorama

Network [n] IPv6 DHCPOptions

Applies to: All products

Requires user role: ADMIN

Retrieve a set of DHCP options, for example NTP and DNS server addresses, from a DHCPv6 server.

Default value:

On

Value space:

Off/On

Off: Disable the retrieval of DHCP options from a DHCPv6 server.

On: Enable the retrieval of a selected set of DHCP options from a DHCPv6 server.

n: Index that identifies the network.

Range: 1..1

Network [n] IPv6 InterfacelIdentifier

Applies to: All products

Requires user role: ADMIN

Define the IPv6 interface identifier for the device. The interface identifier you choose, either MAC or Opaque, will determine the method that is used for generating part of the the IPv6 address. This is applicable to both link-local IPv6 addresses and Stateless Address Autoconfiguration (SLAAC) addresses.

The address contains a 64-bit prefix and a 64-bit interface identifier generated by the device. With MAC, an EUI-64 based interface identifier is generated, as described in RFC-2373.

With Opaque, a random 64-bit interface identifier is generated as described in RFC-7217 on the first boot of the device, and this is used forever, or until factory reset.

Default value:

MAC

Value space:

MAC/Opaque

MAC: Select MAC as the Interface Identifier method.

Opaque: Select Opaque as the Interface Identifier method.

n: Index that identifies the network.

Range: 1..1

Board

Network [n] MTU

Applies to: All products

Requires user role: ADMIN

Define the Ethernet MTU (Maximum Transmission Unit) size. The MTU size must be supported by your network infrastructure. The minimum size is 576 for IPv4 and 1280 for IPv6.

Default value:

1500

Value space:

Integer (576..1500)

Set a value for the MTU (bytes).

n: Index that identifies the network.

Range: 1..1

Network [n] QoS Mode

Applies to: All products

Requires user role: ADMIN

The QoS (Quality of Service) is a method which handles the priority of audio, video and other data in the network. The QoS settings must be supported by the infrastructure. DiffServ (Differentiated Services) is a networking architecture that specifies a simple, scalable and coarse-grained mechanism for classifying and managing network traffic. It provides QoS priorities on IP networks.

Default value:

Diffserv

Value space:

Off/Diffserv

Off: No QoS method is used.

Diffserv: The Network QoS Diffserv Audio, Network QoS Diffserv Video, Network QoS Diffserv Data, Network QoS Diffserv Signalling, Network QoS Diffserv ICMPv6 and Network QoS Diffserv NTP settings are used to prioritize packets.

n: Index that identifies the network.

Range: 1..1

Network [n] QoS Diffserv Audio

Applies to: All products

Requires user role: ADMIN

This setting takes effect only if Network QoS Mode is set to Diffserv.

Define which priority Audio packets should have in the IP network. The traffic classes recommended in the DiffServ RFCs map to a decimal value between 0 and 63. We recommend you use EF for Audio. EF equals the decimal value 46. This setting also applies to WebRTC meetings.

The priority set here might be overridden when packets are leaving the network controlled by the local network administrator.

Default value:

46

Value space:

Integer (0..63)

Set the priority of the audio packets in the IP network. 0 means "best-effort".

n: Index that identifies the network.

Range: 1..1

Network [n] QoS Diffserv Video

Applies to: All products

Requires user role: ADMIN

This setting takes effect only if Network QoS Mode is set to Diffserv.

Define which priority Video packets should have in the IP network. The packets of the presentation channel (shared content) are also in the Video packet category. The traffic classes recommended in the DiffServ RFCs map to a decimal value between 0 and 63. We recommend you use AF41 for Video. AF41 equals the decimal value 34. This setting also applies to WebRTC meetings.

The priority set here might be overridden when packets are leaving the network controlled by the local network administrator.

Default value:

34

Value space:

Integer (0..63)

Set the priority of the video packets in the IP network. 0 means "best-effort".

n: Index that identifies the network.

Range: 1..1

Board

Network [n] QoS Diffserv Data

Applies to: All products

Requires user role: ADMIN

This setting takes effect only if Network QoS Mode is set to Diffserv.

Define which priority Data packets should have in the IP network. The traffic classes recommended in the DiffServ RFCs map to a decimal value between 0 and 63. We recommend you use AF41 for Data. AF41 equals the decimal value 34.

The priority set here might be overridden when packets are leaving the network controlled by the local network administrator.

Default value:

34

Value space:

Integer (0..63)

Set the priority of the data packets in the IP network. 0 means "best-effort".

n: Index that identifies the network.

Range: 1..1

Network [n] QoS Diffserv Signalling

Applies to: All products

Requires user role: ADMIN

This setting takes effect only if Network QoS Mode is set to Diffserv.

Define which priority Signalling packets that are deemed critical (time-sensitive) for the real-time operation should have in the IP network. The traffic classes recommended in the DiffServ RFCs map to a decimal value between 0 and 63. We recommend you use CS3 for Signalling. CS3 equals the decimal value 24.

The priority set here might be overridden when packets are leaving the network controlled by the local network administrator.

Default value:

24

Value space:

Integer (0..63)

Set the priority of the signalling packets in the IP network. 0 means "best-effort".

n: Index that identifies the network.

Range: 1..1

Network [n] QoS Diffserv ICMPv6

Applies to: All products

Requires user role: ADMIN

This setting takes effect only if Network QoS Mode is set to Diffserv.

Define which priority ICMPv6 packets should have in the IP network. The traffic classes recommended in the DiffServ RFCs map to a decimal value between 0 and 63. We recommend you use 0 for ICMPv6.

The priority set here might be overridden when packets are leaving the network controlled by the local network administrator.

Default value:

0

Value space:

Integer (0..63)

Set the priority of the ICMPv6 packets in the IP network. 0 means "best effort".

n: Index that identifies the network.

Range: 1..1

Network [n] QoS Diffserv NTP

Applies to: All products

Requires user role: ADMIN

This setting takes effect only if Network QoS Mode is set to Diffserv.

Define which priority NTP packets should have in the IP network. The traffic classes recommended in the DiffServ RFCs map to a decimal value between 0 and 63. We recommend you use 0 for NTP.

The priority set here might be overridden when packets are leaving the network controlled by the local network administrator.

Default value:

0

Value space:

Integer (0..63)

Set the priority of the NTP packets in the IP network. 0 means "best-effort".

n: Index that identifies the network.

Range: 1..1

Board

BoardPro,
BoardPro
G2

Codec EQ

Codec
PlusCodec
ProDesk,
DeskPro,
DeskMiniRoom Bar
Pro,
Room BarRoom Kit,
Room Kit
MiniRoom Kit
EQX

Room 55

Room 55
Dual,
Room 70Room 70
G2Room 70
PanoramaRoom
Panorama

Network [n] RemoteAccess Allow

Applies to: All products

Requires user role: ADMIN

Define which IP addresses (IPv4/IPv6) are allowed for remote access to the device from SSH/HTTP/HTTPS. Multiple IP addresses are separated by a white space.

A network mask (IP range) is specified by <ip address>/N, where N is 1-32 for IPv4, and N is 1-128 for IPv6. The /N is a common indication of a network mask where the first N bits are set. Thus 192.168.0.0/24 would match any address starting with 192.168.0, since these are the first 24 bits in the address.

Default value:

""

Value space:

String (0, 255)

A valid IPv4 address or IPv6 address.

n: Index that identifies the network.

Range: 1..1

Network [n] Speed

Applies to: All products

Requires user role: ADMIN, INTEGRATOR

Define the Ethernet link speed. We recommend not to change from the default value, which negotiates with the network to set the speed automatically. If you do not use auto-negotiation, make sure that the speed you choose is supported by the closest switch in your network infrastructure.

Default value:

Auto

Value space:

Auto/10half/10full/100half/100full/1000full

Auto: Auto-negotiate link speed.

10half: Force link to 10 Mbps half-duplex.

10full: Force link to 10 Mbps full-duplex.

100half: Force link to 100 Mbps half-duplex.

100full: Force link to 100 Mbps full-duplex.

1000full: Force link to 1 Gbps full-duplex.

n: Index that identifies the network.

Range: 1..1

Network [n] TrafficControl Mode

Applies to: All products

Requires user role: ADMIN

Define the network traffic control mode to decide how to control the video packets transmission speed.

Default value:

On

Value space:

Off/On

Off: Transmit video packets at link speed.

On: Transmit video packets at maximum 20 Mbps. Can be used to smooth out bursts in the outgoing network traffic.

n: Index that identifies the network.

Range: 1..1

Network [n] VLAN Voice Mode

Applies to: All products

Requires user role: ADMIN

Define the VLAN voice mode. The VLAN Voice Mode will be set to Auto automatically if you have Cisco UCM (Cisco Unified Communications Manager) as provisioning infrastructure. Note that Auto mode will NOT work if the NetworkServices CDP Mode setting is Off.

Default value:

Auto

Value space:

Auto/Manual/Off

Auto: The Cisco Discovery Protocol (CDP), if available, assigns an id to the voice VLAN. If CDP is not available, VLAN is not enabled.

Manual: The VLAN ID is set manually using the Network VLAN Voice VlanId setting. If CDP is available, the manually set value will be overruled by the value assigned by CDP.

Off: VLAN is not enabled.

n: Index that identifies the network.

Range: 1..1

Board

BoardPro,
BoardPro
G2

Codec EQ

Codec
PlusCodec
ProDesk,
DeskPro,
DeskMiniRoom Bar
Pro,
Room BarRoom Kit,
Room Kit
MiniRoom Kit
EQX

Room 55

Room 55
Dual,
Room 70Room 70
G2Room 70
PanoramaRoom
Panorama

Network [n] VLAN Voice VlanId

Applies to: All products

Requires user role: ADMIN

Define the VLAN voice ID. This setting will only take effect if Network VLAN Voice Mode is set to Manual.

Default value:

1

Value space:

Integer (1..4094)

Set the VLAN voice ID.

n: Index that identifies the network.

Range: 1..1

NetworkServices settings

NetworkServices CDP Mode

Applies to: All products

Requires user role: ADMIN

Enable or disable the CDP (Cisco Discovery Protocol) daemon. Enabling CDP will make the device report certain statistics and device identifiers to a CDP-enabled switch. If CDP is disabled, the Network VLAN Voice Mode: Auto setting will not work.

Default value:

On

Value space:

Off/On

Off: The CDP daemon is disabled.

On: The CDP daemon is enabled.

NetworkServices CommonProxy

Applies to: All products

Requires user role: ADMIN

A new proxy support module is being phased in gradually in RoomOS. Use this setting to enable or disable the new module. When enabled all outgoing HTTP/S traffic from RoomOS goes through the new support module.

This setting will be removed once the switchover to the new module is complete.

The main visible effect of enabling it in the current software release is that the web engine on locally paired Room Navigators will gain access to the internet (using HTTP proxies as configured on the device). It is also a requirement for the NetworkServices HTTP Proxy Authentication Method setting to take effect.

Default value:

Disabled

Value space:

Disabled/Enabled

Board

NetworkServices H323 Mode

Applies to: All products

Requires user role: ADMIN

Define whether the device should be able to place and receive H.323 calls or not.

Default value:

Off

Value space:

Off/On

Off: Disable the possibility to place and receive H.323 calls.

On: Enable the possibility to place and receive H.323 calls.

BoardPro,
BoardPro
G2

Codec EQ

Codec
PlusCodec
ProDesk,
DeskPro,
DeskMiniRoom Bar
Pro,
Room BarRoom Kit,
Room Kit
MiniRoom Kit
EQX

Room 55

Room 55
Dual,
Room 70Room 70
G2Room 70
PanoramaRoom
Panorama

NetworkServices HTTP Mode

Applies to: All products

Requires user role: ADMIN

Define whether or not to allow access to the device using the HTTP or HTTPS (HTTP Secure) protocols. Note that the device web interface use HTTP or HTTPS. If this setting is switched Off, you cannot use the device web interface.

For additional security (encryption and decryption of requests and pages that are returned by the web server), allow only HTTPS.

Note: The default value is HTTP+HTTPS for devices that have been upgraded to CE9.4 (or later) from an earlier software version, provided that the device has not been factory reset after the upgrade.

Default value:

HTTPS (changed from HTTP+HTTPS to HTTPS in CE9.4)

Value space:

Off/HTTP+HTTPS/HTTPS

Off: Access to the device is not allowed via HTTP or HTTPS.

HTTP+HTTPS: Access to the device is allowed via both HTTP and HTTPS.

HTTPS: Access to the device is allowed via HTTPS, but not via HTTP.

NetworkServices HTTP Proxy Authentication Method

Applies to: All products

Requires user role: ADMIN

When the device is configured to use an HTTP proxy with authentication, setting this to Basic makes the device send the outgoing proxy-authentication header in the initial HTTP CONNECT, saving an HTTP authentication challenge/response round trip for each new connection.

The NetworkServices CommonProxy setting must be set to Enabled for this setting to take effect.

Default value:

Auto

Value space:

Auto/Basic

Auto: The device will choose authentication scheme automatically, as described in the NetworkServices HTTP Proxy LoginName setting.

Basic: Only the Basic HTTP authentication scheme will be used. The outgoing proxy-authentication header will be sent without a separate authentication challenge from the proxy.

NetworkServices HTTP Proxy LoginName

Applies to: All products

Requires user role: ADMIN

This is the username part of the credentials for authentication towards the HTTP proxy. We support the following HTTP authentication schemes: Digest using the MD5 algorithm, and the Basic HTTP authentication scheme.

Default value:

""

Value space:

String (0, 80)

The authentication login name.

Board

BoardPro,
BoardPro
G2

Codec EQ

Codec
PlusCodec
ProDesk,
DeskPro,
DeskMiniRoom Bar
Pro,
Room BarRoom Kit,
Room Kit
MiniRoom Kit
EQX

Room 55

Room 55
Dual,
Room 70Room 70
G2Room 70
PanoramaRoom
Panorama

NetworkServices HTTP Proxy Mode

Applies to: All products

Requires user role: ADMIN

You can configure a proxy server for HTTP, HTTPS, and WebSocket traffic. The HTTP proxy can be set up manually, it can be auto-configured (PACUrl), fully automated (WPAD), or it can be turned off.

If NetworkServices HTTP Proxy Mode is not turned Off, you can further specify which services shall use the proxy in the HttpClient UseHttpProxy, HttpFeedback UseHttpProxy, and WebEngine UseHttpProxy settings.

Communication with the Webex cloud will always go via the proxy if NetworkServices HTTP Proxy Mode is not turned Off.

Regardless of the Proxy Mode, the device will never communicate with CUCM or MRA (CUCM via Expressway) via proxy.

If NetworkServices CommonProxy is set to Enabled, HTTP proxy authentication is supported in all proxy modes. The authentication data is configured in the NetworkServices HTTP Proxy LoginName/Password settings. A PAC file can return any number of different proxies for a given request; the device will try to authenticate using these credentials to any proxy requesting it. If NetworkServices CommonProxy set to Disabled, HTTP proxy authentication is supported only in Manual proxy mode.

Default value:

Off

Value space:

Manual/Off/PACUrl/WPAD

Manual: Enter the address of the proxy server in the NetworkServices HTTP Proxy URL setting.

Off: The HTTP proxy mode is turned off.

PACUrl: The HTTP proxy is auto-configured. You must enter the URL for the PAC (Proxy Auto Configuration) script in the NetworkServices HTTP Proxy PACUrl setting.

WPAD: With WPAD (Web Proxy Auto Discovery) the HTTP proxy is fully automated and auto-configured.

NetworkServices HTTP Proxy PACUrl

Applies to: All products

Requires user role: ADMIN

Set the URL of the PAC (Proxy Auto Configuration) script. Requires that the NetworkServices HTTP Proxy Mode is set to PACUrl.

Default value:

""

Value space:

String (0, 255)

The URL of the PAC (Proxy Auto Configuration) script.

NetworkServices HTTP Proxy Password

Applies to: All products

Requires user role: ADMIN

This is the password part of the credentials for authentication towards the HTTP proxy. We support the following HTTP authentication schemes: Digest using the MD5 algorithm, and the Basic HTTP authentication scheme.

Default value:

""

Value space:

String (0, 64)

The authentication password.

NetworkServices HTTP Proxy Url

Applies to: All products

Requires user role: ADMIN

Set the URL of the HTTP proxy server. Requires that the NetworkServices HTTP Proxy Mode is set to Manual.

Default value:

""

Value space:

String (0, 255)

The URL of the HTTP proxy server.

Board

BoardPro,
BoardPro
G2

Codec EQ

Codec
PlusCodec
ProDesk,
DeskPro,
DeskMiniRoom Bar
Pro,
Room BarRoom Kit,
Room Kit
MiniRoom Kit
EQX

Room 55

Room 55
Dual,
Room 70Room 70
G2Room 70
PanoramaRoom
Panorama

NetworkServices HTTPS OCSP Mode

Applies to: All products

Requires user role: ADMIN

When a client certificate is used as login credentials to the web user interface and xConfiguration NetworkServices HTTPS VerifyClientCertificate is enabled, an Online Certificate Status Protocol (OCSP) responder service can be used to verify the client certificate's revocation status.

If Mode is set to On, the web UI examines the client certificate for an OCSP URL and contacts the host to check the client's certificate validity status.

Default value:

Off

Value space:

Off/On

Off/On: Disable/enable OSCP client certificate verification.

NetworkServices HTTPS OCSP URL

Applies to: All products

Requires user role: ADMIN

Specify the URL of the OCSP server that will be used to check the client's certificate validity status.

Default value:

""

Value space:

String (0, 255)

A valid URL.

NetworkServices HTTPS Server MinimumTLSVersion

Applies to: All products

Requires user role: ADMIN

Set the lowest version of the TLS (Transport Layer Security) protocol that is allowed for HTTPS.

Default value:

TLSv1.2

Value space:

TLSv1.1/TLSv1.2/TLSv1.3

TLSv1.1: Support of TLS version 1.1 or higher.

TLSv1.2: Support of TLS version 1.2 or higher.

TLSv1.3: Support of TLS version 1.3 or higher.

NetworkServices HTTPS StrictTransportSecurity

Applies to: All products

Requires user role: ADMIN

The HTTP Strict Transport Security header lets a web site inform the browser that it should never load the site using HTTP and should automatically convert all attempts to access the site using HTTP to HTTPS requests instead.

Default value:

Off

Value space:

Off/On

Off: The HTTP strict transport security feature is disabled.

On: The HTTP strict transport security feature is enabled.

NetworkServices HTTPS VerifyClientCertificate

Applies to: All products

Requires user role: ADMIN

When the video device connects to an HTTPS client (like a web browser), the client can be asked to present a certificate to the video device to identify itself.

Default value:

Off

Value space:

Off/On

Off: Do not verify client certificates.

On: Requires the client to present a certificate that is signed by a trusted Certificate Authority (CA). This requires that a list of trusted CAs are uploaded to the device in advance.

Board

BoardPro,
BoardPro
G2

Codec EQ

Codec
PlusCodec
ProDesk,
DeskPro,
DeskMiniRoom Bar
Pro,
Room BarRoom Kit,
Room Kit
MiniRoom Kit
EQX

Room 55

Room 55
Dual,
Room 70Room 70
G2Room 70
PanoramaRoom
Panorama

NetworkServices NTP Mode

Applies to: All products

Requires user role: ADMIN

The Network Time Protocol (NTP) is used to synchronize the device's time and date to a reference time server. The time server will be queried regularly for time updates.

Default value:

Auto

Value space:

Auto/Manual/Off

Auto: The device will use an NTP server for time reference. As default, the server address will be obtained from the network's DHCP server. If a DHCP server is not used, or if the DHCP server does not provide an NTP server address, the NTP server address that is specified in the NetworkServices NTP Server [n] Address setting will be used.

Manual: The device will use the NTP server that is specified in the NetworkServices NTP Server [n] Address setting for time reference.

Off: The device will not use an NTP server. The NetworkServices NTP Server [n] Address setting will be ignored.

NetworkServices NTP Server [n] Address

Applies to: All products

Requires user role: ADMIN

The address of the NTP server that will be used when NetworkServices NTP Mode is set to Manual, and when NetworkServices NTP Mode is set to Auto and no address is supplied by a DHCP server.

Default value:

"0.tandberg.pool.ntp.org"

Value space:

String (0, 255)

A valid IPv4 address, IPv6 address or DNS name.

n: Unique ID for the NTP server.

Range: 1..3

NetworkServices NTP Server [n] Key

Applies to: All products

Requires user role: ADMIN

To make sure that the NTP information comes from a trusted source, the video device must know the ID/key pair that the NTP source uses. Use the NetworkServices NTP Server [n] Key setting to supply the key. Prefix the key with "HEX:".

Default value:

""

Value space:

String (0, 2045)

The key, which is part of the ID/key pair that the NTP source uses.

n: Unique ID for the NTP server.

Range: 1..3

NetworkServices NTP Server [n] KeyId

Applies to: All products

Requires user role: ADMIN

To make sure that the NTP information comes from a trusted source, the video device must know the ID/key pair that the NTP source uses. Use the NetworkServices NTP Server [n] KeyId settings for the ID.

Default value:

""

Value space:

String (0, 10)

The ID, which is part of the ID/key pair that the NTP source uses.

n: Unique ID for the NTP server.

Range: 1..3

Board

NetworkServices NTP Server [n] KeyAlgorithm

Applies to: All products

Requires user role: ADMIN

Choose the authentication hash function that the NTP server uses, and that the video device must use to authenticate the time messages.

Default value:

""

Value space:

None/SHA1/SHA256

None: The NTP server doesn't use a hash function.

SHA1: The NTP server uses the SHA-1 hash function.

SHA256: The NTP server uses the SHA-256 hash function (from the SHA-2 family of hash functions).

n: Unique ID for the NTP server.

Range: 1..3

NetworkServices PTP Priority

Applies to: RoomBarPro RoomKitEQX CodecEQ BoardProG2

Requires user role: ADMIN

Determines the codec PTP priority on the codec internal network. The device with the highest PTP priority will be elected as timeLeader. Lower value means higher priority.

Default value:

255

Value space:

Integer (0..255)

Adjust this value on the codec you want to make timeLeader in relation to the rest of the devices on the codec internal network.

NetworkServices SIP Mode

Applies to: All products

Requires user role: ADMIN

Define whether the device should be able to place and receive SIP calls or not.

Default value:

On

Value space:

Off/On

Off: Disable the possibility to place and receive SIP calls.

On: Enable the possibility to place and receive SIP calls.

NetworkServices SMTP Mode

Applies to: RoomKitMini RoomBar RoomBarPro RoomKitEQX CodecEQ CodecPro DeskMini Desk DeskPro Board BoardPro BoardProG2

Requires user role: ADMIN

You can set up the device to use SMTP (Simple Mail Transfer Protocol) for sending email from the device to a mail server for relaying. This is required if you want to allow users to send their whiteboards and presentations via email to people inside or outside their organization.

If the device is set up for encrypted communication (see the NetworkServices SMTP Security setting), the device only allows connections where the SMTP server's certificate is validated. There is no option for ignoring the certificate check.

SMTP is available only on devices with a touch screen (either built-in or connected). Room Kit Mini must be used with Samsung Flip (Webex on Flip).

Default value:

Off

Value space:

Off/On

Off: Disable SMTP (and email) support.

On: Enable SMTP support for sending email.

BoardPro,
BoardPro
G2

Codec EQ

Codec
PlusCodec
ProDesk,
DeskPro,
DeskMiniRoom Bar
Pro,
Room BarRoom Kit,
Room Kit
MiniRoom Kit
EQX

Room 55

Room 55
Dual,
Room 70Room 70
G2Room 70
PanoramaRoom
Panorama

Board

NetworkServices SMTP Server

Applies to: RoomKitMini RoomBar RoomBarPro RoomKitEQX CodecEQ CodecPro DeskMini Desk DeskPro Board BoardPro BoardProG2

Requires user role: ADMIN

This is the address of the SMTP server.

SMTP is available only on devices with a touch screen (either built-in or connected). Room Kit Mini must be used with Samsung Flip (Webex on Flip).

Default value:

""

Value space:

String (0, 255)

A valid IPv4 address, IPv6 address or DNS name.

BoardPro
BoardPro
G2

Codec EQ

Codec
PlusCodec
ProDesk,
DeskPro,
DeskMiniRoom Bar
Pro,
Room BarRoom Kit,
Room Kit
MiniRoom Kit
EQX

Room 55

Room 55
Dual,
Room 70Room 70
G2Room 70
PanoramaRoom
Panorama

NetworkServices SMTP Username

Applies to: RoomKitMini RoomBar RoomBarPro RoomKitEQX CodecEQ CodecPro DeskMini Desk DeskPro Board BoardPro BoardProG2

Requires user role: ADMIN

This is the username part of the credentials that are used to authenticate the device with the SMTP server. This setting may be required by the SMTP server.

SMTP is available only on devices with a touch screen (either built-in or connected). Room Kit Mini must be used with Samsung Flip (Webex on Flip).

Default value:

""

Value space:

String (0, 80)

A valid username.

NetworkServices SMTP Password

Applies to: RoomKitMini RoomBar RoomBarPro RoomKitEQX CodecEQ CodecPro DeskMini Desk DeskPro Board BoardPro BoardProG2

Requires user role: ADMIN

This is the password part of the credentials that are used to authenticate the device with the SMTP server. This setting may be required by the SMTP server.

SMTP is available only on devices with a touch screen (either built-in or connected). Room Kit Mini must be used with Samsung Flip (Webex on Flip).

Default value:

""

Value space:

String (0, 64)

A valid password.

NetworkServices SMTP Port

Applies to: RoomKitMini RoomBar RoomBarPro RoomKitEQX CodecEQ CodecPro DeskMini Desk DeskPro Board BoardPro BoardProG2

Requires user role: ADMIN

This port is used for outgoing emails from the device to the SMTP server.

Set a port number based on the encryption setting (NetworkServices SMTP Security) and the requirements of the SMTP server. Do not use the default value.

SMTP is available only on devices with a touch screen (either built-in or connected). Room Kit Mini must be used with Samsung Flip (Webex on Flip).

Default value:

0

Value space:

Integer (0..65535)

The port used for outgoing emails from the device.

Board

NetworkServices SMTP From

Applies to: RoomKitMini RoomBar RoomBarPro RoomKitEQX CodecPro DeskMini Desk DeskPro Board BoardPro BoardProG2

Requires user role: ADMIN

When sending an email message from this device, this is the name of the mailbox that the message is sent from.

SMTP is available only on devices with a touch screen (either built-in or connected). Room Kit Mini must be used with Samsung Flip (Webex on Flip).

Default value:

""

Value space:

String (0, 255)

An email address that meets the requirements of the SMTP server.

NetworkServices SMTP Security

Applies to: RoomKitMini RoomBar RoomBarPro RoomKitEQX CodecEQ CodecPro DeskMini Desk DeskPro Board BoardPro BoardProG2

Requires user role: ADMIN

Choose if and how to secure the communication between the device and the SMTP server.

SMTP is available only on devices with a touch screen (either built-in or connected). Room Kit Mini must be used with Samsung Flip (Webex on Flip).

Default value:

StartTls

Value space:

None/StartTls/Tls

None: Connect to the SMTP server without encryption.

StartTls: Initially connect to the SMTP server without encryption, and then send a STARTTLS command to upgrade to an encrypted connection (TLS).

Tls: Connect to the SMTP server over TLS (Transport Layer Security).

BoardPro,
BoardPro
G2

Codec EQ

Codec
PlusCodec
ProDesk,
DeskPro,
DeskMiniRoom Bar
Pro,
Room BarRoom Kit,
Room Kit
MiniRoom Kit
EQX

Room 55

Room 55
Dual,
Room 70Room 70
G2Room 70
PanoramaRoom
Panorama

NetworkServices SNMP CommunityName

Applies to: All products

Requires user role: ADMIN, INTEGRATOR

Define the name of the SNMP community. The SNMP community name is used to authenticate SNMP requests when using SNMP v2c. If an SNMP request from a management system does not include a matching community name (case sensitive), the message is dropped and the SNMP agent in the video device will not send a response.

If you have the Cisco TelePresence Management Suite (TMS) you must make sure the same SNMP community is configured there.

This setting has no effect if using SNMP v3; users and authentication for SNMP v3 is managed using the Network SNMP USM User commands.

Default value:

""

Value space:

String (0, 50)

The SNMP community name. An empty string means that SNMP v2c is not supported.

NetworkServices SNMP Mode

Applies to: All products

Requires user role: ADMIN, INTEGRATOR

SNMP (Simple Network Management Protocol) is used by network management systems to monitor and manage network devices. The video device supports both SNMP v2c and v3. In both cases the device exposes the following object identifiers (OIDs), so that management systems can read and write basic parameters: SNMPv2-MIB::sysDescr (read), SNMPv2 -MIB::sysObjectID (read), DISMAN-EVENT-MIB::sysUpTimeInstance (read), SNMPv2 -MIB::sysContact (read/write), SNMPv2 -MIB::sysName (read/write), SNMPv2 -MIB::sysLocation (read/write), and SNMPv2 -MIB::sysServices (read).

You can limit the SNMP support to v3 only, by setting the NetworkServices SNMP CommunityName to an empty string ("").

Default value:

Off

Value space:

Off/ReadOnly/ReadWrite

Off: Disable the SNMP network service.

ReadOnly: Enable the SNMP network service for queries only.

ReadWrite: Enable the SNMP network service for both queries and commands.

Board

NetworkServices SNMP SystemContact

Applies to: All products

Requires user role: ADMIN, INTEGRATOR

Define contact information that SNMP servers can use.

Default value:

""

Value space:

String (0, 50)

String that describes the contact information for the video device.

BoardPro,
BoardPro
G2

Codec EQ

Codec
PlusCodec
ProDesk,
DeskPro,
DeskMiniRoom Bar
Pro,
Room BarRoom Kit,
Room Kit
MiniRoom Kit
EQX

Room 55

Room 55
Dual,
Room 70Room 70
G2Room 70
PanoramaRoom
Panorama

NetworkServices SNMP SystemLocation

Applies to: All products

Requires user role: ADMIN, INTEGRATOR

Defines location information that SNMP servers can use.

Default value:

""

Value space:

String (0, 50)

String that describes the location of the video device.

NetworkServices SSH KeyExchangeAlgorithms AllowLegacy

Applies to: All products

Requires user role: ADMIN

Specifies whether legacy SSH key exchange algorithms are allowed.

Default value:

On

Value space:

Off/On

Off: The legacy algorithms are disallowed.

On:The legacy algorithms are allowed.

NetworkServices SSH Mode

Applies to: All products

Requires user role: ADMIN

The SSH (or Secure Shell) protocol can provide secure encrypted communication between the video device and your local computer.

Default value:

On

Value space:

Off/On

Off: The SSH protocol is disabled.

On: The SSH protocol is enabled.

NetworkServices SSH HostKeyAlgorithm

Applies to: All products

Requires user role: ADMIN

Choose the cryptographic algorithm that shall be used for the SSH host key. Choices are RSA (Rivest-Shamir-Adleman) with 2048 bits keysize, ECDSA (Elliptic Curve Digital Signature Algorithm) with NIST curve P-384, and EdDSA (Edwards-curve Digital Signature Algorithm) with ed25519 signature schema.

Default value:

RSA

Value space:

ECDSA/RSA/ed25519

ECDSA: Use the ECDSA algorithm (nist-384p).

RSA: Use the RSA algorithm (2048 bits).

ed25519: Use the ed25519 algorithm.

Board

NetworkServices UPnP Mode

Applies to: All products

Requires user role: ADMIN

Fully disable UPnP (Universal Plug and Play), or enable UPnP for a short time period after the video device has been switched on or restarted.

The default operation is that UPnP is enabled when you switch on or restart the video device. Then UPnP is automatically disabled after the timeout period that is defined in the NetworkServices UPnP Timeout setting.

When UPnP is enabled, the device advertises its presence on the network. The advertisement permits a touch controller to discover video devices automatically, and you do not need to manually enter the device's IP address in order to pair the touch controller.

Default value:

On

Value space:

Off/On

Off: UPnP is disabled. The video device does not advertise its presence, and you have to enter the device's IP address manually in order to pair a touch controller to the device.

On: UPnP is enabled. The video device advertises its presence until the timeout period expires.

Desk,
Desk Pro,
Desk MiniRoom Bar
Pro,
Room BarRoom Kit,
Room Kit
MiniRoom Kit
EQX

Room 55

Room 55
Dual,
Room 70Room 70
G2Room 70
PanoramaRoom
Panorama

NetworkServices Websocket

Applies to: All products

Requires user role: ADMIN

It is possible to interact with the API of the device over the WebSocket protocol, both the insecure and secure versions (ws and wss). A WebSocket is tied to HTTP, so that also HTTP or HTTPS must be enabled before you can use WebSockets (see the NetworkServices HTTP Mode setting).

Default value:

FollowHTTPService

Value space:

FollowHTTPService/Off

FollowHTTPService: Communication over the WebSocket protocol is allowed when HTTP or HTTPS is enabled.

Off: Communication over the WebSocket protocol is not allowed.

NetworkServices WelcomeText

Applies to: All products

Requires user role: ADMIN

Choose which information the user should see when logging on to the device through SSH.

Default value:

On

Value space:

Off/On

Off: The welcome text is: Login successful

On: The welcome text is: Welcome to <system name>; Software version; Software release date; Login successful.

NetworkServices UPnP Timeout

Applies to: All products

Requires user role: ADMIN

Define for how many seconds UPnP shall stay enabled after the device is switched on or restarted. The NetworkServices UPnP Mode setting must be On for this setting to take any effect.

Default value:

600

Value space:

Integer (0..3600)

Range: Select a value between 0 and 3600 seconds.

Board

BoardPro,
BoardPro
G2

Codec EQ

Codec
PlusCodec
ProDesk,
DeskPro,
DeskMiniRoom Bar
Pro,
Room BarRoom Kit,
Room Kit
MiniRoom Kit
EQX

Room 55

Room 55
Dual,
Room 70Room 70
G2Room 70
PanoramaRoom
Panorama

NetworkServices Wifi Allowed

Applies to: All products

Requires user role: ADMIN, USER

Devices that have a built-in Wi-Fi adapter, can connect to the network either via Ethernet or Wi-Fi. Both Ethernet and Wi-Fi are allowed by default, and the user can choose which one to use from the user interface. With this setting, the administrator can disable Wi-Fi configuration, so that it cannot be set up from the user interface.

The devices support the following standards: IEEE 802.11a, IEEE 802.11b, IEEE 802.11g, IEEE 802.11n, and IEEE 802.11ac. Codec EQ and Room Bar Pro also support IEEE 802.11ax.

The devices support both open and secured networks. They support WPA2 and WPA3 for Personal or Enterprise, with SHA-128, SHA-256, or Fast Transition (802.11r) key management.

For Personal the following key management protocols are supported: WPA2-PSK and WPA3-SAE, both with CCMP128 (AES) cipher. For Enterprise, IEEE 802.1X (EAP) with CCMP128 (AES) cipher can be used. The following EAP-types are supported: EAP-TLS, EAP-TTLS, EAP-FAST, PEAP (with EAP-MSCHAPv2 or EAP-GTC).

If the PID (Product ID), found on the rating label at the rear of the device, contains the letters NR (No Radio) the device does not support Wi-Fi.

Default value:

True

Value space:

False/True

False: Wi-Fi cannot be used. You must connect to the network via Ethernet.

True: Both Ethernet and Wi-Fi are allowed.

NetworkServices Wifi Settings FrequencyBand

Applies to: All products

Requires user role: ADMIN

Set which frequency band to use when connecting the device to the network via Wi-Fi.

Default value:

Auto

Value space:

2_4Ghz/5Ghz/Auto [RoomKit RoomKitMini RoomBar CodecPlus CodecPro Room55 Room70/Room55D Room70G2 RoomPanorama/Room70Panorama DeskMini Desk DeskPro Board BoardPro]

2_4Ghz/5Ghz/6Ghz/Auto [RoomBarPro RoomKitEQX CodecEQ BoardProG2]

2_4Ghz: Use the 2.4 GHz band.

5Ghz: Use the 5 GHz band.

6Hz: Use the 6 GHz band.

Auto: Use the frequency band that gives the strongest signal. Or, if the access point is set up with band steering, follow the decision made by the access point.

NetworkServices Wifi Enabled

Applies to: All products

Requires user role: ADMIN, USER

Provided that the device is allowed to connect to the network via Wi-Fi (see the NetworkServices WIFI Allowed setting), you can use this setting to enable and disable Wi-Fi.

You cannot use Ethernet and Wi-Fi at the same time. If you try to configure Wi-Fi while an Ethernet cable is connected, you must unplug the Ethernet cable to proceed. If you connect an Ethernet cable while connected to Wi-Fi, Ethernet will take precedence. If you unplug the Ethernet cable, the device will automatically connect to the last connected Wi-Fi network, if available.

Default value:

True

Value space:

False/True

False: Wi-Fi is disabled.

True: Wi-Fi is enabled.

NetworkServices XMLAPI Mode

Applies to: All products

Requires user role: ADMIN

Enable or disable the device's XML API. For security reasons this may be disabled. Disabling the XML API will limit the remote manageability with for example TMS, which no longer will be able to connect to the device.

Default value:

On

Value space:

Off/On

Off: The XML API is disabled.

On: The XML API is enabled.

Board

Peripherals settings

BoardPro,
BoardPro
G2

Peripherals ActivePen Enabled

Applies to: BoardPro BoardProG2

Requires user role: ADMIN

Enable or disable the use of active pens.

Default value:

True

Value space:

True/False

True: Active pens are enabled.

False: Active pens are not enabled and using the pen will have no effect.

Codec EQ

Codec
PlusCodec
ProDesk,
DeskPro,
DeskMiniRoom Bar
Pro,
Room BarRoom Kit,
Room Kit
MiniRoom Kit
EQX

Room 55

Room 55
Dual,
Room 70Room 70
G2Room 70
PanoramaRoom
Panorama

Peripherals InputDevice Mode

Applies to: RoomKit RoomKitMini RoomBar RoomBarPro RoomKitEQX CodecEQ CodecPlus CodecPro Room55 Room70/Room55D Room70G2 RoomPanorama/Room70Panorama DeskMini Desk DeskPro BoardPro BoardProG2

Requires user role: ADMIN

Define whether or not to allow the use of a third-party input device, such as a USB keyboard or a wireless remote control with a USB dongle. The input device must advertise itself as a USB keyboard. You must define and implement the actions to be taken as response to key clicks yourself.

Default value:

Off

Value space:

Off/On

Off: A third-party USB input device is not allowed.

On: A third-party USB input device can be used to control certain functions on the video device.

Peripherals Pairing CiscoTouchPanels EmcResilience

Applies to: RoomKit RoomKitMini RoomBar RoomBarPro RoomKitEQX CodecEQ CodecPlus CodecPro Room55 Room70/Room55D Room70G2 RoomPanorama/Room70Panorama Board BoardPro BoardProG2

Requires user role: ADMIN

If the Touch 10 touch controller is used in environments with considerable amounts of electromagnetic noise present, you may experience an appearance of false signals—for example as if someone tapped the touch controller when nobody did so. To prevent this you may enable the EMC Resilience Mode. This applies only to Touch 10, not to Room Navigator.

Default value:

Off

Value space:

Off/On

Off: The EMC resilience is disabled.

On: The EMC resilience is enabled.

Peripherals Pairing CiscoTouchPanels HttpProxy

Applies to: RoomKit RoomKitMini RoomBar RoomBarPro RoomKitEQX CodecEQ CodecPlus CodecPro Room55 Room70/Room55D Room70G2 RoomPanorama/Room70Panorama Board BoardPro BoardProG2

Requires user role: ADMIN

This allows a Room Navigator that is directly connected to the video device (that is, locally paired), to access external HTTP(S) servers. To prevent such access, switch this setting Off.

Default value:

Auto

Value space:

Auto/Off

Auto: The Room Navigator is allowed to access content on external HTTP(S) servers. The video device will act as an HTTP proxy.

Off: The Room Navigator cannot access content on external HTTP(S) servers.

Board

Peripherals Pairing CiscoTouchPanels RemotePairing

Applies to: All products

Requires user role: ADMIN

In order to use a touch controller (Room Navigator or Touch 10) as user interface for the video device, the touch controller must be paired to the device. When the touch controller is paired via the network (LAN), this is referred to as remote pairing. Remote pairing is allowed by default; you must switch this setting Off if you want to prevent remote pairing.

Board 55/70 only support Touch 10, not Room Navigator. Board 55S/75S/85S, Codec Plus, Codec Pro, Room Kit, Room Kit Mini, Room 55, Room 55 Dual, Room 70, Room 70 G2, Room 70 Panorama, and Room Panorama support both Room Navigator and Touch 10. The other products support only Room Navigator.

Default value:

On

Value space:

Off/On

Off: Remote pairing of the touch controller is not allowed.

On: Remote pairing of the touch controller is allowed.

Peripherals Profile Cameras

Applies to: RoomKit RoomKitMini RoomBar RoomBarPro RoomKitEQX CodecEQ CodecPlus CodecPro Room55 Room70/Room55D Room70G2 RoomPanorama/Room70Panorama DeskMini Desk DeskPro BoardPro BoardProG2

Requires user role: ADMIN, INTEGRATOR

Define the number of external cameras that are expected to be connected to the video device. This information is used by the device's diagnostics service. If the number of connected cameras does not match this setting, the diagnostics service will report it as an inconsistency.

Default value:

Minimum1 [*RoomKit RoomKitMini RoomBar RoomBarPro RoomKitEQX CodecEQ CodecPlus CodecPro Room55 Room70/Room55D Room70G2 RoomPanorama/Room70Panorama BoardPro BoardProG2*]

0 [*DeskMini Desk DeskPro*]

Value space:

NotSet/Minimum1/0/1/2/3/4/5/6/7 [*RoomKit RoomKitMini RoomBar RoomBarPro RoomKitEQX CodecEQ CodecPlus CodecPro Room55 Room70/Room55D Room70G2 RoomPanorama/Room70Panorama BoardPro BoardProG2*]

0 [*DeskMini Desk DeskPro*]

NotSet: No camera check is performed.

Minimum1: At least one camera should be connected to the device.

0-7: Select the number of cameras that are expected to be connected to the device.

Peripherals Profile Cameras

Applies to: Board

Requires user role: ADMIN, INTEGRATOR

Define the number of external cameras that are expected to be connected to the device. This information is used by the device's diagnostics service. If the number of connected cameras does not match this setting, the diagnostics service will report it as an inconsistency.

Default value:

0

Value space:

0

0: The number of cameras that are expected to be connected to the device.

Peripherals Profile ControlSystems

Applies to: All products

Requires user role: ADMIN, INTEGRATOR

Define if a third-party control system, for example Crestron or AMX, is expected to be connected to the video device. This information is used by the video device's diagnostics service. If the number of connected control systems does not match this setting, the diagnostics service will report it as an inconsistency. Note that only one third-party control system is supported.

If set to 1, the control system must send heart beats to the video device using xCommand Peripherals HeartBeat command. Failing to do so will cause the video device to show a warning that it has lost connectivity to the control system.

Default value:

NotSet

Value space:

1/NotSet

1: One third-party control system should be connected to the device.

NotSet: No check for a third-party control system is performed.

Board

Peripherals Profile NetworkSwitches

Applies to: RoomPanorama/Room70Panorama

Requires user role: ADMIN, INTEGRATOR

Define the number of network switches that are expected to be connected to the device. This information is used by the device's diagnostics service. If the number of connected network switches does not match this setting, the diagnostics service will report it as an inconsistency.

Default value:

Room Panorama: 2; Room 70 Panorama: NotSet

Value space:

1/2/Minimum1/NotSet

NotSet: No network switch is connected.

Minimum1: At least one network switch should be connected to the device.

1-2: Specify the number of network switches that are expected to be connected to the device.

BoardPro,
BoardPro
G2

Codec EQ

Codec
PlusCodec
ProDesk,
DeskPro,
DeskMiniRoom Bar
Pro,
Room BarRoom Kit,
Room Kit
MiniRoom Kit
EQX

Room 55

Room 55
Dual,
Room 70Room 70
G2Room 70
PanoramaRoom
Panorama

Peripherals Profile TouchPanels

Applies to: RoomKit RoomKitMini RoomBar RoomBarPro RoomKitEQX CodecEQ CodecPlus CodecPro Room55 Room70/Room55D Room70G2 RoomPanorama/Room70Panorama DeskMini Desk DeskPro BoardPro BoardProG2

Requires user role: ADMIN, INTEGRATOR

Define the number of Cisco touch controllers that are expected to be connected to the device. This information is used by the device's diagnostics service. If the number of connected touch controllers does not match this setting, the diagnostics service will report it as an inconsistency.

Default value:

Auto [RoomKit RoomKitMini RoomBar RoomBarPro RoomKitEQX CodecEQ CodecPlus CodecPro Room55 Room70/Room55D Room70G2 RoomPanorama/Room70Panorama]

0 [DeskMini Desk DeskPro BoardPro BoardProG2]

Value space:

Auto/NotSet/Minimum1/0/1/2/3/4/5 [RoomKit RoomKitMini RoomBar RoomBarPro RoomKitEQX CodecEQ CodecPlus CodecPro Room55 Room70/Room55D Room70G2 RoomPanorama/Room70Panorama BoardPro BoardProG2]

0 [DeskMini Desk DeskPro]

Auto: Resolves to Minimum1 for devices without a touch screen, and to 0 for devices with a touch screen.

NotSet: No touch controller check is performed.

Minimum1: At least one Cisco touch controller should be connected to the device.

0-5: Select the number of Cisco touch controllers that are expected to be connected to the device. The number of Cisco touch controllers that are officially supported are: 0 for Desk series devices, 2 for Room Panorama and Room 70 Panorama, and 1 for the other products.

Board

BoardPro,
BoardPro
G2

Codec EQ

Codec
PlusCodec
ProDesk,
DeskPro,
Desk MiniRoom Bar
Pro,
Room BarRoom Kit,
Room Kit
MiniRoom Kit
EQX

Room 55

Room 55
Dual,
Room 70Room 70
G2Room 70
PanoramaRoom
Panorama

Peripherals Security Certificates SyncToPeripherals Enabled

Applies to: All products

Requires user role: ADMIN

Choose whether the CA certificates that you upload to the device also shall apply to a Room Navigator that is connected to the device. It applies both to Navigators that are directly paired and remotely paired to the device.

If you don't want a Room Navigator to get the same certificates as the device it's connected to, this setting must be False.

If this setting is True, also previously uploaded CA certificates will be synchronized to a connected Room Navigator. For the Room Navigator's webengine to be able to use them, you must reboot the device.

Default value:

True

Value space:

False/True

False: The uploaded CA certificates only apply to the device itself, not to connected peripherals.

True: The uploaded CA certificates apply both to the device itself and to connected peripherals.

Phonebook settings

Phonebook Server [n] ID

Applies to: All products

Requires user role: ADMIN

Define a name for the external phone book.

Default value:

""

Value space:

String (0, 64)

The name for the external phone book.

n: Unique ID that identifies the phonebook server.

Range: 1..1

Phonebook Server [n] Pagination

Applies to: All products

Requires user role: ADMIN

Configure if the phonebook server supports pagination (paging) or not. Pagination means that the server supports consecutive searches, and these searches can be relative to an offset. This allows the user interface to perform as many consecutive searches as required to get the complete search result.

If Pagination is Disabled the device does a single search and returns a maximum of 100 entries in the search result. It is not possible to scroll to any further search results beyond that.

Default value:

Enabled

Value space:

Disabled/Enabled

Disabled: The phonebook server does not support pagination. The device does a single search, and the maximum number of entries in the search result is 100.

Enabled: The phonebook server supports pagination.

n: Unique ID that identifies the phonebook server.

Range: 1..1

Board

BoardPro,
BoardPro
G2

Codec EQ

Codec
PlusCodec
ProDesk,
DeskPro,
DeskMiniRoom Bar
Pro,
Room BarRoom Kit,
Room Kit
MiniRoom Kit
EQX

Room 55

Room 55
Dual,
Room 70Room 70
G2Room 70
PanoramaRoom
Panorama

Phonebook Server [n] TlsVerify

Applies to: All products

Requires user role: ADMIN

This setting applies when a video device connects to an external phone book server via HTTPS.

Before establishing a connection between the device and the HTTPS server, the device checks if the certificate of the server is signed by a trusted Certificate Authority (CA). The CA certificate must be included in the CA list on the device, manually uploaded using the web interface or API.

In general, the minimum TLS (Transport Layer Security) version for the HTTPS connection is 1.1. There are two exceptions to this rule: 1) For compatibility reasons, the minimum TLS version is 1.0 for devices that are registered to CUCM. 2) Devices registered to the Webex cloud service always use version 1.2.

Note: The value is set to Off for a device that has been upgraded to CE9.9 (or later) from CE9.8 or earlier software versions, provided that the device has not been factory reset after the upgrade, and that the old NetworkServices HTTPS VerifyServerCertificate setting was not explicitly set to On.

Default value:

On

Value space:

Off/On

Off: The device doesn't check the certificate of the HTTPS server.

On: The device checks if the certificate of the HTTPS server can be trusted. If not, the connection between the device and the server is not established.

Phonebook Server [n] Type

Applies to: All products

Requires user role: ADMIN

Select the phonebook server type.

Default value:

Off

Value space:

Off/CUCM/Spark/TMS/VCS

Off: Do not use a phonebook.

CUCM: The phonebook is located on the Cisco Unified Communications Manager.

Spark: The phonebook is located in the Webex cloud service.

TMS: The phonebook is located on the Cisco TelePresence Management Suite server.

VCS: The phonebook is located on the Cisco TelePresence Video Communication Server.

n: Unique ID that identifies the phonebook server.

Range: 1..1

Phonebook Server [n] URL

Applies to: All products

Requires user role: ADMIN

Define the address (URL) to the external phone book server.

Default value:

""

Value space:

String (0, 255)

A valid address (URL) to the phone book server.

n: Unique ID that identifies the phonebook server.

Range: 1..1

Board

BoardPro,
BoardPro
G2

Codec EQ

Codec
PlusCodec
ProDesk,
DeskPro,
DeskMiniRoom Bar
Pro,
Room BarRoom Kit,
Room Kit
MiniRoom Kit
EQX

Room 55

Room 55
Dual,
Room 70Room 70
G2Room 70
PanoramaRoom
Panorama

Provisioning settings

Provisioning Connectivity

Applies to: All products

Requires user role: ADMIN, USER

This setting controls how the device discovers whether it should request an internal or external configuration from the provisioning server.

Default value:

Auto

Value space:

Internal/External/Auto

Internal: Request internal configuration.

External: Request external configuration.

Auto: Automatically discover using NAPTR queries whether internal or external configurations should be requested. If the NAPTR responses have the "e" flag, external configurations will be requested. Otherwise internal configurations will be requested.

Provisioning CUCM CallManagementRecords CallDiagnostics

Applies to: All products

Requires user role: ADMIN, USER

Enable devices to send call statistics to CUCM which will then be populated in CUCM's Call Management Records The call statistics are sent to CUCM upon termination of a call.

Default value:

Enabled

Value space:

Disabled/Enabled

Enabled: Enables support for CUCM Call Management Records.

Disabled: Disables support for CUCM Call Management Records.

Provisioning ExternalManager Address

Applies to: All products

Requires user role: ADMIN, USER

Define the IP Address or DNS name of the external manager / provisioning system.

If an External Manager Address (and Path) is configured, the device will send a message to this address when starting up. When receiving this message the external manager / provisioning system can return configurations/commands to the unit as a result.

When using CUCM or TMS provisioning, the DHCP server can be set up to provide the external manager address automatically (DHCP Option 242 for TMS, and DHCP Option 150 for CUCM). An address set in the Provisioning ExternalManager Address setting will override the address provided by DHCP.

Default value:

""

Value space:

String (0, 64)

A valid IPv4 address, IPv6 address or DNS name.

Provisioning ExternalManager AlternateAddress

Applies to: All products

Requires user role: ADMIN, USER

Only applicable when the device is provisioned by Cisco Unified Communication Manager (CUCM) and an alternate CUCM is available for redundancy. Define the address of the alternate CUCM. If the main CUCM is not available, the device will be provisioned by the alternate CUCM. When the main CUCM is available again, the device will be provisioned by this CUCM.

Default value:

""

Value space:

String (0, 64)

A valid IPv4 address, IPv6 address or DNS name.

Board

Provisioning ExternalManager Protocol

Applies to: All products

Requires user role: ADMIN, USER

Define whether to use the HTTP (unsecure communication) or HTTPS (secure communication) protocol when sending requests to the external manager / provisioning system.

The selected protocol must be enabled in the NetworkServices HTTP Mode setting.

Default value:

HTTP

Value space:

HTTPS/HTTP

HTTPS: Send requests via HTTPS.

HTTP: Send requests via HTTP.

BoardPro,
BoardPro
G2

Codec EQ

Codec
PlusCodec
ProDesk,
DeskPro,
DeskMiniRoom Bar
Pro,
Room BarRoom Kit,
Room Kit
MiniRoom Kit
EQX

Room 55

Room 55
Dual,
Room 70Room 70
G2Room 70
PanoramaRoom
Panorama

Provisioning Mode

Applies to: All products

Requires user role: ADMIN, USER

It is possible to configure a device using a provisioning system (external manager). This allows video conferencing network administrators to manage many devices simultaneously. With this setting you choose which type of provisioning system to use. Provisioning can also be switched off. Contact your provisioning system provider/representative for more information.

Default value:

Auto

Value space:

Off/Auto/CUCM/Edge/Webex/TMS/VCS

Off: The device is not configured by a provisioning system.

Auto: The provisioning server is automatically selected as set up in the DHCP server.

CUCM: Push configurations to the device from CUCM (Cisco Unified Communications Manager).

Edge: Push configurations to the device from CUCM (Cisco Unified Communications Manager). The device connects to CUCM via the Expressway infrastructure. In order to register over Expressway the encryption option key must be installed on the device.

Webex: Push configurations to the device from the Webex cloud service. In order to register to the Webex cloud service, the encryption option key must be installed on the device.

TMS: Push configurations to the device from TMS (Cisco TelePresence Management System).

VCS: Push configurations to the device from VCS (Cisco TelePresence Video Communication Server).

Provisioning ExternalManager Path

Applies to: All products

Requires user role: ADMIN, USER

Define the Path to the external manager / provisioning system. This setting is required when several management services reside on the same server, that is, when they share the same External Manager address.

Default value:

""

Value space:

String (0, 255)

A valid path to the external manager or provisioning system.

Provisioning ExternalManager Domain

Applies to: All products

Requires user role: ADMIN, USER

Define the SIP domain for the VCS provisioning server.

Default value:

""

Value space:

String (0, 64)

A valid domain name.

Provisioning LoginName

Applies to: All products

Requires user role: ADMIN, USER

This is the username part of the credentials used to authenticate the device with the provisioning server. This setting must be used when required by the provisioning server.

Default value:

""

Value space:

String (0, 80)

A valid username.

Board

BoardPro,
BoardPro
G2

Codec EQ

Codec
PlusCodec
ProDesk,
DeskPro,
DeskMiniRoom Bar
Pro,
Room BarRoom Kit,
Room Kit
MiniRoom Kit
EQX

Room 55

Room 55
Dual,
Room 70Room 70
G2Room 70
PanoramaRoom
Panorama

Provisioning Password

Applies to: All products

Requires user role: ADMIN, USER

This is the password part of the credentials used to authenticate the device with the provisioning server. This setting must be used when required by the provisioning server.

Default value:

""

Value space:

String (0, 64)

A valid password.

Provisioning TlsVerify

Applies to: All products

Requires user role: ADMIN, USER

This setting applies when a video device connects to a provisioning server via HTTPS.

Before establishing a connection between the device and the HTTPS server, the device checks if the certificate of the server is signed by a trusted Certificate Authority (CA). The CA certificate must be included in the CA list on the device, manually uploaded using the web interface or API.

In general, the minimum TLS (Transport Layer Security) version for the HTTPS connection is 1.1. There are two exceptions to this rule: 1) For compatibility reasons, the minimum TLS version is 1.0 for devices that are registered to CUCM. 2) Devices registered to the Webex cloud service always use version 1.2.

Note: The value is set to Off for a device that has been upgraded to CE9.9 (or later) from CE9.8 or earlier software versions, provided that the device has not been factory reset after the upgrade, and that the old NetworkServices HTTPS VerifyServerCertificate setting was not explicitly set to On.

The certificate check is always performed, regardless of this setting, if the device is provisioned from the Webex cloud service or from CUCM via Expressway (also known as MRA or Edge).

Default value:

On

Value space:

Off/On

Off: The device doesn't check the certificate of the HTTPS server.

On: The device checks if the certificate of the HTTPS server can be trusted. If not, the connection between the device and the server is not established.

Provisioning WebexEdge

Applies to: All products

Requires user role: ADMIN, USER

Define if the device is linked to Webex Edge for Devices, which gives access to select Webex cloud services.

The setting applies only to devices that are registered to an on-premises service.

Default value:

Off

Value space:

Off/On

Off: The device is not linked to Webex Edge for Devices.

On: The device is linked to Webex Edge for Devices.

Board

BoardPro,
BoardPro
G2

Codec EQ

Codec
PlusCodec
ProDesk,
DeskPro,
DeskMiniRoom Bar
Pro,
Room BarRoom Kit,
Room Kit
MiniRoom Kit
EQX

Room 55

Room 55
Dual,
Room 70Room 70
G2Room 70
PanoramaRoom
Panorama

Proximity settings

Proximity AlternatePort Enabled

Applies to: All products

Requires user role: ADMIN

This setting applies only when NetworkServices HTTP Mode is set to HTTP+HTTPS or HTTPS.

By default, Proximity connections use TCP port 443. Use this setting to allow Proximity connections also on port 65533.

Default value:

False

Value space:

False/True

False: Proximity connections always use TCP port 443.

True: Proximity connections can use either TCP port 443 or 65533. The port used depends on the client.

Proximity Mode

Applies to: All products

Requires user role: ADMIN, USER

The Proximity Mode setting has no effect for devices that are registered to the Webex cloud service. To prevent a cloud registered device from sending ultrasound pairing messages, you must set Audio Ultrasound MaxVolume to 0.

For devices registered on-premises, the Proximity Mode setting determines whether the device will emit ultrasound pairing messages or not. When the device emits ultrasound pairing messages, Cisco collaboration clients can detect that they are close to the device.

In order to use a client, at least one of the Proximity services must be enabled (refer to the Proximity Services settings) as well. In general, Cisco recommends enabling all the Proximity services.

The Proximity Mode and Audio Ultrasound MaxVolume settings only affect ultrasound pairing messages. To stop all ultrasound emissions, the RoomAnalytics PeoplePresenceDetector and Standby WakeupOnMotionDetection settings must also be switched Off.

Default value:

On [RoomKit RoomKitMini RoomBar Room55 Room70/Room55D Room70G2 RoomPanorama/Room70Panorama Board BoardPro BoardProG2]

Off [RoomBarPro RoomKitEQX CodecEQ CodecPlus CodecPro DeskMini Desk DeskPro]

Value space:

Off/On

Off: Cisco collaboration clients cannot detect that they are close to the device, thus Proximity services cannot be used.

On: Cisco collaboration clients can detect that they are close to the device, and enabled Proximity services can be used.

Proximity Services CallControl

Applies to: All products

Requires user role: ADMIN, USER

Enable or disable basic call control features on Cisco collaboration clients. When this setting is enabled, you are able to control a call using a Cisco collaboration client (for example dial, mute, adjust volume and hang up). This service is supported by mobile devices (iOS and Android). Proximity Mode must be On for this setting to take any effect.

Default value:

Disabled

Value space:

Enabled/Disabled

Enabled: Call control from a Cisco collaboration client is enabled.

Disabled: Call control from a Cisco collaboration client is disabled.

Board

BoardPro,
BoardPro
G2

Codec EQ

Codec
PlusCodec
ProDesk,
DeskPro,
DeskMiniRoom Bar
Pro,
Room BarRoom Kit,
Room Kit
MiniRoom Kit
EQX

Room 55

Room 55
Dual,
Room 70Room 70
G2Room 70
PanoramaRoom
Panorama

Proximity Services ContentShare FromClients

Applies to: All products

Requires user role: ADMIN, USER

Enable or disable content sharing from Cisco collaboration clients. When this setting is enabled, you can share content from a Cisco collaboration client wirelessly on the device, for example, share your laptop screen. This service is supported by laptops (OS X and Windows). Proximity Mode must be On for this setting to take any effect.

Default value:

Enabled

Value space:

Enabled/Disabled

Enabled: Content sharing from a Cisco collaboration client is enabled.

Disabled: Content sharing from a Cisco collaboration client is disabled.

Proximity Services ContentShare ToClients

Applies to: All products

Requires user role: ADMIN, USER

This is no longer applicable.

Default value:

Disabled

Value space:

Disabled

RemoteAccess settings

RemoteAccess Mode

Applies to: All products

Requires user role: ADMIN

Allows remote access from Control Hub and Web UI to the device.

Default value:

Off

Value space:

Off/On

Off: disables remote access on individual devices.

On: enables remote access on individual devices.

RemoteAccess ShowTapIndicator

Applies to: All products

Requires user role: ADMIN, INTEGRATOR

Configures to show mouse taps on the screen in Remote access mode.

Default value:

True

Value space:

False/True

True: shows mouse taps on the screen in remote access mode.

False: Does not show mouse taps on the screen in remote access mode.

Board

BoardPro,
BoardPro
G2

Codec EQ

Codec
PlusCodec
ProDesk,
DeskPro,
DeskMiniRoom Bar
Pro,
Room BarRoom Kit,
Room Kit
MiniRoom Kit
EQX

Room 55

Room 55
Dual,
Room 70Room 70
G2Room 70
PanoramaRoom
Panorama

RoomAnalytics settings

RoomAnalytics AmbientNoiseEstimation Interval

Applies to: All products

Requires user role: ADMIN, INTEGRATOR, USER

Set the interval at which the ambient noise estimation is run, if enabled. The xConfiguration RoomAnalytics AmbientNoiseEstimation Mode can be used to enable or disable ambient noise estimations.

Default value:

10

Value space:

Integer (10..60)

Set the interval, in seconds, for how often the ambient noise estimation is run.

RoomAnalytics AmbientNoiseEstimation Mode

Applies to: All products

Requires user role: ADMIN, INTEGRATOR, USER

The device can estimate the stationary ambient noise level (background noise level) in the room. The result is reported in the RoomAnalytics AmbientNoise Level dBA status. The status is updated when a new ambient noise level is detected.

Default value:

Off

Value space:

Off/On

On: The device regularly estimates the stationary ambient noise level.

Off: The device doesn't estimate the stationary ambient noise level.

RoomAnalytics PeopleCountOutOfCall

Applies to: All products

Requires user role: ADMIN, INTEGRATOR, USER

By using its camera and head detection, the device has the capability to find how many people are in the room. This setting determines in which scenarios people count is active.

People count is never active in networked standby (the second low power / standby stage), which is available for Desk, Desk Mini, Room Bar, and Room Bar Pro. And these devices will not enter networked standby until people count reaches 0.

Codec EQ, Codec Plus, Codec Pro: Applies only when the device has a Quad Camera connected.

Default value:

Off

Value space:

Off/On

Off: The device counts people only when the device is in a call or when self-view is on.

On: The device also counts people outside of call, even if self-view is off. For shared mode devices that are not set up for hot desking, people count is also active when the device is in display off mode (the first low power / standby stage).

RoomAnalytics PeoplePresenceDetector

Applies to: All products

Requires user role: ADMIN, INTEGRATOR, USER

The device has the capability to find whether people are present in the room and report the result in the RoomAnalytics PeoplePresence status. The device will not keep record of who was in the room, only whether there are people present in the room. Use the RoomAnalytics PeoplePresence Input Ultrasound and RoomAnalytics PeoplePresence Input HeadDetector settings to specify whether to base the people presence detection on ultrasound, head detection, or both.

Ultrasound signals for presence detection are not emitted when both this setting and the Standby WakeupOnMotionDetection Mode setting are switched Off. The Audio Ultrasound MaxVolume and Proximity Mode settings has no effect on presence detection.

Default value:

On

Value space:

Off/On

Off: The presence of people in the room is not reported in the device's status.

On: The presence of people in the room is reported in the device's status, provided that at least one of the RoomAnalytics PeoplePresence Input Ultrasound and RoomAnalytics PeoplePresence Input HeadDetector settings are turned On.

Board

RoomAnalytics PeoplePresence Input HeadDetector

Applies to: All products

Requires user role: ADMIN

Use this setting to decide whether to use head detection as input source for the people presence reported in the device's RoomAnalytics PeoplePresence status.

This setting has no effect if people presence detection, in general, is switched Off (RoomAnalytics PeoplePresenceDetector: Off).

Default value:

On

Value space:

Off/On

Off: Don't use head detection as input source for detecting people presence.

On: Use head detection as input source for detecting people presence.

RoomAnalytics PeoplePresence Input Ultrasound

Applies to: All products

Requires user role: ADMIN

Use this setting to decide whether to use ultrasound as input source for the people presence reported in the device's RoomAnalytics PeoplePresence status.

This setting has no effect if people presence detection, in general, is switched Off (RoomAnalytics PeoplePresenceDetector:Off).

Default value:

Off

Value space:

Off/On

Off: Don't use ultrasound as input for detecting people presence.

On: Use ultrasound as input for detecting people presence.

RoomAnalytics ReverberationTime Interval

Applies to: All products

Requires user role: ADMIN, INTEGRATOR, USER

Defines how often the RT60 will be measured and reported to the RoomAnalytics status. The interval is in seconds.

The RoomAnalytics ReverberationTime Mode configuration must be enabled to set the interval.

Default value:

1800

Value space:

Integer (60..3600)

Interval in seconds.

RoomAnalytics ReverberationTime Mode

Applies to: All products

Requires user role: ADMIN, INTEGRATOR, USER

Reverberation time is a measure of how fast a sound will "fade away" or decay in a room. This is highly related to the perception of the acoustic quality of a room.

The Cisco devices are capable of measuring the reverberation time, RT60, directly from the acoustic echo canceller.

As opposed to traditional reverberation time measurement where it is required to emit a noise or impulse signal in the room, the Cisco device will measure RT60 as a "silent measurement".

Due to the silent measurement behavior, the RT60 values will be indicative and not strictly correct according to the ISO 3382-2 standard.

The measurements will measure the RT60 values for each octave band from 125 Hz to 4 kHz.

Default value:

Off

Value space:

Off/On

On: activate the silent RT60 measurements.

Off: deactivate the silent RT60 measurements.

BoardPro,
BoardPro
G2

Codec EQ

Codec
PlusCodec
ProDesk,
DeskPro,
DeskMiniRoom Bar
Pro,
Room BarRoom Kit,
Room Kit
MiniRoom Kit
EQX

Room 55

Room 55
Dual,
Room 70Room 70
G2Room 70
PanoramaRoom
Panorama

Board

RoomAnalytics RoomInUse InCall

Applies to: All products

Requires user role: ADMIN

This setting help determine if the room should be marked as "In Use" both for the purpose of making the LED red on a wall mounted navigator (scheduler mode), and to report it in the RoomAnalytics RoomInUse status.

Also see the RoomAnalytics RoomInUse LocalUsage setting.

Default value:

Enabled

Value space:

Disabled/Enabled

Disabled: The room will not be marked as "In Use", just because the device is in a call.

Enabled: Any type of call will mark the room "In Use".

RoomAnalytics RoomInUse LocalUsage

Applies to: All products

Requires user role: ADMIN

This setting help determine if the room should be marked as "In Use" both for the purpose of making the LED red on a wall mounted navigator (scheduler mode), and to report it in the RoomAnalytics RoomInUse status.

Also see the RoomAnalytics RoomInUse InCall setting.

Default value:

Enabled

Value space:

Disabled/Enabled

Disabled: The room will not be marked as "In Use", just because someone is using the whiteboard app or sharing content locally on the device.

Enabled: If someone is using the whiteboard app or sharing content locally, the room will be marked as "In Use".

RoomAnalytics T3AlarmDetection Mode

Applies to: All products

Requires user role: ADMIN, INTEGRATOR

T3 alarm detection allows the device to recognize the audio signal of a T3 fire alarm (T3 is the industry-standard alarm pattern in the United States). If an alarm is detected, the RoomAnalytics T3AlarmDetected status changes from False to True.

Important: It is not guaranteed that the device will detect an alarm. For example, low microphone levels will block detection. Therefore, you should not rely on this feature to raise awareness of an alarm and it does not replace any other safety and security measures and documentation.

Default value:

Off

Value space:

Off/On

Off: T3 alarm detection is disabled.

On: T3 alarm detection is enabled.

RoomAnalytics T3AlarmDetection Timeout

Applies to: All products

Requires user role: ADMIN, INTEGRATOR

When T3 alarm detection is enabled, if the system detects an alarm the RoomAnalytics T3AlarmDetected status will switch from False to True. The status switches back to False when no alarm has been detected for the number of seconds defined as the timeout.

Default value:

10

Value space:

Integer (5..60)

The timeout period in seconds.

Board

BoardPro,
BoardPro
G2

Codec EQ

Codec
PlusCodec
ProDesk,
DeskPro,
DeskMiniRoom Bar
Pro,
Room BarRoom Kit,
Room Kit
MiniRoom Kit
EQX

Room 55

Room 55
Dual,
Room 70Room 70
G2Room 70
PanoramaRoom
Panorama

Board

BoardPro,
BoardPro
G2

Codec EQ

Codec
PlusCodec
ProDesk,
DeskPro,
DeskMiniRoom Bar
Pro,
Room BarRoom Kit,
Room Kit
MiniRoom Kit
EQX

Room 55

Room 55
Dual,
Room 70Room 70
G2Room 70
PanoramaRoom
Panorama

RoomCleanup settings

RoomCleanup AutoRun ContentType TemporaryAccounts

Applies to: All products

Requires user role: ADMIN

Delete any temporary accounts that may be logged-in on the device (for example, a OneDrive account accessed through an Enterprise Content Management (ECM) service).

Default value:

Daily

Value space:

Daily/Off

Daily: Enable the daily clearing of temporary accounts.

Off: Disable the daily clearing of temporary accounts.

RoomCleanup AutoRun ContentType WebData

Applies to: All products

Requires user role: ADMIN

Enable or disable the daily room cleanup of web data. Use RoomCleanup AutoRun HourOfDay to set the time of day.

Default value:

Daily

Value space:

Daily/Off

Daily: Enable the daily clearing of web data.

Off: Disable the daily clearing of web data.

RoomCleanup AutoRun ContentType Whiteboards

Applies to: All products

Requires user role: ADMIN

Enable or disable the daily room cleanup of whiteboards. Use RoomCleanup AutoRun HourOfDay to set the time of day.

Default value:

Daily

Value space:

Daily/Off

Daily: Enable the daily clearing of whiteboards.

Off: Disable the daily clearing of whiteboards.

RoomCleanup AutoRun HourOfDay

Applies to: All products

Requires user role: ADMIN

Set the hour of the day when room cleanup will be performed each day.

Default value:

0

Value space:

Integer (0..23)

The hour of the day at which the room cleanup will occur.

Board

BoardPro,
BoardPro
G2

Codec EQ

Codec
PlusCodec
ProDesk,
DeskPro,
DeskMiniRoom Bar
Pro,
Room BarRoom Kit,
Room Kit
MiniRoom Kit
EQX

Room 55

Room 55
Dual,
Room 70Room 70
G2Room 70
PanoramaRoom
Panorama

RoomReset settings

RoomReset Control

Applies to: All products

Requires user role: ADMIN

This setting is for use with control systems or macros. Macros allow you to write snippets of JavaScript code that can automate parts of your video device, thus creating custom behavior.

When a room has been idle for some time the video device can send an event to indicate that the room is ready to be reset.

The events that are sent when this setting is enabled are:

```
*e RoomReset SecondsToReset: 30
```

```
** end
```

```
*e RoomReset Reset
```

```
** end
```

Default value:

On

Value space:

Off/On

Off: No RoomReset events will be sent.

On: The room reset control is enabled and RoomReset events will be sent.

RoomScheduler settings

RoomScheduler BookingTimeout

Applies to: All products

Requires user role: ADMIN

This setting will soon be deprecated. We recommend you start using the AdhocBooking BookingTimeout setting instead.

The scheduler will provide immediate feedback to a user when they book a room or a device; however, the calendar service can take some time to confirm the booking. If it takes too long to get the confirmation and this time exceeds the value set here, the booking will be cleared, and the device or room will be shown as available.

This is applicable to devices registered to the Webex cloud service or linked to Webex Edge for devices.

Default value:

60

Value space:

Integer (60..300)

The number of seconds to wait for a confirmation.

RoomScheduler Enabled

Applies to: All products

Requires user role: ADMIN

This setting will soon be deprecated. We recommend you start using the AdhocBooking Enabled setting instead.

The room scheduling feature allows you to book a room directly from the touch controller that is in the meeting room. You can also extend an ongoing meeting if the room is still available. You can also use the Webex Assistant (voice-driven virtual assistant) to book or extend a meeting.

The room scheduling feature requires that the device is registered to the Webex cloud service or linked to Webex Edge for devices. In addition, the room must be set up with a calendar service that allows booking. The room scheduling feature is not supported on personal mode devices.

Default value:

False

Value space:

False/True

False: The room scheduling feature is not available.

True: The room scheduling feature is available if the prerequisites listed above are met.

Board

UserInterface RoomScheduler OverlayOpacity

Applies to: All products

Requires user role: ADMIN

Allows you to configure the opacity of the top panels of the Room Navigator, which can show or hide more of the background.

Default value:

50

Value space:

Integer (0..100)

Set up a number between 0 and 100 to configure the opacity.

BoardPro,
BoardPro
G2

Codec EQ

Codec
PlusCodec
ProDesk,
DeskPro,
DeskMiniRoom Bar
Pro,
Room BarRoom Kit,
Room Kit
MiniRoom Kit
EQX

Room 55

Room 55
Dual,
Room 70Room 70
G2Room 70
PanoramaRoom
Panorama

UserInterface RoomScheduler State Busy Color

Applies to: All products

Requires user role: ADMIN

This setting applies when a Room Navigator is set up as a room booking device (also referred to as scheduler mode). You can change the color of the LED strip and the room status icon on Room Navigators. The chosen color is applied to both the LED strip and the room status icon. This setting determines which color to use when the room is occupied.

Use the UserInterface RoomScheduler State Available Color and UserInterface RoomScheduler State Pending Color settings to choose which colors to use when the room is available, or booked without being occupied, respectively.

Default value:

Red

Value space:

Aquamarine/Blue/Cyan/Fuchsia/Gold/Green/Lime/Magenta/Off/Orange/Orchid/Purple/
Red/Scarlet/Turquoise/Violet/Yellow

Choose a color from the list.

UserInterface RoomScheduler State Pending Color

Applies to: All products

Requires user role: ADMIN

This setting applies when a Room Navigator is set up as a room booking device (also referred to as scheduler mode). You can change the color of the LED strip and the room status icon on Room Navigators. The chosen color is applied to both the LED strip and the room status icon. This setting determines which color to use when the room is booked without being occupied.

Use the UserInterface RoomScheduler State Available Color and UserInterface RoomScheduler State Busy Color settings to choose which colors to use when the room is available or occupied, respectively.

Default value:

Yellow

Value space:

Aquamarine/Blue/Cyan/Fuchsia/Gold/Green/Lime/Magenta/Off/Orange/Orchid/Purple/
Red/Scarlet/Turquoise/Violet/Yellow

Choose a color from the list.

Board

BoardPro,
BoardPro
G2

Codec EQ

Codec
PlusCodec
ProDesk,
Desk Pro,
Desk MiniRoom Bar
Pro,
Room BarRoom Kit,
Room Kit
MiniRoom Kit
EQX

Room 55

Room 55
Dual,
Room 70Room 70
G2Room 70
PanoramaRoom
Panorama

RTP settings

RTP Ports Range Start

Applies to: All products

Requires user role: ADMIN

Define the first port in the range of RTP ports.

The device is using the ports in the range defined by the RTP Ports Range Start and Stop settings for RTP and RTCP media data. The minimum range is 100 when RTP Video Ports Range is disabled, and 20 when RTP Video Ports Range is enabled.

If the RTP Video Ports Range is enabled, audio will use the range defined by the RTP Ports Range settings, and other media data will use the range defined by the RTP Video Ports Range settings. The two ranges must not overlap.

A change in the setting will take effect on new calls.

Note that the device uses another default RTP Port Range for Webex meetings and Webex optimized calls. The RTP range for Webex meetings and Webex optimised calls is defined in the RTP Audio Ports Range Webex Start/Stop and RTP Video Ports Range Webex Start/Stop settings.

Default value:

2326

Value space:

Integer (1024..65438)

Set the first port in the range of RTP ports. The value must be an even number.

RTP Ports Range Stop

Applies to: All products

Requires user role: ADMIN

Define the last port in the range of RTP ports.

The device is using the ports in the range defined by the RTP Ports Range Start and Stop settings for RTP and RTCP media data. If the RTP Video Ports Range is enabled the device is using the ports in the range 1024 to 65436. The minimum range is 100 when RTP Video Ports Range is disabled, and 20 when RTP Video Ports Range is enabled.

If the RTP Video Ports Range is enabled, audio will use the range defined by the RTP Ports Range settings, and other media data will use the range defined by the RTP Video Ports Range settings. The two ranges must not overlap.

A change in the setting will take effect on new calls.

Note that the device uses another default RTP Port Range for Webex meetings and Webex optimized calls. The RTP range for Webex meetings and Webex optimised calls is defined in the RTP Audio Ports Range Webex Start/Stop and RTP Video Ports Range Webex Start/Stop settings.

Default value:

2487

Value space:

Integer (1121..65535)

Set the last port in the range of RTP ports. The value must be an odd number. If you enter an even value, +1 will be automatically applied.

RTP Audio Ports Range Webex Start

Applies to: All products

Requires user role: ADMIN

Define the first port in the range of RTP audio ports for Webex meetings.

The device is using the ports in the range defined by the RTP Audio Ports Range Webex Start and Stop settings for RTP and RTCP media data. The minimum range is 20.

A change in the setting will take effect on new calls.

Default value:

52050

Value space:

Integer (1024..65454)

The first port in the range of RTP ports. The value must be an even number.

Board

RTP Audio Ports Range Webex Stop

Applies to: All products

Requires user role: ADMIN

Define the last port in the range of RTP audio ports for Webex meetings.

The device is using the ports in the range defined by the RTP Audio Ports Range Webex Start and Stop settings for RTP and RTCP media data. The minimum range is 20.

A change in the setting will take effect on new calls.

Default value:

52099

Value space:

Integer (1121..65535)

The last port in the range of RTP ports. The value must be an odd number. If you enter an even value, +1 will be automatically applied.

RTP Video Ports Range Start

Applies to: All products

Requires user role: ADMIN

Define the first port in the range of RTP video ports.

If both the start and stop values are set to 0, the RTP Video Ports Range is disabled. To enable it, set the first port to a value between 1024 and 65454 and the last port between 1024 and 65535. The minimum range is 80.

If the RTP Video Ports Range is enabled, audio will use the range defined by the RTP Ports Range settings, and other media data will use the range defined by the RTP Video Ports Range settings. The two ranges must not overlap.

A change in the setting will take effect on new calls.

Note that the device uses another default RTP Video Port Range for Webex meetings and Webex optimized calls. The RTP range for Webex meetings and Webex optimised calls is defined in the RTP Video Ports Range Webex Start/Stop and RTP Video Ports Range Webex Start/Stop settings.

Default value:

0

Value space:

Integer (0, 1024..65454)

Set the first port in the range of RTP video ports.

RTP Video Ports Range Stop

Applies to: All products

Requires user role: ADMIN

Define the last port in the range of RTP video ports.

If both the start and stop values are set to 0, the RTP Video Ports Range is disabled. To enable it, set the first port to a value between 1024 and 65454 and the last port between 1024 and 65535. The minimum range is 80.

If the RTP Video Ports Range is enabled, audio will use the range defined by the RTP Ports Range settings, and other media data will use the range defined by the RTP Video Ports Range settings. The two ranges must not overlap.

A change in the setting will take effect on new calls.

Note that the device uses another default RTP Video Port Range for Webex meetings and Webex optimized calls. The RTP range for Webex meetings and Webex optimised calls is defined in the RTP Video Ports Range Webex Start/Stop and RTP Video Ports Range Webex Start/Stop settings.

Default value:

0

Value space:

Integer (0, 1024..65535)

Set the last port in the range of RTP video ports.

RTP Video Ports Range Webex Start

Applies to: All products

Requires user role: ADMIN

Define the first port in the range of RTP video ports for Webex meetings.

The device is using the ports in the range defined by the RTP Video Ports Range Webex Start and Stop settings for RTP and RTCP media data. The minimum range is 80.

A change in the setting will take effect on new calls.

Default value:

52200

Value space:

Integer (1024..65454)

The first port in the range of RTP ports for Webex. The value must be an even number.

BoardPro,
BoardPro
G2

Codec EQ

Codec
PlusCodec
ProDesk,
DeskPro,
DeskMiniRoom Bar
Pro,
Room BarRoom Kit,
Room Kit
MiniRoom Kit
EQX

Room 55

Room 55
Dual,
Room 70Room 70
G2Room 70
PanoramaRoom
Panorama

Board

BoardPro,
BoardPro
G2

Codec EQ

Codec
PlusCodec
ProDesk,
DeskPro,
DeskMiniRoom Bar
Pro,
Room BarRoom Kit,
Room Kit
MiniRoom Kit
EQX

Room 55

Room 55
Dual,
Room 70Room 70
G2Room 70
PanoramaRoom
Panorama

RTP Video Ports Range Webex Stop

Applies to: All products

Requires user role: ADMIN

Define the last port in the range of RTP video ports for Webex meetings.

The device is using the ports in the range defined by the RTP Video Ports Range Webex Start and Stop settings for RTP and RTCP media data. The minimum range is 80.

A change in the setting will take effect on new calls.

Default value:

52299

Value space:

Integer (1121..65535)

The last port in the range of RTP ports. The value must be an odd number. If you enter an even value, +1 will be automatically applied.

Security settings

Security Audit Logging Mode

Applies to: All products

Requires user role: AUDIT

Define where to record or transmit the audit logs. The audit logs are sent to a syslog server. This setting has no effect if the Logging Mode setting is set to Off.

When using the External or ExternalSecure mode you must enter the address of the audit server in the Security Audit Server Address setting.

Default value:

Internal

Value space:

External/ExternalSecure/Internal/Off

External: The device sends the audit logs to an external syslog server. The syslog server must support UDP.

ExternalSecure: The device sends encrypted audit logs to an external syslog server that is verified by a certificate in the Audit CA list. The Audit CA list file must be uploaded to the device using the web interface. The `common_name` parameter of a certificate in the CA list must match the IP address or DNS name of the syslog server, and the secure TCP server must be set up to listen for secure (TLS) TCP Syslog messages.

Internal: The device records the audit logs to internal logs, and rotates logs when they are full.

Off: No audit logging is performed.

Board

BoardPro,
BoardPro
G2

Codec EQ

Codec
PlusCodec
ProDesk,
DeskPro,
DeskMiniRoom Bar
Pro,
Room BarRoom Kit,
Room Kit
MiniRoom Kit
EQX

Room 55

Room 55
Dual,
Room 70Room 70
G2Room 70
PanoramaRoom
Panorama

Security Audit OnError Action

Applies to: All products

Requires user role: AUDIT

Define what happens when the connection to the syslog server is lost. This setting is only relevant when Security Audit Logging Mode is set to ExternalSecure.

Default value:

Ignore

Value space:

Halt/Ignore

Halt: If a halt condition is detected the device is rebooted and only the auditor is allowed to operate the unit until the halt condition has passed. When the halt condition has passed the audit logs are re-spooled to the syslog server. Halt conditions are: A network breach (no physical link), no syslog server running (or incorrect address or port to the syslog server), TLS authentication failed (if in use), local backup (re-spooling) log full.

Ignore: The device will continue its normal operation, and rotate internal logs when full. When the connection is restored it will again send its audit logs to the syslog server.

Security Audit Server Address

Applies to: All products

Requires user role: AUDIT

Set the IP address or DNS name of the syslog server that the audit logs are sent to. This setting is only relevant when Security Audit Logging Mode is set to External or ExternalSecure.

Default value:

""

Value space:

String (0, 255)

A valid IPv4 address, IPv6 address, or DNS name.

Security Audit Server Port

Applies to: All products

Requires user role: AUDIT

The audit logs are sent to a syslog server. Define the port of the syslog server that the device shall send its audit logs to. This setting is only relevant when Security Audit Server PortAssignment is set to Manual.

Default value:

514

Value space:

Integer (0..65535)

Set the audit server port.

Security Audit Server PortAssignment

Applies to: All products

Requires user role: AUDIT

The audit logs are sent to a syslog server. You can define how the port number of the external syslog server will be assigned. This setting is only relevant when Security Audit Logging Mode is set to External or ExternalSecure. To see which port number is used you can check the Security Audit Server Port status. Navigate to Setup > Status on the web interface or; if on a command line interface, run the command xStatus Security Audit Server Port.

Default value:

Auto

Value space:

Auto/Manual

Auto: Will use UDP port number 514 when the Security Audit Logging Mode is set to External. Will use TCP port number 6514 when the Security Audit Logging Mode is set to ExternalSecure.

Manual: Will use the port value defined in the Security Audit Server Port setting.

Board

Security Enrollment KeySize

Applies to: All products

Requires user role: ADMIN

Defines the Certificate KeySize of the CSR generated by xCommand Security Certificates Services Enrollment SCEP Request.

Default value:

2048

Value space:

2048/3072/4096

The key length in bit.

BoardPro,
BoardPro
G2

Codec EQ

Codec
PlusCodec
ProDesk,
DeskPro,
DeskMiniRoom Bar
Pro,
Room BarRoom Kit,
Room Kit
MiniRoom Kit
EQX

Room 55

Room 55
Dual,
Room 70Room 70
G2Room 70
PanoramaRoom
Panorama

Security Session FailedLoginsLockoutTime

Applies to: All products

Requires user role: ADMIN

Define how long the device will lock out a user after failed login to a web or SSH session. Restart the device for any change to this setting to take effect.

Default value:

60

Value space:

Integer (0..10000)

Set the lockout time (minutes).

Security Session InactivityTimeout

Applies to: All products

Requires user role: ADMIN

Define how long the device will accept inactivity from the user before automatically logging out from a web or SSH session.

Restart the device for any change to this setting to take effect.

Default value:

0

Value space:

Integer (0..10000)

Set the inactivity timeout (minutes). Specifying 0 will result in a time out of 1 hour. The maximum timeout length is 12 hours.

Security Session MaxFailedLogins

Applies to: All products

Requires user role: ADMIN

Define the maximum number of failed login attempts per user for a web or SSH session. If the user exceeded the maximum number of attempts the user will be locked out. 0 means that there is no limit for failed logins.

Restart the device for any change to this setting to take effect.

Default value:

0

Value space:

Integer (0..10)

Set the maximum number of failed login attempts per user.

Board

Security Session MaxSessionsPerUser

Applies to: All products

Requires user role: ADMIN

The maximum number of simultaneous sessions per user is 20 sessions.

Default value:

20

Value space:

Integer (1..20)

Set the maximum number of simultaneous sessions per user.

Board Pro,
Board Pro
G2

Codec EQ

Codec
PlusCodec
ProDesk,
Desk Pro,
Desk MiniRoom Bar
Pro,
Room BarRoom Kit,
Room Kit
MiniRoom Kit
EQX

Room 55

Room 55
Dual,
Room 70Room 70
G2Room 70
PanoramaRoom
Panorama

Security Xapi WebSocket ApiKey Allowed

Applies to: All products

Requires user role: ADMIN

Enable or disable access to the API over web sockets from a remotely paired Room Navigator. A typical use case that requires API access is a persistent web app, for example a custom booking app that wants to control the color of the LEDs on the Room Navigator. If API access is disabled, apps that don't require any communication with the device's API can still run on the Room Navigator.

Note: Persistent web apps are only available on Room Navigators that are paired to the device over the network.

Default value:

False

Value space:

False/True

True: A Room Navigator can interact with the device's API over web sockets, provided that the device is set up to allow interaction with the API over WebSockets in general (NetworkServices HTTP Mode: HTTPS or HTTP+HTTPS and NetworkServices WebSocket: FollowHTTPService). Also, the domain of the server hosting the app must be listed in the WebEngine Features Xapi Peripherals AllowedHosts Hosts setting.

False: The Room Navigator is not allowed to interact with the device's API over web sockets.

Security Session MaxTotalSessions

Applies to: All products

Requires user role: ADMIN

Set the maximum number of simultaneous sessions in total.

Default value:

30

Value space:

Integer (1..30)

The maximum number of simultaneous sessions.

Security Session ShowLastLogon

Applies to: All products

Requires user role: ADMIN

When logging in to the device using SSH you will see the UserId, time and date of the last session that did a successful login.

Default value:

Off

Value space:

Off/On

On: Show information about the last session.

Off: Do not show information about the last session.

Board

BoardPro,
BoardPro
G2

Codec EQ

Codec
PlusCodec
ProDesk,
DeskPro,
DeskMiniRoom Bar
Pro,
Room BarRoom Kit,
Room Kit
MiniRoom Kit
EQX

Room 55

Room 55
Dual,
Room 70Room 70
G2Room 70
PanoramaRoom
Panorama

Sensors settings

Sensors Radar Mode

Applies to: BoardPro BoardProG2

Requires user role: ADMIN

The device can transmit a radar signal and receive reflections from near-by objects. The device can use these signals to detect if there are people and motion in the room. When using radar, the radar doesn't detect people that are further from the device than 5 meter.

Default value:

Auto

Value space:

Auto/Off

Auto: The device uses radar signals in display off mode and networked standby to detect motion.

Off: The radar sensor is switched off, and the device doesn't transmit radar signals.

Sensors Ultrasound Mode

Applies to: All products

Requires user role: ADMIN, INTEGRATOR

The device can use ultrasound signals to detect if there are people and motion in the room. This setting only affects using ultrasound for motion detection. It has no effect on ultrasound emission for proximity pairing.

Default value:

Auto

Value space:

Auto/Off

Auto: The device uses ultrasound signals to detect motion.

Off: Ultrasound is not used for motion detection.

SerialPort settings

SerialPort Mode

Applies to: All products

Requires user role: ADMIN, INTEGRATOR

Enable/disable the serial port. If the device has more than one serial port, this setting applies to all of them.

This setting is not available for the first generation of boards (Board 55 and Board 70).

Default value:

On

Value space:

Off/On

Off: Serial communication is disabled.

On: Serial communication is enabled.

SerialPort BaudRate

Applies to: All products

Requires user role: ADMIN, INTEGRATOR

Set the baud rate (data transmission rate) for the serial port. A new baud rate takes effect after a device reboot.

Other connection parameters for the serial port are: Data bits: 8; Parity: None; Stop bits: 1; Flow control: None.

This setting does not have any effect on a dedicated maintenance port (micro USB). The maintenance port always uses the default baud rate.

This setting is not available for the first generation of boards (Board 55 and Board 70).

Default value:

115200

Value space:

115200 [RoomKit RoomKitMini RoomBar RoomBarPro RoomKitEQX CodecEQ CodecPlus Room55 Room70/Room55D DeskMini Desk DeskPro Board BoardPro BoardProG2]

9600/19200/38400/57600/115200 [CodecPro Room70G2 RoomPanorama/Room70Panorama]

Choose a baud rate from the list (bits per second).

Board

SerialPort LoginRequired

Applies to: All products

Requires user role: ADMIN

Define if login shall be required when connecting to a serial port. If the device has more than one serial port, this setting applies to all of them.

This setting is not available for the first generation of boards (Board 55 and Board 70).

Default value:

On

Value space:

Off/On

Off: The user can access the device via the serial port without any login.

On: Login is required when connecting to the device via the serial port.

SerialPort Outbound Mode

Applies to: RoomKit RoomKitMini RoomBar RoomBarPro RoomKitEQX CodecEQ CodecPlus CodecPro Room55 RoomPanorama/Room70Panorama DeskMini Desk DeskPro BoardPro BoardProG2

Requires user role: ADMIN, INTEGRATOR

You can set up your device to control third-party peripherals, such as displays, video switches, projectors, or other, via a serial connection. We refer to this as outbound serial control. Note that outbound serial control is supported on Room Panorama, but not on Room 70 Panorama.

You must connect the peripheral to a USB-A port on the device using a USB-to-Serial dongle. You cannot use the built-in serial port on Codec Pro and Room Panorama, or the micro-USB maintenance port on other devices for outbound control; these ports are reserved for inbound control.

The communication between the device and peripheral is connectionless, meaning we don't establish a persistent serial port connection between them. The connection is first established when issuing the SerialPort PeripheralControl Send command, and the connection is dropped once the command is finished.

These serial connection parameters are not configurable: Data bits (8), Stop bits (1), Flow control (None). Baud rate and parity is set in the SerialPort Outbound Port [1] Baudrate and SerialPort Outbound Port [1] Parity settings, respectively.

Default value:

Off

Value space:

Off/On

Off: Serial port outbound control is not enabled.

On: Serial port outbound control is enabled. We allow only one outbound serial connection.

SerialPort Outbound Port [1] BaudRate

Applies to: RoomKit RoomKitMini RoomBar RoomBarPro RoomKitEQX CodecEQ CodecPlus CodecPro Room55 RoomPanorama/Room70Panorama DeskMini Desk DeskPro BoardPro BoardProG2

Requires user role: ADMIN, INTEGRATOR

Set the serial port outbound baud rate (data transmission rate). Refer to the SerialPort Outbound Mode setting for more information about outbound serial control. Outbound serial control is not supported on Room 70 Panorama.

This configuration has no effect on the regular (inbound) serial port / maintenance port.

Default value:

115200

Value space:

115200/19200/38400/57600/9600

Choose a baud rate form the list (bits per second).

SerialPort Outbound Port [1] Description

Applies to: RoomKit RoomKitMini RoomBar RoomBarPro RoomKitEQX CodecEQ CodecPlus CodecPro Room55 RoomPanorama/Room70Panorama DeskMini Desk DeskPro BoardPro BoardProG2

Requires user role: ADMIN, INTEGRATOR

Use this setting to add text that describes what the outbound serial port is intended to be connected to. Refer to the SerialPort Outbound Mode setting for more information about outbound serial control. Outbound serial control is not supported on Room 70 Panorama.

Default value:

""

Value space:

String (0, 512)

Text that describes what the port is connected to, for example "Projector".

Board

BoardPro,
BoardPro
G2

Codec EQ

Codec
PlusCodec
ProDesk,
DeskPro,
DeskMiniRoom Bar
Pro,
Room BarRoom Kit,
Room Kit
MiniRoom Kit
EQX

Room 55

Room 55
Dual,
Room 70Room 70
G2Room 70
PanoramaRoom
Panorama

SerialPort Outbound Port [1] Parity

Applies to: RoomKit RoomKitMini RoomBar RoomBarPro RoomKitEQX CodecEQ CodecPlus CodecPro Room55 RoomPanorama/Room70Panorama DeskMini Desk DeskPro BoardPro BoardProG2

Requires user role: ADMIN, INTEGRATOR

Choose whether to add a parity bit for the serial port outbound data transmission. Refer to the SerialPort Outbound Mode setting for more information about outbound serial control. Outbound serial control is not supported on Room 70 Panorama.

This configuration has no effect on the regular (inbound) serial port / maintenance port.

Default value:

None

Value space:

Even/None/Odd

Even: Add Even parity.

Odd: Add Odd parity.

None: Don't add a parity bit.

SIP settings

SIP ANAT

Applies to: All products

Requires user role: ADMIN

ANAT (Alternative Network Address Types) enables media negotiation for multiple addresses and address types, as specified in RFC 4091.

Default value:

Off

Value space:

Off/On

Off: Disable ANAT.

On: Enable ANAT.

SIP Authentication UserName

Applies to: All products

Requires user role: ADMIN

This is the username part of the credentials used to authenticate towards the SIP proxy.

Default value:

""

Value space:

String (0, 128)

A valid username.

SIP Authentication Password

Applies to: All products

Requires user role: ADMIN

This is the password part of the credentials used to authenticate towards the SIP proxy.

This password is not sent to the Webex cloud, and it cannot be provisioned from the cloud.

Default value:

""

Value space:

String (0, 128)

A valid password.

Board

SIP DefaultTransport

Applies to: All products

Requires user role: ADMIN

Select the transport protocol to be used over the LAN.

Default value:

Auto

Value space:

Auto/TCP/Tls/UDP

TCP: The device will always use TCP as the default transport method.

UDP: The device will always use UDP as the default transport method.

Tls: The device will always use TLS as the default transport method. For TLS connections a SIP CA-list can be uploaded to the device. If no such CA-list is available on the device then anonymous Diffie Hellman will be used.

Auto: The device will try to connect using transport protocols in the following order: TLS, TCP, UDP.

SIP DisplayName

Applies to: All products

Requires user role: ADMIN

When configured the incoming call will report the display name instead of the SIP URI.

Default value:

""

Value space:

String (0, 550)

The name to be displayed instead of the SIP URI.

SIP Ice DefaultCandidate

Applies to: All products

Requires user role: ADMIN

The ICE protocol needs some time to reach a conclusion about which media route to use (up to the first 5 seconds of a call). During this period media for the device will be sent to the Default Candidate as defined in this setting.

Default value:

Host

Value space:

Host/Rflx/Relay

Host: Send media to the device's private IP address.

Rflx: Send media to the device's public IP address, as seen by the TURN server.

Relay: Send media to the IP address and port allocated on the TURN server.

SIP Ice Mode

Applies to: All products

Requires user role: ADMIN

ICE (Interactive Connectivity Establishment, RFC 5245) is a NAT traversal solution that the devices can use to discover the optimized media path. Thus the shortest route for audio and video is always secured between the devices. Initially STUN (Session Traversal Utilities for NAT) messages are exchanged when setting up the media path.

Note that STUN also, regardless of the SIP Ice Mode, is used as a keep-alive mechanism to refresh NAT bindings.

Default value:

Auto

Value space:

Auto/Off/On

Auto: ICE is enabled if a TURN server is provided, otherwise ICE is disabled.

Off: ICE is disabled.

On: ICE is enabled.

BoardPro,
BoardPro
G2

Codec EQ

Codec
PlusCodec
ProDesk,
DeskPro,
DeskMiniRoom Bar
Pro,
Room BarRoom Kit,
Room Kit
MiniRoom Kit
EQX

Room 55

Room 55
Dual,
Room 70Room 70
G2Room 70
PanoramaRoom
Panorama

Board

BoardPro,
BoardPro
G2

Codec EQ

Codec
PlusCodec
ProDesk,
DeskPro,
DeskMiniRoom Bar
Pro,
Room BarRoom Kit,
Room Kit
MiniRoom Kit
EQX

Room 55

Room 55
Dual,
Room 70Room 70
G2Room 70
PanoramaRoom
Panorama

SIP Line

Applies to: All products

Requires user role: ADMIN

When registered to a Cisco Unified Communications Manager (CUCM) the device may be part of a shared line. This means that several devices share the same directory number. The different devices sharing the same number receive status from the other appearances on the line as defined in RFC 4235.

Note that shared lines are set up by CUCM, not by the device. Therefore do not change this setting manually; CUCM pushes this information to the device when required.

Default value:

Private

Value space:

Private/Shared

Shared: The device is part of a shared line and is therefore sharing its directory number with other devices.

Private: This device is not part of a shared line.

SIP ListenPort

Applies to: All products

Requires user role: ADMIN

Turn on or off the listening for incoming connections on the SIP TCP/UDP ports. If turned off, the device will only be reachable through a SIP Proxy (CUCM or VCS). As a security measure, SIP ListenPort should be Off when the device is registered to a SIP Proxy.

Default value:

Off

Value space:

Auto/Off/On

Auto: Listening for incoming connections on the SIP TCP/UDP ports is automatically turned off if the device is registered to a SIP Proxy; otherwise it is turned on.

Off: Listening for incoming connections on the SIP TCP/UDP ports is turned off.

On: Listening for incoming connections on the SIP TCP/UDP ports is turned on.

SIP Mailbox

Applies to: All products

Requires user role: ADMIN

When registered to a Cisco Unified Communications Manager (CUCM) you may be offered the option of having a private voice mailbox.

Default value:

""

Value space:

String (0, 255)

A valid number or address. Leave the string empty if you do not have a voice mailbox.

SIP MinimumTLSVersion

Applies to: All products

Requires user role: ADMIN

Set the lowest version of the TLS (Transport Layer Security) protocol that is allowed for SIP.

Default value:

TLSv1.2

Value space:

TLSv1.0/TLSv1.1/TLSv1.2/TLSv1.3

TLSv1.0: Support TLS version 1.0 or higher.

TLSv1.1: Support TLS version 1.1 or higher.

TLSv1.2: Support TLS version 1.2 or higher.

TLSv1.3: Support TLS version 1.3 or higher.

Board

SIP PreferredIPSignaling

Applies to: All products

Requires user role: ADMIN

Define the preferred IP version for signaling (audio, video, data). Only applicable when both Network IPStack and Conference CallProtocolIPStack are set to Dual, and the network does not have a mechanism for choosing the preferred IP version. It also determines the priority of the A/AAAA lookups in DNS, so that the preferred IP version is used for registration.

Default value:

IPv4

Value space:

IPv4/IPv6

IPv4: The preferred IP version for signaling is IPv4.

IPv6: The preferred IP version for signaling is IPv6.

SIP Proxy [n] Address

Applies to: All products

Requires user role: ADMIN

The Proxy Address is the manually configured address for the outbound proxy. It is possible to use a fully qualified domain name, or an IP address. The default port is 5060 for TCP and UDP but another one can be provided.

Default value:

""

Value space:

String (0, 255)

A valid IPv4 address, IPv6 address or DNS name.

n: Index that identifies the proxy (maximum 4 proxys can be defined).

Range: 1..4

SIP TlsVerify

Applies to: All products

Requires user role: ADMIN

Before establishing a connection over SIP TLS, the device checks if the certificate of the peer is signed by a trusted Certificate Authority (CA). The CA must be included in the CA list that is manually uploaded to the device using the web interface or API. The list of pre-installed certificates is not used to validate certificates for SIP TLS connections.

Note: The value is set to Off for a device that has been upgraded to CE9.9 (or later) from CE9.8 or earlier software versions, provided that the device has not been factory reset after the upgrade, and that the setting was not explicitly set to On.

Use the SIP MinimumTLSVersion setting to specify which TLS versions are allowed.

Default value:

On

Value space:

Off/On

Off: The device doesn't check the certificate of the peer. The SIP TLS connection is established anyway.

On: The device checks if the certificate of the peer can be trusted. If not, the SIP TLS connection is not established.

BoardPro,
BoardPro
G2

Codec EQ

Codec
PlusCodec
ProDesk,
DeskPro,
DeskMiniRoom Bar
Pro,
Room BarRoom Kit,
Room Kit
MiniRoom Kit
EQX

Room 55

Room 55
Dual,
Room 70Room 70
G2Room 70
PanoramaRoom
Panorama

Board

BoardPro,
BoardPro
G2

Codec EQ

Codec
PlusCodec
ProDesk,
DeskPro,
DeskMiniRoom Bar
Pro,
Room BarRoom Kit,
Room Kit
MiniRoom Kit
EQX

Room 55

Room 55
Dual,
Room 70Room 70
G2Room 70
PanoramaRoom
Panorama

SIP TransportSecurity CertificateVerificationMode

Applies to: All products

Requires user role: ADMIN

This configuration determines the method used to validate X.509 Certificates from remote SIP servers when connecting over TLS without a proxy.

It is assumed that the following configurations are set to:

SIP DefaultTransport: Tls

SIP TlsVerify: On

SIP ListenPort: Off

Provisioning WebexCalling Mode: Off

SIP Proxy N Address: ""

SIP Type: Standard

The validation process affects outgoing calls from the device. Any incoming call will be automatically rejected. Relevant Root CA Certificates need to be uploaded to the device. See the following command to upload CA certificates:

```
xCommand Security Certificates CA Add
```

It is recommended to reboot the device if this xConfiguration is changed.

As a security measure, it is also recommended to set

xConfiguration Conference Encryption Mode: On

to make sure that media gets encrypted.

Default value:

Auto

Value space:

Auto/Legacy/RFC5922

Auto: When set to Auto, the device uses either the Legacy or RFC5922 method of certificate verification. A given software version will always use only one of the methods. The method used may change between different software versions.

Legacy: When set to Legacy, the device uses the old verification method. It compares a list of names, including DNS SRV records with those in the received certificate, without applying RFC5922 standards.

RFC5922: When set to RFC5922, the device compares the hostname of the dialed URI (e.g., webex.com or zoomcrc.com) with the Subject Alternative Names (SANs) or Common Name (CN) in the X.509 Certificate, following the rules in RFC5922. RFC5922 provides guidelines for how to extract the identity of a SIP domain from a received certificate and how to use that identity for SIP domain authentication.

SIP Turn Server

Applies to: All products

Requires user role: ADMIN

Define the address of the TURN (Traversal Using Relay NAT) server. It is used as a media relay fallback and it is also used to discover the device's own public IP address.

Default value:

""

Value space:

String (0, 255)

The preferred format is DNS SRV record (for example, _turn._udp.<domain>), or it can be a valid IPv4 or IPv6 address.

SIP Turn UserName

Applies to: All products

Requires user role: ADMIN

Define the username needed for accessing the TURN server.

Default value:

""

Value space:

String (0, 128)

A valid username.

SIP Turn Password

Applies to: All products

Requires user role: ADMIN

Define the password needed for accessing the TURN server.

Default value:

""

Value space:

String (0, 128)

A valid password.

Board

SIP Type

Applies to: All products

Requires user role: ADMIN

Enables SIP extensions and special behavior for a vendor or provider.

Default value:

Standard

Value space:

Standard/Cisco

Standard: Use this when registering to standard SIP Proxy (tested with Cisco TelePresence VCS).

Cisco: Use this when registering to Cisco Unified Communication Manager.

SIP URI

Applies to: All products

Requires user role: ADMIN

The SIP URI (Uniform Resource Identifier) is the address that is used to identify the device. The URI is registered and used by the SIP services to route inbound calls to the device. The SIP URI syntax is defined in RFC 3261.

Default value:

""

Value space:

String (0, 255)

An address (URI) that is compliant with the SIP URI syntax.

BoardPro,
BoardPro
G2

Codec EQ

Codec
PlusCodec
ProDesk,
DeskPro,
DeskMiniRoom Bar
Pro,
Room BarRoom Kit,
Room Kit
MiniRoom Kit
EQX

Room 55

Room 55
Dual,
Room 70Room 70
G2Room 70
PanoramaRoom
Panorama

Standby settings

Standby BootAction

Applies to: All products

Requires user role: ADMIN, INTEGRATOR, USER

Define the camera position after a restart of the video device.

Default value:

DefaultCameraPosition [RoomKit RoomKitMini RoomBar RoomBarPro RoomKitEQX CodecEQ CodecPlus CodecPro Room55 Room70/Room55D Room70G2 RoomPanorama/Room70Panorama DeskMini Desk BoardPro BoardProG2]

RestoreCameraPosition [DeskPro Board]

Value space:

None/DefaultCameraPosition/RestoreCameraPosition

None: No action.

RestoreCameraPosition: When the video device restarts, the camera returns to the position that it had before the restart.

DefaultCameraPosition: When the video device restarts, the camera moves to the factory default position.

Standby BrightnessDelay

Applies to: All products

Requires user role: ADMIN, INTEGRATOR

This setting only applies to devices that are set up with Microsoft Teams Rooms.

Set for how long the device must show the Home screen and be inactive before it dims down the screen light. If the device enters halfwake, display off, or a deeper standby state before this timer runs out, this setting has no effect.

Default value:

30

Value space:

Integer (1..60)

The number of minutes before the dimming the light.

Board

Standby Control

Applies to: All products

Requires user role: ADMIN, INTEGRATOR

Define whether the device should go into standby mode automatically. Regardless, you can always manually set the device in standby mode from the UI or using the Standby Ativate command.

Default value:

On

Value space:

Off/On [[RoomKit](#) [RoomKitMini](#) [RoomBar](#) [RoomBarPro](#) [RoomKitEQX](#) [CodecEQ](#) [CodecPlus](#) [CodecPro](#) [Room55](#) [Room70/Room55D](#) [Room70G2](#) [DeskMini](#) [Desk](#) [DeskPro](#) [Board](#) [BoardPro](#) [BoardProG2](#)]

On [[RoomPanorama/Room70Panorama](#)]

Off: The device will not enter standby mode automatically.

On: The device will enter standby mode when the Standby Delay has timed out.

Standby Delay

Applies to: All products

Requires user role: ADMIN, INTEGRATOR

Define how long (in minutes) the device shall be in idle mode before it goes into standby mode.

Requires the Standby Control to be enabled.

Default value:

10 [[RoomKit](#) [RoomKitMini](#) [RoomBar](#) [RoomBarPro](#) [RoomKitEQX](#) [CodecEQ](#) [CodecPlus](#) [CodecPro](#) [Room55](#) [Room70/Room55D](#) [Room70G2](#) [RoomPanorama/Room70Panorama](#) [DeskMini](#) [Desk](#) [DeskPro](#)]

4 [[Board](#) [BoardPro](#) [BoardProG2](#)]

Value space:

Integer (1..480)

Set the standby delay (minutes).

BoardPro,
BoardPro
G2

Codec EQ

Codec
PlusCodec
ProDesk,
DeskPro,
DeskMiniRoom Bar
Pro,
Room BarRoom Kit,
Room Kit
MiniRoom Kit
EQX

Room 55

Room 55
Dual,
Room 70Room 70
G2Room 70
PanoramaRoom
Panorama

Standby Halfwake Screensaver

Applies to: All products

Requires user role: ADMIN, INTEGRATOR

This setting only applies to devices that are set up with Microsoft Teams Rooms. Choose what to display on screen when the device is in halfwake mode.

Default value:

Halfwake

Value space:

Clock/Halfwake

Clock: Show the clock.

Halfwake: Show the default halfwake image.

Standby Level Networked Delay

Applies to: RoomBar RoomBarPro RoomKitEQX CodecEQ DeskMini Desk BoardPro BoardProG2

Requires user role: ADMIN, INTEGRATOR

Define for how long the device must be in the display off standby mode before it goes into networked standby.

If the delay is set to 0, the device goes from halfwake mode, via a few seconds in display off mode, and then to networked standby.

Default value:

2

Value space:

Integer (0..1440)

The standby level networked delay in minutes.

Board

BoardPro,
BoardPro
G2

Codec EQ

Codec
PlusCodec
ProDesk,
DeskPro,
DeskMiniRoom Bar
Pro,
Room BarRoom Kit,
Room Kit
MiniRoom Kit
EQX

Room 55

Room 55
Dual,
Room 70Room 70
G2Room 70
PanoramaRoom
Panorama

Standby Level Networked Mode

Applies to: RoomBar RoomBarPro RoomKitEQX CodecEQ DeskMini Desk BoardPro BoardProG2

Requires user role: ADMIN, INTEGRATOR

Disable/enable the automatic transition from display off to networked standby mode.

Networked standby mode is a deeper level of standby which reduces power consumption further than the regular display off standby mode.

The device will enter networked standby after it has been in display off standby mode, for x minutes, as defined in the Standby Level Networked Delay setting.

The Standby Control setting must be set to On for standby mode to be automatically initiated; however, you can trigger it manually with the Standby Activate command.

Default value:

On

Value space:

Off/On

On: The device will enter networked standby mode when the Standby Level Networked Delay has timed out.

Off: The device will not enter networked standby mode.

Standby Halfwake Mode

Applies to: All products

Requires user role: ADMIN

Decide whether the device should enter halfwake mode automatically before going to standby, or skip halfwake mode and go directly to standby. The halfwake mode may show a darkened screen with text or it may be configured to show branding information, including web pages or digital signage.

If enabled in the Standby Control setting and regardless of the Standby Halfwake Mode setting, the device will go into standby after x minutes of inactivity, where x is defined in Standby Delay setting.

Default value:

Auto

Value space:

Auto/Manual

Auto: The device goes into halfwake mode after 2 minutes of inactivity. It remains in halfwake mode until it detects activity or until it goes into standby mode.

Manual: The automatic halfwake mode is disabled. It can only be triggered manually with xCommand StandbyHalfwake.

Standby Signage Audio

Applies to: All products

Requires user role: ADMIN, INTEGRATOR

By default, a device does not play out audio in digital signage mode even if the web page has audio. You can use this setting to override the default behavior.

Default value:

Off

Value space:

Off/On

Off: The device does not play out audio with the web page.

On: If the web page has audio, the device plays it out. The volume follows the volume setting of the device.

Standby Signage InteractionMode

Applies to: RoomKitMini RoomBar RoomBarPro RoomKitEQX CodecEQ CodecPro DeskMini Desk DeskPro Board BoardPro BoardProG2

Requires user role: ADMIN, INTEGRATOR

Decide whether to allow users to interact with a digital signage web page.

The Interactive mode requires that the device has a touch screen (either built-in or connected). A Room Kit Mini must be used with Samsung Flip (Webex on Flip).

Default value:

NonInteractive

Value space:

Interactive/NonInteractive

Interactive: Users can interact with the web page.

NonInteractive: Users can't interact with the web page.

Board

Standby Signage Mode

Applies to: All products

Requires user role: ADMIN, INTEGRATOR

Content from a URL (a web page) can replace the traditional halfwake background image and information.

This feature is called digital signage. Users can interact with the web page if the device has an interactive screen, for example click on a link or enter text in a form.

The use of digital signage does not prevent the device from entering standby the normal way. Therefore, the Standby Delay setting determines for how long the digital signage is shown before the device goes into standby.

Default value:

Off

Value space:

Off/On

Off: Digital signage is not enabled on the device.

On: Digital signage is enabled and replaces the device's halfwake mode, provided that also the WebEngine Mode setting is On.

BoardPro,
BoardPro
G2

Codec EQ

Codec
PlusCodec
ProDesk,
DeskPro,
DeskMiniRoom Bar
Pro,
Room BarRoom Kit,
Room Kit
MiniRoom Kit
EQX

Room 55

Room 55
Dual,
Room 70Room 70
G2Room 70
PanoramaRoom
Panorama

Standby Signage Url

Applies to: All products

Requires user role: ADMIN, INTEGRATOR

Set the URL of the web page you want to display on the screen (digital signage).

If the length of the URL is 0, the device retains normal halfwake mode.

If the URL fails, the device retains normal halfwake mode and a diagnostics message is issued.

Default value:

""

Value space:

String (0, 2048)

The URL of the web page.

Standby StandbyAction

Applies to: RoomKit RoomKitMini RoomBar RoomBarPro RoomKitEQX CodecEQ CodecPlus CodecPro Room55 Room70/Room55D Room70G2 RoomPanorama/Room70Panorama DeskMini Desk DeskPro BoardPro BoardProG2

Requires user role: ADMIN, INTEGRATOR

Define the camera position when going into standby mode.

Default value:

PrivacyPosition

Value space:

None/PrivacyPosition

None: No action.

PrivacyPosition: When the video device enters standby, the camera turns to a sideways position for privacy.

Standby Signage RefreshInterval

Applies to: All products

Requires user role: ADMIN, INTEGRATOR

Trigger a web page to refresh at regular intervals (in seconds).

This is useful for web pages that are not able to refresh themselves.

It is not recommended to set a refresh interval with the interactive mode.

Default value:

0

Value space:

Integer (0..1440)

The number of seconds between each web page refresh. The value of 0 means that the web page is never forced to refresh.

Board

Standby WakeupAction

Applies to: All products

Requires user role: ADMIN, INTEGRATOR, USER

Defines the camera position when leaving standby mode.

Default value:

RestoreCameraPosition

Value space:

None/RestoreCameraPosition/DefaultCameraPosition

None: No action.

RestoreCameraPosition: When the video device leaves standby, the camera returns to the position that it had before entering standby.

DefaultCameraPosition: When the video device leaves standby, the camera moves to the factory default position.

BoardPro,
BoardPro
G2

Codec EQ

Codec
PlusCodec
ProDesk,
DeskPro,
DeskMiniRoom Bar
Pro,
Room BarRoom Kit,
Room Kit
MiniRoom Kit
EQX

Room 55

Room 55
Dual,
Room 70Room 70
G2Room 70
PanoramaRoom
Panorama

Standby WakeupOnMotionDetection

Applies to: All products

Requires user role: ADMIN, INTEGRATOR

When Wake Up on Motion Detection is enabled, the device automatically wakes up and enters halfwake mode when it detects people entering the room.

This feature allows the device to detect when people enter the room. When motion is detected, the system will go from Standby to Halfwake, unless a meeting is scheduled at the time of motion detection. In that case, the system will go from Standby to Awake. This feature primarily uses ultrasound for detection, and for specific products like the Board Pro and Board Pro G2, it also uses radar when in standby modes.

The Audio Ultrasound MaxVolume and Proximity Mode settings has no effect on motion detection.

Default value:

On [RoomKit RoomKitMini RoomBar RoomBarPro Room55 Room70/Room55D Room70G2 RoomPanorama/Room70Panorama DeskMini Desk DeskPro Board BoardPro BoardProG2]

Off [RoomKitEQX CodecEQ CodecPlus CodecPro]

Value space:

Off/On

Off: The device doesn't wake up from standby when it detects motion.

On: The device automatically goes from standby to halfwake when it detects motion, for example when people enter the room. If a meeting is scheduled when motion is detected the system will move to fully awake.

Standby WakeupAtMeetingStart

Applies to: All products

Requires user role: ADMIN, INTEGRATOR

Chooses whether the device wakes up automatically when a meeting is scheduled to start. If no one joins the meeting or otherwise interacts with the device, it goes to halfwake and then standby a few minutes after the scheduled start.

Default value:

Auto

Value space:

Auto/Off

Auto: The device wakes up before a scheduled meeting is about to start.

Off: The device remains in standby, even if a meeting is scheduled to start.

Standby WakeupOnPairing

Applies to: All products

Requires user role: ADMIN, INTEGRATOR

Chooses whether the device wakes up automatically when being paired to the Webex app.

Default value:

On

Value space:

Off/On

On: The device wakes up when paired to the Webex app.

Off: The device remains on standby, even if paired to the Webex app.

Board

BoardPro,
BoardPro
G2

Codec EQ

Codec
PlusCodec
ProDesk,
DeskPro,
DeskMiniRoom Bar
Pro,
Room BarRoom Kit,
Room Kit
MiniRoom Kit
EQX

Room 55

Room 55
Dual,
Room 70Room 70
G2Room 70
PanoramaRoom
Panorama

SystemUnit settings

SystemUnit Name

Applies to: All products

Requires user role: ADMIN

Define the device name. The device name will be sent as the hostname in a DHCP request and when the device is acting as an SNMP Agent.

Default value:

""

Value space:

String (0, 50)

Define the device name.

SystemUnit BroadcastName

Applies to: All products

Requires user role: ADMIN

A broadcast name is the name that other devices, such as laptops and mobile phones, will see in their scan lists for services such as Airplay, Miracast, and Bluetooth. You can specify a specific broadcast name with this setting. If you don't specifically set a broadcast name here, the scan lists will include the Webex DisplayName if the device is registered to the Webex cloud service, and the SystemUnit Name if registered to an on-premises service. If neither of these names are set, the product type (id) will be displayed.

We recommend you not include PII (personally identifiable information) in a broadcast name.

Default value:

""

Value space:

String (0, 256)

The broadcast name that will be shown in other devices' scan lists.

SystemUnit CrashReporting Advanced

Applies to: All products

Requires user role: ADMIN

If the device crashes, the device can automatically send logs to the Cisco Automatic Crash Report tool (ACR) for analyses. Refer to the SystemUnit CrashReporting Mode setting for more details.

Default value:

On

Value space:

Off/On

Off: The ACR tool will perform standard log analyses.

On: The ACR tool will perform advanced log analyses.

SystemUnit CrashReporting Mode

Applies to: All products

Requires user role: ADMIN

If the device crashes, the device can automatically send logs to the Cisco Automatic Crash Report tool (ACR) for analyses.

For devices that are registered to the Webex cloud service or linked to Webex Edge for devices, automatic crash reporting is available for all devices. PII information is removed or anonymised before sending the logs to the Webex cloud.

For devices that are registered to an on-premises service such as CUCM, automatic crash reporting is only for Cisco-internal devices. The crash report is sent to the URL given in the SystemUnit CrashReporting URL setting.

Default value:

On

Value space:

Off/On

Off: No logs will be sent to the ACR tool.

On: The logs will automatically be sent to the ACR tool.

Board

SystemUnit CrashReporting URL

Applies to: All products

Requires user role: ADMIN

If the device crashes, the device can automatically send logs to the Cisco Automatic Crash Report tool (ACR) for analyses. Refer to the SystemUnit CrashReporting Mode setting for more details.

Default value:

"acr.cisco.com"

Value space:

String (0, 255)

The URL to the Cisco Automatic Crash Report tool (ACR).

SystemUnit CustomDeviceId

Applies to: All products

Requires user role: ADMIN, INTEGRATOR

The SystemUnit CustomDeviceId provides a place for you to store custom information about a unit. This can be useful, for example, in aiding to track devices in a provisioning setup.

Default value:

""

Value space:

String (0, 255)

SystemUnit Extension MouseSupport

Applies to: RoomBar RoomBarPro RoomKitEQX CodecEQ CodecPro Room70G2 DeskPro BoardPro BoardProG2

Requires user role: ADMIN

You may need to interact with the Microsoft Teams UI, for example to select which Microsoft cloud to onboard to when you are at the Microsoft login screen. In such a case, you can connect a mouse to the USB-A port of the device. You can only use this mouse to interact with the Microsoft Teams UI; not with the regular RoomOS UI.

Connecting a separate keyboard on USB is not supported.

Default value:

Enabled

Value space:

Disabled/Enabled

Disabled: The device doesn't have mouse support.

Enabled: You can interact with the Microsoft Teams UI using a USB mouse.

SystemUnit Hardware USBC[1] Mode

Applies to: RoomBar RoomBarPro RoomKitEQX CodecEQ DeskMini Desk

Requires user role: ADMIN

Use this setting if you want to instruct the device to only use the USB2.0 protocol on the USB-C port, even if it also supports the newer USB 3.0 version.

It may be necessary for certain laptops when using our device as a web camera.

You must reboot the device for this setting to take effect.

Default value:

USB3

Value space:

USB2/USB3

USB2: Offer only USB 2.0 for USB negotiation.

USB3: Offer standard USB negotiation, that is, use USB3.0 if available, otherwise USB 2.0.

SystemUnit SoftwareUpgrade Provider

Applies to: RoomBar RoomBarPro RoomKitEQX CodecEQ CodecPro Room70G2 DeskPro BoardPro BoardProG2

Requires user role: ADMIN

For Cisco devices for Microsoft Teams Rooms that are registered to a Cisco backend service (like Webex or Cisco Unified CM), you can decide from which service to get automatic software upgrades.

The RoomOS software will follow this setting, but please note that the Microsoft Teams application can always be upgraded from Teams Admin Center.

Default value:

Cisco

Value space:

Cisco/Microsoft

Microsoft: Get software upgrades from Microsoft.

Cisco: Get software upgrades from the Cisco service.

Board

BoardPro,
BoardPro
G2

Codec EQ

Codec
PlusCodec
ProDesk,
DeskPro,
DeskMiniRoom Bar
Pro,
Room BarRoom Kit,
Room Kit
MiniRoom Kit
EQX

Room 55

Room 55
Dual,
Room 70Room 70
G2Room 70
PanoramaRoom
Panorama

SystemUnit SoftwareUpgrade WebCache Mode

Applies to: All products

Requires user role: ADMIN

Usually, the device downloads software directly from the Webex cloud. You can choose to set up a web cache (HTTP cache) to optimize transport.

This setting applies to devices that are registered to the Webex cloud service or linked to Webex Edge for devices.

Default value:

Off

Value space:

Manual/Off

Manual: The device downloads software upgrades through a web cache (HTTP cache). The URL for the web cache is specified in the SystemUnit SoftwareUpgrade WebCache URL setting. If the cache is not working, the device will fall back to using its standard network connection.

Off: The device downloads software directly from the Webex cloud, without using a web cache.

SystemUnit SoftwareUpgrade WebCache Url

Applies to: All products

Requires user role: ADMIN

Set the URL for the web cache that can be used for software downloads from the Webex cloud. It is only used if SystemUnit SoftwareUpgrade WebCache Mode is set to Manual.

This setting applies to devices that are registered to the Webex cloud service or linked to Webex Edge for devices.

Default value:

""

Value space:

String (0, 255)

The URL for the web cache.

ThousandEyes settings

ThousandEyes ConnectionString

Applies to: All products

Requires user role: ADMIN

This setting applies to devices that are registered to the Webex cloud service or linked to Webex Edge for devices.

The ThousandEyes agent is part of the RoomOS software, but it must be enabled from Control Hub. The agent requires a Connection String parameter, which acts as a token that accurately identifies the account group where the agent should belong. You must obtain the connection string from the ThousandEyes admin for your organization.

The string is required for the ThousandEyes agent running on the device to be able to register with the ThousandEyes cloud service.

Default value:

""

Value space:

String (0, 512)

The account group connection string.

Board

BoardPro,
BoardPro
G2

Codec EQ

Codec
PlusCodec
ProDesk,
DeskPro,
DeskMiniRoom Bar
Pro,
Room BarRoom Kit,
Room Kit
MiniRoom Kit
EQX

Room 55

Room 55
Dual,
Room 70Room 70
G2Room 70
PanoramaRoom
Panorama

Time settings

Time DateFormat

Applies to: All products

Requires user role: ADMIN, USER

Define the date format.

Default value:

DD_MM_YY

Value space:

DD_MM_YY/MM_DD_YY/YY_MM_DD

DD_MM_YY: The date January 30th 2010 will be displayed: 30.01.10

MM_DD_YY: The date January 30th 2010 will be displayed: 01.30.10

YY_MM_DD: The date January 30th 2010 will be displayed: 10.01.30

Time TimeFormat

Applies to: All products

Requires user role: ADMIN, USER

Define the time format.

Default value:

24H

Value space:

24H/12H

24H: Set the time format to 24 hours.

12H: Set the time format to 12 hours (AM/PM).

Time Zone

Applies to: All products

Requires user role: ADMIN, INTEGRATOR, USER

Define the time zone for the geographical location of the device. The information in the value space is from the tz database, also called the IANA Time Zone Database.

Default value:

Etc/UTC

Value space:

Africa/Abidjan, Africa/Accra, Africa/Addis_Ababa, Africa/Algiers, Africa/Asmara, Africa/Asmera, Africa/Bamako, Africa/Bangui, Africa/Banjul, Africa/Bissau, Africa/Blantyre, Africa/Brazzaville, Africa/Bujumbura, Africa/Cairo, Africa/Casablanca, Africa/Ceuta, Africa/Conakry, Africa/Dakar, Africa/Dar_es_Salaam, Africa/Djibouti, Africa/Douala, Africa/El_Aaiun, Africa/Freetown, Africa/Gaborone, Africa/Harare, Africa/Johannesburg, Africa/Juba, Africa/Kampala, Africa/Khartoum, Africa/Kigali, Africa/Kinshasa, Africa/Lagos, Africa/Libreville, Africa/Lome, Africa/Luanda, Africa/Lubumbashi, Africa/Lusaka, Africa/Malabo, Africa/Maputo, Africa/Maseru, Africa/Mbabane, Africa/Mogadishu, Africa/Monrovia, Africa/Nairobi, Africa/Ndjamena, Africa/Niamey, Africa/Nouakchott, Africa/Ouagadougou, Africa/Porto-Novo, Africa/Sao_Tome, Africa/Timbuktu, Africa/Tripoli, Africa/Tunis, Africa/Windhoek, America/Adak, America/Anchorage, America/Anguilla, America/Antigua, America/Araguaina, America/Argentina/Buenos_Aires, America/Argentina/Catamarca, America/Argentina/ComodRivadavia, America/Argentina/Cordoba, America/Argentina/Jujuy, America/Argentina/La_Rioja, America/Argentina/Mendoza, America/Argentina/Rio_Gallegos, America/Argentina/Salta, America/Argentina/San_Juan, America/Argentina/San_Luis, America/Argentina/Tucuman, America/Argentina/Ushuaia, America/Aruba, America/Asuncion, America/Atikokan, America/Atka, America/Bahia, America/Bahia_Banderas, America/Barbados, America/Belem, America/Belize, America/Blanc-Sablon, America/Boa_Vista, America/Bogota, America/Boise, America/Buenos_Aires, America/Cambridge_Bay, America/Campo_Grande, America/Cancun, America/Caracas, America/Catamarca, America/Cayenne, America/Cayman, America/Chicago, America/Chihuahua, America/Ciudad_Juarez, America/Coral_Harbour, America/Cordoba, America/Costa_Rica, America/Creston, America/Cuiaba, America/Curacao, America/Danmarkshavn, America/Dawson, America/Dawson_Creek, America/Denver, America/Detroit, America/Dominica, America/Edmonton, America/Eirunepe, America/El_Salvador, America/Ensenada, America/Fort_Nelson, America/Fort_Wayne, America/Fortaleza, America/Glace_Bay, America/Godthab, America/Goose_Bay, America/Grand_Turk, America/Grenada, America/Guadeloupe, America/Guatemala, America/Guayaquil, America/Guyana, America/Halifax, America/Havana, America/Hermosillo, America/Indiana/Indianapolis, America/Indiana/Knox, America/Indiana/Marengo, America/Indiana/Petersburg, America/Indiana/Tell_City, America/Indiana/Vevay, America/Indiana/Vincennes, America/Indiana/Winamac, America/Indianapolis, America/Inuvik, America/Iqaluit, America/Jamaica, America/Jujuy, America/Juneau, America/Kentucky/Louisville, America/Kentucky/Monticello, America/Knox_IN, America/Kralendijk, America/La_Paz, America/Lima, America/Los_Angeles, America/Louisville, America/Lower_Princes, America/Maceio, America/Managua, America/Manaus, America/Marigot, America/Martinique, America/Matamoros, America/Mazatlan, America/Mendoza, America/

- Board
- BoardPro, BoardPro G2
- Codec EQ
- Codec Plus
- Codec Pro
- Desk, DeskPro, DeskMini
- Room Bar Pro, Room Bar
- Room Kit, Room Kit Mini
- Room Kit EQX
- Room 55
- Room 55 Dual, Room 70
- Room 70 G2
- Room 70 Panorama
- Room Panorama

Menominee, America/Merida, America/Metlakatla, America/Mexico_City, America/Miquelon, America/Moncton, America/Monterrey, America/Montevideo, America/Montreal, America/Montserrat, America/Nassau, America/New_York, America/Nipigon, America/Nome, America/Noronha, America/North_Dakota/Beulah, America/North_Dakota/Center, America/North_Dakota/New_Salem, America/Nuuk, America/Ojinaga, America/Panama, America/Pangnirtung, America/Paramaribo, America/Phoenix, America/Port-au-Prince, America/Port_of_Spain, America/Porto_Acre, America/Porto_Velho, America/Puerto_Rico, America/Punta_Arenas, America/Rainy_River, America/Rankin_Inlet, America/Recife, America/Regina, America/Resolute, America/Rio_Branco, America/Rosario, America/Santa_Isabel, America/Santarem, America/Santiago, America/Santo_Domingo, America/Sao_Paulo, America/Scoresbysund, America/Shiprock, America/Sitka, America/St_Barthlemy, America/St_Johns, America/St_Kitts, America/St_Lucia, America/St_Thomas, America/St_Vincent, America/Swift_Current, America/Tegucigalpa, America/Thule, America/Thunder_Bay, America/Tijuana, America/Toronto, America/Tortola, America/Vancouver, America/Virgin, America/Whitehorse, America/Winnipeg, America/Yakutat, America/Yellowknife, Antarctica/Casey, Antarctica/Davis, Antarctica/DumontDUrville, Antarctica/Macquarie, Antarctica/Mawson, Antarctica/McMurdo, Antarctica/Palmer, Antarctica/Rothera, Antarctica/South_Pole, Antarctica/Syowa, Antarctica/Troll, Antarctica/Vostok, Arctic/Longyearbyen, Asia/Aden, Asia/Almaty, Asia/Amman, Asia/Anadyr, Asia/Aqtou, Asia/Aqtobe, Asia/Ashgabat, Asia/Ashkhabad, Asia/Atyrau, Asia/Baghdad, Asia/Bahrain, Asia/Baku, Asia/Bangkok, Asia/Barnaul, Asia/Beirut, Asia/Bishkek, Asia/Brunei, Asia/Calcutta, Asia/Chita, Asia/Choibalsan, Asia/Chongqing, Asia/Chungking, Asia/Colombo, Asia/Dacca, Asia/Damascus, Asia/Dhaka, Asia/Dili, Asia/Dubai, Asia/Dushanbe, Asia/Famagusta, Asia/Gaza, Asia/Harbin, Asia/Hebron, Asia/Ho_Chi_Min, Asia/Hong_Kong, Asia/Hovd, Asia/Irkutsk, Asia/Istanbul, Asia/Jakarta, Asia/Jayapura, Asia/Jerusalem, Asia/Kabul, Asia/Kamchatka, Asia/Karachi, Asia/Kashgar, Asia/Kathmandu, Asia/Katmandu, Asia/Khandyga, Asia/Kolkata, Asia/Krasnoyarsk, Asia/Kuala_Lumpur, Asia/Kuching, Asia/Kuwait, Asia/Macao, Asia/Macau, Asia/Magadan, Asia/Makassar, Asia/Manila, Asia/Muscat, Asia/Nicosia, Asia/Novokuznetsk, Asia/Novosibirsk, Asia/Omsk, Asia/Oral, Asia/Phnom_Penh, Asia/Pontianak, Asia/Pyongyang, Asia/Qatar, Asia/Qostanay, Asia/Qyzylorda, Asia/Rangoon, Asia/Riyadh, Asia/Saigon, Asia/Sakhalin, Asia/Samarkand, Asia/Seoul, Asia/Shanghai, Asia/Singapore, Asia/Srednekolymysk, Asia/Taipei, Asia/Tashkent, Asia/Tbilisi, Asia/Tehran, Asia/Tel_Aviv, Asia/Thimbu, Asia/Thimphu, Asia/Tokyo, Asia/Tomsk, Asia/Ujung_Pandang, Asia/Ulaanbaatar, Asia/Ulan_Bator, Asia/Urumqi, Asia/Ust-Nera, Asia/Vientiane, Asia/Vladivostok, Asia/Yakutsk, Asia/Yangon, Asia/Yekaterinburg, Asia/Yerevan, Atlantic/Azores, Atlantic/Bermuda, Atlantic/Canary, Atlantic/Cape_Verde, Atlantic/Faeroe, Atlantic/Faroe, Atlantic/Jan_Mayen, Atlantic/Madeira, Atlantic/Reykjavik, Atlantic/South_Georgia, Atlantic/St_Helena, Atlantic/Stanley, Australia/ACT, Australia/Adelaide, Australia/Brisbane, Australia/Broken_Hill, Australia/Canberra, Australia/Currie, Australia/Darwin, Australia/Eucla, Australia/Hobart, Australia/LHI, Australia/Lindeman, Australia/Lord_Howe, Australia/Melbourne, Australia/NSW, Australia/North, Australia/Perth, Australia/Queensland, Australia/South, Australia/Sydney, Australia/Tasmania, Australia/Victoria, Australia/West, Australia/Yancowinna, Brazil/Acre, Brazil/DeNoronha, Brazil/East, Brazil/West, CET, CST6CDT, Canada/Atlantic, Canada/Central, Canada/Eastern, Canada/Mountain, Canada/Newfoundland, Canada/Pacific, Canada/Saskatchewan, Canada/Yukon, Chile/Continental, Chile/EasterIsland, Cuba, EET, EST, EST5EDT, Egypt, Eire, Etc/GMT, Etc/GMT+0, Etc/GMT+1, Etc/GMT+10, Etc/GMT+11, Etc/GMT+12, Etc/GMT+2, Etc/GMT+3, Etc/GMT+4, Etc/GMT+5, Etc/GMT+6, Etc/GMT+7, Etc/GMT+8, Etc/GMT+9, Etc/

GMT-0, Etc/GMT-1, Etc/GMT-10, Etc/GMT-11, Etc/GMT-12, Etc/GMT-13, Etc/GMT-14, Etc/GMT-2, Etc/GMT-3, Etc/GMT-4, Etc/GMT-5, Etc/GMT-6, Etc/GMT-7, Etc/GMT-8, Etc/GMT-9, Etc/GMT0, Etc/Greenwich, Etc/UCT, Etc/UTC, Etc/Universal, Etc/Zulu, Europe/Amsterdam, Europe/Andorra, Europe/Astrakhan, Europe/Athens, Europe/Belfast, Europe/Belgrade, Europe/Berlin, Europe/Bratislava, Europe/Brussels, Europe/Bucharest, Europe/Budapest, Europe/Busingen, Europe/Chisinau, Europe/Copenhagen, Europe/Dublin, Europe/Gibraltar, Europe/Guernsey, Europe/Helsinki, Europe/Isle_of_Man, Europe/Istanbul, Europe/Jersey, Europe/Kaliningrad, Europe/Kiev, Europe/Kirov, Europe/Kyiv, Europe/Lisbon, Europe/Ljubljana, Europe/London, Europe/Luxembourg, Europe/Madrid, Europe/Malta, Europe/Mariehamn, Europe/Minsk, Europe/Monaco, Europe/Moscow, Europe/Nicosia, Europe/Oslo, Europe/Paris, Europe/Podgorica, Europe/Prague, Europe/Riga, Europe/Rome, Europe/Samara, Europe/San_Marino, Europe/Sarajevo, Europe/Saratov, Europe/Simferopol, Europe/Skopje, Europe/Sofia, Europe/Stockholm, Europe/Tallinn, Europe/Tirane, Europe/Tiraspol, Europe/Ulyanovsk, Europe/Uzhgorod, Europe/Vaduz, Europe/Vatican, Europe/Vienna, Europe/Vilnius, Europe/Volgograd, Europe/Warsaw, Europe/Zagreb, Europe/Zaporozhye, Europe/Zurich, GB, GB-Eire, GMT, GMT+0, GMT-0, GMT0, Greenwich, HST, Hongkong, Iceland, Indian/Antananarivo, Indian/Chagos, Indian/Christmas, Indian/Cocos, Indian/Comoro, Indian/Kerguelen, Indian/Mahe, Indian/Maldives, Indian/Mauritius, Indian/Mayotte, Indian/Reunion, Iran, Israel, Jamaica, Japan, Kwajalein, Libya, MET, MST, MST7MDT, Mexico/BajaNorte, Mexico/BajaSur, Mexico/General, NZ, NZ-CHAT, Navajo, PRC, PST8PDT, Pacific/Apia, Pacific/Auckland, Pacific/Bougainville, Pacific/Chatham, Pacific/Chuuk, Pacific/Easter, Pacific/Efate, Pacific/Enderbury, Pacific/Fakaofu, Pacific/Fiji, Pacific/Funafuti, Pacific/Galapagos, Pacific/Gambier, Pacific/Guadalcanal, Pacific/Guam, Pacific/Honolulu, Pacific/Johnston, Pacific/Kanton, Pacific/Kiritimati, Pacific/Kosrae, Pacific/Kwajalein, Pacific/Majuro, Pacific/Marquesas, Pacific/Midway, Pacific/Nauru, Pacific/Niue, Pacific/Norfolk, Pacific/Noumea, Pacific/Pago_Pago, Pacific/Palau, Pacific/Pitcairn, Pacific/Pohnpei, Pacific/Ponape, Pacific/Port_Moresby, Pacific/Rarotonga, Pacific/Saipan, Pacific/Samoa, Pacific/Tahiti, Pacific/Tarawa, Pacific/Tongatapu, Pacific/Truk, Pacific/Wake, Pacific/Wallis, Pacific/Yap, Poland, Portugal, ROC, ROK, Singapore, Turkey, UCT, US/Alaska, US/Aleutian, US/Arizona, US/Central, US/East-Indiana, US/Eastern, US/Hawaii, US/Indiana-Starke, US/Michigan, US/Mountain, US/Pacific, US/Samoa, UTC, Universal, W-SU, WET, Zulu

Select a time zone from the list.

Board

Time OfficeHours Enabled

Applies to: All products

Requires user role: ADMIN

Setting the office hours on a device will allow you to switch off always-on features like signage, outside of ordinary office hours. This prevents screens from being active all the time, and thereby increases their lifetime. Most screens are not certified for all day use, seven days a week.

Default value:

True

Value space:

False/True

False: The device isn't set up to support Office hours. Therefore, the other OfficeHours settings have no effect.

True: The device supports Office hours. The other OfficeHours settings define when office hours are, and device standby behavior outside of office hours.

Time OfficeHours OutsideOfficeHours Standby AutoWakeup

Applies to: All products

Requires user role: ADMIN

Set how the device responds when it detects motion in the room outside of office hours. Regardless of this setting, the device always wakes up when someone starts using it.

Default value:

Disabled

Value space:

Disabled/Enabled

Disabled: The device will stay in standby even if it detects motion.

Enabled: The device will wake up as usual when it detects motion.

Time OfficeHours OutsideOfficeHours Standby Delay

Applies to: All products

Requires user role: ADMIN

Specify how long the device stays in idle mode before entering display off mode, outside office hours.

Default value:

5

Value space:

Integer (1..30)

The number of minutes the device stays in idle mode before entering display off mode.

Time OfficeHours WorkDay End

Applies to: All products

Requires user role: ADMIN, USER

Set the time when the ordinary office hours end.

Default value:

"19:00"

Value space:

String (5, 5)

The time of day in "hh:mm" format, where hh = two-digit hour, 00 through 23 (am/pm is not supported) and mm = two-digit minute, 00 through 59.

Time OfficeHours WorkDay Start

Applies to: All products

Requires user role: ADMIN, USER

Set the time when the ordinary office hours start.

Default value:

"07:00"

Value space:

String (5, 5)

The time of day in "hh:mm" format, where hh = two-digit hour, 00 through 23 (am/pm is not supported) and mm = two-digit minute, 00 through 59.

BoardPro,
BoardPro
G2

Codec EQ

Codec
PlusCodec
ProDesk,
DeskPro,
DeskMiniRoom Bar
Pro,
Room BarRoom Kit,
Room Kit
MiniRoom Kit
EQX

Room 55

Room 55
Dual,
Room 70Room 70
G2Room 70
PanoramaRoom
Panorama

Board

Time OfficeHours WorkWeek Monday

Applies to: All products

Requires user role: ADMIN

Set whether Monday is included in the working week.

Default value:

True

Value space:

False/True

False: Monday is not included in the working week.

True: Monday is included in the working week.

Time OfficeHours WorkWeek Tuesday

Applies to: All products

Requires user role: ADMIN

Set whether Tuesday is included in the working week.

Default value:

True

Value space:

False/True

False: Tuesday is not included in the working week.

True: Tuesday is included in the working week.

Time OfficeHours WorkWeek Wednesday

Applies to: All products

Requires user role: ADMIN

Set whether Wednesday is included in the working week.

Default value:

True

Value space:

False/True

False: Wednesday is not included in the working week.

True: Wednesday is included in the working week.

Time OfficeHours WorkWeek Thursday

Applies to: All products

Requires user role: ADMIN

Set whether Thursday is included in the working week.

Default value:

True

Value space:

False/True

False: Thursday is not included in the working week.

True: Thursday is included in the working week.

Time OfficeHours WorkWeek Friday

Applies to: All products

Requires user role: ADMIN

Set whether Friday is included in the working week.

Default value:

True

Value space:

False/True

False: Friday is not included in the working week.

True: Friday is included in the working week.

Time OfficeHours WorkWeek Saturday

Applies to: All products

Requires user role: ADMIN

Set whether Saturday is included in the working week.

Default value:

False

Value space:

False/True

False: Saturday is not included in the working week.

True: Saturday is included in the working week.

BoardPro,
BoardPro
G2

Codec EQ

Codec
PlusCodec
ProDesk,
DeskPro,
DeskMiniRoom Bar
Pro,
Room BarRoom Kit,
Room Kit
MiniRoom Kit
EQX

Room 55

Room 55
Dual,
Room 70Room 70
G2Room 70
PanoramaRoom
Panorama

Board

BoardPro,
BoardPro
G2

Codec EQ

Codec
PlusCodec
ProDesk,
DeskPro,
Desk MiniRoom Bar
Pro,
Room BarRoom Kit,
Room Kit
MiniRoom Kit
EQX

Room 55

Room 55
Dual,
Room 70Room 70
G2Room 70
PanoramaRoom
Panorama

Time OfficeHours WorkWeek Sunday

Applies to: All products

Requires user role: ADMIN

Set whether Sunday is included in the working week.

Default value:

False

Value space:

False/True

False: Sunday is not included in the working week.

True: Sunday is included in the working week.

UserInteraction settings

UserInteraction RaiseHand CMS

Applies to: All products

Requires user role: ADMIN, USER

This setting controls the availability of the raise hand feature for CMS meetings. If CMS supports the raise hand feature and this setting is set to True, then the raise hand button will be present on the user interface of the device.

Default value:

True

Value space:

False/True

False: The raise hand button will not be present.

True: The raise hand button will be present if CMS supports the feature.

Board

BoardPro,
BoardPro
G2

Codec EQ

Codec
PlusCodec
ProDesk,
DeskPro,
DeskMiniRoom Bar
Pro,
Room BarRoom Kit,
Room Kit
MiniRoom Kit
EQX

Room 55

Room 55
Dual,
Room 70Room 70
G2Room 70
PanoramaRoom
Panorama

UserInterface settings

UserInterface Accessibility IncomingCallNotification

Applies to: All products

Requires user role: ADMIN, INTEGRATOR, USER

You can enable an incoming call notification with amplified visuals. The screen and touch controller will flash red/white approximately once every second (1.75 Hz) to make it easier for hearing impaired users to notice an incoming call. If the device is already in a call the screen will not flash as this will disturb the on-going call, instead you will get a normal notification on screen and touch panel.

Default value:

Default

Value space:

AmplifiedVisuals/Default

AmplifiedVisuals: Enable the amplified visuals on screen and touch panel when the device receives a call.

Default: Enable the default behavior with a notification on screen and touch panel.

UserInterface Accessibility ScreenReader Default Mode

Applies to: All products

Requires user role: ADMIN

Configures the screen reader mode when the device goes to standby/halfwake.

Default value:

Off

Value space:

Current/Off/On

Current: When set to current, nothing happens when the devices goes to halfwake/standby.

Off: Turns the screen reader off when the devices goes to standby/halfwake.

On: Turns the screen reader on when the devices goes to standby/halfwake.

UserInterface Accessibility ScreenReader Gesture

Applies to: All products

Requires user role: ADMIN

Allows you to enable or disable the "3 fingers tap and hold" gesture on a touch screen device for toggling the screen reader functionality.

Default value:

On

Value space:

Off/On

On: Enables the gesture to toggle the screen reader. When enabling it, it will say "Screen reader enabled" out loud right away.

Off: Disables the gesture, preventing it from toggling the screen reader.

UserInterface Assistant Mode

Applies to: All products

Requires user role: ADMIN

Webex Assistant allows you to control the device by using voice commands. Webex Assistant is a cloud service, so the device must either be registered to the Webex cloud service or registered to an on-premises service and linked to Webex Edge for Devices.

Use this setting to enable or disable the Webex Assistant on the device.

Default value:

On

Value space:

Off/On

Off: Webex Assistant is switched off.

On: Webex Assistant can be used if it is supported by the infrastructure.

Board

BoardPro,
BoardPro
G2

Codec EQ

Codec
PlusCodec
ProDesk,
DeskPro,
DeskMiniRoom Bar
Pro,
Room BarRoom Kit,
Room Kit
MiniRoom Kit
EQX

Room 55

Room 55
Dual,
Room 70Room 70
G2Room 70
PanoramaRoom
Panorama

D15503.06

RoomOS
11.24

02-2025



UserInterface Assistant ProactiveMeetingJoin

Applies to: All products

Requires user role: ADMIN

Proactive Join is a feature that is offered by Webex Assistant. When Proactive Join is enabled and someone is discovered in the meeting room just before the start of an OBTP-meeting, the device will ask if they want to join the meeting that is about to start.

Use this setting to enable or disable the Proactive Join feature on the device.

Default value:

True

Value space:

False/True

False: The Proactive Join feature is switched off.

True: The Proactive Join feature can be used if Webex Assistant is active.

UserInterface Bookings AdhocBooking DefaultTitle

Applies to: All products

Requires user role: ADMIN

The meeting title for ad hoc bookings. This title shows up on the Room Navigator outside the meeting room.

Default value:

"Ad hoc meeting"

Value space:

String (0, 32)

The default title for ad hoc bookings.

UserInterface Bookings AdhocBooking TimeSlotSize

Applies to: All products

Requires user role: ADMIN

Allows the configuration of the time slot size for scheduling bookings. The time slot size determines the predetermined intervals –15, 30, or 60 minutes– at which users can select the start or end time of a booking.

Default value:

30

Value space:

15/30/60

Specifies the predetermined time intervals (in minutes) for selecting the start or end time of a booking.

UserInterface Bookings AdhocBooking UseDefaultTitle

Applies to: All products

Requires user role: ADMIN

Sets a default meeting title when scheduling an ad hoc meeting. The default meeting title is "Ad hoc meeting".

Default value:

False

Value space:

False/True

True: Use the default title.

False: Does not use the default title.

UserInterface Bookings Visibility AllDayMeetings

Applies to: All products

Requires user role: ADMIN, INTEGRATOR, USER

Show or hide meetings set to "all day" length.

Default value:

Auto

Value space:

Auto/Hidden

Auto: Shows meetings set to all day.

Hidden: Does not show meetings set to all day.

Board

UserInterface Bookings Visibility EarlyJoin

Applies to: All products

Requires user role: ADMIN

The Join button in the device's Calendar is available for any meeting that is scheduled for that day, even if it's not yet the scheduled time. If early joining isn't enabled, the Join button appears 5 minutes before the scheduled time. This does not affect the meeting reminder pop up, only the calendar list view.

Default value:

Hidden

Value space:

Auto/Hidden

Auto: Early join is enabled.

Hidden: Early join is not enabled, and the Join button appears 5 minutes before the scheduled meeting time.

BoardPro,
BoardPro
G2

Codec EQ

Codec
PlusCodec
ProDesk,
DeskPro,
DeskMiniRoom Bar
Pro,
Room BarRoom Kit,
Room Kit
MiniRoom Kit
EQX

Room 55

Room 55
Dual,
Room 70Room 70
G2Room 70
PanoramaRoom
Panorama

UserInterface Bookings Visibility NonJoinableMeetings

Applies to: All products

Requires user role: ADMIN, INTEGRATOR, USER

Show or hide meetings or other events without the meeting join information in a workspace.

Default value:

Auto

Value space:

Auto/Hidden

Auto: Shows meetings or events that are non joinable.

Hidden: Hides meetings or events that are non joinable.

UserInterface Bookings Visibility JoinedParticipants Avatars

Applies to: All products

Requires user role: ADMIN

Determine whether or not the avatars of participants who have joined a meeting are displayed on the user interface.

Default value:

Auto

Value space:

Auto/Hidden

Auto: The avatars of the participants are visible.

Hidden: The avatars of the participants are not visible.

UserInterface Bookings Visibility MeetingReminder

Applies to: All products

Requires user role: ADMIN

Display a meeting reminder on screen before the meeting starts.

Default value:

ControllerOnly

Value space:

All/ControllerOnly

All: The reminder is displayed on both the device's screen and touch controller.

ControllerOnly: The reminder is displayed only on the touch controller.

UserInterface Bookings Visibility Organizer

Applies to: All products

Requires user role: ADMIN, INTEGRATOR, USER

Display the organizer of the meeting on the device's screen.

Default value:

Auto

Value space:

Auto/Hidden

Auto: The name of the organizer of the meeting is displayed on the device's screen.

Hidden: The name of the organizer of the meeting is hidden.

UserInterface Bookings Visibility Personal FullDayCalendar

Applies to: All products

Requires user role: ADMIN, INTEGRATOR, USER

Show or hide meetings for the full day on a personal mode device, as opposed to current active meetings only.

Default value:

On

Value space:

Off/On

On: Shows the full day calendar on a personal mode device.

Off: Shows only the current active meetings.

Board

BoardPro,
BoardPro
G2

Codec EQ

Codec
PlusCodec
ProDesk,
DeskPro,
DeskMiniRoom Bar
Pro,
Room BarRoom Kit,
Room Kit
MiniRoom Kit
EQX

Room 55

Room 55
Dual,
Room 70Room 70
G2Room 70
PanoramaRoom
Panorama

UserInterface Bookings Visibility Personal NonJoinableMeetings

Applies to: All products

Requires user role: ADMIN, INTEGRATOR, USER

Show or hide meetings or other events without the meeting join information on personal mode devices.

Default value:

Hidden

Value space:

Auto/Hidden

Auto: Shows non joinable meetings.

Hidden: Hides non joinable meetings.

UserInterface Bookings Visibility TentativeMeetings

Applies to: All products

Requires user role: ADMIN, INTEGRATOR, USER

In general, the list of upcoming meetings is shown on the screen and touch controller. Set whether to include tentative meetings in the list.

Default value:

Auto

Value space:

Auto/Hidden

Auto: Tentative meetings are included in the list.

Hidden: Tentative meetings are not in the list.

UserInterface Bookings Visibility Title

Applies to: All products

Requires user role: ADMIN, INTEGRATOR, USER

Sets the meeting details to private. "Scheduled meeting" will be displayed as the title of the meeting.

Default value:

Auto

Value space:

Auto/Hidden

Auto: The title of the meeting is public and will be displayed on the user interface.

Hidden: The title of the meeting will be hidden and "Scheduled meeting" will be displayed on the user interface.

UserInterface Branding AwakeBranding Colors

Applies to: All products

Requires user role: ADMIN, INTEGRATOR

If the device is set up with branding customizations, this setting affects the colors of the logo that is shown when the device is awake. You can choose whether you want to show the logo in full color, or reduce the opacity of the logo so that it blends in more naturally with the background and other elements on the screen.

Default value:

Auto

Value space:

Auto/Native

Auto: The opacity of the logo is reduced.

Native: The logo has full colors.

UserInterface CameraControl Presets Mode

Applies to: All products

Requires user role: ADMIN

Choose whether to allow users to add, modify, and delete camera presets. If allowed, they can edit presets from the Manual camera controls panel in the user interface.

Default value:

Auto

Value space:

Auto/Locked

Auto: Users can add, modify, and delete camera presets.

Locked: The camera presets are locked. Users can use the presets, but not add, delete, or modify them.

Board

BoardPro,
BoardPro
G2

Codec EQ

Codec
PlusCodec
ProDesk,
DeskPro,
DeskMiniRoom Bar
Pro,
Room BarRoom Kit,
Room Kit
MiniRoom Kit
EQX

Room 55

Room 55
Dual,
Room 70Room 70
G2Room 70
PanoramaRoom
Panorama

UserInterface ContactInfo Type

Applies to: All products

Requires user role: ADMIN

Choose which type of contact information to show on the user interface.

Default value:

Auto

Value space:

Auto/DisplayName/E164Alias/H323Id/IPv4/IPv6/None/SipUri/SystemName/
WebexDisplayName

Auto: Show the address which another device should dial to reach this video device. The address depends on the default call protocol and device registration.

None: Do not show any contact information.

IPv4: Show the device's IPv4 address.

IPv6: Show the device's IPv6 address.

H323Id: Show the device's H.323 ID (refer to the H323 H323Alias ID setting).

E164Alias: Show the device's H.323 E164 Alias as contact information (refer to the H323 H323Alias E164 setting).

SipUri: Show the device's SIP URI (refer to the SIP URI setting).

SystemName: Show the device's name (refer to the SystemUnit Name setting).

DisplayName: Show the device's display name (refer to the SIP DisplayName setting).

WebexDisplayName: The name of a user or device as it appears within the Cisco Webex cloud service.

UserInterface CustomMessage

Applies to: All products

Requires user role: ADMIN, INTEGRATOR

A custom message can be displayed, in the lower left side of the screen, in awake mode.

Default value:

""

Value space:

String (0, 256)

Add a custom message. Add an empty string to remove a custom message.

UserInterface DecemberThemeBeta

Applies to: All products

Requires user role: ADMIN, INTEGRATOR, USER

Enables the winter/seasonal theme during the month of December only.

Default value:

Off

Value space:

Off/On

On: Enables the theme.

Off: Disables the theme.

UserInterface DevicePersonalization QRCodeNotification

Applies to: DeskMini Desk DeskPro Board BoardPro BoardProG2

Requires user role: ADMIN

This is a notification that appears in the top right corner of devices set up with hot desking. It allows users to sign into the device via QR code.

Default value:

On

Value space:

Off/On

Off: the notification is off.

On: the notification is on.

UserInterface Features Share MTRAutoSelectSource

Applies to: All products

Requires user role: ADMIN, INTEGRATOR, TOUCHUSER

Allows users to turn off the auto source selection for Microsoft Teams Rooms (MTR) calls.

Default value:

On

Value space:

Off/On

On: Turn on the auto source selection for Microsoft Teams Rooms (MTR) calls.

Off: Turn off the auto source selection for Microsoft Teams Rooms (MTR) calls.

Board

BoardPro,
BoardPro
G2

Codec EQ

Codec
PlusCodec
ProDesk,
DeskPro,
DeskMiniRoom Bar
Pro,
Room BarRoom Kit,
Room Kit
MiniRoom Kit
EQX

Room 55

Room 55
Dual,
Room 70Room 70
G2Room 70
PanoramaRoom
Panorama

UserInterface InstantMeeting Invite

Applies to: All products

Requires user role: ADMIN, INTEGRATOR

Decide how the add participant (invite people) capability will be shown on the device when starting an instant meeting.

Default value:

Promote

Value space:

ManualAdd/Promote

Promote: The add/invite capability shows up on the screen automatically when you start the meeting.

ManualAdd: The add/invite capability doesn't show up on the screen automatically. You must use the usual Add button on the UI.

UserInterface WallpaperFillMode

Applies to: All products

Requires user role: ADMIN, INTEGRATOR, USER

Decide what to do with the wallpaper if the screen and wallpaper doesn't have the same aspect ratio.

Default value:

Crop

Value space:

Crop/Fit/Stretch

Crop: Scales up the wallpaper so that it fills the entire screen. The wallpaper aspect ratio is kept unchanged, so the top/bottom or left/right side of the image will be cut off as needed.

Fit: Scales the wallpaper up or down so that the complete image fits on the screen. The wallpaper aspect ratio is kept unchanged, and black bars are added to the top/bottom (letterboxing) or the sides (pillarboxing) to fill the screen.

Stretch: Stretch the wallpaper until it fills the entire screen. Changes the wallpaper aspect ratio if needed.

UserInterface CustomWallpaperOverlay

Applies to: All products

Requires user role: ADMIN

When using a custom wallpaper you can choose to apply a transparent black overlay to soften the background image and give more focus to the UI elements.

Default value:

On

Value space:

Off/On

Off: Don't apply a transparent black overlay.

On: Apply a transparent black overlay.

UserInterface Diagnostics Notifications

Applies to: All products

Requires user role: ADMIN

Hide or show diagnostics notifications on the user interface.

Default value:

Auto

Value space:

Auto/Hidden

Auto: The diagnostics notifications will be displayed on the user interface.

Hidden: The diagnostics notifications will not be displayed on the user interface.

UserInterface Features Calendar Start

Applies to: All products

Requires user role: ADMIN, INTEGRATOR

Choose whether to show the calendar widget on the user interface.

Default value:

Auto

Value space:

Auto/Hidden

Auto: Show the calendar widget on the user interface.

Hidden: Don't show the calendar widget on the user interface.

Board

UserInterface Features Call AudioMute

Applies to: All products

Requires user role: ADMIN, INTEGRATOR

Choose to show or hide the default "Mute/Unmute" button on the user interface.

Default value:

Auto

Value space:

Auto/Hidden

Auto: Show the "Mute/Unmute" button on the user interface.

Hidden: The "Mute/Unmute" button is not shown on the user interface.

BoardPro,
BoardPro
G2

Codec EQ

Codec
PlusCodec
ProDesk,
DeskPro,
DeskMiniRoom Bar
Pro,
Room BarRoom Kit,
Room Kit
MiniRoom Kit
EQX

Room 55

Room 55
Dual,
Room 70Room 70
G2Room 70
PanoramaRoom
Panorama

UserInterface Features Call CameraControls

Applies to: All products

Requires user role: ADMIN, INTEGRATOR

Choose to show or hide the camera controls from the user interface (control panel). The setting applies both in-call and out of call.

Default value:

Auto

Value space:

Auto/Hidden

Auto: Shows the camera controls on the user interface.

Hidden: Removes the camera controls from the user interface.

UserInterface Features Call End

Applies to: All products

Requires user role: ADMIN, INTEGRATOR

Choose whether or not to remove the default End Call button from the user interface. The setting removes only the button, not its functionality as such.

Default value:

Auto

Value space:

Auto/Hidden

Auto: Shows the button on the user interface.

Hidden: Removes the button from the user interface.

UserInterface Features Call HdmiPassthrough

Applies to: RoomKit CodecPlus CodecPro Room55 Room70/Room55D Room70G2

Requires user role: ADMIN, INTEGRATOR

Choose whether to show the Call from laptop button on the touch controller.

Refer to the Video Output HDMI Passthrough Allowed setting for more information about HDMI passthrough and the Call from laptop feature. Call from laptop is not supported on Room 55 Dual and Room 70 Dual.

Default value:

Auto

Value space:

Auto/Hidden

Auto: Show the button on the touch controller.

Hidden: Don't show the button on the touch controller.

UserInterface Features Call JoinGoogleMeet

Applies to: All products

Requires user role: ADMIN, INTEGRATOR

Choose to show or hide the Google Meet button on the user interface.

The button allows users to dial into Google Meet meetings using the meeting code generated by the Google invite.

This is only available on devices registered to the Webex cloud service or linked to Webex Edge for devices.

Default value:

Auto

Value space:

Auto/Hidden

Auto: Show the button on the user interface.

Hidden: Don't show the button from the user interface.

Board

UserInterface Features Call JoinMicrosoftTeamsCVI

Applies to: All products

Requires user role: ADMIN

Configures whether to display or hide the CVI (Microsoft Cloud Video Interop) functionality on the Microsoft Teams button in the user interface.

When enabled, users can use the Microsoft Teams button to join Teams meetings via CVI by entering the Video Conference ID and passcode from the meeting invite. If disabled, the Microsoft Teams button still appears, but the CVI-specific input screen for Video ID is hidden.

This feature is available only on devices registered to the Webex cloud service or connected through Webex Edge for Devices.

Default value:

Hidden

Value space:

Auto/Hidden

Auto: Shows the CVI functionality on the Microsoft Teams button where users can enter the Video ID.

Hidden: Doesn't show the CVI functionality on the Microsoft Teams button.

Board Pro,
Board Pro
G2

Codec EQ

Codec
PlusCodec
ProDesk,
Desk Pro,
Desk MiniRoom Bar
Pro,
Room BarRoom Kit,
Room Kit
MiniRoom Kit
EQX

Room 55

Room 55
Dual,
Room 70Room 70
G2Room 70
PanoramaRoom
Panorama

UserInterface Features Call JoinZoom

Applies to: All products

Requires user role: ADMIN, INTEGRATOR

Choose to show or hide the Zoom button on the user interface.

The button allows users to dial into Zoom meetings using the meeting code generated by the Zoom invite.

Default value:

Hidden

Value space:

Auto/Hidden

Auto: Shows the button on the user interface.

Hidden: Removes the button from the user interface.

UserInterface Features Call JoinWebex

Applies to: All products

Requires user role: ADMIN, INTEGRATOR

Choose to show or hide the default Webex button on the user interface.

The button allows users to dial into a Webex meeting using the Webex meeting number, no domain is required. However, for this to work, you must set up the infrastructure to allow calls to be routed to *@webex.com.

Default value:

Auto

Value space:

Auto/Hidden

Auto: Shows the button on the user interface.

Hidden: Removes the button from the user interface.

UserInterface Features Call JoinMicrosoftTeamsDirectGuestJoin

Applies to: All products

Requires user role: ADMIN, INTEGRATOR

Configures whether to display or hide the Direct Guest Join functionality on the Microsoft Teams button in the user interface.

When enabled, users can use the Microsoft Teams button to join Teams meetings via Direct Guest Join by entering the Meeting ID from the invite. If disabled, the Microsoft Teams button still appears, but the input screen for entering the Meeting ID is hidden.

This feature is available only on devices registered to the Webex cloud service or connected through Webex Edge for Devices.

Default value:

Auto

Value space:

Auto/Hidden

Auto: Displays the Direct Guest Join functionality where users can enter the Meeting ID.

Hides the Direct Guest Join functionality on the Microsoft Teams button, preventing users from entering the Meeting ID.

Board

BoardPro,
BoardPro
G2

Codec EQ

Codec
PlusCodec
ProDesk,
DeskPro,
DeskMiniRoom Bar
Pro,
Room BarRoom Kit,
Room Kit
MiniRoom Kit
EQX

Room 55

Room 55
Dual,
Room 70Room 70
G2Room 70
PanoramaRoom
Panorama

UserInterface Features Call Keypad

Applies to: All products

Requires user role: ADMIN, INTEGRATOR

Choose whether or not to remove the default in-call Keypad button from the user interface. This button opens a keypad, which for example can be used for DTMF input.

Default value:

Auto

Value space:

Auto/Hidden

Auto: Shows the button on the user interface.

Hidden: Removes the button from the user interface.

UserInterface Features Call LayoutControls

Applies to: All products

Requires user role: ADMIN, INTEGRATOR

Choose whether to show the Layout button, which by default is available in call, on the user interface.

Default value:

Auto

Value space:

Auto/Hidden

Auto: Show the button on the user interface.

Hidden: Don't show the button on the user interface.

UserInterface Features Call MidCallControls

Applies to: All products

Requires user role: ADMIN, INTEGRATOR

Choose to show or hide buttons for most mid-call options from the user interface, for example Hold, Transfer, and Resume.

The setting removes only the buttons, not their functionality as such.

Default value:

Auto

Value space:

Auto/Hidden

Auto: Shows the buttons on the user interface.

Hidden: Removes the buttons from the user interface.

UserInterface Features Call MusicMode

Applies to: All products

Requires user role: ADMIN, INTEGRATOR

Choose to show or hide the toggle button for Music Mode on the user interface.

Default value:

Hidden

Value space:

Auto/Hidden

Auto: Shows the toggle button for Music Mode on the user interface if this feature is supported in the ongoing call.

Hidden: The toggle button for Music Mode is never shown on the user interface.

UserInterface Features Call ParticipantList

Applies to: All products

Requires user role: ADMIN, INTEGRATOR

Choose whether to show the Participants button, which by default is available in call, on the user interface.

Default value:

Auto

Value space:

Auto/Hidden

Auto: Show the button on the user interface.

Hidden: Don't show the button on the user interface.

UserInterface Features Call SelfviewControls

Applies to: All products

Requires user role: ADMIN, INTEGRATOR

Choose whether to show the self-view controls on the user interface.

Default value:

Auto

Value space:

Auto/Hidden

Auto: Show the self-view controls on the user interface.

Hidden: Don't show the self-view controls on the user interface.

D15503.06

RoomOS
11.24

02-2025



Board

UserInterface Features Call Start

Applies to: All products

Requires user role: ADMIN, INTEGRATOR

Choose to show or hide the default Call button (including the directory, favorites, and recent calls lists) and the default in-call Add participant button on the user interface. The setting removes only the buttons, not their functionality as such.

Default value:

Auto

Value space:

Auto/Hidden

Auto: Shows the buttons on the user interface.

Hidden: Removes the buttons from the user interface.

BoardPro,
BoardPro
G2

Codec EQ

Codec
PlusCodec
ProDesk,
DeskPro,
DeskMiniRoom Bar
Pro,
Room BarRoom Kit,
Room Kit
MiniRoom Kit
EQX

Room 55

Room 55
Dual,
Room 70Room 70
G2Room 70
PanoramaRoom
Panorama

UserInterface Features Files Start

*Applies to: RoomKitMini RoomBar RoomBarPro RoomKitEQX CodecEQ CodecPro DeskMini Desk
DeskPro Board BoardPro BoardProG2*

Requires user role: ADMIN, INTEGRATOR

Choose whether to remove the default Files button from the user interface. The Files button is available only on devices with a touch screen (either built-in or connected). A Room Kit Mini must be used with Samsung Flip (Webex on Flip). The setting removes only the button, not its functionality as such.

This setting applies only to devices that are registered to the Webex cloud service or linked to Webex Edge for Devices.

Default value:

Auto

Value space:

Auto/Hidden

Auto: Shows the button on the user interface.

Hidden: Removes the button from the user interface.

UserInterface Features HideAll

Applies to: All products

Requires user role: ADMIN, INTEGRATOR

Choose to hide all the buttons on the user interface.

The setting removes only the buttons, not their functionality.

Default value:

False

Value space:

False/True

False: Shows all default buttons on the user interface.

True: Removes all default buttons from the user interface.

UserInterface Features Call Webcam

Applies to: RoomKitMini RoomBar RoomBarPro RoomKitEQX CodecEQ BoardPro BoardProG2

Requires user role: ADMIN, INTEGRATOR

Choose whether to show the Call from laptop button on the touch controller.

Default value:

Auto

Value space:

Auto/Hidden

Auto: Show the button on the touch controller.

Hidden: Don't show the button on the touch controller.

D15503.06

RoomOS
11.24

02-2025



Board

BoardPro,
BoardPro
G2

Codec EQ

Codec
PlusCodec
ProDesk,
DeskPro,
DeskMiniRoom Bar
Pro,
Room BarRoom Kit,
Room Kit
MiniRoom Kit
EQX

Room 55

Room 55
Dual,
Room 70Room 70
G2Room 70
PanoramaRoom
Panorama

UserInterface Features Share MTRShareExperience

Applies to: All products

Requires user role: ADMIN, INTEGRATOR, TOUCHUSER

This configuration allows toggling between Microsoft Teams Rooms (MTR) and RoomOS share experiences on devices in MTR mode.

Default value:

RoomOS

Value space:

Microsoft/RoomOS

Microsoft: The sharing experience is fully managed by the MTR application. Previews are initiated and displayed within the Microsoft Teams Rooms app, following its standard behavior and interface.

RoomOS: The sharing experience is managed by Webex RoomOS. Previews are initiated by Webex and overlaid on the screen. RoomOS provides enhanced functionality, including support for multi-source sharing, multi-screen configurations, and 4K resolution.

UserInterface Features Share Start

Applies to: All products

Requires user role: ADMIN, INTEGRATOR

Choose whether or not to remove the default UI elements for sharing and previewing content, both in call and out of call, from the user interface. The setting removes only the buttons and UI elements, not their functionality as such. You can still share content using Cisco Proximity or Cisco Webex apps.

Default value:

Auto

Value space:

Auto/Hidden

Auto: Shows the buttons and UI elements on the user interface.

Hidden: Removes the buttons and UI elements from the user interface.

UserInterface Features Whiteboard Start

Applies to: RoomKitMini RoomBar RoomBarPro RoomKitEQX CodecEQ CodecPro DeskMini Desk DeskPro Board BoardPro BoardProG2

Requires user role: ADMIN, INTEGRATOR

Choose whether to remove the default Whiteboard button from the user interface. The Whiteboard button is available only on devices with a touch screen (either built-in or connected). A Room Kit Mini must be used with Samsung Flip (Webex on Flip). The setting removes only the button, not its functionality as such.

This setting applies only to devices that are registered to the Webex cloud service or linked to Webex Edge for Devices.

Default value:

Auto

Value space:

Auto/Hidden

Auto: Shows the button on the user interface.

Hidden: Removes the button from the user interface.

UserInterface Help Tips

Applies to: All products

Requires user role: ADMIN

Help tips can be accessed through the user interface. When enabled, a Tips button is present on the home screen.

Default value:

Auto

Value space:

Auto/Hidden

Auto: Show the help tips button.

Hidden: Hide the help tips button.

Board

UserInterface HomeScreen Dashboard

Applies to: All products

Requires user role: ADMIN

Choose whether to remove elements, such as the clock and meeting list, from the home screen.

Default value:

On

Value space:

On [DeskMini Desk DeskPro Board BoardPro BoardProG2]

Off/On [RoomKit RoomKitMini RoomBar RoomBarPro RoomKitEQX CodecEQ CodecPlus CodecPro Room55 Room70/Room55D Room70G2 RoomPanorama/Room70Panorama]

Off: Remove home screen elements.

On: Keep all home screen elements.

BoardPro,
BoardPro
G2

Codec EQ

Codec
PlusCodec
ProDesk,
DeskPro,
DeskMiniRoom Bar
Pro,
Room BarRoom Kit,
Room Kit
MiniRoom Kit
EQX

Room 55

Room 55
Dual,
Room 70Room 70
G2Room 70
PanoramaRoom
Panorama

UserInterface KeyTones Mode

Applies to: All products

Requires user role: ADMIN, USER

You can configure the device to make a keyboard click sound effect (key tone) when typing text or numbers.

Default value:

Off [DeskMini Desk DeskPro Board BoardPro BoardProG2]

On [RoomKit RoomKitMini RoomBar RoomBarPro RoomKitEQX CodecEQ CodecPlus CodecPro Room55 Room70/Room55D Room70G2 RoomPanorama/Room70Panorama]

Value space:

Off/On

Off: There is no key tone sound effect.

On: The key tone sound effect is turned on.

UserInterface Kiosk Mode

Applies to: DeskMini Desk DeskPro Board BoardPro BoardProG2

Requires user role: ADMIN, INTEGRATOR

Kiosk mode lets you replace the home screen of the device with your own custom web application that you host and maintain yourself. The URL to the custom web application must be added in the UserInterface Kiosk URL setting. As an example, Kiosk mode can be used in reception areas where you want the device set up for visitor registration, providing the facility overview, or allow direct calls to expert services.

Kiosk mode is using the device's web engine, so the WebEngine Mode setting must be On for kiosk mode to work. To allow for making calls, the WebEngine Features SipUrlHandler setting must be On as well.

Default value:

Off

Value space:

Off/On

Off: The device operates in standard mode.

On: The device is set up in kiosk mode.

UserInterface HomeScreen Peripherals WebApp URL

Applies to: All products

Requires user role: ADMIN

Set the URL of the web application you want to run on the Room Navigator (that is, a persistent web app). The application displays on the entire screen, and it can't be dismissed by the user.

If the app is going to interact with the device's API, remember to set Security Xapi WebSocket ApiKey Allowed: True, and add the domain name of the server hosting the app to the allow list in the WebEngine Features Xapi Peripherals AllowedHosts Hosts setting.

Note: Persistent web apps are only available on Room Navigators that are paired to the device over the network.

Default value:

""

Value space:

String (0, 2048)

The URL of the web application.

Board

UserInterface Kiosk URL

Applies to: DeskMini Desk DeskPro Board BoardPro BoardProG2

Requires user role: ADMIN, INTEGRATOR

The URL of the custom web application that is shown when the device is set up in kiosk mode. Also refer to the UserInterface Kiosk Mode setting.

Default value:

""

Value space:

String (0, 2048)

The URL of the kiosk mode web application.

UserInterface Language

Applies to: All products

Requires user role: ADMIN, USER

Select the language to be used on the user interface. If the language is not supported, the default language (English) will be used.

Default value:

English

Value space:

Arabic/Catalan/ChineseSimplified/ChineseTraditional/Czech/Danish/Dutch/English/
EnglishUK/Finnish/French/FrenchCanadian/German/Hebrew/Hungarian/Italian/
Japanese/Korean/Norwegian/Polish/Portuguese/PortugueseBrazilian/Russian/Spanish/
SpanishLatin/Swedish/Turkish/Ukrainian

Select a language from the list.

UserInterface LedControl Mode

Applies to: All products

Requires user role: ADMIN

The wall mount version of the Room Navigator has LED lights. You can configure how they should be controlled.

Default value:

Auto

Value space:

Auto/Manual/Off

Auto: The video device controls the LED lights automatically, typically based on the room booking status (for example, green: room available, red: room in use). The UserInterface LedControl Color Set Color command will have no effect.

Manual: You can control the LED lights and set the color using the UserInterface LedControl Color Set Color command.

Off: The LED lights are turned off permanently.

UserInterface LedControl OutsideOfficeHours

Applies to: All products

Requires user role: ADMIN

Controls the behavior of the LED strip during non-office hours when the display enters standby mode. By default, the LED strip remains active to indicate room occupancy, even when the display is turned off.

Default value:

On

Value space:

Off/On

Off: The LED strip is disabled when the display enters standby mode during non-office hours.

On: The LED strip remains active to indicate occupancy, even when the display is off.

BoardPro,
BoardPro
G2

Codec EQ

Codec
PlusCodec
ProDesk,
DeskPro,
DeskMiniRoom Bar
Pro,
Room BarRoom Kit,
Room Kit
MiniRoom Kit
EQX

Room 55

Room 55
Dual,
Room 70Room 70
G2Room 70
PanoramaRoom
Panorama

Board

UserInterface LiveAnnotation AvailabilityForPresenter

Applies to: All products

Requires user role: ADMIN, INTEGRATOR

Allows presenters to annotate on the screen share in a meeting without any interruption to the content share flow. This feature only applies if you have a touch screen. Collaborative annotation on a whiteboard shared by someone else is only available for Webex (converged) meetings, and only for devices that are registered to the Webex cloud service or linked to Webex Edge for devices.

Default value:

Always

Value space:

Always/MultiPlayerSupportedByCall

Always: Live annotation is always available for presenters.

MultiPlayerSupportedByCall: Live Annotation is enabled only in calls that support multi-participant (or two-way) annotation, allowing presenters to annotate on shared content collaboratively—whether on their own share or others' shared content. This does not apply to one-on-one calls.

BoardPro,
BoardPro
G2

Codec EQ

Codec
PlusCodec
ProDesk,
DeskPro,
DeskMiniRoom Bar
Pro,
Room BarRoom Kit,
Room Kit
MiniRoom Kit
EQX

Room 55

Room 55
Dual,
Room 70Room 70
G2Room 70
PanoramaRoom
Panorama

UserInterface LiveAnnotation EnabledOutOfCall

Applies to: All products

Requires user role: ADMIN, INTEGRATOR

Use this setting to determine whether you are allowed to annotate live on the content outside of a call. This feature only applies if you have a touch screen. Collaborative annotation on a whiteboard shared by someone else is only available for Webex (converged) meetings, and only for devices that are registered to the Webex cloud service or linked to Webex Edge for devices.

Default value:

True

Value space:

False/True

False: You cannot make live annotation outside a call.

True: You can make live annotation during a call.

UserInterface MeetingJoin CVITenants

Applies to: All products

Requires user role: ADMIN

Set the default hostname/tenant key to be used for Microsoft Teams meetings when the device is set up to use CVI (Cloud Video Interop). This hostname, which identifies the organization hosting the meeting, is combined with the video conference ID to generate the full SIP URI for the meeting.

In the following examples, the video conference ID is 123456. If UserInterface MeetingJoin CVITenants is set to "tenant@m.webex.com", the URI becomes 123456.tenant@m.webex.com. If UserInterface MeetingJoin CVITenants is set to "vc.example.com", the URI becomes 123456@vc.example.com.

Default value:

""

Value space:

String (0, 255)

A valid hostname/tenant key.

UserInterface LiveAnnotation Enabled

Applies to: All products

Requires user role: ADMIN, INTEGRATOR

The live annotation feature allows users to annotate on the screen share in call or outside call without any interruption to the content share flow. This feature only applies if you have a touch screen. Collaborative annotation on a whiteboard shared by someone else is only available for Webex (converged) meetings, and only for devices that are registered to the Webex cloud service or linked to Webex Edge for devices.

Use this setting to determine whether you are allowed to annotate live on the content.

Default value:

True

Value space:

False/True

False: You cannot make live annotation. The annotation button in the floating toolbar doesn't have the "Point and annotate on content" option. The "Annotate on screenshot" option is not affected by this setting.

True: You can make live annotation. Start by tapping the annotation button in the floating toolbar, then select the "Point and annotate on content" option.

Board

UserInterface MuteWarning

Applies to: All products

Requires user role: ADMIN

Choose whether to show a warning on screen if you start talking while your microphone is muted.

Default value:

Enabled

Value space:

Disabled/Enabled

Disabled: Don't show the mute warning.

Enabled: Show the mute warning.

BoardPro,
BoardPro
G2

Codec EQ

Codec
PlusCodec
ProDesk,
DeskPro,
DeskMiniRoom Bar
Pro,
Room BarRoom Kit,
Room Kit
MiniRoom Kit
EQX

Room 55

Room 55
Dual,
Room 70Room 70
G2Room 70
PanoramaRoom
Panorama

UserInterface OSD EncryptionIndicator

Applies to: All products

Requires user role: ADMIN

Define whether to show a "Call encrypted" / "Call not encrypted" notification on screen at the start of a meeting. Regardless of this setting, you can always find information about encryption under Security (blue shield) when tapping the screen (upper right corner) or touch controller (upper).

This setting doesn't apply to Webex and WebRTC calls.

Default value:

Auto

Value space:

Auto/AlwaysOn/AlwaysOff

Auto: If the call is encrypted, the "Call encrypted" notification is shown for 5 seconds. If the call is not encrypted, the "Call not encrypted" notification is shown for 5 seconds.

AlwaysOn: If the call is encrypted, the "Call encrypted" notification is shown for 5 seconds. If the call is not encrypted, the "Call not encrypted" notification is shown for 5 seconds.

AlwaysOff: The "Call encrypted" / "Call not encrypted" notification will not be shown on screen at all.

UserInterface OSD HalfwakeMessage

Applies to: RoomKit RoomKitMini RoomBar RoomBarPro RoomKitEQX CodecEQ CodecPlus CodecPro Room55 Room70/Room55D Room70G2 RoomPanorama/Room70Panorama DeskMini Desk DeskPro BoardPro BoardProG2

Requires user role: ADMIN, INTEGRATOR

A custom message can be displayed in the middle of the main screen when the device is in the halfwake state. The custom message will replace the default message, which gives instructions how to start using the device. You can also delete the default message, without adding a custom message.

Default value:

""

Value space:

String (0, 128)

The custom message. An empty string: Restore the default message. A space only: There will be no message at all.

Board

BoardPro,
BoardPro
G2

Codec EQ

Codec
PlusCodec
ProDesk,
DeskPro,
DeskMiniRoom Bar
Pro,
Room BarRoom Kit,
Room Kit
MiniRoom Kit
EQX

Room 55

Room 55
Dual,
Room 70Room 70
G2Room 70
PanoramaRoom
Panorama

UserInterface OSD Mode

Applies to: All products

Requires user role: ADMIN

You can configure a device to output a clean video stream. This is referred to as broadcast mode. In this mode the indicators, notifications, and controls are removed. This mode is primarily for broadcasting and recording services where you only want to pass on the video to your viewers.

Default value:

Auto

Value space:

Auto/Unobstructed

Auto: Indicators, notifications, and controls are included in the video stream (normal mode).

Unobstructed: Indicators, notifications, and controls are removed from the video stream (broadcast mode). Name labels are not removed.

UserInterface OSD Output

Applies to: All products

Requires user role: ADMIN, INTEGRATOR

Specify the monitor to use for displaying on-screen information and indicators. This is the On-Screen Display (OSD).

Default value:

1 [Room55 DeskMini Desk DeskPro Board BoardPro BoardProG2]

Auto [RoomKit RoomKitMini RoomBar RoomBarPro RoomKitEQX CodecEQ CodecPlus CodecPro Room70/Room55D Room70G2 RoomPanorama/Room70Panorama]

Value space:

1 [Room55 DeskMini Desk DeskPro Board BoardPro BoardProG2]

Auto/1/2 [RoomKit RoomBar CodecPlus Room70/Room55D]

Auto/1/2/3 [RoomBarPro RoomKitEQX CodecEQ CodecPro Room70G2 RoomPanorama/Room70Panorama]

Auto [RoomKitMini]

Auto: For devices with integrated screen, the on-screen information and indicators are sent to the integrated screen. If the device has two integrated screens, the left screen is used.

For devices without integrated screens, the device detects when a screen is connected to a video output, and sends the on-screen information and indicators to the first screen you connect. If you have a multi-screen setup, and all screens are connected before switching on the device, the on-screen information and indicators are sent to the video output with the lowest number, starting with Output Connector 1 (HDMI 1).

1..n: The device sends the on-screen information and indicators to the specified output. Choose n to send the on-screen information and indicators to the device's Output Connector n.

For devices with integrated screens, the lowest numbers refer to the integrated screens.

Board

UserInterface Phonebook DefaultSearchFilter

Applies to: All products

Requires user role: ADMIN, INTEGRATOR

When searching for a name in the directory, you can search through everything or filter to include only people or only rooms. This is only available on devices registered to the Webex cloud service or linked to Webex Edge for devices.

Default value:

All

Value space:

All/People/Rooms

All: Search results include both people and rooms.

People: Search results include only people.

Rooms: Search results include only rooms.

BoardPro,
BoardPro
G2

Codec EQ

Codec
PlusCodec
ProDesk,
DeskPro,
DeskMiniRoom Bar
Pro,
Room BarRoom Kit,
Room Kit
MiniRoom Kit
EQX

Room 55

Room 55
Dual,
Room 70Room 70
G2Room 70
PanoramaRoom
Panorama

UserInterface Proximity Notifications

Applies to: All products

Requires user role: ADMIN, INTEGRATOR

Configure the display of proximity notifications on the user interface.

Default value:

Auto

Value space:

Auto/Off/On

Auto: Allow the system to automatically determine when to display proximity notifications.

Off: Proximity notifications will not be shown on the user interface.

On: All proximity notifications will be shown on the user interface.

UserInterface RoomScheduler AmbientTemperature Show

Applies to: All products

Requires user role: ADMIN

This setting applies when a Room Navigator is set up as a room booking device (also referred to as scheduler mode). The Room Navigator may show the room temperature, if that is available from the device it's connected to. Use this setting to decide whether to display it.

Default value:

Auto

Value space:

Auto/Hidden/ShowCelsius/ShowFahrenheit

Auto: Show the temperature in both degrees Celsius and Fahrenheit.

Hidden: Don't show the temperature.

ShowCelsius: Show the temperature in degrees Celsius

ShowFahrenheit: Show the temperature in degrees Fahrenheit.

Board

UserInterface RoomScheduler DevicePersonalization QRCodePairing

Applies to: All products

Requires user role: ADMIN

Enables the room booking navigator to display a QR code that can be used to sign in from outside the room when hot desking is enabled on a device paired inside the room. This feature facilitates easier user sign-ins for hot desking scenarios.

Default value:

On

Value space:

Off/On

Off: Disables the QR code display on the room booking navigator.

On: Enables the QR code display on the room booking navigator, allowing users to sign in from outside the room.

BoardPro,
BoardPro
G2

Codec EQ

Codec
PlusCodec
ProDesk,
DeskPro,
DeskMiniRoom Bar
Pro,
Room BarRoom Kit,
Room Kit
MiniRoom Kit
EQX

Room 55

Room 55
Dual,
Room 70Room 70
G2Room 70
PanoramaRoom
Panorama

UserInterface RoomScheduler PeopleCount Current

Applies to: All products

Requires user role: ADMIN

This setting applies when a Room Navigator is set up as a room booking device (also referred to as scheduler mode). The Room Navigator may show the number of people currently in the meeting room, if that information is available from the device it's connected to. Use this setting to decide whether to display this information.

Default value:

Auto

Value space:

Auto/Hidden

Auto: Show the number of people.

Hidden: Don't show the number of people.

UserInterface RoomScheduler StatusWhenInUse

Applies to: All products

Requires user role: ADMIN

This setting applies when a Room Navigator is set up as a room booking device (also referred to as scheduler mode). The Room Navigator shows the status of a meeting room, that is, whether the room is free or busy (using the LED color and text on the Room Navigator screen). Use this setting to determine what will affect the status of the room.

Default value:

Auto

Value space:

Auto/Free

Auto: The status of the room (free/busy) is based on whether the room is used. It's marked as free when not in use, and busy when in use. So even if there is no calendar invite, it will be marked as busy if the device detects people in the room.

Free: The status of the room (free/busy) is based only on the calendar booking. It's marked as free when there is no calendar booking, and busy when there is a calendar booking.

UserInterface RoomScheduler Mode

Applies to: All products

Requires user role: ADMIN

This setting applies when a Room Navigator is set up as a room booking device (also referred to as scheduler mode). Configures the mode of operation for a Room Navigator, determining how the device displays and manages room scheduling information.

Default value:

Auto

Value space:

Auto/CalendarOnly/RoomInUseOnly

Auto: Shows both calendar events and room usage status as needed.

CalendarOnly: Displays only calendar-based scheduling information, without integrating room usage status.

RoomInUseOnly: Displays only the room usage status, without showing calendar events.

Board

UserInterface RoomStatusMenu Visibility

Applies to: All products

Requires user role: ADMIN

This setting allows you to show or hide the top left menu of the user interface.

Default value:

Auto

Value space:

Auto/Hidden

Auto: The top left menu is visible.

Hidden: The top left menu is hidden.

Codec EQ

Codec Plus

Codec Pro

Desk,

Desk Pro,

Desk Mini

Room Bar

Pro,

Room Bar

Room Kit,

Room Kit

Mini

Room Kit

EQX

Room 55

Room 55

Dual,

Room 70

Room 70

G2

Room 70

Panorama

Room

Panorama

UserInterface ScreenLock Workspace Allowed

Applies to: All products

Requires user role: ADMIN

Choose whether the user is allowed to add a PIN lock for the device. This setting applies only to shared mode devices, because you are always allowed to add a PIN lock on personal mode devices.

Refer to the UserInterface ScreenLock AdminInitiateRecovery command, how to initiate setting PIN lock on a device.

Default value:

False

Value space:

False/True

False: The user is not allowed to add a PIN lock.

True: The user is allowed to add a PIN lock.

UserInterface Security Mode

Applies to: All products

Requires user role: ADMIN

This setting allows you to hide the contact information from the top left dropdown menu on the user interface. However, this does not hide any details from the Device settings panel, which you can open from the control panel (swipe from right or tap the icon in the upper right corner of the user interface).

Refer to the UserInterface SettingsMenu Mode and UserInterface SettingsMenu Visibility for more information about protecting device settings and hiding information from the user interface.

Default value:

Normal

Value space:

Normal/Strong

Normal: The contact information is shown in the dropdown menu.

Strong: Contact information is not shown in the dropdown menu.

Board

UserInterface SettingsMenu Mode

Applies to: All products

Requires user role: ADMIN

The Device settings panel, which you can open from the control panel (swipe from right or tap the icon in the upper right corner of the user interface), can be protected by the device's admin password. If not password protected, anyone can access these settings and also factory reset the device. If password protected, all settings that require authentication have a padlock symbol.

Refer to the UserInterface SettingsMenu Visibility if you want to remove the control panel (including the device settings panel) from the user interface.

Default value:

Unlocked

Value space:

Locked/Unlocked

Locked: You must sign in with an administrator's username and passphrase to access Device settings.

Unlocked: All users can access the Device settings.

BoardPro,
BoardPro
G2

Codec EQ

Codec
PlusCodec
ProDesk,
DeskPro,
DeskMiniRoom Bar
Pro,
Room BarRoom Kit,
Room Kit
MiniRoom Kit
EQX

Room 55

Room 55
Dual,
Room 70Room 70
G2Room 70
PanoramaRoom
Panorama

UserInterface SoundEffects Mode

Applies to: All products

Requires user role: ADMIN, USER

You can configure the device to make a sound effect, for example, when someone connects a laptop or mobile through Proximity.

The keyboard click sound effect when typing text is not affected by this setting (refer to the UserInterface Keytones Mode setting).

Default value:

On

Value space:

Off/On

Off: There are no sound effects.

On: The sound effects are switched on.

UserInterface Theme Name

Applies to: All products

Requires user role: ADMIN, USER

Change the theme on the user interface.

Note, this config may change or be replaced in the future.

Default value:

Auto

Value space:

Auto/Light/Night

Auto: Use the default settings, letting the system decide what is best.

Light: Use the "Light" background theme.

Night: Use the "Night" background theme.

Board

UserInterface Wallpaper

Applies to: All products

Requires user role: ADMIN, INTEGRATOR, USER

Select a background image (wallpaper) for the video screen when idle.
You may upload a custom wallpaper to the device using the web interface.
The following file formats are supported: JPEG, PNG.
The maximum file size is 8 MByte.

Default value:

Auto

Value space:

Auto/Custom/None

Auto: Use the default wallpaper.

None: There is no background image on the screen.

Custom: Use the custom wallpaper as background image on the screen.

If no custom wallpaper is uploaded to the device, the setting will revert to the default value.

BoardPro,
BoardPro
G2

Codec EQ

Codec
PlusCodec
ProDesk,
DeskPro,
DeskMiniRoom Bar
Pro,
Room BarRoom Kit,
Room Kit
MiniRoom Kit
EQX

Room 55

Room 55
Dual,
Room 70Room 70
G2Room 70
PanoramaRoom
Panorama

UserInterface Whiteboard ActivityIndicators

Applies to: All products

Requires user role: ADMIN

Activity indicators let you see who is drawing and annotating in a call.
The avatars of the participants or the initials of the device are displayed when someone is interacting with the whiteboard, so you can follow who is drawing or annotating.
Applies only to cloud-registered devices.

Default value:

On

Value space:

Off/On

On: Enables activity indicators.

Off: Disables activity indicators.

UserInterface Whiteboard Deletion

Applies to: All products

Requires user role: ADMIN, INTEGRATOR

Choose whether to hide the option to delete a whiteboard from the user interface - both in the whiteboard app and the files app. This does not disable deleting whiteboards as such, it only removes the button from the UI. You can still use the xAPI (Files Delete command).

Default value:

Auto

Value space:

Auto/Hidden

Auto: Shows the delete button on the user interface.

Hidden: Removes the delete button from the user interface.

UserInterface UsbPromotion

Applies to: RoomKitMini RoomBar RoomBarPro

Requires user role: ADMIN

Choose whether or not to show on the halfwake screen, a text that informs you that you can use the device as a USB camera.

Default value:

Off

Value space:

Off/On

Off: The USB camera information text is not shown.

On: The USB camera information text is shown.

UserInterface WebcamOnlyMode

Applies to: RoomKitMini

Requires user role: ADMIN

Not applicable in this software version.

Board

BoardPro,
BoardPro
G2

Codec EQ

Codec
PlusCodec
ProDesk,
DeskPro,
DeskMiniRoom Bar
Pro,
Room BarRoom Kit,
Room Kit
MiniRoom Kit
EQX

Room 55

Room 55
Dual,
Room 70Room 70
G2Room 70
PanoramaRoom
Panorama

UserInterface Whiteboard ShareInCall

Applies to: All products

Requires user role: ADMIN, INTEGRATOR

Choose whether to hide the option to share an existing whiteboard in call from the user interface (the Call app and the Whiteboard app). This does not stop whiteboard being shared in call from another device, and does not disable sharing whiteboard in call from the API.

Default value:

Auto

Value space:

Auto/Hidden

Auto: Show the Share button (share in call option) on the UI.

Hidden: Remove the Share button (share in call option) from the UI. Hence remove the option to share a whiteboard in call from the UI.

Board

Board Pro,
Board Pro
G2

Codec EQ

Codec
PlusCodec
ProDesk,
Desk Pro,
Desk MiniRoom Bar
Pro,
Room BarRoom Kit,
Room Kit
MiniRoom Kit
EQX

Room 55

Room 55
Dual,
Room 70Room 70
G2Room 70
PanoramaRoom
Panorama

UserManagement settings

UserManagement LDAP Admin Filter

Applies to: All products

Requires user role: ADMIN

The LDAP filter is used to determine which users should be granted administrator privileges.

You always have to set either an LDAP Admin Group or an LDAP Admin Filter. An LDAP Admin Filter takes precedence, so if the UserManagement LDAP Admin Filter is set, the UserManagement LDAP Admin Group setting is ignored.

Default value:

""

Value space:

String (0, 1024)

Refer to the LDAP specification for the syntax of this string. Example:
"(|(memberof=CN=admin group, OU=company groups, DC=company, DC=com)
(sAMAccountName=username))"

UserManagement LDAP Admin Group

Applies to: All products

Requires user role: ADMIN

Members of this group will be given administrator access. This setting is a shorthand for saying (memberOf:1.2.840.113556.1.4.1941:=<group name>).

You must always set either an LDAP Admin Group or an LDAP Admin Filter. An LDAP Admin Filter takes precedence, so if the UserManagement LDAP Admin Filter is set, the UserManagement LDAP Admin Group setting is ignored.

Default value:

""

Value space:

String (0, 255)

The distinguished name of the group. Example: "CN=admin group, OU=company groups, DC=company, DC=com"

UserManagement LDAP Attribute

Applies to: All products

Requires user role: ADMIN

The attribute used to map to the provided username. If not set, sAMAccountName is used.

Default value:

""

Value space:

String (0, 255)

The attribute name.

UserManagement LDAP BaseDN

Applies to: All products

Requires user role: ADMIN

The distinguishing name of the entry at which to start a search (base).

Default value:

""

Value space:

String (0, 255)

The distinguishing name of the base. Example: "DC=company, DC=com"

UserManagement LDAP BindDN

Applies to: All products

Requires user role: ADMIN

Look up a user's full DN (distinguishing name) by logging in to the LDAP server using these credentials and use the DN for group look-up. The look-up is based on matching the user's login name to the value of the "Attribute" configuration item. Refer to the UserManagement LDAP MemberAttribute setting.

Default value:

""

Value space:

String (0, 255)

The user's full DN.

Board

BoardPro,
BoardPro
G2

Codec EQ

Codec
PlusCodec
ProDesk,
DeskPro,
DeskMiniRoom Bar
Pro,
Room BarRoom Kit,
Room Kit
MiniRoom Kit
EQX

Room 55

Room 55
Dual,
Room 70Room 70
G2Room 70
PanoramaRoom
Panorama

UserManagement LDAP BindPassword

Applies to: All products

Requires user role: ADMIN

The password associated with the user defined in the UserManagement LDAP BindDN setting.

This password is not sent to the Webex cloud, and it cannot be provisioned from the cloud.

Default value:

""

Value space:

String (0, 255)

The user's password.

UserManagement LDAP Encryption

Applies to: All products

Requires user role: ADMIN

Define how to secure the communication between the device and the LDAP server. You can override the port number by using the UserManagement LDAP Server Port setting.

Default value:

LDAPS

Value space:

LDAPS/None/STARTTLS

LDAPS: Connect to the LDAP server on port 636 over TLS (Transport Layer Security).

None: Connect to the LDAP server on port 389 with no encryption.

STARTTLS: Connect to the LDAP server on port 389, then send a STARTTLS command to upgrade to an encrypted connection (TLS).

UserManagement LDAP MemberAttribute

Applies to: All products

Requires user role: ADMIN

When checking the user's group membership, use this group attribute. If not set, use memberUid.

Default value:

""

Value space:

String (0, 255)

The member attribute name.

UserManagement LDAP MinimumTLSVersion

Applies to: All products

Requires user role: ADMIN

Set the lowest version of the TLS (Transport Layer Security) protocol that is allowed for LDAP.

Default value:

TLSv1.2

Value space:

TLSv1.0/TLSv1.1/TLSv1.2/TLSv1.3

TLSv1.0: Support TLS version 1.0 or higher.

TLSv1.1: Support TLS version 1.1 or higher.

TLSv1.2: Support TLS version 1.2 or higher.

TLSv1.3: Support TLS version 1.3 or higher.

Board

BoardPro,
BoardPro
G2

Codec EQ

Codec
PlusCodec
ProDesk,
DeskPro,
DeskMiniRoom Bar
Pro,
Room BarRoom Kit,
Room Kit
MiniRoom Kit
EQX

Room 55

Room 55
Dual,
Room 70Room 70
G2Room 70
PanoramaRoom
Panorama

UserManagement LDAP Mode

Applies to: All products

Requires user role: ADMIN

The device supports the use of an LDAP (Lightweight Directory Access Protocol) server as a central place to store and validate usernames and passwords. Use this setting to configure whether or not to use LDAP authentication. Our implementation is tested for the Microsoft Active Directory (AD) service.

If you switch on LDAP Mode, make sure to configure the other UserManagement LDAP settings to suit your setup. Here is a few examples.

Example 1:

- UserManagement LDAP Mode: On
- UserManagement LDAP Address: "192.0.2.20"
- UserManagement LDAP BaseDN: "DC=company, DC=com"
- UserManagement LDAP Admin Group: "CN=admin group, OU=company groups, DC=company, DC=com"

Example 2:

- UserManagement LDAP Mode: On
- UserManagement LDAP Address: "192.0.2.20"
- UserManagement LDAP BaseDN: "DC=company, DC=com"
- UserManagement LDAP Admin Filter: "(!(|(memberof=CN=admin group, OU=company groups, DC=company, DC=com)(sAMAccountName=username)))"

Default value:

Off

Value space:

Off/On

Off: LDAP authentication is not allowed.

On: LDAP authentication is allowed.

UserManagement LDAP Server Address

Applies to: All products

Requires user role: ADMIN

Set the IP address or hostname of the LDAP server.

Default value:

""

Value space:

String (0, 255)

A valid IPv4 address, IPv6 address or hostname.

UserManagement LDAP Server Port

Applies to: All products

Requires user role: ADMIN

Set the port to connect to the LDAP server on. If set to 0, use the default for the selected protocol (see the UserManagement LDAP Encryption setting).

Default value:

0

Value space:

Integer (0..65535)

The LDAP server port number.

UserManagement LDAP VerifyServerCertificate

Applies to: All products

Requires user role: ADMIN

When the device connects to an LDAP server, the server will identify itself to the device by presenting its certificate. Use this setting to determine whether or not the device will verify the server certificate.

Default value:

On

Value space:

Off/On

Off: The device will not verify the LDAP server's certificate.

On: The device must verify that the LDAP server's certificate is signed by a trusted Certificate Authority (CA). The CA must be on the list of trusted CAs that are uploaded to the device in advance. Use the device's web interface to manage the list of trusted CAs (see more details in the administrator guide).

Board

UserManagement PasswordPolicy Complexity MinimumDigits

Applies to: All products

Requires user role: ADMIN

When signing in to the device as a local user, the password must follow the rules set by the UserManagement PasswordPolicy settings. These settings replace the "systemtools securitysetting" command that was available in software versions older than CE9.10.

A new password rule will not apply to existing passwords but will take effect on the next password change.

This setting specifies the minimum number of numerical characters (0..9) in the password.

Default value:

0

Value space:

Integer (0..4)

The minimum number of numerical characters. 0 means no restrictions.

BoardPro,
BoardPro
G2

Codec EQ

Codec
PlusCodec
ProDesk,
DeskPro,
DeskMiniRoom Bar
Pro,
Room BarRoom Kit,
Room Kit
MiniRoom Kit
EQX

Room 55

Room 55
Dual,
Room 70Room 70
G2Room 70
PanoramaRoom
Panorama

UserManagement PasswordPolicy Complexity MinimumLowercase

Applies to: All products

Requires user role: ADMIN

When signing in to the device as a local user, the password must follow the rules set by the UserManagement PasswordPolicy settings. These settings replace the "systemtools securitysetting" command that was available in software versions older than CE9.10.

A new password rule will not apply to existing passwords but will take effect on the next password change.

This setting specifies the minimum number of lower-case letters in the password.

Default value:

0

Value space:

Integer (0..4)

The minimum number of lower-case characters. 0 means no restrictions.

UserManagement PasswordPolicy Complexity MinimumSpecial

Applies to: All products

Requires user role: ADMIN

When signing in to the device as a local user, the password must follow the rules set by the UserManagement PasswordPolicy settings. These settings replace the "systemtools securitysetting" command that was available in software versions older than CE9.10.

A new password rule will not apply to existing passwords but will take effect on the next password change.

This setting specifies the minimum number of special characters in the password.

Default value:

0

Value space:

Integer (0..4)

The minimum number of special characters. 0 means no restrictions.

Board

UserManagement PasswordPolicy Complexity MinimumUppercase

Applies to: All products

Requires user role: ADMIN

When signing in to the device as a local user, the password must follow the rules set by the UserManagement PasswordPolicy settings. These settings replace the "systemtools securitysetting" command that was available in software versions older than CE9.10.

A new password rule will not apply to existing passwords but will take effect on the next password change.

This setting specifies the minimum number of upper-case letters in the password.

Default value:

0

Value space:

Integer (0..4)

The minimum number of upper-case characters. 0 means no restrictions.

UserManagement PasswordPolicy MaxLifetime

Applies to: All products

Requires user role: ADMIN

When signing in to the device as a local user, the password must follow the rules set by the UserManagement PasswordPolicy settings. These settings replace the "systemtools securitysetting" command that was available in software versions older than CE9.10.

A new password rule will not apply to existing passwords but will take effect on the next password change.

This setting specifies the maximum number of days before a password becomes invalid.

Default value:

0

Value space:

Integer (0..7300)

The minimum number of days. 0 means no restrictions.

UserManagement PasswordPolicy ReuseLimit

Applies to: All products

Requires user role: ADMIN

When signing in to the device as a local user, the password must follow the rules set by the UserManagement PasswordPolicy settings. These settings replace the "systemtools securitysetting" command that was available in software versions older than CE9.10.

A new password rule will not apply to existing passwords but will take effect on the next password change.

This setting specifies the reuse limit (n), which means that a user cannot change to either of their previous n passwords.

Default value:

12

Value space:

Integer (0..24)

The minimum number of passwords. 0 means no restrictions.

BoardPro,
BoardPro
G2

Codec EQ

Codec
PlusCodec
ProDesk,
DeskPro,
DeskMiniRoom Bar
Pro,
Room BarRoom Kit,
Room Kit
MiniRoom Kit
EQX

Room 55

Room 55
Dual,
Room 70Room 70
G2Room 70
PanoramaRoom
Panorama

Board

BoardPro,
BoardPro
G2

Codec EQ

Codec
PlusCodec
ProDesk,
DeskPro,
DeskMiniRoom Bar
Pro,
Room BarRoom Kit,
Room Kit
MiniRoom Kit
EQX

Room 55

Room 55
Dual,
Room 70Room 70
G2Room 70
PanoramaRoom
Panorama

Video settings

Video ActiveSpeaker DefaultPiPPosition

Applies to: All products

Requires user role: ADMIN, INTEGRATOR

Defines the position on screen of the active speaker picture-in-picture (PiP). The setting only applies when using a video layout where the active speaker is a PiP (refer to the Video DefaultLayoutFamily Local setting). The setting takes effect from the next call onwards. If changed during a call, it will have no effect on the current call.

Default value:

Current

Value space:

Current/UpperLeft/UpperCenter/UpperRight/CenterLeft/CenterRight/LowerLeft/
LowerRight

Current: The position of the active speaker PiP will be kept unchanged when leaving a call.

UpperLeft: The active speaker PiP will appear in the upper left corner of the screen.

UpperCenter: The active speaker PiP will appear in the upper center position.

UpperRight: The active speaker PiP will appear in the upper right corner of the screen.

CenterLeft: The active speaker PiP will appear in the center left position.

CentreRight: The active speaker PiP will appear in the center right position.

LowerLeft: The active speaker PiP will appear in the lower left corner of the screen.

LowerRight: The active speaker PiP will appear in the lower right corner of the screen.

Video DefaultLayoutFamily Local

Applies to: All products

Requires user role: ADMIN

Select which video layout family to use locally.

Default value:

Auto

Value space:

Auto/Equal/Overlay/Prominent/Prominent_L/Single

Auto: The default layout family, as given in the layout database provided by the device, will be used as the local layout.

Equal: The Grid layout family will be used as the local layout. Participants are shown in a grid of equal sized videos. If there is shared content it will appear beside the grid.

Overlay: Not applicable in this software release.

Prominent_L: The Prominent layout family will be used as the local layout. The active speaker is shown in the upper left part of the screen, and other participants are ranged across the bottom and beside on the right.

Single: The Focus layout family will be used as the local layout. The active speaker, or the presentation if present, will be shown in full screen. The other participants are not shown. Transitions between active speakers are voice switched.

Video DefaultLayoutFamily LocalContent

Applies to: All products

Requires user role: ADMIN

Select which video layout family to switch to by default locally, when content sharing starts.

Default value:

Auto

Value space:

Auto/Equal/Overlay/Prominent/Prominent_L/Single

Auto: The default layout family, as given in the layout database provided by the device, will be used as the local layout.

Equal: The Grid layout family will be used as the local layout. Participants are shown in a grid of equal sized videos. Shared content will appear beside the grid.

Overlay: Not applicable in this software release.

Prominent_L: The Prominent layout family will be used as the local layout. Content is shown in the upper left part of the screen, and participants are ranged across the bottom and beside on the right.

Single: The Focus layout family will be used as the local layout. The shared content will be shown in full screen. Participants are not shown.

Board

Video DefaultLayoutFamily Remote

Applies to: All products

Requires user role: ADMIN

Select which video layout family to be used in the stream that is sent to the remote participants (far end). This setting applies only when using a device's built-in MultiSite feature (optional) to host a multipoint video conference.

Default value:

Auto

Value space:

Auto/Equal/Overlay/Prominent/Single

Auto: The default layout family, as given in the layout database provided by the device, will be used as the local layout.

Equal: The Grid layout family will be used as the local layout. Participants are shown in a grid of equal sized videos. If there is shared content it will appear beside the grid.

Overlay: Not applicable in this software release.

Prominent: The Prominent layout family will be used as the local layout. The active speaker is shown in the upper left part of the screen, and other participants are ranged across the bottom and beside on the right.

Single: The Focus layout family will be used as the local layout. The active speaker, or the presentation if present, will be shown in full screen. The other participants are not shown. Transitions between active speakers are voice switched.

Video DefaultMainSource

Applies to: All products

Requires user role: ADMIN, INTEGRATOR, USER

Define the default input source for main video in calls. The main video is played on this source when you switch on or restart the video device. Use the Video Input SetMainVideoSource command to change to another source while the device is running.

Default value:

1

Value space:

1/2/3/4/5/6/7 [CodecPro Room70G2 RoomPanorama/Room70Panorama]

1/2/3/4/5/6 [RoomKitEQX CodecEQ]

1/2/3 [RoomKit CodecPlus Room55 Room70/Room55D DeskMini Desk]

1/2/3/4/5 [RoomBar RoomBarPro DeskPro BoardPro BoardProG2]

1/2 [RoomKit RoomKitMini DeskMini Board]

The default source for main video.

Video Input AirPlay Beacon

Applies to: All products

Requires user role: ADMIN

Turn on discovery beacon support. The discovery beacon makes AirPlay deployment easier in environments where the video device and the iPhone, iPad, or Mac are not guaranteed to be on the same broadcast domain (VLAN or subnet). This is typically the case in enterprise network set ups.

Beacon discovery requires Bluetooth®. On Desk Series, Board Pro, Board Pro G2, Room Bar, and Room Bar Pro, you must enable Bluetooth with the dedicated Bluetooth Allowed and Bluetooth Enabled settings. On devices that don't have dedicated Bluetooth settings, Bluetooth is automatically enabled when you turn on the discovery beacon.

This setting isn't on the first generation of Board (non S-series) because these devices don't support AirPlay.

Default value:

Auto

Value space:

Auto/Off

Auto: The AirPlay beacon is activated, and the device is discoverable. Typically used in enterprise network setups.

Off: The AirPlay beacon is deactivated, and the device will not be discoverable through the beacon service. Typically used in home network set ups.

Video Input AirPlay DiscoveryInstructions NetworkName

Applies to: All products

Requires user role: ADMIN

Insert the name of the network that the Apple device must connect to. If not set, the Video Input AirPlay DiscoveryInstructions ShowNetworkInfo setting will display the name defined in the network itself.

This setting isn't on the first generation of Board (non S-series) because these devices don't support AirPlay.

Default value:

""

Value space:

String (0, 32)

The name of the network.

Codec EQ

Codec Plus

Codec Pro

Desk, Desk Pro, Desk Mini

Room Bar Pro, Room Bar

Room Kit, Room Kit Mini

Room Kit EQX

Room 55

Room 55 Dual, Room 70

Room 70 G2

Room 70 Panorama

Room Panorama

Board

Video Input AirPlay DiscoveryInstructions ShowNetworkInfo

Applies to: All products

Requires user role: ADMIN

Decide whether to show the name of the network that the Apple device must connect to on the AirPlay information screen (Curtain) on the video device. The network name is either defined in the network itself, or explicitly set in the Video Input AirPlay DiscoveryInstructions NetworkName setting. The latter take precedence.

This setting isn't on the first generation of Board (non S-series) because these devices don't support AirPlay.

Default value:

False

Value space:

False/True

False: Don't display the network name on the AirPlay information screen.

True: Display the network name on the AirPlay information screen.

Video Input AirPlay Mode

Applies to: All products

Requires user role: ADMIN

All devices, except the first generation of Board (non S-series), support AirPlay. With AirPlay users can wirelessly connect their iPhone, iPad, or Mac to share their screen, collaborate, and playback audio and video content.

Use this setting to activate AirPlay on a device.

Once activated, users can disable and re-enable AirPlay themselves from the device's Settings menu if using a personal mode device. This is not possible for shared devices.

Default value:

Off

Value space:

Board, non S-series: Off Other devices: Off/On

On: AirPlay is activated on the device.

Off: AirPlay is deactivated on the device.

Video Input AirPlay Password

Applies to: All products

Requires user role: ADMIN

Define the password that must be used for AirPlay pairing when the Video Input AirPlay Security setting is set to Password.

This setting isn't on the first generation of Board (non S-series) because these devices don't support AirPlay.

Default value:

""

Value space:

String (0, 63)

The AirPlay pairing password.

Video Input AirPlay PresentationSelection

Applies to: RoomKit RoomKitMini RoomBar RoomBarPro RoomKitEQX CodecEQ CodecPlus CodecPro Room55 Room70/Room55D Room70G2 RoomPanorama/Room70Panorama DeskMini Desk DeskPro BoardPro BoardProG2

Requires user role: ADMIN

Defines if the content presented through AirPlay is automatically shared.

Default value:

AutoShare

Value space:

AutoShare/OnConnect

When the PresentationSelection setting is set to AutoShare a popup with a 5 second countdown appears before the content is automatically shared. You can dismiss autosharing until the countdown reaches 0.

When the PresentationSelection setting is OnConnect the popup stays on the screen until you tap share or dismiss the popup.

Board

Video Input AirPlay SecurityMode

Applies to: All products

Requires user role: ADMIN

Define the type of authentication to use when pairing an iPhone, iPad, or Mac to the device (AirPlay pairing).

This setting isn't on the first generation of Board (non S-series) because these devices don't support AirPlay.

Default value:

Shared mode devices: PinAlways Personal mode devices: PinFirstTime

Value space:

Password/PinAlways/PinFirstTime

Password: The device will require a password for AirPlay pairing. You must define the password in the Video Input AirPlay Password setting. If you don't define a password, the device will revert to default and request a PIN.

PinAlways: The device will request a PIN at every AirPlay pairing (except if reconnecting within 30 seconds after disconnecting).

PinFirstTime: The device will request a PIN at the first AirPlay pairing. After the first time, the successfully paired device will be remembered.

BoardPro,
BoardPro
G2

Codec EQ

Codec
PlusCodec
ProDesk,
DeskPro,
DeskMiniRoom Bar
Pro,
Room BarRoom Kit,
Room Kit
MiniRoom Kit
EQX

Room 55

Room 55
Dual,
Room 70Room 70
G2Room 70
PanoramaRoom
Panorama

Video Input CameraConfigMode

Applies to: RoomBarPro RoomKitEQX CodecEQ CodecPlus CodecPro Room70/Room55D Room70G2 RoomPanorama/Room70Panorama BoardPro BoardProG2

Requires user role: ADMIN, INTEGRATOR

This setting applies only when connecting a Precision 60, PTZ-12, or PTZ 4K camera as a second or third camera to the device.

When connecting an extra camera to a device, several settings must be changed accordingly. This can be done manually, one setting at a time, or automatically when the device detects that a camera is connected.

In automatic mode these settings will be applied (n is the connector that the camera is connected to).

Video Input Connector [n] CameraControl CameraId: n

Video Input Connector [n] CameraControl Mode: On

Video Input Connector [n] InputSourceType: camera

Video Input Connector [n] PresentationSelection: Manual

Video Input Connector [n] Quality: Motion

If the Cameras Camera [n] AssignedSerialNumber setting has been applied, the settings above will not be pushed even if the CameraConfigMode is set to Auto. In general, this happens when EDID information is not available, and thereby prevents the device from detecting that a camera is connected. In this case the device issues a warning.

Also, don't use Auto mode if the Cameras Camera n DetectedConnector status doesn't correspond to the input connector number (n). Example: If camera 2 is connected to HDMI [2], then only use Auto mode if the Cameras Camera 2 DetectedConnector status returns 2. If these numbers don't match, you must use the Cameras Camera [n] AssignedSerialNumber setting instead.

Default value:

Manual

Value space:

Auto/Manual

Auto: The settings above will be pushed automatically once the device detects that the camera is connected.

Manual: You must configure the settings manually, one by one, when connecting a camera.

Board

BoardPro,
BoardPro
G2

Codec EQ

Codec
PlusCodec
ProDesk,
DeskPro,
DeskMiniRoom Bar
Pro,
Room BarRoom Kit,
Room Kit
MiniRoom Kit
EQX

Room 55

Room 55
Dual,
Room 70Room 70
G2Room 70
PanoramaRoom
Panorama

Video Input Connector [n] CameraControl Camerald

Applies to: All products

Requires user role: ADMIN, INTEGRATOR

The camera ID is a unique identifier of the camera that is connected to this video input. For devices with more than one camera, you can see the currently assigned IDs in the Cameras Camera status.

Default value:

Connector n: n [RoomBarPro RoomKitEQX CodecEQ CodecPlus CodecPro Room70/Room55D Room70G2 RoomPanorama/Room70Panorama]

Connector 1: 1 Connector 2: 3 Connector 3: 2 [BoardPro BoardProG2]
1 [RoomKit RoomKitMini RoomBar Room55 DeskMini Desk DeskPro Board]

Value space:

1/2/3/4/5/6/7 [RoomBarPro RoomKitEQX CodecEQ CodecPlus CodecPro Room70/Room55D Room70G2 RoomPanorama/Room70Panorama BoardPro BoardProG2]

1 [RoomKit RoomKitMini RoomBar Room55 DeskMini Desk DeskPro Board]

For devices with more than one camera, set an ID of the camera. For devices with one camera the value is fixed and cannot be changed.

n: Unique ID that identifies the video input connector.

Range: 1..2 [RoomKit RoomKitMini DeskMini Board]

Range: 1..3 [RoomBar RoomBarPro CodecPlus Room55 Room70/Room55D Desk DeskPro BoardPro BoardProG2]

Range: 1..4 [RoomKitEQX CodecEQ]

Range: 1..6 [CodecPro Room70G2 RoomPanorama/Room70Panorama]

Video Input Connector [n] CameraControl Mode

Applies to: All products

Requires user role: ADMIN, INTEGRATOR

Define whether the camera on this video input connector can be controlled or not. Some connectors cannot be controlled (Off is the only available value).

Default value:

On [CodecPlus Room70/Room55D]

Connector 1,2,3,4,5: On Connector 6: Off [CodecPro Room70G2 RoomPanorama/Room70Panorama]

Connector 1: On Other connectors: Off [RoomKit RoomKitMini RoomBar RoomBarPro RoomKitEQX CodecEQ Room55 DeskMini Desk DeskPro Board BoardPro BoardProG2]

Value space:

Off/On [RoomBarPro RoomKitEQX CodecEQ CodecPlus CodecPro Room70/Room55D Room70G2 RoomPanorama/Room70Panorama]

Connector 1: Off/On Connector 2: Off Connector 3: Off/On [BoardPro BoardProG2]

Connector 1: Off/On Connector 2,3: Off [RoomBar Room55 Desk DeskPro]

Connector 1: Off/On Connector 2: Off [DeskMini]

Connector 1: Off/On Connector 2: Off [RoomKit RoomKitMini Board]

Off: Disable camera control.

On: Enable camera control.

n: Unique ID that identifies the video input connector.

Range: 1..2 [RoomKit RoomKitMini DeskMini Board]

Range: 1..3 [RoomBar RoomBarPro CodecPlus Room55 Room70/Room55D Desk DeskPro BoardPro BoardProG2]

Range: 1..4 [RoomKitEQX CodecEQ]

Range: 1..6 [CodecPro Room70G2 RoomPanorama/Room70Panorama]

Board

BoardPro,
BoardPro
G2

Codec EQ

Codec
PlusCodec
ProDesk,
DeskPro,
DeskMiniRoom Bar
Pro,
Room BarRoom Kit,
Room Kit
MiniRoom Kit
EQX

Room 55

Room 55
Dual,
Room 70Room 70
G2Room 70
PanoramaRoom
Panorama

Video Input Connector [n] CEC Mode

Applies to: All products

Requires user role: ADMIN, INTEGRATOR

The video input (HDMI) supports Consumer Electronics Control (CEC). When this setting is enabled, information about the connected device (for example device type and device name) is available in the video device status (Video Input Connector[n] ConnectedDevice CEC [n]), provided that the connected device also supports CEC.

If you have Quad Camera, do not switch off CEC on that connector because then there will be no sound on the speakers on the camera. CEC is required for HDMI ARC (Audio Return Channel), which is the channel used for sending audio from the video device to the camera.

Default value:

On

Value space:

Off/On [[RoomKit](#) [RoomKitMini](#) [RoomBar](#) [RoomBarPro](#) [RoomKitEQX](#) [CodecEQ](#) [CodecPlus](#) [CodecPro](#) [Room55](#) [Room70G2](#) [RoomPanorama/Room70Panorama](#) [DeskMini](#) [Desk](#) [DeskPro](#) [Board](#) [BoardPro](#) [BoardProG2](#)]

Connector 1: On Other connectors: Off/On [[Room70/Room55D](#)]

Off: CEC is disabled.

On: CEC is enabled.

n: Unique ID that identifies the video input connector.

Range: 1..3 [[CodecPlus](#) [Room70/Room55D](#)]

Range: 1..4 [[RoomKitEQX](#) [CodecEQ](#)]

Range: 1..5 [[CodecPro](#) [Room70G2](#) [RoomPanorama/Room70Panorama](#)]

Range: 2..2 [[RoomKit](#) [RoomKitMini](#) [DeskMini](#) [Board](#)]

Range: 2..3 [[RoomBar](#) [RoomBarPro](#) [Room55](#) [Desk](#) [DeskPro](#) [BoardPro](#) [BoardProG2](#)]

Video Input Connector [n] HDCP Mode

Applies to: RoomKitEQX CodecEQ CodecPlus CodecPro Room55 Room70/Room55D Room70G2 RoomPanorama/Room70Panorama BoardPro BoardProG2

Requires user role: ADMIN, INTEGRATOR

One of the video device's HDMI inputs can be configured to support HDCP protected content (High-bandwidth Digital Content Protection, version 1.4). This allows customers to re-purpose a video device's screen by connecting devices such as a DVD player, Google ChromeCast, AppleTV, or an HDTV decoder. This type of content cannot be shared while in a call.

When the input connector is set up to support HDCP, the following restrictions apply: You can't share any content from this input while in a call. However, you can share both HDCP protected content and non-protected content locally. You can't take web snapshots of this source.

To be able to show HDCP protected content on the device's screen, also ensure that the Video Output Connector [n] HDCPPolicy configuration is set correctly and that the screen itself supports HDCP.

Default value:

Off

Value space:

Connector 1,3: Off, Connector 2: Off/On [[CodecPlus](#) [Room70/Room55D](#)]

Connector 1, 2, 4: Off, Connector 3: Off/On [[RoomKitEQX](#) [CodecEQ](#)]

Connector 1,2,3,4: Off, Connector 5: Off/On [[CodecPro](#) [Room70G2](#) [RoomPanorama/Room70Panorama](#)]

Connector 2: Off, Connector 3: Off/On [[Room55](#) [BoardPro](#) [BoardProG2](#)]

Off: The video input doesn't support HDCP protected content; it supports only non-protected content.

On: The video input supports both HDCP protected content and non-protected content.

n: Unique ID that identifies the video input connector.

Range: 1..3 [[CodecPlus](#) [Room70/Room55D](#)]

Range: 1..4 [[RoomKitEQX](#) [CodecEQ](#)]

Range: 1..5 [[CodecPro](#) [Room70G2](#) [RoomPanorama/Room70Panorama](#)]

Range: 2..3 [[Room55](#) [BoardPro](#) [BoardProG2](#)]

Board

BoardPro,
BoardPro
G2

Codec EQ

Codec
PlusCodec
ProDesk,
DeskPro,
DeskMiniRoom Bar
Pro,
Room BarRoom Kit,
Room Kit
MiniRoom Kit
EQX

Room 55

Room 55
Dual,
Room 70Room 70
G2Room 70
PanoramaRoom
Panorama

Video Input Connector [n] InputSourceType

Applies to: All products

Requires user role: ADMIN, INTEGRATOR

Select which type of input source is connected to the video input.

If the device has an integrated camera, Connector 1 refers to the integrated camera.

Default value:

Connector 1,2,6: camera Connector 3,4,5: PC [*CodecPro Room70G2 RoomPanorama/Room70Panorama*]

Connector 1: camera Other connectors: PC [*RoomKit RoomKitMini RoomBar RoomBarPro RoomKitEQX CodecEQ CodecPlus Room55 Room70/Room55D DeskMini Desk DeskPro Board BoardPro BoardProG2*]

Value space:

PC/camera/document_camera/mediaplayer/whiteboard/other [*RoomKitEQX CodecEQ CodecPlus CodecPro Room70/Room55D Room70G2 RoomPanorama/Room70Panorama*]

Connector 1: camera Other connectors: PC/camera/document_camera/mediaplayer/whiteboard/other [*RoomKit RoomKitMini RoomBar RoomBarPro Room55 DeskMini Desk DeskPro Board BoardPro BoardProG2*]

PC: Use this when a computer is connected to the video input.

camera: Use this when a camera is connected to the video input.

document_camera: Use this when a document camera is connected to the video input.

mediaplayer: Use this when a media player is connected to the video input.

whiteboard: Use this when a whiteboard camera is connected to the video input.

other: Use this when the other options do not match.

n: Unique ID that identifies the video input connector.

Range: 1..2 [*RoomKit RoomKitMini DeskMini Board*]

Range: 1..3 [*RoomBar RoomBarPro CodecPlus Room55 Room70/Room55D Desk DeskPro BoardPro BoardProG2*]

Range: 1..4 [*RoomKitEQX CodecEQ*]

Range: 1..6 [*CodecPro Room70G2 RoomPanorama/Room70Panorama*]

Video Input Connector [n] MaxResolution

Applies to: All products

Requires user role: ADMIN, INTEGRATOR

Set the preferred maximum resolution for a video input. Any content shared on this input will have this resolution and framerate, or lower. By setting a MaxResolution you can avoid unnecessary upscaling and achieve the exact resolution you intend.

For example, on video inputs that support 4K, you can limit the preferred resolution to avoid automatic 4K upscaling.

Default value:

Connector 1,2: 1920_1080_60 Other connectors: 3840_2160_30 [*CodecPro Room70G2 RoomPanorama/Room70Panorama*]

Connector 1: 1920_1080_60 Other connectors: 3840_2160_30 [*CodecPlus Room70/Room55D*]

1920_1080_60 [*DeskMini Desk*]

3840_2160_30 [*RoomKit RoomKitMini RoomBar RoomBarPro RoomKitEQX CodecEQ Room55 Board*]

3840_2160_60 [*DeskPro BoardProG2*]

Connector 2: 3840_2160_60 Connector 3: 3840_2160_30 [*BoardPro*]

Value space:

1920_1080_60 [*DeskMini Desk*]

1920_1080_60/3840_2160_30 [*RoomKit RoomKitMini RoomBar RoomBarPro RoomKitEQX CodecEQ Room55 Board*]

1920_1080_60/3840_2160_30/3840_2160_60 [*DeskPro BoardProG2*]

Connector 1,2: 1920_1080_60 Other connectors: 1920_1080_60/3840_2160_30 [*CodecPro Room70G2 RoomPanorama/Room70Panorama*]

Connector 1: 1920_1080_60 Other connectors: 1920_1080_60/3840_2160_30 [*CodecPlus Room70/Room55D*]

Connector 2: 1920_1080_60/3840_2160_30/3840_2160_60 Connector 3: 1920_1080_60/3840_2160_30 [*BoardPro*]

Resolution (width, height) and framerate (w_h_f)

n: Unique ID that identifies the video input connector.

Range: 2..2 [*RoomKit RoomKitMini RoomBar DeskMini*]

Range: 2..3 [*RoomBarPro Room55 Desk DeskPro Board BoardPro BoardProG2*]

Range: 1..3 [*CodecPlus Room70/Room55D*]

Range: 1..4 [*RoomKitEQX CodecEQ*]

Range: 1..5 [*CodecPro Room70G2 RoomPanorama/Room70Panorama*]

Board

BoardPro,
BoardPro
G2

Codec EQ

Codec
PlusCodec
ProDesk,
DeskPro,
DeskMiniRoom Bar
Pro,
Room BarRoom Kit,
Room Kit
MiniRoom Kit
EQX

Room 55

Room 55
Dual,
Room 70Room 70
G2Room 70
PanoramaRoom
Panorama

Video Input Connector [n] Name

Applies to: All products

Requires user role: ADMIN, INTEGRATOR

Define a name for the video input connector.

Default value:

Connector 1: "Camera 1" Connector 2: "Camera 2" Connector 3: "PC 1 (HDMI)"
Connector 4: "PC 2 (HDMI)" Connector 5: "PC 3 (HDMI)" Connector 6: "Camera 3 (SDI)" [\[CodecPro Room70G2 RoomPanorama/Room70Panorama \]](#)

Connector 1: "Camera" Connector 2: "PC (USB-C)" Connector 3: "PC (HDMI)" [\[RoomBar BoardPro BoardProG2 \]](#)

Connector 1: "Camera" Connector 2: "PC (HDMI)" Connector 3: "PC (USB-C)" [\[RoomBarPro \]](#)

Connector 1: "Camera" Connector 2: "PC 1 (HDMI)" Connector 3: "PC 2 (HDMI)" [\[CodecPlus Room70/Room55D \]](#)

Connector 1: "Camera" Connector 2: "PC 1 (HDMI)" Connector 3: "PC 2 (HDMI)"
Connector 4: "PC (USB-C)" [\[RoomKitEQX CodecEQ \]](#)

Connector 1: "Camera" Connector 2: "PC 1 (HDMI)" Connector 3: "PC 2 (HDMI)" [\[Room55 \]](#)

Connector 1: "Camera" Connector 2: "PC" [\[RoomKit RoomKitMini Board \]](#)

Connector 1: "Camera" Connector 2: "PC (USB-C)" [\[DeskMini \]](#)

Connector 1: "Camera" Connector 2: "PC (USB-C)" Connector 3: "PC (HDMI)" [\[Desk DeskPro \]](#)

Value space:

String (0, 50)

Name for the video input connector.

n: Unique ID that identifies the video input connector.

Range: 1..2 [\[RoomKit RoomKitMini DeskMini Board \]](#)

Range: 1..3 [\[RoomBar RoomBarPro CodecPlus Room55 Room70/Room55D Desk DeskPro BoardPro BoardProG2 \]](#)

Range: 1..4 [\[RoomKitEQX CodecEQ \]](#)

Range: 1..6 [\[CodecPro Room70G2 RoomPanorama/Room70Panorama \]](#)

Video Input Connector [n] OptimalDefinition Profile

Applies to: All products

Requires user role: ADMIN, INTEGRATOR

This setting will not take effect if the corresponding Video Input Connector [n] Quality setting is set to Sharpness.

The optimal definition profile reflects the lighting conditions in the video conferencing room and the quality of the camera. The better lighting conditions and the better quality of the camera, the higher the profile. Generally, the Normal or Medium profiles are recommended. However, when the lighting conditions are very good, the High profile can be set in order to increase the resolution for a given call rate. The resolution must be supported by both the calling and called devices.

Use the Video Input Connector [n] OptimalDefinition Threshold60fps setting to set the lowest resolution where 60 fps is allowed. Below this threshold, 30 fps is the maximum frame rate.

Default value:

Medium [\[RoomKit RoomKitMini RoomBar RoomBarPro RoomKitEQX CodecEQ CodecPlus CodecPro Room55 Room70/Room55D Room70G2 RoomPanorama/Room70Panorama DeskMini Desk Board BoardPro BoardProG2 \]](#)

Connector 1: Medium Connector 2, 3: High [\[DeskPro \]](#)

Value space:

Normal/Medium/High

Normal: Use this profile for a typically to poorly lit environment. Resolutions will be set rather conservative.

Medium: Requires good and stable lighting conditions and a good quality video input. For some call rates this leads to higher resolution.

High: Requires nearly optimal video conferencing lighting conditions and a good quality video input in order to achieve a good overall experience. Rather high resolutions will be used.

n: Unique ID that identifies the video input connector.

Range: 1..2 [\[RoomKit RoomKitMini DeskMini Board \]](#)

Range: 1..3 [\[RoomBar RoomBarPro CodecPlus Room55 Room70/Room55D Desk DeskPro BoardPro BoardProG2 \]](#)

Range: 1..4 [\[RoomKitEQX CodecEQ \]](#)

Range: 1..6 [\[CodecPro Room70G2 RoomPanorama/Room70Panorama \]](#)

Board

Video Input Connector [n] OptimalDefinition Threshold60fps

Applies to: All products

Requires user role: ADMIN

For each video input, this setting tells the device the lowest resolution where it can transmit 60 fps. For all resolutions lower than this value, the maximum transmitted frame rate would be 30 fps. Above this resolution 60fps is possible, if the available bandwidth is adequate.

Default value:

1920_1080 [RoomKitMini RoomBar RoomBarPro RoomKitEQX CodecEQ CodecPlus CodecPro Room70/Room55D Room70G2 RoomPanorama/Room70Panorama DeskMini Desk DeskPro Board BoardPro BoardProG2]

Never [RoomKit Room55]

Value space:

512_288/768_432/1024_576/1280_720/1920_1080/Never

512_288: Set the threshold to 512x288.

768_432: Set the threshold to 768x432.

1024_576: Set the threshold to 1024x576.

1280_720: Set the threshold to 1280x720.

1920_1080: Set the threshold to 1920x1080.

Never: Do not set a threshold for transmitting 60fps.

n: Unique ID that identifies the video input connector.

Range: 1..2 [RoomKit RoomKitMini DeskMini Board]

Range: 1..3 [RoomBar RoomBarPro CodecPlus Room55 Room70/Room55D Desk DeskPro BoardPro BoardProG2]

Range: 1..4 [RoomKitEQX CodecEQ]

Range: 1..6 [CodecPro Room70G2 RoomPanorama/Room70Panorama]

BoardPro,
BoardPro
G2

Codec EQ

Codec
PlusCodec
ProDesk,
DeskPro,
DeskMiniRoom Bar
Pro,
Room BarRoom Kit,
Room Kit
MiniRoom Kit
EQX

Room 55

Room 55
Dual,
Room 70Room 70
G2Room 70
PanoramaRoom
Panorama

Video Input Connector [n] PreferredResolution

Applies to: All products

Requires user role: ADMIN, INTEGRATOR

Define the preferred screen resolution and refresh rate that the video device advertises to the connected input sources (for example a laptop). The logic for selection of the resolution on the source side will choose this resolution and refresh rate automatically, unless it is overridden manually by the source device (for example the laptop's display configuration software).

Note that larger formats than 1920_1080_60 use much more data, and requires a presentation cable (or adapter) that is qualified for at least HDMI 1.4b data rates.

Default value:

1920_1080_60 [CodecPro Room70G2 RoomPanorama/Room70Panorama DeskMini Desk]

Connector 2: 3840_2160_60 Connector 3: 3840_2160_30 [BoardPro]

Connector 1: 1920_1080_60 Other connectors: 3840_2160_30 [RoomKitEQX CodecEQ] 3840_2160_30 [RoomBar RoomBarPro]

3840_2160_60 [DeskPro BoardProG2]

1920_1080_60 [RoomKit RoomKitMini CodecPlus Room55 Room70/Room55D Board]

Value space:

Connector 1,2: 1920_1080_60 Connector 3,4,5: 1920_1080_60/2560_1080_60/2560_1440_60/2880_1200_60/3440_1440_30/3840_1600_30/3840_1620_30/3840_2160_30 [CodecPro Room70G2 RoomPanorama/Room70Panorama]

Connector 1: 1920_1080_60 Other connectors: 1920_1080_60/2560_1440_60/3840_2160_30 [CodecPlus Room70/Room55D]

1920_1080_60/2560_1440_60/3840_2160_30 [RoomKit RoomKitMini Room55 Board]

1920_1080_60/2560_1080_60/2560_1440_60/2880_1200_60/3440_1440_30/3840_1600_30/3840_1620_30/3840_2160_30 [RoomBar RoomBarPro RoomKitEQX CodecEQ]

1920_1080_60/2560_1440_60/3840_2160_30/3840_2160_60 [DeskPro BoardProG2]

1920_1080_60 [DeskMini Desk]

Connector 2: 1920_1080_60/2560_1440_60/3840_2160_30/3840_2160_60

Connector 3: 1920_1080_60/2560_1440_60/3840_2160_30 [BoardPro]

1920_1080_60: The resolution is 1920 x 1080, and the refresh rate is 60 Hz.

2560_1080_60: The resolution is 2560 x 1080, and the refresh rate is 60 Hz.

2560_1440_60: The resolution is 2560 x 1440, and the refresh rate is 60 Hz.

2880_1200_60: The resolution is 2880 x 1200, and the refresh rate is 60 Hz.

3440_1440_30: The resolution is 3440 x 1440, and the refresh rate is 30 Hz.

3840_1600_30: The resolution is 3840 x 1600, and the refresh rate is 30 Hz.

3840_1620_30: The resolution is 3840 x 1620, and the refresh rate is 30 Hz.

3840_2160_30: The resolution is 3840 x 2160, and the refresh rate is 30 Hz.

3840_2160_60: The resolution is 3840 x 2160, and the refresh rate is 60 Hz.

n: Unique ID that identifies the video input connector.

Board

Range: 1..3 [[CodecPlus Room70/Room55D](#)]BoardPro,
BoardPro
G2Range: 1..4 [[RoomKitEQX CodecEQ](#)]

Codec EQ

Range: 1..5 [[CodecPro Room70G2 RoomPanorama/Room70Panorama](#)]Codec
PlusRange: 2..2 [[RoomKit RoomKitMini DeskMini Board](#)]Codec
ProRange: 2..3 [[RoomBar RoomBarPro Room55 Desk DeskPro BoardPro BoardProG2](#)]Desk,
DeskPro,
DeskMiniRoom Bar
Pro,
Room BarRoom Kit,
Room Kit
MiniRoom Kit
EQX

Room 55

Room 55
Dual,
Room 70Room 70
G2Room 70
PanoramaRoom
Panorama

Video Input Connector [n] PresentationSelection

Applies to: All products

Requires user role: ADMIN, INTEGRATOR

Define how the video device will behave when you connect a presentation source to the video input. If the device is in standby mode, it will wake up when you connect a presentation source. Sharing the presentation with the far end requires additional action (select Share on the user interface) except when this setting is set to AutoShare.

For devices with more than one camera: Any input source can be used as a presentation source; usually, the main camera will not be used as a presentation source.

For devices with an integrated camera: The integrated camera is not available as a presentation source.

Default value:

Connector 1,2,6: Manual Connector 3,4,5: OnConnect [[CodecPro Room70G2 RoomPanorama/Room70Panorama](#)]

Connector 1: Manual Other connectors: OnConnect [[CodecPlus Room70/Room55D](#)]

Connector 1,2: Manual Other connectors: OnConnect [[RoomKitEQX CodecEQ](#)]

Desktop [[DeskMini Desk DeskPro](#)]

OnConnect [[RoomKit RoomKitMini RoomBar RoomBarPro Room55 BoardPro BoardProG2](#)]

AutoShare [[Board](#)]

Value space:

AutoShare/Desktop/Manual/OnConnect

AutoShare: While in a call, the content on the video input will automatically be presented to the far end as well as on the local screen when you connect the cable, or when the source is activated otherwise (for example when a connected computer wakes up from sleep mode). You do not have to select Share on the user interface. If a presentation source is already connected when you make or answer a call, you have to manually select Share on the user interface.

Desktop: The content on the video input will be presented on the screen when you connect the cable, or when the source is activated otherwise (for example when a connected computer wakes up from sleep mode). This applies both when idle and in a call. Also, the content on the video input will stay on the screen when you leave the call, provided that it was the active input at the time of leaving.

Manual: The content on the video input will not be presented on the screen until you select Share from the user interface.

OnConnect: The content on the video input will be presented on screen when you connect the cable, or when the source is activated otherwise (for example when a connected computer wakes up from sleep mode). Otherwise, the behavior is the same as in manual mode.

n: Unique ID that identifies the video input connector.

Range: 1..3 [[CodecPlus Room70/Room55D](#)]

Range: 1..4 [[RoomKitEQX CodecEQ](#)]

Range: 1..6 [[CodecPro Room70G2 RoomPanorama/Room70Panorama](#)]

Board

Range: 2..2 [[RoomKit](#) [RoomKitMini](#) [DeskMini](#) [Board](#)]Range: 2..3 [[RoomBar](#) [RoomBarPro](#) [Room55](#) [Desk](#) [DeskPro](#) [BoardPro](#) [BoardProG2](#)]

Video Input Connector [n] Quality

Applies to: All products

Requires user role: ADMIN, INTEGRATOR

When encoding and transmitting video there is a trade-off between high resolution and high frame rate. For some video sources it is more important to transmit high frame rate than high resolution and vice versa. This setting specifies whether to give priority to high frame rate or to high resolution.

If a Quad Camera, SpeakerTrack 60 camera, or Precision 60 camera is detected by the device this setting is automatically set to Motion. If a user changes this setting manually, it will be set back to Motion after a restart or a camera reconnect.

Default value:

Connector 1,2,6: Motion Connector 3,4,5: Auto [[CodecPro](#) [Room70G2](#) [RoomPanorama/Room70Panorama](#)]

Connector 1: Motion Other connectors: Auto [[CodecPlus](#) [Room70/Room55D](#)]

Connector 1,2: Motion Other connectors: Auto [[RoomKitEQX](#) [CodecEQ](#)]

Auto [[RoomKit](#) [RoomKitMini](#) [RoomBar](#) [Room55](#) [DeskMini](#) [Desk](#) [DeskPro](#) [Board](#) [BoardPro](#) [BoardProG2](#)]

Connector 2: Motion Other connectors: Auto [[RoomBarPro](#)]

Value space:

Auto/Motion/Sharpness

Auto: As a starting point Auto resolves to Sharpness and the video stream will be encoded accordingly. The device will continuously analyze the incoming video stream, and if motion is detected it will automatically change to encoding for Motion.

Motion: Gives the highest possible frame rate. Used when there is a need for higher frame rates, typically when there is motion in the picture.

Sharpness: Gives the highest possible resolution. Used when you want the highest quality of detailed images and graphics.

n: Unique ID that identifies the video input connector.

Range: 1..3 [[CodecPlus](#) [Room70/Room55D](#)]

Range: 1..4 [[RoomKitEQX](#) [CodecEQ](#)]

Range: 1..6 [[CodecPro](#) [Room70G2](#) [RoomPanorama/Room70Panorama](#)]

Range: 2..2 [[RoomKit](#) [RoomKitMini](#) [DeskMini](#) [Board](#)]

Range: 2..3 [[RoomBar](#) [RoomBarPro](#) [Room55](#) [Desk](#) [DeskPro](#) [BoardPro](#) [BoardProG2](#)]

Video Input Connector [n] RGBQuantizationRange

Applies to: All products

Requires user role: ADMIN, INTEGRATOR

The devices connected to the video input should follow the rules for RGB video quantization range defined in CTA-861. Unfortunately some devices do not follow the standard and this configuration may be used to override the settings to get a perfect image with any source.

Default value:

Auto

Value space:

Auto/Full/Limited

Auto: RGB quantization range is automatically selected based on video format according to CTA-861-F. CE video formats will use limited quantization range levels. IT video formats will use full quantization range levels.

Full: Full quantization range. The R, G, B quantization range includes all code values (0 - 255). This is defined in CTA-861-F.

Limited: Limited Quantization Range. R, G, B quantization range that excludes some code values at the extremes (16 - 235). This is defined in CTA-861-F.

n: Unique ID that identifies the video input connector.

Range: 1..3 [[CodecPlus](#) [Room70/Room55D](#)]

Range: 1..4 [[RoomKitEQX](#) [CodecEQ](#)]

Range: 1..5 [[CodecPro](#) [Room70G2](#) [RoomPanorama/Room70Panorama](#)]

Range: 2..2 [[RoomKit](#) [RoomKitMini](#) [DeskMini](#) [Board](#)]

Range: 2..3 [[RoomBar](#) [RoomBarPro](#) [Room55](#) [Desk](#) [DeskPro](#) [BoardPro](#) [BoardProG2](#)]

Board

Video Input Connector [n] Visibility

Applies to: All products

Requires user role: ADMIN, INTEGRATOR

Define the visibility of the video input connector in the menus and buttons on the user interface.

For devices with an integrated camera: Connector 1 is the device's integrated camera and is not available as a presentation source.

Default value:

Connector 1: Never Other connectors: IfSignal [[RoomKitEQX](#) [CodecEQ](#) [CodecPro](#) [Room70G2](#) [DeskMini](#) [Desk](#) [DeskPro](#) [Board](#) [BoardPro](#) [BoardProG2](#)]

Connector 1: Never Connector 2: Never Other connectors: IfSignal [[RoomPanorama/Room70Panorama](#)]

Connector 1: Never Other connectors: Always [[RoomKit](#) [RoomKitMini](#) [RoomBar](#) [RoomBarPro](#) [CodecPlus](#) [Room55](#) [Room70/Room55D](#)]

Value space:

Always/IfSignal/Never [[RoomKitEQX](#) [CodecEQ](#) [CodecPlus](#) [CodecPro](#) [Room55](#) [Room70/Room55D](#) [Room70G2](#) [RoomPanorama/Room70Panorama](#)]

Connector 1: Never Other connectors: Always/IfSignal/Never [[RoomKit](#) [RoomKitMini](#) [RoomBar](#) [RoomBarPro](#) [DeskMini](#) [Desk](#) [DeskPro](#) [Board](#) [BoardPro](#) [BoardProG2](#)]

Always: The menu selection for the video input connector will always be visible on the user interface.

IfSignal: The menu selection for the video input connector will only be visible when something is connected to the video input.

Never: The input source is not expected to be used as a presentation source, and will not show up on the user interface.

n: Unique ID that identifies the video input connector.

Range: 1..2 [[RoomKit](#) [RoomKitMini](#) [DeskMini](#) [Board](#)]

Range: 1..3 [[RoomBar](#) [RoomBarPro](#) [CodecPlus](#) [Room55](#) [Room70/Room55D](#) [Desk](#) [DeskPro](#) [BoardPro](#) [BoardProG2](#)]

Range: 1..4 [[RoomKitEQX](#) [CodecEQ](#)]

Range: 1..6 [[CodecPro](#) [Room70G2](#) [RoomPanorama/Room70Panorama](#)]

Video Input Miracast Mode

Applies to: All products

Requires user role: ADMIN

Miracast allows meeting participants to share content wirelessly from their laptop (Windows or Android) to a video device, without the need for a client. Miracast uses either Wi-Fi Direct to establish a direct network connection from a sending device (typically a meeting participant's laptop) to the video device, or infrastructure, which means using the existing network infrastructure for both signaling (MS-MICE and RTSP) and media. You choose which method to use in the Video Input Miracast Transport setting.

Both methods support only the 2.4 GHz band, and use TCP port 7236 for signaling (RTSP) when establishing the connection. In addition, when the connection is via infrastructure, the MS-MICE protocol uses TCP port 7250. For more information about the MS-MICE protocol, refer to Microsoft's documentation.

When Miracast is turned on, the video device emits a beacon that near-by devices can pick up (range in the order of 100 meter). The broadcast name that appears in the near-by devices' scan lists depends on the configuration. To be sure not to include any PII (personal identifiable information), you can specifically set a broadcast name with the SystemUnit BroadcastName setting. Otherwise, the scan lists will include the Webex DisplayName if the device is registered to the Webex cloud service, and the SystemUnit Name if registered to an on-premises service. If neither of these names are set, the product type (id) will be displayed. When the connection is via infrastructure, the beacon also contains the video device's IP address and hostname.

Because Miracast is using Wi-Fi, it is not supported by non-radio devices. Also, you must remember to connect the Wi-Fi antennas on those products where they are optional. Further, the device must be connected to the network with cable (and have an IP address on the wired network interface).

Default value:

Off

Value space:

Manual/Off/On

On: Miracast is activated, and users can't deactivate it.

Off: Miracast is deactivated, and users can't activate it.

Manual: Miracast is deactivated by default, but users can toggle it on and off themselves from the settings panel on the device's user interface.

Board

Video Input Miracast MaxBitrate

Applies to: All products

Requires user role: ADMIN

Set the maximum bitrate for Miracast content between the sending device (for example a laptop) and the local video device. This setting is not for transmission between the local device and far end devices in a meeting.

Default value:

15000

Value space:

Integer (5000..15000)

The bitrate in kbps.

Desk,
Desk Pro,
Desk Mini

Video Input Miracast Pin Length

Applies to: All products

Requires user role: ADMIN

Set the number of digits in the Miracast pin code. Meeting participants must enter this code on their laptop (sending device) when establishing the required Wi-Fi Direct network connection to the video device. The meeting participant must enter the pin code within 30 seconds.

Default value:

4

Value space:

4/8

The number of digits in the pin code.

Room Bar
Pro,
Room BarRoom Kit,
Room Kit
MiniRoom Kit
EQX

Room 55

Room 55
Dual,
Room 70Room 70
G2Room 70
PanoramaRoom
Panorama

Video Input Miracast PresentationSelection

Applies to: All products

Requires user role: ADMIN

When a Miracast connection is established, the presentation will be shown automatically on the local screen. If the device is in standby mode, it will wake up.

This setting decides whether sharing the presentation with the far end requires additional user action.

Default value:

AutoShare

Value space:

AutoShare/OnConnect

AutoShare: There is a 5 second countdown before the presentation is shared automatically with the far end. During the countdown, the user can stop the share from the UI.

OnConnect: The presentation will not be shared automatically with the far end. The user must select share (or dismiss) from a pop-up on the UI.

Video Input Miracast Quality

Applies to: All products

Requires user role: ADMIN, INTEGRATOR

When encoding and transmitting video there is a trade-off between high resolution and high frame rate. For some content it is more important to transmit high frame rate than high resolution and vice versa. This setting specifies whether to give priority to high frame rate or to high resolution.

This setting doesn't have any effect on content shared locally; only on the signal we send to the far end.

Default value:

Auto

Value space:

Auto/Motion/Sharpness

Auto: As a starting point Auto resolves to Sharpness and the video stream will be encoded accordingly. The device will continuously analyze the incoming video stream, and if motion is detected it will automatically change to encoding for Motion.

Motion: Gives the highest possible frame rate. Used when there is a need for higher frame rates, typically when there is motion in the picture.

Sharpness: Gives the highest possible resolution. Used when you want the highest quality of detailed images and graphics.

Board

Video Input Miracast Transport

Applies to: All products

Requires user role: ADMIN

For Miracast sharing, choose whether the media transport between the sending device (for example a laptop) and the video device should be via a Wi-Fi Direct or infrastructure connection.

Only sending devices running Windows 10 v1809 or later support transport via infrastructure. Android devices doesn't support it. The sending device and the video device must be on the same network, or on networks that TCP signaling and UDP media traffic can be routed between. The sending device cannot be on an unencrypted Wi-Fi network.

When the connection is via infrastructure, it's recommended that the network infrastructure provides IPv4 ARP / IPv6 NDP anti-spoofing to prevent man-in-the-middle attacks.

Default value:

Auto

Value space:

Auto/Direct/Infrastructure

Auto: Use Infrastructure when possible, otherwise use Wi-Fi Direct.

Direct: Share media on a direct network connection from the laptop to the device, using Wi-Fi Direct.

Infrastructure: Share media over the company's existing network infrastructure, with signaling over RTSP and MS-MICE (Miracast over Infrastructure Connection Establishment protocol).

Video Monitors

Applies to: RoomKit RoomBar RoomBarPro RoomKitEQX CodecEQ CodecPlus CodecPro Room55 Room70/Room55D Room70G2 RoomPanorama/Room70Panorama DeskMini Desk DeskPro BoardPro BoardProG2

Requires user role: ADMIN, INTEGRATOR

A monitor role is assigned to each screen using the Video Output Connector [n] MonitorRole setting. The monitor role decides which layout (call participants and presentation) will appear on the screen that is connected to this output. Screens with the same monitor role will get the same layout; screens with different monitor roles will have different layouts.

The monitor layout mode that is set in the Video Monitors setting should reflect the number of different layouts you want in your room setup. Note that some screens can be reserved for presentations.

Default value:

Auto

Value space:

Auto/Single/Dual/DualPresentationOnly [*RoomKit RoomBar CodecPlus Room55 Room70/Room55D DeskMini Desk DeskPro BoardPro*]

Auto/Single/Dual/DualPresentationOnly/Triple/TriplePresentationOnly [*RoomBarPro RoomKitEQX CodecEQ CodecPro Room70G2 BoardProG2*]

Auto/TriplePresentationOnly [*RoomPanorama/Room70Panorama*]

Auto: The number of screens connected to the device is automatically detected, and the layout is distributed on the screens according to the monitor role.

Single: The layout is shown on the device's screen. If the device has more than one screen, the same layout is shown on all screens.

Dual: The layout is distributed on screens with monitor role First and Second. If a presentation is part of the layout, all participants in the call are shown on screens with monitor role First, and the presentation is shown on screens with monitor role Second.

DualPresentationOnly: All participants in the call are shown on screens with monitor role First. If a presentation is part of the layout, the presentation is shown on screens with monitor role Second.

Triple: The layout is distributed on screens with monitor role First, Second and Third. Screens with monitor role Second are used first, then First, and finally Third. If a presentation is part of the layout, all participants in the call are shown on screens with monitor role First and Second, and the presentation is shown on the screen with monitor role Third.

TriplePresentationOnly: All participants in the call are distributed on screens with monitor role First and Second. Screens with monitor role Second are used first, then First. If a presentation is part of the layout, the presentation is shown on the screen with monitor role Third.

BoardPro,
BoardPro
G2

Codec EQ

Codec
PlusCodec
ProDesk,
DeskPro,
DeskMiniRoom Bar
Pro,
Room BarRoom Kit,
Room Kit
MiniRoom Kit
EQX

Room 55

Room 55
Dual,
Room 70Room 70
G2Room 70
PanoramaRoom
Panorama

Board

Video Output Connector [n] Brightness

Applies to: Room55 DeskMini Desk DeskPro BoardPro BoardProG2

Requires user role: ADMIN, USER

Define the brightness level for the device's integrated screen.

Default value:

80

Value space:

Integer (0..100)

Range: The value must be between 0 and 100.

n: Unique ID that identifies the video output connector.

Range: 1..1

Codec EQ

Codec Plus

Codec Pro

Desk, DeskPro, DeskMini

Room Bar Pro, Room Bar

Room Kit, Room Kit Mini

Room Kit EQX

Room 55

Room 55 Dual, Room 70

Room 70 G2

Room 70 Panorama

Room Panorama

Video Output Connector [n] BrightnessMode

Applies to: DeskPro

Requires user role: ADMIN, USER

Configure to allow for automatic or manual control of the brightness level on the screen. Connector [1] is the device's integrated screen.

Default value:

Auto

Value space:

Auto/Manual

Auto: Allow for the brightness level of the screen to be set automatically by the device.

Manual: Allow for the brightness level of the screen to be set manually by the user.

n: Unique ID that identifies the video output connector.

Range: 1..1

Video Output Connector [n] CEC Mode

Applies to: RoomKit RoomKitMini RoomBar RoomBarPro RoomKitEQX CodecEQ CodecPlus CodecPro Room55 Room70/Room55D Room70G2 RoomPanorama/Room70Panorama DeskPro BoardPro BoardProG2

Requires user role: ADMIN, INTEGRATOR

This video output (HDMI) supports Consumer Electronics Control (CEC).

When this setting is On, the video device will use CEC to set the screen in standby when the device itself enters standby. Likewise the device will wake up the screen when the device itself wakes up from standby.

The active video input on a screen is sometimes changed by a user. When a call is started the device detects if the active video input has been switched to another input on the screen. The device then switches the input back so the device is the active video input source. If the device is not the active input source when the device goes into standby the screen will not be set to standby.

It's a prerequisite that the screen that is connected to the output is CEC compatible and that CEC is enabled on the screen.

Note that the different manufacturers uses different marketing names for CEC, for example Anynet+ (Samsung); Aquos Link (Sharp); BRAVIA Sync (Sony); HDMI-CEC (Hitachi); Kuro Link (Pioneer); CE-Link and Regza Link (Toshiba); RIHD (Onkyo); HDAVI Control, EZ-Sync, VIERA Link (Panasonic); EasyLink (Philips); and NetCommand for HDMI (Mitsubishi).

Default value:

On [*RoomKit RoomKitMini RoomBar RoomBarPro RoomKitEQX CodecEQ CodecPlus CodecPro Room55 DeskPro BoardPro BoardProG2*]

Off [*Room70/Room55D Room70G2*]

Room Panorama: On ; Room 70 Panorama: Connector 1: Off, Connector 2: Off, Connector 3: On [*RoomPanorama/Room70Panorama*]

Value space:

Off/On [*RoomKit RoomKitMini RoomBar RoomBarPro RoomKitEQX CodecEQ CodecPlus CodecPro Room55 Room70/Room55D Room70G2 DeskPro BoardPro BoardProG2*]

Room Panorama: On;

Room 70 Panorama: Off/On [*RoomPanorama/Room70Panorama*]

Off: CEC is disabled.

On: CEC is enabled.

n: Unique ID that identifies the video output connector.

Range: 1..1 [*RoomKitMini*]

Range: 1..2 [*RoomKit RoomBar CodecPlus*]

Range: 1..3 [*RoomBarPro RoomKitEQX CodecEQ CodecPro Room70G2 RoomPanorama/Room70Panorama*]

Range: 2..2 [*Room55 DeskPro BoardPro*]

Range: 2..3 [*BoardProG2*]

Range: 2..2 for Room 70 Single; not available for Room 70 Dual [*Room70/Room55D*]

Board

Video Output Connector[n] ContentType

Applies to: RoomKit RoomKitMini RoomBar RoomBarPro RoomKitEQX CodecEQ CodecPlus CodecPro Room55 Room70/Room55D Room70G2 RoomPanorama/Room70Panorama DeskPro BoardPro BoardProG2

Requires user role: ADMIN, INTEGRATOR

Decide whether to transmit content type information in the video stream.

In most cases, not sending any content type information works best. But if you experience higher latency than expected, you can try setting the content type to Game (lower latency video). However, note that most displays don't check the transmitted content type information.

Default value:

Default

Value space:

Default/Game

Default: Don't transmit any content type information.

Game: Transmit content type Game in the video stream.

n: Unique ID that identifies the video output connector.

Range: 1..2 [RoomKit RoomBar CodecPlus]

Range: Room 70 Singel: 1..1 Room 55 Dual, Room 70 Dual: 1..2 [Room70/Room55D]

Range: 1..3 [RoomBarPro RoomKitEQX CodecEQ CodecPro Room70G2 RoomPanorama/Room70Panorama]

Range: 1..1 [RoomKitMini]

Range: 2..2 [Room55 DeskPro BoardPro]

Range: 2..3 [BoardProG2]

Video Output Connector [n] HDCPPolicy

Applies to: All products

Requires user role: ADMIN, INTEGRATOR, USER

Some of the video device's HDMI outputs can be set up to allow transmission of HDCP protected content. For HDCP protected content to be displayed on a screen, of course the screen itself must support HDCP as well.

Default value:

Off [RoomKit RoomKitMini Board]

On [RoomBar RoomBarPro RoomKitEQX CodecEQ Room55 DeskMini Desk DeskPro BoardPro]

Connector 1,2: On Connector 3: Off [CodecPro Room70G2 RoomPanorama/Room70Panorama]

Connector 1: On Connector 2: Off [CodecPlus Room70/Room55D]

On [BoardProG2]

Value space:

Off [RoomKit RoomKitMini Board]

Off/On [RoomBar RoomBarPro RoomKitEQX CodecEQ]

On [Room55 DeskMini Desk DeskPro BoardPro]

Connector 1,2: Off/On Connector 3: Off [CodecPro Room70G2 RoomPanorama/Room70Panorama]

Connector 1: Off/On Connector 2: Off [CodecPlus Room70/Room55D]

Connector 1:On Connector 2,3: Off [BoardProG2]

Off: HDCP is disabled on the output link. Therefore, the video output allows only non-protected content.

On: The video output allows both HDCP (HDCP 1.4 or HDCP 2.2) protected content and non-protected content.

n: Unique ID that identifies the video output connector.

Range: 1..2 [RoomKit RoomBar CodecPlus Room55 Room70/Room55D DeskPro BoardPro]

Range: 1..3 [RoomBarPro RoomKitEQX CodecEQ CodecPro Room70G2 RoomPanorama/Room70Panorama BoardProG2]

Range: 1..1 [RoomKitMini DeskMini Desk Board]

BoardPro, BoardPro G2

Codec EQ

Codec Plus

Codec Pro

Desk, DeskPro, DeskMini

Room Bar Pro, Room Bar

Room Kit, Room Kit Mini

Room Kit EQX

Room 55

Room 55 Dual, Room 70

Room 70 G2

Room 70 Panorama

Room Panorama

Board

BoardPro,
BoardPro
G2

Codec EQ

Codec
PlusCodec
ProDesk,
DeskPro,
DeskMiniRoom Bar
Pro,
Room BarRoom Kit,
Room Kit
MiniRoom Kit
EQX

Room 55

Room 55
Dual,
Room 70Room 70
G2Room 70
PanoramaRoom
Panorama

Video Output Connector [n] Location HorizontalOffset

Applies to: [RoomKit](#) [RoomBar](#) [RoomBarPro](#) [RoomKitEQX](#) [CodecEQ](#) [CodecPlus](#) [CodecPro](#) [Room55](#) [Room70/Room55D](#) [Room70G2](#) [RoomPanorama/Room70Panorama](#) [DeskPro](#) [BoardPro](#) [BoardProG2](#)

Requires user role: ADMIN, INTEGRATOR

HorizontalOffset and VerticalOffset settings are associated with each video output. These settings are used to signal the relative position of the displays that are connected to these outputs.

HorizontalOffset = "0" and VerticalOffset = "0" indicates that the display is positioned in center, both horizontally and vertically. A negative horizontal offset indicates that the monitor is left of center, and a positive horizontal offset indicates that the monitor is right of center. A negative vertical offset indicates that the monitor is below center, and a positive vertical offset indicates that the monitor is above center. The magnitude of the offset indicates how far the display is from center (relative to other displays).

Example: You have two screens side by side. The left screen is on Connector 1 and the right screen on Connector 2. Then the following settings will apply:

Video Output Connector 1 Location: HorizontalOffset = "0", VerticalOffset = "0"

Video Output Connector 2 Location: HorizontalOffset = "1", VerticalOffset = "0"

Example: You have two screens, one below the other. The upper screen is on Connector 1 and the lower screen on Connector 2. Then the following settings will apply:

Video Output Connector 1 Location: HorizontalOffset = "0", VerticalOffset = "0"

Video Output Connector 2 Location: HorizontalOffset = "0", VerticalOffset = "-1"

For Board Pro, Board Pro G2, Desk Pro, and Room 55, the integrated screen (Connector 1) has HorizontalOffset = "0" and VerticalOffset = "0" (implicit, not configurable).

Default value:

Connector 1: "-1" Connector 2: "0" Connector 3: "1" [[RoomBarPro](#) [RoomKitEQX](#) [CodecEQ](#) [CodecPro](#) [Room70G2](#)]

Connector 1: "0" Connector 2: "1" Connector 3: "0.5" [[RoomPanorama/Room70Panorama](#)]

Connector 1: "0" Connector 2: "1" [[RoomKit](#) [RoomBar](#) [CodecPlus](#) [Room70/Room55D](#)]

Connector 2: "1" [[Room55](#) [DeskPro](#)]

Connector 2: "0" [[BoardPro](#)]

Connector 2: "-1" Connector 3: "0" [[BoardProG2](#)]

Value space:

String (1, 12)

The string represents a decimal number between -100.0 and 100.0 (these numbers included). Input strings that complies with the `std::stof` function in the C++ `<string>` library are accepted. This means that you can use either decimal notation or E-notation, for example "12", "12.0", "1.2e1", "1.2E1", "-0.12", "-12e-2". Leading whitespace characters are discarded, and the decimal point is "."

n: Unique ID that identifies the video output connector.

Range: 1..2 [[RoomKit](#) [RoomBar](#) [CodecPlus](#) [Room70/Room55D](#)]

Range: 1..3 [[RoomBarPro](#) [RoomKitEQX](#) [CodecEQ](#) [CodecPro](#) [Room70G2](#) [RoomPanorama/](#)

[Room70Panorama](#)]

Range: 2..2 [[Room55](#) [DeskPro](#) [BoardPro](#)]

Range: 2..3 [[BoardProG2](#)]

Board

BoardPro,
BoardPro
G2

Codec EQ

Codec
PlusCodec
ProDesk,
DeskPro,
DeskMiniRoom Bar
Pro,
Room BarRoom Kit,
Room Kit
MiniRoom Kit
EQX

Room 55

Room 55
Dual,
Room 70Room 70
G2Room 70
PanoramaRoom
Panorama

Video Output Connector [n] Location VerticalOffset

Applies to: [RoomKit](#) [RoomBar](#) [RoomBarPro](#) [RoomKitEQX](#) [CodecEQ](#) [CodecPlus](#) [CodecPro](#) [Room55](#) [Room70/Room55D](#) [Room70G2](#) [RoomPanorama/Room70Panorama](#) [DeskPro](#) [BoardPro](#) [BoardProG2](#)

Requires user role: ADMIN, INTEGRATOR

HorizontalOffset and VerticalOffset settings are associated with each video output. These settings are used to signal the relative position of the displays that are connected to these outputs.

HorizontalOffset = "0" and VerticalOffset = "0" indicates that the display is positioned in center, both horizontally and vertically. A negative horizontal offset indicates that the monitor is left of center, and a positive horizontal offset indicates that the monitor is right of center. A negative vertical offset indicates that the monitor is below center, and a positive vertical offset indicates that the monitor is above center. The magnitude of the offset indicates how far the display is from center (relative to other displays).

For Board Pro, Board Pro G2, Desk Pro, and Room 55, the integrated screen (Connector 1) has HorizontalOffset = "0" and VerticalOffset = "0" (implicit, not configurable).

Example: You have two screens side by side. The left screen is on Connector 1 and the right screen on Connector 2. Then the following settings will apply:

Video Output Connector 1 Location: HorizontalOffset = "0", VerticalOffset = "0"

Video Output Connector 2 Location: HorizontalOffset = "1", VerticalOffset = "0"

Example: You have two screens with one below the other. The upper screen is on Connector 1 and the lower screen on Connector 2. Then the following settings will apply:

Video Output Connector 1 Location: HorizontalOffset = "0", VerticalOffset = "0"

Video Output Connector 2 Location: HorizontalOffset = "0", VerticalOffset = "-1"

Default value:

Connector n: "0" [[RoomKit](#) [RoomBar](#) [RoomBarPro](#) [CodecEQ](#) [CodecPlus](#) [CodecPro](#) [Room55](#) [Room70/Room55D](#) [Room70G2](#) [DeskPro](#) [BoardPro](#) [BoardProG2](#)]

Connector 1, 2: "0" Connector 3: "-1" [[RoomKitEQX](#) [RoomPanorama/Room70Panorama](#)]

Value space:

String (1, 12)

The string represents a decimal number between -100.0 and 100.0 (these numbers included). Input strings that complies with the std::stof function in the C++ <string> library are accepted. This means that you can use either decimal notation or E-notation, for example "12", "12.0", "1.2e1", "1.2E1", "-0.12", "-12e-2". Leading whitespace characters are discarded, and the decimal point is ".".

n: Unique ID that identifies the video output connector.

Range: 1..2 [[RoomKit](#) [RoomBar](#) [CodecPlus](#) [Room70/Room55D](#)]

Range: 1..3 [[RoomBarPro](#) [RoomKitEQX](#) [CodecEQ](#) [CodecPro](#) [Room70G2](#) [RoomPanorama/Room70Panorama](#)]

Range: 2..2 [[Room55](#) [DeskPro](#) [BoardPro](#)]

Range: 2..3 [[BoardProG2](#)]

Video Output Connector [n] MonitorRole

Applies to: [RoomKit](#) [RoomKitMini](#) [RoomBar](#) [RoomBarPro](#) [RoomKitEQX](#) [CodecEQ](#) [CodecPlus](#) [CodecPro](#) [Room55](#) [Room70/Room55D](#) [Room70G2](#) [RoomPanorama/Room70Panorama](#) [DeskPro](#) [BoardPro](#) [BoardProG2](#)

Requires user role: ADMIN, INTEGRATOR

The monitor role describes which video streams will be shown on the screen connected to this video output. Together the Video Monitors setting and the MonitorRole settings for all outputs define which layout (video streams) will be shown on each screen.

Default value:

Auto [[RoomKit](#) [RoomBar](#) [RoomBarPro](#) [RoomKitEQX](#) [CodecEQ](#) [CodecPlus](#) [CodecPro](#) [Room55](#) [Room70G2](#) [RoomPanorama/Room70Panorama](#) [DeskPro](#) [BoardPro](#) [BoardProG2](#)]

Dual: Connector 1,2: Auto; Single: Connector 1: Auto Connector 2: PresentationOnly [[Room70/Room55D](#)]

Value space:

Auto/First/Second/PresentationOnly [[RoomKit](#) [RoomBar](#) [CodecPlus](#) [Room55](#) [Room70/Room55D](#) [DeskPro](#) [BoardPro](#)]

Auto/First/Second/Third/PresentationOnly/Recorder [[RoomBarPro](#) [RoomKitEQX](#) [CodecEQ](#) [CodecPro](#) [Room70G2](#) [RoomPanorama/Room70Panorama](#) [BoardProG2](#)]

Auto: The device will detect when a screen is connected, and a monitor role (First, Second, Third) that corresponds with the Video Monitors setting will be assigned automatically.

First/Second/Third: Define the role of the screen in a multi-screen setup. In a single-screen setup, there is no difference between First, Second and Third.

PresentationOnly: Show presentation video stream if active, and nothing else. Screens/outputs with this monitor role are ignored by the Video Monitors setting.

Recorder: Show all participants, including the local main video (self-view). If active, also show the presentation. Screens/outputs with this monitor role are ignored by the Video Monitors setting.

n: Unique ID that identifies the video output connector.

Range: 1..2 [[RoomKit](#) [RoomBar](#) [CodecPlus](#) [Room70/Room55D](#)]

Range: 1..3 [[RoomBarPro](#) [RoomKitEQX](#) [CodecEQ](#) [CodecPro](#) [Room70G2](#) [RoomPanorama/Room70Panorama](#)]

Range: 2..2 [[Room55](#) [DeskPro](#) [BoardPro](#)]

Range: 2..3 [[BoardProG2](#)]

Range: 1..1 [[RoomKitMini](#)]

Board

BoardPro,
BoardPro
G2

Codec EQ

Codec
PlusCodec
ProDesk,
DeskPro,
DeskMiniRoom Bar
Pro,
Room BarRoom Kit,
Room Kit
MiniRoom Kit
EQX

Room 55

Room 55
Dual,
Room 70Room 70
G2Room 70
PanoramaRoom
Panorama

Video Output Connector [n] Resolution

Applies to: All products

Requires user role: ADMIN, INTEGRATOR, USER

Set the resolution and refresh rate to be used on an output. If the specified resolution and refresh rate are not supported by the connected screen/display, or this configuration is set to Auto, the output resolution and refresh rate will be the screen's preferred format (as reported in EDID and passed on into the Video Output Connector [n] ConnectedDevice PreferredFormat status.

You always find the actual resolution and framerate that is sent in the Video Output Connector [n] Width, Height, an Refreshrate statuses.

If you choose a resolution that the connected screen doesn't support, the output format will be the screen's preferred format (as reported in EDID and passed on in the Video Output Connector [n] ConnectedDevice PreferredFormat status.

If the device has an integrated screen, Connector [1] refers to this screen.

The formats larger than 1920_1200_60 requires use of high quality display cables when connecting an external screen.

Some UHD TVs/displays only enable 3840_2160_30 (30 Hz) and not 3840_2160_60 (60 Hz) as their default configuration. In such cases the corresponding setting on the TV/display must be reconfigured to allow 3840_2160_60 for the HDMI input where the device is connected.

Default value:

3840_2160_60 [Board]

1920_1080_60 [DeskMini Desk]

Connector 1: 3840_2160_60 Other connectors: Auto [Room55 DeskPro BoardPro BoardProG2]

Auto [RoomKit RoomKitMini RoomBar RoomBarPro RoomKitEQX CodecEQ CodecPlus CodecPro Room70/Room55D Room70G2]

Connector 1, 2: Auto; Connector 3: 3840_2160_30 [RoomPanorama/Room70Panorama]

Value space:

Connector 1,2: Auto/1920_1080_50/1920_1080_60/1920_1200_50/1920_1200_60/2560_1080_60/2560_1440_60/2880_1200_60/3440_1440_60/3840_1600_60/3840_1620_60/3840_2160_30/3840_2160_60 Connector 3: Auto/1920_1080_50/1920_1080_60/1920_1200_50/1920_1200_60/2560_1440_60/3840_2160_30 [CodecPro Room70G2]

Connector 1,2: Auto/1920_1080_50/1920_1080_60/1920_1200_50/1920_1200_60/2560_1080_60/2560_1440_60/2880_1200_60/3440_1440_60/3840_1600_60/3840_1620_60/3840_2160_30/3840_2160_60 Connector 3: 3840_2160_30 [RoomPanorama/Room70Panorama]

3840_2160_60 [Board]

Connector 1: 3840_2160_60 Other connectors: Auto/1920_1080_50/1920_1080_60/1920_1200_50/1920_1200_60/2560_1080_60/2560_1440_60/2880_1200_60/3440_1440_60/3840_1600_60/3840_1620_60/3840_2160_30/3840_2160_60 [Room55 DeskPro BoardPro BoardProG2]

1920_1080_50 [DeskMini Desk]

Auto/1920_1080_50/1920_1080_60/1920_1200_50/1920_1200_60/2560_1080_60/2560_1440_60/2880_1200_60/3440_1440_60/3840_1600_60/3840_1620_60/3840_2160_30/3840_2160_60 [RoomKit RoomKitMini RoomBar RoomBarPro RoomKitEQX CodecEQ CodecPlus Room70/Room55D]

Auto: The device will automatically try to set the optimal resolution based on negotiation with the connected monitor.

1920_1080_50: The resolution is 1920 x 1080, and the refresh rate is 50 Hz.

1920_1080_60: The resolution is 1920 x 1080, and the refresh rate is 60 Hz.

1920_1200_50: The resolution is 1920 x 1200, and the refresh rate is 50 Hz.

1920_1200_60: The resolution is 1920 x 1200, and the refresh rate is 60 Hz.

2560_1080_60: The resolution is 2560 x 1080, and the refresh rate is 60 Hz.

2560_1440_60: The resolution is 2560 x 1440, and the refresh rate is 60 Hz.

2880_1200_60: The resolution is 2880 x 1200, and the refresh rate is 60 Hz.

3440_1440_60: The resolution is 3440 x 1440, and the refresh rate is 60 Hz.

3840_1600_60: The resolution is 3840 x 1600, and the refresh rate is 60 Hz.

3840_1620_60: The resolution is 3840 x 1620, and the refresh rate is 60 Hz.

3840_2160_30: The resolution is 3840 x 2160, and the refresh rate is 30 Hz.

3840_2160_60: The resolution is 3840 x 2160, and the refresh rate is 60 Hz.

n: Unique ID that identifies the video output connector.

Range: 1..1 [RoomKitMini DeskMini Desk Board]

Range: 1..2 [RoomKit RoomBar CodecPlus Room55 Room70/Room55D DeskPro BoardPro]

Range: 1..3 [RoomBarPro RoomKitEQX CodecEQ CodecPro Room70G2 RoomPanorama/Room70Panorama BoardProG2]

Board

BoardPro,
BoardPro
G2

Codec EQ

Codec
PlusCodec
ProDesk,
DeskPro,
DeskMiniRoom Bar
Pro,
Room BarRoom Kit,
Room Kit
MiniRoom Kit
EQX

Room 55

Room 55
Dual,
Room 70Room 70
G2Room 70
PanoramaRoom
Panorama

Video Output Connector [n] RGBQuantizationRange

*Applies to: RoomKit RoomKitMini RoomBar
RoomBarPro RoomKitEQX CodecEQ
CodecPlus CodecPro Room55 Room70/
Room55D Room70G2 RoomPanorama/*

*Room70Panorama DeskPro BoardPro
BoardProG2*

Requires user role: ADMIN, INTEGRATOR

Connected HDMI displays should follow the rules for RGB video quantization range defined in CTA-861. Unfortunately some displays do not follow the standard and this configuration may be used to override the settings to get a perfect image with any display.

Default value:

Full

Value space:

Auto/Full/Limited

Auto: If the display signals support for "Selectable RGB Quantization Range" in the EDID, then the AVI InfoFrame will signal Full Range in the RGB Quantization Range bits (Q0, Q1). Otherwise Limited Range will be signaled in the AVI InfoFrame for CE video formats and Full Range for IT video formats.

Full: Full quantization range. The R, G, B quantization range includes all code values (0 - 255). This is defined in CTA-861-H.

Limited: Limited Quantization Range. R, G, B quantization range that excludes some code values at the extremes (16 - 235). This is defined in CTA-861-H.

n: Unique ID that identifies the video output connector.

Range: 1..1 [*RoomKitMini*]

Range: 1..2 [*RoomKit RoomBar
CodecPlus Room70/Room55D*]

Range: 1..3 [*RoomBarPro RoomKitEQX
CodecEQ CodecPro Room70G2
RoomPanorama/Room70Panorama*]

Range: 2..2 [*Room55 DeskPro BoardPro*]

Range: 2..3 [*BoardProG2*]

Video Output HDMI Passthrough Allowed

Applies to: RoomKit CodecPlus CodecPro Room55 Room70/Room55D Room70G2

Requires user role: ADMIN

If people connect their laptop to the USB socket of an HDMI-to-USB converter (capturing device) that is connected to one of the device's HDMI outputs, they can use the device's camera and microphone when making calls from their laptop meeting apps. They also need a presentation cable (HDMI) between the laptop and an HDMI input to make use of the device's screen and loudspeakers. This feature is referred to as Call from laptop, Webcam mode, or HDMI passthrough.

Which HDMI output the HDMI-to-USB converter is connected to is set with the Video Output HDMI Passthrough OutputConnector setting. You may also want to check that the Video Monitors and Video Output Connector [n] MonitorRole settings are correct.

Call from laptop is not supported on Room 55 Dual and Room 70 Dual because they don't have an HDMI output available for the converter.

Default value:

False

Value space:

False/True

False: Disable the feature. Calling from a laptop meeting app is not supported.

True: Enable the feature. Calling from a laptop meeting app is supported, and there is a Call from laptop button on the user interface.

Board

BoardPro,
BoardPro
G2

Codec EQ

Codec
PlusCodec
ProDesk,
DeskPro,
DeskMiniRoom Bar
Pro,
Room BarRoom Kit,
Room Kit
MiniRoom Kit
EQX

Room 55

Room 55
Dual,
Room 70Room 70
G2Room 70
PanoramaRoom
Panorama

Video Output HDMI Passthrough HdmiUsbConverter Mode

Applies to: RoomKit CodecPlus CodecPro Room55 Room70/Room55D Room70G2

Requires user role: ADMIN, INTEGRATOR

When using the Call from laptop (HDMI passthrough) feature, users must choose (on their laptops) to use the HDMI-to-USB converter (capturing device) as microphone and camera. With this setting you can customize which name will be displayed in the list of devices to choose from.

Refer to the Video Output HDMI Passthrough Allowed setting for more details about Call from laptop. Call from laptop is not supported on Room 55 Dual and Room 70 Dual because they don't have an HDMI output available for the converter.

Default value:

General

Value space:

Auto/Custom/General

Auto: Display the name that the HDMI-to-USB converter is advertising to the video device. If empty, display a generic name for the HDMI-to-USB converter. You can find the advertised name in the Video Output Connector [n] ConnectedDevice Name status, where n is the HDMI output connector you have connected the HDMI-to-USB converter to.

General: Display a generic term as the name of the HDMI-to-USB converter.

Custom: Display the name defined in the Video Output Hdmi Passthrough HdmiUsbConverter Name setting as the name of the HDMI-to-USB converter.

Video Output HDMI Passthrough HdmiUsbConverter Name

Applies to: RoomKit CodecPlus CodecPro Room55 Room70/Room55D Room70G2

Requires user role: ADMIN, INTEGRATOR

If Video Output Hdmi Passthrough HdmiUsbConverter Mode is set to Custom, you must set a name for the HDMI-to-USB converter (capture device) here. This is the name that will show up in the list of devices to choose from when choosing a camera and microphone from the laptop.

This setting is not available for Room 55 Dual and Room 70 Dual because they don't have an HDMI output available for the converter.

Default value:

""

Value space:

String (0, 25)

The name of the HDMI-to-USB converter.

Video Output HDMI Passthrough OutputConnector

Applies to: RoomKit CodecPlus CodecPro Room55 Room70/Room55D Room70G2

Requires user role: ADMIN, INTEGRATOR

Set the HDMI output connector you have connected the HDMI-to-USB converter (capture device) to. By default, the device is set up to use the HDMI output with the highest number.

This setting only applies when Call from laptop is enabled, that is, Video Output HDMI Passthrough Allowed is set to True.

This setting is not available for Room 55 Dual and Room 70 Dual because they don't have an HDMI output available for the converter.

Default value:

3 [CodecPro Room70G2]

2 [RoomKit CodecPlus Room70/Room55D]

1 [Room55]

Value space:

Integer (1..3) [CodecPro]

Room 70 Dual G2: Integer (3..3) Room 70 Single G2: Integer (2..3) [Room70G2]

Integer (1..2) [RoomKit CodecPlus]

Integer (1..1) [Room55]

Room 70 Single: Integer (2..2) [Room70/Room55D]

Range: The unique identifier of the selected video output connector.

Video Output HDMI Passthrough AutoDisconnect Enabled

Applies to: RoomKit CodecPlus CodecPro Room55 Room70/Room55D Room70G2

Requires user role: ADMIN, INTEGRATOR

Decide whether the device shall automatically disconnect the HDMI Passthrough after a given delay, for example if the user forgets to disconnect from the touch controller. The delay is set with the Video Output HDMI Passthrough AutoDisconnect Delay.

Refer to the Video Output HDMI Passthrough Allowed setting for more information about HDMI passthrough and the Call from laptop feature. Call from laptop is not supported on Room 55 Dual and Room 70 Dual.

Default value:

True

Value space:

False/True

False: HDMI Passthrough will not be disconnected automatically; the user must always disconnect from the touch controller.

True: HDMI Passthrough will disconnect when the Video Output HDMI Passthrough AutoDisconnect Delay times out.

Board

Video Output HDMI Passthrough AutoDisconnect Delay

Applies to: RoomKit CodecPlus CodecPro Room55 Room70/Room55D Room70G2

Requires user role: ADMIN, INTEGRATOR

Set how long (minutes) the device shall be in HDMI Passthrough mode before it disconnects automatically. This setting only has an effect when Video Output HDMI Passthrough AutoDisconnect Enabled is set to True.

Refer to the Video Output HDMI Passthrough Allowed setting for more information about HDMI passthrough and the Call from laptop feature. Call from laptop is not supported on Room 55 Dual and Room 70 Dual.

Default value:

120

Value space:

Integer (1..1440)

The delay measured in minutes.

BoardPro,
BoardPro
G2

Codec EQ

Codec
PlusCodec
ProDesk,
DeskPro,
DeskMiniRoom Bar
Pro,
Room BarRoom Kit,
Room Kit
MiniRoom Kit
EQX

Room 55

Room 55
Dual,
Room 70Room 70
G2Room 70
PanoramaRoom
Panorama

Video Output MirroringType

Applies to: All products

Requires user role: ADMIN, INTEGRATOR

This setting decides on which screen(s) local content is displayed when the device is not in a call.

Default value:

Multiscreen [RoomKit RoomKitMini RoomBar RoomBarPro RoomKitEQX CodecEQ CodecPlus CodecPro Room55 Room70/Room55D Room70G2 RoomPanorama/Room70Panorama DeskMini Desk Board BoardPro BoardProG2]

LastOnly [DeskPro]

Value space:

LastOnly/Mirror/Multiscreen

LastOnly: Local content will be shown only on the last available screen. It will not be duplicated to any other screen. An available screen is a screen that is showing the home screen or nothing.

Mirror: Local content will be mirrored onto all available screens. When connecting a new source, the previous source will be replaced on all screens.

Multiscreen: Local content will be dispersed across all available screens. The first source you connect will be mirrored on all available screens. The next source you connect will leave one screen for the previous source (if available), and so on.

Video Output Webcam USBMode

Applies to: RoomKitMini RoomBar RoomBarPro RoomKitEQX CodecEQ BoardPro BoardProG2

Requires user role: ADMIN, INTEGRATOR

Specify whether to enter USB mode (and also do-not-disturb mode) when you connect video or when you start streaming video.

Default value:

OnStreaming

Value space:

OnConnect/OnStreaming

OnConnect: Go into USB mode when you connect video.

OnStreaming: Go into USB mode when you start streaming video.

Video Output Connector [n] Whitebalance Level

Applies to: Room55 DeskMini Desk DeskPro BoardPro BoardProG2

Requires user role: ADMIN, USER

The integrated screen's color temperature (white balance) is adjustable from 4000 K (warm) to 9000 K (cool).

Default value:

6500

Value space:

Integer (4000..9000)

The color temperature in Kelvin.

n: Unique ID that identifies the video output connector.

Range: 1..1

Board

BoardPro,
BoardPro
G2

Codec EQ

Codec
PlusCodec
ProDesk,
Desk Pro,
Desk MiniRoom Bar
Pro,
Room BarRoom Kit,
Room Kit
MiniRoom Kit
EQX

Room 55

Room 55
Dual,
Room 70Room 70
G2Room 70
PanoramaRoom
Panorama

Video Presentation DefaultPIPPosition

Applies to: All products

Requires user role: ADMIN, INTEGRATOR

Define the position on screen of the presentation picture-in-picture (PiP). The setting only takes effect when the presentation is explicitly minimized to a PiP, for example using the user interface. The setting takes effect from the next call onwards; if changed during a call, it will have no effect on the current call.

Default value:

Current

Value space:

Current/UpperLeft/UpperCenter/UpperRight/CenterLeft/CenterRight/LowerLeft/
LowerRight

Current: The position of the presentation PiP will be kept unchanged when leaving a call.

UpperLeft: The presentation PiP will appear in the upper left corner of the screen.

UpperCenter: The presentation PiP will appear in the upper center position.

UpperRight: The presentation PiP will appear in the upper right corner of the screen.

CenterLeft: The presentation PiP will appear in the center left position.

CenterRight: The presentation PiP will appear in the center right position.

LowerLeft: The presentation PiP will appear in the lower left corner of the screen.

LowerRight: The presentation PiP will appear in the lower right corner of the screen.

Video Presentation DefaultSource

Applies to: All products

Requires user role: ADMIN, USER

Define which video input source to use as a default presentation source. This setting may be used by the API and third-party user interfaces. It is not relevant when using the user interfaces provided by Cisco.

Default value:

2 [RoomKit RoomKitMini RoomBar RoomBarPro RoomKitEQX CodecEQ CodecPlus Room55 Room70/
Room55D DeskMini Desk DeskPro Board BoardPro BoardProG2]

3 [CodecPro Room70G2 RoomPanorama/Room70Panorama]

Value space:

1/2 [RoomKit RoomKitMini DeskMini Board]

1/2/3 [CodecPlus Room55 Room70/Room55D Desk]

1/2/3/4/5 [RoomBar RoomBarPro DeskPro BoardPro BoardProG2]

1/2/3/4 [RoomKitEQX CodecEQ]

1/2/3/4/5/6/7 [CodecPro Room70G2 RoomPanorama/Room70Panorama]

The video input source to use as default presentation source.

Video Presentation Priority

Applies to: All products

Requires user role: ADMIN

Specify how to distribute the bandwidth between the presentation channel and the main video channel. This setting applies only to SIP and H.323 calls.

Default value:

Equal

Value space:

Equal/High/Low [RoomKit RoomKitMini RoomBar RoomBarPro RoomKitEQX CodecEQ CodecPlus
CodecPro Room55 Room70/Room55D Room70G2 DeskMini Desk DeskPro Board BoardPro BoardProG2]

Equal [RoomPanorama/Room70Panorama]

Equal: The available bandwidth is shared equally between the presentation channel and the main video channel.

High: The presentation channel is assigned a larger portion of the available bandwidth at the expense of the main video channel.

Low: The main video channel is assigned a larger portion of the available bandwidth at the expense of the presentation channel.

Video Selfview Default FullscreenMode

Applies to: All products

Requires user role: ADMIN, INTEGRATOR

Define if the main video source (self-view) shall be shown in full screen or as a small picture-in-picture (PiP) after a call. The setting only takes effect when self-view is switched on (see the Video Selfview Default Mode setting).

For Desk and Desk Pro, if you use the user interface to turn full screen self-view off, it will come back as a PiP the next time that you use the user interface to turn it on.

Default value:

Current

Value space:

Off/Current/On

Off: Self-view will be shown as a PiP.

Current: The size of the self-view picture will be kept unchanged when leaving a call. That is, if it was a PiP during the call, it remains a PiP after the call; if it was fullscreen during the call, it remains fullscreen after the call.

On: The self-view picture will be shown in fullscreen.

Board

BoardPro,
BoardPro
G2

Codec EQ

Codec
PlusCodec
ProDesk,
DeskPro,
DeskMiniRoom Bar
Pro,
Room BarRoom Kit,
Room Kit
MiniRoom Kit
EQX

Room 55

Room 55
Dual,
Room 70Room 70
G2Room 70
PanoramaRoom
Panorama

Video Selfview Default Mode

Applies to: All products

Requires user role: ADMIN, INTEGRATOR

Specify if the main video source (self-view) shall be displayed on screen outside of call. Whether it's on or off during call setup and throughout the call, is given by the Video Selfview OnCall Mode.

The position and size of the self-view window is determined by the Video Selfview Default PIPPosition and the Video Selfview Default FullscreenMode settings respectively.

Default value:

Auto

Value space:

Auto/Current/Off/On

Auto: Self-view is always off outside of call.

Current: Self-view is left as is. That is, if it was on during the call, it remains on after the call; if it was off during the call, it remains off after the call.

Off: Self-view is always off outside of call.

On: Self-view is always on outside of call.

Video Selfview Default OnMonitorRole

Applies to: All products

Requires user role: ADMIN, INTEGRATOR

Define which screen/output to display the main video source (self-view) after a call. The value reflects the monitor roles set for the different outputs in the Video Output Connector [n] MonitorRole setting.

The setting applies both when self-view is displayed in full screen, and when it is displayed as picture-in-picture (PiP).

Default value:

Current

Value space:

Current/First/Second [RoomKit RoomKitMini RoomBar RoomBarPro CodecPlus Room55 Room70/
Room55D DeskMini Desk DeskPro Board BoardPro BoardProG2]

Current/First/Second/Third [RoomKitEQX CodecEQ CodecPro Room70G2 RoomPanorama/
Room70Panorama]

Current: When leaving a call, the self-view picture will be retained on the same output as it was during the call.

First: The self-view picture will be shown on outputs with monitor role First.

Second: The self-view picture will be shown on outputs with monitor role Second.

Third: The self-view picture will be shown on outputs with monitor role Third.

Video Selfview Default PIPPosition

Applies to: All products

Requires user role: ADMIN, INTEGRATOR

Define the position on screen of the small self-view picture-in-picture (PiP) after a call. The setting only takes effect when self-view is switched on (see the Video Selfview Default Mode setting) and fullscreen view is switched off (see the Video Selfview Default FullscreenMode setting).

Default value:

Current [RoomKit RoomKitMini RoomBar RoomBarPro RoomKitEQX CodecEQ CodecPlus CodecPro
Room55 Room70/Room55D Room70G2 DeskMini Desk DeskPro BoardPro BoardProG2]

LowerRight [RoomPanorama/Room70Panorama]

Current [Board]

Value space:

Current/UpperLeft/UpperCenter/UpperRight/CenterLeft/CenterRight/LowerLeft/
LowerRight

Current: The position of the self-view PiP will be kept unchanged when leaving a call.

UpperLeft: The self-view PiP will appear in the upper left corner of the screen.

UpperCenter: The self-view PiP will appear in the upper center position.

UpperRight: The self-view PiP will appear in the upper right corner of the screen.

CenterLeft: The self-view PiP will appear in the center left position.

CentreRight: The self-view PiP will appear in the center right position.

LowerLeft: The self-view PiP will appear in the lower left corner of the screen.

LowerRight: The self-view PiP will appear in the lower right corner of the screen.

Board

BoardPro,
BoardPro
G2

Codec EQ

Codec
PlusCodec
ProDesk,
DeskPro,
DeskMiniRoom Bar
Pro,
Room BarRoom Kit,
Room Kit
MiniRoom Kit
EQX

Room 55

Room 55
Dual,
Room 70Room 70
G2Room 70
PanoramaRoom
Panorama

Video Selfview OnCall Mode

Applies to: All products

Requires user role: ADMIN, INTEGRATOR

Specify if self-view shall be visible during call setup and throughout the call. This setting specifies the default behavior; users can at any time turn self-view on and off from the UI during their call. For the next call, the behavior will be as specified in this setting again.

Default value:

Auto

Value space:

Auto/Current/Off/On

Auto: Self-view is turned on during call setup and remains on for the duration specified in the Video Selfview OnCall Duration setting. If the Video Selfview Default Mode setting is On, self-view will remain on for the entire call.

Current: Keeps the self-view as it was before setting up the call.

Off: Self-view is not shown during call setup and remains off for the entire call. This applies even if self-view was on before starting the call.

On: Self-view is shown during call setup and remains on for the entire call.

Video Selfview OnCall Duration

Applies to: All products

Requires user role: ADMIN, INTEGRATOR

This setting only has an effect when the Video Selfview OnCall Mode setting is Auto. In this case, the number of seconds set here determines for how long self-view is shown before it is automatically switched off.

Default value:

5

Value space:

Integer (1..60)

Range: Choose for how long self-view remains on. The valid range is between 1 and 60 seconds.

VoiceControl settings

VoiceControl Wakeword Mode

Applies to: All products

Requires user role: ADMIN, INTEGRATOR

Use this setting to enable or disable the wakeword (for example, "Ok Webex") that is used by the Webex Assistant. The Webex Assistant allows you to use the device hands free, and by using the wakeword you can initiate tasks, such as placing a call and starting a presentation.

Use the UserInterface Assistant Mode setting to switch on the Webex Assistant.

Default value:

On

Value space:

Off/On

Off: Disable the use of a wakeword.

On: Enable the use of a wakeword.

Board

BoardPro,
BoardPro
G2

Codec EQ

Codec
PlusCodec
ProDesk,
DeskPro,
DeskMiniRoom Bar
Pro,
Room BarRoom Kit,
Room Kit
MiniRoom Kit
EQX

Room 55

Room 55
Dual,
Room 70Room 70
G2Room 70
PanoramaRoom
Panorama

WebEngine settings

WebEngine Certificates RevocationChecks NetworkAccess

Applies to: All products

Requires user role: ADMIN

By default, the webengine does not use the network during revocation checks, and thereby is only checking Stapled OCSP responses and built-in CRL lists.

Enabling this configuration causes the webengine to be allowed to go on the network and ask the OCSP and CRL responders in the cases where there is no Stapled OCSP response.

Default value:

Allow

Value space:

Allow/Deny

Allow. The webengine does not use the network during revocation checks.

Deny: The webengine to be allowed to go on the network and ask the OCSP and CRL responders

WebEngine Features AllowDeviceCertificate

Applies to: All products

Requires user role: ADMIN

Decide whether the video device and Room Navigator webviews are allowed to trust the video device's self-signed certificate.

Default value:

False

Value space:

False/True

False: Don't trust the video device's self-signed certificate.

True: Trust the video device's self-signed certificate

WebEngine Features GpuRasterization

Applies to: All products

Requires user role: ADMIN

Decide whether to allow the webview to offload rasterization of the webpage to the GPU.

Default value:

Off

Value space:

Off/On

Off: The webpage rasterization is done on the CPU.

On: The webview may offload rasterization to the GPU.

WebEngine Features LocalWebAppManagement

Applies to: RoomKitMini RoomBar RoomBarPro RoomKitEQX CodecEQ DeskMini Desk DeskPro Board BoardPro BoardProG2

Requires user role: ADMIN

Determines whether to show a list of installed web apps in the Settings menu on the user interface of the device, and whether the user can manage the web apps (add, edit, or delete) from this menu.

Only web apps that are set up directly on the device, from the device's local web interface, or by using the API can be managed from the Settings menu (locally managed). Web apps that are set up from Control Hub (externally managed) are shown in the list, but the user can never manage them.

Web apps are available only on devices with a touch screen (either built-in or connected). A Room Kit Mini must be used with Samsung Flip (Webex on Flip).

Default value:

Off

Value space:

Allowed/NotAllowed/Off

Allowed: A user can add, edit, and delete locally managed web apps from the Settings menu on the user interface of the device.

NotAllowed: The list of installed web apps is shown in the Settings menu, but the user cannot manage them.

Off: There is no entry for listing or managing web apps in the Settings menu.

Board

BoardPro,
BoardPro
G2

Codec EQ

Codec
PlusCodec
ProDesk,
DeskPro,
DeskMiniRoom Bar
Pro,
Room BarRoom Kit,
Room Kit
MiniRoom Kit
EQX

Room 55

Room 55
Dual,
Room 70Room 70
G2Room 70
PanoramaRoom
Panorama

WebEngine Features Peripherals AudioOutput

Applies to: All products

Requires user role: ADMIN

Set whether to allow audio playback from the web browser (web engine) on the Room Navigator. For example, to allow playing audio files in a web app.

Default value:

Off

Value space:

Off/On

Off: Don't allow audio to be played from the Room Navigator web browser.

On: Allow audio to be played from the Room Navigator web browser.

WebEngine Features Peripherals WebGL

Applies to: All products

Requires user role: ADMIN

Set whether to enable WebGL™ in the web browser (web engine) on the Room Navigator. WebGL is a web standard for a low-level 3D graphics.

Default value:

Off

Value space:

Off/On

On: WebGL is enabled on the Room Navigator web browser.

Off: WebGL is disabled on the Room Navigator web browser.

WebEngine Features WebGL

Applies to: All products

Requires user role: ADMIN

WebGL™ is a web standard for a low-level 3D graphics. WebGL support in RoomOS is an experimental feature and might change in the future.

Default value:

Off

Value space:

Off/On

On: WebGL is enabled.

Off: WebGL is disabled.

WebEngine Features SipUrlHandler

Applies to: RoomKitMini DeskMini Desk DeskPro Board BoardPro BoardProG2

Requires user role: ADMIN

This configuration allows you to start SIP calls directly from web view based features (for example, a web app or digital signage). The user selects a button labeled with SIP:yourSipUrl to initiate a call, and the call is then placed by the device.

Default value:

Off

Value space:

Off/On

Off: Starting SIP calls from a web view is disabled.

On: Starting SIP calls from a web view is enabled.

WebEngine Features Xapi Peripherals AllowedHosts Hosts

Applies to: All products

Requires user role: ADMIN

If the domain name of the server hosting a persistent web app is listed here, the app is allowed to run API commands on the device. Otherwise, only apps that don't require any communication with the device can run on the Room Navigator.

The URL, specified with UserInterface HomeScreen Peripherals WebApp URL setting, will be checked, and matched against this list of allowed hosts before it's allowed to run API commands on the device.

Note: Persistent web apps are only available on Room Navigators that are paired to the device over the network.

Default value:

""

Value space:

String (0, 1024)

Specify one or more domain names. If more than one, separate them by comma. You can use the "*" as a wildcard. For example, "*.cisco.com" allows any host ending in cisco.com. To allow any domain, specify "*".

Board

WebEngine FpsCounter

Applies to: All products

Requires user role: ADMIN

Not applicable in this release.

Default value:

Off

Value space:

Off/On

BoardPro,
BoardPro
G2

Codec EQ

Codec
PlusCodec
ProDesk,
DeskPro,
DeskMiniRoom Bar
Pro,
Room BarRoom Kit,
Room Kit
MiniRoom Kit
EQX

Room 55

Room 55
Dual,
Room 70Room 70
G2Room 70
PanoramaRoom
Panorama

WebEngine MinimumTLSVersion

Applies to: All products

Requires user role: ADMIN

Set the lowest version of the TLS (Transport Layer Security) protocol that is allowed for WebEngine.

Default value:

TLSv1.2

Value space:

TLSv1.0/TLSv1.1/TLSv1.2/TLSv1.3

TLSv1.0: Support of TLS version 1.0 or higher.

TLSv1.1: Support of TLS version 1.1 or higher.

TLSv1.2: Support of TLS version 1.2 or higher.

TLSv1.3: Support of TLS version 1.3 or higher.

WebEngine Mode

Applies to: All products

Requires user role: ADMIN

The web engine is a prerequisite for features that use the device's web view, for example digital signage and web apps.

Default value:

Off

Value space:

Off/On

Off: The web engine is disabled.

On: The web engine is enabled.

WebEngine RemoteDebugging

Applies to: All products

Requires user role: ADMIN

If you encounter a problem with a web page, it can be a good idea to turn on remote debugging. Remote debugging lets you access the Chrome developer console and identify potential issues with a web page. When enabled, a banner is displayed at the bottom of the screen, warning the users that they may be monitored. The banner also shows the URL that you can enter in your local Chrome browser to open the developer console.

Make sure to turn off remote debugging after use.

Default value:

Off

Value space:

Off/On

Off: Remote debugging is switched off.

On: Remote debugging is switched on.

WebEngine UseHttpProxy

Applies to: All products

Requires user role: ADMIN

There are several UseHttpProxy settings that specify if a service shall communicate via an HTTP proxy or not. The WebEngine UseHttpProxy setting applies to all web view based features, such as digital signage, API-driven web views, and web apps.

For this setting to have any effect, a proxy server for HTTP, HTTPS, and WebSocket traffic must be set up using the NetworkServices HTTP Proxy settings.

Default value:

On

Value space:

Off/On

Off: Set up communication directly with the server (not using a proxy).

On: Set up communication via proxy.

Board

BoardPro,
BoardPro
G2

Codec EQ

Codec
PlusCodec
ProDesk,
DeskPro,
DeskMiniRoom Bar
Pro,
Room BarRoom Kit,
Room Kit
MiniRoom Kit
EQX

Room 55

Room 55
Dual,
Room 70Room 70
G2Room 70
PanoramaRoom
Panorama

Webex settings

Webex CloudProximity GuestShare

Applies to: All products

Requires user role: ADMIN

This setting allows you to turn off the guest share (via devices.webex.com) feature.

Default value:

Auto

Value space:

Auto/Off

Auto: Allow the system to automatically determine whether or not to allow guest sharing. This is currently enabled by default.

Off: Turn off the guest share feature.

Webex CloudProximity ManualPairing

Applies to: All products

Requires user role: ADMIN

This setting allows you to turn off the manual pairing feature. Manual pairing requires you to first enter a device name or guest pairing code on the client to be paired. Then, to assure that you are in the same room as the device, you must confirm pairing with a pin code that shows up on the device screen.

This setting applies to devices that are registered to the Webex cloud service or linked to Webex Edge for Devices with the Webex optimized experience enabled.

Default value:

Enabled

Value space:

Disabled/Enabled

Disabled: The possibility to use manual pairing is turned off. Guest share (refer to the Webex CloudProximity GuestShare setting) is also disabled.

Enabled: Manual pairing is enabled.

Webex CloudUpgrades Mode

Applies to: All products

Requires user role: ADMIN

On devices that are registered to an on-premises service and linked to Webex Edge for Devices, you can choose whether to upgrade the software from the on-premises provisioning service or from the Webex cloud service (cloud-managed software upgrade).

With cloud-managed software upgrade the device is upgraded automatically when a new RoomOS software version is available, that is at the same time as cloud registered devices are upgraded. You get the latest updates and bug fixes faster without having to upgrade the device manually.

Default value:

Off

Value space:

Off/On

Off: The device software is not upgraded from the cloud. You must use an on-premises provisioning service, such as CUCM, or rely on manual upgrades.

On: The device software is automatically upgraded when a new software version is available in the cloud.

Webex DevicePersonalization Features Whiteboard SignInRequired

Applies to: DeskMini Desk DeskPro Board BoardPro BoardProG2

Requires user role: ADMIN

As an added privacy and security measure, whiteboard use can be set to require a user to sign in.

When no user is signed in, opening the whiteboard app prompts users to sign in using the QR code.

They are also reminded to sign out when exiting the whiteboarding feature.

Default value:

False

Value space:

False/True

False: Users can use the whiteboard feature without signing in.

True: The user is required to sign in to be allowed to use the whiteboard feature.

Board

BoardPro,
BoardPro
G2

Codec EQ

Codec
PlusCodec
ProDesk,
DeskPro,
DeskMiniRoom Bar
Pro,
Room BarRoom Kit,
Room Kit
MiniRoom Kit
EQX

Room 55

Room 55
Dual,
Room 70Room 70
G2Room 70
PanoramaRoom
Panorama

Webex Hotdesking DefaultBookingEndTime

Applies to: DeskMini Desk DeskPro

Requires user role: ADMIN

This setting applies only to a device that is set up with hot desking capabilities, which implies that it must be in shared mode and registered to the Webex cloud service or linked to Webex Edge for Devices.

Since companies and organizations have different normal working hours, you can configure the time when a booking, by default, should expire. This is just the default time, so the user can specify a different end time when booking the device.

Default value:

17

Value space:

Integer (0..24)

The default booking end time in 24-hour clock notation. Some examples: 0 is 00:00 / 12:00 a.m. – midnight; 12 is 12:00 / 12:00 p.m. – noon; and 17 is 17:00 / 5:00 p.m.

Webex Meetings HttpProxyForMedia Mode

Applies to: All products

Requires user role: ADMIN

This setting applies to devices that are registered to the Webex cloud service or linked to Webex Edge for devices with the Webex optimized experience enabled.

You can set up the device to use a proxy server for HTTPS and WebSocket traffic, see the NetworkServices HTTP Proxy settings. If the NetworkServices HTTP Proxy Mode is not turned Off, you can choose whether to use this proxy also for media traffic.

Using a proxy may lead to lower media quality. To keep media quality as good as possible, the proxy needs to support the bitrates that are used by the deployed devices in the environment, and the total round-trip time from the device to the media server should be as low as possible.

Default value:

Off

Value space:

Auto/Off

Auto: Use a proxy server for media traffic, provided that the server is available and set up correctly and the NetworkServices HTTP Proxy Mode is not set to Off.

Off: Never use the proxy for media traffic.

Webex Meetings JoinProtocol

Applies to: All products

Requires user role: ADMIN

Devices that are registered to an on-premises service and linked to Webex Edge for Devices may use the Webex cloud service for calling into Webex meetings. Calling via Webex gives you the full set of native Webex Meetings in-call features, such as advanced mute, cohost, transfer host, and face recognition.

These are the cases when Webex Meetings call routing may be used: When using the Join Webex button, when using the Webex Assistant to join a Personal Room meeting (PMR), and when using the Call button or the Dial API command with a URI with one of the following domains: @webex.com, @*.webex.com, and @meet.ciscospark.com. Other calls will use the default protocol.

Also, native Webex Meetings call routing requires that the device is enabled for cloud-managed software upgrade, configuration from Control Hub is enabled, and the Conference Multipoint Mode is set to Auto.

Default value:

SIP

Value space:

SIP/Webex

SIP: The call protocol is SIP.

Webex: The call protocol is Webex, provided that the requirements above are met. Otherwise, it is SIP.

Board

BoardPro,
BoardPro
G2

Codec EQ

Codec
PlusCodec
ProDesk,
DeskPro,
Desk MiniRoom Bar
Pro,
Room BarRoom Kit,
Room Kit
MiniRoom Kit
EQX

Room 55

Room 55
Dual,
Room 70Room 70
G2Room 70
PanoramaRoom
Panorama

Webex Meetings MeetingChatNotifications Mode

Applies to: All products

Requires user role: ADMIN, INTEGRATOR

Decide how the chat notifications, by default, are displayed on the screen. You can use the UI or the Conference MeetingChatNotification Default command to change the mode both during meetings and between meetings.

Shared devices will return to the default behavior set here after every meeting. Personal devices will remember its current mode and keep it until changed from the UI or by using the commands.

For more information about chat notifications, refer to the Webex Meetings MeetingChatPreview setting.

Default value:

Preview

Value space:

Disabled/Focused/Preview

Disabled: You don't get any chat notifications on the device's screen.

Focused: You are notified on the device's screen that there are in-meeting messages. The notification is only shown when the first message is sent. This mode removes distractions from the meeting and may be suitable for larger meetings.

Preview: You get a notification preview on the device's screen for every new message that is sent. This is suitable if you want to keep up with the meeting chat.

Webex Meetings MeetingChatPreview

Applies to: All products

Requires user role: ADMIN

Set whether to allow meeting messages (chat) to pop up in a notification on the device's screen during a meeting. This lets the device users see what's happening in the chat.

Individual meeting chat notifications remain on screen for 8 seconds. If there is a queue of messages sent around the same time, then they will show for a slightly shorter time of 5 seconds to avoid a big build-up of messages. A chat notification contains a maximum of three lines of text.

Chat notifications are only available on devices that are registered to the Webex cloud service or linked to Webex Edge for devices with the Webex optimized experience enabled.

Default value:

False

Value space:

False/True

False: Meeting chat notifications are not available on the device.

True: Meeting chat notifications are available on the device. You can decide whether to display them on the device's screen from the UI or by using the Conference MeetingChatNotification commands.

Webex Privacy AllowUsageDataLogging

Applies to: RoomBar RoomBarPro RoomKitEQX CodecEQ CodecPro Room70G2 DeskPro BoardPro BoardProG2

Requires user role: ADMIN

When enabled in conjunction with xConfiguration Webex ProvisionalActivationService, logs and metrics can be sent anonymously to Cisco.

Default value:

False

Value space:

False/True

False: Usage data logging is disabled. No logs or metrics will be sent.

True: Usage data logging is enabled. Logs and metrics can be sent anonymously.

Board

BoardPro,
BoardPro
G2

Codec EQ

Codec
PlusCodec
ProDesk,
DeskPro,
DeskMiniRoom Bar
Pro,
Room BarRoom Kit,
Room Kit
MiniRoom Kit
EQX

Room 55

Room 55
Dual,
Room 70Room 70
G2Room 70
PanoramaRoom
Panorama

Webex ProvisionalActivationService

Applies to: RoomBar RoomBarPro RoomKitEQX CodecEQ CodecPro Room70G2 DeskPro BoardPro BoardProG2

Requires user role: ADMIN

Allows the device to reach out to Cisco for provisioning a default account for interacting with Control Hub in order to send metrics, logs, and other base services (even without an organization).

Default value:

Disabled

Value space:

Disabled/Enabled

Webex UpgradeChannel

Applies to: All products

Requires user role: ADMIN

Determines the software channel that the device will download and install. For example, "Preview" will offer early access to new releases while "Stable" offers more reliable software.

Default value:

Stable

Value space:

String (1, 255)

The software channel that will be downloaded and installed.

WebRTC settings

WebRTC EndCallTimeout

Applies to: RoomKit RoomKitMini RoomBar RoomBarPro RoomKitEQX CodecEQ CodecPlus CodecPro Room55 Room70/Room55D Room70G2 RoomPanorama/Room70Panorama DeskMini Desk DeskPro Board BoardPro BoardProG2

Requires user role: ADMIN

You can extend the period between pressing End call in a WebRTC meeting and the closing of the web view.

In normal operation, you do not need to change this setting, but it can be useful for troubleshooting.

WebRTC is only available for devices that are registered to an on-premises service and linked to Webex Edge for Devices, and for devices that are registered to the Webex cloud service.

Default value:

2

Value space:

Integer (0..600)

The period in seconds.

WebRTC InteractionMode

Applies to: RoomKitMini DeskMini Desk DeskPro Board BoardPro BoardProG2

Requires user role: ADMIN

When in a WebRTC meeting, you can use the device's call controls or the WebRTC app's built-in controls.

WebRTC is only available for devices that are registered to an on-premises service and linked to Webex Edge for Devices, and for devices that are registered to the Webex cloud service.

Default value:

NonInteractive

Value space:

Interactive/NonInteractive

Interactive: You can use the WebRTC app's built-in controls directly from the device's touch screen. This will give you access to the built-in WebRTC features.

NonInteractive: The WebRTC app's built-in controls are not available; you can only use the regular call controls of the device.

Board

BoardPro,
BoardPro
G2

Codec EQ

Codec
PlusCodec
ProDesk,
DeskPro,
DeskMiniRoom Bar
Pro,
Room BarRoom Kit,
Room Kit
MiniRoom Kit
EQX

Room 55

Room 55
Dual,
Room 70Room 70
G2Room 70
PanoramaRoom
Panorama

WebRTC Provider MicrosoftTeams CompatibilityMode

Applies to: RoomKit RoomKitMini RoomBarPro RoomKitEQX CodecEQ CodecPlus CodecPro Room55 Room70/Room55D Room70G2 RoomPanorama/Room70Panorama DeskPro Board

Requires user role: ADMIN

An option that can be applied temporarily for intermittent troubleshooting of Microsoft Teams calls using WebRTC. Cisco TAC can advise when to set this configuration. The recommendation is otherwise to leave it off.

Default value:

Off

Value space:

Off/On

Off: Compatibility mode is turned off.

On: Compatibility mode is turned on.

Zoom settings

Zoom DefaultDomain

Applies to: All products

Requires user role: ADMIN

The domain that you enter here is used by the Zoom Join command; hence it's also used when you tap the Zoom button on the device UI. If the Zoom Join command fetches join information from a booking (BookingID), the domain entered here is ignored.

Default value:

zoomcrc.com

Value space:

String (1, 256)

The domain to use for Zoom calls.

Zoom DialStringOptions

Applies to: All products

Requires user role: ADMIN

The dial string options that you enter here are used by the Zoom Join command; hence they're also used when you tap the Zoom button on the device UI. Amongst other, options for dual-screen and other visual features are available. Read more about Zoom's dial string options at "<https://support.zoom.us/hc/en-us/articles/202405539-SIP-H-323-Room-Connector-Dial-Strings>".

If the Zoom Join command fetches join information from a booking (BookingID), and the fetched uri has a format other than <meetingid>@<domain>, the dial string options entered here are ignored.

Default value:

""

Value space:

String (0, 200)

The options for the Zoom dial string.

Board

BoardPro,
BoardPro
G2

Codec EQ

Codec
Plus

Codec
Pro

Desk,
Desk Pro,
Desk Mini

Room Bar
Pro,
Room Bar

Room Kit,
Room Kit
Mini

Room Kit
EQX

Room 55

Room 55
Dual,
Room 70

Room 70
G2

Room 70
Panorama

Room
Panorama

Zoom EnhancedCallControls

Applies to: All products

Requires user role: ADMIN

Cisco's custom Zoom user interface. This ensures a consistent experience every time you join a Zoom call, no matter how you dial in.

Default value:

Enabled

Value space:

Disabled/Enabled

Disabled: the Cisco's custom user interface is disabled.

Enabled: the Cisco's custom user interface is enabled, ensuring consistency.

Experimental settings

The Experimental settings are for testing only and should not be used unless agreed with Cisco. These settings are not documented and WILL change in later releases.

Board

BoardPro,
BoardPro
G2

Codec EQ

Codec
Plus

Codec
Pro

Desk,
Desk Pro,
Desk Mini

Room Bar
Pro,
Room Bar

Room Kit,
Room Kit
Mini

Room Kit
EQX

Room 55

Room 55
Dual,
Room 70

Room 70
G2

Room 70
Panorama

Room
Panorama

Chapter 6

Physical interfaces

Board

Board Pro,
Board Pro
G2

Codec EQ

Codec
Plus

Codec
Pro

Desk,
Desk Pro,
Desk Mini

Room Bar
Pro,
Room Bar

Room Kit,
Room Kit
Mini

Room Kit
EQX

Room 55

Room
55 Dual,
Room 70

Room 70
G2

Room 70
Panorama

Room
Panorama

Power On/Off and LED behavior (page 1 of 11)

Codec EQ, Codec Plus, and Codec Pro

The power switch on the codec's rear side is its main On/Off switch.

It may take a few minutes for the codec to start up. The LED lights steadily when the codec is ready for use.

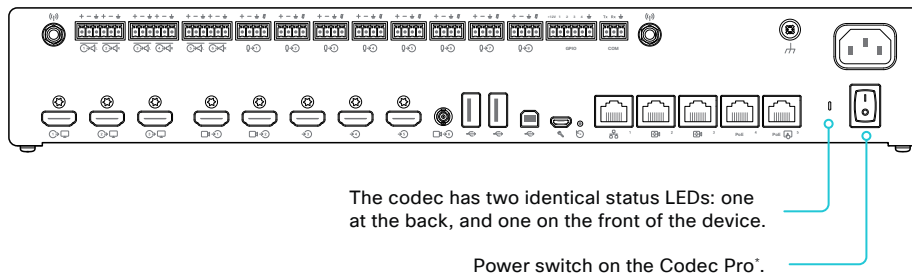
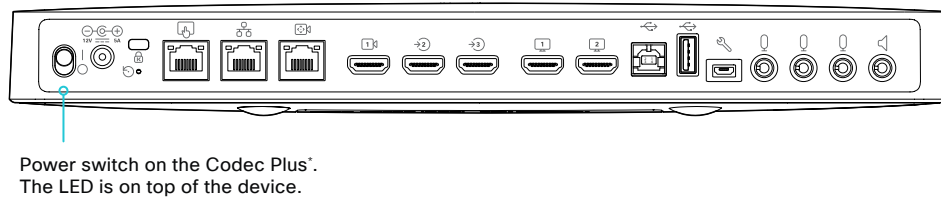
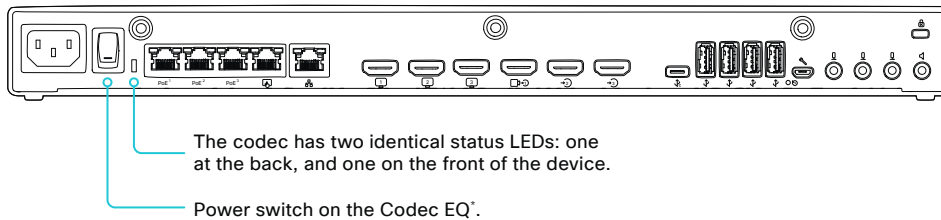

LED behavior

In idle mode (screens are awake):

Steady light.

In standby mode (screens are off):

Steady light.

The device needs attention (e.g. missed call or no network connection):

The LED repeatedly flashes twice.

During startup (boot):

The LED flashes. It turns steady when the device is ready for use.

* Configuration changes might be lost if you shut down the device using the power switch just a few seconds after saving the changes.

Board

Board Pro,
Board Pro
G2

Codec EQ

Codec
Plus

Codec
Pro

Desk,
Desk Pro,
Desk Mini

Room Bar
Pro,
Room Bar

Room Kit,
Room Kit
Mini

Room Kit
EQX

Room 55

Room
55 Dual,
Room 70

Room 70
G2

Room 70
Panorama

Room
Panorama

D15503.06

RoomOS
11.24

02-2025



Power On/Off and LED behavior (page 2 of 11)

Room Bar, Room Kit, and Room Kit Mini

The main On/Off switch is located on the back of the Room Bar, Room Kit, and Room Kit Mini. Switch it to the On position. It may take a few minutes to start up. The system LED lights steadily when the device is ready for use.

Keep in mind that once the device is mounted on top of a screen, the power switch may be difficult to access.



Power switch on the Room Bar*.
The LEDs are on the front of the device.

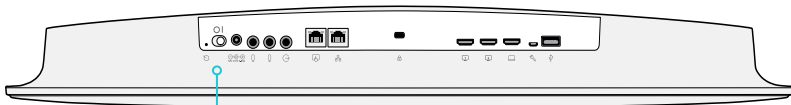

Power switch on the Room Kit*. The
LEDs are on the front of the device.

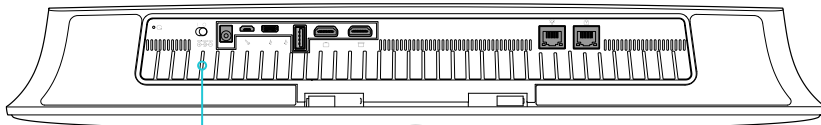

Power switch on the Room Kit Mini*.
The LEDs are on the front of the device.

LED behavior

System LED

In idle mode (screens are awake):

Steady light.

In standby mode (screens are off):

Steady light.

The device needs attention (e.g. missed call or no network connection):

The LED repeatedly flashes twice.

During startup (boot):

The LED flashes. It turns steady when the device is ready for use.

Camera LED

Incoming call:

The LED flashes.

In call:

Steady light.

Selfview on:

Steady light.

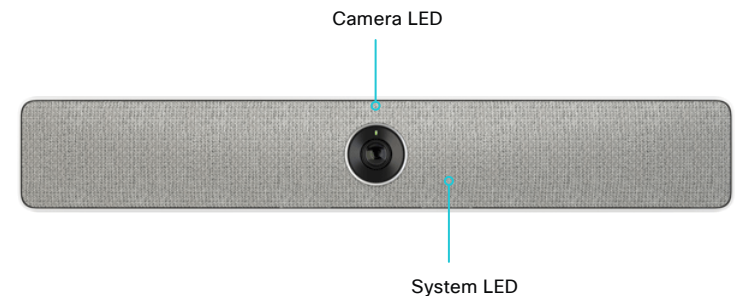

* Configuration changes might be lost if you shut down the device using the power switch just a few seconds after saving the changes.

Board

BoardPro,
BoardPro
G2

Codec EQ

Codec
Plus

Codec
Pro

Desk,
Desk Pro,
DeskMini

**Room Bar
Pro,
Room Bar**

Room Kit,
Room Kit
Mini

Room Kit
EQX

Room 55

Room
55 Dual,
Room 70

Room 70
G2

Room 70
Panorama

Room
Panorama

Power On/Off and LED behavior (page 3 of 11)

Room Bar Pro

The device starts up once you have plugged in the power. It may take a few minutes to start up. The system LED lights steadily when the device is ready for use.

The standby button is located on top of the device (below, if you have mounted the device upside-down below the screen). This button puts the device into standby mode; you can wake it up using the same button.

There is no power switch on the Room Bar Pro. You must pull the plug to power it off completely.

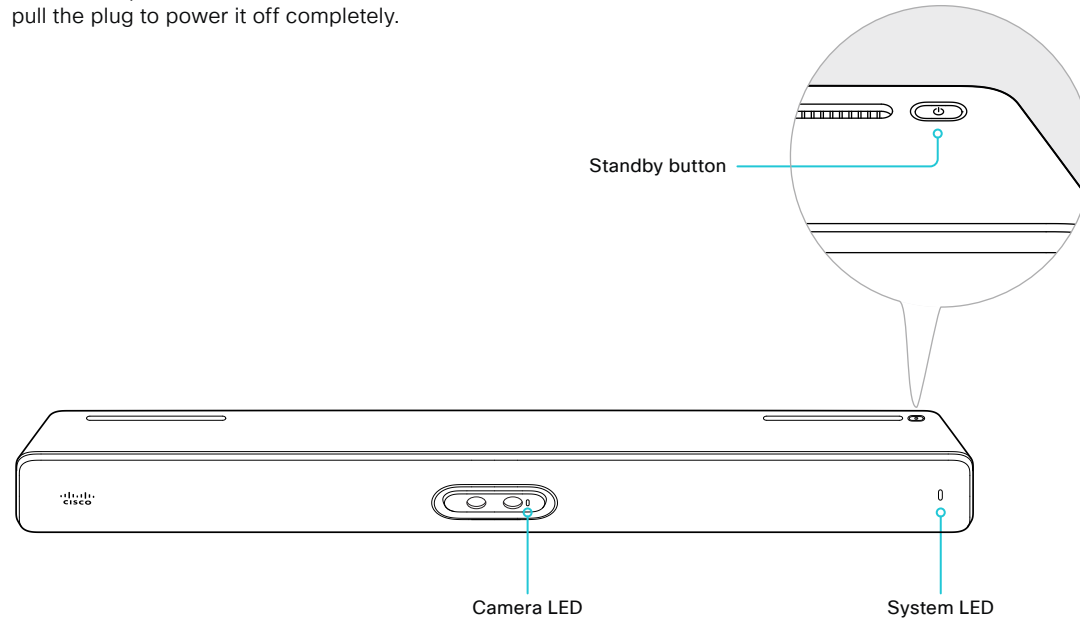

LED behavior

System LED

In idle mode (screens are awake):

Steady light.

In standby mode (screens are off):

Steady light.

The device needs attention (e.g. missed call or no network connection):

The LED repeatedly flashes twice.

During startup (boot):

The LED flashes. It turns steady when the device is ready for use.

Camera LED

Incoming call:

The LED flashes.

In call:

Steady light.

Selfview on:

Steady light.

Board

Board Pro,
Board Pro
G2

Codec EQ

Codec
Plus

Codec
Pro

Desk,
Desk Pro,
DeskMini

Room Bar
Pro,
Room Bar

Room Kit,
Room Kit
Mini

Room Kit
EQX

Room 55

Room
55 Dual,
Room 70

Room 70
G2

Room 70
Panorama

Room
Panorama

Power On/Off and LED behavior (page 4 of 11)

Room Kit EQX

Multiple components connected to wall sockets

The system consists of several components that are connected either to the internal power strip, which is connected to a wall socket, or directly to a wall socket.¹ The internal power strip is behind the left screen.²

A few components have a power switch. To fully turn off power for the complete system, pull out the plugs from the wall socket outlets.

It may take a few minutes for the codec and other components to start up. The status LED lights steadily when the codec is ready for use.

The codec power switch: The codec is behind the right screen. The power switch is set to On as part of the installation.

The camera power switch: The camera has a power switch that is set to On as part of the installation.

You don't have easy access to this switch when the system is assembled.

The 24V PSU power switch: This PSU is behind the left screen. The power switch is set to On as part of the installation.

The screen power buttons: The screens are not delivered by Cisco. They may or may not automatically power up when connected to power.

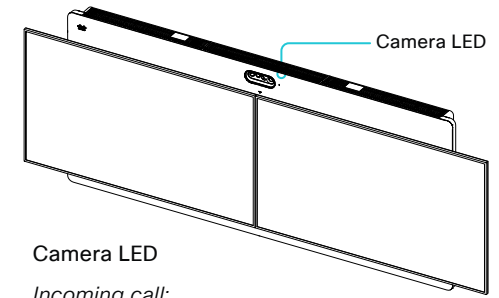

Camera LED

Incoming call:

The LED flashes.

In call:

Steady light.

Selfview on:

Steady light.

Codec ²

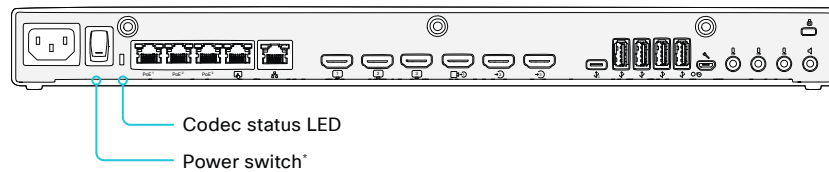

Amplifier status LED

During startup (boot):

Steady light.

The device is not connected to a codec (un-paired):

Blinking fast.

The device is connected to a codec:

Steady light.

The codec is in standby mode:

Blinking slowly.

Codec status LED

In idle mode (screens are awake):

Steady light.

In standby mode (screens are off):

Steady light.

The device needs attention (e.g. missed call or no network connection):

The LED repeatedly flashes twice.

During startup (boot):

The LED flashes. It turns steady when the device is ready for use.

Amplifier: Cisco Natural Audio Module IV ²

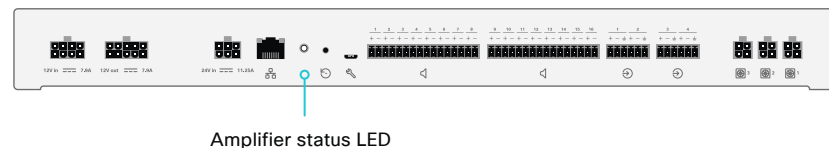

¹ Configuration changes might be lost if you shut down the device using the power switch just a few seconds after saving the changes.

² Pop out the left screen to see the amplifier; the right screen to see the codec.

Board

BoardPro,
BoardPro
G2

Codec EQ

Codec
Plus

Codec
Pro

Desk,
Desk Pro,
DeskMini

Room Bar
Pro,
Room Bar

Room Kit,
Room Kit
Mini

Room Kit
EQX

Room 55

Room
55 Dual,
Room 70

Room 70
G2

Room 70
Panorama

Room
Panorama

Power On/Off and LED behavior (page 5 of 11)

Room 55

When Room 55 is mounted to a wall, you cannot access the power switch. Ensure that Room 55 is mounted with the power switch in the *On* position so that once it's plugged in, it will automatically power-on.

Before unplugging the device, shut it down via the device web interface: *Backup and Recovery > Restart and Shutdown > Shutdown*.

You may experience problems if you unplug the device before shutting it down properly. If this happens, try restarting the video system using the device web interface to restore normal behavior.

On a floor stand or wheel base mounted Room 55, remove the cover on the back to get access to the connectors. The power switch is next to the power connector.

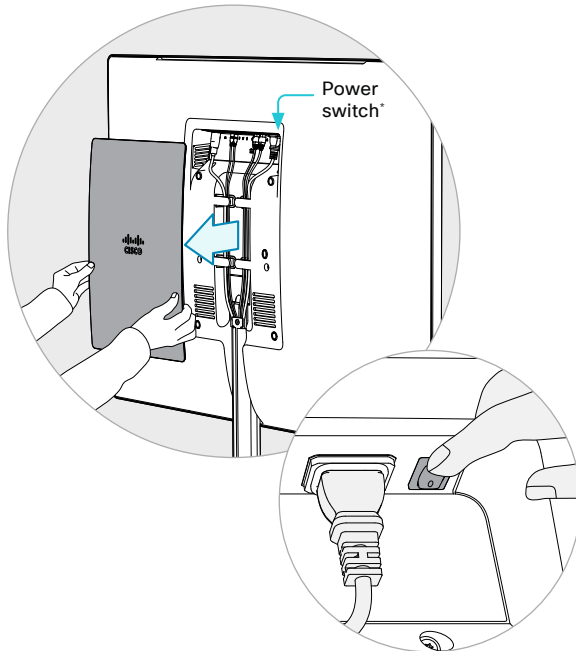

LED behavior

System LED

The system LED is to the right of the camera. The normal LED color is white. A red light indicates hardware failure.

In idle mode (screens are awake):

LED is off.

In standby mode (screens are off):

Steady light.

The device needs attention (e.g. missed call or no network connection):

The LED repeatedly flashes twice.

During startup (boot):

The LED flashes. It turns steady when the device is ready for use.

Camera LED

The camera LED is just above the camera lens.

Incoming call:

The LED flashes.

In call:

Steady light.

Selfview on:

Steady light.

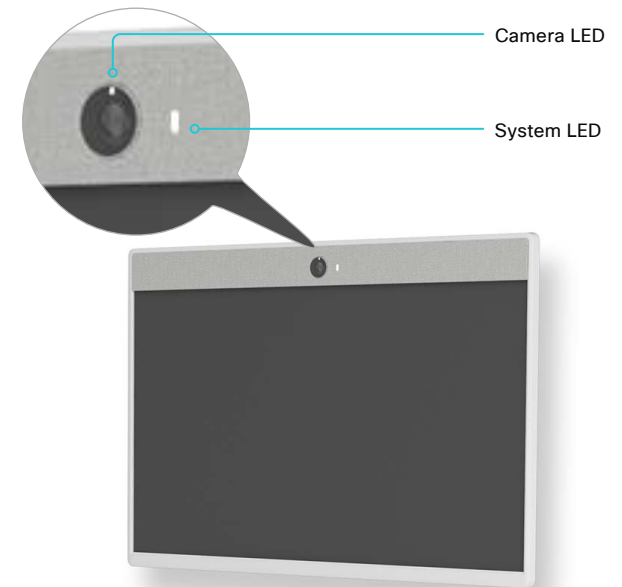

* Configuration changes might be lost if you shut down the device using the power switch or by unplugging it just a few seconds after saving the changes.

Board

Board Pro,
Board Pro
G2

Codec EQ

Codec Plus

Codec Pro

Desk,
Desk Pro,
Desk Mini

Room Bar Pro,
Room Bar

Room Kit,
Room Kit Mini

Room Kit EQX

Room 55

Room 55 Dual,
Room 70

Room 70 G2

Room 70 Panorama

Room Panorama

Power On/Off and LED behavior (page 6 of 11)

Room 70, Room 55 Dual, Room 70 G2, Room 70 Panorama

The power switch is behind the left side cover, in the same place for all mounting options.

To access the switch, remove the left side cover. It snaps in/out of place with magnets. The power switch is next to the main power connector below the codec.

(Room 70 G2, Room 70 Panorama) Also make sure that the codec power switch is on.

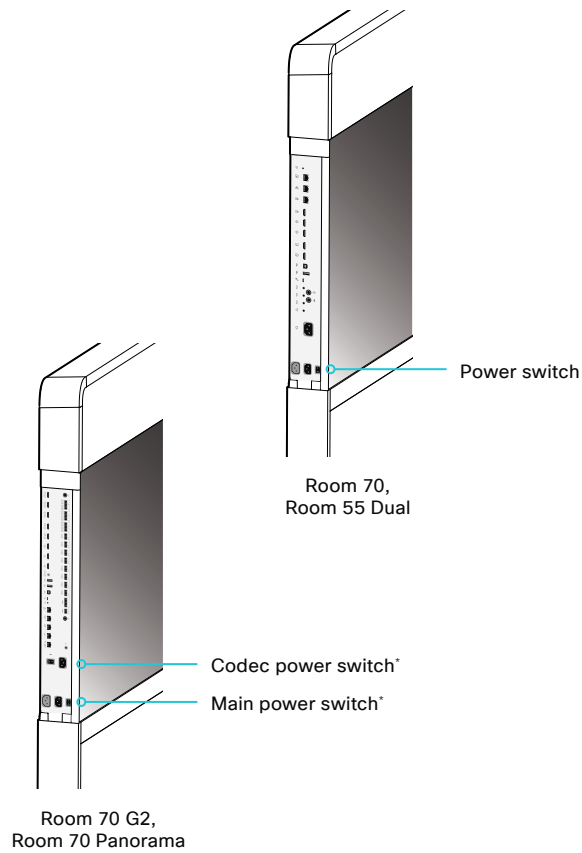

LED behavior

System LED

The system LED is behind the fabric to the right of the camera. The normal LED color is white. A red light indicates hardware failure.

In idle mode (screens are awake):
LED is off.

In standby mode (screens are off):
Steady light.

The device needs attention (e.g. missed call or no network connection):
The LED repeatedly flashes twice.

During startup (boot):
The LED flashes. It turns steady when the device is ready for use.

Camera LED

The camera LED is just above the camera lenses.

Incoming call:
The LED flashes.

In call:
Steady light.

Selfview on:
Steady light.

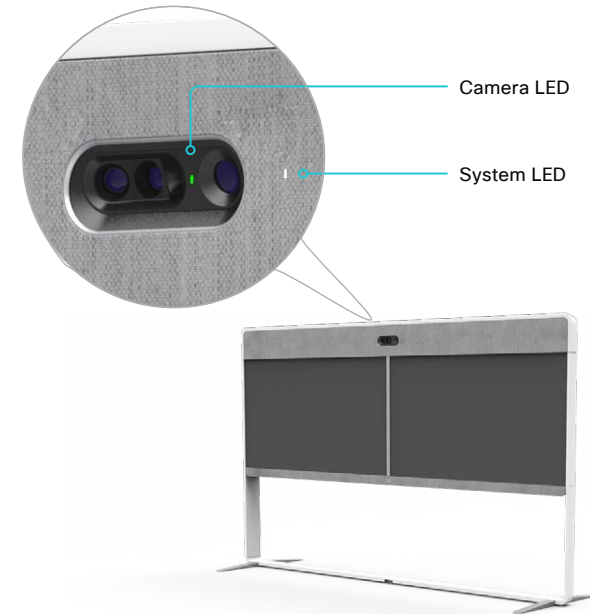

* Configuration changes might be lost if you shut down the device using the power switch just a few seconds after saving the changes.

- Board
- BoardPro, BoardPro G2
- Codec EQ
- Codec Plus
- Codec Pro
- Desk, Desk Pro, DeskMini
- Room Bar Pro, Room Bar
- Room Kit, Room Kit Mini
- Room Kit EQX
- Room 55
- Room 55 Dual, Room 70
- Room 70 G2
- Room 70 Panorama
- Room Panorama

Power On/Off and LED behavior (page 7 of 11)

Room Panorama (page 1 of 2)

Multiple components connected to wall sockets

Room Panorama consists of many components. Each component has a power cord that is connected directly to a wall socket.*

There are socket outlets on both sides of the system. Use the handles at the bottom of the deco grilles, and pull down the left and right screens to get access to all the outlets.

Only a few components have a power switch. To fully turn off power for the complete system, pull out the plugs from the wall socket outlets.

The codec power switch

The codec is behind the left screen. Using the handle at the bottom of the deco grille, pull down the left screen to get access to the codec.

- The power switch is set to On as part of the installation.

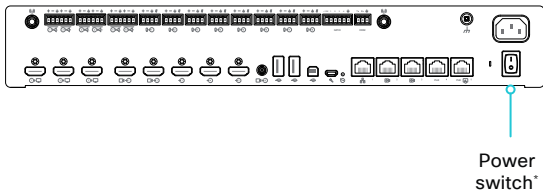

The camera power switch

The camera has a power switch that is set to On as part of the installation.

You don't have easy access to this switch when the system is assembled.

The 24V PSU power switch

This PSU is in the left cavity behind the left screen.

- Using the handle at the bottom of the deco grille, pull down the left screen to get access to the PSU.
- The power switch is set to On as part of the installation.

The screen power buttons

The screens should automatically power up when connected to power. If they don't, use the remote control or the power button to switch them on.

- Main screens: power button below the logo (lower right)
- Content screen: power button (lower center)

* Configuration changes might be lost if you shut down the device using the power switch just a few seconds after saving the changes.

- Board
- Board Pro, Board Pro G2
- Codec EQ
- Codec Plus
- Codec Pro
- Desk, Desk Pro, Desk Mini
- Room Bar Pro, Room Bar
- Room Kit, Room Kit Mini
- Room Kit EQX
- Room 55
- Room 55 Dual, Room 70
- Room 70 G2
- Room 70 Panorama
- Room Panorama

Power On/Off and LED behavior (page 8 of 11)

Room Panorama (page 2 of 2)

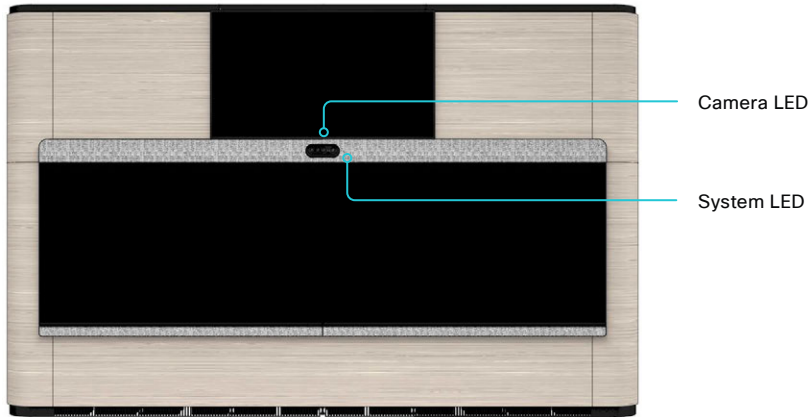

Pull down the left screen to see the amplifier and codec. Both units are mounted with the connector panel facing upward.

Amplifier: Cisco Natural Audio Module IV

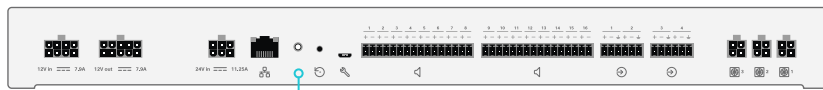

Amplifier Status LED

Codec: Cisco Webex Codec Pro

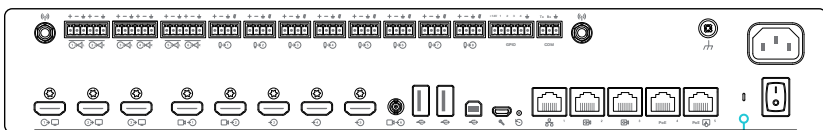

Codec Status LED

System LED

In idle mode (screens are awake):
LED is off.

In standby mode (screens are off):
Steady light.

During startup (boot):
The LED flashes. It turns steady when the codec is ready for use.

The LED goes off before the whole system (all peripherals) is ready for use.

Camera LED

Incoming call:
The LED flashes.

In call:
Steady light.

Selfview on:
Steady light.

Amplifier status LED

During startup (boot):
Steady light.

The device is not connected to a codec (un-paired):
Blinking fast.

The device is connected to a codec:
Steady light.

The codec is in standby mode:
Blinking slowly.

Codec status LED

In idle mode (screens are awake):
Steady light.

In standby mode (screens are off):
Steady light.

The device needs attention (e.g. missed call or no network connection):
The LED repeatedly flashes twice.

During startup (boot):
The LED flashes. It turns steady when the device is ready for use.

Board

Board Pro,
Board Pro
G2

Codec EQ

Codec
Plus

Codec
Pro

Desk,
Desk Pro,
Desk Mini

Room Bar
Pro,
Room Bar

Room Kit,
Room Kit
Mini

Room Kit
EQX

Room 55

Room
55 Dual,
Room 70

Room 70
G2

Room 70
Panorama

Room
Panorama

Power On/Off and LED behavior (page 9 of 11)

Desk, Desk Mini, and Desk Pro

The power button with LED indicator is on the back, as shown below.

To switch the device on, press the power button once. To switch it off, press the power button once. It takes at least 10 seconds before the device turns off.



LED behavior

System LED

In idle mode (screen is active):

The LED is off.

In standby mode (screen is off):

Steady light.

Missed call:

The LED is off in idle mode, but repeatedly flashes twice when in standby mode.

No network connection:

The LED repeatedly flashes twice.

During startup (boot):

The LED flashes.

Camera LED

The camera LED is on the top of the screen, just above the camera lens.

Incoming call:

The LED flashes.

In call:

Steady light.

Selfview on:

Steady light.

During startup (boot):

The LED is lit for a short while.

Microphone LED

In call, the microphone is on:

Steady green.

In call, the microphone is off:

Steady red.

* Configuration changes might be lost if you shut down the device using the power button just a few seconds after saving the changes.

Board

Board Pro,
Board Pro
G2

Codec EQ

Codec
Plus

Codec
Pro

Desk,
Desk Pro,
Desk Mini

Room Bar
Pro,
Room Bar

Room Kit,
Room Kit
Mini

Room Kit
EQX

Room 55

Room
55 Dual,
Room 70

Room 70
G2

Room 70
Panorama

Room
Panorama

Power On/Off and LED behavior (page 10 of 11)

Board Pro and Board Pro G2

There is no power button on the device. Pull the plug to power it off completely.



LED behavior

Camera LED

The camera LED is on the top of the screen, just above the camera lens.

Incoming call:

The LED flashes.

In call:

Steady light.

Selfview on:

Steady light.

During startup (boot):

The LED is lit for a short while.

Soft power button LED

In idle mode (screen is active):

The LED is off.

In standby mode (screen is off):

Steady light.

Board

BoardPro,
BoardPro
G2

Codec EQ

Codec
PlusCodec
ProDesk,
Desk Pro,
Desk MiniRoom Bar
Pro,
Room BarRoom Kit,
Room Kit
MiniRoom Kit
EQX

Room 55

Room 55
Dual,
Room 70Room 70
G2Room 70
PanoramaRoom
Panorama

Power On/Off and LED behavior (page 11 of 11)

Restart and standby using the user interface

Restart the device

1. Swipe in from the right or tap the controls icon  in the upper, right corner to open the control panel. Then select [Device settings](#).
2. Select [Restart](#).
3. Select [Restart](#) again to confirm.

Enter standby mode

1. Swipe in from the right or tap the controls icon  in the upper, right corner to open the control panel.
2. Select [Standby](#).

Exit standby mode

To exit standby mode, tap the touch screen of the device, or a connected touch controller.

Shutdown or restart the device remotely

Sign in to the device web interface and navigate to [Backup and Recovery > Restart and Shutdown](#).

Restart the device

Click [Restart](#) and confirm your choice.

It takes a few minutes before the device is ready for use.

Shutdown the device

Click [Shutdown](#) and confirm your choice.

 Shutting down the device will require physical presence to turn it on again.

To turn on the device after a remote shutdown:

- Disconnect the power plug and connect it again.
(Board, Board Pro, and Board Pro G2)
- Press the standby button, which is located on the top of the device (or at the bottom if mounted upside down below the screen). *(Room Bar Pro)*
- Tilt the unit and turn the power switch Off and then On. You may have to readjust the unit/camera to get the best overview of the room after tilting it back. Alternatively, disconnect the power plug and connect it again. *(Room Bar, Room Kit, and Room Kit Mini)*
- Turn the power switch Off and then On.
(Codec EQ, Codec Plus, Codec Pro, Room 70 G2, Room 70, Room 55 Dual, Room Panorama, Room 70 Panorama, Desk, Desk Mini, and Desk Pro)
- Disconnect the power plug and connect it again, or pop-out the right screen and turn the codec power switch Off and then On.
(Room Kit EQX)
- Turn the power switch Off and then On, or disconnect the power plug and plug it in again. *(Room 55)*

Connector panel: Codec EQ

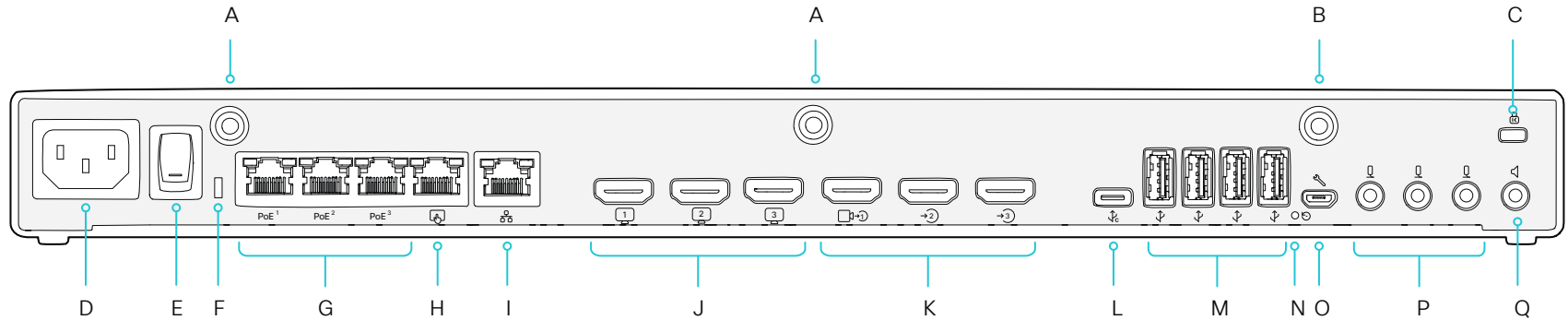

A. Wi-Fi antenna (RP-SMA connector)

- The codec is delivered with whip antennas. For best performance ensure free line of sight.

B. Bluetooth® antenna (RP-SMA connector)

- The codec is delivered with a whip antenna. For best performance ensure free line of sight.

C. Kensington lock

- To prevent the device from being moved and to prevent theft.

D. Power (100-240V_{AC}, 50-60Hz, 2.0-1.2A)

E. Power On/Off

F. Status LED

- Mirrors the front status LED.

G. Ethernet ports for internal network (RJ45)

- For camera control, digital microphones, and more.
- PoE++ (IEEE 802.3bt): Maximum 90W per port; and maximum 90W in total for these 3 ports (G) and the dedicated touch controller port (H).

H. Touch controller (RJ45)

- Dedicated PoE port for the touch controller.
- PoE++ (IEEE 802.3bt): Maximum 90W for this port; and maximum 90W in total for this port (H) and the three other PoE ports (G).

I. Network

- Ethernet interface, 10 Mb / 100 Mb / 1 Gb Ethernet LAN interface (RJ45).

J. HDMI outputs, typically used for screens

- HDMI 2.0, resolutions up to 3840 × 2160 at 60 fps.
- Audio and video (audio is disabled if a Quad camera, which has loudspeakers, is connected to the HDMI 1 input).

K. HDMI inputs, typically used for cameras and other content sources

- In general, we recommend using HDMI 1 for the main camera. You must use HDMI 1 for Quad camera.
- HDMI 2.0. Resolutions up to 3840 × 2160 at 30 fps.
- Content sharing.
- Supports HDCP (High-bandwidth Digital Content Protection) encrypted content on HDMI 3.

L. USB-C

- Supports formats up to 3840 × 2160 at 30 fps, using DisplayPort Alternate Mode.
- Content sharing.
- Use the camera, microphone and speakers with any software client (USB-camera mode).
- 15W charging capability.

M. USB 3.0 type A

- 1.5A charging capability per port.
- For loudspeakers, microphones, headset, DSPs, and future integrations.

N. Factory reset pinhole

- Use the pinhole as last resort. If possible, we recommend that you reset the device from the user interface or the device web interface.

O. Maintenance (micro USB)

- For serial communication with the device.

P. Analog microphones (3.5mm mini-jack, 4-pin connectors)

Q. Audio line output (3.5mm mini-jack, 3-pin connector)

- Analog line out (stereo).
- To be used with active loudspeakers (built-in amplifier).

Connector panel: Codec Plus

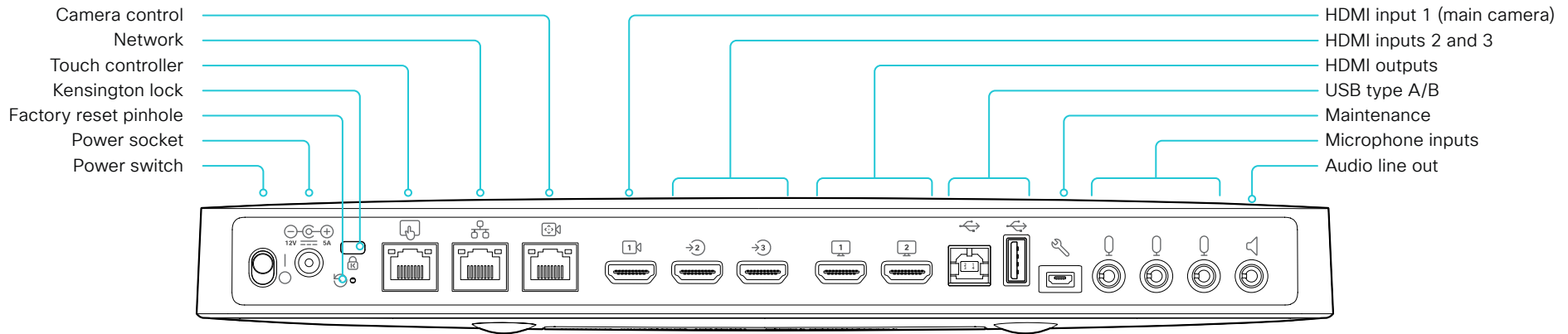

Power

Always use the provided power supply:

- DC output: 5A, 12 V
- AC input: 100-240V, 50-60Hz, max 1.2A

The device powers up automatically, as long as the power switch is in its On position.

Factory reset pinhole

Use the pinhole as last resort. If possible, we recommend that you reset the device from the user interface or the device web interface.

Kensington lock

The Kensington lock may be used to prevent the device from being moved and to prevent theft.

Touch controller

The touch controller is powered over Ethernet (PoE), which is provided through this socket.

Network

Ethernet interface, 10Mb/100Mb/1Gb Ethernet LAN interface (RJ45).

HDMI inputs

HDMI 1: HDMI version 1.4b, resolutions up to 1920 × 1080 at 60fps. Most often used for the main camera. You must always use the HDMI 1 for a Quad camera.

HDMI 2 and 3: HDMI version 1.4b, resolutions up to 3840 × 2160 at 30fps / 1920 × 1080 at 60fps. Used for different types of input sources, like computers, cameras, or external playback devices (audio and video). You need a High Speed HDMI 1.4b cable to support the high resolutions and frame rates. We recommend a Cisco qualified presentation cable. The second HDMI input connector allows display of HDCP (High-bandwidth Digital Content Protection) encrypted content.

HDMI outputs

HDMI version 2.0, resolutions up to 3840 × 2160 at 60fps. Use output 1 for the main monitor and output 2 for the optional second monitor. You need Premium HDMI cables to support the high resolutions and frame rates. We recommend Cisco qualified display cables.

There is no audio on the HDMI outputs if the connected camera has loudspeakers (Quad Camera). Otherwise there is audio on Connector 1.

Camera control

Camera control (pan, tilt, zoom) for the camera. If you connect an extra camera you need an Ethernet switch to allow for camera control on both cameras.

USB

USB 2.0 type A/B.

Maintenance

Micro USB connector for serial communication with the device.

Microphones

Three 3.5 mm mini-jack, 4-pin connectors for external microphones: Cisco Table Microphone 20 or Cisco TelePresence Ceiling Microphone.

Audio line out

3.5 mm mini-jack, 3-pin connector. To be used with active loudspeakers (built-in amplifier).

Board

Board Pro,
Board Pro
G2

Codec EQ

Codec Plus

Codec Pro

Desk,
Desk Pro,
Desk Mini

Room Bar
Pro,
Room Bar

Room Kit,
Room Kit
Mini

Room Kit
EQX

Room 55

Room
55 Dual,
Room 70

Room 70
G2

Room 70
Panorama

Room
Panorama

D15503.06

RoomOS
11.24

02-2025



Connector panel: Codec Pro and Room Panorama

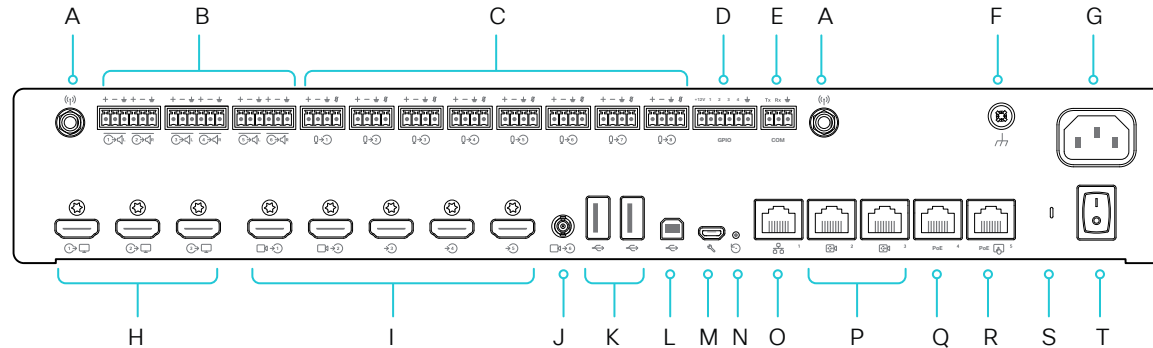

A. Antenna connector (2)

2.4GHz and 5GHz antennas for use with wireless networks or Bluetooth® connections.

B. Line outputs (6)

Balanced line level outputs. 3 or 6 pin Euroblock connectors.

C. Microphone/line inputs (8)

8 microphones, 48V phantom powered, each with separate echo cancellers and noise reduction; all microphones can be set for balanced line level. 4 pin Euroblock connectors.

D. Programmable GPIO port. 6 pin Euroblock connector.

E. COM port. 3 pin Euroblock connector.

F. Ground. Protective earth.

G. Power (100–240V_{AC}, 50–60Hz, max 1.3 – 0.6 A)

H. HDMI outputs (3)

Audio and video. HDMI version 2.0, resolutions up to 3840 × 2160 at 60 fps. Use Premium HDMI cables to support the high resolutions and frame rates. We recommend Cisco qualified display cables. There is no audio on the HDMI outputs if the connected camera has loudspeakers (Quad Camera). Otherwise, there is audio out from this connector.

HDMI 1: Main display

HDMI 2 and HDMI 3: Optional second and third display

I. HDMI inputs (5)

Audio and video. HDMI version 1.4b, resolutions up to 3840 × 2160 at 30 fps / 1920 × 1080 at 60 fps. Use a High-Speed HDMI 1.4b cable to support the high resolutions and frame rates. We recommend a Cisco qualified presentation cable.

HDMI 1 and HDMI 2: Use as main camera inputs. Quad camera always connects to HDMI 1.

HDMI 3 to HDMI 5: Use for different types of input sources, like computers, cameras, or external playback devices (audio and video). HDMI 5 input connector allows display of HDCP (High-bandwidth Digital Content Protection) encrypted content.

J. 3G-SDI/HD-SDI input

Video. Resolutions up to 1920 × 1080 at 60 fps.
HD-BNC: 1080p60, Level A 10-bit data native color encoding 4:2:2 YCbCr, 75 Ω.

K. USB connectors (2), 2.0 type A

L. USB connector, 2.0 type B

M. Maintenance

Micro USB connector for serial communication with device.

N. Factory reset pinhole

Use the pinhole as last resort. If possible, we recommend that you reset the device from the user interface or the device web interface.

O. Network

RJ45: Ethernet interface, 1Gb Ethernet interface.

P. Camera control (2)

RJ45: Camera control (pan, tilt, zoom). Connecting an extra camera requires an Ethernet switch for control on both cameras.

Q. Ethernet PoE

RJ45: Internal network port for PoE devices.

R. Touch controller

RJ45: Dedicated PoE port for the touch controller.

S. Status LED

Mirrors the front status LED.

T. Power On/Off

The device powers up automatically, as long as the power switch is in its On position.

Connector panel: Room Kit

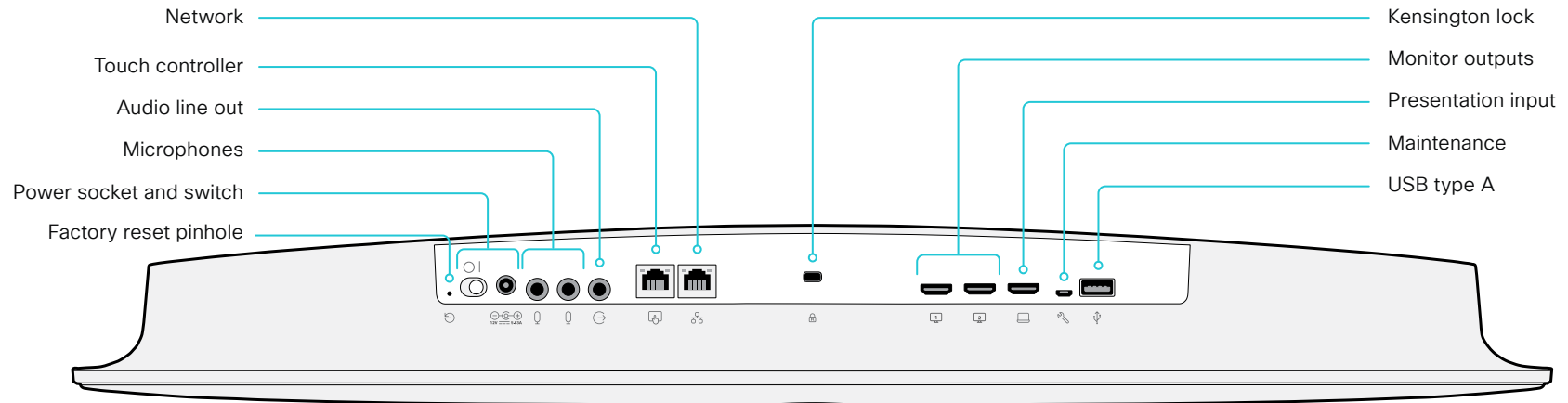

Network

Ethernet interface, 10Mb / 100Mb / 1Gb Ethernet LAN interface (RJ45).

Touch controller

The touch controller is powered over Ethernet, which is not provided through this socket. Therefore, you need a mid-span power injector between the touch controller and the video conferencing device, see the [Connect the touch controller](#) chapter for more details

Audio line out

3.5 mm mini-jack, 3-pin connector. To be used with active loudspeakers (built-in amplifier) or with a self-powered subwoofer (refer to the *Audio Output Line OutputType* setting).

Microphones

Two 3.5 mm mini-jack, 4-pin connectors for external microphones: Cisco Table Microphone 20 or Cisco TelePresence Ceiling Microphone.

Power

Always use the provided power supply:

- DC output: 5.83A, 12 V
- AC input: 100-240V, 50-60Hz, max 1.2A

The device powers up automatically, as long as the power switch is in its On position.

Factory reset pinhole

Use the pinhole as a last resort. We recommend to perform a factory reset from the touch controller or the device web interface.

Monitor outputs

HDMI version 2.0, resolutions up to 3840 × 2160 at 60 fps. Use output 1 for the main monitor and output 2 for the optional second monitor. There is no audio on these outputs. You need Premium HDMI cables to support the high resolutions and frame rates. We recommend Cisco qualified display cables.

Presentation input

HDMI version 1.4b, resolutions up to 3840 × 2160 at 30 fps. Used for different types of input sources, like computers or external playback devices (audio and video). You need a High Speed HDMI 1.4b cable to support the high resolutions and frame rates. We recommend a Cisco qualified presentation cable.

Maintenance

Micro USB connector for serial communication with the device.

USB

USB 2.0 type A.

Kensington lock

The Kensington lock may be used to prevent the device from being moved and to prevent theft.

Board

BoardPro,
BoardPro
G2

Codec EQ

Codec
Plus

Codec
Pro

Desk,
Desk Pro,
DeskMini

Room Bar
Pro,
Room Bar

Room Kit,
Room Kit
Mini

Room Kit
EQX

Room 55

Room
55 Dual,
Room 70

Room 70
G2

Room 70
Panorama

Room
Panorama

D15503.06

RoomOS
11.24

02-2025



Connector panel: Room Kit Mini

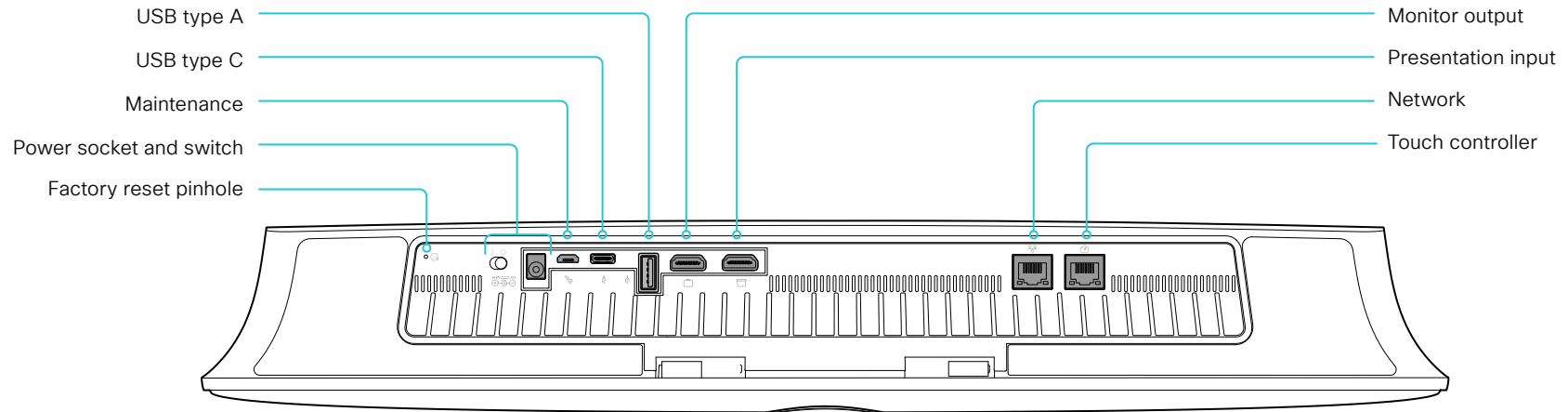

Factory reset pinhole

Use the pinhole as a last resort. We recommend to perform a factory reset from the touch user interface or the device web interface.

Power

Always use the provided power supply. The device powers up automatically, as long as the power switch is in its On position.

Maintenance

Micro USB connector for serial communication with the device.

USB

- USB 2.0 type A
- USB 2.0 type C

Monitor output

HDMI version 2.0, resolutions up to 3840 × 2160 at 60fps. There is no audio on the output. You need Premium HDMI cables to support the high resolutions and frame rates. We recommend Cisco qualified display cables.

Presentation input

HDMI version 1.4b, resolutions up to 3840 × 2160 at 30fps for computer. You need a High Speed HDMI 1.4b cable to support the high resolutions and frame rates. We recommend a Cisco qualified presentation cable.

Network

Ethernet interface, 10Mb / 100Mb / 1Gb Ethernet LAN interface (RJ45).

Touch controller

The touch controller is powered over Ethernet, which is provided through this socket.

Board

Board Pro,
Board Pro
G2

Codec EQ

Codec
Plus

Codec
Pro

Desk,
Desk Pro,
Desk Mini

Room Bar
Pro,
Room Bar

Room Kit,
Room Kit
Mini

Room Kit
EQX

Room 55

Room
55 Dual,
Room 70

Room 70
G2

Room 70
Panorama

Room
Panorama

D15503.06

RoomOS
11.24

02-2025

CISCO

Connector panel: Room Bar

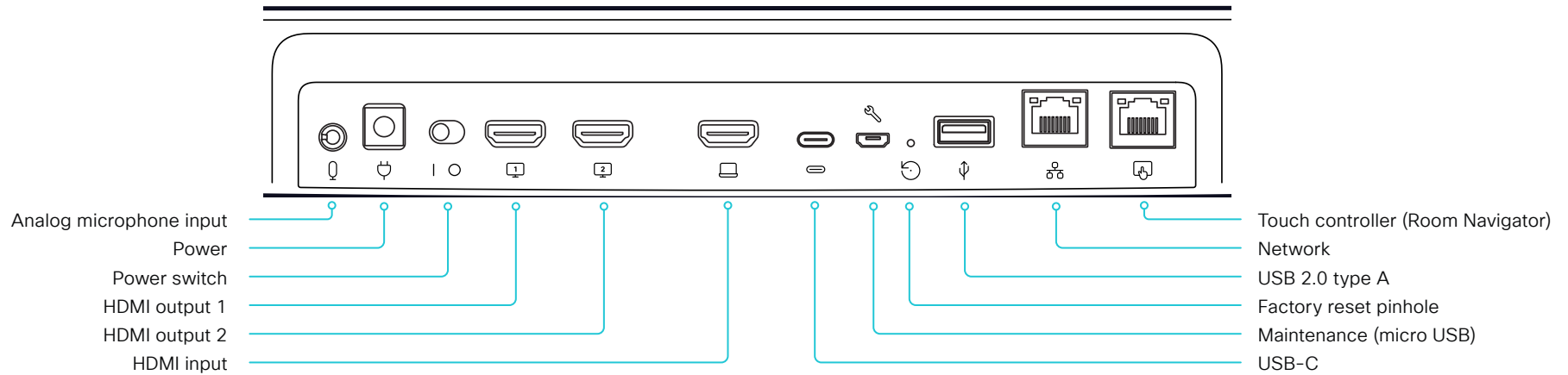

Analog microphone input

- 3.5 mm mini-jack, 4-pin connector for external microphone; for example Cisco Table Microphone or Cisco TelePresence Ceiling Microphone

Power

- Always use the provided power supply. The device powers up automatically, as long as the power switch is in its On position
- 100 to 240VAC, 50/60 Hz, 12V DC input
- Power consumption:
 - Average: 20W
 - Peak: 86W

HDMI outputs

- Two HDMI 2.0 outputs supporting formats up to 3840 × 2160 at 60 fps
- There is no audio on the outputs
- You need Premium HDMI cables to support the high resolutions and frame rates. We recommend Cisco qualified display cables

HDMI input

- HDMI 1.4 type A input
- Supports formats up to 3840 × 2160 at 30 fps, including 1920 × 1080 at 60 fps
- Content sharing and screen extension (external screen for computer)
- You need a High Speed HDMI 1.4b cable to support the high resolutions and frame rates. We recommend a Cisco qualified presentation cable

USB-C

- Supports formats up to 3840 × 2160 at 30 fps, including 1920 × 1080 at 60 fps, using DisplayPort Alternate Mode
- Content sharing and screen extension (external screen for computer)
- Ability to provide camera, microphone, and speakers over one USB-C cable to a connected computer (USB-C passthrough)

Maintenance - micro USB

- For serial communication with the device

Factory reset pinhole

- Use the pinhole as a last resort. If possible, we recommend that you reset the device from the user interface or the device web interface

Network

- Ethernet (RJ45) 100/1000Mbps for LAN (external network)

Touch controller - Room Navigator

- Ethernet (RJ45) 100/1000Mbps with PoE enabled for direct connection of a touch controller (Room Navigator)
- Room Navigator is powered over Ethernet

Connector panel: Room Bar Pro

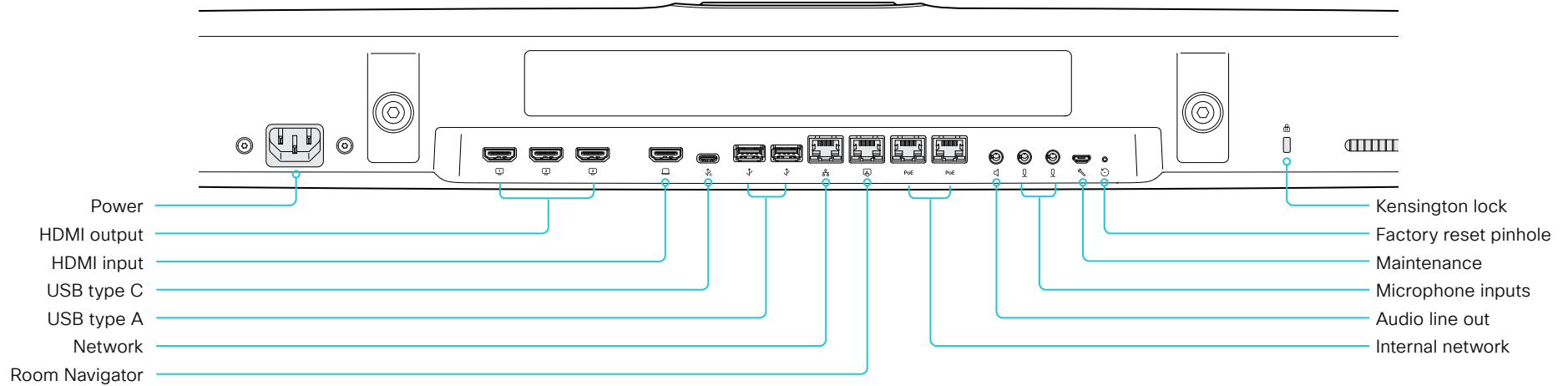

Power

- 100 - 240V_{AC}, 50-60Hz, 12V DC input/2.0-1.2A
- Always use the provided power cable

HDMI outputs

- Three HDMI 2.0 outputs supporting formats up to 3840 × 2160 at 60 fps
- There is no audio on the outputs
- You need Premium HDMI cables to support the high resolutions and frame rates. We recommend Cisco qualified display cables

HDMI input

- HDMI 1.4 type A input
- Supports formats up to 3840 × 2160 at 30 fps, including 1920 × 1080 at 60 fps
- Content sharing and screen extension (external screen for computer)
- You need a High Speed HDMI 1.4b cable to support the high resolutions and frame rates. We recommend a Cisco qualified presentation cable

USB

- USB type A
- USB type C
 - For content sharing and screen extension (external screen for computer)
 - Ability to provide camera, microphone, and speakers over one USB-C cable to a connected computer (USB-C passthrough)

Network

- Ethernet interface, 10Mb /100Mb / 1Gb Ethernet LAN interface (RJ45)

Touch controller - Room Navigator

- Dedicated Ethernet PoE port (RJ45) for the touch controller (Room Navigator)

Internal network, Ethernet PoE

- Two internal network connectors for PoE devices (RJ45)

Audio line out

- 3.5 mm mini-jack, 3-pin connector
- Analog line out (stereo)
- To be used with active loudspeakers (built-in amplifier)

Microphones

- Two 3.5 mm mini-jack, 4-pin connectors for external microphones; for example, Cisco Table Microphone or Cisco TelePresence Ceiling Microphone

Maintenance

- Micro USB for serial communication with the device

Factory reset pinhole

- Use the pinhole as a last resort. If possible, we recommend that you reset the device from the user interface or the device web interface

Kensington lock

- The Kensington lock may be used to prevent the device from being moved and to prevent theft

Board

Board Pro,
Board Pro
G2

Codec EQ

Codec
Plus

Codec
Pro

Desk,
Desk Pro,
Desk Mini

Room Bar
Pro,
Room Bar

Room Kit,
Room Kit
Mini

Room Kit
EQX

Room 55

Room
55 Dual,
Room 70

Room 70
G2

Room 70
Panorama

Room
Panorama

D15503.06

RoomOS

11.24

02-2025



Board

Board Pro,
Board Pro
G2

Codec EQ

Codec
Plus

Codec
Pro

Desk,
Desk Pro,
DeskMini

Room Bar
Pro,
Room Bar

Room Kit,
Room Kit
Mini

Room Kit
EQX

Room 55

Room
55 Dual,
Room 70

Room 70
G2

Room 70
Panorama

Room
Panorama

Connector panel: Room 55

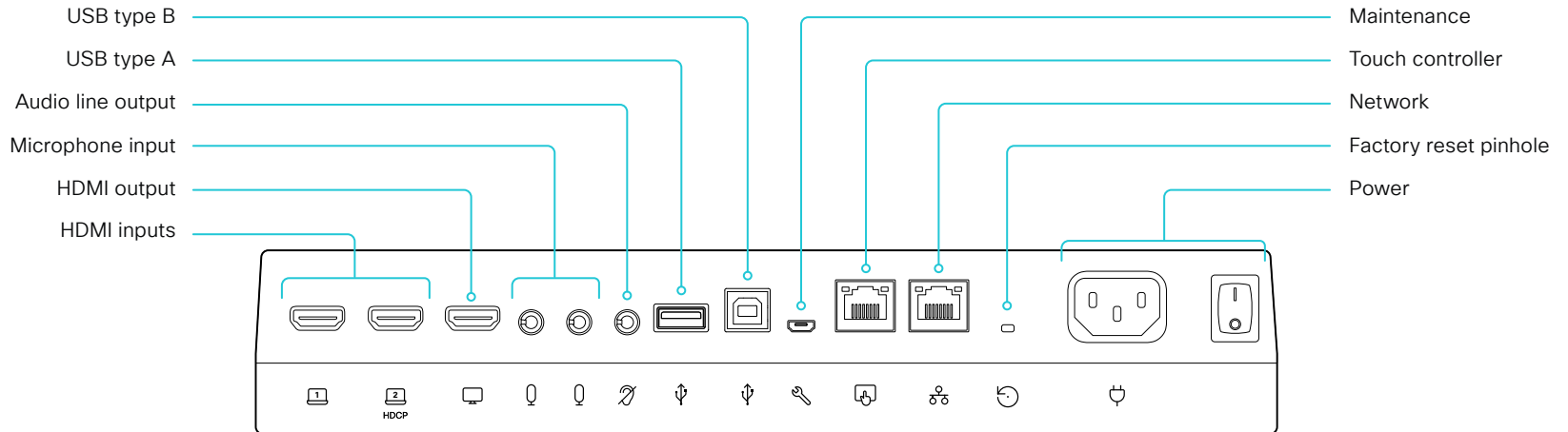

HDMI inputs

HDMI version 1.4b, resolutions up to 3840 × 2160 at 30fps. Used for different types of input sources, like computers, or external playback devices (audio and video). You need a High Speed HDMI 1.4b cable to support the high resolutions and frame rates. We recommend a Cisco qualified presentation cable.

The second HDMI input allows display of HDCP (High-bandwidth Digital Content Protection) encrypted content.

HDMI output

HDMI version 2.0, resolutions up to 3840 × 2160 at 60fps. Used for an optional second display (only video). You need Premium HDMI cables to support the high resolutions and frame rates. We recommend Cisco qualified display cables.

Microphones

Two 3.5 mm mini-jack, 4-pin connectors for external microphones: Cisco Table Microphone 20 or Cisco TelePresence Ceiling Microphone.

Audio line out

3.5 mm mini-jack, 3-pin connector. For example to be used with an audio induction loop system.

USB

- USB 2.0 type A
- USB 2.0 type B

Maintenance

Micro USB connector for serial communication with the device.

Touch controller

The touch controller is powered over Ethernet, which is provided through this socket. See the [Connect the touch controller](#) chapter for more details.

Network

Ethernet interface, 10Mb / 100Mb / 1Gb Ethernet LAN interface (RJ45).

Factory reset pinhole

Use the pinhole as a last resort. We recommend to perform a factory reset from the touch controller or the device web interface.

Power

100-240VAC, 1.8-0.8A, 50/60Hz
The device powers up automatically, as long as the power switch is in its On position.

Connector panel: Room Kit EQX

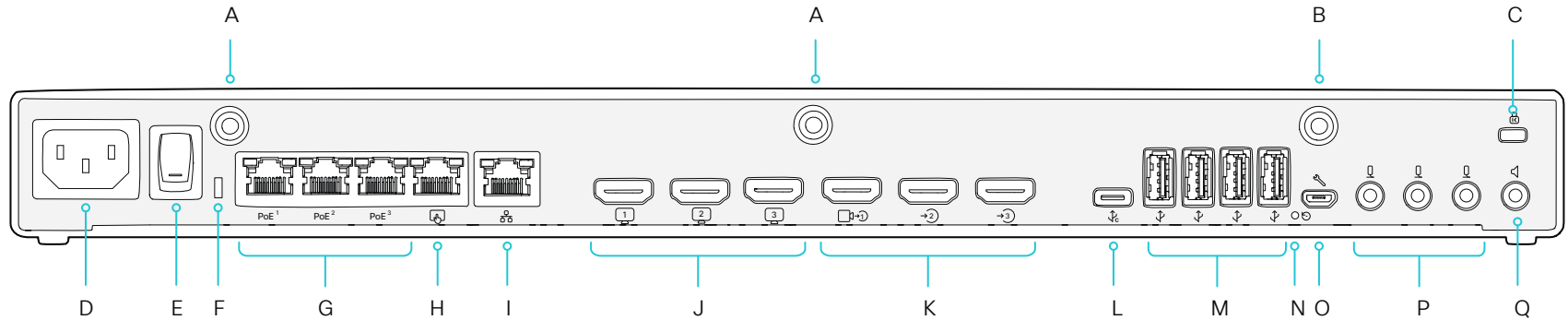

A. 2x Wi-Fi antenna (RP-SMA connector)

- The whip antennas are mounted on a bracket on top of the system, behind the speaker grille. For best performance ensure free line of sight.

B. Bluetooth® antenna (RP-SMA connector)

- The whip antenna is mounted on a bracket on top of the system, behind the speaker grille. For best performance ensure free line of sight.

C. Kensington lock

- To prevent the device from being moved and to prevent theft.

D. Power (100–240V_{AC}, 50–60Hz, 2.0–1.2A)

- Only for the codec.

E. Power On/Off

- Only for the codec.

F. Status LED

G. 3x Ethernet ports for internal network (RJ45)

- For camera control, the system's amplifier, digital microphones, and more.
- PoE++ (IEEE 802.3bt): Maximum 90W per port; and maximum 90W in total for these 3 ports (G) and the dedicated touch controller port (H).

H. Touch controller (RJ45)

- Dedicated PoE port for the touch controller.
- PoE++ (IEEE 802.3bt): Maximum 90W for this port; and maximum 90W in total for this port (H) and the three other PoE ports (G).

I. Network

- Ethernet interface, 10Mb / 100Mb / 1Gb Ethernet LAN interface (RJ45).

J. 3x HDMI outputs

- HDMI 2.0, resolutions up to 3840 × 2160 at 60fps.
- Audio and video (audio is disabled by default).
- HDMI 1 and HDMI 2 are used by the system's integrated screens. HDMI 1 is the left screen, HDMI 2 is the right screen.

K. 3x HDMI inputs, typically used for cameras and other content sources

- HDMI 2.0. Resolutions up to 3840 × 2160 at 30fps.
- Content sharing.
- HDMI 1 is the system's integrated camera.
- Supports HDCP (High-bandwidth Digital Content Protection) encrypted content on HDMI 3.

L. USB-C

- Supports formats up to 3840 × 2160 at 30fps, using DisplayPort Alternate Mode.
- Content sharing.
- Use the camera, microphone and speakers with any software client (USB-camera mode).
- 15W charging capability.

M. 4x USB 3.0 type A

- 1.5A charging capability per port.
- For loudspeakers, microphones, headset, DSPs, and future integrations.

N. Factory reset pinhole

- Use the pinhole as last resort. If possible, we recommend that you reset the device from the user interface or the device web interface.

O. Maintenance (micro USB)

- For serial communication with the device.

P. 3x analog microphones (3.5mm mini-jack, 4-pin connectors)

- ### Q. Audio line output (3.5mm mini-jack, 3-pin connector)
- Analog line out (stereo).
 - To be used with active loudspeakers (built-in amplifier).

Board

BoardPro,
BoardPro
G2

Codec EQ

Codec
Plus

Codec
Pro

Desk,
Desk Pro,
DeskMini

Room Bar
Pro,
Room Bar

Room Kit,
Room Kit
Mini

Room Kit
EQX

Room 55

Room
55 Dual,
Room 70

Room 70
G2

Room 70
Panorama

Room
Panorama

D15503.06

RoomOS
11.24

02-2025

CISCO

Connector panel: Room 55 Dual and Room 70

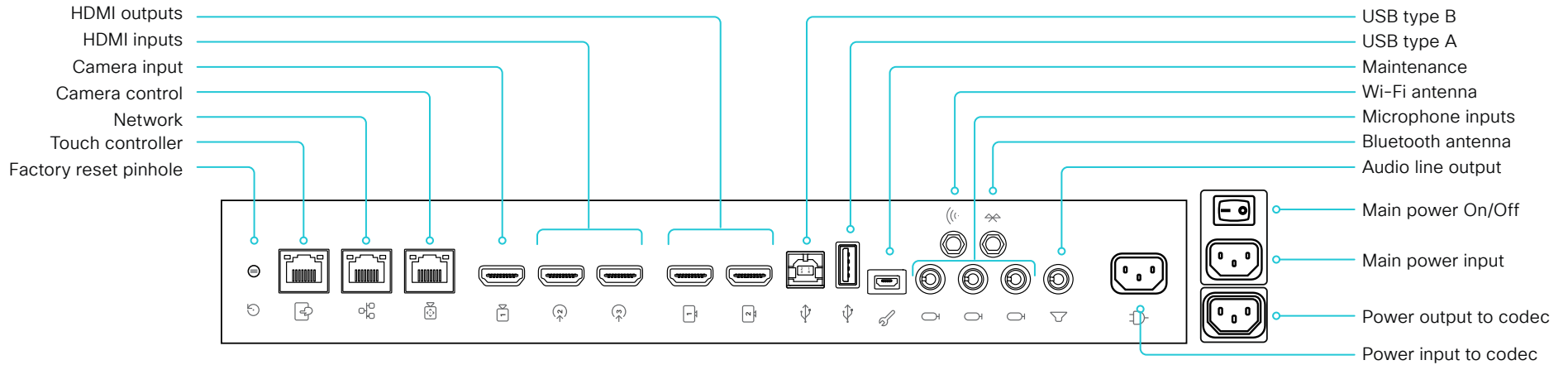

Factory reset pinhole

Use the pinhole as last resort. If possible, we recommend that you reset the device from the user interface or the device web interface.

Touch controller

The touch controller is powered over Ethernet (PoE), which is provided through this socket.

Network

Ethernet interface, 10Mb / 100Mb / 1 Gb Ethernet LAN interface (RJ45).

Camera control

Camera control (pan, tilt, zoom) for the integrated camera.

Camera input

This HDMI input is reserved for the integrated camera.

HDMI inputs with audio

HDMI version 1.4b, resolutions up to 3840 × 2160 at 30 fps. For computer, extra camera, or external playback devices. You need a High Speed HDMI 1.4b cable to support the high resolutions and frame rates. We recommend a Cisco qualified presentation cable. The second HDMI input connector allows display of HDCP (High-bandwidth Digital Content Protection) encrypted content.

HDMI outputs with 4K resolution

HDMI version 2.0, resolutions up to 3840 × 2160 at 60 fps. Output 1 is reserved for the internal screen for single screen devices. Both outputs are reserved for the internal screens for dual screen devices. You need Premium HDMI cables to support the high resolutions and frame rates. We recommend Cisco qualified display cables. There is no audio on HDMI output connector 2 on a single screen device.

Audio line output

3.5 mm mini-jack, 3-pin connector.

Microphones

Three 3.5 mm mini-jack, 4-pin connectors for external microphones: Cisco Table Microphone 20 or Cisco TelePresence Ceiling Microphone.

USB connectors

- USB 2.0 type B
- USB 2.0 type A, reserved for internal use
- Micro USB socket for maintenance

Antenna connectors

- Wi-Fi antenna for wireless network connection
- Bluetooth antenna (for future use)

Power

- Reserved for power input to codec
- Reserved for power output to codec
- Main power input (100-240 VAC, 3.5-2.0 A, 50/60 Hz)
- Main power On/Off

Board

Board Pro,
Board Pro
G2

Codec EQ

Codec
Plus

Codec
Pro

Desk,
Desk Pro,
Desk Mini

Room Bar
Pro,
Room Bar

Room Kit,
Room Kit
Mini

Room Kit
EQX

Room 55

Room 55
Dual,
Room 70

Room 70
G2

Room 70
Panorama

Room
Panorama

D15503.06

RoomOS
11.24

02-2025



- Board
- Board Pro, Board Pro G2
- Codec EQ
- Codec Plus
- Codec Pro
- Desk, Desk Pro, Desk Mini
- Room Bar Pro, Room Bar
- Room Kit, Room Kit Mini
- Room Kit EQX
- Room 55
- Room 55 Dual, Room 70
- Room 70 G2**
- Room 70 Panorama
- Room Panorama

Connector panel: Room 70 G2 and Room 70 Panorama

- | | |
|--|---|
| <p>A. Antenna connector (2)
2.4GHz and 5GHz antennas for use with wireless networks or Bluetooth connections.</p> <p>B. Line outputs (6)
Balanced line level outputs. Euroblock, 3.5 mm.</p> <p>C. Microphone/line inputs (8)
8 microphones, 48V phantom powered, each with separate echo cancellers and noise reduction; all microphones can be set for balanced line level. Euroblock, 3.5 mm..</p> <p>D. Programmable GPIO port. 3.5 mm Euroblock connector.</p> <p>E. COM port. 3.5 mm Euroblock connector.</p> <p>F. Antenna connector, see A</p> <p>G. Ground. Protective earth.</p> <p>H. Power input
Power input to codec and power on/off switch.</p> <p>I. Main power input
Main power input (100-240 VAC, 5.5-2.5 A, 50/60 Hz) and power on/off switch.</p> <p>J. HDMI outputs (2).
Audio and video. Connectors 1 and 2, 4Kp60.</p> <p>K. HDMI output (1)
Audio and video. Connector 3, 4Kp30.</p> <p>L. Camera inputs (2)
HDMI, connector 1-2, 1080p60.</p> <p>M. HDMI inputs (3)
Audio and video. Connector 3-5, 4Kp30. Connector 5</p> | <p>supports HDCP.</p> <p>N. Camera input
3G-SDI/HD-SDI. Connector 6, 1080p60, Level A only, HD-BNC, 75Ω.</p> <p>O. USB connectors (2), 2.0 type A.</p> <p>P. USB connector, 2.0 type B.</p> <p>Q. Maintenance
Micro USB connector for serial communication with device.</p> <p>R. Factory reset pinhole
Use the pinhole as last resort. If possible, we recommend that you reset the device from the user interface or the device web interface.</p> <p>S. Network
RJ45: Ethernet interface, 1Gb Ethernet interface.</p> <p>T. Camera control (2)
RJ45: Camera control (pan, tilt, zoom). Connecting an extra camera requires an Ethernet switch for control on both cameras.</p> <p>U. Ethernet PoE
RJ45: Internal network port for PoE devices.</p> <p>V. Touch controller
RJ45: Dedicated PoE port for the touch controller.</p> <p>W. Status LED
Mirrors the front status LED.</p> <p>X. Power output
Codec power output.</p> |
|--|---|

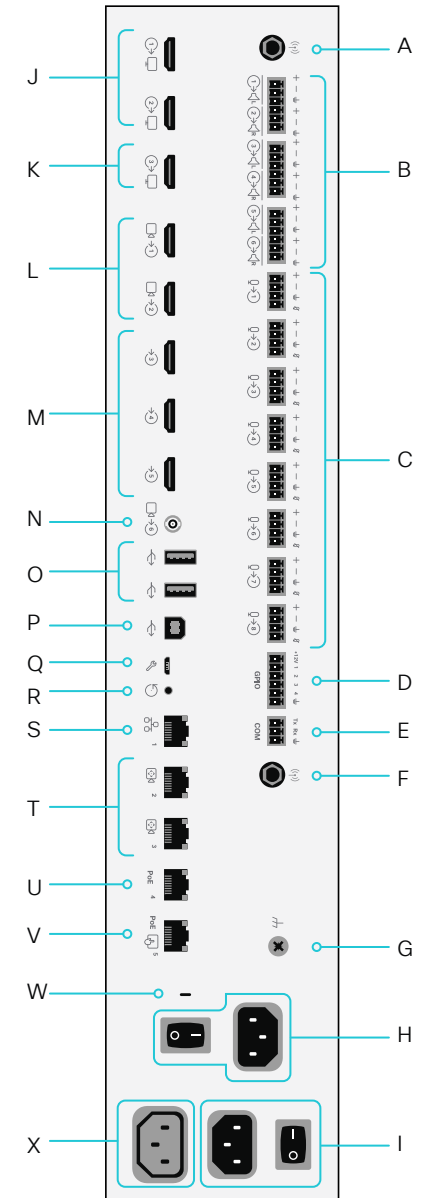

Board

Board Pro,
Board Pro
G2

Codec EQ

Codec
Plus

Codec
Pro

Desk,
Desk Pro,
Desk Mini

Room Bar
Pro,
Room Bar

Room Kit,
Room Kit
Mini

Room Kit
EQX

Room 55

Room
55 Dual,
Room 70

Room 70
G2

Room 70
Panorama

Room
Panorama

Connector panel: Desk Mini

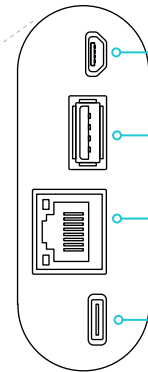
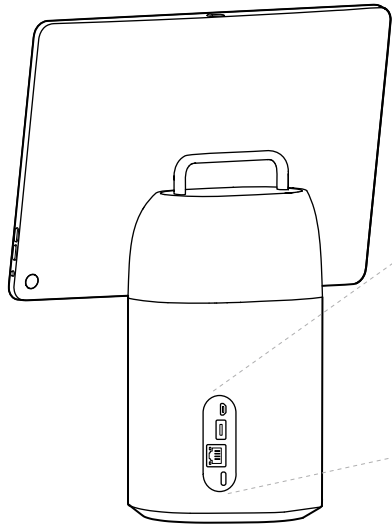

- Maintenance (micro USB)
 - For serial communication with the device
- USB 2.0 type A
- Network
 - Ethernet interface, 10Mb / 100Mb / 1Gb
 - Ethernet LAN interface (RJ45)
- USB-C
 - Supports formats up to 1920 × 1080 at 60 fps (1080p60), using DisplayPort Alternate Mode
 - Content sharing and screen extension (external screen for computer)
 - Touch forwarding capabilities on supported operating systems
 - Use the camera, microphone and speakers with any software client (USB-camera mode)

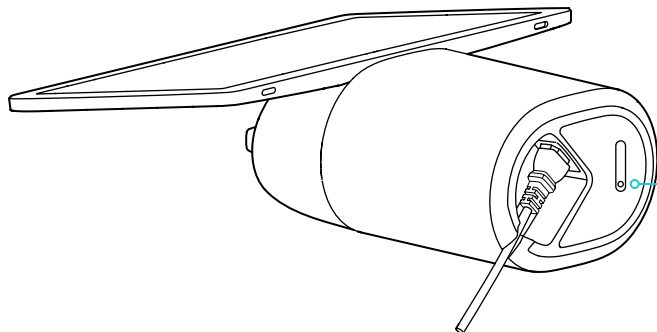

- Factory reset pinhole
 - Use the pinhole as last resort. If possible, we recommend that you reset the device from the user interface or the device web interface.

Connector panel: Desk and Desk Pro

1. USB
 - USB 2.0 type A
2. Maintenance (micro USB)
 - For serial communication with the device
3. HDMI out: for connecting a second screen *(Only Desk Pro)*
 - HDMI 2.0 type A
 - Supports formats up to 3840 × 2160 at 60 fps (4k60)
4. Network for PC *(Only Desk Pro)*
 - Ethernet interface, 10 Mb / 100 Mb / 1 Gb Ethernet LAN interface (RJ45)
5. Network
 - Ethernet interface, 10 Mb / 100 Mb / 1 Gb Ethernet LAN interface (RJ45)
6. HDMI input
 - HDMI 2.0 type A input. Supports formats up to:
 - 3840 × 2160 at 60 fps (4k60) *(Desk Pro)*
 - 1920 × 1080 at 60 fps (1080p60) *(Desk)*
 - Content sharing and screen extension (external screen for computer)
7. USB-C
 - Supports formats up to the following, using DisplayPort Alternate Mode:
 - 3840 × 2160 at 60 fps (4k60) *(Desk Pro)*
 - 1920 × 1080 at 60 fps (1080p60) *(Desk)*
 - Content sharing and screen extension (external screen for computer)
 - Touch forwarding capabilities on supported operating systems
 - Use the camera, microphone and speakers with any software client (USB-camera mode)
 - Laptop charging (60W maximum) *(Only Desk Pro)*
8. Power
 - Rated:
 - 200W maximum *(Desk Pro)*, 70W maximum *(Desk)*
 - Standby power consumption:
 - 15W; display off mode *(Desk Pro)*, 7.5 W; networked standby *(Desk)*

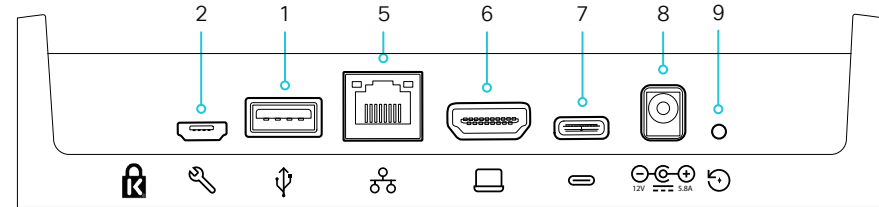

Main connector panel at the back
(Desk)

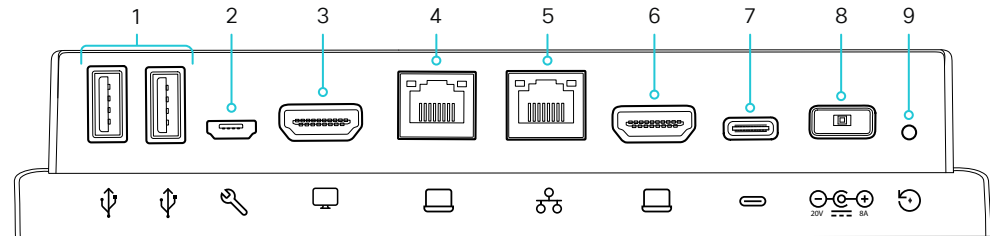

Main connector panel at the back
(Desk Pro)

9. Factory reset pinhole
 - Use the pinhole as last resort. If possible, we recommend that you reset the device from the user interface or the device web interface.

- A. Analog audio output *(Only Desk Pro)*
 - 3.5 mm stereo mini-jack (3-pin)
 - For headphones
- B. USB, audio input and output *(Only Desk Pro)*
 - USB 2.0 type A
 - For USB headset

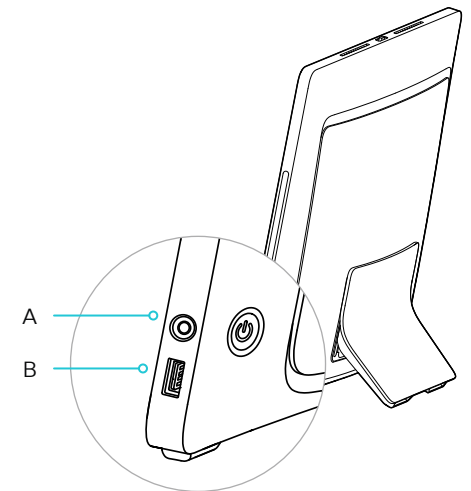

Audio connectors on the right side
(Desk Pro)

- Board
- BoardPro, BoardPro G2
- Codec EQ
- Codec Plus
- Codec Pro
- Desk, Desk Pro, DeskMini
- Room Bar Pro, Room Bar
- Room Kit, Room Kit Mini
- Room Kit EQX
- Room 55
- Room 55 Dual, Room 70
- Room 70 G2
- Room 70 Panorama
- Room Panorama

Connector panel: Board

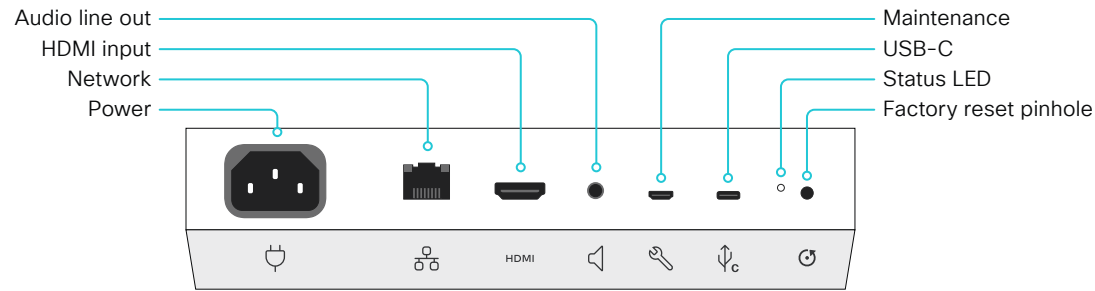

Board 55S, 70S, and 85S ¹

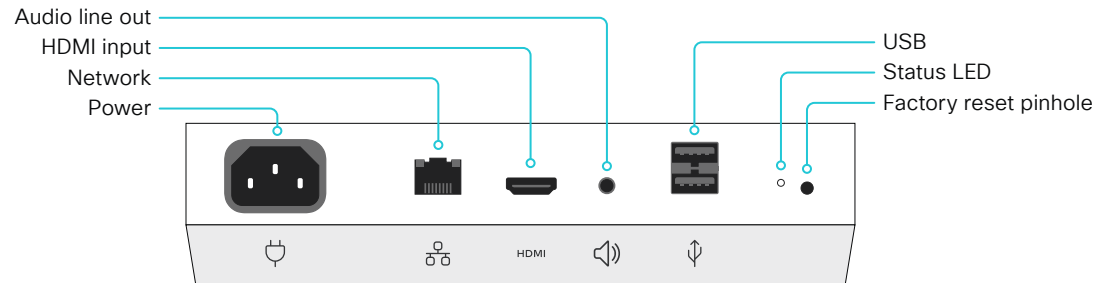

Board 55

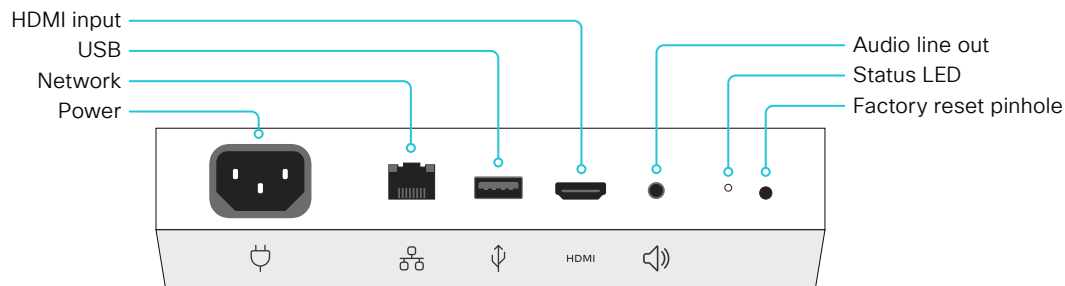

Board 70

Power

- Board 55S: 100-240VAC, 3.0-1.5A, 50/60Hz
- Board 70S: 100-240VAC, 3.5-2.0A, 50/60Hz
- Board 85S: 100-240VAC, 4.6-2.0A, 50/60Hz
- Board 55, 70: 100-240VAC, 3.5A max, 50/60Hz

Network

- Ethernet interface, 10Mb / 100Mb / 1 Gb Ethernet LAN interface (RJ45). ²

HDMI input

- HDMI version 1.4b, resolutions up to 3840 × 2160 at 30 fps. For computer or external playback devices. You need a High Speed HDMI 1.4b cable to support the high resolutions and frame rates. We recommend a Cisco qualified presentation cable.

Audio line output

- 3.5mm mini-jack, 3-pin connector.

USB

- Board 55: Two USB 2.0 type A for maintenance
- Board 70: One USB 2.0 type A for maintenance
- Board 55S, 70S, and 85S: Micro USB for maintenance
- Board 55S, 70S, and 85S: USB-C

Factory reset pinhole

- Use the pinhole as last resort. If possible, we recommend that you reset the device from the user interface or the device web interface.

¹ The second generation Webex Board family (*S Series*) has some minor hardware platform optimizations.

² All models also support Wi-Fi.

- Board
- Board Pro, Board Pro G2**
- Codec EQ
- Codec Plus
- Codec Pro
- Desk, Desk Pro, Desk Mini
- Room Bar Pro, Room Bar
- Room Kit, Room Kit Mini
- Room Kit EQX
- Room 55
- Room 55 Dual, Room 70
- Room 70 G2
- Room 70 Panorama
- Room Panorama

Connector panel: Board Pro

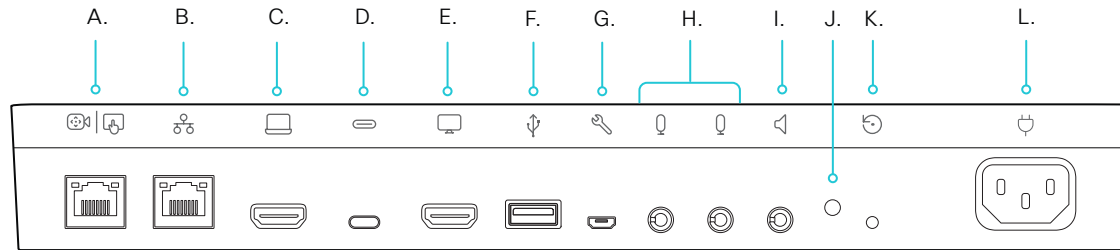

A. Touch controller

- RJ45: Dedicated PoE port for the touch controller.

B. Network

- Ethernet interface, 10 Mb / 100 Mb / 1 Gb Ethernet LAN interface (RJ45)

C. HDMI input

- HDMI 2.0 type A input. Supports formats up to:
 - 3840 × 2160 at 30fps (4kp30)
- Content sharing and screen extension (external screen for computer)
- Supports HDCP (High-bandwidth Digital Content Protection) encrypted content.

D. USB-C

- Supports formats up to the following, using DisplayPort Alternate Mode:
 - 3840 × 2160 at 60fps (4kp60)
- Content sharing and screen extension (external screen for computer)
- Touch forwarding capabilities on supported operating systems
- Use the camera, microphone and speakers with any software client (USB-camera mode)
- Laptop charging (60W maximum)

E. HDMI output, for connecting a second screen

- HDMI 2.0 type A
- Supports formats up to 3840 × 2160 at 60fps (4kp60)

F. USB

- USB 2.0 type A

G. Maintenance (micro USB)

- For serial communication with the device

H. Microphone inputs (3.5 mm mini-jack)

- 2 analog microphone inputs

I. Audio line output (3.5mm mini-jack)

- Analog line out (stereo)

J. Status LED

K. Factory reset pinhole

- Use the pinhole as last resort. If possible, we recommend that you reset the device from the user interface or the device web interface.

L. Power

Electrical rating:

- Board Pro 55: 100-240 VAC, 3.5-2.5 A, 50/60 Hz, Class I
- Board Pro 75: 100-240 VAC, 4.5-3.5 A, 50/60 Hz, Class I

- Board
- Board Pro, Board Pro G2
- Codec EQ
- Codec Plus
- Codec Pro
- Desk, Desk Pro, Desk Mini
- Room Bar Pro, Room Bar
- Room Kit, Room Kit Mini
- Room Kit EQX
- Room 55
- Room 55 Dual, Room 70
- Room 70 G2
- Room 70 Panorama
- Room Panorama

Connector panel: Board Pro G2

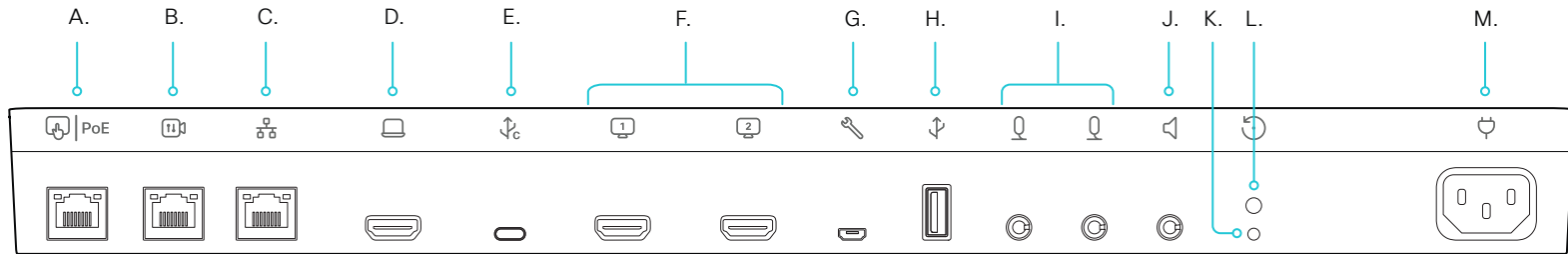

A. Ethernet with PoE

- RJ45, 100Mb / 1 Gb Ethernet
- For example for Room Navigator (touch controller)

B. Ethernet

- RJ45, 100Mb / 1 Gb Ethernet
- For example for Cisco PTZ 4K camera control

C. Network (LAN)

- Ethernet interface (RJ45), 100Mb / 1 Gb Ethernet

D. HDMI input

- HDMI 2.0 type A
- With ARC (audio return channel)
- Supports formats up to 3840 × 2160 at 60 fps (4kp60)
- Content sharing and screen extension (external screen for computer)
- Supports HDCP (High-bandwidth Digital Content Protection) encrypted content.

E. USB-C

- Supports formats up to the following, using DisplayPort Alternate Mode:
 - 3840 × 2160 at 60 fps (4kp60)
- Content sharing and screen extension (external screen for computer)
- Touch forwarding capabilities on supported operating systems
- Use the camera, microphone and speakers with any software client (USB-camera mode)
- Laptop charging (60W maximum)

F. HDMI output, for connecting a second screen

- HDMI 2.0 type A
- Supports formats up to 3840 × 2160 at 60 fps (4kp60)

G. Maintenance (micro USB)

- For serial communication with the device

H. USB

- USB 2.0 type A

I. Microphone inputs (3.5 mm mini-jack)

- Balanced analog microphone inputs
- With mute signalling for Cisco Table Microphone

J. Audio line output (3.5 mm mini-jack)

- Analog line out (stereo)

K. Factory reset pinhole

- Use the pinhole as last resort. If possible, we recommend that you reset the device from the user interface or the device web interface.

L. Status LED

M. Power

Electrical rating:

- Board Pro 55 G2:100-240VAC, 3.0-1.5 A, 50/60 Hz, Class I
- Board Pro 75 G2:100-240VAC, 4.0-2.0 A, 50/60 Hz, Class I

Connector panel: Cisco Natural Audio Module IV amplifier

The Cisco Natural Audio Module IV is an essential component of Room Kit EQX and RoomPanorama. It is a 16 channel audio power amplifier with Ethernet and analog inputs.

12V Power input and output

This is a passthrough current limited power connection for the Cisco Quad Camera, which is part of a Room Kit EQX and Room Panorama system.

Factory reset

- Pinhole

Maintenance

- Micro USB

Fan outputs

There are three fan output ports to control the fans in a Cisco Room Panorama system.

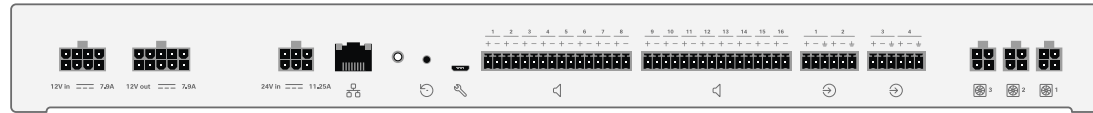

Amplifier power input

This is the DC power supply input for the amplifier.

- 24VDC, 11.25A

Ethernet

The Ethernet port is used for audio streaming from a Codec EQ (for Room Kit EQX) or Codec Pro (for Room Panorama) and for control and software upgrades.

- 1000BASE-T

Speaker outputs

Each speaker output channel is a bridged/differential amplifier output. The + and - connections should be connected to a single speaker only, and not connected to another speaker output or to ground.

Bridged differential output on 3.5 mm Euroblock connectors.

- Max 25 W / 8ohm at 0.1% THD per channel.
- < 0.1% THD at all levels below clipping.
- 106 dB SNR.
- Max 200W total output power.

Analog inputs / Line inputs

Each analog input is a differential analog line input. For best performance it should be connected to balanced analog line output signals. However it can be used with unbalanced sources, in that case the - terminal should be connected to ground.

Differential input on 3.5 mm Euroblock connectors.

- Max 24 dBu input level.
- 106 dB SNR.

Board

Board Pro,
Board Pro
G2

Codec EQ

Codec
Plus

Codec
Pro

Desk,
Desk Pro,
Desk Mini

Room Bar
Pro,
Room Bar

Room Kit,
Room Kit
Mini

Room Kit
EQX

Room 55

Room
55 Dual,
Room 70

Room 70
G2

Room 70
Panorama

Room
Panorama

D15503.06

RoomOS
11.24

02-2025



- Board
- BoardPro, BoardPro G2
- Codec EQ
- Codec Plus
- Codec Pro
- Desk, Desk Pro, DeskMini
- Room Bar Pro, Room Bar
- Room Kit, Room Kit Mini
- Room Kit EQX
- Room 55
- Room 55 Dual, Room 70
- Room 70 G2
- Room 70 Panorama
- Room Panorama

Room Navigator physical interface

This touch controller was launched early 2021. It has the same functionality as the Touch 10, but also offers environmental sensors for monitoring things like air quality and temperature.

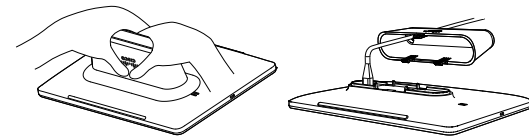
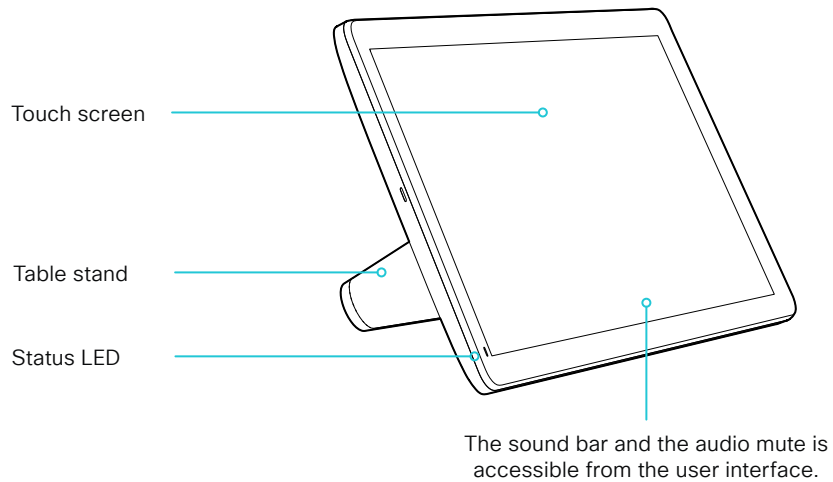

Remove the table stand to access the connector panel. Press firmly and pivot.

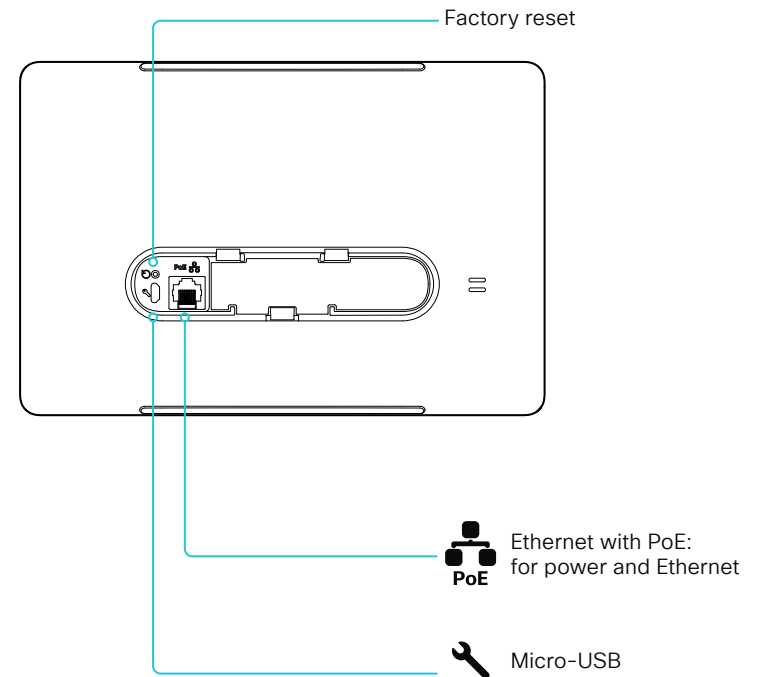

- Board
- Board Pro, Board Pro G2
- Codec EQ
- Codec Plus
- Codec Pro
- Desk, Desk Pro, Desk Mini
- Room Bar Pro, Room Bar
- Room Kit, Room Kit Mini
- Room Kit EQX
- Room 55
- Room 55 Dual, Room 70
- Room 70 G2
- Room 70 Panorama
- Room Panorama

Touch 10 physical interface

Cisco Touch 10

This is the second version of the Touch 10 controller (launched late 2017). It has the same functionality as the first version, but has a slightly different physical interface. The new device is identified by the logo on front, and fewer connectors at the back.

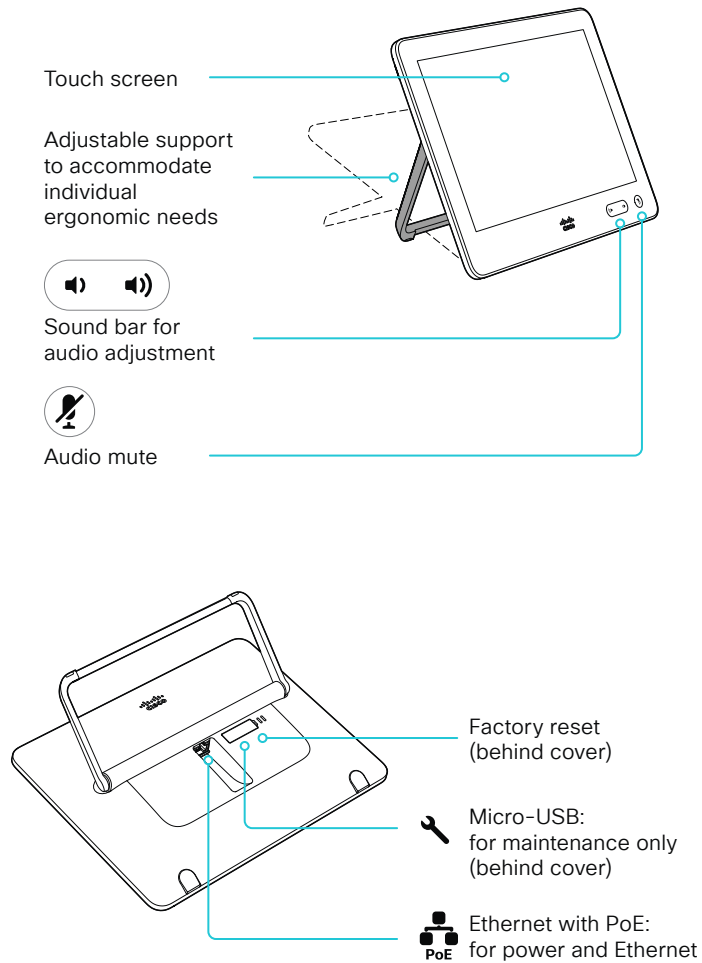

Cisco TelePresence Touch 10

This is the first version of the Touch 10 controller.

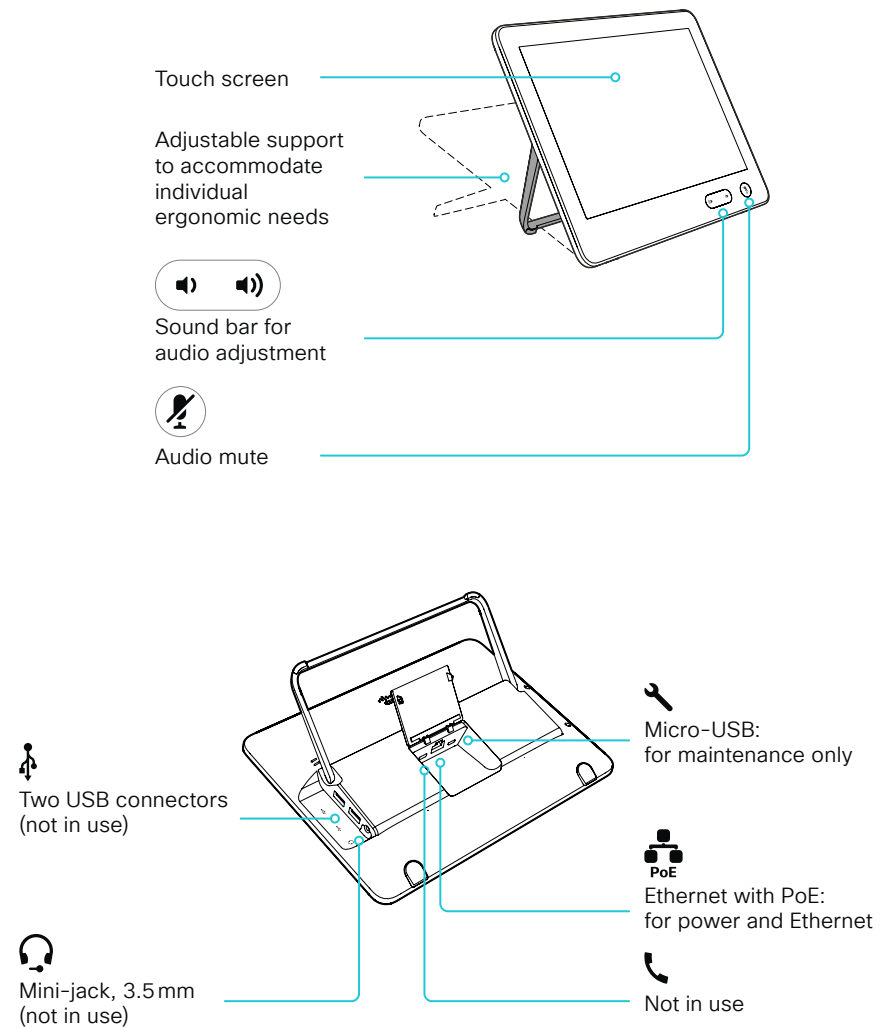

Board

BoardPro,
BoardPro
G2

Codec EQ

Codec
Plus

Codec
Pro

Desk,
DeskPro,
Desk Mini

Room Bar
Pro,
Room Bar

Room Kit,
Room Kit
Mini

Room Kit
EQX

Room 55

Room 55
Dual,
Room 70

Room 70
G2

Room 70
Panorama

Room
Panorama

Chapter 7

Appendices

Board

BoardPro,
BoardPro
G2

Codec EQ

Codec
PlusCodec
ProDesk,
Desk Pro,
Desk MiniRoom Bar
Pro,
Room BarRoom Kit,
Room Kit
MiniRoom Kit
EQX

Room 55

Room 55
Dual,
Room 70Room 70
G2Room 70
PanoramaRoom
Panorama

Call from laptop using the device as a web camera (page 1 of 4)

If you connect a laptop to the video conferencing device, you can use the device as an advanced web camera when making calls from laptop meeting apps¹.

In this mode you will make use of the following device resources:

- Camera, microphones, loudspeakers
- Screen – built-in or external, depending on product. For products without a built-in screen, you must have an external screen connected.

From the laptop meeting app: You must select the video conferencing device as camera, microphone and loudspeaker source!

The setup and use of this feature varies because the different devices have different capabilities:

- *Devices with full USB-C support:*
 - Board Pro, Board Pro G2
 - Desk Pro, Desk, Desk Mini
 - Codec EQ, Room Kit EQX
 - Room Bar, Room Bar Pro
- *Devices with limited USB-C support:*
 - Room Kit Mini
- *Devices without USB-C support:*
 - Codec Plus, Codec Pro
 - Room Kit, Room 55
 - Room 70 Single, Room 70 G2 Single and Dual

Minimum requirements

Minimum USB version:

- USB 2.0

Minimum computer operating system:

- Windows 7
- OS X 10.6

In-call behavior

Muting audio

People can always mute their microphones from the laptop meeting app.

As an administrator, you can use these settings to decide whether people should be allowed to mute from the device (or a touch controller or external microphones that are connected to the device) as well.

- [Audio > Microphones > USBPassthrough > MuteButton](#)
- [Audio > Microphones > HDMIPassthrough > MuteButton](#)

Inactive: People can't mute from the device (default behavior for Desk series)

Active: People can mute from the device (default behavior for other products)

The device and meeting app mute indicators are not synchronized. This has some side effects:

- If people mute themselves from the laptop meeting app, the microphone LEDs of the device, touch controller, and external microphones don't change to the mute color.
- If people mute themselves from the device, touch controller, or external microphones, the other participants in the call will not be notified that they are muted.
- If people forget to select the device as microphone source for the app, the app will use the laptop microphones. In such a case the microphone LEDs of the device, touch controller, and external microphones may be red (mute color), while the audio is **not** muted.

Other things to do from the device

You can do the following from the device UI:

- Control the camera. Note that the camera LED is on when the camera is in use.
- Adjust the volume.
- Remove background noise and optimize the audio quality.

Other things to do from the laptop meeting app

The laptop app must use the video conferencing device as camera, microphone and loudspeaker source.

The laptop meeting app controls all the in-call features that are not controlled by the device UI. This includes disconnecting the call.

Devices without USB-C support:

- You also have to stop the *Call from laptop* app on the device itself.

Do not disturb mode

In general, the device itself is put in *Do not disturb* mode when you are in a meeting from a laptop. Hence, you won't receive any incoming calls to the device during the meeting.

Devices with full USB-C support:

- The device will not be in *Do not disturb* mode when in audio-only meetings.

Devices without USB-C support:

- The device will stay in *Do not disturb* mode as long as the *Call from laptop* app is active on the device, even if minimized.

¹ For example Microsoft Teams, Skype for business, Slack, or Zoom. Cisco successfully tested these clients before product launch. Compatibility between different software versions will not be tested regularly.

Board

Board Pro,
Board Pro G2

Codec EQ

Codec Plus

Codec Pro

Desk,
Desk Pro,
Desk MiniRoom Bar Pro,
Room BarRoom Kit,
Room Kit Mini

Room Kit EQX

Room 55

Room 55 Dual,
Room 70

Room 70 G2

Room 70 Panorama

Room Panorama

Call from laptop using the device as a web camera (page 2 of 4)

Devices with full USB-C support

Applies to: Board Pro, Board Pro G2, Desk Pro, Desk, Desk Mini, Codec EQ, Room Bar, Room Bar Pro, and Room Kit EQX

Devices in this category have a USB-C connector, and you can share content from a laptop to the device on the USB-C connection.

The device supports up to 1080p video in this mode.

As an administrator, you don't have to do any special configuration to set up and use the device as a web camera. As described in the [In-call behavior](#) section, you can do some customizations regarding mute.

You don't have to register the device to a call service (cloud or on-premises) if you are going to use it only for laptop calling. If you skip registration at first-time setup, you can go back and register the device with Cisco later. Open the control panel, go to [Device settings](#), and select [Device activation](#).

NOTE: If there is no display connected to the Room Bar, or if the Room Bar's [Video Input Connector 2 PresentationSelection = Manual](#), the Room Bar can be selected as a loudspeaker output the steps above will not result in the laptop audio being heard over the Room Bar's loudspeakers.

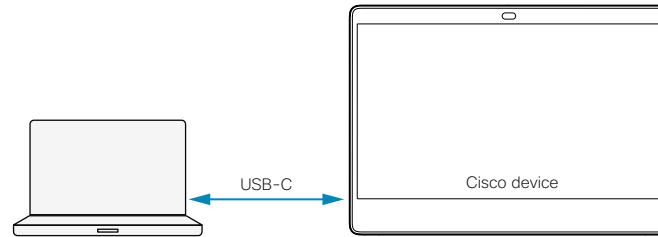

USB-C:

- Video and audio from the camera and microphone of the video device to the computer client.
- Video and audio from the computer client (far end) to the speakers and screen of the video device.

Board

Board Pro,
Board Pro
G2

Codec EQ

Codec
Plus

Codec
Pro

Desk,
Desk Pro,
Desk Mini

Room Bar
Pro,
Room Bar

Room Kit,
Room Kit
Mini

Room Kit
EQX

Room 55

Room
55 Dual,
Room 70

Room 70
G2

Room 70
Panorama

Room
Panorama

Call from laptop using the device as a web camera (page 3 of 4)

Devices with limited USB-C support

Applies to: Room Kit Mini

This device has a USB-C connector, but you cannot share content from a laptop to the device on the USB-C connection. To support content sharing, you must also connect an HDMI cable.

The device supports up to 1080p video when used as a web camera.

As an administrator, you don't have to do any special configuration to set up and use the device as a web camera. As described in the [In-call behavior](#) section, you can do some customizations regarding mute.

You don't have to register the device to a call service (cloud or on-premises) if you are going to use it only for laptop calling. If you skip registration at first-time setup, you can go back and register the device with Cisco later. Open the control panel, go to [Device settings](#), and select [Device activation](#).

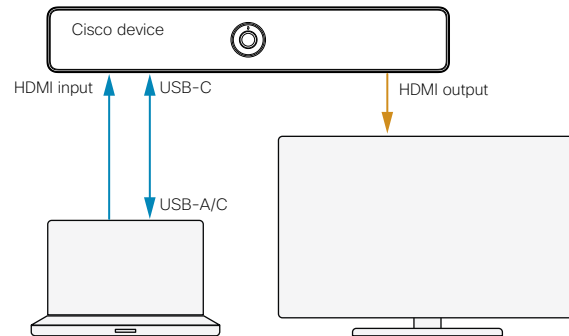

USB-C:

- Video and audio from the camera and microphone of the video conferencing device to the computer client.
- Audio from computer client to the loudspeakers of the video conferencing device.

HDMI-in and HDMI-out:

- Video from the computer client (far end), via the video conferencing device, to the screen.

Call from laptop using the device as a web camera (page 4 of 4)

Devices without USB-C support

Applies to: *Codec Plus, Codec Pro, Room Kit, Room 55, Room 70 Single, Room 70 G2 Single, and Room 70 G2 Dual*

The devices in this category don't have a USB-C connector, so you need an HDMI-to-USB converter (also known as capturing device) between the laptop and the device, see illustration. Apart from that, connect device peripherals as usual.

Set up the feature, also known as HDMI Passthrough, as follows:

1. Connect the HDMI-to-USB converter to one of the device's HDMI outputs as shown in the illustration.^{1,2}
2. Set *Video > Output > HDMI > Passthrough > Allowed* to **True** to enable the feature.
3. By default, the device is set up to use the HDMI output with the highest number for the HDMI-to-USB converter.

Use the *Video > Output > HDMI > Passthrough > OutputConnector* setting if you want to change to another HDMI output. If so, also check that the monitor roles are set correctly on the output connectors, *Video > Output > Connector [n] > MonitorRole*.

4. If you have an HDMI-to-USB converter with external power supply, and with no screen connected to it, you must manually set how many screens the device has. Use the *Video > Monitors* setting.

A mismatch gives layout issues when joining meetings from the device itself.

5. Set *Audio > Microphones > HDMIPassthrough > MuteButton* to **Inactive** if you don't want to allow people to mute audio from the device's touch controller or external microphones. Read about mute in the [In-call behavior](#) section.

6. Decide whether the device shall automatically disconnect the *Call from laptop* app after 120 minutes. Read more details in the side bar.

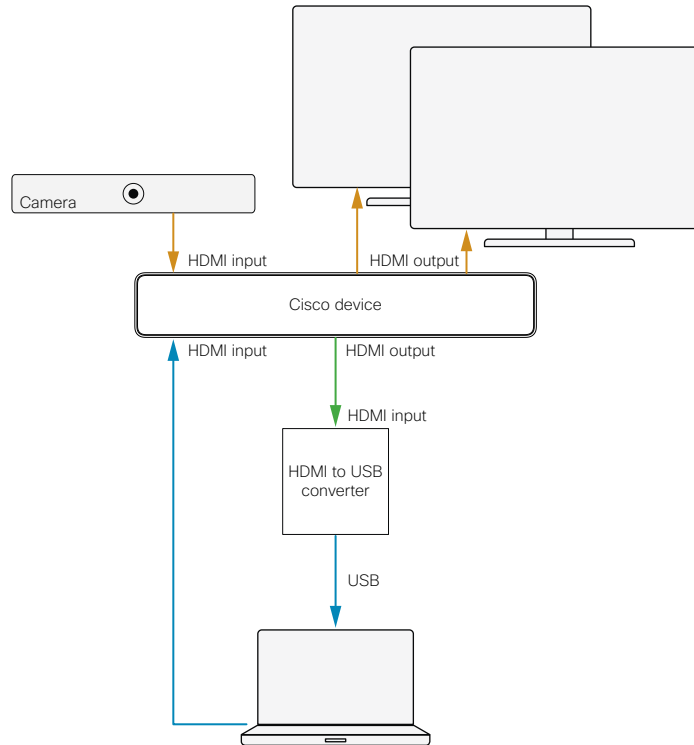

HDMI/USB (to client):

- Video and audio from the device's camera and microphones to the computer client via the HDMI-to-USB converter.

HDMI (from client):

- Video from the computer client (far end), to the device's screen.
- Audio from the computer client (far end) to the device's loudspeakers.

¹ Room 55 Dual, Room 70 Dual, Room 70 Panorama, and Room Panorama don't have a spare HDMI output for the HDMI-to-USB converter, hence these devices don't support the *Call from laptop* feature.

² We have tested and recommend the Inogeni 4KX-PLUS converter; you may use others.

Close the *Call from laptop* app

You always disconnect the call from the laptop meeting app. But, on these devices, you also have to close the *Call from laptop* app on the device itself. Until it's closed, the device will stay in *Do not disturb* mode.

If not closed manually, the default behavior is that the app closes automatically after 120 minutes.

Use these settings to change from the default behavior:

- *Video > Output > HDMI > Passthrough > AutoDisconnect > Enabled*: **True/False**
- *Video > Output > HDMI > Passthrough > AutoDisconnect > Delay*: number of minutes before disconnecting

Advanced audio setups for Codec Pro and Room 70 G2

We recommend you keep the *Audio > Output > ConnectorSetup* configuration at **Auto**.

If your room setup requires it to be **Manual**, use the Audio Console (recommended) or API commands to set up microphone passthrough manually.

Board

Board Pro,
Board Pro
G2

Codec EQ

Codec
Plus

Codec
Pro

Desk,
Desk Pro,
Desk Mini

Room Bar
Pro,
Room Bar

Room Kit,
Room Kit
Mini

Room Kit
EQX

Room 55

Room 55
Dual,
Room 70

Room 70
G2

Room 70
Panorama

Room
Panorama

D15503.06

RoomOS
11.24

02-2025



- Board
- Board Pro, Board Pro G2
- Codec EQ
- Codec Plus
- Codec Pro
- Desk, Desk Pro, Desk Mini
- Room Bar Pro, Room Bar
- Room Kit, Room Kit Mini
- Room Kit EQX
- Room 55
- Room 55 Dual, Room 70
- Room 70 G2
- Room 70 Panorama
- Room Panorama

Panoramic video

In Panoramic video we are using two of the camera's telelenses simultaneously to create a wide camera view.

Panoramic video is *always* used in the supported scenarios. It's not a feature that you can switch off, neither permanently nor temporarily.

Supported scenarios

Panoramic video is used in the following scenarios:

- Point-to-point calls between two devices that support Panoramic video
- CMS meeting between two devices that support Panoramic video

More scenarios will be available in later software releases.

Devices that support Panoramic video

- Room Panorama
- Room 70 Panorama



Video captured by the right telelense

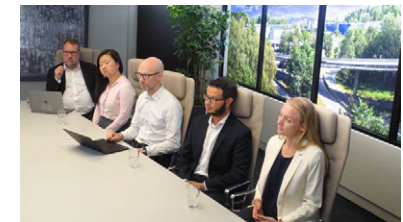

Video captured by the left telelense

Video from the camera's right and left telelenses are stitched together to create the wide panorama view.

Board

BoardPro,
BoardPro
G2

Codec EQ

Codec
PlusCodec
ProDesk,
DeskPro,
DeskMiniRoom Bar
Pro,
Room BarRoom Kit,
Room Kit
MiniRoom Kit
EQX

Room 55

Room 55
Dual,
Room 70Room 70
G2Room 70
PanoramaRoom
Panorama

Set up remote monitoring

Requirement:

- *RemoteMonitoring* option

Remote monitoring is useful when you want to control the device from another location.

Snapshots from input sources appear in the device web interface, so you can check the camera view and control the camera without being in the room.

If enabled, snapshots are refreshed automatically approximately every 5 seconds.

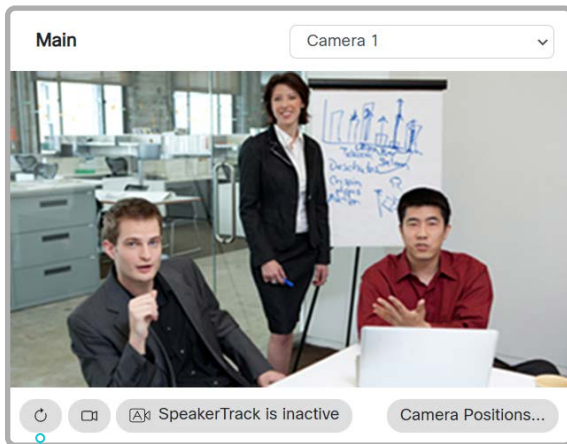

Automatically refresh snapshots

Check whether or not the device has the *RemoteMonitoring* option

1. Sign in to the device web interface, go to [Software](#), and select [Option Keys](#).
2. Check if *RemoteMonitoring* is marked as **Active** on the list of *Installed Option Keys*.
If not, remote monitoring is not available.

Enable remote monitoring

Install the *RemoteMonitoring* option key. How to install option keys is described in the [Add option keys](#) chapter.

PLEASE BE AWARE THAT IF YOU ENABLE THE REMOTE MONITORING OPTION YOU MUST MAKE SURE THAT YOU COMPLY WITH LOCAL LAWS AND REGULATIONS WITH REGARD TO PRIVACY AND PROVIDE ADEQUATE NOTICE TO USERS OF THE DEVICE THAT THE SYSTEM ADMINISTRATOR MAY MONITOR AND CONTROL THE CAMERA AND SCREEN. IT IS YOUR RESPONSIBILITY TO COMPLY WITH PRIVACY REGULATIONS WHEN USING THE DEVICE AND CISCO DISCLAIMS ALL LIABILITY FOR ANY UNLAWFUL USE OF THIS FEATURE.

About snapshots

Local input sources

Snapshots of the local input sources of the device appear on the Call Control page.

Snapshots appear both when the device is idle, and when in a call.

Far end snapshots

When in call, you may also see snapshots from the far end camera. It does not matter whether or not the far end device has the *RemoteMonitoring* option.

Far end snapshots are not displayed if the call is encrypted.

Board

BoardPro,
BoardPro
G2

Codec EQ

Codec
PlusCodec
ProDesk,
DeskPro,
DeskMiniRoom Bar
Pro,
Room BarRoom Kit,
Room Kit
MiniRoom Kit
EQX

Room 55

Room 55
Dual,
Room 70Room 70
G2Room 70
PanoramaRoom
Panorama

Access call information and answer a call while using the device web interface

A green banner at the top of the web page is present to notify you about an incoming call, and to show when the device is in a call.

If the device is idle, there is no green banner.

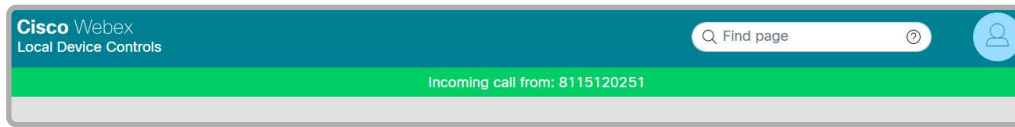





Notification of an incoming call

Click the *green banner* to open the *Call* page, where you can accept or decline the call.

Control the call

Relevant control buttons are present on the *Call* page. Use the buttons to:

-  Show call details
-  Put the call on hold
-  Answer the call
-  Disconnect the call

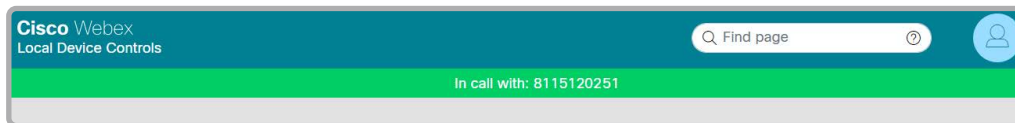

The device is in a call

The *green banner* shows if the device is in a call. It will also show if the device has multiple active calls.

Board

BoardPro,
BoardPro
G2

Codec EQ

Codec
Plus

Codec
Pro

Desk,
DeskPro,
DeskMini

Room Bar
Pro,
Room Bar

Room Kit,
Room Kit
Mini

Room Kit
EQX

Room 55

Room 55
Dual,
Room 70

Room 70
G2

Room 70
Panorama

Room
Panorama

Place a call using the device web interface (page 1 of 2)

Sign in to the device web interface and go to [Call](#).

Place a call

i Even if the device web interface is used to initiate the call, it is the video conferencing device (display, microphones and loudspeakers) that is used for the call; it is not the PC running the web interface.

1. Navigate the *Favorites*, *Directory* or *Recents* lists to find the correct entry; or enter one or more characters in the *Search* or *Dial* field*. Click the correct contact name.
2. Click [Call](#) in the contact card.

Alternatively, enter the complete URI or number in the *Search* and *Dial* field. Then click the [Call](#) button that appears next to the URI or number.

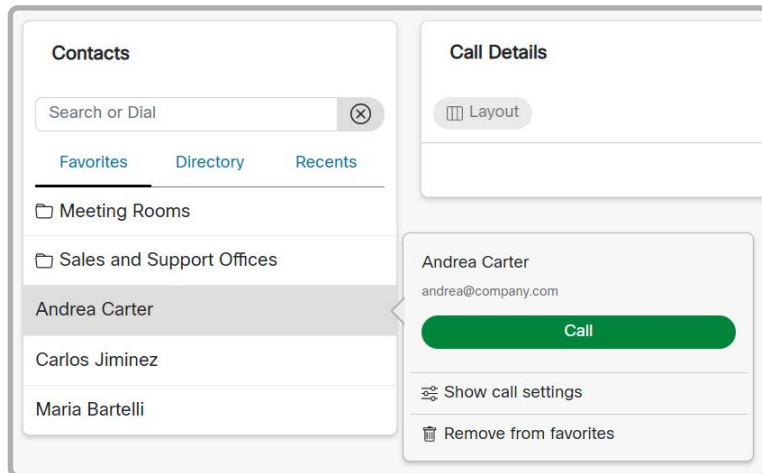

Send DTMF tones

Click to open a key pad that you can use if your application requires DTMF (dual-tone multi-frequency) signaling.

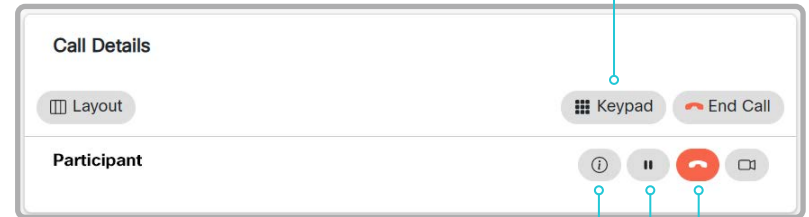

Show/hide call details

Click the information button to show details about the call.

Click the button again to hide the information.

Hold and resume a call

Use the **||** button next to a participant's name to put that participant on hold.

To resume the call, use the **▶** button that is present when a participant is on hold.

End a call

If you want to terminate a call or conference, click [End Call](#). Confirm your choice in the dialog that appears.

To disconnect just one participant in a conference, click the **▶** button for that participant.

* When searching, matching entries from the *Favorites*, *Directory* and *Recents* lists will be shown as you type.

Board

BoardPro,
BoardPro
G2

Codec EQ

Codec
Plus

Codec
Pro

Desk,
Desk Pro,
Desk Mini

Room Bar
Pro,
Room Bar

Room Kit,
Room Kit
Mini

Room Kit
EQX

Room 55

Room 55
Dual,
Room 70

Room 70
G2

Room 70
Panorama

Room
Panorama

Place a call using the device web interface (page 2 of 2)

Sign in to the device web interface and go to [Call](#).

Calling more than one

A point-to-point video call (a call involving two parties only) can be expanded to include one more participant on audio-only*.

If your device is using the optional built-in MultiSite feature, up to four or five participants, yourself included, can join the video call (conference), see the table.

Video conferencing device	Maximum number of participants in a MultiSite call
Board, Codec Plus, Room Kit, Room Kit Mini, Room 55, Room 55 Dual, Room 70	4
Board Pro, Codec EQ, Codec Pro, Desk, Desk Mini, Desk Pro, Room Bar, Room Bar Pro, Room Kit EQX, Room 70 G2, Room 70 Panorama, Room Panorama	5

Follow the same procedure to call the next conference participant as you did when calling the first participant.

Adjust the volume

Mute the microphone

Click [Microphone: On](#) to mute the microphone. Then the text changes to [Microphone: Off](#).

Click [Microphone: Off](#) to unmute.

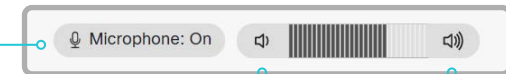

Volume down

Volume up

* An extra audio-only participant is supported only by the following products: Board, Codec Plus, Codec Pro, Desk Pro, Room Kit, Room Kit Mini, Room 55, Room 55 Dual, Room 70, and Room 70 G2.

- Board
- BoardPro, BoardPro G2
- Codec EQ
- Codec Plus
- Codec Pro
- Desk, DeskPro, DeskMini
- Room Bar Pro, Room Bar
- Room Kit, Room Kit Mini
- Room Kit EQX
- Room 55
- Room 55 Dual, Room 70
- Room 70 G2
- Room 70 Panorama
- Room Panorama

Share content using the device web interface

Sign in to the device web interface and go to [Call](#).

Share content

1. Choose which content source to share in the *Presentation* source drop down list.

Products that support only one input source, have only one entry in the drop down list.
2. Click [Start Presentation](#). Then the text changes to [Stop Presentation](#).

Stop content sharing:

Click the [Stop Presentation](#) button that is present while sharing.

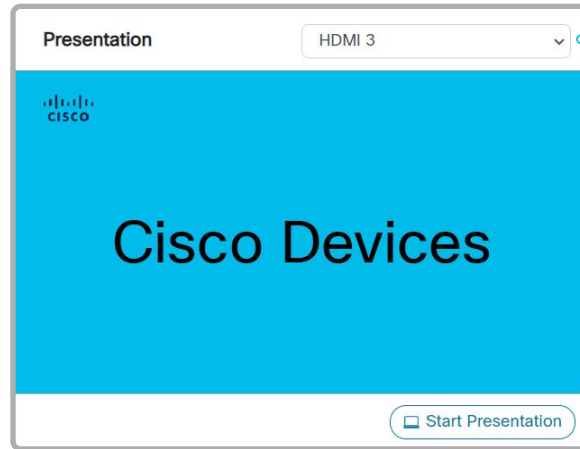

Presentation source drop down list

Choose which input source to share, from the drop down list.

Snapshot area

Shows snapshots of the selected presentation source.

Only available on devices that have the *Remote Monitoring* option.

About content sharing

You can connect a presentation source to a video input on your device. Most often a PC is used as presentation source, but other options may be available depending on your device setup.

While in a call you can share content with the other participants in the call (far end).

If you are not in a call, the content is shown locally.

- Board
- BoardPro, BoardPro G2
- Codec EQ
- Codec Plus
- Codec Pro
- Desk, DeskPro, DeskMini
- Room Bar Pro, Room Bar
- Room Kit, Room Kit Mini
- Room Kit EQX
- Room 55
- Room 55 Dual, Room 70
- Room 70 G2
- Room 70 Panorama
- Room Panorama

Local layout control

Sign in to the device web interface and go to [Call](#).

Note: Local layout control is not available in Panoramic video scenarios.

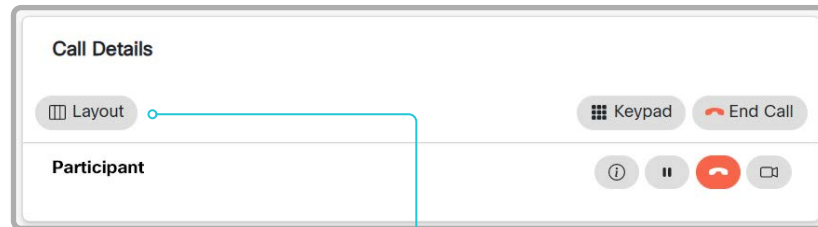

Change the layout

Click [Layout](#), and choose your preferred layout in the window that opens. *

The set of layouts to choose from depends on the device configuration.

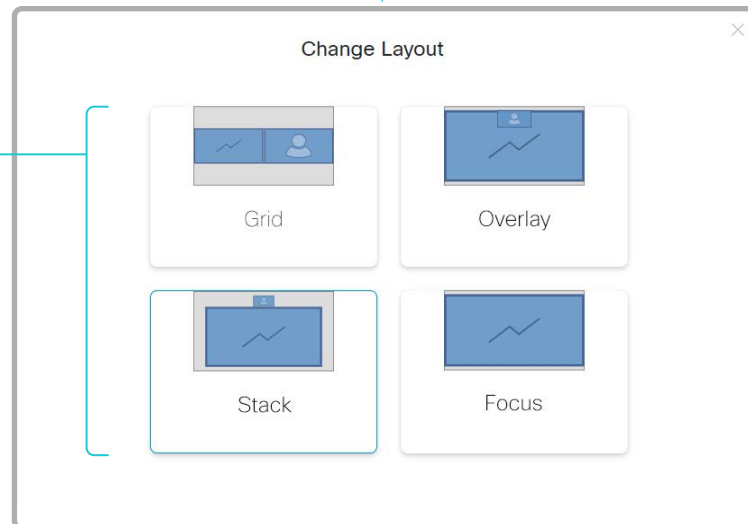

About layouts

The term layout is used to describe the various ways presentations and videos can appear on the screens. Different types of meetings may require different layouts.

The number of call or conference participants are reflected in the available choices.

Note: The set of layouts are currently being renamed. For a short period, you might see a mix of both the old and new names in use.

Old name	New name
Equal	Grid
Overlay	Overlay
Prominent	Stack
Single	Focus

* Changing the participant layout from the device web interface is not supported when calling a conference bridge, even if it is supported on the video conferencing device itself.

- Board
- Board Pro, Board Pro G2
- Codec EQ
- Codec Plus
- Codec Pro
- Desk, Desk Pro, Desk Mini
- Room Bar Pro, Room Bar
- Room Kit, Room Kit Mini
- Room Kit EQX
- Room 55
- Room 55 Dual, Room 70
- Room 70 G2
- Room 70 Panorama
- Room Panorama

Control a local camera

Sign in to the device web interface and go to [Call](#).

Prerequisites for manual camera control

- The [Video > Input > Connector n > CameraControl > Mode](#) setting is switched On .
- The camera has pan, tilt or zoom functionality.
- Best overview / Speaker tracking is switched off.
- Panoramic video is not in use.

Snapshot area

Shows snapshots of the selected camera (main input source).

Only available on devices that have the *Remote Monitoring* option.

Automatically refresh snapshots

Move the camera using the pan/tilt/zoom controls

Camera control is not available when speaker tracking / best overview is active.

1. If applicable, choose which camera to control in the *Main* source drop down list.
2. Click the camera icon to open the camera control window.
Video snapshots from the room are only displayed for devices that have the *Remote Monitoring* option.
3. Use the left and right arrows to pan the camera; the up and down arrows to tilt it; and + and - to zoom in and out.
Only relevant controls appear in the window.
4. Click *Close* to close the window.

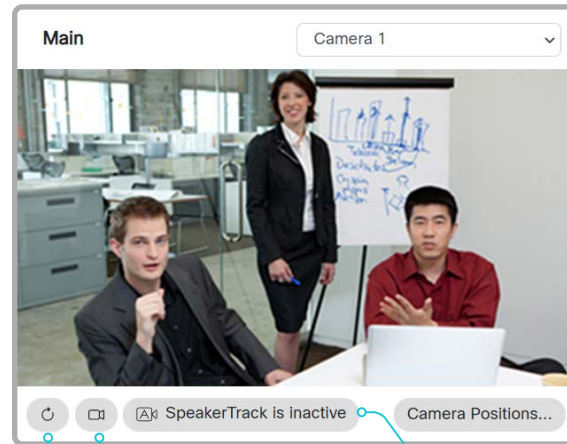

Main source drop down list

Choose which camera to control from the drop down list.

Products that support only one camera don't have a drop down list.

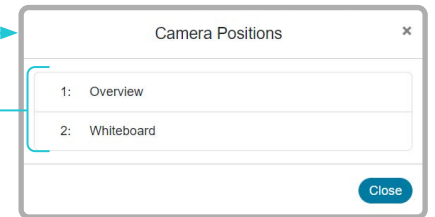

Move the camera to a preset position

1. If applicable, choose which camera to control in the *Main* source drop down list.
2. Click *Camera Positions...* to open a list of available presets.
If no presets are defined, the button is disabled and named *No Camera Positions*.
3. Click a preset's name to move the camera to the preset position.
4. Click *Close* to close the window.



You cannot use the device web interface to define a preset; you should use the user interface of the device.

When you select a preset camera position, speaker tracking / best overview will be switched off automatically.

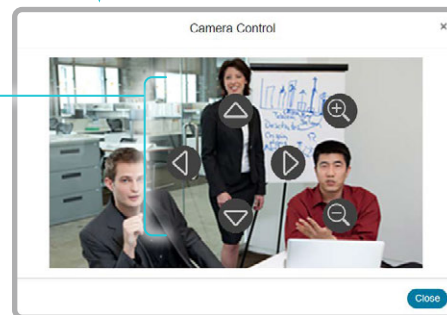

Best overview / Speaker tracking

Click to toggle the feature on and off.

- Board
- BoardPro, BoardPro G2
- Codec EQ
- Codec Plus
- Codec Pro
- Desk, DeskPro, DeskMini
- Room Bar Pro, Room Bar
- Room Kit, Room Kit Mini
- Room Kit EQX
- Room 55
- Room 55 Dual, Room 70
- Room 70 G2
- Room 70 Panorama
- Room Panorama

Control a far end camera

Sign in to the device web interface and go to [Call](#).

Prerequisites

While in a call, you can control the remote participant's camera (far end) provided that:

- Panoramic video is *not* in use.
- The [Conference > FarEndControl > Mode](#) setting is either switched On or set to Auto on the far end device.
 - If set to Auto, speaker tracking must be switched Off.
 - If set to On, speaker tracking will be disabled automatically when the device receives the first move command, and then re-enabled when the call ends.
- The far end camera has pan, tilt or zoom functionality. Only the relevant controls will appear.
- The local device has the *Remote Monitoring* option.



Control the remote participant's camera

1. Click the camera icon to open the remote camera control window.
2. Use the left and right arrows to pan the camera; the up and down arrows to tilt it; and + and - to zoom in and out.

If you are not allowed to control the far end camera, the controls will not appear in the image.

If the call is encrypted, the far end snapshot behind the controls are not displayed.

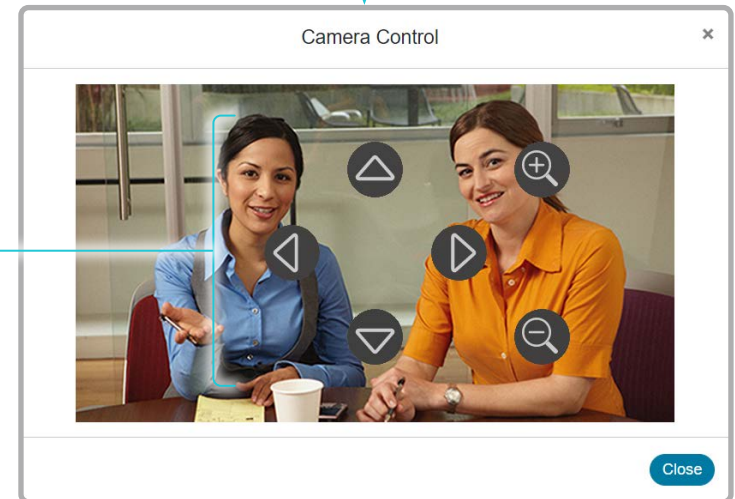

Board

BoardPro,
BoardPro
G2

Codec EQ

Codec
PlusCodec
ProDesk,
DeskPro,
DeskMiniRoom Bar
Pro,
Room BarRoom Kit,
Room Kit
MiniRoom Kit
EQX

Room 55

Room 55
Dual,
Room 70Room 70
G2Room 70
PanoramaRoom
Panorama

Room analytics (page 1 of 2)

The room analytics feature uses several variables from the conference room and re-uses them to analyze the room utilization over time or per call.

To find the settings referred below, sign in to the device web interface, go to [Settings](#), and select [Configurations](#). To find a status, go to [Settings](#), and select [Statuses](#).

Ambient noise reporting

The devices can report the stationary ambient noise level in the room. The reported value is an A-weighted decibel value (dBA), which reflects the response of the human ear. All signal processing related to this feature is local, the only data transmitted is the calculated noise level.

This value can be used to detect abnormal changes to the noise level. Such changes may be caused by noise that can be an annoyance for people working in the room. Facility management can then quickly intervene to troubleshoot the issue.

You can turn the ambient noise detection on or off from the device web interface. Use the [RoomAnalytics > AmbientNoiseEstimation > Mode](#) setting.

People presence detection

The device has the capability to find whether people are present in the room. It takes a minimum of two minutes to detect people presence, and after the room becomes vacant, it may take up to two minutes for the status to change.

This feature is based on ultrasound or head detection. It will not keep record of who was in the room, only whether there are people present.

You can turn the people presence detection on or off from the device web interface. Use the [RoomAnalytics > PeoplePresenceDetector](#) setting.

When turned on, you can further specify whether to use ultrasound, head detection, or both as input source for detection. Use the [RoomAnalytics > PeoplePresence > Input > HeadDetector](#) and [RoomAnalytics > PeoplePresence > Input > Ultrasound](#) settings.

People count

By using head detection*, the device can find how many people are in the room. It will not keep record of who was in the room, only the average number of people that were detected. Objects or pictures in the room that can be detected as heads might be counted.

The call must have a duration of minimum two minutes in order to get a reliable average. Calls that last less than two minutes, and calls which are made with people count disabled, will show "N/A" when you retrieve the call history.

By default, the device only counts people when in a call, or when it displays the selfview picture.

Use the [RoomAnalytics > PeopleCountOutOfCall](#) setting to enable people count also outside of call. Then people count is active even when selfview is off, and for shared devices that are not set up for hot desking, people count is also active when the device is in display off mode (the first low power / standby stage). However, people count is never active if the device is in networked standby (the second low power / standby stage).

For Codec EQ, Codec Pro and Codec Plus

- People count in call requires the use of a Quad Camera or SpeakerTrack 60 camera (*not supported by Codec EQ*).
- People count outside of call requires a Quad Camera.

Status

You may see the status at a given moment of people's presence and people count. Look at the [RoomAnalytics](#) status.

* Exception: The SpeakerTrack 60 camera is using a face detection algorithm instead of a head detection algorithm.

Board

BoardPro,
BoardPro
G2

Codec EQ

Codec
PlusCodec
ProDesk,
DeskPro,
DeskMiniRoom Bar
Pro,
Room BarRoom Kit,
Room Kit
MiniRoom Kit
EQX

Room 55

Room 55
Dual,
Room 70Room 70
G2Room 70
PanoramaRoom
Panorama

Room analytics (page 2 of 2)

Diagnostics

You can see the live people counter and other speaker track diagnostics information on-screen by enabling the SpeakerTrack Diagnostics mode from the user interface.

1. Swipe in from the right or tap the controls icon  in the upper, right corner to open the control panel. Then select *Device settings*.
2. Select *Issues and diagnostics* and toggle on *SpeakerTrack diagnostics*.

Now, the live people counter and other speaker track diagnostics information are both shown in selfview (outside of call and in a call) and sent to the far end (when in call).

Call history command

After a call the average people count value can be extracted from the Call History command.

- `xCommand CallHistory Get DetailLevel: Full`

The Call History command is available from the API (Application Programming Interface). Refer to the RoomOS API Reference Guide, for details. Go to:

► <https://www.cisco.com/go/room-docs>

► <https://www.cisco.com/go/board-docs>

► <https://www.cisco.com/go/desk-docs>

Board

Board Pro,
Board Pro
G2

Codec EQ

Codec
Plus

Codec
Pro

Desk,
Desk Pro,
Desk Mini

Room Bar
Pro,
Room Bar

Room Kit,
Room Kit
Mini

Room Kit
EQX

Room 55

Room 55
Dual,
Room 70

Room 70
G2

Room 70
Panorama

Room
Panorama

Customization

Customize the video conferencing device's user interface (page 1 of 2)

You can customize the user interface to allow control of peripherals in a meeting room, for example lights and blinds, or to modify the video conferencing device's behavior by triggering macros.

This allows for the powerful combination of a control system's functionality and the video conferencing device's user-friendly touch user interface.

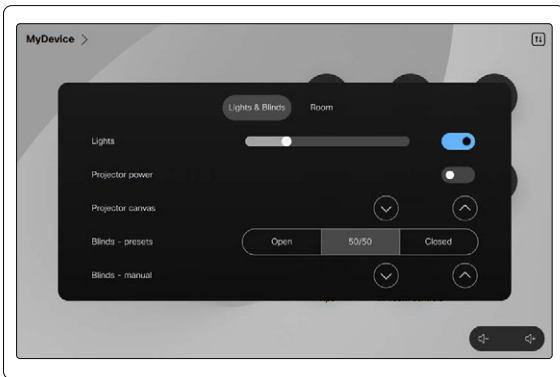

Example in-room control panel

Read the *Customization guide* for full details about how to design custom user interface panels, action buttons, and web apps using the UI Extensions editor, and how to use the video conferencing device's API to program the controls and actions. Go to:

[▶ https://www.cisco.com/go/in-room-control-docs](https://www.cisco.com/go/in-room-control-docs)

Also check out the Cisco RoomOS web site to find more information, examples, and other resources for customizations and macros. Go to:

[▶ https://roomos.cisco.com](https://roomos.cisco.com)

UI extensions control architecture

You need a Cisco video conferencing device with a touch interface (touch controller or integrated touch screen), and a macro or control system.

- The macro can use the device's API (events and commands) to trigger all sorts of functionality: Speed dial, language selection, customized system reset, and much more.
- The control system may be a third-party system, such as Crestron or AMX, with hardware drivers for peripherals. It is the control system, not the video conferencing device, that controls the peripherals.

When you program the control system you must use the video conferencing device's API (events and commands) in order to connect with the controls on the video conferencing device's user interface.

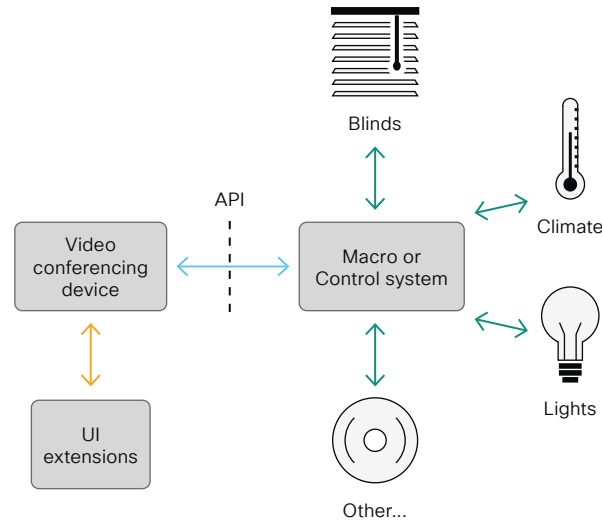

UI extensions control schematics

Board

BoardPro,
BoardPro
G2

Codec EQ

Codec
PlusCodec
ProDesk,
DeskPro,
DeskMiniRoom Bar
Pro,
Room BarRoom Kit,
Room Kit
MiniRoom Kit
EQX

Room 55

Room 55
Dual,
Room 70Room 70
G2Room 70
PanoramaRoom
Panorama

Customization

Customize the video conferencing device's user interface (page 2 of 2)

The UI Extensions editor

Free of charge editor

An easy to use drag-and-drop editor, which you should use to compose the custom user interface extensions (action buttons, web apps, and custom panels such as in-room controls), comes free of charge with the video conferencing device's software.

Sign in* to the device web interface and go to [UI Extensions Editor](#).

- The editor opens directly in the device web interface.
You can create and push a new panel, action button, or web app to the device, and see the result immediately on its user interface.

Preview function

The editor also provides a preview function, which allows you to see how the custom interfaces will appear on the user interface.

- Click  to start the preview.

The preview function is also a complete software version of your custom panels, so clicking the controls will result in the same actions as selecting them on the real user interface.

Therefore, you can use the preview function to test your integrations without having a real user interface available. You can also use the device's custom panels from a remote location.

* You need a user that holds the ROOMCONTROL, INTEGRATOR, or ADMIN user roles in order to access the UI Extensions editor and the API commands that you need when programming.

Board

BoardPro,
BoardPro
G2

Codec EQ

Codec
PlusCodec
ProDesk,
DeskPro,
DeskMiniRoom Bar
Pro,
Room BarRoom Kit,
Room Kit
MiniRoom Kit
EQX

Room 55

Room 55
Dual,
Room 70Room 70
G2Room 70
PanoramaRoom
Panorama

Customization

Customize the video conferencing device's behavior using macros

With macros, you can create your own snippets of code that run on the device. The language is JavaScript / ECMAScript 6 with support for features such as arrow functions, promises and classes.

The macro framework allows an integrator to write scripts that tailor a device's behavior to suite an individual customer's requirements. The integrators can, for example, implement their own features or variations of features, automate specific configurations or re-configurations, and create custom tests and monitoring functions.

By combining the use of macros and creation of a custom user interface panel (UI extension), you can amend the user interface to trigger customized local functionality. For examples:

- Add speed dial buttons
- Add a button for room reset, which set all configurations back to your preferred default setup

Consult the *Customization guide* for details about macros and how to use the device's built in Macro editor. Go to:

▶ <https://www.cisco.com/go/in-room-control-docs>

Also check out the Cisco RoomOS web site to find more information, examples, and other resources for customizations and macros. Go to:

▶ <https://roomos.cisco.com>

Allow using macros on the device

Sign in to the device web interface, go to *Settings*, and select *Configurations*.

- Set *Macros > Mode* to On.

If you try to launch the Macro editor while this setting is Off, a pop-up message appears. If you respond by tapping *Enable Macros*, the *Macros > Mode* setting will automatically change to On, and the editor will launch.

Launch the macro editor

Sign in* to the device web interface and go to *Macro Editor*.

This opens the Macro Editor, which is embedded in the device web interface. We don't offer a stand-alone editor.

The Macro editor

The Macro editor is a powerful tool where you can:

- Load our code examples, which you can modify, use as is, or use as inspiration when writing your own macros.
- Read our detailed macro scripting tutorial, which also explains the code examples in more detail.
- Write your own macros, and upload them to the device.
- Enable/Disable individual macros.
- Check in an embedded Log Console what happens when you run a macro.

* You need a user that holds the ADMIN user role in order to access the Macro editor.

Customization

Show or hide buttons and other elements on the user interface

In some use cases, you may never use a button, like *Call* or *Share*. Such unused buttons may cause confusion. In these cases, you can remove the unused buttons from the user interface. Custom UI buttons can be exposed still. Removing standard buttons while adding custom buttons makes it possible fully to customize the user interface.

For example, you can remove the *Call* and *Share* buttons if nobody is going to share content or call from this device. Instead, add custom buttons and panels for the tasks that are going to be performed.

You can also choose to hide other types of UI elements, for example camera controls, layout controls, booking and meeting information, participant list, web widgets, and more.

For a full list, check all the [UserInterface](#) configurations that are described in the [Device settings](#) chapter.

Further Information

Find more details about how to customize the user interface in the *Customization guide*. Go to:

► <https://www.cisco.com/go/in-room-control-docs>

Configurations

These are some of the configurations that show or hide buttons and UI elements. The configurations are available both from the device web interface, and in the API.

- [UserInterface > Features > Call > Start](#): Show or hide the default *Call* button (including the directory, favorites, and recent calls lists). Also affects the *Add participant* button while in a call.
- [UserInterface > Features > Call > JoinWebex](#): Show or hide the default button for joining a Webex meeting.
- [UserInterface > Features > Call > JoinGoogleMeet](#): Show or hide the button that allows users to dial into Google Meet meetings just by entering the meeting code. *(Only for devices that are registered to the Webex cloud service or linked to Webex Edge for Devices)*
- [UserInterface > Features > Call > JoinMicrosoftTeamsCVI](#): Show or hide the button that allows users to dial into Microsoft Teams meetings using the CVI solution, just by entering the video conference ID and passcode.
- [UserInterface > Features > Call > JoinZoom](#): Show or hide the button for joining a Zoom meeting.
- [UserInterface > Features > Share > Start](#): Removes the default user interface for sharing and previewing content, both in call and out of call.
- [UserInterface > Features > Whiteboard > Start](#): Show or hide the default button for starting a whiteboard. *(Only Board and Desk series devices, which have a touch screen, and Room devices that are connected to a touch screen; applies only to devices that are registered to the Webex cloud service or linked to Webex Edge for Devices)*
- [UserInterface > Features > Call > VideoMute](#): Show or hide the default *Turn video off* button.
- [UserInterface > Features > Call > End](#): Show or hide the *End Call* button.
- [UserInterface > Features > Call > MidCallControls](#): Show or hide the *Hold*, *Resume*, and *Transfer* in-call buttons.
- [UserInterface > Features > Call > LayoutControls](#): Show or hide the *Layout* button, which by default is available in call.
- [UserInterface > Features > Call > ParticipantList](#): Show or hide the *Participants* button, which by default

is available in call.

- [UserInterface > Features > Call > MusicMode](#): Removes the toggle button that enables Music mode on the device. Music mode is useful when the microphones should capture music.
- [UserInterface > Features > Call > Keypad](#): Removes the in-call *Keypad* button, which opens a keypad that can be used for DTMF input.
- [UserInterface > Features > Call > SelfviewControls](#): Show or hide the self-view controls on the user interface.
- [UserInterface > Features > Call > CameraControls](#): Show or hide the camera controls on the user interface (control panel).
- [UserInterface > Features > Call > HdmiPassthrough](#): Show or hide the *Call from laptop* button. *(Only Codec Plus, Codec Pro, Room Kit, Room 55, Room 70 Single, Room 70 G2)*
- [UserInterface > Features > Call > Webcam](#): Show or hide the *Call from laptop* button. *(Only Codec EQ, Room Bar, Room Bar Pro, Room Kit Mini, Room Kit EQX, Board Pro, Board Pro G2)*
- [UserInterface > Features > Files > Start](#): Show or hide the *Files* button. *(Only Board and Desk series devices, which have a touch screen, and Room devices that are connected to a touch screen; applies only to devices that are registered to the Webex cloud service or linked to Webex Edge for Devices)*
- [UserInterface > Help > Tips](#): Show or hide the *Tips* button, which gives access to information how to use the device.
- [UserInterface > Features > HideAll](#): Removes all the default buttons. Custom buttons are not removed.



The configurations remove only the buttons and UI elements, not the functionality as such. For example, you can share content using Proximity, even if you have removed the *Share* button from the user interface.

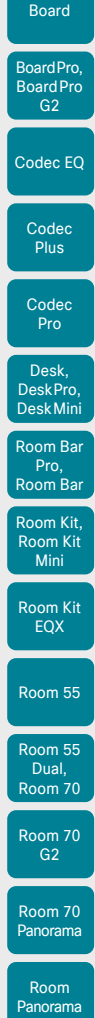

Board

BoardPro,
BoardPro
G2

Codec EQ

Codec
PlusCodec
ProDesk,
DeskPro,
DeskMiniRoom Bar
Pro,
Room BarRoom Kit,
Room Kit
MiniRoom Kit
EQX

Room 55

Room 55
Dual,
Room 70Room 70
G2Room 70
PanoramaRoom
Panorama

Customization

Use of a third-party USB input device

You can use a third-party USB input device to control certain functions on the video conferencing device. A Bluetooth remote control (with a USB dongle) and a USB keyboard are examples of such input devices.

This feature is meant to complement the functionality of the video conferencing device's user interface, wherever convenient. It is not meant to replace the user interface.

Examples of applications:

- In classrooms and during lectures, a small remote control can be used to wake up a video conferencing device from standby mode. Also, it may be convenient to use a remote control to select which input source to present.
- Controlling the camera view (pan, tilt, and zoom) in situations where you are not allowed to use the touch interface. For example, in operating rooms in a hospital.

Functional Overview

Pressing a button on the USB input device, generates an event in the API. Macros or third-party control devices can listen for such events, and respond to them. This behavior is similar to the behavior of custom UI buttons (UI extensions). It is also possible to listen for the events using webhooks, directly in an SSH session.

There isn't a library of actions readily available to select actions from. You must define and implement the actions to be taken as response to the events yourself. For example:

- Increase the volume of the video conferencing device when the Volume Up key is pressed.
- Put the video conferencing device in standby mode when the Sleep key is pressed.

Configurations, Events, and Status

The support for third-party USB input devices is disabled by default. Enable it explicitly by setting the *Peripherals > InputDevice > Mode* to On.

Pressing and releasing a button generates a Pressed and a Released event:

```
*e UserInterface InputDevice Key Action Key: <name of the key>
*e UserInterface InputDevice Key Action Code: <id of the key>
*e UserInterface InputDevice Key Action Type: Pressed
** end
*e UserInterface InputDevice Key Action Key: <name of the key>
*e UserInterface InputDevice Key Action Code: <id of the key>
*e UserInterface InputDevice Key Action Type: Released
** end
```

To listen for events, you must register feedback from the InputDevice events:

```
xFeedback Register /event/UserInterface/InputDevice
** end
```

When the video conferencing device detects the third-party input device, the input device is listed in the video conferencing device's *UserInterface > Peripherals > ConnectedDevice* status. The input device may be reported as multiple devices.

Required Equipment

- A device from the Cisco Webex Room, Board, or Desk Series.
- A third-party input device that advertises itself as a USB keyboard, for example a Bluetooth remote control with a USB dongle.

Further Information

Find more information about the use of a third-party input device in the *Customization guide*. Go to:

► <https://www.cisco.com/go/in-room-control-docs>

Cisco support (TAC) doesn't support debugging of third-party code, including macros. Please check the ► [Cisco Collaboration Developer community](#) if you need help with macros and third-party code.

Customization

Sending HTTP(S) requests

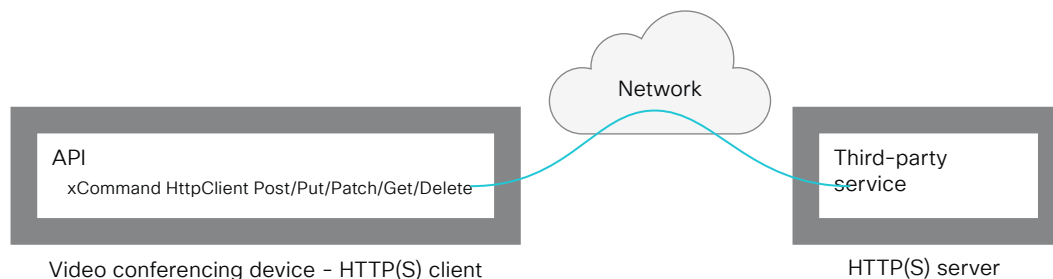

The HTTP(S) request feature makes it possible to send arbitrary HTTP(S) requests from a video conferencing device to an HTTP(S) server. Furthermore, the device receives the response that the server sends back. The device supports the **Post**, **Put**, **Patch**, **Get**, and **Delete** methods.

By using macros, you can send data to an HTTP(S) server whenever you want. You can choose what data to send, and structure them as you like. By doing it this way, you can adapt the data to an already established service.

Security measures:

- The HTTP(S) request feature is disabled by default. A system administrator must explicitly enable the feature by setting `HttpClient > Mode` to **On**.
- The system administrator can prevent the use of HTTP by setting `HttpClient > AllowHTTP` to **False**.
- The system administrator can specify a list of HTTP(S) servers that the device is allowed to send data to.
- The number of concurrent HTTP(S) requests is limited.

List of Allowed HTTP(S) servers

The system administrator can use these commands to set up and maintain a list of up to ten allowed HTTP(S) servers (hosts):

- `xCommand HttpClient Allow Hostname Add`
Expression: <Regular expression that matches the host name or IP address of the HTTP(S) server>
- `xCommand HttpClient Allow Hostname Clear`
- `xCommand HttpClient Allow Hostname List`
- `xCommand HttpClient Allow Hostname Remove Id:`
<id of an entry in the list>

If the list is not empty, you can send HTTP(S) requests only to the servers in the list. If the list is empty, you can send the requests to any HTTP(S) server.

The check against the list of allowed servers is performed both when using insecure (HTTP) and secure (HTTPS) transfer of data.

HTTPS without certificate validation

When sending requests over HTTPS, the video conferencing device checks the certificate of the HTTPS server by default. If the HTTPS server certificate is not found to be valid, you get an error message. The device doesn't send any data to that server.

We recommend using HTTPS with certificate validation. If certificate validation is not possible, the system administrator can set `HttpClient > AllowInsecureHTTPS` to **On**. This allows the use of HTTPS without validating the certificate of the server.

Sending HTTP(S) requests

Once the HTTP(S) request feature is enabled, you can use the following commands to send requests to an HTTP(S) server:

```

xCommand HttpClient <Method>
  [AllowInsecureHTTPS: <True/False>]
  [Header: <Header text>]
  [ResponseSizeLimit: <Maximum response size>]
  [ResponseBody: <None/PlainText/Base64>]
  [Timeout: <Timeout period>]
  Url: <URL to send the request to>
  
```

where <Method> is either **Post**, **Put**, **Patch**, **Get**, or **Delete**.

The **Post**, **Put**, and **Patch** commands are multiline commands. Read the API guide to find out how to use multiline commands, and also to find a detailed description of the command parameters

Further information

Find more information about HTTP(S) Post requests in the *Customization guide*. Go to:

► <https://www.cisco.com/go/in-room-control-docs>

Board

BoardPro,
BoardPro
G2

Codec EQ

Codec
PlusCodec
ProDesk,
DeskPro,
DeskMiniRoom Bar
Pro,
Room BarRoom Kit,
Room Kit
MiniRoom Kit
EQX

Room 55

Room 55
Dual,
Room 70Room 70
G2Room 70
PanoramaRoom
Panorama

Board

Board Pro,
Board Pro
G2

Codec EQ

Codec
PlusCodec
ProDesk,
Desk Pro,
Desk MiniRoom Bar
Pro,
Room BarRoom Kit,
Room Kit
MiniRoom Kit
EQX

Room 55

Room 55
Dual,
Room 70Room 70
G2Room 70
PanoramaRoom
Panorama

Web view based features

Digital signage

Digital signage allows you to show custom content (a web page) on a device when it's in half-wake state. Digital signage is a way to display advertising content and promote your brand, but also to show visitor and internal employee information, dashboards, or calendars.

The content replaces the traditional half-wake background image and information, and is always shown on full screen. Only one web window or tab is supported. If a web page tries to open a page in a new window or tab, it replaces the current page.

Data, such as cache, cookies, and local storage, is NOT automatically cleared when the device restarts. You must use the delete storage command to delete the data.

- `xCommand WebEngine DeleteStorage [Type: WebApps]`

If a web page is not supported, the device goes directly to normal half-wake mode.

Interactive mode

Applies to: Board, Board Pro, Board Pro G2, Desk, Desk Mini, Desk Pro, and Room devices that are connected to a touch screen

Users can interact with the content on the screen, for example click on a link or enter text in a form.

Set up digital signage

1. Sign in to the device web interface, go to [Settings](#), and select [Configurations](#).
2. Set [WebEngine > Mode](#) to **On** to enable the web engine.
3. Set [Standby > Signage > Mode](#) to **On** to enable digital signage.
4. Enter the URL of the web page that you want to show in [Standby > Signage > Url](#).
5. The web page is shown *before* the device enters standby mode. Use the following settings to determine for how long the web page is shown.

[Standby > Mode](#): If set to **Off**, the device never enters standby mode (not recommended). If set to **On**, the device enters standby mode when the [Standby > Delay](#) has timed out.

[Standby > Delay](#): Define how long (in minutes) the device shows the web page before going into standby mode.

[Standby > WakeUpOnMotionDetection](#): If set to **On**, the device wakes up automatically from standby, and starts showing the web page when people enter the room. If set to **Off**, the device is not affected by people entering the room.

Other digital signage settings:

- Decide whether to play out the audio for web pages that have audio.
 - [Standby > Signage > Audio](#)
- If supported, decide whether to allow interaction with the web page.
 - [Standby > Signage > InteractionMode](#)
- Force a web page to refresh at regular intervals. This is useful for web pages that don't refresh themselves.
 - [Standby > Signage > RefreshInterval](#)

The web engine

All web view based features are using the web engine. Therefore the web engine must be enabled before you can use a web view based feature.

The web engine is based on Chromium / Qt WebEngine with V8 JavaScript. The Chromium version is updated regularly, but it might be older than your Chrome laptop version.

These features are not supported: PDF, WebGL, password manager, plug-ins, downloading and uploading files, and notifications. Devices that are not registered to the Webex cloud service or linked to Webex Edge for devices neither support WebRTC.

Remote debugging

If you encounter a problem with a web page, you can turn on remote debugging.

[WebEngine > RemoteDebugging](#)

Remote debugging lets you access the Chrome developer console and identify potential issues with a web page. When enabled, a banner is displayed at the bottom of the screen, warning the users that they may be monitored. The banner also shows the URL that you can enter in your local Chrome browser to open the developer console.

Using a proxy

You can set up the device to use an HTTP proxy for web view based features.

[NetworkServices > HTTP Proxy](#)

Additionally, this setting must be **On**:

[WebEngine > UseHttpProxy](#)

Board

BoardPro,
BoardPro
G2

Codec EQ

Codec
PlusCodec
ProDesk,
DeskPro,
DeskMiniRoom Bar
Pro,
Room BarRoom Kit,
Room Kit
MiniRoom Kit
EQX

Room 55

Room
55 Dual,
Room 70Room 70
G2Room 70
PanoramaRoom
Panorama

Web view based features

Web apps

A web app is a web page or application that a user can access from the home screen of the device. The web app is available only when not in a call.

A web app launches in full screen, and times out after 15 minutes if not being used. The web app may be interactive.

Data, such as cache, cookies, and local storage, is automatically cleared when the session ends.

You must use the *UI Extensions editor*, which is available from the device web interface, to create web apps. The editor also lets you configure the label and icon to be used on the Home screen. By default, the web page's icon is used, but you can choose another icon instead.

Icon details:

- Formats: .ico, .png, .jpg, .svg, or .gif
- Icon size: Minimum 60×60 pixels, maximum 1200×1200 pixels

Typical apps may be Office 365, Trello, Wikipedia, YouTube or company internal web pages and tools.

Further information

Find more information about how to create web apps in the *Customization guide*. Go to:

► <https://www.cisco.com/go/in-room-control-docs>

Create a web app

1. Sign in* to the device web interface, go to *Settings*, and select *Configurations*.
2. Set *WebEngine > Mode* to On to enable the web engine.
3. Go to *UI Extensions Editor*, and the editor opens directly in the device web interface.
4. Click *New* and select the Web App *Add* button.
5. Fill in the web app properties in the right side bar:
 - Id: Unique identifier of the app.
 - Name: The label of the button.
 - Web app URL: The web app URL.
 - Web app icon URL (optional): The icon for the button.
 - Web app location: On the Home screen, in the call controls, both places, or nowhere.
6. Click the export button  in the top bar to upload the configuration to the device.
Now you can see the button for the new web app on the Home screen.



Web app button with label and icon on the Home screen

The web engine

All web view based features are using the web engine. Therefore the web engine must be enabled before you can use a web view based feature.

The web engine is based on Chromium / Qt WebEngine with V8 JavaScript. The Chromium version is updated regularly, but it might be older than your Chrome laptop version.

These features are not supported: PDF, WebGL, password manager, plug-ins, downloading and uploading files, and notifications. Devices that are not registered to the Webex cloud service or linked to Webex Edge for devices neither support WebRTC.

Remote debugging

If you encounter a problem with a web page, you can turn on remote debugging.

[WebEngine > RemoteDebugging](#)

Remote debugging lets you access the Chrome developer console and identify potential issues with a web page. When enabled, a banner is displayed at the bottom of the screen, warning the users that they may be monitored. The banner also shows the URL that you can enter in your local Chrome browser to open the developer console.

Using a proxy

You can set up the device to use an HTTP proxy for web view based features.

[NetworkServices > HTTP Proxy](#)

Additionally, this setting must be On:

[WebEngine > UseHttpProxy](#)

* You need a user that holds the ROOMCONTROL, INTEGRATOR, or ADMIN user roles in order to access the UI Extensions editor and the API commands that you need when programming.

Board

BoardPro,
BoardPro
G2

Codec EQ

Codec
PlusCodec
ProDesk,
DeskPro,
DeskMiniRoom Bar
Pro,
Room BarRoom Kit,
Room Kit
MiniRoom Kit
EQX

Room 55

Room 55
Dual,
Room 70Room 70
G2Room 70
PanoramaRoom
Panorama

Web view based features

API-driven web views

Web views can be opened and closed using API commands. Integrators can use these commands when making third-party integrations or macros. The integrator decides which URL to load based on external events. An example is to show important company alerts.

The web view is fullscreen and will time out after 15 minutes, or by calling the API command to close the view.

Open the web view:

- `xCommand UserInterface WebView Display Url: <url>`

Close the web view:

- `xCommand UserInterface WebView Clear`

Data, such as cache, cookies, and local storage, is automatically cleared when the session ends.

By combining API-driven web views, macros, and custom buttons on the touch controller, an integrator can make interactive solutions also for devices without touch screens. Tapping different buttons on the touch controller shows different web views on the main screen. For example to open and browse basic help pages or show instructional videos.

The web engine

All web view based features are using the web engine. Therefore the web engine must be enabled before you can use a web view based feature.

The web engine is based on Chromium / Qt WebEngine with V8 JavaScript. The Chromium version is updated regularly, but it might be older than your Chrome laptop version.

These features are not supported: PDF, WebGL, password manager, plug-ins, downloading and uploading files, and notifications. Devices that are not registered to the Webex cloud service or linked to Webex Edge for devices neither support WebRTC.

Remote debugging

If you encounter a problem with a web page, you can turn on remote debugging.

[WebEngine > RemoteDebugging](#)

Remote debugging lets you access the Chrome developer console and identify potential issues with a web page. When enabled, a banner is displayed at the bottom of the screen, warning the users that they may be monitored. The banner also shows the URL that you can enter in your local Chrome browser to open the developer console.

Using a proxy

You can set up the device to use an HTTP proxy for web view based features.

[NetworkServices > HTTP Proxy](#)

Additionally, this setting must be On:

[WebEngine > UseHttpProxy](#)

- Board
- BoardPro, BoardPro G2
- Codec EQ
- Codec Plus
- Codec Pro
- Desk, DeskPro, DeskMini
- Room Bar Pro, Room Bar
- Room Kit, Room Kit Mini
- Room Kit EQX
- Room 55
- Room 55 Dual, Room 70
- Room 70 G2
- Room 70 Panorama
- Room Panorama

Input source composition (page 1 of 2)

You can use the device's API to combine up to four input sources in a single main video stream.

The maximum number of *different* input sources depends on the device:

Video conferencing device	Maximum number of different input sources
Desk Mini, Room Kit, Room Kit Mini	2
Codec Plus, Room Bar, Room Bar Pro, Room 55, Room 55 Dual, Room 70, Desk, Desk Pro, Board Pro, Board Pro G2	3
Codec EQ, Codec Pro, Room Kit EQX, Room 70 G2, Room Panorama*, Room 70 Panorama*	4

Source composition

Composition layout

You can choose between three layouts:

- Grid
- Stack
- PIP (only available when composing two input sources)

You can modify the PIP position to one of the corners. The size of the PIP can be normal or large.

The composition and layout can be modified at any time, both in call and outside of call.

Selfview

Selfview shows the same composed image that is being sent to the far end.

Individual camera control

You can control individual cameras using API commands (`xCommand Camera *`), but you cannot use the controls on the user interface.

When you select a camera in the user interface, the main video stream will automatically switch from the composed video stream to the single stream from the chosen camera.

Change compositions and layouts on demand

Input source composition is only available using API commands; we don't provide a dedicated user interface for it.

To be able to easily change compositions and layouts on demand, we recommend that you use macros and create a custom user interface panel (UI extension) for it.

Layouts

Grid

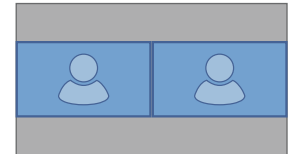

Number of sources: 2

Stack

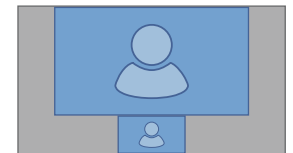

Number of sources: 2

Picture-in-Picture (PIP)

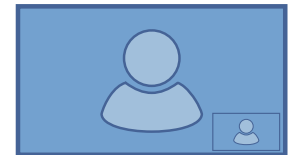

Lower right corner



Lower right corner, large PIP

* *Room 70 Panorama and Room Panorama*: These devices use two input sources for the main camera.

- Board
- BoardPro, BoardPro G2
- Codec EQ
- Codec Plus
- Codec Pro
- Desk, DeskPro, Desk Mini
- Room Bar Pro, Room Bar
- Room Kit, Room Kit Mini
- Room Kit EQX
- Room 55
- Room 55 Dual, Room 70
- Room 70 G2
- Room 70 Panorama
- Room Panorama

Input source composition (page 2 of 2)

API command

```
xCommand Video Input SetMainVideoSource
ConnectorId: <1..n> SourceId: <1..m>
Layout: <Equal, PIP, Prominent>
PIPPosition <LowerLeft, LowerRight,
UpperLeft, UpperRight>
PIPSize <Auto, Large>
```

where

The input source can be identified by either the physical connector that it is connected to (ConnectorId), or by the logical source identifier (SourceId). There cannot be a mix of different types of identifiers in the same command; use either ConnectorId or SourceId. You can find these identifiers in the *Video Input Connector* and *Video Input Source* statuses.

You see the difference between the Grid (Layout: Equal), PIP (Layout: PIP), and Stack (Layout: Prominent) layouts in the examples.

You can modify the PIP position to one of the corners. The size of the PIP can be normal (auto) or large.

Refer to the API-guide for more details.

Examples

```
xCommand Video Input SetMainVideoSource ConnectorId: 1 ConnectorId: 2 ConnectorId: 3 ConnectorId: 4 Layout: Equal
```

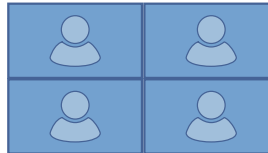

```
xCommand Video Input SetMainVideoSource ConnectorId: 1 ConnectorId: 2 Layout: Equal
```

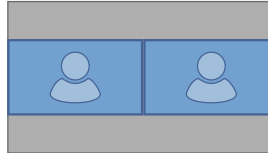

```
xCommand Video Input SetMainVideoSource SourceId: 1 SourceId: 2 Layout: PIP PIPPosition: LowerRight PIPSize: Large
```

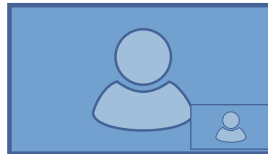

```
xCommand Video Input SetMainVideoSource SourceId: 1 SourceId: 2 SourceId: 3 SourceId: 4 Layout: Prominent
```

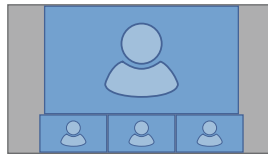

```
xCommand Video Input SetMainVideoSource SourceId: 1 SourceId: 2 Layout: Prominent
```

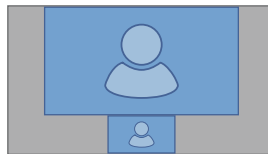

- Board
- Board Pro, Board Pro G2
- Codec EQ
- Codec Plus
- Codec Pro
- Desk, Desk Pro, Desk Mini
- Room Bar Pro, Room Bar
- Room Kit, Room Kit Mini
- Room Kit EQX
- Room 55
- Room 55 Dual, Room 70
- Room 70 G2
- Room 70 Panorama
- Room Panorama

Presentation source composition (page 1 of 2)

You can use the device's API to combine up to four presentation sources in a single video stream.*

The maximum number of *different* presentation sources depends on the device:

Video conferencing device	Maximum number of different presentation sources
Desk Mini, Room Kit, Room Kit Mini, Board	2
Codec Plus, Room Bar, Room Bar Pro, Room 55, Room 55 Dual, Room 70, Desk, Desk Pro, Board Pro, Board Pro G2	3
Codec EQ, Codec Pro, Room Kit EQX, Room 70 G2, Room Panorama*, Room 70 Panorama*	4

You can only share sources that has been shared through a cable (HDMI or USB-C - depending on the device).

Source composition

Composition layout

You can choose between two layouts:

- Grid
- Stack

You can change the number of sources at any time, both in call and outside of call. The image sizes cannot be modified.

The order in which the sources appear on the screen depends on the order they have in the command; starting from upper left, ending at bottom right.

Change compositions and layouts on demand

Presentation source composition is only available using API commands; we don't provide a dedicated user interface for it.

To be able to easily change compositions and layouts on demand, we recommend that you use macros and create a custom user interface panel (UI extension) for it.

Layouts

Grid

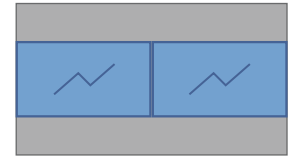

Number of sources: 2

Stack



Number of sources: 2

* *Room 70 Panorama and Room Panorama*: These devices use two input sources for the main camera.

Board

BoardPro,
BoardPro
G2

Codec EQ

Codec
Plus

Codec
Pro

Desk,
DeskPro,
DeskMini

Room Bar
Pro,
Room Bar

Room Kit,
Room Kit
Mini

Room Kit
EQX

Room 55

Room 55
Dual,
Room 70

Room 70
G2

Room 70
Panorama

Room
Panorama

Presentation source composition (page 2 of 2)

API command

```
xCommand Presentation Start
ConnectorId: <1..n>
PresentationSource: <None, 1..n>
Instance: <New, 1..n>
Layout: <Equal, Prominent>
SendingMode: <LocalRemote, LocalOnly>
```

where

The input source can be identified by either the physical connector that it is connected to (ConnectorId), or by the logical source identifier (PresentationSource). There cannot be a mix of different types of identifiers in the same command; use either ConnectorId or PresentationSource.

You can find these identifiers in the *Video Input Connector* and *Video Input Source* statuses.

If you select PresentationSource: None, a black frame is inserted. *

You see the difference between the Grid (Layout: Equal) and Stack (Layout: Prominent) layouts in the examples.

Refer to the API-guide for more details.

Examples

```
xCommand Presentation Start PresentationSource: 1 PresentationSource: 2 Layout: Equal
```



```
xCommand Presentation Start ConnectorId: 1 ConnectorId: 2 Layout: Prominent
```

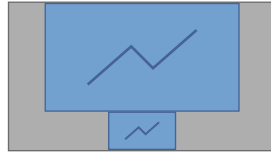

```
xCommand Presentation Start ConnectorId: 1 ConnectorId: 2 ConnectorId: 3 Layout: Equal
```



```
xCommand Presentation Start PresentationSource: 1 PresentationSource: 2 PresentationSource: 3 Layout: Prominent
```



* Board: None is not available.

Board

BoardPro,
BoardPro
G2

Codec EQ

Codec
PlusCodec
ProDesk,
DeskPro,
DeskMiniRoom Bar
Pro,
Room BarRoom Kit,
Room Kit
MiniRoom Kit
EQX

Room 55

Room 55
Dual,
Room 70Room 70
G2Room 70
PanoramaRoom
Panorama

Access the device's XML files

Sign in to the device web interface and go to [Developer API](#).

The XML files are part of the device's API. They structure information about the device in a hierarchy.

- *Configuration.xml* contains the current device settings (configuration). These settings are controlled from the device web interface or from the API (Application Programmer Interface).
- The information in *status.xml* is constantly updated by the device to reflect system and process changes. The status information is monitored from the device web interface or from the API.
- *Command.xml* contains an overview of the commands available to instruct the device to perform an action. The commands are issued from the API.
- *Valuespace.xml* contains an overview of all the value spaces of device settings, status information, and commands.

Open an XML file

Click the file name to open the XML file.

About the API

The application programming interface (API) is a tool for integration professionals and developers working with the device. The API is described in detail in the API guide for the device.

Also, find information for integrators and developers on:

► <https://roomos.cisco.com>

Board

BoardPro,
BoardPro
G2

Codec EQ

Codec
Plus

Codec
Pro

Desk,
Desk Pro,
Desk Mini

Room Bar
Pro,
Room Bar

Room Kit,
Room Kit
Mini

Room Kit
EQX

Room 55

Room 55
Dual,
Room 70

Room 70
G2

Room 70
Panorama

Room
Panorama

Execute API commands and configurations from the device web interface

Sign in to the device web interface and go to [Developer API](#).

Commands (xCommand) and configurations (xConfiguration) can be executed from the device web interface. Syntax and semantics are explained in the API guide for the device.

Execute API commands and configurations

1. Enter a command (xCommand or xConfiguration), or a sequence of commands, in the text area.
2. Click *Execute* to issue the command(s).

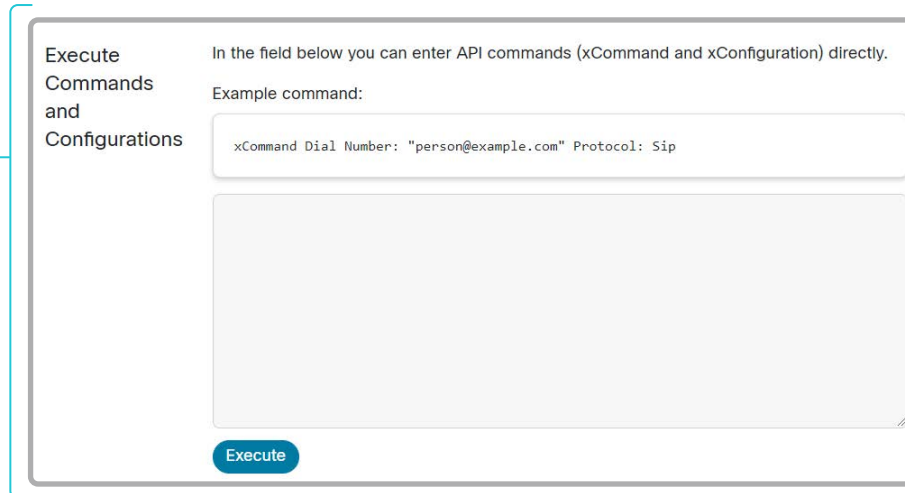

About the API

The application programming interface (API) is a tool for integration professionals and developers working with the device. The API is described in detail in the API guide for the device.

Also, find information for integrators and developers on:

► <https://roomos.cisco.com>

Board

BoardPro,
BoardPro
G2

Codec EQ

Codec
PlusCodec
ProDesk,
Desk Pro,
DeskMiniRoom Bar
Pro,
Room BarRoom Kit,
Room Kit
MiniRoom Kit
EQX

Room 55

Room
55 Dual,
Room 70Room 70
G2Room 70
PanoramaRoom
Panorama

Advanced customization of audio (page 1 of 5)

Introducing Audio Console

The Audio Console application provides a graphical interface to advanced customizable audio features. It lets you define how to connect audio inputs to outputs, using simple drag and drop techniques.

The main features of the Audio Console are:

- Configure the audio system of the codec
- Change the default mixing, routing and equalizers
- Set various input and output connector properties
- Configure advanced features such as local reinforcement

These products support Audio Console:

- Codec Pro / Room Kit Pro
- Room 70 G2
- Room 70 Panorama and Room Panorama
- Codec EQ with AVIntegrator option¹
- Room Kit EQX with AVIntegrator option¹

Open the Audio Console

Sign in to the device web interface and go to [Audio Console](#).

This opens the Audio Console application, which is embedded in the device web interface.

Using the Audio Console

Start by defining logical input and output groups. These can be given names as defined by you. Then assign physical, and in some cases logical, inputs and outputs to the logical input and output groups.

New logical groups may be added or removed at any time.

Changes applied to the settings are immediately saved and put into effect.

A physical output cannot be assigned to more than a single logical output group; however, a physical input, such as a microphone, can be assigned to more than one input. This comes in handy when working with local sound reinforcement and extra loudspeakers, for example when using a video device in a lecture hall where the local audience also must hear what is being said through the microphone.

Through Audio Console you can set up *Echo Control* on the part of the microphone signal that is sent to the far end. At the same time, it omit *Echo Control* for the part used locally. This is done by assigning that microphone to more than one logical group by using *Direct: On*.

You may also apply noise reduction and equalizer settings to the microphone signal.

Line level on microphone inputs

Neither Codec EQ nor Codec Pro based devices^{2,3} have dedicated line inputs, but you may use the microphone inputs for line level. Which actions to take depend on the device type.

Codec Pro based devices:

Deactivate phantom power ([Audio > Input > Microphone \[n\] > PhantomPower](#)) and lower the input gain ([Audio > Input > Microphone \[n\] > Level](#)). The maximum input level when configured for minimum gain is +24 dBu.

If you don't want the regular mute buttons to mute and unmute an input that is set up for line level, set [Audio > Input > Microphone \[n\] > MuteOverride](#) to On.

Codec EQ based devices:

The maximum input level when configured for minimum gain is -18 dBu. If the source delivers a higher maximum level external attenuation is needed to avoid clipping the input signal.

The regular mute buttons will mute and unmute an input that is set up for line level just like the other microphone inputs.

Audio from the device's local web browser

To receive audio from WebRTC calls or other WebEngine related sources, the Audio Console needs an input group containing the WebView 1 connector that is routed to the output group with the loudspeakers.

If WebEngine mode is enabled when you first set up the Audio Console, this input group is already in place. However, if WebEngine mode is enabled after that first setup, you will need to create the group manually.

Local sound reinforcement

See the [Using Extra Loudspeakers and Sound Reinforcement](#) guide for a comprehensive description and best practices for such a solution.

Go to: <https://www.cisco.com/go/in-room-control-docs>

¹ See the [Add option keys](#) chapter how to install an option key.

² Room 70 G2, Room 70 Panorama, and Room Panorama are based on Codec Pro.

³ Room Kit EQX is based on Codec EQ.

Board

Board Pro,
Board Pro
G2

Codec EQ

Codec
Plus

Codec
Pro

Desk,
Desk Pro,
Desk Mini

Room Bar
Pro,
Room Bar

Room Kit,
Room Kit
Mini

Room Kit
EQX

Room 55

Room
55 Dual,
Room 70

Room 70
G2

Room 70
Panorama

Room
Panorama

Advanced customization of audio (page 2 of 5)

Audio Return Channels (ARC)

HDMI offers the ability to transmit audio in either direction. When audio is sent in reverse, this is referred to as an Audio Return Channel (ARC).

Consider the illustrated configuration, showing a Quad Camera, a screen, and a Codec Pro connected via HDMI. The Quad Camera will act as both camera and soundbar in this setting. Codec Pro is just an example; it can be replaced by any of the products that support Audio Console.

Using the loudspeakers of the Quad Camera

Typically, the HDMI 1 Input is used to provide video from the camera to the codec, and the audio return channel of the same HDMI Input is used to route the audio from the codec to the loudspeakers of the camera.

Using the Quad Camera as soundbar for a TV

Codec Pro, Room 70G2, Room 70 Panorama, Room Panorama

If you want to use the setup as just a TV with a soundbar, the system will send audio from the screen to the codec through the ARC of the codec's HDMI 1 Output, and the codec will send that audio further to the Quad Camera through the ARC of the codec's HDMI 1 Input.

In order to be able to do this, the screen must be CEC+ARC enabled. If your setup makes use of 4K video, the screen must support CEC+ARC in 4K format.

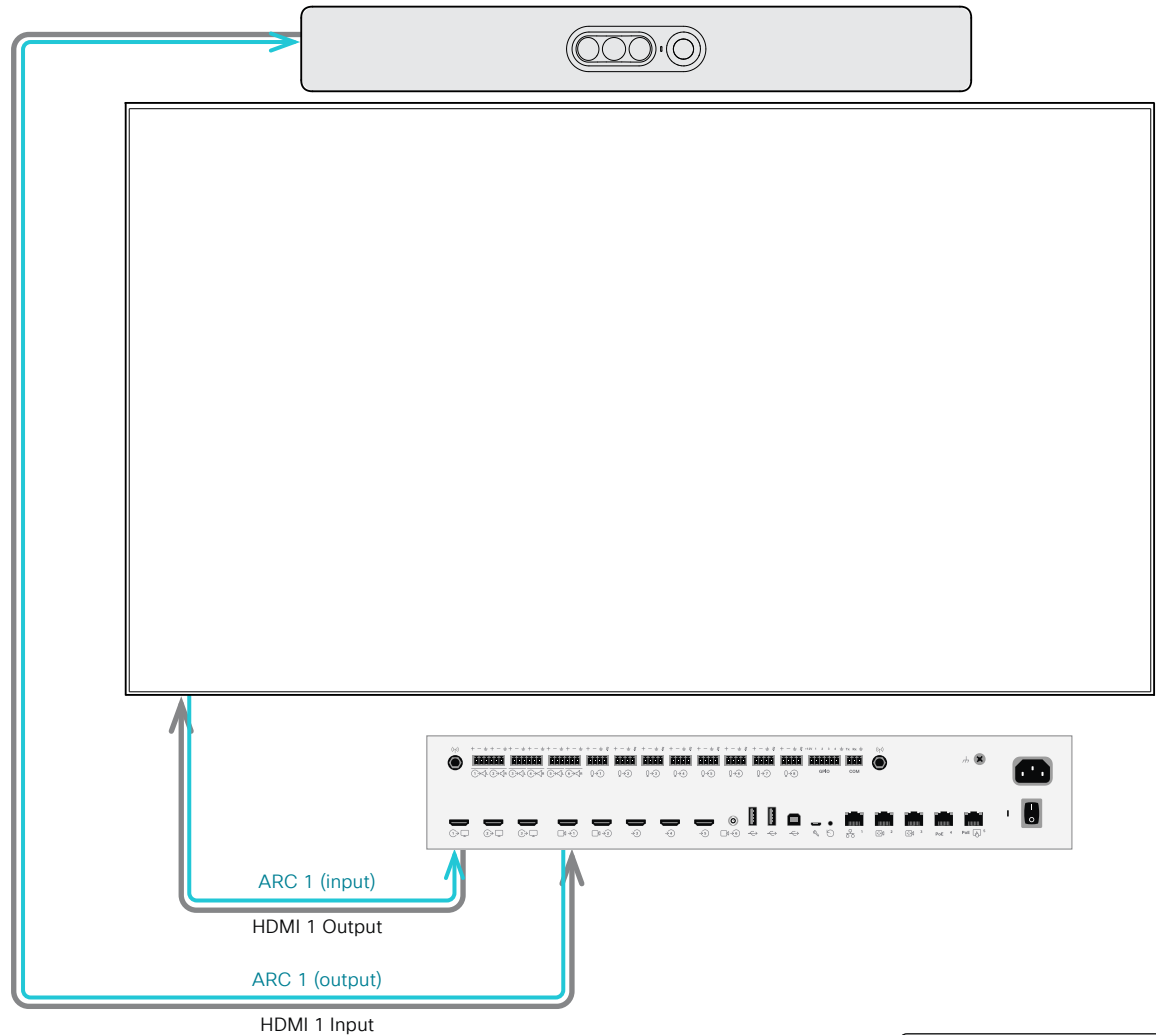

Advanced customization of audio (page 3 of 5)

The Audio Console panel

The Audio Console can be found under *Customization* in the Web interface of your device.

To delete a connection or adjust its gain, right-click on the cable illustration.

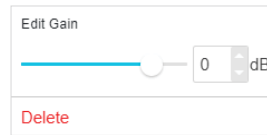

Reset to default will create a preset of connections based on connected devices detected.

The pool of Input connectors (physical or logical) available.

The Input connectors are assigned to logical Input groups. These logical Input groups are created by you.

The name of a logical group is specified by you when clicking on *New input group*.

A given *Input* connector may be assigned to more than one logical group. Use drag-and-drop.

To remove a group or a member of a group, hover the mouse over the group or member. An X will appear. Click on this to remove the item.

Expand the logical group rather than the individual members when using it for local reinforcement.

In local reinforcement scenarios, set the microphones to *Direct* to bypass extra processing, such as echo control.

This will minimize latency and also serve to avoid that the main volume control also affects the volume of the local presenter.

The screenshot shows the 'Audio Console' interface with several panels:

- Input connectors:** A list of physical connectors including HDMI 1-3, Line 1-4, and Microphone 1-8.
- Input groups:** A list of logical groups including Microphone (with members 1-8), HDMI input 1-3 (all muted), and Local reinforcement (with member Microphone 1).
- Output groups:** A list of logical groups including Loudspeaker (with members HDMI 1-2, Line 1-2), Recorder (with members Line 5-6), and Local reinforcement (with members Line 3 and Line 4).
- Output connectors:** A list of physical connectors, currently showing 'None available'.
- Local reinforcement settings:** Detailed settings for 'Local reinforcement' including Direct (Off), Mixer Mode (Fixed), Mute (Off), AGC (Off), Channels (1), and Equalizer (Off).
- Local reinforcement settings (Line 3):** Detailed settings for 'Local reinforcement' Line 3 including Mode (On), Level (dB) (-4), Channel (Left), Delay (ms) (32), Delay Mode (Fixed), and Equalizer (Off).
- Local reinforcement settings (Line 4):** Detailed settings for 'Local reinforcement' Line 4 including Mode (On), Level (dB) (-4), Channel (Right), Delay (ms) (32), Delay Mode (Fixed), and Equalizer (Off).

Click a connector and drag it into a group.

Click and drag between an Input group and Output group to establish a connection between them.

This is the pool of physical output connectors. Those that are not used are considered to be inactive.

The logical output groups are similar to the logical Input groups, but a physical output cannot be assigned to more than one logical output group.

We recommend that you set *Delay Mode* to *Fixed* to avoid potential delay caused by external screens.

- Board
- Board Pro, Board Pro G2
- Codec EQ
- Codec Plus
- Codec Pro
- Desk, Desk Pro, Desk Mini
- Room Bar Pro, Room Bar
- Room Kit, Room Kit Mini
- Room Kit EQX
- Room 55
- Room 55 Dual, Room 70
- Room 70 G2
- Room 70 Panorama
- Room Panorama

Advanced customization of audio (page 4 of 5)

Setting up analog microphones

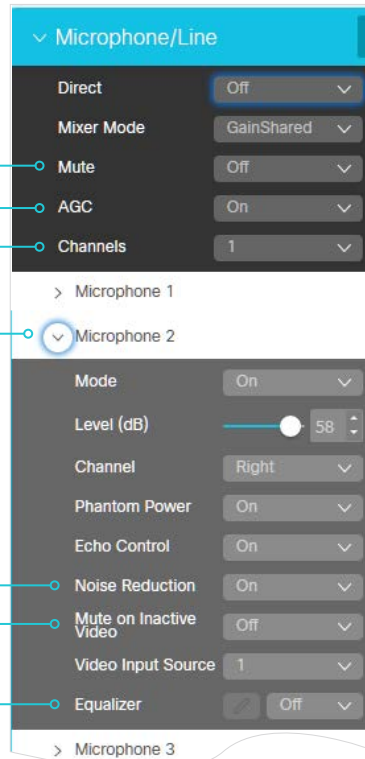

Mute: Mute the entire logical group.

AGC: Enable/Disable Automatic Gain Control applying to the entire logical group.

Channels: 1 (mono) or 2 (stereo).

You may expand a logical group to get access to settings on a group level.

Noise Reduction: Setting this to On will reduce any continuous noise present in the room (for example, fan noise). Impulsive noise will not be reduced.

Mute on Inactive Video: Use this feature in scenarios with, for example, a presenter's microphone. This microphone will be muted unless the associated camera (the one filming the presenter) actually sends video, provided that you have set up a camera/microphone combination this way.

Equalizer: The equalizer lets you choose among up to 8 predefined equalizer presets (or none, to indicate *Off*).

The graphical tool to set up the equalizer is described in the [▶ Setting up equalizers](#) section.

In local reinforcement scenarios, make sure you set the Microphone(s) **Direct** to On to bypass extra processing like *Echo Control*. This will minimize latency and serve to avoid that the master volume control also affects the volume of the local presenter. For other use cases, leave it **Off**.

Mixer Mode can be GainShared or Fixed. If GainShared is selected, the summed level of the microphone signals will never exceed a certain value, but their individual offsets will be retained. In Fixed mode, the levels are just summed together.

Mode: A microphone can be set to On or Off.

Level (dB) / Gain (dB): Adjust the gain to suit the output level of the connected audio source. *

If **Channels** has been set to 2 (at the Group level), you may use the **Channel** setting at the lower level to specify whether this particular microphone belongs to the group of left or right channel microphones.

If the entire logical group has been set to **Direct** on group level, **Echo Control** will be set to N/A.

Phantom power: This setting provides power submitted through the microphone cable. This can be switched off when microphones are used with a preamplifier providing line level signals.

Make sure you reduce the gain (typically by 40 dB or more) if you decide to use a Microphone input as a Line input.

* This is the gain on the input connector. Depending on device, this field is called:

Level (dB) (Codec Pro, Room 70 G2, Room 70 Panorama, Room Panorama)
Gain (dB) (Codec EQ, Room Kit EQX)

Board

Board Pro,
Board Pro
G2

Codec EQ

Codec
Plus

Codec
Pro

Desk,
Desk Pro,
Desk Mini

Room Bar
Pro,
Room Bar

Room Kit,
Room Kit
Mini

Room Kit
EQX

Room 55

Room
55 Dual,
Room 70

Room 70
G2

Room 70
Panorama

Room
Panorama

Advanced customization of audio (page 5 of 5)

Setting up equalizers

There are 8 user-definable parametric equalizer presets available.

A preset consists of up to 6 sections, each of which has its own filter type, gain, center/crossover frequency, and Q value.

Each section is shown with its own color. A white line shows the combined frequency response of the equalizer.

The effect of altering any of the parameters will become visible in the graph when you press Enter or select a different field.

Your settings are saved automatically.

Go to the next preset (if applicable).

Gain access to the equalizer from the top bar or the input group.

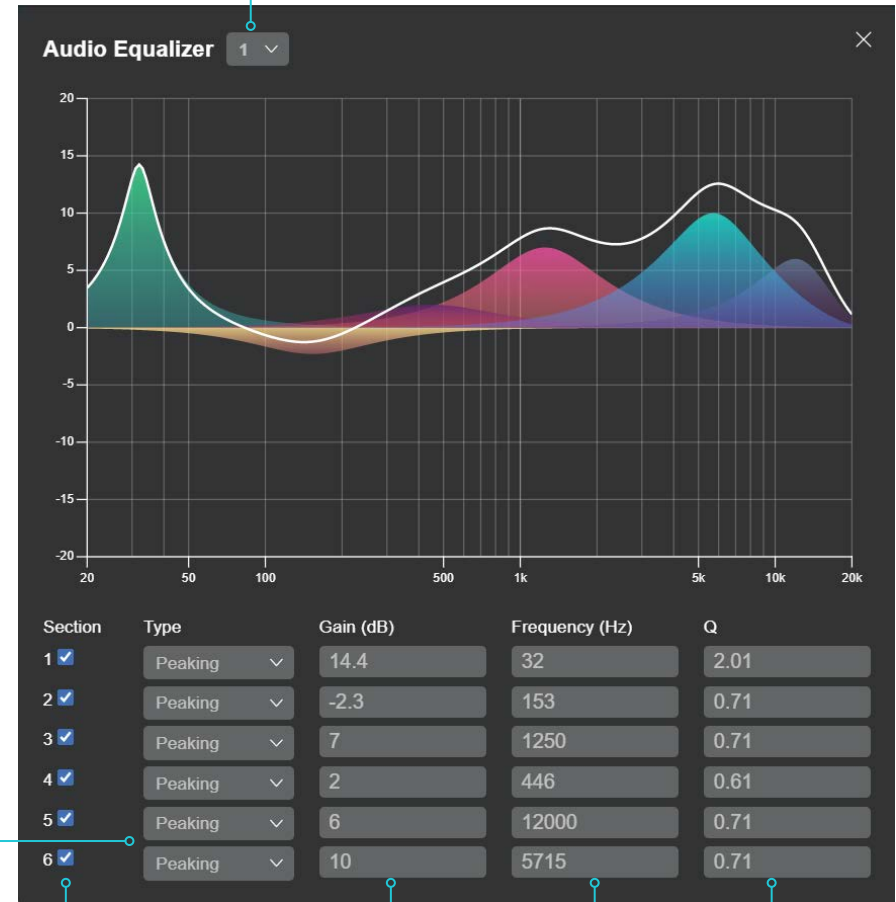
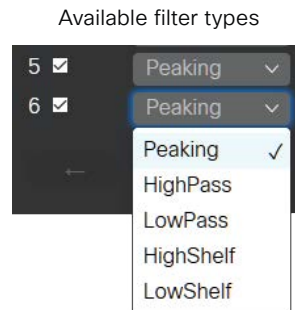
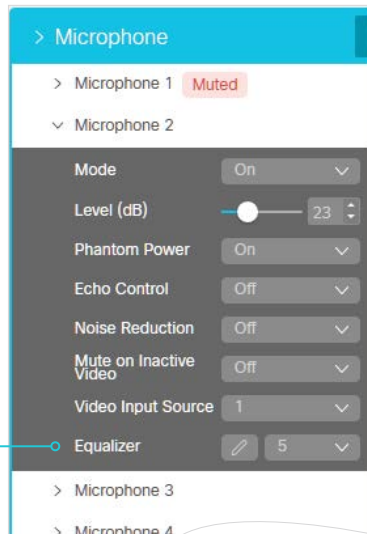
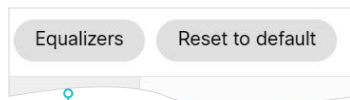

To activate or deactivate a filter section, click the corresponding checkbox.

Valuespace for the Gain is 0dB ± 20dB

Valuespace for Frequency is 20–20000 Hz.

Valuespace for the Q value is 0.1–10.0.

Board

BoardPro, BoardPro G2

Codec EQ

Codec Plus

Codec Pro

Desk, Desk Pro, DeskMini

Room Bar Pro, Room Bar

Room Kit, Room Kit Mini

Room Kit EQX

Room 55

Room 55 Dual, Room 70

Room 70 G2

Room 70 Panorama

Room Panorama

- Board
- BoardPro, BoardPro G2
- Codec EQ
- Codec Plus
- Codec Pro
- Desk, DeskPro, DeskMini
- Room Bar Pro, Room Bar
- Room Kit, Room Kit Mini
- Room Kit EQX
- Room 55
- Room 55 Dual, Room 70
- Room 70 G2
- Room 70 Panorama
- Room Panorama

About Ethernet ports

The main network port

The main network port - Network port 1 - is always reserved for the connection to LAN. This applies to all video conferencing devices.

Depending on the device, Network port 1 is marked with the number 1, the network symbol (🌐), or both.

Auxiliary network ports

Most video conferencing devices have more than one network port. The additional ports can be used for peripherals like cameras, touch controllers, third-party control systems, and more.

A peripheral that is connected to one of these network ports gets a local IP-address on the video conferencing device's internal network. It is not possible for packets to traverse the device between the main network port (LAN) and the other network ports.

Note: The allowed IP-address range on the internal network is different for Cisco and third-party (non-Cisco) peripherals.

Allowed IP-addresses	
Cisco peripheral	• 169.254.1.41 to 169.254.1.200 (dynamic, DHCP)
Non-Cisco peripheral	• 169.254.1.30 (dynamic, DHCP) • 169.254.1.225 to 169.254.1.254 (static)

On the local network you can use SSH or HTTP (port 443) to reach the video conferencing device on 169.254.1.1.

Power over Ethernet (PoE)

Some of the network ports provide Power over Ethernet (PoE). These ports can power peripherals, such as the touch controller.

Product	Number of auxiliary network ports	Number of auxiliary network ports with PoE
Room Bar Pro	3	3 (🌐, PoE)
Room Bar	1	1 (🌐)
Room Kit	1	0
Room Kit Mini	1	1 (🌐)
Room 55	1	1 (🌐)
Room Kit EQX ¹	4	4 (🌐, PoE)
Room 70 ¹ / Room 55 Dual ¹	2	1 (🌐)
Room 70 G2 ¹	4	2 (🌐, PoE)
Room 70 Panorama ¹ / Room Panorama ¹	4	2 (🌐, PoE)
Codec EQ	4	4 (🌐, PoE)
Codec Plus	2	1 (🌐)
Codec Pro	4	2 (🌐, PoE)
Board	0	0
Board Pro	1	1 (🌐)
Board Pro G2	2	1 (🌐, PoE)
Desk	0	0
Desk Mini	0	0
Desk Pro ²	1	0

¹ One or more of the auxiliary ports on this product is reserved for internal use.

² The auxiliary port on this product is a network expansion port. You can connect a computer or other device to this port and get access to the same network/LAN as the video conferencing device itself. This port is not used for peripheral devices, and you don't get a local IP address from the codec.

Mini-jack connector pin-out schemes

3.5 mm mini-jack, 3-pin (*line-out*)

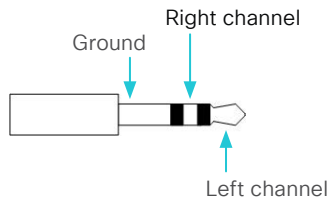

3.5 mm mini-jack, 4-pin (*microphone*)

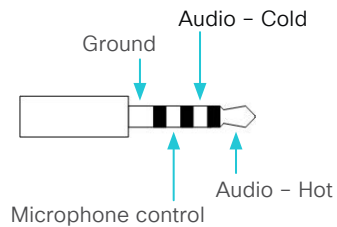

Audio connectors (mini-jack) *		
	Microphone	Line-out
Connector pin out	Tip = Hot Ring 1 = Cold Ring 2 = Mic. control Shield = GND	Tip = Left channel Ring = Right channel Shield = GND
Signal type	Balanced	Unbalanced
Connector (codec)	Mini-jack 3.5 mm, 4-conductor	Mini-jack 3.5 mm, 3-conductor
Input impedance	900 Ohm/leg	N/A
Output impedance	N/A	470 Ohm
Maximum input level	-18.3 dBu ±2 dB	N/A
Maximum output level	N/A	8.2 dBu ±2 dB
Phantom power	10V ± 0.5V	N/A
Phantom power resistor pin "tip"	1.0kOhm	N/A
Phantom power resistor pin "ring 1"	1.0kOhm	N/A
Frequency response	20Hz-20kHz ±1 dB	20Hz-20kHz ±1 dB
Signal to Noise Ratio	-95 dB	-100 dB

* *Board and Desk Pro*: These devices have a mini-jack socket only for line-out.
Desk, Desk Mini, and Room Kit Mini don't have any mini-jack sockets.
Room Bar has a mini-jack socket only for microphone.

- Board
- BoardPro, BoardPro G2
- Codec EQ
- Codec Plus
- Codec Pro
- Desk, Desk Pro, Desk Mini
- Room Bar Pro, Room Bar
- Room Kit, Room Kit Mini
- Room Kit EQX
- Room 55
- Room 55 Dual, Room 70
- Room 70 G2
- Room 70 Panorama
- Room Panorama

Board

Board Pro,
Board Pro
G2

Codec EQ

Codec
Plus

Codec
Pro

Desk,
Desk Pro,
Desk Mini

Room Bar
Pro,
Room Bar

Room Kit,
Room Kit
Mini

Room Kit
EQX

Room 55

Room
55 Dual,
Room 70

Room 70
G2

Room 70
Panorama

Room
Panorama

Audio inputs and outputs (page 1 of 2)

Audio inputs

The audio inputs can be used as both microphone and line inputs, because you can adjust the gain and switch on or off phantom power on each input individually. Use the following settings:

- **Audio > Input > Microphone [n] > Level:** Adjust the gain on the input connector to suit the connected audio source. The gain can be tuned from 0 to 70 dB in steps of 1 dB. The maximum input level with 0 dB gain is 24 dBu.
- **Audio > Input > Microphone [n] > PhantomPower:** In the default configuration, there is phantom power on the input (48V ± 1V). This required for some microphones, such as the Cisco table and ceiling microphones. You can switch off the phantom power when connecting to equipment that don't need it, such as external mixers.



The audio inputs are configured for the use of Euroblock connectors with up to 4 ports.



If you use a Euroblock with 3 ports make sure it is inserted in the leftmost position possible. That is, port 4 (microphone mute) is not used.

Audio outputs



The audio outputs are configured for the use of Euroblock connectors with 3 ports.

Connecting to unbalanced connectors

These illustrations show best practice when connecting the video conferencing device to unbalanced connectors.

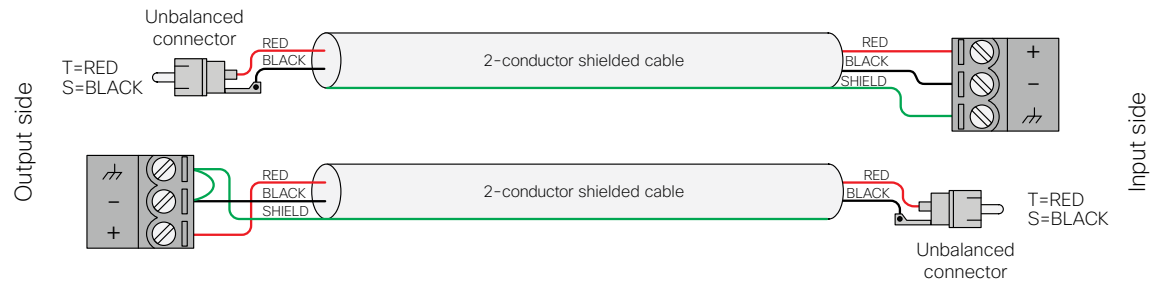

Audio inputs and outputs (page 2 of 2)

Audio input/output specification		
	Microphone/Line Input	Line Output
Connector type	<ul style="list-style-type: none"> Balanced input 3.5 mm pitch Phoenix/Euroblock type male header 	<ul style="list-style-type: none"> Impedance-balanced output 3.5 mm pitch Phoenix/Euroblock type male header
Phantom Power	<ul style="list-style-type: none"> 48V, 6.8 kohm impedance / 7 mA max current per leg. Independently switchable. 	N/A
Input Impedance	<ul style="list-style-type: none"> 2.5 kohm per leg 	N/A
Output Impedance	N/A	<ul style="list-style-type: none"> 200 ohm per leg
Recommended Load Impedance	N/A	<ul style="list-style-type: none"> > 600 ohm
Signal Level	<ul style="list-style-type: none"> 0 dB input gain: 24 dBu max. (1 kHz, +/-1 dB) Input gain independently adjustable from 0 dB to +70dB in 1 dB steps 	<ul style="list-style-type: none"> 0 dB output gain: 18 dBu max. (1 kHz, +/-1 dB) Output gain independently adjustable from 0 to -24 dB in 1 dB steps
Frequency Response	<ul style="list-style-type: none"> 20 Hz-20 kHz: +0/-1 dB 	<ul style="list-style-type: none"> 20 Hz-20 kHz: +0/-0.5 dB
Total Harmonic Distortion + Noise (THD+N)	<ul style="list-style-type: none"> 0 dB input gain, 22 dBu signal level: < 0.005% (20 Hz-20 kHz, 22 kHz BW) 46 dB input gain, -24 dBu signal level: < 0.01% (20 Hz-20 kHz, 22 kHz BW) 	<ul style="list-style-type: none"> 0 dB output gain, 17 dBu signal level: < 0.005% (20 Hz-20 kHz, 22 kHz BW)
Equivalent Input Noise (EIN)	<ul style="list-style-type: none"> 46 dB input gain, Rs=150 ohm: < -124 dBu (20 Hz-20 kHz A-weighted) 	N/A
Dynamic Range	<ul style="list-style-type: none"> 0 dB input gain, Rs=150 ohm: > 107 dB (20 Hz-20 kHz, 22 kHz BW) 46 dB input gain, Rs=150 ohm: > 102 dB (20 Hz-20 kHz, 22 kHz BW) 	<ul style="list-style-type: none"> 0 dB output gain: > 109 dB (20 Hz-20 kHz un-weighted)
Crosstalk	<ul style="list-style-type: none"> 0 dB input gain, 23 dBu signal level, 10 kHz: < -110 dB 46 dB input gain, -23 dBu signal level, 10 kHz: < -110 dB 	<ul style="list-style-type: none"> 0 dB output gain, 17 dBu signal level 10 kHz: < -100 dB

Board

Board Pro,
Board Pro
G2

Codec EQ

Codec
Plus

Codec
Pro

Desk,
Desk Pro,
Desk Mini

Room Bar
Pro,
Room Bar

Room Kit,
Room Kit
Mini

Room Kit
EQX

Room 55

Room
55 Dual,
Room 70

Room 70
G2

Room 70
Panorama

Room
Panorama

Board

Board Pro,
Board Pro
G2

Codec EQ

Codec
PlusCodec
ProDesk,
Desk Pro,
Desk MiniRoom Bar
Pro,
Room BarRoom Kit,
Room Kit
MiniRoom Kit
EQX

Room 55

Room
55 Dual,
Room 70Room 70
G2Room 70
PanoramaRoom
Panorama

The GPIO and 3G-SDI connectors

GPIO connector

The device has one 6-pin Euroblock GPIO (General Purpose Input/Output) port with GND, +12V, and 4 GPIO pins.



You can configure the mode for the four GPIO pins individually. A pin can be configured to trigger an action (input) or to report some status of the device (output). For example:

- Mute the microphones (input), or report whether the microphones are muted (output).
- Accept or disconnect a call (input), or report whether the device is in a call (output).

Operating principles

The +12V pin provides +12V_{DC}, and it is capable of sourcing up to 500mA.

The GND pin is a common ground for all pins in the GPIO connector.

When used as input, a GPIO pin detects state as follows:

- Low state for voltages 0-1V_{DC}
- High state for voltages 2-12V_{DC}

When used as output, a GPIO pin is set as follows:

- Low state will drive a pin low, i.e. to GND
- High state will set a pin to open-drain with internal pull-up, i.e. it will set the pin to 12V unless an external connection drives it low

Commands and configurations

To set the mode of a pin:

Read the description of the setting for more details about the pre-defined input and output modes:

- `GPIO > Pin [n] > Mode`
(xConfiguration GPIO Pin [n] Mode)

To retrieve the state of a pin:

- `GPIO > Pin [n] > State`
(xStatus GPIO Pin [n] State)

To set the state of a pin that is in manual mode:

- `xCommand GPIO ManualState Set`

For more information about the API commands, see the API guide for RoomOS software. Go to <https://www.cisco.com/go/room-docs>

3G-SDI connector

The Codec Pro has one 3G-SDI input connector.

The connector is HD-BNC, supporting resolutions up to 1080p60. The 3G-SDI signal is Level A, 75 Ω, 10-bit data native color encoding 4:2:2 YCbCr.

Use the 3G-SDI connector if you want to place a camera far away from the codec – for example, in bigger rooms where you want to have a camera in the back.

Since the total coaxial cable length can be up to 100m, it allows extra flexibility when building or setting up a video conferencing room.

Board

BoardPro,
BoardPro
G2

Codec EQ

Codec
PlusCodec
ProDesk,
Desk Pro,
DeskMiniRoom Bar
Pro,
Room BarRoom Kit,
Room Kit
MiniRoom Kit
EQX

Room 55

Room
55 Dual,
Room 70Room 70
G2Room 70
PanoramaRoom
Panorama

API access using the COM port

The device has a COM port that you can use to access the device's API over a serial connection.*

It is a 3 pin Euroblock, with Tx (transmit), Rx (receive), and GND pins.

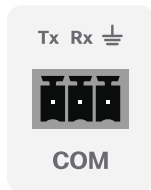

Serial communication is enabled by default. Use the following configuration if you want to disable it:

[SerialPort > Mode](#)

For security reasons, you are asked to sign in before using the serial interface. Use the following setting if you want to switch off the sign in prompt:

[SerialPort > LoginRequired](#)

The device can give very much feedback, so we recommend keeping the connection at the highest baud rate possible. In some situations, such as when using long cables, a lower rate may be used to avoid bit errors. Use the following setting if you want to adjust the baud rate.

[SerialPort > BaudRate](#)

If your device is provisioned by CUCM, the serial port settings should be configured from CUCM.

The parameters for the serial connection are:

- Baud rate: 9600, 19200, 38400, 57600, or 115200bps
- Data bits: 8
- Parity: None
- Stop bits: 1
- Flow control: None

The same set of configurations and parameters are used for the micro-USB maintenance port, except for the baud rate. The baud rate for the maintenance port is always 115200bps.

* Don't use the COM port for maintenance; use the micro-USB port instead.

- Board
- BoardPro, BoardPro G2
- Codec EQ
- Codec Plus
- Codec Pro
- Desk, DeskPro, Desk Mini
- Room Bar Pro, Room Bar
- Room Kit, Room Kit Mini
- Room Kit EQX
- Room 55
- Room 55 Dual, Room 70
- Room 70 G2
- Room 70 Panorama
- Room Panorama

Serial interface for maintenance (page 1 of 6)

Use the micro USB connector for direct communication with the device¹. You need a micro USB to USB cable. If the computer doesn't auto-install a serial port driver, you need to install a serial port driver on the computer manually².

Use a terminal emulator to connect to the serial interface. For the most common computer types (PC, MAC) and operating systems, PuTTY or Tera Term will work.

Parameters:

- Baud rate: 115200 bps
- Data bits: 8
- Parity: None
- Stop bit: 1
- Hardware flow control: Off

Device settings

Serial communication is enabled by default. Use the following configuration to change the behavior:

[SerialPort > Mode](#)

For security reasons, you are asked to sign in before using the serial interface. Use the following setting to change the behavior:

[SerialPort > LoginRequired](#)

If your device is provisioned by CUCM, the serial port settings should be configured from CUCM.

[Codec Pro, Room 70 G2, Room 70 Panorama, and Room Panorama](#)

- The [SerialPort > BaudRate](#) setting has no effect on the maintenance port. The maintenance port always uses the default baud rate.

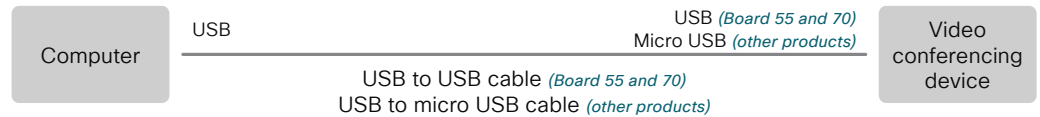

i See the illustrations on the following pages to find the micro USB maintenance port the different products.

Webex Board 55S, 70S, and 85S:

1. Connect a USB cable from a computer to the micro-USB port on the board.
You will see two USB to Serial Port devices on your computer. The names depend on the operating system of the computer. On Linux, you typically see `/dev/ttyUSB0` for the camera and `/dev/ttyUSB1` for main.
These ports are connected to the native serial interface (UART) on the two CPUs. They show everything printed by the system to this port, including logs from bootloaders.
2. Sign in with admin credentials when you get the sign-in prompt after bootup is completed. You can only sign in to the main CPU, not to the camera CPU.
After signing in, you have access to the API of the board.
If your board has been factory reset, the sign-in is *admin* with an empty password.

Webex Board 55 and 70:

1. Connect a USB cable from your computer to the USB-A port on the board. On Webex Board 55, use the USB port closest to the panel.
2. Power up the board. You will see the virtual serial port on the computer. Its name depends on the operating system of the computer. On Linux, you typically see `/dev/ttyACM0`.
NOTE: If you power up the board before you connect the computer, the computer can't see the board.
3. Sign in with admin credentials when you get the sign-in prompt. After signing in, you have access to the API of the board.
If your board has been factory reset, the sign-in is *admin* with an empty password.

¹ The micro-USB port is for maintenance. If you want to access the device's API over a serial connection, refer to the API guide for details.

² You need a CP210x USB to UART Bridge Virtual COM Port (VCP) driver, see <http://www.silabs.com/products/development-tools/software/usb-to-uart-bridge-vcp-drivers>

Board

Board Pro,
Board Pro
G2

Codec EQ

Codec
Plus

Codec
Pro

Desk,
Desk Pro,
DeskMini

Room Bar
Pro,
Room Bar

Room Kit,
Room Kit
Mini

Room Kit
EQX

Room 55

Room 55
Dual,
Room 70

Room 70
G2

Room 70
Panorama

Room
Panorama

Serial interface for maintenance (page 2 of 6)

Room 55 Dual and Room 70

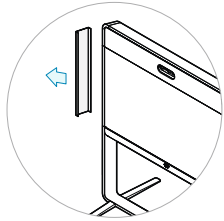

Remove the left side cover of the device to get access to the codec connector panel. The cover snaps to magnets.

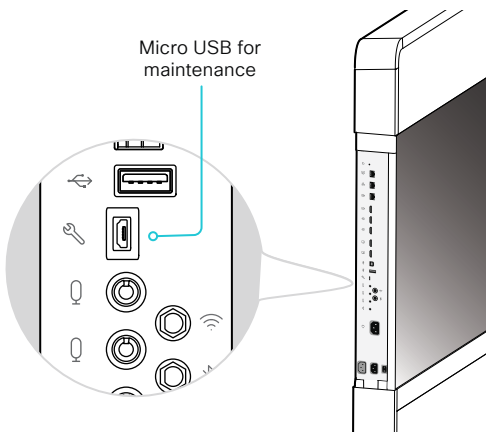

Room 70 G2 and Room 70 Panorama

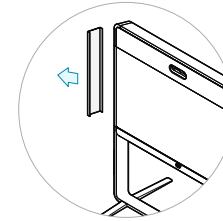

Remove the left side cover of the device to get access to the codec connector panel. The cover snaps to magnets.

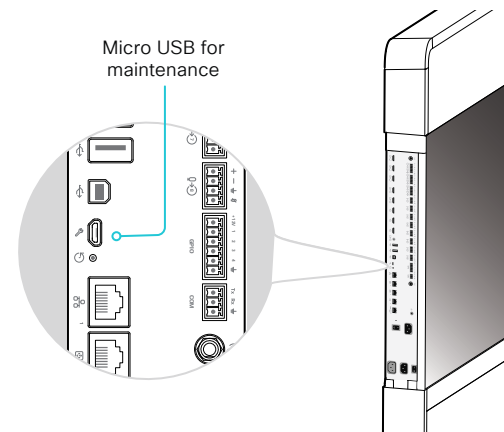

- Board
- Board Pro, Board Pro G2
- Codec EQ
- Codec Plus
- Codec Pro
- Desk, Desk Pro, Desk Mini
- Room Bar Pro, Room Bar
- Room Kit, Room Kit Mini
- Room Kit EQX
- Room 55
- Room 55 Dual, Room 70
- Room 70 G2
- Room 70 Panorama
- Room Panorama

Serial interface for maintenance (page 3 of 6)

Codec EQ and Room Kit EQX

Room Kit EQX:
Pop out the right screen to access the codec.

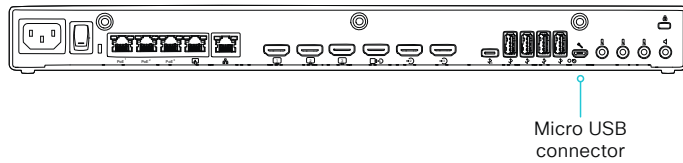

Codec Plus

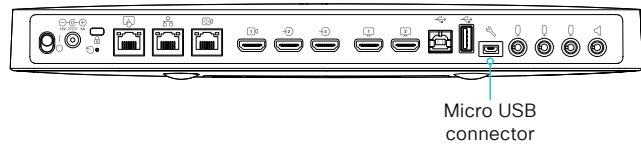

Codec Pro and Room Panorama

Room Panorama:
Use the handle at the bottom of the deco grille, and pull down the left monitor to get access to the codec.

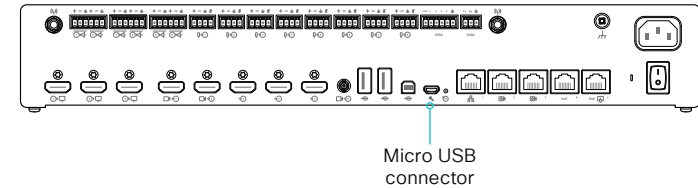

Room 55

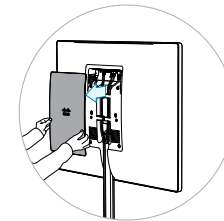

Remove the rear cover to get access to the connector panel.

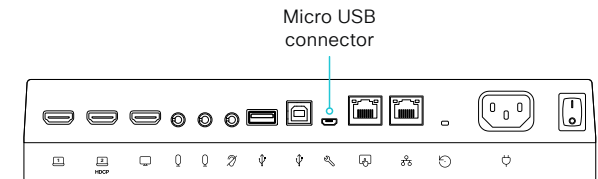

Board

Board Pro,
Board Pro
G2

Codec EQ

Codec
Plus

Codec
Pro

Desk,
Desk Pro,
Desk Mini

Room Bar
Pro,
Room Bar

Room Kit,
Room Kit
Mini

Room Kit
EQX

Room 55

Room
55 Dual,
Room 70

Room 70
G2

Room 70
Panorama

Room
Panorama

Serial interface for maintenance (page 4 of 6)

Room Bar

Tilt the unit forward to get access to the connector panel.

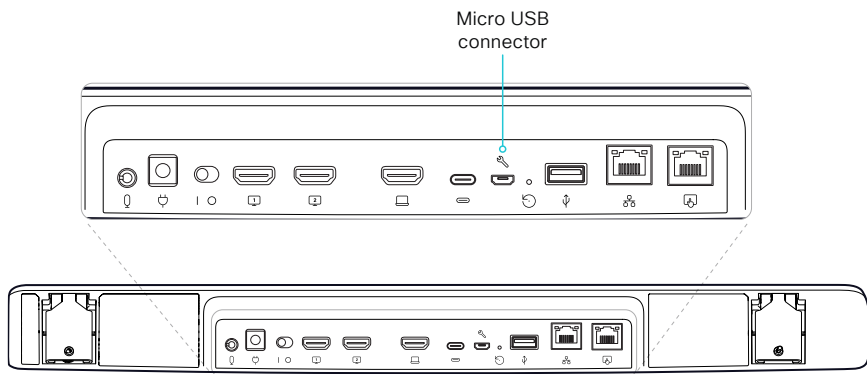

Room Kit

Tilt the unit forward to get access to the connector panel.

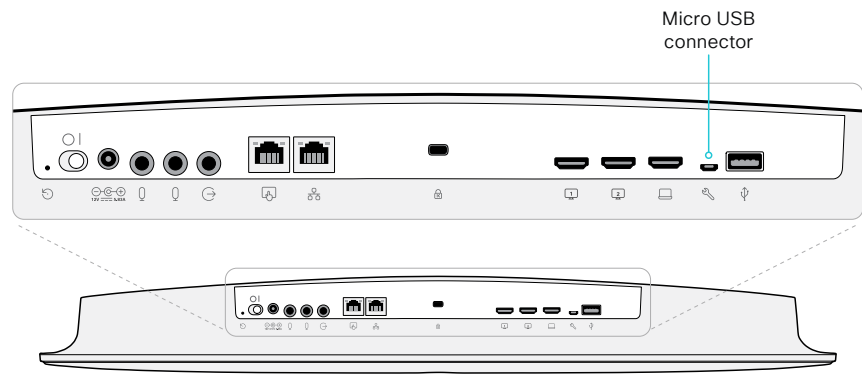

Room Bar Pro

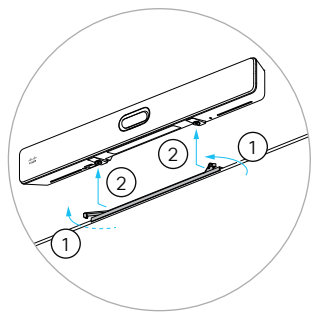

First, unlock the device by pulling the locking handles on each side of the mounting bar (1). Then, pull the device gently towards you and lift it off the mounting bar (2) to get access to the connector panel.

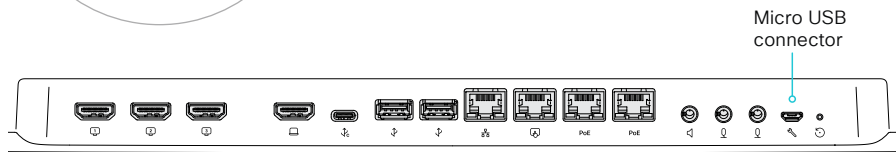

Room Kit Mini

Tilt the unit forward to get access to the connector panel.

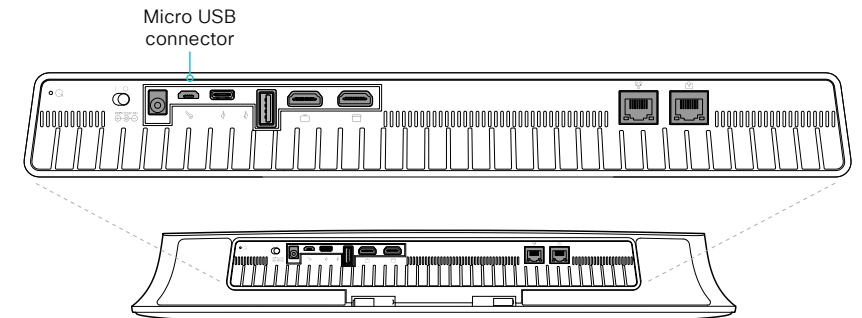

Board

Board Pro,
Board Pro
G2

Codec EQ

Codec
Plus

Codec
Pro

Desk,
Desk Pro,
Desk Mini

Room Bar
Pro,
Room Bar

Room Kit,
Room Kit
Mini

Room Kit
EQX

Room 55

Room
55 Dual,
Room 70

Room 70
G2

Room 70
Panorama

Room
Panorama

Serial interface for maintenance (page 5 of 6)

Desk and Desk Pro

Flip the cover on the back of the device to get access to the connector panel.

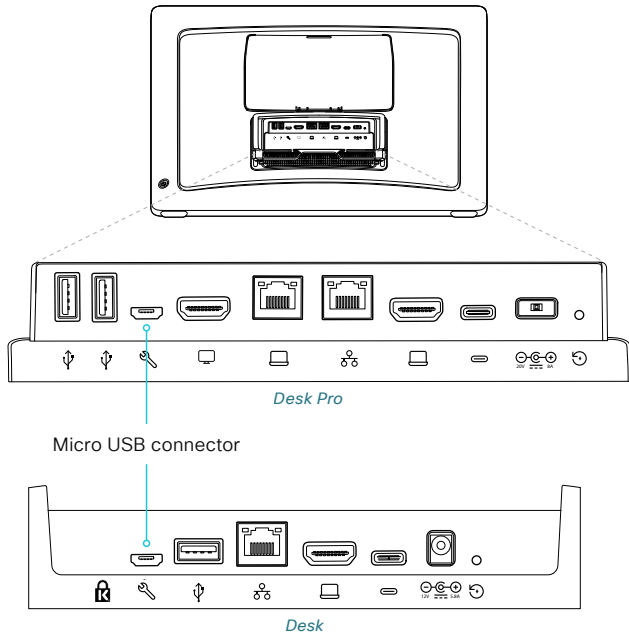

Desk Mini

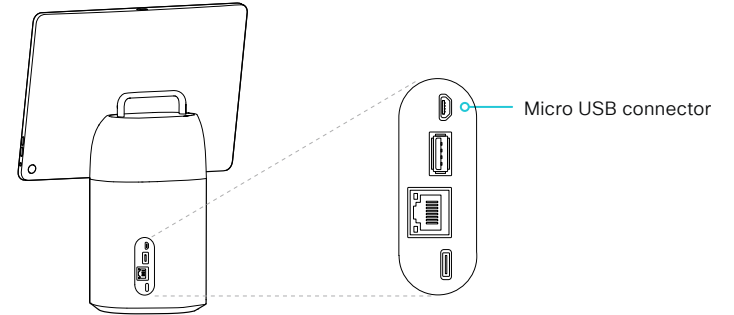

Board

BoardPro,
BoardPro
G2

Codec EQ

Codec
Plus

Codec
Pro

Desk,
Desk Pro,
DeskMini

Room Bar
Pro,
Room Bar

Room Kit,
Room Kit
Mini

Room Kit
EQX

Room 55

Room
55 Dual,
Room 70

Room 70
G2

Room 70
Panorama

Room
Panorama

Serial interface for maintenance (page 6 of 6)

Board

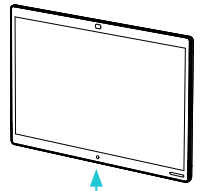

The connector panel is at the bottom

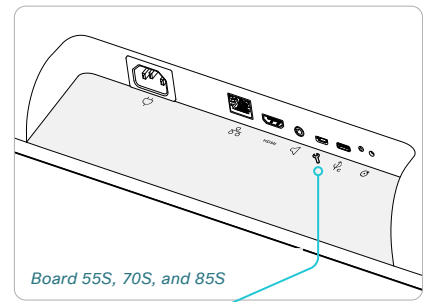

Board 55S, 70S, and 85S

Micro USB connector
USB connector

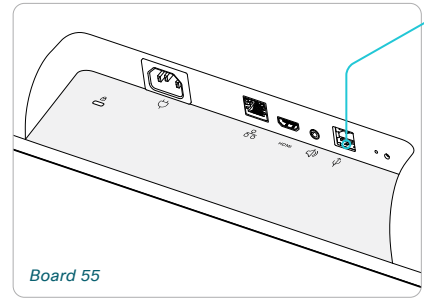

Board 55

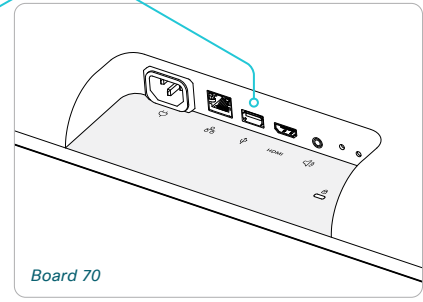

Board 70

Board Pro

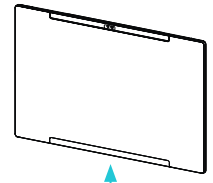

The connector panel is at the bottom



Micro USB connector

Board Pro G2

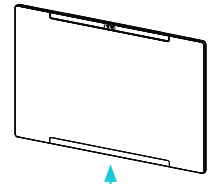

The connector panel is at the bottom

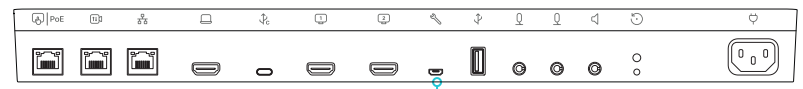

Micro USB connector

Board

BoardPro,
BoardPro
G2

Codec EQ

Codec
PlusCodec
ProDesk,
DeskPro,
Desk MiniRoom Bar
Pro,
Room BarRoom Kit,
Room Kit
MiniRoom Kit
EQX

Room 55

Room 55
Dual,
Room 70Room 70
G2Room 70
PanoramaRoom
Panorama

The systemtools commands

The systemtools commands are used for administrative control of the device and are only available from a command line interface. Systemtools should not be used to program the device.

To get an overview of the supported commands type “systemtools ?”.

Example:

```
systemtools ?
selectsw
whoami
license
network
ntp
ps
securitystatus
bootlogo
idefixversion
touch
```

To see the usage of the commands add a question mark after the command.

Example:

```
systemtools network ?
usage: network ping <hostname> | traceroute
<hostname> | netstat | addr | ifconfig |
ifstats <ifname>
```

`systemtools idefixversion` (*Board, Codec Plus, Codec Pro, Room Kit, Room Kit Mini, Room 55, Room 55 Dual, Room 70, Room 70 G2, Room 70 Panorama, and Room Panorama*)

Returns the software version a connected Touch 10 should have.

`systemtools license list`

Lists all the licenses for the device.

`systemtools license show <name>`

Shows the content of a license file, defined by the name.

<name>: The name of the license file.

`systemtools network ping <hostname>`

Network debug command.

<hostname>: The IP-address or URL of the host.

`systemtools network traceroute <hostname>`

Network debug command.

<hostname>: The IP-address or URL of the host.

`systemtools network netstat`

Network debug command.

`systemtools network addr`

Shows the device’s IP-addresses.

`systemtools network ifconfig`

Network debug command.

`systemtools network ifstats <ifname>`

Network debug command. Prints out network interface statistics.

<ifname>: The name of the interface.

`systemtools ntp`

Shows the NTP status.

`systemtools ps`

Lists all running processes.

`systemtools securitystatus`

Shows the security status for the device.

`systemtools selectsw [image name]`

Select which of the available software images to use. Changing the software image will restart the device.

No argument given: Lists the version of the available software images, and shows which one is active.

image name: Swap to the software with this name.

`systemtools touch start` (*only for Board, Board Pro, Board Pro G2, Desk, Desk Mini, and Desk Pro*)

Debug command for testing the touch screen.

`systemtools touch stop` (*only for Board, Board Pro, Board Pro G2, Desk, Desk Mini, and Desk Pro*)

Debug command for testing the touch screen.

`systemtools touch forever` (*only for Board, Board Pro, Board Pro G2, Desk, Desk Mini, and Desk Pro*)

Debug command for testing the touch screen.

`systemtools whoami`

Lists the name and id of the signed in user, and the user roles held by this user.

Board

BoardPro,
BoardPro
G2

Codec EQ

Codec
PlusCodec
ProDesk,
DeskPro,
DeskMiniRoom Bar
Pro,
Room BarRoom Kit,
Room Kit
MiniRoom Kit
EQX

Room 55

Room 55
Dual,
Room 70Room 70
G2Room 70
PanoramaRoom
Panorama

Open TCP ports

The web server within the codec prohibit or restrict the use of nonsecure or unnecessary ports, protocols, modules, and/or services. Some ports are open by default.

You can configure the device settings from the device web interface. Open a web browser, enter the IP address of the device, and sign in. Go to [Settings](#), and select [Configurations](#).

TCP 22: SSH

You can close the port by setting SSH mode to **Off**.

```
NetworkServices SSH Mode: Off/On
```

TCP 80: HTTP

You can close the port by setting HTTP mode to **Off** or **HTTPS**. **Off** redirects to port 443.

```
NetworkServices HTTP Mode: HTTP+HTTPS/HTTPS/Off
```

TCP 443: HTTPS

You can close the port by setting HTTP mode to **Off**.

```
NetworkServices HTTP Mode: HTTP+HTTPS/HTTPS/Off
```

TCP 4043: Remote pairing software download (*legacy upgrade*)

Applies to all products that support Touch 10

This port is open for backwards compatibility reasons. The port is used for downloading software to the Touch 10 if Touch 10 was paired to the codec on older software that didn't support secure upgrade (TCP 4060) for Touch 10.

You can close the port by setting remote pairing for the touch controller to **Off**.

```
Peripherals Pairing CiscoTouchPanels RemotePairing: Off/On
```

TCP 4045: Remote pairing version information

You can close the port by setting remote pairing for the touch controller to **Off**.

```
Peripherals Pairing CiscoTouchPanels RemotePairing: Off/On
```

TCP 4047: Remote pairing session connection

The port is only available (and open) when a touch controller is remote paired with the video conferencing device. You can close the port by setting remote pairing for the touch controller to **Off**.

```
Peripherals Pairing CiscoTouchPanels RemotePairing: Off/On
```

TCP 4051: Remote pairing port (*Deprecated*)

You can close the port by setting remote pairing for the touch controller to **Off**.

```
Peripherals Pairing CiscoTouchPanels RemotePairing: Off/On
```

TCP 4053: Remote pairing port

You can close the port by setting remote pairing for the Touch panel to **Off**.

```
Peripherals Pairing CiscoTouchPanels RemotePairing: Off / On
```

TCP 4060: Remote pairing software download (*secure upgrade*)

Applies to all products that support Room Navigator or Touch 10

This port is used when downloading software to a touch controller. You can close the port by setting remote pairing for the touch controller to **Off**.

```
Peripherals Pairing CiscoTouchPanels RemotePairing: Off/On
```

TCP 4062: Remote pairing port

You can close the port by setting remote pairing for the touch controller to **Off**.

```
Peripherals Pairing CiscoTouchPanels RemotePairing: Off/On
```

TCP 4190: UPnP port

You can close the ports by setting the SIP listen ports to **Off**.

```
NetworkServices UPnP Mode: Off
```

TCP 5060/5061: SIP listen ports

The SIP listen ports are open by default. The SIP listen ports are disabled by the Cisco UCM (Unified Communication Manager). You can close the ports by setting the SIP listen ports to **Off**.

```
SIP ListenPort: Off/On
```

TCP 65533: Alternate port for Proximity connections

The port is closed by default. The port is open for Proximity connections when the setting to enable an alternate port for Proximity is set to **True**.

```
Proximity AlternatePort Enabled: False/True
```

Board

BoardPro,
BoardPro
G2

Codec EQ

Codec
Plus

Codec
Pro

Desk,
Desk Pro,
Desk Mini

Room Bar
Pro,
Room Bar

Room Kit,
Room Kit
Mini

Room Kit
EQX

Room 55

Room 55
Dual,
Room 70

Room 70
G2

Room 70
Panorama

Room
Panorama

Ephemeral IP ports

Ephemeral IP port range: 32768 - 60999

Board

BoardPro,
BoardPro
G2

Codec EQ

Codec
PlusCodec
ProDesk,
DeskPro,
Desk MiniRoom Bar
Pro,
Room BarRoom Kit,
Room Kit
MiniRoom Kit
EQX

Room 55

Room 55
Dual,
Room 70Room 70
G2Room 70
PanoramaRoom
Panorama

HTTPFeedback address from TMS

When a device is added to Cisco TelePresence Management Suite (TMS), it is automatically configured to send information (events) back to TMS. The device receives the address, that these events should be sent to, from TMS (HTTPFeedback address). If this address is absent or misconfigured, the device cannot send events to TMS.

Missing response to events

If the device does not receive a response to an event, it will retry sending it to the HTTPFeedback address up to 6 times at increasing intervals.

If the device does not receive a response to any of the retries, the endpoint tries to send a message to the HTTPFeedback address every ten minutes. The HTTPFeedback status will indicate that it has failed, and there is a diagnostic message indicating the type of failure.

While retrying to send messages, there will be a loss of Call Detail Records (CDR) on TMS.

Get a new HTTPFeedback address from TMS

In order to get a new address to send events to, you must restart the device and wait for the next management address push from TMS (scheduled or triggered by the TMS administrator).

- Board
- BoardPro, BoardPro G2
- Codec EQ
- Codec Plus
- Codec Pro
- Desk, DeskPro, DeskMini
- Room Bar Pro, Room Bar
- Room Kit, Room Kit Mini
- Room Kit EQX
- Room 55
- Room 55 Dual, Room 70
- Room 70 G2
- Room 70 Panorama
- Room Panorama

Link an on-premises registered device to Cisco Webex Edge for Devices

You can use *Webex Edge for Devices* to link your on-premises registered devices to the Webex cloud service. This gives you access to select cloud features, while your registration, device configuration management, calling¹, and media services remain on-premises. You can manage the cloud services and get device diagnostics in Webex Control Hub.

More detailed information

To find more details about how to link a device to Webex Edge for Devices, supported features, prerequisites, and limitations, read the [▶ Webex Edge for Devices \(https://help.webex.com/cy2l2z/\)](https://help.webex.com/cy2l2z/) article on Webex Help Center.

Setup

We recommend that you register the device to the on-premises service first; then you link it to the Webex Edge.

Find details in the *Webex Edge for Devices* article referenced to the left.

Features

Find a comprehensive list of features and functionality in the *Webex Edge for Devices* article referenced to the left. Some of them are:

- Online/Offline connection status in Control Hub
- Device diagnostics with the ability to set administrator alerts
- Device historical analytics available directly in Control Hub
- Access to device settings from Control Hub
- Cloud xAPI access
- Real time media metrics when joining Webex calls
- Manage logs from Control Hub
- Hybrid calendar through Control Hub ²
- Webex Assistant (voice-driven virtual assistant)

The *Webex Edge for Devices* article referenced above has an updated list of all available features and limitations.

Prerequisites

Find a comprehensive list of prerequisites and limitations in the *Webex Edge for Devices* article referenced to the left. Some of them are:

- Encrypted version of RoomOS or CE software
- If registered to CUCM: CUCM version 12.5su1, or 11.5.x with the latest device pack
- Control Hub administrator access
- Cisco Webex Device Connector (to set up the link to Webex Edge)
- A cloud services license (Cisco Collaboration Flex Plan)

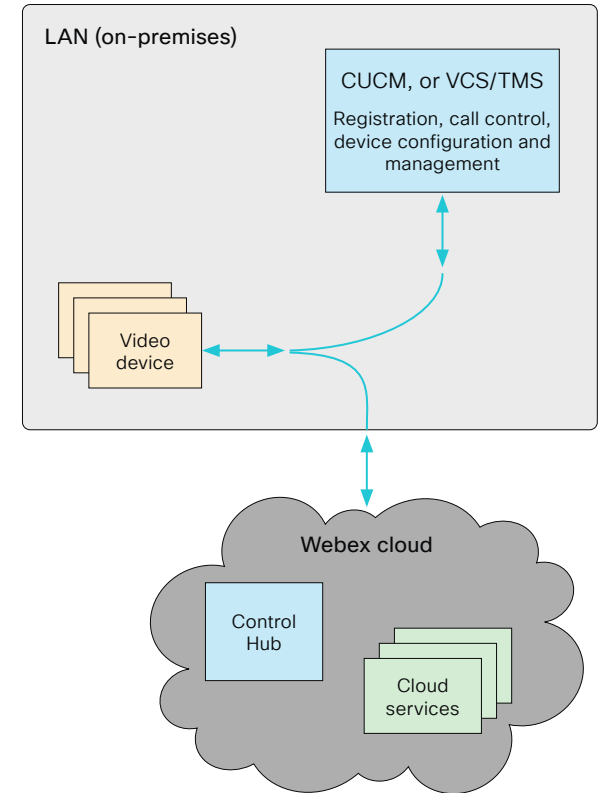

¹ You can configure the device to use the Webex cloud service for calling into Webex meetings. For details, read about *Webex optimized experience for Webex Edge for Devices* in the [▶ Webex Edge for Devices \(https://help.webex.com/cy2l2z/\)](https://help.webex.com/cy2l2z/) article on Webex Help Center.

² TMS based bookings will be ignored.

Board

BoardPro,
BoardPro
G2

Codec EQ

Codec
PlusCodec
ProDesk,
DeskPro,
Desk MiniRoom Bar
Pro,
Room BarRoom Kit,
Room Kit
MiniRoom Kit
EQX

Room 55

Room 55
Dual,
Room 70Room 70
G2Room 70
PanoramaRoom
Panorama

Register a device to the Cisco Webex cloud service

You can register a device to Cisco Webex remotely from the device web interface instead of using the on-screen setup assistant.

From the web interface, you can only register a device that is not currently registered to a service.

NOTE: All local users and any customizations that have been created for this device will be deactivated.

Create an activation code

To register a device to Cisco Webex, you need an activation code.

Devices in shared mode:

An administrator has to create an activation code on Control Hub.

To learn how to create an activation code for devices in shared mod, see [▶ Create a Workspace and Add Services for a Cisco Webex Room Device or a Cisco Webex Board \(https://help.webex.com/1mqb9cb/\)](#).

Devices in personal mode:

From *Cisco Webex Settings* (<https://settings.webex.com>), you can get your activation code without having to be an administrator.

To learn how to create an activation code for devices in personal mode, see [▶ Set Up a Webex Board, Room or Desk Device as a Personal Device \(https://help.webex.com/n3alqtv/\)](#).

1. Sign in to the device web interface and go to *Home*. Find the *Register System* card.

This card is only available if the device is not registered to a service already.

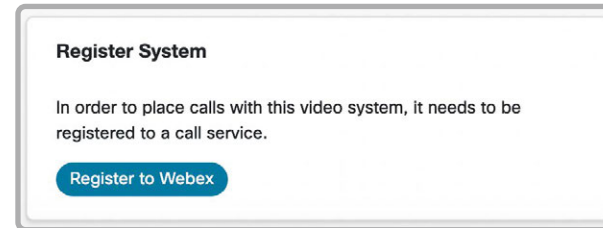

2. Click *Register to Webex*.
3. A pop-up appears and you can enter the activation code.
Format:
 - xxxx-xxxx-xxxx-xxxx, or
 - xxxxxxxxxxxxxxxx
4. After registration, you must setup the time zone and language settings from the on-screen setup assistant. If the setup assistant times out, default settings will be applied.

Limitations

Some of the available configurations only apply to on-premises registered devices. They don't apply to Webex registered devices. In the API guide's *Supported Commands Matrix*, these items are marked with "On-prem only".

Among the non-applicable configurations, are those related to H.323, SIP, NTP, CUCM, LDAP, Proximity, and Far End Camera Control.

Board

BoardPro,
BoardPro
G2

Codec EQ

Codec
PlusCodec
ProDesk,
DeskPro,
Desk MiniRoom Bar
Pro,
Room BarRoom Kit,
Room Kit
MiniRoom Kit
EQX

Room 55

Room 55
Dual,
Room 70Room 70
G2Room 70
PanoramaRoom
Panorama

Supported RFCs

The RFC (Request for Comments) series contains technical and organizational documents about the Internet, including the technical specifications and policy documents produced by the Internet Engineering Task Force (IETF).

RoomOS software supports a range of RFCs, including the following:

- RFC 2782 - DNS RR for specifying the location of services (DNS SRV)
- RFC 3261 - SIP: Session Initiation Protocol
- RFC 3263 - Locating SIP Servers
- RFC 3361 - DHCP Option for SIP Servers
- RFC 3550 - RTP: A Transport Protocol for Real-Time Applications
- RFC 3711 - The Secure Real-time Transport Protocol (SRTP)
- RFC 4091 - The Alternative Network Address Types (ANAT) Semantics for the Session Description Protocol (SDP) Grouping Framework
- RFC 4092 - Usage of the Session Description Protocol (SDP) Alternative Network Address Types (ANAT) Semantics in the Session Initiation Protocol (SIP)
- RFC 4582 - The Binary Floor Control Protocol
draft-ietf-bfcpbis-rfc4582bis-00 Revision of the Binary Floor Control Protocol (BFCP) for use over an unreliable transport
- RFC 4733 - RTP Payload for DTMF Digits, Telephony Tones and Telephony Signals
- RFC 5245 - Interactive Connectivity Establishment (ICE): A Protocol for Network Address Translator (NAT) Traversal for Offer/Answer Protocols
- RFC 5321 - Simple Mail Transfer Protocol (*Board, Board Pro, Board Pro G2, Desk, Desk Mini, Desk Pro, and Room Kit Mini*)
- RFC 5589 - SIP Call Control Transfer
- RFC 5766 - Traversal Using Relays around NAT (TURN): Relay Extensions to Session Traversal Utilities for NAT (STUN)
- RFC 5905 - Network Time Protocol Version 4: Protocol and Algorithms Specification

Board

BoardPro,
BoardPro
G2

Codec EQ

Codec
PlusCodec
ProDesk,
DeskPro,
Desk MiniRoom Bar
Pro,
Room BarRoom Kit,
Room Kit
MiniRoom Kit
EQX

Room 55

Room 55
Dual,
Room 70Room 70
G2Room 70
PanoramaRoom
Panorama

Calculating minimum bandwidth

The minimum bandwidth requirements are specified in the technical specifications. When dual-stream is used, the available bandwidth is split into two streams.

To calculate the minimum bandwidth for a desired resolution in dual-stream, double the minimum bit rate (bps) for that resolution (e.g., 720p30).

For example, if there is a minimum bandwidth of 768 kbps for the resolution 720p30. Then, the dual-stream minimum bandwidth will be 768×2 , or 1536 kbps.

Board

BoardPro,
BoardPro
G2

Codec EQ

Codec
PlusCodec
ProDesk,
DeskPro,
DeskMiniRoom Bar
Pro,
Room BarRoom Kit,
Room Kit
MiniRoom Kit
EQX

Room 55

Room 55
Dual,
Room 70Room 70
G2Room 70
PanoramaRoom
Panorama

User documentation on the Cisco web site

In general, you can find user documentation for all Cisco collaboration devices at ► <https://www.cisco.com/c/en/us/support/collaboration-endpoints>

We recommend you use the following short-links to find documentation for devices running RoomOS software.

Room series:

► <https://www.cisco.com/go/room-docs>

Desk series:

► <https://www.cisco.com/go/desk-docs>

Board series:

► <https://www.cisco.com/go/board-docs>

To find a specific document, click *Documentation* and look for the category that the document belongs to.

For example, to find an Administration guide click *Documentation* and look for *Maintain and Operate > Maintain and Operate Guides*.

Categories and document types

These lists show which category a document type belongs to. All types of documents are not available for all types of devices.

Install and Upgrade > Install and Upgrade Guides

- *Installation guides:*
How to assemble and install the device
- *Getting started guide:*
Initial configurations required to get the device up and running for the first time
- *RCSI guide:* Regulatory compliance and safety information

Maintain and Operate > Maintain and Operate Guides

- *Getting started guide:*
Initial configurations required to get the device up and running for the first time
- *Administration guide:*
Information required to configure and administer the device
- *Spare parts overview, Spare parts replacement guides, Cable schemas:* Useful information when connecting cables and replacing spare parts

Maintain and Operate > End-User Guides

- *User guides:*
How to use the device
- *Quick reference guides:*
How to use the device's main features

Reference > Command references

- *API reference guide:*
Reference guide for the device's public API

Reference > Technical References

- *CAD drawings:*
2D CAD drawings of the device, with dimensions

Configuration > Configuration Guides

- *Customization guide:*
How to customize the user interface, how to use the device's API to program in-room controls, making macros, configure advanced audio setups using the Audio Console, and other customizations.

Release and Compatibility > Release Notes

- *Software release notes*

Board

BoardPro,
BoardPro
G2

Codec EQ

Codec
PlusCodec
ProDesk,
DeskPro,
DeskMiniRoom Bar
Pro,
Room BarRoom Kit,
Room Kit
MiniRoom Kit
EQX

Room 55

Room 55
Dual,
Room 70Room 70
G2Room 70
PanoramaRoom
Panorama

Cisco contacts

On our web site you will find an overview of the worldwide Cisco contacts.

Go to: ► <https://www.cisco.com/go/offices>

Corporate Headquarters
Cisco Systems, Inc.
170 West Tasman Dr.
San Jose, CA 95134 USA

Intellectual property rights

THE SPECIFICATIONS AND INFORMATION REGARDING THE PRODUCTS IN THIS MANUAL ARE SUBJECT TO CHANGE WITHOUT NOTICE. ALL STATEMENTS, INFORMATION, AND RECOMMENDATIONS IN THIS MANUAL ARE BELIEVED TO BE ACCURATE BUT ARE PRESENTED WITHOUT WARRANTY OF ANY KIND, EXPRESS OR IMPLIED. USERS MUST TAKE FULL RESPONSIBILITY FOR THEIR APPLICATION OF ANY PRODUCTS.

THE SOFTWARE LICENSE AND LIMITED WARRANTY FOR THE ACCOMPANYING PRODUCT ARE SET FORTH IN THE INFORMATION PACKET THAT SHIPPED WITH THE PRODUCT AND ARE INCORPORATED HEREIN BY THIS REFERENCE. IF YOU ARE UNABLE TO LOCATE THE SOFTWARE LICENSE OR LIMITED WARRANTY, CONTACT YOUR CISCO REPRESENTATIVE FOR A COPY.

The Cisco implementation of TCP header compression is an adaptation of a program developed by the University of California, Berkeley (UCB) as part of UCB's public domain version of the UNIX operating system. All rights reserved. Copyright © 1981, Regents of the University of California.

NOTWITHSTANDING ANY OTHER WARRANTY HEREIN, ALL DOCUMENT FILES AND SOFTWARE OF THESE SUPPLIERS ARE PROVIDED "AS IS" WITH ALL FAULTS. CISCO AND THE ABOVE-NAMED SUPPLIERS DISCLAIM ALL WARRANTIES, EXPRESSED OR IMPLIED, INCLUDING, WITHOUT LIMITATION, THOSE OF MERCHANTABILITY, FITNESS FOR A PARTICULAR PURPOSE AND NONINFRINGEMENT OR ARISING FROM A COURSE OF DEALING, USAGE, OR TRADE PRACTICE.

IN NO EVENT SHALL CISCO OR ITS SUPPLIERS BE LIABLE FOR ANY INDIRECT, SPECIAL, CONSEQUENTIAL, OR INCIDENTAL DAMAGES, INCLUDING, WITHOUT LIMITATION, LOST PROFITS OR LOSS OR DAMAGE TO DATA ARISING OUT OF THE USE OR INABILITY TO USE THIS MANUAL, EVEN IF CISCO OR ITS SUPPLIERS HAVE BEEN ADVISED OF THE POSSIBILITY OF SUCH DAMAGES.

Any Internet Protocol (IP) addresses and phone numbers used in this document are not intended to be actual addresses and phone numbers. Any examples, command display output, network topology diagrams, and other figures included in the document are shown for illustrative purposes only. Any use of actual IP addresses or phone numbers in illustrative content is unintentional and coincidental.

All printed copies and duplicate soft copies are considered un-Controlled copies and the original on-line version should be referred to for latest version.

Cisco has more than 200 offices worldwide. Addresses, phone numbers, and fax numbers are listed on the Cisco website at www.cisco.com/go/offices.

Cisco and the Cisco logo are trademarks or registered trademarks of Cisco and/or its affiliates in the U.S. and other countries. To view a list of Cisco trademarks, go to this URL: www.cisco.com/go/trademarks. Third-party trademarks mentioned are the property of their respective owners. The use of the word partner does not imply a partnership relationship between Cisco and any other company. (1110R)

Cisco product security overview

This product contains cryptographic features and is subject to United States and local country laws governing import, export, transfer, and use. Delivery of Cisco cryptographic products does not imply third-party authority to import, export, distribute, or use encryption. Importers, exporters, distributors, and users are responsible for compliance with U.S. and local country laws. By using this product you agree to comply with applicable laws and regulations. If you are unable to comply with U.S. and local laws, return this product immediately.

Further information regarding U.S. export regulations may be found at <http://www.bis.doc.gov/policiesandregulations/ear/index.htm>.