



Configure the Appliance Using the Maglev Wizard

- [Appliance Configuration Overview](#), on page 1
- [Maglev Wizard Interface Configuration Order](#), on page 2
- [IPv4 and IPv6 Considerations](#), on page 2
- [Configure the Primary Node Using the Maglev Wizard](#), on page 3
- [Configure a Secondary Node Using the Maglev Wizard](#), on page 23
- [Upgrade to the Latest Cisco DNA Center Release](#), on page 43

Appliance Configuration Overview

You can deploy the appliance in your network in one of the following two modes:

- **Standalone:** As a single node offering all the functions. This option is usually preferred for initial or test deployments and in smaller network environments. If you choose Standalone mode for your initial deployment, you can add more appliances later to form a cluster. When configuring the standalone host, ensure that it is set up as the first, or primary, node in the cluster.
- **Cluster:** As a node that belongs to a three-node cluster. In this mode, all the services and data are shared among the hosts. This is the preferred option for large deployments. If you choose Cluster mode for your initial deployment, be sure to finish configuring the primary node before configuring the secondary nodes.

To proceed, complete the following tasks:

1. Configure the primary node in your cluster. See [Configure the Primary Node Using the Maglev Wizard, on page 3](#).
2. If you have installed three appliances and want to add the second and third nodes to your cluster, see [Configure a Secondary Node Using the Maglev Wizard, on page 23](#).

Maglev Wizard Interface Configuration Order

The order in which Cisco DNA Center appliance interfaces are configured in the Maglev Configuration wizard differ between the first and second-generation appliance, as illustrated in the following table. Refer to these Cisco part numbers to determine whether you have a first or second-generation appliance:

- First-generation 44-core appliance: DN1-HW-APL
- Second-generation:
 - 44-core appliance: DN2-HW-APL
 - 44-core promotional appliance: DN2-HW-APL-U
 - 56-core appliance: DN2-HW-APL-L
 - 56-core promotional appliance: DN2-HW-APL-L-U
 - 112-core appliance: DN2-HW-APL-XL
 - 112-core promotional appliance: DN2-HW-APL-XL-U

Cisco DNA Center Appliance Interface and Function	Appliance Type	Configuration Order in the Maglev Wizard
Enterprise: Links the appliance to your enterprise network.	First-generation	Network Adapter #4
	Second-generation	Network Adapter #1
Intracluster: Links the appliance to your cluster nodes.	First-generation	Network Adapter #1
	Second-generation	Network Adapter #2
Management: Allows you to access the Cisco DNA Center GUI from your management network.	First-generation	Network Adapter #2
	Second-generation	Network Adapter #3
Internet: Provides internet access when another interface is not available for this purpose.	First-generation	Network Adapter #3
	Second-generation	Network Adapter #4

IPv4 and IPv6 Considerations

Keep these points in mind regarding Cisco DNA Center and IPv4/IPv6 addressing:

- Cisco DNA Center does not support dual stack addressing—the simultaneous use of both IPv4 and IPv6 addressing.
- To switch from one addressing scheme to the other, you must [Reimage the Appliance](#).
- Restoring the backup file for an appliance using IPv4 onto an appliance using IPv6 (and vice versa) is not supported.

- If your appliance uses IPv6 addressing, see the "IPv6 Limitations" section in the [Release Notes for Cisco Cisco DNA Center](#) for a description of the features that are not supported.

Configure the Primary Node Using the Maglev Wizard

Perform the steps in this procedure to configure the first installed appliance as the primary node. You must always configure the first appliance as the primary node, whether it will operate standalone or as part of a cluster.

If you are configuring the installed appliance as a secondary node for an existing cluster that already has a primary node, follow the steps described in [Configure a Secondary Node Using the Maglev Wizard](#), on page 23 instead.



Note Ensure that all of the IP addresses you enter while completing this procedure are valid IPv4 addresses with valid IPv4 netmasks. Also make sure that the addresses and their corresponding subnets do not overlap. Service communication issues can result if they do.



Important Before you configure the appliances in a three-node cluster, ensure that you have logged out of those appliances. Otherwise, the Quick Start workflow (which you complete to discover your network's devices and enable telemetry) will not start after you have configured your cluster's appliances and log in to Cisco DNA Center for the first time.

Before you begin

Ensure that you:

- Collected all of the information specified in [Required IP Addresses and Subnets](#) and [Required Configuration Information](#).
- Installed the first appliance, as described in [Appliance Installation Workflow](#).
- Configured Cisco IMC browser access on the primary node, as described in [Enable Browser Access to Cisco Integrated Management Controller](#).
- Checked that the primary node appliance's ports, and the switches they use, are properly configured, as described in [Execute Preconfiguration Checks](#).
- Confirmed that you are using a compatible browser. For a list of compatible browsers, see the [Release Notes](#) document for the version of Cisco DNA Center you are installing.
- Enabled ICMP on the firewall between Cisco DNA Center and both the default gateway and the DNS server you specify in the following procedure. The Maglev Configuration wizard uses ping to verify the gateway and DNS server you specify. This ping might get blocked if a firewall is in place and ICMP is not enabled on that firewall. When this happens, you will not be able to complete the wizard.

Procedure

Step 1 Point your browser to the Cisco IMC IP address you set during the Cisco IMC GUI configuration you performed, and log in to the Cisco IMC GUI as the Cisco IMC user (see [Enable Browser Access to Cisco Integrated Management Controller](#)).

After successful login, the appliance displays the **Cisco Integrated Management Controller Chassis Summary** window, with a hyperlinked menu at the top of the window, as shown below.



Step 2 From the hyperlinked menu, choose **Launch KVM** and then select either **Java based KVM** or **HTML based KVM**. If you select **Java-based KVM**, you will need to launch the Java startup file from your browser or file manager in order to view the KVM console in its own window. If you select **HMTL-based KVM**, it launches the KVM console in a separate window or tab automatically.

Irrespective of the KVM type you choose, use the KVM console to monitor the progress of the configuration and respond to the Maglev Configuration wizard prompts.

Step 3 With the KVM displayed, reboot the appliance by making one of the following selections:

- In the main Cisco IMC GUI browser window: Choose **Host Power > Power Cycle**, and switch to the KVM console to continue.
- In the KVM console: Choose **Power > Power Cycle System (cold boot)**.

If you are asked to confirm your choice to reboot the appliance, click **OK**.

After displaying reboot messages, the KVM console displays the Maglev Configuration wizard welcome screen.

```
Welcome to the Maglev Configuration Wizard!

The wizard will walk you through the steps to configure this host. Select one of the options below to specify how you
would like to configure this host:

Start a Cisco DNA Center Cluster
Join a Cisco DNA Center Cluster

< exit >

Web installation: https://172.29.131.224:9004/
```

Step 4 Click **Start a Cisco DNA Center Cluster** to begin configuring the primary node.

The screen updates.

```
Welcome to Maglev Configuration Wizard!

This wizard will walk you through the steps to configure this host. Select one of the options below to specify how would
you like to configure this host:

Start using DNAC pre manufactured cluster
Start configuration of DNAC in advanced mode

< back > < exit >

This mode will enable you to stand up the DNAC Node in it's default manufactured state. This mode supports bringing up
DNAC only in IPv4 mode. Use Advanced mode for deploying DNAC in IPv6 mode.
```

Step 5 Choose one of the following options:

- **Start using DNAC pre manufactured cluster:** Choose this option to configure an appliance with its default settings in place:
 - Intracluster interface IP address: **169.254.6.66**
 - Intracluster interface subnet mask: **255.255.255.128**
 - Container subnet: **169.254.32.0/20**
 - Cluster subnet: **169.254.48.0/20**
 - IPv4 addressing
 - Admin superuser password: **maglev1@3**

You will *not* be able to change any of these settings, so choose this option only if you want to use them.

- **Start configuration of DNAC in advanced mode:** Choose this option to configure an appliance that doesn't use one or more of the default settings listed in the previous bullet. Also choose this option if you want to use IPv6 addressing on your appliance.

Step 6 Specify whether the applications and services running on your Cisco DNA Center appliance will use IPv4 or IPv6 addressing. After making your selection, click **next>>** to proceed.

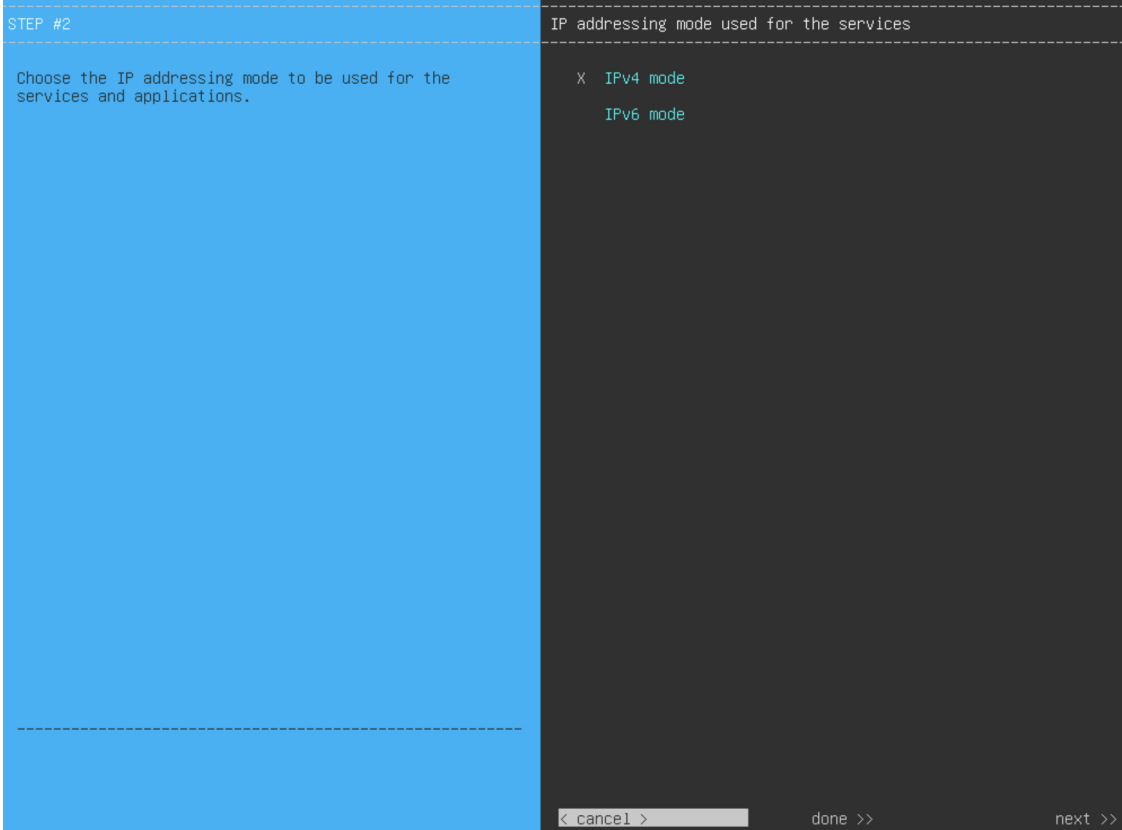

Important In the next wizard screen, you can enable the **VLAN mode** feature, which creates a single bonded interface that connects to your network using both the primary and secondary instance of your appliance's Enterprise interface. This feature is not commonly used, so only enable it if you know it's required by your Cisco DNA Center deployment.

- If this is the case, complete the next step.
- Otherwise, click **next>>** in the next wizard screen without making any selections. You can enable the NIC bonding functionality that was described previously in this guide in the wizard's Enterprise and Intracluster interface configuration screens.

Step 7

(Optional) Do the following to enable Layer 2 port channel mode (with VLAN tagging) for the appliance. After making your selections, click **next>>** to proceed.

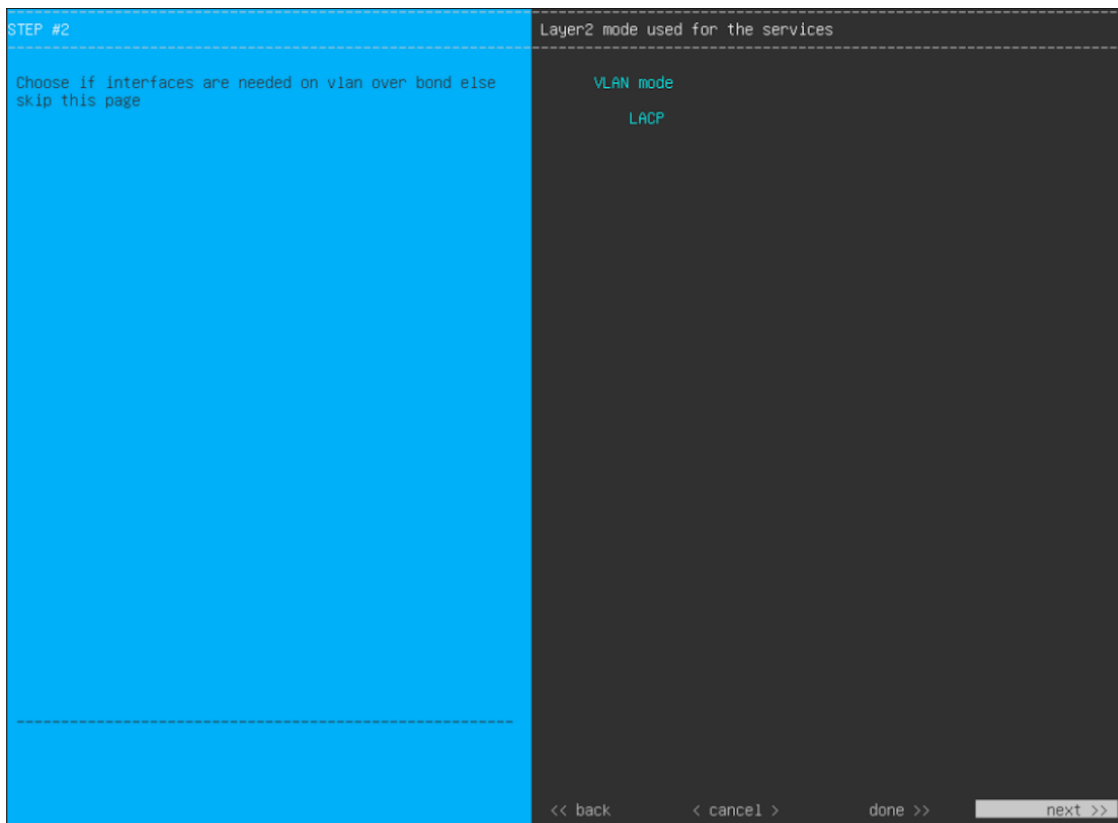

- a) Choose the **VLAN mode** option to enable dot1q/VLAN trunking and convert your appliance's Enterprise, Cluster, Management, and Internet interfaces into VLAN subinterfaces that reside on the bonded interface (as illustrated in the following figure). By default, this interface operates in Active-Backup mode (which enables HA).

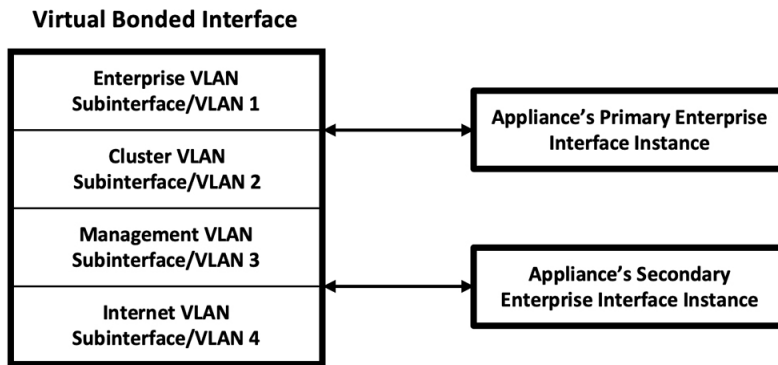

- b) If you want this interface to operate in LACP mode instead (which enables load balancing and higher bandwidth), you must also choose the **LACP** option.
- c) When you enter the settings for your appliance's Enterprise and Cluster interfaces, ensure that you enter a unique VLAN ID in the **VLAN ID of Interface** field for the subinterfaces you want to configure on the virtual bonded interface.

Important Even though one physical appliance interface (the Enterprise interface) is connected, you can configure all of the subinterfaces that reside on the virtual bonded interface.

The wizard discovers all of the ports on the appliance and presents them to you one by one, in separate screens, in the following order:

- a. (Required) 10-Gbps Enterprise Port—Network Adapter #1
- b. (Required) 10-Gbps Cluster Port—Network Adapter #2
- c. (Optional) 1-Gbps/10-Gbps Management Port—Network Adapter #3
- d. (Optional) 1-Gbps/10-Gbps Internet Port—Network Adapter #4

If the wizard fails to display either or both of the Enterprise and Cluster ports during the course of configuration, it might indicate that these ports are nonfunctional or disabled. These two ports are required for Cisco DNA Center functionality. If you discover that they are nonfunctional, choose **cancel** to exit the configuration wizard immediately. Be sure that you have completed all of the steps provided in [Execute Preconfiguration Checks](#) before resuming the configuration or contacting the Cisco Technical Assistance Center (for more information, see the "Get Assistance from the Cisco TAC" topic in the [Release Notes](#) document).

Step 8

The wizard first presents the 10-Gbps Enterprise port as **NETWORK ADAPTER #1**. As explained in [Interface Cable Connections](#), this is a required port used to link the appliance to the enterprise network. Apply the host IP address, netmask, and other values that are appropriate for this purpose (see [Required IP Addresses and Subnets](#) and [Required Configuration Information](#) for the values to enter).

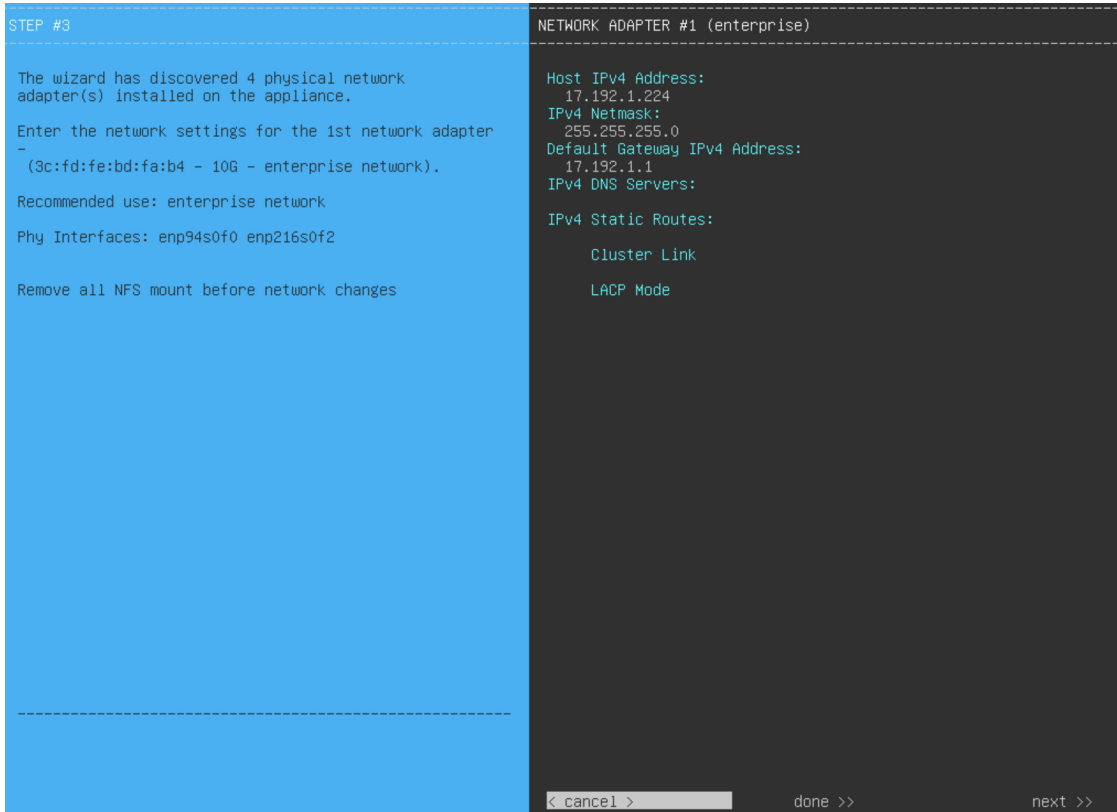

Enter the configuration values for **NETWORK ADAPTER #1**, as shown in the table below.

Table 1: Primary Node Entries for Network Adapter #1: 10-Gbps Enterprise Port

Host IPv4/IPv6 Address field	Enter the IP address for the Enterprise port. This is required.
IPv4 Netmask/IPv6 Prefix Length field	Do one of the following: <ul style="list-style-type: none"> • If you selected IPv4 addressing, enter the netmask for the port's IP address. This is required. • If you selected IPv6 addressing, enter the prefix length (in bits). Valid values range from 10 through 127.
Default Gateway IPv4/IPv6 Address field	Enter a default gateway IP address to use for the port. <p>Important Ensure that you enter a default gateway IP address for at least one of your appliance's interfaces. Otherwise, you will not be able to complete the configuration wizard.</p>

IPv4/IPv6 DNS Servers field	<p>Enter the IP address of the preferred DNS server. If you are entering multiple DNS servers, separate the IP addresses in the list with spaces.</p> <p>Important For each appliance in your cluster, configure a maximum of three DNS servers. Problems can occur if you configure more than three DNS servers for an appliance.</p>
IPv4/IPv6 Static Routes field	<p>Enter one or more static routes in the following format, separated by spaces: <code><network>/<netmask>/<gateway></code>. This is usually required on the Cisco DNA Center Management port only.</p>
Vlan Id of Interface field	<p>Enter the VLAN ID that will be tagged over the LACP link to be created for the appliance you are configuring.</p> <p>Note This field is displayed only if you set Layer 2 LACP portchannel mode for the appliance by choosing both options in Step 7.</p>
Cluster Link field	<p>Leave this field blank. It is required on the Cluster port only.</p>
LACP Mode field	<p>Do one of the following:</p> <ul style="list-style-type: none"> • Leave this field blank and the port will operate in Active-Backup mode. This mode provides fault tolerance by aggregating two Ethernet interfaces into a single logical channel. When the interface that's currently active goes down, the other interface takes its place and becomes active. • Check the check box to enable LACP mode on this port. This mode aggregates two Ethernet interfaces that share the same speed and duplex settings into a single logical channel. This provides load balancing and higher bandwidth. <p>For more information about Cisco DNA Center's implementation of NIC bonding, see NIC Bonding Overview.</p> <p>Note This field is displayed if you didn't choose any of the options in Step 7.</p>

After you finish entering the configuration values, click **next**>> to proceed. The wizard validates the values you entered and issues an error message if any are incorrect. If you receive an error message, check that the value you entered is correct, then reenter it. If needed, click <<**back** to reenter it.

Step 9

After successful validation of the Enterprise port values you entered, the wizard presents the 10-Gbps Cluster port and presents it as **NETWORK ADAPTER #2**. As explained in [Interface Cable Connections](#), this port is used to link the

appliance to the cluster, so apply the host IP address, netmask, and other values that are appropriate for this purpose (see [Required IP Addresses and Subnets](#) and [Required Configuration Information](#) for the values to enter).



Enter the configuration values for **NETWORK ADAPTER #2**, as shown in the table below.

Table 2: Primary Node Entries for Network Adapter #2: 10-Gbps Cluster Port

Host IPv4/IPv6 address field	Enter the IP address for the Cluster port. This is required. Note that you cannot change the address of the Cluster port later.
IPv4 Netmask/IPv6 Prefix Length field	Do one of the following: <ul style="list-style-type: none"> • If you selected IPv4 addressing, enter the netmask for the port's IP address. This is required. • If you selected IPv6 addressing, enter the prefix length (in bits). Valid values range from 10 through 127.
Default Gateway IPv4/IPv6 address field	Enter a default gateway IP address to use for the port. Important Ensure that you enter a default gateway IP address for at least one of your appliance's interfaces. Otherwise, you will not be able to complete the configuration wizard.

IPv4/IPv6 DNS Servers field	<p>Enter the IP address of the preferred DNS server. If you are entering multiple DNS servers, separate the IP addresses in the list with spaces.</p> <p>Important For each appliance in your cluster, configure a maximum of three DNS servers. Problems can occur if you configure more than three DNS servers for an appliance.</p>
IPv4/IPv6 Static Routes field	<p>Enter one or more static routes in the following format, separated by spaces: <code><network>/<netmask>/<gateway></code>. This is usually required on the Management port only.</p>
Vlan Id of Interface field	<p>Enter the VLAN ID that will be tagged over the LACP link to be created for the appliance you are configuring.</p> <p>Note This field is displayed only if you set Layer 2 LACP portchannel mode for the appliance by choosing both options in Step 7.</p>
Cluster Link field	<p>Check the check box to set this port as the link to a Cisco DNA Center cluster. This is required on the Cluster port only.</p>
LACP Mode field	<p>Do one of the following:</p> <ul style="list-style-type: none"> • Leave this field blank and the port will operate in Active-Backup mode. This mode provides fault tolerance by aggregating two Ethernet interfaces into a single logical channel. When the interface that's currently active goes down, the other interface takes its place and becomes active. • Check the check box to enable LACP mode on this port. This mode aggregates two Ethernet interfaces that share the same speed and duplex settings into a single logical channel. This provides load balancing and higher bandwidth. <p>For more information about Cisco DNA Center's implementation of NIC bonding, see NIC Bonding Overview.</p> <p>Note This field is displayed if you didn't choose any of the options in Step 7.</p>

After you provide the necessary information, click **next>>** to proceed. Correct validation errors, if any, as you did in previous screens. The wizard validates and applies your network adapter configurations.

Step 10

After successful validation of the Cluster port values you entered, the wizard presents the 1-Gbps/10-Gbps Management port and presents it as **NETWORK ADAPTER #3**. As explained in [Interface Cable Connections](#), this port is used to access the Cisco DNA Center GUI from your management network. Apply the host IP address, netmask, and other

values that are appropriate for this purpose (see [Required IP Addresses and Subnets](#) and [Required Configuration Information](#) for the values to enter).

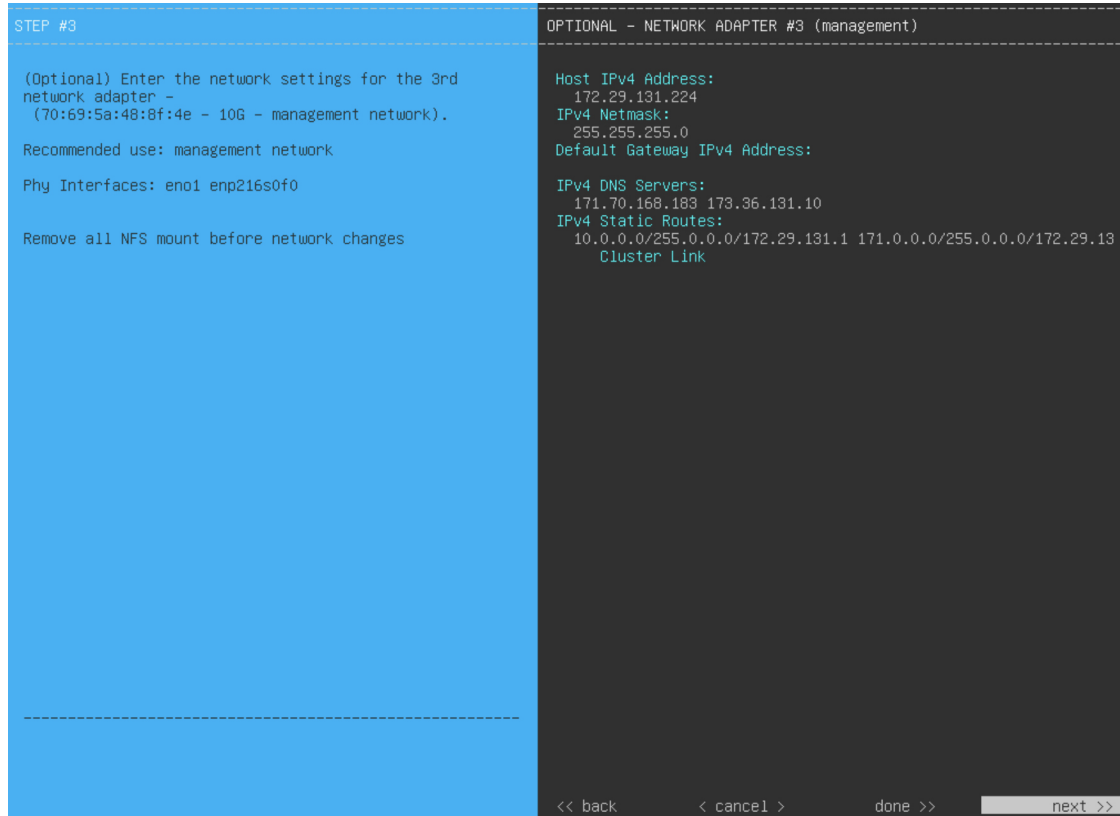

Enter the configuration values for **NETWORK ADAPTER #3**, as shown in the table below.

Table 3: Primary Node Entries for Network Adapter #3: 1-Gbps/10-Gbps Management Port

Host IPv4/IPv6 address field	Enter the IP address for the Management Port. This is required only if you are using this port to access the Cisco DNA Center GUI from your management network; otherwise, you can leave it blank.
IPv4 Netmask/IPv6 Prefix Length field	Do one of the following if you entered an IP address: <ul style="list-style-type: none"> • If you selected IPv4 addressing, enter the netmask for the port's IP address. This is required. • If you selected IPv6 addressing, enter the prefix length (in bits). Valid values range from 10 through 127.
Default Gateway IPv4/IPv6 address field	Enter a default gateway IP address to use for the port. <p>Important Ensure that you enter a default gateway IP address for at least one of your appliance's interfaces. Otherwise, you will not be able to complete the configuration wizard.</p>

IPv4/IPv6 DNS Servers field	<p>Enter the IP address of the preferred DNS server. If you are entering multiple DNS servers, separate the IP addresses in the list with spaces.</p> <p>Important</p> <ul style="list-style-type: none"> • For NTP, ensure port 123 (UDP) is open between Cisco DNA Center and your NTP server. • For each appliance in your cluster, configure a maximum of three DNS servers. Problems can occur if you configure more than three DNS servers for an appliance.
IPv4/IPv6 Static Routes field	Enter one or more static routes in the following format, separated by spaces: <code><network>/<netmask>/<gateway></code> .
Cluster Link field	Leave this field blank. It is required on the Cluster port only.

After you provide the necessary information, click **next>>** to proceed. Correct validation errors, if any, as you did in previous screens. The wizard validates and applies your network adapter configurations.

Step 11

After successful validation of the Management port values you entered, the wizard presents the 1-Gbps/10-Gbps Internet port as **NETWORK ADAPTER #4**. As explained in [Interface Cable Connections](#), this is an optional port used to link the appliance to the Internet when you cannot do so through the 10-Gbps Enterprise port. Apply the host IP address, netmask, and other values that are appropriate for this purpose (see [Required IP Addresses and Subnets](#) and [Required Configuration Information](#) for the values to enter).

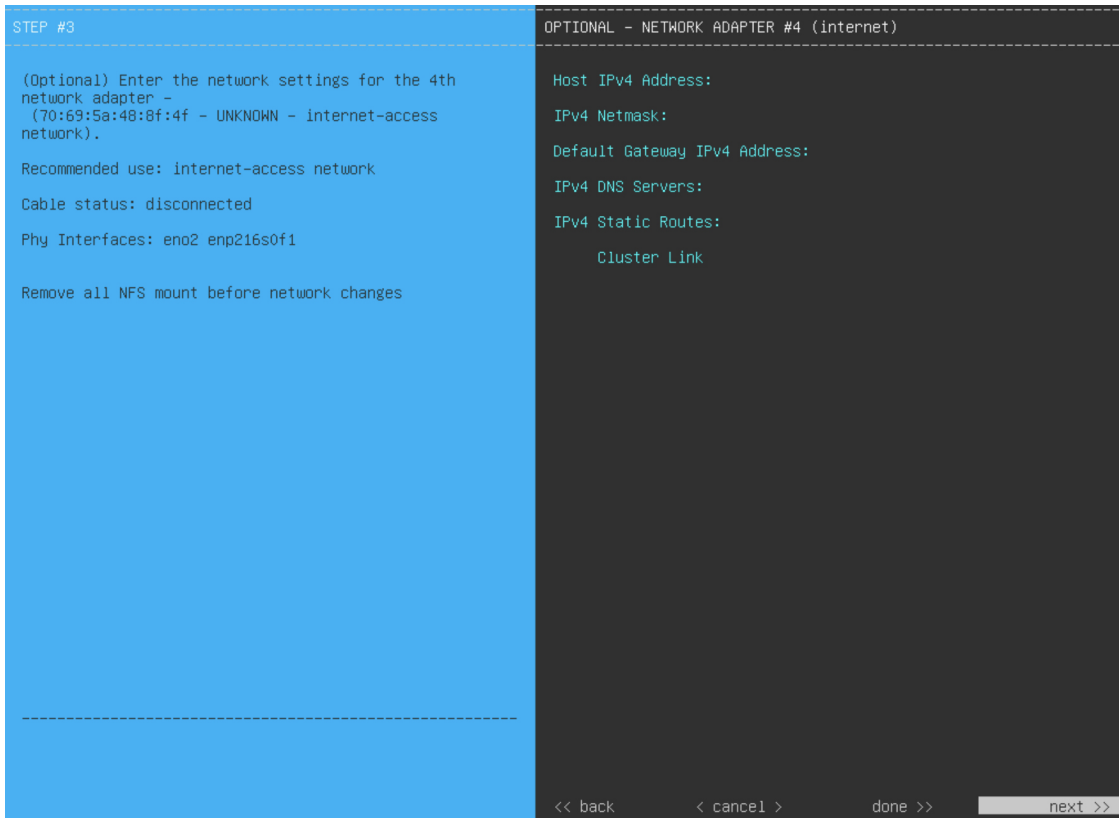

Enter the configuration values for **NETWORK ADAPTER #4**, as shown in the table below.

Table 4: Primary Node Entries for Network Adapter #4: 1-Gbps/10-Gbps Internet Port

Host IPv4/IPv6 address field	Enter the IP address for the Internet port. This is required only if you are using the Internet port for internet connection; otherwise, you can leave it blank.
IPv4 Netmask/IPv6 Prefix Length field	Do one of the following if you entered an IP address: <ul style="list-style-type: none"> • If you selected IPv4 addressing, enter the netmask for the port's IP address. This is required. • If you selected IPv6 addressing, enter the prefix length (in bits). Valid values range from 10 through 127.
Default Gateway IPv4/IPv6 address field	Enter a default gateway IP address to use for the Internet port. <p>Important Ensure that you enter a default gateway IP address for at least one of your appliance's interfaces. Otherwise, you will not be able to complete the configuration wizard.</p>

IPv4/IPv6 DNS Servers field	<p>Enter the IP address of the preferred DNS server. If you are entering multiple DNS servers, separate the IP addresses in the list with spaces.</p> <p>Important For each appliance in your cluster, configure a maximum of three DNS servers. Problems can occur if you configure more than three DNS servers for an appliance.</p>
IPv4/IPv6 Static Routes field	<p>Enter one or more static routes in the following format, separated by spaces: <i><network>/<netmask>/<gateway></i>. This is usually required on the Management port only.</p>
Cluster Link field	<p>Leave this field blank. It is required on the Cluster port only.</p>

After you provide the necessary information, click **next>>** to proceed. Correct validation errors, if any, as you did in previous screens. The wizard validates and applies your network adapter configurations.

Step 12 After the network adapter configuration is complete, the wizard prompts you to enter configuration values for the **NETWORK PROXY** that you are using, as shown below.

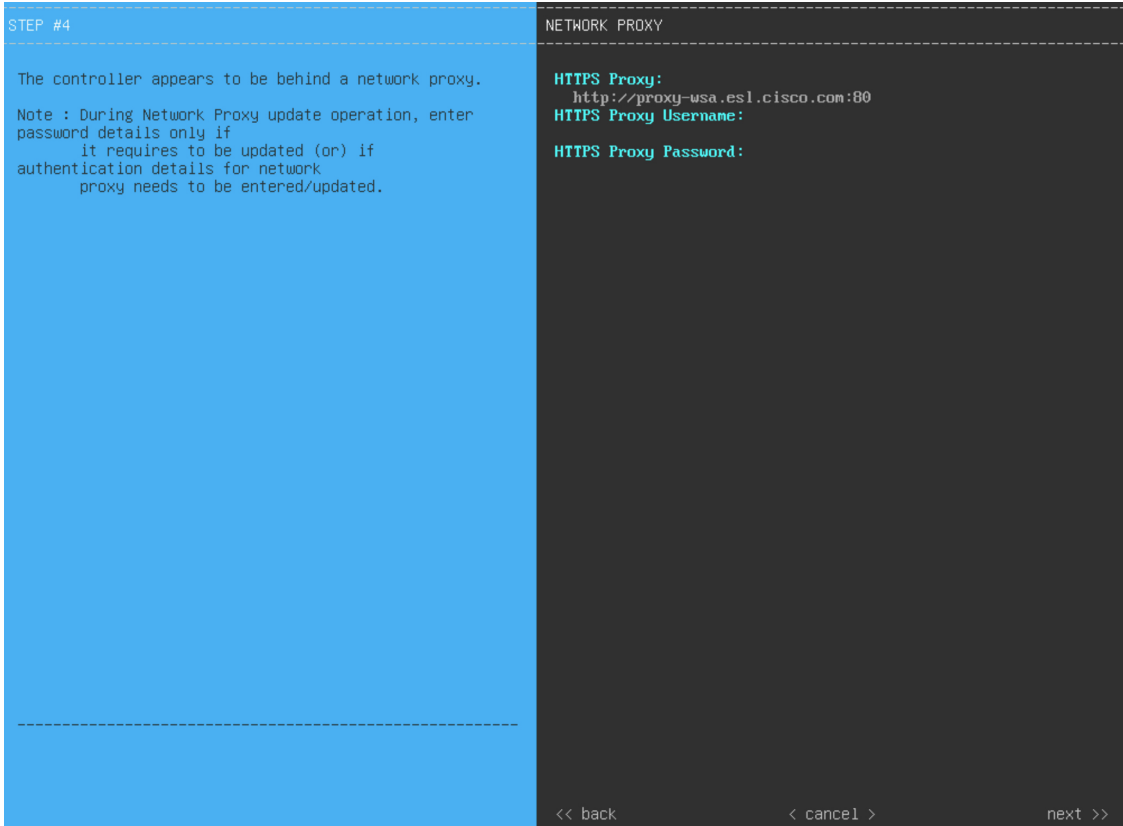

Enter the configuration values for the **NETWORK PROXY**, as shown in the table below.

Table 5: Primary Node Entries for Network Proxy

HTTPS Proxy field	<p>Enter the URL or host name of an HTTPS network proxy used to access the Internet.</p> <p>Note</p> <ul style="list-style-type: none"> • Connection from Cisco DNA Center to the HTTPS proxy is supported only through HTTP in this release. • If you enter an IPv6 URL that contains a port number, enclose the IP address portion of the URL in square brackets. In this example, 443 is the port number: http://[2001:db8:85a3:8d3:1319:8a2e:370:7348]:443/
HTTPS Proxy Username field	Enter the user name used to access the network proxy. If no proxy login is required, leave this field blank.
HTTPS Proxy Password field	Enter the password used to access the network proxy. If no proxy login is required, leave this field blank.

After you provide the necessary information, click **next>>** to proceed. Correct validation errors, if any, as you did in previous screens.

Step 13

After network proxy configuration completes, the wizard prompts you to enter virtual IP addresses for the primary node, in **MAGLEV CLUSTER DETAILS** (as shown below).



Enter a space-separated list of the virtual IP addresses used for traffic between the cluster and your network. This is required for both three-node clusters and single-node clusters that will be converted into a three-node cluster in the future. If you have a single-node cluster setup and plan to stick with it, skip this step and proceed to the next step.

Important You must enter one virtual IP address for each configured network interface. You will not be able to complete the wizard unless you do so. These addresses are tied to the cluster link's status, which must be in the **UP** state.

You also have the option to specify the fully qualified domain name (FQDN) for your cluster. Cisco DNA Center uses this domain name to do the following:

- It uses this hostname to access your cluster's web interface and the Representational State Transfer (REST) APIs used by devices in the enterprise network that Cisco DNA Center manages.
- In the Subject Alternative Name (SAN) field of Cisco DNA Center certificates, it uses the FQDN to define the Plug and Play server that should be used for device provisioning.

After you provide the necessary information, click **next>>** to proceed. Correct validation errors, if any, as you did in previous screens.

Step 14 After you have entered the cluster details, the wizard prompts you to enter **USER ACCOUNT SETTINGS** values, as shown below.

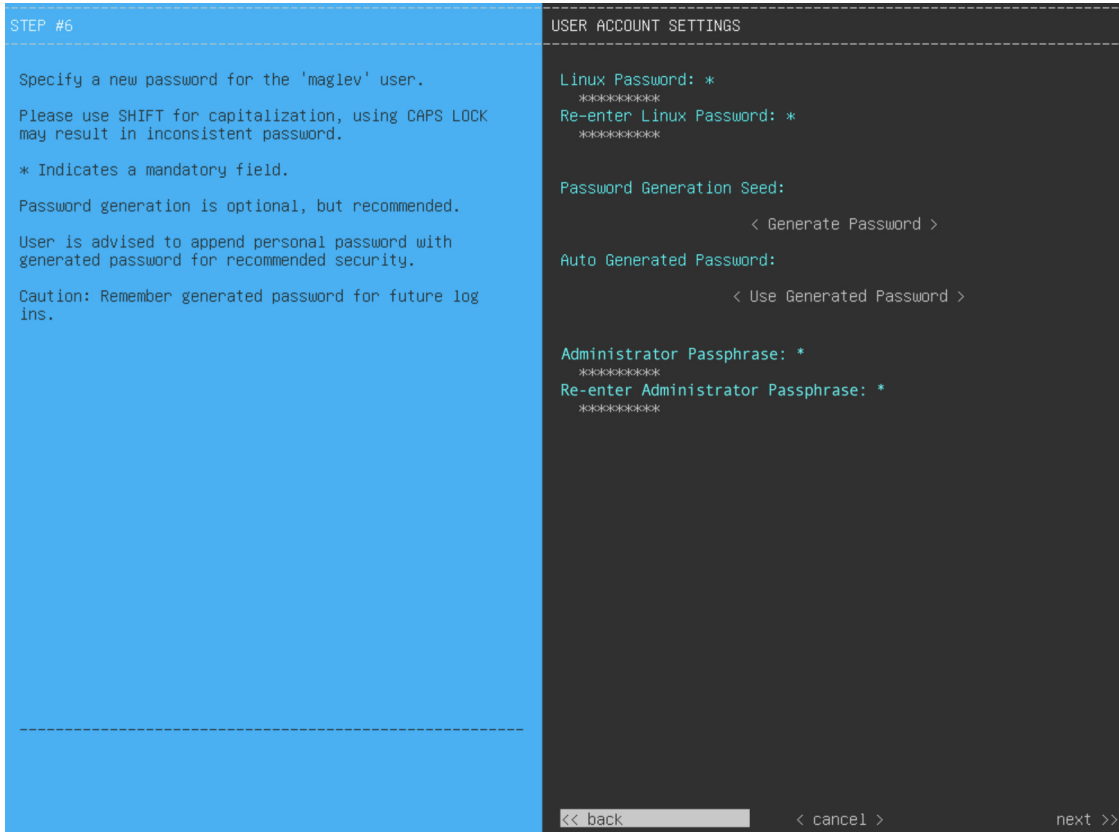

Enter the values for **USER ACCOUNT SETTINGS**, as shown in the table below.

Table 6: Primary Node Entries for User Account Settings

Linux Password field	Enter a Linux password for the maglev user.
Re-enter Linux Password field	Confirm the Linux password by entering it a second time.
Password Generation Seed field	If you do not want to create the Linux password yourself, enter a seed phrase in this field and then press <Generate Password> to generate the password.
Auto Generated Password field	(Optional) The seed phrase appears as part of a random and secure password. If desired, you can either use this password "as is", or you can further edit this auto-generated password. Press <Use Generated Password> to save the password.

<p>Administrator Password field</p>	<p>Enter a password for the default admin superuser, used to log in to Cisco DNA Center for the first time.</p> <p>Note If you chose the Start using DNAC pre manufactured cluster option in Step 5, the default password (maglev1@3) has already been set for the appliance and cannot be changed in the configuration wizard. As a result, this and the following field are not displayed in this screen.</p>
<p>Re-enter Administrator Password field</p>	<p>Confirm the administrator password by entering it a second time.</p>

After you provide the necessary information, click **next>>** to proceed. Correct validation errors, if any, as you did in previous screens.

Step 15

After you have entered the user account details, the wizard prompts you to enter **NTP SERVER SETTINGS** values, as shown below.

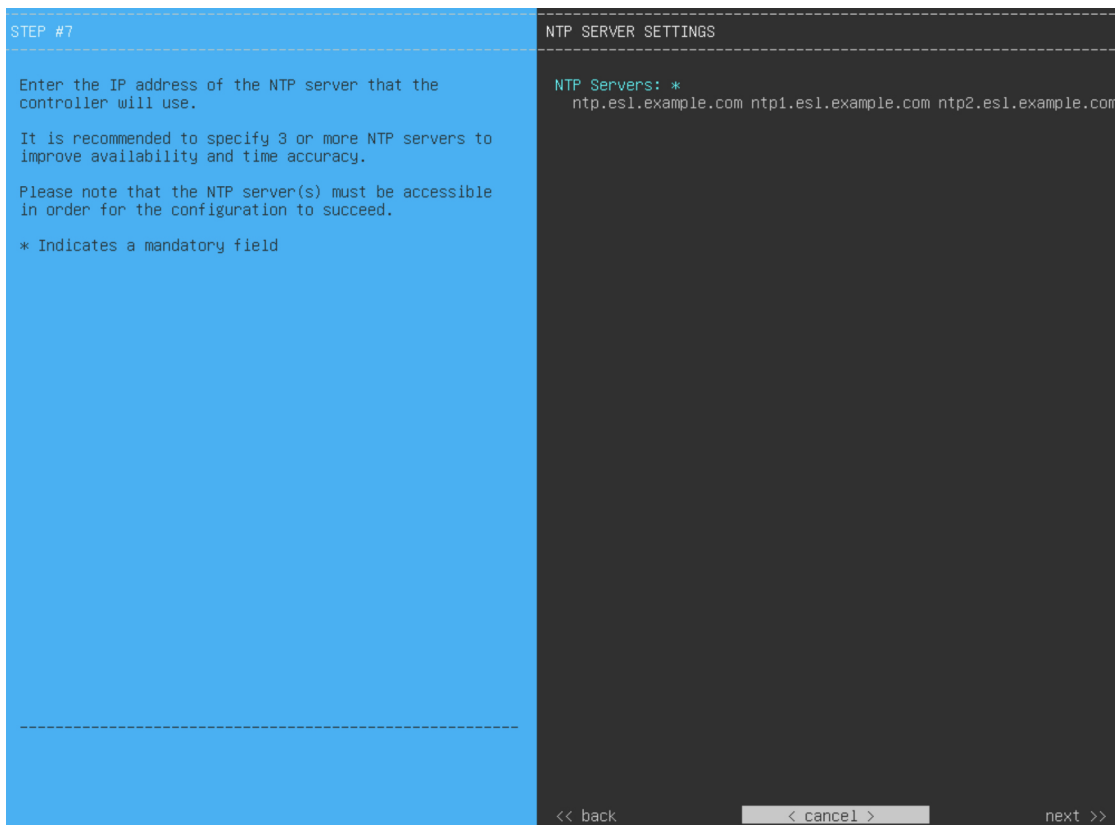

Enter one or more NTP server addresses or hostnames, separated by spaces. At least one NTP address or hostname is required. For a production deployment, we recommend that you configure a minimum of three NTP servers.

After you provide the necessary information, click **next>>** to proceed. Correct validation errors, if any, as you did in previous screens. The wizard validates and applies your NTP server configuration.

Step 16

After you have specified the appropriate NTP servers, the wizard prompts you to enter **MAGLEV ADVANCED SETTINGS** values, as shown below.

Note If you chose the **Start using DNAC pre manufactured cluster** option in Step 5, the default Container and Cluster subnets have already been set for the appliance and cannot be changed in the configuration wizard. As a result, you will not see the following wizard screen. Proceed to Step 17.

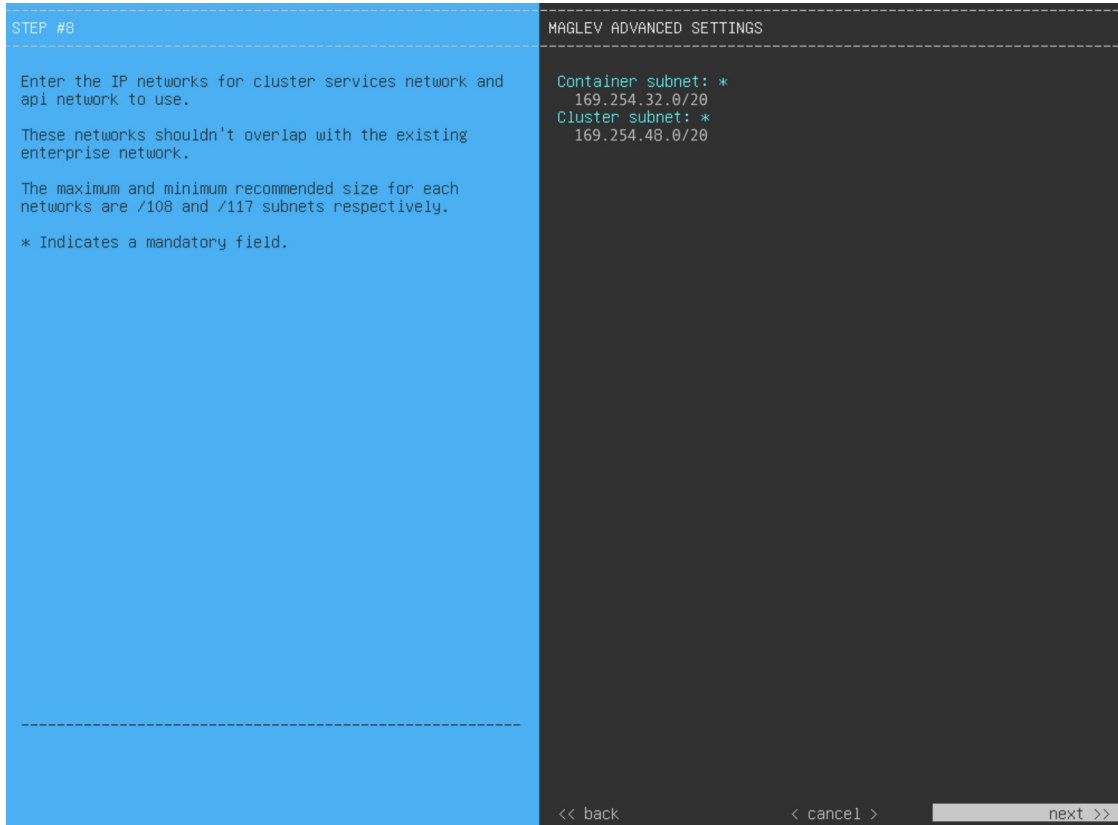

Enter the configuration values for **MAGLEV ADVANCED SETTINGS**, as shown in the table below.

Table 7: Primary Node Entries for Maglev Advanced Settings

<p>Container Subnet field</p>	<p>A dedicated, non-routed IP subnet that Cisco DNA Center uses to manage internal services. By default, this is already set to 169.254.32.0/20, and we recommend that you use this subnet. If you choose to enter another subnet, ensure that it does not conflict with or overlap any other subnet used by the Cisco DNA Center internal network or an external network. For more information, see the Container Subnet description in Required IP Addresses and Subnets.</p>
-------------------------------	--

Cluster Subnet field	A dedicated, non-routed IP subnet that Cisco DNA Center uses to manage internal cluster services. By default, this is already set to 169.254.48.0/20 , and we recommend that you use this subnet. If you choose to enter another subnet, ensure that it does not conflict with or overlap any other subnet used by the Cisco DNA Center internal network or an external network. For more information, see the Cluster Subnet description in Required IP Addresses and Subnets .
----------------------	---

When you are finished, click **next>>** to proceed. Correct validation errors, if any, as you did in previous screens.

Step 17

After you have entered the Maglev advanced settings, a final message appears, stating that the wizard is ready to apply the configuration (as shown below).

```
The wizard is now ready to apply the configuration on the controller.
Use the [back] button below to verify/modify controller settings.
Use the [cancel] button to discard your changes and exit the wizard.
Use the [proceed] button to save your changes and proceed with applying them on the controller.
```

<< back < cancel > proceed >>

Click **proceed>>** to complete the configuration wizard.

The host will reboot automatically and display messages on the KVM console as it applies your settings and brings up services. This process can take several hours. You can monitor its progress via the KVM console.

At the end of the configuration process, the appliance power-cycles again, then displays a **CONFIGURATION SUCCEEDED!** message.

```
CONFIGURATION SUCCEEDED
The configuration wizard has completed successfully!
To access the Maglev Web UI, please point your browser to one of the following URLs:

To access the Maglev Web Console, please point your browser to one of the following URLs:
https://17.192.1.224
https://169.254.6.66
https://172.29.131.224

The wizard will automatically close in 30 seconds
```

What to do next

- If you are deploying this appliance in standalone mode only, perform the first-time setup: [First-Time Setup Workflow](#).
- If you are deploying this appliance as the primary node in a cluster, configure the second and third installed appliances in the cluster: [Configure a Secondary Node Using the Maglev Wizard, on page 23](#).

Configure a Secondary Node Using the Maglev Wizard

Perform the steps in this procedure to configure the second and third appliances in the cluster.



Important

In order to build a three-node cluster, the same version of the **System** package must be installed on your three Cisco DNA Center appliances. Otherwise, unexpected behavior and possible downtime can occur.



Note

Ensure that all of the IP addresses you enter while completing this procedure are valid IPv4 addresses with valid IPv4 netmasks. Also make sure that the addresses and their corresponding subnets do not overlap. Service communication issues can result if they do.



Important

Before you configure the appliances in a three-node cluster, ensure that you have logged out of those appliances. Otherwise, the Quick Start workflow (which you complete to discover your network's devices and enable telemetry) will not start after you have configured your cluster's appliances and log in to Cisco DNA Center for the first time.

When joining each new secondary node to the cluster, you must specify the first host in the cluster as the primary node. Note the following when joining secondary nodes to a cluster:

- Be sure to join only a single node to the cluster at a time. Do not attempt to add multiple nodes at the same time, because this results in unpredictable behavior.
- Before adding a new node to the cluster, be sure that all installed packages are deployed on the primary node. You can check this by using Secure Shell to log in to the primary node's Cisco DNA Center Management port as the Linux User (maglev) and then running the command `maglev package status`.

All installed packages should appear in the command output as `DEPLOYED`. In the following example, a few packages were not installed, such as the `application-policy` and `sd-access` packages. They are the only packages whose status is `NOT_DEPLOYED`. Your package status should look similar to this before configuring a secondary node.

```
maglev-1 [main - https://172.29.131.224:443]
```

NAME	DISPLAY_NAME	DEPLOYED	AVAILABLE	STATUS	PROGRESS
access-control-application	Access Control Application	2.1.388.60364	-	DEPLOYED	
ai-network-analytics	AI Network Analytics	2.7.8.528	-	DEPLOYED	
app-hosting	Application Hosting	1.7.0.2108120753	-	DEPLOYED	
application-policy	Application Policy	2.1.388.170155	-	DEPLOYED	
application-registry	Application Registry	2.1.388.170155	-	DEPLOYED	
application-visibility-service	Application Visibility Service	2.1.388.170155	-	DEPLOYED	
assurance	Assurance - Base	2.2.3.337	-	DEPLOYED	
automation-core	NCP - Services	2.1.388.60364	-	DEPLOYED	
base-provision-core	Automation - Base	2.1.388.60364	-	DEPLOYED	
cloud-connectivity-contextual-content	Cloud Connectivity - Contextual Content	1.3.1.364	-	DEPLOYED	
cloud-connectivity-data-hub	Cloud Connectivity - Data Hub	1.6.0.380	-	DEPLOYED	
cloud-connectivity-tethering	Cloud Connectivity - Tethering	2.1.1.43	-	DEPLOYED	
cloud-provision-core	Cloud Device Provisioning Application	2.1.388.60364	-	DEPLOYED	
command-runner	Command Runner	2.1.388.60364	-	DEPLOYED	
device-onboarding	Device Onboarding	2.1.388.60364	-	DEPLOYED	
disaster-recovery	Disaster Recovery	2.1.388.3600024	-	DEPLOYED	
dna-core-apps	Network Experience Platform - Core	2.1.388.60364	-	DEPLOYED	
dnac-platform	Cisco DNA Center Platform	1.6.1.126	-	DEPLOYED	
dnac-search	Cisco DNA Center Global Search	1.6.99.10	-	DEPLOYED	
endpoint-analytics	AI Endpoint Analytics	1.5.0.226	-	DEPLOYED	
group-based-policy-analytics	Group-Based Policy Analytics	2.2.3.55	-	DEPLOYED	
icap-automation	Automation - Intelligent Capture	2.1.388.60364	-	DEPLOYED	
image-management	Image Management	2.1.388.60364	-	DEPLOYED	
machine-reasoning	Machine Reasoning	2.1.388.210008	-	DEPLOYED	
ncp-system	NCP - Base	2.1.388.60364	-	DEPLOYED	
ndp-base-analytics	Network Data Platform - Base Analytics	1.6.1686	-	DEPLOYED	
ndp-platform	Network Data Platform - Core	1.6.1705	-	DEPLOYED	
ndp-ui	Network Data Platform - Manager	1.6.1662	-	DEPLOYED	
network-visibility	Network Controller Platform	2.1.388.60364	-	DEPLOYED	
path-trace	Path Trace	2.1.388.60364	-	DEPLOYED	
platform-ui	Cisco DNA Center UI	1.6.3.155	-	DEPLOYED	
rbac-extensions	RBAC Extensions	2.1.388.190003	-	DEPLOYED	
rogue-management	Rogue and aWIPS	2.3.0.24	-	DEPLOYED	
sd-access	SD Access	2.1.388.60364	-	DEPLOYED	
sensor-assurance	Assurance - Sensor	2.2.3.317	-	DEPLOYED	
sensor-automation	Automation - Sensor	2.1.388.60364	-	DEPLOYED	
ssa	Stealthwatch Security Analytics	2.1.388.1090064	-	DEPLOYED	
system	System	1.6.551	-	DEPLOYED	
system-commons	System Commons	2.1.388.60364	-	DEPLOYED	
umbrella	Cisco Umbrella	2.1.388.590077	-	DEPLOYED	
wide-area-bonjour	Wide Area Bonjour	2.4.364.75035	-	DEPLOYED	

- Expect some service downtime during the cluster attachment process for each secondary node. Services will need to be redistributed across the nodes and the cluster will be down for periods of time during that process.

Before you begin

Ensure that you:

- Configured the first appliance in the cluster, following the steps in [Configure the Primary Node Using the Maglev Wizard, on page 3](#).
- Collected all of the information specified in [Required IP Addresses and Subnets](#) and [Required Configuration Information](#).
- Installed the second and third appliances, as described in [Appliance Installation Workflow](#).
- Have done the following:

1. Ran the **maglev package status** command on the first appliance.

You can also access this information from the Cisco DNA Center GUI by clicking the **Help** icon (🔍) and choosing **About > Packages**.

2. Contacted the Cisco TAC, gave them the output of this command, and asked them to point you to the ISO that you should install on your second and third appliances.

- Configured Cisco IMC browser access on both secondary appliances, as described in [Enable Browser Access to Cisco Integrated Management Controller](#).
- Checked that both the secondary appliances' ports and the switches they use are properly configured (as described in [Execute Preconfiguration Checks](#)).
- Confirmed that you are using a compatible browser. For a list of compatible browsers, see the [Release Notes](#) document for the version of Cisco DNA Center you are installing.
- Enabled ICMP on the firewall between Cisco DNA Center and both the default gateway and the DNS server you specify in the following procedure. The Maglev Configuration wizard uses ping to verify the gateway and DNS server you specify. This ping might get blocked if a firewall is in place and ICMP is not enabled on that firewall. When this happens, you will not be able to complete the wizard.

Procedure

Step 1

Point your browser to the Cisco IMC IP address you set during the Cisco IMC GUI configuration you performed, and log in to the Cisco IMC GUI as the Cisco IMC user (see [Enable Browser Access to Cisco Integrated Management Controller](#)).

After successful login, the appliance displays the **Cisco Integrated Management Controller Chassis Summary** window, with a hyperlinked menu at the top of the window, as shown below.



Step 2

From the hyperlinked menu, choose **Launch KVM** and then select either **Java based KVM** or **HTML based KVM**. If you select **Java-based KVM**, you will need to launch the Java startup file from your browser or file manager in order to view the KVM console in its own window. If you select **HMTL-based KVM**, it launches the KVM console in a separate window or tab automatically.

Irrespective of the KVM type you choose, use the KVM console to monitor the progress of the configuration and respond to the Maglev Configuration wizard prompts.

Step 3

With the KVM displayed, reboot the appliance by choosing one of the following options:

- In the main Cisco IMC GUI browser window: Choose **Host Power > Power Cycle**, and switch to the KVM console to continue.
- In the KVM console: Choose **Power > Power Cycle System (cold boot)**.

If you are asked to confirm your choice to reboot the appliance, click **OK**.

After displaying reboot messages, the KVM console displays the Maglev Configuration wizard welcome screen.

```
Welcome to the Maglev Configuration Wizard!

The wizard will walk you through the steps to configure this host. Select one of the options below to specify how you
would like to configure this host:

Start a Cisco DNA Center Cluster
Join a Cisco DNA Center Cluster

< exit >

Web Installation: https://172.29.131.224:9004/
```

Step 4 Click **Join a Cisco DNA Center Cluster** to begin configuring the secondary node.

Step 5 Specify whether the applications and services running on your Cisco DNA Center appliance will use IPv4 or IPv6 addressing. After making your selection, click **next>>** to proceed.

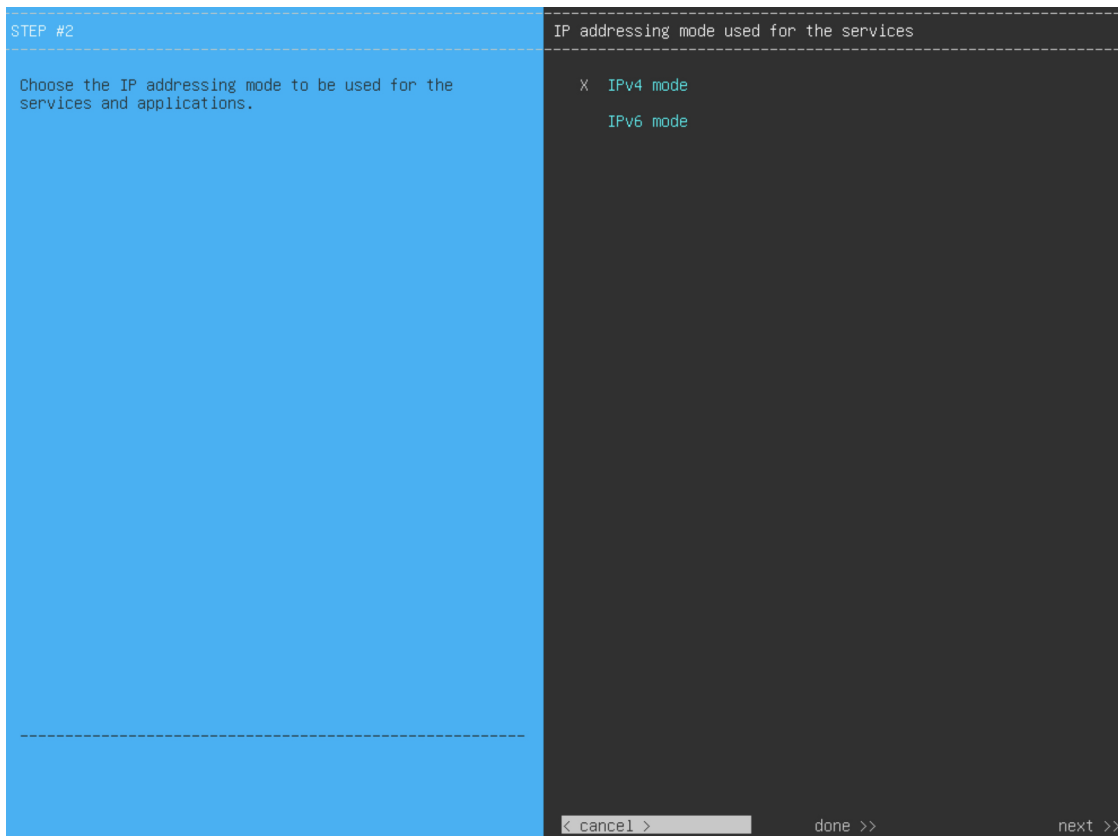

Important In the next wizard screen, you can enable the **VLAN mode** feature, which creates a single bonded interface that connects to your network using both the primary and secondary instance of your appliance's Enterprise interface. This feature is not commonly used, so only enable it if you know it's required by your Cisco DNA Center deployment.

- If this is the case, complete the next step.
- Otherwise, click **next>>** in the next wizard screen without making any selections. You can enable the NIC bonding functionality that was described previously in this guide in the wizard's Enterprise and Intracluster interface configuration screens.

Step 6 (Optional) Do the following to enable Layer 2 port channel mode (with VLAN tagging) for the appliance. After making your selections, click **next>>** to proceed.

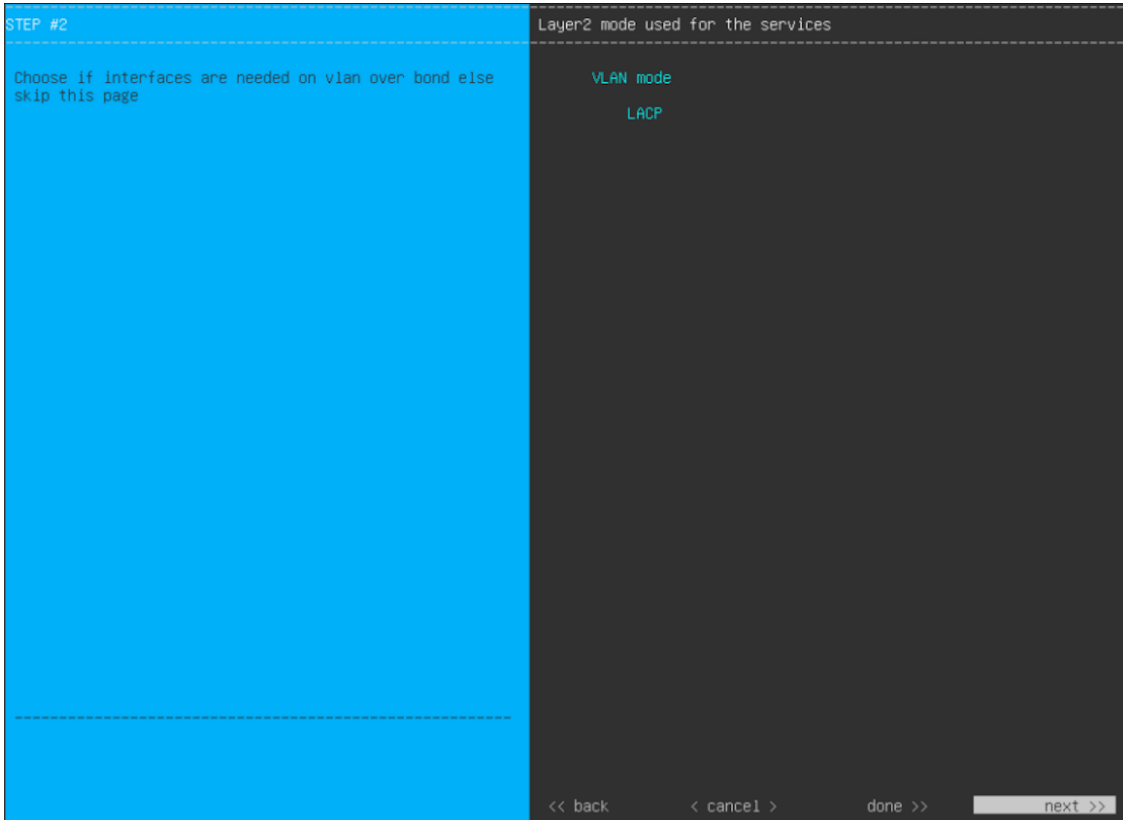

- a) Choose the **VLAN mode** option to enable dot1q/VLAN trunking and convert your appliance's Enterprise, Cluster, Management, and Internet interfaces into VLAN subinterfaces that reside on the bonded interface (as illustrated in the following figure). By default, this interface operates in Active-Backup mode (which enables HA).

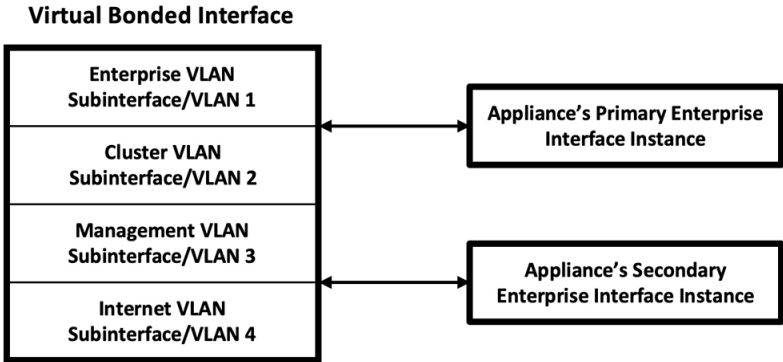

- b) If you want this interface to operate in LACP mode instead (which enables load balancing and higher bandwidth), you must also choose the **LACP** option.
- c) When you enter the settings for your appliance's Enterprise and Cluster interfaces, ensure that you enter a unique VLAN ID in the **VLAN ID of Interface** field for the subinterfaces you want to configure on the virtual bonded interface.

Important Even though one physical appliance interface (the Enterprise interface) is connected, you can configure all of the subinterfaces that reside on the virtual bonded interface.

The wizard discovers all of the ports on the appliance and presents them to you one by one, in separate screens, in the following order:

- a. (Required) 10-Gbps Enterprise Port—Network Adapter #1
- b. (Required) 10-Gbps Cluster Port—Network Adapter #2
- c. (Optional) 1-Gbps/10-Gbps Management Port—Network Adapter #3
- d. (Optional) 1-Gbps/10-Gbps Internet Port—Network Adapter #4

If the wizard fails to display either or both of the Enterprise and Cluster ports during the course of configuration, it might indicate that these ports are nonfunctional or disabled. These two ports are required for Cisco DNA Center functionality. If you discover that they are nonfunctional, choose **cancel** to exit the configuration wizard immediately. Be sure that you have completed all of the steps provided in [Execute Preconfiguration Checks](#) before resuming the configuration or contacting the Cisco Technical Assistance Center (for more information, see the "Get Assistance from the Cisco TAC" topic in the [Release Notes](#) document).

Step 7

The wizard first presents the 10-Gbps Enterprise port as **NETWORK ADAPTER #1**. As explained in [Interface Cable Connections](#), this is a required port used to link the appliance to the enterprise network. Apply the host IP address, netmask, and other values that are appropriate for this purpose (see [Required IP Addresses and Subnets](#) and [Required Configuration Information](#) for the values to enter).

```

STEP #3
-----
The wizard has discovered 4 physical network
adapter(s) installed on the appliance.

Enter the network settings for the 1st network adapter
-
(3c:fd:fe:bd:fa:b4 - 10G - enterprise network).

Recommended use: enterprise network
Phy Interfaces: enp94s0f0 enp216s0f2

Remove all NFS mount before network changes

-----

NETWORK ADAPTER #1 (enterprise)
-----
Host IPv4 Address:
  17.192.1.226
IPv4 Netmask:
  255.255.255.0
Default Gateway IPv4 Address:
  17.192.1.1
IPv4 DNS Servers:

IPv4 Static Routes:
  Cluster Link
  LACP Mode

-----
< cancel >      done >>      next >>

```

Enter the configuration values for **NETWORK ADAPTER #1**, as shown in the table below.

Table 8: Secondary Node Entries for Network Adapter #1: 10-Gbps Enterprise Port

Host IPv4/IPv6 Address field	Enter the IP address for the Enterprise port. This is required.
IPv4 Netmask/IPv6 Prefix Length field	Do one of the following if you entered an IP address: <ul style="list-style-type: none"> • If you selected IPv4 addressing, enter the netmask for the port's IP address. This is required. • If you selected IPv6 addressing, enter the prefix length (in bits). Valid values range from 10 through 127.
Default Gateway IPv4/IPv6 address field	Enter a default gateway IP address to use for the port. Important Ensure that you enter a default gateway IP address for at least one of your appliance's interfaces. Otherwise, you will not be able to complete the configuration wizard.
IPv4/IPv6 DNS Servers field	Enter the IP address of the preferred DNS server. If you are entering multiple DNS servers, separate the IP addresses in the list with spaces. Important For each appliance in your cluster, configure a maximum of three DNS servers. Problems can occur if you configure more than three DNS servers for an appliance.
IPv4/IPv6 Static Routes field	Enter one or more static routes in the following format, separated by spaces: <code><network>/<netmask>/<gateway></code> . This is usually required on the Cisco DNA Center Management port only.
Vlan Id of Interface field	Enter the VLAN ID that will be tagged over the LACP link to be created for the appliance you are configuring. Note This field is displayed only if you set Layer 2 LACP portchannel mode for the appliance by choosing both options in Step 6.
Cluster Link field	Leave this field blank. It is required on the Cluster port only.

LACP Mode field	<p>Do one of the following:</p> <ul style="list-style-type: none"> • Leave this field blank and the port will operate in Active-Backup mode. This mode provides fault tolerance by aggregating two Ethernet interfaces into a single logical channel. When the interface that's currently active goes down, the other interface takes its place and becomes active. • Check the check box to enable LACP mode on this port. This mode aggregates two Ethernet interfaces that share the same speed and duplex settings into a single logical channel. This provides load balancing and higher bandwidth. <p>For more information about Cisco DNA Center's implementation of NIC bonding, see NIC Bonding Overview.</p> <p>Note This field is displayed if you didn't choose any of the options in Step 6.</p>
-----------------	--

After you finish entering the configuration values, click **next>>** to proceed. The wizard validates the values you entered and issues an error message if any are incorrect. If you receive an error message, check that the value you entered is correct, then reenter it. If needed, click <<**back** to reenter it.

Step 8

After successful validation of the Enterprise port values you entered, the wizard presents the 10-Gbps Cluster port and presents it as **NETWORK ADAPTER #2**. As explained in [Interface Cable Connections](#), this port is used to link the appliance to the cluster, so apply the host IP address, netmask, and other values that are appropriate for this purpose (see [Required IP Addresses and Subnets](#) and [Required Configuration Information](#) for the values to enter).

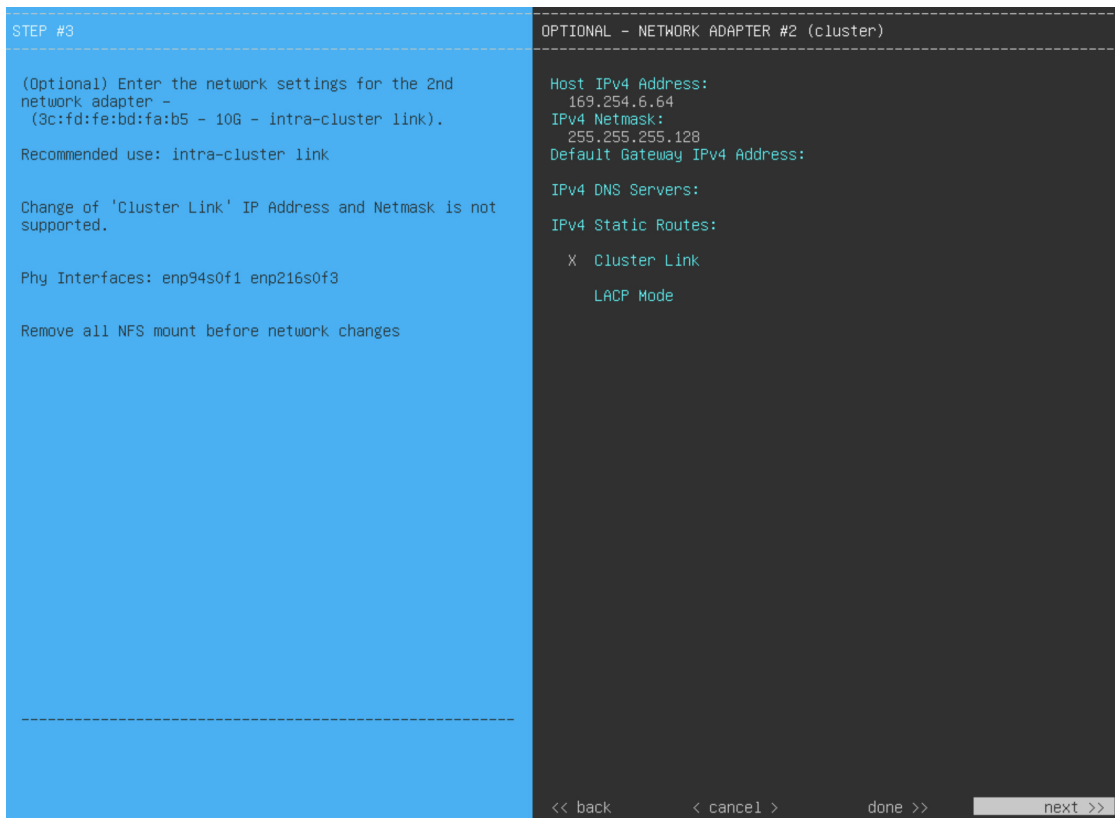

Enter the configuration values for **NETWORK ADAPTER #2**, as shown in the table below.

Table 9: Secondary Node Entries for Network Adapter #2: 10-Gbps Cluster Port

Host IPv4/IPv6 address field	Enter the IP address for the Cluster port. This is required. Note that you cannot change the address of the Cluster port later.
IPv4 Netmask/IPv6 Prefix Length field	Do one of the following if you entered an IP address: <ul style="list-style-type: none"> • If you selected IPv4 addressing, enter the netmask for the port's IP address. This is required. • If you selected IPv6 addressing, enter the prefix length (in bits). Valid values range from 10 through 127.
Default Gateway IPv4/IPv6 address field	Enter a default gateway IP address to use for the port. <p>Important Ensure that you enter a default gateway IP address for at least one of your appliance's interfaces. Otherwise, you will not be able to complete the configuration wizard.</p>

IPv4/IPv6 DNS Servers field	<p>Enter the IP address of the preferred DNS server. If you are entering multiple DNS servers, separate the IP addresses in the list with spaces.</p> <p>Important For each appliance in your cluster, configure a maximum of three DNS servers. Problems can occur if you configure more than three DNS servers for an appliance.</p>
IPv4/IPv6 Static Routes field	<p>Enter one or more static routes in the following format, separated by spaces: <code><network>/<netmask>/<gateway></code>. This is usually required on the Management port only.</p>
Vlan Id of Interface field	<p>Enter the VLAN ID that will be tagged over the LACP link to be created for the appliance you are configuring.</p> <p>Note This field is displayed only if you set Layer 2 LACP portchannel mode for the appliance by choosing both options in Step 6.</p>
Cluster Link field	<p>Check the check box to set this port as the link to a Cisco DNA Center cluster. This is required on the Cluster port only.</p>
LACP Mode field	<p>Do one of the following:</p> <ul style="list-style-type: none"> • Leave this field blank and the port will operate in Active-Backup mode. This mode provides fault tolerance by aggregating two Ethernet interfaces into a single logical channel. When the interface that's currently active goes down, the other interface takes its place and becomes active. • Check the check box to enable LACP mode on this port. This mode aggregates two Ethernet interfaces that share the same speed and duplex settings into a single logical channel. This provides load balancing and higher bandwidth. <p>For more information about Cisco DNA Center's implementation of NIC bonding, see NIC Bonding Overview.</p> <p>Note This field is displayed if you didn't choose any of the options in Step 6.</p>

After you provide the necessary information, click **next>>** to proceed. Correct validation errors, if any, as you did in previous screens. The wizard validates and applies your network adapter configurations.

Step 9

After successful validation of the Cluster port values you entered, the wizard presents the 1-Gbps/10-Gbps Management port and presents it as **NETWORK ADAPTER #3**. As explained in [Interface Cable Connections](#), this port is used to access the Cisco DNA Center GUI from your management network. Apply the host IP address, netmask, and other

values that are appropriate for this purpose (see [Required IP Addresses and Subnets](#) and [Required Configuration Information](#) for the values to enter).

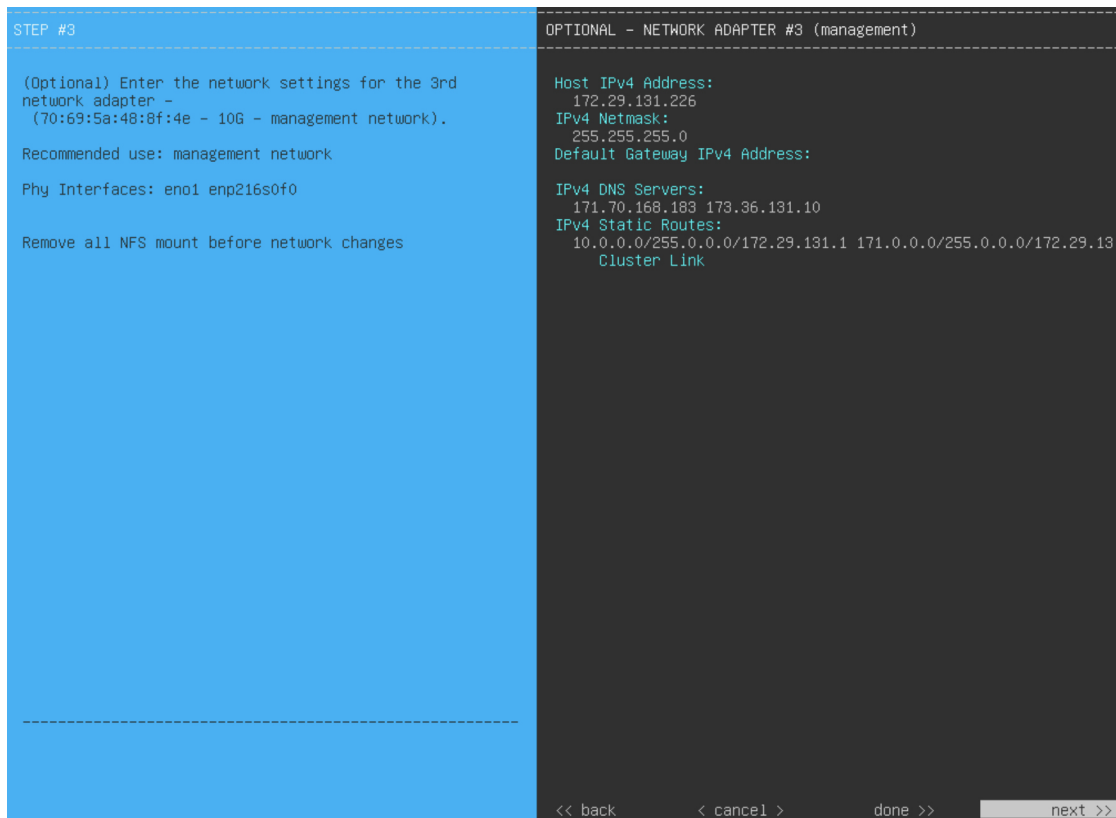

Enter the configuration values for **NETWORK ADAPTER #3**, as shown in the table below.

Table 10: Secondary Node Entries for Network Adapter #3: 1-Gbps/10-Gbps Management Port

Host IPv4/IPv6 address field	Enter the IP address for the Management Port. This is required only if you are using this port to access the Cisco DNA Center GUI from your management network; otherwise, you can leave it blank.
IPv4 Netmask/IPv6 Prefix Length field	Do one of the following: <ul style="list-style-type: none"> • If you selected IPv4 addressing, enter the netmask for the port's IP address. This is required. • If you selected IPv6 addressing, enter the prefix length (in bits). Valid values range from 10 through 127.
Default Gateway IPv4/IPv6 address field	Enter a default gateway IP address to use for the port. <p>Important Ensure that you enter a default gateway IP address for at least one of your appliance's interfaces. Otherwise, you will not be able to complete the configuration wizard.</p>

IPv4/IPv6 DNS Servers field	<p>Enter the IP address of the preferred DNS server. If you are entering multiple DNS servers, separate the IP addresses in the list with spaces.</p> <p>Important</p> <ul style="list-style-type: none"> • For NTP, ensure port 123 (UDP) is open between Cisco DNA Center and your NTP server. • For each appliance in your cluster, configure a maximum of three DNS servers. Problems can occur if you configure more than three DNS servers for an appliance.
IPv4/IPv6 Static Routes field	<p>Enter one or more static routes in the following format, separated by spaces: <code><network>/<netmask>/<gateway></code>.</p>
Cluster Link field	<p>Leave this field blank. It is required on the Cluster port only.</p>

After you provide the necessary information, click **next>>** to proceed. Correct validation errors, if any, as you did in previous screens. The wizard validates and applies your network adapter configurations.

Step 10

After successful validation of the Management port values you entered, the wizard presents the 1-Gbps/10-Gbps Internet port as **NETWORK ADAPTER #4**. As explained in [Interface Cable Connections](#), this is an optional port used to link the appliance to the Internet when you cannot do so through the 10-Gbps Enterprise port. Apply the host IP address, netmask, and other values that are appropriate for this purpose (see [Required IP Addresses and Subnets](#) and [Required Configuration Information](#) for the values to enter).

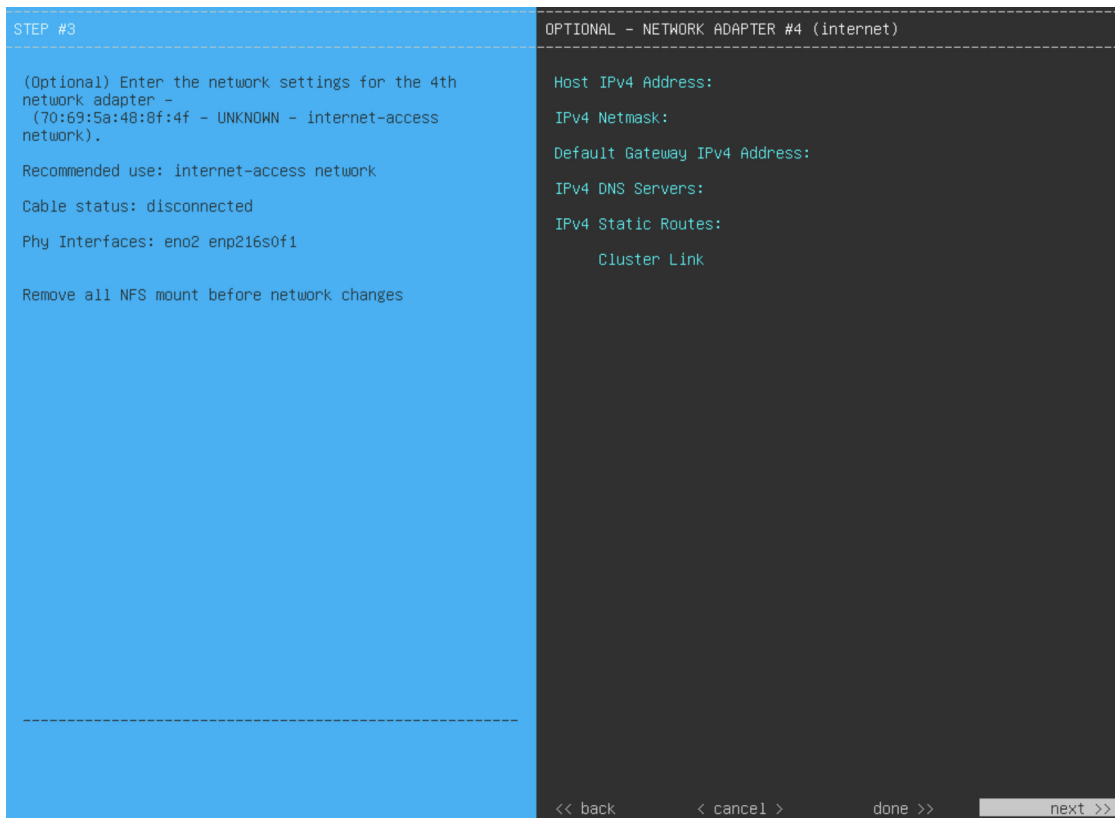

Enter the configuration values for **NETWORK ADAPTER #4**, as shown in the table below.

Table 11: Secondary Node Entries for Network Adapter #4: 1-Gbps/10-Gbps Internet Port

Host IPv4/IPv6 address field	Enter the IP address for the Internet port. This is required only if you are using the Internet port for internet connection; otherwise, you can leave it blank.
IPv4 Netmask/IPv6 Prefix Length field	Do one of the following: <ul style="list-style-type: none"> • If you selected IPv4 addressing, enter the netmask for the port's IP address. This is required. • If you selected IPv6 addressing, enter the prefix length (in bits). Valid values range from 10 through 127.
Default Gateway IPv4/IPv6 address field	Enter a default gateway IP address to use for the Internet port. <p>Important Ensure that you enter a default gateway IP address for at least one of your appliance's interfaces. Otherwise, you will not be able to complete the configuration wizard.</p>

IPv4/IPv6 DNS Servers field	<p>Enter the IP address of the preferred DNS server. If you are entering multiple DNS servers, separate the IP addresses in the list with spaces.</p> <p>Important For each appliance in your cluster, configure a maximum of three DNS servers. Problems can occur if you configure more than three DNS servers for an appliance.</p>
IPv4/IPv6 Static Routes field	<p>Enter one or more static routes in the following format, separated by spaces: <i><network>/<netmask>/<gateway></i>. This is usually required on the Management port only.</p>
Cluster Link field	<p>Leave this field blank. It is required on the Cluster port only.</p>

After you provide the necessary information, click **next>>** to proceed. Correct validation errors, if any, as you did in previous screens. The wizard validates and applies your network adapter configurations.

Step 11

After the network adapter configuration is complete, the wizard prompts you to enter configuration values for the **NETWORK PROXY** that you are using, as shown below.

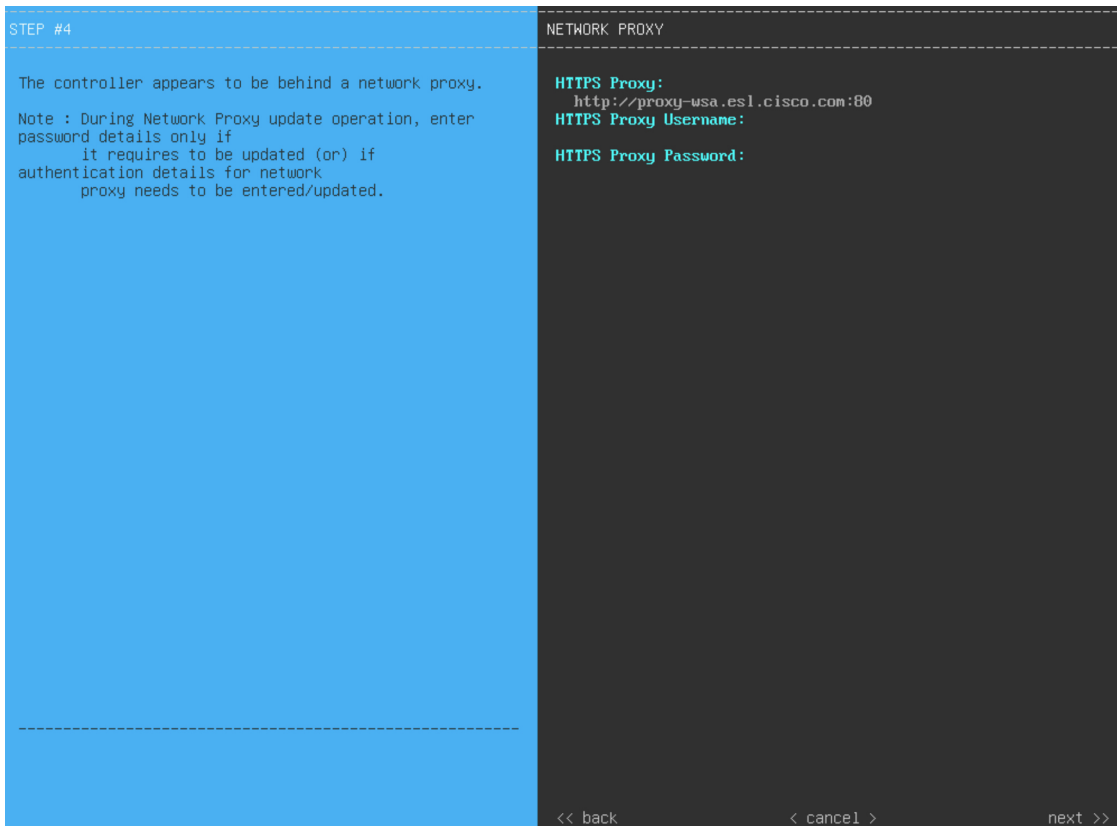

Enter the configuration values for the **NETWORK PROXY**, as shown in the table below.

Table 12: Secondary Node Entries for Network Proxy

HTTPS Proxy field	<p>Enter the URL or host name of an HTTPS network proxy used to access the Internet.</p> <p>Note</p> <ul style="list-style-type: none"> • Connection from Cisco DNA Center to the HTTPS proxy is supported only through HTTP in this release. • If you enter an IPv6 URL that contains a port number, enclose the IP address portion of the URL in square brackets. In this example, 443 is the port number: http://[2001:db8:85a3:8d3:1319:8a2e:370:7348]:443/
HTTPS Proxy Username field	Enter the user name used to access the network proxy. If no proxy login is required, leave this field blank.
HTTPS Proxy Password field	Enter the password used to access the network proxy. If no proxy login is required, leave this field blank.

After you provide the necessary information, click **next>>** to proceed. Correct validation errors, if any, as you did in previous screens.

Step 12

After network proxy configuration completes, the wizard prompts you to identify the Cluster port on the primary node and primary node login details, in **MAGLEV CLUSTER DETAILS** (as shown below).

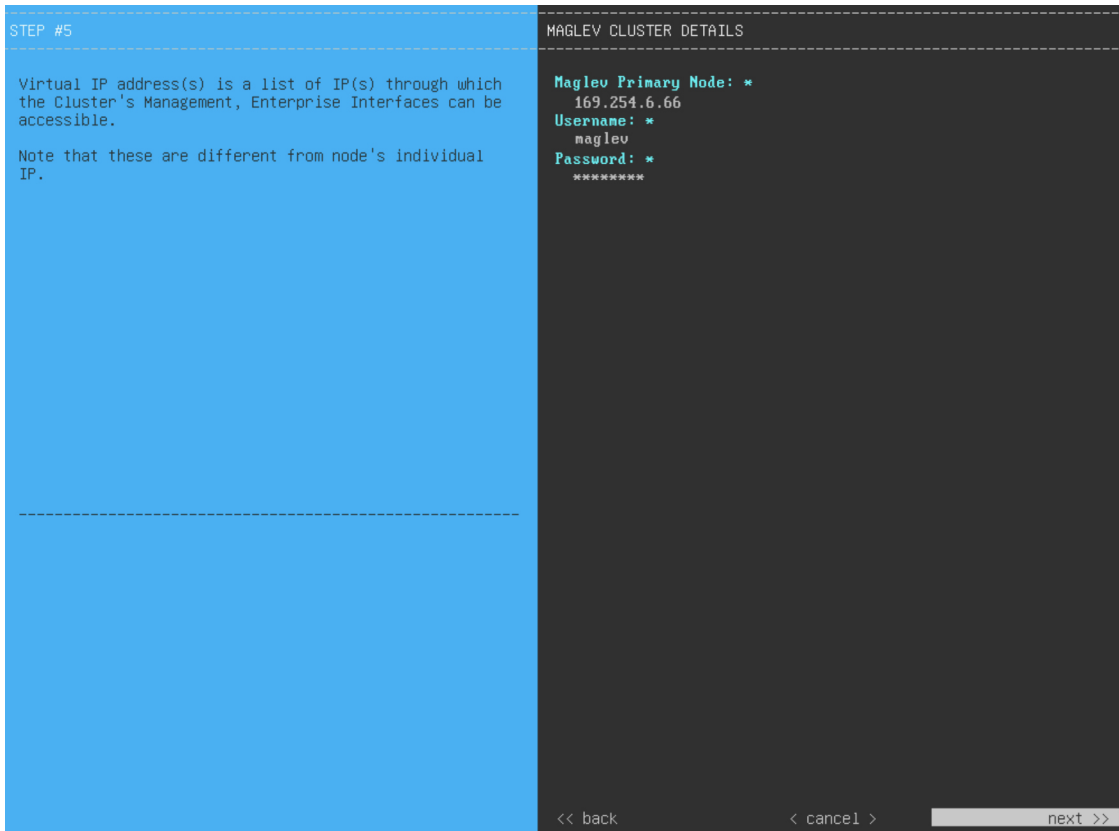

Enter the values for **MAGLEV CLUSTER DETAILS**, as shown in the table below.

Table 13: Secondary Node Entries for Maglev Cluster Details

Maglev Primary Node field	Enter the IP address of the Cluster port on the primary node in the cluster. If you have followed the recommendations for port assignment, this will be the IP address of Network Adapter #2 on the primary node.
Username field	Enter maglev .
Password field	Enter the Linux password you configured on the primary node.

After you provide the necessary information, click **next>>** to proceed. Correct validation errors, if any, as you did in previous screens.

Step 13

After you have entered the cluster details, the wizard prompts you to enter **USER ACCOUNT SETTINGS** values, as shown below.

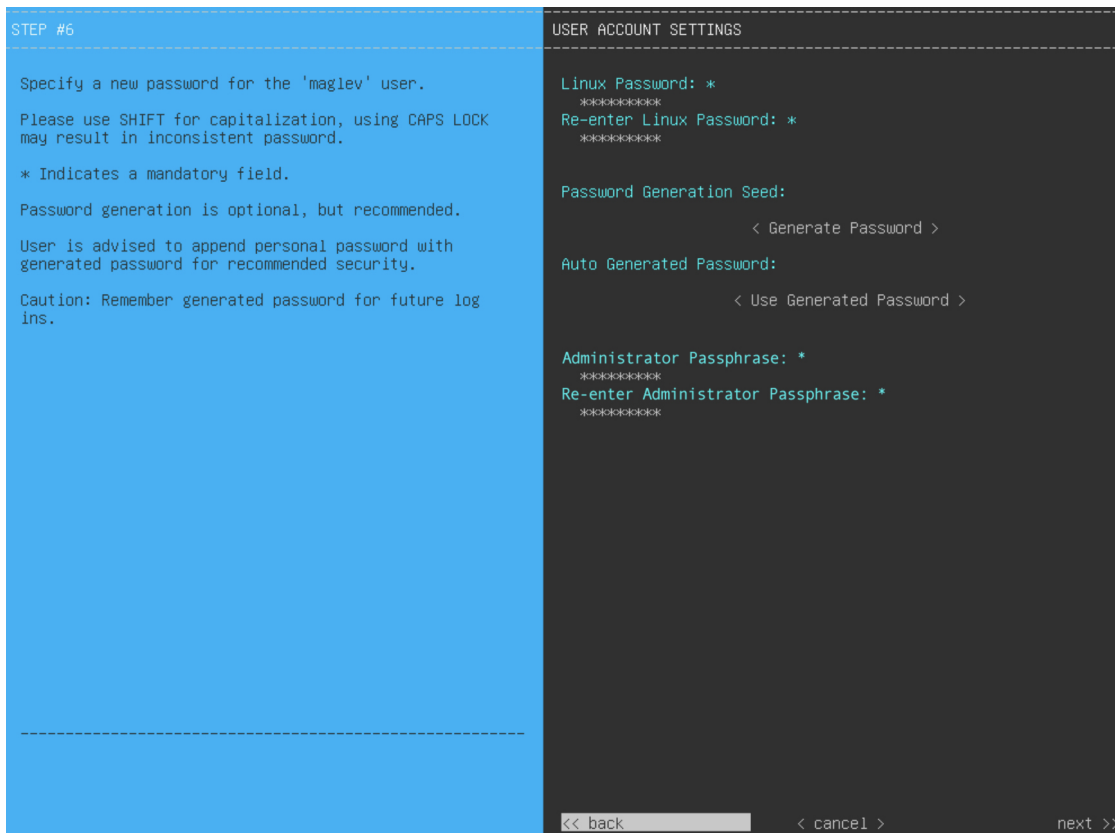

Enter the values for **USER ACCOUNT SETTINGS**, as shown in the table below.

Table 14: Secondary Node Entries for User Account Settings

Linux Password field	Enter a Linux password for the maglev user.
Re-enter Linux Password field	Confirm the Linux password by entering it a second time.
Password Generation Seed field	If you do not want to create the Linux password yourself, enter a seed phrase in this field and then press <Generate Password> to generate the password.
Auto Generated Password field	(Optional) The seed phrase appears as part of a random and secure password. If required, you can either use this password as is, or you can further edit this auto-generated password. Click <Use Generated Password> to save the password.
Administrator Password field	Enter a password for the default admin superuser, used to log in to Cisco DNA Center for the first time.
Re-enter Administrator Password field	Confirm the administrator password by entering it a second time.

After you provide the necessary information, click **next>>** to proceed. Correct validation errors, if any, as you did in previous screens.

Step 14 After you have entered the user account details, the wizard prompts you to enter **NTP SERVER SETTINGS** values, as shown below.

```
STEP #7
-----
Enter the IP address of the NTP server that the
controller will use.

It is recommended to specify 3 or more NTP servers to
improve availability and time accuracy.

Please note that the NTP server(s) must be accessible
in order for the configuration to succeed.

* Indicates a mandatory field

-----

NTP SERVER SETTINGS
-----
NTP Servers: *
ntp.es1.example.com ntp1.es1.example.com ntp2.es1.example.com

<< back      < cancel >      next >>
```

Enter one or more NTP server addresses or hostnames, separated by spaces. At least one NTP address or hostname is required. They should be the same NTP servers that you specified for the primary node.

After you provide the necessary information, click **next>>** to proceed. Correct validation errors, if any, as you did in previous screens. The wizard validates and applies your NTP server configuration.

Step 15 When you are finished entering the NTP server settings, a final message appears, stating that the wizard is ready to apply the configuration (as shown below).

```
The wizard is now ready to apply the configuration on the controller.
Use the [back] button below to verify/modify controller settings.
Use the [cancel] button to discard your changes and exit the wizard.
Use the [proceed] button to save your changes and proceed with applying them on the controller.

<< back                < cancel >                proceed >>
```

Click **proceed>>** to complete the configuration wizard.

The host will reboot automatically and display messages on the KVM console as it applies your settings and brings up services. This process can take several hours. You can monitor its progress via the KVM console.

At the end of the configuration process, the appliance power-cycles again, then displays a **CONFIGURATION SUCCEEDED!** message.

```
CONFIGURATION SUCCEEDED
The configuration wizard has completed successfully!
To access the Maglev Web UI, please point your browser to one of the following URLs:
To access the Maglev Web Console, please point your browser to one of the following URLs:
https://17.192.1.226
https://169.254.6.64
https://172.29.131.226
The wizard will automatically close in 30 seconds
```

What to do next

- If you have an additional appliance to deploy as the third and final node in the cluster, repeat this procedure.
- If you have finished adding hosts to the cluster, perform the first-time setup: [First-Time Setup Workflow](#).

Upgrade to the Latest Cisco DNA Center Release

For information about upgrading your current release of Cisco DNA Center, see the [Cisco DNA Center Upgrade Guide](#).

