



Cisco APIC Layer 3 Networking Configuration Guide, Release 5.3(x)

First Published: 2023-11-15

Americas Headquarters

Cisco Systems, Inc.
170 West Tasman Drive
San Jose, CA 95134-1706
USA
<http://www.cisco.com>
Tel: 408 526-4000
800 553-NETS (6387)
Fax: 408 527-0883



Trademarks

THE SPECIFICATIONS AND INFORMATION REGARDING THE PRODUCTS REFERENCED IN THIS DOCUMENTATION ARE SUBJECT TO CHANGE WITHOUT NOTICE. EXCEPT AS MAY OTHERWISE BE AGREED BY CISCO IN WRITING, ALL STATEMENTS, INFORMATION, AND RECOMMENDATIONS IN THIS DOCUMENTATION ARE PRESENTED WITHOUT WARRANTY OF ANY KIND, EXPRESS OR IMPLIED.

The Cisco End User License Agreement and any supplemental license terms govern your use of any Cisco software, including this product documentation, and are located at:

<http://www.cisco.com/go/softwareterms>. Cisco product warranty information is available at <http://www.cisco.com/go/warranty>. US Federal Communications Commission Notices are found here <http://www.cisco.com/c/en/us/products/us-fcc-notice.html>.

IN NO EVENT SHALL CISCO OR ITS SUPPLIERS BE LIABLE FOR ANY INDIRECT, SPECIAL, CONSEQUENTIAL, OR INCIDENTAL DAMAGES, INCLUDING, WITHOUT LIMITATION, LOST PROFITS OR LOSS OR DAMAGE TO DATA ARISING OUT OF THE USE OR INABILITY TO USE THIS MANUAL, EVEN IF CISCO OR ITS SUPPLIERS HAVE BEEN ADVISED OF THE POSSIBILITY OF SUCH DAMAGES.

Any products and features described herein as in development or available at a future date remain in varying stages of development and will be offered on a when-and-if-available basis. Any such product or feature roadmaps are subject to change at the sole discretion of Cisco and Cisco will have no liability for delay in the delivery or failure to deliver any products or feature roadmap items that may be set forth in this document.

Any Internet Protocol (IP) addresses and phone numbers used in this document are not intended to be actual addresses and phone numbers. Any examples, command display output, network topology diagrams, and other figures included in the document are shown for illustrative purposes only. Any use of actual IP addresses or phone numbers in illustrative content is unintentional and coincidental.

The documentation set for this product strives to use bias-free language. For the purposes of this documentation set, bias-free is defined as language that does not imply discrimination based on age, disability, gender, racial identity, ethnic identity, sexual orientation, socioeconomic status, and intersectionality. Exceptions may be present in the documentation due to language that is hardcoded in the user interfaces of the product software, language used based on RFP documentation, or language that is used by a referenced third-party product.

Cisco and the Cisco logo are trademarks or registered trademarks of Cisco and/or its affiliates in the U.S. and other countries. To view a list of Cisco trademarks, go to this URL: [www.cisco.com go trademarks](http://www.cisco.com/go/trademarks). Third-party trademarks mentioned are the property of their respective owners. The use of the word partner does not imply a partnership relationship between Cisco and any other company. (1721R)



CONTENTS

PREFACE	Trademarks iii
----------------	-----------------------

CHAPTER 1	New and Changed Information 1
	New and Changed Information 1

PART I	Layer 3 Configuration 3
---------------	--------------------------------

CHAPTER 2	Cisco ACI Forwarding 5
	Forwarding Within the Fabric 5
	ACI Fabric Optimizes Modern Data Center Traffic Flows 5
	VXLAN in ACI 6
	Layer 3 VNIDs Facilitate Transporting Inter-subnet Tenant Traffic 8

CHAPTER 3	Prerequisites for Configuring Layer 3 Networks 11
	Layer 3 Prerequisites 11
	Bridge Domain Configurations 11

CHAPTER 4	Common Pervasive Gateway 13
	Overview 13
	Configuring Common Pervasive Gateway Using the GUI 14

CHAPTER 5	IP Aging 17
	Overview 17
	Configuring the IP Aging Policy Using the GUI 17

CHAPTER 6	Static Route on a Bridge Domain 19
------------------	---

About Static Routes in Bridge Domains	19
Configuring a Static Route on a Bridge Domain Using the GUI	19

CHAPTER 7**Dataplane IP Address Learning 21**

Overview of Dataplane IP Address Learning	21
Guidelines and Limitations for Dataplane IP Address Learning	21
Feature Interaction for Dataplane IP Address Learning Being Disabled	22
Configuring Dataplane IP Address Learning per VRF Instance Using the GUI	23
Configuring Dataplane IP Address Learning per Endpoint Using the GUI	24
Configuring Dataplane IP Address Learning per Subnet Using the GUI	25

CHAPTER 8**IPv6 Neighbor Discovery 27**

Neighbor Discovery	27
Configuring IPv6 Neighbor Discovery on a Bridge Domain	28
Creating the Tenant, VRF, and Bridge Domain with IPv6 Neighbor Discovery on the Bridge Domain Using the GUI	28
Configuring IPv6 Neighbor Discovery on a Layer 3 Interface	30
Guidelines and Limitations	30
Configuring an IPv6 Neighbor Discovery Interface Policy with RA on a Layer 3 Interface Using the GUI	30
Configuring IPv6 Neighbor Discovery Duplicate Address Detection	31
About Neighbor Discovery Duplicate Address Detection	31
Configuring Neighbor Discovery Duplicate Address Detection Using the GUI	31

CHAPTER 9**Microsoft NLB 33**

About Microsoft NLB	33
Understanding Unicast Mode	34
Understanding Multicast Mode	35
Understanding IGMP Mode	36
Cisco ACI Configuration for Microsoft NLB Servers	37
Microsoft Network Load Balancing Guidelines and Limitations	40
Configuring Microsoft NLB in Unicast Mode Using the GUI	41
Configuring Microsoft NLB in Multicast Mode Using the GUI	42
Configuring Microsoft NLB in IGMP Mode Using the GUI	43

CHAPTER 10	IGMP Snooping	45
	About Cisco APIC and IGMP Snooping	45
	How IGMP Snooping is Implemented in the ACI Fabric	45
	Virtualization Support	47
	The APIC IGMP Snooping Function, IGMPv1, IGMPv2, and the Fast Leave Feature	47
	The APIC IGMP Snooping Function and IGMPv3	47
	Cisco APIC and the IGMP Snooping Querier Function	48
	Guidelines and Limitations for the APIC IGMP Snooping Function	48
	Configuring and Assigning an IGMP Snooping Policy	48
	Configuring and Assigning an IGMP Snooping Policy to a Bridge Domain in the Advanced GUI	48
	Configuring an IGMP Snooping Policy Using the GUI	49
	Assigning an IGMP Snooping Policy to a Bridge Domain Using the GUI	50
	Enabling IGMP Snooping Static Port Groups	51
	Enabling IGMP Snooping Static Port Groups	51
	Prerequisite: Deploy EPGs to Static Ports	51
	Enabling IGMP Snooping and Multicast on Static Ports Using the GUI	51
	Enabling IGMP Snoop Access Groups	52
	Enabling IGMP Snoop Access Groups	52
	Enabling Group Access to IGMP Snooping and Multicast Using the GUI	52

CHAPTER 11	MLD Snooping	55
	About Cisco APIC and MLD Snooping	55
	Guidelines and Limitations	57
	Configuring and Assigning an MLD Snooping Policy to a Bridge Domain in the GUI	57
	Configuring an MLD Snooping Policy Using the GUI	57
	Assigning an MLD Snooping Policy to a Bridge Domain Using the GUI	58

CHAPTER 12	Tenant Routed Multicast	61
	Tenant Routed Multicast	61
	Support for Layer 3 Multicast with Remote Leaf Switches	62
	About the Fabric Interface	63
	Enabling IPv4/IPv6 Tenant Routed Multicast	64
	Allocating VRF GIPo	65

Multiple Border Leaf Switches as Designated Forwarder	65
PIM/PIM6 Designated Router Election	66
Non-Border Leaf Switch Behavior	66
Active Border Leaf Switch List	67
Overload Behavior On Bootup	67
First-Hop Functionality	67
The Last-Hop	67
Fast-Convergence Mode	67
About Rendezvous Points	68
About Inter-VRF Multicast	69
Inter-VRF Multicast Requirements	69
ACI Multicast Feature List	70
Guidelines, Limitations, and Expected Behaviors for Configuring Layer 3 IPv4/IPv6 Multicast	76
Configuring Layer 3 IPv4 Multicast Using the GUI	78
Configuring Layer 3 IPv6 Multicast Using the GUI	80
About BGP IPv4/IPv6 Multicast Address-Family	82
Guidelines and Limitations for BGP IPv4/IPv6 Multicast Address-Family	82
Configuring BGP IPv4/IPv6 Multicast Address-Family Using the GUI	83
About Multicast Filtering	86
Guidelines and Restrictions for Multicast Filtering	88
Configuring Multicast Filtering Using the GUI	89
About Layer 3 Multicast on an SVI L3Out	92
Configuring Layer 3 Multicast on an SVI L3Out Using the GUI	96

CHAPTER 13
Multi-Pod 99

About Multi-Pod	99
Multi-Pod Provisioning	100
Guidelines for Setting Up a Cisco ACI Multi-Pod Fabric	101
Setting Up the Multi-Pod Fabric	104
Preparing the Pod for IPN Connectivity	104
Adding a Pod to Create a Multi-Pod Fabric	106
Sample IPN Configurations for Multi-Pod For Cisco Nexus 9000 Series Switches	107
Moving an APIC from One Pod to Another Pod	109
Migrating from an OSPF IPN Underlay to a BGP IPN Underlay	110

About Multi-Pod Spines Back-to-Back	111
Troubleshooting Multi-Site and Multi-Pod	112

CHAPTER 14**Remote Leaf Switches 115**

About Remote Leaf Switches in the ACI Fabric	115
About Remote Leaf Back-to-Back Connection	121
Remote Leaf Switch Hardware Requirements	123
Remote Leaf Switch Restrictions and Limitations	123
WAN Router and Remote Leaf Switch Configuration Guidelines	127
Configure the Pod and Fabric Membership for Remote Leaf Switches Using the GUI	128
Configure the Pod and Fabric Membership for Remote Leaf Switches Using a Wizard	128
Configure the Pod and Fabric Membership for Remote Leaf Switches Using the GUI (Without a Wizard)	134
About Direct Traffic Forwarding	138
Upgrade the Remote Leaf Switches and Enable Direct Traffic Forwarding	139
Disable Direct Traffic Forwarding and Downgrade the Remote Leaf Switches	142
Remote Leaf Switch Failover	143
Requirements for Remote Leaf Failover	144
Enable Remote Leaf Switch Failover	144
Prerequisites Required Prior to Downgrading Remote Leaf Switches	145

CHAPTER 15**SR-MPLS Handoff 147**

Understanding ACI Handoffs	147
ACI Handoffs Prior to Release 5.0(1): IP Handoff	147
ACI Handoffs in Release 5.0(1): SR Handoff	148
Understanding ACI Implementation of SR-MPLS Handoff	152
SR-MPLS Infra L3Out	152
SR-MPLS VRF L3Out	157
SR-MPLS Custom QoS Policy	158
Understanding the SR-MPLS Configuration Model	160
Guidelines and Limitations for SR-MPLS	164
Configuring an SR-MPLS Infra L3Out Using the GUI	172
Configuring an SR-MPLS VRF L3Out Using the GUI	180
Creating SR-MPLS Custom QoS Policy Using the GUI	183

- Displaying MPLS Statistics 185
 - Displaying SR-MPLS Statistics for Interfaces 186
 - Displaying SR-MPLS Statistics for VRFs 187
- Configuring SR-MPLS Global Block (GB) 187
- Migrating from IP Handoff Configuration to SR Handoff Configuration 189
 - Configuring External EPGs on the SR-MPLS VRF L3Out 190
 - Redirecting Traffic to SR-MPLS L3Out 191
 - Disconnecting the IP-Based L3Out 195
- About the BGP Domain-Path Feature for Loop Prevention 196
 - Configuring the BGP Domain-Path Feature for Loop Prevention Using the GUI 201

PART II

External Routing (L3Out) Configuration 205

CHAPTER 16

WAN and Other External Network Forwarding 207

- Networking Domains 207
- Router Peering and Route Distribution 208
- Route Import and Export, Route Summarization, and Route Community Match 209
- ACI Route Redistribution 212
- Route Distribution Within the ACI Fabric 212
- External Layer 3 Outside Connection Types 213
- About the Modes of Configuring Layer 3 External Connectivity 215
- Controls Enabled for Subnets Configured under the L3Out Network Instance Profile 217
- ACI Layer 3 Outside Network Workflows 218

CHAPTER 17

Routed Connectivity to External Networks 221

- About Routed Connectivity to Outside Networks 221
 - Layer 3 Out for Routed Connectivity to External Networks 221
- Create L3Out Wizard 223
 - Example L3Out Configuration 223
 - Example Topology 224
 - Prerequisites 226
 - Create Example L3Out Using the Create L3Out Wizard 226
 - Review - Create Example L3Out Using the Create L3Out Wizard 231
 - Configure Advertise the BD Subnet with a Route Map 232

Verify the Contract	234
Change the OSPF Interface Level Parameters (Optional)	235
Advertise Host Routes	236
Configuring Route Reflectors	237
Configuring an MP-BGP Route Reflector Using the GUI	238
Verifying the MP-BGP Route Reflector Configuration	238

CHAPTER 18**Node and Interface for L3Out 241**

Modifying Interfaces for L3Out	241
Modifying Interfaces for L3Out Using the GUI	241
Customizing SVI for L3Out	243
SVI External Encapsulation Scope	243
About SVI External Encapsulation Scope	243
Encapsulation Scope Syntax	245
Guidelines for SVI External Encapsulation Scope	245
Configuring SVI External Encapsulation Scope Using the GUI	245
Support for Multiple Encapsulation for L3Outs With SVI	246
Grouping Multiple SVIs With Different Access Encapsulation	247
Guidelines and Limitations	249
Configuring Multiple Encapsulation for L3Outs With SVI Using the GUI	249
Configuring Multiple Encapsulation for L3Outs With SVI Using the CLI	250
Configuring Multiple Encapsulation for L3Outs With SVI Using the REST API	251
SVI Auto State	252
About SVI Auto State	252
Guidelines and Limitations for SVI Auto State Behavior	252
Configuring SVI Auto State Using the GUI	252
About Cisco Floating L3Outs	253

CHAPTER 19**Routing Protocol Support 255**

About Routing Protocol Support	255
BGP External Routed Networks with BFD Support	255
Guidelines for Configuring a BGP Layer 3 Outside Network Connection	255
BGP Connection Types and Loopback Guidelines	257
BGP Protocol Peering to External BGP Speakers	257

Configuring BGP External Routed Networks	259
Configuring BGP L3Out Using the GUI	259
Configuring BGP Max Path	265
Configuring BGP Max Path Using the GUI	265
Configuring AS Path Prepend	266
Configuring AS Path Prepend	266
Configuring AS Path Prepend Using the GUI	266
BGP External Routed Networks with AS Override	267
About BGP Autonomous System Override	267
Configuring BGP External Routed Network with Autonomous System Override Enabled Using the GUI	268
BGP Neighbor Shutdown and Soft Reset	269
About BGP Neighbor Shutdown and Soft Reset	269
Configuring BGP Neighbor Shutdown Using the GUI	269
Configuring BGP Neighbor Soft Reset Using the GUI	271
Configuring Per VRF Per Node BGP Timer Values	272
Per VRF Per Node BGP Timer Values	272
Configuring a Per VRF Per Node BGP Timer Using the Advanced GUI	273
Troubleshooting Inconsistency and Faults	274
Configuring BFD Support	274
Bidirectional Forwarding Detection	274
Optimizing BFD on Subinterfaces	276
Configuring Bidirectional Forwarding Detection on a Secondary IP Address Using the GUI	276
Configuring BFD Globally on Leaf Switch Using the GUI	277
Configuring BFD Globally on Spine Switch Using the GUI	278
Configuring BFD Interface Override Using the GUI	279
Configuring BFD Consumer Protocols Using the GUI	281
BFD Multihop	283
Configuring a BFD Multihop Policy	283
Micro BFD	285
Configuring Micro BFD on a Port Channel	286
OSPF External Routed Networks	287
OSPF Layer 3 Outside Connections	287
Creating an OSPF L3Out for Management Tenant Using the GUI	289

EIGRP External Routed Networks	291
About EIGRP Layer 3 Outside Connections	291
EIGRP Protocol Support	291
Guidelines and Limitations When Configuring EIGRP	293
Configuring EIGRP Using the GUI	294

CHAPTER 20**Route Summarization 297**

Introduction	297
Route Summarization at the L3Out External EPG Level	297
Route Filtering and Aggregation at the VRF Level	298
BGP Route Summarization Policy	298
Intra-VRF Import Route Control Policy	299
VRF Export Route Control Policy	300
Guidelines and Limitations	301
Configuring Route Summarization at L3out External EPG Level Using the GUI	301
Configuring Route Control Policy in VRF Using the GUI	303

CHAPTER 21**Route Control with Route Maps and Route Profiles 305**

Route Control Profile Policies	305
About Route Control Per BGP Peer	307
Guidelines and Restrictions for Route Control Per BGP Peer	307
Configuring Route Control Per BGP Peer Using the GUI	308
Route Maps/Profiles with Explicit Prefix Lists	311
About Route Map/Profile	311
About Explicit Prefix List Support for Route Maps/Profile	311
Match Rules	312
Set Rules	315
Aggregation Support for Explicit Prefix List	315
Guidelines and Limitations	319
Configuring a Route Map/Profile with Explicit Prefix List Using the GUI	319
Routing Control Protocols	321
About Configuring a Routing Control Protocol Using Import and Export Controls	321
Configuring a Route Control Protocol to Use Import and Export Controls, With the GUI	322
Interleak Redistribution for MP-BGP	324

Overview of Interleak Redistribution for MP-BGP	324
Configuring a Route Map for Interleak Redistribution Using the GUI	324
Applying a Route Map for Interleak Redistribution Using the GUI	325

CHAPTER 22**Route and Subnet Scope 327**

L3Out EPG Scope and Control Parameters	327
Scope and Aggregate Controls for Subnets	327
Security Import Policies	328
Static L3Out EPG	328
Dynamic L3Out EPG Classification	329
Guidelines and Limitations for DEC	329
Configuring Dynamic L3Out EPG Classification Using GUI	330

CHAPTER 23**Transit Routing 333**

Transit Routing in the ACI Fabric	333
Transit Routing Use Cases	334
Supported Transit Combination Matrix	339
Transit Routing Guidelines	341
Guidelines for Transit Routing	341
Transit Route Control	345
Scope and Aggregate Controls for Subnets	347
Configuring Transit Routing	348
Transit Routing Overview	348
Configure Transit Routing Using the GUI	350

CHAPTER 24**Shared Services 355**

Shared Layer 3 Out	355
Layer 3 Out to Layer 3 Out Inter-VRF Leaking	359
Configuring Shared Layer 3 Out Inter-VRF Leaking Using the Advanced GUI	360

CHAPTER 25**QoS for L3Outs 363**

L3Outs QoS	363
L3Outs QoS Guidelines and Limitations	363
Configuring QoS Directly on L3Out Using GUI	364

Configuring QoS Contracts for L3Outs Using GUI 365

CHAPTER 26

IP SLAs 367

About ACI IP SLAs 367

IP SLA Monitoring Policy 372

TCP Connect Operation 373

ICMP Echo Operation 373

IP SLA Track Members 374

IP SLA Track Lists 374

Example IP SLA Configuration Component Associations 375

Guidelines and Limitations for IP SLA 376

Configuring and Associating ACI IP SLAs for Static Routes 377

Configuring an IP SLA Monitoring Policy Using the GUI 377

Configuring IP-SLA Track Members Using the GUI 379

Configuring an IP-SLA Track List Using the GUI 379

Associating a Track List with a Static Route Using the GUI 380

Associating a Track List with a Next Hop Profile Using the GUI 381

Viewing ACI IP SLA Monitoring Information 382

Viewing IP SLA Probe Statistics Using the GUI 382

CHAPTER 27

HSRP 385

About HSRP 385

About Cisco APIC and HSRP 386

HSRP Versions 387

Guidelines and Limitations 387

Default HSRP Settings 389

Configuring HSRP Using the GUI 389

CHAPTER 28

Cisco ACI GOLF 393

Cisco ACI GOLF 393

Guidelines and Limitations for Cisco ACI GOLF 395

APIC GOLF Connections Shared by Multi-Site Sites 396

Configuring ACI GOLF Using the GUI 397

Distributing BGP EVPN Type-2 Host Routes to a DCIG 399

Distributing BGP EVPN Type-2 Host Routes to a DCIG 399

Distributing BGP EVPN Type-2 Host Routes to a DCIG Using the GUI 399

Troubleshooting EVPN Type-2 Route Advertisement 400

Troubleshooting EVPN Type-2 Route Advertisement 400

Troubleshooting EVPN Type-2 Route Distribution to a DCIG 400

APPENDIX A **Guidelines for Layer 3 Networking 403**

 Guidelines for Layer 3 Networking 403

APPENDIX B **Performing Tasks Using the NX-OS Style CLI 407**

 Part I: Layer 3 Configuration 407

 Configuring Common Pervasive Gateway Using the NX-OS Style CLI 407

 Configuring Common Pervasive Gateway Using the NX-OS Style CLI 407

 Configuring IP Aging Using the NX-OS Style CLI 408

 Configuring the IP Aging Policy Using the NX-OS-Style CLI 408

 Configuring a Static Route on a Bridge Domain Using the NX-OS Style CLI 408

 Configuring a Static Route on a Bridge Domain Using the NX-OS Style CLI 408

 Configuring Dataplane IP Learning per VRF Using the NX-OS Style CLI 409

 Configuring Dataplane IP Learning Using the NX-OS-Style CLI 409

 Configuring IPv6 Neighbor Discovery Using the NX-OS Style CLI 410

 Configuring a Tenant, VRF, and Bridge Domain with IPv6 Neighbor Discovery on the Bridge Domain Using the NX-OS Style CLI 410

 Configuring an IPv6 Neighbor Discovery Interface Policy with RA on a Layer 3 Interface Using the NX-OS Style CLI 411

 Configuring Microsoft NLB Using the NX-OS Style CLI 413

 Configuring Microsoft NLB in Unicast Mode Using the NX-OS Style CLI 413

 Configuring Microsoft NLB in Multicast Mode Using the NX-OS Style CLI 414

 Configuring Microsoft NLB in IGMP Mode Using the NX-OS Style CLI 415

 Configuring IGMP Snooping Using the NX-OS Style CLI 416

 Configuring and Assigning an IGMP Snooping Policy to a Bridge Domain using the NX-OS Style CLI 416

 Enabling IGMP Snooping and Multicast on Static Ports in the NX-OS Style CLI 419

 Enabling Group Access to IGMP Snooping and Multicast using the NX-OS Style CLI 420

 Configuring MLD Snooping Using the NX-OS Style CLI 422

Configuring and Assigning an MLD Snooping Policy to a Bridge Domain using the NX-OS Style CLI	422
Configuring IP Multicast Using the NX-OS Style CLI	425
Configuring Layer 3 Multicast Using the NX-OS Style CLI	425
Configuring Layer 3 IPv6 Multicast Using the NX-OS Style CLI	426
Configuring Multicast Filtering Using the NX-OS Style CLI	427
Configuring Multi-Pod Using the NX-OS Style CLI	430
Setting Up Multi-Pod Fabric Using the NX-OS CLI	430
Configuring Remote Leaf Switches Using the NX-OS Style CLI	433
Configure Remote Leaf Switches Using the NX-OS Style CLI	433
Part II: External Routing (L3Out) Configuration	436
Routed Connectivity to External Networks	436
Configuring an MP-BGP Route Reflector Using the NX-OS Style CLI	436
Node and Interface for L3Out	436
Configuring Layer 3 Routed and Sub-Interface Port Channels Using the NX-OS Style CLI	436
Configuring a Switch Virtual Interface Using the NX-OS Style CLI	442
Configuring Routing Protocols Using the NX-OS Style CLI	444
Configuring BGP External Routed Networks with BFD Support Using the NX-OS Style CLI	444
Configuring OSPF External Routed Networks Using the NX-OS Style CLI	453
Configuring EIGRP External Routed Networks Using the NX-OS Style CLI	456
Configuring Route Summarization Using the NX-OS Style CLI	459
Configuring Route Summarization for BGP, OSPF, and EIGRP Using the NX-OS Style CLI	459
Configuring Route Control with Route Maps and Route Profile Using NX-OS Style CLI	460
Configuring Route Control Per BGP Peer Using the NX-OS Style CLI	460
Configuring Route Map/Profile with Explicit Prefix List Using NX-OS Style CLI	461
Configuring a Route Control Protocol to Use Import and Export Controls, With the NX-OS Style CLI	464
Configuring Interleak Redistribution Using the NX-OS-Style CLI	465
Configuring Transit Routing Using the NX-OS Style CLI	466
Configure Transit Routing Using the NX-OS Style CLI	466
Example: Transit Routing	470
Configuring Shared Services Using the NX-OS Style CLI	472
Configuring Shared Layer 3 Out Inter-VRF Leaking Using the NX-OS Style CLI - Named Example	472

Configuring Shared Layer 3 Out Inter-VRF Leaking Using the NX-OS Style CLI - Implicit Example	474
Configuring QoS for L3Outs Using the NX-OS Style CLI	475
Configuring QoS Directly on L3Out Using CLI	475
Configuring QoS Contract for L3Out Using CLI	476
Configuring ACI IP SLAs Using the NX-OS Style CLI	477
Configuring an IP SLA Monitoring Policy Using the NX-OS-Style CLI	477
Configuring an IP-SLA Track Member Using the NX-OS Style CLI	478
Configuring an IP-SLA Track List Using the NX-OS Style CLI	480
Associating a Track List with a Static Route Using the NX-OS Style CLI	481
Associating a Track List with a Next Hop Profile Using the NX-OS Style CLI	482
Viewing Track List and Track Member Status Using the CLI	483
Viewing Track List and Track Member Detail Using the CLI	483
Configuring HSRP Using the NX-OS Style CLI	485
Configuring HSRP in Cisco APIC Using Inline Parameters in NX-OS Style CLI	485
Configuring HSRP in Cisco APIC Using Template and Policy in NX-OS Style CLI	486
Configuring Cisco ACI GOLF Using the NX-OS Style CLI	487
Recommended Shared GOLF Configuration Using the NX-OS Style CLI	487
Cisco ACI GOLF Configuration Example, Using the NX-OS Style CLI	488
Enabling Distributing BGP EVPN Type-2 Host Routes to a DCIG Using the NX-OS Style CLI	491

APPENDIX C**Performing Tasks Using REST API 493**

Part I: Layer 3 Configuration 493

Configuring Common Pervasive Gateway Using REST API	493
Configuring Common Pervasive Gateway Using the REST API	493
Configuring IP Aging Using REST API	494
Configuring IP Aging Using the REST API	494
Configuring a Static Route on a Bridge Domain Using REST API	494
Configuring a Static Route on a Bridge Domain Using the REST API	494
Configuring IPv6 Neighbor Discovery Using REST API	495
Creating the Tenant, VRF, and Bridge Domain with IPv6 Neighbor Discovery on the Bridge Domain Using the REST API	495
Configuring an IPv6 Neighbor Discovery Interface Policy with RA on a Layer 3 Interface Using the REST API	496
Configuring Neighbor Discovery Duplicate Address Detection Using the REST API	497

Configuring Microsoft NLB Using REST API	498
Configuring Microsoft NLB in Unicast Mode Using the REST API	498
Configuring Microsoft NLB in Multicast Mode Using the REST API	498
Configuring Microsoft NLB in IGMP Mode Using the REST API	499
Configuring IGMP Snooping Using REST API	500
Configuring and Assigning an IGMP Snooping Policy to a Bridge Domain using the REST API	500
Enabling IGMP Snooping and Multicast on Static Ports Using the REST API	500
Enabling Group Access to IGMP Snooping and Multicast using the REST API	501
Configuring MLD Snooping Using REST API	502
Configuring and Assigning an MLD Snooping Policy to a Bridge Domain using the REST API	502
Configuring IP Multicast Using REST API	502
Configuring Layer 3 Multicast Using REST API	502
Configuring Layer 3 IPv6 Multicast Using REST API	505
Configuring Multicast Filtering Using the REST API	506
Configuring Multi-Pod Using REST API	508
Setting Up Multi-Pod Fabric Using the REST API	508
Configuring Remote Leaf Switches Using REST API	510
Configure Remote Leaf Switches Using the REST API	510
Configuring SR-MPLS Handoff Using REST API	513
Configuring an SR-MPLS Infra L3Out Using the REST API	513
Configuring an SR-MPLS VRF L3Out Using the REST API	515
Creating SR-MPLS Custom QoS Policy Using REST API	517
Part II: External Routing (L3Out) Configuration	518
Routed Connectivity to External Networks	518
Configuring an MP-BGP Route Reflector Using REST API	518
Configuring the BGP Domain-Path Feature for Loop Prevention Using the REST API	519
Node and Interface for L3Out	519
Configuring Layer 3 Routed and Sub-Interface Port Channels Using REST API	519
Configuring a Switch Virtual Interface Using REST API	522
Configuring Routing Protocols Using REST API	523
Configuring BGP External Routed Networks with BFD Support Using REST API	523
Configuring OSPF External Routed Networks Using REST API	536
Configuring EIGRP External Routed Networks Using REST API	537
Configuring Route Summarization Using REST API	539

Configuring Route Summarization for BGP, OSPF, and EIGRP Using the REST API	539
Configuring Route Control with Route Maps and Route Profile Using REST API	541
Configuring Route Control Per BGP Peer Using the REST API	541
Configuring Route Map/Profile with Explicit Prefix List Using REST API	542
Configuring a Route Control Protocol to Use Import and Export Controls, With the REST API	543
Configuring Interleak Redistribution Using the REST API	544
Configuring Transit Routing Using REST API	545
Configuring Transit Routing Using the REST API	545
REST API Example: Transit Routing	549
Shared L3Out	550
Configuring Shared Services Using REST API	550
Configuring Two Shared Layer 3 Outs in Two VRFs Using REST API	550
Configuring QoS for L3Outs Using REST API	551
Configuring QoS Directly on L3Out Using REST API	551
Configuring QoS Contract for L3Out Using REST API	552
Creating SR-MPLS Custom QoS Policy Using REST API	553
Configuring ACI IP SLAs Using REST API	554
Configuring an IP SLA Monitoring Policy Using the REST API	554
Configuring an IP-SLA Track Member Using the REST API	555
Configuring an IP-SLA Track List Using the REST API	555
Associating a Track List with a Static Route Using the REST API	556
Associating a Track List with a Next Hop Profile Using the REST API	556
Configuring HSRP Using REST API	557
Configuring HSRP in APIC Using REST API	557
Configuring Cisco ACI GOLF Using REST API	559
Configuring GOLF Using the REST API	559
Enabling Distributing BGP EVPN Type-2 Host Routes to a DCIG Using the REST API	565



CHAPTER 1

New and Changed Information

This chapter contains the following section:

- [New and Changed Information, on page 1](#)

New and Changed Information

The following table provides an overview of the significant changes to the organization and features in this guide up to this current release. The table does not provide an exhaustive list of all changes made to the guide or of the new features up to this release.

Table 1: New Features and Changed Behavior in Cisco APIC Release 5.3(1)

Feature or Change	Description	Where Documented
N/A	This document has no changes from the previous release.	N/A



PART I

Layer 3 Configuration

- [Cisco ACI Forwarding](#), on page 5
- [Prerequisites for Configuring Layer 3 Networks](#), on page 11
- [Common Pervasive Gateway](#), on page 13
- [IP Aging](#), on page 17
- [Static Route on a Bridge Domain](#), on page 19
- [Dataplane IP Address Learning](#), on page 21
- [IPv6 Neighbor Discovery](#), on page 27
- [Microsoft NLB](#), on page 33
- [IGMP Snooping](#), on page 45
- [MLD Snooping](#), on page 55
- [Tenant Routed Multicast](#), on page 61
- [Multi-Pod](#), on page 99
- [Remote Leaf Switches](#), on page 115
- [SR-MPLS Handoff](#), on page 147



CHAPTER 2

Cisco ACI Forwarding

- [Forwarding Within the Fabric, on page 5](#)

Forwarding Within the Fabric

ACI Fabric Optimizes Modern Data Center Traffic Flows

The Cisco ACI architecture addresses the limitations of traditional data center design, and provides support for the increased east-west traffic demands of modern data centers.

Today, application design drives east-west traffic from server to server through the data center access layer. Applications driving this shift include big data distributed processing designs like Hadoop, live virtual machine or workload migration as with VMware vMotion, server clustering, and multi-tier applications.

North-south traffic drives traditional data center design with core, aggregation, and access layers, or collapsed core and access layers. Client data comes in from the WAN or Internet, a server processes it, and then it exits the data center, which permits data center hardware oversubscription due to WAN or Internet bandwidth constraints. However, Spanning Tree Protocol is required to block loops. This limits available bandwidth due to blocked links, and potentially forces traffic to take a suboptimal path.

In traditional data center designs, IEEE 802.1Q VLANs provide logical segmentation of Layer 2 boundaries or broadcast domains. However, VLAN use of network links is inefficient, requirements for device placements in the data center network can be rigid, and the VLAN maximum of 4094 VLANs can be a limitation. As IT departments and cloud providers build large multi-tenant data centers, VLAN limitations become problematic.

A spine-leaf architecture addresses these limitations. The ACI fabric appears as a single switch to the outside world, capable of bridging and routing. Moving Layer 3 routing to the access layer would limit the Layer 2 reachability that modern applications require. Applications like virtual machine workload mobility and some clustering software require Layer 2 adjacency between source and destination servers. By routing at the access layer, only servers connected to the same access switch with the same VLANs trunked down would be Layer 2-adjacent. In ACI, VXLAN solves this dilemma by decoupling Layer 2 domains from the underlying Layer 3 network infrastructure.

Figure 1: ACI Fabric

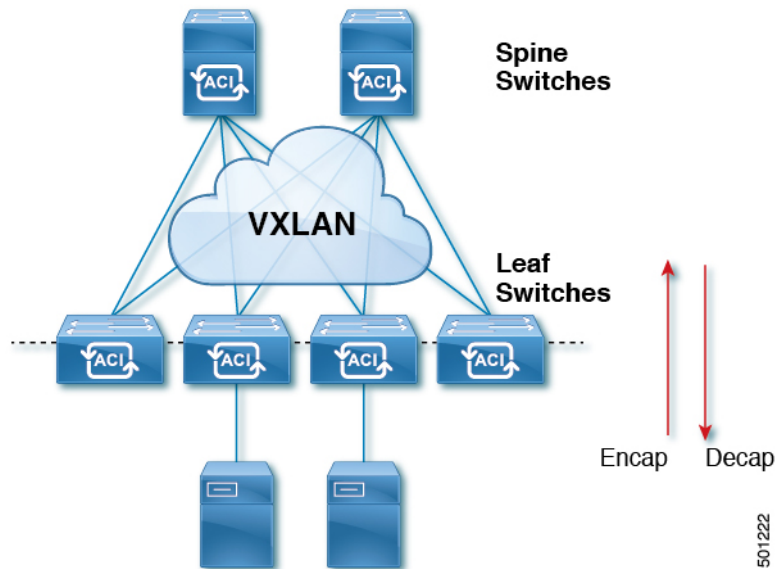

As traffic enters the fabric, ACI encapsulates and applies policy to it, forwards it as needed across the fabric through a spine switch (maximum two-hops), and de-encapsulates it upon exiting the fabric. Within the fabric, ACI uses Intermediate System-to-Intermediate System Protocol (IS-IS) and Council of Oracle Protocol (COOP) for all forwarding of endpoint to endpoint communications. This enables all ACI links to be active, equal cost multipath (ECMP) forwarding in the fabric, and fast-reconverging. For propagating routing information between software defined networks within the fabric and routers external to the fabric, ACI uses the Multiprotocol Border Gateway Protocol (MP-BGP).

VXLAN in ACI

VXLAN is an industry-standard protocol that extends Layer 2 segments over Layer 3 infrastructure to build Layer 2 overlay logical networks. The ACI infrastructure Layer 2 domains reside in the overlay, with isolated broadcast and failure bridge domains. This approach allows the data center network to grow without the risk of creating too large a failure domain.

All traffic in the ACI fabric is normalized as VXLAN packets. At ingress, ACI encapsulates external VLAN, VXLAN, and NVGRE packets in a VXLAN packet. The following figure shows ACI encapsulation normalization.

Figure 2: ACI Encapsulation Normalization

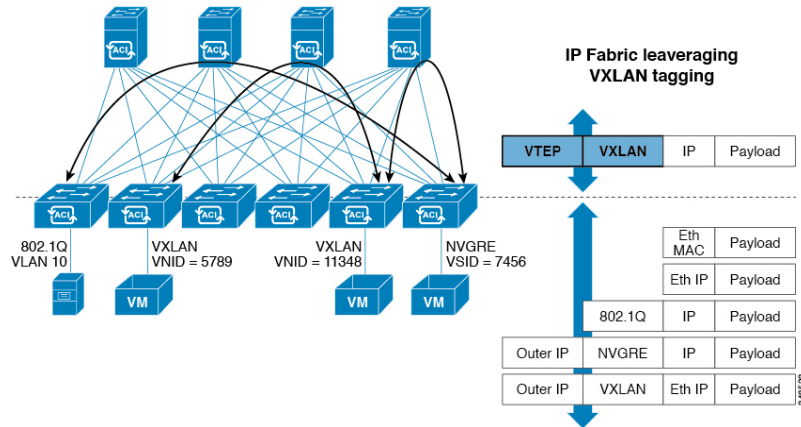

Forwarding in the ACI fabric is not limited to or constrained by the encapsulation type or encapsulation overlay network. An ACI bridge domain forwarding policy can be defined to provide standard VLAN behavior where required.

Because every packet in the fabric carries ACI policy attributes, ACI can consistently enforce policy in a fully distributed manner. ACI decouples application policy EPG identity from forwarding. The following illustration shows how the ACI VXLAN header identifies application policy within the fabric.

Figure 3: ACI VXLAN Packet Format

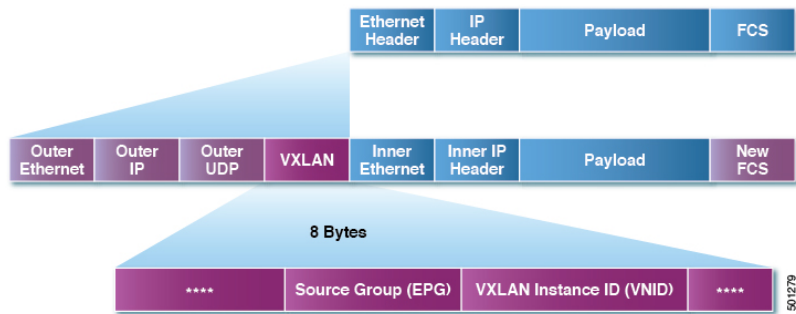

The ACI VXLAN packet contains both Layer 2 MAC address and Layer 3 IP address source and destination fields, which enables efficient and scalable forwarding within the fabric. The ACI VXLAN packet header source group field identifies the application policy endpoint group (EPG) to which the packet belongs. The VXLAN Instance ID (VNID) enables forwarding of the packet through tenant virtual routing and forwarding (VRF) domains within the fabric. The 24-bit VNID field in the VXLAN header provides an expanded address space for up to 16 million unique Layer 2 segments in the same network. This expanded address space gives IT departments and cloud providers greater flexibility as they build large multitenant data centers.

VXLAN enables ACI to deploy Layer 2 virtual networks at scale across the fabric underlay Layer 3 infrastructure. Application endpoint hosts can be flexibly placed in the data center network without concern for the Layer 3 boundary of the underlay infrastructure, while maintaining Layer 2 adjacency in a VXLAN overlay network.

Layer 3 VNIDs Facilitate Transporting Inter-subnet Tenant Traffic

The ACI fabric provides tenant default gateway functionality that routes between the ACI fabric VXLAN networks. For each tenant, the fabric provides a virtual default gateway that spans all of the leaf switches assigned to the tenant. It does this at the ingress interface of the first leaf switch connected to the endpoint. Each ingress interface supports the default gateway interface. All of the ingress interfaces across the fabric share the same router IP address and MAC address for a given tenant subnet.

The ACI fabric decouples the tenant endpoint address, its identifier, from the location of the endpoint that is defined by its locator or VXLAN tunnel endpoint (VTEP) address. Forwarding within the fabric is between VTEPs. The following figure shows decoupled identity and location in ACI.

Figure 4: ACI Decouples Identity and Location

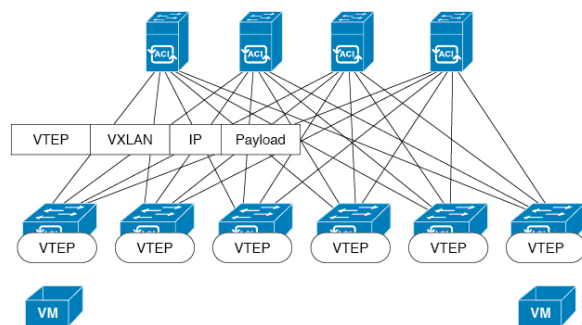

VXLAN uses VTEP devices to map tenant end devices to VXLAN segments and to perform VXLAN encapsulation and de-encapsulation. Each VTEP function has two interfaces:

- A switch interface on the local LAN segment to support local endpoint communication through bridging
- An IP interface to the transport IP network

The IP interface has a unique IP address that identifies the VTEP device on the transport IP network known as the infrastructure VLAN. The VTEP device uses this IP address to encapsulate Ethernet frames and transmit the encapsulated packets to the transport network through the IP interface. A VTEP device also discovers the remote VTEPs for its VXLAN segments and learns remote MAC Address-to-VTEP mappings through its IP interface.

The VTEP in ACI maps the internal tenant MAC or IP address to a location using a distributed mapping database. After the VTEP completes a lookup, the VTEP sends the original data packet encapsulated in VXLAN with the destination address of the VTEP on the destination leaf switch. The destination leaf switch de-encapsulates the packet and sends it to the receiving host. With this model, ACI uses a full mesh, single hop, loop-free topology without the need to use the spanning-tree protocol to prevent loops.

The VXLAN segments are independent of the underlying network topology; conversely, the underlying IP network between VTEPs is independent of the VXLAN overlay. It routes the encapsulated packets based on the outer IP address header, which has the initiating VTEP as the source IP address and the terminating VTEP as the destination IP address.

The following figure shows how routing within the tenant is done.

Figure 5: Layer 3 VNIDs Transport ACI Inter-subnet Tenant Traffic

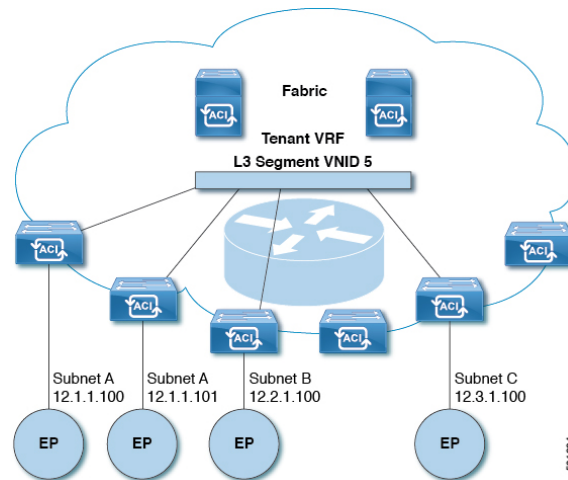

For each tenant VRF in the fabric, ACI assigns a single L3 VNID. ACI transports traffic across the fabric according to the L3 VNID. At the egress leaf switch, ACI routes the packet from the L3 VNID to the VNID of the egress subnet.

Traffic arriving at the fabric ingress that is sent to the ACI fabric default gateway is routed into the Layer 3 VNID. This provides very efficient forwarding in the fabric for traffic routed within the tenant. For example, with this model, traffic between 2 VMs belonging to the same tenant, on the same physical host, but on different subnets, only needs to travel to the ingress switch interface before being routed (using the minimal path cost) to the correct destination.

To distribute external routes within the fabric, ACI route reflectors use multiprotocol BGP (MP-BGP). The fabric administrator provides the autonomous system (AS) number and specifies the spine switches that become route reflectors.



Note Cisco ACI does not support IP fragmentation. Therefore, when you configure Layer 3 Outside (L3Out) connections to external routers, or Multi-Pod connections through an Inter-Pod Network (IPN), it is recommended that the interface MTU is set appropriately on both ends of a link.

IGP Protocol Packets (EIGRP, OSPFv3) are constructed by components based on the Interface MTU size. In Cisco ACI, if the CPU MTU size is less than the Interface MTU size and if the constructed packet size is greater than the CPU MTU, then the packet is dropped by the kernel, especially in IPv6. To avoid such control packet drops always configure the same MTU values on both the control plane and on the interface.

On some platforms, such as Cisco ACI, Cisco NX-OS, and Cisco IOS, the configurable MTU value does not take into account the Ethernet headers (matching IP MTU, and excluding the 14-18 Ethernet header size), while other platforms, such as IOS-XR, include the Ethernet header in the configured MTU value. A configured value of 9000 results in a max IP packet size of 9000 bytes in Cisco ACI, Cisco NX-OS, and Cisco IOS, but results in a max IP packet size of 8986 bytes for an IOS-XR untagged interface.

For the appropriate MTU values for each platform, see the relevant configuration guides.

We highly recommend that you test the MTU using CLI-based commands. For example, on the Cisco NX-OS CLI, use a command such as `ping 1.1.1.1 df-bit packet-size 9000 source-interface ethernet 1/1`.



CHAPTER 3

Prerequisites for Configuring Layer 3 Networks

This chapter contains the following sections:

- [Layer 3 Prerequisites, on page 11](#)

Layer 3 Prerequisites

Before you begin to perform the tasks in this guide, complete the following:

- Ensure that the ACI fabric and the APIC controllers are online, and the APIC cluster is formed and healthy—For more information, see *Cisco APIC Getting Started Guide, Release 2.x*.
- Ensure that fabric administrator accounts for the administrators that will configure Layer 3 networks are available—For instructions, see the *User Access, Authentication, and Accounting and Management* chapters in *Cisco APIC Basic Configuration Guide*.
- Ensure that the target leaf and spine switches (with the necessary interfaces) are available—For more information, see *Cisco APIC Getting Started Guide, Release 2.x*.

For information about installing and registering virtual switches, see *Cisco ACI Virtualization Guide*.

- Configure the tenants, bridge domains, VRFs, and EPGs (with application profiles and contracts) that will consume the Layer 3 networks—For instructions, see the *Basic User Tenant Configuration* chapter in *Cisco APIC Basic Configuration Guide*.
- Configure NTP, DNS Service, and DHCP Relay policies—For instructions, see the *Provisioning Core ACI Fabric Services* chapter in *Cisco APIC Basic Configuration Guide, Release 2.x*.



Caution

If you install 1 Gigabit Ethernet (GE) or 10GE links between the leaf and spine switches in the fabric, there is risk of packets being dropped instead of forwarded, because of inadequate bandwidth. To avoid the risk, use 40GE or 100GE links between the leaf and spine switches.

Bridge Domain Configurations

The **Layer 3 Configurations** tab of the bridge domain panel allows the administrator to configure the following parameters:

- **Unicast Routing:** If this setting is enabled and a subnet address is configured, the fabric provides the default gateway function and routes the traffic. Enabling unicast routing also instructs the mapping database to learn the endpoint IP-to-VTEP mapping for this bridge domain. The IP learning is not dependent upon having a subnet configured under the bridge domain.
- **Subnet Address:** This option configures the SVI IP addresses (default gateway) for the bridge domain.
- **Limit IP Learning to Subnet:** This option is similar to a unicast reverse-forwarding-path check. If this option is selected, the fabric will not learn IP addresses from a subnet other than the one configured on the bridge domain.



Caution Enabling **Limit IP Learning to Subnet** is disruptive to the traffic in the bridge domain.



CHAPTER 4

Common Pervasive Gateway

This chapter contains the following sections:

- [Overview, on page 13](#)
- [Configuring Common Pervasive Gateway Using the GUI, on page 14](#)

Overview



Note The Common Pervasive Gateway feature is being deprecated and is not actively maintained anymore.

When operating more than one Cisco ACI fabric, we highly recommend that you deploy Multi-Site instead of interconnecting multiple individual ACI fabrics to each other through leaf switches using the Common Pervasive Gateway feature. The Common Pervasive Gateway feature is currently not supported because no validations and quality assurance tests are performed in this topology for many other new features, such as L3 multicast. Hence, although Cisco ACI had the Common Pervasive Gateway feature for interconnecting ACI fabrics prior to Multi-Site, we highly recommend that you design a new ACI fabric with Multi-Site instead when there is a requirement to interconnect separate APIC domains.

This example shows how to configure Common Pervasive Gateway for IPv4 when using the Cisco APIC.

Two ACI fabrics can be configured with an IPv4 common gateway on a per bridge domain basis. Doing so enables moving one or more virtual machine (VM) or conventional hosts across the fabrics while the host retains its IP address. VM host moves across fabrics can be done automatically by the VM hypervisor. The ACI fabrics can be co-located, or provisioned across multiple sites. The Layer 2 connection between the ACI fabrics can be a local link, or can be across a bridged network. The following figure illustrates the basic common pervasive gateway topology.

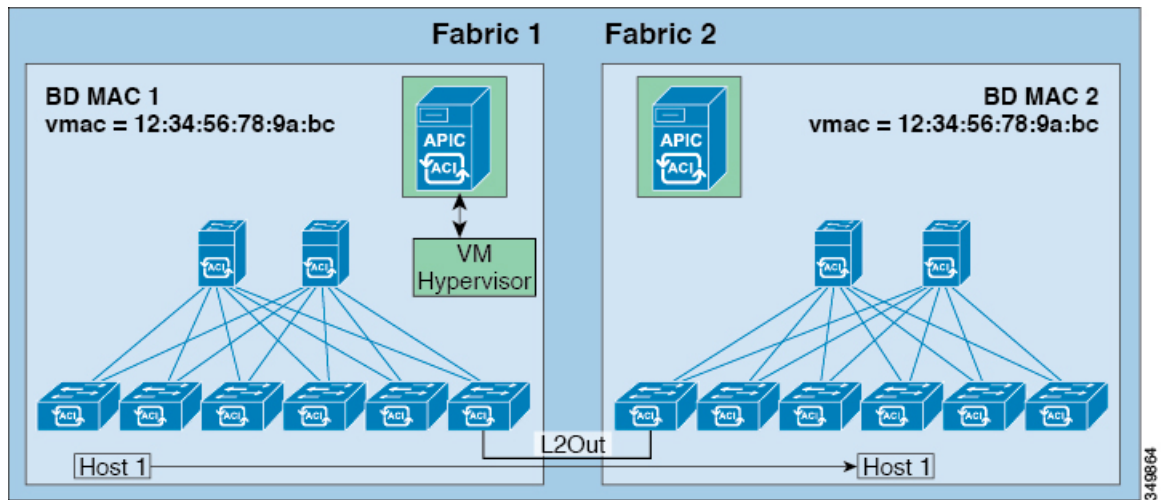

Note Depending upon the topology used to interconnect two Cisco ACI fabrics, it is required that the interconnecting devices filter out the traffic source with the Virtual MAC address of the gateway switch virtual interface (SVI).

Configuring Common Pervasive Gateway Using the GUI

Before you begin

- The tenant and VRF are created.
- The bridge domain virtual MAC address and the subnet virtual IP address must be the same across all Cisco Application Centric Infrastructure (ACI) fabrics for that bridge domain. Multiple bridge domains can be configured to communicate across connected Cisco ACI fabrics. The virtual MAC address and the virtual IP address can be shared across bridge domains.
- The Bridge domain that is configured to communicate across Cisco ACI fabrics must be in **fluid** mode
- Only one EPG from a bridge domain, if the bridge domain has multiple EPGs, should be configured on a border leaf switch on the port which is connected to the second fabric.
- Do not connect hosts directly to an inter-connected Layer 2 network that enables a pervasive common gateway among the two Cisco ACI fabrics.

Procedure

- Step 1** On the menu bar, click **Tenants**.
- Step 2** In the **Navigation** pane, expand the *Tenant_name* > **Networking** > **Bridge Domains**.
- Step 3** Right-click **Bridge Domains**, and click **Create Bridge Domain**.
- Step 4** In the **Create Bridge Domain** dialog box, perform the required actions to choose the appropriate attributes:

- a) In the **Main** tab, in the **Name** field, enter a name for the bridge domain, and choose the desired values for the remaining fields.
- b) In the **L3 configurations** tab, expand **Subnets**, and in the **Create Subnets** dialog box, in the **Gateway IP** field, enter the IP address.

For example, 192.0.2.1/24.

- c) In the **Treat as virtual IP address** field, check the check box.
- d) In the **Make this IP address primary** field, check the check box to specify this IP address for DHCP relay.

Checking this check box affects DHCP relay only.

- e) Click **Ok**, then click **Next** to advance to the **Advanced/Troubleshooting** tab, then click **Finish**.

Step 5 Double click the **Bridge Domain** that you just created in the **Work** pane, and perform the following action:

- a) Click the **Policy** tab, then click the **L3 Configurations** subtab.
- b) Expand **Subnets** again, and in the **Create Subnets** dialog box, to create the physical IP address in the **Gateway IP** field, use the same subnet which is configured as the virtual IP address.

For example, if you used 192.0.2.1/24 for the virtual IP address, you might use 192.0.2.2/24 here for the physical IP address.

Note

The physical IP address must be unique across the Cisco ACI fabric.

- c) Click **Submit** to complete the configuration in the **Create Subnet** window.

Step 6 In the **L3 Configurations** tab for the same bridge domain that you just created, click the **Virtual MAC Address** field, and change **Not Configured** to the appropriate value, then click **Submit**.

Note

The default bridge domain MAC address values are the same for all Cisco ACI fabrics; this configuration requires the bridge domain MAC values to be unique for each Cisco ACI fabric.

Confirm that the bridge domain MAC (pMAC) values for each fabric are unique.

Note

This step essentially ties the virtual MAC address that you enter in this field with the virtual IP address that you entered in the previous step. If you were to delete the virtual MAC address at some point in the future, you should also remove the check from the **Treat as virtual IP address** field for the IP address that you entered in the previous step.

Step 7 To create an L2Out EPG to extend the bridge domain to another fabric, in the Navigation pane, right-click **L2Outs**, click **Create L2Out**, and perform the following actions:

- a) In the **Name** field, enter a name for the bridged outside.
- b) In the **Bridge Domain** field, select the bridge domain already previously created.
- c) In the **Encap** field, enter the VLAN encapsulation to match the other fabric l2out encapsulation.
- d) In the **Path Type** field, select **Port**, **PC**, or **VPC** to deploy the EPG and click **Next**.
- e) To create an External EPG network click in the **Name** field, enter a name for the network and you can specify the QoS class and click **Finish** to complete Common Pervasive configuration.



CHAPTER 5

IP Aging

This chapter contains the following sections:

- [Overview, on page 17](#)
- [Configuring the IP Aging Policy Using the GUI, on page 17](#)

Overview

The IP Aging policy tracks and ages unused IP addresses on an endpoint. Tracking is performed using the endpoint retention policy configured for the bridge domain to send ARP requests (for IPv4) and neighbor solicitations (for IPv6) at 75% of the local endpoint aging interval. When no response is received from an IP address, that IP address is aged out.

This document explains how to configure the IP Aging policy.

Configuring the IP Aging Policy Using the GUI

This section explains how to enable and disable the IP Aging policy.

Procedure

- Step 1** From the menu bar, click the **System** tab.
 - Step 2** From the submenu bar, click **System Settings**.
 - Step 3** In the navigation pane, click **Endpoint Controls**.
 - Step 4** In the work pane, click **Ip Aging**.
The **IP Aging Policy** appears with the **Administrative State Disabled** button selected.
 - Step 5** From the **Administrative State**, click one of the following options:
 - **Enabled**—Enables IP aging
 - **Disabled**—Disables IP aging
-

What to do next

To specify the interval used for tracking IP addresses on endpoints, create an End Point Retention policy by navigating to **Tenants** > *tenant-name* > **Policies** > **Protocol**, right-click **End Point Retention**, and choose **Create End Point Retention Policy**.



CHAPTER 6

Static Route on a Bridge Domain

This chapter contains the following sections:

- [About Static Routes in Bridge Domains, on page 19](#)
- [Configuring a Static Route on a Bridge Domain Using the GUI, on page 19](#)

About Static Routes in Bridge Domains

With Cisco APIC Release 3.0(2), support is added to configure a static route in a pervasive bridge domain (BD) to enable routes to virtual services behind firewalls.

This feature enables endpoint (EP) reachability to IP addresses that are not directly connected to the pervasive bridge domain, using regular EPGs.

When a static route is configured, the APIC deploys it to all the leaf switches that use the bridge domain and all the leaf switches that have contracts associated to the bridge domain.

You can configure endpoint reachability using the APIC GUI, the NX-OS Style CLI, and the REST API.

Guidelines and Limitations

- The subnet mask must be /32 (/128 for IPv6) pointing to one IP address out of the fabric. Do not add routes within bridge domain subnets that are already defined.
- The next hop must be inside the same bridge domain that this EPG is associated with.
- The feature is supported on Cisco Nexus 9000 series switches with names that end in EX, and later (for example, N9K-C93180LC-EX).

Configuring a Static Route on a Bridge Domain Using the GUI

- When creating the subnet for the static route, it is configured under the EPG (fvSubnet object under fvAEPg), associated with the pervasive BD (fvBD), not the BD itself.
- The subnet mask must be /32 (/128 for IPv6) pointing to one IP address or one endpoint. It is contained in the EPG associated with the pervasive BD.

Before you begin

Create the tenant, VRF, BD, and EPG.

Procedure

-
- Step 1** On the menu bar, click **Tenants** > *tenant-name* .
- Step 2** In the Navigation pane, expand **Application Profiles** and click the application profile name.
- Step 3** Click **Application EPGs** and expand the EPG for the static route.
- Step 4** Expand **Subnets**, right-click the subnet for the static route, and choose **Create Endpoints Behind EPG Subnet**.
- Step 5** Enter the **NextHop IP Address** for the endpoint and click **Update**.
- Step 6** Click **Submit**.
-



CHAPTER 7

Dataplane IP Address Learning

This chapter contains the following sections:

- [Overview of Dataplane IP Address Learning, on page 21](#)
- [Guidelines and Limitations for Dataplane IP Address Learning, on page 21](#)
- [Feature Interaction for Dataplane IP Address Learning Being Disabled, on page 22](#)
- [Configuring Dataplane IP Address Learning per VRF Instance Using the GUI, on page 23](#)
- [Configuring Dataplane IP Address Learning per Endpoint Using the GUI, on page 24](#)
- [Configuring Dataplane IP Address Learning per Subnet Using the GUI, on page 25](#)

Overview of Dataplane IP Address Learning

Endpoint IP and MAC addresses are learned by the Cisco Application Centric Infrastructure (ACI) fabric through common network methods such as ARP, GARP, and ND. Cisco ACI also uses an internal method that learns IP and MAC addresses through the dataplane. Dataplane IP address learning is enabled by default on the Cisco ACI fabric.

Dataplane IP address learning per VRF instance is unique to the Cisco ACI network much in the same way as endpoint learning. While endpoint learning is identified as both IP address and MAC address, dataplane IP address learning is specific to IP addressing only in VRF instances. In the Cisco Application Policy Infrastructure Controller (APIC), you can enable or disable dataplane IP address learning at the VRF instance level.

Beginning with Cisco APIC release 5.2(1), you can disable dataplane IP address learning for specific endpoints or subnets for more granular control.

Guidelines and Limitations for Dataplane IP Address Learning

The following guidelines and limitations apply to dataplane IP address learning per VRF instance, bridge domain subnet, and EPG subnet:

- When dataplane IP address learning is disabled, all the remote IP address entries in the tenant VRF instance are removed. The local IP entries are aged out and, subsequently, will not be re-learned through the dataplane, but can still be learned from the control plane.
- When dataplane IP address learning is disabled, already learned local IP endpoints are retained and require control plane refreshes (ARP) to be kept alive (assuming IP aging is also enabled). Dataplane Layer 3 traffic will not keep IP endpoints alive.

- For EPG-to-EPG intra-VRF instance Layer 3 traffic, the policy is always applied on the egress leaf switch because the ingress leaf switch cannot resolve the destination class. The remote IP address is not learned.
- For EPG-to-EPG intra-VRF instance Layer 2 traffic, the policy can be applied on the ingress leaf switch because the switch can still learn the remote MAC address, but not the remote IP address.
- When dataplane IP address learning is enabled for an endpoint or subnet, a dataplane IP address is not learned using an endpoint-to-endpoint ARP request that does not reach a CPU. However, an ARP request to a bridge domain SVI gateway is still learned.
- When dataplane IP address learning is enabled for a VRF instance, local and remote MAC addresses are learned using an endpoint-to-endpoint ARP request.

The following guidelines and limitations apply to disabling dataplane IP address learning per endpoint or subnet:

- If there is communication between endpoints in the same bridge domain, the **L2 unknown Unicast** property must be set to **Flood** on the bridge domain. ARP flooding must also be enabled. Otherwise, ARP between endpoints in the same bridge domain does not work because the local MAC address and remote MAC address are not learned through an endpoint-to-endpoint ARP request.
- Instead of flushing, the local IP address is converted to the `dp-learn-dis` (dataplane learn disabled) state.
- You cannot have endpoint dataplane IP address learning enabled when the subnet for an endpoint is configured with dataplane IP address learning disabled. For example, you cannot have a bridge domain with subnet 100.10.0.1/24 with learning disabled and an EPG with 100.10.0.100/32 with learning enabled.
- When dataplane IP address learning is disabled for an endpoint or subnet, the switch will not learn/refresh Layer 2 MAC addresses from routed Layer 3 data traffic. Layer 2 MAC addresses will only be learned from Layer 2 data traffic or ARP packets.
- When dataplane IP address learning is disabled for an endpoint or subnet, an IP address learn or move triggered from a GARP packet is only possible with the ARP flood mode along with GARP-based endpoint move detection enabled.

Feature Interaction for Dataplane IP Address Learning Being Disabled

This section provides information about the interaction of disabling dataplane IP address learning with other features.

- Anycast
 - Enabled: Local anycast IP addresses can be learned from both the data and control planes.
 - Disabled: Local anycast IP addresses are aged out, but can be learned through the control plane and host tracking.
 - Remote IP addresses are not learned in anycast regardless of how dataplane IP address learning per VRF instance is configured.
- Rogue Endpoint Detection
 - Enabled: A rogue IP address is generated and moves are detected as expected.

- Disabled: Remote IP addresses are flushed and rogue IP addresses are aged out. Rogue IP addresses are not detected on local moves. The only moves that are detected are from control traffic. Bounce is learned from COOP, but these are dropped once the bounce timer expires.
- Layer 4 to Layer 7 services virtual IP (VIP) address
 - Enabled: A Layer 4 to Layer 7 services VIP address functions as expected (endpoint IP address learning for a VIP address is only through the control plane). Consider the following functional stream:
 1. From client to load balancer (Layer 3 traffic)
 2. Load balancer to server (Layer 2 traffic)
 3. Server to client (Layer 3)Clients (IP endpoints) behind the EPG are learned through the data/control plane. The VIP address is learned only through the control plane on the load balancer EPG. Even though it is through the control plane, the VIP address is not learned on other EPGs.
 - Disabled:
 - Client to load balancer: No remote IP address learned for VIP address. The remote IP address is cleared. It will use the spine-proxy. If the IP address of the VIP address is learned, spine-proxy look-up will be successful, otherwise it will generate glean for the VIP address and learn it through the control plane.
 - Load balancer to server: No effect. Only bridging between the load balancer/server is supported for the DSR use case.
 - Server to client: The remote IP address for the client is cleared and the spine-proxy will be used. If the remote IP address for the client entry is deleted in the spine switch, it is re-learned through glean. For clients behind an L3Out, there is no Layer 3 remote IP address.

Configuring Dataplane IP Address Learning per VRF Instance Using the GUI

This section explains how to disable dataplane IP address learning per VRF instance.

The following procedure assumes that you have already configured a tenant and VRF instance.

Procedure

-
- Step 1** Navigate to **Tenants** > *tenant_name* > **Networking** > **VRFs** > *vrf_name*.
 - Step 2** On the **VRF - *vrf_name*** work pane, click the **Policy** tab.
 - Step 3** Scroll to the bottom of the **Policy** work pane and locate **IP Data-plane Learning**.
 - Step 4** Click one of the following:
 - **Disabled**: Disables dataplane IP address learning on the VRF instance.

- **Enabled:** Enables dataplane IP address learning on the VRF instance.

Step 5 Click **Submit**.

Configuring Dataplane IP Address Learning per Endpoint Using the GUI

The following procedure enables or disables dataplane IP address learning for an endpoint of the chosen endpoint group. You can configure dataplane IP address learning for an endpoint only if the EPG subnet IP address has a mask of /32 for an IPv4 address or /128 for an IPv6 address. Dataplane IP address learning is enabled by default.

Procedure

Step 1 On the menu bar, choose **Tenants > All Tenants**.

Step 2 In the Work pane, double-click the tenant's name.

Step 3 If you are modifying an existing subnet, perform the following substeps:

- In the Navigation pane, choose **Tenant *tenant_name* > Application Profiles > *app_profile_name* > Application EPGs > *app_epg_name* > Subnets > *subnet_address***.

The chosen subnet must meet the following requirements:

- The **Default Gateway IP** field must have a mask of /32 for an IPv4 address or /128 for an IPv6 address.
 - There must be a check in the **No Default SVI Gateway** checkbox.
 - The **Type Behind Subnet** must be **None** or **Anycast MAC**.
- In the Work pane, for the **IP Data-plane Learning** toggle, choose **Enable** or **Disable**, as desired.
This enables or disables IP address dataplane learning for the endpoint.

Step 4 If you are creating a new subnet, perform the following substeps:

- In the Navigation pane, choose **Tenant *tenant_name* > Application Profiles > *app_profile_name* > Application EPGs > *app_epg_name* > Subnets**.
- Right click **Subnets** and choose **Create EPG Subnet**.
- For the **Default Gateway IP** field, you must specify a mask of /32 for an IPv4 address or /128 for an IPv6 address.
- Put a check in the **No Default SVI Gateway** checkbox.
- For the **Type Behind Subnet** buttons, choose **None** or **Anycast MAC**.
- For the **IP Data-plane Learning** toggle, choose **Enable** or **Disable**, as desired.

This enables or disables IP address dataplane learning for the endpoint.

- Fill out the remaining fields as necessary.

Step 5 Click **Submit**.

Configuring Dataplane IP Address Learning per Subnet Using the GUI

The following procedure enables or disables dataplane IP address learning for a subnet. Dataplane IP address learning is enabled by default.

Procedure

Step 1 On the menu bar, choose **Tenants > All Tenants**.

Step 2 In the Work pane, double-click the tenant's name.

Step 3 If you are modifying an existing subnet, perform the following substeps:

a) In the Navigation pane, choose **Tenant *tenant_name* > Networking > Bridge Domains > *bridge_domain_name* > Subnets > *subnet_address***.

If you want to disable dataplane IP address learning, there must not be a check in the **No Default SVI Gateway** checkbox.

b) In the Work pane, for the **IP Data-plane Learning** toggle, choose **Enable** or **Disable**, as desired.
This enables or disables IP address dataplane learning for the subnet.

Step 4 If you are creating a new subnet, perform the following substeps:

a) In the Navigation pane, choose **Tenant *tenant_name* > Networking > Bridge Domains > *bridge_domain_name* > Subnets**.

b) Right click **Subnets** and choose **Create Subnet**.

c) For the **Default Gateway IP** field, enter the IP address and mask.

d) If you want to disable dataplane IP address learning, do not put a check in the **No Default SVI Gateway** checkbox.

e) For the **IP Data-plane Learning** toggle, choose **Enable** or **Disable**, as desired.

This enables or disables IP address dataplane learning for the subnet.

f) Fill out the remaining fields as necessary.

Step 5 Click **Submit**.



CHAPTER 8

IPv6 Neighbor Discovery

This chapter contains the following sections:

- [Neighbor Discovery, on page 27](#)
- [Configuring IPv6 Neighbor Discovery on a Bridge Domain, on page 28](#)
- [Configuring IPv6 Neighbor Discovery on a Layer 3 Interface, on page 30](#)
- [Configuring IPv6 Neighbor Discovery Duplicate Address Detection , on page 31](#)

Neighbor Discovery

The IPv6 Neighbor Discovery (ND) protocol is responsible for the address auto configuration of nodes, discovery of other nodes on the link, determining the link-layer addresses of other nodes, duplicate address detection, finding available routers and DNS servers, address prefix discovery, and maintaining reachability information about the paths to other active neighbor nodes.

ND-specific Neighbor Solicitation or Neighbor Advertisement (NS or NA) and Router Solicitation or Router Advertisement (RS or RA) packet types are supported on all ACI fabric Layer 3 interfaces, including physical, Layer 3 sub interface, and SVI (external and pervasive). Up to APIC release 3.1(1x), RS/RA packets are used for auto configuration for all Layer 3 interfaces but are only configurable for pervasive SVIs.

Starting with APIC release 3.1(2x), RS/RA packets are used for auto configuration and are configurable on Layer 3 interfaces including routed interface, Layer 3 sub interface, and SVI (external and pervasive).

ACI bridge domain ND always operates in flood mode; unicast mode is not supported.

The ACI fabric ND support includes the following:

- Interface policies (`nd:IfPol`) control ND timers and behavior for NS/NA messages.
- ND prefix policies (`nd:PxPol`) control RA messages.
- Configuration of IPv6 subnets for ND (`fv:Subnet`).
- ND interface policies for external networks.
- Configurable ND subnets for external networks, and arbitrary subnet configurations for pervasive bridge domains are not supported.

Configuration options include the following:

- Adjacencies

- Configurable Static Adjacencies: (<vrf, L3Iface, ipv6 address> --> mac address)
- Dynamic Adjacencies: Learned via exchange of NS/NA packets

- Per Interface
 - Control of ND packets (NS/NA)
 - Neighbor Solicitation Interval
 - Neighbor Solicitation Retry count
 - Control of RA packets
 - Suppress RA
 - Suppress RA MTU
 - RA Interval, RA Interval minimum, Retransmit time

- Per Prefix (advertised in RAs) control
 - Lifetime, preferred lifetime
 - Prefix Control (auto configuration, on link)

- Neighbor Discovery Duplicate Address Detection (DAD)

Configuring IPv6 Neighbor Discovery on a Bridge Domain

Creating the Tenant, VRF, and Bridge Domain with IPv6 Neighbor Discovery on the Bridge Domain Using the GUI

This task shows how to create a tenant, a VRF, and a bridge domain (BD) within which two different types of Neighbor Discovery (ND) policies are created. They are ND interface policy and ND prefix policy. While ND interface policies are deployed under BDs, ND prefix policies are deployed for individual subnets. Each BD can have its own ND interface policy. The ND interface policy is deployed on all IPv6 interfaces by default. In Cisco APIC, there is already an ND interface default policy available to use. If desired, you can create a custom ND interface policy to use instead. The ND prefix policy is on a subnet level. Every BD can have multiple subnets, and each subnet can have a different ND prefix policy.

Procedure

-
- Step 1** On the menu bar, click **Tenant > Add Tenant**.
- Step 2** In the **Create Tenant** dialog box, perform the following tasks:
- a) in the **Name** field, enter a name.
 - b) Click the **Security Domains +** icon to open the **Create Security Domain** dialog box.
 - c) In the **Name** field, enter a name for the security domain. Click **Submit**.

- d) In the **Create Tenant** dialog box, check the check box for the security domain that you created, and click **Submit**.

Step 3 In the **Navigation** pane, expand *Tenant-name* > **Networking**.

Step 4 In the **Work** pane, drag the **VRF** icon to the canvas to open the **Create VRF** dialog box, and perform the following actions:

- a) In the **Name** field, enter a name.
- b) Click **Submit** to complete the **VRF** configuration.

Step 5 In the **Networking** area, drag the **Bridge Domain** icon to the canvas while connecting it to the **VRF** icon. In the **Create Bridge Domain** dialog box that displays, perform the following actions:

- a) In the **Name** field, enter a name.
- b) Click the **L3 Configurations** tab, and expand **Subnets** to open the **Create Subnet** dialog box, enter the subnet mask in the **Gateway IP** field.

Step 6 In the **Subnet Control** field, ensure that the **ND RA Prefix** check box is checked.

Step 7 In the **ND Prefix policy** field drop-down list, click **Create ND RA Prefix Policy**.

Note

There is already a default policy available that will be deployed on all IPv6 interfaces. Alternatively, you can create an ND prefix policy to use as shown in this example. By default, the IPv6 gateway subnets are advertised as ND prefixes in the ND RA messages. A user can choose to not advertise the subnet in ND RA messages by un-checking the ND RA prefix check box.

Step 8 In the **Create ND RA Prefix Policy** dialog box, perform the following actions:

- a) In the **Name** field, enter the name for the prefix policy.

Note

For a given subnet there can only be one prefix policy. It is possible for each subnet to have a different prefix policy, although subnets can use a common prefix policy.

- b) In the **Controller State** field, check the desired check boxes.
- c) In the **Valid Prefix Lifetime** field, choose the desired value for how long you want the prefix to be valid.
- d) In the **Preferred Prefix Lifetime** field, choose a desired value. Click **OK**.

Note

An ND prefix policy is created and attached to the specific subnet.

Step 9 In the **ND policy** field drop-down list, click **Create ND Interface Policy** and perform the following tasks:

- a) In the **Name** field, enter a name for the policy.
- b) Click **Submit**.

Step 10 Click **OK** to complete the bridge domain configuration.

Similarly you can create additional subnets with different prefix policies as required.

A subnet with an IPv6 address is created under the BD and an ND prefix policy has been associated with it.

Configuring IPv6 Neighbor Discovery on a Layer 3 Interface

Guidelines and Limitations

The following guidelines and limitations apply to Neighbor Discovery Router Advertisement (ND RA) Prefixes for Layer 3 Interfaces:

- An ND RA configuration applies only to IPv6 Prefixes. Any attempt to configure an ND policy on IPv4 Prefixes will fail to apply.

Configuring an IPv6 Neighbor Discovery Interface Policy with RA on a Layer 3 Interface Using the GUI



Note The steps here show how to associate an IPv6 neighbor discovery interface policy with a Layer 3 interface. The specific example shows how to configure using the non-VPC interface.

Before you begin

- The tenant, VRF, BD are created.
- The L3Out is created under External Routed Networks.

Procedure

-
- Step 1** In the **Navigation** pane, navigate to the appropriate external routed network under the appropriate Tenant.
- Step 2** Under **L3Outs**, expand > **Logical Node Profiles** > *Logical Node Profile_name* > **Logical Interface Profiles**.
- Step 3** Double-click the appropriate **Logical Interface Profile**, and in the **Work** pane, click **Policy** > **Routed Interfaces**.

Note

If you do not have a Logical Interface Profile created, you can create a profile here.

- Step 4** In the **Routed Interface** dialog box, perform the following actions:
- a) In the **ND RA Prefix** field, check the check box to enable ND RA prefix for the interface.
When enabled, the routed interface is available for auto configuration.
Also, the **ND RA Prefix Policy** field is displayed.
 - b) In the **ND RA Prefix Policy** field, from the drop-down list, choose the appropriate policy.
 - c) Choose other values on the screen as desired. Click **Submit**.

Note

When you configure using a VPC interface, you must enable the ND RA prefix for both side A and side B as both are members in the VPC configuration. In the Work Pane, in the Logical Interface Profile screen, click the SVI tab. Under Properties, check the check boxes to enable the ND RA Prefix for both Side A and Side B. Choose the identical ND RA Prefix Policy for Side A and Side B.

Configuring IPv6 Neighbor Discovery Duplicate Address Detection

About Neighbor Discovery Duplicate Address Detection

Duplicate Address Detection (DAD) is a process that is used by Neighbor Discovery to detect the duplicated addresses in the network. By default, DAD is enabled for the link-local and global-subnet IPv6 addresses used on the ACI fabric leaf layer 3 interfaces. Optionally, you can disable the DAD process for a IPv6 global-subnet by configuring the knob through the REST API (using the `ipv6Dad="disabled"` setting) or through the GUI. Configure this knob when the same shared secondary address is required to be used across L3Outs on different border leaf switches to provide border leaf redundancy to the external connected devices. Disabling the DAD process in this case will avoid the situation where the DAD considers the same shared secondary address on multiple border leaf switches as duplicates. If you do not disable the DAD process in this case, the shared secondary address might enter into the DUPLICATE DAD state and become unusable.

Configuring Neighbor Discovery Duplicate Address Detection Using the GUI

Use the procedures in this section to disable the Neighbor Discovery Duplicate Address Detection process for a subnet.

Procedure

-
- Step 1** Navigate to the appropriate page to access the DAD field for that interface. For example:
- Navigate to **Tenants > Tenant > Networking > L3Outs > L3Out > Logical Node Profiles > node > Logical Interface Profiles**, then select the interface that you want to configure.
 - Click on *Routed Sub-interfaces* or *SVI*, then click on the Create (+) button to configure that interface.
- Step 2** For this interface, make the following settings for the DAD entries:
- For the primary address, set the value for the DAD entry to **enabled**.
 - For the shared secondary address, set the value for the DAD entry to **disabled**. Note that if the secondary address is not shared across border leaf switches, then you do not need to disable the DAD for that address.

Example:

For example, if you were configuring this setting for the SVI interface, you would:

- Set the Side A IPv6 DAD to **enabled**.

- Set the Side B IPv6 DAD to **disabled**.

Example:

As another example, if you were configuring this setting for the routed sub-interface interface, you would:

- In the main Select Routed Sub-Interface page, set the value for IPv6 DAD for the routed sub-interface to **enabled**.
- Click on the Create (+) button on the IPv4 Secondary/IPv6 Additional Addresses area to access the Create Secondary IP Address page, then set the value for IPv6 DAD to **disabled**. Then click on the OK button to apply the changes in this screen.

Step 3 Click on the Submit button to apply your changes.

Step 4 Enter the **show ipv6 int** command on the leaf switch to verify that the configuration was pushed out correctly to the leaf switch. For example:

```
swtb23-leaf5# show ipv6 int vrf icmpv6:v1
IPv6 Interface Status for VRF "icmpv6:v1" (9)

vlan2, Interface status: protocol-up/link-up/admin-up, iod: 73
if_mode: ext
IPv6 address:
  2001:DB8:A::2/64 [VALID] [PREFERRED]
  2001:DB8:A::11/64 [VALID] [dad-disabled]
IPv6 subnet: 2001:DB8:A::/64
IPv6 link-local address: fe80::863d:c6ff:fe9f:eb8b/10 (Default) [VALID]
```



CHAPTER 9

Microsoft NLB

This chapter contains the following sections:

- [About Microsoft NLB, on page 33](#)
- [Cisco ACI Configuration for Microsoft NLB Servers, on page 37](#)
- [Microsoft Network Load Balancing Guidelines and Limitations, on page 40](#)
- [Configuring Microsoft NLB in Unicast Mode Using the GUI, on page 41](#)
- [Configuring Microsoft NLB in Multicast Mode Using the GUI, on page 42](#)
- [Configuring Microsoft NLB in IGMP Mode Using the GUI, on page 43](#)

About Microsoft NLB

The Microsoft Network Load Balancing (NLB) feature distributes the client traffic across many servers, with each server running its individual copy of the application. Network Load Balancing uses Layer 2 unknown unicast or multicast to simultaneously distribute the incoming network traffic to all cluster hosts.

A group of Microsoft NLB nodes is collectively known as an NLB cluster. An NLB cluster serves one or more virtual IP (VIP) addresses. Nodes in the NLB cluster use a load-balancing algorithm to decide which individual node will service the particular traffic flow that is destined for the NLB VIP. Every node within the cluster receives every packet of traffic, but only one node services a request.

The following figure shows a graphical representation of how Microsoft NLB is implemented with Cisco APIC.

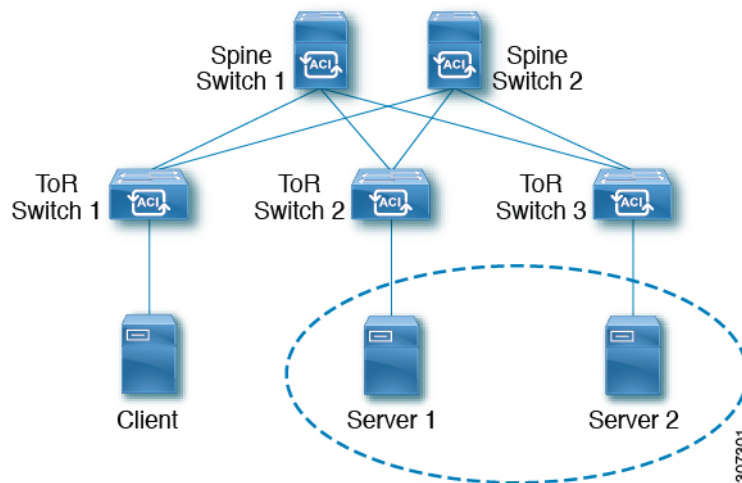

In this figure, Server 1 and Server 2 are in the MS NLB cluster. These servers appear as a single-host server to outside clients. All servers in the MS NLB cluster receive all incoming requests, then MS NLB distributes the load between the servers.

Microsoft NLB functions in three different operational modes:

- **Unicast Mode:** In this mode, each NLB cluster VIP is assigned a unicast MAC address. This mode relies on unknown unicast flooding to deliver traffic to the cluster.
- **Multicast Mode:** In this mode, each NLB cluster VIP is assigned a non-Internet Assigned Numbers Authority (IANA) multicast MAC address (03xx.xxxx.xxxx).
- **IGMP Mode:** In this mode, an NLB cluster VIP is assigned a unique IPv4 multicast group address. The multicast MAC address for this is derived from the standard MAC derivation for IPv4 multicast addresses.

Understanding Unicast Mode

In the unicast mode of operation, Network Load Balancing reassigns the MAC address of the network adapter on which it is enabled (called the cluster adapter), and all cluster hosts are assigned the same MAC address. This MAC address is derived from the cluster's primary IP address. For example, for a primary IP address of 1.2.3.4, the unicast MAC address is set to 02-BF-1-2-3-4.

Network Load Balancing's unicast mode induces switch flooding in order to simultaneously deliver incoming network traffic to all cluster hosts, as shown in the following figure.

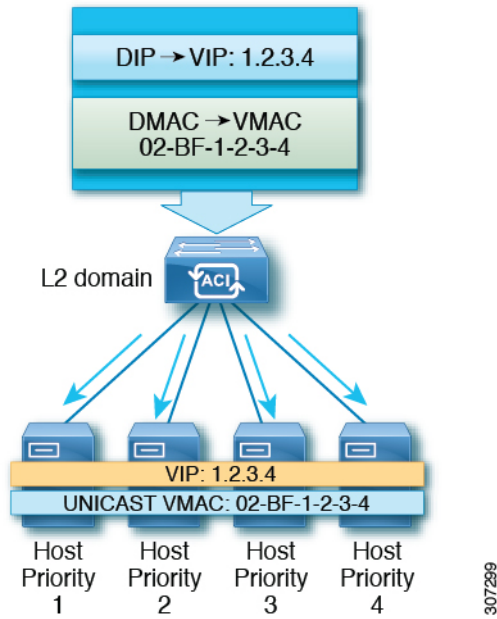

The use of a common MAC address would normally create a conflict, since Layer 2 switches expect to see unique source MAC addresses on all switch ports. To avoid this problem, Network Load Balancing uniquely modifies the source MAC address for outgoing packets. If the cluster MAC address is 02-BF-1-2-3-4, then each host's source MAC address is set to 02-x-1-2-3-4, where x is the host's priority within the cluster, as shown in the following figure.

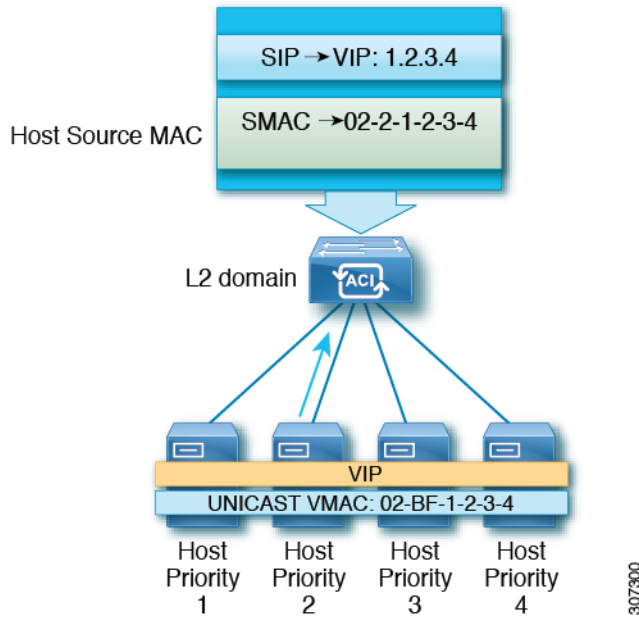

Understanding Multicast Mode

Network Load Balancing also provides multicast mode for distributing incoming network traffic to all cluster hosts. Multicast mode assigns a Layer 2 multicast address to the cluster adapter instead of changing the

adapter's MAC address. For example, the multicast MAC address could be set to 03-BF-0A-14-1E-28 for a cluster's primary IP address of 10.20.30.40. Cluster communication doesn't require a separate adapter.

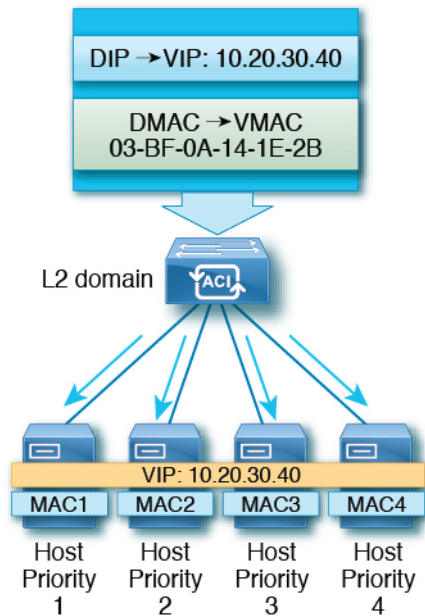

307298

Understanding IGMP Mode

Microsoft NLB servers can also be configured to use IGMP to join the multicast group. This, combined with a querier on a switch and IGMP snooping, can optimize the scope of the flooding of multicast messages.

Microsoft NLB servers send IGMP joins to a multicast group address, where the last two octets of the multicast address correspond to the last two octets of the cluster IP. For example, in a situation where the Microsoft NLB servers send IGMP joins to a multicast address of 239.255.x.x, the following would occur:

- Cluster IP: 10.20.**30.40**
- IGMP sent to 239.255.**30.40**
- MAC used in client-to-server direction: 0100.5E7F.**1E28**
- Cluster communication doesn't require a separate adapter

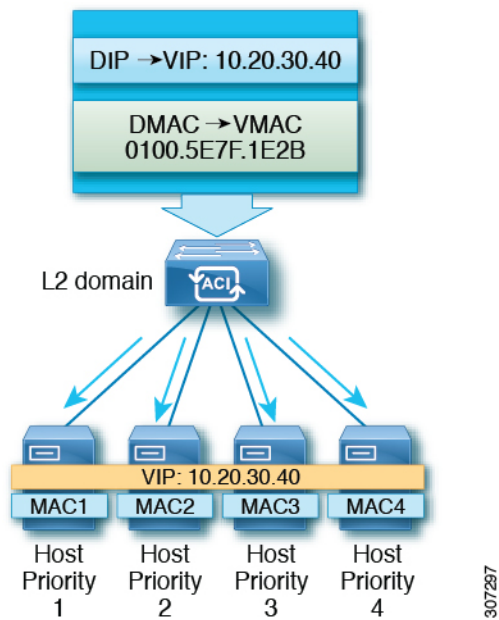

Cisco ACI Configuration for Microsoft NLB Servers

Prior to Release 4.1, Microsoft NLB deployment requires the Cisco ACI fabric to be Layer 2 only and uses an external router as the Layer 3 gateway for endpoints. Starting with Release 4.1, the Cisco ACI fabric can be a Layer 3 gateway for Microsoft NLB deployment.

The following table summarizes the deployment considerations for each Microsoft NLB deployment mode.

Table 2: Cisco ACI Deployment Modes with Microsoft NLB

	Unicast Mode	Multicast Mode	IGMP Mode
Cisco ACI as a Layer 2 Network, With External Router as Layer 3 Gateway	Supported on leaf switch models with -EX, -FX, or -FX2 at the end of the switch name.	Supported on leaf switch models with -EX, -FX, or -FX2 at the end of the switch name, as well as leaf switch models that do not have a suffix at the end of the switch name.	Supported on leaf switch models with -EX, -FX, or -FX2 at the end of the switch name, as well as leaf switch models that do not have a suffix at the end of the switch name. However, Microsoft NLB traffic is not scoped by IGMP, but rather is flooded instead.
Cisco ACI as a Layer 3 Gateway	Supported on Release 4.1 and later.	Supported on Release 4.1 and later.	Supported on Release 4.1 and later.

The following table provides more information on the configuration options available for deploying Microsoft NLB using Cisco ACI as Layer 2.

Table 3: External Router and ACI Bridge Domain Configuration for the Three Microsoft NLB Modes

	Unicast Mode	Multicast Mode	IGMP Mode ¹
ACI Bridge Domain Configuration	<ul style="list-style-type: none"> • Bridge domain configured for unknown unicast flooding (not hw-proxy) • No IP routing 	<ul style="list-style-type: none"> • Bridge domain configured for unknown unicast flooding (not hw-proxy) • No IP routing • Layer 3 unknown multicast: flood (even with optimized multicast flooding, Microsoft NLB traffic is flooded) • IGMP snooping configuration: Not applicable 	<ul style="list-style-type: none"> • Bridge domain configured for unknown unicast flooding (not hw-proxy) • No IP routing • Layer3 unknown multicast: Optional, but can be configured for future compatibility • Querier configuration: Optional, but can be enabled for future compatibility; Configure subnet under the bridge domain, no need for IP routing • IGMP snooping configuration: Optional, but can be enabled for future compatibility
External Router ARP Table Configuration	<ul style="list-style-type: none"> • No special ARP configuration • External router learns VIP to VMAC mapping 	Static ARP configuration for unicast VIP to multicast MAC	Static ARP configuration for unicast VIP to multicast MAC

¹ As of Release 3.2, using Microsoft NLB IGMP mode compared with Microsoft NLB multicast mode offers no benefits in terms of scoping of the multi-destination traffic

Beginning with Release 4.1, configuring Cisco ACI to connect Microsoft NLB servers consists of the following general tasks:

- Configuring the VRF, where you can configure the VRF in egress or ingress mode.
- Configuring a bridge domain (BD) for the Microsoft NLB servers, with L2 unknown unicast in flooding mode and not in hardware-proxy mode.
- Defining an EPG for all the Microsoft NLB servers that share the same VIP. You must associate this EPG with the previously defined BD.
- Entering the Microsoft NLB VIP as a subnet under the EPG. You can configure the Microsoft NLB in the following modes:
 - **Unicast mode:** You will enter the unicast MAC address as part of the Microsoft NLB VIP configuration. In this mode, the traffic from the client to the Microsoft NLB VIP is flooded to all the EPGs in the Microsoft NLB BD.

- **Multicast mode:** You will enter the multicast MAC address while configuring the Microsoft NLB VIP itself. You will go to the static ports under the Microsoft NLB EPG and add the Microsoft NLB multicast MAC to the EPG ports where the Microsoft NLB servers are connected. In this mode, the traffic is forwarded to the ports that have the static MAC binding.
- **IGMP mode:** You will enter a Microsoft NLB group address while configuring the Microsoft NLB VIP itself. In this mode, the traffic from the client to the Microsoft NLB VIP is forwarded to the ports where the IGMP join is received for the Microsoft NLB group address.
- Configuring a contract between the Microsoft NLB EPG and the client EPG. You must configure the Microsoft NLB EPG as the provider side of the contract and the client EPG as the consumer side of the contract.

Microsoft NLB is a route plus flood solution. Traffic from the client to the Microsoft NLB VIP is first routed at the consumer ToR switch, and is then flooded on the Microsoft NLB BD toward the provider ToR switch. Once traffic leaves the consumer ToR switch, traffic is flooded and contracts cannot be applied to flood traffic. Therefore, the contract enforcements must be done on consumer ToR switch.

For a VRF in ingress mode, intra-VRF traffic from the L3Out to the Microsoft NLB EPG may be dropped on the consumer ToR switch because the border leaf switch (consumer ToR switch) does not have a policy. To work around this issue, use one of the following options:

- **Option 1:** Configure the VRF in egress mode. When you configure the VRF in egress mode, the policy is downloaded on the border leaf switch.
- **Option 2:** Add the Microsoft NLB EPG and L3external of the L3Out in a preferred group. Traffic will hit the default-allow policy on the consumer ToR switch.
- **Option 3:** Deploy the Microsoft NLB EPG on an unused port that is in an up state, or on a port connected to a Microsoft NLB server on the border leaf switch. By doing so, the Microsoft NLB EPG becomes a local endpoint on the border leaf switch. The policy is downloaded for local endpoints, so the border leaf switch would therefore have the policy downloaded.
- **Option 4:** Use a shared service. Deploy an L3Out in the consumer VRF, which is different from the provider Microsoft NLB VRF. For the Microsoft NLB VIP under the Microsoft NLB EPG, check the **Shared between VRFs** box. Configure a contract between L3Out from the consumer VRF and the Microsoft NLB EPG. By using a shared service, the policy is downloaded on the border leaf switch.

The following table provides more information on supported EPG and BD configurations for the Microsoft NLB modes.

Table 4: Cisco ACI EPG and BD Configurations for the Microsoft NLB Modes

	Unicast Mode	Multicast Mode	IGMP Mode
Bridge Domain Configuration	<ul style="list-style-type: none"> • IP routing on • Bridge domain configured for unknown unicast flooding (not hw-proxy) • Do not change the bridge domain MAC address 	<ul style="list-style-type: none"> • IP routing on • Bridge domain configured for unknown unicast flooding (not hw-proxy) • Do not change the bridge domain MAC address 	<ul style="list-style-type: none"> • IP routing on • Bridge domain configured for unknown unicast flooding (not hw-proxy) • Do not change the bridge domain MAC address

	Unicast Mode	Multicast Mode	IGMP Mode
EPG Configuration	<ul style="list-style-type: none"> • Subnet for the VIP • Unicast MAC address defined as part of the subnet 	<ul style="list-style-type: none"> • Subnet for the VIP • Multicast MAC address defined as part of the subnet • Static binding to the ports where the servers are • Static group MAC address on each path 	<ul style="list-style-type: none"> • Subnet for the VIP • No need to enter a MAC address • You can choose dynamic group or static group • If you choose the static group option, then enter static paths and enter the multicast group in each path
VMM Domain	You can enter a VMM domain	Multicast mode requires a static path, so you cannot use a VMM domain in this situation	In dynamic group mode, you can use a VMM domain

Microsoft Network Load Balancing Guidelines and Limitations

Following are the guidelines and limitations for Microsoft Network Load Balancing (NLB):

- In a bridge domain's **Policy > Advanced/Troubleshooting** properties, you must disable the **Drop ARP with Multicast SMAC** knob if the Microsoft NLB VIP address is configured under any EPG in that bridge domain.
- Microsoft NLB is not supported when a bridge domain's multi-destination flooding is set to **drop**.
- For an existing bridge domain that is created before the upgrade, **Drop ARP with Multicast SMAC** knob is disabled by default. For bridge domains created after the upgrade, this knob is enabled by default. If you create a bridge domain for the Microsoft NLB after the upgrade you must disable this knob for Microsoft NLB to work.
- Layer 3 multicast is not supported (you cannot enable PIM on the Microsoft NLB bridge domain).
- For IGMP, the allowable mode group is IPv4 (IPv6 is not supported).
- Only Cisco Nexus 9000 series switches with names that end in EX and later are supported.
- Shared services and microsegment (uSeg) EPGs are supported with Microsoft NLB.
- Cisco ACI Multi-Site is currently not supported.
- You must configure Microsoft NLB in layer 2 unknown unicast flooding mode.

If you configure the bridge domain for hardware-proxy instead, Cisco ACI raises a fault, which is cleared by fixing the bridge domain configuration. If you leave the bridge domain incorrectly configured for hardware-proxy, ACI tries to get the faulty configuration up every 30 seconds, which is an unnecessary overhead for the switch.

- You should configure Microsoft NLB bridge domain with the default SVI MAC address. Under layer 3 configurations, you should configure the bridge domain MAC address with the default setting of 00:22:BD:F8:19:FF. Do not modify this default SVI MAC address for the Microsoft NLB bridge domain.
- There is a hardware limit of 128 Microsoft NLB VIPs per fabric.
- Virtualized servers that are configured for Microsoft NLB can connect to Cisco ACI with static binding in all modes (unicast, multicast, and IGMP).
- Virtualized servers that are configured for Microsoft NLB can connect to Cisco ACI through VMM integration in unicast mode and IGMP mode.
- Microsoft NLB unicast mode is not supported with VMM integration behind Cisco UCS B-Series Blade Servers in end-host mode.

Microsoft NLB in unicast mode relies on unknown unicast flooding for delivery of cluster-bound packets. Unicast mode will not work on Cisco UCS B-Series Blade Servers when the fabric interconnect is in end-host mode, because unknown unicast frames are not flooded as required by this mode. For more details on the layer 2 forwarding behavior of Cisco UCS B-Series Blade Servers in end-host mode, see:

https://www.cisco.com/c/en/us/solutions/collateral/data-center-virtualization/unified-computing/whitepaper_c11-701962.html

Configuring Microsoft NLB in Unicast Mode Using the GUI

This task configures Microsoft NLB to flood all of the ports in the bridge domain.

Before you begin

Have the following information available before proceeding with these procedures:

- Microsoft NLB cluster VIP
- Microsoft NLB cluster MAC address

Procedure

-
- Step 1** In the **Navigation** pane, choose **Tenant** > *tenant_name* > **Application Profiles** > *application_profile_name* > **Application EPGs** > *application_EPG_name* > **Subnets**.
- Step 2** Right-click **Subnets** and select **Create EPG Subnet**.
- Step 3** In the **Create EPG Subnet** dialog box, fill in the following fields:
- a) In the **Default Gateway IP** field, enter the Microsoft NLB cluster VIP.
For example, 192.0.2.1/32.
 - b) In the **Scope** area, for shared services, check **Shared between VRFs**.
Uncheck **Private to VRF**, if it is selected.
 - c) Under **Subnet Control**, check the **No Default SVI Gateway** check box.
 - d) In the **Type Behind Subnet** area, click **EpNlb**.

The **Mode** field appears.

- e) From the **Mode** drop-down list, choose **NLB in unicast mode**.

The **MAC Address** field appears.

- f) In the **MAC Address** field, enter the Microsoft NLB cluster MAC address.

For example, 00:01:02:03:04:05.

Step 4 Click **Submit**.

Configuring Microsoft NLB in Multicast Mode Using the GUI

This task configures Microsoft NLB to flood only on certain ports in the bridge domain.

Before you begin

Have the following information available before proceeding with these procedures:

- Microsoft NLB cluster VIP
- Microsoft NLB cluster MAC address

Procedure

Step 1 In the **Navigation** pane, choose **Tenant** > *tenant_name* > **Application Profiles** > *application_profile_name* > **Application EPGs** > *application_EPG_name* > **Subnets**.

Step 2 Right-click **Subnets** and select **Create EPG Subnet**.

Step 3 In the **Create EPG Subnet** dialog box, fill in the following fields:

- a) In the **Default Gateway IP** field, enter the Microsoft NLB cluster VIP.

For example, 192.0.2.1/32.

- b) In the **Scope** area, for shared services, check **Shared between VRFs**.

Uncheck **Private to VRF**, if it is selected.

- c) Under **Subnet Control**, check the **No Default SVI Gateway** check box.

- d) In the **Type Behind Subnet** area, click **MSNLB**.

The **Mode** field appears.

- e) From the **Mode** drop-down list, choose **NLB in static multicast mode**.

The **MAC Address** field appears.

- f) In the **MAC Address** field, enter the Microsoft NLB cluster MAC address.

For the Microsoft NLB cluster MAC address for the multicast mode, the cluster MAC address has to start with 03.

For example, 03:BF:01:02:03:04.

g) Copy the Microsoft NLB cluster MAC address that you entered in this field for the multicast mode.

Step 4 Click **Submit**.

Step 5 In the **Navigation** pane, choose **Tenant** *tenant_name* > **Application Profiles** > *application_profile_name* > **Application EPGs** > *application_EPG_name* > **Static Ports** > *static_port*.

Choose the static port that you want to configure Microsoft NLB to flood onto in the bridge domain.

Step 6 On the **Static Path** page for this port, fill in the following field:

a) In the **NLB Static Group** area, click + (Create), then paste the MAC address that you copied from 3.g, on page 43 into the **Mac Address** field.

b) Click **Update** underneath the **Mac Address** field.

Step 7 In the **Static Path** page, click **Submit**.

Any traffic to this Microsoft NLB cluster MAC address will now go out on this static port.

Configuring Microsoft NLB in IGMP Mode Using the GUI

This task configures Microsoft NLB to flood only on certain ports in the bridge domain.

Before you begin

Have the following information available before proceeding with these procedures:

- Microsoft NLB cluster VIP

Procedure

Step 1 In the **Navigation** pane, choose **Tenant** > *tenant_name* > **Application Profiles** > *application_profile_name* > **Application EPGs** > *application_EPG_name* > **Subnets**.

Step 2 Right-click **Subnets** and select **Create EPG Subnet**.

Step 3 In the **Create EPG Subnet** dialog box, fill in the following fields:

a) In the **Default Gateway IP** field, enter the Microsoft NLB cluster VIP.

For example, 192.0.2.1/32.

b) In the **Scope** area, for shared services, check **Shared between VRFs**.

Uncheck **Private to VRF**, if it is selected.

c) Under **Subnet Control**, check the **No Default SVI Gateway** check box.

d) In the **Type Behind Subnet** area, click **EpNlb**.

The **Mode** field appears.

e) From the **Mode** drop-down list, choose **NLB in IGMP mode**.

The **Group Id** field appears.

- f) In the **Group Id** field, enter the Microsoft NLB multicast group address.

For the Microsoft NLB multicast group address, the last two octets of the address correspond to the last two octets of the instance cluster IP address. For example, if the instance cluster IP address is 10.20.30.40, then the Microsoft NLB multicast group address that you would enter into this field might be 239.255.30.40.

Step 4 Click **Submit**.

Traffic to the Microsoft NLB cluster VIP will be flooded to the outgoing interface list that is either configured statically from the APIC or dynamically based on IGMP joins from the NLB cluster.

Step 5 Determine if you want to have a static join or a dynamic join.

You can have a combination of static joins and dynamic joins, where some ports can have a static join and other ports can have a dynamic join.

- **Dynamic Join:** In the dynamic join, the join is sent by the Microsoft NLB cluster on the respective ports, then the switch dynamically comes up with that outgoing interface list.
- **Static Join:** In the static join, traffic to the Microsoft NLB cluster VIP will go to the ports that you configure in the following steps.

If you want to have a static join:

- a. Copy the Microsoft NLB multicast group address that you entered in the **Group Id** field in [3.f, on page 44](#).
- b. In the **Navigation** pane, choose **Tenant** > *tenant_name* > **Application Profiles** > *application_profile_name* > **Application EPGs** > *application_EPG_name* > **Static Ports** > *static_port*.
Choose the static port that you want to configure Microsoft NLB to flood onto in the bridge domain.
- c. On the **Static Path** page for this port, fill in the following field:
 - In the **IGMP Snoop Static Group** area, click + (Create), then paste the group address that you copied from [3.f, on page 44](#) into the **Group Address** field.
 - Click **Update** underneath the **Group Address** field.
- d. In the **Static Path** page, click **Submit**.

IGMP snooping is enabled by default on the bridge domain because the IGMP snooping policy default that is associated with the bridge domain has **Enabled** as the administrative state of the policy. For more information, see [Configuring an IGMP Snooping Policy Using the GUI, on page 49](#).



CHAPTER 10

IGMP Snooping

- [About Cisco APIC and IGMP Snooping, on page 45](#)
- [Configuring and Assigning an IGMP Snooping Policy, on page 48](#)
- [Enabling IGMP Snooping Static Port Groups, on page 51](#)
- [Enabling IGMP Snoop Access Groups, on page 52](#)

About Cisco APIC and IGMP Snooping

How IGMP Snooping is Implemented in the ACI Fabric



Note We recommend that you do not disable IGMP snooping on bridge domains. If you disable IGMP snooping, you may see reduced multicast performance because of excessive false flooding within the bridge domain.

IGMP snooping software examines IP multicast traffic within a bridge domain to discover the ports where interested receivers reside. Using the port information, IGMP snooping can reduce bandwidth consumption in a multi-access bridge domain environment to avoid flooding the entire bridge domain. By default, IGMP snooping is enabled on the bridge domain.

This figure shows the IGMP routing functions and IGMP snooping functions both contained on an ACI leaf switch with connectivity to a host. The IGMP snooping feature snoops the IGMP membership reports, and leaves messages and forwards them only when necessary to the IGMP router function.

Figure 6: IGMP Snooping function

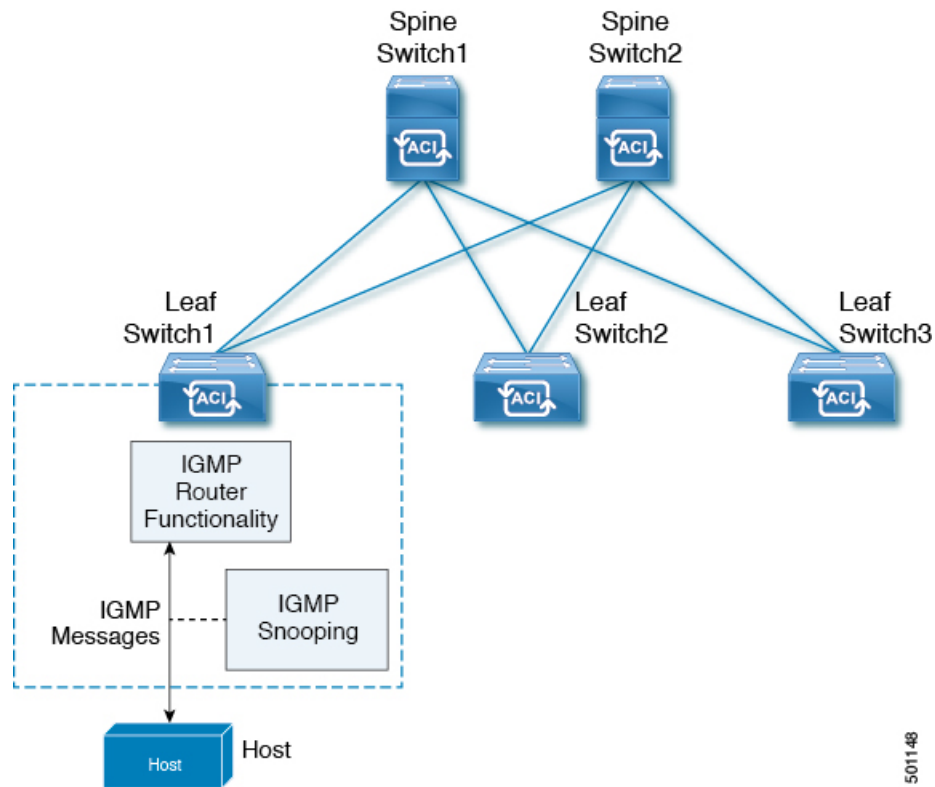

IGMP snooping operates upon IGMPv1, IGMPv2, and IGMPv3 control plane packets where Layer 3 control plane packets are intercepted and influence the Layer 2 forwarding behavior.

IGMP snooping has the following proprietary features:

- Source filtering that allows forwarding of multicast packets based on destination and source IP addresses
- Multicast forwarding based on IP addresses rather than the MAC address
- Multicast forwarding alternately based on the MAC address

The ACI fabric supports IGMP snooping only in proxy-reporting mode, in accordance with the guidelines provided in Section 2.1.1, "IGMP Forwarding Rules," in RFC 4541:

IGMP networks may also include devices that implement "proxy-reporting", in which reports received from downstream hosts are summarized and used to build internal membership states. Such proxy-reporting devices may use the all-zeros IP Source-Address when forwarding any summarized reports upstream. For this reason, IGMP membership reports received by the snooping switch must not be rejected because the source IP address is set to 0.0.0.0.

As a result, the ACI fabric will send IGMP reports with the source IP address of 0.0.0.0.



Note For more information about IGMP snooping, see RFC 4541.

Virtualization Support

You can define multiple virtual routing and forwarding (VRF) instances for IGMP snooping.

On leaf switches, you can use the **show** commands with a VRF argument to provide a context for the information displayed. The default VRF is used if no VRF argument is supplied.

The APIC IGMP Snooping Function, IGMPv1, IGMPv2, and the Fast Leave Feature

Both IGMPv1 and IGMPv2 support membership report suppression, which means that if two hosts on the same subnet want to receive multicast data for the same group, the host that receives a member report from the other host suppresses sending its report. Membership report suppression occurs for hosts that share a port.

If no more than one host is attached to each switch port, you can configure the fast leave feature in IGMPv2. The fast leave feature does not send last member query messages to hosts. As soon as APIC receives an IGMP leave message, the software stops forwarding multicast data to that port.

IGMPv1 does not provide an explicit IGMP leave message, so the APIC IGMP snooping function must rely on the membership message timeout to indicate that no hosts remain that want to receive multicast data for a particular group.



Note The IGMP snooping function ignores the configuration of the last member query interval when you enable the fast leave feature because it does not check for remaining hosts.

The APIC IGMP Snooping Function and IGMPv3

The IGMPv3 snooping function in APIC supports full IGMPv3 snooping, which provides constrained flooding based on the (S, G) information in the IGMPv3 reports. This source-based filtering enables the device to constrain multicast traffic to a set of ports based on the source that sends traffic to the multicast group.

By default, the IGMP snooping function tracks hosts on each VLAN port in the bridge domain. The explicit tracking feature provides a fast leave mechanism. Because every IGMPv3 host sends membership reports, report suppression limits the amount of traffic that the device sends to other multicast-capable routers. When report suppression is enabled, and no IGMPv1 or IGMPv2 hosts requested the same group, the IGMP snooping function provides proxy reporting. The proxy feature builds the group state from membership reports from the downstream hosts and generates membership reports in response to queries from upstream queriers.

Even though the IGMPv3 membership reports provide a full accounting of group members in a bridge domain, when the last host leaves, the software sends a membership query. You can configure the parameter last member query interval. If no host responds before the timeout, the IGMP snooping function removes the group state.

Cisco APIC and the IGMP Snooping Querier Function

When PIM is not enabled on an interface because the multicast traffic does not need to be routed, you must configure an IGMP snooping querier function to send membership queries. In APIC, within the IGMP Snoop policy, you define the querier in a bridge domain that contains multicast sources and receivers but no other active querier.

Cisco ACI has by default, IGMP snooping enabled. Additionally, if the Bridge Domain subnet control has “querier IP” selected, then the leaf switch behaves as a querier and starts sending query packets. Querier on the ACI leaf switch must be enabled when the segments do not have an explicit multicast router (PIM is not enabled). On the Bridge Domain where the querier is configured, the IP address used must be from the same subnet where the multicast hosts are configured.



Note The IP address for the querier should not be a broadcast IP address, multicast IP address, or 0 (0.0.0.0).

When an IGMP snooping querier is enabled, it sends out periodic IGMP queries that trigger IGMP report messages from hosts that want to receive IP multicast traffic. IGMP snooping listens to these IGMP reports to establish appropriate forwarding.

The IGMP snooping querier performs querier election as described in RFC 2236. Querier election occurs in the following configurations:

- When there are multiple switch queriers configured with the same subnet on the same VLAN on different switches.
- When the configured switch querier is in the same subnet as with other Layer 3 SVI queriers.

Guidelines and Limitations for the APIC IGMP Snooping Function

The APIC IGMP snooping has the following guidelines and limitations:

- Layer 3 IPv6 multicast routing is not supported.
- Layer 2 IPv6 multicast packets will be flooded on the incoming bridge domain.
- IGMPv3 snooping will forward multicast based on the group and source entry only when PIM is enabled on the bridge domain. If PIM is not enabled, forwarding will be based on the group only.

Configuring and Assigning an IGMP Snooping Policy

Configuring and Assigning an IGMP Snooping Policy to a Bridge Domain in the Advanced GUI

To implement IGMP snooping functionality, you configure an IGMP Snooping policy then assign that policy to one or more bridge domains.

Configuring an IGMP Snooping Policy Using the GUI

Create an IGMP Snooping policy whose IGMP settings can be assigned to one or multiple bridge domains.

Procedure

-
- Step 1** Click the **Tenants** tab and the name of the tenant on whose bridge domain you intend to configure IGMP snooping support.
- Step 2** In the **Navigation** pane, click **Policies > Protocol > IGMP Snoop**.
- Step 3** Right-click **IGMP Snoop** and select **Create IGMP Snoop Policy**.
- Step 4** In the **Create IGMP Snoop Policy** dialog, configure a policy as follows:
- In the **Name** and **Description** fields, enter a policy name and optional description.
 - In the **Admin State** field, select **Enabled** or **Disabled** to enable or disable IGMP snooping for this particular policy.
 - Select or unselect **Fast Leave** to enable or disable IGMP V2 immediate dropping of queries through this policy.
 - Select **Enable querier** to enable or disable the IGMP querier activity through this policy.

Note

For this option to be effectively enabled, the **Subnet Control: Querier IP** setting must also be enabled in the subnets assigned to the bridge domains to which this policy is applied. The navigation path to the properties page on which this setting is located is **Tenants > tenant_name > Networking > Bridge Domains > bridge_domain_name > Subnets > subnet_name**.

- In the **Querier Version** field, select **Version 2** or **Version 3** to choose IGMP snooping querier version for this particular policy.
- Specify in seconds the **Last Member Query Interval** value for this policy.

IGMP uses this value when it receives an IGMPv2 Leave report. This means that at least one host wants to leave the group. After it receives the Leave report, it checks that the interface is not configured for IGMP Fast Leave and if not, it sends out an out-of-sequence query.
- Specify in seconds the **Query Interval** value for this policy.

This value is used to define the amount of time the IGMP function will store a particular IGMP state if it does not hear any reports on the group.
- Specify in seconds **Query Response Interval** value for this policy.

When a host receives the query packet, it starts counting to a random value, less than the maximum response time. When this timer expires, host replies with a report.
- Specify the **Start query Count** value for this policy.

Number of queries sent at startup that are separated by the startup query interval. Values range from 1 to 10. The default is 2.
- Specify in seconds a **Start Query Interval** for this policy.

By default, this interval is shorter than the query interval so that the software can establish the group state as quickly as possible. Values range from 1 to 18,000 seconds. The default is 31 seconds.

Step 5 Click **Submit**.

The new IGMP Snoop policy is listed in the **Protocol Policies - IGMP Snoop** summary page.

What to do next

To put this policy into effect, assign it to any bridge domain.

Assigning an IGMP Snooping Policy to a Bridge Domain Using the GUI

Assigning an IGMP Snooping policy to a bridge domain configures that bridge domain to use the IGMP Snooping properties specified in that policy.

Before you begin

- Configure a bridge domain for a tenant.
- Configure the IGMP Snooping policy that will be attached to the bridge domain.



Note For the **Enable Querier** option on the assigned policy to be effectively enabled, the **Subnet Control: Querier IP** setting must also be enabled in the subnets assigned to the bridge domains to which this policy is applied. The navigation path to the properties page on which this setting is located is **Tenants > *tenant_name* > Networking > Bridge Domains > *bridge_domain_name* > Subnets > *subnet_name***.

Procedure

-
- Step 1** Click the APIC **Tenants** tab and select the name of the tenant whose bridge domains you intend to configure with an IGMP Snoop policy.
- Step 2** In the APIC navigation pane, click **Networking > Bridge Domains**, then select the bridge domain to which you intend to apply your policy-specified IGMP Snoop configuration.
- Step 3** On the main **Policy** tab, scroll down to the **IGMP Snoop Policy** field and select the appropriate IGMP policy from the drop-down menu.
- Step 4** Click **Submit**.
-

The target bridge domain is now associated with the specified IGMP Snooping policy.

Enabling IGMP Snooping Static Port Groups

Enabling IGMP Snooping Static Port Groups

IGMP static port grouping enables you to pre-provision ports, that were previously statically-assigned to an application EPG, to enable the switch ports to receive and process IGMP multicast traffic. This pre-provisioning prevents the join latency which normally occurs when the IGMP snooping stack learns ports dynamically.

Static group membership can be pre-provisioned only on static ports assigned to an application EPG.

Static group membership can be configured through the APIC GUI, CLI, and REST API interfaces.

Prerequisite: Deploy EPGs to Static Ports

Enabling IGMP snoop processing on ports requires as a prerequisite that the target ports be statically-assigned to associated EPGs.

Static deployment of ports can be configured through the APIC GUI, CLI, or REST API interfaces. For information, see the following topics in the *Cisco APIC Layer 2 Networking Configuration Guide*:

- *Deploying an EPG on a Specific Node or Port Using the GUI*
- *Deploying an EPG on a Specific Port with APIC Using the NX-OS Style CLI*
- *Deploying an EPG on a Specific Port with APIC Using the REST API*

Enabling IGMP Snooping and Multicast on Static Ports Using the GUI

You can enable IGMP snooping and multicast on ports that have been statically assigned to an EPG. Afterwards you can create and assign access groups of users that are permitted or denied access to the IGMP snooping and multicast traffic enabled on those ports.

Before you begin

Before you begin to enable IGMP snooping and multicast for an EPG, complete the following tasks:

- Identify the interfaces to enable this function and statically assign them to that EPG



Note For details on static port assignment, see *Deploying an EPG on a Specific Node or Port Using the GUI* in the *Cisco APIC Layer 2 Networking Configuration Guide*.

- Identify the IP addresses that you want to be recipients of IGMP snooping and multicast traffic.

Procedure

Step 1 Click **Tenant** > *tenant_name* > **Application Profiles** > *application_name* > **Application EPGs** > *epg_name* > **Static Ports**.

Navigating to this spot displays all the ports you have statically assigned to the target EPG.

Step 2 Click the port to which you intend to statically assign group members for IGMP snooping. This action displays the **Static Path** page.

Step 3 On the IGMP Snoop Static Group table, click + to add an IGMP Snoop Address Group entry.

Adding an IGMP Snoop Address Group entry associates the target static port with a specified multicast IP address and enables it to process the IGMP snoop traffic received at that address.

- a) In the **Group Address** field, enter the multicast IP address to associate with this interface and this EPG.
- b) In the **Source Address** field enter the IP address of the source to the multicast stream, if applicable.
- c) Click **Submit**.

When configuration is complete, the target interface is enabled to process IGMP Snooping protocol traffic sent to its associated multicast IP address.

Note

You can repeat this step to associate additional multicast addresses with the target static port.

Step 4 Click **Submit**.

Enabling IGMP Snoop Access Groups

Enabling IGMP Snoop Access Groups

An “access-group” is used to control what streams can be joined behind a given port.

An access-group configuration can be applied on interfaces that are statically assigned to an application EPG in order to ensure that the configuration can be applied on ports that will actually belong to the that EPG.

Only Route-map-based access groups are allowed.

IGMP snoop access groups can be configured through the APIC GUI, CLI, and REST API interfaces.

Enabling Group Access to IGMP Snooping and Multicast Using the GUI

After you enable IGMP snooping and multicasting on ports that have been statically assigned to an EPG, you can then create and assign access groups of users that are permitted or denied access to the IGMP snooping and multicast traffic enabled on those ports.

Before you begin

Before you enable access to IGMP snooping and multicasting for an EPG, identify the interfaces to enable this function and statically assign them to that EPG.



Note For details on static port assignment, see *Deploying an EPG on a Specific Node or Port Using the GUI* in the *Cisco APIC Layer 2 Networking Configuration Guide*.

Procedure

Step 1 Click **Tenant** > *tenant_name* > **Application Profiles** > *application_name* > **Application EPGs** > *epg_name* > **Static Ports**.

Navigating to this spot displays all the ports you have statically assigned to the target EPG.

Step 2 Click the port to which you intend to assign multicast group access, to display the **Static Port Configuration** page.

Step 3 Click **Actions** > **Create IGMP Access Group** to display the IGMP Snoop Access Group table.

Step 4 Locate the IGMP Snoop Access Group table and click + to add an access group entry.

Adding an IGMP Snoop Access Group entry creates a user group with access to this port, associates it with a multicast IP address, and permits or denies that group access to the IGMP snoop traffic received at that address.

- a) Select **Create Route Map Policy for Multicast** to display the **Create Route Map Policy for Multicast** window.
- b) In the **Name** field assign the name of the group that you want to allow or deny multicast traffic.
- c) In the **Route Maps** table click + to display the route map dialog.
- d) In the **Order** field, if multiple access groups are being configured for this interface, select a number that reflects the order in which this access group will be permitted or denied access to the multicast traffic on this interface. Lower-numbered access groups are ordered before higher-numbered access groups.
- e) In the **Group IP** field enter the multicast IP address whose traffic is to be allowed or blocked for this access group.
- f) In the **Source IP** field, enter the IP address of the source if applicable.
- g) In the **Action** field, choose **Deny** to deny access for the target group or **Permit** to allow access for the target group.
- h) Click **OK**.
- i) Click **Submit**.

When the configuration is complete, the configured IGMP snoop access group is assigned a multicast IP address through the target static port and permitted or denied access to the multicast streams that are received at that address.

Note

- You can repeat this step to configure and associate additional access groups with multicast IP addresses through the target static port.
- To review the settings for the configured access groups, click to the following location: **Tenant** > *tenant_name* > **Policies** > **Protocol** > **Route Maps for Multicast** > *route_map_access_group_name*.

Step 5 Click **Submit**.



CHAPTER 11

MLD Snooping

This chapter contains the following sections:

- [About Cisco APIC and MLD Snooping, on page 55](#)
- [Guidelines and Limitations, on page 57](#)
- [Configuring and Assigning an MLD Snooping Policy to a Bridge Domain in the GUI, on page 57](#)

About Cisco APIC and MLD Snooping

Multicast Listener Discovery (MLD) snooping enables the efficient distribution of IPv6 multicast traffic between hosts and routers. It is a Layer 2 feature that restricts IPv6 multicast traffic within a bridge domain to a subset of ports that have transmitted or received MLD queries or reports. In this way, MLD snooping provides the benefit of conserving the bandwidth on those segments of the network where no node has expressed interest in receiving the multicast traffic. This reduces the bandwidth usage instead of flooding the bridge domain, and also helps hosts and routers save unwanted packet processing.

The MLD snooping functionality is similar to IGMP snooping, except that the MLD snooping feature snoops for IPv6 multicast traffic and operates on MLDv1 (RFC 2710) and MLDv2 (RFC 3810) control plane packets. MLD is a sub-protocol of ICMPv6, so MLD message types are a subset of ICMPv6 messages and MLD messages are identified in IPv6 packets by a preceding next header value of 58. Message types in MLDv1 include listener queries, multicast address-specific (MAS) queries, listener reports, and done messages. MLDv2 is designed to be interoperable with MLDv1 except that it has an extra query type, the multicast address and source-specific (MASS) query. The protocol level timers available in MLD are similar to those available in IGMP.

The following figure shows the different components in an MLD snooping arrangement.

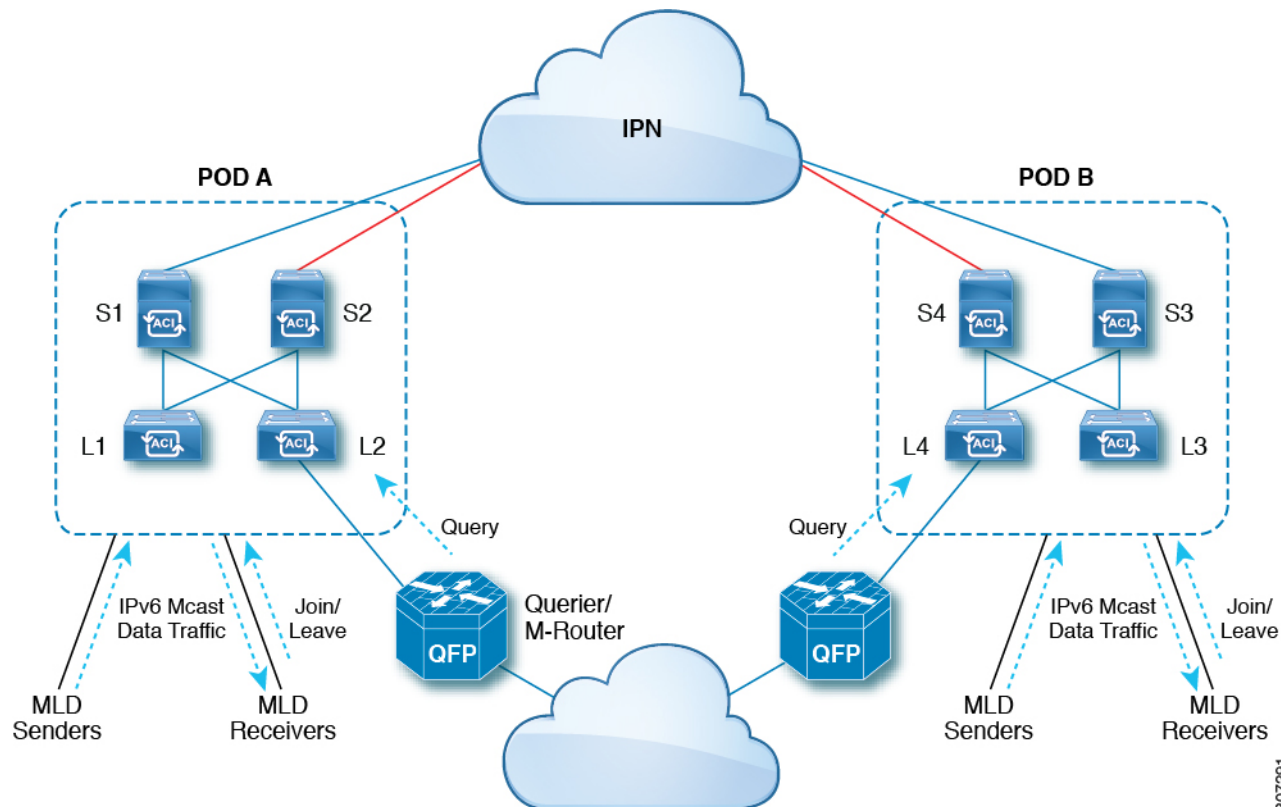

Following are explanations of the components in the figure:

- **MLD Senders (sources):** Hosts that send IPv6 traffic into the fabric.
- **MLD Receivers:** Hosts interested in receiving the IPv6 multicast packets. They can choose to join or leave the sessions.
- **Querier/M-Router:** A router or switch that periodically sends queries, and maintains a group membership database. The querier will periodically send queries to determine who might be interested in joining a multicast stream. The M-Router (multicast router) is a gateway to the world outside of the fabric. If there is multicast data traffic inside the fabric, that stream can go outside of the fabric through the multicast router.

When MLD snooping is disabled, then all the multicast traffic is flooded to all the ports, whether they have an interest or not. When MLD snooping is enabled, the fabric will forward IPv6 multicast traffic based on MLD interest. Unknown IPv6 multicast traffic will be flooded based on the bridge domain's IPv6 L3 unknown multicast flood setting.

There are two modes for forwarding unknown IPv6 multicast packets:

- **Flooding mode:** All EPGs and all ports under the bridge domain will get the flooded packets.
- **OMF (Optimized Multicast Flooding) mode:** Only multicast router ports will get the packet.

Guidelines and Limitations

The MLD snooping feature has the following guidelines and limitations:

- MLD snooping is supported only on new generation ToR switches, which are switch models with "EX", "FX" or "FX2" at the end of the switch name.
- Support is enabled for up to 2000 IPv6 multicast groups to be snooped across the fabric.
- Hardware forwarding happens with the (*,G) lookup, even for the source-specific snoop entry with MLDv2.
- The following features are not supported for MLD snooping in this release:
 - Layer 3 multicast routing across bridge domains or VRFs is not supported for IPv6 multicast traffic
 - Static MLD snooping entry
 - Access filter for MLD snoop entries through a route map
 - Virtual endpoints behind the VTEPs (VL)

Configuring and Assigning an MLD Snooping Policy to a Bridge Domain in the GUI

To implement MLD snooping functionality, you configure an MLD snooping policy then assign that policy to one or more bridge domains.

Configuring an MLD Snooping Policy Using the GUI

Create an MLD snooping policy whose MLD snooping settings can be assigned to one or multiple bridge domains.

Procedure

-
- Step 1** Click the **Tenants** tab and the name of the tenant on whose bridge domain you intend to configure MLD snooping support.
 - Step 2** In the **Navigation** pane, click **Policies > Protocol > MLD Snoop**.
 - Step 3** Right-click **MLD Snoop** and select **Create MLD Snoop Policy**.
 - Step 4** In the **Create MLD Snoop Policy** dialog, configure a policy as follows:
 - a) In the **Name** and **Description** fields, enter a policy name and optional description.
 - b) In the **Admin State** field, select **Enabled** or **Disabled** to enable or disable this entire policy.
The default entry for this field is **Disabled**.
 - c) In the **Control** field, select or unselect **Fast Leave** to enable or disable MLD v1 immediate dropping of queries through this policy.

- d) In the **Control** field, select or unselect **Enable querier** to enable or disable the MLD querier activity through the MLD Snoop Policy.

Note

For this option to be effectively enabled, you must enable **Querier** in the MLD Snoop Policy of the bridge domains to which this policy is applied. The navigation path to the properties page on which this setting is located is **Tenants > tenant_name > Networking > Bridge Domains > bridge_domain_name > MLD Snoop Policy**.

- e) Specify in seconds the **Query Interval** value for this policy.

The Query Interval is the interval between general queries sent by the querier. The default entry for this field is 125 seconds.

- f) Specify in seconds **Query Response Interval** value for this policy.

When a host receives the query packet, it starts counting to a random value, less than the maximum response time. When this timer expires, the host replies with a report.

This is used to control the maximum response time for hosts to answer an MLD query message. Configuring a value less than 10 seconds enables the router to prune groups much faster, but this action results in network burstiness because hosts are restricted to a shorter response time period.

- g) Specify in seconds the **Last Member Query Interval** value for this policy.

MLD uses this value when it receives an MLD Leave report. This means that at least one host wants to leave the group. After it receives the Leave report, it checks that the interface is not configured for MLD Fast Leave and, if not, it sends out an out-of-sequence query.

If no reports are received in the interval, the group state is deleted. The software can detect the loss of the last member of a group or source more quickly when the values are smaller. Values range from 1 to 25 seconds. The default is 1 second.

- h) Specify the **Start Query Count** value for this policy.

Number of queries sent at startup that are separated by the startup query interval. Values range from 1 to 10. The default is 2.

- i) Specify in seconds a **Start Query Interval** for this policy.

By default, this interval is shorter than the query interval so that the software can establish the group state as quickly as possible. Values range from 1 to 18,000 seconds. The default is 31 seconds.

Step 5 Click **Submit**.

The new MLD Snoop policy is listed in the **Protocol Policies - MLD Snoop** summary page.

What to do next

To put this policy into effect, assign it to any bridge domain.

Assigning an MLD Snooping Policy to a Bridge Domain Using the GUI

Assigning an MLD Snooping policy to a bridge domain configures that bridge domain to use the MLD Snooping properties specified in that policy.

Before you begin

- Configure a bridge domain for a tenant.
- Configure the MLD Snooping policy that will be attached to the bridge domain.



Note For the **Enable Querier** option on the assigned policy to be effectively enabled, the **Subnet Control: Querier IP** setting must also be enabled in the subnets assigned to the bridge domains to which this policy is applied. The navigation path to the properties page on which this setting is located is **Tenants > *tenant_name* > Networking > Bridge Domains > *bridge_domain_name* > Subnets > *bd_subnet***.

Procedure

-
- Step 1** Click the APIC **Tenants** tab and select the name of the tenant whose bridge domains you intend to configure with an MLD Snoop policy.
- Step 2** In the APIC navigation pane, click **Networking > Bridge Domains**, then select the bridge domain to which you intend to apply your policy-specified MLD Snoop configuration.
- Step 3** On the main **Policy** tab, scroll down to the **MLD Snoop Policy** field and select the appropriate MLD policy from the drop-down menu.
- Step 4** Click **Submit**.
- The target bridge domain is now associated with the specified MLD Snooping policy.
- Step 5** To configure the node forwarding parameter for Layer 3 unknown IPv6 Multicast destinations for the bridge domain:
- a) Select the bridge domain that you just configured.
 - b) Click the **Policy** tab, then click the **General** sub-tab.
 - c) In the **IPv6 L3 Unknown Multicast** field, select either **Flood** or **Optimized Flood**.
- Step 6** To change the Link-Local IPv6 address for the switch-querier feature:
- a) Select the bridge domain that you just configured.
 - b) Click the **Policy** tab, then click the **L3 Configurations** sub-tab.
 - c) In the **Link-local IPv6 Address** field, enter a Link-Local IPv6 address, if necessary.
- The default Link-Local IPv6 address for the bridge domain is internally generated. Configure a different Link-Local IPv6 address for the bridge domain in this field, if necessary.
-



CHAPTER 12

Tenant Routed Multicast

This chapter contains the following sections:

- [Tenant Routed Multicast, on page 61](#)
- [About the Fabric Interface, on page 63](#)
- [Enabling IPv4/IPv6 Tenant Routed Multicast, on page 64](#)
- [Allocating VRF GIPo, on page 65](#)
- [Multiple Border Leaf Switches as Designated Forwarder, on page 65](#)
- [PIM/PIM6 Designated Router Election, on page 66](#)
- [Non-Border Leaf Switch Behavior, on page 66](#)
- [Active Border Leaf Switch List, on page 67](#)
- [Overload Behavior On Bootup, on page 67](#)
- [First-Hop Functionality, on page 67](#)
- [The Last-Hop, on page 67](#)
- [Fast-Convergence Mode, on page 67](#)
- [About Rendezvous Points, on page 68](#)
- [About Inter-VRF Multicast, on page 69](#)
- [ACI Multicast Feature List, on page 70](#)
- [Guidelines, Limitations, and Expected Behaviors for Configuring Layer 3 IPv4/IPv6 Multicast, on page 76](#)
- [Configuring Layer 3 IPv4 Multicast Using the GUI, on page 78](#)
- [Configuring Layer 3 IPv6 Multicast Using the GUI, on page 80](#)
- [About BGP IPv4/IPv6 Multicast Address-Family, on page 82](#)
- [About Multicast Filtering, on page 86](#)
- [About Layer 3 Multicast on an SVI L3Out, on page 92](#)

Tenant Routed Multicast

Cisco Application Centric Infrastructure (ACI) Tenant Routed Multicast (TRM) enables Layer 3 multicast routing in Cisco ACI tenant VRF instances. TRM supports multicast forwarding between senders and receivers within the same or different subnets. Multicast sources and receivers can be connected to the same or different leaf switches or external to the fabric using L3Out connections.

In the Cisco ACI fabric, most unicast and IPv4/IPv6 multicast routing operate together on the same border leaf switches, with the IPv4/IPv6 multicast protocol operating over the unicast routing protocols.

In this architecture, only the border leaf switches run the full Protocol Independent Multicast (PIM) or PIM6 protocol. Non-border leaf switches run PIM/PIM6 in a passive mode on the interfaces. They do not peer with any other PIM/PIM6 routers. The border leaf switches peer with other PIM/PIM6 routers connected to them over L3Outs and also with each other.

The following figure shows border leaf switch 1 and border leaf switch 2 connecting to router 1 and router 2 in the IPv4/IPv6 multicast cloud. Each virtual routing and forwarding (VRF) instance in the fabric that requires IPv4/IPv6 multicast routing will peer separately with external IPv4/IPv6 multicast routers.

Figure 7: Overview of Multicast Cloud

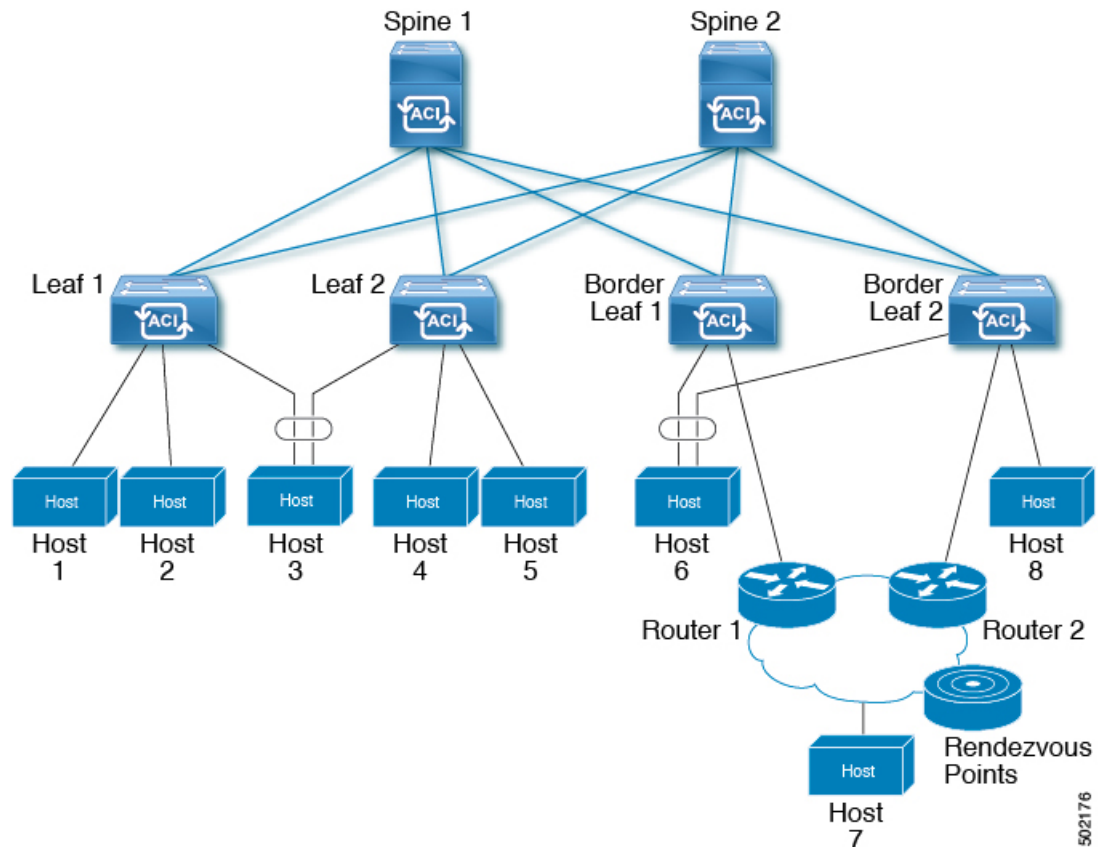

Support for Layer 3 Multicast with Remote Leaf Switches

Prior to Release 5.1(3), support has been available for Layer 3 multicast routing in single-pod, multi-pod, and multi-site topologies on local leaf switches. Beginning with Release 5.1(3), support is also available for Layer 3 multicast routing on remote leaf switches. As part of this support, the remote leaf switch can act as a border leaf switch or non-border leaf switch.

There is no difference between the newly-supported remote leaf switches and the previously-supported local leaf switches with regards to the implementation of Layer 3 multicast routing through Cisco APIC or Cisco ACI Multi-Site Orchestrator. The main difference between the two is based on how traffic is forwarded:

- Layer 3 multicast between local leaf switches in a single fabric is forwarded as VXLAN multicast packets where the outer destination IP address is the VRF GIPo multicast address

- Layer 3 multicast packets sent to or sent by remote leaf switches are encapsulated as VXLAN unicast head-end replicated packets

When Layer 3 multicast routing is enabled for a VRF, the VRF GIPo multicast address is programmed on all leaf switches where the VRF is deployed. Layer 3 multicast packets will be forwarded across the pod or between pods as multicast packets and will be received by all leaf switches where the VRF is deployed. For remote leaf switches, the Layer 3 multicast packets will be forwarded using head-end replication to all remote leaf switches where the VRF is deployed. This head-end replication occurs on the pod or remote leaf where the multicast source is connected. For example, if the multicast source is connected to a local leaf switch, one of the spine switches in that pod will be selected to replicate these multicast packets to every remote leaf switch where the VRF is deployed, even if these remote leaf switches are associated with other pods. When a Layer 3 multicast source is connected to a remote leaf switch, the remote leaf switch will also use head-end replication to send a copy of the multicast packet to a spine in every pod as well as all other remote leaf switches where the VRF is deployed.

Multicast forwarding using head-end replication replicates the multicast packet as a separate unicast packet for every head-end replication tunnel. Layer 3 multicast in a remote leaf switch design should ensure that the IP network (IPN) where the remote leaf switches are connected has sufficient bandwidth to support multicast traffic requirements.

Remote leaf switches support L3Out connections with or without PIM enabled. All leaf switches in a VRF that have PIM-enabled L3Outs are eligible to send PIM joins from the fabric towards external sources and rendezvous points. When a multicast receiver connected to the fabric sends an IGMP join for a group, the fabric will select one of the PIM-enabled border leaf switches to send the join (known as the stripe winner). A remote leaf switch with a PIM-enabled L3Out can be selected as the stripe winner for a group even when the receivers for that group are connected to local leaf switches in the main pod. Due to potential sub-optimal forwarding of Layer 3 multicast traffic, deploying PIM-enabled L3Outs on remote leaf switches is not recommended.

Guidelines and Limitations

- Pod redundancy is supported for Layer 3 multicast forwarding with remote leaf switches. If all spine switches in the pod where the remote leaf switch is associated fail, the remote leaf switch can establish control plane connectivity to spine switches in another pod.
- Remote leaf switches must have connectivity to at least one spine switch in any pod. Layer 3 multicast traffic will not be forwarded if the remote leaf switches lose connectivity to all spine switches. This includes Layer 3 multicast traffic between senders and receivers on the same leaf switch.

About the Fabric Interface

The fabric interface is a virtual interface between software modules and represents the fabric for IPv4/IP6 multicast routing. The interface takes the form of a tunnel interface with the tunnel destination being the VRF GIPo (Group IP outer address)². PIM6 shares the same tunnel that PIM4 uses. For example, if a border leaf is the designated forwarder responsible for forwarding traffic for a group, then the fabric interface would be in the outgoing interface (OIF) list for the group. There is no equivalent for the interface in hardware. The operational state of the fabric interface should follow the state published by the intermediate system-to-intermediate system (IS-IS).

² The GIPo (Group IP outer address) is the destination multicast IP address used in the outer IP header of the VXLAN packet for all multi-destination packets (Broadcast, Unknown unicast, and Multicast) packets forwarded within the fabric.



Note Each multicast-enabled VRF requires one or more border leaf switches configured with a loopback interface. You must configure a unique IPv4 loopback address on all nodes in a PIM-enabled L3Out. The Router-ID loopback or another unique loopback address can be used.

Any loopback configured for unicast routing can be reused. This loopback address must be routed from the external network and will be injected into the fabric MP-BGP (Multiprotocol Border Gateway Protocol) routes for the VRF. The fabric interface source IP will be set to this loopback as the loopback interface. The following figure shows the fabric for IPv4/IPv6 multicast routing.

Figure 8: Fabric for IPv4/IPv6 Multicast Routing

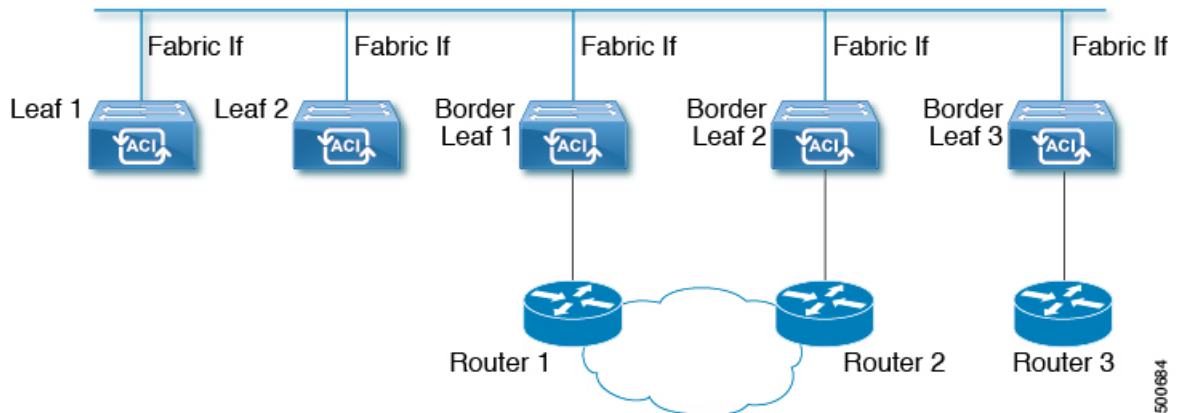

Enabling IPv4/IPv6 Tenant Routed Multicast

The process to enable or disable IPv4 or IPv6 multicast routing in a Cisco ACI fabric occurs at three levels:

- **VRF level:** Enable multicast routing at the VRF level.
- **L3Out level:** Enable PIM/PIM6 for one or more L3Outs configured in the VRF instance.
- **Bridge domain level:** Enable PIM/PIM6 for one or more bridge domains where multicast routing is needed.

At the top level, IPv4/IPv6 multicast routing must be enabled on the VRF instance that has any multicast routing-enabled bridge domains. On an IPv4/IPv6 multicast routing-enabled VRF instance, there can be a combination of IPv4/IPv6 multicast routing-enabled bridge domains and bridge domains where IPv4/IPv6 multicast routing is disabled. A bridge domain with IPv4/IPv6 multicast routing disabled will not show on the VRF IPv4/IPv6 multicast panel. An L3Out with IPv4/IPv6 multicast routing-enabled will show up on the panel, but any bridge domain that has IPv4/IPv6 multicast routing enabled will always be a part of a VRF instance that has IPv4/IPv6 multicast routing enabled.

IPv4/IPv6 multicast routing is not supported on the leaf switches such as Cisco Nexus 93128TX, 9396PX, and 9396TX. All the IPv4/IPv6 multicast routing and any IPv4/IPv6 multicast-enabled VRF instance should be deployed only on the switches with -EX and -FX in their product IDs.



- Note** L3Out ports and sub-interfaces are supported. Support for external SVIs varies, depending on the release:
- For releases prior to release 5.2(3), external SVIs are not supported.
 - Beginning with release 5.2(3), support is available for Layer 3 multicast on an SVI L3Out. PIM is supported on SVI L3Outs for physical ports and port channels but not for vPCs. PIM6 is not supported on L3Out SVIs.

Allocating VRF GIPo

VRF GIPo is allocated implicitly based on configuration. There will be one GIPo for the VRF and one GIPo for every BD under that VRF. Additionally, any given GIPo might be shared between multiple BDs or multiple VRFs, but not a combination of VRFs and BDs. APIC will be required to ascertain this. In order to handle the VRF GIPo in addition to the BD GIPos already handled and build GIPo trees for them, IS-IS is modified.



- Note** For the same VRF, VRF GIPo is common for both IPv4 and IPv6.

All multicast traffic for PIM/PIM6 enabled BDs will be forwarded using the VRF GIPo. This includes both Layer 2 and Layer 3 IPv4/IPv6 multicast. Any broadcast or unicast flood traffic on the multicast enabled BDs will continue to use the BD GIPo. Non-IPv4/IPv6 multicast enabled BDs will use the BD GIPo for all multicast, broadcast, and unicast flood traffic.

The APIC GUI will display a GIPo multicast address for all BDs and VRFs. The address displayed is always a /28 network address (the last four bits are zero). When the VXLAN packet is sent in the fabric, the destination multicast GIPo address will be an address within this /28 block and is used to select one of 16 FTAG trees. This achieves load balancing of multicast traffic across the fabric.

Table 5: GIPo Usage

Traffic	Non-MC Routing-enabled BD	MC Routing-enabled BD
Broadcast	BD GIPo	BD GIPo
Unknown Unicast Flood	BD GIPo	BD GIPo
Multicast	BD GIPo	VRF GIPo

Multiple Border Leaf Switches as Designated Forwarder

When there are multiple border leaf (BL) switches in the fabric doing IPv4/IPv6 multicast routing, only one of the border leafs is selected as the designated forwarder for attracting traffic from the external IPv4/IPv6 multicast network and forwarding it to the fabric. This prevents multiple copies of the traffic and it balances the load across the multiple BL switches.

This is done by striping ownership for groups across the available BL switches, as a function of the group address and the VRF virtual network ID (VNID). A BL that is responsible for a group sends PIM/PIM6 joins to the external network to attract traffic into the fabric on behalf of receivers in the fabric.

Each BL in the fabric has a view of all the other active BL switches in the fabric in that VRF. So each of the BL switches can independently stripe the groups consistently. Each BL monitors PIM/PIM6 neighbor relations on the fabric interface to derive the list of active BL switches. When a BL switch is removed or discovered, the groups are re-striped across the remaining active BL switches. The striping is similar to the method used for hashing the GIPos to external links in multi-pod deployment, so that the group-to-BL mapping is sticky and results in fewer changes on up or down.

Figure 9: Model for Multiple Border Leafs as Designated Forwarder

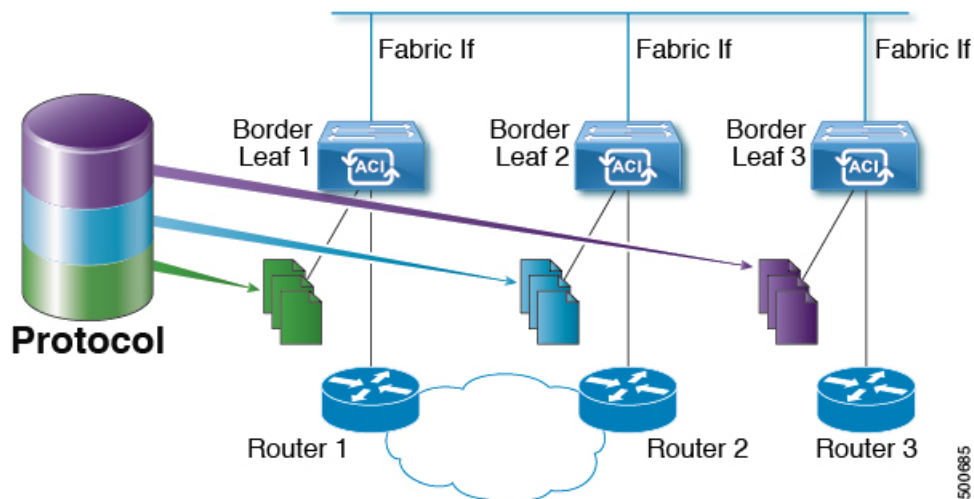

PIM/PIM6 Designated Router Election

For Layer 3 IPv4/IPv6 multicast on ACI fabric, the PIM/PIM6 DR (designated router) mechanism for different interface types is as follows:

- PIM/PIM6-enabled L3 Out interfaces: Follows standard PIM/PIM6 DR mechanism in these types of interfaces.
- Fabric interface: DR election on this interface is not of much significance as the DR functionality is determined by the striping. PIM/PIM6 DR election continues unaltered on this interface.
- IPv4/IPv6 multicast routing-enabled pervasive BDs: The pervasive BDs in the fabric are all stubs with respect to IPv4/IPv6 multicast routing. Hence, on all the leaf switches, the SVI interfaces for pervasive BDs including vPC, are considered DR on the segment.

Non-Border Leaf Switch Behavior

On the non-border leaf switches, PIM/PIM6 runs in passive mode on the fabric interface and on the pervasive BD SVIs. PIM/PIM6 is in a new passive-probe mode where it sends only *hellos*. PIM/PIM6 neighbors are not expected on these pervasive BD SVIs. It is desirable to raise a fault when a PIM/PIM6 *hello* is heard from

a router on a pervasive BD. PIM/PIM6, on the non-border leaf switches, does not send any PIM/PIM6 protocol packets except for *hellos* on pervasive BDs and source register packets on the fabric interface.

At the same time, PIM/PIM6 will receive and process the following PIM/PIM6 packets on the fabric interface:

- **PIM/PIM6 Hellos:** This is used to track the active BL list on the fabric interface and on the pervasive BDs, this is used to raise faults.
- **PIM BSR, Auto-RP advertisements:** Supported only for PIM, not supported for PIM6. This is received on the fabric interface and is processed to glean the RP to group-range mapping.

Active Border Leaf Switch List

On every leaf switch, PIM/PIM6 maintains a list of active border leaf switches that is used for striping and other purposes. On the border leaf switches themselves this active border leaf list is derived from the active PIM/PIM6 neighbor relations. On non-border leaf switches, the list is generated by PIM/PIM6 using the monitored PIM/PIM6 *Hello* messages on the fabric interface. The source IP on the *hello* messages is the loopback IPv4/IPv6 assigned to each border leaf switch.

Overload Behavior On Bootup

When a border leaf switch gains connectivity to the fabric for the first time after bootup or after losing connectivity, it is not desirable to cause the border leaf switch to be part of the active border leaf switch list till the border leaf switch has had a chance to pull the **COOP** repo³ information and to bring up its southbound protocol adjacencies. This can be achieved by delaying the transmission of PIM/PIM6 *hello* messages for a non-configured period of time.

First-Hop Functionality

The directly connected leaf switch will handle the first-hop functionality needed for PIM/PIM6 sparse mode.

The Last-Hop

The last-hop router is connected to the receiver and is responsible for doing a Shortest-Path Tree (SPT) switchover in case of PIM/PIM6 any-source multicast (ASM). The border leaf switches will handle this functionality. The non-border leaf switches do not participate in this function.

Fast-Convergence Mode

The fabric supports a configurable fast-convergence mode where every border leaf switch with external connectivity towards the root (*RP for (*, G)* and source for (*S, G*)) pulls traffic from the external network. To prevent duplicates, only one of the BL switches forwards the traffic to the fabric. The BL that forwards the

³ All IPv4/IPv6 multicast group membership information is stored in the COOP database on the spines. When a border leaf boots up it pulls this information from the spine

traffic for the group into the fabric is called the designated forwarder (DF) for the group. The stripe winner for the group decides on the DF. If the stripe winner has reachability to the root, then the stripe winner is also the DF. If the stripe winner does not have external connectivity to the root, then that BL chooses a DF by sending a PIM/PIM6 join over the fabric interface. All non-stripe winner BL switches with external reachability to the root send out PIM/PIM6 joins to attract traffic but continue to have the fabric interface as the RPF interface for the route. This results in the traffic reaching the BL switch on the external link, but getting dropped.

The advantage of the fast-convergence mode is that when there is a stripe owner change due to a loss of a BL switch for example, the only action needed is on the new stripe winner of programming the right Reverse Path Forwarding (RPF) interface. There is no latency incurred by joining the PIM/PIM6 tree from the new stripe winner. This comes at the cost of the additional bandwidth usage on the non-stripe winners' external links.



Note Fast-convergence mode can be disabled in deployments where the cost of additional bandwidth outweighs the convergence time saving.

About Rendezvous Points

A rendezvous point (RP) is an IP address that you choose in a multicast network domain that acts as a shared root for a multicast shared tree. You can configure as many RPs as you like, and you can configure them to cover different group ranges. When multiple RPs are configured, each RP must be configured for a unique group range.

PIM enabled border leafs are required for VRFs where multicast routing is enabled. PIM is enabled for a border leaf by enabling PIM at the L3Out level. When PIM is enabled for an L3Out this will enable PIM for all nodes and interfaces configured under that L3Out.

You can configure two types of RPs:

- **Static RP**—Enables you to statically configure an RP for a multicast group range. To do so, you must configure the address of the RP on every router in the domain.
- **Fabric RP**—Enables a PIM anycast RP loopback interface on all PIM-enabled border leaf switches in the VRF, which is necessary for supporting inter-VRF multicast (see [About Inter-VRF Multicast, on page 69](#)). A PIM-enabled L3Out (with loopback interfaces) is required for fabric RP configuration. When configured, external routers can use the fabric RP using static RP configuration. Auto-RP and BSR are not supported with Fabric RP. Fabric RP peering with an external anycast RP member is not supported.



Note Fabric RP has the following restrictions:

- Fabric RP does not support fast-convergence mode.
 - The fabric IP:
 - Must be unique across all the static RP entries within the static RP and fabric RP.
 - Cannot be one of the Layer 3 out router IDs
-

For information about configuring an RP, see the following sections:

- [Configuring Layer 3 IPv4 Multicast Using the GUI, on page 78](#)
- [Configuring Layer 3 Multicast Using the NX-OS Style CLI, on page 425](#)
- [Configuring Layer 3 Multicast Using REST API, on page 502](#)

About Inter-VRF Multicast



Note Inter-VRF multicast is not supported for IPv6 multicast.

In typical data center with multicast networks, the multicast sources and receivers are in the same VRF, and all multicast traffic is forwarded within that VRF. There are use cases where the multicast sources and receivers may be located in different VRFs:

- Surveillance cameras are in one VRF while the people viewing the camera feeds are on computers in a different VRF.
- A multicast content provider is in one VRF while different departments of an organization are receiving the multicast content in different VRFs.

ACI release 4.0 adds support for inter-VRF multicast, which enables sources and receivers to be in different VRFs. This allows the receiver VRF to perform the reverse path forwarding (RPF) lookup for the multicast route in the source VRF. When a valid RPF interface is formed in the source VRF, this enables an outgoing interface (OIF) in the receiver VRF. All inter-VRF multicast traffic will be forwarded within the fabric in the source VRF. The inter-VRF forwarding and translation is performed on the leaf switch where the receivers are connected.



Note

- For any-source multicast, the RP used must be in the same VRF as the source.
- Inter-VRF multicast supports both shared services and share L3Out configurations. Sources and receivers can be connected to EPGs or L3Outs in different VRFs.

For ACI, inter-VRF multicast is configured per receiver VRF. Every NBL/BL that has the receiver VRF will get the same inter-VRF configuration. Each NBL that may have directly connected receivers, and BLs that may have external receivers, need to have the source VRF deployed. Control plane signaling and data plane forwarding will do the necessary translation and forwarding between the VRFs inside the NBL/BL that has receivers. Any packets forwarded in the fabric will be in the source VRF.

Inter-VRF Multicast Requirements

This section explains the inter-vrf multicast requirements.

- All sources for a particular group must be in the same VRF (the source VRF).
- Source VRF and source EPGs need to be present on all leafs where there are receiver VRFs.

- For ASM:
 - The RP must be in the same VRF as the sources (the source VRF).
 - For releases prior to 4.2(4), the source VRF must be using fabric RP. This restriction does not apply for Release 4.2(4) and later.
 - The same RP address configuration must be applied under the source and all receiver VRFs for the given group-range.

ACI Multicast Feature List

The following sections provide a list of ACI multicast features with comparisons to similar NX-OS features.

- [IGMP Features, on page 70](#)
- [IGMP Snooping Features, on page 71](#)
- [MLD Snooping Features, on page 72](#)
- [PIM Features \(Interface Level\), on page 73](#)
- [PIM Features \(VRF Level\), on page 74](#)

IGMP Features

ACI Feature Name	NX-OS Feature	Description
Allow V3 ASM	ip igmp allow-v3-asm	Allow accepting IGMP version 3 source-specific reports for multicast groups outside of the SSM range. When this feature is enabled, the switch will create an (S,G) mroute entry if it receives an IGMP version 3 report that includes both the group and source even if the group is outside of the configured SSM range. This feature is not required if hosts send (*,G) reports outside of the SSM range, or send (S,G) reports for the SSM range.
Fast Leave	ip igmp immediate-leave	Option that minimizes the leave latency of IGMPv2 group memberships on a given IGMP interface because the device does not send group-specific queries. When immediate leave is enabled, the device removes the group entry from the multicast routing table immediately upon receiving a leave message for the group. The default is disabled. Note: Use this command only when there is one receiver behind the BD/interface for a given group
Report Link Local Groups	ip igmp report-link-local-groups	Enables sending reports for groups in 224.0.0.0/24. Reports are always sent for nonlink local groups. By default, reports are not sent for link local groups.
Group Timeout (sec)	ip igmp group-timeout	Sets the group membership timeout for IGMPv2. Values can range from 3 to 65,535 seconds. The default is 260 seconds.
Query Interval (sec)	ip igmp query-interval	Sets the frequency at which the software sends IGMP host query messages. Values can range from 1 to 18,000 seconds. The default is 125 seconds.

ACI Feature Name	NX-OS Feature	Description
Query Response Interval (sec)	ip igmp query-max-response-time	Sets the response time advertised in IGMP queries. Values can range from 1 to 25 seconds. The default is 10 seconds.
Last Member Count	ip igmp last-member-query-count	Sets the number of times that the software sends an IGMP query in response to a host leave message. Values can range from 1 to 5. The default is 2.
Last Member Response Time (sec)	ip igmp last-member-query-response-time	Sets the query interval waited after sending membership reports before the software deletes the group state. Values can range from 1 to 25 seconds. The default is 1 second.
Startup Query Count	ip igmp startup-query-count	Sets the query count used when the software starts up. Values can range from 1 to 10. The default is 2.
Querier Timeout	ip igmp querier-timeout	Sets the query timeout that the software uses when deciding to take over as the querier. Values can range from 1 to 65,535 seconds. The default is 255 seconds.
Robustness Variable	ip igmp robustness-variable	Sets the robustness variable. You can use a larger value for a lossy network. Values can range from 1 to 7. The default is 2.
Version	ip igmp version <2-3>	IGMP version that is enabled on the bridge domain or interface. The IGMP version can be 2 or 3. The default is 2.
Report Policy Route Map*	ip igmp report-policy <route-map>	Access policy for IGMP reports that is based on a route-map policy. IGMP group reports will only be selected for groups allowed by the route-map
Static Report Route Map*	ip igmp static-oif	Statically binds a multicast group to the outgoing interface, which is handled by the switch hardware. If you specify only the group address, the (*, G) state is created. If you specify the source address, the (S, G) state is created. You can specify a route-map policy name that lists the group prefixes, group ranges, and source prefixes. Note A source tree is built for the (S, G) state only if you enable IGMPv3.
Maximum Multicast Entries	ip igmp state-limit	Limit the mroute states for the BD or interface that are created by IGMP reports. Default is disabled, no limit enforced. Valid range is 1-4294967295.
Reserved Multicast Entries	ip igmp state-limit <limit> reserved <route-map>	Specifies to use the route-map policy name for the reserve policy and set the maximum number of (*, G) and (S, G) entries allowed on the interface.
State Limit Route Map*	ip igmp state-limit <limit> reserved <route-map>	Used with Reserved Multicast Entries feature

IGMP Snooping Features

ACI Feature Name	NX-OS Feature	Description
IGMP snooping admin state	[no] ipigmp snooping	Enables/disables the IGMP snooping feature. Cannot be disabled for PIM enabled bridge domains

ACI Feature Name	NX-OS Feature	Description
Fast Leave	ip igmp snooping fast-leave	Option that minimizes the leave latency of IGMPv2 group memberships on a given IGMP interface because the device does not send group-specific queries. When immediate leave is enabled, the device removes the group entry from the multicast routing table immediately upon receiving a leave message for the group. The default is disabled. Note: Use this command only when there is one receiver behind the BD/interface for a given group
Enable Querier	ip igmp snooping querier <ip address>	Enables the IP IGMP snooping querier feature on the Bridge Domain. Used along with the BD subnet Querier IP setting to configure an IGMP snooping querier for bridge domains. Note: Should not be used with PIM enabled bridge domains. The IGMP querier function is automatically enabled for when PIM is enabled on the bridge domain.
Query Interval	ip igmp snooping query-interval	Sets the frequency at which the software sends IGMP host query messages. Values can range from 1 to 18,000 seconds. The default is 125 seconds.
Query Response Interval	ip igmp snooping query-max-response-time	Sets the response time advertised in IGMP queries. Values can range from 1 to 25 seconds. The default is 10 seconds.
Last Member Query Interval	ip igmp snooping last-member-query-interval	Sets the query interval waited after sending membership reports before the software deletes the group state. Values can range from 1 to 25 seconds. The default is 1 second.
Start Query Count	ip igmp snooping startup-query-count	Configures snooping for a number of queries sent at startup when you do not enable PIM because multicast traffic does not need to be routed. Values can range from 1 to 10. The default is 2.
Start Query Interval (sec)	ip igmp snooping startup-query-interval	Configures a snooping query interval at startup when you do not enable PIM because multicast traffic does not need to be routed. Values can range from 1 to 18,000 seconds. The default is 31 seconds

MLD Snooping Features

ACI Feature Name	NX-OS Feature	Description
MLD snooping admin state	ipv6 mld snooping	IPv6 MLD snooping feature. Default is disabled
Fast Leave	ipv6 mld snooping fast-leave	Allows you to turn on or off the fast-leave feature on a per bridge domain basis. This applies to MLDv2 hosts and is used on ports that are known to have only one host doing MLD behind that port. This command is disabled by default.
Enable Querier	ipv6 mld snooping querier	Enables or disables IPv6 MLD snooping querier processing. MLD snooping querier supports the MLD snooping in a bridge domain where PIM and MLD are not configured because the multicast traffic does not need to be routed.
Query Interval	ipv6 mld snooping query-interval	Sets the frequency at which the software sends MLD host query messages. Values can range from 1 to 18,000 seconds. The default is 125 seconds.

ACI Feature Name	NX-OS Feature	Description
Query Response Interval	ipv6 mld snooping query-interval	Sets the response time advertised in MLD queries. Values can range from 1 to 25 seconds. The default is 10 seconds.
Last Member Query Interval	ipv6 mld snooping last-member-query-interval	Sets the query response time after sending membership reports before the software deletes the group state. Values can range from 1 to 25 seconds. The default is 1 second.

PIM Features (Interface Level)

ACI Feature Name	NX-OS Feature	Description
Authentication	ip pim hello-authentication ah-md5	Enables MD5 hash authentication for PIM IPv4 neighbors
Multicast Domain Boundary	ip pim border	Enables the interface to be on the border of a PIM domain so that no bootstrap, candidate-RP, or Auto-RP messages are sent or received on the interface. The default is disabled.
Passive	ip pim passive	If the passive setting is configured on an interface, it will enable the interface for IP multicast. PIM will operate on the interface in passive mode, which means that the leaf will not send PIM messages on the interface, nor will it accept PIM messages from other devices across this interface. The leaf will instead consider that it is the only PIM device on the network and thus act as the DR. IGMP operations are unaffected by this command.
Strict RFC Compliant	ip pim strict-rfc-compliant	When configured, the switch will not process joins from unknown neighbors and will not send PIM joins to unknown neighbors
Designated Router Delay (sec)	ip pimdr-delay	Delays participation in the designated router (DR) election by setting the DR priority that is advertised in PIM hello messages to 0 for a specified period. During this delay, no DR changes occur, and the current switch is given time to learn all of the multicast states on that interface. After the delay period expires, the correct DR priority is sent in the hello packets, which retriggers the DR election. Values are from 1 to 65,535. The default value is 3. Note: This command delays participation in the DR election only upon bootup or following an IP address or interface state change. It is intended for use with multicast-access non-vPC Layer 3 interfaces only.
Designated Router Priority	ip pim dr-priority	Sets the designated router (DR) priority that is advertised in PIM hello messages. Values range from 1 to 4294967295. The default is 1.
Hello Interval (milliseconds)	ip pim hello-interval	Configures the interval at which hello messages are sent in milliseconds. The range is from 1000 to 18724286. The default is 30000.
Join-Prune Interval Policy (seconds)	ip pim jp-interval	Interval for sending PIM join and prune messages in seconds. Valid range is from 60 to 65520. Value must be divisible by 60. The default value is 60.

ACI Feature Name	NX-OS Feature	Description
Interface-level Inbound Join-Prune Filter Policy*	ip pimjp-policy	Enables inbound join-prune messages to be filtered based on a route-map policy where you can specify group, group and source, or group and RP addresses. The default is no filtering of join-prune messages.
Interface-level Outbound Join-Prune Filter Policy*	ip pim jp-policy	Enables outbound join-prune messages to be filtered based on a route-map policy where you can specify group, group and source, or group and RP addresses. The default is no filtering of join-prune messages.
Interface-level Neighbor Filter Policy*	ip pim neighbor-policy	Controls which PIM neighbors to become adjacent to based on route-map policy where you specify the source address/address range of the permitted PIM neighbors

PIM Features (VRF Level)

ACI Feature Name	NX-OS Feature	Description
Static RP	ip pim rp-address	Configures a PIM static RP address for a multicast group range. You can specify an optional route-map policy that lists multicast group ranges for the static RP. If no route-map is configured, the static RP will apply to all multicast group ranges excluding any configured SSM group ranges. The mode is ASM.
Fabric RP	n/a	Configures an anycast RP on all multicast enabled border leaf switches in the fabric. Anycast RP is implemented using PIM anycast RP. You can specify an optional route-map policy that lists multicast group ranges for the static RP.
Auto-RP Forward Auto-RP Updates	ip pim auto-rp forward	Enables the forwarding of Auto-RP messages. The default is disabled.
Auto-RP Listen to Auto-RP Updates	ip pim auto-rp listen	Enables the listening for Auto-RP messages. The default is disabled.
Auto-RP MA Filter *	ip pim auto-rp mapping-agent-policy	Enables Auto-RP discover messages to be filtered by the border leaf based on a route-map policy where you can specify mapping agent source addresses. This feature is used when the border leaf is configured to listen for Auto-RP messages. The default is no filtering of Auto-RP messages.
BSR Forward BSR Updates	ip pim bsr forward	Enables forwarding of BSR messages. The default is disabled, which means that the leaf does not forward BSR messages.
BSR Listen to BRS Updates	ip pim bsr listen	Enables listening for BSR messages. The default is disabled, which means that the leaf does not listen for BSR messages.
BSR Filter	ip pim bsr bsr-policy	Enables BSR messages to be filtered by the border leaf based on a route-map policy where you can specify BSR source. This command can be used when the border leaf is configured to listen to BSR messages. The default is no filtering of BSR messages.
ASM Source, Group Expiry Timer Policy *	ip pim sg-expiry-timer <timer> sg-list	Applies a route map to the ASM Source, Group Expiry Timer to specify a group/range of groups for the adjusted expiry timer.

ACI Feature Name	NX-OS Feature	Description
ASM Source, Group Expiry Timer Expiry (sec)	ip pim sg-expiry-timer	To adjust the (S,G) expiry timer interval for Protocol Independent Multicast sparse mode (PIM-SM) (S,G) multicast routes. This command creates persistency of the SPT (source based tree) over the default 180 seconds for intermittent sources. Range is from 180 to 604801 seconds.
Register Traffic Policy: Max Rate	ip pim register-rate-limit	Configures the rate limit in packets per second. The range is from 1 to 65,535. The default is no limit.
Register Traffic Policy: Source IP	ip pim register-source	Used to configure a source IP address of register messages. This feature can be used when the source address of register messages is routed in the network where the RP can send messages. This may happen if the bridge domain where the source is connected is not configured to advertise its subnet outside of the fabric.
SSM Group Range Policy*	ip pim ssm route-map	Can be used to specify different SSM group ranges other than the default range 232.0.0.0/8. This command is not required if you want to only use the default group range. You can configure a maximum of four ranges for SSM multicast including the default range.
	ip pim ssm-range none	Can be used to deny the default SSM group range 232.0.0.0/8. You can instead handle this range as an ASM group range. The same can be achieved by creating a SSM group range policy with no route-map entries (empty route map).
Fast Convergence	n/a	<p>When fast convergence mode is enabled, every border leaf in the fabric will send PIM joins towards the root (RP for (*,G) and source (S,G)) in the external network. This allows all PIM enabled BLs in the fabric to receive the multicast traffic from external sources but only one BL will forward traffic onto the fabric. The BL that forwards the multicast traffic onto the fabric is the designated forwarder. The stripe winner BL decides on the DF. The advantage of the fast-convergence mode is that when there is a changed of the stripe winner due to a BL failure there is no latency incurred in the external network by having the new BL send joins to create multicast state.</p> <p>Note: Fast convergence mode can be disabled in deployments where the cost of additional bandwidth outweighs the convergence time saving.</p>
Strict RFC Compliant	ip pim strict-rfc-compliant	When configured, the switch will not process joins from unknown neighbors and will not send PIM joins to unknown neighbors
MTU Port	ip pim mtu	Enables bigger frame sizes for the PIM control plane traffic and improves the convergence. Range is from 1500 to 9216 bytes
Resource Policy Maximum Limit	ip pim state-limit	Sets the maximum (*,G)/(S,G) entries allowed per VRF. Range is from 1 to 4294967295
Resource Policy Reserved Route Map*	ip pim state-limit <limit> reserved <route-map>	Configures a route-map policy matching multicast groups or groups and sources to be applied to the Resource Policy Maximum Limit reserved entries.
Resource Policy Reserved Multicast Entries	ip pim state-limit <limit> reserved <route-map> <limit>	Maximum reserved (*, G) and (S, G) entries allowed in this VRF. Must be less than or equal to the maximum states allowed. Used with the Resource Policy Reserved Route Map policy

Guidelines, Limitations, and Expected Behaviors for Configuring Layer 3 IPv4/IPv6 Multicast

See the following guidelines and restrictions:

- [Guidelines and Limitations for IPv4 and IPv6 Multicast, on page 76](#)
- [Guidelines and Limitations for IPv4 Multicast, on page 77](#)
- [Guidelines and Limitations for IPv6 Multicast, on page 78](#)

Guidelines and Limitations for IPv4 and IPv6 Multicast

The following restrictions apply for both IPv4 and IPv6 multicast:

- The Layer 3 IPv4/IPv6 multicast feature is supported on second generation leaf switches. A second generation switch is one with -EX, -FX, -FX2, -FX3, -GX, or any later suffix in the product ID.
- Custom QoS policy is not supported for Layer 3 multicast traffic sourced from outside the Cisco Application Centric Infrastructure (ACI) fabric (received from L3Out).
- Enabling PIMv4/PIM6 and Advertise Host routes on a bridge domain is supported.
- Layer 3 multicast is enabled at the VRF level and the multicast protocols will function within the VRF instance. Each VRF instance can have multicast enabled or disabled independently.
- After a VRF instance is enabled for multicast, the individual bridge domains and L3Outs under the enabled VRF instance can be enabled for multicast configuration. By default, multicast is disabled in all bridge domains and L3Outs.
- Bidirectional PIMv4/PIM6 is currently not supported.
- Multicast routers are not supported in pervasive bridge domains.
- The supported route scale is 2,000. The multicast scale number is a combined scale that includes both IPv4 and IPv6. The total route limit is defined as route counts. Each IPv4 route is counted as 1, and each IPv6 route is counted as 4. Even with node profiles that support more multicast scales, the IPv6 route scale will remain at 2,000.
- PIMv4/PIM6 is supported on L3Out routed interfaces, routed subinterfaces including Layer 3 port channel and Layer 3 port channel subinterfaces. Starting from Cisco ACI release 5.2(3), PIMv4 is supported on L3Out SVI interfaces for physical and directly connected port channels. PIMv4/PIMv6 is not supported on L3Out SVIs with vPC interfaces.
- Enabling PIMv4/PIM6 on an L3Out causes an implicit external network to be configured. This action results in the L3Out being deployed and protocols potentially coming up even if you have not defined an external network.
- If the multicast source is connected to Leaf-A as an orphan port and you have an L3Out on Leaf-B, and Leaf-A and Leaf-B are in a vPC pair, the EPG encapsulation VLAN tied to the multicast source will need to be deployed on Leaf-B.
- The behavior of an ingress leaf switch receiving a packet from a source that is attached to a bridge domain differs for Layer 3 IPv4 or IPv6 multicast support:

- For Layer 3 IPv4 multicast support, when the ingress leaf switch receives a packet from a source that is attached on a bridge domain, and the bridge domain is enabled for IPv4 multicast routing, the ingress leaf switch sends only a routed VRF instance copy to the fabric (routed implies that the TTL is decremented by 1, and the source-mac is rewritten with a pervasive subnet MAC). The egress leaf switch also routes the packet into receivers in all the relevant bridge domains. Therefore, if a receiver is on the same bridge domain as the source, but on a different leaf switch than the source, that receiver continues to get a routed copy, although it is in the same bridge domain. This also applies if the source and receiver are on the same bridge domain and on the same leaf switch, if PIM is enabled on this bridge domain.

For more information, see details about Layer 3 multicast support for multipod that leverages existing Layer 2 design, at the following link [Adding Pods](#).

- For Layer 3 IPv6 multicast support, when the ingress leaf switch receives a packet from a source that is attached on a bridge domain, and the bridge domain is enabled for IPv6 multicast routing, the ingress leaf switch sends only a routed VRF instance copy to the fabric (routed implies that the TTL is decremented by 1, and the source-mac is rewritten with a pervasive subnet MAC). The egress leaf switch also routes the packet into receivers. The egress leaf also decrements the TTL in the packet by 1. This results in TTL being decremented two times. Also, for ASM the multicast group must have a valid RP configured.
- You cannot use a filter with inter-VRF multicast communication.
- Do not use the **clear ip mroute** command. This command is used for internal debugging and is not supported in a production network.



Note Cisco ACI does not support IP fragmentation. Therefore, when you configure Layer 3 Outside (L3Out) connections to external routers, or Multi-Pod connections through an Inter-Pod Network (IPN), it is recommended that the interface MTU is set appropriately on both ends of a link. On some platforms, such as Cisco ACI, Cisco NX-OS, and Cisco IOS, the configurable MTU value does not take into account the Ethernet headers (matching IP MTU, and excluding the 14-18 Ethernet header size), while other platforms, such as IOS-XR, include the Ethernet header in the configured MTU value. A configured value of 9000 results in a max IP packet size of 9000 bytes in Cisco ACI, Cisco NX-OS, and Cisco IOS, but results in a max IP packet size of 8986 bytes for an IOS-XR untagged interface.

For the appropriate MTU values for each platform, see the relevant configuration guides.

We highly recommend that you test the MTU using CLI-based commands. For example, on the Cisco NX-OS CLI, use a command such as `ping 1.1.1.1 df-bit packet-size 9000 source-interface ethernet 1/1`.

Guidelines and Limitations for IPv4 Multicast

The following restrictions apply specifically for IPv4 multicast:

- If the border leaf switches in your Cisco ACI fabric are running multicast and you disable multicast on the L3Out while you still have unicast reachability, you will experience traffic loss if the external peer is a Cisco Nexus 9000 switch. This impacts cases where traffic is destined towards the fabric (where the sources are outside the fabric but the receivers are inside the fabric) or transiting through the fabric (where the source and receivers are outside the fabric, but the fabric is transit).
- Any Source Multicast (ASM) and Source-Specific Multicast (SSM) are supported for IPv4.

- You can configure a maximum of four ranges for SSM multicast in the route map per VRF instance.
- IGMP snooping cannot be disabled on pervasive bridge domains with multicast routing enabled.
- Layer 3 multicast is supported with FEX. Multicast sources or receivers that are connected to FEX ports are supported. For further details about how to add FEX in your testbed, see Configure a Fabric Extender with Application Centric Infrastructure at this URL: <https://www.cisco.com/c/en/us/support/docs/cloud-systems-management/application-policy-infrastructure-controller-apic/200529-Configure-a-Fabric-Extender-with-Applica.html>. Multicast sources or receivers that are connected to FEX ports are not supported.

Guidelines and Limitations for IPv6 Multicast

The following restrictions apply specifically for IPv6 multicast:

- Source Specific Multicast (SSM) is supported, but *RFC 3306 - Unicast-Prefix-based IPv6 Multicast Addresses* specifies a fixed SSM range. Therefore, the SSM range cannot be changed in IPv6.
- You can configure a maximum of four ranges for SSM multicast in the route map per VRF instance.
- Any Source Multicast (ASM) is supported for IPv6.
- OIF and VRF scale numbers for IPv6 are the same as they are for IPv4.
- For PIM6 only static RP configuration is supported. Auto-RP and BSR are not supported for PIM6.
- Receivers inside the fabric are not supported. MLD Snoop Policy must be disabled when enabling IPv6 multicast. MLD snooping and PIM6 cannot be enabled in the same VRF instance.
- Currently, Layer 3 Multicast Listener Discovery (MLD) is not supported with Cisco ACI.
- Fabric Rendezvous Point (RP) is not supported for IPv6 multicast.
- Cisco Multi-Site Orchestrator support is not available.

Configuring Layer 3 IPv4 Multicast Using the GUI

This section explains how to configure Layer 3 multicast using the Cisco APIC GUI.



Note Click the help icon (?) located in the top-right corner of the **Work** pane and of each dialog box for information about a visible tab or a field.

Before you begin

- The desired VRF, bridge domains, Layer 3 Out interfaces with IP addresses must be configured to enable PIM and IGMP.
- Basic unicast network must be configured.

Procedure

-
- Step 1** Navigate to **Tenants > Tenant_name > Networking > VRFs > VRF_name > Multicast**. In the **Work** pane, a message is displayed as follows: **PIM is not enabled on this VRF. Would you like to enable PIM?**
- Step 2** Click **YES, ENABLE MULTICAST**.
- Step 3** Configure interfaces:
- From the **Work** pane, click the **Interfaces** tab.
 - Expand the **Bridge Domains** table to display the **Create Bridge Domain** dialog and enter the appropriate value in each field.
 - Click **Select**.
 - Expand the **Interfaces** table to display the **Select an L3 Out** dialog.
 - Click the **L3 Out** drop-down arrow to choose an L3 Out.
 - Click **Select**.
- Step 4** Configure a rendezvous point (RP):
- In the **Work** pane, click the **Rendezvous Points** tab and choose from the following rendezvous point (RP) options:
 - **Static RP**
 - Expand the **Static RP** table.
 - Enter the appropriate value in each field.
 - Click **Update**.
 - **Fabric RP**
 - Expand the **Fabric RP** table.
 - Enter the appropriate value in each field.
 - Click **Update**.
 - **Auto-RP**
 - Enter the appropriate value in each field.
 - **Bootstrap Router (BSR)**
 - Enter the appropriate value in each field.
- Step 5** Configure the pattern policy:
- From the **Work** pane, click the **Pattern Policy** tab and choose the **Any Source Multicast (ASM)** or **Source Specific Multicast (SSM)** option.
 - Enter the appropriate value in each field.
- Step 6** Configure the PIM settings:
- Click the **PIM Setting** tab.

b) Enter the appropriate value in each field.

Step 7 Configure the IGMP settings:

- a) Click the **IGMP Setting** tab.
- b) Expand the **IGMP Context SSM Translate Policy** table.
- c) Enter appropriate value in each field.
- d) Click **Update**.

Step 8 Configure inter-VRF multicast:

- a) In the **Work** pane, click the **Inter-VRF Multicast** tab.
- b) Expand the **Inter-VRF Multicast** table.
- c) Enter appropriate value in each field.
- d) Click **Update**.

Step 9 When finished, click **Submit**.

Step 10 On the menu bar, navigate to **Tenants > Tenant_name > Networking > VRFs > VRF_name > Multicast**, and perform the following actions:

- a) In the **Work** pane, **Interfaces** tab, choose the appropriate L3 Out, and from the **PIM Policy** drop-down list, choose the appropriate PIM policy to attach.
- b) Click **Submit**.

Step 11 To verify the configuration perform the following actions:

- a) In the **Work** pane, click **Interfaces** to display the associated **Bridge Domains**.
- b) Click **Interfaces** to display the associated **L3 Out** interfaces.
- c) In the **Navigation** pane, navigate to the **BD**.
- d) In the **Work** pane, the configured IGMP policy and PIM functionality are displayed as configured earlier.
- e) In the **Navigation** pane, the L3 Out interface is displayed.
- f) In the **Work** pane, the PIM functionality is displayed as configured earlier.
- g) In the **Work** pane, navigate to **Fabric > Inventory > Protocols > IGMP** to view the operational status of the configured IGMP interfaces.
- h) In the **Work** pane, navigate to **Fabric > Inventory > Pod name > Leaf_Node > Protocols > IGMP > IGMP Domains** to view the domain information for multicast enabled/disabled nodes.

Configuring Layer 3 IPv6 Multicast Using the GUI

Before you begin

- The desired VRF, bridge domains, Layer 3 Out interfaces with IPv6 addresses must be configured to enable PIM6. For Layer 3 Out, for IPv6 multicast to work, an IPv6 loopback address is configured for the node in the logical node profile.
- Basic unicast network must be configured.

Procedure

-
- Step 1** On the menu bar, navigate to **Tenants > Tenant_name > Networking > VRFs > VRF_name > Multicast IPv6**.
In the **Work** pane, a message is displayed as follows: **PIM6 is not enabled on this VRF. Would you like to enable PIM6?**
- Step 2** Click **YES, ENABLE MULTICAST IPv6**.
- Step 3** Configure interfaces:
- From the **Work** pane, click the **Interfaces** tab.
 - Expand the **Bridge Domains** table to display the **Create Bridge Domain** dialog, and choose the appropriate BD from drop-down list.
 - Click **Select**.
 - Expand the **Interfaces** table to display the **Select an L3 Out** dialog box.
 - Click the **L3 Out** drop-down arrow to choose an L3 Out.
 - Click **Select**.
- Step 4** Configure a rendezvous point (RP).
- In the **Work** pane, click the **Rendezvous Points** tab, choose **Static RP**.
 - Enter the appropriate value in each field.
 - Click **Update**.
- Step 5** Configure the pattern policy.
- From the **Work** pane, click the **Pattern Policy** tab and choose **Any Source Multicast (ASM)**.
 - Enter the appropriate values in each field.
- Step 6** Configure the PIM settings.
- Click the **PIM Setting** tab.
 - Enter the appropriate value in each field.
- Step 7** When finished, click **Submit**.
- Step 8** On the menu bar, navigate to **Tenants > Tenant_name > Networking > VRFs > VRF_name > Multicast IPv6**, and perform the following actions:
- In the **Work** pane, **Interfaces** tab, choose the appropriate **L3 Out** and from the **PIM Policy** drop-down list, choose the appropriate PIM policy to attach.
 - Click **Submit**.
- Step 9** To verify the configuration perform the following actions:
- In the **Work** pane, click **Interfaces** to display the associated **Bridge Domains**.
 - In the **Navigation** pane, navigate to the associated BD with IPv6 multicast.
In the **Work** pane, the configured PIM functionality is displayed as configured earlier.
 - In the **Navigation** pane, navigate to the associated L3 Out interface.
In the **Work** pane, the PIM6 check box is checked.
 - In the **Work** pane, navigate to **Fabric > Inventory > Pod NodeProtocols > PIM6** and expand PIM.
Under the appropriate PIM6 protocol that was created earlier, you can view information about the associated Neighbors, PIM Interfaces, Routes, Group Ranges, and RPs. You can verify that all these objects are set up.
-

About BGP IPv4/IPv6 Multicast Address-Family



Note The IPv4 version of the BGP IPv4/IPv6 multicast address-family feature was available as part of Cisco APIC Release 4.1.

Beginning with Cisco APIC release 4.2(1), the BGP multicast address-family feature adds support for IPv6 for BGP peers towards external routers in the tenant VRF on the border leaf switch. You can specify if the peer will also be used separately to carry multicast routes in the IPv4/IPv6 multicast address-family.

The following figure shows how this feature might be implemented.

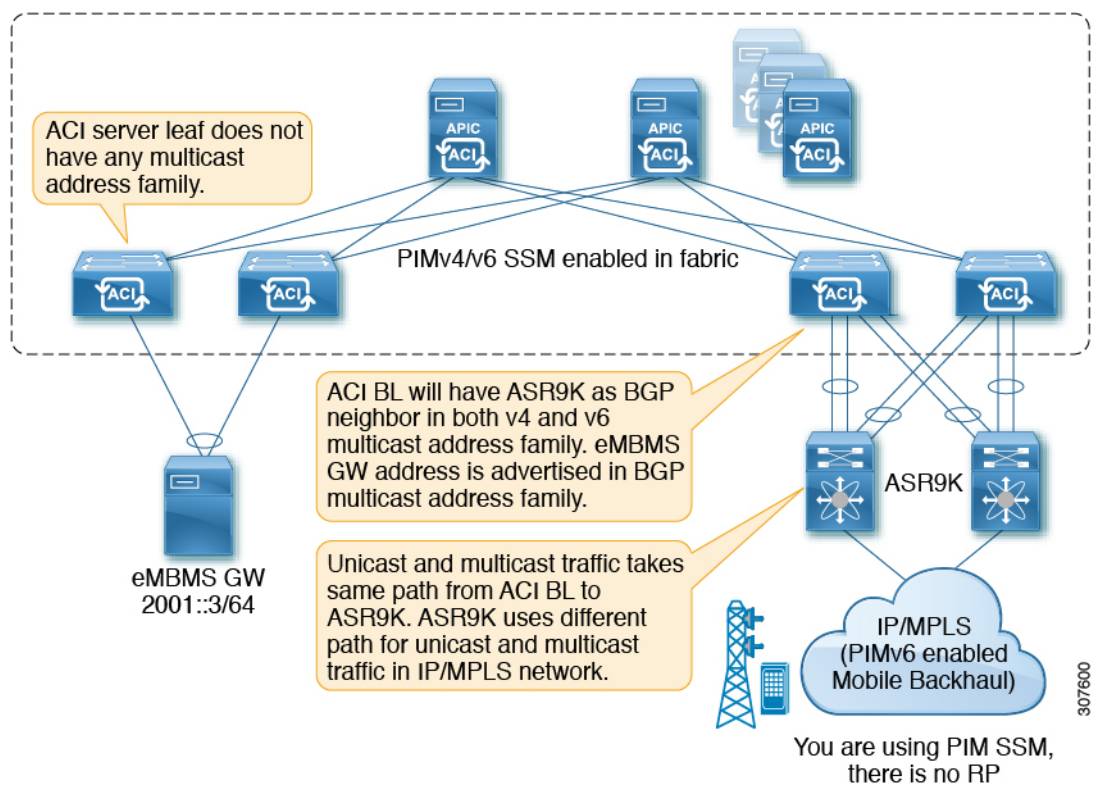

Guidelines and Limitations for BGP IPv4/IPv6 Multicast Address-Family

Guidelines and Restrictions for the BGP Multicast Address-Family Feature for IPv6

- The Rendezvous Point (RP) is an IP address that is external the Cisco ACI fabric. Fabric RP is not supported for IPv6 multicast.
- The multicast source is within the Cisco ACI fabric, and the receivers are outside of the fabric.
- Transit L3Out is not supported for BGPv4/v6 address-family.

Guidelines and Restrictions for the BGP Multicast Address-Family Feature for Both IPv4 and IPv6

- There is no support for BGPv4/v6 multicast address-family within the Cisco ACI fabric.
- RP reachability should be present in the unicast address-family, if that is being used. For PIM Source-Specific Multicast (SSM), there is no need for RP.

Configuring BGP IPv4/IPv6 Multicast Address-Family Using the GUI

The following procedure describes how to configure the BGP IPv4/IPv6 multicast address-family feature using the GUI.

Before you begin

Complete the standard prerequisites before configuring an L3Out, such as:

- Configure the tenant, node, port, functional profile, AEP, and Layer 3 domain.
- Configure a BGP Route Reflector policy to propagate the routes within the fabric.

Procedure

-
- Step 1** Locate the VRF that you will be using with the L3Out, or create the VRF, if necessary.
- Tenants** > *tenant* > **Networking** > **VRFs**
- Step 2** Enable PIMv4 or PIMv6 under the VRF.
- To enable PIMv4 under the VRF, on the menu bar, navigate to **Tenants** > *Tenant_name* > **Networking** > **VRFs** > *VRF_name* > **Multicast**.
 - If you see the message **PIM is not enabled on this VRF. Would you like to enable PIM?**, then click **Yes, enable Multicast**.
 - If you see the main **Multicast** window, check the **Enable** box, if it is not already checked.
 - To enable PIMv6 under the VRF, on the menu bar, navigate to **Tenants** > *Tenant_name* > **Networking** > **VRFs** > *VRF_name* > **Multicast IPv6**.
 - If you see the message **PIMv6 is not enabled on this VRF. Would you like to enable PIMv6?**, then click **Yes, enable multicast IPv6**.
 - If you see the main **Multicast IPv6** window, check the **Enable** box, if it is not already checked.
- Step 3** Create the L3Out and configure the BGP for the L3Out:
- a) On the **Navigation** pane, expand **Tenant** and **Networking**.
 - b) Right-click **L3Outs** and choose **Create L3Out**.
 - c) Enter the necessary information to configure BGP for the L3Out.
- In the **Identity** page:
- Select the VRF that you configured in the previous step.

- Select **BGP** in the **Identity** page in the L3Out creation wizard to configure the BGP protocol for this L3Out.

Create L3Out

1. Identity | 2. Nodes And Interfaces | 3. Protocols | 4. External EPG

Protocol

Leaf (L) --- Router (R)

Identity

A Layer 3 Outside network configuration (L3Out) defines how traffic is forwarded outside of the fabric. Layer 3 is used to discover the addresses of other nodes, select routes, select quality of service, and forward the traffic that is entering, exiting, and transiting the fabric.

Prerequisites:

- Configure the node, port, functional profile, AEP, and Layer 3 domain.
- Configure a BGP route reflector policy to propagate the routes within the fabric.

Name: L3Out-demo

VRF: VRF-demo

Layer 3 Domain: L3Domain-demo

Use for GOLP:

BGP | EIGRP | OSPF

Previous | Cancel | Next

- d) Continue through the remaining pages (**Nodes and Interfaces**, **Protocols**, and **External EPG**) to complete the configuration for the L3Out.

Step 4

After you have completed the L3Out configuration, configure the BGP IPv4/IPv6 multicast address-family feature:

- a) Navigate to the BGP Peer Connectivity Profile screen:

Tenants > *tenant* > **Networking** > **L3Outs** > *L3out-name* > **Logical Node Profiles** > *logical-node-profile-name* > **Logical Interface Profiles** > *logical-interface-profile-name* > **BGP Peer Connectivity Profile IP-address**

- b) Scroll down to the **Address Type Controls** field and make the following selections:

- Select **AF Mcast**.
- Leave **AF Ucast** selected, if it is already selected.

Peer Connectivity Profile - BGP Peer Connectivity Profile **192.3.3.3**

Properties

Address: **192.3.3.3**

Description: optional

BGP Controls:

Allow Self AS

AS override

Disable Peer AS Check

Next-hop Self

Send Community

Send Extended Community

Password:

Confirm Password:

Allowed Self AS Count: 3

Peer Controls: Bidirectional Forwarding Detection

Disable Connected Check

EBGP Multihop TTL: 1

Weight for routes from this neighbor: 0

Private AS Control: Remove all private AS

Remove private AS

Replace private AS with local AS

Address Type Controls: AF Mcast

AF Ucast

BGP Peer Prefix Policy: select a value

Pre-existing BGP session must be reset to apply the Prefix policy

Remote Autonomous System Number: 8

Local-AS Number Confir:

307998

- c) Click **Submit**.
- d) Navigate to the bridge domain with the subnet that needs to be redistributed to the peer's IPv4 or IPv6 multicast address-family:

Tenants > tenant > Networking > Bridge Domains > bridge_domain-name
- e) In the main pane, click the **Policy/General** tabs.
- f) Enable PIMv4 or PIMv6 on the bridge domain.
 - To enable PIMv4 on the bridge domain, scroll down to the **PIM** field and check the box next to that field to enable it.
 - To enable PIMv6 on the bridge domain, scroll down to the **PIMv6** field and check the box next to that field to enable it.

Bridge Domain - demoBD

100

Properties

Advertise Host Routes:

Enable Legacy Mode:

Legacy Mode: No

VLAN: _____

VRF: select a value

Resolved VRF: common/default

L2 Unknown Unicast: Flood Hardware Proxy

L3 Unknown Multicast Flooding: Flood Optimized Flood

IPv6 L3 Unknown Multicast: Flood Optimized Flood

Multi Destination Flooding: Flood in BD Drop Flood in Encapsulation

PIM:

PIMv6:

IGMP Policy: select an option

ARP Flooding:

IP Data-plane Learning: no yes

307699

g) Click **Submit**.

About Multicast Filtering

ACI supports control plane configurations that can be used to control who can receive multicast feeds and from which sources. The filtering options can be IGMP report filters, PIM join or prune filters, PIM neighbor filters, and Rendezvous Point (RP) filters. These options rely on control plane protocols, namely IGMP and PIM.

In some deployments, it may be desirable to constrain the sending and/or receiving of multicast streams at the data plane level. For example, you may want to allow multicast senders in a LAN to only send to specific multicast groups or to allow receivers in a LAN to only receive specific multicast groups originated from all the possible sources or from specific sources.

Beginning with Cisco APIC Release 5.0(1), the multicast filtering feature is now available, which allows you to filter multicast traffic from two directions:

- [Configuring Multicast Filtering: Source Filtering at First-Hop Router, on page 87](#)
- [Configuring Multicast Filtering: Receiver Filtering at Last-Hop Router, on page 87](#)
- [Combined Source and Receiver Filtering on Same Bridge Domain, on page 87](#)

Configuring Multicast Filtering: Source Filtering at First-Hop Router

For any sources that are sending traffic on a bridge domain, if you have configured a multicast source filter for that bridge domain, then the source and group will be matched against one of the entries in the source filter route map, where one of the following actions will take place, depending on the action that is associated with that entry:

- If the source and group is matched against an entry with a **Permit** action in the route map, then the bridge domain will allow traffic to be sent out from that source to that group.
- If the source and group is matched against an entry with a **Deny** action in the route map, then the bridge domain will block traffic from being sent out from that source to that group.
- If there is no match with any entries in the route map, then the bridge domain will block traffic from being sent out from that source to that group as the default option. This means that once the route map is applied, there is always an implicit "deny all" statement in effect at the end.

You can configure multiple entries in a single route map, where some entries can be configured with a **Permit** action and other entries can be configured with a **Deny** action, all within the same route map.



Note When a source filter is applied to a bridge domain, it will filter multicast traffic at the source. The filter will prevent multicast from being received by receivers in different bridge domains, the same bridge domain, and external receivers.

Configuring Multicast Filtering: Receiver Filtering at Last-Hop Router

Multicast receiver filtering is used to restrict from which sources receivers in a bridge domain can receive multicast for a particular group. This feature provides source or group data plane filtering functionality for IGMPv2 hosts, similar to what IGMPv3 provides at the control plane.

For any receivers sending joins on a bridge domain, if you have configured a multicast receiver filter for that bridge domain, then the source and group will be matched against one of the entries in the receiver filter route map, where one of the following actions will take place, depending on the action that is associated with that entry:

- If the source and group is matched against an entry with a **Permit** action in the route map, then the bridge domain will allow traffic to be received from that source for that group.
- If the source and group is matched against an entry with a **Deny** action in the route map, then the bridge domain will block traffic from being received from that source for that group.
- If there is no match with any entries in the route map, then the bridge domain will block traffic from being received from that source for that group as the default option. This means that once the route map is applied, there is always an implicit "deny all" statement in effect at the end.

You can configure multiple entries in a single route map, where some entries can be configured with a **Permit** action and other entries can be configured with a **Deny** action, all within the same route map.

Combined Source and Receiver Filtering on Same Bridge Domain

You can also enable both multicast source filtering and multicast receiver filtering on the same bridge domain, where one bridge domain can perform blocking or can permit sources to filtering when sending traffic to a

group range, and can also perform restricting or can allow restricting to filtering when receiving traffic from sources to a group range.

Guidelines and Restrictions for Multicast Filtering

Following are the guidelines and restrictions for the multicast filtering feature:

- While you can enable either the multicast source filtering or the receiver filtering on a bridge domain, you can also have both multicast source filtering and receiver filtering enabled on the same bridge domain.
- Multicast filtering is supported only for IPv4.
- If you do not want to have multicast filters on a bridge domain, then do not configure a source filter or destination filter route maps on that bridge domain. By default, no route maps are associated with a bridge domain, which means that all sources and groups are allowed. If a route map with source filters or destination filters is associated with a bridge domain, only the permit entries in that route map will be allowed, and all deny entries will be blocked (including the implicit "deny-all" statement always present at the end).
- If you attach an empty route map to a bridge domain, route maps assume a deny-all by default, so all sources and groups will be blocked on that bridge domain.
- The multicast filtering feature is applied at the bridge domain level. ACI supports configuration of multiple EPGs in a single bridge domain. When this configuration is used with the bridge domain filtering features, the filter will be applied across all EPGs in the bridge domain as it is a bridge domain level setting.
- The multicast filtering feature is intended to be used for Any-Source Multicast (ASM) ranges only. If, however, you have support for Source-Specific Multicast (SSM) ranges, then we recommend that sources and joins be filtered in the SSM join itself using IGMPv3.

If you configure SSM ranges for the multicast filtering feature, the following restrictions apply:

- **Bridge domain source filtering with SSM:** Source filtering is not supported with SSM.
- **Bridge domain receiver filtering with SSM:** Receiver filtering can be used with SSM group ranges. One of the main use cases for receiver filtering is to filter multicast streams from specific sources. In most cases, receiver filtering is not needed with SSM as this functionality is already provided by the SSM protocol.
- Source and receiver filtering use an ordered list of route-map entries. Route-map entries are executed with the lowest number first until there is a match. If there is a match, even if it is not the longest match in the list, it will exit the program and will not consider the rest of the entries.

For example, assume that you have the following route map for a specific source (192.0.3.1/32), with these entries:

Table 6: Route Map

Order	Source IP	Action
1	192.0.0.0/16	Permit
2	192.0.3.0/24	Deny

The route map is evaluated based on the order number. Therefore, even though the second entry (192.0.3.0/24) is a longer match for the source IP, the first entry (192.0.0.0/16) will be matched because of the earlier order number.

Configuring Multicast Filtering Using the GUI

You will be configuring multicast filtering at the bridge domain level. Use the procedures in this topic to configure either source filtering or receiver filtering, or both, at the bridge domain level.

Before you begin

- The bridge domain where you will be configuring multicast filtering is already created.
- The bridge domain is a PIM-enabled bridge domain.
- Layer 3 multicast is enabled at the VRF level.

Procedure

Step 1 Navigate to the bridge domain where you want to configure multicast filtering.

Tenant > *tenant-name* > **Networking** > **Bridge Domains** > *bridge-domain-name*

The Summary page for this bridge domain appears.

Step 2 Select the **Policy** tab, then select the **General** subtab.

Step 3 In the **General** window, locate the **PIM** field and verify that PIM is enabled (that there is a check in the box next to the **PIM** field).

If PIM is not enabled, put a check in the box next to the **PIM** field to enable that now. The **Source Filter** and **Destination Filter** fields become available.

Note

Multicast filtering is supported only for IPv4 (PIM), and is not supported for IPv6 (PIM6) at this time.

Step 4 Determine whether you want to enable multicast *source* or *receiver* filtering.

Note

You can also enable both source and receiver filtering on the same bridge domain.

- If you want to enable multicast *source* filtering at the first-hop router, in the **Source Filter** field, make one of the following selections:
 - **Existing route map policy**: Select an existing route map policy for multicast for the source filtering, then go to [Step 7, on page 91](#).
 - **New route map policy**: Select **Create Route Map Policy for Multicast**, then proceed to [Step 5, on page 90](#).
- If you want to enable multicast *receiver* filtering at the last-hop router, in the **Destination Filter** field, make one of the following selections:

- **Existing route map policy:** Select an existing route map policy for multicast for the receiver filtering, then go to [Step 7, on page 91](#).
- **New route map policy:** Select **Create Route Map Policy for Multicast**, then proceed to [Step 6, on page 91](#).

Step 5 If you selected the **Create Route Map Policy for Multicast** option to enable multicast **source** filtering at the first-hop router, the **Create Route Map Policy for Multicast** window appears. Enter the following information in this window:

- In the **Name** field, enter a name for this route map, and enter a description in the **Description** field, if desired.
 - In the **Route Maps** area, click +.
- The **Create Route Map Entry** window appears.
- In the **Order** field, if multiple access groups are being configured for this interface, select a number that reflects the order in which this access group will be permitted or denied access to the multicast traffic on this interface.

Lower-numbered entries are ordered before higher-numbered entries. The range is from 0 to 65535.

- Determine how you want to allow or deny traffic to be sent for multicast source filtering.
 - If you want to allow or deny multicast traffic to be sent from **a specific source to any group**, in the **Source IP** field, enter the IP address of the specific source from which the traffic is sent, and leave the **Group IP** field empty.
 - If you want to allow or deny multicast traffic to be sent from **any source to a specific group**, in the **Group IP** field, enter the multicast IP address to which the traffic is sent, and leave the **Source IP** field empty.
 - If you want to allow or deny multicast traffic to be sent from **a specific source to a specific group**, enter the necessary information in both the **Group IP** and the **Source IP** fields.

Note

The **RP IP** field is not applicable for multicast source filtering or multicast receiver filtering. Any entry in this field will be ignored for multicast filtering, so do not enter a value in this field for this feature.

- In the **Action** field, choose **Deny** to deny access or **Permit** to allow access for the target source.
- Click **OK**.

The **Create Route Map Policy for Multicast** window appears again, with the route map entry that you configured displayed in the **Route Maps** table.

- Determine if you want to create additional route map entries for this route map.

You can create multiple route map entries for a route map, each with their own IP addresses and related actions. For example, you might want to have one set of IP addresses with a **Permit** action applied, and another set of IP addresses with a **Deny** action applied, all within the same route map.

If you want to create additional route map entries for this route map, click + in the **Route Maps** area again, then go to [5.c, on page 90](#) to repeat the steps for filling in the necessary information in the **Create Route Map Entry** window for the additional route map entries for this route map.

- When you have completed all of the route map entries for this route map, click **Submit**. Go to [Step 7, on page 91](#).

Step 6 If you selected the **Create Route Map Policy for Multicast** option to enable multicast **destination** (receiver) filtering at the last-hop router, the **Create Route Map Policy for Multicast** window appears. Enter the following information in this window:

- a) In the **Name** field, enter a name for this route map, and enter a description in the **Description** field, if desired.
- b) In the **Route Maps** area, click +.

The **Create Route Map Entry** window appears.

- c) In the **Order** field, if multiple access groups are being configured for this interface, select a number that reflects the order in which this access group will be permitted or denied access to the multicast traffic on this interface.

Lower-numbered entries are ordered before higher-numbered entries. The range is from 0 to 65535.

- d) Determine if you want to allow or deny traffic to be received for multicast receiver filtering.
 - If you want to allow or deny traffic from being received from **any source to a specific group**, in the **Group IP** field, enter the multicast IP address to which the traffic is sent, and leave the **Source IP** field empty.
 - If you want to allow or deny traffic from being received from **a specific source to any group**, in the **Source IP** field, enter the IP address of the specific source from which the traffic is sent, and leave the **Group IP** field empty.
 - If you want to allow or deny traffic from being received from **a specific source to a specific group**, enter the necessary information in both the **Group IP** and the **Source IP** fields.

Note

The **RP IP** field is not applicable for multicast source filtering or multicast receiver filtering. Any entry in this field will be ignored for multicast filtering, so do not enter a value in this field for this feature.

- e) In the **Action** field, choose **Deny** to deny access or **Permit** to allow access for the target group.
- f) Click **OK**.

The **Create Route Map Policy for Multicast** window appears again, with the route map entry that you configured displayed in the **Route Maps** table.

- g) Determine if you want to create additional route map entries for this route map.

You can create multiple route map entries for a route map, each with their own IP addresses and related actions. For example, you might want to have one set of IP addresses with a **Permit** action applied, and another set of IP addresses with a **Deny** action applied, all within the same route map.

If you want to create additional route map entries for this route map, click + in the **Route Maps** area again, then go to [6.c, on page 91](#) to repeat the steps for filling in the necessary information in the **Create Route Map Entry** window for the additional route map entries for this route map.

- h) When you have completed all of the route map entries for this route map, click **Submit**. Go to [Step 7, on page 91](#).

Step 7 At the bottom righthand corner of the Policy/General page, click **Submit**.

The **Policy Usage Warning** window appears.

- Step 8** Verify that it is acceptable that the nodes and policies displayed in the table in the Policy Usage Warning window will be affected by this policy change to enable multicast source and/or destination filtering, then click **Submit Changes**.

About Layer 3 Multicast on an SVI L3Out

Layer 3 multicast on an L3Out SVI adds support for enabling PIM on L3Out SVIs. This allows the ACI border leaf switch configured with an L3Out SVI to establish PIM adjacencies with an external multicast router or firewall.

Firewalls are usually deployed in active/standby pairs, where both firewalls connect to the fabric on the same VLAN and subnet, as shown below.

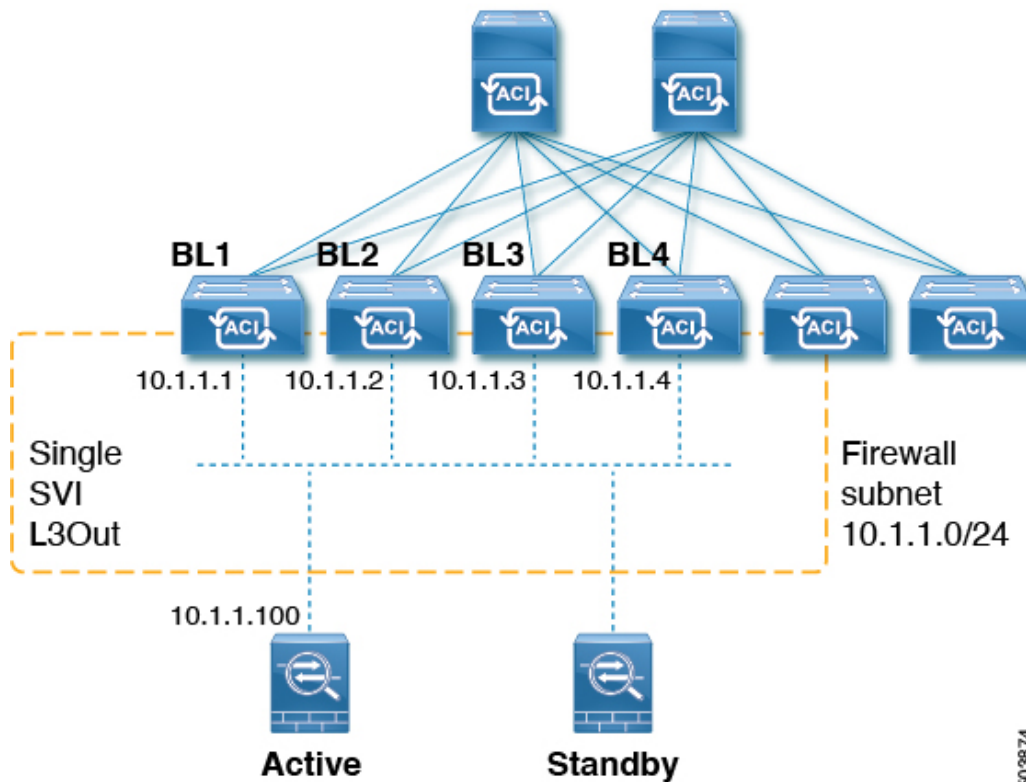

503874

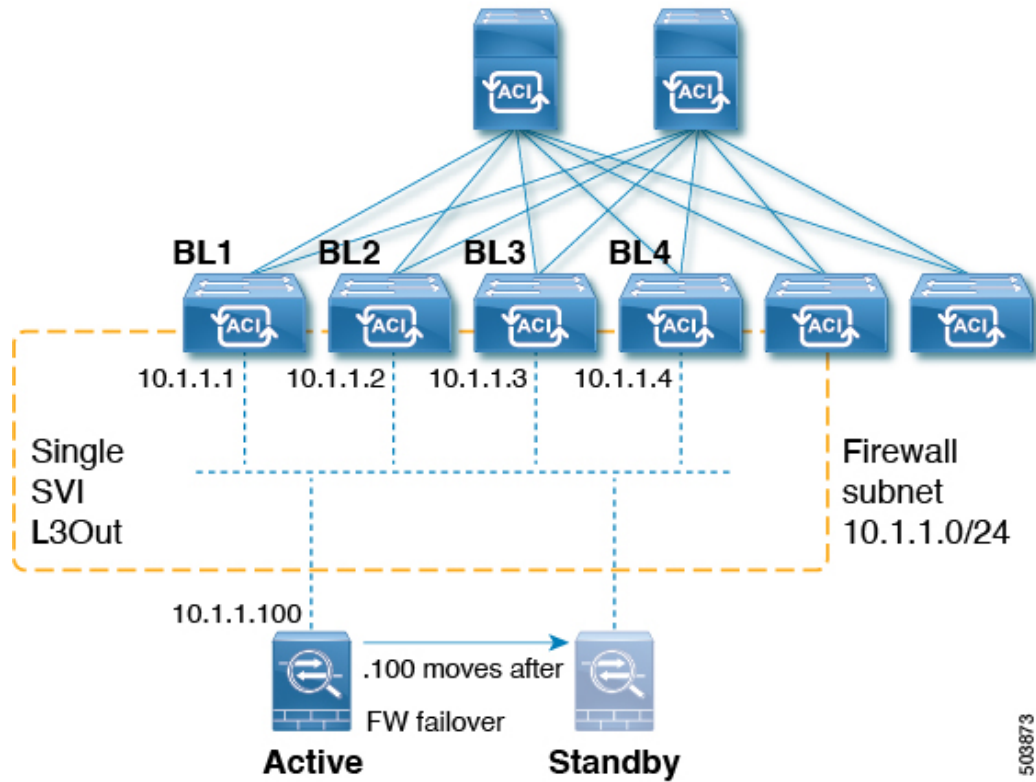

Because this is a LAN-like topology, it requires an SVI L3Out on the fabric side. Beginning with release 5.2(3), support is available for Layer 3 multicast on an SVI L3Out.

An L3Out SVI is an interface type where a Layer 3 SVI interface is configured on every border leaf switch where the SVI is deployed. When PIM is enabled on an L3Out that is configured with an SVI, the PIM protocol will be enabled on the border leaf switch that is part of the SVI. All SVIs will then form PIM adjacencies with each other and any external PIM-enabled devices.

L3Out to Firewall Example Topology

The following figure shows an example topology for an L3Out to firewalls.

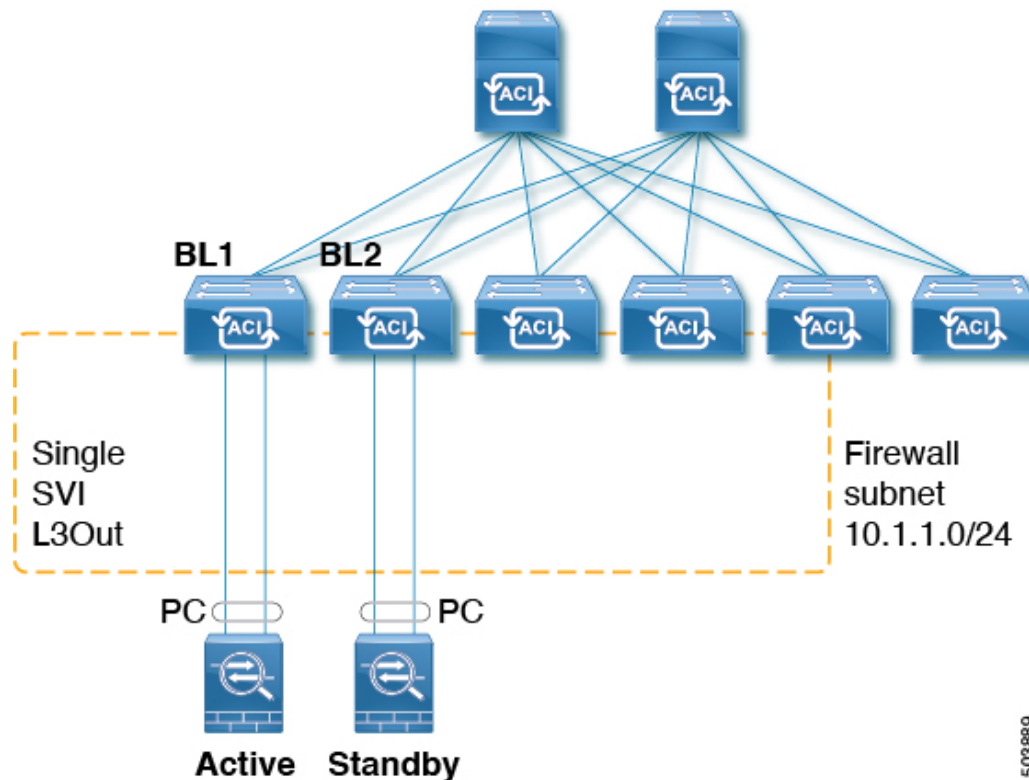

In this example, BL1 and BL2 are the border leaf switches on the fabric. Both border leaf switches are on the same SVI L3Out that connects to the external firewalls. Each firewall is connected to one of the two border leaf switches over a port-channel (non-vPC).

- Each border leaf switch will form a PIM neighbor adjacency to the active firewall.
- BL2 in the example will peer to the active firewall over the fabric tunnel for the L3Out external bridge domain.
- The active firewall can send PIM joins/prunes to both BL1 and BL2.
- One of the two border leaf switches will send the PIM joins towards the firewall. The border leaf switch that sends the PIM join towards the firewall is determined by the stripe winner selection for the multicast group (group and source for SSM).
- BL2 can be selected as the stripe winner for a multicast group. BL2 in the example topology is not directly connected to the active firewall. BL1 will notify BL2 that it is the directly connected reverse path forwarding (RPF) to the source. BL2 can send the PIM via BL1. BL2 must be able to perform a recursive lookup for the IP address of the firewall. This functionality is provided by the attached-host redistribution feature. A route-map matching the firewall subnet must be configured for attached-host redistribution on the L3Out.

L3Out SVI to External Switch/Router Example Topology

The following figure shows an example topology for an L3Out SVI to external switches or routers.

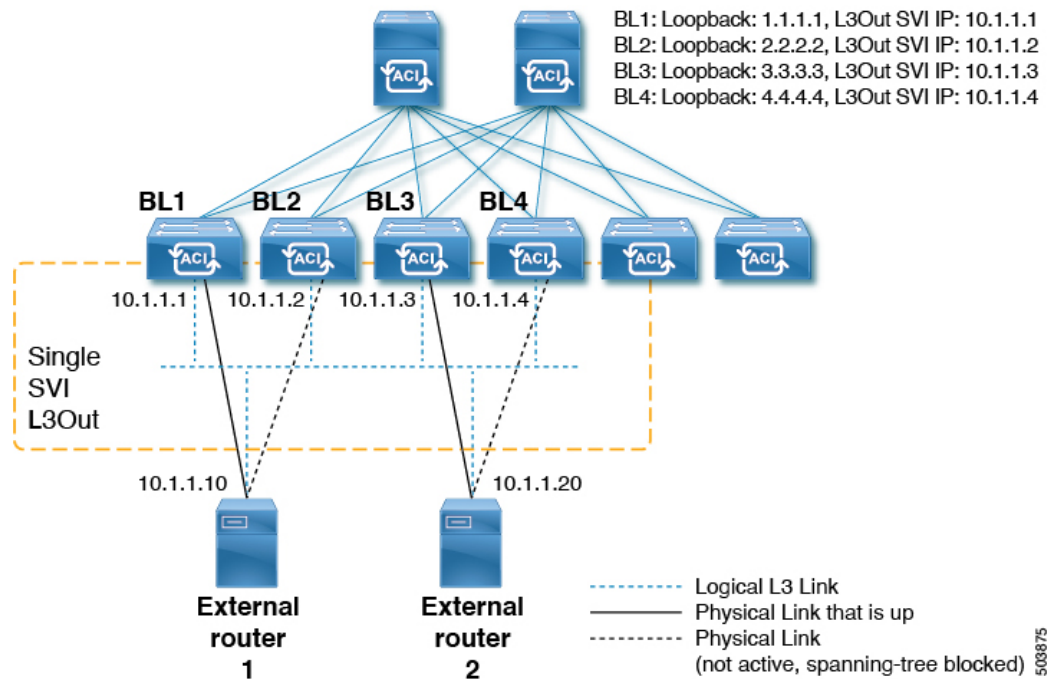

With respect to the Layer 3 multicast states and multicast data traffic, the components in the figure above are affected in the following manner:

- BL1, BL2, BL3, and BL4 are the border leaf switches on the fabric. All of these border leaf switches are on the same SVI L3Out that connect to the external boxes, where the external boxes could be any external switch or router.
- Logically, the Layer 3 link is up between the border leaf switches and the external routers. So a full mesh adjacency exists with regards to unicast routing protocol(s) or PIM across the border leaf switches and the external switches/routers on the SVI L3Out.
- Since the SVI L3Out is a bridge domain, even if there are multiple physical connections from border leaf switches to the external switches/routers, only one link among them will be up at the Layer 2 level to each external switch/router. All of the other links will be blocked by STP.

For example, in the figure above, only the following links at the Layer 2 level are up:

- The link between BL1 and external router 1
- The link between BL3 and external router 2

So for all of the other border leaf switches, this makes the IP addresses 10.1.1.10 reachable only through BL1 and 10.1.1.20 reachable only through BL3.

Guidelines and Limitations

- An attached-host route-map must be configured for the PIM-enabled SVI L3Out. This route-map should match all directly-connected external PIM neighbors. The 0.0.0.0/0 subnet can be used.
- For the Layer 3 multicast on an SVI L3Out feature, the following areas are supported or unsupported:
 - **Supported:**

- Protocol Independent Multicast (PIM) Any Source Multicast (ASM) and Source-Specific Multicast (SSM)
- SVI with physical interfaces
- SVI with direct port-channels (non-vPC)
- All topology combinations:
 - Source inside receiver inside (SIRI)
 - Source inside receiver outside (SIRO)
 - Source outside receiver inside (SORI)
 - Source outside receiver outside (SORO)
- **Unsupported:**
 - Layer 3 multicast with VPC over an SVI L3Out
 - Source or receiver hosts connected directly on the SVI subnet (source or receiver hosts must be connected behind a router on the SVI L3Out)
 - Stretched SVI L3Out between local leaf switches (ACI main data center switches) and remote leaf switches
 - Stretched SVI L3Out across sites (Cisco ACI Multi-Site)
 - SVI L3Out for PIMv6
 - Secondary IP addresses. PIM joins/prunes will not be processed if sent to the secondary IP address of the border leaf switch. Secondary IP address are typically used for configuring a shared (virtual) IP address across border leaf switches for static routing. We recommend that you use dynamic routing when configuring PIM over SVIs or create static routes to each border leaf switch primary address.

Configuring Layer 3 Multicast on an SVI L3Out Using the GUI

Procedure

-
- Step 1** Configure a standard L3Out using the Create L3Out wizard with `svi` set as the Layer 3 interface type.
- a) In the GUI **Navigation** pane, under the Tenant Example, navigate to **Networking > L3Outs**.
 - b) Right-click and choose **Create L3Out**.
 - c) In the **Create L3Out** screen, in the **Identity** window, enter a name for the L3Out and select a VRF and L3 domain to associate with this L3Out.
 - d) Click Next when you have entered the necessary information in the **Identity** window. The **Nodes and Interfaces** window appears.
 - e) In the **Nodes and Interfaces** window, in the **Interface Types: Layer 3** field, choose `svi` as the Layer 3 interface type.

- f) Continue configuring the individual fields through the Create L3Out wizard until you have completed the L3Out configuration.

Step 2 Navigate to the configured L3Out:

Tenants > *tenant_name* > **Networking** > **L3Outs** > *L3Out_name*

The **Summary** page for the configured L3Out is displayed.

Step 3 Click on the **Policy** tab, then the **Main** subtab.

The **Properties** page for the configured L3Out is displayed.

Step 4 In the **Route Profile for Redistribution** field, click + to configure a route profile for redistribution.

Step 5 In the **Source** field, choose **attached-host**.

Step 6 In the **Route Map** field, configure a route map that permits all.

- a) Click **Create Route Maps for Route Control**.

The **Create Route Maps for Route Control** window is displayed.

- b) Enter a name and description for this route map, then click + in the **Contexts** area.

The **Create Route Control Context** window is displayed.

- c) Configure the necessary parameters in the **Create Route Control Context** window, with the value in the **Action** field set to **Permit**.

- d) Click + in the **Associated Match Rules** area, then choose **Create Match Rule for a Route Map** to configure the match rules for this route control context.

The **Create Match Rule** window is displayed.

- e) Click + in the **Match Prefix** area.

The **Create Match Route Destination Rule** window is displayed.

- f) In the **Create Match Route Destination Rule** window, enter the following values in these fields to configure a match rule with an aggregate route matching the subnet or 0.0.0.0/0 route and aggregate setting:

- **IP:** 0.0.0.0/0
- **Aggregate:** Check the box in this field. The **Greater Than Mask** and **Less Than Mask** fields appear.
- **Greater Than Mask:** 0
- **Less Than Mask:** 0

- g) Click **Submit** to configure this match route destination rule.

Step 7 Once you have configured a route map that permits all, configure an external EPG with an export route control subnet that does an aggregate export of the aggregate route or the 0.0.0.0/0 route.

- a) Navigate to the configured external EPG:

Tenants > *tenant_name* > **Networking** > **L3Outs** > *L3Out_name* > **External EPGs** > *external_EPG_name*

The **Properties** page for the configured L3Out is displayed. You should be in the **Policy/General** page by default.

- b) In the **Subnets** area, double-click on the 0.0.0.0/0 entry that you just configured. The **Properties** window for this configured subnet is displayed.
 - c) In the **Route Control** area, make the following selections:
 - Check the box next to the **Export Route Control Subnet** field.
 - In the **Aggregate** area, check the box next to the **Aggregate Export** field.
 - d) Click **Submit**.
-



CHAPTER 13

Multi-Pod

This chapter contains the following sections:

- [About Multi-Pod, on page 99](#)
- [Multi-Pod Provisioning, on page 100](#)
- [Guidelines for Setting Up a Cisco ACI Multi-Pod Fabric, on page 101](#)
- [Setting Up the Multi-Pod Fabric, on page 104](#)
- [Sample IPN Configurations for Multi-Pod For Cisco Nexus 9000 Series Switches, on page 107](#)
- [Moving an APIC from One Pod to Another Pod, on page 109](#)
- [Migrating from an OSPF IPN Underlay to a BGP IPN Underlay, on page 110](#)
- [About Multi-Pod Spines Back-to-Back, on page 111](#)
- [Troubleshooting Multi-Site and Multi-Pod, on page 112](#)

About Multi-Pod

Multi-Pod enables provisioning a more fault-tolerant fabric comprised of multiple pods with isolated control plane protocols. Also, Multi-Pod provides more flexibility with regard to the full mesh cabling between leaf and spine switches. For example, if leaf switches are spread across different floors or different buildings, Multi-Pod enables provisioning multiple pods per floor or building and providing connectivity between pods through spine switches.

Multi-Pod uses MP-BGP EVPN as the control-plane communication protocol between the ACI spines in different pods.

In releases before Cisco APIC Release 5.2(3), OSPF is used in the underlay to peer between the physical spines and the IPN. Beginning with Cisco APIC Release 5.2(3), the underlay protocol can be OSPF or BGP (eBGP only) or a mixture, with some pods using OSPF and some using BGP.

WAN routers can be provisioned in the Inter-Pod Network (IPN), directly connected to spine switches, or connected to border leaf switches. Spine switches connected to the IPN are connected to at least one leaf switch in the pod.

Multi-Pod uses a single APIC cluster for all the pods; all the pods act as a single fabric. Individual APIC controllers are placed across the pods but they are all part of a single APIC cluster.

Figure 10: Multi-Pod Overview

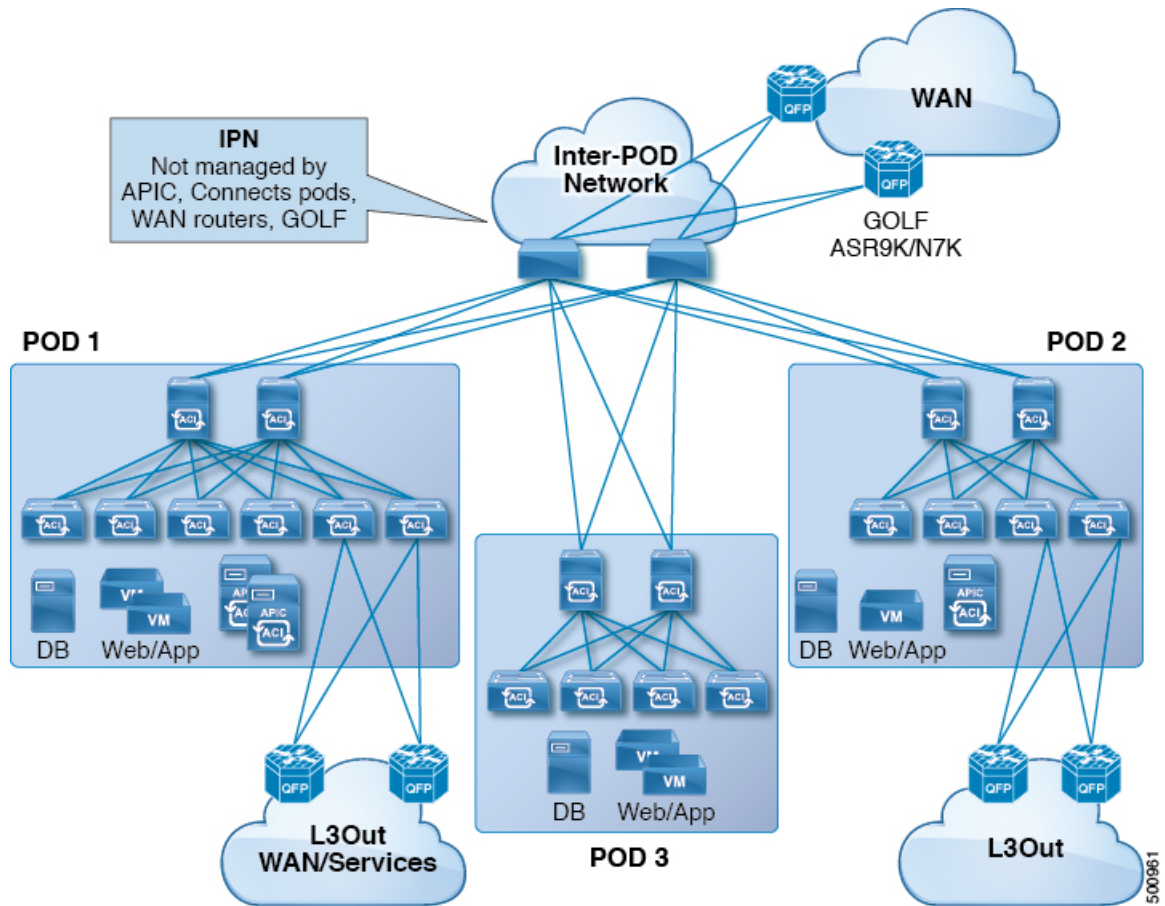

Note Beginning with Cisco APIC Release 5.2(3), a fabric consisting of only two pods can be connected directly, without an IPN. For information about this Multi-Pod Spines Back-to-Back topology, see [About Multi-Pod Spines Back-to-Back](#), on page 111.

Multi-Pod Provisioning

The IPN is not managed by the APIC. It must be preconfigured with the following information:

- Configure the interfaces connected to the spines of all pods. Use Layer 3 sub-interfaces tagging traffic with VLAN-4 and increase the MTU at least 50 bytes above the maximum MTU required for inter-site control plane and data plane traffic.

If remote leaf switches are included in any pods, see [Remote Leaf Switches](#), on page 115 and the [Cisco ACI Remote Leaf Architecture White Paper](#).

- If the IPN underlay protocol will be OSPF, enable OSPF on sub-interfaces with the correct area ID. Beginning with Cisco APIC Release 5.2(3), the IPN underlay protocol can be either OSPF or BGP (eBGP only).

- Enable DHCP Relay on IPN interfaces connected to all spines.
- Enable PIM.
- Add bridge domain GIPO range as PIM Bidirectional (**bidir**) group range (default is 225.0.0.0/15).
A group in **bidir** mode has only shared tree forwarding capabilities.
- Add 239.255.255.240/28 as PIM **bidir** group range.
- Enable PIM and IGMP on the interfaces connected to all spines.



Note When deploying PIM **bidir**, at any given time it is only possible to have a single active RP (Rendezvous Point) for a given multicast group range. RP redundancy is hence achieved by leveraging a **Phantom RP** configuration. Because multicast source information is no longer available in Bidir, the Anycast or MSDP mechanism used to provide redundancy in sparse-mode is not an option for **bidir**.

Figure 11: Multi-Pod Provisioning

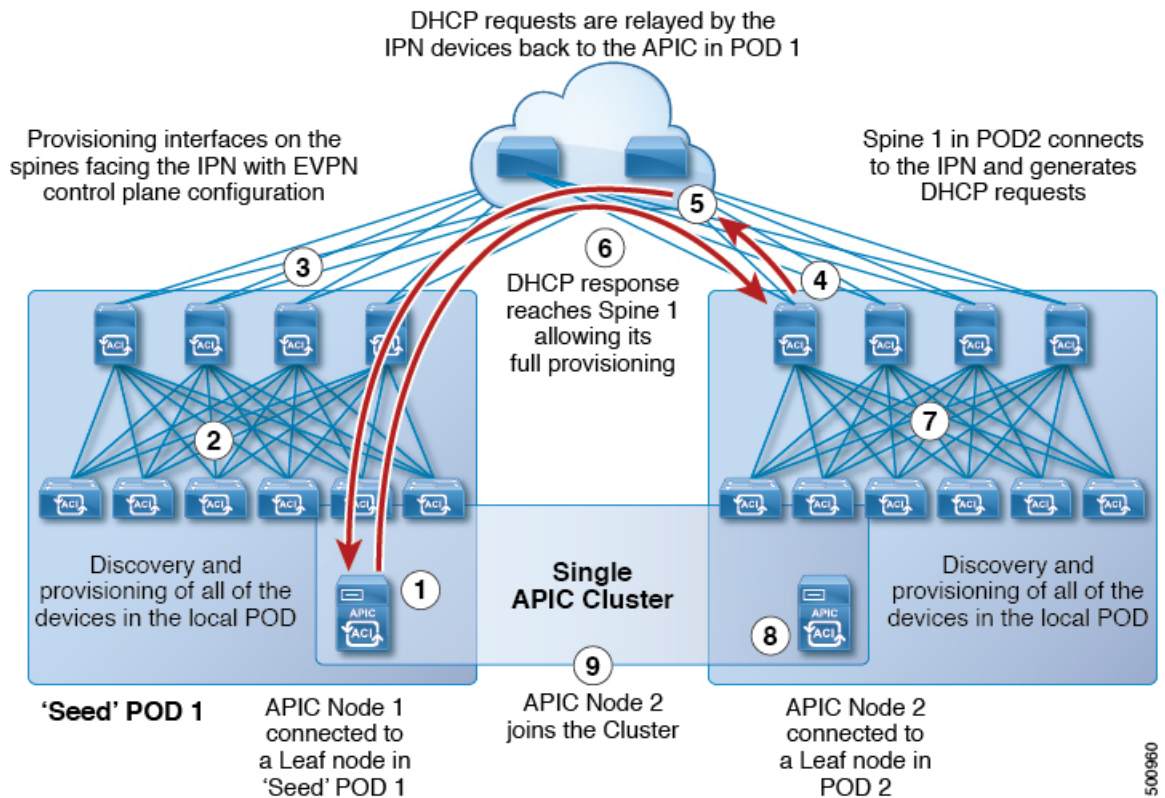

500960

Guidelines for Setting Up a Cisco ACI Multi-Pod Fabric

To configure a Cisco ACI Multi-Pod fabric, follow these guidelines:

- Cisco ACI Multi-Pod is supported on the following:

- All ACI-mode spine switches
 - All Cisco Nexus 9000 Series ACI-mode leaf switches
 - All of the Cisco Nexus 9500 platform ACI-mode switch line cards and fabric modules
- Create the associated node group and Layer 3 Outside (L3Out) policies.
 - Before you make any changes to a spine switch, ensure that there is at least one operationally “up” external link that is participating in the Cisco ACI Multi-Pod topology. Failure to do so could bring down the Cisco ACI Multi-Pod connectivity.
 - If you have to convert a Cisco ACI Multi-Pod setup to a single pod (containing only Pod 1), the Cisco Application Policy Infrastructure Controllers (APICs) connected to the pods that are decommissioned should be re-initialized and connected to the leaf switches in Pod 1, which will allow them to re-join the cluster after going through the initial setup script. See [Moving an APIC from One Pod to Another Pod, on page 109](#) for those instructions. The TEP pool configuration should not be deleted.
 - Cisco ACI GOLF (also known as Layer 3 EVPN Services for Fabric WAN) and Cisco ACI Multi-Pod can be deployed together over all the switches used in the Cisco ACI Multi-Pod and EVPN topologies. For more information on GOLF, see [Cisco ACI GOLF, on page 393](#).
 - In a Cisco ACI Multi-Pod fabric, the Pod 1 configuration (with the associated TEP pool) must always exist on Cisco APIC, as the Cisco APIC nodes are always addressed from the Pod 1 TEP pool. This remains valid also in the scenario where the Pod 1 is physically decommissioned (which is a fully supported procedure) so that the original Pod 1 TEP pool is not re-assigned to other pods that may be added to the fabric.
 - In a Cisco ACI Multi-Pod fabric setup, if a new spine switch is added to a pod, it must first be connected to at least one leaf switch in the pod. This enables the Cisco APIC to discover the spine switch and join it to the fabric.
 - After a pod is created and nodes are added in the pod, deleting the pod results in stale entries from the pod that are active in the fabric. This occurs because the Cisco APIC uses open source DHCP, which creates some resources that the Cisco APIC cannot delete when a pod is deleted
 - If you connect spine switches belonging to separate pods with direct back-to-back links, an OSPF neighborhood might get established on the peer interface between the two spine switches. If there is a mismatch between the peer interfaces, with one of the peers having the Cisco ACI Multi-Pod direct flag disabled, the session won't be up and forwarding will not happen. Even though the system will throw a fault in this situation, this is expected behavior.
 - Beginning with Cisco APIC release 5.2(3), the IPN underlay protocol can be external BGP (eBGP). Internal BGP (iBGP) is not supported as the underlay protocol.

When preparing to migrate a Cisco ACI Multi-Pod fabric between OSPF and BGP as the IPN underlay, follow these guidelines:

- A BGP underlay is not supported if the Cisco ACI fabric is connected to a cloud site or to a GOLF router.
 - A BGP underlay supports only an IPv4 address family, not an IPv6 address family.
- When deploying Cisco APIC cluster connectivity to the fabric over a Layer 3 network, which was introduced in Cisco APIC release 5.2(1), the IPN network can use OSPF as the underlay protocol, or a

BGP underlay if the Cisco APIC connects to the fabric using the same network that provides Cisco ACI Multi-Pod or remote leaf switch connectivity.

- If you delete and recreate the Cisco ACI Multi-Pod L3Out, for example to change the name of a policy, a clean reload of some of the spine switches in the fabric must be performed. The deletion of the Cisco ACI Multi-Pod L3Out causes one or more of the spine switches in the fabric to lose connectivity to the Cisco APICs and these spine switches are unable to download the updated policy from the Cisco APIC. Which spine switches get into such a state depends upon the deployed topology. To recover from this state, a clean reload must be performed on these spine switches. The reload is performed using the **setup-clean-config,sh** command, followed by the reload command on the spine switch.

**Note**

Cisco ACI does not support IP fragmentation. Therefore, when you configure Layer 3 Outside (L3Out) connections to external routers, or Multi-Pod connections through an Inter-Pod Network (IPN), it is recommended that the interface MTU is set appropriately on both ends of a link. On some platforms, such as Cisco ACI, Cisco NX-OS, and Cisco IOS, the configurable MTU value does not take into account the Ethernet headers (matching IP MTU, and excluding the 14-18 Ethernet header size), while other platforms, such as IOS-XR, include the Ethernet header in the configured MTU value. A configured value of 9000 results in a max IP packet size of 9000 bytes in Cisco ACI, Cisco NX-OS, and Cisco IOS, but results in a max IP packet size of 8986 bytes for an IOS-XR untagged interface.

For the appropriate MTU values for each platform, see the relevant configuration guides.

We highly recommend that you test the MTU using CLI-based commands. For example, on the Cisco NX-OS CLI, use a command such as `ping 1.1.1.1 df-bit packet-size 9000 source-interface ethernet 1/1`.

**Note**

Cisco APIC will always establish a TCP connection to fabric switches with an MTU of 1496 bytes (TCP MSS 1456) regardless of the CP-MTU setting. The IPN network for remote pods and remote leaf switches must support at least 1500 byte MTU for fabric discovery.

- You can set the global MTU for control plane (CP) packets sent by the nodes (Cisco APIC and the switches) in the fabric at **System > System Settings > Control Plane MTU**.
- In a Cisco ACI Multi-Pod topology, the MTU set for the fabric external ports must be greater than or equal to the CP MTU value set. Otherwise, the fabric external ports might drop the CP MTU packets.
- If you change the IPN or CP MTU, we recommend changing the CP MTU value first, then changing the MTU value on the spine of the remote pod. This reduces the risk of losing connectivity between the pods due to MTU mismatch. This is to ensure that the MTU across all the interfaces of the IPN devices between the pods is large enough for both control plane and VXLAN data plane traffic at any given time. For data traffic, keep in mind the extra 50 bytes due to VXLAN.
- To decommission a pod, decommission all the nodes in the pod. For instructions, see *Decommissioning and Re-commissioning a Pod* in *Cisco APIC Troubleshooting Guide*.

Setting Up the Multi-Pod Fabric

In Cisco Application Policy Infrastructure Controller (APIC) 4.0(1) and later, a wizard was added to the GUI to simplify Multi-Pod configuration. To configure Multi-Pod using the GUI, follow the procedures in this section.

Setting up Multi-Pod between two physical pods involves preparing an existing physical pod to communicate over the interpod network (IPN) with the new pod. You then add the physical pod, and Cisco APIC creates the Multi-Pod fabric.

You can also configure Multi-Pod using the NX-OS style CLI and REST API. See the sections [Setting Up Multi-Pod Fabric Using the NX-OS CLI, on page 430](#) and [Setting Up Multi-Pod Fabric Using the REST API, on page 508](#) in this guide for instructions.

Preparing the Pod for IPN Connectivity

Before you create a new pod, you first must ensure that the existing physical pod can communicate with the new pod.

Procedure

-
- Step 1** Log in to the Cisco APIC.
- Step 2** Navigate to **Fabric > Inventory**.
- Step 3** Expand **Quick Start** and click **Add Pod**.
- Step 4** In the work pane, click **Add Pod**.
- Step 5** In the **Configure Interpod Connectivity STEP 1 > Overview** panel, review the tasks that are required to configure interpod network (IPN) connectivity, and then click **Get Started**.
- Step 6** In the **Configure Interpod Connectivity STEP 2 > IP Connectivity** dialog box, complete the following steps:
- If you see a **Name** field in an **L3 Outside Configuration** area, choose an existing fabric external routing profile from the **Name** drop-down list.
 - Using the **Spine ID** selector, choose the spine.
Click the + (plus) icon to add the IDs of more spines.
 - In the **Interfaces** area, in the **Interface** field, enter the spine switch interface (slot and port) used to connect to the IPN.
Click the + (plus) icon to add more interfaces.
 - In the **IPv4 Address** field, enter the IPv4 gateway address and network mask for the interface.
 - From the **MTU (bytes)** drop-down list, choose a value for the maximum transmit unit of the external network.
The range is 1500 to 9216.
 - Click **Next**.
- Step 7** In the **Configure Interpod Connectivity STEP 3 > Routing Protocols** dialog box, you configure the underlay protocol to peer between the physical spines and the IPN. In releases before Cisco APIC Release 5.2(3), Open

Shortest Path First (OSPF) is the only supported underlay. For those earlier releases, or in a later release if you choose **OSPF** as the **Underlay**, complete the following substeps in the **OSPF** area:

- a) Leave the **Use Defaults** checked or uncheck it.

When the **Use Defaults** check box is checked, the GUI conceals the optional fields for configuring OSPF. When it is unchecked, it displays all the fields. The check box is checked by default.

- b) In the **Area ID** field, enter the OSPF area ID.
- c) In the **Area Type** area, choose an OSPF area type.

You can choose **NSSA area** or **Regular area**. **Stub area** is not supported.

- d) (Optional) With the **Area Cost** selector, choose an appropriate OSPF area cost value. This field appears only when the **Use Defaults** checkbox is unchecked.
- e) From the **Interface Policy** drop-down list, choose or configure an OSPF interface policy.

You can choose an existing policy, or you can create one with the **Create OSPF Interface Policy** dialog box.

- Step 8** Beginning with Cisco APIC Release 5.2(3), the underlay protocol can be either OSPF or BGP. For releases before Cisco APIC Release 5.2(3), or if you chose **OSPF** as the **Underlay** in the preceding step, skip this step. If you choose **BGP** as the **Underlay** in the **Configure Interpod Connectivity STEP 3 > Routing Protocols** dialog box, complete the following substeps in the **BGP** area to configure the BGP underlay:

In the **MP-BGP** area, leave the **Use Defaults** check box checked. The GUI conceals the fields for configuring Multiprotocol Border Gateway Protocol (MP-BGP).

- a) Note the nonconfigurable values in the **Spine ID**, **Interface**, and **IPv4 Address** fields.
- b) In the **Peer Address** field, enter the IP address of the BGP neighbor.
- c) In the **Remote AS** field, enter the Autonomous System (AS) number of the BGP neighbor.
- d) Click **Next**.

- Step 9** In the **Configure Interpod Connectivity STEP 4 > External TEP** dialog box, complete the following steps:

- a) Leave the **Use Defaults** checked or uncheck it.

When the **Use Defaults** check box is checked, the GUI conceals the optional fields for configuring the external TEP pool. When it is unchecked, it displays all the fields. The check box is checked by default.

- b) Note the nonconfigurable values in the **Pod** and **Internal TEP Pool** fields.
- c) In the **External TEP Pool** field, enter the external TEP pool for the physical pod.

The external TEP pool must not overlap the internal TEP pool or external TEP pools belonging to other pods.

- d) In the **Data Plane TEP IP** field enter the address that is used to route traffic between pods. This address must have a /32 subnet mask.

You can accept the default address that is generated when you configure the **External TEP Pool**. Alternatively, you can enter another address, but it must be outside of the external TEP pool.

- e) In the **Router ID** field, enter the IPN router IP address.
- f) (Optional) In the **Loopback Address** field, enter the IPN router loopback IP address.

If you uncheck the **Use Defaults**, the Cisco APIC displays the nonconfigurable **Unicast TEP IP** and **Spine ID** fields.

- g) Click **Finish**.

The **Summary** panel appears, displaying details of the IPN configuration. You can also click **View JSON** to view the REST API for the configuration. You can save the REST API for later use.

What to do next

Take one of the following actions:

- You can proceed directly with adding a pod, continuing with the procedure [Adding a Pod to Create a Multi-Pod Fabric, on page 106](#) in this guide.
- Close the **Configure Interpod Connectivity** dialog box and add the pod later, returning to the procedure [Adding a Pod to Create a Multi-Pod Fabric, on page 106](#) in this guide.

Adding a Pod to Create a Multi-Pod Fabric

The **Add Physical Pod** dialog enables you to set up a Multi-Pod environment. You define a new physical pod ID and tunnel endpoint (TEP) pool. You also configure the new pod network settings and the subinterfaces for the physical spines.

Before you begin

You have performed the following tasks:

- Created the node group and L3Out policies.
- Configured the interpod network (IPN). For a sample configuration, see [Sample IPN Configurations for Multi-Pod For Cisco Nexus 9000 Series Switches, on page 107](#) in this guide.
- Prepared an existing pod to communicate with the new pod over the IPN. See the procedure [Preparing the Pod for IPN Connectivity, on page 104](#) in this guide.
- Made sure that the spine switch that connects to the IPN also connects to at least one leaf switch in the pod.
- Created a tunnel endpoint (TEP) pool. See the procedure [Preparing the Pod for IPN Connectivity, on page 104](#) in this guide.

Procedure

-
- Step 1** Log in to Cisco Application Policy Infrastructure Controller (APIC).
- Step 2** Take one of the following actions:
- If you completed the procedure [Preparing the Pod for IPN Connectivity, on page 104](#) and have not closed the **Configure Interpod Connectivity** dialog box, skip Step 3 through Step 5, and resume this procedure at Step 6.
 - If you have completed the procedure [Preparing the Pod for IPN Connectivity, on page 104](#) and have closed the **Configure Interpod Connectivity** dialog box, proceed to Step 3 in this procedure.
- Step 3** Choose **Fabric > Inventory**.
- Step 4** Click **Quick Start** and click **Add Pod**.

Step 5 In the work pane, click **Add Pod**.

Step 6 In the **Add Physical Pod STEP 2 > Pod Fabric** dialog box, complete the following steps:

- a) In the **Pod ID** field, choose the pod ID.

The pod ID can be any positive integer; however, it must be unique in the Cisco ACI fabric.

- b) In the **Pod TEP Pool** field, enter the pool address and subnet.

The pod TEP pool represents a range of traffic encapsulation identifiers and is a shared resource and can be consumed by multiple domains.

- c) With the **Spine ID** selector, choose the spine ID.

Choose more spine IDs by clicking the + (plus) icon.

- d) In the **Interfaces** area, in the **Interface** field, enter the spine switch interface (slot and port) that is used to connect to the interpod network (IPN).

- e) In the **IPv4 Address** field, enter the IPv4 gateway address and network mask for the interface.

- f) In the **MTU (bytes)** field, choose a value for the maximum transmit unit (MTU) of the external network.

You can configure another interface by clicking the + (plus) icon.

Step 7 In the **Add Physical Pod STEP 3 > External TEP** dialog box, complete the following steps:

- a) Leave the **Use Defaults** check box checked or uncheck it to display the optional fields to configure an external TEP pool.

- b) Note the values in the **Pod** and **Internal TEP Pool** fields, which are already configured.

- c) In the **External TEP Pool** field, enter the external TEP pool for the physical pod.

The external TEP pool must not overlap the internal TEP pool.

- d) In the **Dataplane TEP IP** field, enter the address that is used to route traffic between pods.

- e) (Optional) In the **Unicast TEP IP** field, enter the unicast TEP IP address.

Cisco APIC automatically configures the unicast TEP IP address when you enter the data plane TEP IP address.

- f) (Optional) Note the value in the nonconfigurable **Node** field.

- g) (Optional) In the **Router ID** field, enter the IPN router IP address.

Cisco APIC automatically configures the router IP address when you enter the data plane TEP address.

- h) In the **Loopback Address** field, enter the router loopback IP address.

Leave the **Loopback Address** blank if you use a router IP address.

- i) Click **Finish**.

Sample IPN Configurations for Multi-Pod For Cisco Nexus 9000 Series Switches

For releases before Cisco APIC Release 5.2(3), the IPN underlay protocol is OSPF. Beginning with Cisco APIC Release 5.2(3), the IPN underlay protocol can be either OSPF or BGP (eBGP only).

**Note**

- The deployment of a dedicated VRF in the IPN for Inter-Pod connectivity is optional, but is a best practice recommendation. You can also use a global routing domain as an alternative.
- For the area of the sample configuration that shows `ip dhcp relay address 10.0.0.1`, this configuration is valid based on the assumption that the TEP pool of Pod 1 is 10.0.0.0/x.

Sample IPN Configuration with OSPF Underlay Protocol

```
(pod1-spine1)-----2/7[ IPN-N9K ]2/9----- (pod2-spine1)

feature dhcp
feature pim

service dhcp
ip dhcp relay
ip pim ssm range 232.0.0.0/8

# Create a new VRF for Multipod.
vrf context fabric-mpod
 ip pim rp-address 12.1.1.1 group-list 225.0.0.0/15 bidir
 ip pim rp-address 12.1.1.1 group-list 239.255.255.240/28 bidir
 ip pim ssm range 232.0.0.0/8

interface Ethernet2/7
 no switchport
 mtu 9150
 no shutdown

interface Ethernet2/7.4
 description pod1-spine1
 mtu 9150
 encapsulation dot1q 4
 vrf member fabric-mpod
 ip address 201.1.2.2/30
 ip router ospf a1 area 0.0.0.0
 ip pim sparse-mode
 ip dhcp relay address 10.0.0.1
 ip dhcp relay address 10.0.0.2
 ip dhcp relay address 10.0.0.3
 no shutdown

interface Ethernet2/9
 no switchport
 mtu 9150
 no shutdown

interface Ethernet2/9.4
 description to pod2-spine1
 mtu 9150
 encapsulation dot1q 4
 vrf member fabric-mpod
 ip address 203.1.2.2/30
 ip router ospf a1 area 0.0.0.0
 ip pim sparse-mode
 ip dhcp relay address 10.0.0.1
```



```

ip dhcp relay address 10.0.0.2
ip dhcp relay address 10.0.0.3
no shutdown

interface loopback29
 vrf member fabric-mpod
 ip address 12.1.1.1/32

router ospf a1
 vrf fabric-mpod
  router-id 29.29.29.29

```

Sample IPN Configuration with BGP Underlay Protocol

Beginning with Cisco APIC Release 5.2(3), the IPN underlay protocol can be BGP instead of OSPF. The following configuration can be appended to the previous example and the OSPF configuration can be removed.

```

router bgp 200
  router-id 29.29.29.29
  vrf fabric-mpod
  address-family ipv4 unicast
neighbor 201.1.2.3
  remote-as 65000
  address-family ipv4 unicast
  disable-peer-as-check
neighbor 203.1.2.3
  remote-as 65000
  address-family ipv4 unicast
  disable-peer-as-check

```

Moving an APIC from One Pod to Another Pod

Use this procedure to move an APIC from one pod to another pod in an Multi-Pod setup.

Procedure

-
- Step 1** Decommission the APIC in the cluster.
- On the menu bar, choose **System > Controllers**.
 - In the **Navigation** pane, expand **Controllers > apic_controller_name > Cluster as Seen by Node**.
 - In the **Navigation** pane, click an **apic_controller_name** that is within the cluster and not the controller that is being decommissioned.
 - In the **Work** pane, verify that the **Health State** in the **Active Controllers** summary table indicates the cluster is **Fully Fit** before continuing.
 - In the **Work** pane, click **Actions > Decommission**.
 - Click **Yes**.
The decommissioned controller displays **Unregistered** in the **Operational State** column. The controller is then taken out of service and no longer visible in the **Work** pane.
- Step 2** Move the decommissioned APIC to the desired pod.

Step 3 Enter the following commands to reboot the APIC.

```
apic1# acidiag touch setup
apic1# acidiag reboot
```

Step 4 In the APIC setup script, specify the pod ID where the APIC node has been moved.

- a) Log in to Cisco Integrated Management Controller (CIMC).
- b) In the pod ID prompt, enter the pod ID.

Note

Do not modify the **TEP Pool** address information.

Step 5 Recommission the APIC.

- a) From the menu bar, choose **SYSTEM > Controllers**.
- b) In the **Navigation** pane, expand **Controllers > apic_controller_name > Cluster as Seen by Node**.
- c) From the **Work** pane, verify in the **Active Controllers** summary table that the cluster **Health State** is **Fully Fit** before continuing.
- d) From the **Work** pane, click the decommissioned controller that displaying **Unregistered** in the **Operational State** column.
- e) From the **Work** pane, click **Actions > Commission**.
- f) In the **Confirmation** dialog box, click **Yes**.
- g) Verify that the commissioned Cisco APIC controller is in the operational state and the health state is **Fully Fit**.

Migrating from an OSPF IPN Underlay to a BGP IPN Underlay

Beginning with Cisco APIC Release 5.2(3), the IPN underlay protocol can be either OSPF or BGP. To migrate a pod from using an OSPF underlay to a BGP underlay, add a BGP interface to the Logical Interface Profile under the existing IPN-connected L3Out. When that interface is successfully connected to a running BGP peer, you can delete the OSPF Interface Profile.



Note When both OSPF and BGP are used in the underlay for Multi-Pod, Multi-Site, or Remote Leaf, do not redistribute router-ids into BGP from OSPF on IPN routers. Doing so may cause a routing loop and bring down OSPF and BGP sessions between the spine switch and IPN routers.



Note Migrating the underlay protocol is a disruptive action and should be done only during a maintenance window.

Procedure

Step 1 From the APIC menu bar, navigate to **Tenants > infra > Networking > L3Outs > your IPN L3Out**, where **your IPN L3Out** is the L3Out that connects to the IPN.

- Step 2** In the Navigation pane, expand *your IPN L3Out* and navigate to **Logical Node Profiles** > *your IPN node profile* > **Logical Interface Profiles** > *your IPN interface*, where *your IPN interface* is the Logical Interface Profile for the current IPN connection.
- The Logical Interface Profile table appears in the work pane.
- Step 3** In the work pane, click the **Policy** tab and the **Routed Sub-Interfaces** tab below the **Policy** tab.
- Step 4** In the **Routed Sub-Interfaces** table, double-click the interface of the current IPN connection.
- The **Routed Sub-Interface** dialog box opens.
- Step 5** In the **Routed Sub-Interface** dialog box, perform the following actions:
- Click the + icon in the **BGP Peer Connectivity Profiles** bar to add a BGP peer connection.
- The **Create Peer Connectivity Profiles** dialog box opens.
- In the **Peer IPv4 Address** field, enter the IP address of the BGP peer.
 - Configure any other desired settings for the BGP peer connection.
- Note**
- If you are configuring for migration but not actually migrating at this time, you can set the **Admin State** to **Disabled** for now and return to this step when you are ready to migrate. Migration should be done during a maintenance window.
- Click **Submit** to return to the **Routed Sub-Interface** dialog box.
- Step 6** In the **Routed Sub-Interface** dialog box, click **Submit**.
- Step 7** In the Navigation pane, navigate to **Logical Node Profiles** > *your IPN node profile* > **Configured Nodes** > *your IPN node*. Follow these steps to verify that the BGP neighbor is UP.
- Expand *your IPN node* and locate the BGP entry, such as *BGP for VRF-overlay-1*.
 - Expand the BGP entry and click **Neighbors**.
 - In the **Neighbors** table, find the peer IP address that you configured in **Peer IPv4 Address**, and verify that the **State** is "established."
- Step 8** In the Navigation pane, under **Logical Interface Profiles**, right-click the current OSPF Interface Profile and select **Delete**.
- Note**
- Before deleting the OSPF Interface Profile, make sure that the BGP neighbor is UP.
- Step 9** In the Navigation pane, navigate to **Tenants** > **infra** > **Networking** > **L3Outs** > *your IPN L3Out*.
- Step 10** In the work pane, click the **Policy** tab and the **Main** tab below the **Policy** tab.
- Step 11** In the work pane, in the **Enable BGP/EIGRP/OSPF** section, uncheck **OSPF**, leaving **BGP** checked.
- Step 12** Click **Submit**.

About Multi-Pod Spines Back-to-Back

Beginning with Cisco APIC Release 5.2(3), the ACI Multi-Pod architecture is enhanced to support connecting the spines of two Pods directly with back-to-back ("B2B") links. With this solution, called Multi-Pod Spines Back-to-Back, the IPN requirement can be removed for small ACI Multi-Pod deployments. Multi-Pod Spines

Back-to-Back also brings operational simplification and end-to-end fabric visibility, as there are no external devices to configure.

In the Multi-Pod Spines Back-to-Back topology, the back-to-back spine link interfaces are implemented as L3Outs in the infra tenant. These links are typically carried on direct cable or dark fiber connections between the Pods. Multi-Pod Spines Back-to-Back supports only Open Shortest Path First (OSPF) connectivity between the spine switches belonging to different Pods.

The following figure shows a Multi-Pod Spines Back-to-Back topology with back-to-back spines connected between Pod1 and Pod2.

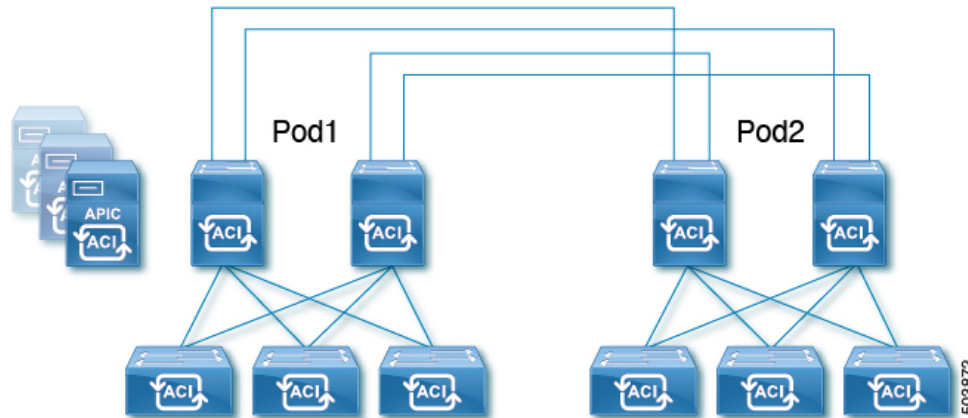

For detailed information about Multi-Pod Spines Back-to-Back, see the Cisco knowledge base article [Cisco ACI Multi-Pod Spines Back-to-Back](#).

Troubleshooting Multi-Site and Multi-Pod

This section describes how to troubleshoot Multi-Site and Multi-Pod.

Error:400

If you receive the following error:

```
Error:400 - Invalid Configuration Following Intersite Spines are not configured as Mpod Spines: 1202
```

You must enable the fabric external connectivity for all the existing spines and if you are trying to add new spines use the **Setup Multipod** GUI wizard.

There are two ways to resolve this issue.

- Enable all the spines under the external routed network:
 - In the APIC GUI, on the menu bar, click **Tenant > infra**.
 - In the **Navigation** pane, expand **Networking > External Routed Networks**, right-click on the external routed network and choose **Enable Fabric External Connectivity**.
- Add new spines under the external routed network:
 - In the APIC GUI, on the menu bar, click **Fabric**.

- In the **Navigation** pane, expand **Quick Start > Node or Pod Setup > Setup Multipod** and complete the Multipod setup.



CHAPTER 14

Remote Leaf Switches

This chapter contains the following sections:

- [About Remote Leaf Switches in the ACI Fabric, on page 115](#)
- [Remote Leaf Switch Hardware Requirements, on page 123](#)
- [Remote Leaf Switch Restrictions and Limitations, on page 123](#)
- [WAN Router and Remote Leaf Switch Configuration Guidelines, on page 127](#)
- [Configure the Pod and Fabric Membership for Remote Leaf Switches Using the GUI, on page 128](#)
- [About Direct Traffic Forwarding, on page 138](#)
- [Remote Leaf Switch Failover, on page 143](#)
- [Prerequisites Required Prior to Downgrading Remote Leaf Switches, on page 145](#)

About Remote Leaf Switches in the ACI Fabric

With an ACI fabric deployed, you can extend ACI services and APIC management to remote data centers with Cisco ACI leaf switches that have no local spine switch or APIC attached.

The remote leaf switches are added to an existing pod in the fabric. All policies deployed in the main data center are deployed in the remote switches, which behave like local leaf switches belonging to the pod. In this topology, all unicast traffic is through VXLAN over Layer 3. Layer 2 broadcast, unknown unicast, and multicast (BUM) messages are sent using Head End Replication (HER) tunnels without the use of Layer 3 multicast (bidirectional PIM) over the WAN. Any traffic that requires use of the spine switch proxy is forwarded to the main data center.

The APIC system discovers the remote leaf switches when they come up. From that time, they can be managed through APIC, as part of the fabric.



Note

- All inter-VRF traffic (pre-release 4.0(1)) goes to the spine switch before being forwarded.
- For releases prior to Release 4.1(2), before decommissioning a remote leaf switch, you must first delete the vPC.

Characteristics of Remote Leaf Switch Behavior in Release 4.0(1)

Starting in Release 4.0(1), remote leaf switch behavior takes on the following characteristics:

- Reduction of WAN bandwidth use by decoupling services from spine-proxy:
 - PBR: For local PBR devices or PBR devices behind a vPC, local switching is used without going to the spine proxy. For PBR devices on orphan ports on a peer remote leaf, a RL-vPC tunnel is used. This is true when the spine link to the main DC is functional or not functional.
 - ERSPAN: For peer destination EPGs, a RL-vPC tunnel is used. EPGs on local orphan or vPC ports use local switching to the destination EPG. This is true when the spine link to the main DC is functional or not functional.
 - Shared Services: Packets do not use spine-proxy path reducing WAN bandwidth consumption.
 - Inter-VRF traffic is forwarded through an upstream router and not placed on the spine.
 - This enhancement is only applicable for a remote leaf vPC pair. For communication across remote leaf pairs, a spine proxy is still used.
- Resolution of unknown L3 endpoints (through ToR glean process) in a remote leaf location when spine-proxy is not reachable.

Characteristics of Remote Leaf Switch Behavior in Release 4.1(2)

Before Release 4.1(2), all local switching (within the remote leaf vPC peer) traffic on the remote leaf location is switched directly between endpoints, whether physical or virtual, as shown in the following figure.

Figure 12: Local Switching Traffic: Prior to Release 4.1(2)

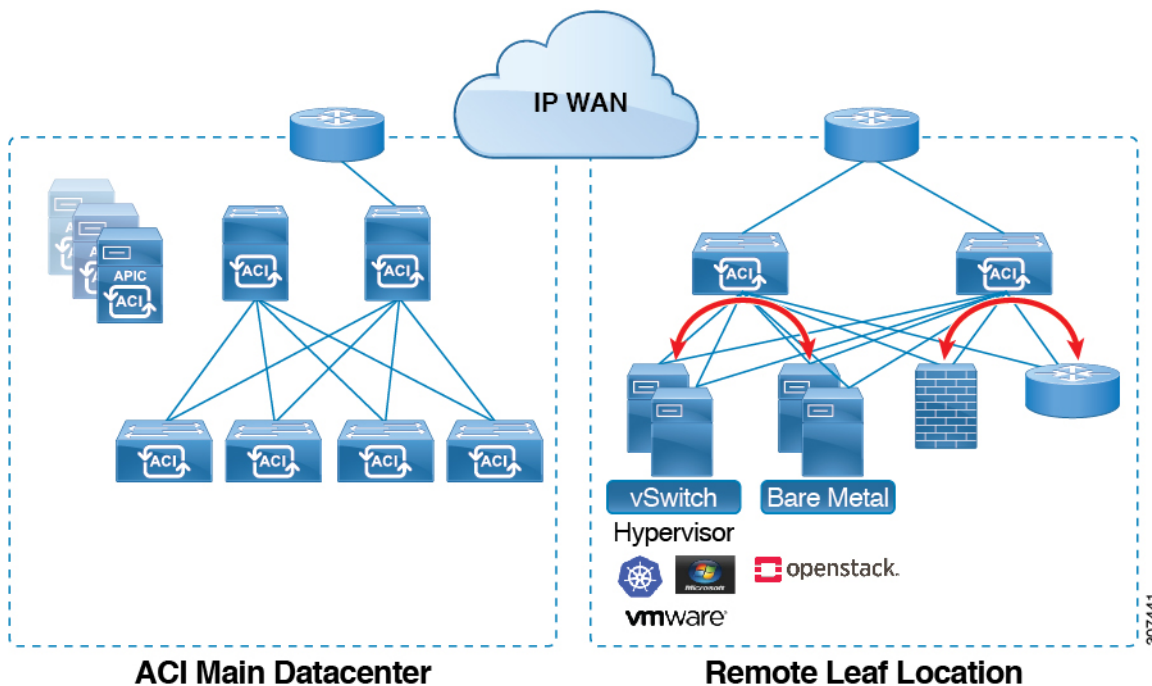

In addition, before Release 4.1(2), traffic between the remote leaf switch vPC pairs, either within a remote location or between remote locations, is forwarded to the spine switches in the ACI main data center pod, as shown in the following figure.

Figure 13: Remote Switching Traffic: Prior to Release 4.1(2)

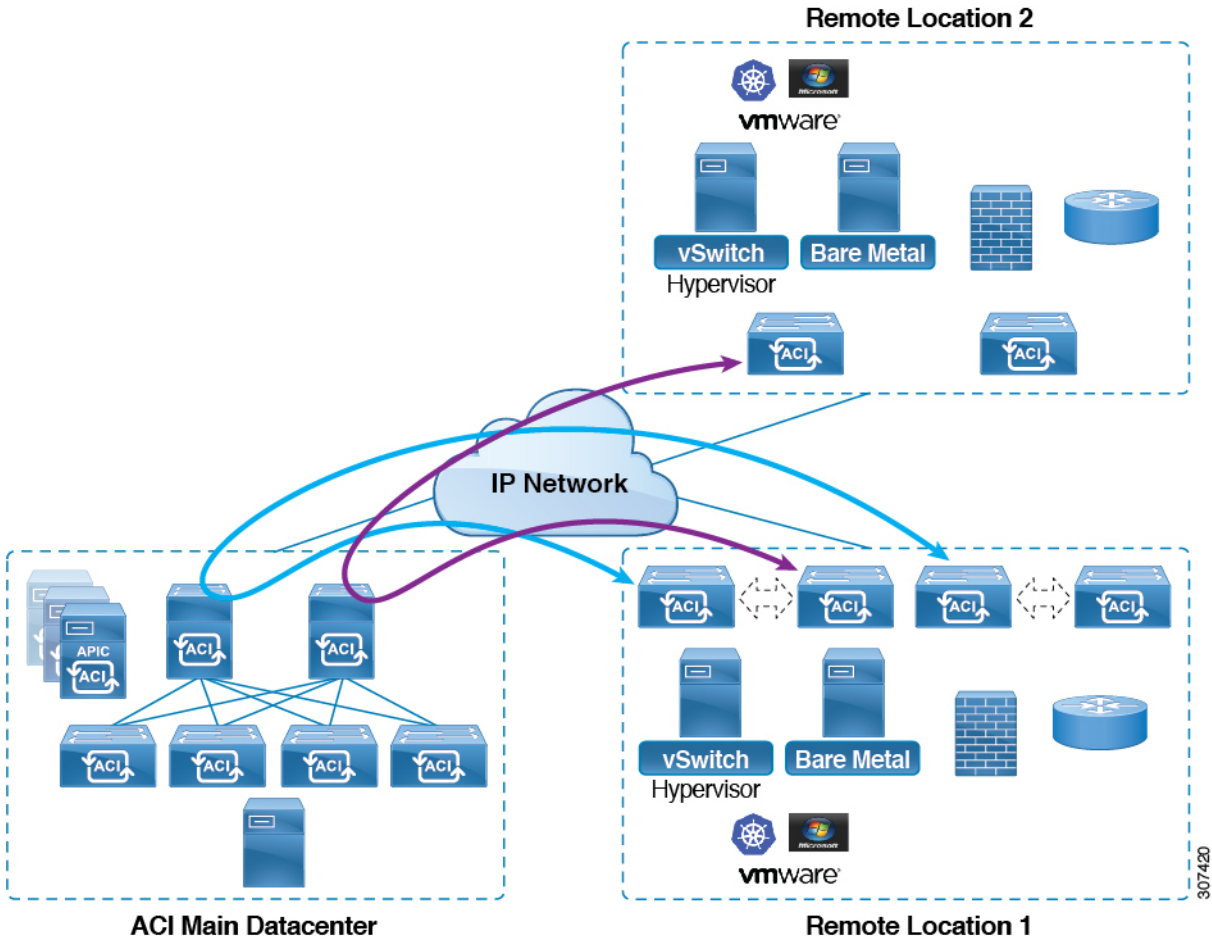

Starting in Release 4.1(2), support is now available for direct traffic forwarding between remote leaf switches in different remote locations. This functionality offers a level of redundancy and availability in the connections between remote locations, as shown in the following figure.

Figure 14: Remote Leaf Switch Behavior: Release 4.1(2)

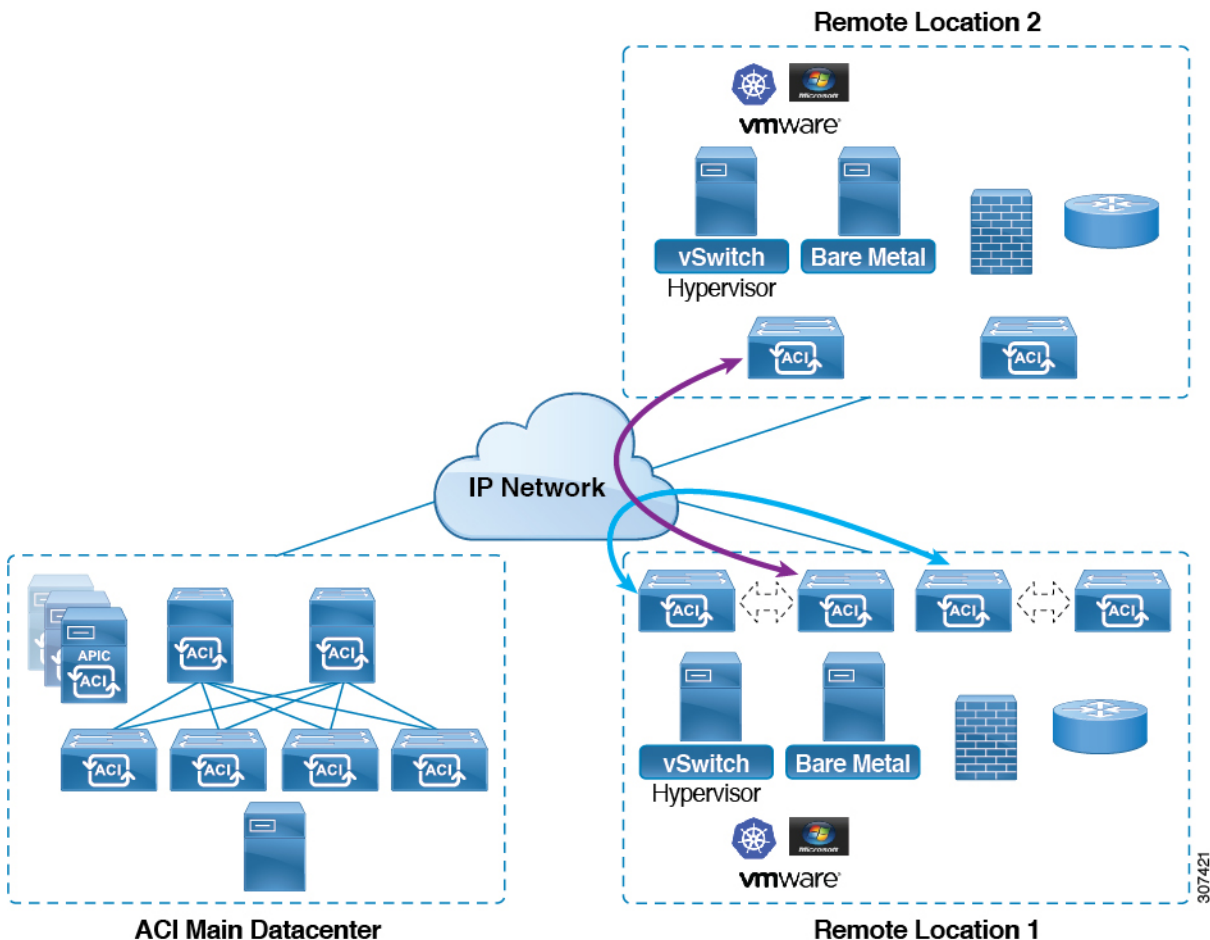

In addition, remote leaf switch behavior also takes on the following characteristics starting in release 4.1(2):

- Starting with Release 4.1(2), with direct traffic forwarding, when a spine switch fails within a single-pod configuration, the following occurs:
 - Local switching will continue to function for existing and new end point traffic between the remote leaf switch vPC peers, as shown in the "Local Switching Traffic: Prior to Release 4.1(2)" figure above.
 - For traffic between remote leaf switches across remote locations:
 - New end point traffic will fail because the remote leaf switch-to-spine switch tunnel would be down. From the remote leaf switch, new end point details will not get synced to the spine switch, so the other remote leaf switch pairs in the same or different locations cannot download the new end point information from COOP.
 - For uni-directional traffic, existing remote end points will age out after 300 secs, so traffic will fail after that point. Bi-directional traffic within a remote leaf site (between remote leaf VPC pairs) in a pod will get refreshed and will continue to function. Note that bi-directional traffic to remote locations (remote leaf switches) will be affected as the remote end points will be expired by COOP after a timeout of 900 seconds.

- For shared services (inter-VRF), bi-directional traffic between end points belonging to remote leaf switches attached to two different remote locations in the same pod will fail after the remote leaf switch COOP end point age-out time (900 sec). This is because the remote leaf switch-to-spine COOP session would be down in this situation. However, shared services traffic between end points belonging to remote leaf switches attached to two different pods will fail after 30 seconds, which is the COOP fast-aging time.
- L3Out-to-L3Out communication would not be able to continue because the BGP session to the spine switches would be down.
- When there is remote leaf direct uni-directional traffic, where the traffic is sourced from one remote leaf switch and destined to another remote leaf switch (which is not the vPC peer of the source), there will be a milli-second traffic loss every time the remote end point (XR EP) timeout of 300 seconds occurs.
- With a remote leaf switches with ACI Multi-Site configuration, all traffic continues from the remote leaf switch to the other pods and remote locations, even with a spine switch failure, because traffic will flow through an alternate available pod in this situation.

10 Mbps Bandwidth Support in IPN for Remote Leaf Switches

You might have situations where most of the data traffic from the remote leaf switches is local and the Inter-Pod Network (IPN) is needed only for management purposes. In these situations, you may not need a 100 Mbps IPN. To support these environments, starting with Release 4.2(4), support is now available for 10 Mbps as a minimum bandwidth in the IPN.

To support this, the following requirements should be met:

- The IPN path is only used for managing remote leaf switches (management functions such as upgrades and downgrades, discovery, COOP, and policy pushes).
- Configure IPN with the QoS configuration in order to prioritize control and management plane traffic between the Cisco ACI datacenter and remote leaf switch pairs based on the information provided in the section "Creating DSCP Translation Policy Using Cisco APIC GUI".
- All traffic from the Cisco ACI datacenter and remote leaf switches is through the local L3Out.
- The EPG or bridge domain are not stretched between the remote leaf switch and the ACI main datacenter.
- You should pre-download software images on the remote leaf switches to reduce upgrade time.

The following figure shows a graphical representation of this feature.

Figure 15: Remote Leaf Switch Behavior, Release 4.2(4): Remote Leaf Switch Management through IPN

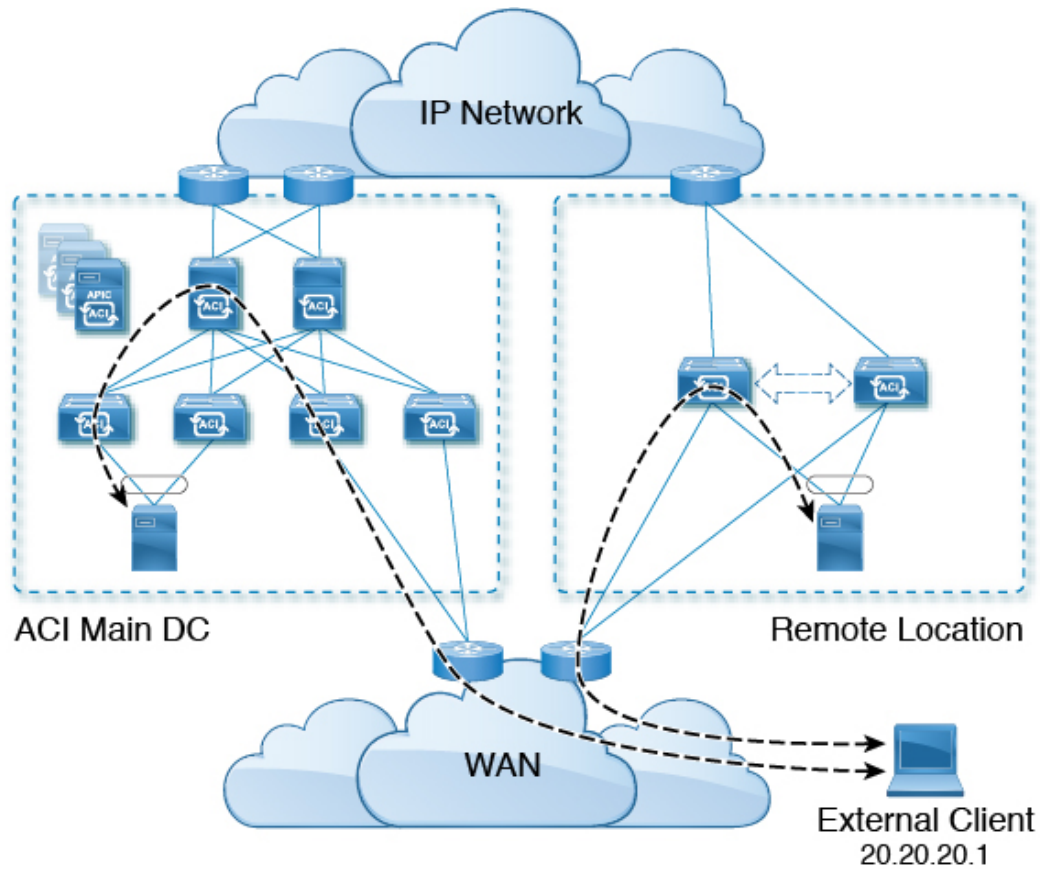

Dot1q Tunnel Support on Remote Leaf Switches

In some situations, a co-location provider might be hosting multiple customers, where each customer is using thousands of VLANs per remote leaf switch pair. Starting with Release 4.2(4), support is available to create an 802.1Q tunnel between the remote leaf switch and the ACI main datacenter, which provides the flexibility to map multiple VLANs into a single 802.1Q tunnel, thereby reducing the EPG scale requirement.

The following figure shows a graphical representation of this feature.

Figure 16: Remote Leaf Switch Behavior, Release 4.2(4): 802.1Q Tunnel Support on Remote Leaf Switches

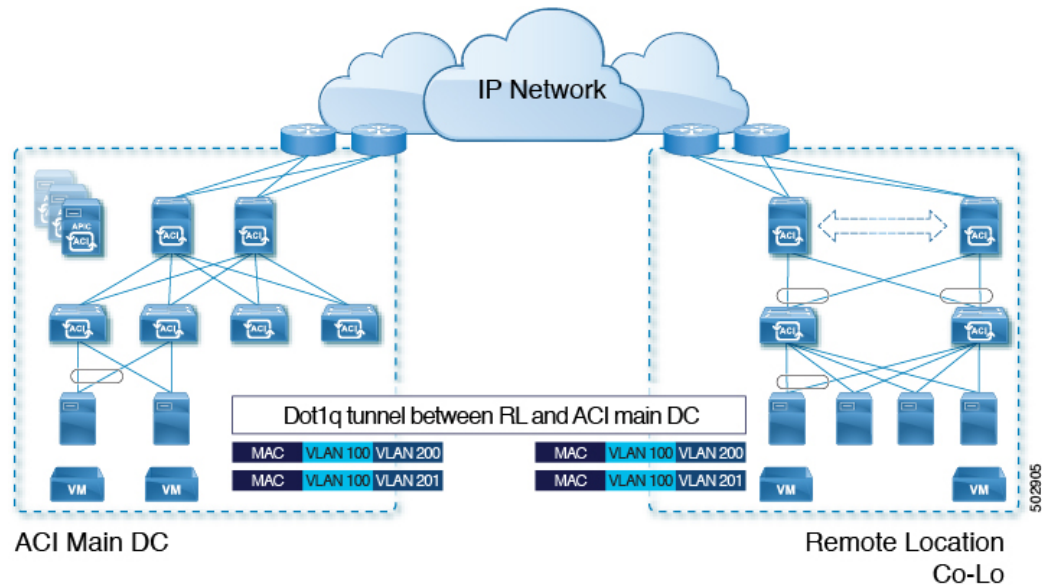

Create this 802.1Q tunnel between the remote leaf switch and the ACI main datacenter using the instructions provided in the "802.1Q Tunnels" chapter in the *Cisco APIC Layer 2 Networking Configuration Guide*, located in the [Cisco APIC documentation landing page](#).

You can configure remote leaf switches in the APIC GUI, either with and without a wizard, or use the REST API or the NX-OS style CLI.

About Remote Leaf Back-to-Back Connection

Beginning with Cisco APIC Release 5.2(1), you can connect remote leaf switch pairs directly to each other ("back-to-back") by fabric links to carry local east-west traffic. An example of a scenario with significant east-west data traffic is unicast traffic from an EPG to an L3Out in a vPC pair, as shown in the figure below.

Figure 17: Remote Leaf Back-to-Back Connection

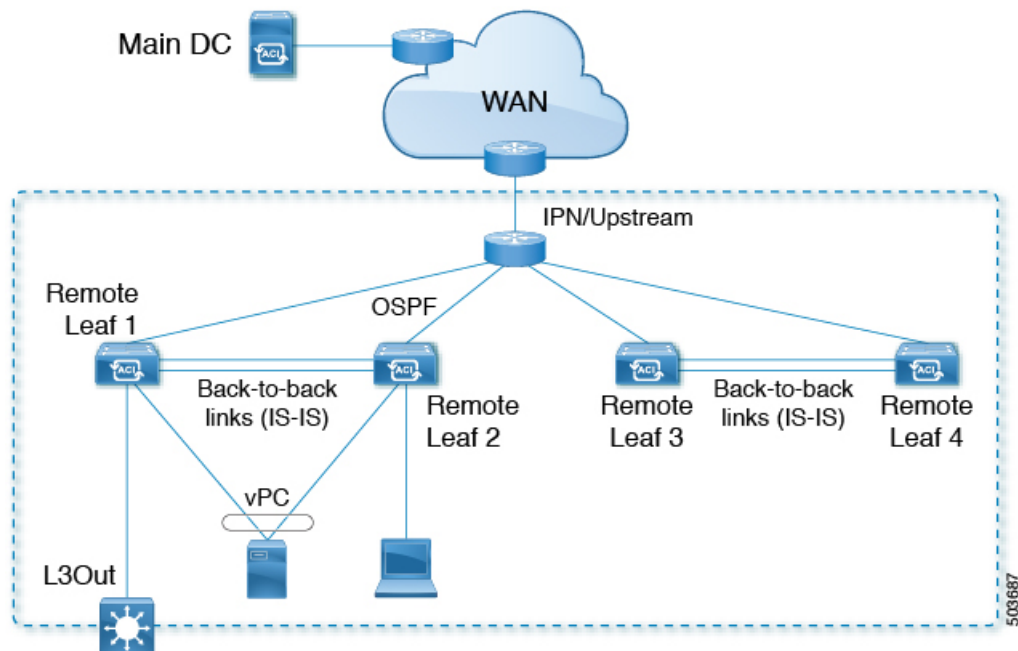

Only traffic between non-vPC connected hosts traverses the back-to-back links. A vPC connected host can send traffic locally from the remote leaf switch nearest the destination, so such traffic will not use the back-to-back links.

When uplinks and a back-to-back connection are active between a pair of remote leaf switches, the back-to-back links are preferred for east-west traffic, while the uplinks carry traffic to and from any other remote leaf switches and switches in the main datacenter.

Although the remote leaf architecture normally calls for a spine switch or the IPN router to route traffic between proximately located remote leaf switches, a direct back-to-back leaf connection can save bandwidth on the upstream device.

Guidelines and Limitations for Remote Leaf Back-to-Back Connection

- The back-to-back links between the remote leaf switches must be direct, with no intermediate devices.
- The back-to-back connection can use fabric ports or front panel ports that are converted to fabric ports.
- Remote leaf switches can be connected with back-to-back links only in pairs. Interconnecting more than two remote leaf switches by back-to-back links is not supported.
- When a pair of remote leaf switches is connected back-to-back and one of the pair loses its uplink connectivity, the same remote leaf switch will be reachable via the other remote leaf switch through the back-to-back link. In this case, traffic from the main datacenter will also be carried on the back-to-back link.
- PTP and SyncE are not supported on back-to-back links.

Deploying the Remote Leaf Back-to-Back Connection

In releases before Cisco APIC Release 5.2(1), a back-to-back connection between remote leaf switch fabric ports would result in a wiring error. With Cisco APIC Release 5.2(1), such a connection is recognized automatically in either of the following situations:

- The connection is made between two remote leaf vPC peers.
- The connection is made between remote leaf switches that are not members of any vPC in a single remote location.

In these cases, no specific configuration is necessary.

Remote Leaf Switch Hardware Requirements

The following switches are supported for the remote leaf switch feature.

Fabric Spine Switches

For the spine switch at the Cisco Application Centric Infrastructure (ACI) main data center that is connected to the WAN router, the following spine switches are supported:

- Fixed spine switches Cisco Nexus 9000 series:
 - N9K-C9332C
 - N9K-C9364C
 - All GX and GX2 switches
- For modular spine switches, only Cisco Nexus 9000 series switches with names that end in EX, and later (for example, N9K-X9732C-EX) are supported.
- Older generation spine switches, such as the fixed spine switch N9K-C9336PQ or modular spine switches with the N9K-X9736PQ linecard are supported in the main data center, but only next generation spine switches are supported to connect to the WAN.

Remote Leaf Switches

- For the remote leaf switches, only Cisco Nexus 9000 series switches with names that end in EX, and later (for example, N9K-C93180LC-EX) are supported.
- The remote leaf switches must be running a switch image of 13.1.x or later (aci-n9000-dk9.13.1.x.x.bin) before they can be discovered. This may require manual upgrades on the leaf switches.

Remote Leaf Switch Restrictions and Limitations

The following guidelines and restrictions apply to remote leaf switches:

- The remote leaf solution requires the /32 tunnel end point (TEP) IP addresses of the remote leaf switches and main data center leaf/spine switches to be advertised across the main data center and remote leaf switches without summarization.

- If you move a remote leaf switch to a different site within the same pod and the new site has the same node ID as the original site, you must delete and recreate the virtual port channel (vPC).
- With the Cisco N9K-C9348GC-FXP switch, you can perform the initial remote leaf switch discovery only on ports 1/53 or 1/54. Afterward, you can use the other ports for fabric uplinks to the ISN/IPN for the remote leaf switch.
- Beginning with the 6.0(3) release, when you have dynamic packet prioritization enabled and either a CoS preservation policy or a Cisco ACI Multi-Pod policy enabled, the expected behavior is mice flows should egress the fabric with a VLAN CoS priority of 0 if you also enabled CoS preservation or if you also enabled Cisco ACI Multi-Pod DSCP translation along with dynamic packet prioritization. However, the actual behavior is as follows:
 - Mice flows egress the fabric with the VLAN CoS priority of 0 if you enabled CoS preservation with the dynamic packet prioritization feature in the physical leaf and remote leaf switches.
 - Mice flows egress the fabric with the VLAN CoS priority of 0 if you enabled Cisco ACI Multi-Pod DSCP translation with the dynamic packet prioritization feature in a physical leaf switch.
 - Mice flows egress the fabric with the VLAN CoS priority of 3 if you enabled Cisco ACI Multi-Pod DSCP translation with the dynamic packet prioritization feature in a remote leaf switch.

If you do not want the mice flows to have a VLAN CoS priority of 3 when they egress a remote leaf switch on which you enabled Cisco ACI Multi-Pod DSCP translation, use the CoS preservation feature instead.

The following sections provide information on what is supported and not supported with remote leaf switches:

- [Supported Features, on page 124](#)
- [Unsupported Features, on page 125](#)
- [Changes For Release 5.0\(1\), on page 126](#)
- [Changes For Release 5.2\(3\), on page 127](#)

Supported Features

Stretching of an L3Out SVI within a vPC remote leaf switch pair is supported.

Beginning with Cisco APIC release 4.2(4), the 802.1Q (Dot1q) tunnels feature is supported.

Beginning with Cisco APIC release 4.1(2), the following features are supported:

- Remote leaf switches with ACI Multi-Site
- Traffic forwarding directly across two remote leaf vPC pairs in the same remote data center or across data centers, when those remote leaf pairs are associated to the same pod or to pods that are part of the same multipod fabric
- Transit L3Out across remote locations, which is when the main Cisco ACI data center pod is a transit between two remote locations (the L3Out in RL `location-1` and L3Out in RL `location-2` are advertising prefixes for each other)

Beginning with Cisco APIC release 4.0(1), the following features are supported:

- Q-in-Q Encapsulation Mapping for EPGs

- PBR Tracking on remote leaf switches (with system-level global GIPo enabled)
- PBR Resilient Hashing
- Netflow
- MacSec Encryption
- Troubleshooting Wizard
- Atomic counters

Unsupported Features

Full fabric and tenant policies are supported on remote leaf switches in this release with the exception of the following features, which are unsupported:

- GOLF
- vPod
- Floating L3Out
- Stretching of L3Out SVI between local leaf switches (ACI main data center switches) and remote leaf switches or stretching across two different vPC pairs of remote leaf switches
- Copy service is not supported when deployed on local leaf switches and when the source or destination is on the remote leaf switch. In this situation, the routable TEP IP address is not allocated for the local leaf switch. For more information, see the section "Copy Services Limitations" in the "Configuring Copy Services" chapter in the *Cisco APIC Layer 4 to Layer 7 Services Deployment Guide*, available in the [APIC documentation page](#).
- Layer 2 Outside Connections (except Static EPGs)
- Copy services with vzAny contract
- FCoE connections on remote leaf switches
- Flood in encapsulation for bridge domains or EPGs
- Fast Link Failover policies are for ACI fabric links between leaf and spine switches, and are not applicable to remote leaf connections. Alternative methods are introduced in Cisco APIC Release 5.2(1) to achieve faster convergence for remote leaf connections.
- Managed Service Graph-attached devices at remote locations
- Traffic Storm Control
- Cloud Sec Encryption
- First Hop Security
- Layer 3 Multicast routing on remote leaf switches
- Maintenance mode
- TEP to TEP atomic counters

The following scenarios are not supported when integrating remote leaf switches in a Multi-Site architecture in conjunction with the intersite L3Out functionality:

- Transit routing between L3Outs deployed on remote leaf switch pairs associated to separate sites
- Endpoints connected to a remote leaf switch pair associated to a site communicating with the L3Out deployed on the remote leaf switch pair associated to a remote site
- Endpoints connected to the local site communicating with the L3Out deployed on the remote leaf switch pair associated to a remote site
- Endpoints connected to a remote leaf switch pair associated to a site communicating with the L3Out deployed on a remote site



Note The limitations above do not apply if the different data center sites are deployed as pods as part of the same Multi-Pod fabric.

The following deployments and configurations are not supported with the remote leaf switch feature:

- It is not supported to stretch a bridge domain between remote leaf nodes associated to a given site (APIC domain) and leaf nodes part of a separate site of a Multi-Site deployment (in both scenarios where those leaf nodes are local or remote) and a fault is generated on APIC to highlight this restriction. This applies independently from the fact that BUM flooding is enabled or disabled when configuring the stretched bridge domain on the Multi-Site Orchestrator (MSO). However, a bridge domain can always be stretched (with BUM flooding enabled or disabled) between remote leaf nodes and local leaf nodes belonging to the same site (APIC domain).
- Spanning Tree Protocol across remote leaf switch location and main data center.
- APICs directly connected to remote leaf switches.
- Orphan port channel or physical ports on remote leaf switches, with a vPC domain (this restriction applies for releases 3.1 and earlier).
- With and without service node integration, local traffic forwarding within a remote location is only supported if the consumer, provider, and services nodes are all connected to remote leaf switches are in vPC mode.
- /32 loopbacks advertised from the spine switch to the IPN must not be suppressed/aggregated toward the remote leaf switch. The /32 loopbacks must be advertised to the remote leaf switch.

Changes For Release 5.0(1)

Beginning with Cisco APIC release 5.0(1), the following changes have been applied for remote leaf switches:

- The direct traffic forwarding feature is enabled by default and cannot be disabled.
- A configuration without direct traffic forwarding for remote leaf switches is no longer supported. If you have remote leaf switches and you are upgrading to Cisco APIC Release 5.0(1), review the information provided in the section "About Direct Traffic Forwarding" and enable direct traffic forwarding using the instructions in that section.

Changes For Release 5.2(3)

Beginning with Cisco APIC release 5.2(3), the following changes have been applied for remote leaf switches:

- The IPN underlay protocol to peer between the remote leaf switches and the upstream router can be either OSPF or BGP. In previous releases, only an OSPF underlay is supported.

WAN Router and Remote Leaf Switch Configuration Guidelines

Before a remote leaf is discovered and incorporated in APIC management, you must configure the WAN router and the remote leaf switches.

Configure the WAN routers that connect to the fabric spine switch external interfaces and the remote leaf switch ports, with the following requirements:

WAN Routers

- Enable OSPF on the interfaces, with the same details, such as area ID, type, and cost.
- Configure DHCP Relay on the interface leading to each APIC's IP address in the main fabric.
- The interfaces on the WAN routers which connect to the VLAN-5 interfaces on the spine switches must be on different VRFs than the interfaces connecting to a regular multipod network.

Remote Leaf Switches

- Connect the remote leaf switches to an upstream router by a direct connection from one of the fabric ports. The following connections to the upstream router are supported:
 - 40 Gbps & higher connections
 - With a QSFP-to-SFP Adapter, supported 1G/10G SFPs

Bandwidth in the WAN varies, depending on the release:

- For releases prior to 4.2(4), bandwidth in the WAN must be a minimum of 100 Mbps and maximum supported latency is 300 msec.
- For Release 4.2(4) and later, bandwidth in the WAN must be a minimum of 10 Mbps and maximum supported latency is 300 msec.
- It is recommended, but not required to connect the pair of remote leaf switches with a vPC. The switches on both ends of the vPC must be remote leaf switches at the same remote datacenter.
- Configure the northbound interfaces as Layer 3 sub-interfaces on VLAN-4, with unique IP addresses.
If you connect more than one interface from the remote leaf switch to the router, configure each interface with a unique IP address.
- Enable OSPF on the interfaces, but do not set the OSPF area type as stub area.
- The IP addresses in the remote leaf switch TEP Pool subnet must not overlap with the pod TEP subnet pool. The subnet used must be /24 or lower.
- Multipod is supported, but not required, with the Remote Leaf feature.

- When connecting a pod in a single-pod fabric with remote leaf switches, configure an L3Out from a spine switch to the WAN router and an L3Out from a remote leaf switch to the WAN router, both using VLAN-4 on the switch interfaces.
- When connecting a pod in a multipod fabric with remote leaf switches, configure an L3Out from a spine switch to the WAN router and an L3Out from a remote leaf switch to the WAN router, both using VLAN-4 on the switch interfaces. Also configure a multipod-internal L3Out using VLAN-5 to support traffic that crosses pods destined to a remote leaf switch. The regular multipod and multipod-internal connections can be configured on the same physical interfaces, as long as they use VLAN-4 and VLAN-5.
- When configuring the Multipod-internal L3Out, use the same router ID as for the regular multipod L3Out, but deselect the **Use Router ID as Loopback Address** option for the router-id and configure a different loopback IP address. This enables ECMP to function.

Configure the Pod and Fabric Membership for Remote Leaf Switches Using the GUI

You can configure and enable Cisco APIC to discover and connect the IPN router and remote switches, either by using a wizard or by using the APIC GUI, without a wizard.

Configure the Pod and Fabric Membership for Remote Leaf Switches Using a Wizard

You can configure and enable Cisco APIC to discover and connect the IPN router and remote switches, using a wizard as in this topic, or in an alternative method using the APIC GUI. See [Configure the Pod and Fabric Membership for Remote Leaf Switches Using the GUI \(Without a Wizard\)](#), on page 134.

Before you begin

- The IPN and WAN routers and remote leaf switches are active and configured; see [WAN Router and Remote Leaf Switch Configuration Guidelines](#), on page 127.



Note Cisco recommends that you configure the connectivity between the physical Pod and the IPN before launching the wizard. For information on configuring interpod connectivity, see [Preparing the Pod for IPN Connectivity](#), on page 104.

- The remote leaf switch pair are connected with a vPC.
- The remote leaf switches are running a switch image of 14.1.x or later (aci-n9000-dk9.14.1.x.x.bin).
- The pod in which you plan to add the remote leaf switches is created and configured.
- The spine switch that will be used to connect the pod with the remote leaf switches is connected to the IPN router.

Procedure

- Step 1** On the menu bar, click **Fabric > Inventory**.
- Step 2** In the Navigation pane, expand **Quick Start** and click **Add Remote Leaf**.
- Step 3** In the **Remote Leaf** pane of the working pane, click **Add Remote Leaf**.

The **Add Remote Leaf** wizard appears.

If you have not yet configured the interpod connectivity, you will see a **Configure Interpod Connectivity** screen, and the order of the other wizard steps will be different from what is described in this procedure. In this situation, you will configure the IP connectivity, routing protocols, and external TEP addresses. Interpod connectivity is a prerequisite before extending ACI to another location.

For information on configuring interpod connectivity, see [Preparing the Pod for IPN Connectivity, on page 104](#).

- Step 4** In the **Add Remote Leaf** wizard, review the information in the **Overview** page.

This panel provides high-level information about the steps that are required for adding a remote leaf switch to a pod in the fabric. The information that is displayed in the **Overview** panel, and the areas that you will be configuring in the subsequent pages, varies depending on your existing configuration:

- If you are adding a new remote leaf switch to a single-pod or multi-pod configuration, you will typically see the following items in the **Overview** panel, and you will be configuring these areas in these subsequent pages:
 - **External TEP**
 - **Pod Selection**
 - **Routing Protocol**
 - **Remote Leafs**

In addition, because you are adding a new remote leaf switch, it will automatically be configured with the direct traffic forwarding feature.

- If you already have remote leaf switches configured and you are using the remote leaf wizard to configure these existing remote leaf switches, but the existing remote leaf switches were upgraded from a software release prior to Release 4.1(2), then those remote leaf switches might not be configured with the direct traffic forwarding feature. You will see a warning at the top of the Overview page in this case, beginning with the statement "Remote Leaf Direct Communication is not enabled."

You have two options when adding a remote leaf switch using the wizard in this situation:

- **Enable the direct traffic forwarding feature on these existing remote leaf switches.** This is the recommended course of action in this situation. You must first manually enable the direct traffic forwarding feature on the switches using the instructions provided in [Upgrade the Remote Leaf Switches and Enable Direct Traffic Forwarding, on page 139](#). Once you have manually enabled the direct traffic forwarding feature using those instructions, return to this remote leaf switch wizard and follow the process in the wizard to add the remote leaf switches to a pod in the fabric.
- **Add the remote leaf switches without enabling the direct traffic forwarding feature.** This is an acceptable option, though not recommended. To add the remote leaf switches without enabling

the direct traffic forwarding feature, continue with the remote leaf switch wizard configuration without manually enabling the direct traffic forwarding feature.

- Step 5** When you have finished reviewing the information in the **Overview** panel, click **Get Started** at the bottom right corner of the page.
- If you adding a new remote leaf switch, where it will be running Release 4.1(2) or above and will be automatically configured with the direct traffic forwarding feature, the **External TEP** page appears. Go to [Step 6, on page 130](#).
 - If you are adding a remote leaf switch without enabling the direct traffic forwarding feature, or if you upgraded your switches to Release 4.1(2) and you manually enabled the direct traffic forwarding feature on the switches using the instructions provided in [Upgrade the Remote Leaf Switches and Enable Direct Traffic Forwarding, on page 139](#), then the **Pod Selection** page appears. Go to [Step 7, on page 130](#).

- Step 6** In the **External TEP** page, configure the necessary parameters.

External TEP addresses are used by the physical pod to communicate with remote locations. In this page, configure a subnet that is routable across the network connecting the different locations. The external TEP pool cannot overlap with other internal TEP pools, remote leaf TEP pools, or external TEP pools from other pods. The wizard will automatically allocate addresses for pod-specific TEP addresses and spine router IDs from the external TEP pool. You can modify the proposed addresses, if necessary.

- a) Leave the **Use Defaults** checkbox checked, or uncheck it if necessary.

When checked, the wizard automatically allocates data plane and unicast TEP addresses. Those fields are not displayed when the **Use Defaults** box is checked. Uncheck the **Use Defaults** box to view or modify the proposed addresses, if necessary.
- b) In the **External TEP Pool** field, enter the external TEP for the physical pod.

The external TEP pool must not overlap the internal TEP pool.
- c) In the **Unicast TEP IP** field, change the value that is automatically populated in this field, if necessary.

This address is automatically allocated by Cisco APIC from the External TEP Pool, and will be used for sending traffic from the remote leaf switch to the local leaf switches on that pod.

Cisco APIC automatically configures the unicast TEP IP address when you enter the External TEP Pool address.
- d) Repeat these steps for each pod, if you have a multi-pod configuration.
- e) When you have entered all of the necessary information in this page, click the **Next** button at the bottom right corner of the page.

The **Pod Selection** page appears.

- Step 7** In the **Pod Selection** page, configure the necessary parameters.

The remote leaf switch logically connects to one of the pods in the Cisco ACI fabric. In this page, select the pod ID of the pod where the remote leaf switches will be associated. A remote leaf TEP pool is needed to allocate IP addresses to the remote leaf switches. Select an existing remote leaf TEP pool or enter a remote leaf TEP pool to create a new one. The remote leaf TEP pool must be different from existing TEP pools. Multiple remote leaf pairs can be part of the same remote TEP pool.

- a) In the **Pod ID** field, select the pod ID of the pod where the remote leaf switches will be associated.

- b) In the **Remote Leaf TEP Pool** field, select an existing remote leaf TEP pool or enter a remote leaf TEP pool to allocate IP addresses to the remote leaf switches.

Click the **View existing TEP Pools** link underneath the **Remote Leaf TEP Pool** field to see the existing TEP pools (internal TEP pools, remote leaf TEP pools, and external TEP pools). Use this information to avoid creating duplicate or overlapping pools.

- c) When you have entered all of the necessary information in this page, click the **Next** button at the bottom right corner of the page.

The **Routing Protocol** page appears.

Step 8

In the **Routing Protocol** page, select and configure the necessary parameters for the underlay protocol to peer between the remote leaf switches and the upstream router. Follow these substeps.

- a) Under the **L3 Outside Configuration** section, in the **L3 Outside** field, create or select an existing L3Out to represent the connection between the remote leaf switches and the upstream router. Multiple remote leaf pairs can use the same L3 Outside to represent their upstream connection.

For the remote leaf switch configuration, we recommend that you use or create an L3Out that is different from the L3Out used in the multi-pod configuration.

- b) In Cisco APIC Release 5.2(3) and later releases, set the **Underlay** control to either **OSPF** or **BGP**

In releases before Cisco APIC Release 5.2(3), no selection is necessary because OSPF is the only supported underlay protocol.

Note

When both OSPF and BGP are used in the underlay for Multi-Pod, Multi-Site, or Remote Leaf, do not redistribute router-ids into BGP from OSPF on IPN routers. Doing so may cause a routing loop and bring down OSPF and BGP sessions between the spine switch and IPN routers.

- c) Choose the appropriate next configuration step.
 - For an OSPF underlay, configure the OSPF parameters in Step [Step 9, on page 131](#), then skip Step [Step 10, on page 132](#).
 - For a BGP underlay, skip Step [Step 9, on page 131](#) and configure the BGP parameters in Step [Step 10, on page 132](#).

Step 9

(For an OSPF underlay only) To configure an OSPF underlay, follow these substeps in the **Routing Protocol** page.

Configure the OSPF Area ID, an Area Type, and OSPF Interface Policy in this page. The OSPF Interface Policy contains OSPF-specific settings, such as the OSPF network type, interface cost, and timers. Configure the OSPF Authentication Key and OSPF Area Cost by unchecking the **Use Defaults** checkbox.

Note

If you peer a Cisco ACI-mode switch with a standalone Cisco Nexus 9000 switch that has the default OSPF authentication key ID of 0, the OSPF session will not come up. Cisco ACI only allows an OSPF authentication key ID of 1 to 255.

- a) Under the **OSPF** section, leave the **Use Defaults** checkbox checked, or uncheck it if necessary.

The checkbox is checked by default. Uncheck it to reveal the optional fields, such as area cost and authentication settings.

- b) Gather the configuration information from the IPN, if necessary.

For example, from the IPN, you might enter the following command to gather certain configuration information:

```
IPN# show running-config interface ethernet slot/chassis-number
```

For example:

```
IPN# show running-config interface ethernet 1/5.11
...
ip router ospf infra area 0.0.0.59
...
```

- c) In the **Area ID** field, enter the OSPF area ID.

Looking at the OSPF area 59 information shown in the output in the previous step, you could enter a different area in the **Area ID** field (for example, 0) and have a different L3Out. If you are using a different area for the remote leaf switch, you must create a different L3Out. You can also create a different L3Out, even if you are using the same OSPF area ID.

- d) In the **Area Type** field, select the OSPF area type.

You can choose one of the following OSPF types:

- **NSSA area**
- **Regular area**

Note

You might see **Stub area** as an option in the **Area Type** field; however, stub area will not advertise the routes to the IPN, so stub area is not a supported option for infra L3Outs.

Regular area is the default.

- e) In the **Interface Policy** field, enter or select the OSPF interface policy.

You can choose an existing policy or create a new one using the **Create OSPF Interface Policy** dialog box. The OSPF interface policy contains OSPF-specific settings such as OSPF network type, interface cost, and timers.

- f) When you have entered all of the necessary information in this page, click the **Next** button at the bottom right corner of the page.

The **Remote Leafs** page appears.

Step 10

(For a BGP underlay only) If the following BGP fields appear in the **Routing Protocol** page, follow these substeps. Otherwise, click **Next** to continue.

- a) Under the **BGP** section, leave the **Use Defaults** checkbox checked, or uncheck it if necessary.

The checkbox is checked by default. Uncheck it to reveal the optional fields, such as peering type, peer password, and route reflector nodes.

- b) Note the nonconfigurable values in the **Spine ID**, **Interface**, and **IPv4 Address** fields.

- c) In the **Peer Address** field, enter the IP address of the BGP neighbor.

- d) In the **Remote AS** field, enter the Autonomous System (AS) number of the BGP neighbor.

- e) When you have entered all of the necessary information in this page, click the **Next** button at the bottom right corner of the page.

The **Remote Leafs** page appears.

Step 11 In the **Remote Leafs** page, configure the necessary parameters.

The interpod network (IPN) connects Cisco ACI locations to provide end-to-end network connectivity. To achieve this, remote leaf switches need IP connectivity to the upstream router. For each remote leaf switch, enter a router ID that will be used to establish the control-plane communication with the upstream router and the rest of the Cisco ACI fabric. Also provide the IP configuration for at least one interface for each remote leaf switch. Multiple interfaces are supported.

- a) In the **Serial** field, enter the serial number for the remote leaf switch or select a discovered remote leaf switch from the dropdown menu.
- b) In the **Node ID** field, assign a node ID to the remote leaf switch.
- c) In the **Name** field, assign a name to the remote leaf switch.
- d) In the **Router ID** field, enter a router ID that will be used to establish the control-plane communication with the upstream router and the rest of the Cisco ACI fabric.
- e) In the **Loopback Address** field, enter the IPN router loopback IP address, if necessary.

Leave this field blank if you use a router ID address.

- f) Under the **Interfaces** section, in the **Interface** field, enter interface information for this remote leaf switch.
- g) Under the **Interfaces** section, in the **IPv4 Address** field, enter the IPv4 IP address for the interface.
- h) Under the **Interfaces** section, in the **MTU** field, assign a value for the maximum transmit unit of the external network.

The range is 1500 to 9216.

- i) If you selected a BGP underlay, enter the IP address of the BGP neighbor in the **Peer Address** field, and enter the Autonomous System (AS) number of the BGP neighbor in the **Remote AS** field.
- j) Enter information on additional interfaces, if necessary.

Click + within the Interfaces box to enter information for multiple interfaces.

- k) When you have entered all of the necessary information for this remote leaf switch, enter information for additional remote leaf switches, if necessary.

Click + to the right of the Interfaces box to enter information for multiple remote leaf switches.

- l) When you have entered all of the necessary information in this page, click the **Next** button at the bottom right corner of the page.

The **Confirmation** page appears.

Step 12 In the **Confirmation** page, review the list of policies that the wizard will create and change the names of any of the policies, if necessary, then click **Finish** at the bottom right corner of the page.

The **Remote Leaf Summary** page appears.

Step 13 In the **Remote Leaf Summary** page, click the appropriate button.

- If you want to view the API for the configuration in a JSON file, click **View JSON**. You can copy the API and store it for future use.
- If you are satisfied with the information in this page and you do not want to view the JSON file, click **OK**.

Step 14 In the Navigation pane, click **Fabric Membership**, then click the **Nodes Pending Registration** tab to view the status of the remote leaf switch configuration.

You should see `Undiscovered` in the **Status** column for the remote leaf switch that you just added.

Step 15 Log into the spine switch connected to the IPN and enter the following command:

```
switch# show nattable
```

Output similar to the following appears:

```
----- NAT TABLE -----
Private Ip   Routeable Ip
10.0.0.1     192.0.2.100
10.0.0.2     192.0.2.101
10.0.0.3     192.0.2.102
```

Step 16 On the IPN sub-interfaces connecting the remote leaf switches, configure the DHCP relays for each interface.

For example:

```
switch# configure terminal
switch(config)# interface ethernet 1/5.11
switch(config-subif)# ip dhcp relay address 192.0.2.100
switch(config-subif)# ip dhcp relay address 192.0.2.101
switch(config-subif)# ip dhcp relay address 192.0.2.102
switch(config-subif)# exit
switch(config)# interface ethernet 1/7.11
switch(config-subif)# ip dhcp relay address 192.0.2.100
switch(config-subif)# ip dhcp relay address 192.0.2.101
switch(config-subif)# ip dhcp relay address 192.0.2.102
switch(config-subif)# exit
switch(config)# exit
switch#
```

Step 17 In the Navigation pane, click **Fabric Membership**, then click the **Registered Nodes** tab to view the status of the remote leaf switch configuration.

After a few moments, you should see `Active` in the **Status** column for the remote leaf switch that you just added.

Step 18 On the menu bar click **System > System Settings**.

Step 19 In the Navigation pane, choose **System Global GIPo**.

Step 20 For **Use Infra GIPo as System GIPo**, choose **Enabled**.

Configure the Pod and Fabric Membership for Remote Leaf Switches Using the GUI (Without a Wizard)

Although we recommend that you configure remote leaf switches using the **Add Remote Leaf** wizard (see [Configure the Pod and Fabric Membership for Remote Leaf Switches Using a Wizard, on page 128](#)), you can use this GUI procedure as an alternative.

Before you begin

- The routers (IPN and WAN) and remote leaf switches are active and configured; see [WAN Router and Remote Leaf Switch Configuration Guidelines, on page 127](#).

- The remote leaf switches are running a switch image of 13.1.x or later (aci-n9000-dk9.13.1.x.x.bin).
- The pod in which you plan to add the remote leaf switches is created and configured.
- The spine switch that will be used to connect the pod with the remote leaf switches is connected to the IPN router.

Procedure

Step 1

Configure the TEP pool for the remote leaf switches, with the following steps:

- a) On the menu bar, click **Fabric > Inventory**.
- b) In the Navigation pane, click **Pod Fabric Setup Policy**.
- c) On the **Fabric Setup Policy** panel, double-click the pod where you want to add the pair of remote leaf switches.
- d) Click the + on the **Remote Pools** table.
- e) Enter the remote ID and a subnet for the remote TEP pool and click **Submit**.
- f) On the **Fabric Setup Policy** panel, click **Submit**.

Step 2

Configure the L3Out for the spine switch connected to the IPN router, with the following steps:

- a) On the menu bar, click **Tenants > infra**.
- b) In the Navigation pane, expand **Networking**, right-click **L3Outs**, and choose **Create L3Out**.
- c) In the **Name** field, enter a name for the L3Out.
- d) From the **VRF** drop-down list, choose **overlay-1**.
- e) From the **L3 Domain** drop-down list, choose the external routed domain that you previously created.
- f) In the **Use for** control, select **Remote Leaf**.
- g) To use BGP as the IPN underlay protocol, uncheck the **OSPF** checkbox.

Beginning with Cisco APIC Release 5.2(3), the IPN underlay protocol can be either OSPF or BGP.

- h) To use OSPF as the IPN underlay protocol, in the **OSPF** area, where OSPF is selected by default, check the box next to **Enable Remote Leaf with Multipod**, if the pod where you are adding the remote leaf switches is part of a multipod fabric.

This option enables a second OSPF instance using VLAN-5 for multipod, which ensures that routes for remote leaf switches are only advertised within the pod they belong to.

- i) Click **Next** to move to the **Nodes and Interfaces** window.

Step 3

Configure the details for the spine and the interfaces used in the L3Out, with the following steps:

- a) Determine if you want to use the default naming convention.

In the **Use Defaults** field, check if you want to use the default node profile name and interface profile names:

- The default node profile name is `L3Out-name_nodeProfile`, where `L3Out-name` is the name that you entered in the **Name** field in the **Identity** page.
- The default interface profile name is `L3Out-name_interfaceProfile`, where `L3Out-name` is the name that you entered in the **Name** field in the **Identity** page.

- b) Enter the following details.

- **Node ID**—ID for the spine switch that is connected to the IPN router.
- **Router ID**—IP address for the IPN router
- **External Control Peering**—disable if the pod where you are adding the remote leaf switches is in a single-pod fabric

- c) Enter necessary additional information in the **Nodes and Interfaces** window.
- d) When you have entered the remaining additional information in the **Nodes and Interfaces** window, click **Next**.

The **Protocols** window appears.

Step 4 Enter the necessary information in the **Protocols** window of the **Create L3Out** wizard.

- a) If you chose BGP as the IPN underlay protocol, enter the **Peer Address** and the **Remote AS** of the BGP peer.
- b) If you chose OSPF as the IPN underlay protocol, select an OSPF policy in the **Policy** field.
- c) Click **Next**.

The **External EPG** window appears.

Step 5 Enter the necessary information in the **External EPG** window of the **Create L3Out** wizard, then click **Finish** to complete the necessary configurations in the **Create L3Out** wizard.

Step 6 Navigate to **Tenants > infra > Networking > L3Outs > L3Out_name > Logical Node Profiles > bLeaf > Logical Interface Profiles > portIf > OSPF Interface Profile**.

Step 7 Enter the name of the interface profile.

Step 8 In the **Associated OSPF Interface Policy Name** field, choose a previously created policy or click **Create OSPF Interface Policy**.

Step 9 a) Under **OSPF Profile**, click **OSPF Policy** and choose a previously created policy or click **Create OSPF Interface Policy**.

b) Click **Next**.

c) Click **Routed Sub-Interface**, click the + on the **Routed Sub-Interfaces** table, and enter the following details:

- **Node**—Spine switch where the interface is located.
- **Path**—Interface connected to the IPN router
- **Encap**—Enter **4** for the VLAN

d) Click **OK** and click **Next**.

e) Click the + on the **External EPG Networks** table.

f) Enter the name of the external network, and click **OK**.

g) Click **Finish**.

Step 10 To complete the fabric membership configuration for the remote leaf switches, perform the following steps:

a) Navigate to **Fabric > Inventory > Fabric Membership**.

At this point, the new remote leaf switches should appear in the list of switches registered in the fabric. However, they are not recognized as remote leaf switches until you configure the Node Identity Policy, with the following steps.

- b) For each remote leaf switch, double-click on the node in the list, configure the following details, and click **Update**:
- Node ID—Remote leaf switch ID
 - RL TEP Pool—Identifier for the remote leaf TEP pool, that you previously configured
 - Node Name—Name of the remote leaf switch

After you configure the Node Identity Policy for each remote leaf switch, it is listed in the **Fabric Membership** table with the role `remote leaf`.

Step 11 Configure the L3Out for the remote leaf location, with the following steps:

- a) Navigate to **Tenants > infra > Networking**.
- b) Right-click **L3Outs**, and choose **Create L3Out**.
- c) Enter a name for the L3Out.
- d) Click the **OSPF** checkbox to enable OSPF, and configure the OSPF details the same as on the IPN and WAN router.

Note

Do not check the **Enable Remote Leaf with Multipod** check box if you are deploying new remote leaf switches running Release 4.1(2) or later and you are enabling direct traffic forwarding on those remote leaf switches. This option enables an OSPF instance using VLAN-5 for multipod, which is not needed in this case. See [About Direct Traffic Forwarding, on page 138](#) for more information.

- e) Choose the **overlay-1** VRF.

Step 12 Configure the nodes and interfaces leading from the remote leaf switches to the WAN router, with the following steps:

- a) In the **Nodes and Interfaces** window in the Create L3Out wizard, enter the following details:
 - Node ID—ID for the remote leaf that is connected to the WAN router
 - Router ID—IP address for the WAN router
 - External Control Peering—only enable if the remote leaf switches are being added to a pod in a multipod fabric

Step 13 Navigate to **Tenants > infra > Networking > L3Outs > L3Out_name > Logical Node Profiles > bLeaf > Logical Interface Profiles > portIf > OSPF Interface Profile**.

Step 14 In **OSPF Interface Profiles**, configure the following details for the routed sub-interface used to connect a remote leaf switch with the WAN router.

- Identity—Name of the OSPF interface profile
- Protocol Profiles—A previously configured OSPF profile or create one
- Interfaces—On the **Routed Sub-Interface** tab, the path and IP address for the routed sub-interface leading to the WAN router

Step 15 Configure the Fabric External Connection Profile, with the following steps:

- a) Navigate to **Tenants > infra > Policies > Protocol**.
- b) Right-click **Fabric Ext Connection Policies** and choose **Create Intrasite/Intersite Profile**.
- c) Enter the mandatory **Community** value in the format provided in the example.

- d) Click the + on **Fabric External Routing Profile**.
- e) Enter the name of the profile and add uplink interface subnets for all of the remote leaf switches.
- f) Click **Update** and click **Submit**.

Step 16 On the menu bar click **System > System Settings**.

Step 17 In the Navigation pane, choose **System Global GIPo**.

Step 18 For **Use Infra GIPo as System GIPo**, choose **Enabled**.

Step 19 To verify that the remote leaf switches are discovered by the APIC, navigate to **Fabric > Inventory > Fabric Membership**, or **Fabric > Inventory > Pod > Topology**.

Step 20 To view the status of the links between the fabric and the remote leaf switches, enter the **show ip ospf neighbors vrf overlay-1** command on the spine switch that is connected to the IPN router.

Step 21 To view the status of the remote leaf switches in the fabric, enter the **acdiag fmvread** NX-OS style command on the APIC using the CLI.

About Direct Traffic Forwarding

As described in [Characteristics of Remote Leaf Switch Behavior in Release 4.1\(2\), on page 116](#), support for direct traffic forwarding is supported starting in Release 4.1(2), and is enabled by default starting in Release 5.0(1) and cannot be disabled. However, the method that you use to enable or disable direct traffic forwarding varies, depending on the version of software running on the remote leaf switches:

- If your remote leaf switches are currently running on Release 4.1(2) or later [if the remote leaf switches were never running on a release prior to 4.1(2)], go to [Configure the Pod and Fabric Membership for Remote Leaf Switches Using a Wizard, on page 128](#).
- If your remote leaf switches are currently running on a release prior to 4.1(2), go to [Upgrade the Remote Leaf Switches and Enable Direct Traffic Forwarding, on page 139](#) to upgrade the switches to Release 4.1(2) or later, then make the necessary configuration changes and enable direct traffic forwarding on those remote leaf switches.
- If your remote leaf switches are running on Release 4.1(2) or later and have direct traffic forwarding enabled, but you want to **downgrade** to a release prior to 4.1(2), go to [Disable Direct Traffic Forwarding and Downgrade the Remote Leaf Switches, on page 142](#) to disable the direct traffic forwarding feature before downgrading those remote leaf switches.
- If your remote leaf switches are running on a release prior to Release 5.0(1) and you want to upgrade to Release 5.0(1) or later:
 1. If your remote leaf switches are running on a release prior to 4.1(2), first upgrade to release 4.1(2) and enable direct traffic forwarding on those remote switches using the procedures described in [Upgrade the Remote Leaf Switches and Enable Direct Traffic Forwarding, on page 139](#).
 2. Once your remote leaf switches are on Release 4.1(2) and have direct traffic forwarding enabled, upgrade the remote leaf switches to Release 5.0(1) or later.
- If your remote leaf switches are running on Release 5.0(1) or later, where direct traffic forwarding is enabled by default, and you want to downgrade to any of these previous releases that also supported direct traffic forwarding:
 - Release 4.2(x)

- Release 4.1(2)

Then direct traffic forwarding may or may not continue to be enabled by default, depending on your configuration:

- If both Routable Subnets and Routable Ucast were enabled for all pods prior to the downgrade, then direct traffic forwarding continues to be enabled by default after the downgrade.
- If Routable Subnets were enabled for all pods but Routable Ucast was *not* enabled, then direct traffic forwarding is not enabled after the downgrade.

Upgrade the Remote Leaf Switches and Enable Direct Traffic Forwarding

If your remote leaf switches are currently running on a release prior to 4.1(2), follow these procedures to upgrade the switches to Release 4.1(2) or later, then make the necessary configuration changes and enable direct traffic forwarding on those remote leaf switches.



Note When upgrading to Release 4.1(2) or later, enabling direct traffic forwarding might be optional or mandatory, depending on the release you are upgrading to:

- If you are upgrading to a release prior to Release 5.0(1), then enabling direct traffic forwarding is **optional**; you can upgrade your switches without enabling the direct traffic forwarding feature. You can enable this feature at some point after you've made the upgrade, if necessary.
- If you are upgrading to Release 5.0(1) or later, then enabling direct traffic forwarding is **mandatory**. Direct traffic forwarding is enabled by default starting in Release 5.0(1) and cannot be disabled.

If, at a later date, you have to downgrade the software on the remote leaf switches to a version that doesn't support remote leaf switch direct traffic forwarding [to a release prior to Release 4.1(2)], follow the procedures provided in [Disable Direct Traffic Forwarding and Downgrade the Remote Leaf Switches, on page 142](#) to disable the direct traffic forwarding feature before downgrading the software on the remote leaf switches.

Procedure

-
- Step 1** Upgrade Cisco APIC and all the nodes in the fabric to Release 4.1(2) or later.
- Step 2** Verify that the routes for the Routable Subnet that you wish to configure will be reachable in the Inter-Pod Network (IPN), and that the subnet is reachable from the remote leaf switches.
- Step 3** Configure Routable Subnets in all the pods in the fabric:
- On the menu bar, click **Fabric > Inventory**.
 - In the Navigation pane, click **Pod Fabric Setup Policy**.
 - On the **Fabric Setup Policy** panel, double-click the pod where you want to configure routable subnets.
 - Access the information in the subnets or TEP table, depending on the release of your APIC software:
 - For releases prior to 4.2(3), click the + on the **Routable Subnets** table.
 - For 4.2(3) only, click the + on the **External Subnets** table.

- For 4.2(4) and later, click the + on the **External TEP** table.
- e) Enter the IP address and Reserve Address, if necessary, and set the state to **active** or **inactive**.
 - The IP address is the subnet prefix that you wish to configure as the routeable IP space.
 - The Reserve Address is a count of addresses within the subnet that must not be allocated dynamically to the spine switches and remote leaf switches. The count always begins with the first IP in the subnet and increments sequentially. If you wish to allocate the Unicast TEP (covered later in these procedures) from this pool, then it must be reserved.
 - f) Click **Update** to add the external routable subnet to the subnets or TEP table.
 - g) On the **Fabric Setup Policy** panel, click **Submit**.

Note

If you find that you have to make changes to the information in the subnets or TEP table after you've made these configurations, follow the procedures provided in "Changing the External Routable Subnet" in the *Cisco APIC Getting Started Guide* to make those changes successfully.

Step 4

Add Routable Ucast for each pod:

- a) On the menu bar, click **Tenants > infra > Policies > Protocol > Fabric Ext Connection Policies > *intrasite-intersite_profile_name***.
- b) In the properties page for this intrasite/intersite profile, click + in the **Pod Connection Profile** area. The **Create Pod Connection Profile** window appears.
- c) Select a pod and enter the necessary information in the **Create Pod Connection Profile** window.

In the **Unicast TEP** field, enter a routable TEP IP address, including the bit-length of the prefix, to be used for unicast traffic over the IPN. This IP address is used by the spine switches in their respective pod for unicast traffic in certain scenarios. For example, a unicast TEP is required for remote leaf switch direct deployments.

Note

Beginning with Release 4.2(5), the APIC software will automatically raise the appropriate faults after an upgrade from a pre-4.2(5) release to 4.2(5) or later if you have any of the following incorrect configurations:

- Unicast TEP IP address of one pod configured with one of the IP addresses on the non-reserved portion of the external TEP pool of any pod with a 0 or non-zero reserve address count
- Unicast TEP IP address on one pod matches the Unicast TEP IP address of other pods in the fabric
- Unicast TEP IP address overlaps with the remote leaf TEP pool in all pods in the fabric

You must make the appropriate configuration changes after upgrading to Release 4.2(5) or later in this case to clear the faults. You must make these configuration changes before attempting any kind of configuration export, otherwise a failure will occur on a configuration import, configuration rollback, or ID recovery going from Release 4.2(5) and later.

Step 5

Click **Submit**.

The following areas are configured after configuring Routable Subnets and Routable Ucast for each pod:

- On the spine switch, the Remote Leaf Multicast TEP Interface (rl-mcast-hrep) and Routable CP TEP Interface (rt-cp-etep) are created.

- On the remote leaf switches, the private Remote Leaf Multicast TEP Interface (rl-mcast-hrep) tunnel remains as-is.
- Traffic continues to use the private Remote Leaf Multicast TEP Interface (rl-mcast-hrep).
- Traffic will resume with the newly configured Routable Ucast TEP Interface. The private Remote Leaf Unicast TEP Interface (rl_ucast) tunnel is deleted from the remote leaf switch. Since traffic is converging on the newly configured Unicast TEP, expect a very brief disruption in service.
- The remote leaf switch and spine switch COOP (council of oracle protocol) session remains with a private IP address.
- The BGP route reflector switches to Routable CP TEP Interface (rt-cp-etep).

Step 6 Verify that COOP is configured correctly.

```
# show coop internal info global
# netstat -anp | grep 5000
```

Step 7 Verify that the BGP route reflector session in the remote leaf switch is configured correctly.

```
remote-leaf# show bgp vpnv4 unicast summary vrf all | grep 14.0.0
14.0.0.227 4 100 1292 1164 395 0 0 19:00:13 52
14.0.0.228 4 100 1296 1164 395 0 0 19:00:10 52
```

Step 8 Enable direct traffic forwarding on the remote leaf switches.

- On the menu bar, click **System > System Settings**.
- Click **Fabric Wide Setting**.
- Click the check box on **Enable Remote Leaf Direct Traffic Forwarding**.

When this is enabled, the spine switches will install Access Control Lists (ACLs) to prevent traffic coming from remote leaf switches from being sent back, since the remote leaf switches will now send directly between each remote leaf switches' TEPs. There may be a brief disruption in service while the tunnels are built between the remote leaf switches.

- Click **Submit**.
- To verify that the configuration was set correctly, on the spine switch, enter the following command:

```
spine# cat /mit/sys/summary
```

You should see the following highlighted line in the output, which is verification that the configuration was set correctly (full output truncated):

```
...
podId : 1
remoteNetworkId : 0
remoteNode : no
rldirectMode : yes
rn : sys
role : spine
...
```

At this point, the following areas are configured:

- Network Address Translation Access Control Lists (NAT ACLs) are created on the data center spine switches.

- On the remote leaf switches, private Remote Leaf Unicast TEP Interface (rl_ucast) and Remote Leaf Multicast TEP Interface (rl-mcast-hrep) tunnels are removed and routable tunnels are created.
- The **rlRoutableMode** and **rldirectMode** attributes are set to **yes**, as shown in the following example:

```
remote-leaf# moquery -d sys | egrep "rlRoutableMode|rldirectMode"
rlRoutableMode : yes
rldirectMode : yes
```

Step 9 Add the Routable IP address of Cisco APIC as DHCP relay on the IPN interfaces connecting the remote leaf switches.

Each APIC in the cluster will get assigned an address from the pool. These addresses must be added as the DHCP relay address on the interfaces facing the remote leaf switches. You can find these addresses by running the following command from the APIC CLI:

```
remote-leaf# moquery -c infraWiNode | grep routable
```

Step 10 Decommission and recommission each remote leaf switch one at a time to get it discovered on the routable IP address for the Cisco APIC.

The COOP configuration changes to Routable CP TEP Interface (rt-cp-etep). After each remote leaf switch is decommissioned and recommissioned, the DHCP server ID will have the routable IP address for the Cisco APIC.

Disable Direct Traffic Forwarding and Downgrade the Remote Leaf Switches

If your remote leaf switches are running on Release 4.1(2) or later and have direct traffic forwarding enabled, but you want to downgrade to a release prior to 4.1(2), follow these procedures to disable the direct traffic forwarding feature before downgrading the remote leaf switches.

Before you begin

Procedure

- Step 1** For a multipod configuration, configure a multipod-internal L3Out using VLAN-5.
- Step 2** Provision back private network reachability if it was removed when you enabled the direct traffic forwarding feature on the remote leaf switches.
- For example, configure the private IP route reachability in IPN and configure the private IP address of the Cisco APIC as a DHCP relay address on the layer 3 interfaces of the IPN connected to the remote leaf switches.
- Step 3** Disable remote leaf switch direct traffic forwarding for all remote leaf switches by posting the following policy:

```
POST URL : https://<ip address>/api/node/mo/uni/infra/settings.xml
<imdata>
  <infraSetPol dn="uni/infra/settings" enableRemoteLeafDirect="no" />
</imdata>
```

This will post the MO to Cisco APIC, then the configuration will be pushed from Cisco APIC to all nodes in the fabric.

At this point, the following areas are configured:

- The Network Address Translation Access Control Lists (NAT ACLs) are deleted on the data center spine switches.
- The **rlRoutableMode** and **rldirectMode** attributes are set to **no**, as shown in the following example:

```
remote-leaf# moquery -d sys | egrep "rlRoutableMode|rldirectMode"  
rlRoutableMode : no  
rldirectMode : no
```

Step 4 Remove the Routable Subnets and Routable Ucast from the pods in the fabric.

The following areas are configured after removing the Routable Subnets and Routable Ucast from each pod:

- On the spine switch, the Remote Leaf Multicast TEP Interface (rl-mcast-hrep) and Routable CP TEP Interface (rt-cp-etestep) are deleted.
- On the remote leaf switches, the tunnel to the routable Remote Leaf Multicast TEP Interface (rl-mcast-hrep) is deleted, and a private Remote Leaf Multicast TEP Interface (rl-mcast-hrep) is created. The Remote Leaf Unicast TEP Interface (rl_ucast) tunnel remains routable at this point.
- The remote leaf switch and spine switch COOP (council of oracle protocol) and route reflector sessions switch to private.
- The tunnel to the routable Remote Leaf Unicast TEP Interface (rl_ucast) is deleted, and a private Remote Leaf Unicast TEP Interface (rl_ucast) tunnel is created.

Step 5 Decommission and recommission each remote leaf switch to get it discovered on the non-routable internal IP address of the Cisco APIC.

Step 6 Downgrade the Cisco APIC and all the nodes in the fabric to a release prior to 4.1(2).

Remote Leaf Switch Failover

Beginning in Cisco Application Policy Infrastructure Controller (APIC) Release 4.2(2), remote leaf switches are pod redundant. That is, in a multipod setup, if a remote leaf switch in a pod loses connectivity to the spine switch, it is moved to another pod. This enables traffic between endpoints of the remote leaf switches that are connected to the original pod to work.

Remote leaf switches are associated, or pinned, to a pod, and the spine proxy path is determined through the configuration. In previous releases, Council of Oracle Protocol (COOP) communicated mapping information to the spine proxy. Now, when communication to the spine switch fails, COOP sessions move to a pod on another spine switch.

Previously, you added a Border Gateway Protocol (BGP) route reflector to the pod. Now you use an external route reflector and make sure that the remote leaf switches in the pod have a BGP relationship with other pods.

Remote leaf switch failover is disabled by default. You enable Remote Leaf Pod Redundancy Policy in the Cisco Application Policy Infrastructure Controller (APIC) GUI under the **Systems > System Settings** tab.

You also can enable redundancy pre-emption. If you enable pre-emption, the remote leaf switch is reassociated with the parent pod once that pod is back up. If you do not enable pre-emption, the remote leaf remains associated with the operational pod even when the parent pod comes back up.



Note Movement of a remote leaf switch from one pod to another could result in traffic disruption of several seconds.

Requirements for Remote Leaf Failover

This section lists the requirements that you must meet in order for remote leaf switch failover to work. The requirements are in addition to the remote leaf switch [Remote Leaf Switch Hardware Requirements](#) in this chapter.

- Configure multipod in route reflector mode instead of full mesh mode.
- Enable direct traffic forwarding with a routable IP address on the remote leaf switches.
- Configure an external Border Gateway Protocol (BGP) route reflector.
 - We recommend that you use an external route reflector for multipod to reduce the BGP session between spine switches.

You can dedicate one spine switch in each pod as an external route reflector.
 - Configure external BGP route reflector nodes on all the remote leaf pods in full mesh mode.
 - If you are already using multipod in full mesh mode, you can continue using the full mesh; however, enable route reflector for the remote leaf switch.

Enable Remote Leaf Switch Failover

Enable remote leaf switch failover by creating a remote leaf switch pod redundancy policy. You can also enable redundancy pre-emption, which reassociates the remote leaf switch with the parent pod once that pod is back up.

Before you begin

Perform the following tasks before you enable remote leaf switch failover:

- Fulfill the requirements in the section [Requirements for Remote Leaf Failover, on page 144](#).
- Enable remote leaf direct (RLD).
- Make sure that all the pods are running Cisco Application Policy Infrastructure Controller (APIC) Release 4.2(2) or later.
- Make sure that all the pods have at least two data center interconnect (DCI)-capable spine switches.

Make sure that you use Cisco Nexus 9000-series spine switches with the suffix "EX" in their product names. For example, N9K-C93180YC-EX.



Note If you have a single remote leaf switch in a pod and the switch is clean reloaded, it is attached to the failover pod (parent configured pod) of the spine switch. If you have multiple remote leaf switches in a pod, make sure that at least one of switches is **not** clean-reloaded. Doing so ensures that the other remote leaf switches can move to the pod where the remote leaf switch that was not reloaded is present.

Procedure

-
- Step 1** Log in to Cisco APIC.
- Step 2** Go to **System > System Settings**.
- Step 3** In the **System Settings** navigation pane, choose **Remote Leaf POD Redundancy Policy**.
- Step 4** In the **Remote Leaf POD Redundancy Policy** work pane, check the **Enable Remote Leaf Pod Redundancy Policy** check box.
- Step 5** (Optional) Check the **Enable Remote Leaf Pod Redundancy pre-emption** check box.
- Checking the check box reassociates the remote leaf switch with the parent pod once that pod is back up. Leaving the check box unchecked, the remote leaf remains associated with the operational pod even when the parent pod comes back up.
-

What to do next

Enter the following commands on the remote leaf switch when failover occurs to verify which pod remote leaf switch is operational:

```
cat /mit/sys/summary
moquery -c rlpodredRlSwitchoverPod
```

Prerequisites Required Prior to Downgrading Remote Leaf Switches



Note If you have remote leaf switches deployed, if you downgrade the APIC software from Release 3.1(1) or later, to an earlier release that does not support the Remote Leaf feature, you must decommission the remote nodes and remove the remote leaf-related policies (including the TEP Pool), before downgrading. For more information on decommissioning switches, see *Decommissioning and Recommissioning Switches* in the *Cisco APIC Troubleshooting Guide*.

Before you downgrade remote leaf switches, verify that the followings tasks are complete:

- Delete the vPC domain.
- Delete the vTEP - Virtual Network Adapter if using SCVMM.

- Decommission the remote leaf nodes, and wait 10 -15 minutes after the decommission for the task to complete.
- Delete the remote leaf to WAN L3out in the infra tenant.
- Delete the infra-l3out with VLAN 5 if using Multipod.
- Delete the remote TEP pools.



CHAPTER 15

SR-MPLS Handoff

Beginning with Release 5.0(1), segment routing (SR) Multiprotocol Label Switching (MPLS) handoff on the Cisco ACI border leaf switches is available as a new feature.



Note Procedures in this document describe how to configure SR-MPLS handoff using the GUI and REST API. You cannot configure SR-MPLS handoff through the NX-OS style CLI at this time.

- [Understanding ACI Handoffs, on page 147](#)
- [Understanding ACI Implementation of SR-MPLS Handoff, on page 152](#)
- [Understanding the SR-MPLS Configuration Model, on page 160](#)
- [Guidelines and Limitations for SR-MPLS, on page 164](#)
- [Configuring an SR-MPLS Infra L3Out Using the GUI, on page 172](#)
- [Configuring an SR-MPLS VRF L3Out Using the GUI, on page 180](#)
- [Creating SR-MPLS Custom QoS Policy Using the GUI, on page 183](#)
- [Displaying MPLS Statistics, on page 185](#)
- [Configuring SR-MPLS Global Block \(GB\), on page 187](#)
- [Migrating from IP Handoff Configuration to SR Handoff Configuration, on page 189](#)
- [About the BGP Domain-Path Feature for Loop Prevention, on page 196](#)

Understanding ACI Handoffs

The following sections describe how ACI handoffs are handled for releases prior to Cisco APIC Release 5.0(1), using IP handoff, and how they are handled starting with Cisco APIC Release 5.0(1), using SR-MPLS handoff.

ACI Handoffs Prior to Release 5.0(1): IP Handoff

Prior to Cisco APIC Release 5.0(1), when setting up an ACI fabric connecting the ACI border leaf nodes to a data center provider edge (DC-PE), if you have a configuration with a multi-tenant network, that means that you would need multiple VRFs, and you would need a routing protocol for each VRF. You would also need to dedicate an interface for each VRF, where the interface is either a physical interface or a logical interface. This configuration is typically called VRF-Lite, as shown in the following figure.

Figure 18: ACI Handoff to DC-PE Using IP Handoff (VRF-Lite)

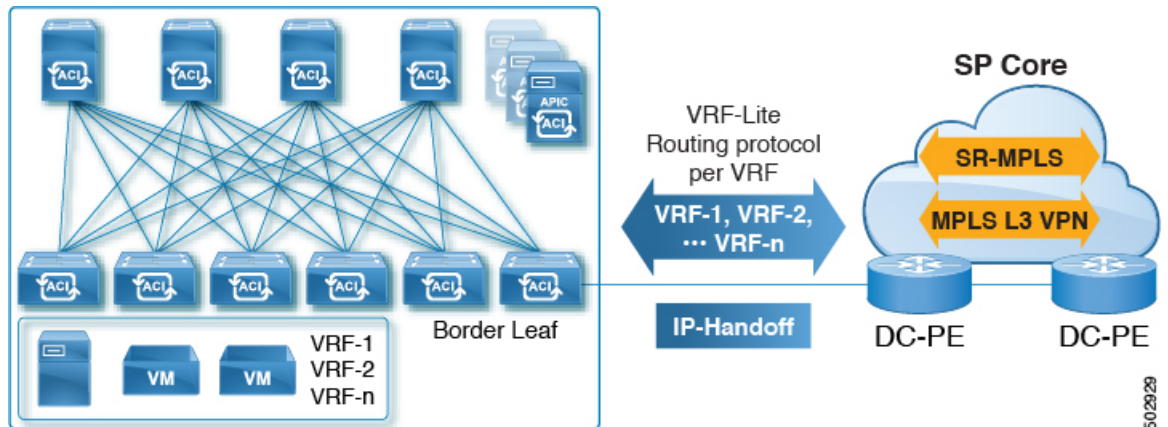

In this configuration, the border leaf switch is connected to the DC-PE using VRF-Lite. The interface and routing protocol session configurations between the border leaf switch and the DC-PE is done using separate VRFs. Differentiated Services Code Point (DSCP) is configured on the border leaf switch for outgoing traffic. On the DC-PE, the DSCP is mapped to the segment routing for traffic engineering (SR-TE) policy, which is used to steer traffic through the transport network.

This configuration becomes cumbersome if you have a large number of sessions between the border leaf switch and the data center. Therefore, automation and scalability are key challenges when configuring using VRF-Lite.

ACI Handoffs in Release 5.0(1): SR Handoff

Beginning with Cisco APIC Release 5.0(1), you can now set up an ACI fabric connection between border leaf switches and DC-PE routers using SR-MPLS handoff. SR is a better solution than other options, because other options such as VXLAN may not be a common technology in an SP Core, whereas SR is a much more common and mature solution for transport devices.

The following scenarios show how configuring the ACI handoff to the DC-PE using SR-MPLS is beneficial:

- [Unified Segment Routing Transport, on page 148](#)
- [Monitoring DC-to-DC Flows in the Transport Network, on page 149](#)
- [Single Control Plane Session for Multiple VRFs, on page 150](#)
- [SR-TE/Flex Algo in Transport Using Color Community or Destination Prefix, on page 151](#)
- [DC and Transport QoS with SR or MPLS, on page 152](#)

Unified Segment Routing Transport

The following scenario highlights the deployment of a unified SR or MPLS transport network to interconnect different ACI DC networks. The VXLAN to SR-MPLS handoff is leveraged in each location between the ACI network and the DC-PE routers.

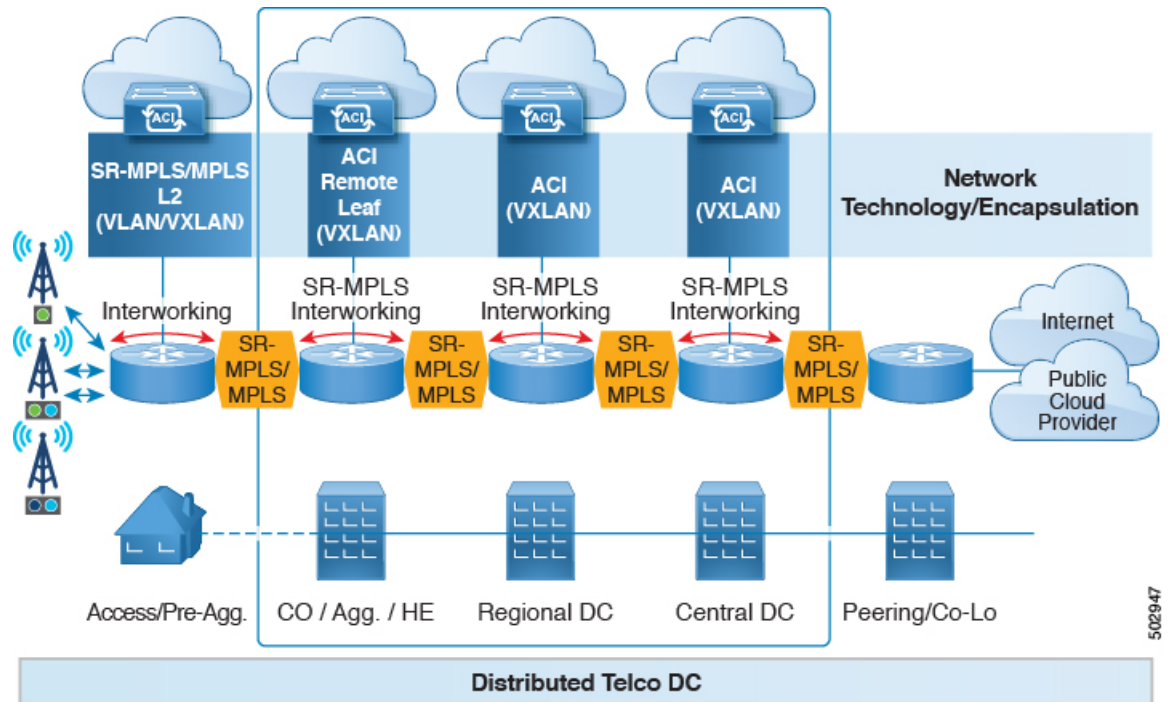

In this scenario, VXLAN is being used in the ACI fabric area, whereas segment routing is being used in the transport network. Rather than use VXLAN outside of the ACI fabric area, it would be preferable to use the same SR-based routing, where you would do an SR handoff or an MPLS handoff towards the transport device. By changing VXLAN to SR at the ACI border, the transport devices only need to run SR or MPLS and does not need to run VXLAN.

Monitoring DC-to-DC Flows in the Transport Network

In the following scenario, DC-to-DC flows are encapsulated using segment routing instead of VXLAN.

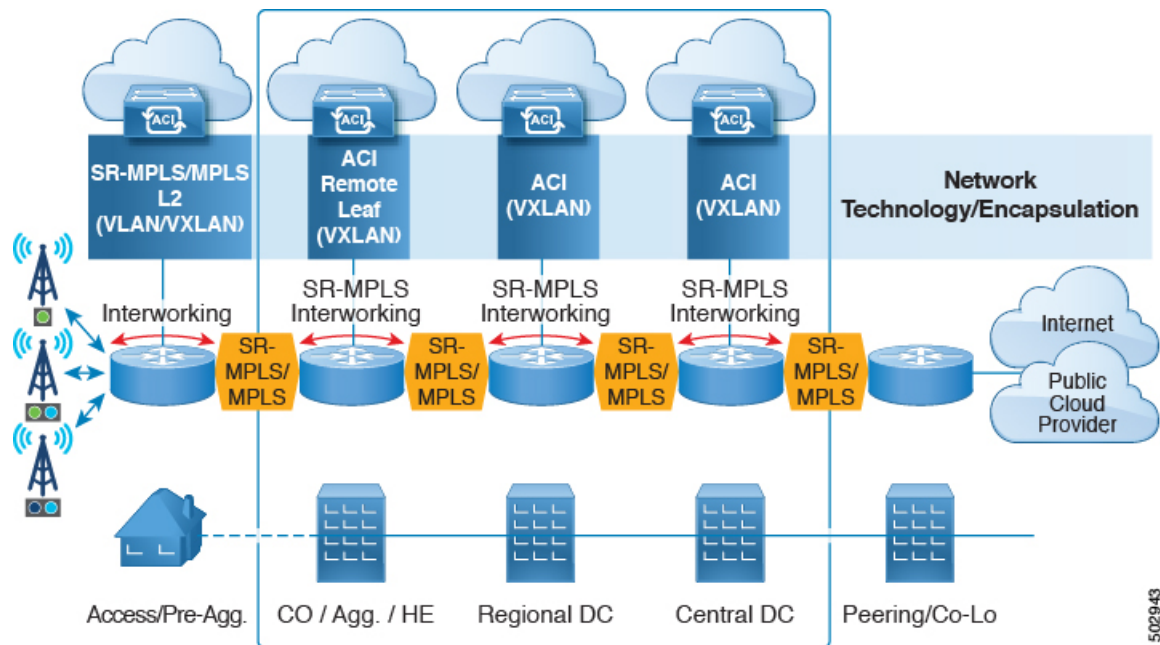

In this scenario, the existing monitoring tools used for the transport network can monitor MPLS traffic, but cannot monitor VXLAN packets. By using ACI to SR-MPLS handoff, this allows the transport team to monitor the DC-to-DC flows using existing monitoring tools.

Single Control Plane Session for Multiple VRFs

Using SR handoff, a single control plane session (MP-BGP EVPN) is used for all VRFs, rather than having per-VRF sessions that you would have to use in the IP handoff configuration. This provides better automation and scalability options for multiple VRFs between the ACI data center and the DC-PE.

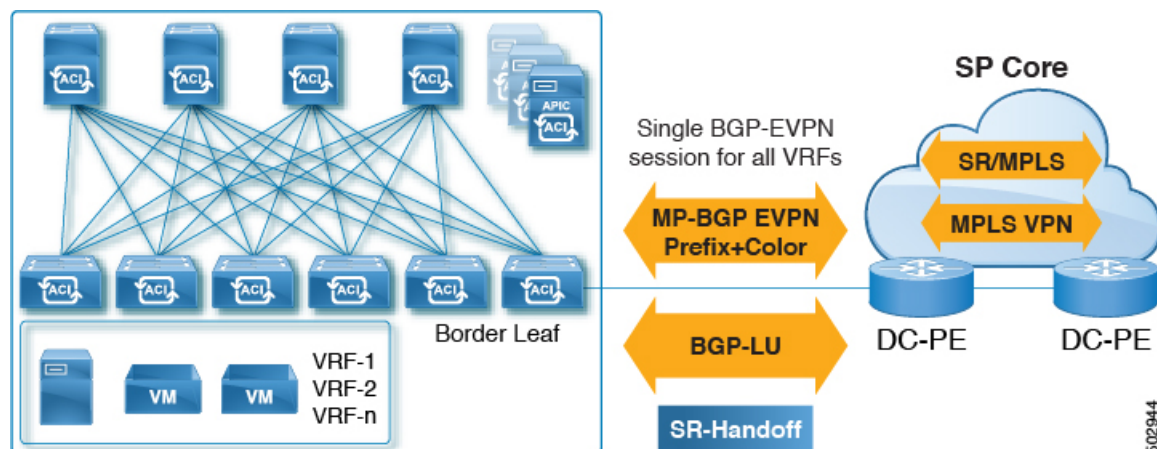

With SR handoff, a single control plane and data plane session is used instead of per-VRF control plane and data plane sessions, with a unified SR transport from the Cisco ACI fabric to the SP core. The BGP Label Unicast (BGP LU) address-family is used for the underlay label exchange. The MP-BGP EVPN address-family carries the prefix and MPLS label per VRF information.

SR-TE/Flex Algo in Transport Using Color Community or Destination Prefix

SR handoff is beneficial because it automates the signaling of SR in the SP core. In this situation, the ACI border leaf switch advertises an EVPN type 5 route with a BGP color extended community to the DC-PE. The DC-PE can then create a segment routing policy based on the color community or destination prefix received from the ACI border leaf switch. This functionality allows seamless integration between the DC and the transport network.

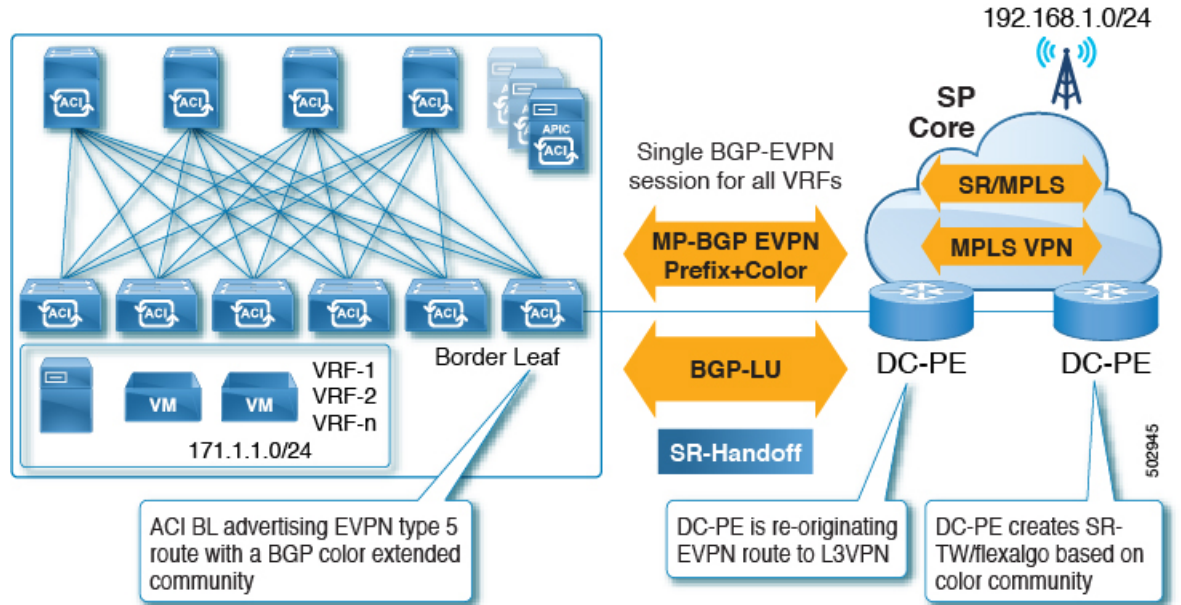

Similarly, you can advertise an EVPN type 5 prefix from the ACI border leaf switch and the DC-PE could create an SR-TE or Flex Algo routing policy based on the destination prefix, as shown in the following figure.

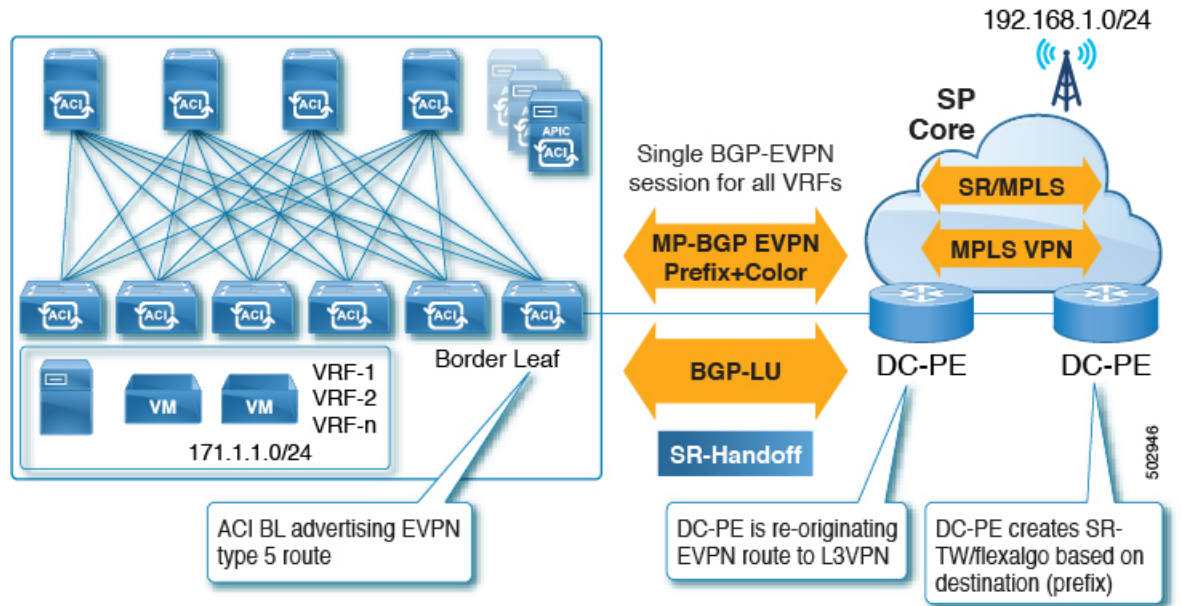

Of the two methods, we recommend using color community to reduce the configurations on the DC-PE. However, for either of these situations, you must verify that your DC-PE has the capability of supporting this functionality before utilizing SR-MPLS in this way.

DC and Transport QoS with SR or MPLS

Within the ACI fabric, non-border leaf switches can mark packets with DSCP values using EPG, contract and L3Out QoS policies. Using these DSCP values, you can set MPLS egress rules on the ACI border leaf switch to then mark packets with experimental bits (EXP) or Class of Service (COS) values. The transport network can then perform QoS actions or pick different SR or MPLS paths, based on the DSCP or EXP values coming from the data center.

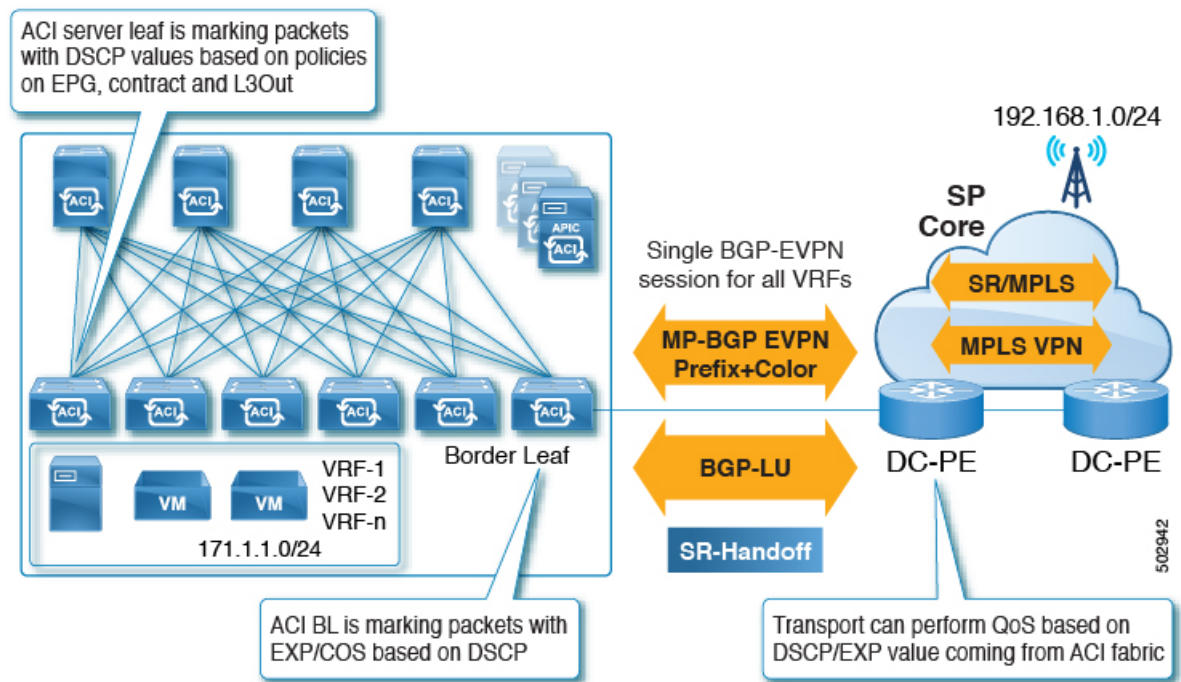

Similarly, using MPLS ingress rules, the ACI border leaf switch can mark the ingress packets coming into the fabric with COS, DSCP and QoS levels based on EXP values, where the QoS levels define the QoS actions within fabric.

Understanding ACI Implementation of SR-MPLS Handoff

ACI implements SR-MPLS handoff using the following ACI components that have been introduced in Cisco APIC Release 5.0(1).

SR-MPLS Infra L3Out

The SR-MPLS infra L3Out provides SR-MPLS connectivity. You will configure the SR-MPLS infra L3Out in the infra tenant on the border leaf switch to set up the underlay MP-BGP EVPN sessions for the SR-MPLS handoff. Tenant VRF instances are selectively mapped to the Cisco Application Centric Infrastructure (ACI) SR-MPLS infra L3Outs to advertise tenant subnets to the DC-PE routers and import MPLS VPN routes from

the DC-PE. An SR-MPLS infra L3Out is scoped to a pod or a remote leaf switch site, and is not extended across pods or remote leaf switch pairs.

Figure 19: SR-MPLS Infra L3Out

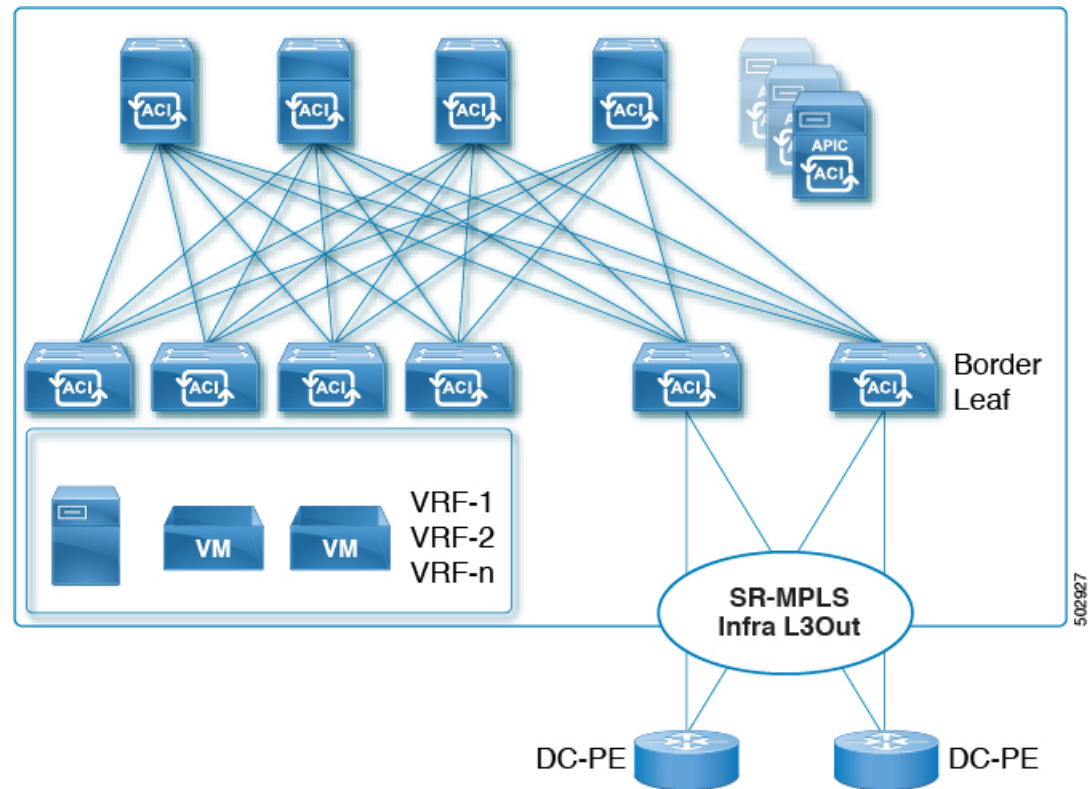

A pod or remote leaf switch site can have one or more SR-MPLS infra L3Outs.

See [Configuring an SR-MPLS Infra L3Out Using the GUI](#), on page 172 for the procedures for configuring the SR-MPLS infra L3Out.

As part of the configuration process for the SR-MPLS infra L3Out, you will configure the following areas:

- [MP-BGP EVPN Session Between the Cisco ACI Border Leaf Switch and the DC-PE](#), on page 153
- [Multi-Hop BFD for BGP EVPN Session](#), on page 154
- [Underlay BGP Sessions \(BGP-Labeled Unicast and IPv4 Address-family\) On the Cisco ACI Border Leaf Switch and Next-Hop Router](#), on page 155
- [Single-Hop BFD for BGP-Labeled Unicast Session](#), on page 156

MP-BGP EVPN Session Between the Cisco ACI Border Leaf Switch and the DC-PE

You will need to provide the necessary information to configure the MP-BGP EVPN sessions between the EVPN loopbacks of the border leaf switches and the DC-PE routers to advertise the overlay prefixes, as shown in the following figure.

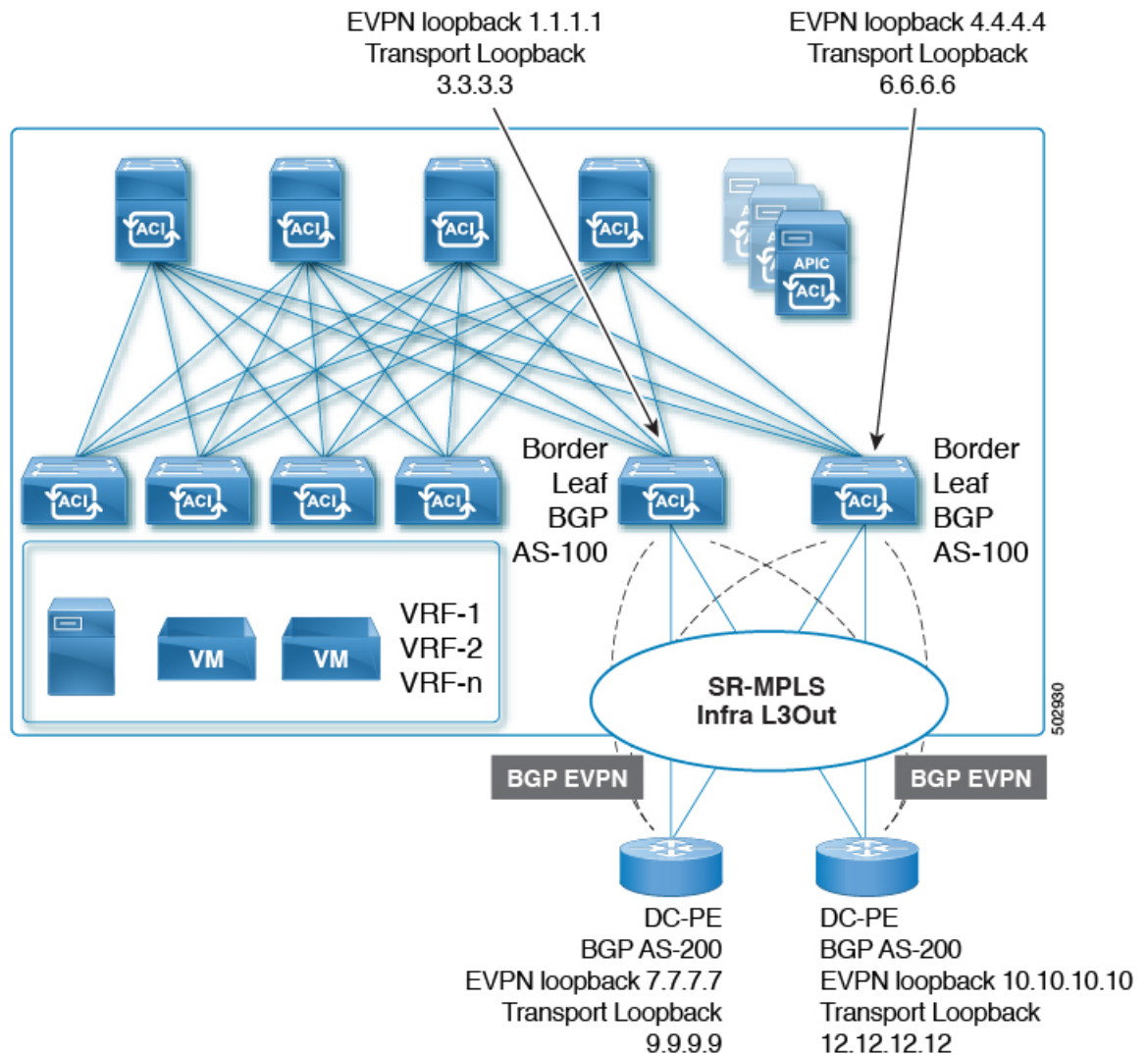

The following configurations take place in this area:

- The label advertisement for the transport loopback using the BGP-labeled unicast address family.
- A unique router ID on the border leaf switch in the SR-MPLS infra VRF instance.
- The router ID should be different from the BGP-EVPN loopback and transport loopback addresses.

While you can use a different IP address for the loopback for the MP-BGP EVPN and the transport as shown in the figure, we recommend that you use the same loopback for the MP-BGP EVPN and the transport loopback on the Cisco ACI border leaf switch.

Only eBGP sessions are supported at this time.

Multi-Hop BFD for BGP EVPN Session

Beginning with release 5.0(1), support is now available for multi-hop BFD, where you can configure multi-hop BFD EVPN sessions between EVPN loopbacks, as shown in the following figure.

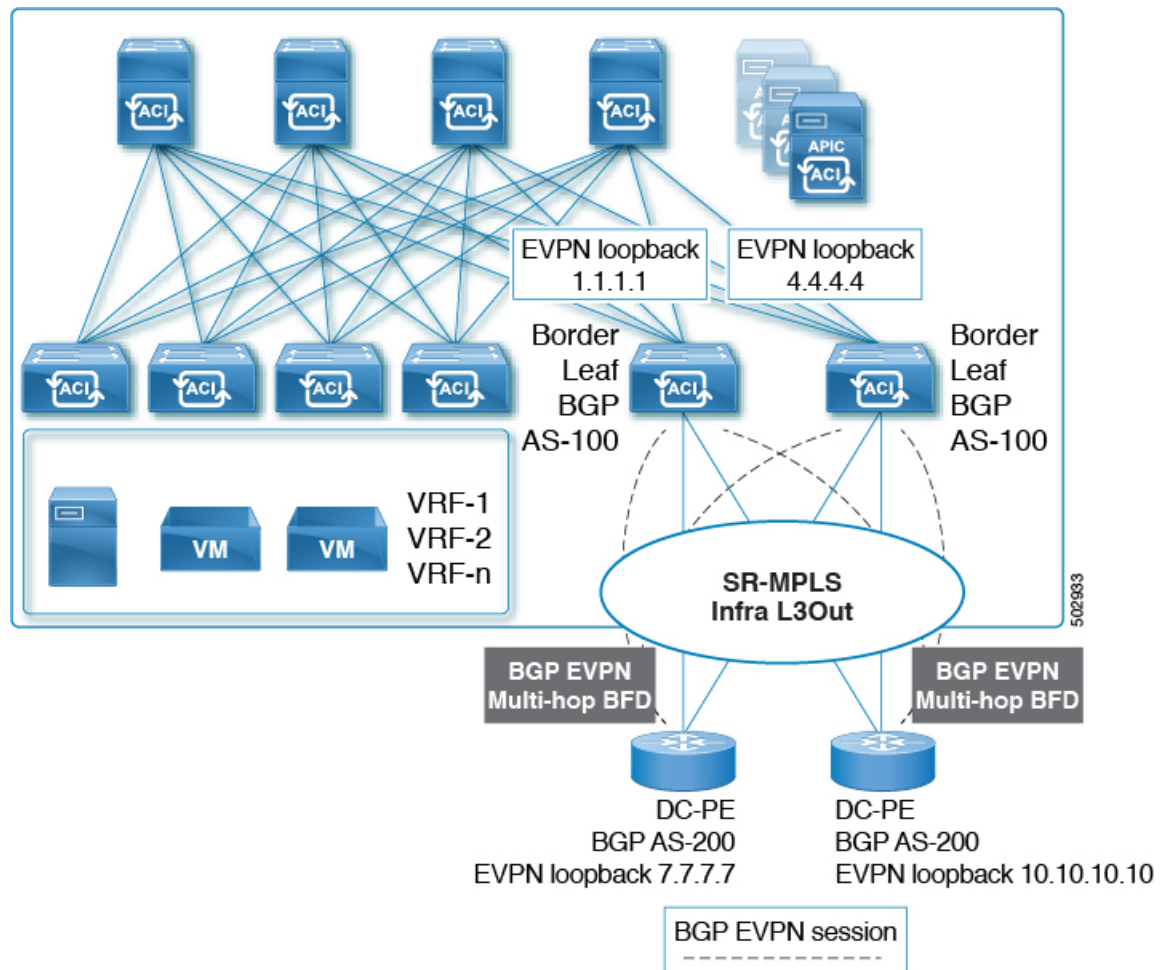

A multi-hop BFD with a minimum timer of 250 milliseconds and a detect multiplier of 3 is supported for the BGP EVPN session between the Cisco ACI border leaf switch and the DC-PE. You can modify this timer value based on your requirements.

Underlay BGP Sessions (BGP-Labeled Unicast and IPv4 Address-family) On the Cisco ACI Border Leaf Switch and Next-Hop Router

You will also configure the BGP IPv4 and labeled unicast address-family per interface between the Cisco ACI border leaf switches and the DC-PE, as shown in the following figure.

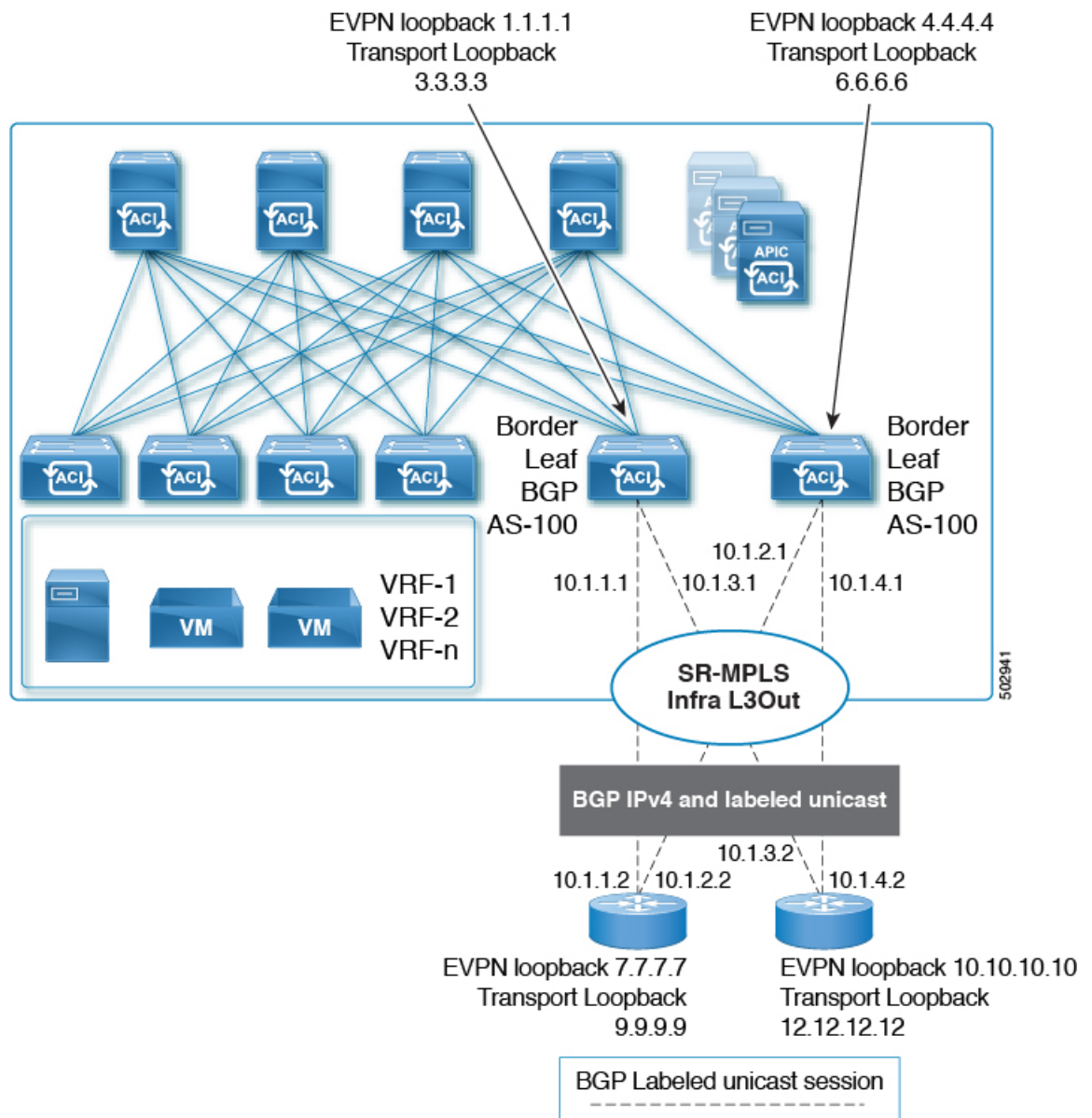

The BGP IPv4 address family automatically advertises the EVPN loopbacks, and the BGP-labeled unicast address family will automatically advertise the SR transport loopback with the SR-MPLS label.

Only eBGP sessions are supported at this time.

Single-Hop BFD for BGP-Labeled Unicast Session

To prevent an issue related to soft failure, where the link remains up but the forwarding capability of the link is impacted, you can configure a single-hop BFD session for the underlay BGP session for the IPv4 and BGP-labeled unicast session, as shown in the following figure.

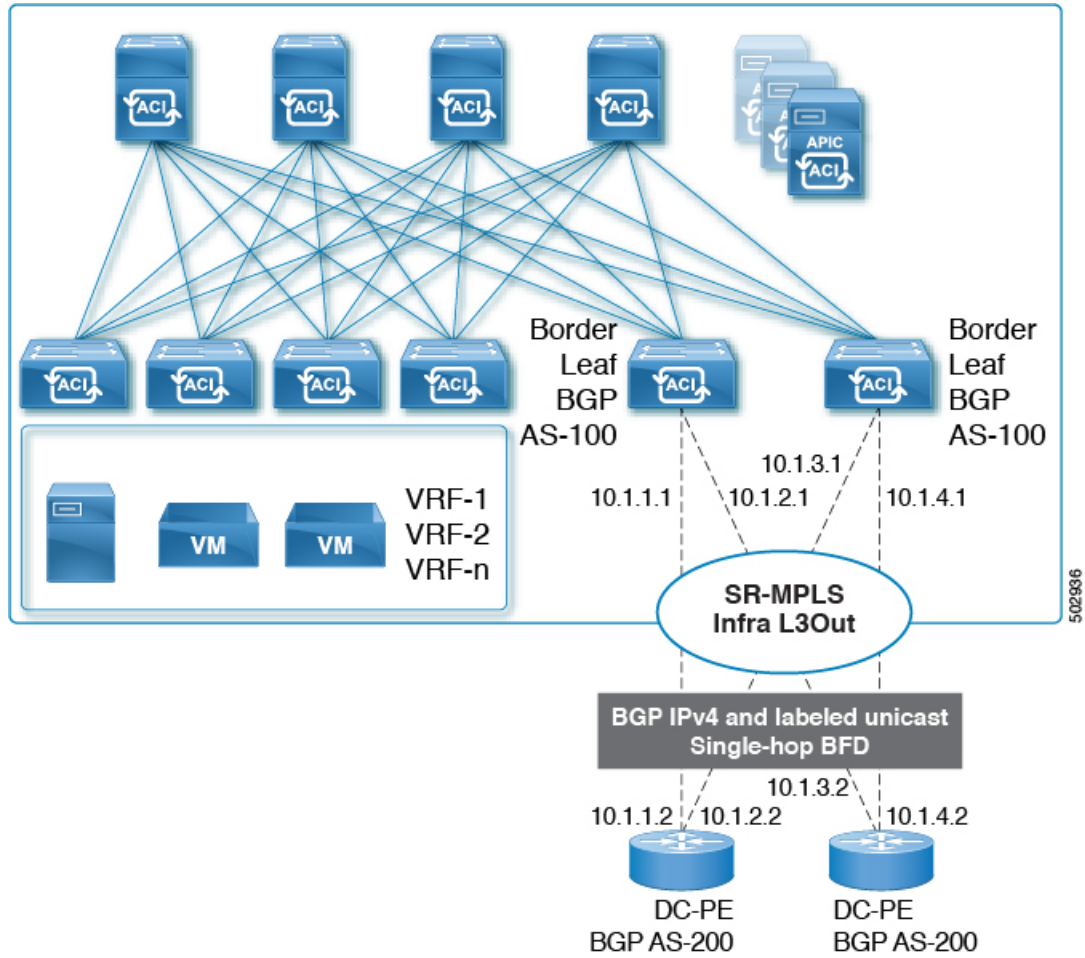

A single-hop BFD with a minimum timer of 50 milliseconds and a detect multiplier of 3 is supported for the BGP EVPN session between the Cisco ACI border leaf switch and the DC-PE. You can modify this timer value based on your requirements.

You can configure the BFD echo function on one or both ends of a BFD-monitored link. The echo function slows down the required minimum receive interval, based on the configured slow timer. The *RequiredMinEchoRx* BFD session parameter is set to *zero* if the echo function is disabled. The slow timer becomes the required minimum receive interval if the echo function is enabled.

SR-MPLS VRF L3Out

Each VRF, whose prefixes need to be advertised towards an SR-MPLS transport, must be associated with the SR-MPLS infra L3Out. You will configure these associations using the SR-MPLS VRF L3Outs, which are attached to the SR-MPLS infra L3Out.

Figure 20: User Tenant SR-MPLS L3Out

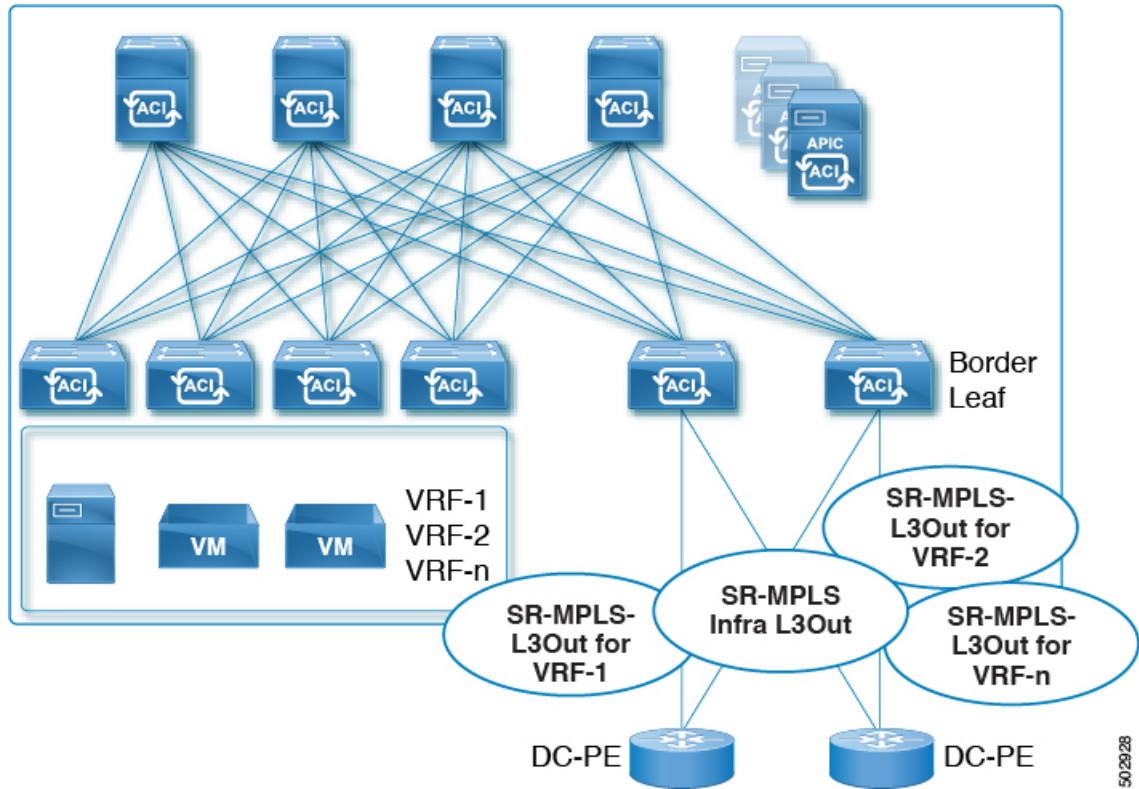

You can attach one or more SR-MPLS VRF L3Outs to the same SR-MPLS infra L3Out. Through the SR-MPLS VRF L3Outs, you can configure import and export route maps to do the following things:

- Apply route policies based on prefixes and/or communities
- Advertise prefixes into the SR network
- Filter out prefixes received from the SR network

You will also configure an external EPG with one or more subnets on each SR-MPLS VRF L3Out tenant, which is used for the following:

- Security policies (contract)
- Policy-Based Redirect (PBR) policies
- Route leaking between VRFs

See [Configuring an SR-MPLS VRF L3Out Using the GUI, on page 180](#) for the procedures for configuring SR-MPLS VRF L3Outs.

SR-MPLS Custom QoS Policy

You can use custom QoS policies to define how traffic coming from an MPLS network is prioritized within the ACI fabric. You can also use these policies to re-mark the traffic when it leaves the fabric via an MPLS L3Out.

When configuring a custom QoS policy, you define the following two rules that are applied on the border leaf switch:

- **Ingress rules:** Any traffic coming into the border leaf switch connected to the MPLS network will be checked for the MPLS experimental bits (EXP) value and if a match is found, the traffic is classified into an ACI QoS Level and marked with appropriate CoS and differentiated services code point (DSCP) values.

The values are derived at the border leaf using a custom QoS translation policy. The original DSCP values for traffic coming from SR-MPLS are retained without any remarking. If a custom policy is not defined or not matched, the default QoS Level (Level13) is assigned.

- **Egress rules:** When the traffic is leaving the fabric out of the border leaf's MPLS interface, it will be matched based on the DSCP value of the packet and if a match is found, the MPLS EXP and CoS values will be set based on the policy.

If the egress MPLS QoS policy is not configured, the MPLS EXP will default to zero. If they are configured based on the MPLS Custom QoS policy, it will remark the EXP.

The following two figures summarize when the ingress and egress rules are applied as well as how the internal ACI traffic may remark the packets' QoS fields while inside the fabric.

Figure 21: Ingress QoS

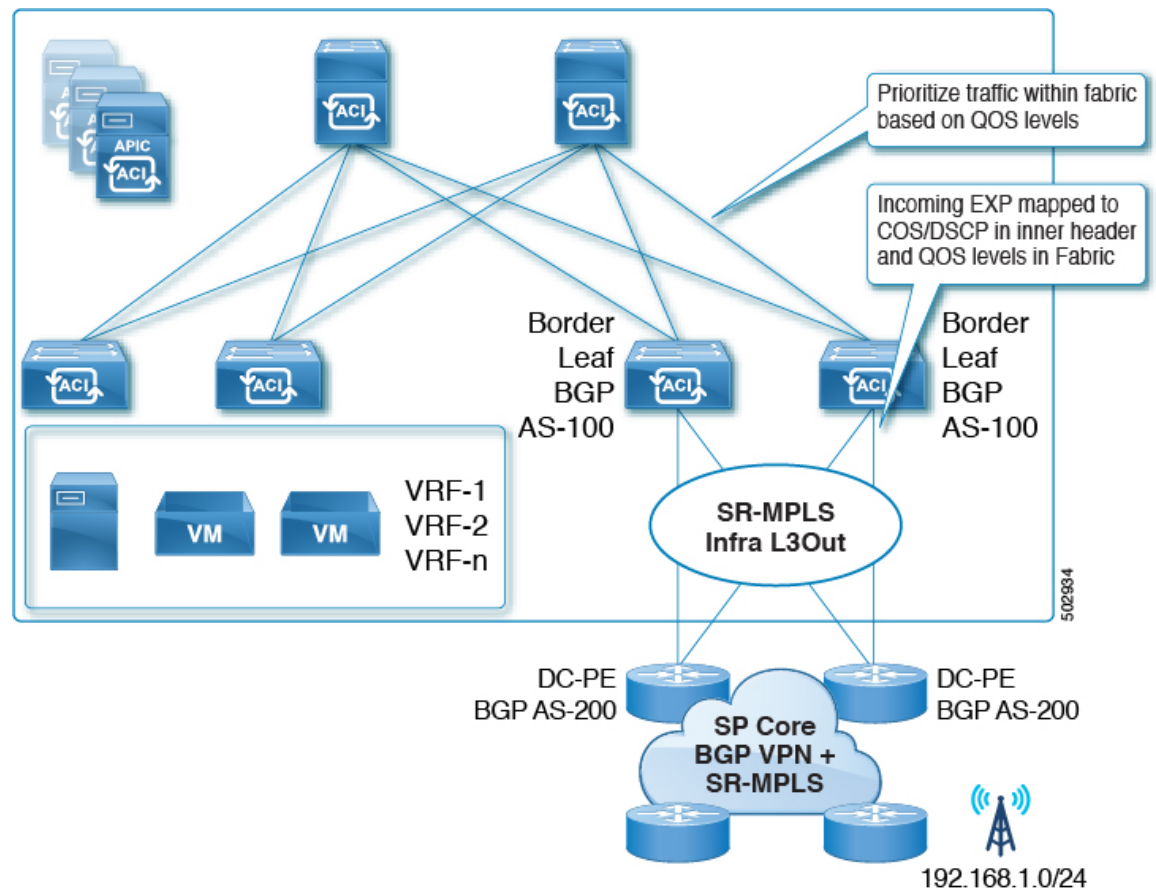
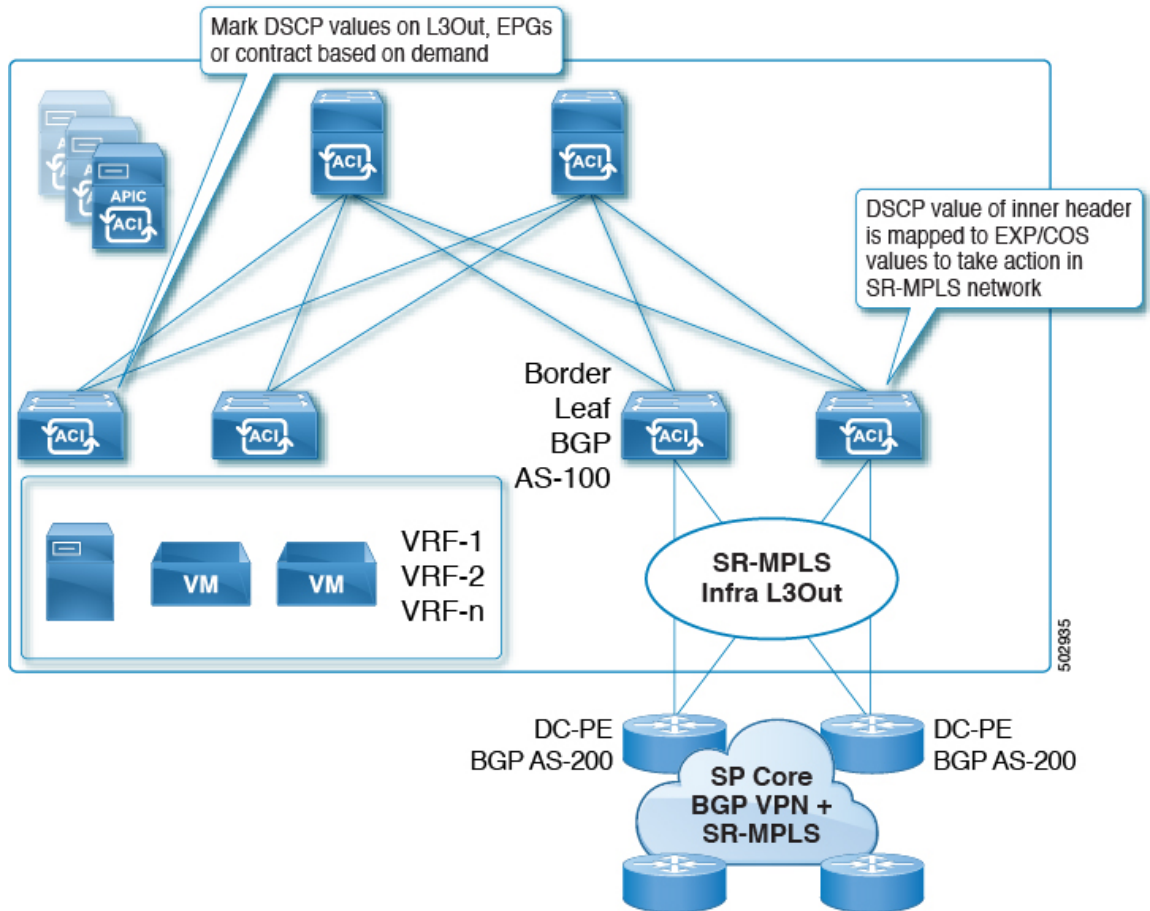

Figure 22: Ingress QoS



You can define multiple custom QoS policies and apply them to each SR-MPLS Infra L3Out you create, as described in [Creating SR-MPLS Custom QoS Policy Using the GUI](#), on page 183.

Understanding the SR-MPLS Configuration Model

The following figure shows the configuration model for the ACI implementation of SR-MPLS handoff.

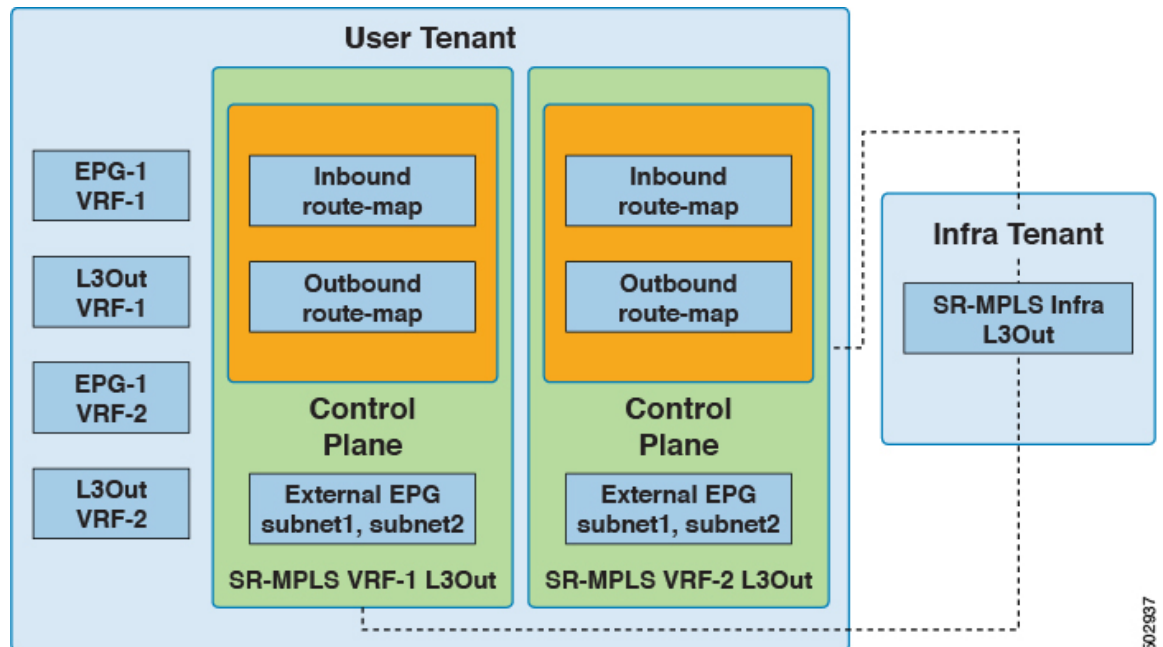

502937

Configuration of SR-MPLS handoff takes place within these tenants:

- **Infra Tenant:** Underneath the infra tenant, you will configure the SR-MPLS infra L3Out, as described in [SR-MPLS Infra L3Out, on page 152](#). The SR-MPLS infra L3Out is where you define the connectivity between the ACI fabric and the external devices connected to the border leaf switches. You will specify the overlay and underlay node path in the SR-MPLS infra L3Out.
- **User Tenant:** Underneath the user tenant, you may have multiple VRFs, EPGs, and L3Outs, as shown in the left area in the figure. Within the user tenant, you will configure the SR-MPLS VRF L3Out that you will use as part of the SR-MPLS handoff configuration, as described in [SR-MPLS VRF L3Out, on page 157](#).

Within the SR-MPLS VRF L3Out, you will also configure the following route maps:

- **Inbound route map:** By default, the policy for the inbound route map is to accept all prefixes. An explicit inbound route map can be configured to:
 - Match prefixes to selectively deny their advertisement inside the fabric
 - Match prefixes and community to selectively deny their advertisement inside the fabric
- **Outbound route map:** You must configure the policy for the outbound route map to advertise any prefix, including bridge domain subnets. By default, the policy for the outbound route map is to not advertise any prefix. An explicit outbound route map can be configured to:
 - Match prefixes to be advertised to the SR-MPLS network
 - Match prefixes and community to advertise prefixes to the SR-MPLS network
 - Set community, including color community, based on the prefix and/or community match

Both the inbound route map and the outbound route map are used for the control plane, to set which prefixes are permitted or denied in and out of the fabric.

Within the SR-MPLS VRF L3Out, you will also configure the external EPG and the subnets within this external EPG, which is used for the data plane. These subnets will be used to apply ACI security policies. The external EPG subnet is also used to leak prefixes in another VRF using flags. If you enable the route-leak and security flag on an external EPG subnet, then that subnet can be leaked to another VRF. You can also configure the external EPG subnet with the aggregated flag to leak prefixes to another VRF. In this case, you will need to define a contract to the leaf switch prefixes and allow communication across VRFs.



Note The external EPG on the SR-MPLS VRF L3Out is not used for routing policies, such as applying a route map to advertise or deny prefix advertisement.

In this example, the SR-MPLS VRF-1 L3Out within the user tenant is attached to the SR-MPLS infra L3Out, and the SR-MPLS VRF-2 L3Out within the user tenant is also attached to the SR-MPLS infra L3Out.

EPG to SR-MPLS L3Out

The following figure shows an example of an EPG to SR-MPLS L3Out configuration.

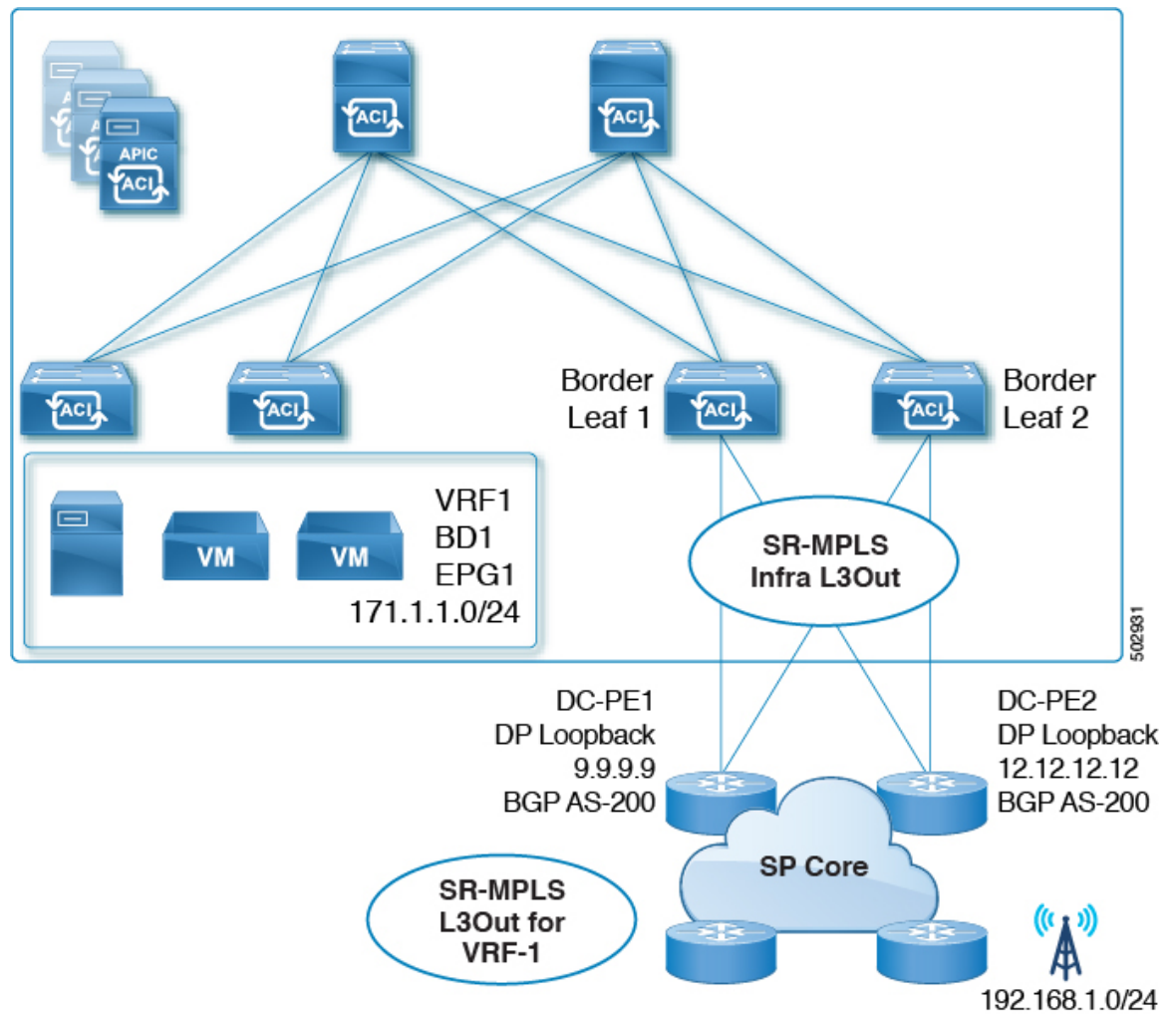

In this scenario, you would make the following configurations:

- Configure the SR-MPLS infra L3Out on the border leaf switches (BL1 and BL2 in the figure above)
- Configure the SR-MPLS VRF L3Out in the user tenant, along with the EPG, bridge domain and user VRFs
- Configure the route map for exporting and importing on prefixes and apply it to the SR-MPLS VRF L3Out
- Configure the contract and apply it between the EPG and the external EPG defined on the SR-MPLS VRF L3Out for traffic forwarding between the EPG and the SR-MPLS L3Out

IP L3Out to SR-MPLS L3Out

The following figure shows an example of a configuration to enable transit routing between a regular IP L3Out and an SR-MPLS L3Out.

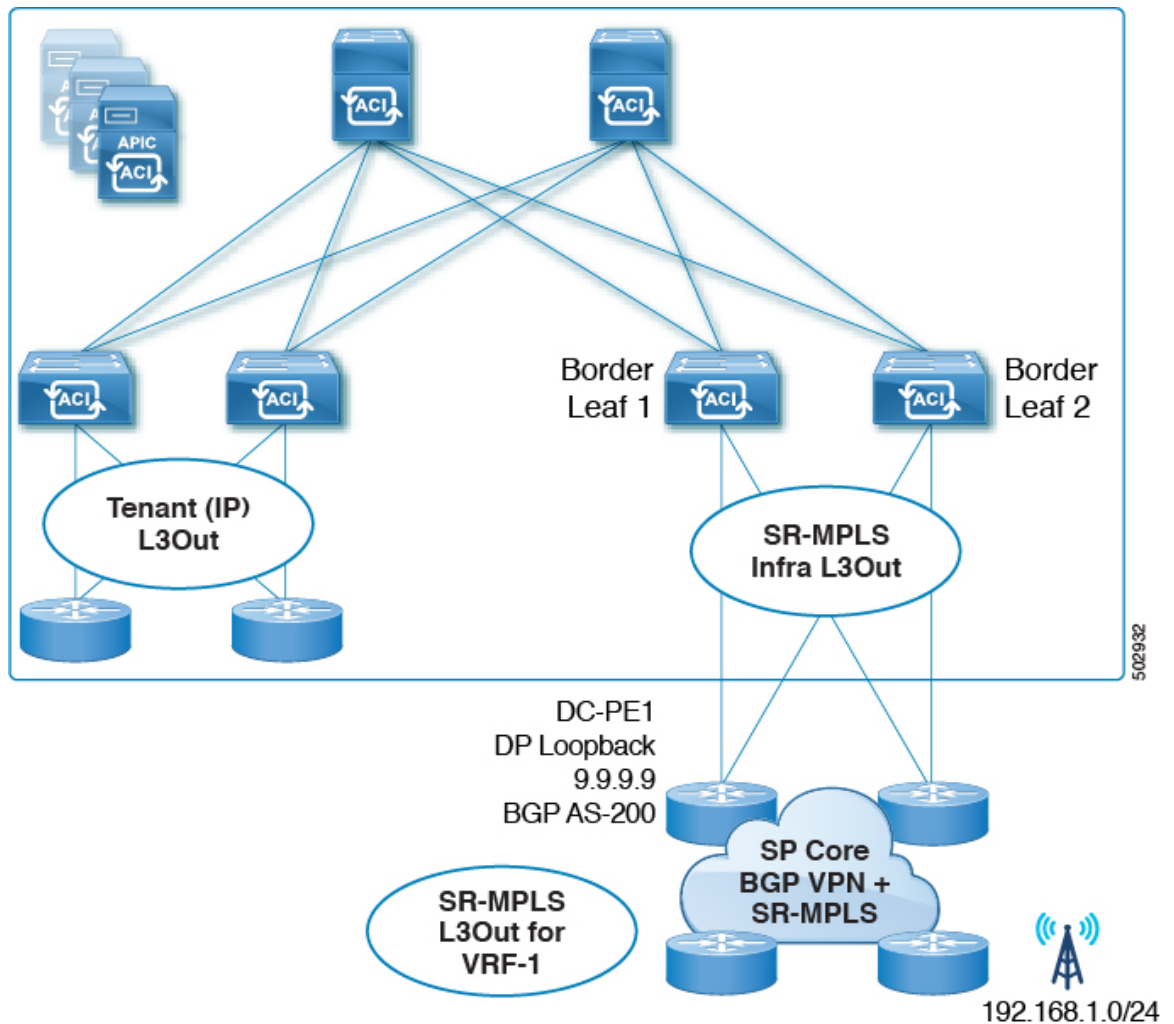

In this scenario, you would make configurations similar to the EPG to SR-MPLS L3Out configuration described previously, with the differences highlighted below:

- Configure the SR-MPLS infra L3Out on the border leaf switches (BL1 and BL2 in the figure above)
- Configure the SR-MPLS VRF L3Out in the user tenant, along with the **IP L3Out** and user VRFs
- Configure the route map for exporting and importing on prefixes and apply it to the SR-MPLS VRF L3Out
- Configure the contract and apply it between the external EPGs associated to the IP L3Out and the SR-MPLS VRF L3Out for traffic forwarding between the **IP L3Out** and the SR-MPLS L3Out

Guidelines and Limitations for SR-MPLS

Following are the guidelines and limitations for the SR-MPLS handoff feature.

- [Supported Platforms for SR-MPLS, on page 165](#)

- [Platform Limitations for SR-MPLS, on page 165](#)
- [Guidelines and Limitations for the SR-MPLS Infra L3Out, on page 166](#)
- [Guidelines and Limitations for the SR-MPLS VRF L3Out, on page 166](#)
- [Guidelines and Limitations for MPLS Custom QoS Policies, on page 171](#)
- [Guidelines and Limitations for SR-MPLS Statistics, on page 172](#)

Supported Platforms for SR-MPLS

The SR-MPLS handoff feature is supported on the following platforms:

- **Border leaf switches:** -FX switch models and later (for example, switch models with "FX", "FX2", "FX3", "GX", and so on at the end of the switch name)
- **Spine switches:**
 - Modular spine switch models with "LC-EX", "LC-FX", and "GX" at the end of the linecard name
 - Fixed spine switches Cisco Nexus 9000 series N9K-C9332C and N9K-C9364C
- **DC-PE routers:**
 - Network Convergence System (NCS) 5500 Series
 - ASR 9000 Series
 - NCS 540 or 560 routers
 - ASR1000/ IOS-XE platforms
- The Cisco Application Centric Infrastructure (ACI)-to-SR-MPLS handoff solution uses a standards-based implementation with SR-MPLS, BGP-LU, BGP EVPN, and prefix re-origination between BGP EVPN and VPNv4/v6. Any DC-PE that supports these technologies should be able to support Cisco ACI to SR-MPLS handoff.



Note When the Cisco Application Centric Infrastructure (ACI) border leaf switch with the SR-MPLS handoff is connected to a PE device running IOS-XE software, the IOS-XE device should be configured with "neighbor <aci-leaf> next-hop-unchanged" under the BGP L2VPN EVPN address-family. With next-hop-unchanged configuration, Cisco ACI border leaf switch must learn the remote PE loopback.

Platform Limitations for SR-MPLS

- On the FX platform, enabling the SR-MPLS feature would enable MPLS parsing on all ports, including ports where MPLS is not enabled or deployed. On FX2 platforms and later, MPLS parsing is enabled only on ports where SR-MPLS is enabled or deployed.
- On ports where MPLS parsing is enabled, pure Layer 2 switching of MPLS encapsulated packets are not supported. Non-MPLS Layer 2 traffic can use the Cisco ACI fabric as Layer 2 transit, without any issues.
- As SR-MPLS handoff in Cisco ACI is supported only in pipe mode and the TTL value is hardcoded to TTL=32 in the MPLS header for all the data plane packets it may lead to some reachability issues with

some cloud hosted SaaS that are more than 32 hops away. The workaround solution would be to disable the TTL propagation on the neighboring router to prevent copy back of the MPLS TTL to the IP header by using the following command:

```
mpls ip-ttl-propagation disable
```

Guidelines and Limitations for the SR-MPLS Infra L3Out

- Even though a border leaf switch can be in multiple SR-MPLS infra L3Outs, a border leaf switch/provider edge router combination can only be in one SR-MPLS infra L3Out as there can be only one routing policy for a user VRF/border leaf switch/DC-PE combination.
- If there is a requirement to have SR-MPLS connectivity from multiple pods and remote locations, ensure that you have a different SR-MPLS infra L3Out in each of those pods and remote leaf locations with SR-MPLS connectivity.
- SR-MPLS infra L3Outs do not support multicast.

Routing Policy

- **Supported:** Beginning with Cisco APIC release 6.1(1), fabric ports on a remote leaf can now be deployed on SRMPLS infra l3outs, as a routed sub interface.

Guidelines and Limitations for the SR-MPLS VRF L3Out

Routing Policy

- Within each SR-MPLS VRF L3Out, defining the outbound route map (export routing policy) is mandatory, but defining the inbound route map (import routing policy) is optional.
- Routing policies associated with any SR-MPLS VRF L3Outs have to be a global type. In other words, you have to explicitly add all the routes, including bridge domain subnets.
- Host-based routing is not supported with SR-MPLS.
- Transit routing is supported, but with some restrictions:
 - **Supported:** Transit SR-MPLS traffic **with a single VRF using different border leaf pairs**, as shown in the following figure. For this configuration, you must advertise the unique prefixes range through each SR-MPLS infra L3out (border leaf pair). You must also ensure that there is no routing loop in the transport network (in other words, that the fabric is acting as a hub with the two-transport network acting as a spoke).

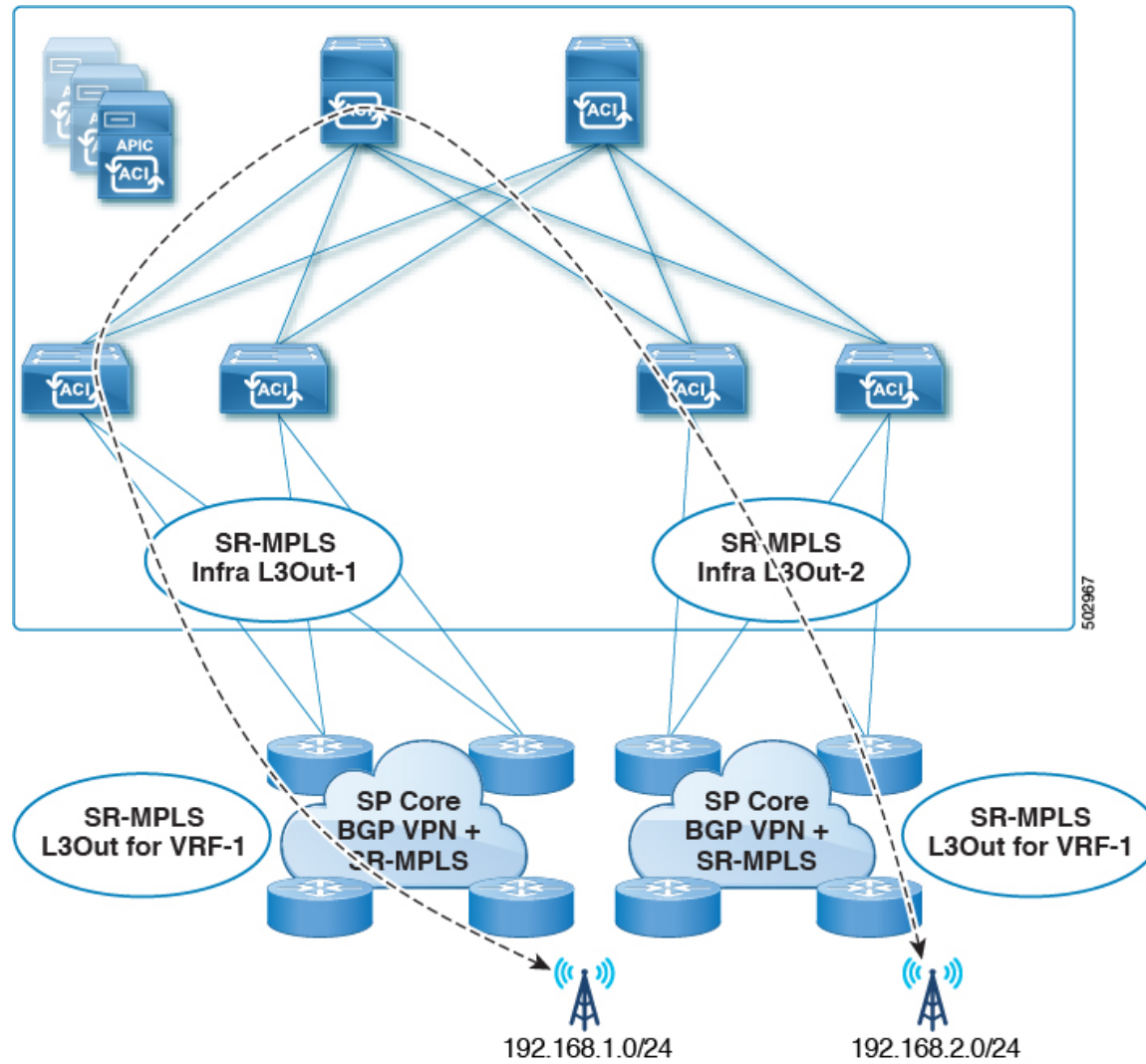

- **Supported:** Transit SR-MPLS traffic with the same border leaf pair and different VRFs, as shown in the following figure.

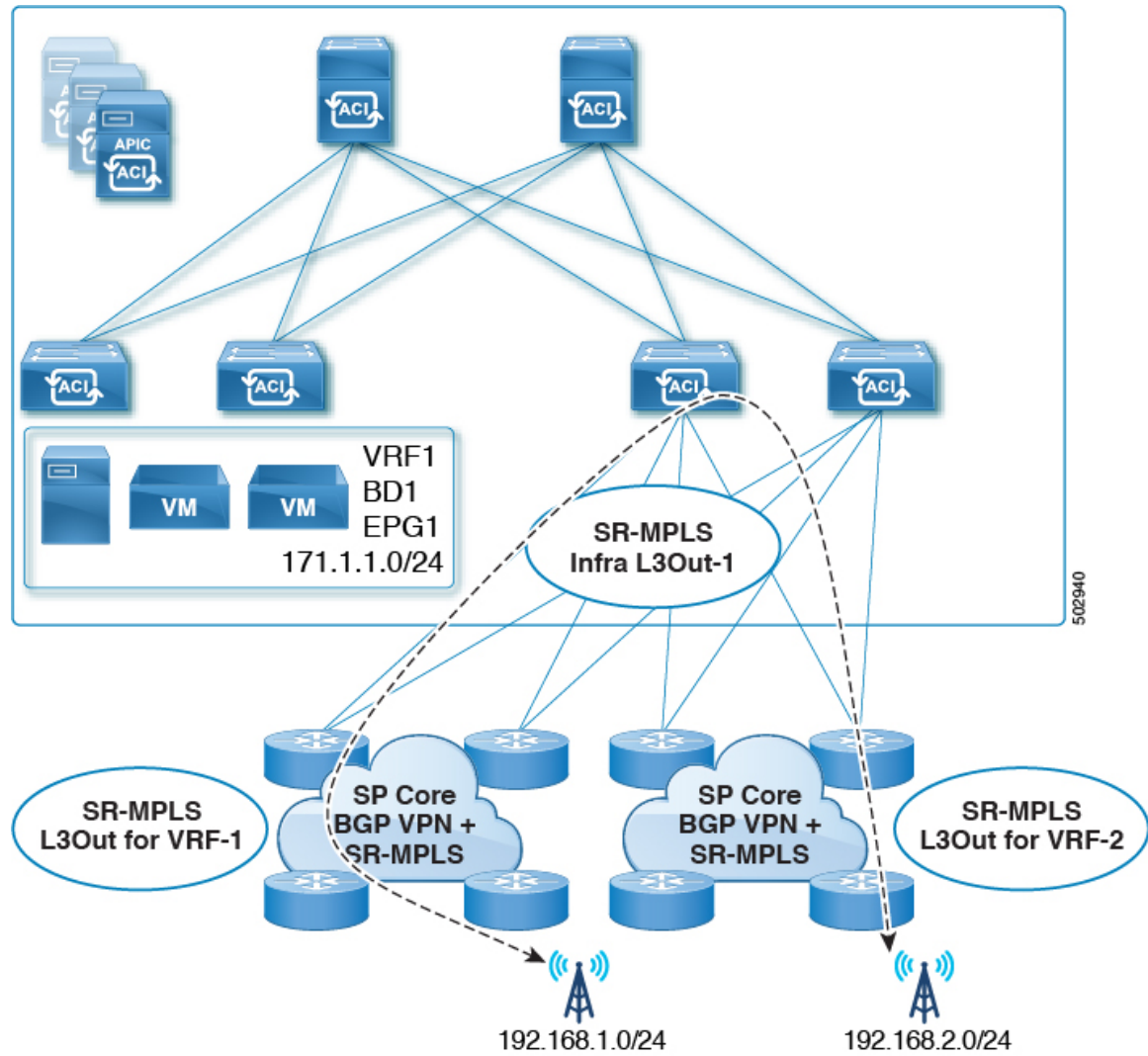

- **Supported:** Transit SR-MPLS traffic with different border leaf pairs and different VRFs, as shown in the following figure.

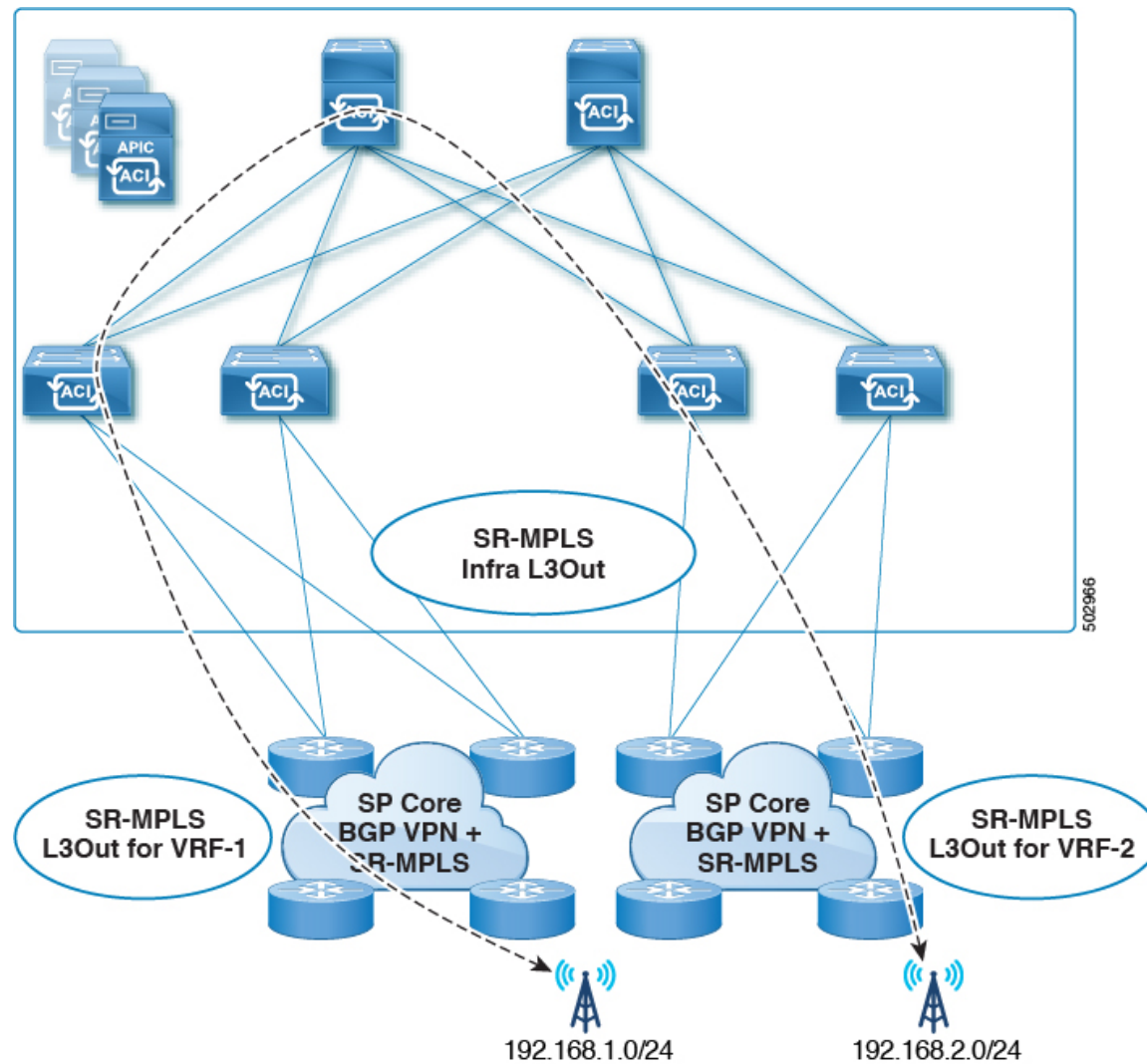

- Transit SR-MPLS traffic **within the same VRF and on the same border leaf pair**, as shown in the following figure:
 - **Unsupported** for releases prior to Release 5.1(1).
 - **Supported** for Release 5.1(1) and later, where re-originated routes are prevented from being advertised back into the same Infra L3Out peers to avoid transient loops in the system.

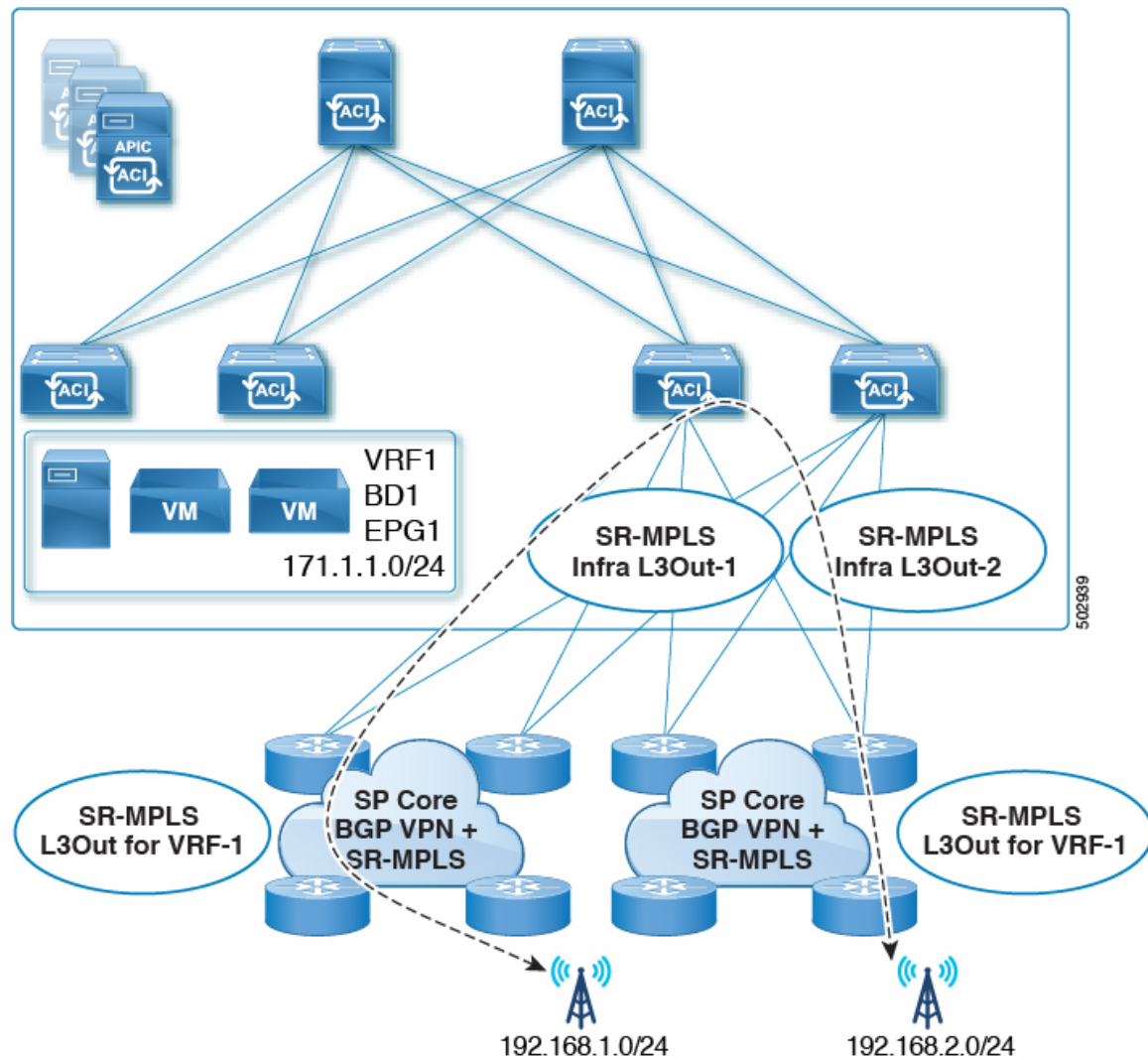

- If a leaf switch is configured on multiple SR-MPLS infra L3Outs, the same subnets can be advertised out of all the L3Outs if the prefixes are configured in a single prefix list (in one match rule), and the route map with that prefix list is then associated with all the SR-MPLS VRF L3Outs.

For example, consider the following configuration:

- A single prefix list P1, with subnets S1 and S2
- SR-MPLS VRF L3Out 1, which is associated with route map R1, with prefix list P1
- SR-MPLS VRF L3Out 2, which is associated with route map R2, with prefix list P1

Because the prefixes are configured in the same prefix list (P1), even though they are associated with different SR-MPLS VRF L3Outs, the same subnets within prefix list P1 are advertised out of both L3Outs.

On the other hand, consider the following configuration:

- Two prefix lists:
 - Prefix list P1, with subnets S1 and S2

- Prefix list P2, with subnets S1 and S2
- SR-MPLS VRF L3Out 1, which is associated with route map R1, with prefix list P1
- SR-MPLS VRF L3Out 2, which is associated with route map R2, with prefix list P2

Because the prefixes are configured in the two prefix lists (P1 and P2), and they are associated with different SR-MPLS VRF L3Outs, subnets S1 and S2 are not advertised out of both of the L3Outs.

- SR-MPLS VRF L3Outs do not support multicast.

Security Policy

- You can configure a security policy through the external EPG instance profile, which is defined within an SR-MPLS VRF L3Out. The external EPG instance profile contains IP prefixes that are reachable through the SR-MPLS network from one or more SR-MPLS infra L3Outs and need the same security policy.
- You can configure 0/0 prefix in the external EPG instance profile to classify, as part of the external EPG, the inbound traffic flows originated from any external IP address.
- You can associate an external EPG in the external EPG instance profile with one or more SR-MPLS VRF L3Outs. When the external EPG instance profile is external to multiple SR-MPLS infra L3Outs, multiple SR-MPLS VRF L3Outs point to the same external EPG instance profile.
- You must configure contracts between local EPGs and external EPG instance profiles or between external EPGs associated to different VRF L3Outs (to enable transit routing).

Guidelines and Limitations for MPLS Custom QoS Policies

Following is the default MPLS QoS behavior:

- Class of Service (COS) preservation is not supported for intra ToR MPLS egress QoS policies, where the destination port is an MPLS port.
- All incoming MPLS traffic on the border leaf switch is classified into QoS Level 3 (the default QoS level).
- The border leaf switch will retain the original DSCP values for traffic coming from SR-MPLS without any remarking.
- The border leaf switch will forward packets with the default MPLS EXP (0) to the SR-MPLS network.

Following are the guidelines and limitations for configuring MPLS Custom QoS policies:

- Data Plane Policers (DPP) are not supported at the SR-MPLS L3Out.
- Layer 2 DPP works in the ingress direction on the MPLS interface.
- Layer 2 DPP works in the egress direction on the MPLS interface in the absence of an egress custom MPLS QoS policy.
- VRF level policing is not supported.

Guidelines and Limitations for SR-MPLS Statistics

Following are the guidelines and limitations for SR-MPLS statistics:

- To see the SR-MPLS statistics, you have to perform a one-time stateful reload when enabling the SR-MPLS configuration on any leaf switch.
- The SR-MPLS interface statistics are only supported only on border leaf switch models with "FX2" or "GX" at the end of the switch name.
- The SR-MPLS VRF instance statistics are supported on border leaf switch models with "FX," "FX2", or "GX" at the end of the switch name.
- For the 15 minute historic stats, it might take 20 minutes to update the 15 minute interval data.
- SR-MPLS interface statistics shown in a switch's CLI get cleared after an admin or operational down event.
- SR-MPLS interface statistics in a switch's CLI are reported every 10 seconds. If, for example, an interface goes down 3 seconds after the collection of the statistics, the CLI reports only 3 seconds of the statistics and clears all of the other statistics.

Configuring an SR-MPLS Infra L3Out Using the GUI

- The SR-MPLS infra L3Out is configured on the border leaf switch, which is used to set up the underlay BGP-LU and overlay MP-BGP EVPN sessions that are needed for the SR-MPLS handoff.
- An SR-MPLS infra L3Out will be scoped to a pod or a remote leaf switch site.
- A pod or remote leaf switch site can have one or more SR-MPLS infra L3Outs.

You will configure the following pieces when configuring the SR-MPLS infra L3Out:

• Nodes

- Only leaf switches are allowed to be configured as nodes in the SR-MPLS infra L3Out (border leaf switches and remote leaf switches).
- Each SR-MPLS infra L3Out can have border leaf switches from one pod or remote leaf switch from the same site.
- Each border leaf switch or remote leaf switch can be configured in multiple SR-MPLS infra L3Outs if it connects to multiple SR-MPLS domains.
- You will also configure the loopback interface underneath the node, and a node SID policy underneath the loopback interface.

• Interfaces

- Supported types of interfaces are:
 - Routed interface or sub-interface
 - Routed port channel or port channel sub-interface

For sub-interfaces, any VLAN tag is supported.

- You will also configure the underlay BGP peer policy underneath the interfaces area in the SR-MPLS infra L3Out.

- **QoS rules**

- You can configure the MPLS ingress rule and MPLS egress rule through the MPLS QoS policy in the SR-MPLS infra L3Out.
- If you do not create an MPLS QoS policy, any ingressing MPLS traffic is assigned the default QoS level.

You will also configure the underlay and overlay through the SR-MPLS infra L3Out:

- **Underlay:** BGP peer IP (BGP LU and IPv4 peer) configuration as part of the interface configuration.
- **Overlay:** MP-BGP EVPN remote IPv4 address (MP-BGP EVPN peer) configuration as part of the logical node profile configuration.

Before you begin

- Review the SR-MPLS guidelines and limitations provided in [Guidelines and Limitations for SR-MPLS, on page 164](#), especially the guidelines and limitations provided in [Guidelines and Limitations for the SR-MPLS Infra L3Out, on page 166](#).
- Configure an MPLS custom QoS policy using the procedures provided in [Creating SR-MPLS Custom QoS Policy Using the GUI, on page 183](#)

Procedure

- Step 1** Navigate to **Tenants > infra > Networking > SR-MPLS Infra L3Outs**.
- Step 2** Right-click on **SR-MPLS Infra L3Outs** and choose **Create SR-MPLS Infra L3Out**.
The **Connectivity** window appears.

Create SR-MPLS Infra L3Out

1. Connectivity 2. Nodes And Interfaces

Connectivity

SR-MPLS Infra Layer3 outside (L3out) is required to configure SR/MPLS handoff from ACI. SR-MPLS Infra L3out configures following important components of ACI to SR handoff:

- BGP EVPN session from ACI Border Leaf (BL) to remote BGP peer - ACI BL can advertise SR/MPLS labels for multiple VRFs using a single BGP session. BGP EVPN session is formed between EVPN loopbacks of BL and DC Provider Edge (DC-PE) router. By doing so removes the need for per VRF sub-interface and routing protocol session from BL to DC-PE. We recommend enabling Multi-hop BFD for faster convergence. Multiple BGP EVPN session can be configured on each BL.
- BGP-LU and IPv4 address family - To provide reachability to router (DC-PE) from BL. BGP-LU between ACI BL and router is used to advertise SR/MPLS labels for transport loopback of the ACI BL and router BGP-IPv4 address family between ACI BL and router is used to provide reachability between BGP EVPN control plane loopbacks. We recommend enabling Single-hop BFD for faster convergence.
- MPLS custom QoS policy to the ingress and egress SR/MPLS QoS for the SR-MPLS handoff.

Prerequisites:

- Configure the node, port, functional profile, AEP, and Layer 3 domain.

Name: Layer 3 Domain:

Pod: MPLS Custom QoS Policy:

BGP-EVPN Connectivity

BFD Multihop Policy:

BGP-EVPN Remote IPv4 Address Remote ASN TTL

Previous Cancel Next

Step 3 In the **Connectivity** window, enter the necessary information.

- a) In the **Name** field, enter a name for the SR-MPLS Infra L3Out.

This will be the name for the policy controlling connectivity to the outside. The name can be up to 64 alphanumeric characters.

Note

You cannot change this name after the object has been saved.

- b) In the **Layer 3 Domain** field, choose an existing Layer 3 domain or choose **Create L3 Domain** to create a new layer 3 domain.
- c) In the **Pod** field, choose a pod, if you have a Multi-Pod configuration.
If you do not have a Multi-Pod configuration, leave the selection at pod 1.
- d) (Optional) In the **MPLS Custom QoS Policy** field, choose an existing QoS policy or choose **Create MPLS Custom QoS Policy** to create a new QoS policy.

For more information on creating a new QoS policy, see [Creating SR-MPLS Custom QoS Policy Using the GUI, on page 183](#).

If you do not create a custom QoS policy, the following default values are assigned:

- All incoming MPLS traffic on the border leaf switch is classified into QoS Level 3 (the default QoS level).
- The border leaf switch does the following:
 - Retains the original DSCP values for traffic coming from SR-MPLS without any remarking.

- Forwards packets to the MPLS network with the original COS value of the tenant traffic if the COS preservation is enabled.
 - Forwards packets with the default MPLS EXP value (0) to the SR-MPLS network.
- In addition, the border leaf switch does not change the original DSCP values of the tenant traffic coming from the application server while forwarding to the SR network.

- e) Navigate to the **BGP-EVPN Connectivity** area.
- f) (Optional) In the **BFD Multihop Policy** field, choose an existing BFD multihop policy or choose **Create BFD Multihop Node Policy** to create a new policy.

If you have a MP-BGP EVPN multihop session from the border leaf switch to the DC-PE, when you enable the **BFD Multihop Policy** option, the BGP session will not depend on the regular BGP timer; instead, it will get terminated faster, based on the BFD timers. See [Multi-Hop BFD for BGP EVPN Session, on page 154](#) for more information.

- g) In the **BGP-EVPN Remote IPv4 Address** field, enter the MP-BGP EVPN remote IPv4 address.
- This BGP peer IP address is part of the overlay configuration. This is the loopback address of the DC-PE (one entry per remote DC-PE).
- h) In the **Remote ASN** field, enter a number that uniquely identifies the neighbor autonomous system of the DC-PE.

The Autonomous System Number can be in 4-byte as plain format from 1 to 4294967295.

Note

ACI does not support asdot or asdot+ format AS numbers. For more information on asdot or asdot+ format AS numbers, see the [Explaining 4-Byte Autonomous System \(AS\) ASPLAIN and ASDOT Notation for Cisco IOS](#) document.

- i) In the **TTL** field, enter the connection time to live (TTL).
- The range is from 2 to 255 hops.
- j) Click **Next**.
- The **Nodes and Interfaces** window appears.

Create SR-MPLS Infra L3Out

Nodes and Interfaces

Select the Border leaf (BL) switches for the SR-MPLS configuration. Configure BGP EVPN control plane loopback, router id and transport loopback for each BL. Multiple interface can be configured for each BL, and for each interface of BL, BGP labeled unicast (BGP-LU) peer is configured. BGP IPv4 address family is automatically enabled once BGP-LU peer is configured. Single hop BFD can be enabled for each BGP-LU and IPv4 address family session.

Step 4 In the **Nodes and Interfaces** window, enter the necessary information to configure the border leaf nodes and interfaces.

- a) In the **Node Profile Name** and **Interface Profile Name** fields, determine if you want to use the default naming convention for the node profile and interface profile names.

The default node profile name is *L3Out-name_nodeProfile*, and the default interface profile name is *L3Out-name_interfaceProfile*, where *L3Out-name* is the name that you entered in the **Name** field in the **Connectivity** page. Change the profile names in these fields, if necessary.

- b) (Optional) In the **BFD Interface Policy** field, choose an existing BFD interface policy or choose **Create BFD Interface Policy** to create a new BFD interface policy.
- c) In the **Transport Data Plane** field, determine the type of routing that you would like to use for the handoff on the Cisco ACI border leaf switches.

The options are:

- **MPLS**: Select this option to use Multiprotocol Label Switching (MPLS) for the handoff towards the transport device.
- **SR-MPLS**: Select this option to use segment routing (SR) Multiprotocol Label Switching (MPLS) for the handoff towards the transport device.

- d) In the **Interface Types** area, make the necessary selections in the Layer 3 and Layer 2 fields.

The options are:

- Layer 3:

- **Interface:** Choose this option to configure a Layer 3 interface to connect the border leaf switch to the external router.

When choosing this option, the Layer 3 interface can be either a physical port or a direct port-channel, depending on the specific option selected in the **Layer 2** field in this page.

- **Sub-Interface:** Choose this option to configure a Layer 3 sub-interface to connect the border leaf switch to the external router.

When choosing this option, a Layer 3 sub-interface is created for either a physical port or a direct port-channel, depending on the specific option selected in the **Layer 2** field in this page.

- Layer 2:
 - **Port**
 - **Direct Port Channel**

- e) From the **Node ID** field drop-down menu, choose the border leaf switch, or node, for the L3Out.

For multi-pod configurations, only the leaf switches (nodes) that are part of the pod that you selected in the previous screen are displayed.

You might see a warning message appear on your screen, describing how to configure the router ID.

- If you do not have a router ID already configured for this node, go to [4.f, on page 177](#) for instructions on configuring a router ID for this node.
- If you have a router ID already configured for this node (for example, if you had configured MP-BGP route reflectors previously), you have several options:
 - **Use the same router ID for the SR-MPLS configuration:** This is the recommended option. Make a note of the router ID displayed in this warning to use in the next step in this case, and go to [4.f, on page 177](#) for instructions on configuring a router ID for this node.
 - **Use a different router ID for the SR-MPLS configuration:** In this situation, you must first take the node out of the active path to avoid traffic disruption to the existing application before entering the router ID in the next step. To take the node out of the active path:
 1. Put the node in maintenance mode.
 2. Enter the different router ID for the SR-MPLS configuration, as described in [4.f, on page 177](#).
 3. Reload the node.

- f) In the **Router ID** field, enter a unique router ID (the IPv4 or IPv6 address) for the border leaf switch part of the infra L3Out.

The router ID must be unique across all border leaf switches and the DC-PE.

As described in [4.e, on page 177](#), if a router ID has already been configured on this node, you have several options:

- If you want to use the same router ID for the SR-MPLS configuration, enter the router ID that was displayed in the warning message in [4.e, on page 177](#).

- If you do not want to use the same router ID for the SR-MPLS configuration, or if you did not have a router ID already configured, enter an IP address (IPv4 or IPv6) in this field for the border leaf switch part of the infra L3Out, keeping in mind that it has to be a unique router ID.

Once you have settled on an entry for the **Router ID**, the entries in the **BGP-EVPN Loopback** and **MPLS Transport Loopback** fields are automatically populated with the entry that you provided in the **Router ID** field.

- g) (Optional) Enter an IP address in the **BGP-EVPN Loopback** field, if necessary.

For BGP-EVPN sessions, the BGP-EVPN loopback is used for the control plane session. Use this field to configure the MP-BGP EVPN session between the EVPN loopbacks of the border leaf switch and the DC-PE to advertise the overlay prefixes. The MP-BGP EVPN sessions are established between the BP-EVPN loopback and the BGP-EVPN remote peer address (configured in the **BGP-EVPN Remote IPv4 Address** field in the **Connectivity** window).

The **BGP-EVPN Loopback** field is automatically populated with the same entry that you provide in the **Router ID** field. Enter a different IP address for the BGP-EVPN loopback address, if you don't want to use the router ID as the BGP-EVPN loopback address.

Note the following:

- For BGP-EVPN sessions, we recommend that you use a different IP address in the **BGP-EVPN Loopback** field from the IP address that you entered in the **Router ID** field.
- While you can use a different IP address for the BGP-EVPN loopback and the MPLS transport loopback, we recommend that you use the same loopback for the BGP-EVPN and the MPLS transport loopback on the ACI border leaf switch.

- h) In the **MPLS Transport Loopback** field, enter the address for the MPLS transport loopback.

The MPLS transport loopback is used to build the data plane session between the ACI border leaf switch and the DC-PE, where the MPLS transport loopback becomes the next-hop for the prefixes advertised from the border leaf switches to the DC-PE routers. See [MP-BGP EVPN Session Between the Cisco ACI Border Leaf Switch and the DC-PE, on page 153](#) for more information.

Note the following:

- For BGP-EVPN sessions, we recommend that you use a different IP address in the **MPLS Transport Loopback** field from the IP address that you entered in the **Router ID** field.
- While you can use a different IP address for the BGP-EVPN loopback and the MPLS transport loopback, we recommend that you use the same loopback for the BGP-EVPN and the MPLS transport loopback on the ACI border leaf switch.

- i) In the **Segment ID (SID) Index** field, enter the SID index.

The SID index is configured on each node for the MPLS transport loopback. The SID index value is advertised using BGP-LU to the peer router, and the peer router uses the SID index to calculate the local label.

The supported value for the SID index entry is between 0 and 4294967295. The SID index has to be unique across the entire segment routing domain.

- j) If you selected **Port** in the Layer 2 area above, the **Interface** field appears. Choose a port from the drop-down list.

- k) If you selected **Direct Port Channel** in the Layer 2 area above, the **PC Paths** field appears. Choose the port channel from the drop-down list. This is the path to the port channel end points for the interface profile.
- l) If you selected **Sub-Interface** in the Layer 3 area above, the **VLAN Encap** field appears. Enter the encapsulation used for the layer 3 outside profile.
- m) In the **MTU (bytes)** field, enter the maximum transmit unit of the external network.
Acceptable entries in this field are from 576-9216. To inherit the value, enter **inherit** in this field.
- n) In the **IPv4 Address** field, enter an IP address for the BGP-Label unicast source.
This is the IP address assigned to the Layer 3 interface/sub-interface/port channel that you configured in a previous step.
- o) In the **Peer IPv4 Address** field, enter the BGP-Label unicast peer IP address.
This is the interface's IP address of the router directly connected to the border leaf switch.
- p) In the **Remote ASN** field, enter the BGP-Label Autonomous System Number of the directly-connected router.
- q) Determine if you want to configure additional interfaces for this node for the SR-MPLS infra L3Out.
- If you do not want to configure additional interfaces for this node for this SR-MPLS infra L3Out, skip to [4.s, on page 179](#).
 - If you want to configure additional interfaces for this node for this SR-MPLS infra L3Out, click + in the **Interfaces** area to bring up the same options for another interface for this node.
- Note**
If you want to delete the information that you entered for an interface for this node, or if you want to delete an interface row that you added by accident, click the trash can icon for the interface row that you want to delete.
- r) Determine if you want to configure additional nodes for this SR-MPLS infra L3Out.
- If you do not want to configure additional nodes for this SR-MPLS infra L3Out, skip to [4.s, on page 179](#).
 - If you want to configure additional nodes for this SR-MPLS infra L3Out, click + in the **Nodes** area to bring up the same options for another node.
- Note**
If you want to delete the information that you entered for a node, or if you want to delete a node row that you added by accident, click the trash can icon for the node row that you want to delete.
- s) When you have entered the remaining additional information in the **Nodes and Interfaces** window, click **Finish** to complete the necessary configurations in the **Create SR-MPLS Infra L3Out** wizard.

What to do next

Configure an SR-MPLS VRF L3Out using the procedures provided in [Configuring an SR-MPLS VRF L3Out Using the GUI, on page 180](#).

Configuring an SR-MPLS VRF L3Out Using the GUI

Using the procedures in this section, you will configure a SR-MPLS VRF L3Out, which will be used to forward traffic from the SR-MPLS infra L3Out that you configured in the previous set of procedures.

- User tenant VRFs are mapped to the SR-MPLS infra L3Outs to advertise tenant bridge domain subnets to the DC-PE routers and import the MPLS VPN routes received from the DC-PE.
- You must specify routing and security policies in the SR-MPLS VRF L3Out for each VRF. These policies point to one or more SR-MPLS infra L3Outs.
- One SR-MPLS VRF L3Out is supported for each VRF.

Before you begin

- Review the SR-MPLS guidelines and limitations provided in [Guidelines and Limitations for SR-MPLS, on page 164](#), especially the guidelines and limitations provided in [Guidelines and Limitations for the SR-MPLS VRF L3Out, on page 166](#).
- Configure an SR-MPLS infra L3Out using the procedures provided in [Configuring an SR-MPLS Infra L3Out Using the GUI, on page 172](#).

Procedure

-
- Step 1** Configure the SR-MPLS VRF L3Out by navigating to the **Create SR-MPLS VRF L3Out** window for the tenant (**Tenants > tenant > Networking > SR-MPLS VRF L3Outs**).
- Step 2** Right-click on **SR-MPLS VRF L3Outs** and select **Create SR-MPLS VRF L3Out**.
The **Create SR-MPLS VRF L3Out** window appears.

Figure 23: Create SR-MPLS VRF L3Out

The screenshot shows the 'Create SR-MPLS VRF L3Out' configuration page. At the top, there are three dropdown menus: 'Name', 'VRF', and 'SR-MPLS Infra L3Out', each with a red error icon. Below these is the 'External EPGs' section, which includes an 'External EPG Name' field with a red error icon and a '+ Hide Subnets and Contracts' button. The 'Subnets and Contracts' section contains an 'IP Prefix' field (with 'address/mask' below it), an 'Inter VRF Policy' section with checkboxes for 'Route Leaking' and 'Security', and two dropdown menus for 'Provided Contract' and 'Consumed Contract'. The 'Route Maps' section has 'Outbound' and 'Inbound' dropdown menus, both with red error icons. At the bottom right, there are 'Cancel' and 'Submit' buttons.

Step 3 In the **Name** field, enter a name for the SR-MPLS VRF L3Out.

This will be the name for the policy controlling connectivity to the outside. The name can be up to 64 alphanumeric characters.

Note

You cannot change this name after the object has been saved.

Step 4 In the **VRF** field, select an existing VRF or click **Create VRF** to create a new VRF.

Step 5 In the **SR-MPLS Infra L3Out** field, select an existing SR-MPLS infra L3Out or click **Create SR-MPLS Infra L3Out** to create a new SR-MPLS infra L3Out.

For more information on creating an SR-MPLS infra L3Out, see [Configuring an SR-MPLS Infra L3Out Using the GUI, on page 172](#).

Step 6 Navigate to the **External EPGs** area and, in the **External EPG Name** area, enter a unique name for the external EPG to be used for this SR-MPLS VRF L3Out.

Step 7 Navigate to the **Subnets and Contracts** area and configure individual subnets within this EPG.

Note

If you want to configure the subnet fields but you do not see the following fields, click **Show Subnets and Contracts** to display the following fields.

- a) In the **IP Prefix** field, enter an IP address and netmask for the subnet.
- b) In the **Inter VRF Policy** field, determine if you want configure inter-VRF policies.
 - If you do not want to configure inter-VRF policies, skip to [7.c, on page 182](#).
 - If you want to configure inter-VRF policies, select the appropriate inter-VRF policy that you want to use.

The options are:

- **Route Leaking.**

If you select **Route Leaking**, the **Aggregate** field appears. Click the box next to **Aggregate** if you also want to enable this option.

- **Security.**

Note that you can select one of the two options listed above or both options for the **Inter VRF Policy** field.

- c) In the **Provided Contract** field, select an existing provider contract or click **Create Contract** to create a provider contract.
- d) In the **Consumed Contract** field, select an existing consumer contract or click **Create Contract** to create a consumer contract.
- e) Determine if you want to configure additional subnets for this external EPG.
 - If you do not want to configure additional subnets for this external EPG, skip to [Step 8, on page 182](#).
 - If you want to configure additional subnets for this external EPG, click + in the **Subnet and Contracts** area to bring up the same options for another subnet.

Note

If you want to delete the information that you entered for a subnet, or if you want to delete a subnet row that you added by accident, click the trash can icon for the subnet row that you want to delete.

Step 8 Determine if you want to create additional external EPGs to be used for this SR-MPLS VRF L3Out.

- If you do not want to configure additional external EPGs to be used for this SR-MPLS VRF L3Out, skip to [Step 9, on page 182](#).
- If you want to configure additional external EPGs to be used for this SR-MPLS VRF L3Out, click + in the **External EPG Name** area to bring up the same options for another external EPG.

Note

If you want to delete the information that you entered for an external EPG, or if you want to delete an external EPG area that you added by accident, click the trash can icon for the external EPG area that you want to delete.

Step 9 In the **Route Maps** area, configure the outbound and inbound route maps.

Within each SR-MPLS VRF L3Out:

- Defining the outbound route map (export routing policy) is mandatory. This is needed to be able to advertise prefixes toward the external DC-PE routers.

- Defining the inbound route map (import routing policy) is optional, because, by default, all the prefixes received from the DC-PE routers are allowed into the fabric.

- a) In the **Outbound** field, select an existing export route map or click **Create Route Maps for Route Control** to create a new export route map.
- b) In the **Inbound** field, select an existing import route map or click **Create Route Maps for Route Control** to create a new import route map.

Step 10 When you have completed the configurations in the **Create SR-MPLS VRF L3Out** window, click **Submit**.

Creating SR-MPLS Custom QoS Policy Using the GUI

SR-MPLS Custom QoS policy defines the priority of the packets coming from an SR-MPLS network while they are inside the ACI fabric based on the incoming MPLS EXP values defined in the MPLS QoS ingress policy. It also marks the CoS and MPLS EXP values of the packets leaving the ACI fabric through an MPLS interface based on IPv4 DSCP values defined in MPLS QoS egress policy.

If no custom ingress policy is defined, the default QoS Level (`Level13`) is assigned to packets inside the fabric. If no custom egress policy is defined, the default EXP value of 0 will be marked on packets leaving the fabric.

Procedure

- Step 1** From the top menu bar, navigate to **Tenants > infra**.
- Step 2** In the left pane, select **infra > Policies > Protocol > MPLS Custom QoS**.
- Step 3** Right click the **MPLS Custom QoS** folder and choose **Create MPLS Custom QoS Policy**.
- Step 4** In the **Create MPLS Custom QoS Policy** window that opens, provide the name and description of the policy you're creating.

Step 5 In the **MPLS Ingress Rule** area, click + to add an ingress QoS translation rule.

Any traffic coming into the border leaf (BL) connected to the MPLS network will be checked for the MPLS EXP value and if a match is found, the traffic is classified into an ACI QoS Level and marked with appropriate CoS and DSCP values.

a) In the **Priority** field, select the priority for the ingress rule.

This is the QoS Level you want to assign for the traffic within ACI fabric, which ACI uses to prioritize the traffic within the fabric.. The options range from Level1 to Level6. The default value is Level13. If you do not make a selection in this field, the traffic will automatically be assigned a Level13 priority.

b) In the **EXP Range From** and **EXP Range To** fields, specify the EXP range of the ingressing MPLS packet you want to match.

c) In the **Target DSCP** field, select the DSCP value to assign to the packet when it's inside the ACI fabric.

The DSCP value specified is set in the original traffic received from the external network, so it will be re-exposed only when the traffic is VXLAN decapsulated on the destination ACI leaf node.

The default is `Unspecified`, which means that the original DSCP value of the packet will be retained.

- d) In the **Target CoS** field, select the CoS value to assign to the packet when it's inside the ACI fabric.

The CoS value specified is set in the original traffic received from the external network, so it will be re-exposed only when the traffic is VXLAN decapsulated on the destination ACI leaf node.

The default is `Unspecified`, which means that the original CoS value of the packet will be retained, but only if the CoS preservation option is enabled in the fabric.

- e) Click **Update** to save the ingress rule.
f) Repeat this step for any additional ingress QoS policy rules.

Step 6 In the **MPLS Egress Rule** area, click + to add an egress QoS translation rule.

When the traffic is leaving the fabric out of the border leaf's MPLS interface, it will be matched based on the DSCP value of the packet and if a match is found, the MPLS EXP and CoS values will be set based on the policy.

- a) Using the **DSCP Range From** and **DSCP Range To** dropdowns, specify the DSCP range of the ACI fabric packet you want to match for assigning the egressing MPLS packet's priority.
b) From the **Target EXP** dropdown, select the EXP value you want to assign to the egressing MPLS packet.
c) From the **Target CoS** dropdown, select the CoS value you want to assign to the egressing MPLS packet.
d) Click **Update** to save the ingress rule.
e) Repeat this step for any additional egress QoS policy rules.

Step 7 Click **OK** to complete the creation of the MPLS custom QoS Policy.

Displaying MPLS Statistics

Following are the MPLS-specific statistics that you can choose to display in the statistics screens described in this topic:

- At the interface level, as described in [Displaying SR-MPLS Statistics for Interfaces, on page 186](#)
- At the VRF level, as described in [Displaying SR-MPLS Statistics for VRFs, on page 187](#)

To display statistics information for all the interfaces and VRFs in your system, navigate to:

Tenant > infra > Networking > SR-MPLS Infra L3Outs

The **SR-MPLS Infra L3Outs** panel is displayed, showing all of the SR-MPLS infra L3Outs configured on your system. Remaining at the upper-level **SR-MPLS Infra L3Outs** panel, navigate to the appropriate statistics page, depending on the type of statistics that you want to display:

- Click the **Interface Stats** tab to display a summary of the statistics for all of the MPLS interfaces on your system. Each row in this window displays MPLS statistics information for a specific interface on a specific node.



Note The interface statistics shown in the main SR-MPLS infra L3Outs page are for all the SR-MPLS-enabled interfaces only on border leaf switch models with "FX2" or "GX" at the end of the switch name.

To see other levels of MPLS interface statistics information, see [Displaying SR-MPLS Statistics for Interfaces, on page 186](#).

- Click the **VRF Stats** tab to display a summary of the statistics for all of the MPLS VRFs on your system. Each row in this window displays MPLS statistics information for a specific VRF configured on a specific node.

The VRF statistics provided in the SR-MPLS infra L3Out properties page are the individual VRF statistics on the given border leaf switch or remote leaf switch where the provider label of the SR-MPLS infra L3Out is consumed.

To see other levels of MPLS VRF statistics information, see [Displaying SR-MPLS Statistics for VRFs, on page 187](#).

Displaying SR-MPLS Statistics for Interfaces

Following are the MPLS-specific interface statistics that you can choose to display in the statistics screens described in this topic:

- Mpls Egress Drop Bytes
- Mpls Egress Admit Bytes
- Mpls Egress Drop Packets
- Mpls Egress Admit Packets
- Mpls Ingress Drop Bytes
- Mpls Ingress Admit Bytes
- Mpls Ingress Drop Packets
- Mpls Ingress Admit Packets

To change the type of statistics that are shown on a statistics page, click the checkbox to bring up the **Select Stats** window, then move entries from the left column to the right column to show different statistics, and from the right column to the left column to remove certain statistics from view.

To change the layout of the statistics in this page to show statistics in a table format, click the icon with three horizontal bars and select **Table View**.

- To display detailed aggregate interface statistics for all of the interfaces in the SR-MPLS VRF L3Outs under an SR-MPLS infra L3Out, navigate to that SR-MPLS infra L3Out:

Tenant > **infra** > **Networking** > **SR-MPLS Infra L3Outs** > *SR-MPLS_infra_L3Out_name*

Click the **Stats** tab to display detailed aggregate interface statistics for all of the interfaces in the SR-MPLS VRF L3Outs under that particular SR-MPLS infra L3Out.

- To display statistics for a specific interface on a specific leaf switch, navigate to that interfaces area on the leaf switch:

Fabric > Inventory > Pod # > leaf_switch > Interfaces, then click either **Routed Interfaces** or **Encapsulated Routed Interfaces**.

Click on the specific interface that you want statistic information for, then click the **Stats** tab.

Displaying SR-MPLS Statistics for VRFs

Following are the MPLS-specific VRF statistics that you can choose to display in the statistics screens described in this topic:

- Mpls Vrf Egress Drop Bytes
- Mpls Vrf Egress Admit Bytes
- Mpls Vrf Egress Drop Packets
- Mpls Vrf Egress Admit Packets
- Mpls Vrf Ingress Drop Bytes
- Mpls Vrf Ingress Admit Bytes
- Mpls Vrf Ingress Drop Packets
- Mpls Vrf Ingress Admit Packets

To change the type of statistics that are shown on a statistics page, click the checkbox to bring up the **Select Stats** window, then move entries from the left column to the right column to show different statistics, and from the right column to the left column to remove certain statistics from view.

To change the layout of the statistics in this page to show statistics in a table format, click the icon with three horizontal bars and select **Table View**.

- To display detailed aggregate VRF statistics for a specific VRF, navigate to that VRF:

Tenant > tenant_name > Networking > VRFs > VRF_name

Click the **Stats** tab to display the aggregate VRF statistics for this particular VRF. Note that this VRF is being used by one of the SR-MPLS L3Outs, and this SR-MPLS L3Out might have multiple leaf switches, with multiple interfaces for each leaf switch. The statistics shown in this window is an aggregate of all the interfaces in this SR-MPLS L3Out that is being used by this VRF.

- To display VRF statistics for a specific leaf switch, navigate to the VRF contexts for that leaf switch:

Fabric > Inventory > Pod # > leaf_switch > VRF Contexts > VRF_context_name

Click the **Stats** tab to display the statistics for this VRF for this specific leaf switch.

Configuring SR-MPLS Global Block (GB)

Configure SR-MPLS global block (GB) if you have an SR network between the border leaf switch in the ACI fabric and the DC-PE, as shown in the following figure.

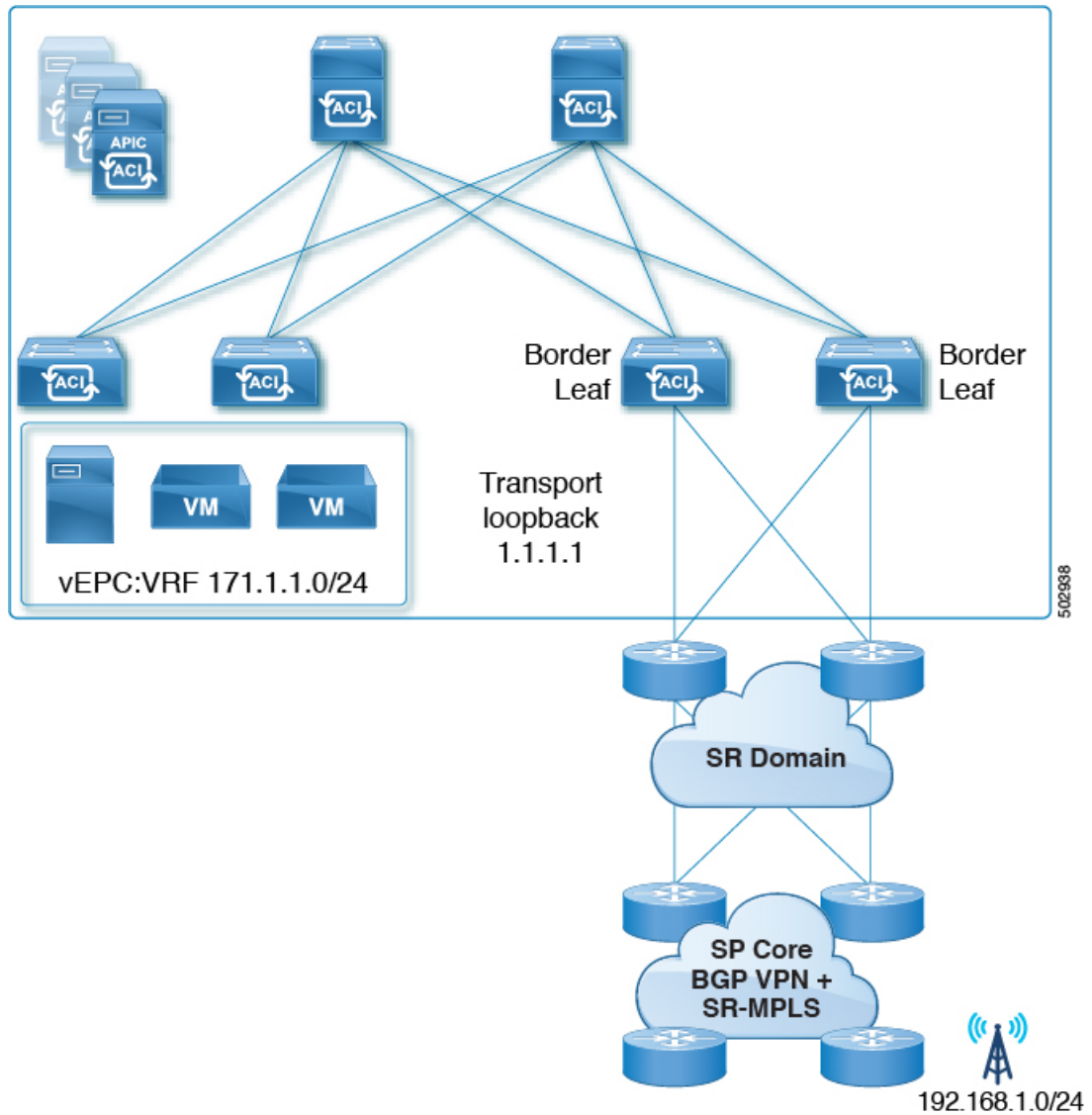

We recommend that all nodes in an SR domain have the same SR-GB configuration.

Following are important guidelines to consider when configuring SR-MPLS global block:

- The allowed configurable SR-GB range is 16000-471804.
- The default SR-GB range in the ACI fabric is 16000-23999.
- ACI always advertises implicit null for the underlay label (transport loopback).

Procedure

Step 1 Navigate to the SR-MPLS Global Configurations window.

Tenants > infra > Policies > Protocol > MPLS Global Configurations

- Step 2** Access the default **MPLS Global Configurations** screen by double-clicking on **default** in the main SR-MPLS Global Configurations screen or by clicking on **default** in the left nav bar, under **Mpls Global Configurations**. The default SR-MPLS Global Configurations window appears.

SR-MPLS Global Configurations

Policy History

Properties

Name: default

Description: optional

SR Global Block Minimum: 16001

SR Global Block Maximum: 23999

Show Usage Reset Submit

- Step 3** In the **SR Global Block Minimum** field, enter the minimum value for the SR-GB range. The lowest allowable value in this field is 16000.
- Step 4** In the **SR Global Block Maximum** field, enter the maximum value for the SR-GB range. The highest allowable value in this field is 471804.
- Step 5** Click **Submit**.

Migrating from IP Handoff Configuration to SR Handoff Configuration

Before you begin:

You have an previously-configured L3Out that is using a pre-Release 5.0(1) IP handoff configuration, as described in [ACI Handoffs Prior to Release 5.0\(1\): IP Handoff, on page 147](#)

About this task:

These procedures provide instructions for migrating an L3Out that you configured previously with an IP handoff configuration (described in [ACI Handoffs Prior to Release 5.0\(1\): IP Handoff, on page 147](#)) to an SR handoff configuration using the new SR-MPLS components that have been introduced in Cisco APIC Release 5.0(1), as described in [ACI Handoffs in Release 5.0\(1\): SR Handoff, on page 148](#).

For these instructions, it is assumed that the two handoffs are used to connect to the same external network infrastructure, that an external device is able to access the ACI fabric using both L3Outs. The assumption is

that, currently, external clients are able to come in through the L3Outs used in the IP handoff configuration, but once you have completed the procedures in this section, the external clients can then come in through the L3Outs used in the SR-MPLS handoff configuration.



-
- Note** Throughout these procedures, the following terms are used to distinguish between the two types of L3Outs:
- **IP-based L3Out:** Used for the previously-configured user tenant L3Out that is using a pre-Release 5.0(1) IP handoff configuration.
 - **SR-MPLS L3Out:** Used for the newly-configured user tenant L3Out that has been configured using the new SR-MPLS components that have been introduced in Cisco APIC Release 5.0(1).
-

Following are the overall steps that you will go through as part of this process:

- Configure the external EPGs on the SR-MPLS VRF L3Out to mirror the IP-based L3Out configuration. This includes the subnets configuration for classification of inbound traffic and the contracts provided or consumed by the external EPGs.
- Redirect inbound and outbound traffic to ensure that it starts preferring the SR-MPLS L3Out.
- Disconnect the IP-based L3Out.

The following sections provide detailed instructions for each of the overall steps listed above.

Configuring External EPGs on the SR-MPLS VRF L3Out

In this task, you will configure the external EPGs on the SR-MPLS VRF L3Out to mirror the IP-based L3Out configuration (the L3Out that you configured previously that is using a pre-Release 5.0(1) IP handoff configuration). This includes the subnets configuration for classification of inbound traffic and the contracts provided or consumed by the external EPGs.

Before you begin

Review the information provided in [Migrating from IP Handoff Configuration to SR Handoff Configuration, on page 189](#).

Procedure

-
- Step 1** Create a new infra SR-MPLS L3Out, if you have not done so already.
- See [Configuring an SR-MPLS Infra L3Out Using the GUI, on page 172](#) for those instructions, then return here.
- Step 2** Create a new user tenant SR-MPLS L3Out, if you have not done so already.
- See [Configuring an SR-MPLS VRF L3Out Using the GUI, on page 180](#) for those instructions, then return here. Note that this L3Out should be associated to the same VRF of the previously-configured IP-based L3Out.
- As part of the process for creating the new user tenant SR-MPLS L3Out, you will be asked to configure the external EPG for this SR-MPLS L3Out.

- For the external EPG for the new SR-MPLS L3Out, enter the same IP prefix information that you currently have for your previously-configured IP-based L3Out.
- If you have more than one external EPG configured for your previously-configured IP-based L3Out, create additional external EPGs for the new SR-MPLS L3Out and match the same IP prefix information for each EPG.

In the end, the external EPG settings that you configure for the new SR-MPLS L3Out, with the accompanying subnet settings, should match the external EPG and subnet settings that you had previously configured for the IP-based L3Out.

Once you have completed the procedures for creating the new user tenant SR-MPLS L3Out, you should now have two L3Outs (two paths in BGP):

- The existing, previously-configured IP-based L3Out that is using a pre-Release 5.0(1) IP handoff configuration, as mentioned in the **Before you begin** area in [Migrating from IP Handoff Configuration to SR Handoff Configuration, on page 189](#).
- The new SR-MPLS L3Out that you created using the new SR-MPLS components that have been introduced in Cisco APIC Release 5.0(1).

Step 3 Ensure the same security policy is applied to the external EPGs of the SR-MPLS L3Out as you had for the IP-based L3Out.

In the non-border leaf switches and the border leaf switches, the new security policy in the external EPG that you configured when you created the new SR-MPLS L3Out will result in a fault for every subnet whose prefix clashes with the subnet prefix in any EPG of the previously-configured IP-based L3Out. This is a fault that does not impact functionality, as long as the same security policies are applied to the same external EPGs of both L3Outs.

What to do next

Redirect inbound and outbound traffic to ensure that it starts preferring the SR-MPLS L3Out using the procedures provided in [Redirecting Traffic to SR-MPLS L3Out, on page 191](#).

Redirecting Traffic to SR-MPLS L3Out

In this task, you will redirect inbound and outbound traffic to ensure that it starts preferring the SR-MPLS L3Out.

Before you begin

- Review the information provided in [Migrating from IP Handoff Configuration to SR Handoff Configuration, on page 189](#).
- Configure the external EPGs on the SR-MPLS VRF L3Out to mirror the IP-based L3Out configuration using the procedures provided in [Configuring External EPGs on the SR-MPLS VRF L3Out, on page 190](#).

Procedure

-
- Step 1** Navigate to the BGP Peer Connectivity Profile for the previously-configured IP-based L3Out.
- In the Navigation pane, navigate to **Tenants > tenant_name_for_IP_handoff_L3Out > Networking > L3Outs > L3Out_name > Logical Node Profiles > logical_profile_name > Logical Interface Profiles > logical_interface_profile_name > BGP_peer_connectivity_profile**.
- Step 2** Click on the BGP Peer Connectivity Profile in the left nav bar so that the **BGP Peer Connectivity Profile** page is displayed in the right main window.
- Step 3** Scroll down the page until you see the **Route Control Profile** area in the **BGP Peer Connectivity Profile** page.
- Step 4** Determine if route control policies were already configured for the existing IP-based L3Out.
- You may or may not have had route control policies configured for the existing IP-based L3Out; however, for the new SR-MPLS L3Out, you will need to have route control policies configured. If you had route control policies configured for the existing IP-based L3Out, you can use those route control policies for the new SR-MPLS L3Out; otherwise, you will have to create new route control policies for the SR-MPLS L3Out.
- If you see two route control profiles displayed in the Route Control Profile table:
 - An export route control policy, shown with Route Export Policy in the Direction column in the table.
 - An import route control policy, shown with Route Import Policy in the Direction column in the table.

then route control policies have already been configured for the IP-based L3Out. Go to [Step 5, on page 193](#).
 - If you do not see two route control profiles displayed in the Route Control Profiles table, then create a new route map that will be used for the SR-MPLS L3Out:
 - a) In the **Navigation** pane, expand the **Tenants > tenant_name_for_IP_handoff_L3Out > Policies > Protocol**.
 - b) Right-click on **Route Maps for Route Control** and select **Create Route Maps for Route Control**.
 - c) In the **Create Route Maps for Route Control** dialog box, in the **Name** field, enter a route profile name.
 - d) In the **Type** field, you must choose **Match Routing Policy Only**.
 - e) In the **Contexts** area, click the + sign to open the **Create Route Control Context** dialog box and perform the following actions:
 1. Populate the **Order** and the **Name** fields as desired.
 2. In the **Match Rule** field, click **Create Match Rule**.
 3. In the **Create Match Rule** dialog box, in the **Name** field, enter a name for the match rule.
 4. Enter the necessary information in the appropriate fields (**Match Regexp Community Terms**, **Match Community Terms** and **Match Prefix**), then click **Submit**.
 5. In the **Set Rule** field, click **Create Set Rules for a Route Map**

6. In the **Create Set Rules for a Route Map** dialog box, in the **Name** field, enter a name for the action rule profile.
 7. Choose the desired attributes, and related community, criteria, tags, and preferences. Click **Finish**.
 8. In the **Create Route Control Context** window, click **OK**.
 9. In the **Create Route Maps for Route Control** dialog box, click **Submit**.
- f) Navigate to the BGP Peer Connectivity Profile screen:
- Tenants** > *tenant_name_for_IP_handoff_L3Out* > **Networking** > **L3Outs** > *L3out-name* > **Logical Node Profiles** > *logical-node-profile-name* > **Logical Interface Profiles** > *logical-interface-profile-name* > **BGP_peer_connectivity_profile**
- g) Click on the BGP Peer Connectivity Profile in the left nav bar so that the **BGP Peer Connectivity Profile** page is displayed in the right main window.
 - h) Scroll down to the **Route Control Profile** field, then click + to configure the following:
 - **Name**: Select the route-map that you just configured for the route import policy.
 - **Direction**: Select **Route Import Policy** in the Direction field.

Repeat these steps to select the route-map for the route export policy and set the **Route Export Policy** in the Direction field.

Step 5

Force the BGP to choose the new SR path by configuring the route policies for all the peers in the border leaf switches for the VRF that will be undergoing the migration.

- If the previously-configured IP-based L3Out was configured for **eBGP**, configure both the route import policy and the route export policy for the IP-based L3Out peer to have an additional AS path entry (for example, the same AS as local entry). This is the most typical scenario.

Note

The following procedures assume you do not have set rules configured already for the route map. If you do have set rules configured already for the route map, edit the existing set rules to add the additional AS path entry (check the **Set AS Path** checkbox and select the criterion **Prepend AS**, then click + to prepend AS numbers).

- a. Navigate to **Tenant** > *tenant_name_for_IP_handoff_L3Out* > **Policies** > **Protocol** > **Set Rules** and right click **Create Set Rules for a Route Map**.
The **Create Set Rules For A Route Map** window appears.
- b. In the **Create Set Rules For A Route Map** dialog box, perform the following tasks:
 1. In the **Name** field, enter a name for these set rules.
 2. Check the **Set AS Path** checkbox, then click **Next**.
 3. In the **AS Path** window, click + to open the **Create Set AS Path** dialog box.
- c. Select the criterion **Prepend AS**, then click + to prepend AS numbers.
- d. Enter the AS number and its order and then click **Update**.
- e. Click **OK**.

- f. In the **Create Set Rules For A Route Map** window, confirm the listed criteria for the set rule based on AS Path and click **Finish**.
 - g. Navigate back to the BGP Peer Connectivity Profile screen for this existing IP-based L3Out:
Tenants > *tenant_name_for_IP_handoff_L3Out* > **Networking** > **L3Outs** > *L3out-name* > **Logical Node Profiles** > *logical-node-profile-name* > **Logical Interface Profiles** > *logical-interface-profile-name* > *BGP_peer_connectivity_profile*
 - h. Scroll down to the Route Control Profile area and note the route profile names for both the export route control policy and the import route control policy that are being used for this existing IP-based L3Out.
 - i. Navigate to **Tenants** > *tenant_name_for_IP_handoff_L3Out* > **Policies** > **Protocol** > **Route Maps for Route Control**.
 - j. First locate the **export** route control profile that is being used for this existing IP-based L3Out and click on that route profile.
 The properties page for this route control profile appears in the main panel.
 - k. Locate the route control context entry in the page and double-click the route control context entry.
 The properties page for this route control context appears.
 - l. In the **Set Rule** area, select the set rule that you created earlier in these procedures with the additional AS path entry, then click **Submit**.
 - m. Now locate the **import** route control profile that is being used for this existing IP-based L3Out and click on that route profile, then repeat these steps to use the set rule with the additional AS path entry for the import route control profile. Doing this will influence inbound traffic, where an external source should start preferring.
- If the previously-configured IP-based L3Out was configured for **iBGP**, due to the fact that SR-MPLS only supports eBGP, you will need to use the local preference setting to steer traffic to an eBGP-configured SR-MPLS L3Out, as described in the previous bullet. Configure both the route import policy and the route export policy for the IP-based L3Out peer to have a lower local preference value:
 - a. Navigate to **Tenant** > *tenant_name_for_IP_handoff_L3Out* > **Policies** > **Protocol** > **Set Rules** and right click **Create Set Rules for a Route Map**.
 The **Create Set Rules For A Route Map** window appears.
 - b. In the **Name** field, enter a name.
 - c. Check the **Set Preference** checkbox.
 The Preference field appears.
 - d. Enter the BGP local preference path value.
 The range is 0-4294967295.
 - e. Click **Finish**.
 - f. Navigate back to the BGP Peer Connectivity Profile screen for this existing IP-based L3Out:
Tenants > *tenant_name_for_IP_handoff_L3Out* > **Networking** > **L3Outs** > *L3out-name* > **Logical Node Profiles** > *logical-node-profile-name* > **Logical Interface Profiles** > *logical-interface-profile-name* > *BGP_peer_connectivity_profile*

- g. Scroll down to the Route Control Profile area and note the route profile names for both the export route control policy and the import route control policy that are being used for this existing IP-based L3Out.
- h. Navigate to **Tenants** > *tenant_name_for_IP_handoff_L3Out* > **Policies** > **Protocol** > **Route Maps for Route Control**.
- i. First locate the **export** route control profile that is being used for this existing IP-based L3Out and click on that route profile.
The properties page for this route control profile appears in the main panel.
- j. Locate the route control context entry in the page and double-click the route control context entry.
The properties page for this route control context appears.
- k. In the **Set Rule** area, select the set rule that you created earlier in these procedures with the BGP local preference path, then click **Submit**.
- l. Now locate the **import** route control profile that is being used for this existing IP-based L3Out and click on that route profile, then repeat these steps to use the set rule with the BGP local preference path entry for the import route control profile.

Step 6 Confirm that traffic is now choosing the SR-MPLS path.

The routing/path selection should be through SR-MPLS (BGP should choose the SR-MPLS path over the IP path). You can monitor the traffic and routes in URIB for each VRF to verify that the SR-MPLS path is selected.

What to do next

Disconnect the IP-based L3Out using the procedures provided in [Disconnecting the IP-Based L3Out, on page 195](#).

Disconnecting the IP-Based L3Out

In this task, you will be disconnecting the IP-based L3Out.

Before you begin

- Review the information provided in [Migrating from IP Handoff Configuration to SR Handoff Configuration, on page 189](#).
- Configure the external EPGs on the SR-MPLS VRF L3Out to mirror the IP-based L3Out configuration using the procedures provided in [Configuring External EPGs on the SR-MPLS VRF L3Out, on page 190](#).
- Redirect inbound and outbound traffic to ensure that it starts preferring the SR-MPLS L3Out using the procedures provided in [Redirecting Traffic to SR-MPLS L3Out, on page 191](#).

Procedure

Step 1 Clean up the IP paths.

You can clean up the IP paths using one of the following methods:

- Remove one subnet at a time in the external EPG in the previously-configured IP-based L3Out.
- Remove the external EPGs in the previously-configured IP-based L3Out.

Either of the methods above will result in the fault being cleared, and the external EPG in the SR-MPLS L3Out will now be deployed.

As part of the process of changing the security policy from the IP-based L3Out to the SR-MPLS L3Out, there might be up to a 15-second drop. After that period, the outbound traffic from ACI to outside will take the SR-MPLS path.

If you see that the previously-configured IP-based L3Out was migrated successfully to the new SR-MPLS L3Out, you can then delete the previously-configured IP-based L3Out.

Step 2 Determine if you have additional L3Outs/VRFs that you want to migrate to SR-MPLS.

Repeat the procedures in [Migrating from IP Handoff Configuration to SR Handoff Configuration, on page 189](#) to migrate other user L3Outs and VRFs to SR-MPLS.

The same procedures in [Migrating from IP Handoff Configuration to SR Handoff Configuration, on page 189](#) can also be used to migrate between a tenant GOLF L3Out and a tenant SR-MPLS L3Out.

About the BGP Domain-Path Feature for Loop Prevention

BGP routing loops might occur in certain situations due to various conditions, such as:

- Intentional disabling of existing BGP loop prevention mechanisms, such as AS Path checks
- Route leaks across different VRFs or VPNs

Following is an example scenario where a BGP routing loop might occur:

1. A prefix P1 received from a BGP IP L3Out peer is advertised in the ACI fabric using the Multiprotocol Border Gateway Protocol (MP-BGP).

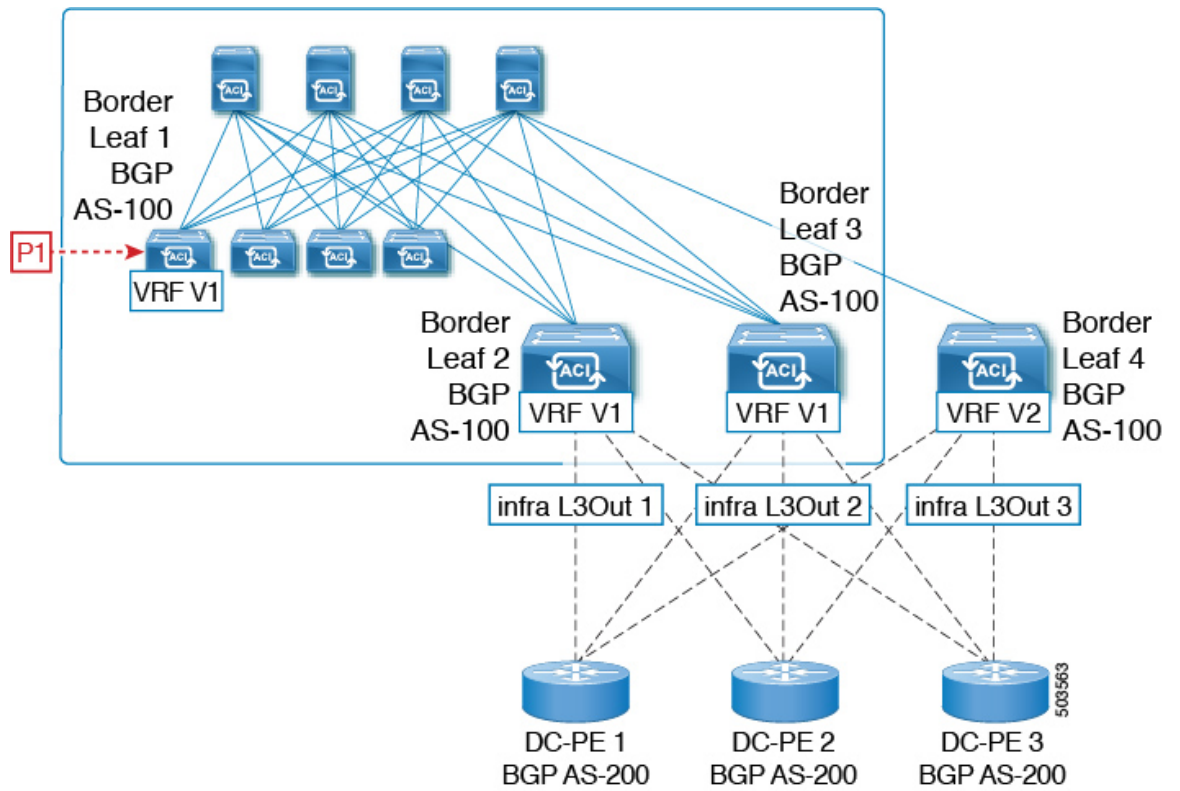

2. As a transit case, this prefix can be advertised out externally through an SR-MPLS infra L3Out.

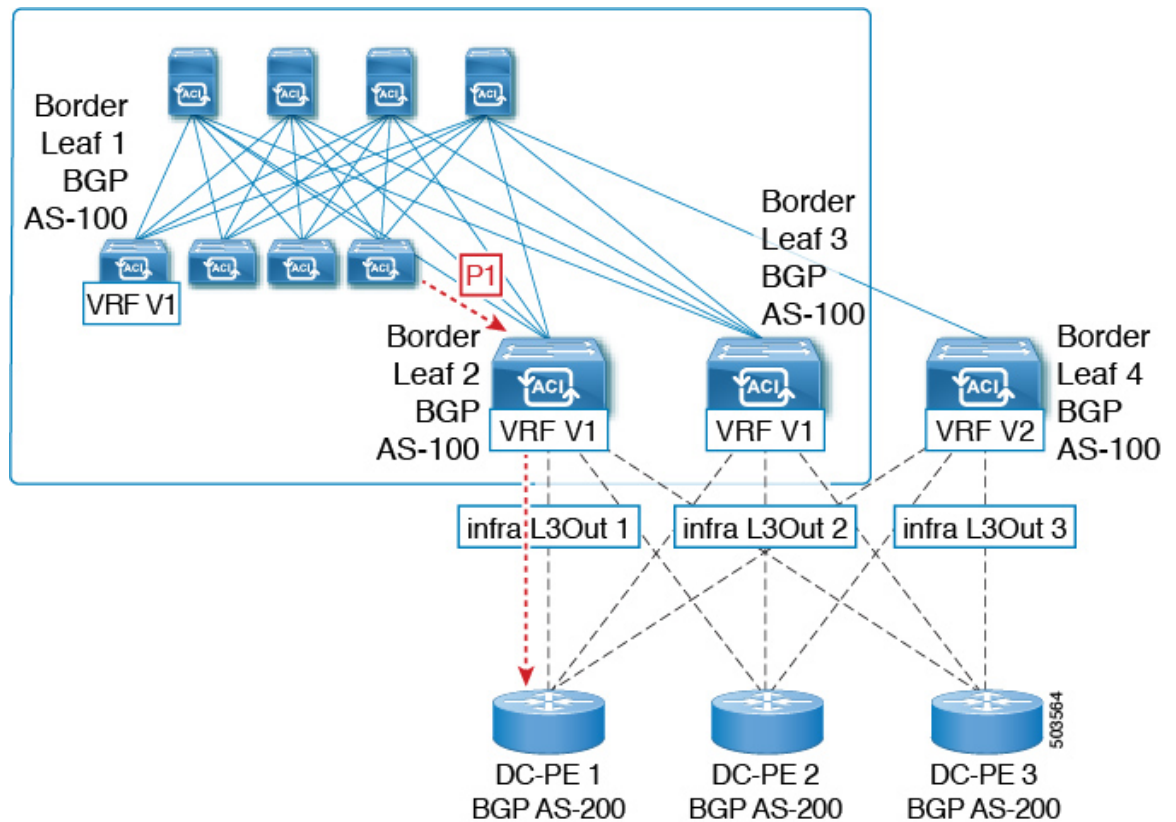

3. This prefix could then be imported back into the ACI fabric from the core, either in the same VRF or in a different VRF.

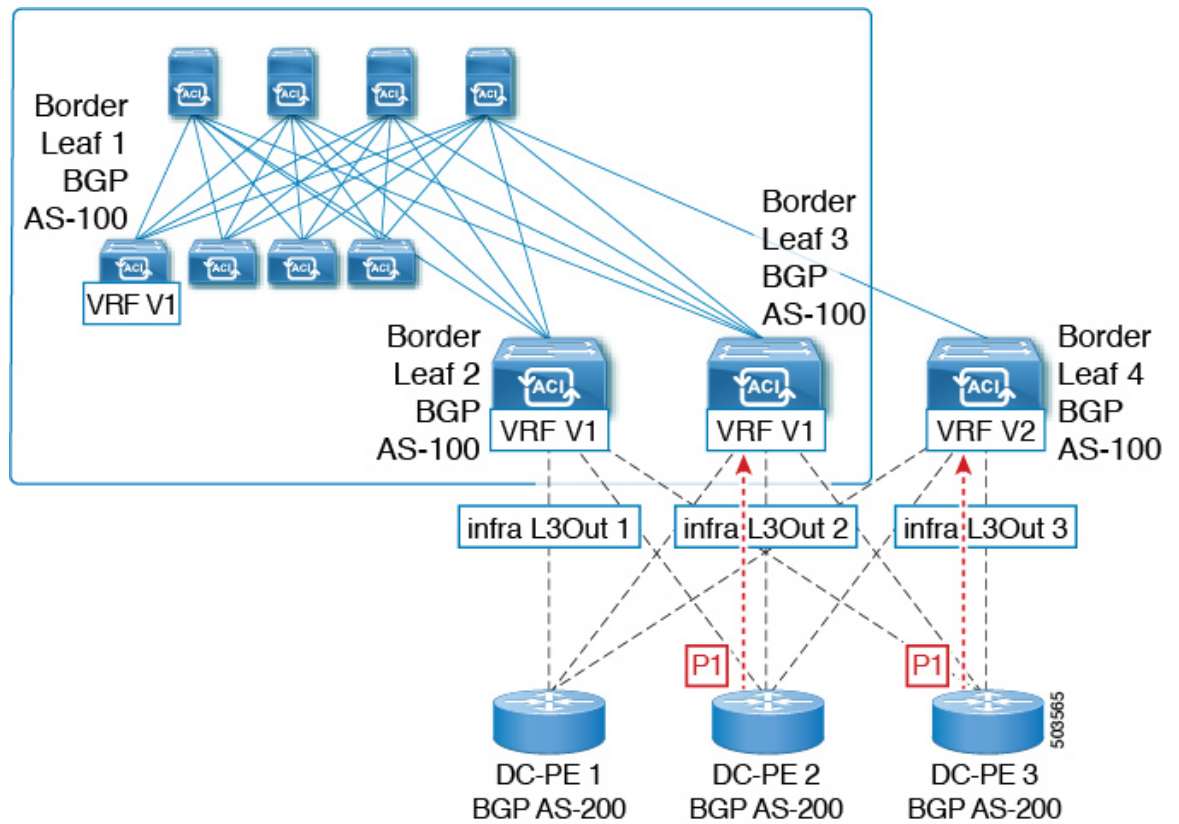

4. A BGP routing loop would occur when this imported prefix is then advertised back to the originating switch, either from the same VRF or through a leak from a different VRF.

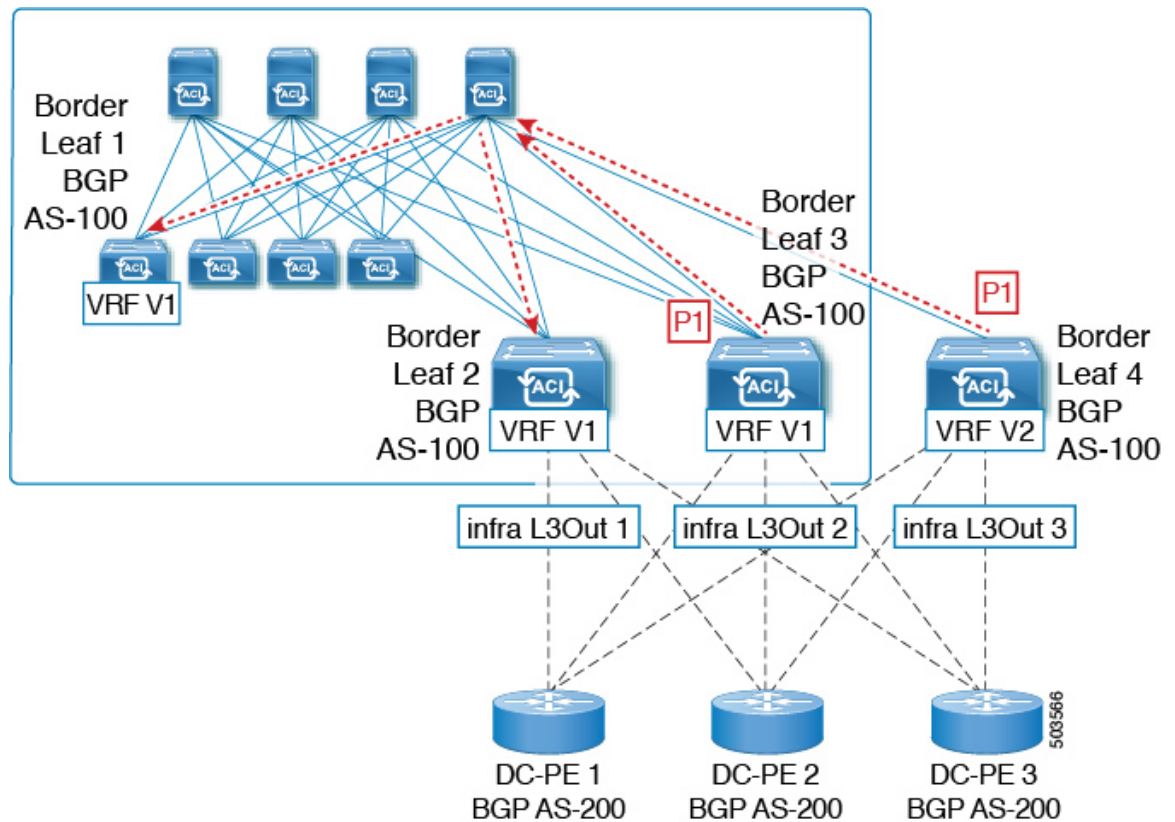

Beginning with Release 5.1(3), the new BGP Domain-Path feature is available, which helps with BGP routing loops in the following ways:

- Keeps track of the distinct routing domains traversed by a route within the same VPN or extended VRFs, as well as across different VPNs or VRFs
- Detects when a route loops back to a VRF in a domain where it has already traversed (typically at a border leaf switch that is the stitching point between domains, but also at an internal switch, in some cases)
- Prevents the route from getting imported or accepted when it would lead to a loop

Within an ACI fabric, the VRF scope is global and is extended to all switches where it is configured. Therefore, a route that is exported out of a domain in a VRF is blocked from being received back into the VRF on any other switch.

The following components are used with the BGP Domain-Path feature for loop prevention:

- **Routing domain ID:** Every tenant VRF in an ACI site is associated with one internal fabric domain, one domain for each VRF in each SR-MPLS infra L3Out, and one domain for each IP L3Out. When the BGP Domain-Path feature is enabled, each of these domains is assigned a unique routing domain ID, in the format *Base*:<variable>, where:
 - *Base* is the non-zero value that was entered in the **Domain ID Base** field in the **BGP Route Reflector Policy** page
 - <variable> is a randomly-generated value specifically for that domain

- **Domain path:** The domain segments traversed by a route are tracked using a BGP domain path attribute:
 - The domain ID of the VRF for the source domain where the route is received is prepended to the domain path
 - The source domain ID is prepended to the domain path while re-originating a route across domains on the border leaf switches
 - An external route is not accepted if any of the local domain IDs for the VRFs is in the domain path
 - The domain path is carried as an optional and transitive BGP path attribute with each domain segment, represented as <Domain-ID:SAFI>
 - The ACI border leaf switches prepend the VRF internal domain ID for both locally originated and external routes to track leaks within the domain
 - A route from the internal domain can be imported and installed in a VRF on a node with a conflicting external domain ID to provide an internal backup or transit path
 - For infra L3Out peers, the advertisement of a route to a peer is skipped if the domain ID of the peer domain is present in the domain path of the route (outbound check is not applicable for IP L3Out peers)
 - The border leaf switches and non-border leaf switches will both process the domain path attribute



Note You can configure the BGP Domain-Path feature for loop prevention, or simply enable the configuration to send a received domain path, through the GUI or REST API. You cannot configure the BGP Domain-Path feature for loop prevention or enable the configuration to send a received domain path through the NX-OS style CLI.



Note When upgrading to Release 5.1(3) from a previous release, if you have contracts configured for inter-VRF shared services, those contracts might not work as expected with the BGP Domain-Path feature for loop prevention because the BGP domain ID would not have been set in those contracts that were configured before you upgraded to Release 5.1(3). In those situations, delete the contract and then add the contract back, which will allow the BGP domain update to occur. This is only an issue when you have contracts that were configured prior to your upgrade to Release 5.1(3); this is not an issue when you create new contracts after you've completed the upgrade to Release 5.1(3).

Configuring the BGP Domain-Path Feature for Loop Prevention Using the GUI

Before you begin

Become familiar with the BGP Domain-Path feature using the information provided in [About the BGP Domain-Path Feature for Loop Prevention, on page 196](#).

Procedure

Step 1 If you want to use the BGP Domain-Path feature for loop prevention, set the BGP Domain-Path attribute on the BGP route reflector.

Note

If you do not want to use the BGP Domain-Path feature for loop prevention but you still want to send a received domain path, do not enable the BGP Domain-Path feature on the BGP route reflector in this step. Instead, go directly to [Step 2, on page 202](#) to only enable the **Send Domain Path** field in the appropriate BGP connectivity window.

a) Navigate to **System > System Settings > BGP Route Reflector**.

The **BGP Route Reflector** window appears. Verify that the **Policy** page tab is selected in this window.

b) Locate the **Domain ID Base** field.

c) Enter a number in the **Domain ID Base** field.

- Enter a value between 1-4294967295 to enable the BGP Domain-Path feature. If your ACI fabric is part of a Multi-Site environment, make sure that you use a unique value that will be specific for this ACI fabric in this **Domain ID Base** field.
- To disable the BGP Domain-Path feature, enter 0 in this **Domain ID Base** field.

When the BGP Domain-Path feature for loop prevention is enabled, an implicit routing domain ID of the format `Base:<variable>` will be allocated, where:

- `Base` is the non-zero value that you entered in this Domain ID Base field
- `<variable>` is a randomly-generated value specifically for the VRF or L3Out that will be used for the BGP Domain-Path feature for loop prevention

This routing domain ID is passed to BGP to identify the following domains:

- **VRF**: Identified by an internal domain ID using a randomly-generated value specifically for each VRF, as shown in the **Routing Domain ID** field in the **Policy** tab in the VRF window for that tenant
- **IP L3Out**: Identified by an external domain ID using a randomly-generated value specifically for each IP L3Out, as shown in the **Routing Domain ID** field in the **BGP Peer Connectivity Profile** window for that IP L3Out
- **SR-MPLS infra L3Out**: Identified by an external domain ID using a randomly-generated value specifically for each VRF in each SR-MPLS infra L3Out, as shown in the **Routing Domain ID** column in the **SR-MPLS Infra L3Outs** table in the window for each SR-MPLS VRF L3Out

The Domain-Path attribute is processed on the inbound directions to check for loops based on the routing domain IDs in the path. The Domain-Path attribute is sent to a peer, which is controlled separately through the BGP peer-level **Send Domain Path** field in the IP L3Out or in the SR-MPLS infraL3Out, as described in the next step.

Step 2 To send the BGP domain path attribute to a peer, enable the **Send Domain Path** field in the appropriate BGP connectivity window.

If you want to use the BGP Domain-Path feature for loop prevention, first set the **Domain Base ID** in [Step 1, on page 202](#), then enable the **Send Domain Path** field here. If you do not want to use the BGP Domain-Path feature for loop prevention but you still want to send a received domain path, only enable the **Send Domain Path** field here (do not set the **Domain Base ID** in [Step 1, on page 202](#) in that case).

- To enable the **Send Domain Path** field for a IP L3Out peer:

- a. Navigate to the **BGP Peer Connectivity Profile** window for the IP L3Out peer:

Tenant > *tenant_name* > **Networking** > **L3Outs** > *L3Out_name* > **Logical Node Profile** > *log_node_prof_name* > **Logical Interface Profile** > *log_int_prof_name* > **BGP Peer** <*address*>-**Node**-<*node_ID*>

The **BGP Peer Connectivity Profile** window for this configured L3Out appears.

- b. Locate the **BGP Controls** area in the **BGP Peer Connectivity Profile** window.
- c. In the **BGP Controls** area, click the box next to the **Send Domain Path** field.
- d. Click **Submit**.

This action sends the BGP domain path attribute to a peer.

- To enable the **Send Domain Path** field for a SR-MPLS infra L3Out peer:

- a. Navigate to **Tenant** > **infra** > **Networking** > **SR-MPLS Infra L3Outs** > *SR-MPLS-infra-L3Out_name* > **Logical Node Profiles** > *log_node_prof_name*.

The **Logical Node Profile** window for this configured SR-MPLS infra L3Out appears.

- b. Locate the **BGP-EVPN Connectivity Profile** area, then determine if you want to create a new BGP-EVPN connectivity policy or if you want to enable the **Send Domain Path** field in an existing BGP-EVPN connectivity policy.

- If you want to create a new a create a new BGP-EVPN connectivity policy, click + above the table in the **BGP-EVPN Connectivity Profile** area. The **Create BGP-EVPN Connectivity Policy** window appears.
- If you want to enable the **Send Domain Path** field in an existing BGP-EVPN connectivity policy, double-click on that policy in the table in the **BGP-EVPN Connectivity Profile** area. The **BGP-EVPN Connectivity Policy** window appears.

- c. Locate the **BGP Controls** area in the window.
- d. In the **BGP Controls** area, click the box next to the **Send Domain Path** field.
- e. Click **Submit**.

This action sends the BGP domain path attribute to a peer.

Step 3 Navigate to the appropriate areas to see the routing IDs assigned to the various domains.

- To see the routing ID assigned to the VRF domain, navigate to:

Tenants > *tenant_name* > **Networking** > **VRFs** > *VRF_name*, then click on the **Policy** tab for that VRF and locate the entry in the **Routing Domain ID** field in the **VRF** window.

- To see the routing ID assigned to the IP L3Out domain, navigate to:

Tenants > *tenant_name* > **Networking** > **L3Outs** > *L3Out_name* > **Logical Node Profiles** > *log_node_prof_name* > **BGP Peer**, then locate the entry in the **Routing Domain ID** field in the **BGP Peer Connectivity Profile** window.

- To see the routing ID assigned to the SR-MPLS infra L3Out domain, navigate to:

Tenants > *tenant_name* > **Networking** > **SR-MPLS VRF L3Outs** > *SR-MPLS_VRF_L3Out_name*, then locate the entry in the **Routing Domain ID** column in the **SR-MPLS Infra L3Outs** table in the window for that SR-MPLS VRF L3Out.



PART II

External Routing (L3Out) Configuration

- [WAN and Other External Network Forwarding, on page 207](#)
- [Routed Connectivity to External Networks, on page 221](#)
- [Node and Interface for L3Out, on page 241](#)
- [Routing Protocol Support, on page 255](#)
- [Route Summarization, on page 297](#)
- [Route Control with Route Maps and Route Profiles, on page 305](#)
- [Route and Subnet Scope, on page 327](#)
- [Transit Routing, on page 333](#)
- [Shared Services, on page 355](#)
- [QoS for L3Outs, on page 363](#)
- [IP SLAs, on page 367](#)
- [HSRP, on page 385](#)
- [Cisco ACI GOLF, on page 393](#)



CHAPTER 16

WAN and Other External Network Forwarding

This chapter contains the following sections:

- [Networking Domains, on page 207](#)
- [Router Peering and Route Distribution, on page 208](#)
- [Route Import and Export, Route Summarization, and Route Community Match , on page 209](#)
- [ACI Route Redistribution, on page 212](#)
- [Route Distribution Within the ACI Fabric, on page 212](#)
- [External Layer 3 Outside Connection Types, on page 213](#)
- [About the Modes of Configuring Layer 3 External Connectivity, on page 215](#)
- [Controls Enabled for Subnets Configured under the L3Out Network Instance Profile, on page 217](#)
- [ACI Layer 3 Outside Network Workflows, on page 218](#)

Networking Domains

A fabric administrator creates domain policies that configure ports, protocols, VLAN pools, and encapsulation. These policies can be used exclusively by a single tenant, or shared. Once a fabric administrator configures domains in the ACI fabric, tenant administrators can associate tenant endpoint groups (EPGs) to domains.

The following networking domain profiles can be configured:

- VMM domain profiles (`vmmDomP`) are required for virtual machine hypervisor integration.
- Physical domain profiles (`physDomP`) are typically used for bare metal server attachment and management access.
- Bridged outside network domain profiles (`l2extDomP`) are typically used to connect a bridged external network trunk switch to a leaf switch in the ACI fabric.
- Routed outside network domain profiles (`l3extDomP`) are used to connect a router to a leaf switch in the ACI fabric.
- Fibre Channel domain profiles (`fcDomP`) are used to connect Fibre Channel VLANs and VSANs.

A domain is configured to be associated with a VLAN pool. EPGs are then configured to use the VLANs associated with a domain.



Note EPG port and VLAN configurations must match those specified in the domain infrastructure configuration with which the EPG associates. If not, the APIC will raise a fault. When such a fault occurs, verify that the domain infrastructure configuration matches the EPG port and VLAN configurations.

Router Peering and Route Distribution

As shown in the figure below, when the routing peer model is used, the leaf switch interface is statically configured to peer with the external router's routing protocol.

Figure 24: Router Peering

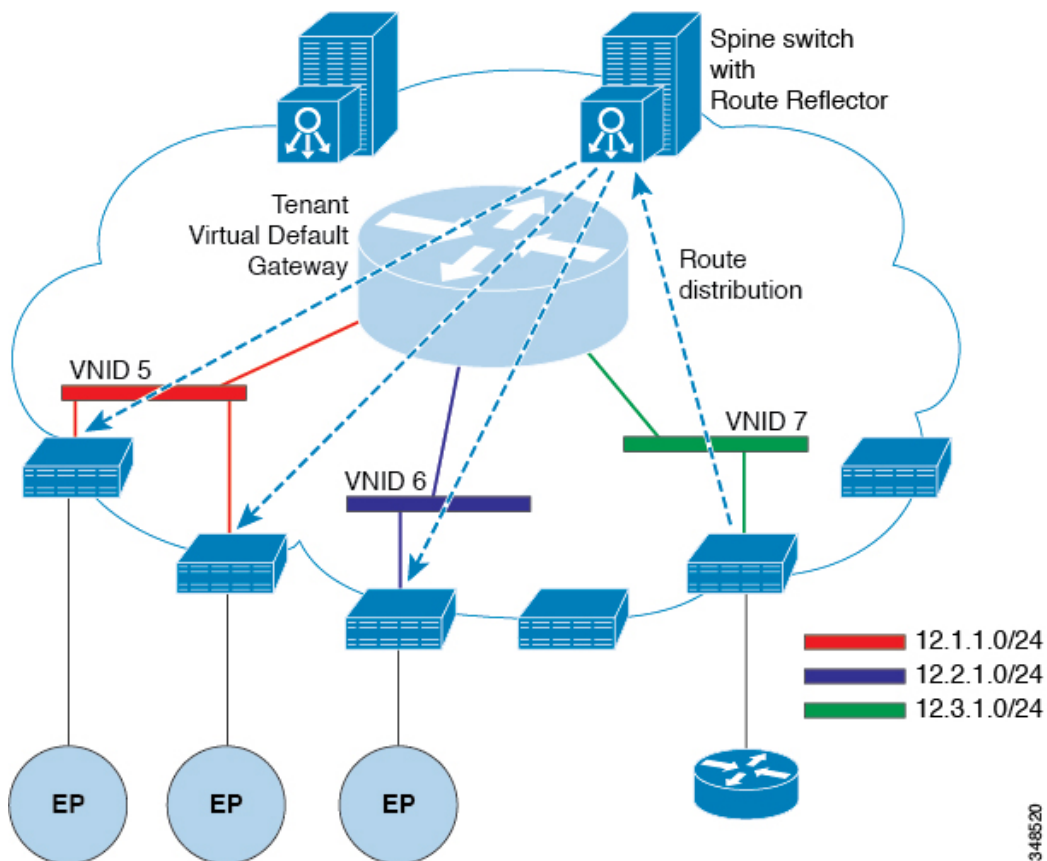

The routes that are learned through peering are sent to the spine switches. The spine switches act as route reflectors and distribute the external routes to all of the leaf switches that have interfaces that belong to the same tenant. These routes are longest prefix match (LPM) summarized addresses and are placed in the leaf switch's forwarding table with the VTEP IP address of the remote leaf switch where the external router is connected. WAN routes have no forwarding proxy. If the WAN routes do not fit in the leaf switch's forwarding table, the traffic is dropped. Because the external router is not the default gateway, packets from the tenant endpoints (EPs) are sent to the default gateway in the ACI fabric.

Route Import and Export, Route Summarization, and Route Community Match

Subnet route export or import configuration options can be specified according to the scope and aggregation options described below.

For routed subnets, the following scope options are available:

- Export Route Control Subnet: Controls the export route direction.
- Import Route Control Subnet: Controls the import route direction.



Note Import route control is supported for BGP and OSPF, but not EIGRP.

- External Subnets for the External EPG (Security Import Subnet): Specifies which external subnets have contracts applied as part of a specific external L3Out EPG (`l3extInstP`). For a subnet under the `l3extInstP` to be classified as an external EPG, the scope on the subnet should be set to "import-security". Subnets of this scope determine which IP addresses are associated with the `l3extInstP`. Once this is determined, contracts determine with which other EPGs that external subnet is allowed to communicate. For example, when traffic enters the ACI switch on the Layer 3 external outside network (`L3extOut`), a lookup occurs to determine which source IP addresses are associated with the `l3extInstP`. This action is performed based on Longest Prefix Match (LPM) so that more specific subnets take precedence over more general subnets.
- Shared Route Control Subnet: In a shared service configuration, only subnets that have this property enabled will be imported into the consumer EPG Virtual Routing and Forwarding (VRF). It controls the route direction for shared services between VRFs.
- Shared Security Import Subnet: Applies shared contracts to imported subnets. The default specification is External Subnets for the external EPG.

Routed subnets can be aggregated. When aggregation is not set, the subnets are matched exactly. For example, if 11.1.0.0/16 is the subnet, then the policy will not apply to a 11.1.1.0/24 route, but it will apply only if the route is 11.1.0.0/16. However, to avoid a tedious and error prone task of defining all the subnets one by one, a set of subnets can be aggregated into one export, import or shared routes policy. At this time, only 0/0 subnets can be aggregated. When 0/0 is specified with aggregation, all the routes are imported, exported, or shared with a different VRF, based on the selection option below:

- Aggregate Export: Exports all transit routes of a VRF (0/0 subnets).
- Aggregate Import: Imports all incoming routes of given L3 peers (0/0 subnets).



Note Aggregate import route control is supported for BGP and OSPF, but not for EIGRP.

- Aggregate Shared Routes: If a route is learned in one VRF but needs to be advertised to another VRF, the routes can be shared by matching the subnet exactly, or can be shared in an aggregate way according to a subnet mask. For aggregate shared routes, multiple subnet masks can be used to determine which

specific route groups are shared between VRFs. For example, 10.1.0.0/16 and 12.1.0.0/16 can be specified to aggregate these subnets. Or, 0/0 can be used to share all subnet routes across multiple VRFs.



Note Routes shared between VRFs function correctly on Generation 2 switches (Cisco Nexus N9K switches with "EX" or "FX" on the end of the switch model name, or later; for example, N9K-93108TC-EX). On Generation 1 switches, however, there may be dropped packets with this configuration, because the physical ternary content-addressable memory (TCAM) tables that store routes do not have enough capacity to fully support route parsing.

Route summarization simplifies route tables by replacing many specific addresses with a single address. For example, 10.1.1.0/24, 10.1.2.0/24, and 10.1.3.0/24 are replaced with 10.1.0.0/16. Route summarization policies enable routes to be shared efficiently among border leaf switches and their neighbor leaf switches. BGP, OSPF, or EIGRP route summarization policies are applied to a bridge domain or transit subnet. For OSPF, inter-area and external route summarization are supported. Summary routes are exported; they are not advertised within the fabric. In the example above, when a route summarization policy is applied, and an EPG uses the 10.1.0.0/16 subnet, the entire range of 10.1.0.0/16 is shared with all the neighboring leaf switches.



Note When two L3extOut policies are configured with OSPF on the same leaf switch, one regular and another for the backbone, a route summarization policy configured on one L3extOut is applied to both L3extOut policies because summarization applies to all areas in the VRF.

As illustrated in the figure below, route control profiles derive route maps according to prefix-based and community-based matching.

Figure 25: Route Community Matching

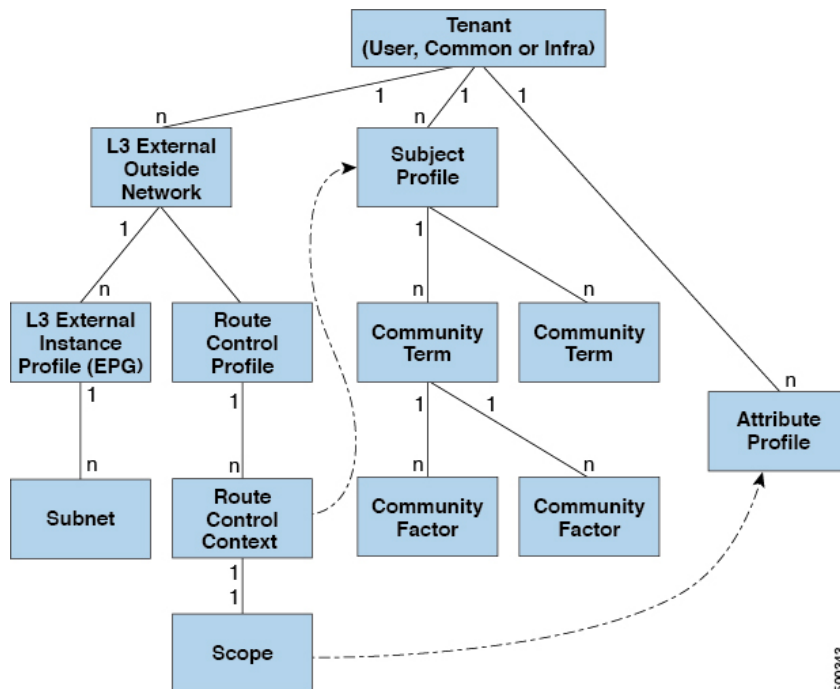

500343

The route control profile (`rtctrlProfile`) specifies what is allowed. The Route Control Context specifies what to match, and the scope specifies what to set. The subject profile contains the community match specifications, which can be used by multiple `L3extOut` instances. The subject profile (`SubjP`) can contain multiple community terms each of which contains one or more community factors (`communities`). This arrangement enables specifying the following boolean operations:

- Logical `or` among multiple community terms
- Logical `and` among multiple community factors

For example, a community term called `northeast` could have multiple communities that each include many routes. Another community term called `southeast` could also include many different routes. The administrator could choose to match one, or the other, or both. A community factor type can be regular or extended. Care should be taken when using extended type community factors, to ensure there are no overlaps among the specifications.

The scope portion of the route control profile references the attribute profile (`rtctrlAttrP`) to specify what set-action to apply, such as preference, next hop, community, and so forth. When routes are learned from an `L3extOut`, route attributes can be modified.

The figure above illustrates the case where an `L3extOut` contains a `rtctrlProfile`. A `rtctrlProfile` can also exist under the tenant. In this case, the `L3extOut` has an interleaf relation policy (`L3extRsInterleafPol`) that associates it with the `rtctrlProfile` under the tenant. This configuration enables reusing the `rtctrlProfile` for multiple `L3extOut` connections. It also enables keeping track of the routes the fabric learns from OSPF to which it gives BGP attributes (BGP is used within the fabric). A `rtctrlProfile` defined under an `L3extOut` has a higher priority than one defined under the tenant.

The `rtctrlProfile` has two modes: `combinable`, and `global`. The default `combinable` mode combines pervasive subnets (`fvSubnet`) and external subnets (`L3extSubnet`) with the match/set mechanism to render the route map. The `global` mode applies to all subnets within the tenant, and overrides other policy attribute settings. A `global rtctrlProfile` provides permit-all behavior without defining explicit (0/0) subnets. A `global rtctrlProfile` is used with non-prefix based match rules where matching is done using different subnet attributes such as community, next hop, and so on. Multiple `rtctrlProfile` policies can be configured under a tenant.

`rtctrlProfile` policies enable enhanced default import and default export route control. Layer 3 Outside networks with aggregated import or export routes can have import/export policies that specify supported default-export and default-import, and supported 0/0 aggregation policies. To apply a `rtctrlProfile` policy on all routes (inbound or outbound), define a `global default rtctrlProfile` that has no match rules.



Note While multiple `L3extOut` connections can be configured on one switch, all Layer 3 outside networks configured on a switch must use the same `rtctrlProfile` because a switch can have only one route map.

The protocol interleaf and redistribute policy controls externally learned route sharing with ACI fabric BGP routes. Set attributes are supported. Such policies are supported per `L3extOut`, per node, or per VRF. An interleaf policy applies to routes learned by the routing protocol in the `L3extOut`. Currently, interleaf and redistribute policies are supported for OSPF v2 and v3. A route control policy `rtctrlProfile` has to be defined as `global` when it is consumed by an interleaf policy.

ACI Route Redistribution

Figure 26: ACI Route Redistribution

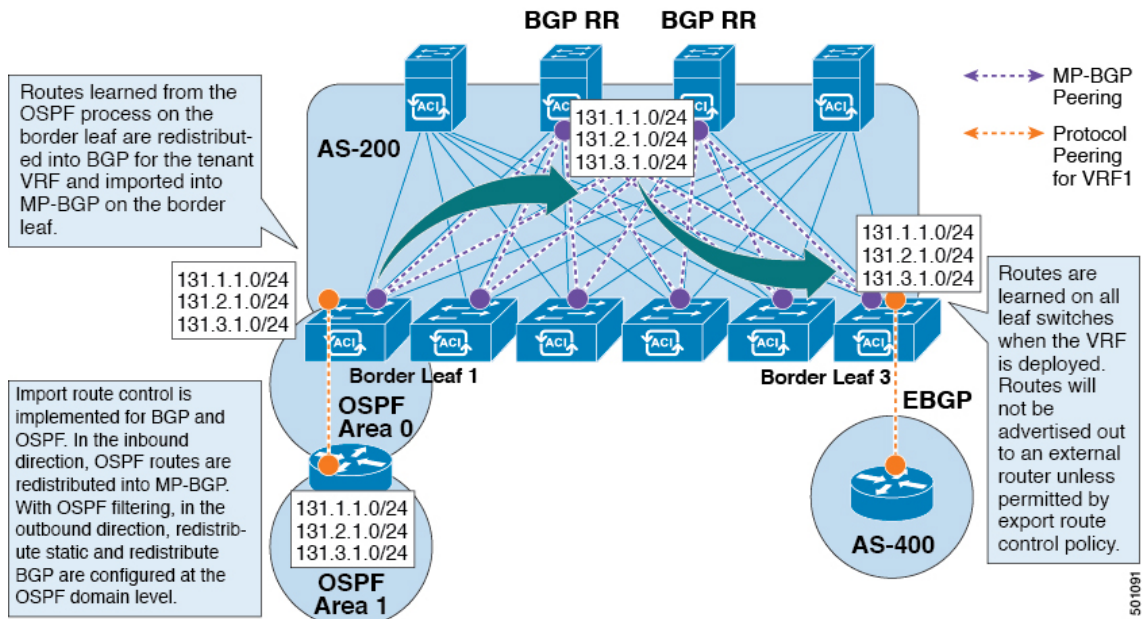

- The routes that are learned from the OSPF process on the border leaf are redistributed into BGP for the tenant VRF and they are imported into MP-BGP on the border leaf.
- Import route control is supported for BGP and OSPF, but not for EIGRP.
- Export route control is supported for OSPF, BGP, and EIGRP.
- The routes are learned on the border leaf where the VRF is deployed. The routes are not advertised to the External Layer 3 Outside connection unless it is permitted by the export route control.



Note When a subnet for a bridge domain/EPG is set to Advertise Externally, the subnet is programmed as a static route on a border leaf. When the static route is advertised, it is redistributed into the EPG's Layer 3 outside network routing protocol as an external network, not injected directly into the routing protocol.

Route Distribution Within the ACI Fabric

ACI supports the following routing mechanisms:

- Static Routes
- OSPFv2 (IPv4)
- OSPFv3 (IPv6)

- iBGP
- eBGP (IPv4 and IPv6)
- EIGRP (IPv4 and IPv6) protocols

ACI supports the VRF-lite implementation when connecting to the external routers. Using sub-interfaces, the border leaf can provide Layer 3 outside connections for the multiple tenants with one physical interface. The VRF-lite implementation requires one protocol session per tenant.

Within the ACI fabric, Multiprotocol BGP (MP-BGP) is implemented between the leaf and the spine switches to propagate the external routes within the ACI fabric. The BGP route reflector technology is deployed in order to support a large number of leaf switches within a single fabric. All of the leaf and spine switches are in one single BGP Autonomous System (AS). Once the border leaf learns the external routes, it can then redistribute the external routes of a given VRF to an MP-BGP address family VPN version 4 or VPN version 6. With address family VPN version 4, MP-BGP maintains a separate BGP routing table for each VRF. Within MP-BGP, the border leaf advertises routes to a spine switch, that is a BGP route reflector. The routes are then propagated to all the leaves where the VRFs (or private network in the APIC GUI's terminology) are instantiated.

External Layer 3 Outside Connection Types

ACI supports the following external Layer 3 Outside connection options:

- Static Routing (supported for IPv4 and IPv6)
- OSPFv2 for normal and NSSA areas (IPv4)
- OSPFv3 for normal and NSSA areas (IPv6)
- iBGP (IPv4 and IPv6)
- eBGP (IPv4 and IPv6)
- EIGRP (IPv4 and IPv6)

The external Layer 3 Outside connections are supported on the following interfaces:

- Layer 3 Routed Interface
- Subinterface with 802.1Q tagging - With subinterface, you can use the same physical interface to provide a Layer 2 outside connection for multiple private networks.
- Switched Virtual Interface (SVI) - With an SVI interface, the same physical interface that supports Layer 2 and Layer 3 and the same physical interface can be used for a Layer 2 outside connection and a Layer 3 outside connection.

Figure 27: ACI Layer 3 Managed Objects

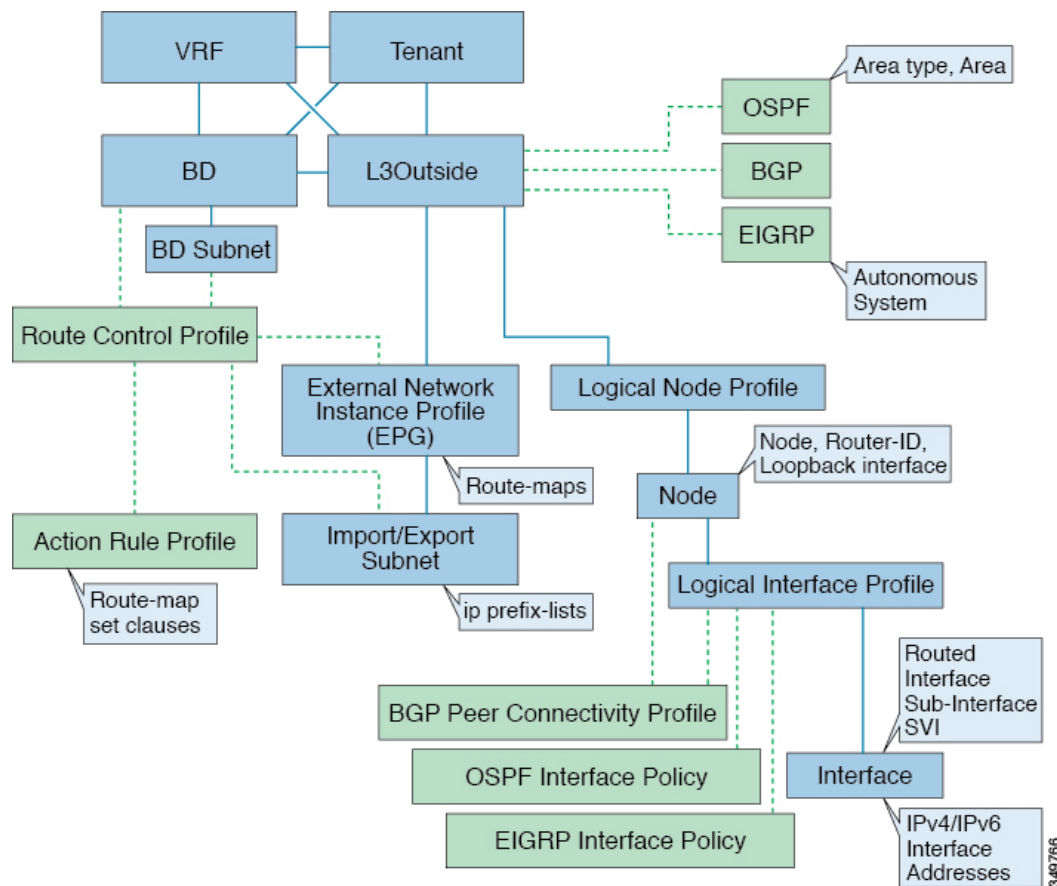

The managed objects that are used for the L3Outside connections are:

- External Layer 3 Outside (L3ext): Routing protocol options (OSPF area type, area, EIGRP autonomous system, BGP), private network, External Physical domain.
- Logical Node Profile: Profile where one or more nodes are defined for the external Layer 3 Outside connections. The configurations of the router-IDs and the loopback interface are defined in the profile.



Note Use the same router-ID for the same node across multiple external Layer 3 Outside connections.



Note Within a single L3Out, a node can only be part of one Logical Node Profile. Configuring the node to be a part of multiple Logical Node Profiles in a single L3Out might result in unpredictable behavior, such as having a loopback address pushed from one Logical Node Profile but not from the other. Use more path bindings under the existing Logical Interface Profiles or create a new Logical Interface Profile under the existing Logical Node Profile instead.

- Logical Interface Profile: IP interface configuration for IPv4 and IPv6 interfaces. It is supported on the Route Interfaces, Routed subinterfaces, and SVIs. The SVIs can be configured on physical ports, port-channels, or vPCs.
- OSPF Interface Policy: Includes details such as OSPF Network Type and priority.
- EIGRP Interface Policy: Includes details such as Timers and split horizon.
- BGP Peer Connectivity Profile: The profile where most BGP peer settings, remote-as, local-as, and BGP peer connection options are configured. You can associate the BGP peer connectivity profile with the logical interface profile or the loopback interface under the node profile. This determines the update-source configuration for the BGP peering session.
- External Layer 3 Outside EPG (l3extInstP): The external EPG is also referred to as the prefix-based EPG or InstP. The import and export route control policies, security import policies, and contract associations are defined in this profile. You can configure multiple external EPGs under a single L3Out. You may use multiple external EPGs when a different route or a security policy is defined on a single external Layer 3 Outside connections. An external EPG or multiple external EPGs combine into a route-map. The import/export subnets defined under the external EPG associate to the IP prefix-list match clauses in the route-map. The external EPG is also where the import security subnets and contracts are associated. This is used to permit or drop traffic for this L3out.
- Action Rules Profile: The action rules profile is used to define the route-map set clauses for the L3Out. The supported set clauses are the BGP communities (standard and extended), Tags, Preference, Metric, and Metric type.
- Route Control Profile: The route-control profile is used to reference the action rules profiles. This can be an ordered list of action rules profiles. The Route Control Profile can be referenced by a tenant BD, BD subnet, external EPG, or external EPG subnet.

There are more protocol settings for BGP, OSPF, and EIGRP L3Outs. These settings are configured per tenant in the ACI Protocol Policies section in the GUI.



Note When configuring policy enforcement between external EPGs (transit routing case), you must configure the second external EPG (InstP) with the default prefix 0/0 for export route control, aggregate export, and external security. In addition, you must exclude the preferred group, and you must use an any contract (or desired contract) between the transit InstPs.

About the Modes of Configuring Layer 3 External Connectivity

Because APIC supports multiple user interfaces (UIs) for configuration, the potential exists for unintended interactions when you create a configuration with one UI and later modify the configuration with another UI. This section describes considerations for configuring Layer 3 external connectivity with the APIC NX-OS style CLI, when you may also be using other APIC user interfaces.

When you configure Layer 3 external connectivity with the APIC NX-OS style CLI, you have the choice of two modes:

- Implicit mode, a simpler mode, is not compatible with the APIC GUI or the REST API.
- Named (or Explicit) mode is compatible with the APIC GUI and the REST API.

In either case, the configuration should be considered read-only in the incompatible UI.

How the Modes Differ

In both modes, the configuration settings are defined within an internal container object, the "L3 Outside" (or "L3Out"), which is an instance of the **l3extOut** class in the API. The main difference between the two modes is in the naming of this container object instance:

- Implicit mode—the naming of the container is implicit and does not appear in the CLI commands. The CLI creates and maintains these objects internally.
- Named mode—the naming is provided by the user. CLI commands in the Named Mode have an additional **l3Out** field. To configure the named L3Out correctly and avoid faults, the user is expected to understand the API object model for external Layer 3 configuration.



Note Except for the procedures in the *Configuring Layer 3 External Connectivity Using the Named Mode* section, this guide describes Implicit mode procedures.

Guidelines and Restrictions

- In the same APIC instance, both modes can be used together for configuring Layer 3 external connectivity with the following restriction: The Layer 3 external connectivity configuration for a given combination of tenant, VRF, and leaf can be done only through one mode.
- For a given tenant VRF, the policy domain where the External-l3 EPG can be placed can be in either the Named mode or in the Implicit mode. The recommended configuration method is to use only one mode for a given tenant VRF combination across all the nodes where the given tenant VRF is deployed for Layer 3 external connectivity. The modes can be different across different tenants or different VRFs and no restrictions apply.
- In some cases, an incoming configuration to a Cisco APIC cluster will be validated against inconsistencies, where the validations involve externally-visible configurations (northbound traffic through the L3Outs). An Invalid Configuration error message will appear for those situations where the configuration is invalid.
- The external Layer 3 features are supported in both configuration modes, with the following exception:
 - Route-peering and Route Health Injection (RHI) with a L4-L7 Service Appliance is supported only in the Named mode. The Named mode should be used across all border leaf switches for the tenant VRF where route-peering is involved.
- Layer 3 external network objects (l3extOut) created using the Implicit mode CLI procedures are identified by names starting with “_ui_” and are marked as read-only in the GUI. The CLI partitions these external-l3 networks by function, such as interfaces, protocols, route-map, and EPG. Configuration modifications performed through the REST API can break this structure, preventing further modification through the CLI.

For the steps to remove such objects, see *Troubleshooting Unwanted _ui_ Objects* in the *APIC Troubleshooting Guide*.

Controls Enabled for Subnets Configured under the L3Out Network Instance Profile

The following controls can be enabled for the subnets that are configured under the L3Out Network Instance Profile.

Table 7: Route Control Options

Route control Setting	Use	Options
Export Route Control	Controls which external networks are advertised out of the fabric using route-maps and IP prefix lists. An IP prefix list is created on the BL switch for each subnet that is defined. The export control policy is enabled by default and is supported for BGP, EIGRP, and OSPF.	Specific match (prefix and prefix length).
Import Route Control	Controls the subnets that are allowed into the fabric. Can include set and match rules to filter routes. Supported for BGP and OSPF, but not for EIGRP. If you enable the import control policy for an unsupported protocol, it is automatically ignored. The import control policy is not enabled by default, but you can enable it on the Create L3Out panel. On the Identity tab, enable Route Control Enforcement: Import .	Specific match (prefix and prefix length) .
Security Import Subnet	Used to permit the packets to flow between two prefix-based EPGs. Implemented with ACLs.	Uses the ACL match prefix or wildcard match rules.
Aggregate Export	Used to allow all prefixes to be advertised to the external peers. Implemented with the 0.0.0.0/ le 32 IP prefix-list.	Only supported for 0.0.0.0/0 subnet (all prefixes).
Aggregate Import	Used to allow all prefixes that are inbound from an external BGP peer. Implemented with the 0.0.0.0/0 le 32 IP prefix-list.	Only supported for the 0.0.0.0/0 subnet (all prefixes).

You may prefer to advertise all the transit routes out of an L3Out connection. In this case, use the aggregate export option with the prefix 0.0.0.0/0. Using this aggregate export option creates an IP prefix-list entry (permit

0.0.0.0/0 le 32) that the APIC system uses as a match clause in the export route-map. Use the **show route-map <outbound route-map>** and **show ip prefix-list <match-clause>** commands to view the output.

If you enable aggregate shared routes, if a route learned in one VRF must be advertised to another VRF, the routes can be shared by matching the subnet exactly, or they can be shared by using an aggregate subnet mask. Multiple subnet masks can be used to determine which specific route groups are shared between VRFs. For example, 10.1.0.0/16 and 12.1.0.0/16 can be specified to aggregate these subnets. Or, 0/0 can be used to share all subnet routes across multiple VRFs.



Note Routes shared between VRFs function correctly on Generation 2 switches (Cisco Nexus N9K switches with "EX" or "FX" on the end of the switch model name, or later; for example, N9K-93108TC-EX). On Generation 1 switches, however, there may be dropped packets with this configuration, because the physical ternary content-addressable memory (TCAM) tables that store routes do not have enough capacity to fully support route parsing.

ACI Layer 3 Outside Network Workflows

This workflow provides an overview of the steps required to configure a Layer 3 Outside (L3Out) network connection.

Figure 28: Layer 3 outside network connection

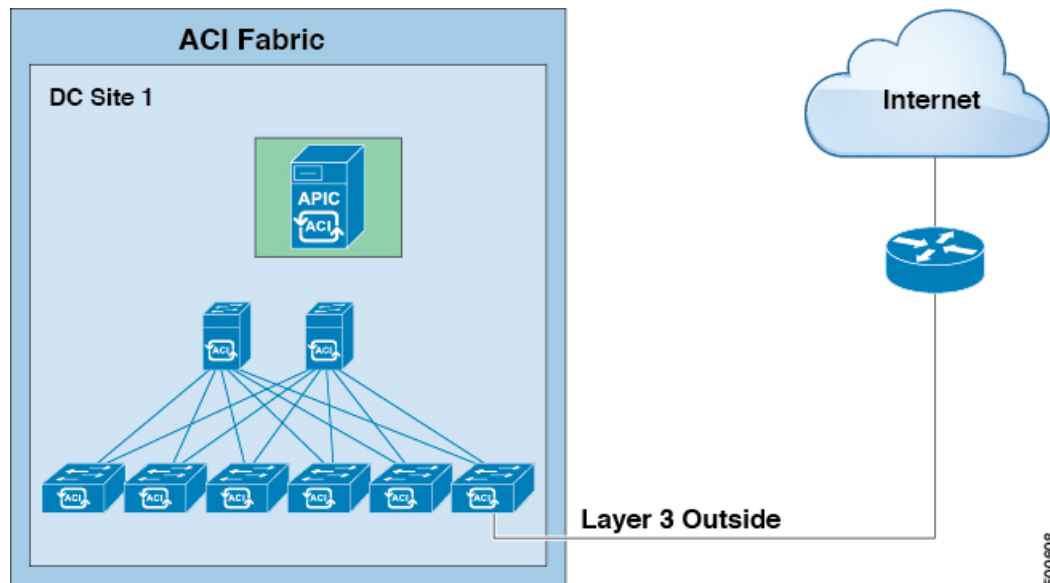

1. Prerequisites

- Ensure that you have read/write access privileges to the infra security domain.
- Ensure that the target leaf switches with the necessary interfaces are available.

Configure a Layer 3 Outside Network

Choose which of these L3Out scenarios you will use:

- For an L3Out that will be consumed within a single tenant, follow the instructions for configuring BGP or OSPF.
- For an L3Out that will be consumed (shared) among multiple tenants, follow the "Shared Layer 3 Out" guidelines.
- For an L3Out transit routing use case, follow ACI transit routing instructions.

Note: This feature requires APIC release 1.2(1x) or later.



CHAPTER 17

Routed Connectivity to External Networks

This chapter contains the following sections:

- [About Routed Connectivity to Outside Networks, on page 221](#)
- [Create L3Out Wizard, on page 223](#)
- [Advertise Host Routes, on page 236](#)
- [Configuring Route Reflectors, on page 237](#)

About Routed Connectivity to Outside Networks

A Layer 3 outside network configuration (L3Out) defines how traffic is forwarded outside of the fabric. Layer 3 is used to discover the addresses of other nodes, select routes, select quality of service, and forward the traffic that is entering, exiting, and transiting the fabric.



Note For guidelines and cautions for configuring and maintaining Layer 3 outside connections, see [Guidelines for Layer 3 Networking, on page 403](#).

For information about the types of L3Outs, see [External Layer 3 Outside Connection Types, on page 213](#).

Layer 3 Out for Routed Connectivity to External Networks

Routed connectivity to external networks is enabled by associating a fabric access (`infraInfra`) external routed domain (`l3extDomP`) with a tenant Layer 3 external instance profile (`l3extInstP` or external EPG) of a Layer 3 external outside network (`l3extOut`), in the hierarchy in the following diagram:

Figure 29: Policy Model for Layer 3 External Connections

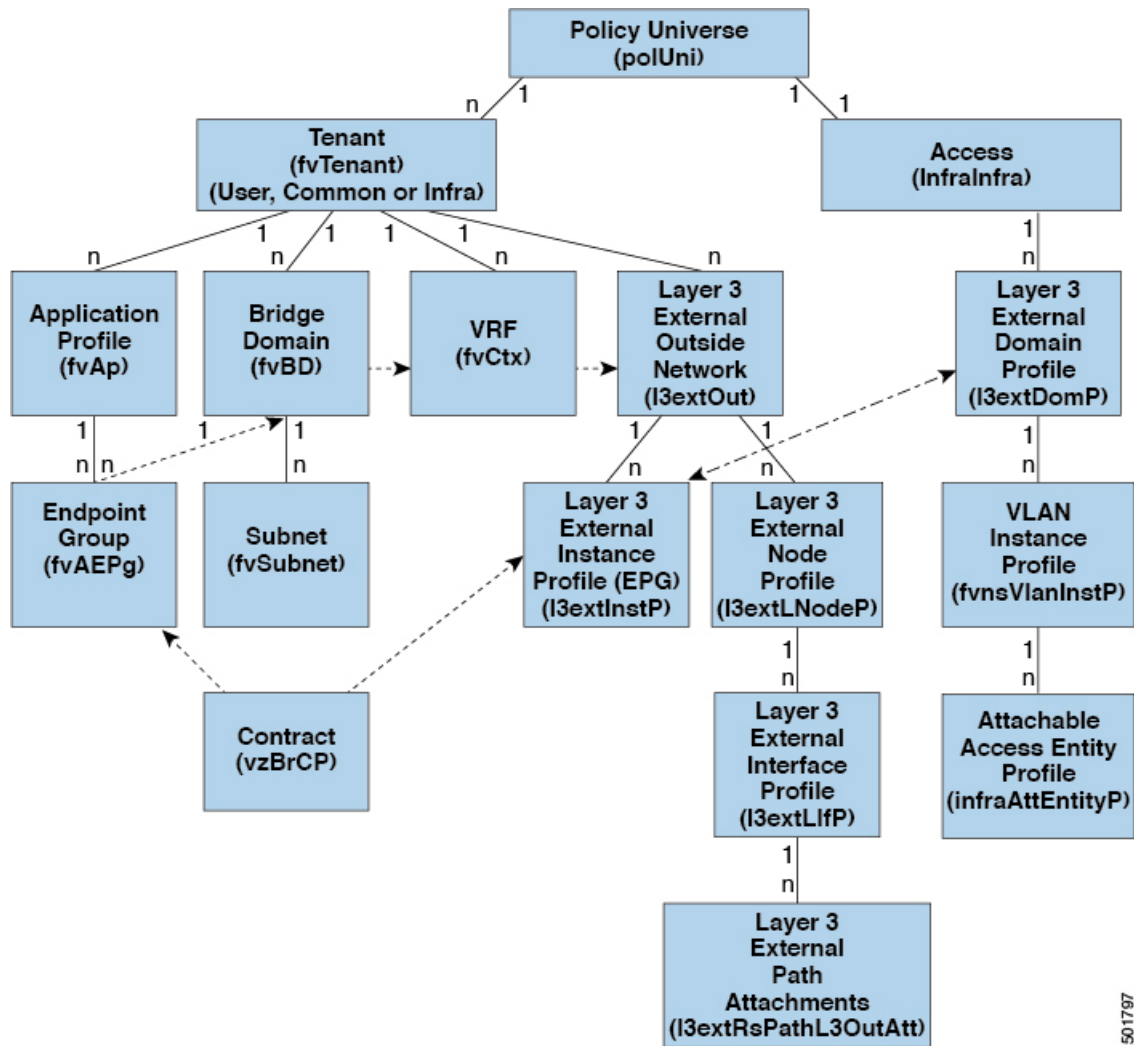

A Layer 3 external outside network (`l3extOut` object) includes the routing protocol options (BGP, OSPF, or EIGRP or supported combinations) and the switch-specific and interface-specific configurations. While the `l3extOut` contains the routing protocol (for example, OSPF with its related Virtual Routing and Forwarding (VRF) and area ID), the Layer 3 external interface profile contains the necessary OSPF interface details. Both are needed to enable OSPF.

The `l3extInstP` EPG exposes the external network to tenant EPGs through a contract. For example, a tenant EPG that contains a group of web servers could communicate through a contract with the `l3extInstP` EPG according to the network configuration contained in the `l3extOut`. The outside network configuration can easily be reused for multiple nodes by associating the nodes with the L3 external node profile. Multiple nodes that use the same profile can be configured for fail-over or load balancing. Also, a node can be added to multiple `l3extOuts` resulting in VRFs that are associated with the `l3extOuts` also being deployed on that node. For scalability information, refer to the current *Verified Scalability Guide for Cisco ACI*.

Create L3Out Wizard

A new Create L3Out wizard is introduced in APIC release 4.2(1) that provides a straightforward walk-through for configuring an L3Out.

The Create L3Out wizard streamlines the process for configuring an L3Out, which defines how the ACI fabric connects to external layer 3 networks. With the Create L3Out wizard, you make the necessary basic configurations for the L3Out components in the following pages:

- **Identity page:** This page is used to configure the basic settings for the L3Out, as well as the static routing and dynamic routing protocols settings.
- **Nodes and Interfaces page:** This page is used to configure the node profiles and interface profiles for the Layer 3 and Layer 2 interface types.
- **Protocols page:** This page is used to configure specific polices based on the protocols that you selected in the Identity page.
- **External EPG page:** This page is used to configure the contract and subnets for the external EPG.

Example L3Out Configuration

There are many different options available to you when configuring an L3Out using the **Create L3Out** wizard. Following is one example L3Out configuration, where you will configure an OSPF L3Out with two external routers, that will help you to understand the general configuration process.



Note This example uses Cisco APIC release 4.2(x) and the associated GUI screens.

Example Topology

Figure 30: Example Topology for an OSPF L3Out with Two External Routers

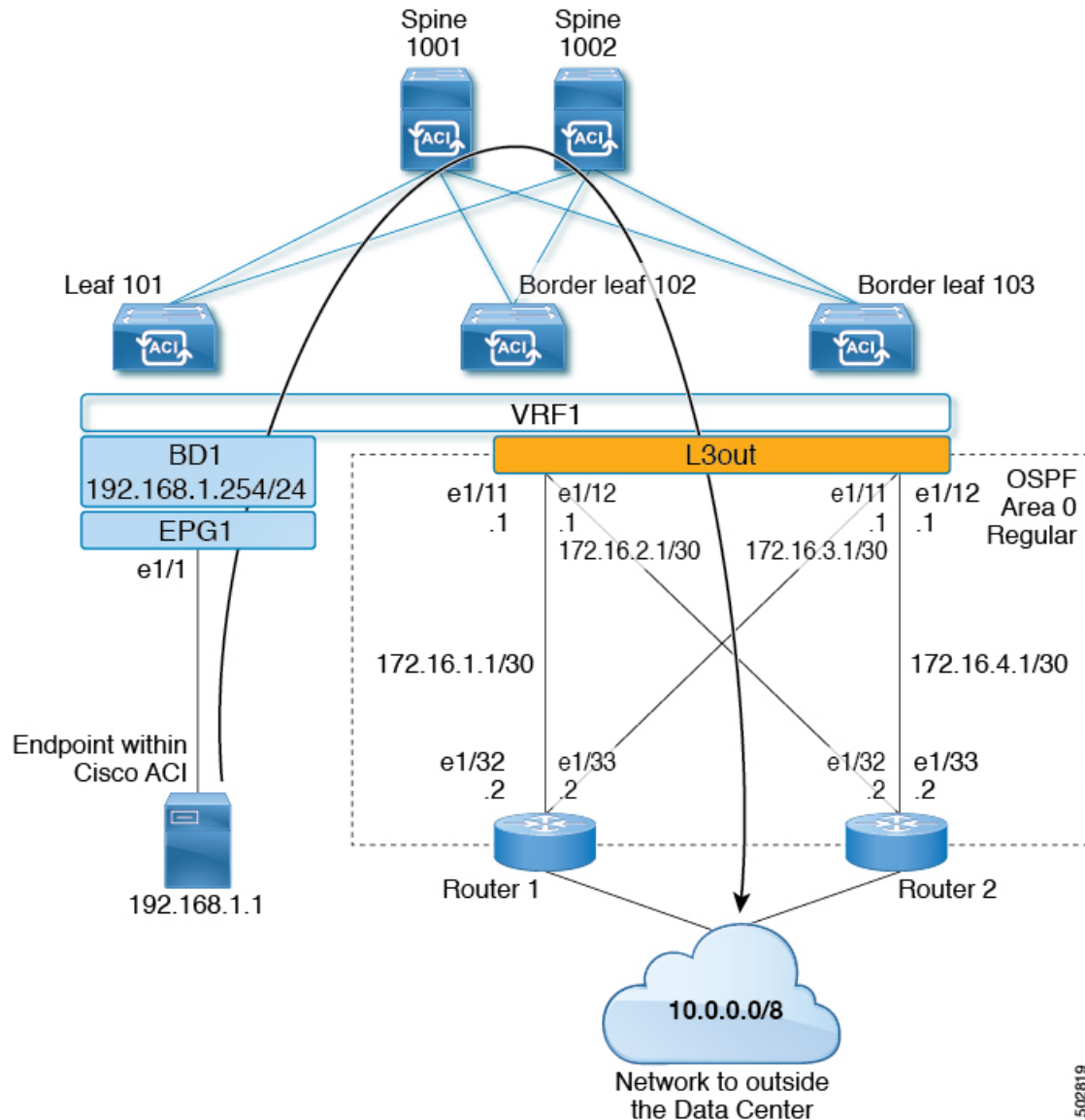

This basic L3Out example shows you how to:

- Configure an L3Out with the following specifications:
 - With Area 0 OSPF
 - With two external routers
 - With routed interfaces
 - On two border leaf switches
- Advertise a BD subnet using default route-map (default-export)

- Allow communication with a contract between EPG1 and external route (10.0.0.0/8)

Figure 31: OSPF Configuration Diagram

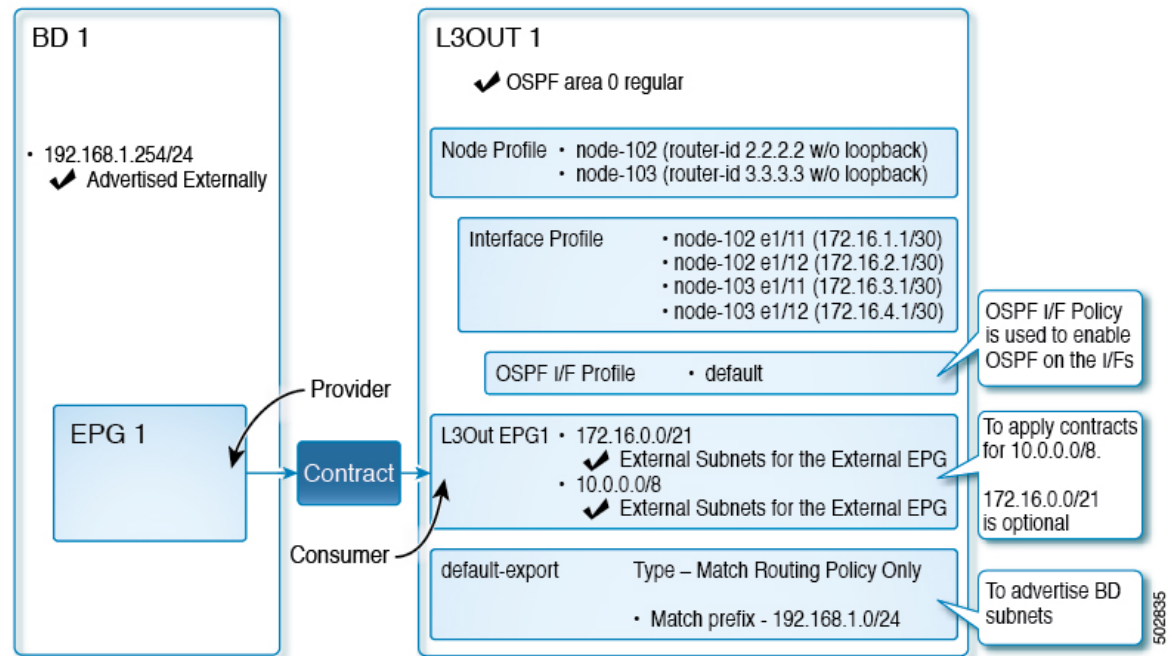

The preceding diagram illustrates the configuration for the example topology in [Figure 30: Example Topology for an OSPF L3Out with Two External Routers, on page 224](#). The configuration flow for this example is as follows:

1. L3Out: This creates
 - L3Out itself (OSPF parameters)
 - Node, Interface, OSPF I/F Profiles
 - L3Out EPG with **External Subnets for the External EPG** scope
2. Advertise a BD subnet: This uses
 - **default-export** route-map
 - BD subnet with **Advertise Externally** scope
3. Allow EPG - L3Out communication: This uses a contract between EPG1 and L3Out EPG1

Prerequisites

Figure 32: Example Screen of Objects Created as Prerequisites

The screenshot displays the Cisco ACI configuration interface. On the left, a navigation tree shows the hierarchy: Example > Application Profiles > AP1 > Application EPGs > EPG1 > Static Ports > Pod-1/Node-101/eth1/1. The main panel shows the configuration for 'Static Ports' with a table listing objects under 'Node: Pod-1'.

Path	Primary VLAN for Micro-Seg	Port Encap (or Secondary VLAN for Micro-Seg)	Deployment Immediacy	Mode
Pod-1/Node-101...	unknown	vlan-10	Immediate	Trunk

An inset window shows the configuration for the IP address 192.168.1.254/24:

- IP Address: 192.168.1.254/24
- Description: optional
- Treat as virtual IP address:
- Make this IP address primary:
- Scope: Advertised Externally, Shared between VRFs
- Subnet Control: No Default SVI Gateway, Querier IP
- L3 Out for Route Profile: select a value
- Route Profile: select a value

- This configuration example focuses only on the L3Out configuration part. The other configurations such as for VRF, BD, EPG, Application Profiles, and Access Policies (Layer 3 Domain etc.) are not covered. The preceding screenshot displays the prerequisite tenant configurations that are as follows:

- VRF1
- BD1 with the subnet 192.168.1.254/24
- EPG1 with a static port towards endpoints

Create Example L3Out Using the Create L3Out Wizard

This task creates the OSPF L3Out described in Example Topology. Following this task, Cisco ACI will be configured with two border leaf switches and OSPF neighborhood with two external routers as shown in [Figure 30: Example Topology for an OSPF L3Out with Two External Routers](#), on page 224.

Procedure

Step 1 In the GUI **Navigation** pane, under the Tenant Example, navigate to **Networking > L3Outs**.

Step 2 Right-click and choose **Create L3Out**.

Step 3 In the **Create L3Out** screen, **Identity** tab, perform the following actions:

Create L3Out

1. Identity 2. Nodes And Interfaces 3. Protocols 4. External EPG

Leaf Router

Identity

A Layer 3 Outside (L3Out) network configuration defines how the ACI fabric connects to external layer 3 networks. The L3Out supports connecting to external networks using static routing and dynamic routing protocols (BGP, OSPF, and EIGRP).

Prerequisites:

- Configure an L3 Domain and Fabric Access Policies for interfaces used in the L3Out (AAEP, VLAN pool, Interface selectors).
- Configure a BGP Route Reflector Policy for the fabric infra MP-BGP.

Name:

VRF:

L3 Domain:

Use for GOLP:

BGP EIGRP OSPF

OSPF Area ID:

OSPF Area Control: Send redistributed LSAs into NSSA area
 Originate summary LSA
 Suppress forwarding address in translated LSA

OSPF Area Type: NSSA area Regular area Stub area

OSPF Area Cost:

Previous Cancel Next

- In the **Name** field, enter the name for an L3Out. (EXAMPLE_L3Out1)
- In the **VRF** field and the **L3 Domain** field, choose the appropriate values. (VRF1, EXAMPLE_L3DOM)
- In the **OSPF** field, check the checkbox.
- In the **OSPF Area ID** field, choose the value **0** or the text **backbone**.
- In the **OSPF Area Type** field, choose **Regular area**.
- Keep the rest of the fields with their default values.

Step 4

Click **Next** to display the **Nodes and Interfaces** screen, and perform the following actions:

Create L3Out

1. Identity 2. Nodes And Interfaces 3. Protocols 4. External EPG

Nodes and Interfaces

The L3Out configuration consists of node profiles and interface profiles. An L3Out can span across multiple nodes in the fabric. All nodes used by the L3Out can be included in a single node profile and is required for nodes that are part of a VPC pair. Interface profiles can include multiple interfaces. When configuring dual stack interfaces a separate interface profile is required for the IPv4 and IPv6 configuration, that is automatically taken care of by this wizard.

Use Defaults:

Interface Types

Layer 3: Routed Routed Sub SVI Floating SVI

Layer 2: Port Direct Port Channel

Nodes

Node ID	Router ID	Loopback Address	
leaf2 (Node-102)	2.2.2.2		+ Hide Interfaces
Interface	IP Address	MTU (bytes)	
eth1/11	172.16.1.1/30 address/mask	inherit	+ -
Interface	IP Address	MTU (bytes)	
eth1/12	172.16.2.1/30 address/mask	inherit	+ -

Node ID	Router ID	Loopback Address	
leaf3 (Node-103)	3.3.3.3		+ Hide Interfaces
Interface	IP Address	MTU (bytes)	
eth1/11	172.16.3.1/30 address/mask	inherit	+ -
Interface	IP Address	MTU (bytes)	
eth1/12	172.16.4.1/30 address/mask	inherit	+ -

Previous Cancel Next

- In the **Interface Types** area, in the **Layer 3** field and in the **Layer 2** field, ensure that your selections match the choices in the preceding screenshot (Routed and Port).
- In the **Nodes** area, in the **Node ID** field, from the drop-down list, choose the appropriate node ID. (leaf2 (Node 102))
- In the **Router ID** field, enter the appropriate router ID. (2.2.2.2)

The **Loopback Address** field auto populates based on the router ID value you enter. You do not require the loopback address, so delete the value and leave the field blank.

- In the **Interface** field, choose the interface ID. (eth1/11)
- In the **IP Address** field, enter the associated IP address. (172.16.1.1/30)
- In the **MTU** field, keep the default value. (inherit)
- Click the + icon next to the **MTU** field to add an additional interface for node leaf2. (Node-102)
- In the **Interface** field, choose the interface ID. (eth1/12)
- In the **IP Address** field, enter the associated IP address. (172.16.2.1/30)
- In the **MTU** field, keep the default value. (inherit)

Step 5

To add another node, click the + icon next to the **Loopback Address** field, and perform the following actions:

Note

When you click the + icon, the new **Nodes** area is displayed below the area that you had populated earlier.

- a) In the **Nodes** area, in the **Node ID** field, from the drop-down list, choose the node ID. (leaf3 (Node-103))
- b) In the **Router ID** field, enter the router ID. (3.3.3.3)

The **Loopback Address** field auto populates based on the router ID value you enter. You do not require the loopback address, so delete the value and leave the field blank.

- c) In the **Interface** field, choose the interface ID. (eth1/11)
- d) In the **IP Address** field, enter the IP address. (172.16.3.1/30)
- e) In the **MTU** field, keep the default value. (inherit)
- f) Click the + icon next to the **MTU** field to add an additional interface for node leaf3. (Node-103)
- g) In the **Interface** field, choose the interface ID. (eth1/12)
- h) In the **IP Address** field, enter the associated IP address. (172.16.4.1/30)
- i) In the **MTU** field, keep the default value. (inherit), and click **Next**.

We have specified the node, interface, and IP address for each interface.

Step 6 Click **Next** to view the **Protocols** screen.

This screen allows you to specify the OSPF interface level policy to configure hello-interval, network-type, Create L3Out

In this example, nothing is selected. Therefore, the default policy is used. The default OSPF interface profile uses **Unspecified** as network-type which defaults to broadcast network type. To optimize this with point-to-point network-type for sub-interface, see **Change the OSPF Interface Level Parameters (Optional)**.

Step 7 Click **Next**.

The **External EPG** screen is displayed with L3Out EPG details. This configuration is to classify the traffic into the EPG to apply to the contract.

Step 8 In the **External EPG** screen, perform the following actions:

Create L3Out

External EPG

The L3Out Network or External EPG is used for traffic classification, contract associations, and route control policies. Classification is matching external networks to this EPG for applying contracts. Route control policies are used for filtering dynamic routes exchanged between the ACI fabric and external devices, and leaked into other VRFs in the fabric.

Name: L3Out_EPG1

Provided Contract: select a value

Consumed Contract: common/default

Default EPG for all external networks:

Subnets

IP Address	Scope	Name	Aggregate	Route Control Profile	Route Summarization Policy
10.0.0.0/8	External Subnets for the External EPG				
172.16.0.0/21	External Subnets for the External EPG				

Previous Cancel Finish

- In the **External EPG** area, **Name** field, enter a name for the external EPG. (L3Out_EPG1)
- In the **Provided Contract** field, do not choose a value.

In this example, there is no provided contract for L3Out_EPG1 because a normal EPG (EPG1) is the provider.

- In the **Consumed Contract** field, choose **default** from the drop-down list.

Step 9 In the **Default EPG for all external networks** field, uncheck the checkbox, and perform the following actions:

- Click the + icon in the **Subnets** area, to display the **Create Subnet** dialog box.
- In the **IP Address** field, enter the subnet. (10.0.0.0/8)
- In the **External EPG Classification** field, check the checkbox for **External Subnets for the External EPG**. Click **OK**.

Step 10 Click the + icon in the **Subnets** area once more to display the **Create Subnet** dialog box, and perform the following actions:**Note**

Although this is an optional configuration, it is a best practice to specify the L3Out interface subnets in case endpoints have to communicate with those IPs.

- In the **IP Address** field, enter the subnet. (172.16.0.0/21)
This subnet covers all the interfaces in the L3Out. This can be each individual subnet for each routed interface instead.
- In the **External EPG Classification** field, check the checkbox for **External Subnets for the External EPG**. Click **OK**.
- Click **Finish**.

The L3Out OSPF is now deployed.

Review - Create Example L3Out Using the Create L3Out Wizard

Review how the configuration using the wizard is presented in the Cisco APIC GUI, and verify that the configurations are accurate.

Procedure

Step 1 Navigate to your **Tenant_name** > **Networking** > **L3Outs** > **EXAMPLE_L3Out1**, in the **Work** pane, scroll to view the details as follows:

At this location in the GUI, verify the main L3Out parameters such as VRF, domain, and OSPF parameters that are configured in the **Identity** screen in the **Create L3Out** wizard.

The screenshot displays the configuration for the L3Out **EXAMPLE_L3Out1**. The configuration is as follows:

- VRF:** VRF1
- Resolved VRF:** Example/VRF1
- L3 Domain:** EXAMPLE_L3_DOM
- Route Profile for Interleak:** select a value
- Enable BGP/EIGRP/OSPF:** BGP (unchecked), OSPF (checked), EIGRP (unchecked)
- OSPF Area ID:** 0
- OSPF Area Control:** Send redistributed LSAs into NSSA area (checked), Originate summary LSA (checked), Suppress forwarding address in translated LSA (unchecked)
- OSPF Area Type:** NSSA area (selected), Regular area, Stub area
- OSPF Area Cost:** 1

The **Nodes** table is as follows:

Node ID	Router ID	Loopback Address
topology/pod-1/node-102	2.2.2.2	
topology/pod-1/node-103	3.3.3.3	

The **Routed Interfaces** table is as follows:

Path	IP Address	Secondary IP Address	MAC Address	MTU (bytes)
Pod-1/Node-102/eth1/11	172.16.1.1/30		00:22:BD:FB:19:FF	inherit
Pod-1/Node-102/eth1/12	172.16.2.1/30		00:22:BD:FB:19:FF	inherit
Pod-1/Node-103/eth1/11	172.16.3.1/30		00:22:BD:FB:19:FF	inherit
Pod-1/Node-103/eth1/12	172.16.4.1/30		00:22:BD:FB:19:FF	inherit

Step 2 Verify that OSPF is enabled with the specified parameters such as Area ID and Area Type.

Step 3 Under **Logical Node Profiles**, *EXAMPLE_L3Out1_nodeProfile* is created to specify border leaf switches with their router IDs.

Step 4 Under **Logical Interface Profile**, *EXAMPLE_L3Out1_interfaceProfile* is created.

Verify the interface parameters such as interface ID, IP addresses, in this example, as routed interfaces. The default MAC addresses gets auto populated. OSPF interface profile is also created under this for OSPF interface level parameters.

The review is complete.

Configure Advertise the BD Subnet with a Route Map

In this example, a route map, **default-export**, is used with the IP prefix list to advertise the BD subnet.



Note This **default-export** route map will be applied to the L3Out (EXAMPLE_L3Out1) without being associated to anything specific.

Procedure

- Step 1** To enable a BD subnet to be advertised, navigate to **Tenant > Networks > Bridge Domains > BD1 > Subnets > 192.168.1.254/24**, and select **Advertised Externally** scope.

The screenshot displays the Cisco APIC configuration interface. On the left, a navigation tree shows the path: Tenant > Networks > Bridge Domains > BD1 > Subnets > 192.168.1.254/24. The right pane shows the configuration for this subnet, with the 'Policy' tab selected. The 'Properties' section includes fields for IP Address (192.168.1.254/24) and Description (optional). Under the 'Scope' section, the 'Advertised Externally' checkbox is checked, while other options like 'Private to VRF' and 'Shared between VRFs' are unchecked. The 'Subnet Control' section has 'No Default SVI Gateway' and 'Querier IP' unchecked. At the bottom, there are 'Show Usage', 'Reset', and 'Submit' buttons.

- Step 2** To create a route map under your L3Out (EXAMPLE_L3Out1), navigate to **Route map for import and export route control**.

The screenshot illustrates the configuration process in the Cisco APIC. On the left, a navigation tree shows the path: Example > Networking > L3Outs > EXAMPLE_L3Out1 > Route map for import and export route control > default-export. Three callout boxes provide details:

- Top Callout:** Shows the 'default-export' route map configuration. The 'Name' is 'default-export', the 'Type' is 'Match Prefix AND Routing Policy', and the 'Action' is 'Match Routing Policy Only'. A table below shows a context with Order 0, Name 'BD_Subnets', and Action 'Permit'.
- Middle Callout:** Shows the configuration for the 'BD_Subnets' context. The 'Order' is 0, 'Name' is 'BD_Subnets', and the 'Action' is 'Permit'. The 'Match Rule' is 'BD1_prefix'.
- Bottom Callout:** Shows the 'Match Prefix' table with the following data:

IP	Description	Aggregate
192.168.1.0/24		False

Step 3 Right-click and choose **Create Route map for import and export route control**.

Step 4 In the **Create Route map for import and export route control** dialog box, in the **Name** field, choose **default-export**.

Step 5 In the **Type** field, choose **Matching Route Policy Only**.

Note

Match Routing Policy Only: By choosing this **Type** with default-export route map, all route advertisement configuration is performed by this route map. BD associations and export route control subnets configured under the external EPG will not apply. You should configure all match rules within this route-map for all routes that will be advertised from this L3Out.

Match Prefix and Routing Policy: By choosing this **Type** with default-export route map, route advertisement is matched by any match rules configured in this route map **in addition to** any BD to L3Out associations and export route control subnets defined under the External EPG.

When using a route profile, it is recommended to use **Match Routing Policy Only** for a simpler configuration that is easier to maintain.

Step 6 In the **Contexts** area, click the + icon, to display the **Create Route Control Context** dialog box, and perform the following actions:

- In the **Order** field, configure the order. (0)
In this example, we have only one order.
- In the **Name** field, enter a name for the context. (BD_Subnets)
- In the **Action** field, choose **Permit**.

This enables the route map to permit the prefix we will configure.

In this example, we require the match rule that requires the IP prefix list, **BD1_prefix**. This IP prefix list points to the BD subnet advertised.

- Step 7** In the **Match Rule** field, create the IP prefix-list by performing the following actions;
- Choose **Create Match Rule for a Route-Map**.
 - In the **Name** field, enter a name *BD1_prefix*.
 - In the **Match Prefix** area, click the + icon, and enter the BD subnet (192.168.1.0/24).

Verify the Contract

In this task, you verify the contract to enable communication between an endpoint (192.168.1.1) and external prefixes (10.0.0.0/8, and optionally 172.16.0.0/21). In this example, the EPG for the endpoint is EPG1 and the external EPG for external prefixes is L3Out_EPG1.

The required configuration should already be present from the **Create L3Out** wizard.

Procedure

- Step 1** Under your L3Out, navigate to **External EPGs > L3Out_EPG1**.

Name	Tenant	Type	QoS Class	State
default	common	Contract	Unspecified	formed

- Step 2** In the **Work** pane, in the **External EPG Instance Profile** area, under **Policy > General** sub-tab, look at the Properties and verify that the two subnets are displayed with **External Subnets for the External EPG**.
- Step 3** Next, click the **Contracts** sub-tab and verify the contract you specified earlier is consumed correctly. In case you want to add more contracts, you can perform the actions from this location in GUI.
- Step 4** Navigate to **Application Profile > Application EPGs > EPG1 > Contracts**, and verify that EPG1 is providing the appropriate contract.

Change the OSPF Interface Level Parameters (Optional)

If you wish to change the OSPF interface-level parameters, such as **Hello Interval**, **OSPF network type**, then you can configure it in the OSPF Interface Profile. The node level OSPF parameters are already configured.

Procedure

- Step 1** Under your L3Out, navigate to **Logical Interface Profile > EXAMPLE_L3Out1_interfaceProfile > OSPF Interface Profile**.

The screenshot shows the Cisco APIC GUI navigation tree on the left. The path is: Example > L3Outs > EXAMPLE_L3Out1 > Logical Interface Profiles > EXAMPLE_L3Out1_interfaceProfile > OSPF Interface Profile. The 'OSPF Interface Profile' item is highlighted with a red box. An arrow points from this box to the configuration page on the right.

The configuration page on the right shows the following fields and options:

- Name: [text input]
- Description: optional
- Authentication Key: [password input]
- Confirm Authentication Key: [password input]
- Authentication Key ID: 1
- Authentication Type: MD5 authentication (selected), No authentication, Simple authentication
- Associated OSPF Interface Policy Name: point-to-point
- Network Type: Broadcast, Point-to-point (selected), Unspecified
- Priority: 1
- Cost of Interface: unspecified
- Interface Controls:
 - Advertise subnet
 - BFD
 - MTU ignore
 - Passive participation
- Hello Interval (sec): 10
- Dead Interval (sec): 40
- Retransmit Interval (sec): 5
- Transmit Delay (sec): 1

- Step 2** In the **Work** pane, in the **Properties** area, choose the OSPF Interface Policy you wish to use.

This modifies your OSPF interface level parameters.

Advertise Host Routes

Enabling Advertise Host Routes on the BD, individual host-routes (/32 and /128 prefixes) are advertised from the Border-Leaf switches (BL). The BD must be associated to the L3out or an explicit prefix list matching the host routes. The host routes must be configured to advertise host routes out of the fabric.

Border-Leaf switches along with the subnet advertise the individual end-point(EP) prefixes. The route information is advertised only if the host is connected to the local POD. If the EP is moved away from the local POD or once the EP is removed from EP database (even if the EP is attached to a remote leaf), the route advertisement is then withdrawn.

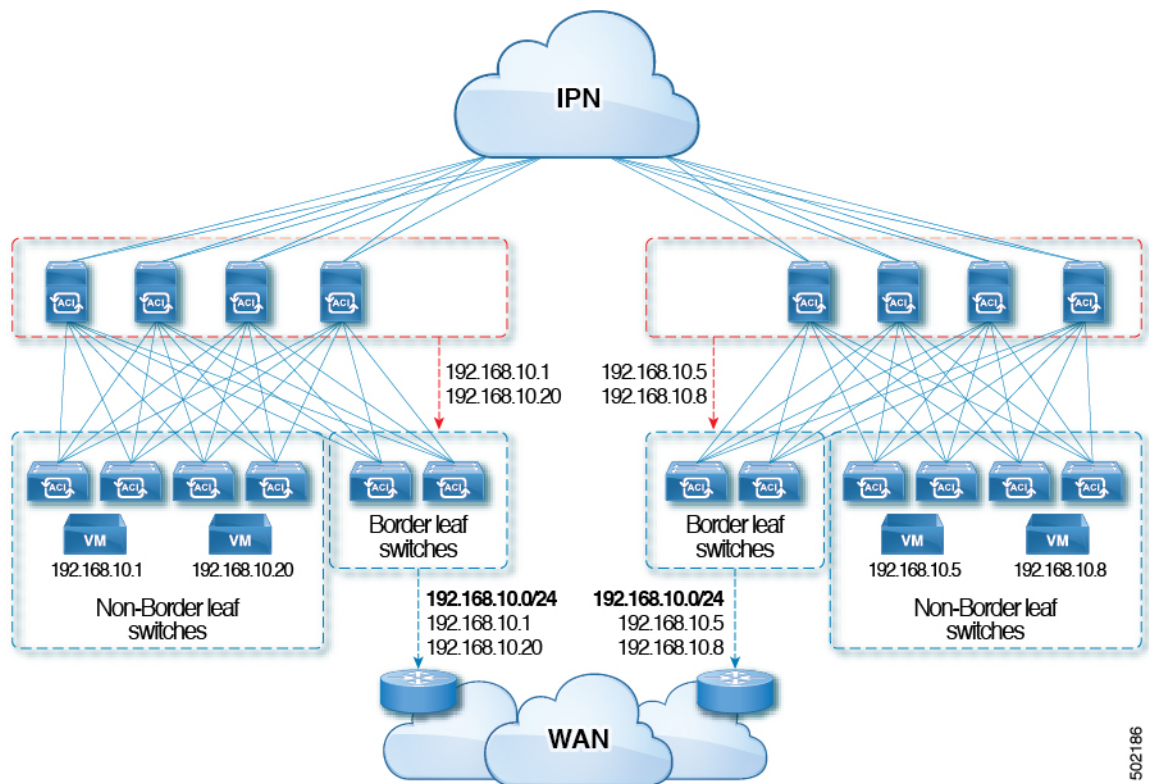

502186

Advertise Host Route configuration guidelines and limitations are:

- When host routes are advertised, the VRF Transit Route Tag is set in order to prevent them from being advertised back into the fabric and installed. In order for this loop protection to work properly, external routers must preserve this route-tag if advertising to another L3Out.
- If a bridge domain is tied to an EPG that has the same subnet configured for internal leaking, you must also enable the "Advertised Externally" flag on the EPG subnet.
- The Advertise Host Routes feature is supported on Generation 2 switches or later (Cisco Nexus N9K switches with "EX", "FX", or "FX2" on the end of the switch model name or later; for example, N9K-93108TC-EX).
- Host route advertisement supports both BD to L3out Association and the explicit route map configurations. We recommend using explicit route map configuration which allows you greater control in selecting individual or a range of host routes to configure.

- EPs/Host routes in SITE-1 will not be advertised out through Border Leafs in other SITES.
- When EPs is aged out or removed from the database, Host routes are withdrawn from the Border Leaf.
- When EP is moved across SITES or PODs, Host routes should be withdrawn from first SITE/POD and advertised in new POD/SITE.
- EPs learned on a specific BD, under any of the BD subnets are advertised from the L3out on the border leaf in the same POD.
- EPs are advertised out as Host Routes only in the local POD through the Border Leaf.
- Host routes are not advertised out from one POD to another POD.
- In the case of Remote Leaf, if EPs are locally learned in the Remote Leaf, they are then advertised only through a L3out deployed in Remote Leaf switches in same POD.
- EPs/Host routes in a Remote Leaf are not advertised out through Border Leaf switches in main POD or another POD.
- EPs/Host routes in the main POD are not advertised through L3out in Remote Leaf switches of same POD or another POD.
- The BD subnet must have the **Advertise Externally** option enabled.
- The BD must be associated to an L3out or the L3out must have explicit route-map configured matching BD subnets.
- There must be a contract between the EPG in the specified BD and the External EPG for the L3out.



Note If there is no contract between the BD/EPG and the External EPG the BD subnet and host routes will not be installed on the border leaf.

- Advertise Host Route is supported for shared services. For example: epg1/BD1 deployed is in VRF-1 and L3out in another VRF-2. By providing shared contract between EPG and L3out host routes are pulled from one VRF-1 to another VRF-2.
- When Advertise Host Route is enabled on BD custom tag cannot be set on BD Subnet using route-map.
- When Advertise Host Route is enabled on a BD and the BD is associated with an L3Out, BD subnet is marked public. If there's a rogue EP present under the BD, that EP is advertised out on L3Out.

Configuring Route Reflectors

ACI fabric route reflectors use multiprotocol BGP (MP-BGP) to distribute external routes within the fabric. To enable route reflectors in the ACI fabric, the fabric administrator must select the spine switches that will be the route reflectors, and provide the autonomous system (AS) number. It is recommended to configure at least two spine nodes per pod as MP-BGP route reflectors for redundancy.

After route reflectors are enabled in the ACI fabric, administrators can configure connectivity to external networks through leaf nodes using a component called Layer 3 Out (L3Out). A leaf node configured with an L3Out is called a border leaf. The border leaf exchanges routes with a connected external device via a routing protocol specified in the L3Out. You can also configure static routes via L3Outs.

After both L3Outs and spine route reflectors are deployed, border leaf nodes learn external routes via L3Outs, and those external routes are distributed to all leaf nodes in the fabric via spine MP-BGP route reflectors.

Check the *Verified Scalability Guide for Cisco APIC* for your release to find the maximum number of routes supported by a leaf.

Configuring an MP-BGP Route Reflector Using the GUI

Procedure

-
- Step 1** On the menu bar, choose **System > System Settings**.
- Step 2** In the **Navigation** pane, right-click **BGP Route Reflector**, and click **Create Route Reflector Node**.
- Step 3** In the **Create Route Reflector Node** dialog box, from the **Spine Node** drop-down list, choose the appropriate spine node. Click **Submit**.
- Note**
Repeat the above steps to add additional spine nodes as required.
- The spine switch is marked as the route reflector node.
- Step 4** In the **BGP Route Reflector** properties area, in the **Autonomous System Number** field, choose the appropriate number. Click **Submit**.
- Note**
The autonomous system number must match the leaf connected router configuration if Border Gateway Protocol (BGP) is configured on the router. If you are using routes learned using static or Open Shortest Path First (OSPF), the autonomous system number value can be any valid value.
- Step 5** On the menu bar, choose **Fabric > Fabric Policies > Pods > Policy Groups**.
- Step 6** In the **Navigation** pane, expand and right-click **Policy Groups**, and click **Create Pod Policy Group**.
- Step 7** In the **Create Pod Policy Group** dialog box, in the **Name** field, enter the name of a pod policy group.
- Step 8** In the **BGP Route Reflector Policy** drop-down list, choose the appropriate policy (default). Click **Submit**. The BGP route reflector policy is associated with the route reflector pod policy group, and the BGP process is enabled on the leaf switches.
- Step 9** On the menu bar, choose **Fabric > Fabric Policies > Profiles > Pod Profile default > default**.
- Step 10** In the **Work** pane, from the **Fabric Policy Group** drop-down list, choose the pod policy that was created earlier. Click **Submit**.
The pod policy group is now applied to the fabric policy group.
-

Verifying the MP-BGP Route Reflector Configuration

Procedure

-
- Step 1** Verify the configuration by performing the following actions:

- a) Use secure shell (SSH) to log in as an administrator to each leaf switch as required.
- b) Enter the **show processes | grep bgp** command to verify the state is S.
If the state is NR (not running), the configuration was not successful.

Step 2 Verify that the autonomous system number is configured in the spine switches by performing the following actions:

- a) Use the SSH to log in as an administrator to each spine switch as required.
- b) Execute the following commands from the shell window

Example:

```
cd /mit/sys/bgp/inst
```

Example:

```
grep asn summary
```

The configured autonomous system number must be displayed. If the autonomous system number value displays as 0, the configuration was not successful.



CHAPTER 18

Node and Interface for L3Out

- [Modifying Interfaces for L3Out, on page 241](#)
- [Customizing SVI for L3Out, on page 243](#)
- [About Cisco Floating L3Outs, on page 253](#)

Modifying Interfaces for L3Out

Modifying Interfaces for L3Out Using the GUI

This procedure modifies an L3Out interface.



Note The steps for filling out the fields are not necessarily listed in the same order that you see them in the GUI.

Before you begin

- The Cisco ACI fabric is installed, the Cisco APICs are online, and the Cisco APIC cluster is formed and healthy.
- A Cisco APIC fabric administrator account is available that enables creating the necessary fabric infrastructure configurations.
- The target leaf switches are registered in the Cisco ACI fabric and available.
- Port channels are configured when port channels are used for L3Out interfaces.

Procedure

- Step 1** On the menu bar, choose **Tenants > All Tenants**.
- Step 2** In the Work pane, double click the tenant's name.
- Step 3** In the Navigation pane, expand **tenant_name > Networking > L3Outs > L3Out > Logical Node Profiles > node_profile > Logical Interface Profiles** and choose the profile that you want to modify.
- Step 4** Choose an interface type tab: **Routed Sub-Interfaces**, **Routed Interfaces**, **SVI**, or **Floating SVI**.

- Step 5** Double click an existing interface to modify it, or click the **Create (+)** button to add a new interface to the logical interface profile.
- Step 6** For interface types other than floating SVI, perform the following substeps:
- To add a new interface in the **Path Type** field, choose the appropriate path type.
For the routed sub-interface and routed interface interface types, choose **Port** or **Direct Port Channel**.
For the SVI interface type, choose **Port**, **Direct Port Channel**, or **Virtual Port Channel**.
 - In the **Node** drop-down list, choose a node.
Note
This is applicable only for the non-port channel path types. If you selected **Path Type** as **Port**, then perform this step. Otherwise, proceed to the next step.
 - In the **Path** drop-down list, choose the interface ID or the port channel name.
An example of an interface ID is eth 1/1. The port channel name is the interface policy group name for each direct or virtual port channel.
- Step 7** For the floating SVI interface type, in the **Anchor Node** drop-down list, choose a node.
- Step 8** (Optional) In the **Description** field, enter a description of the L3Out interface.
- Step 9** For the routed sub-interfaces, SVI, and floating SVI interface types, in the **Encap** drop-down list, choose **VLAN** and enter an integer value for this entry.
- Step 10** For the SVI and floating SVI interface types, perform the following substeps:
- For the **Encap Scope** buttons, choose the scope of the encapsulation used for the Layer 3 Outside profile.
 - VRF**: Use the same transit VLAN in all Layer 3 Outsides in the same VRF instance for a given VLAN encapsulation. This is a global value.
 - Local**: Use a unique transit VLAN per Layer 3 Outside.
 - For the **Auto State** buttons, choose whether to enable or disable this feature.
 - disabled**: The SVI or floating SVI remains active even if no interfaces are operational in the corresponding VLANs.
 - enabled**: When a VLAN interface has multiple ports in the VLAN, the SVI or floating SVI goes to the down state when all the ports in the VLAN go down.
 - For the **Mode** buttons, choose the VLAN tagging mode.
- Step 11** In the **IPv4 Primary / IPv6 Preferred Address** field, enter the primary IP addresses of the path attached to the Layer 3 outside profile.
- Step 12** In the **IPv4 Secondary / IPv6 Additional Addresses** table, click the + to enter the secondary IP addresses of the path attached to the Layer 3 outside profile.
- Step 13** (Optional) In the **Link-local Address** field, enter an IPv6 link-local address. This is the override of the system-generated IPv6 link-local address.
- Step 14** In the **MAC Address** field, enter the MAC address of the path attached to the Layer 3 outside profile.
- Step 15** In the **MTU (bytes)** field, set the maximum transmit unit of the external network. The range is 576 to 9216. To inherit the value, enter *inherit* in the field.
- Step 16** In the **Target DSCP** drop-down list, choose the target differentiated services code point (DSCP) of the path attached to the Layer 3 outside profile.

Step 17 Click **Submit**.

Customizing SVI for L3Out

SVI External Encapsulation Scope

About SVI External Encapsulation Scope

In the context of a Layer 3 Out configuration, a switch virtual interfaces (SVI), is configured to provide connectivity between the ACI leaf switch and a router.

By default, when a single Layer 3 Out is configured with SVI interfaces, the VLAN encapsulation spans multiple nodes within the fabric. This happens because the ACI fabric configures the same bridge domain (VXLAN VNI) across all the nodes in the fabric where the Layer 3 Out SVI is deployed as long as all SVI interfaces use the same external encapsulation (SVI) as shown in the figure.

However, when different Layer 3 Outs are deployed, the ACI fabric uses different bridge domains even if they use the same external encapsulation (SVI) as shown in the figure:

Figure 33: Local Scope Encapsulation and One Layer 3 Out

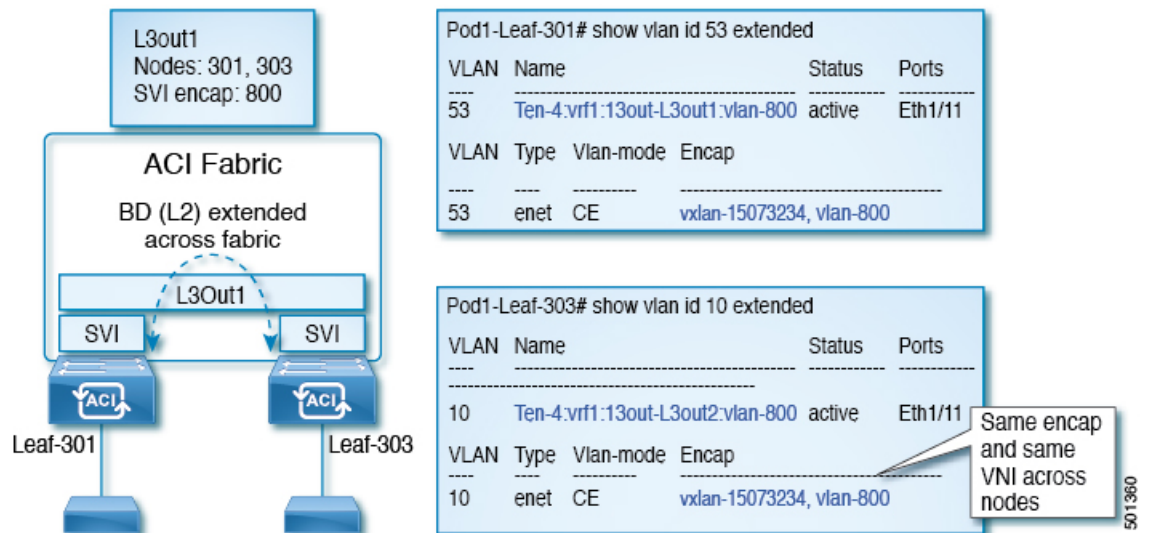
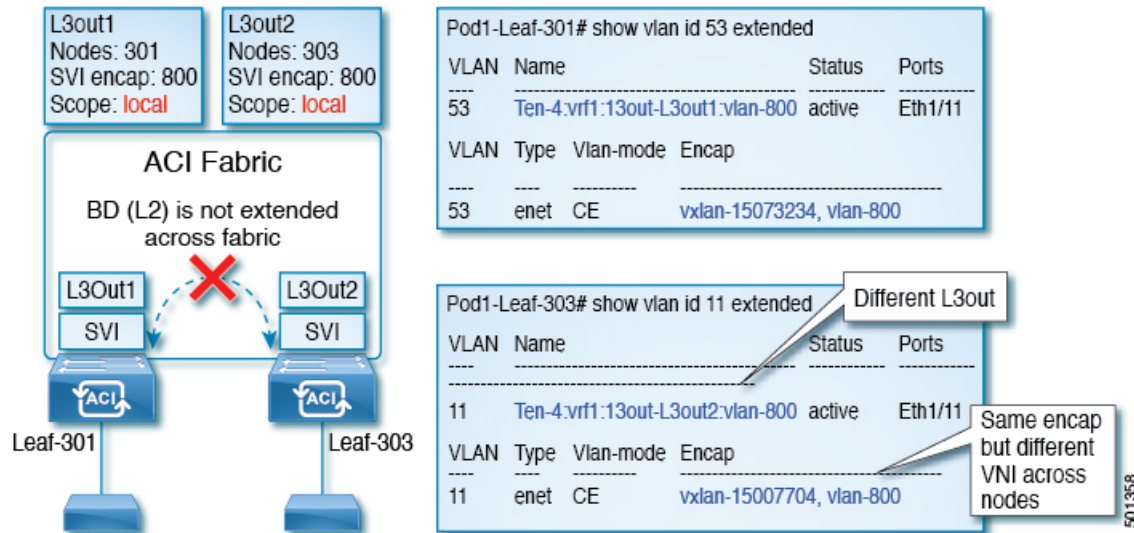

Figure 34: Local Scope Encapsulation and Two Layer 3 Outs



Starting with Cisco APIC release 2.3, it is now possible to choose the behavior when deploying two (or more) Layer 3 Outs using the same external encapsulation (SVI).

The encapsulation scope can now be configured as Local or VRF:

- Local scope (default): The example behavior is displayed in the figure titled *Local Scope Encapsulation and Two Layer 3 Outs*.
- VRF scope: The ACI fabric configures the same bridge domain (VXLAN VNI) across all the nodes and Layer 3 Out where the same external encapsulation (SVI) is deployed. See the example in the figure titled *VRF Scope Encapsulation and Two Layer 3 Outs*.

Figure 35: VRF Scope Encapsulation and Two Layer 3 Outs

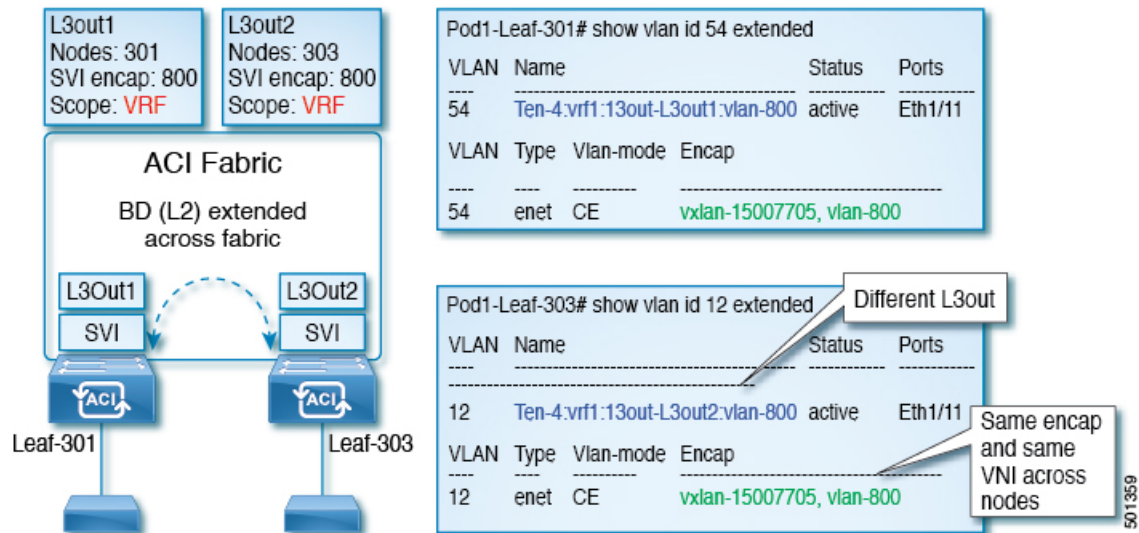

Encapsulation Scope Syntax

The options for configuring the scope of the encapsulation used for the Layer 3 Out profile are as follows:

- **Ctx**—The same external SVI in all Layer 3 Outs in the same VRF for a given VLAN encapsulation. This is a global value.
- **Local**—A unique external SVI per Layer 3 Out. This is the default value.

The mapping among the CLI, API, and GUI syntax is as follows:

Table 8: Encapsulation Scope Syntax

CLI	API	GUI
l3out	local	Local
vrf	ctx	VRF



Note The CLI commands to configure encapsulation scope are only supported when the VRF is configured through a named Layer 3 Out configuration.

Guidelines for SVI External Encapsulation Scope

To use SVI external encapsulation scope, follow these guidelines:

- If deploying the Layer 3 Outs on the same node, the OSPF areas in both the Layer 3 Outs must be different.
- If deploying the Layer 3 Outs on the same node, the BGP peer configured on both the Layer 3 Outs must be different.

Configuring SVI External Encapsulation Scope Using the GUI

Before you begin

- The tenant and VRF configured.
- An L3Out is configured and a logical node profile under the L3Out is configured.

Procedure

- Step 1** On the menu bar, click **> Tenants > Tenant_name**.
- Step 2** In the **Navigation** pane, click **Networking > L3Outs > L3Out_name > Logical Node Profiles > LogicalNodeProfile_name > Logical Interface Profiles**.
- Step 3** In the **Navigation** pane, right-click **Logical Interface Profiles**, and click **Create Interface Profile**.
- Step 4** In the **Create Interface Profile** dialog box, perform the following actions:
 - a) In the **Step 1 Identity** screen, in the **Name** field, enter a name for the interface profile.

- b) In the remaining fields, choose the desired options, and click **Next**.
- c) In the **Step 2 Protocol Profiles** screen, choose the desired protocol profile details, and click **Next**.
- d) In the **Step 3 Interfaces** screen, click the **SVI** tab, and click the + icon to open the **Select SVI** dialog box.
- e) In the **Specify Interface** area, choose the desired values for the various fields.
- f) In the **Encap Scope** field, choose the desired encapsulation scope value. Click **OK**.

The default value is **Local**.

The SVI External encapsulation scope is configured in the specified interface.

Support for Multiple Encapsulation for L3Outs With SVI

When an L3Out is configured with SVI interfaces on different leaf switches using the same encapsulation VLAN, the SVI VLAN will be mapped to the same VXLAN network identifier (VNID). This forms a single bridge domain (external bridge domain) and broadcast domain across the fabric. An SVI interface configured with a different VLAN will form a separate external bridge domain as illustrated in the diagram below. Prior to release 5.2(3) it was not possible to create a single external bridge domain with different encapsulation VLANs on different switches.

Figure 36: Separate VNID Associated to External Bridge Domains with Different Encapsulation (pre-ACI 5.2(3) Releases).

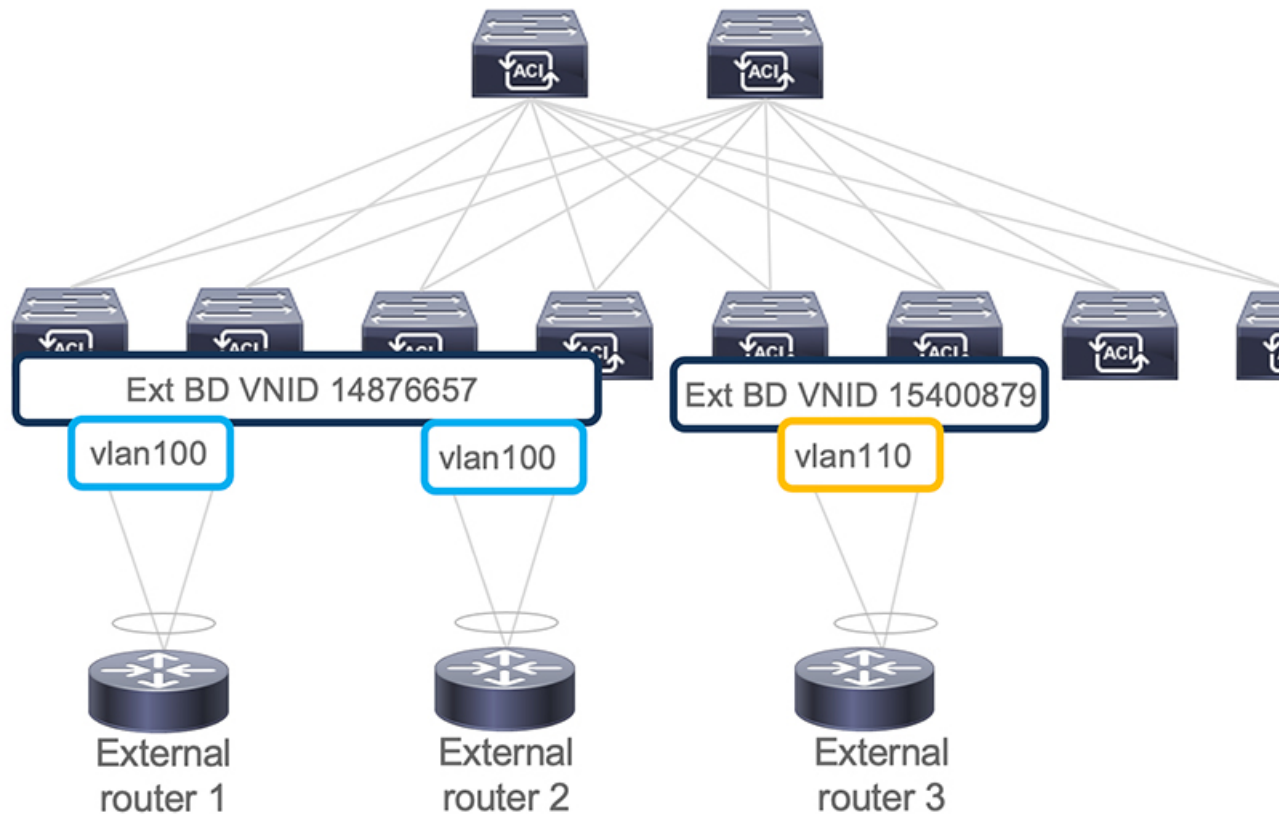

Release 5.2(3) added support for configuring a single external bridge that can be configured with different encapsulation VLANs on different leaf switches. The multiple encapsulation support feature uses the floating

SVI object to define the external bridge domain for floating L3Outs or an external bridge group profile for defining the external bridge domain for regular L3Outs. The use case for this feature may be where the same VLAN cannot be used on different leaf switches because it may already be in use.

Figure 37: Single VNID Associated to External Bridge Domains with Different Encapsulation (post-ACI 5.2(3) Releases).

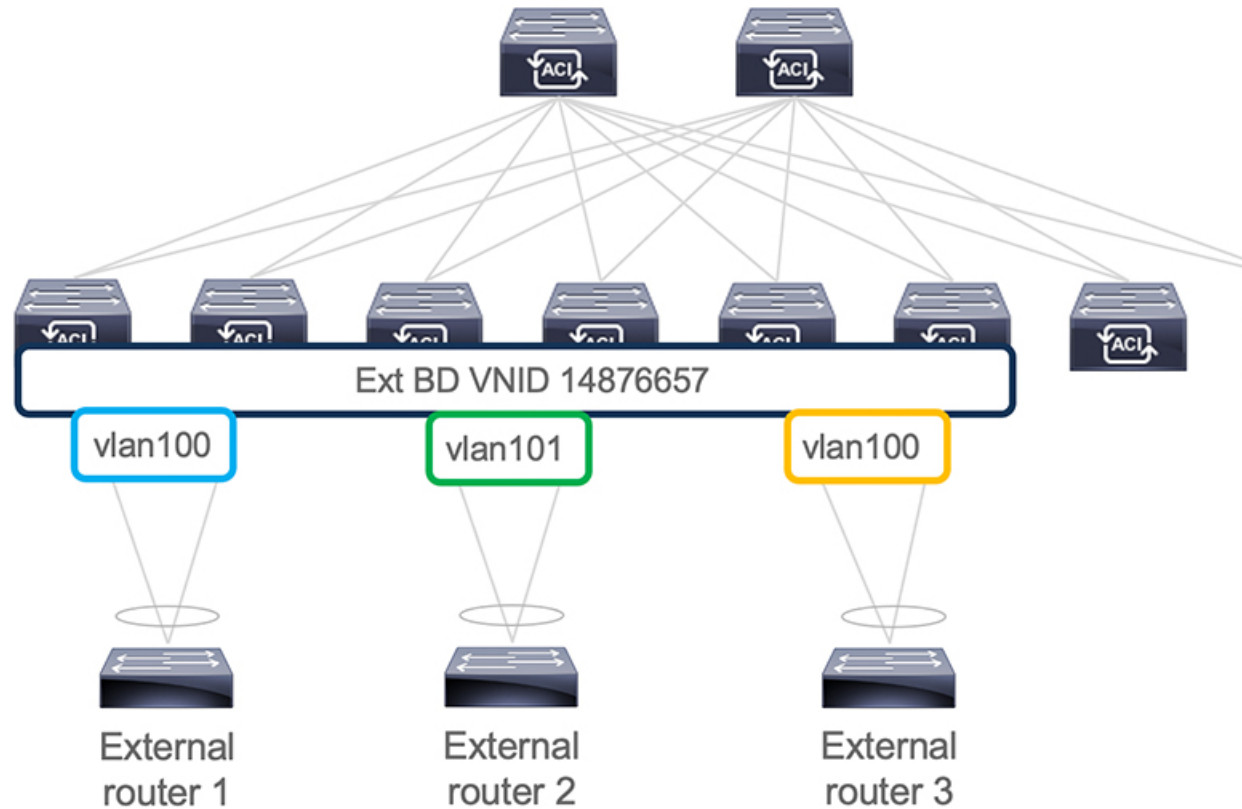

As of ACI release 6.0(1), this feature is supported for physical domain L3Outs only, not for VMM domain L3Outs.

Grouping Multiple SVIs With Different Access Encapsulation

The following figure shows a configuration where multiple SVIs are grouped together with different access encapsulation.

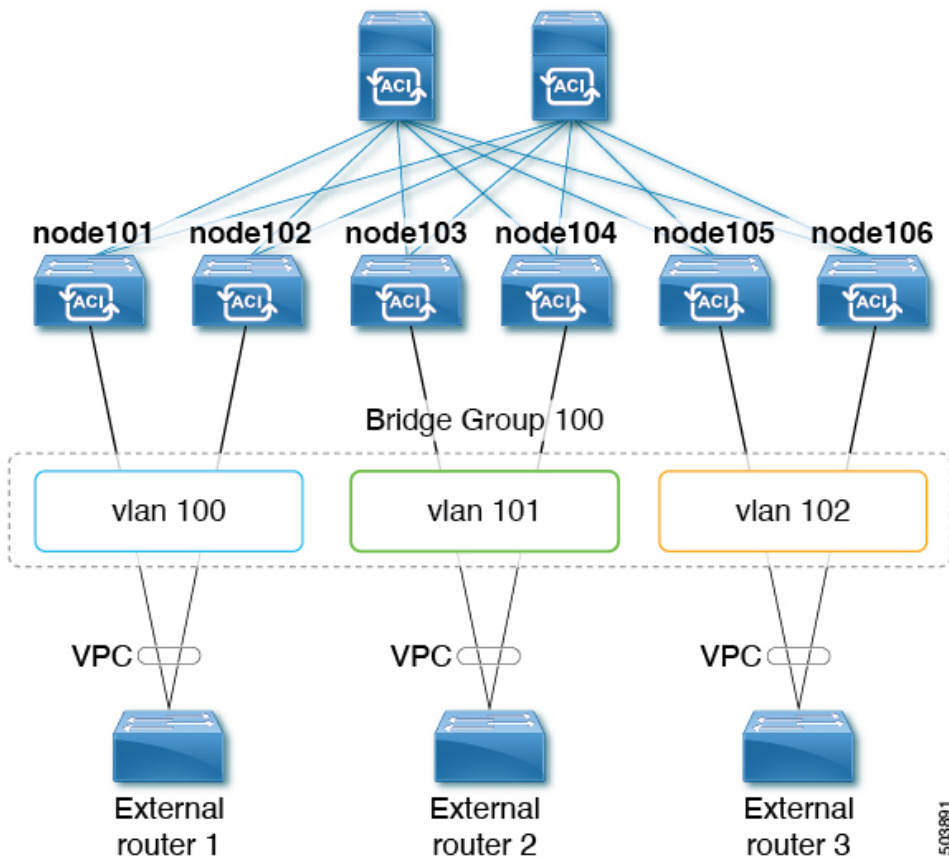

For this use case:

- The following leaf switches are VPC pairs:
 - node101 and node102
 - node103 and node104
 - node105 and node106

To configure the use case shown above, where you are grouping multiple SVIs into a Layer 2 bridge group:

1. Create three regular SVIs for each VPC pair:
 - Create the regular SVI **svi-100** on leaf switches node101 and node102
 - Create the regular SVI **svi-101** on leaf switches node103 and node104
 - Create the regular SVI **svi-102** on leaf switches node105 and node106
2. Configure the leaf switches with access encapsulations:
 - Configure leaf switches node101 and node102 with access encapsulation **vlan100**
 - Configure leaf switches node103 and node104 with access encapsulation **vlan101**
 - Configure leaf switches node105 and node106 with access encapsulation **vlan102**

3. Group the regular SVIs **svi-100**, **svi-101**, and **svi-102** together to behave as part of a single Layer 2 broadcast domain:
 - a. Create a bridge domain profile.
The bridge domain profile is represented by the new MO *l3extBdProfile*
 - b. Provide a unique name string for the bridge domain profile.
 - c. Associate each of the regular SVIs that need to be grouped together to the same bridge domain profile.
Two new MOs are available for this association: *l3extBdProfileCont* and *l3extRsBdProfile*.

Guidelines and Limitations

- Layer 2 loops are blocked by the external device/hypervisor. Loops may occur if this feature is used with external switches that rely on spanning tree protocol to prevent loops.
- The SVI will be deleted and re-added after configuring the external bridge domain profile on them.
- The external bridge domain profile is L3Out-scoped. On a node, you cannot have two different access encapsulation mappings to the same external bridge domain profile.
- Bridge domain grouping is not supported with encapsulation scope **ctx** (the **VRF** option in the APIC GUI).
- Grouped SVIs with different line encapsulation can not share any common nodes.
- If you downgrade from release 5.2(3) to a previous release where multiple encapsulation for L3Outs with SVI is not supported, the following actions will be performed on the L3Out that was configured with multiple encapsulations and/or the external bridge domain profile:
 - The new allocator used for the multiple encapsulation support (*l3extBdProfileEncapAllocator*) will be deleted
 - All external bridge domain profiles (new *l3extBdProfile* MOs) will be deleted
 - All new *l3extBdProfileCont* MOs will be deleted
 - All new *l3extRsBdProfile* MOs will be deleted

Configuring Multiple Encapsulation for L3Outs With SVI Using the GUI

Procedure

-
- Step 1** Create the regular SVIs and configure the leaf switches with access encapsulations.
See [Configuring SVI External Encapsulation Scope Using the GUI, on page 245](#) for those procedures.
 - Step 2** Create an external bridge group profile that will be used for SVI grouping.
 - a) Navigate to **Tenants > tenant-name > Policies > Protocol > External Bridge Group Profiles**.
A page showing the already-configured external bridge group profiles is displayed.
 - b) Right-click on **External Bridge Group Profiles** and choose **Create External Bridge Group Profile**.

The **Create External Bridge Group Profile** page is displayed.

- c) Enter a name for the external bridge group profile, then click **Submit**.
The page showing the already-configured external bridge group profiles is updated with the new external bridge group profile.

Step 3 Associate a regular SVI with the bridge domain profile.

- a) Navigate to **Tenants > tenant-name > Networking > L3Outs > L3Out-name > Logical Node Profile > log-node-profile-name > Logical Interface Profile > log-int-profile-name**.
The **General** page for this logical interface profile is displayed.
- b) Click on the **SVI** tab.
A page showing the already-configured switch virtual interfaces is displayed.
- c) Double-click on the switch virtual interface that you want to associate with the external bridge domain profile.
General information for this switch virtual interface is displayed.
- d) In the **External Bridge Group Profile** field, select the external bridge domain profile that you want to associate with this switch virtual interface.
- e) Click **Submit**.

Configuring Multiple Encapsulation for L3Outs With SVI Using the CLI

Procedure

Step 1 Create the regular SVIs and configure the leaf switches with access encapsulations.

See [Configuring SVI Interface Encapsulation Scope Using NX-OS Style CLI, on page 442](#) for those procedures.

Step 2 Log into your APIC through the CLI, then go into configuration mode and tenant configuration mode.

```
apic1#
apic1# configuration
apic1(config)# tenant <tenant-name>
apic1(config-tenant)#
```

Step 3 Enter the following commands to create an external bridge profile that will be used for SVI grouping.

```
apic1(config-tenant)# external-bridge-profile <bridge-profile-name>
apic1(config-tenant-external-bridge-profile)# ?
```

Step 4 Enter the following commands to associate a regular SVI with the bridge domain profile.

```
apic1(config)# leaf <leaf-ID>
apic1(config-leaf)# interface vlan <vlan-num>
apic1(config-leaf-if)# vrf member tenant <tenant-name> vrf <VRF-name>
apic1(config-leaf-if)# ip address <IP-address>
apic1(config-leaf-if)# external-bridge-profile <bridge-profile-name>
```

Configuring Multiple Encapsulation for L3Outs With SVI Using the REST API

Procedure

Step 1 Create the regular SVIs and configure the leaf switches with access encapsulations.
See [Configuring SVI Interface Encapsulation Scope Using the REST API, on page 522](#) for those procedures.

Step 2 Enter a post such as the following example to create an external bridge profile that will be used for SVI grouping.

```
<fvTenant name="t1" dn="uni/tn-t1" >
  <l3extBdProfile name="bd100" status=""/>
</fvTenant>
```

Step 3 Enter a post such as the following example to associate a regular SVI with the bridge domain profile.

```
<fvTenant name="t1">
  <l3extOut name="l1">
    <l3extLNodeP name="n1">
      <l3extLIIfP name="i1">
        <l3extRsPathL3OutAtt encap="vlan-108"
          tDn="topology/pod-1/paths-108/pathep-[eth1/10]"
          ifInstT="ext-svi">
          <l3extBdProfileCont>
            <l3extRsBdProfile tDn="uni/tn-t1/bdprofile-bd100" status=""/
          </l3extBdProfileCont>
          </l3extRsPathL3OutAtt>
        </l3extLIIfP>
      </l3extLNodeP>
    </l3extOut>
  </fvTenant>
```

Step 4 Enter a post such as the following example to specify the separate encapsulation for floating nodes.

```
<fvTenant name="t1">
  <l3extOut name="l1">
    <l3extLNodeP name="n1">
      <l3extLIIfP name="i1">
        <l3extVirtualLIIfP addr="10.1.0.1/24"
          encap="vlan-100"
          nodeDn="topology/pod-1/node-101"
          ifInstT="ext-svi">
          <l3extRsDynPathAtt floatingAddr="10.1.0.100/24"
            encap="vlan-104"
            tDn="uni/phys-phyDom"/>
          </l3extVirtualLIIfP>
        </l3extLIIfP>
      </l3extLNodeP>
    </l3extOut>
  </fvTenant>
```

SVI Auto State

About SVI Auto State



Note This feature is available in the APIC Release 2.2(3x) release and going forward with APIC Release 3.1(1). It is not supported in APIC Release 3.0(x).

The Switch Virtual Interface (SVI) represents a logical interface between the bridging function and the routing function of a VLAN in the device. SVI can have members that are physical ports, direct port channels, or virtual port channels. The SVI logical interface is associated with VLANs, and the VLANs have port membership.

The SVI state does not depend on the members. The default auto state behavior for SVI in Cisco APIC is that it remains in the up state when the auto state value is disabled. This means that the SVI remains active even if no interfaces are operational in the corresponding VLAN/s.

If the SVI auto state value is changed to enabled, then it depends on the port members in the associated VLANs. When a VLAN interface has multiple ports in the VLAN, the SVI goes to the down state when all the ports in the VLAN go down.

Table 9: SVI Auto State

SVI Auto State	Description of SVI State
Disabled	SVI remains in the up state even if no interfaces are operational in the corresponding VLAN/s. Disabled is the default SVI auto state value.
Enabled	SVI depends on the port members in the associated VLANs. When a VLAN interface contains multiple ports, the SVI goes into the down state when all the ports in the VLAN go down.

Guidelines and Limitations for SVI Auto State Behavior

Read the following guidelines:

- When you enable or disable the auto state behavior for SVI, you configure the auto state behavior per SVI. There is no global command.

Configuring SVI Auto State Using the GUI

Before you begin

- The tenant and VRF configured.
- An L3Out is configured and a logical node profile and a logical interface profile under the L3Out is configured.

Procedure

-
- Step 1** On the menu bar, click > **Tenants** > *Tenant_name*.
- Step 2** In the **Navigation** pane, click **Networking** > **L3Outs** > *L3Out_name* > **Logical Node Profiles** > *LogicalNodeProfile_name* > **Logical Interface Profiles**.
- Step 3** In the **Navigation** pane, expand **Logical Interface Profile**, and click the appropriate logical interface profile.
- Step 4** In the **Work** pane, click the **SVI** tab, then click the + sign to display the **SVI** dialog box.
- Step 5** To add an additional SVI, in the **SVI** dialog box, perform the following actions:
- In the **Path Type** field, choose the appropriate path type.
 - In the **Path** field, from the drop-down list, choose the appropriate physical interface.
 - In the **Encap** field, choose the appropriate values.
 - In the **Auto State** field, choose the SVI in the **Work** pane, to view/change the Auto State value.

The default value is **Disabled**.

Note

To verify or change the Auto State value for an existing SVI, choose the appropriate SVI and verify or change the value.

About Cisco Floating L3Outs

Beginning with the Cisco Application Policy Infrastructure Controller (APIC) release 4.2(1), you no longer need to specify multiple Layer 3 outside network connection (L3Out) logical interface paths in a virtual environment.

The floating L3Out feature enables you to configure a L3Out without specifying logical interfaces. The feature saves you from having to configure multiple L3Out logical interfaces to maintain routing when virtual machines move from one host to another. Floating L3Out is supported for VMware vSphere Distributed Switch (VDS).

Beginning with the Cisco APIC release 5.0(1), physical domains are supported.

For more information, see the *Using Floating L3Out to Simplify Outside Network Connections* knowledge base article:

<https://www.cisco.com/c/en/us/td/docs/switches/datacenter/aci/apic/sw/kb/Cisco-ACI-Floating-L3Out.html>



CHAPTER 19

Routing Protocol Support

This chapter contains the following sections:

- [About Routing Protocol Support, on page 255](#)
- [BGP External Routed Networks with BFD Support, on page 255](#)
- [OSPF External Routed Networks, on page 287](#)
- [EIGRP External Routed Networks, on page 291](#)

About Routing Protocol Support

Routing within the Cisco ACI fabric is implemented using BGP (with BFD support) and the OSPF or EIGRP routing protocols.

IP source routing is not supported in the ACI fabric.

BGP External Routed Networks with BFD Support

The following sections provide more information on BGP external routed networks with BFD support.

Guidelines for Configuring a BGP Layer 3 Outside Network Connection

When configuring a BGP external routed network, follow these guidelines:

- The BGP direct route export behavior changed after release 3.2(1), where ACI does not evaluate the originating route type (such as static, direct, and so on) when matching export route map clauses. As a result, the "match direct" deny clause that is always included in the outbound neighbor route map no longer matches direct routes, and direct routes are now advertised based on whether or not a user-defined route map clause matches.

Therefore, the direct route must be advertised explicitly through the route map. Failure to do so will implicitly deny the direct route being advertised.

- The **AS override** option in the **BGP Controls** field in the BGP Peer Connectivity Profile for an L3Out was introduced in release 3.1(2). It allows Cisco Application Centric Infrastructure (ACI) to overwrite a remote AS in the AS_PATH with ACI BGP AS. In Cisco ACI, it is typically used when performing transit routing from an eBGP L3Out to another eBGP L3Out with the same AS number.

However, an issue arises if you enable the **AS override** option when the eBGP neighbor has a different AS number. In this situation, strip the peer-as from the AS_PATH when reflecting it to a peer.

- The **Local-AS Number** option in the BGP Peer Connectivity Profile is supported only for eBGP peering. This enables Cisco ACI border leaf switches to appear to be a member of another AS in addition to its real AS assigned to the fabric MP-BGP Route Reflector Policy. This means that the local AS number must be different from the real AS number of the Cisco ACI fabric. When this feature is configured, Cisco ACI border leaf switches prepend the local AS number to the AS_PATH of the incoming updates and append the same to the AS_PATH of the outgoing updates. Prepending of the local AS number to the incoming updates can be disabled by the **no-prepend** setting in the **Local-AS Number Config**. The **no-prepend + replace-as** setting can be used to prevent the local AS number from being appended to the outgoing updates in addition to not prepending the same to the incoming updates.
- A router ID for an L3Out for any routing protocols cannot be the same IP address or the same subnet as the L3Out interfaces such as routed interface, sub-interface or SVI. However, if needed, a router ID can be the same as one of the L3Out loopback IP addresses.
- If you have multiple L3Outs of the same routing protocol on the same leaf switch in the same VRF instance, the router ID for those must be the same. If you need a loopback with the same IP address as the router ID, you can configure the loopback in only one of those L3Outs.
- There are two ways to define the BGP peer for an L3Out:
 - Through the BGP peer connectivity profile (**bgpPeerP**) at the logical node profile level (**l3extLNodeP**), which associates the BGP peer to the loopback IP address. When the BGP peer is configured at this level, a loopback address is expected for BGP connectivity, so a fault is raised if the loopback address configuration is missing.
 - Through the BGP peer connectivity profile (**bgpPeerP**) at the logical interface profile level (**l3extRsPathL3OutAtt**), which associates the BGP peer to the respective interface or sub-interface.
- You must configure an IPv6 address to enable peering over loopback using IPv6.
- Tenant networking protocol policies for BGP `l3extOut` connections can be configured with a maximum prefix limit that enables monitoring and restricting the number of route prefixes received from a peer. After the maximum prefix limit is exceeded, a log entry can be recorded, further prefixes can be rejected, the connection can be restarted if the count drops below the threshold in a fixed interval, or the connection is shut down. You can use only one option at a time. The default setting is a limit of 20,000 prefixes, after which new prefixes are rejected. When the reject option is deployed, BGP accepts one more prefix beyond the configured limit and the Cisco Application Policy Infrastructure Controller (APIC) raises a fault.



Note Cisco ACI does not support IP fragmentation. Therefore, when you configure Layer 3 Outside (L3Out) connections to external routers, or Multi-Pod connections through an Inter-Pod Network (IPN), it is recommended that the interface MTU is set appropriately on both ends of a link. On some platforms, such as Cisco ACI, Cisco NX-OS, and Cisco IOS, the configurable MTU value does not take into account the Ethernet headers (matching IP MTU, and excluding the 14-18 Ethernet header size), while other platforms, such as IOS-XR, include the Ethernet header in the configured MTU value. A configured value of 9000 results in a max IP packet size of 9000 bytes in Cisco ACI, Cisco NX-OS, and Cisco IOS, but results in a max IP packet size of 8986 bytes for an IOS-XR untagged interface.

For the appropriate MTU values for each platform, see the relevant configuration guides.

We highly recommend that you test the MTU using CLI-based commands. For example, on the Cisco NX-OS CLI, use a command such as `ping 1.1.1.1 df-bit packet-size 9000 source-interface ethernet 1/1`.

BGP Connection Types and Loopback Guidelines

The ACI supports the following BGP connection types and summarizes the loopback guidelines for them:

BGP Connection Type	Loopback required	Loopback same as Router ID	Static/OSPF route required
iBGP direct	No	Not applicable	No
iBGP loopback peering	Yes, a separate loopback per L3Out	No, if multiple Layer 3 out are on the same node	Yes
eBGP direct	No	Not applicable	No
eBGP loopback peering (multi-hop)	Yes, a separate loopback per L3Out	No, if multiple Layer 3 out are on the same node	Yes

BGP Protocol Peering to External BGP Speakers

ACI supports peering between the border leaves and the external BGP speakers using iBGP and eBGP. ACI supports the following connections for BGP peering:

- iBGP peering over OSPF
- eBGP peering over OSPF
- iBGP peering over direct connection
- eBGP peering over direct connection

- iBGP peering over static route



Note When OSPF is used with BGP peering, OSPF is only used to learn and advertise the routes to the BGP peering addresses. All route control applied to the Layer 3 Outside Network (EPG) are applied at the BGP protocol level.

ACI supports a number of features for iBGP and eBGP connectivity to external peers. The BGP features are configured on the **BGP Peer Connectivity Profile**.

The BGP peer connectivity profile features are described in the following table.



Note ACI supports the following BGP features. NX-OS BGP features not listed below are not currently supported in ACI.

Table 10: BGP Peer Connectivity Profile Features

BGP Features	Feature Description	NX-OS Equivalent Commands
Allow Self-AS	Works with Allowed AS Number Count setting.	allowas-in
Disable peer AS check	Disable checking of the peer AS number when advertising.	disable-peer-as-check
Next-hop self	Always set the next hop attribute to the local peering address.	next-hop-self
Send community	Send the community attribute to the neighbor.	send-community
Send community extended	Send the extended community attribute to the neighbor.	send-community extended
Password	The BGP MD5 authentication.	password
Allowed AS Number Count	Works with Allow Self-AS feature.	allowas-in
Disable connected check	Disable connected check for the directly connected EBGp neighbors (allowing EBGp neighbor peering from the loopbacks).	
TTL	Set the TTL value for EBGp multihop connections. It is only valid for EBGp.	ebgp-multihop <TTL>

BGP Features	Feature Description	NX-OS Equivalent Commands
Autonomous System Number	Remote Autonomous System number of the peer.	neighbor <x.x.x.x> remote-as
Local Autonomous System Number Configuration	Options when using the Local AS feature. (No Prepend+replace-AS+dual-AS etc).	
Local Autonomous System Number	The local AS feature used to advertise a different AS number than the AS assigned to the fabric MP-BGP Route Reflector Profile. It is only supported for the EBGp neighbors and the local AS number must be different than the route reflector policy AS.	local-as xxx <no-prepend> <replace-as> <dual-as>
Site of Origin	The site-of-origin (SoO) is a BGP extended community attribute that is used to uniquely identify the site from which a route is learned in order to prevent routing loops.	soo <value>

Configuring BGP External Routed Networks

Use the procedures in the following sections to configure BGP external routed networks.

Configuring BGP L3Out Using the GUI

Before you begin

The tenant, VRF, and bridge domain where you configure the BGP L3Out is already created, and you selected the **Configure BGP Policies** option when you were creating the VRF.

Procedure

-
- Step 1** In the **Navigation** pane, expand *Tenant_name* > **Networking** > **L3Outs**.
- Step 2** Right-click, and click **Create L3Out**.
The **Create L3Out** wizard appears.
- Step 3** Enter the necessary information in the **Identity** window of the **Create L3Out** wizard.
- Enter the necessary information in the **Name**, **VRF** and **L3 Domain** fields.
 - In the area with the routing protocol check boxes, choose **BGP**.
 - Click **Next** to move to the **Nodes and Interfaces** window.

Step 4 Enter the necessary information in the **Nodes and Interfaces** window of the **Create L3Out** wizard.

- a) In the **Layer 3** area, select **Routed**.
- b) From the **Node ID** field drop-down menu, choose the node for the L3Out.

For the topology in these examples, use node 103.

- c) In the **Router ID** field, enter the router ID.
- d) (Optional) You can configure another IP address for a loopback address, if necessary.

The **Loopback Address** field is automatically populated with the same entry that you provide in the **Router ID** field. This is the equivalent of the **Use Router ID for Loopback Address** option in previous builds. Enter a different IP address for a loopback address, if you don't want to use route ID for the loopback address, or leave this field empty if you do not want to use the router ID for the loopback address.

- e) Enter necessary additional information in the **Nodes and Interfaces** window.

The fields shown in this window varies, depending on the options that you select in the **Layer 3** and **Layer 2** areas.

- f) When you have entered the remaining additional information in the **Nodes and Interfaces** window, click **Next**.

The **Protocols** window appears.

Step 5 Enter the necessary information in the **Protocols** window of the **Create L3Out** wizard.

- a) In the **BGP Loopback Policies** and **BGP Interface Policies** areas, enter the following information:

- **Peer Address:** Enter the peer IP address
- **EBGP Multihop TTL:** Enter the connection time to live (TTL). The range is from 1 to 255 hops; if zero, no TTL is specified. The default is 1.
- **Remote ASN:** Enter a number that uniquely identifies the neighbor autonomous system. The Autonomous System Number can be in 4-byte as plain format from 1 to 4294967295.

Note

ACI does not support asdot or asdot+ format AS numbers.

- b) Click **Next**.

The **External EPG** window appears.

Step 6 Enter the necessary information in the **External EPG** window of the **Create L3Out** wizard.

- a) In the **Name** field, enter a name for the external network.
- b) In the **Provided Contract** field, enter the name of a provided contract.
- c) In the **Consumed Contract** field, enter the name of a consumed contract.
- d) In the **Default EPG for all external networks** field, uncheck if you don't want to advertise all the transit routes out of this L3Out connection.

The Subnets area appears if you uncheck this box. Specify the desired subnets and controls as described in the following steps.

- e) Click the + icon to expand **Subnet**, then perform the following actions in the **Create Subnet** dialog box.
- f) In the **IP address** field, enter the IP address and network mask for the external network.

Note

Enter an IPv4 or IPv6 address depending upon what you have entered in earlier steps.

When creating the external subnet, you must configure either both the BGP loopbacks in the prefix EPG or neither of them. If you configure only one BGP loopback, then BGP neighborship is not established.

- g) In the **Name** field, enter the name of the subnet.
- h) In the **Scope** field, check the check boxes for **Export Route Control Subnet**, **Import Route Control Subnet**, and **Security Import Subnet**. Click **OK**.

Note

Check the **Import Route Control Subnet** check box if you wish to enforce import control with BGP.

- i) Click **OK** when you have completed the necessary configurations in the **Create Subnet** window.
- j) Click **Finish** to complete the necessary configurations in the **Create L3Out** wizard.

Step 7

(Optional) Navigate to the **BGP Peer Connectivity Profile** window to make additional configurations for the BGP external routed network, if necessary:

Tenants > *tenant_name* > **Networking** > **L3Outs** > *L3Out_name* > **Logical Node Profiles** > *log_node_prof_name* > **BGP Peer** <*address*>

The **BGP Peer Connectivity Profile** for this L3Out appears.

- a) In the **BGP Controls** field, check the desired controls.

The peer controls specify which Border Gateway Protocol (BGP) attributes are sent to a peer. The peer control options are:

- **Allow Self AS**—Enables the autonomous number check on itself. This allows BGP peer to inject updates if the same AS number is being used.
- **AS override**—Enables the BGP AS override feature to override the default setting. The AS override function will replace the AS number from the originating router with the AS number of the sending BGP router in the AS Path of outbound routes. This feature can be enabled per feature per address family (IPv4 or IPv6).

Note:

The **Disable Peer AS Check** check box must also be checked in order to enable the AS override feature.

- **Disable Peer AS Check**—Disables the peer autonomous number check. When the check box is checked, if the advertising router finds the AS number of the receiver in the AS path, it will not send the route to the receiver.

Note:

The **Disable Peer AS Check** check box must be checked in order to enable the AS override feature.

- **Next-hop Self**—Sends the BGP next hop attribute to itself.
- **Send Community**—Sends the BGP community attribute to a peer.
- **Send Extended Community**—Sends the BGP extended community attribute to a peer.
- **Send Domain Path**—Sends the BGP domain path to a peer.

- b) In the **Password** and **Confirm Password** field, enter the administrative password.

- c) In the **Allow Self AS Number Count** field, choose the allowed number of occurrences of a local Autonomous System Number (ASN).

The range is from 1 to 10. The default is 3.

- d) In the **Peer Controls** field, enter the neighbor check parameters.

The options are:

- **Bidirectional Forwarding Detection**—Enables BFD on the peer.
- **Disable Connected Check**—Disables the check for peer connection.

- e) In the **Address Type Controls** field, configure the BGP IPv4/IPv6 address-family feature, if desired.

- **AF Mcast**: Check to enable the multicast address-family feature.
- **AF Ucast**: Check to enable the unicast address-family feature.

- f) Note the entry in the **Routing Domain ID**, if necessary.

The value in the **Routing Domain ID** field reflects the global Domain ID Base value that was entered in the **BGP Route Reflector Policy** page. See [About the BGP Domain-Path Feature for Loop Prevention, on page 196](#) for more information.

- g) In the **EBGP Multihop TTL** field, enter the connection time to live (TTL).

The range is from 1 to 255 hops; if zero, no TTL is specified. The default is 1.

- h) In the **Weight for routes from this neighbor** field, choose the allowed weight for routes from the peer.

The weight assigned locally to the router is used to select the best path. The range is from 0 to 65535.

- i) In the **Private AS Control** field, configure the private AS control.

These options are valid only when ACI BGP AS is a public AS number, or when the **Local-AS Number Config** with the **no-Prepend+replace-as** option is configured using a public AS number on the given BGP peer connectivity profile (the BGP neighbor configuration). The **replace-as** option is used to remove the actual local private AS from the AS_PATH because the **Private AS Control** feature does not remove its own local private AS.

The options are:

- **Remove all private AS**—In outgoing eBGP route updates to this neighbor, this option removes all private AS numbers from the AS_PATH, regardless of whether a public AS number is included in the AS_PATH.

If the neighbor remote AS is in the AS_PATH, this option is not applied.

To enable this option, **Remove private AS** must be enabled.

- **Remove private AS**—In outgoing eBGP route updates to this neighbor, this option removes all private AS numbers from the AS_PATH when the AS_PATH has only private AS numbers.

If the neighbor remote AS is in the AS_PATH, this option is not applied.

- **Replace private AS with local AS**—In outgoing eBGP route updates to this neighbor, this option replaces all private AS numbers in the AS_PATH with ACI local AS, regardless of whether a public AS or the neighbor remote AS is included in the AS_PATH.

To enable this option, **Remove all private AS** must be enabled.

- j) In the **BGP Peer Prefix Policy** field, select an existing peer prefix policy or create a new one.

The peer prefix policy defines how many prefixes can be received from a neighbor and the action to take when the number of allowed prefixes is exceeded. This feature is commonly used for external BGP peers, but can also be applied to internal BGP peers.

- k) In the **Site of Origin** field, enter an extended community value to identify this peer.

The site-of-origin (SoO) extended community is a BGP extended community attribute that is used to identify routes that have originated from a site so that the readvertisement of that prefix back to the source site can be prevented. The SoO extended community uniquely identifies the site from which a router has learned a route. BGP can use the SoO value associated with a route to prevent routing loops.

Valid formats are:

- extended:as2-nn2:<2-byte number>:<2-byte number>

For example: extended:as2-nn2:1000:65534

- extended:as2-nn4:<2-byte number>:<4-byte number>

For example: extended:as2-nn4:1000:6554387

- extended:as4-nn2:<4-byte number>:<2-byte number>

For example: extended:as4-nn2:1000:65504

- extended:ipv4-nn2:<IPv4 address>:<2-byte number>

For example: extended:ipv4-nn2:1.2.3.4:65515

Note

When configuring the SoO for the User Tenant L3Outs, make sure not to configure the same SoO value as that of the global Fabric, Pod, or Multi-Site SoO configured within the ACI fabric. You can view the Fabric, Pod, and Multi-Site SoO values configured within the fabric by executing the following command on the switch:

```
show bgp process vrf overlay-1 | grep SOO
```

- l) In the **Remote Autonomous System Number** field, choose a number that uniquely identifies the neighbor autonomous system.

The Autonomous System Number can be in 4-byte asplain format from 1 to 4294967295.

Note

ACI does not support asdot or asdot+ format AS numbers.

- m) In the **Local-AS Number Config** field, choose the local Autonomous System Number (ASN) configuration.

Using a local AS number rather than the Global AS permits the routing devices in the associated network to appear to belong to the former AS. The configuration can be:

- **no-Prepend+replace-as+dual-as**—Does not allow prepending on local AS and is replaced with both AS numbers.

Note: You can prepend one or more autonomous system (AS) numbers at the beginning of an AS path. The AS numbers are added at the beginning of the path after the actual AS number from which the route originates has been added to the path. Prepending an AS path makes a shorter AS path look longer and therefore less preferable to BGP.

- **no-prepend**—Does not allow prepending on local AS.

- **no options**—Does not allow alteration of local AS.
- **no-Prepend+replace-as**—Does not allow prepending on local AS and is replaces AS number.

n) In the **Local-AS Number** field, choose the desired value.

Optionally required for the local autonomous system feature for eBGP peers. The local Autonomous System Number can be in 4-byte asplain format from 1 to 4294967295.

Note

ACI does not support asdot or asdot+ format AS numbers.

o) In the **Admin State** field, select **Disabled** or **Enabled**.

The **Admin State** field allows you to shut down the corresponding BGP neighbor. Using this feature shuts down the BGP sessions without the need to delete the BGP peer configuration.

Options are:

- **Disabled**: Disables the BGP neighbor's admin state.
- **Enabled**: Enables the BGP neighbor's admin state.

p) In the **Route Control Profile** field, configure route control policies per BGP peer.

Click + to configure the following:

- **Name**: The route control profile name.
- **Direction**: Choose one of the following options:
 - **Route Import Policy**
 - **Route Export Policy**

q) Click **Submit**.

Step 8 Navigate to **Tenants** > *tenant_name* > **Networking** > **L3Outs** > *L3Out_name* .

Step 9 Click the **Policy/Main** tab and perform the following actions:

a) (Optional) In the **Route Control Enforcement** field, check the **Import** check box.

Note

Check this check box if you wish to enforce import control with BGP.

b) Expand the **Route Control for Dampening** field, and choose the desired address family type and route dampening policy. Click **Update**.

In this step, the policy can be created either with step 4 or there is also an option to **Create route profile** in the drop-down list where the policy name is selected.

Step 10 Navigate to **Tenants** > *tenant_name* > **Networking** > **L3Outs** > *L3Out_name* .

Step 11 Right-click **Route map for import and export route control** and select **Create Route map for import and export route control**.

Step 12 Enter the necessary information in this window, then click + in the Context area to bring up the **Create Route Control Context** window.

- a) In the **Name** field, enter a name for the route control VRF.
- b) From the **Set Attribute** drop-down list, choose **Create Action Rule Profile**.

When creating an action rule, set the route dampening attributes as desired.

Configuring BGP Max Path

The following feature enables you to add the maximum number of paths to the route table to enable equal cost, multipath load balancing.

Configuring BGP Max Path Using the GUI

Before you begin

The appropriate tenant and the BGP external routed network are created and available.

Procedure

- Step 1** Log in to the APIC GUI, and on the menu bar, click **Tenants** > *tenant_name* > **Policies** > **Protocol** > **BGP** > **BGP Address Family Context** and right click **Create BGP Address Family Context Policy**.
- Step 2** In the **Create BGP Address Family Context Policy** dialog box, perform the following tasks.
- Refer to the *Verified Scalability Guide for Cisco APIC* on the [Cisco APIC documentation page](#) for the acceptable values for the following fields.
- In the **Name** field, enter a name for the policy.
 - In the **eBGP Distance** field, enter a value for the administrative distance of eBGP routes.
 - In the **iBGP Distance** field, enter a value for the administrative distance of iBGP routes.
 - In the **Local Distance** field, enter a value for the local distance.
 - In the **eBGP Max ECMP** field, enter a value for the maximum number of equal-cost paths for eBGP load sharing.
 - In the **iBGP Max ECMP** field, enter a value for the maximum number of equal-cost paths for iBGP load sharing.
 - In the **Enable Host Route Leak** field, click the box to enable distributing EVPN type-2 (MAC/IP) host routes to the DCIG.
 - Click **Submit** after you have updated your entries.
- Step 3** Click **Tenants** > *tenant_name* > **Networking** > **VRFs** > *vrf_name*
- Step 4** Review the configuration details of the subject VRF.
- Step 5** Locate the **BGP Context Per Address Family** field and, in the **BGP Address Family Type** area, select either **IPv4 unicast address family** or **IPv6 unicast address family**.
- Step 6** Access the BGP Address Family Context you created in the **BGP Address Family Context** drop-down list and associate it with the subject VRF.
- Step 7** Click **Submit**.
-

Configuring AS Path Prepend

Use the procedures in the following sections to configure AS Path Prepend.

Configuring AS Path Prepend

A BGP peer can influence the best-path selection by a remote peer by increasing the length of the AS-Path attribute. AS-Path Prepend provides a mechanism that can be used to increase the length of the AS-Path attribute by prepending a specified number of AS numbers to it.

AS-Path prepending can only be applied in the outbound direction using route-maps. AS Path prepending does not work in iBGP sessions.

The AS Path Prepend feature enables modification as follows:

Prepend	Appends the specified AS number to the AS path of the route matched by the route map. Note <ul style="list-style-type: none"> You can configure more than one AS number. 4 byte AS numbers are supported. You can prepend a total 32 AS numbers. You must specify the order in which the AS Number is inserted into the AS Path attribute.
Prepend-last-as	Prepends the last AS numbers to the AS path with a range between 1 and 10.

The following table describes the selection criteria for implementation of AS Path Prepend:

Prepend	1	Prepend the specified AS number.
Prepend-last-as	2	Prepend the last AS numbers to the AS path.
DEFAULT	Prepend(1)	Prepend the specified AS number.

Configuring AS Path Prepend Using the GUI

Before you begin

A configured tenant.

Procedure

Step 1 Log in to the APIC GUI, and on the menu bar, click **Tenants** > *tenant_name* > **Policies** > **Protocol** > **Set Rules** and right click **Create Set Rules for a Route Map**.

The **Create Set Rules For A Route Map** window appears.

Step 2 In the **Create Set Rules For A Route Map** dialog box, perform the following tasks:

- In the **Name** field, enter a name.
- Check the **Set AS Path** checkbox, then click **Next**.

- c) In the **AS Path** window, click + to open the **Create Set AS Path** dialog box.
- Step 3** Select the criterion **Prepend AS**, then click + to prepend AS numbers.
- Step 4** Enter the AS number and its order and then click **Update**. Repeat by clicking + again if multiple AS numbers must be prepended.
- Step 5** When you have completed the prepend AS number configurations, select the criterion **Prepend Last-AS** to prepend the last AS number a specified number of times.
- Step 6** Enter **Count** (1-10).
- Step 7** Click **OK**.
- Step 8** In the **Create Set Rules For A Route Map** window, confirm the listed criteria for the set rule based on AS Path and click **Finish**.
- Step 9** On the APIC GUI menu bar, click **Tenants** > *tenant_name* > **Policies** > **Protocol** > **Set Rules** and right click your profile.
- Step 10** Confirm the **Set AS Path** values the bottom of the screen.
-

BGP External Routed Networks with AS Override

Use the procedures in the following sections to configure BGP external routed networks with AS override.

About BGP Autonomous System Override

Loop prevention in BGP is done by verifying the Autonomous System number in the Autonomous System Path. If the receiving router sees its own Autonomous System number in the Autonomous System path of the received BGP packet, the packet is dropped. The receiving router assumes that the packet originated from its own Autonomous System and has reached the same place from where it originated initially. This setting is the default to prevent route loops from occurring.

The default setting to prevent route loops from occurring could create an issue if you use the same Autonomous System number along various sites and disallow user sites with identical Autonomous System numbers to link by another Autonomous System number. In such a scenario, routing updates from one site is dropped when the other site receives them.

To prevent such a situation from occurring, beginning with the Cisco APIC Release 3.1(2m), you can now enable the BGP Autonomous System override feature to override the default setting. You must also enable the Disable Peer AS Check at the same time.

The Autonomous System override function replaces the Autonomous System number from the originating router with the Autonomous System number of the sending BGP router in the AS Path of the outbound routes. This feature can be enabled per feature per address family (IPv4 or IPv6).

The Autonomous System Override feature is supported with GOLF Layer 3 configurations and Non-GOLF Layer 3 configurations.

Figure 38: Example Topology Illustrating the Autonomous System Override Process

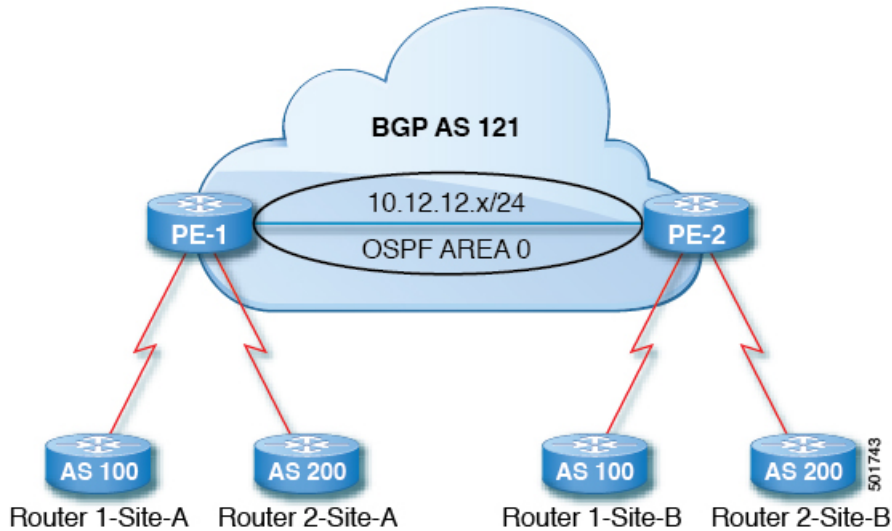

Router 1 and Router 2 are the two customers with multiple sites (Site-A and Site-B). Customer Router 1 operates under AS 100 and customer Router 2 operates under AS 200.

The above diagram illustrates the Autonomous System (AS) override process as follows:

1. Router 1-Site-A advertises route 10.3.3.3 with AS100.
2. Router PE-1 propagates this as an internal route to PE2 as AS100.
3. Router PE-2 prepends 10.3.3.3 with AS121 (replaces 100 in the AS path with 121), and propagates the prefix.
4. Router 2-Site-B accepts the 10.3.3.3 update.

Configuring BGP External Routed Network with Autonomous System Override Enabled Using the GUI

Before you begin

- The Tenant, VRF, Bridge Domain are created.
- The External Routed Network that is in a non-GOLF setting, a logical node profile, and the BGP peer connectivity profile are created.

Procedure

-
- Step 1** On the menu bar, choose **Tenants** > *Tenant_name* > **Networking** > **L3Outs** > *Non-GOLF Layer 3 Out_name* > **Logical Node Profiles**.
- Step 2** In the **Navigation** pane, choose the appropriate **BGP Peer Connectivity Profile**.
- Step 3** In the **Work** pane, under **Properties** for the **BGP Peer Connectivity Profile**, in the **BGP Controls** field, perform the following actions:

- a) Check the check box for the **AS override** field to enable the **Autonomous System override** function.
- b) Check the check box for the **Disable Peer AS Check** field.

Note

You must check the check boxes for **AS override** and **Disable Peer AS Check** for the AS override feature to take effect.

- c) Choose additional fields as required.

Step 4 Click **Submit**.

BGP Neighbor Shutdown and Soft Reset

Use the procedures in the following sections to configure BGB neighbor shutdown and soft reset.

About BGP Neighbor Shutdown and Soft Reset

Beginning with Release 4.2(1), support is now available for the following features:

- [BGP Neighbor Shutdown, on page 269](#)
- [BGP Neighbor Soft Reset, on page 269](#)

BGP Neighbor Shutdown

The BGP neighbor shutdown feature is similar to the neighbor shutdown command in NX-OS, which shuts down the corresponding BGP neighbor. Use this policy to disable and enable the BGP neighbor's admin state. Using this feature shuts down the BGP sessions without the need to delete the BGP peer configuration.

BGP Neighbor Soft Reset

Using the BGP route refresh capability, the BGP neighbor soft reset feature provides automatic support for a dynamic soft reset of inbound and outbound BGP routing table updates that are not dependent upon stored routing table update information. Use this policy to enable the soft dynamic inbound reset and soft outbound reset.

Configuring BGP Neighbor Shutdown Using the GUI

The following procedure describes how to use the BGP neighbor shutdown feature using the GUI.

Before you begin

Complete the standard prerequisites before configuring an L3Out, such as:

- Configure the node, port, functional profile, AEP, and Layer 3 domain.
- Configure a BGP Route Reflector policy to propagate the routes within the fabric.

Procedure

Step 1 Create the L3Out and configure the BGP for the L3Out:

- a) On the **Navigation** pane, expand **Tenant** and **Networking**.
- b) Right-click **L3Outs** and choose **Create L3Out**.
- c) Enter the necessary information to configure BGP for the L3Out.

You will select **BGP** in the **Identity** page in the L3Out creation wizard to configure the BGP protocol for this L3Out.

The screenshot shows the 'Create L3Out' wizard in the Identity page. At the top, there are four steps: 1. Identity (active), 2. Nodes And Interfaces, 3. Protocols, and 4. External EPG. Below the steps is a diagram showing a Leaf node (L) connected to a Router node (R) via a Route. The Identity page contains the following text:

Identity

A Layer 3 Outside network configuration (L3Out) defines how traffic is forwarded outside of the fabric. Layer 3 is used to discover the addresses of other nodes, select routes, select quality of service, and forward the traffic that is entering, exiting, and transiting the fabric.

Prerequisites:

- Configure the node, port, functional profile, AEP, and Layer 3 domain.
- Configure a BGP route reflector policy to propagate the routes within the fabric.

Configuration fields:

- Name: L3Out-demo
- VRF: VRF-demo
- Layer 3 Domain: L3Domain-demo
- Use for GOLP:

Protocol selection:

- BGP (circled in red)
- EIGRP
- OSPF

At the bottom right, there are buttons for Previous, Cancel, and Next.

- d) Continue through the remaining pages (**Nodes and Interfaces**, **Protocols**, and **External EPG**) to complete the configuration for the L3Out.

Step 2 After you have completed the L3Out configuration, configure the BGP neighbor shutdown:

- a) Navigate to the BGP Peer Connectivity Profile screen:

Tenants > *tenant* > **Networking** > **L3Outs** > *L3out-name* > **Logical Node Profiles** > *logical-node-profile-name* > **Logical Interface Profiles** > *logical-interface-profile-name* > **BGP Peer Connectivity Profile IP-address**

- b) Scroll down to the **Admin State** field and make the appropriate selection in this field.
 - **Disabled:** Disables the BGP neighbor's admin state.

- **Enabled:** Enables the BGP neighbor's admin state.

Configuring BGP Neighbor Soft Reset Using the GUI

The following procedure describes how to use the BGP neighbor soft reset feature using the GUI.

Before you begin

Complete the standard prerequisites before configuring an L3Out, such as:

- Configure the node, port, functional profile, AEP, and Layer 3 domain.
- Configure a BGP Route Reflector policy to propagate the routes within the fabric.

Procedure

Step 1

Create the L3Out and configure the BGP for the L3Out:

- On the **Navigation** pane, expand **Tenant** and **Networking**.
- Right-click **L3Outs** and choose **Create L3Out**.
- Enter the necessary information to configure BGP for the L3Out.

You will select **BGP** in the **Identity** page in the L3Out creation wizard to configure the BGP protocol for this L3Out.

Create L3Out

1. Identity | 2. Nodes And Interfaces | 3. Protocols | 4. External EPG

Protocol

L Leaf --- Route --- R Router

Identity

A Layer 3 Outside network configuration (L3Out) defines how traffic is forwarded outside of the fabric. Layer 3 is used to discover the addresses of other nodes, select routes, select quality of service, and forward the traffic that is entering, exiting, and transiting the fabric.

Prerequisites:

- Configure the node, port, functional profile, AEP, and Layer 3 domain.
- Configure a BGP route reflector policy to propagate the routes within the fabric.

Name:

VRF:

Layer 3 Domain:

Use for GOLP:

BGP EIGRP OSPF

Previous Cancel Next

- d) Continue through the remaining pages (**Nodes and Interfaces**, **Protocols**, and **External EPG**) to complete the configuration for the L3Out.

Step 2

After you have completed the L3Out configuration, configure the BGP neighbor soft reset:

- a) Navigate to the BGP Peer Entry screen:

Tenants > *tenant* > **Networking** > **L3Outs** > *L3out-name* > **Logical Node Profiles** > *logical-node-profile-name* > **Configured Nodes** > *node* > **BGP for VRF-vrf-name** > **Neighbors**

- b) Right-click on the appropriate neighbor entry and select **Clear BGP Peer**.

The **Clear BGP** page appears.

- c) In the **Mode** field, select **Soft**.

The **Direction** fields appear.

- d) Select the appropriate value in the **Direction** field:

- **Incoming**: Enables the soft dynamic inbound reset.
- **Outgoing**: Enables the soft outbound reset.

Configuring Per VRF Per Node BGP Timer Values

Use the procedures in the following sections to configure per VRF per node BGP timer values.

Per VRF Per Node BGP Timer Values

Prior to the introduction of this feature, for a given VRF, all nodes used the same BGP timer values.

With the introduction of the per VRF per node BGP timer values feature, BGP timers can be defined and associated on a per VRF per node basis. A node can have multiple VRFs, each corresponding to a `fvCtx`. A node configuration (`l3extLNodeP`) can now contain configuration for BGP Protocol Profile (`bgpProtP`) which in turn refers to the desired BGP Context Policy (`bgpCtxPol`). This makes it possible to have a different node within the same VRF contain different BGP timer values.

For each VRF, a node has a `bgpDom` concrete MO. Its name (primary key) is the VRF, `<fvTenant>:<fvCtx>`. It contains the BGP timer values as attributes (for example, `holdIntvl`, `kaIntvl`, `maxAsLimit`).

All the steps necessary to create a valid Layer 3 Out configuration are required to successfully apply a per VRF per node BGP timer. For example, MOs such as the following are required: `fvTenant`, `fvCtx`, `l3extOut`, `l3extInstP`, `LNodeP`, `bgpRR`.

On a node, the BGP timer policy is chosen based on the following algorithm:

- If `bgpProtP` is specified, then use `bgpCtxPol` referred to under `bgpProtP`.
- Else, if specified, use `bgpCtxPol` referred to under corresponding `fvCtx`.
- Else, if specified, use the default policy under the tenant, for example, `uni/tn-<tenant>/bgpCtxP-default`.
- Else, use the `default` policy under tenant `common`, for example, `uni/tn-common/bgpCtxP-default`. This one is pre-programmed.

Configuring a Per VRF Per Node BGP Timer Using the Advanced GUI

When a BGP timer is configured on a specific node, then the BGP timer policy on the node is used and the BGP policy timer associated with the VRF is ignored.

Before you begin

A tenant and a VRF are already configured.

Procedure

- Step 1** On the menu bar, choose **Tenant** > *Tenant_name* > **Policies** > **Protocol** > **BGP** > **BGP Timers**, then right-click **Create BGP Timers Policy**.
- Step 2** In the **Create BGP Timers Policy** dialog box, perform the following actions:
 - a) In the **Name** field, enter the BGP Timers policy name.
 - b) In the available fields, choose the appropriate values as desired. Click **Submit**.A BGP timer policy is created.
- Step 3** Navigate to **Tenant** > *Tenant_name* > **Networking** > **L3Outs**, and right-click **Create L3Out**.
The **Create L3Out** wizard appears. Create an L3Out with BGP enabled by performing the following actions.
- Step 4** Enter the necessary information in the **Identity** window of the **Create L3Out** wizard.
 - a) In the **Name** field, enter a name for the L3Out.
 - b) From the **VRF** drop-down list, choose the VRF.
 - c) From the **L3 Domain** drop-down list, choose an external routed domain.
 - d) In the area with the routing protocol check boxes, check the **BGP** box.
 - e) Click **Next** to move to the **Nodes and Interfaces** window.
 - f) Continue through the remaining windows in the **Create L3Out** wizard to complete the L3Out creation process.
- Step 5** After you have created the L3Out, navigate to the logical node profile in the L3Out that you just created: **Tenant** > *Tenant_name* > **Networking** > **L3Outs** > *L3Out_name* > **Logical Node Profiles** > *LogicalNodeProfile-name* .
- Step 6** In the **Logical Node Profile** window, check next to **Create BGP Protocol Profile**.
The **Create Node Specific BGP Protocol Profile** window appears.
- Step 7** In the **BGP Timers** field, from the drop-down list, choose the BGP timer policy that you want to associate with this specific node. Click **Submit**.
A specific BGP timer policy is now applied to the node.
Note
To associate an existing node profile with a BGP timer policy, right-click the node profile, and associate the timer policy.
If a timer policy is not chosen specifically in the **BGP Timers** field for the node, then the BGP timer policy that is associated with the VRF under which the node profile resides automatically gets applied to this node.
- Step 8** To verify the configuration, in the **Navigation** pane, perform the following steps:
 - a) Expand **Tenant** > *Tenant_name* > **Networking** > **L3Outs** > *L3Out_name* > **Logical Node Profiles** > *LogicalNodeProfile-name* > **BGP Protocol Profile**.

- b) In the **Work** pane, the BGP protocol profile that is associated with the node profile is displayed.

Troubleshooting Inconsistency and Faults

The following inconsistencies or faults could occur under certain conditions:

If different Layer 3 Outs (`l3Out`) are associated with the same VRF (`fVCtx`), and on the same node, the `bgpProtP` is associated with different policies (`bgpCtxPol`), a fault will be raised. In the case of the example below, both Layer 3 Outs (`out1` and `out2`) are associated with the same VRF (`ctx1`). Under `out1`, `node1` is associated with the BGP timer protocol `pol1` and under `out2`, `node1` is associated with a different BGP timer protocol `pol2`. This will raise a fault.

```
tn1
  ctx1
  out1
    ctx1
    node1
    protp pol1

  out2
    ctx1
    node1
    protp pol2
```

If such a fault is raised, change the configuration to remove the conflict between the BGP timer policies.

Configuring BFD Support

Use the procedures in the following sections to configure BFD support.

Bidirectional Forwarding Detection

Use Bidirectional Forwarding Detection (BFD) to provide sub-second failure detection times in the forwarding path between Cisco Application Centric Infrastructure (ACI) fabric border leaf switches configured to support peering router connections.

BFD is particularly useful in the following scenarios:

- When the peering routers are connected through a Layer 2 device or a Layer 2 cloud where the routers are not directly connected to each other. Failures in the forwarding path may not be visible to the peer routers. The only mechanism available to control protocols is the hello timeout, which can take tens of seconds or even minutes to time out. BFD provides sub-second failure detection times.
- When the peering routers are connected through a physical media that does not support reliable failure detection, such as shared Ethernet. In this case too, routing protocols have only their large hello timers to fall back on.
- When many protocols are running between a pair of routers, each protocol has its own hello mechanism for detecting link failures, with its own timeouts. BFD provides a uniform timeout for all the protocols, which makes convergence time consistent and predictable.

Observe the following BFD guidelines and limitations:

- Beginning with Cisco APIC release 3.1(1), BFD between leaf and spine switches is supported on fabric-interfaces for IS-IS. In addition, BFD feature on spine switch is supported for OSPF and static routes.
- Beginning with Cisco APIC release 5.2(4), the BFD feature is supported for static routes that are reachable using secondary IPv4/IPv6 subnets. Static BFD session cannot be sourced from a secondary subnet of L3Out interface if there are more than one addresses configured in the subnet. Shared subnet address (used for vPC scenario) and floating IP address used for floating L3Out are allowed as additional addresses in the subnet and are automatically skipped, and are not used to source static BFD session.



Note Modifying the secondary address that is being used for sourcing the session is allowed by adding a new address in the same subnet and later removing the previous one.

- BFD is supported on modular spine switches that have -EX and -FX line cards (or newer versions), and BFD is also supported on the Nexus 9364C non-modular spine switch (or newer versions).
- BFD between vPC peers is not supported.
- Beginning with Cisco APIC release 5.0(1), BFD multihop is supported on leaf switches. The maximum number of BFD sessions is unchanged, as BFD multihop sessions are now included in the total.
- Beginning with Cisco APIC release 5.0(1), Cisco ACI supports C-bit-aware BFD. The C-bit on incoming BFD packets determines whether BFD is dependent or independent of the control plane.
- BFD over iBGP is not supported for loopback address peers.
- BFD sub interface optimization can be enabled in an interface policy. One sub-interface having this flag will enable optimization for all the sub-interfaces on that physical interface.
- BFD for BGP prefix peer not supported.



Note Cisco ACI does not support IP fragmentation. Therefore, when you configure Layer 3 Outside (L3Out) connections to external routers, or Multi-Pod connections through an Inter-Pod Network (IPN), it is recommended that the interface MTU is set appropriately on both ends of a link. On some platforms, such as Cisco ACI, Cisco NX-OS, and Cisco IOS, the configurable MTU value does not take into account the Ethernet headers (matching IP MTU, and excluding the 14-18 Ethernet header size), while other platforms, such as IOS-XR, include the Ethernet header in the configured MTU value. A configured value of 9000 results in a max IP packet size of 9000 bytes in Cisco ACI, Cisco NX-OS, and Cisco IOS, but results in a max IP packet size of 8986 bytes for an IOS-XR untagged interface.

For the appropriate MTU values for each platform, see the relevant configuration guides.

We highly recommend that you test the MTU using CLI-based commands. For example, on the Cisco NX-OS CLI, use a command such as `ping 1.1.1.1 df-bit packet-size 9000 source-interface ethernet 1/1`.

Optimizing BFD on Subinterfaces

You can optimize BFD on subinterfaces. BFD creates sessions for all configured subinterfaces. BFD sets the subinterface with the lowest configured VLAN ID as the master subinterface and that subinterface uses the BFD session parameters of the parent interface. The remaining subinterfaces use the slow timer.

If the optimized subinterface session detects an error, BFD marks all subinterfaces on that physical interface as down.

You can configure the BFD echo function on one or both ends of a BFD-monitored link. The echo function slows down the required minimum receive interval, based on the configured slow timer. The *RequiredMinEchoRx* BFD session parameter is set to *zero* if the echo function is disabled. The slow timer becomes the required minimum receive interval if the echo function is enabled.



Note If one of the subinterfaces flap, subinterfaces on that physical interface are impacted and will go down for a second.

Configuring Bidirectional Forwarding Detection on a Secondary IP Address Using the GUI

This procedure configures bidirectional forwarding detection (BFD) on a secondary IP address using the GUI.

Procedure

-
- Step 1** On the menu bar, choose **Tenants > All Tenants**.
- Step 2** In the Work pane, double-click the tenant's name.
- Step 3** In the Navigation pane, choose *tenant_name* > **Networking** > **L3Outs** > *l3out_name* > **Logical Node Profiles** > *node_profile_name* > **Logical Interface Profiles** > *interface_profile_name*.
- Step 4** In the Work pane, choose **Policy > Routed Sub-interfaces**, **Policy > Routed Interfaces**, or **Policy > SVI**, as appropriate.
- Step 5** Double-click an interface to edit its properties.
- Step 6** Perform one of the following substeps depending on the type of interface:
- If the interface is a routed sub-interface or routed interface, or a Switch Virtual Interface (SVI) with the **Path Type** set to **Port** or **Direct Port Channel**, in the **IPv4 secondary/IPv6 Additional Addresses** table, click the **+**, enter the IP address and subnet, and click **Submit**.
 - If the interface is a Switch Virtual Interface (SVI) with the **Path Type** set to **Virtual Port Channel**, in the **Side B IPv4 Secondary/IPv6 Additional Addresses** table, click the **+**, enter the IP address and subnet, and click **OK**.
- Step 7** In the Navigation pane, choose *tenant_name* > **Networking** > **L3Outs** > *l3out_name* > **Logical Node Profiles** > *node_profile_name* > **Configured Nodes** > *node_name*.
- Step 8** In the **Static Routes** table, click the **+** and perform the following substeps:
- In the **Prefix** field, enter the static route IP address and mask that is assigned to the outside network.
 - Put a check in the **BFD** check box.
 - In the **Next Hop Addresses** table, click the **+** and in the **Next Hop Address** field, enter an IP address that is reachable by the secondary IP address that you specified for the interface.
 - Fill out the remaining fields as necessary.

e) Click **OK**.

Step 9 Fill out the remaining fields as necessary.

Step 10 Click **Submit**.

Configuring BFD Globally on Leaf Switch Using the GUI

Procedure

Step 1 On the menu bar, choose **Fabric > Access Policies**.

Step 2 In the **Navigation** pane, expand **Policies > Switch > BFD**.
There are two types of bidirectional forwarding detection (BFD) configurations available:

- BFD IPV4
- BFD IPV6

For each of these BFD configurations, you can choose to use the default policy or create a new one for a specific switch (or set of switches).

Note

By default, the APIC controller creates default policies when the system comes up. These default policies are global, bi-directional forwarding detection (BFD) configuration policies. You can set attributes within that default global policy in the **Work** pane, or you can modify these default policy values. However, once you modify a default global policy, note that your changes affect the entire system (all switches). If you want to use a specific configuration for a particular switch (or set of switches) that is not the default, create a switch profile as described in the next step.

Step 3 To create a switch profile for a specific global BFD policy (which is not the default), in the **Navigation** pane, expand **Switches > Leaf Switches > Profiles**.

The **Leaf Switches - Profiles** screen appears in the **Work** pane.

Step 4 On the right side of the **Work** pane, under the actions icon, select **Create Leaf Profile**.

The **Create Leaf Profile** dialog box appears.

Step 5 In the **Create Leaf Profile** dialog box, perform the following actions:

- a) In the **Name** field, enter a name for the leaf switch profile.
- b) (Optional) In the **Description** field, enter a description of the profile.
- c) (Optional) In the **Leaf Selectors** toolbar, click +
- d) Enter the appropriate values for **Name** (name the switch), **Blocks** (select the switch), and **Policy Group** (select **Create Access Switch Policy Group**).

The **Create Access Switch Policy Group** dialog box appears where you can specify the Policy Group identity properties.

Step 6 (If configuring a leaf selector) In the **Create Access Switch Policy Group** dialog box, perform the following actions:

- a) In the **Name** field, enter a name for the policy group.
- b) (Optional) In the **Description** field, enter a description of the policy group.
- c) Choose a BFD policy type (**BFD IPV4 Policy** or **BFD IPV6 Policy**), then select a value (**default** or **Create BFD Global Ipv4 Policy** for a specific switch or set of switches).

d) Click **Update**.

Step 7 Click **Next** to advance to **Associations**.

(Optional) In the **Associations** menu, you can associate the leaf profile with leaf interface profiles and access module profiles.

Step 8 Click **Finish**.

Another way to create a BFD global policy is to right-click on either **BFD IPV4** or **BFD IPV6** in the **Navigation** pane.

Step 9 To view the BFD global configuration you created, in the **Navigation** pane, expand **Policies > Switch > BFD**.

Configuring BFD Globally on Spine Switch Using the GUI

Procedure

Step 1 On the menu bar, choose **Fabric > Access Policies**.

Step 2 In the **Navigation** pane, expand **Policies > Switch > BFD**.

There are two types of bidirectional forwarding detection (BFD) configurations available:

- BFD IPV4
- BFD IPV6

For each of these BFD configurations, you can choose to use the default policy or create a new one for a specific switch (or set of switches).

Note

By default, the APIC controller creates default policies when the system comes up. These default policies are global, bi-directional forwarding detection (BFD) configuration policies. You can set attributes within that default global policy in the **Work** pane, or you can modify these default policy values. However, once you modify a default global policy, note that your changes affect the entire system (all switches). If you want to use a specific configuration for a particular switch (or set of switches) that is not the default, create a switch profile as described in the next step.

Step 3 To create a spine switch profile for a specific global BFD policy (which is not the default), in the **Navigation** pane, expand **Switches > Spine Switches > Profiles**.

The **Spine Switches - Profiles** screen appears in the **Work** pane.

Step 4 On the right side of the **Work** pane, under the actions icon, select **Create Spine Profile**.

The **Create Spine Profile** dialog box appears.

Step 5 In the **Create Spine Profile** dialog box, perform the following actions:

- a) In the **Name** field, enter a name for the switch profile.
- b) In the **Description** field, enter a description of the profile. (This step is optional.)
- c) (Optional) In the **Spine Selectors** toolbar, click +
- d) Enter the appropriate values for **Name** (name the switch), **Blocks** (select the switch), and **Policy Group** (select **Create Spine Switch Policy Group**).

The **Create Spine Switch Policy Group** dialog box appears where you can specify the Policy Group identity properties.

- Step 6** (If configuring a spine selector) In the **Create Spine Switch Policy Group** dialog box, perform the following actions:
- In the **Name** field, enter a name for the policy group.
 - (Optional) In the **Description** field, enter a description of the policy group.
 - Choose a BFD policy type (**BFD IPV4 Policy** or **BFD IPV6 Policy**), then select a value (**default** or **Create BFD Global Ipv4 Policy** for a specific switch or set of switches).
 - Click **Update**.
- Step 7** Click **Next** to advance to **Associations**.
- (Optional) In the **Associations** menu, you can associate the spine profile with spine interface profiles.
- Step 8** Click **Finish**.
- Another way to create a BFD global policy is to right-click on either **BFD IPV4** or **BFD IPV6** in the **Navigation** pane.
- Step 9** To view the BFD global configuration you created, in the **Navigation** pane, expand the **Policies > Switch > BFD**.

Configuring BFD Interface Override Using the GUI

There are three supported interfaces (routed Layer 3 interfaces, the external SVI interface, and the routed sub-interfaces) on which you can configure an explicit bi-directional forwarding detection (BFD) configuration. If you don't want to use the global configuration, yet you want to have an explicit configuration on a given interface, you can create your own global configuration, which gets applied to all the interfaces on a specific switch or set of switches. This interface override configuration should be used if you want more granularity on a specific switch on a specific interface.



Note When a BFD interface policy is configured over a parent routed interface, by default all of its routed sub-interfaces with the same address family as that of the parent interface will inherit this policy. If any of the inherited configuration needs to be overridden, configure an explicit BFD interface policy on the sub-interfaces. However, if **Admin State** or **Echo Admin State** is disabled on the parent interface, the property cannot be overridden on the sub-interfaces.

Before you begin

A tenant has already been created.

Procedure

- Step 1** On the menu bar, choose **Tenant**.
- Step 2** In the **Navigation** pane (under Quick Start), expand the Tenant you created *Tenant_name* > **Networking > L3Outs**.
- Step 3** Right-click on **L3Outs** and select **Create L3Out**.
The **Create L3Out** wizard appears.
- Step 4** Enter the necessary information in the **Identity** window of the **Create L3Out** wizard.

- a) Enter the necessary information in the **Name**, **VRF** and **L3 Domain** fields.
- b) In the area with the routing protocol check boxes, choose **BGP**.
- c) Click **Next** to move to the **Nodes and Interfaces** window.

Step 5 Enter the necessary information in the **Nodes and Interfaces** window of the **Create L3Out** wizard.

- a) In the **Layer 3** area, select **Routed**.
- b) From the **Node ID** field drop-down menu, choose the node for the L3Out.

For the topology in these examples, use node 103.

- c) In the **Router ID** field, enter the router ID.
- d) (Optional) You can configure another IP address for a loopback address, if necessary.

The **Loopback Address** field is automatically populated with the same entry that you provide in the **Router ID** field. This is the equivalent of the **Use Router ID for Loopback Address** option in previous builds. Enter a different IP address for a loopback address, if you don't want to use route ID for the loopback address, or leave this field empty if you do not want to use the router ID for the loopback address.

- e) Enter necessary additional information in the **Nodes and Interfaces** window.

The fields shown in this window varies, depending on the options that you select in the **Layer 3** and **Layer 2** areas.

- f) When you have entered the remaining additional information in the **Nodes and Interfaces** window, click **Next**.

The **Protocols** window appears.

Step 6 Enter the necessary information in the **Protocols** window of the **Create L3Out** wizard.

- a) In the **BGP Loopback Policies** and **BGP Interface Policies** areas, enter the following information:
 - **Peer Address**: Enter the peer IP address
 - **EBGP Multihop TTL**: Enter the connection time to live (TTL). The range is from 1 to 255 hops; if zero, no TTL is specified. The default is zero.
 - **Remote ASN**: Enter a number that uniquely identifies the neighbor autonomous system. The Autonomous System Number can be in 4-byte as plain format from 1 to 4294967295.

Note

ACI does not support asdot or asdot+ format AS numbers.

- b) In the **OSPF** area, choose the default OSPF policy, a previously created OSPF policy, or **Create OSPF Interface Policy**.
- c) Click **Next**.

The **External EPG** window appears.

Step 7 Enter the necessary information in the **External EPG** window of the **Create L3Out** wizard.

- a) In the **Name** field, enter a name for the external network.
- b) In the **Provided Contract** field, enter the name of a provided contract.
- c) In the **Consumed Contract** field, enter the name of a consumed contract.
- d) In the **Default EPG for all external networks** field, uncheck if you don't want to advertise all the transit routes out of this L3Out connection.

The Subnets area appears if you uncheck this box. Specify the desired subnets and controls as described in the following steps.

e) Click **Finish** to complete the necessary configurations in the **Create L3Out** wizard.

- Step 8** Navigate to **Tenants > tenant_name > Networking > L3Outs > L3Out_name > Logical Node Profiles > logical_node_profile_name > Logical Interface Profiles > logical_interface_profile_name**
- Step 9** In the **Logical Interface Profile** window, scroll down to the **Create BFD Interface Profile** field, then check the box next to this field.
- Step 10** In the **Create BFD Interface Profile** window, enter BFD details.
- In the **Authentication Type** field, choose **No authentication** or **Keyed SHA1**.
If you choose to authenticate (by selecting Keyed SHA1), enter the **Authentication Key ID**, enter the **Authentication Key** (password), then confirm the password by re-entering it next to **Confirm Key**.
 - In the **BFD Interface Policy** field, select either the **common/default** configuration (the default BFD policy), or create your own BFD policy by selecting **Create BFD Interface Policy**.
If you select **Create BFD Interface Policy**, the **Create BFD Interface Policy** dialog box appears where you can define the BFD interface policy values.
- Step 11** Click **SUBMIT**.
- Step 12** To see the configured interface level BFD policy, navigate to **Policies > Protocol > BFD**.

Configuring BFD Consumer Protocols Using the GUI

This procedure provides the steps to enable bi-directional forwarding detection (BFD) in the consumer protocols (OSPF, BGP, EIGRP, Static Routes, and IS-IS), which are consumers of the BFD feature. To consume the BFD on these protocols, you must enable a flag in them.



Note These four consumer protocols are located in the left navigation pane under **Tenant > Policies > Protocol**.

Before you begin

A tenant has already been created.

Procedure

- Step 1** Create an L3Out using the **Create L3Out** wizard.
- Step 2** On the menu bar, choose **Tenant**.
- Step 3** To configure BFD in the BGP protocol, in the **Navigation** pane (under Quick Start), expand the Tenant you created **Tenant_name > Policies > Protocol > BGP > BGP Peer Prefix**.
- Step 4** On the right side of the **Work** pane, under **ACTIONS**, select **Create BGP Peer Prefix Policy**. The **Create BGP Peer Prefix Policy** dialog box appears.

Note

You can also right-click on **BGP Peer Prefix** from the left navigation pane to select **Create BGP Peer Prefix** to create the policy.

- Step 5** Enter a name in the **Name** field and provide values in the remaining fields to define the BGP peer prefix policy.
- Step 6** Click **Submit**.
The BGP peer prefix policy you created now appears under **BGP Peer Prefix** in the left navigation pane.
- Step 7** Navigate to **Tenants > tenant_name > Networking > L3Outs > L3Out_name > Logical Node Profiles > logical_node_profile_name > Logical Interface Profiles > logical_interface_profile_name > BGP Peer Connectivity Profile**.
- Step 8** In the **BGP Peer Connectivity Profile** window, scroll down to the BGP Peer Prefix Policy field and select the BGP peer prefix policy that you just created.
- Step 9** In the **Peer Controls** field, select **Bidirectional Forwarding Detection** to enable BFD on the BGP consumer protocol (or uncheck the box to disable BFD).
- Step 10** To configure BFD in the OSPF protocol, in the **Navigation** pane, go to **Policies > Protocol > OSPF > OSPF Interface**.
- Step 11** On the right side of the **Work** pane, under **ACTIONS**, select **Create OSPF Interface Policy**.
The **Create OSPF Interface Policy** dialog box appears.

Note

You can also right-click on **OSPF Interface** from the left navigation pane and select **Create OSPF Interface Policy** to create the policy.

- Step 12** Enter a name in the **Name** field and provide values in the remaining fields to define the OSPF interface policy.
- Step 13** In the **Interface Controls** section of this dialog box, you can enable or disable BFD. To enable it, check the box next to **BFD**, which adds a flag to the OSPF consumer protocol, shown as follows (or uncheck the box to disable BFD).
- Step 14** Click **Submit**.
- Step 15** To configure BFD in the EIGRP protocol, in the **Navigation** pane, go back to **tenant_name > Policies > Protocol > EIGRP > EIGRP Interface**.
- Step 16** On the right side of the **Work** pane, under **ACTIONS**, select **Create EIGRP Interface Policy**.
The **Create EIGRP Interface Policy** dialog box appears.

Note

You can also right-click on **EIRGP Interface** from the left navigation pane and select **Create EIGRP Interface Policy** to create the policy.

- Step 17** Enter a name in the **Name** field and provide values in the remaining fields to define the OSPF interface policy.
- Step 18** In the **Control State** section of this dialog box, you can enable or disable BFD. To enable it, check the box next to **BFD**, which adds a flag to the EIGRP consumer protocol (or uncheck the box to disable BFD).
- Step 19** Click **Submit**.
- Step 20** To configure BFD in the Static Routes protocol, in the **Navigation** pane, go back to **Networking > L3Outs > L3Out_name > Configured Nodes**, then click on the configured node to bring up the **Node Association** window.
- Step 21** In the **Static Routes** section, click the "+" (expand) button.
The **Create Static Route** dialog box appears. Enter values for the required fields in this section.
- Step 22** Next to **Route Control**, check the box next to **BFD** to enable (or uncheck the box to disable) BFD on the specified Static Route.

- Step 23** Click **Submit**.
- Step 24** To configure BFD in the IS-IS protocol, in the **Navigation** pane go to **Fabric > Fabric Policies > Policies > Interface > L3 Interface**.
- Step 25** On the right side of the **Work** pane, under **ACTIONS**, select **Create L3 Interface Policy**. The **Create L3 Interface Policy** dialog box appears.
- Note**
You can also right-click on **L3 Interface** from the left navigation pane and select **Create L3 Interface Policy** to create the policy.
- Step 26** Enter a name in the **Name** field and provide values in the remaining fields to define the L3 interface policy.
- Step 27** To enable BFD ISIS Policy, in the BFD ISIS Policy Configuration field, click **enabled**.
- Step 28** Click **Submit**.
-

BFD Multihop

BFD multihop provides subsecond forwarding failure detection for a destination with more than one hop and up to 255 hops. Beginning with Release 5.0(1), APIC supports BFD multihop for IPv4 and BFD multihop for IPv6 in compliance with RFC5883. BFD multihop sessions are set up between a unique source and destination address pair. A BFD multihop session is created between a source and destination rather than with an interface, as with single-hop BFD sessions.

BFD multihop sets the TTL field to the maximum limit supported by BGP, and does not check the value on reception. The ACI leaf has no impact on the number of hops a BFD multihop packet can traverse, but the number of hops is limited to 255.

Guidelines and Limitations for BFD Multihop

- The default and minimum transmit and receive interval timers for BFD multihop are 250 ms.
- The default and minimum detection multiplier is 3.
- Echo mode is not supported for BFD multihop.

Configuring a BFD Multihop Policy

You can configure a BFD multihop policy in several locations in the GUI, depending on the purpose of the policy.

- **Global Policies:** By default, the APIC controller creates default policies when the system comes up. These default policies are global BFD multihop configuration policies. You can set attributes within the default global policy in the **Work** pane, or you can modify these default policy values. However, once you modify a default global policy, your changes affect the entire system (all switches). If you want to use a specific configuration for a particular switch or set of switches that isn't the default, create a switch profile and modify the BFD multihop values in the switch profile.

You can create or modify global BFD multihop configuration policies for IPv4 or IPv6 in these GUI locations:

- **Fabric > Access Policies > Policies > Switch > BFD Multihop > BFD Multihop IPv4:** right-click and select **Create BFD Global IPv4 MH Policy**.

- **Fabric > Access Policies > Policies > Switch > BFD Multihop > BFD Multihop IPv6**: right-click and select **Create BFD Global IPv6 MH Policy**.

- **Node Policies**: A BFD Multihop node policy applies to interfaces under a node profile.

You can create or modify BFD multihop node policies in this GUI location:

- **Tenants > tenant > Policies > Protocol > BFD Multihop > Node Policies**: right-click and select **Create BFD Multihop Node Policy**.

- **Interface Policies**: A BFD Multihop interface policy applies to interfaces under an interface profile.

You can create or modify BFD multihop interface policies in this GUI location:

- **Tenants > tenant > Policies > Protocol > BFD Multihop > Interface Policies**: right-click and select **Create BFD Multihop Interface Policy**.

- **Overriding Global Policies**: If you don't want to use the default global configuration, but you want to have an explicit configuration on a given interface, you can create your own global configuration. This configuration is then applied to all the interfaces on a specific switch or set of switches. You can use this interface override configuration when you want more granularity on a specific switch on a specific interface.

You can create or modify BFD multihop override policies for a node profile or interface profile in these GUI locations:

- **Tenants > tenant > Networking > L3Outs > l3out > Logical Node Profiles > logical_node_profile**: right-click, select **Create BFD Interface Protocol Profile**, specify BFD Multihop node policy.
- **Tenants > tenant > Networking > L3Outs > l3out > Logical Node Profiles > logical_node_profile > Logical Interface Profiles > logical_interface_profile**: right-click, select **Create MH-BFD Interface Protocol Profile**, specify BFD Multihop interface policy.
- **Tenants > infra > Networking > SR-MPLS Infra L3Outs > l3out > Logical Node Profiles > logical_node_profile > Logical Interface Profiles > logical_interface_profile**: right-click, select **Create MH-BFD Interface Profile**, specify BFD Multihop interface policy.

Procedure

Step 1 Navigate to the GUI location where you will create or configure the BFD multihop policy.

Step 2 Edit an existing profile or policy or launch the dialog box to create a new profile.

Step 3 In the profile, choose an **Authentication Type** for BFD multihop sessions.

You can choose to require no authentication or SHA-1 authentication.

Step 4 If you are creating a new policy, configure the settings in the dialog box:

- Enter a **Name** for the policy.
- Set the **Admin State** to **Enabled**.
- Set the **Detection Multiplier** value.

Specifies the minimum number of consecutive packets that can be missed before BFD declares a session to be down. The range is from 1 to 50 packets. The default is 3.

- d) Set the **Minimum Transmit Interval** value.

The minimum interval time for packets being transmitted. The range is from 250 to 999 milliseconds. The default is 250.

- e) Set the **Maximum Receive Interval** value.

The maximum interval time for packets being received. The range is from 250 to 999 milliseconds. The default is 250.

- f) Click **Submit**.

Micro BFD

Beginning with Cisco APIC Release 5.2(3), APIC supports Micro BFD, as defined in IETF RFC 7130. When Bidirectional Forwarding Detection (BFD) is configured on a port channel, keep-alive packets are sent on any available member link. The failure of a single member link might not be detected, because the keep-alive packets can merely traverse a remaining link. Micro BFD is an enhancement to BFD that establishes individual BFD sessions on each member link of a port channel, as shown in the following figure.

Figure 39: Micro BFD Sessions on a Port Channel

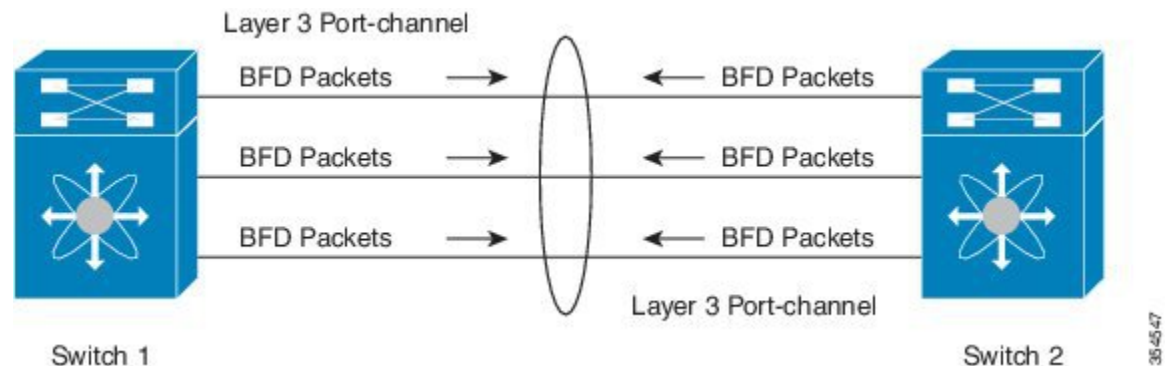

When a per-link BFD session senses a failure on its member link, the failed link is removed from the forwarding table. This mechanism delivers faster failure detection and assists in identifying which link has failed on the port channel.

Guidelines and Limitations for Micro BFD

- Micro BFD is supported on both LACP and non-LACP port channels.
- Micro BFD can run simultaneously with multi-hop BFD on the same port channel, but not with single-hop BFD.
- Micro BFD is a single-hop BFD implementation. It does not function if a Layer 2 switch exists between the main port channel on a switch and the switch's peer.
- Micro BFD is not supported on first-generation leaf switches. First-generation switches are those that do not contain a suffix, such as -EX or -FX, in the PID (product identifier).
- Micro BFD is supported only on the routed interface over a port channel.

- Client protocols can run on a sub-interface on the same port-channel where Micro BFD is enabled.
- Micro BFD is not supported on FEX ports or fabric ports.
- BFD Echo is not supported on Micro BFD sessions.
- On a dual IP stack port channel (IPv4 and IPv6) with Micro BFD enabled, you must configure Micro BFD with either an IPv4 address or an IPv6 address but not both. You cannot have both IPv4 and IPv6 Micro BFD sessions.
- Beginning with Cisco APIC Release 5.2(3), Cisco APIC allows using L3 port channel main interface along with sub-interfaces on the same L3 port channel. But creating or deleting L3 port channel main interface will flap port channel physical member ports. This will cause traffic loss if the port channel sub-interfaces are already active.

Configuring Micro BFD on a Port Channel

This procedure modifies an L3Out port channel interface to enable Micro BFD. Micro BFD establishes individual BFD sessions on each member link of a port channel.

Before you begin

- A direct port channel is configured for an L3Out interface.

Procedure

-
- Step 1** Navigate to **Tenants > *tenant_name* > Networking > L3Outs > *L3Out_name* > Logical Node Profiles > *logical_node_profile_name* > Logical Interface Profiles**
- Step 2** Select the **Logical Interface Profile** that you want to modify.
- Step 3** Select the **Routed Interfaces** tab.
- Micro BFD is supported only on the routed interface over a port channel.
- Step 4** In the **Routed Interfaces** section, double click the existing interface to modify it, or click the + icon to add a new interface to the Logical Interface Profile.
- The remaining steps of this procedure describe only the enabling of Micro BFD on an existing logical interface. If you are adding a new interface to the Logical Interface Profile, refer to [Modifying Interfaces for L3Out Using the GUI, on page 241](#).
- Step 5** In the configured properties of the selected interface, verify that the selected **Path Type** is **Direct Port Channel**.
- Micro BFD is applicable only on a port channel.
- Step 6** Check the checkbox for **Enable Micro BFD**.
- Step 7** Type the destination IP address of the port channel in **Micro BFD Destination Address**.
- Step 8** Enter a value between 60 to 3600 seconds in **Micro BFD Start Timer (sec)**.
- The start timer delays activation of BFD monitoring on member links in order to allow BFD sessions to establish. The timer is optional. If the timer is not configured, activation is not delayed.

Step 9 Click **Submit**.**What to do next**

You can verify the Micro BFD sessions using the CLI, as shown in the following example:

```
leaf4# show port-channel database interface port-channel 3
port-channel3
Last membership update is successful
4 ports in total, 4 ports up
First operational port is Ethernet1/44
Age of the port-channel is 0d:22h:46m:03s
Time since last bundle is 0d:22h:42m:43s
Last bundled member is Ethernet1/44
Ports: Ethernet1/41 [on] [up]
Ethernet1/42 [on] [up]
Ethernet1/43 [on] [up]
Ethernet1/44 [on] [up] *
```

```
leaf4# show bfd neighbors vrf tenant1:vrf1

OurAddr NeighAddr
LD/RD RH/RS Holdown(mult) State Int Vrf Type

2003:190:190:1::1 2003:190:190:1::2
1090519041/0 Up 6000(3) Up Po3 tenant1:vrf1 singlehop

2003:190:190:1::1 2003:190:190:1::2
1090519042/2148074790 Up 180(3) Up Eth1/44 tenant1:vrf1 singlehop

2003:190:190:1::1 2003:190:190:1::2
1090519043/2148074787 Up 180(3) Up Eth1/41 tenant1:vrf1 singlehop

2003:190:190:1::1 2003:190:190:1::2
1090519044/2148074789 Up 180(3) Up Eth1/43 tenant1:vrf1 singlehop

2003:190:190:1::1 2003:190:190:1::2
1090519045/2148074788 Up 180(3) Up Eth1/42 tenant1:vrf1 singlehop
```

OSPF External Routed Networks

Use the procedures in the following sections to configure OSPF external routed networks.

OSPF Layer 3 Outside Connections

OSPF Layer 3 Outside connections can be normal or NSSA areas. The backbone (area 0) area is also supported as an OSPF Layer 3 Outside connection area. Cisco Application Centric Infrastructure (ACI) supports both OSPFv2 for IPv4 and OSPFv3 for IPv6. When creating an OSPF Layer 3 Outside, it is not necessary to configure the OSPF version. The correct OSPF process is created automatically based on the interface profile configuration (IPv4 or IPv6 addressing). Both IPv4 and IPv6 protocols are supported on the same interface (dual stack) but it is necessary to create two separate interface profiles.

Layer 3 Outside connections are supported for the routed interfaces, routed sub-interfaces, and SVIs. The SVIs are used when there is a need to share the physical connect for both Layer 2 and Layer 3 traffic. The SVIs are supported on ports, port channels, and virtual port channels.

Figure 40: OSPF Layer3 Out Connections

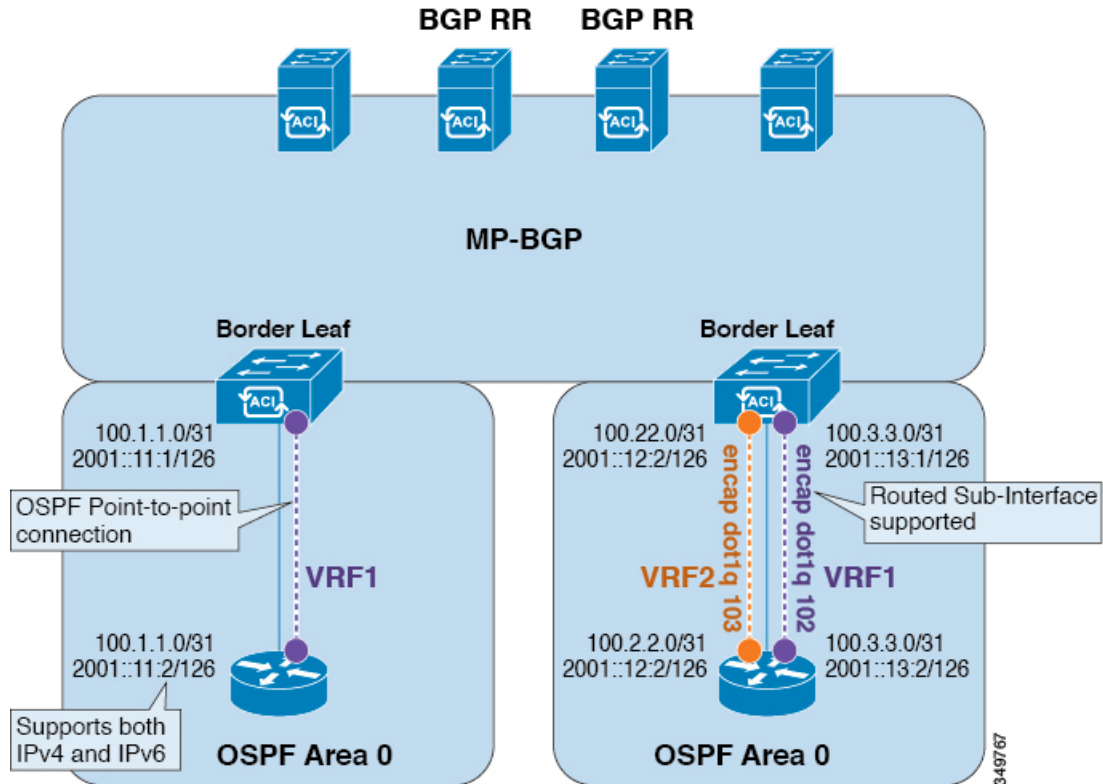

When an SVI is used for a Layer 3 Outside connection, an external bridge domain is created on the border leaf switches. The external bridge domain allows connectivity between the two vPC switches across the Cisco ACI fabric. This allows both the vPC switches to establish the OSPF adjacencies with each other and the external OSPF device.

When running OSPF over a broadcast network, the time to detect a failed neighbor is the dead time interval (default 40 seconds). Reestablishing the neighbor adjacencies after a failure may also take longer due to designated router (DR) election.

**Note**

- A link or port channel failure to one vPC node does not cause OSPF adjacency to go down. OSPF adjacency can stay up using the external bridge domain that is accessible through the other vPC node.
- When an OSPF time policy or a OSPF or EIGRP address family policy is applied to an L3Out, you can observe the following behaviors:
 - If the L3Out and the policy are defined in the same tenant, then there is no change in behavior.
 - If the L3Out is configured in a user tenant other than the common tenant, the L3Out VRF instance is resolved to the common tenant, and the policy is defined in the common tenant, then only the default values are applied. Any change in the policy will not take effect.
- If a border leaf switch forms OSPF adjacency with two external switches and one of the two switches experiences a route loss while the adjacent switches does not, the Cisco ACI border leaf switch reconverges the route for both neighbors.
- OSPF supports aggressive timers. However, these timers quickly bring down the adjacency and cause CPU churn. Therefore, we recommend that you use the default timers and use bidirectional forwarding detection (BFD) to get sub-second failure detection.

Creating an OSPF L3Out for Management Tenant Using the GUI

- You must verify that the router ID and the logical interface profile IP address are different and do not overlap.
- The following steps are for creating an OSPF L3Out for a management tenant. To create an OSPF L3Out for a tenant, you must choose a tenant and create a VRF for the tenant.
- For more details, see *Cisco APIC and Transit Routing*.

Procedure

-
- Step 1** On the menu bar, choose **Tenants > mgmt**.
- Step 2** In the **Navigation** pane, expand **Networking > L3Outs**.
- Step 3** Right-click **L3Outs**, and click **Create L3Out**.
The **Create L3Out** wizard appears.
- Step 4** In the **Identity** window in the **Create L3Out** wizard, perform the following actions:
- a) In the **Name** field, enter a name (RtdOut).
 - b) In the **VRF** field, from the drop-down list, choose the VRF (inb).
- Note**
This step associates the routed outside with the in-band VRF.
- c) From the **L3 Domain** drop-down list, choose the appropriate domain.
 - d) Check the **OSPF** check box.

- e) In the **OSPF Area ID** field, enter an area ID.
- f) In the **OSPF Area Control** field, check the appropriate check box.
- g) In the **OSPF Area Type** field, choose the appropriate area type.
- h) In the **OSPF Area Cost** field, choose the appropriate value.
- i) Click **Next**.

The **Nodes and Interfaces** window appears.

Step 5 In the **Nodes and Interfaces** window, perform the following actions:

- a) Uncheck the **Use Defaults** box.

This allows you to edit the **Node Profile Name** field.

- b) In the **Node Profile Name** field, enter a name for the node profile. (borderLeaf).
- c) In the **Node ID** field, from the drop-down list, choose the first node. (leaf1).
- d) In the **Router ID** field, enter a unique router ID.
- e) In the **Loopback Address** field, use a different IP address or leave this field empty if you do not want to use the router ID for the loopback address.

Note

The **Loopback Address** field is automatically populated with the same entry that you provide in the **Router ID** field. This is the equivalent of the **Use Router ID for Loopback Address** option in previous builds. Use a different IP address or leave this field empty if you do not want to use the router ID for the loopback address.

- f) Enter the appropriate information in the **Interface**, **IP Address**, **Interface Profile Name** and **MTU** fields for this node, if necessary.
- g) In the **Nodes** field, click + icon to add a second set of fields for another node.

Note

You are adding a second node ID.

- h) In the **Node ID** field, from the drop-down list, choose the first node. (leaf1).
- i) In the **Router ID** field, enter a unique router ID.
- j) In the **Loopback Address** field, use a different IP address or leave this field empty if you do not want to use the router ID for the loopback address.

Note

The **Loopback Address** field is automatically populated with the same entry that you provide in the **Router ID** field. This is the equivalent of the **Use Router ID for Loopback Address** option in previous builds. Use a different IP address or leave this field empty if you do not want to use the router ID for the loopback address.

- k) Enter the appropriate information in the **Interface**, **IP Address**, **Interface Profile Name** and **MTU** fields for this node, if necessary.
- l) Click **Next**.

The **Protocols** window appears.

Step 6 In the **Protocols** window, in the **Policy** area, click **default**, then click **Next**.

The **External EPG** window appears.

Step 7 In the **External EPG** window, perform the following actions:

- a) In the **Name** field, enter a name for the external network (extMgmt).
- b) Uncheck the **Default EPG for all external networks** field.
The **Subnets** area appears.
- c) Click + to access the **Create Subnet** dialog box.
- d) In the **Create Subnet** dialog box, in the **IP address** field, enter an IP address and mask for the subnet.
- e) In the **Scope** field, check the desired check boxes. Click **OK**.
- f) In the **External EPG** dialog box, click **Finish**.

Note

In the **Work** pane, in the **L3Outs** area, the L3Out icon (RtdOut) is now displayed.

EIGRP External Routed Networks

Use the procedures in the following sections to configure EIGRP external routed networks.

About EIGRP Layer 3 Outside Connections

This example shows how to configure Enhanced Interior Gateway Routing Protocol (EIGRP) when using the Cisco APIC. The following information applies when configuring EIGRP:

- The tenant, VRF, and bridge domain must already be created.
- The Layer 3 outside tenant network must already be configured.
- The route control profile under routed outside must already be configured.
- The EIGRP VRF policy is the same as the EIGRP family context policy.
- EIGRP supports only export route control profile. The configuration related to route controls is common across all the protocols.

You can configure EIGRP to perform automatic summarization of subnet routes (route summarization) into network-level routes. For example, you can configure subnet 131.108.1.0 to be advertised as 131.108.0.0 over interfaces that have subnets of 192.31.7.0 configured. Automatic summarization is performed when there are two or more network router configuration commands configured for the EIGRP process. By default, this feature is enabled. For more information, see *Route Summarization*.

EIGRP Protocol Support

EIGRP protocol is modeled similar to other routing protocols in the Cisco Application Centric Infrastructure (ACI) fabric.

Supported Features

The following features are supported:

- IPv4 and IPv6 routing
- Virtual routing and forwarding (VRF) and interface controls for each address family

- Redistribution with OSPF across nodes
- Default route leak policy per VRF
- Passive interface and split horizon support
- Route map control for setting tag for exported routes
- Bandwidth and delay configuration options in an EIGRP interface policy
- Authentication support

Unsupported Features

The following features are not supported:

- Stub routing
- EIGRP used for BGP connectivity
- Multiple EIGRP `L3extOuts` on the same node
- Per-interface summarization (an EIGRP summary policy will apply to all interfaces configured under an `L3Out`)
- Per interface distribute lists for import and export

Categories of EIGRP Functions

EIGRP functions can be broadly categorized as follows:

- Protocol policies
- `L3extOut` configurations
- Interface configurations
- Route map support
- Default route support
- Transit support

Primary Managed Objects That Support EIGRP

The following primary managed objects provide EIGRP support:

- **EIGRP Address Family Context Policy** `eigrpCtxAfPol`: Address Family Context policy configured under `fvTenant` (Tenant/Protocols).
- `fvRsCtxToEigrpCtxAfPol`: Relation from a VRF to a `eigrpCtxAfPol` for a given address family (IPv4 or IPv6). There can be only one relation for each address family.
- `eigrpIfPol`: EIGRP Interface policy configured in `fvTenant`.
- `eigrpExtP`: Enable flag for EIGRP in an `L3extOut`.
- `eigrpIfP`: EIGRP interface profile attached to an `L3extLIfP`.

- `eigrpRsIfPol`: Relation from EIGRP interface profile to an `eigrpIfPol`.
- `DefrtLeak`: Default route leak policy under an `L3ExtOut`.

EIGRP Protocol Policies Supported Under a Tenant

The following EIGRP protocol policies are supported under a tenant:

- **EIGRP Interface policy** (`eigrpIfPol`)—contains the configuration that is applied for a given address family on an interface. The following configurations are allowed in the interface policy:
 - *Hello interval* in seconds
 - *Hold interval* in seconds
 - One or more of the following interface control flags:
 - *split horizon*
 - *passive*
 - *next hop self*
- **EIGRP Address Family Context Policy** (`eigrpCtxAfPol`)—contains the configuration for a given address family in a given VRF. An `eigrpCtxAfPol` is configured under tenant protocol policies and can be applied to one or more VRFs under the tenant. An `eigrpCtxAfPol` can be enabled on a VRF through a relation in the VRF-per-address family. If there is no relation to a given address family, or the specified `eigrpCtxAfPol` in the relation does not exist, then the default VRF policy created under the `common` tenant is used for that address family.

The following configurations are allowed in the `eigrpCtxAfPol`:

- Administrative distance for internal route
- Administrative distance for external route
- Maximum ECMP paths allowed
- Active timer interval
- Metric version (32-bit / 64-bit metrics)

Guidelines and Limitations When Configuring EIGRP

When configuring EIGRP, follow these guidelines:

- Configuring EIGRP and BGP for the same Layer 3 outside is not supported.
- Configuring EIGRP and OSPF for the same Layer 3 outside is not supported.
- There can be one EIGRP Layer 3 Out per node per VRF. If multiple VRFs are deployed on a node, each VRF can have its own Layer 3 Out.
- Multiple EIGRP peers from a single Layer 3 Out is supported. This enables you to connect to multiple EIGRP devices from the same node with a single Layer 3 Out.

The following configurations will cause the EIGRP neighbors to flap:

- Changing administrative distances or metric style (wide/narrow) through an EIGRP address family context in the VRF
- Setting the following configurations that will cause a table-map used internally to be updated:
 - Changing the route tag for the VRF
 - Setting configurations of import direction route control for an OSPF L3Out in the same VRF on the same border leaf switch as an EIGRP L3Out (for example, enabling or disabling the Route Control Enforcement “Import” option or changing routes that are allowed or denied for the import direction). Note that such configurations are not allowed in an EIGRP L3Out itself as the feature is not supported for EIGRP. However, the configurations in an OSPF L3Out still impacts EIGRP L3Outs in the same VRF and leaf switch. This is because the import route control for OSPF utilizes a table-map that is shared, for other purposes, with EIGRP in the same VRF on the same border leaf switch.

Configuring EIGRP Using the GUI

Procedure

-
- Step 1** On the menu bar, choose **Tenants > All Tenants**.
- Step 2** In the **Work** pane, double click a tenant.
- Step 3** In the **Navigation** pane, expand the *Tenant_name* > **Policies > Protocol > EIGRP**.
- Step 4** Right-click **EIGRP Address Family Context** and choose **Create EIGRP Address Family Context Policy**.
- Step 5** In the **Create EIGRP Address Family Context Policy** dialog box, perform the following actions:
- In the **Name** field, enter a name for the context policy.
 - In the **Active Interval (min)** field, choose an interval timer.
 - In the **External Distance** and the **Internal Distance** fields, choose the appropriate values.
 - In the **Maximum Path Limit** field, choose the appropriate load balancing value between interfaces (per node/per leaf switch).
 - In the **Metric Style** field, choose the appropriate metric style. Click **Submit**.
- In the **Work** pane, the context policy details are displayed.
- Step 6** To apply the context policy on a VRF, in the **Navigation** pane, expand **Networking > VRFs**.
- Step 7** Choose the appropriate VRF, and in the **Work** pane under the **Policy** tab, expand **EIGRP Context Per Address Family**.
- Step 8** In the **EIGRP Address Family Type** drop-down list, choose an IP version.
- Step 9** In the **EIGRP Address Family Context** drop-down list, choose the context policy. Click **Update**, and Click **Submit**.
- Step 10** To enable EIGRP within the Layer 3 Out, in the **Navigation** pane, click **Networking > L3Outs**, and click the desired Layer 3 outside network.
- Step 11** In the **Work** pane under the **Policy** tab, check the checkbox for **EIGRP**, and enter the EIGRP Autonomous System number. Click **Submit**.
- Step 12** To create an EIGRP interface policy, in the **Navigation** pane, click *Tenant_name* > **Policies > Protocol > EIGRP** and perform the following actions:
- Right-click **EIGRP Interface**, and click **Create EIGRP Interface Policy**.

- b) In the **Create EIGRP Interface Policy** dialog box, in the **Name** field, enter a name for the policy.
- c) In the **Control State** field, check the desired checkboxes to enable one or multiple controls.
- d) In the **Hello Interval (sec)** field, choose the desired interval.
- e) In the **Hold Interval (sec)** field, choose the desired interval. Click **Submit**.
- f) In the **Bandwidth** field, choose the desired bandwidth.
- g) In the **Delay** field, choose the desired delay in tens of microseconds or pico seconds.

In the **Work** pane, the details for the EIGRP interface policy are displayed.

Step 13

In the **Navigation** pane, click the appropriate external routed network where EIGRP was enabled, expand **Logical Node Profiles** and perform the following actions:

- a) Expand an appropriate node and an interface under that node.
- b) Right-click the interface and click **Create EIGRP Interface Profile**.
- c) In the **Create EIGRP Interface Profile** dialog box, in the **EIGRP Policy** field, choose the desired EIGRP interface policy. Click **Submit**.

Note

The EIGRP VRF policy and EIGRP interface policies define the properties that are used when EIGRP is enabled. EIGRP VRF policy and EIGRP interface policies are also available as default policies if you do not want to create new policies. So, if you do not explicitly choose either one of the policies, the default policy is automatically utilized when EIGRP is enabled.

This completes the EIGRP configuration.



CHAPTER 20

Route Summarization

This chapter contains the following sections:

- [Introduction, on page 297](#)
- [Route Summarization at the L3Out External EPG Level, on page 297](#)
- [Route Filtering and Aggregation at the VRF Level, on page 298](#)
- [Guidelines and Limitations, on page 301](#)
- [Configuring Route Summarization at L3out External EPG Level Using the GUI, on page 301](#)
- [Configuring Route Control Policy in VRF Using the GUI, on page 303](#)

Introduction

Route summarization simplifies route tables by replacing many specific addresses with a single address. For example, 10.1.1.0/24, 10.1.2.0/24, and 10.1.3.0/24 can be replaced with 10.1.0.0/16. Route summarization policies enable routes to be shared efficiently among border leaf switches and their neighboring switches.

Two forms of route summarization are supported in ACI beginning in the Cisco APIC 5.2(4) release:

- **Route Summarization at the L3Out External EPG Level:**

This configuration of route summarization at the L3Out External EPG Level allows route summarization towards external L3Out peers only.

- **Route Filtering and Aggregation at the VRF Level:**

Beginning in the Cisco APIC 5.2(4) release, Cisco APIC also provides option to perform route filtering and aggregation of routes that are advertised in a fabric to reduce the scale requirements of the fabric. This feature is configured at the VRF level. Enabling route summarization at the VRF level helps to achieve summarization of routes into the ACI fabric, as well as towards external BGP L3Out peers.

Details of both of the above mentioned forms of summarization are described in the upcoming sections below.

Route Summarization at the L3Out External EPG Level

BGP, OSPF, or EIGRP route summarization policies are applied to a bridge domain or transit subnet. For OSPF, inter-area and external route summarization are supported. Summary routes are exported; they are not advertised within the fabric.

Enabling route summarization at the L3Out External EPG helps to achieve route summarization towards L3Out peers only and not within the ACI fabric. To achieve summarization of routes into the ACI fabric as well as towards external L3Out peers, see [Route Filtering and Aggregation at the VRF Level, on page 298](#).

Also, with this route summarization configured, the aggregate prefix would be advertised to external L3Out peers and more-specific prefixes would not be advertised to the L3Out peers.

Route Filtering and Aggregation at the VRF Level

By default, border leaf nodes receive many prefixes from the directly connected, static route, and routing protocols and these prefixes get redistributed in MP-BGP and these prefixes are advertised to all leaf and spine switches. Leaf switches programs all the prefixes of configured VRFs in the LPM. By using this feature, administrators can selectively import prefixes of a VRF into LPM table or export prefixes of a VRF to MP-BGP or L3Out peers.

Beginning in the Cisco APIC 5.2(4) release, Cisco APIC provides option to summarize or filter routes that are advertised in a fabric to reduce the scale requirements of the fabric.

The following route control policies are added under VRF.

BGP Route Summarization Policy

This policy allows you to aggregate prefixes to a larger subnet irrespective of whether the subnet is learned directly from an external router or not. You can specify in the policy whether to advertise only the aggregated subnets or to advertise all prefixes within the subnet. This policy controls aggregation for L3Out peers and MP-BGP.

The following configurations are available in this policy:

- **Nodes:** A list of border leaf nodes on which the route profile needs to be applied.
 - At least one border leaf must be configured for the policy to be deployed.
 - Spine switches are not supported in this policy.
 - You can configure multiple policies for each VRF instance, border leaf node pair.
 - This policy is vPC unaware. Therefore, you can configure different policies between nodes in a vPC pair.
 - This policy is applicable only for the unicast address family.
- **Subnets:** A list of subnets with each subnet pointing to the BGP route summarization policy configured under tenant.
 - You must configure at least one subnet to deploy the policy.
 - There should be no overlap between subnets that are associated with different route summarization policies for the same node.
- **BGP route summarization policy:** Using the route summarization policy control state options, you can either enable advertisement of only the aggregate prefixes to peers, or you can allow advertisement of both the aggregate as well as specific prefixes to peers.

- When you configure route summarization for the same subnet on a VRF instance as well as l3extSubnet, the Cisco APIC raises a fault. Clear this fault before performing a fabric upgrade or switch reload.
- To configure a BGP route summarization policy, see [Configuring Route Control Policy in VRF Using the GUI, on page 303](#).

Intra-VRF Import Route Control Policy

This policy allows you to control the prefixes to be registered in the routing table.

The following configurations are available in this policy:

- Nodes: A list of leaf nodes on which the route profile needs to be applied.
 - At least one leaf must be configured for the policy to be deployed.
 - Spine switches are not supported in this policy.
 - If there is no import route control policy that is configured for the VRF, leaf node, then all prefixes of the VRF from MP-BGP will be registered in the node's routing table.
 - This policy is vPC unaware. Therefore, you can configure different policies between nodes in a vPC pair.
- Route Map: Configure the same way that you configure an existing route profile configuration for a tenant. Following route-map match and set clauses are applicable in the Import Route Control configuration:

Match Clauses:

- IP Prefix List
- Community
- Extended Community (match on color extended community is not supported)
- Regex Community
- Regex Extended Community

Set Clauses:

- Community
- Extended Community
- Tag
- Weight
- Preference
- Metric

If route summarization or fabric export control is configured to suppress a prefix in MP-BGP, then this policy will not be updated in the receiver leaf's routing table even if it is allowed by the import route control policy for the leaf.

The procedures for configuring an inter-VRF import route control policy is provided in [Configuring Route Control Policy in VRF Using the GUI, on page 303](#).

VRF Export Route Control Policy

This policy allows you to control the prefixes to be advertised to a fabric.

The following configurations are available in this policy:

- Nodes: A list of border leaf nodes on which the route profile needs to be applied.
 - At least one border leaf must be configured for the policy to be deployed.
 - Spine switches are not supported in this policy.
 - If there is no export route control policy that is configured for the VRF, border leaf pair, then all prefixes of the VRF from border leaves to MP-BGP will be advertised.
 - This policy is vPC unaware. Therefore, you can configure different policies between nodes in a vPC pair.
- Route Map: Configure the same way that you configure an existing route profile configuration for a tenant. Following route-map match and set clauses are applicable to the Export Route Control configuration:

Match Clauses:

- IP Prefix List
- Community
- Extended Community (match on color extended community is not supported)
- Regex Community
- Regex Extended Community

Set Clauses:

- Community
- Extended Community (except setting extended community to **None**)
- Weight
- Preference
- Metric

The procedures for configuring a VRF export route control policy is provided in [Configuring Route Control Policy in VRF Using the GUI, on page 303](#).

Guidelines and Limitations

A route summarization policy configured under an external EPG will result in the summarized prefix being advertised to all of the BGP peers that are connected to the same border leaf switch and in the same VRF. This includes BGP peers that belong to different L3Outs if the same border leaf switch and VRF condition is met.

If you do not want this behavior to take place and you want to limit which BGP peers receive the aggregate route, block the routes where applicable using outbound route-maps on the respective L3Outs.

Configuring Route Summarization at L3out External EPG Level Using the GUI

This section explains the steps to configure route summarization associated to an L3Out External EPG. Enabling route summarization using these configuration steps helps to achieve route summarization towards L3Out peers only, and not within the ACI fabric.

Also, with the route summarization configured, the aggregate prefix would be advertised to external L3Out peers and more-specific prefixes would not be advertised to the L3Out peers.

To achieve summarization of routes into the ACI fabric as well as towards external L3Out peers, see [Configuring Route Control Policy in VRF Using the GUI, on page 303](#).

Before you begin

For each of the following configurations, you have already created an L3 Out. For the L3 Out, you can create external routed networks, subnets, and route summarization policies.

Procedure

-
- Step 1** Configure BGP route summarization using the GUI as follows:
- On the menu bar, choose **Tenants > common**
 - In the Navigation pane, expand **Networking > L3Outs**.
 - Right-click on **L3Outs**, then select **Create L3Out**.
The **Create L3Out** wizard appears.
 - In the work pane, enter the necessary information (**Name**, **VRF**, and **L3 Domain**), then check the check box next to **BGP**.
 - Click **Next**.
The **Nodes and Interfaces** window appears.
 - In the **Nodes and Interfaces** window, fill in the appropriate fields, then click **Next**.
The **Protocols** window appears.
 - In the **Protocols** window, fill in the appropriate fields, then click **Next**.
The **External EPG** window appears.
 - Enter a name in the **Name** field, then uncheck the **Default EPG for all external networks** field.
The **Subnets** field appears.
 - Click + above **Route Summarization Policy**.

The **Create Subnet** dialog box appears.

- j) In the **Specify the Subnet** dialog box, you can associate a route summarization policy to the subnet as follows:

Example:

- Enter an IP address in the **IP Address** field.
- Check the check box next to **Export Route Control Subnet**.
- Check the check box next to **External Subnets for the External EPG**.
- From the **BGP Route Summarization Policy** drop-down menu, select either **default** for an existing (default) policy or **Create BGP route summarization policy** to create a new policy.
- If you selected **Create BGP route summarization policy**, the **Create BGP Route Summarization Policy** dialog box appears. Enter a name for it in the **Name** field, check the **Control State** check box for **Generate AS-SET information**, click **Submit**, click **OK**, then click **Finish**.

Note

The **Do not advertise more specifics** control state option and **Address Type Control** option are applicable only when a policy is applied on the VRF Route Control policy. Here, both AF Ucast and AF Mcast are enabled by default.

Step 2 Configure OSPF inter-area and external summarization using the GUI as follows:

- a) On the menu bar, choose **Tenants > common**.
- b) In the Navigation pane, expand **Networking > L3Outs > External EPGs**, then click on the configured external EPG.
The overview information for that configured external EPG appears.
- c) In the work pane, click the + sign above **Route Summarization Policy**.
The **Create Subnet** dialog box appears.
- d) In the **Specify the Subnet** dialog box, you can associate a route summarization policy to the subnet as follows:

Example:

- Enter an IP address in the **IP Address** field.
- Check the check box next to **Export Route Control Subnet**.
- Check the check box next to **External Subnets for the External EPG**.
- From the **OSPF Route Summarization Policy** drop-down menu, choose either **default** for an existing (default) policy or **Create OSPF route summarization policy** to create a new policy.
- If you chose **Create OSPF route summarization policy**, the **Create OSPF Route Summarization Policy** dialog box appears. Enter a name for it in the **Name** field, check the check box next to **Inter-Area Enabled**, enter a value next to **Cost**, click **SUBMIT**.

Step 3 Configure EIGRP summarization using the GUI as follows:

- a) On the menu bar, choose **Tenants > common**
- b) In the Navigation pane, expand **Networking.> L3Outs**.
- c) Right-click on **L3Outs**, choose **Create L3Out**.
The **Create L3Out** dialog box appears.
- d) In the work pane, check the check box next to **EIGRP**.

- e) Enter a name in the **Name** field, click **NEXT**.
The **External EPG Networks** dialog box appears.
- f) In the work pane, click the + sign.
The **Define an External Network** dialog box appears.
- g) Enter a name in the **Name** field, then click the + sign above **Route Summarization Policy**.
The **Create Subnet** dialog box appears.
- h) In the **Specify the Subnet** dialog box, you can associate a route summarization policy to the subnet as follows:

Example:

- Enter an IP address in the **IP Address** field.
- Check the check box next to **Export Route Control Subnet**.
- Check the check box next to **External Subnets for the External EPG**.
- Check the check box next to **EIGRP Route Summarization**, click **OK**, click **OK**, click **FINISH**.

Configuring Route Control Policy in VRF Using the GUI

This section explains the steps to configure route summarization for a VRF. This includes steps to configure a route summarization policy, intra-VRF import route control, and VRF export route control.

Enabling route summarization using the steps in this section helps to achieve summarization of routes into the ACI fabric, as well as towards external BGP L3Out peers. Further, with the route summarization configured using the steps in this section, the more-specific prefixes may or may not be advertised along with the aggregate prefix, based on the control state option enabled.

Procedure

-
- Step 1** Navigate to **Tenants** > *tenant_name* > **Networking** > **VRFs** > *vrf_name*.
 - Step 2** On the **VRF - vrf_name** work pane, click the **Route Control** tab.
 - Step 3** Determine how you want to configure route filtering and aggregation at the VRF level.
 - To configure a BGP route summarization policy, go to [Step 4, on page 303](#).
 - To configure an inter-VRF import route control policy, go to [Step 5, on page 304](#).
 - To configure a VRF export route control policy, go to [Step 6, on page 304](#).
 - Step 4** Configure the Route Summarization Policy using the GUI as follows:
 - a) Click + next to the **Route Summarization Policy**.
The **Create Route Summarization Policy** dialog box appears.
 - b) Enter a name in the **Name** field and select switches from the **Nodes** list.
 - c) Click + next to **Subnets**.
The **Create Association of Subnet to Summarization Policy** dialog box appears.
 - d) Enter an IP address in the **Subnet** field.

- e) Select a policy from the **BGP Route Summary Policy** list.
The **Create BGP Route Summarization Policy** dialog box appears.
- f) Enter a name in the **Name** field and select the appropriate **Control State** and **Address Type Controls** options.

If the **Do not advertise more specifics** control state option in the BGP route summarization policy configuration is enabled, aggregate prefix would be advertised and more-specific prefixes would not be advertised to peers. If the **Do not advertise more specifics** option is not enabled, both the aggregate and the more-specific prefixes would be advertised to the peers.

- g) Click **Submit** and confirm the previous configurations.

Note

If the aggregate prefix is learned from L3Out peers and from the locally originated aggregate prefix at the border leafs using the route summarization policy configuration, to prefer the externally learned aggregate prefix as the BGP best path over the locally originated aggregate prefix, the incoming weight of all routes originating from the L3Out peers must be set to 32769 or greater.

Step 5 Configure the Intra-VRF Import Route Configuration Policy using the GUI as follows:

- a) Click + next to the **Intra-VRF Import Route Configuration Policy**.
The **Create VRF Import Route Control Policy** dialog box appears.
- b) Enter a name in the **Name** field and select switches from the **Nodes** list.
- c) Select a policy from the **Route Profile for Import** list.
- d) Click **Submit**.

Step 6 Configure the VRF Export Route Configuration Policy using the GUI as follows:

- a) Click + next to the **VRF Export Route Configuration Policy**.
The **Create VRF Export Route Control Policy** dialog box appears.
 - b) Enter a name in the **Name** field and select switches from the **Nodes** list.
 - c) Select a policy from the **Route Profile for Export** list.
 - d) Click **Submit**.
-



CHAPTER 21

Route Control with Route Maps and Route Profiles

This chapter contains the following sections:

- [Route Control Profile Policies](#), on page 305
- [About Route Control Per BGP Peer](#), on page 307
- [Route Maps/Profiles with Explicit Prefix Lists](#), on page 311
- [Routing Control Protocols](#), on page 321
- [Interleak Redistribution for MP-BGP](#), on page 324

Route Control Profile Policies

The ACI fabric also supports the route-map set clauses for the routes that are advertised into and out of the fabric. The route-map set rules are configured with the Route Control Profile policies and the Action Rule Profiles.



Note The ACI fabric only supports the use of route map related policies, such as match and set rules, within the tenant they were created in. If a route map related policy is created in the common tenant then it is only supported for use in the common tenant.

ACI supports the following set options:

Table 11: Action Rule Profile Properties (route-map set clauses)

Property	OSPF	EIGRP	BGP	Comments
Set Community			Yes	Supports regular and extended communities.
Set Additional Community			Yes	Supports regular and extended communities.

Property	OSPF	EIGRP	BGP	Comments
Route Tag	Yes	Yes		Supported only for BD subnets. Transit prefixes are always assigned the tag 4294967295.
Preference			Yes	Sets BGP local preference.
Metric	Yes		Yes	Sets MED for BGP. Will change the metric for EIGRP but you cannot specify the EIGRP composite metric.
Metric Type	Yes			OSPF Type-1 and OSPF Type-2.

The Route Profile Policies are created under the Layer 3 Outside connection. A Route Control Policy can be referenced by the following objects:

- Tenant BD Subnet
- Tenant BD
- External EPG
- External EPG import/export subnet

Here is an example of using Import Route Control for BGP and setting the local preference for an external route learned from two different Layer 3 Outsides. The Layer 3 Outside connection for the external connection to AS300 is configured with the Import Route Control enforcement. An action rule profile is configured to set the local preference to 200 in the Action Rule Profile for Local Preference window.

The Layer 3 Outside connection External EPG is configured with a 0.0.0.0/0 import aggregate policy to allow all the routes. This is necessary because the import route control is enforced but any prefixes should not be blocked. The import route control is enforced to allow setting the local preference. Another import subnet 151.0.1.0/24 is added with a Route Profile that references the Action Rule Profile in the External EPG settings for Route Control Profile window.

Use the **show ip bgp vrf overlay-1** command to display the MP-BGP table. The MP-BGP table on the spine displays the prefix 151.0.1.0/24 with local preference 200 and a next hop of the border leaf for the BGP 300 Layer 3 Outside connection.

There are two special route control profiles—default-import and default-export. If the user configures using the names default-import and default-export, then the route control profile is automatically applied at the Layer3 outside level for both import and export. The default-import and default-export route control profiles cannot be configured using the 0.0.0.0/0 aggregate.

A route control profile is applied in the following sequential order for fabric routes:

1. Tenant BD subnet

2. Tenant BD
3. Layer3 outside

The route control profile is applied in the following sequential order for transit routes:

1. External EPG prefix
2. External EPG
3. Layer3 outside

About Route Control Per BGP Peer

Route control policies determine what routes are advertised out to the external network (export) or allowed into the fabric (import). For Cisco APIC releases before Release 4.2(1), you configure these policies at the L3Out level, under the L3Out profile (l3extInstP) or through the L3Out subnet under the L3Out (l3extSubnet), so those policies apply to protocols configured for all nodes or paths included in the L3Out. With this configuration, there could be multiple node profiles configured in the L3Out, and each could have multiple nodes or paths with the BGP neighbor specified. Because of this, there is no way to apply individual policies to each protocol entity.

Beginning with Cisco APIC Release 4.2(1), the route control per BGP peer feature is introduced to begin to address this situation, where more granularity in route export and import control is needed.

Guidelines and Restrictions for Route Control Per BGP Peer

Following are the guidelines and restrictions for the route control per BGP peer feature:

- You must configure route profiles used per BGP peer under a tenant.
- The methods to configure route map match, set rule or route profile, and the behavior of each of those components, do not change from previous releases.
- The route profile for this feature can only be set to **Match Routing Policy Only** (global policy), where the route profile is the only source of information to generate the per BGP peer route map. You cannot set the route profile for this feature to **Match Prefix and Routing Policy**.

In addition, you must explicitly specify the BD subnets in the prefix list if you want them to be exported.

- You can only associate one route-control profile with a BGP peer for a particular direction.
- Default policy is not supported for these route-maps (only a named route profile can be applied to a BGP peer).
- If you specify a route-control profile for a BGP peer, then a route-map will be generated solely based on that information. Any route-control profile configured in the L3Out profile (l3extInstP) or through the L3Out subnet under the L3Out (l3extSubnet) will not contribute to this route-map. Similarly, if there is no per BGP peer route-control profile configuration, then the route-control profiles under the L3Out will take effect.
- If you specify a private BD subnet in the match prefix list, then it will be included. You do not have to go through additional configurations to exclude private BD subnets.

- If you configure 0.0.0.0/0 in the match prefix list, then it will match all prefixes, including BD subnets.
- Cisco APIC creates and deploys the route-map on border leaf switches with <tenant name>_<route profile name>_<L3Out name>-<direction>. For example, a route map with these settings:
 - **Tenant name:** t1
 - **Route profile name:** rp1
 - **L3Out name:** l3out1
 - **Direction:** import

will have this as the route map name: **t1_rp1_l3out1-in**

- Configuring the route control per BGP peer feature should not affect the behavior of the shared service route-map.
- Keep the following considerations in mind when upgrading or downgrading the APIC software:
 - **Upgrading the APIC software:** If you configured route profiles in the L3Out before upgrading the APIC software, then the route profiles in the L3Out will continue to behave normally until you configure a per BGP peer route profile, at which point the normal guideline and restrictions listed above would apply.
 - **Downgrading the APIC software:** If you configure a per BGP peer route profile and you want to downgrade the APIC software afterwards, you must remove the policy before proceeding with the downgrade.

Configuring Route Control Per BGP Peer Using the GUI

The following procedure describes how to configure the route control per BGP peer feature using the GUI.

Before you begin

- Configure the node, port, functional profile, AEP, and Layer 3 domain.
- Configure a BGP Route Reflector policy to propagate the routes within the fabric.

Procedure

-
- Step 1** Create the tenant and VRF:
- On the menu bar, choose **Tenants > Add Tenant**.
- The **Create Tenant** dialog box appears.
- In the **Name** field, enter the tenant name.
 - In the **VRF Name** field, enter the VRF name.
 - Click **Submit**.
- Step 2** Create a bridge domain:
- In the **Navigation** pane, expand **Tenant** and **Networking**.

- b) Right-click **Bridge Domains** and choose **Create Bridge Domain**.
- c) In the **Name** field, enter a name for the bridge domain (BD).
- d) (Optional) Click the box for **Advertise Host Routes** to enable advertisement to all deployed border leafs.
- e) In the **VRF** field, from the drop-down list, choose the VRF you created (v1 in this example).
- f) Click **Next**.
- g) Click the + icon on **Subnets**.
- h) In the **Gateway IP** field, enter the subnet for the BD.
- i) In the **Scope** field, choose **Advertised Externally**.

Add the **L3 Out for Route Profile** later, after you create it.

Note

If **Advertise Host Routes** is enabled, the route-map also matches all host routes.

- j) Click **OK**.
- k) Click **Next** and click **Finish**.

Step 3 Create an application EPG:

- a) Right-click **Application Profiles** and choose **Create Application Profile**.
- b) Enter a name for the application.
- c) Click the + icon for EPGs.
- d) Enter a name for the EPG.
- e) From the BD drop-down list, choose the bridge domain you previously created.
- f) Click **Update**.
- g) Click **Submit**.

Step 4 Create a tenant level route-map that will be used as the BGP Per Peer Route-Map:

- a) In the **Navigation** pane, expand the **Tenants > Tenant_name > Policies > Protocol**.
- b) Right-click on **Route Maps for Route Control** and select **Create Route Maps for Route Control**.
- c) In the **Create Route Maps for Route Control** dialog box, in the **Name** field, enter a route profile name.
- d) In the **Type** field, you must choose **Match Routing Policy Only**.
- e) In the **Contexts** area, click the + sign to open the **Create Route Control Context** dialog box and perform the following actions:
 - 1. Populate the **Order** and the **Name** fields as desired.
 - 2. In the **Match Rule** field, click **Create Match Rule**.
 - 3. In the **Create Match Rule** dialog box, in the **Name** field, enter a name for the match rule.
 - 4. Enter the necessary information in the appropriate fields (**Match Regex Community Terms**, **Match Community Terms**, **Match AS Path Regex Terms**, and **Match Prefix**), then click **Submit**.
 - 5. In the **Set Rule** field, click **Create Set Rules for a Route Map**.
 - 6. In the **Create Set Rules for a Route Map** dialog box, in the **Name** field, enter a name for the action rule profile.
 - 7. Choose the desired attributes, and related community, criteria, tags, and preferences. Click **Finish**.
 - 8. In the **Create Route Control Context** window, click **OK**.
 - 9. In the **Create Route Maps for BGP Dampening, Inter-leak** dialog box, click **Submit**.

Step 5 Create the L3Out and configure the BGP for the L3Out:

- On the **Navigation** pane, expand **Tenant** and **Networking**.
- Right-click **L3Outs** and choose **Create L3Out**.
- Enter the necessary information to configure BGP for the L3Out.

You will select **BGP** in the **Identity** page in the L3Out creation wizard to configure the BGP protocol for this L3Out.

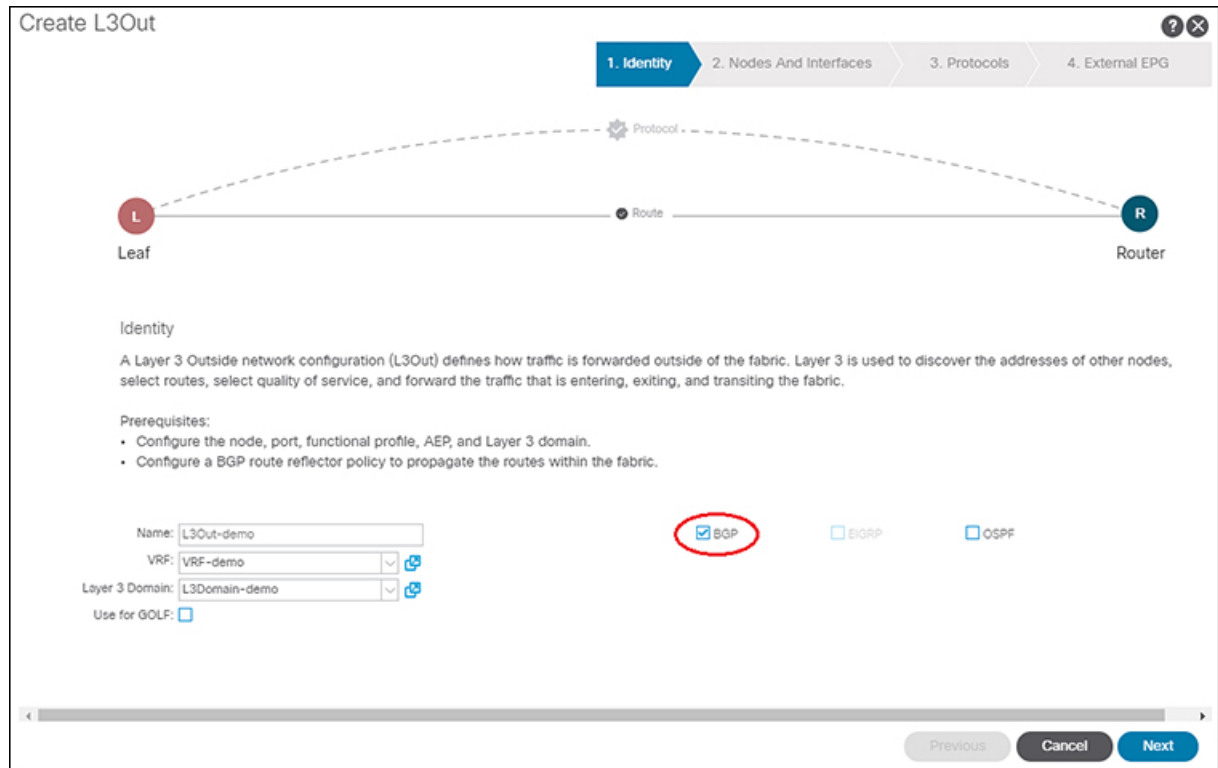

- Continue through the remaining pages (**Nodes and Interfaces**, **Protocols**, and **External EPG**) to complete the configuration for the L3Out.

Step 6 After you have completed the L3Out configuration, configure the route control per BGP peer feature:

- Navigate to the BGP Peer Connectivity Profile screen:

Tenants > *tenant* > **Networking** > **L3Outs** > *L3out-name* > **Logical Node Profiles** > *logical-node-profile-name* > **Logical Interface Profiles** > *logical-interface-profile-name* > **BGP Peer Connectivity Profile IP-address**

- Scroll down to the **Route Control Profile** field, then click + to configure the following:
 - Name:** Select the route-map that you configured in [Step 4, on page 309](#).
 - Direction:** Choose one of the following options:
 - Route Import Policy**
 - Route Export Policy**

Route Maps/Profiles with Explicit Prefix Lists

About Route Map/Profile

The route profile is a logical policy that defines an ordered set (rtctrlCtxP) of logical match action rules with associated set action rules. The route profile is the logical abstract of a route map. Multiple route profiles can be merged into a single route map. A route profile can be one of the following types:

- **Match Prefix and Routing Policy:** Pervasive subnets (fvSubnet) and external subnets (l3extSubnet) are combined with a route profile and merged into a single route map (or route map entry). Match Prefix and Routing Policy is the default value.
- **Match Routing Policy Only:** The route profile is the only source of information to generate a route map, and it will overwrite other policy attributes.



Note When explicit prefix list is used, the type of the route profile should be set to "match routing policy only".

After the match and set profiles are defined, the route map must be created in the Layer 3 Out. Route maps can be created using one of the following methods:

- Create a "default-export" route map for export route control, and a "default-import" route map for import route control.
- Create other route maps (not named default-export or default-import) and setup the relation from one or more l3extInstPs or subnets under the l3extInstP.
- In either case, match the route map on explicit prefix list by pointing to the rtctrlSubjP within the route map.

In the export and import route map, the set and match rules are grouped together along with the relative sequence across the groups (rtctrlCtxP). Additionally, under each group of match and set statements (rtctrlCtxP) the relation to one or more match profiles are available (rtctrlSubjP).

Any protocol enabled on Layer 3 Out (for example BGP protocol), will use the export and import route map for route filtering.

About Explicit Prefix List Support for Route Maps/Profile

In Cisco APIC, for public bridge domain (BD) subnets and external transit networks, inbound and outbound route controls are provided through an explicit prefix list. Inbound and outbound route control for Layer 3 Out is managed by the route map/profile (rtctrlProfile). The route map/profile policy supports a fully controllable prefix list for Layer 3 Out in the Cisco ACI fabric.

The subnets in the prefix list can represent the bridge domain public subnets or external networks. Explicit prefix list presents an alternate method and can be used instead of the following:

- Advertising BD subnets through BD to Layer 3 Out relation.



Note The subnet in the BD must be marked public for the subnet to be advertised out.

- Specifying a subnet in the l3extInstP with export/import route control for advertising transit and external networks.

Explicit prefix list is defined through a new match type that is called match route destination (rtctrlMatchRtDest). An example usage is provided in the API example that follows.

Figure 41: External Policy Model of API

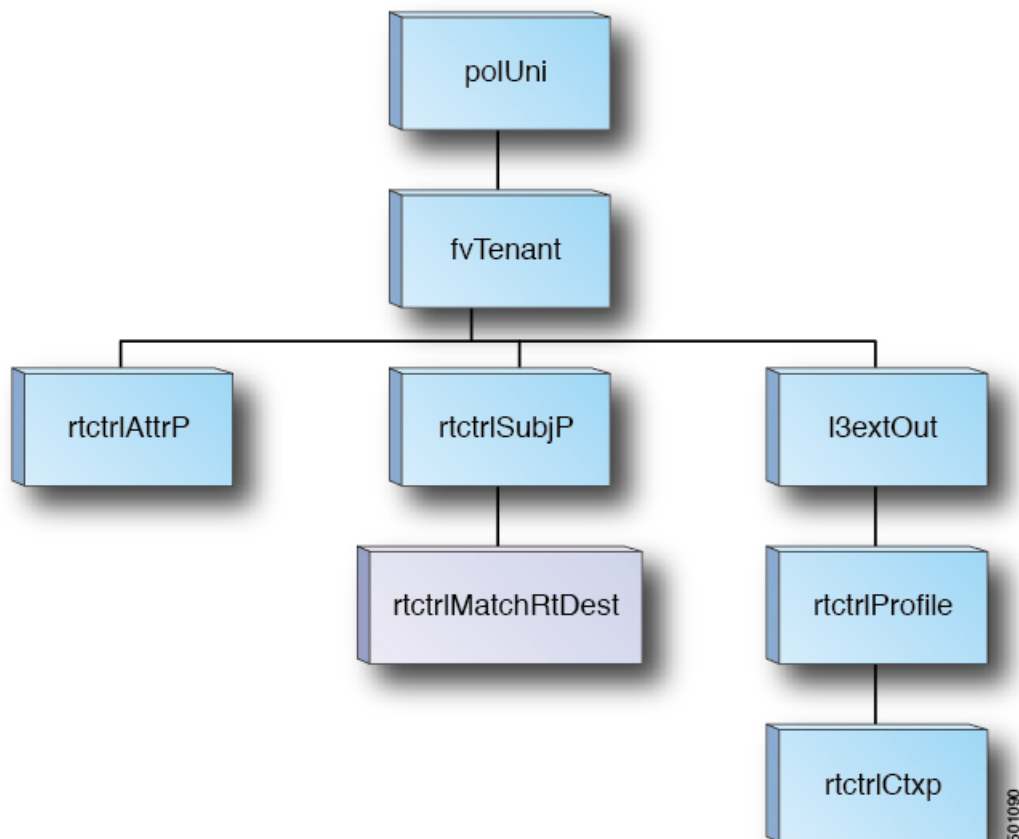

Additional information about match rules, set rules when using explicit prefix list are as follows:

Match Rules

- Under the tenant (fvTenant), you can create match profiles (rtctrlSubjP) for route map filtering. Each match profile can contain one or more match rules. Match rule supports multiple match types. Prior to Cisco APIC release 2.1, match types supported were explicit prefix list and community list.

Beginning with Cisco APIC release 2.1, explicit prefix match or match route destination (rtctrlMatchRtDest) is supported.

Match prefix list (rtctrlMatchRtDest) supports one or more subnets with an optional aggregate flag. Aggregate flags are used for allowing prefix matches with multiple masks starting with the mask mentioned in the configuration till the maximum mask allowed for the address family of the prefix. This is the equivalent of the "le" option in the prefix-list in NX-OS software (example, 10.0.0.0/8 le 32).

The prefix list can be used for covering the following cases:

- Allow all (0.0.0.0/0 with aggregate flag, equivalent of 0.0.0.0/0 le 32)
- One or more of specific prefixes (example: 10.1.1.0/24)
- One or more of prefixes with aggregate flag (example, equivalent of 10.1.1.0/24 le 32).



Note When a route map with a match prefix “0.0.0.0/0 with aggregate flag” is used under an L3Out EPG in the export direction, the rule is applied only for redistribution from dynamic routing protocols. Therefore, the rule is not applied to the following (in routing protocol such as OSPF or EIGRP):

- Bridge domain (BD) subnets
 - Directly connected subnets on the border leaf switch
 - Static routes defined on the L3Out
-
- The explicit prefix match rules can contain one or more subnets, and these subnets can be bridge domain public subnets or external networks. Subnets can also be aggregated up to the maximum subnet mask (/32 for IPv4 and /128 for IPv6).
 - When multiple match rules of different types are present (such as match community and explicit prefix match), the match rule is allowed only when the match statements of all individual match types match. This is the equivalent of the AND filter. The explicit prefix match is contained by the subject profile (rtctrlSubjP) and will form a logical AND if other match rules are present under the subject profile.
 - Within a given match type (such as match prefix list), at least one of the match rules statement must match. Multiple explicit prefix match (rtctrlMatchRtDest) can be defined under the same subject profile (rtctrlSubjP) which will form a logical OR.
 - When a per-peer route-map is configured with a permit-all rule followed by an exact match rule, then any specific properties that were set in the exact match rule may not be processed.
 - If an empty route in a route map is matched with action permit or deny without a match clause, all the routes will be either permitted or denied. A regular route map for import or export route control does not permit an empty route. Beginning with Cisco APIC release 5.2(4), static and direct routes will not permit routes without any route matches.

Enhancements for Match Prefix

Beginning with Cisco APIC release 4.2(3), two new fields are now available in the Match Prefix field when you create a match rule and you enable aggregation. Based on the release, these fields have a different naming conventions as outlined in the table below.

Release	Field
Cisco APIC release 4.2(3)	From Prefix
	To Prefix
Cisco APIC release 5.2(2)	Greater Than Mask
	Less Than Mask
Cisco APIC release 5.2(6)	Greater Equal Mask
	Less Equal Mask

Use these fields to specify the mask range when you create a prefix match rule and enable aggregation. Following are example situations where you might use these fields:

- Allow all (0.0.0.0/0 with mask length between 24 to 30, the equivalent of 0.0.0.0/0 ge 24 le 30)
- Prefixes with a specific IP address and a netmask greater than 28 (for example, the equivalent of 10.1.1.0/24 ge 28)

The following table provides more information on the various scenarios where you might use these two new fields and the result for each scenario. Note the following:

- The **Greater Equal Mask** and **Less Equal Mask** fields are available only if you select the **Aggregate** option in the **Create Match Route Destination Rule** window.
- A value of **0** in the **Greater Equal Mask** and **Less Equal Mask** fields is considered **unspecified** and assumes the following default values:
 - Greater Equal Mask=0
 - Less Equal Mask=32 or 128, depending on whether the IP address family is IPv4 or IPv6.

This situation assumes legacy behavior and provides support for importing old configurations where these properties are missing. Refer to the second row in the following table for more information.

IP Address/Netmask	Aggregate	Greater Equal Mask Entry (fromPfxLen)	Less Equal Mask Entry (toPfxLen)	Result	Additional Information
192.0.2.0/24	Not enabled	N/A	N/A	192.0.2.0/24	Exact match
192.0.2.0/24	Enabled	0	0	192.0.2.0/24 le 32	Legacy behavior
192.0.2.0/24	Enabled	24	Irrelevant value (error occurs because of value provided in Greater Equal Mask entry)	ERROR: Invalid configuration.	The Greater Equal Mask entry must be larger than the netmask length.

IP Address/Netmask	Aggregate	Greater Equal Mask Entry (fromPfxLen)	Less Equal Mask Entry (toPfxLen)	Result	Additional Information
192.0.2.0/24	Enabled	28	30	192.0.2.0/24 ge 28 le 30	New behavior with these new fields
192.0.2.0/24	Enabled	30	0	192.0.2.0/24 ge 30	New behavior with these new fields
192.0.2.0/24	Enabled	28	28	192.0.2.0/24 eq 28	New behavior with these new fields
192.0.2.0/24	Enabled	0	28	192.0.2.0/24 le 28	New behavior with these new fields
192.0.2.0/24	Enabled	30	28	ERROR: Invalid configuration.	The Greater Equal Mask entry cannot be larger than the Less Equal Mask entry.

Set Rules

Set policies must be created to define set rules that are carried with the explicit prefixes such as set community and set tag.

Aggregation Support for Explicit Prefix List

Each prefix (rtctrlMatchRtDest) in the match prefixes list can be aggregated to support multiple subnets matching with one prefix list entry.

Aggregated Prefixes and BD Private Subnets

Although subnets in the explicit prefix list match may match the BD private subnets using aggregated or exact match, private subnets will not be advertised through the routing protocol using the explicit prefix list. The scope of the BD subnet must be set to "public" for the explicit prefix list feature to advertise the BD subnets.

Differences in Behavior for 0.0.0.0/0 with Aggregation

The 0.0.0.0/0 with Aggregate configuration creates an IP prefix-list equivalent to "0.0.0.0/0 le 32". The 0.0.0.0/0 with Aggregate configuration can be used mainly in two situations:

- "Export Route Control Subnet" with "Aggregate Export" scope in L3Out subnet under the L3Out network (L3Out EPG)
- An explicit prefix-list (Match Prefix rule) assigned to a route map with the name "default-export"

When used with the “Export Route Control Subnet” scope under the L3Out subnet, the route map will only match routes learned from dynamic routing protocols. It will not match BD subnets or directly-connected networks.

When used with the explicit route map configuration, the route map will match all routes, including BD subnets and directly-connected networks.

Consider the following examples to get a better understanding of the expected and unexpected (inconsistent) behavior in the two situations described above.

Scenario 1

For the first scenario, we configure a route map (with a name of `rpm_with_catch_all`) using a configuration post similar to the following:

```
<l3extOut annotation="" descr="" dn="uni/tn-t9/out-L3-out" enforceRtctrl="export"
name="L3-out" nameAlias="" ownerKey="" ownerTag="" targetDscp="unspecified">
  <rtctrlProfile annotation="" descr="" name="rpm_with_catch_all" nameAlias="" ownerKey=""
ownerTag="" type="combinable">
    <rtctrlCtxP action="permit" annotation="" descr="" name="catch_all" nameAlias=""
order="0">
      <rtctrlScope annotation="" descr="" name="" nameAlias="">
        <rtctrlRsScopeToAttrP annotation="" tnRtctrlAttrPName="set_metric_type"/>
      </rtctrlScope>
    </rtctrlCtxP>
  </rtctrlProfile>
  <ospfExtP annotation="" areaCost="1" areaCtrl="redistribute,summary" areaId="backbone"
areaType="regular" descr="" multipodInternal="no" nameAlias=""/>
  <l3extRsEctx annotation="" tnFvCtxName="ctx0"/>
  <l3extLNodeP annotation="" configIssues="" descr="" name="leaf" nameAlias="" ownerKey=""
ownerTag="" tag="yellow-green" targetDscp="unspecified">
    <l3extRsNodeL3OutAtt annotation="" configIssues="" rtrId="20.2.0.2" rtrIdLoopBack="no"
tDn="topology/pod-1/node-104">
      <l3extLoopBackIfP addr="14.1.1.1/32" annotation="" descr="" name="" nameAlias=""/>

      <l3extInfraNodeP annotation="" descr="" fabricExtCtrlPeering="no"
fabricExtIntersiteCtrlPeering="no" name="" nameAlias="" spineRole=""/>
    </l3extRsNodeL3OutAtt>
    <l3extLIIfP annotation="" descr="" name="interface" nameAlias="" ownerKey=""
ownerTag="" tag="yellow-green">
      <ospfIfP annotation="" authKeyId="1" authType="none" descr="" name=""
nameAlias="">
        <ospfRsIfPol annotation="" tnOspfIfPolName=""/>
      </ospfIfP>
      <l3extRsPathL3OutAtt addr="36.1.1.1/24" annotation="" autostate="disabled"
descr="" encap="vlan-3063" encapScope="local" ifInstT="ext-svi" ipv6Dad="enabled" llAddr="::"
mac="00:22:BD:F8:19:FF" mode="regular" mtu="inherit"
tDn="topology/pod-1/paths-104/pathep-[accBndlGrp_104_pcl3]" targetDscp="unspecified"/>
        <l3extRsNdIfPol annotation="" tnNdIfPolName=""/>
        <l3extRsIngressQosDppPol annotation="" tnQosDppPolName=""/>
        <l3extRsEgressQosDppPol annotation="" tnQosDppPolName=""/>
      </l3extLIIfP>
    </l3extLNodeP>
    <l3extInstP annotation="" descr="" exceptionTag="" floodOnEncap="disabled"
matchT="AtleastOne" name="epg" nameAlias="" prefGrMemb="exclude" prio="unspecified"
targetDscp="unspecified">
      <l3extRsInstPToProfile annotation="" direction="export"
tnRtctrlProfileName="rpm_with_catch_all"/>
      <l3extSubnet aggregate="" annotation="" descr="" ip="0.0.0.0/0" name="" nameAlias=""
scope="import-security"/>
      <fvRsCustQosPol annotation="" tnQosCustomPolName=""/>
    </l3extInstP>
```



```

</l3extOut>

<rtctrlAttrP annotation="" descr="" dn="uni/tn-t9/attr-set_metric_type" name="set_metric_type"
  nameAlias="">
  <rtctrlSetRtMetricType annotation="" descr="" metricType="ospf-type1" name="" nameAlias=""
    type="metric-type"/>
</rtctrlAttrP>

<rtctrlSubjP annotation="" descr="" dn="uni/tn-t9/subj-catch_all_ip" name="catch_all_ip"
  nameAlias="">
  <rtctrlMatchRtDest aggregate="yes" annotation="" descr="" ip="0.0.0.0/0" name=""
    nameAlias=""/>
</rtctrlSubjP>

```

With this route map, what we would expect with 0.0.0.0/0 is that all the routes would go with the property `metricType="ospf-type1"`, but only for the OSPF route.

In addition, we also have a subnet configured under a bridge domain (for example, 209.165.201.0/27), with a bridge domain to L3Out relation, using a route map with a pervasive subnet (fvSubnet) for a static route. However, even though the route map shown above is combinable, we do not want it applied for the subnet configured under the bridge domain, because we want 0.0.0.0/0 in the route map above to apply only for the transit route, not on the static route.

Following is the output for the `show route-map` and `show ip prefix-list` commands, where `exp-ctx-st-2555939` is the name of the outbound route map for the subnet configured under the bridge domain, and the name of the prefix list is provided within the output from the `show route-map` command:

```

leaf4# show route-map exp-ctx-st-2555939
route-map exp-ctx-st-2555939, deny, sequence 1
  Match clauses:
    tag: 4294967295
  Set clauses:
route-map exp-ctx-st-2555939, permit, sequence 15801
  Match clauses:
    ip address prefix-lists: IPv4-st16391-2555939-exc-int-inferred-export-dst
    ipv6 address prefix-lists: IPv6-deny-all
  Set clauses:

leaf4# show ip prefix-list IPv4-st16391-2555939-exc-int-inferred-export-dst
ip prefix-list IPv4-st16391-2555939-exc-int-inferred-export-dst: 1 entries
  seq 1 permit 209.165.201.0/27

leaf4#

```

In this situation, everything behaves as expected, because when the bridge domain subnet goes out, it is not applying the `rpm_with_catch_all` route map policies.

Scenario 2

For the second scenario, we configure a "default-export" route map for export route control, where an explicit prefix-list (Match Prefix rule) is assigned to the "default-export" route map, using a configuration post similar to the following:

```

<l3extOut annotation="" descr="" dn="uni/tn-t9/out-L3-out" enforceRtctrl="export"
  name="L3-out" nameAlias="" ownerKey="" ownerTag="" targetDscp="unspecified">
  <rtctrlProfile annotation="" descr="" name="default-export" nameAlias="" ownerKey=""
    ownerTag="" type="combinable">
    <rtctrlCtxP action="permit" annotation="" descr="" name="set-rule" nameAlias=""
      order="0">

```

```

    <rtctrlScope annotation="" descr="" name="" nameAlias="">
      <rtctrlRsScopeToAttrP annotation="" tnRtctrlAttrPName="set_metric_type"/>
    </rtctrlScope>
  </rtctrlCtxP>
</rtctrlProfile>
<ospfExtP annotation="" areaCost="1" areaCtrl="redistribute,summary" areaId="backbone"
areaType="regular" descr="" multipodInternal="no" nameAlias=""/>
<l3extRsEctx annotation="" tnFvCtxName="ctx0"/>
<l3extLNodeP annotation="" configIssues="" descr="" name="leaf" nameAlias="" ownerKey=""
ownerTag="" tag="yellow-green" targetDscp="unspecified">
  <l3extRsNodeL3OutAtt annotation="" configIssues="" rtrId="20.2.0.2" rtrIdLoopBack="no"
tDn="topology/pod-1/node-104">
    <l3extLoopBackIfP addr="14.1.1.1/32" annotation="" descr="" name="" nameAlias=""/>

    <l3extInfraNodeP annotation="" descr="" fabricExtCtrlPeering="no"
fabricExtIntersiteCtrlPeering="no" name="" nameAlias="" spineRole=""/>
  </l3extRsNodeL3OutAtt>
  <l3extLIIfP annotation="" descr="" name="interface" nameAlias="" ownerKey=""
ownerTag="" tag="yellow-green">
    <ospfIfP annotation="" authKeyId="1" authType="none" descr="" name=""
nameAlias="">
      <ospfRsIfPol annotation="" tnOspfIfPolName=""/>
    </ospfIfP>
    <l3extRsPathL3OutAtt addr="36.1.1.1/24" annotation="" autostate="disabled"
descr="" encap="vlan-3063" encapScope="local" ifInstT="ext-svi" ipv6Dad="enabled" llAddr=":"
mac="00:22:BD:F8:19:FF" mode="regular" mtu="inherit"
tDn="topology/pod-1/paths-104/pathep-[accBndlGrp_104_pc13]" targetDscp="unspecified"/>
    <l3extRsNdIfPol annotation="" tnNdIfPolName=""/>
    <l3extRsIngressQosDppPol annotation="" tnQosDppPolName=""/>
    <l3extRsEgressQosDppPol annotation="" tnQosDppPolName=""/>
  </l3extLIIfP>
</l3extLNodeP>
<l3extInstP annotation="" descr="" exceptionTag="" floodOnEncap="disabled"
matchT="AtleastOne" name="epg" nameAlias="" prefGrMemb="exclude" prio="unspecified"
targetDscp="unspecified">
  <l3extSubnet aggregate="" annotation="" descr="" ip="0.0.0.0/0" name="" nameAlias=""
scope="import-security"/>
  <fvRsCustQosPol annotation="" tnQosCustomPolName=""/>
</l3extInstP>
</l3extOut>

```

Notice that this default-export route map has similar information as the rpm_with_catch_all route map, where the IP is set to 0.0.0.0/0 (ip=0.0.0.0/0), and the set rule in the default-export route map is configured only with the Set Metric Type (tnRtctrlAttrPName=set_metric_type).

Similar to the situation in the previous example, we also have the same subnet configured under the bridge domain, with a bridge domain to L3Out relation, as we did in the previous example.

However, following is the output in this scenario for the show route-map and show ip prefix-list commands:

```

leaf4# show route-map exp-ctx-st-2555939
route-map exp-ctx-st-2555939, deny, sequence 1
  Match clauses:
    tag: 4294967295
  Set clauses:
route-map exp-ctx-st-2555939, permit, sequence 8201
  Match clauses:
    ip address prefix-lists:
IPv4-st16391-2555939-exc-int-out-default-export2set-rule0pfx-only-dst
    ipv6 address prefix-lists: IPv6-deny-all
  Set clauses:
    metric-type type-1

```

```
leaf4# show ip prefix-list IPv4-st16391-2555939-exc-int-inferred-export-dst
% Policy IPv4-st16391-2555939-exc-int-inferred-export-dst not found
ifav82-leaf4# show ip prefix-list
IPv4-st16391-2555939-exc-int-out-default-export2set-rule0pfx-only-dst
ip prefix-list IPv4-st16391-2555939-exc-int-out-default-export2set-rule0pfx-only-dst: 1
entries
  seq 1 permit 209.165.201.0/27

leaf4#
```

Notice that in this situation, when the bridge domain subnet goes out, it is applying the `default-export` route map policies. In this situation, that route map matches all routes, including BD subnets and directly-connected networks. This is inconsistent behavior.

Guidelines and Limitations

- You must choose one of the following two methods to configure your route maps. If you use both methods, it will result in double entries and undefined route maps.
 - Add routes under the bridge domain (BD) and configure a BD to Layer 3 Outside relation
 - Configure the match prefix under `rtctrlSubjP` match profiles.
- Starting 2.3(x), **deny-static** implicit entry has been removed from Export Route Map. The user needs to configure explicitly the permit and deny entries required to control the export of static routes.
- Route-map per peer in an L3Out is not supported for OSPF and EIGRP. Route-map can only be applied on L3Out as a whole. Starting 4.2(x), route-map per peer in an L3Out is supported for BGP.

Following are possible workarounds to this issue:

- Block the prefix from being advertised from the other side of the neighbor.
- Block the prefix on the route-map on the existing L3Out where you don't want to learn the prefix, and move the neighbor to another L3Out where you want to learn the prefix and create a separate route-map.
- Creating route-maps using a mixture of GUI and API commands is not supported. As a possible workaround, you can create a route-map different from the default route-map using the GUI, but the route-map created through the GUI on an L3Out cannot be applied to per-peer.

Configuring a Route Map/Profile with Explicit Prefix List Using the GUI

Before you begin

- Tenant and VRF must be configured.
- The VRF must be enabled on the leaf switch.

Procedure

-
- Step 1** On the menu bar, click **Tenant**, and in the **Navigation** pane, expand *Tenant_name* > **Policies** > **Protocol** > **Match Rules**.
- Step 2** Right click **Match Rules**, and click **Create Match Rule for a Route Map**.
- Step 3** In the **Create Match Rule** window, enter a name for the rule and choose the desired community terms.
- Step 4** Enter the necessary information for the match prefix.

The method that you use to enter information for the match prefix varies, depending on the APIC release.

- For APIC releases prior to 4.2(3), in the **Create Match Rule** window, expand **Match Prefix** and perform the following actions:
 - a. In the **IP** field, enter the explicit prefix list.
The explicit prefix can denote a BD subnet or an external network.
 - b. (Optional) In the **Description** field, enter descriptive information about the route destination policy.
 - c. Check the **Aggregate** check box only if you desire an aggregate prefix.
 - d. Click **Update**.

- For APIC releases 4.2(3) and later, in the **Create Match Rule** window, click + in the **Match Prefix** area.

The **Create Match Route Destination Rule** window appears. Perform the following actions in this window:

- a. In the **IP** field, enter the explicit prefix list.
The explicit prefix can denote a BD subnet or an external network.
- b. (Optional) In the **Description** field, enter descriptive information about the route destination policy.
- c. Determine if you want an aggregate prefix or not.

- If you do not want an aggregate prefix, leave the **Aggregate** unchecked and click **Submit**, then go to [Step 5, on page 321](#).

- If you want an aggregate prefix, check the **Aggregate** check box.

The **Greater Equal Mask** and **Less Equal Mask** fields become available.

1. In the **Greater Equal Mask** field, specify the prefix length to match.

The range is from 0 to 128. A value of 0 is considered unspecified.

2. In the **Less Equal Mask** field, specify the prefix length to match.

The range is from 0 to 128. A value of 0 is considered unspecified.

See [Enhancements for Match Prefix, on page 313](#) for more information on the **Greater Equal Mask** and **Less Equal Mask** fields for APIC releases 4.2(3) and later.

- d. Click **Submit** in the **Create Match Route Destination Rule** window.

- Step 5** In the **Create Match Rule** window, click **Submit**.
- The match rule can have one or more of the match destination rules and one or more match community terms. Across the match types, the AND filter is supported, so all conditions in the match rule must match for the route match rule to be accepted. When there are multiple match prefixes in **Match Destination Rules**, the OR filter is supported. Any one match prefix is accepted as a route type if it matches.
- Step 6** Under **L3Outs**, click and choose the available default layer 3 out.
- If you desire another layer 3 out, you can choose that instead.
- Step 7** Right-click **Route map for import and export route control**, and click **Create Route map for import and export route control**.
- Step 8** In the **Create Route map for import and export route control** dialog box, use a default route map, or enter a name for the desired route map.
- For the purpose of this example, we use **default_export** route map.
- Step 9** In the **Type** field, choose **Match Routing Policy Only**.
- The Match Routing policy is the global RPC match destination route. The other option in this field is Match Prefix and Routing Policy which is the combinable RPC match destination route.
- Step 10** In the **Contexts** area, expand the + icon to display the **Create Route Control Context** dialog box.
- Step 11** Enter a name for route control context, and choose the desired options for each field. To deny routes that match criteria that are defined in the match rule (which you will be choosing in the next step), select the action **deny**. The default action is **permit**.
- Step 12** In the **Match Rule** field, choose the rule that was created earlier.
- Step 13** In the **Set Rule** field, choose **Create Set Rules for a Route Map**.
- Typically in the route map/profile you have a match and so the prefix list is allowed in and out, but in addition some attributes are being set for these routes, so that the routes with the attributes can be matched further.
- Step 14** In the **Create Set Rules for a Route Map** dialog box, enter a name for the action rule and check the desired check boxes. Click **Finish**.
- Step 15** In the **Create Route Control Context** dialog box, click **OK**. And in the **Create Route map for import and export route control** dialog box, click **Submit**.
- This completes the creation of the route map/profile. The route map is a combination of match action rules and set action rules. The route map is associated with export profile or import profile or redistribute profile as desired by the user. You can enable a protocol with the route map.

Routing Control Protocols

About Configuring a Routing Control Protocol Using Import and Export Controls

This topic provides a typical example that shows how to configure a routing control protocol using import and export controls. It assumes that you have configured Layer 3 outside network connections with BGP. You can also perform these tasks for a Layer 3 outside network configured with OSPF.

Configuring a Route Control Protocol to Use Import and Export Controls, With the GUI

This example assumes that you have configured the Layer 3 outside network connections using BGP. It is also possible to perform these tasks for a network configured using OSPF.

This task lists steps to create import and export policies. By default, import controls are not enforced, so the import control must be manually assigned.

Before you begin

- The tenant, private network, and bridge domain are created.
- The Layer 3 outside for tenant networks is created.

Procedure

-
- Step 1** On the menu bar, click **TENANTS** > *Tenant_name* > **Networking** > **L3Outs** > *Layer3_Outside_name* .
- Step 2** Right click *Layer3_Outside_name* and click **Create Route map for import and export route control**.
- Step 3** In the **Create Route map for import and export route control** dialog box, perform the following actions:
- From the **Name** field drop-down list, choose the appropriate route profile.
Depending on your selection, whatever is advertised on the specific outside is automatically used.
 - In the **Type** field, choose **Match Prefix AND Routing Policy**.
 - In the **Contexts** area, click + to bring up the **Create Route Control Context** window.
- Step 4** In the **Create Route Control Context** dialog box, perform the following actions:
- In the **Order** field, choose the desired order number.
 - In the **Name** field, enter a name for the route control private network.
 - From the **Match Rule** field drop-down list, click **Create Match Rule For a Route Map**.
 - In the **Create Match Rule** dialog box, in the **Name** field, enter a route match rule name. Click **Submit**.
Specify the match community regular expression term and match community terms as desired. Match community factors will require you to specify the name, community and scope.
 - From the **Set Rule** drop-down list, choose **Create Set Rules For a Route Map**.
 - In the **Create Set Rules For a Route Map** dialog box, in the **Name** field, enter a name for the rule.
 - Check the check boxes for the desired rules you want to set, and choose the appropriate values that are displayed for the choices. Click **Finish**.
The policy is created and associated with the action rule.
 - In the **Create Route Control Context** window, click **OK**.
 - In the **Create Route map for import and export route control** dialog box, click **Submit**.
- Step 5** In the **Navigation** pane, choose **Route Profile** > *route_profile_name* > *route_control_private_network_name* .
In the **Work** pane, under **Properties** the route profile policy and the associated action rule name are displayed.
- Step 6** In the **Navigation** pane, click the *Layer3_Outside_name* , then click the **Policy/Main** tabs.
In the **Work** pane, the **Properties** are displayed.

Step 7 (Optional) Next to the **Route Control Enforcement** field, check the **Import** check box to enable the import policy.

The import control policy is not enabled by default but can be enabled by the user. The import control policy is supported for BGP and OSPF, but not for EIGRP. If the user enables the import control policy for an unsupported protocol, it will be automatically ignored. The export control policy is supported for BGP, EIGRP, and OSPF.

Note

If BGP is established over OSPF, then the import control policy is applied only for BGP and ignored for OSPF.

Step 8 To create a customized export policy, right-click **Route map for import and export route control**, click **Create Route map for import and export route control**, and perform the following actions:

- a) In the **Create Route map for import and export route control** dialog box, from the drop-down list in the **Name** field, choose or enter a name for the export policy.
- b) In the **Contexts** area, click + to bring up the **Create Route Control Context** window.
- c) In the **Create Route Control Context** dialog box, in the **Order** field, choose a value.
- d) In the **Name** field, enter a name for the route control private network.
- e) (Optional) From the **Match Rule** field drop-down list, choose **Create Match Rule For a Route Map**, and create and attach a match rule policy if desired.
- f) From the **Set Rule** field drop-down list, choose **Create Set Rules For a Route Map** and click **OK**.

Alternatively, if desired, you can choose an existing set action, and click **OK**

- g) In the **Create Set Rules For A Route Map** dialog box, in the **Name** field, enter a name.
- h) Check the check boxes for the desired rules you want to set, and choose the appropriate values that are displayed for the choices. Click **Finish**.

In the **Create Route Control Context** dialog box, the policy is created and associated with the action rule.

- i) Click **OK**.
- j) In the **Create Route map for import and export route control** dialog box, click **Submit**.

In the **Work** pane, the export policy is displayed.

Note

To enable the export policy, it must first be applied. For the purpose of this example, it is applied to all the subnets under the network.

Step 9 In the **Navigation** pane, expand **L3Outs > L3Out_name > External EPGs > externalEPG_name**, and perform the following actions:

- a) Expand **Route Control Profile**.
- b) In the **Name** field drop-down list, choose the policy created earlier.
- c) In the **Direction** field drop-down list, choose **Route Export Policy**. Click **Update**.

Interleak Redistribution for MP-BGP

Overview of Interleak Redistribution for MP-BGP

This topic provides how to configure an interleak redistribution in the Cisco Application Centric Infrastructure (ACI) fabric using Cisco Application Policy Infrastructure Controller (APIC).

In Cisco ACI, a border leaf node on which Layer 3 Outsides (L3Outs) are deployed redistributes L3Out routes to the BGP IPv4/IPv6 address family and then to the MP-BGP VPNv4/VPNv6 address family along with the VRF information so that L3Out routes are distributed from a border leaf node to other leaf nodes through the spine nodes. Interleak redistribution in the Cisco ACI fabric refers to this redistribution of L3Out routes to the BGP IPv4/IPv6 address family. By default, interleak happens for all L3Out routes, such as routes learned through dynamic routing protocols, static routes, and directly-connected subnets of L3Out interfaces, except for routes learned through BGP. Routes learned through BGP are already in the BGP IPv4/IPv6 table and are ready to be exported to MP-BGP VPNv4/VPNv6 without interleak.

Interleak redistribution allows users to apply a route-map to redistribute L3Out routes selectively into BGP to control which routes should be visible to other leaf nodes, or to set some attributes to the routes, such as BGP community, preference, metric, and so on. This redistribution enables selective transit routing to be performed on another border leaf node based on the attributes set by the ingress border leaf node or so that other leaf nodes can prefer routes from one border leaf node to another.

Applying a route map to interleak redistribution from OSPF and EIGRP routes has been available in earlier releases.

Beginning in the Cisco APIC 4.2(1) release, applying a route map to interleak redistribution from static routes is supported.

Beginning in the Cisco APIC 5.1(4) release, applying a route map to interleak redistribution from direct subnets (L3Out interfaces) is supported. This feature was originally added in the Cisco APIC 4.2(6h) release, but was not available in any of the 5.x releases until the 5.1(4) release.

Beginning in the Cisco APIC 5.1(4) release, you can configure **deny** action in the route-map for interleak redistribution for static routes and direct subnets. This feature was originally added in the Cisco APIC 4.2(6h) release, but was not available in any of the 5.x releases until the 5.1(4) release.

Configuring a Route Map for Interleak Redistribution Using the GUI

Route maps for interleak redistribution can be created under **Tenant > Policies > Protocol > Route Maps for Route Control**.

Before you begin

Create the tenant.

Procedure

-
- Step 1** On the menu bar, click **Tenants**.
 - Step 2** In the Work pane, double click the tenant's name.

- Step 3** In the **Navigation** pane, expand *tenant_name* > **Policies** > **Protocol** > **Route Maps for Route Control**.
- Step 4** Right-click **Route Maps for Route Control** and click **Create Route Maps for Route Control**. The **Create Route Maps for Route Control** dialog box appears.
- Step 5** In the **Name** field, enter a name for the route map to control interleak (redistribution to BGP).
- Step 6** In the **Contexts** area, click the + sign to open the **Create Route Control Context** dialog box, and perform the following actions:
- Populate the **Order** and the **Name** fields as desired.
 - In the **Action** field, choose **Permit**.
 - In the **Match Rule** field, choose your desired match rule or create a new one.
 - In the **Set Rule** field, choose your desired set rule or create a new one.
 - Click **OK**.
- Repeat this step for each route control context that you need to create.
- Step 7** In the **Create Route Maps for Route Control** dialog box, click **Submit**.
-

Applying a Route Map for Interleak Redistribution Using the GUI

A route map to customize interleak redistribution from a specific L3Out must be applied through the L3Out.

Before you begin

Create the tenant, VRF, and L3Out.

Procedure

- Step 1** On the menu bar, click **Tenants**.
- Step 2** In the Work pane, double click the tenant's name.
- Step 3** In the **Navigation** pane, expand *tenant_name* > **Networking** > **L3Outs** > *L3Out_name*.
- Step 4** Click the **Policy** > **Main** tab to access the **Properties** window for this L3Out.
- Step 5** For the OSPF or EIGRP routes, perform the following actions:
- In the **Route Profile for Interleak** field, choose or create a route map/profile.
 - In the Work pane, click **Submit**, then **Submit Changes**.
- Step 6** For static routes, perform the following actions:
- In the **Route Profile for Redistribution** field, click + icon.
 - In the **Source** field, choose **static** for static routes as the source for the interleak redistribution.
 - Click **Update**.
-



CHAPTER 22

Route and Subnet Scope

This chapter contains the following sections:

- [L3Out EPG Scope and Control Parameters, on page 327](#)
- [Security Import Policies, on page 328](#)

L3Out EPG Scope and Control Parameters

Scope and Aggregate Controls for Subnets

The following section describes some scope and aggregate options available when creating a subnet:

Export Route Control Subnet—The control advertises specific transit routes out of the fabric. This is for transit routes only, and it does not control the internal routes or default gateways that are configured on a bridge domain (BD).

Import Route Control Subnet—This control allows routes to be advertised into the fabric with Border Gateway Protocol (BGP) and Open Shortest Path First (OSPF) when Import Route Control Enforcement is configured.

External Subnets for the External EPG (also called Security Import Subnet)—This option does not control the movement of routing information into or out of the fabric. If you want traffic to flow from one external EPG to another external EPG or to an internal EPG, the subnet must be marked with this control. If you do not mark the subnet with this control, then routes learned from one EPG are advertised to the other external EPG, but packets are dropped in the fabric. The drops occur because the APIC operates in a allowed list model where the default behavior is to drop all data plane traffic between EPGs, unless it is explicitly permitted by a contract. The allowed list model applies to external EPGs and application EPGs. When using security policies that have this option configured, you must configure a contract and a security prefix.

Shared Route Control Subnet—Subnets that are learned from shared L3Outs in inter-VRF leaking must be marked with this control before being advertised to other VRFs. Starting with APIC release 2.2(2e), shared L3Outs in different VRFs can communicate with each other using a contract. For more about communication between shared L3Outs in different VRFs, see the *Cisco APIC Layer 3 Networking Configuration Guide*.

Shared Security Import Subnet—This control is the same as External Subnets for the External EPG for Shared L3Out learned routes. If you want traffic to flow from one external EPG to another external EPG or to another internal EPG, the subnet must be marked with this control. If you do not mark the subnet with this control, then routes learned from one EPG are advertised to the other external EPG, but packets are dropped in the fabric. When using security policies that have this option configured, you must configure a contract and a security prefix.

Aggregate Export, Aggregate Import, and Aggregate Shared Routes—This option adds 32 in front of the 0.0.0.0/0 prefix. Currently, you can only aggregate the 0.0.0.0/0 prefix for the import/export route control subnet. If the 0.0.0.0/0 prefix is aggregated, no route control profile can be applied to the 0.0.0.0/0 network.

Aggregate Shared Route—This option is available for any prefix that is marked as Shared Route Control Subnet.

Route Control Profile—The ACI fabric also supports the route-map set clauses for the routes that are advertised into and out of the fabric. The route-map set rules are configured with the Route Control Profile policies and the Action Rule Profiles.

Security Import Policies

Static L3Out EPG

The policies discussed in the documentation have dealt with the exchange of the routing information into and out of the ACI fabric and the methods that are used to control and tag the routes. The fabric operates in a allowed list model in which the default behavior is to drop all dataplane traffic between the endpoint groups unless it is explicitly permitted by a contract. This allowed list model applies to the external EPGs and the tenant EPGs.

There are some differences in how the security policies are configured and how they are implemented for the transit traffic compared to the tenant traffic.

Transit Security Policies

- Uses prefix filtering.
- Starting with Release 2.0(1m), support for Ethertype, protocol, L4 port, and TCP flag filters is available.
- Implemented with the security import subnets (prefixes) and the contracts that are configured under the external EPG.

Tenant EPG Security Policies

- Do not use prefix filtering.
- Support Ethertype, protocol, L4 port, and TCP flag filters.
- Supported for tenant EPGs ↔ EPGs and tenant EPGs ↔ External EPGs.

If there are no contracts between the external prefix-based EPGs, the traffic is dropped. To allow traffic between two external EPGs, you must configure a contract and a security prefix. As only prefix filtering is supported, the default filter can be used in the contract.

External L3Out Connection Contracts

The union of prefixes for L3Out connections is programmed on all the leaf nodes where the L3Out connections are deployed. When more than two L3Out connections are deployed, the use of the aggregate rule 0.0.0.0/0 can allow traffic to flow between L3Out connections that do not have a contract.

You configure the provider and consumer contract associations and the security import subnets in the L3Out Instance Profile (instP).

When security import subnets are configured and the aggregate rule, 0.0.0.0/0, is supported, the security import subnets follow the ACL type rules. The security import subnet rule 10.0.0.0/8 matches all the addresses from 10.0.0.0 to 10.255.255.255. It is not required to configure an exact prefix match for the prefixes to be permitted by the route control subnets.

Be careful when configuring the security import subnets if more than two L3Out connections are configured in the same VRF, due to the union of the rules.

Transit traffic flowing into and out of the same L3Out is dropped by policies when configured with the 0.0.0.0/0 security import subnet. This behavior is true for dynamic or static routing. To prevent this behavior, define more specific subnets.

Dynamic L3Out EPG Classification

Prior to Cisco APIC 5.2(4) release, pcTag for external subnets was derived from external EPG's pcTag as the external subnets were configured under external EPG. When routing changed, external subnets were learned from another L3Out or external EPG. pcTag would not change with changes in routing.

Beginning in the Cisco APIC 5.2(4) release, the Dynamic L3Out EPG Classification (DEC) feature is introduced to enable dynamic changes in pcTag with routing changes.

This feature would also allow administrators to configure external EPG with route-maps by matching subnets or BGP communities. Route-map with a set external EPG configuration can be applied either on L3Out using default-import or on BGP peer by using route control profile. External EPG and contract configuration on L3Out remains same as before. Based on the route-map, a particular external EPG and associated contract is determined for prefixes.



Note External EPG selection made through route-map has precedence over the external EPG subnets configured on L3Out. For example, if route-map configuration associates 10.1.1.0/24 to *external EPG1*, and subnet 10.1.1.0/24 is configured on *external EPG2*, then *external EPG1* will be programmed in hardware for 10.1.1.0/24 because external EPG determination through route-map is preferred.

Guidelines and Limitations for DEC

- This feature supports only BGP and OSPF.
- DEC is only supported with L3Out default-import route-maps or BGP peer import route-maps.
- To enable shared security, configure external EPGs with the shared security flags and subnets that you want to share.
- DEC does not support the following features:
 - Intersite
 - Integration with a floating L3Out
 - Static routing
 - EIGRP
 - Segment routing
 - AM

- BGP next-hop propagation with floating L3Out
- Cisco ACI GOLF, SR-MPLS, and coexistence with a fallback route

Configuring Dynamic L3Out EPG Classification Using GUI

This procedure configures the dynamic L3Out EPG classification (DEC), and assumes that you have configured the Layer 3 outside network connections using BGP. You can also perform these tasks for an L3Out configured using OSPF.

This task lists steps to create import and export policies. By default, import controls are not enforced, so you must manually assign the import control.

Before you begin

- The tenant, private network, and bridge domain are created.
- The Layer 3 outside for tenant networks is created.

Procedure

-
- Step 1** On the menu bar, choose **Tenants > All Tenants**.
- Step 2** In the **Work** pane, double click the tenant's name.
- Step 3** In the **Navigation** pane, choose *tenant_name* > **Networking** > **L3Outs** > *l3out_name*.
- Step 4** Right click *l3out_name* and click **Create Route map for import and export route control**.
- Step 5** In the **Create Route map for import and export route control** dialog box, perform the following actions:
- From the **Name** field drop-down list, choose **default-import**.
Depending on your selection, whatever is advertised on the specific L3Out is automatically used.
 - In the **Type** field, choose **Match Prefix AND Routing Policy**.
 - In the **Contexts** area, click + to open the **Create Route Control Context** dialog.
- Step 6** In the **Create Route Control Context** dialog box, perform the following actions:
- In the **Order** field, enter the desired order number.
 - In the **Name** field, enter a name for the route control private network.
 - In the **Associated Matched Rules** table, click +.
 - From the **Rule Name** drop-down list, choose **Create Match Rule for a Route Map**.
 - In the **Create Match Rule for a Route Map** dialog box, in the **Name** field, enter a route match rule name.
 - Specify the match community regular expression term and match community terms as desired.

Match community factors will require you to specify the name, community, and scope.
 - Click **Submit**.
 - From the **Set Rule** drop-down list, choose **Create Set Rules for a Route Map**.
 - In the **Create Set Rules for a Route Map** dialog box, in the **Name** field, enter a name for the rule.
 - Put a check in the **Set External EPG** check box, choose an EPG in the **External EPG** drop-down list, and click **Finish**.
The policy is created and associated with the action rule.
 - In the **Create Route Control Context** window, click **OK**.

l) In the **Create Route map for import and export route control** dialog box, click **Submit**.

Step 7 In the **Work** pane, choose the **Policy > Main** tabs.

In the **Work** pane, the **Properties** are displayed.

Step 8 (Optional) Next to **Route Control Enforcement**, put a check in the **Import** check box to enable the import policy, then click **Submit**.

The import control policy is disabled by default. The import control policy is supported for BGP and OSPF, but not for EIGRP. If you enable the import control policy for an unsupported protocol, the protocol will be automatically ignored. The export control policy is supported for BGP, EIGRP, and OSPF. Also, you need not put a check in the **Import** check box for the import policy when you configure BGP per neighbor import route-map.

Note

If BGP is established over OSPF, then the import control policy is applied only for BGP and ignored for OSPF.

Step 9 To create a customized export policy, in the **Navigation** pane, right-click **Route map for import and export route control**, choose **Create Route map for import and export route control**, and perform the following actions:

- a) In the **Create Route map for import and export route control** dialog box, from the **Name** drop-down list, choose or enter a name for the export policy.
- b) In the **Contexts** table, click + to open the **Create Route Control Context** dialog.
- c) In the **Create Route Control Context** dialog box, in the **Order** field, enter a value.
- d) In the **Name** field, enter a name for the route control private network.
- e) (Optional) From the **Associated Match Rules** table, click +, choose **Create Match Rule For a Route Map** from the **Rule Name** drop-down list, fill out the fields as desired, and click **Submit**.
- f) From the **Set Rule** drop-down list, choose **Create Set Rules For a Route Map**.

Alternatively, you can choose an existing set rule.

- g) If you chose **Create Set Rules For a Route Map**, in the **Create Set Rules For A Route Map** dialog box, enter a name for the set rules in the **Name** field, put a check in the box for the rules you want to set, enter the appropriate values for the rules, then click **Finish**.

In the **Create Route Control Context** dialog box, the policy is created and associated with the action rule.

- h) Click **OK**.
- i) In the **Create Route map for import and export route control** dialog box, click **Submit**.

In the **Work** pane, the export policy is displayed.

Note

To enable the export policy, it must first be applied. For the purpose of this example, the policy is applied to all the subnets under the network.

Step 10 In the **Navigation** pane, expand *tenant_name* > **Networking** > **L3Outs** > *L3Out_name* > **External EPGs** > *external_EPG_name*, and perform the following actions:

- a) In the **Route Control Profile** table, click +.
- b) In the **Name** drop-down list, choose the policy that you created earlier.
- c) In the **Direction** drop-down list, choose **Route Export Policy**.
- d) Click **Update**.

e) Click **Submit**.



CHAPTER 23

Transit Routing

This chapter contains the following sections:

- [Transit Routing in the ACI Fabric, on page 333](#)
- [Transit Routing Use Cases, on page 334](#)
- [Supported Transit Combination Matrix, on page 339](#)
- [Transit Routing Guidelines, on page 341](#)
- [Configuring Transit Routing, on page 348](#)

Transit Routing in the ACI Fabric

The Cisco APIC software supports external Layer 3 connectivity with OSPF (NSSA) and iBGP. The fabric advertises the tenant bridge domain subnets out to the external routers on the External Layer 3 Outside (L3Out) connections. The routes that are learned from the external routers are not advertised to other external routers. The fabric behaves like a stub network that can be used to carry the traffic between the external Layer 3 domains.

Figure 42: Transit Routing in the Fabric

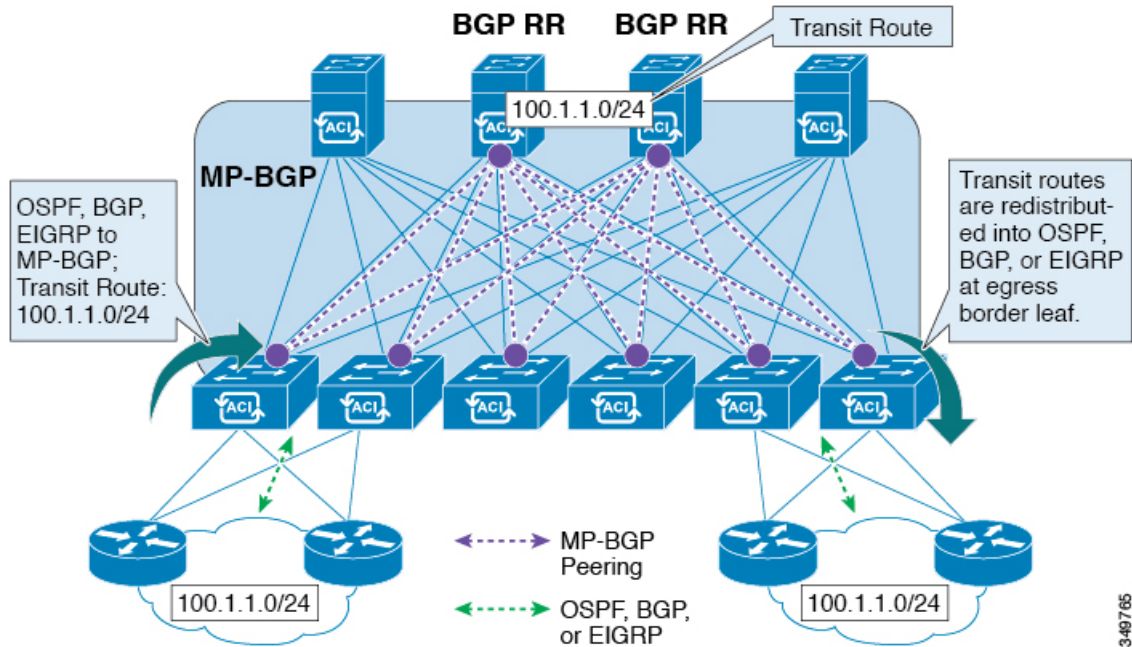

In transit routing, multiple L3Out connections within a single tenant and VRF are supported and the APIC advertises the routes that are learned from one L3Out connection to another L3Out connection. The external Layer 3 domains peer with the fabric on the border leaf switches. The fabric is a transit Multiprotocol-Border Gateway Protocol (MP-BGP) domain between the peers.

The configuration for external L3Out connections is done at the tenant and VRF level. The routes that are learned from the external peers are imported into MP-BGP at the ingress leaf per VRF. The prefixes that are learned from the L3Out connections are exported to the leaf switches only where the tenant VRF is present.



Note For cautions and guidelines for configuring transit routing, see [Guidelines for Transit Routing, on page 341](#)

Transit Routing Use Cases

Transit Routing Between Layer 3 Domains

Multiple Layer 3 domains such as external pods, mainframes, service nodes, or WAN routers can peer with the ACI fabric to provide transit functionality between them.

Figure 43: Transit Routing Between Layer 3 Domains

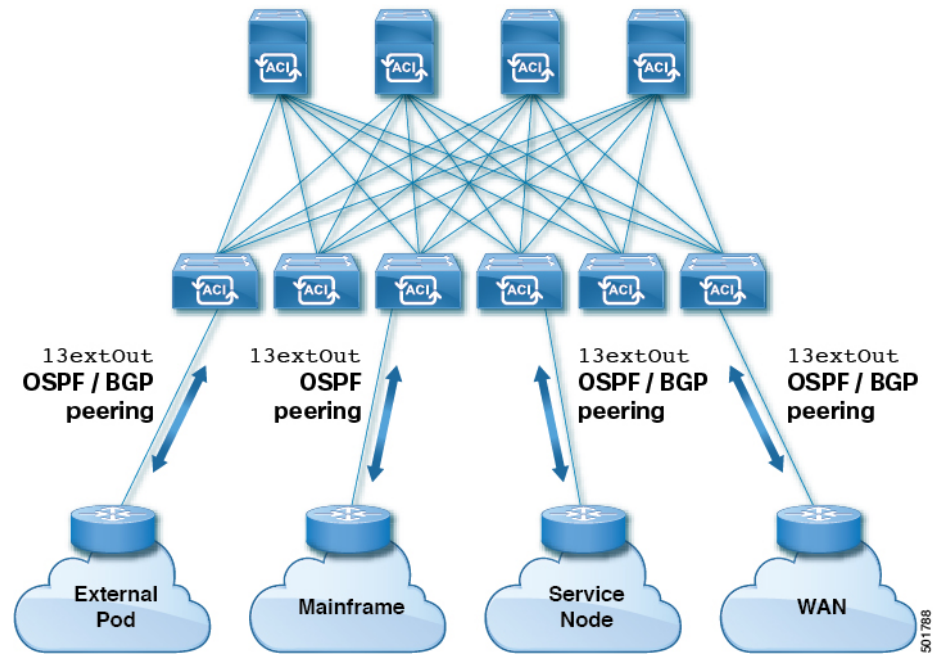

Mainframe Traffic Transiting the ACI Fabric

Mainframes can function as IP servers running standard IP routing protocols that accommodate requirements from Logical Partitions (LPARs) and Virtual IP Addressing (VIPA).

Figure 44: Mainframe Transit Connectivity

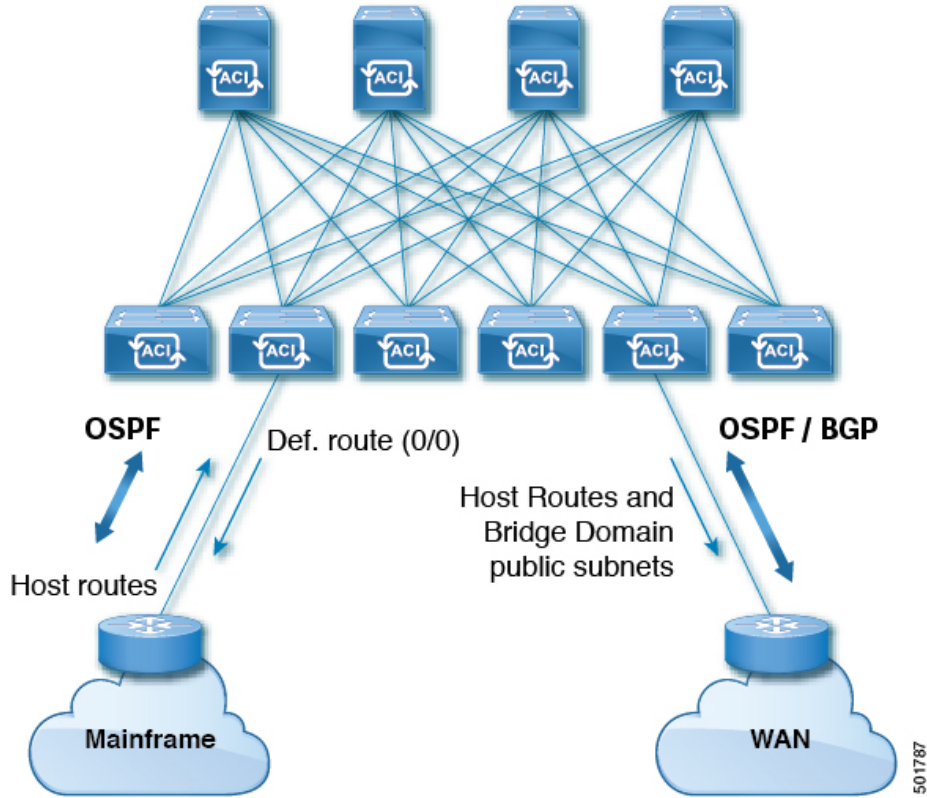

In this topology, mainframes require the ACI fabric to be a transit domain for external connectivity through a WAN router and for east-west traffic within the fabric. They push host routes to the fabric to be redistributed within the fabric and out to external interfaces.

Service Node Transit Connectivity

Service nodes can peer with the ACI fabric to advertise a Virtual IP (VIP) route that is redistributed to an external WAN interface.

Figure 45: Service Node Transit Connectivity

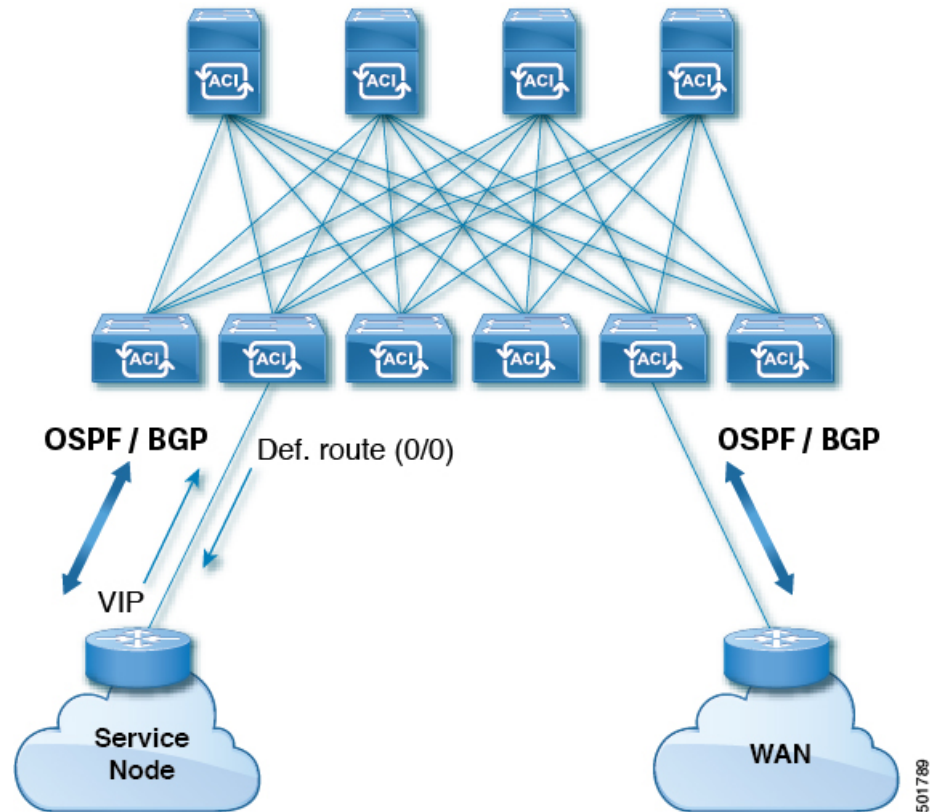

The VIP is the external facing IP address for a particular site or service. A VIP is tied to one or more servers or nodes behind a service node.

Multipod in a Transit-Routed Configuration

In a multipod topology, the fabric acts as a transit for external connectivity and interconnection between multiple pods. Cloud providers can deploy managed resource pods inside a customer datacenter. The demarcation point can be an L3Out with OSPF or BGP peering with the fabric.

Figure 46: Multiple Pods with L3Outs in a Transit-Routed Configuration

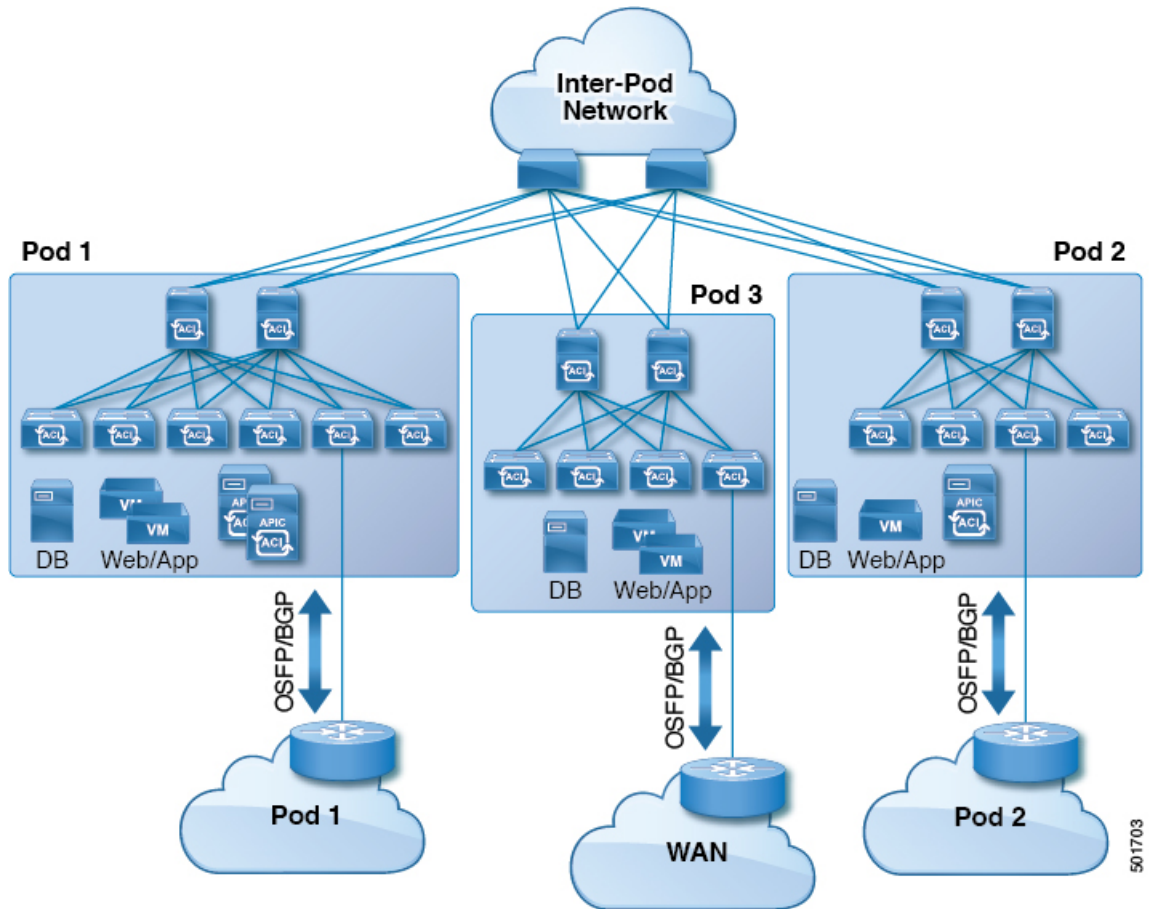

In such scenarios, the policies are administered at the demarcation points and ACI policies need not be imposed.

Layer 4 to Layer 7 route peering is a special use case of the fabric as a transit where the fabric serves as a transit OSPF or BGP domain for multiple pods. You configure route peering to enable OSPF or BGP peering on the Layer 4 to Layer 7 service device so that it can exchange routes with the leaf node to which it is connected. A common use case for route peering is Route Health Injection where the SLB VIP is advertised over OSPF or iBGP to clients outside the fabric. See *L4-L7 Route Peering with Transit Fabric - Configuration Walkthrough* for a configuration walk-through of this scenario.

GOLF in a Transit-Routed Configuration

In APIC, release 2.0 and later, the Cisco ACI supports transit routing with GOLF L3Outs (with BGP and OSPF). For example, the following diagram shows traffic transiting the fabric with GOLF L3Outs and a border leaf L3Out.

Figure 47: GOLF L3Outs and a Border Leaf L3Out in a Transit-Routed Configuration

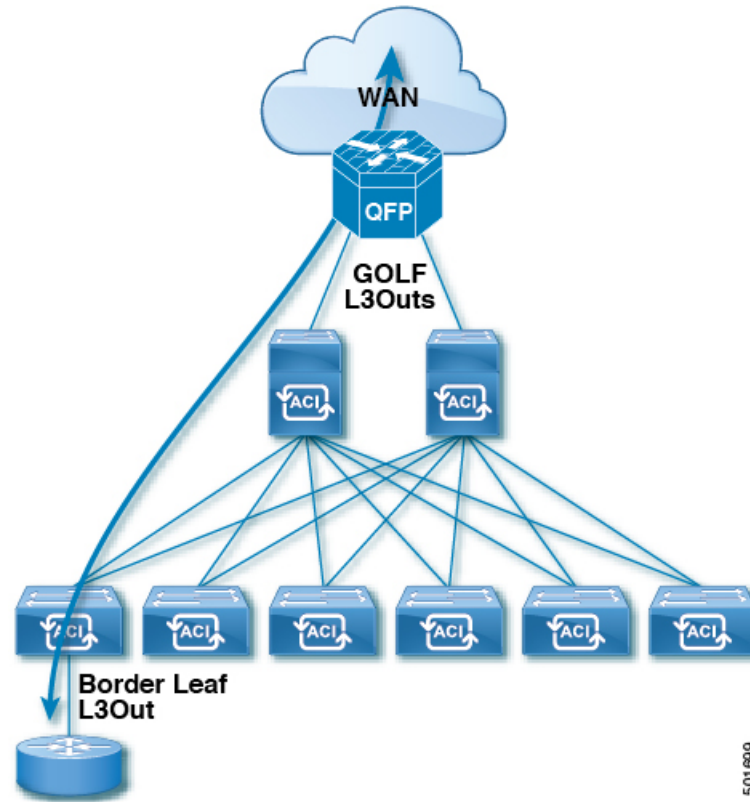

Supported Transit Combination Matrix

Layer 3 Outside Connection Type	OSPF	iBGP			eBGP			EIGRP v4	EIGRP v6	Static Route
		iBGP over OSPF	iBGP over Static Route	iBGP over Direct Connection	eBGP over OSPF	eBGP over Static Route	eBGP over Direct Connection			
OSPF	Yes	Yes*	Yes	Yes* (tested in APIC release 1.3c)	Yes	Yes	Yes	Yes	Yes* (tested in APIC release 1.2g)	Yes

Layer 3 Outside Connection Type		OSPF	iBGP			eBGP			EIGRP v4	EIGRP v6	Static Route
			iBGP over OSPF	iBGP over Static Route	iBGP over Direct Connection	eBGP over OSPF	eBGP over Static Route	eBGP over Direct Connection			
iBGP	iBGP over OSPF	Yes*	X	X	X	Yes* (tested in APIC release 1.3c)	X	Yes	Yes	X	Yes
	iBGP over Static Route	Yes	X	X	X	Yes* (tested in APIC release 1.2g)	X	Yes* (tested in APIC release 1.2g)	Yes	X	Yes
	iBGP over Direct Connection	Yes	X	X	X	-	X	Yes* (tested in APIC release 1.2g)	Yes	X	Yes
eBGP	eBGP over OSPF	Yes	Yes* (tested in APIC release 1.3c)	Yes* (tested in APIC release 1.3c)	Yes* (tested in APIC release 1.3c)	Yes	Yes* (tested in APIC release 1.3c)	Yes* (tested in APIC release 1.3c)	Yes	X	Yes* (tested in APIC release 1.3c)
	eBGP over Static Route	Yes	X	X	X	Yes* (tested in APIC release 1.2g)	Yes (tested in APIC release 3.0)	Yes* (tested in APIC release 1.2g)	Yes	X	Yes
	eBGP over Direct Connection	Yes	Yes	Yes	Yes* (tested in APIC release 1.3c)	Yes* (tested in APIC release 1.3c)	Yes* (tested in APIC release 1.3c)	Yes	Yes	X	Yes
EIGRPv4		Yes	Yes	Yes	Yes	Yes	Yes	Yes	Yes (tested in APIC release 1.3c)	X	Yes

Layer 3 Outside Connection Type	OSPF	iBGP			eBGP			EIGRP v4	EIGRP v6	Static Route
		iBGP over OSPF	iBGP over Static Route	iBGP over Direct Connection	eBGP over OSPF	eBGP over Static Route	eBGP over Direct Connection			
EIGRPv6	Yes (tested in APIC release 1.2g)	X	X	X	X	X	X	X	Yes (tested in APIC release 1.3c)	Yes (tested in APIC release 1.2g)
Static Route	Yes	Yes	Yes	Yes	Yes (tested in APIC release 1.3c)	Yes	Yes	Yes	Yes (tested in APIC release 1.2g)	Yes

- connec. = connection
- * = Not supported on the same leaf switch
- X = Unsupported/Untested combinations

Transit Routing Guidelines

Guidelines for Transit Routing

Use the following guidelines when creating and maintaining transit routing connections:

Topic	Caution or Guideline
OSPF/EIGRP Redistribution into ACI Fabric iBGP when Transit Routing across Multiple VRFs - Route Tags	<p>In a transit routing scenario where external routers are used to route between multiple VRFs, and when an entry other than the default route tag (4294967295) is used to identify the policy in different VRFs, there is a risk of routing loops when there's one or more routes withdrawn from a tenant L3Out in OSPF or EIGRP.</p> <p>This is expected behavior. Upon the EIGRP/OSPF redistribution of routes into the ACI fabric, the default iBGP anti-routing loop mechanisms on the border leaf switches either use the specific default route tag 4294967295 or they use the same tag that is assigned in the Transit Route Tag Policy field in the VRF/Policy page.</p> <p>If you configure a different, specific transit route tag for each VRF, the default anti-routing loop mechanism does not work. In order to avoid this situation, use the same value for the Transit Route Tag Policy field across all VRFs. For additional details regarding route-maps and tags usage, see the row for "OSPF or EIGRP in Back to Back Configuration" and other information on route control profile policies in this table.</p> <p>Note The route tag policy is configured in the Create Route Tag Policy page, which is accessed through the Transit Route Tag Policy field in the VRF/Policy page:</p> <p>Tenants > <i>tenant_name</i> > Networking > VRFs > <i>VRF_name</i></p>

Topic	Caution or Guideline
Transit Routing with a Single L3Out Profile	<p>Before Cisco APIC release 2.3(1f), transit routing was not supported within a single L3Out profile. In Cisco APIC release 2.3(1f) and later, you can configure transit routing with a single L3Out profile, with the following limitations:</p> <ul style="list-style-type: none"> • If the VRF instance is unenforced, you can use an external subnet (l3extSubnet) of 0.0.0.0/0 to allow traffic between the routers sharing the same Layer 3 EPG. • If the VRF instance is enforced, you cannot use an external default subnet (0.0.0.0/0) to match both source and destination prefixes for traffic within the same Layer 3 EPG. To match all traffic within the same Layer 3 EPG, Cisco APIC supports the following prefixes: <ul style="list-style-type: none"> • IPv4 <ul style="list-style-type: none"> • 0.0.0.0/1—with external subnets for the external EPG • 128.0.0.0/1—with external subnets for the external EPG • 0.0.0.0/0—with import route control subnet, aggregate import • IPv6 <ul style="list-style-type: none"> • 0::0/1—with external subnets for the external EPG • 8000::0/1—with external subnets for the external EPG • 0:0/0—with import route control subnet, aggregate import <p>You do not need a contract for intra-Layer 3 EPG forwarding.</p> <ul style="list-style-type: none"> • Alternatively, you can use a single default subnet (0.0.0.0/0) when combined with a contract that has at least one other EPG (application or external). You cannot use vzAny as a replacement for this EPG. However, you do not need to deploy the other EPG anywhere. <p>As an example, use an application EPG provided contract and a Layer 3 EPG consumed contract (matching 0.0.0.0/0) or an application EPG consumed contract and a Layer 3 EPG provided contract (matching 0.0.0.0/0).</p>
Shared Routes: Differences in Hardware Support	<p>Routes shared between VRFs function correctly on generation 2 switches (Cisco Nexus N9K switches with "EX" or "FX" on the end of the switch model name, or later; for example, N9K-93108TC-EX). On generation 1 switches, however, there may be dropped packets with this configuration, because the physical ternary content-addressable memory (TCAM) tables that store routes do not have enough capacity to fully support route parsing.</p>

Topic	Caution or Guideline
OSPF or EIGRP in Back to Back Configuration	<p>Cisco APIC supports transit routing in export route control policies that are configured on the L3Out. These policies control which transit routes (prefixes) are redistributed into the routing protocols in the L3Out. When these transit routes are redistributed into OSPF or EIGRP, they are tagged 4294967295 to prevent routing loops. The Cisco ACI fabric does not accept routes matching this tag when learned on an OSPF or EIGRP L3Out. However, in the following cases, it is necessary to override this behavior:</p> <ul style="list-style-type: none"> • When connecting two Cisco ACI fabrics using OSPF or EIGRP. • When connecting two different VRFs in the same Cisco ACI fabric using OSPF or EIGRP. <p>Where an override is required, you must configure the VRF with a different tag policy at the following APIC GUI location: Tenant > Tenant_name > Policies > Protocol > Route Tag. Apply a different tag.</p> <p>In addition to creating the new route-tag policy, update the VRF to use this policy at the following APIC GUI location: Tenant > Tenant_name > Networking > VRFs > Tenant_VRF. Apply the route tag policy that you created to the VRF.</p> <p>Note When multiple L3Outs or multiple interfaces in the same L3Out are deployed on the same leaf switch and used for transit routing, the routes are advertised within the IGP (not redistributed into the IGP). In this case the route-tag policy does not apply.</p>
Advertising BD Subnets Outside the Fabric	<p>The import and export route control policies only apply to the transit routes (the routes that are learned from other external peers) and the static routes. The subnets internal to the fabric that are configured on the tenant BD subnets are not advertised out using the export policy subnets. The tenant subnets are still permitted using the IP prefix-lists and the route-maps but they are implemented using different configuration steps. See the following configuration steps to advertise the tenant subnets outside the fabric:</p> <ol style="list-style-type: none"> 1. Configure the tenant subnet scope as Public Subnet in the subnet properties window. 2. Optional. Set the Subnet Control as ND RA Prefix in the subnet properties window. 3. Associate the tenant bridge domain (BD) with the external Layer 3 Outside (L3Out). 4. Create contract (provider or consumer) association between the tenant EPG and the external EPG. <p>Setting the BD subnet to Public scope and associating the BD to the L3Out creates an IP prefix-list and the route-map sequence entry on the border leaf for the BD subnet prefix.</p>

Topic	Caution or Guideline
Advertising a Default Route	<p>For external connections to the fabric that only require a default route, there is support for originating a default route for OSPF, EIGRP, and BGP L3Out connections. If a default route is received from an external peer, this route can be redistributed out to another peer following the transit export route control as described earlier in this article.</p> <p>A default route can also be advertised out using a Default Route Leak policy. This policy supports advertising a default route if it is present in the routing table or it always supports advertising a default route. The Default Route Leak policy is configured in the L3Out connection.</p> <p>When creating a Default Route Leak policy, follow these guidelines:</p> <ul style="list-style-type: none"> • For BGP, the Always property is not applicable. • For BGP, when configuring the Scope property, choose Outside. • For OSPF, the scope value Context creates a type-5 LSA while the Scope value Outside creates type-7 LSA. Your choice depends on the area type configured in the L3Out. If the area type is Regular, set the scope to Context. If the area type is NSSA, set the scope to Outside. • For EIGRP, when choosing the Scope property, you must choose Context.
MTU	<p>Cisco ACI does not support IP fragmentation. Therefore, when you configure Layer 3 Outside (L3Out) connections to external routers, or multipod connections through an Inter-Pod Network (IPN), it is critical that the MTU is set appropriately on both sides. On some platforms, such as ACI, Cisco NX-OS, and Cisco IOS, the configurable MTU value takes into account the IP headers (resulting in a max packet size to be set as 9216 bytes for ACI and 9000 for NX-OS and IOS). However, other platforms such as IOS-XR configure the MTU value exclusive of packet headers (resulting in a max packet size of 8986 bytes).</p> <p>For the appropriate MTU values for each platform, see the relevant configuration guides.</p> <p>Cisco highly recommends you test the MTU using CLI-based commands. For example, on the Cisco NX-OS CLI, use a command such as <code>ping 1.1.1.1 df-bit packet-size 9000 source-interface ethernet 1/1</code>.</p>

Transit Route Control

A route transit is defined to import traffic through a Layer 3 outside network `L3extOut` profile (`l3extInstP`), where it is to be imported. A different route transit is defined to export traffic through another `l3extInstP` where it is to be exported.

Since multiple `l3extOut` policies can be deployed on a single node or multiple nodes in the fabric, a variety of protocol combinations are supported. Every protocol combination can be deployed on a single node using multiple `l3extOut` policies or multiple nodes using multiple `l3extOut` policies. Deployments of more than two protocols in different `l3extOut` policies in the fabric are supported.

Export route-maps are made up of prefix-list matches. Each prefix-list consists of bridge domain (BD) public subnet prefixes in the VRF and the export prefixes that need to be advertised outside.

Route control policies are defined in an `l3extOut` policy and controlled by properties and relations associated with the `l3extOut`. APIC uses the `enforceRtctrl` property of the `l3extOut` to enforce route control directions. The default is to enforce control on export and allow all on import. Imported and exported routes (`l3extSubnets`), are defined in the `l3extInstP`. The default scope for every route is import. These are the routes and prefixes which form a prefix-based EPG.

All the import routes form the import route map and are used by BGP and OSPF to control import. All the export routes form the export route map used by OSPF and BGP to control export.

Import and export route control policies are defined at different levels. All IPv4 policy levels are supported for IPv6. Extra relations that are defined in the `l3extInstP` and `l3extSubnet` MOs control import.

Default route leak is enabled by defining the `l3extDefaultRouteLeakP` MO under the `l3extOut`.

`l3extDefaultRouteLeakP` can have Virtual Routing and Forwarding (VRF) scope or `L3extOut` scope per area for OSPF and per peer for BGP.

The following set rules provide route control:

- `rtctrlSetPref`
- `rtctrlSetRtMetric`
- `rtctrlSetRtMetricType`

Additional syntax for the `rtctrlSetComm` MO includes the following:

- `no-advertise`
- `no-export`
- `no-peer`

BGP

The ACI fabric supports BGP peering with external routers. BGP peers are associated with an `l3extOut` policy and multiple BGP peers can be configured per `l3extOut`. BGP can be enabled at the `l3extOut` level by defining the `bgpExtP` MO under an `l3extOut`.



Note Although the `l3extOut` policy contains the routing protocol (for example, BGP with its related VRF), the L3Out interface profile contains the necessary BGP interface configuration details. Both are needed to enable BGP.

BGP peer reachability can be through OSPF, EIGRP, a connected interface, static routes, or a loopback. iBGP or eBGP can be used for peering with external routers. The BGP route attributes from the external router are preserved since MP-BGP is used for distributing the external routes in the fabric. BGP enables IPv4 and/or IPv6 address families for the VRF associated with an `l3extOut`. The address family to enable on a switch is determined by the IP address type defined in `bgpPeerP` policies for the `l3extOut`. The policy is optional; if not defined, the default will be used. Policies can be defined for a tenant and used by a VRF that is referenced by name.

You must define at least one peer policy to enable the protocol on each border leaf (BL) switch. A peer policy can be defined in two places:

- Under `l3extRsPathL3OutAtt`—a physical interface is used as the source interface.
- Under `l3extLNodeP`—a loopback interface is used as the source interface.

OSPF

Various host types require OSPF to enable connectivity and provide redundancy. These include mainframe devices, external pods and service nodes that use the ACI fabric as a Layer 3 transit within the fabric and to the WAN. Such external devices peer with the fabric through a nonborder leaf switch running OSPF. Configure the OSPF area as an NSSA (stub) area to enable it to receive a default route and not participate in full-area routing. Typically, existing routing deployments avoid configuration changes, so a stub area configuration is not mandated.

You enable OSPF by configuring an `ospfExtP` managed object under an `l3extOut`. OSPF IP address family versions configured on the BL switch are determined by the address family that is configured in the OSPF interface IP address.



Note Although the `l3extOut` policy contains the routing protocol (for example, OSPF with its related VRF and area ID), the Layer 3 external interface profile contains the necessary OSPF interface details. Both are needed to enable OSPF.

You configure OSPF policies at the VRF level by using the `fvRsCtxToOspfCtxPol` relation, which you can configure per address family. If you do not configure it, default parameters are used.

You configure the OSPF area in the `ospfExtP` managed object, which also exposes IPv6 the required area properties.

Scope and Aggregate Controls for Subnets

The following section describes some scope and aggregate options available when creating a subnet:

Export Route Control Subnet—The control advertises specific transit routes out of the fabric. This is for transit routes only, and it does not control the internal routes or default gateways that are configured on a bridge domain (BD).

Import Route Control Subnet—This control allows routes to be advertised into the fabric with Border Gateway Protocol (BGP) and Open Shortest Path First (OSPF) when Import Route Control Enforcement is configured.

External Subnets for the External EPG (also called Security Import Subnet)—This option does not control the movement of routing information into or out of the fabric. If you want traffic to flow from one external EPG to another external EPG or to an internal EPG, the subnet must be marked with this control. If you do not mark the subnet with this control, then routes learned from one EPG are advertised to the other external EPG, but packets are dropped in the fabric. The drops occur because the APIC operates in a allowed list model where the default behavior is to drop all data plane traffic between EPGs, unless it is explicitly permitted by a contract. The allowed list model applies to external EPGs and application EPGs. When using security policies that have this option configured, you must configure a contract and a security prefix.

Shared Route Control Subnet—Subnets that are learned from shared L3Outs in inter-VRF leaking must be marked with this control before being advertised to other VRFs. Starting with APIC release 2.2(2e), shared L3Outs in different VRFs can communicate with each other using a contract. For more about communication between shared L3Outs in different VRFs, see the *Cisco APIC Layer 3 Networking Configuration Guide*.

Shared Security Import Subnet—This control is the same as External Subnets for the External EPG for Shared L3Out learned routes. If you want traffic to flow from one external EPG to another external EPG or to another internal EPG, the subnet must be marked with this control. If you do not mark the subnet with this control, then routes learned from one EPG are advertised to the other external EPG, but packets are dropped in the fabric. When using security policies that have this option configured, you must configure a contract and a security prefix.

Aggregate Export, Aggregate Import, and Aggregate Shared Routes—This option adds 32 in front of the 0.0.0.0/0 prefix. Currently, you can only aggregate the 0.0.0.0/0 prefix for the import/export route control subnet. If the 0.0.0.0/0 prefix is aggregated, no route control profile can be applied to the 0.0.0.0/0 network.

Aggregate Shared Route—This option is available for any prefix that is marked as Shared Route Control Subnet.

Route Control Profile—The ACI fabric also supports the route-map set clauses for the routes that are advertised into and out of the fabric. The route-map set rules are configured with the Route Control Profile policies and the Action Rule Profiles.

Configuring Transit Routing

Transit Routing Overview

This topic provides a typical example of how to configure Transit Routing when using Cisco APIC.

The examples in this chapter use the following topology:

Figure 48:

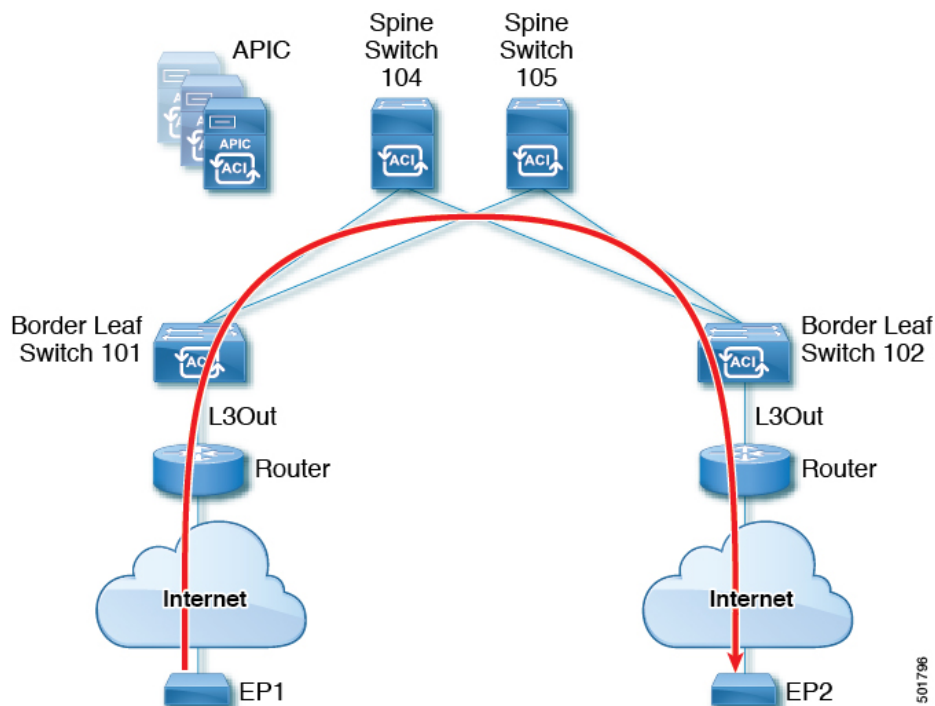

501796

In the examples in this chapter, the Cisco ACI fabric has 2 leaf switches and two spine switches, that are controlled by an APIC cluster. The border leaf switches 101 and 102 have L3Outs on them providing connections to two routers and thus to the Internet. The goal of this example is to enable traffic to flow from EP 1 to EP 2 on the Internet into and out of the fabric through the two L3Outs.

In this example, the tenant that is associated with both L3Outs is `t1`, with VRF `v1`.

Before configuring the L3Outs, configure the nodes, ports, functional profiles, AEPs, and a Layer 3 domain. You must also configure the spine switches 104 and 105 as BGP route reflectors.

Configuring transit routing includes defining the following components:

1. Tenant and VRF
2. Node and interface on leaf 101 and leaf 102
3. Primary routing protocol on each L3Out (used to exchange routes between border leaf switch and external routers; in this example, BGP)
4. Connectivity routing protocol on each L3Out (provides reachability information for the primary protocol; in this example, OSPF)
5. Two external EPGs
6. One route map
7. At least one filter and one contract
8. Associate the contract with the external EPGs



Note For transit routing cautions and guidelines, see [Guidelines for Transit Routing, on page 341](#).

The following table lists the names that are used in the examples in this chapter:

Property	Names for L3Out1 on Node 101	Names for L3Out2 on Node 102
Tenant	<code>t1</code>	<code>t1</code>
VRF	<code>v1</code>	<code>v1</code>
Node	<code>nodep1</code> with router ID 11.11.11.103	<code>nodep2</code> with router ID 22.22.22.203
OSPF Interface	<code>ifp1</code> at <code>eth/1/3</code>	<code>ifp2</code> at <code>eth/1/3</code>
BGP peer address	15.15.15.2/24	25.25.25.2/24
External EPG	<code>extnw1</code> at 192.168.1.0/24	<code>extnw2</code> at 192.168.2.0/24
Route map	<code>rp1</code> with <code>ctx1</code> and route destination 192.168.1.0/24	<code>rp2</code> with <code>ctx2</code> and route destination 192.168.2.0/24
Filter	<code>http-filter</code>	<code>http-filter</code>
Contract	<code>httpCtrct</code> provided by <code>extnw1</code>	<code>httpCtrct</code> consumed by <code>extnw2</code>

Configure Transit Routing Using the GUI

These steps describe how to configure transit routing for a tenant. This example deploys two L3Outs, in one VRF, on two border leaf switches, that are connected to separate routers.

Except for the step to create the tenant and VRF, perform these steps twice, to create the two L3Outs under the same tenant and VRF.

For sample names, see [Transit Routing in the ACI Fabric, on page 333](#).

Before you begin

- Configure an L3 Domain and Fabric Access Policies for interfaces that are used in the L3Out (AAEP, VLAN pool, Interface selectors).
- Configure a BGP Route Reflector Policy for the fabric infra MPBGP.

Procedure

-
- Step 1** To create the tenant and VRF, on the menu bar, choose **Tenants > Add Tenant** and in the **Create Tenant** dialog box, perform the following tasks:
- In the **Name** field, enter the tenant name.
 - In the **VRF Name** field, enter the VRF name.
 - Click **Submit**.
- Note**
After this step, perform the steps twice to create two L3Outs in the same tenant and VRF for transit routing.
- Step 2** To start creating the L3Out, on the **Navigation** pane, expand **Tenant** and **Networking**, then right-click **L3Outs** and choose **Create L3Out**.
- The **Create L3Out** wizard appears. The following steps provide the steps for an example L3Out configuration using the **Create L3Out** wizard.
- Step 3** Enter the necessary information in the **Identity** window of the **Create L3Out** wizard.
- In the **Name** field, enter a name for the L3Out.
 - From the **VRF** drop-down list, choose the VRF.
 - From the **L3 Domain** drop-down list, choose the external routed domain that you previously created.
 - In the area with the routing protocol check boxes, check the desired protocols (BGP, OSPF, or EIGRP).
For the example in this chapter, choose **BGP** and **OSPF**.
Depending on the protocols you choose, enter the properties that must be set.
 - Enter the OSPF details, if you enabled OSPF.
For the example in this chapter, use the OSPF area **0** and type **Regular area**.
 - Click **Next** to move to the **Nodes and Interfaces** window.
- Step 4** Enter the necessary information in the **Nodes and Interfaces** window of the **Create L3Out** wizard.
- Determine if you want to use the default naming convention.

In the **Use Defaults** field, check if you want to use the default node profile name and interface profile names:

- The default node profile name is *L3Out-name_nodeProfile*, where *L3Out-name* is the name that you entered in the **Name** field in the **Identity** page.
- The default interface profile name is *L3Out-name_interfaceProfile*, where *L3Out-name* is the name that you entered in the **Name** field in the **Identity** page.

- b) In the **Interface Types** area, make the necessary selections in the Layer 3 and Layer 2 fields.

The options are:

- Layer 3:
 - **Routed**: Select this option to configure a Layer 3 route to the port channels.
When selecting this option, the Layer 3 route can be to either physical ports or direct port channels, which are selected in the **Layer 2** field in this page.
 - **Routed Sub**: Select this option to configure a Layer 3 sub-interface route to the port channels.
When selecting this option, the Layer 3 sub-interface route can be to either physical ports or direct port channels, which are selected in the **Layer 2** field in this page.
 - **SVI**: Select this option to configure a Switch Virtual Interface (SVI), which is used to provide connectivity between the ACI leaf switch and a router.
SVI can have members that are physical ports, direct port channels, or virtual port channels, which are selected in the **Layer 2** field in this page.
 - **Floating SVI**: Select this option to configure floating L3Out.
Floating L3Out enables you to configure an L3Out that allows a virtual router to move from under one leaf switch to another. The feature saves you from having to configure multiple L3Out interfaces to maintain routing when VMs move from one host to another.
- Layer 2: (not available if you select Virtual SVI in the Layer 3 area)
 - Port
 - Virtual Port Channel (available if you select **SVI** in the Layer 3 area)
 - Direct Port Channel

- c) From the **Node ID** field drop-down menu, choose the node for the L3Out.

For the topology in these examples, use node 103.

- d) In the **Router ID** field, enter the router ID (IPv4 or IPv6 address for the router that is connected to the L3Out).
- e) (Optional) You can configure another IP address for a loopback address, if necessary.

The **Loopback Address** field is automatically populated with the same entry that you provide in the **Router ID** field. This is the equivalent of the **Use Router ID for Loopback Address** option in previous builds. Enter a different IP address for a loopback address, if you don't want to use route ID for the loopback address, or leave this field empty if you do not want to use the router ID for the loopback address.

- f) Enter necessary additional information in the **Nodes and Interfaces** window.

The fields shown in this window varies, depending on the options that you select in the **Layer 3** and **Layer 2** areas.

- g) When you have entered the remaining additional information in the **Nodes and Interfaces** window, click **Next**.

The **Protocols** window appears.

Step 5 Enter the necessary information in the **Protocols** window of the **Create L3Out** wizard.

Because you BGP and OSPF as the protocols for this example, the following steps provide information for those fields.

- a) In the **BGP Loopback Policies** and **BGP Interface Policies** areas, enter the following information:
- **Peer Address:** Enter the peer IP address
 - **EBGP Multihop TTL:** Enter the connection time to live (TTL). The range is from 1 to 255 hops; if zero, no TTL is specified. The default is zero.
 - **Remote ASN:** Enter a number that uniquely identifies the neighbor autonomous system. The Autonomous System Number can be in 4-byte as plain format from 1 to 4294967295.

Note

ACI does not support asdot or asdot+ format AS numbers.

- b) In the **OSPF** area, choose the default OSPF policy, a previously created OSPF policy, or **Create OSPF Interface Policy**.
- c) Click **Next**.

The **External EPG** window appears.

Step 6 Enter the necessary information in the **External EPG** window of the **Create L3Out** wizard.

- a) In the **Name** field, enter a name for the external network.
- b) In the **Provided Contract** field, enter the name of a provided contract.
- c) In the **Consumed Contract** field, enter the name of a consumed contract.
- d) In the **Default EPG for all external networks** field, uncheck if you don't want to advertise all the transit routes out of this L3Out connection.

The Subnets area appears if you uncheck this box. Specify the desired subnets and controls as described in the following steps.

- e) Click the + icon to expand **Subnet**, then perform the following actions in the **Create Subnet** dialog box.
- f) In the **IP address** field, enter the IP address and network mask for the external network.
- g) In the **Name** field, enter the name of the subnet.
- h) In the **Scope** field, check the appropriate check boxes to control the import and export of prefixes for the L3Out.

Note

For more information about the scope options, see the online help for this **Create Subnet** panel.

- i) (Optional) Click the check box for **Export Route Control Subnet**.

The **BGP Route Summarization Policy** field now becomes available.

- j) In the **BGP Route Summarization Policy** field, from the drop-down list, choose an existing route summarization policy or create a new one as desired.

The type of route summarization policy depends on the routing protocols that are enabled for the L3Out.

- k) Click **OK** when you have completed the necessary configurations in the **Create Subnet** window.
- l) (Optional) Repeat to add more subnets.
- m) Click **Finish** to complete the necessary configurations in the **Create L3Out** wizard.

Step 7 Navigate to the L3Out that you just created, then right-click on the L3Out and select **Create Route map for import and export route control**.

Step 8 In the **Create Route map for import and export route control** window, perform the following actions:

- a) In the **Name** field, enter the route map name.
- b) Choose the **Type**.

For this example, leave the default, **Match Prefix AND Routing Policy**.

- c) Click the + icon to expand **Contexts** and create a route context for the route map.
- d) Enter the order and name of the profile context.
- e) Choose **Deny** or **Permit** for the action to be performed in this context.
- f) (Optional) In the **Set Rule** field, choose **Create Set Rules for a Route Map**.

Enter the name for the set rules, click the objects to be used in the rules, and click **Finish**.

- g) In the **Match Rule** field, choose **Create Match Rule for a Route Map**.
- h) Enter the name for the match rule and enter the **Match Regex Community Terms**, **Match Community Terms**, or **Match Prefix** to match in the rule.
- i) When you have finished filling in the fields in the **Create Match Rule** window, click **Submit**.
- j) In the **Create Route Control Context** dialog box, click **OK**.
- k) In the **Create Route map for import and export route control** dialog box, click **Submit**.

Step 9 In the Navigation pane, expand **L3Outs > L3Out_name > External EPGs > externalEPG_name**, and perform the following actions:

- a) Click the + icon to expand **Route Control Profile**.
- b) In the **Name** field, choose the route control profile that you previously created from the drop-down list.
- c) In the **Direction** field, choose **Route Export Policy**.
- d) Click **Update**.

Step 10 Navigate to the L3Out that you just created, then right-click on the L3Out and select **Create Route map for import and export route control**.

Step 11 In the **Create Route map for import and export route control** window, perform the following actions.

Note

To set attributes for BGP, OSPF, or EIGRP for received routes, create a default-import route control profile, with the appropriate set actions and no match actions.

- a) In the **Name** field, choose **default-import**.
- b) In the **Type** field, you must select **Match Routing Policy Only**.
- c) In the **Create Route map for import and export route control** dialog box, click **Submit**.

Step 12 To enable communications between the EPGs consuming the L3Out, create at least one filter and contract, using the following steps:

- a) In the Navigation pane, under the tenant consuming the L3Out, expand **Contracts**.

- b) Right-click **Filters** and choose **Create Filter**.
- c) In the **Name** field, enter a filter name.
A filter is essentially an Access Control List (ACL).
- d) Click the + icon to expand **Entries**, and add a filter entry.
- e) Add the Entry details.

For example, for a simple web filter, set criteria such as the following:

- **EtherType—IP**
- **IP Protocol—tcp**
- **Destination Port Range From—Unspecified**
- **Destination Port Range To to https**

- f) Click **Update**.
- g) In the **Create Filter** dialog box, click **Submit**.

Step 13

To add a contract, use the following steps:

- a) Under **Contracts**, right-click **Standard** and choose **Create Contract**.
- b) Enter the name of the contract.
- c) Click the + icon to expand **Subjects** to add a subject to the contract.
- d) Enter a name for the subject.
- e) Click the + icon to expand **Filters** and choose the filter that you previously created from the drop-down list.
- f) Click **Update**.
- g) In the **Create Contract Subject** dialog box, click **OK**.
- h) In the **Create Contract** dialog box, click **Submit**.

Step 14

Associate the EPGs for the L3Out with the contract, with the following steps:

The first L3 external EPG (`extnw1`) is the provider of the contract and the second L3 external EPG (`extnw2`) is the consumer.

- a) To associate the contract to the L3 external EPG, as the provider, under the tenant, click **Networking**, expand **L3Outs**, and expand the L3Out.
- b) Expand **External EPGs**, click the L3 external EPG, and click the **Contracts** tab.
- c) Click the the + icon to expand **Provided Contracts**.

For the second L3 external EPG, click the + icon to expand Consumed Contracts.

- d) In the **Name** field, choose the contract that you previously created from the list.
 - e) Click **Update**.
 - f) Click **Submit**.
-



CHAPTER 24

Shared Services

This chapter contains the following sections:

- [Shared Layer 3 Out, on page 355](#)
- [Layer 3 Out to Layer 3 Out Inter-VRF Leaking, on page 359](#)

Shared Layer 3 Out

A shared Layer 3 Outside (L3Out or `l3extOut`) configuration provides routed connectivity to an external network as a shared service across VRF instances or tenants. An external EPG instance profile (external EPG or `l3extInstP`) in an L3Out provides the configurations to control which routes can be shared from both the routing perspective and contract perspective. A contract under an external EPG determines to which VRF instances or tenants those routes should be leaked.

An L3Out can be provisioned as a shared service in any tenant (*user*, *common*, *infra*, or *mgmt*). An EPG in any tenant can use a shared services contract to connect with an external EPG regardless of where in the fabric that external EPG is provisioned. This simplifies the provisioning of routed connectivity to external networks; multiple tenants can share a single external EPG for routed connectivity to external networks. Sharing an external EPG is more efficient because it consumes only one session on the switch regardless of how many EPGs use the single shared external EPG.

The figure below illustrates the major policy model objects that are configured for a shared external EPG.

Figure 49: Shared L3Out Policy Model

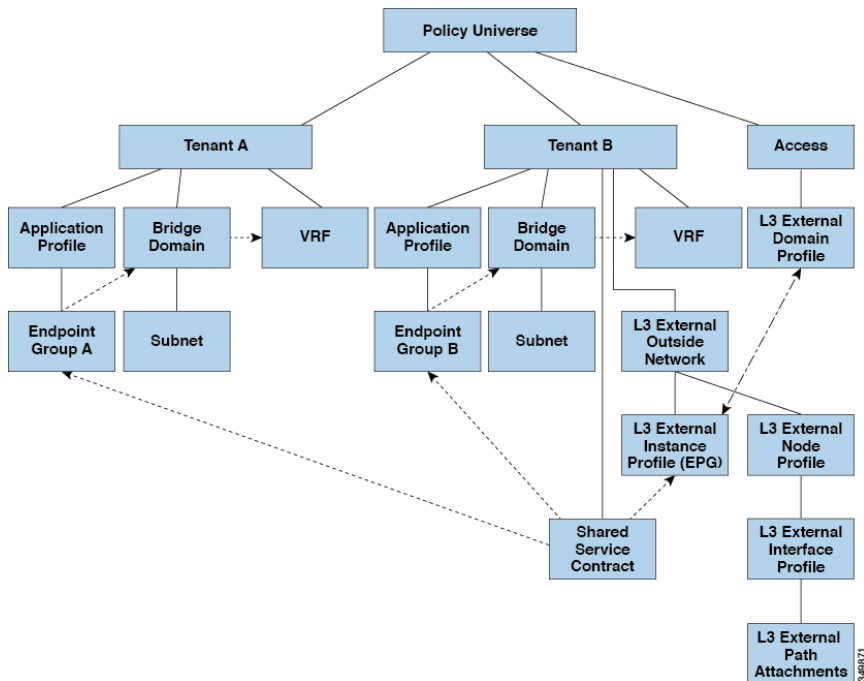

Take note of the following guidelines and limitations for shared L3Out network configurations:

- No tenant limitations: Tenants A and B can be any kind of tenant (*user*, *common*, *infra*, *mgmt*). The shared external EPG does not have to be in the *common* tenant.
- Flexible placement of EPGs: EPG A and EPG B in the illustration above are in different tenants. EPG A and EPG B could use the same bridge domain and VRF instance, but they are not required to do so. EPG A and EPG B are in different bridge domains and different VRF instances but still share the same external EPG.
- A subnet can be *private*, *public*, or *shared*. A subnet that is to be advertised into a consumer or provider EPG of an L3Out must be set to *shared*. A subnet that is to be exported to an L3Out must be set to *public*.
- The shared service contract is exported from the tenant that contains the external EPG that provides shared L3Out network service. The shared service contract is imported into the tenants that contain the EPGs that consume the shared service.
- Do not use taboo contracts with a shared L3Out; this configuration is not supported.
- The external EPG as a shared service provider is supported, but only with non-external EPG consumers (where the L3Out EPG is the same as the external EPG).
- Traffic Disruption (Flap): When an external EPG is configured with an external subnet of 0.0.0.0/0 with the scope property of the external EPG subnet set to shared route control (*shared-rctrl*), or shared security (*shared-security*), the VRF instance is redeployed with a global *pcTag*. This will disrupt all the external traffic in that VRF instance (because the VRF instance is redeployed with a global *pcTag*).
- Prefixes for a shared L3Out must be unique. Multiple shared L3Out configurations with the same prefix in the same VRF instance will not work. Be sure that the external subnets (external prefixes) that are advertised into a VRF instance are unique (the same external subnet cannot belong to multiple external EPGs). An L3Out configuration (for example, named *L3Out1*) with prefix1 and a second L3Out

configuration (for example, named `L3Out2`) also with `prefix1` belonging to the same VRF instance will not work (because only 1 `pcTag` is deployed).

- Different behaviors of L3Out are possible when configured on the same leaf switch under the same VRF instance. The two possible scenarios are as follows:

- Scenario 1 has an L3Out with an SVI interface and two subnets (10.10.10.0/24 and 0.0.0.0/0) defined. If ingress traffic on the L3Out network has the matching prefix 10.10.10.0/24, then the ingress traffic uses the external EPG `pcTag`. If ingress traffic on the L3Out network has the matching default prefix 0.0.0.0/0, then the ingress traffic uses the external bridge `pcTag`.
- Scenario 2 has an L3Out using a routed or routed-sub-interface with two subnets (10.10.10.0/24 and 0.0.0.0/0) defined. If ingress traffic on the L3Out network has the matching prefix 10.10.10.0/24, then the ingress traffic uses the external EPG `pcTag`. If ingress traffic on the L3Out network has the matching default prefix 0.0.0.0/0, then the ingress traffic uses the VRF instance `pcTag`.
- As a result of these described behaviors, the following use cases are possible if the same VRF instance and same leaf switch are configured with `L3Out-A` and `L3Out-B` using an SVI interface:

Case 1 is for `L3Out-A`: This external EPG has two subnets defined: 10.10.10.0/24 and 0.0.0.0/1. If ingress traffic on `L3Out-A` has the matching prefix 10.10.10.0/24, it uses the external EPG `pcTag` and `contract-A`, which is associated with `L3Out-A`. When egress traffic on `L3Out-A` has no specific match found, but there is a maximum prefix match with 0.0.0.0/1, it uses the external bridge domain `pcTag` and `contract-A`.

Case 2 is for `L3Out-B`: This external EPG has one subnet defined: 0.0.0.0/0. When ingress traffic on `L3Out-B` has the matching prefix 10.10.10.0/24 (which is defined under `L3Out-A`), it uses the external EPG `pcTag` of `L3Out-A` and the `contract-A`, which is tied with `L3Out-A`. It does not use `contract-B`, which is tied with `L3Out-B`.

- Traffic not permitted: Traffic is not permitted when an invalid configuration sets the scope of the external subnet to shared route control (`shared-rtctrl`) as a subset of a subnet that is set to shared security (`shared-security`). For example, the following configuration is invalid:

- *shared rtctrl*: 10.1.1.0/24, 10.1.2.0/24
- *shared security*: 10.1.0.0/16

In this case, ingress traffic on a non-border leaf with a destination IP of 10.1.1.1 is dropped, since prefixes 10.1.1.0/24 and 10.1.2.0/24 are installed with a drop rule. Traffic is not permitted. Such traffic can be enabled by revising the configuration to use the `shared-rtctrl` prefixes as `shared-security` prefixes as well.

- Inadvertent traffic flow: Prevent inadvertent traffic flow by avoiding the following configuration scenarios:

- **Case 1** configuration details:

- A L3Out network configuration (for example, named `L3Out-1`) with VRF1 is called `provider1`.
- A second L3Out network configuration (for example, named `L3Out-2`) with VRF2 is called `provider2`.
- `L3Out-1` VRF1 advertises a default route to the Internet, 0.0.0.0/0, which enables both *shared-rtctrl* and *shared-security*.
- `L3Out-2` VRF2 advertises specific subnets to DNS and NTP, 192.0.0.0/8, which enables *shared-rtctrl*.

- L3Out-2 VRF2 has specific subnet 192.1.0.0/16, which enables *shared-security*.
- **Variation A:** EPG traffic goes to multiple VRF instances.
 - Communications between EPG1 and L3Out-1 is regulated by an *allow_all* contract.
 - Communications between EPG1 and L3Out-2 is regulated by an *allow_all* contract.
 - Result:** Traffic from EPG1 to L3Out-2 also goes to 192.2.x.x.
- **Variation B:** An EPG conforms to the *allow_all* contract of a second shared L3Out network.
 - Communications between EPG1 and L3Out-1 is regulated by an *allow_all* contract.
 - Communications between EPG1 and L3Out-2 is regulated by an *allow_icmp* contract.
 - Result:** Traffic from EPG1 to L3Out-2 to 192.2.x.x conforms to the *allow_all* contract.
- **Case 2** configuration details:

- An external EPG has one shared prefix and other non-shared prefixes.
- Traffic coming in with `src = non-shared` is allowed to go to the EPG.

- **Variation A:** Unintended traffic goes through an EPG.

External EPG traffic goes through an L3Out that has these prefixes:

```
Unit 192.0.0.0/8 = import-security, shared-rtctrl
```

List

bullet

5

```
Unit 192.1.0.0/16 = shared-security
```

List

bullet

5

```
Unit The EPG has 1.1.0.0/16 = shared.
```

List

bullet

5

Result: Traffic going from 192.2.x.x also goes through to the EPG.

- **Variation B:** Unintended traffic goes through an EPG. Traffic coming in a shared L3Out can go through the EPG.

```
Unit The shared L3Out VRF instance has an EPG with pcTag = prov vrf and a contract
List set to allow_all.
```

bullet

5

```
Unit The EPG <subnet> = shared.
```

List

bullet

5

Result: The traffic coming in on the L3Out can go through the EPG.

Layer 3 Out to Layer 3 Out Inter-VRF Leaking

Starting with Cisco APIC release 2.2(2e), when there are two Layer 3 Outs in two different VRFs, inter-VRF leaking is supported.

For this feature to work, the following conditions must be satisfied:

- A contract between the two Layer 3 Outs is required.
- Routes of connected and transit subnets for a Layer 3 Out are leaked by enforcing contracts (L3Out-L3Out as well as L3Out-EPG) and without leaking the dynamic or static routes between VRFs.
- Dynamic or static routes are leaked for a Layer 3 Out by enforcing contracts (L3Out-L3Out as well as L3Out-EPG) and without advertising directly connected or transit routes between VRFs.
- Shared Layer 3 Outs in different VRFs can communicate with each other.
- There is no associated L3Out required for the bridge domain. When an Inter-VRF shared L3Out is used, it is not necessary to associate the user tenant bridge domains with the L3Out in tenant `common`. If you had a tenant-specific L3Out, it would still be associated to your bridge domains in your respective tenants.
- Two Layer 3 Outs can be in two different VRFs, and they can successfully exchange routes.
- This enhancement is similar to the Application EPG to Layer 3 Out inter-VRF communications. The only difference is that instead of an Application EPG there is another Layer 3 Out. Therefore, in this case, the contract is between two Layer 3 Outs.

In the following figure, there are two Layer 3 Outs with a shared subnet. There is a contract between the Layer 3 external instance profile (l3extInstP) in both the VRFs. In this case, the Shared Layer 3 Out for VRF1 can communicate with the Shared Layer 3 Out for VRF2.

Figure 50: Shared Layer 3 Outs Communicating Between Two VRFs

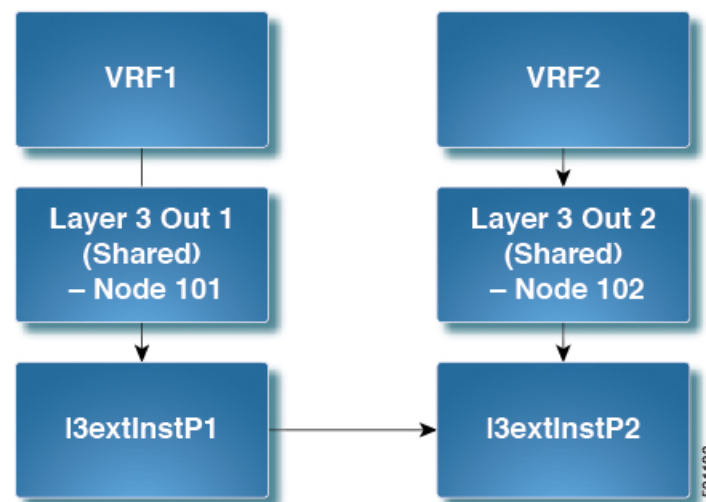

Configuring Shared Layer 3 Out Inter-VRF Leaking Using the Advanced GUI

Before you begin

The contract label to be used by the consumer and provider is already created.

Procedure

-
- Step 1** On the menu bar, choose **Tenants > Add Tenant**.
- Step 2** In the **Create Tenant** dialog box, enter a tenant name for the provider.
- Step 3** In the **VRF Name** field, enter a VRF name for the provider, then click **Submit** to create the tenant.
- Step 4** In the **Navigation** pane, under the new tenant name, navigate to **L3Outs**.
- Step 5** Right-click on **L3Outs** and select **Create L3Out**.
The **Create L3Out** wizard appears.
- Step 6** In the **Create L3Out** dialog box, perform the following actions:
- In the **Name** field, enter a name for the L3Out.
 - In the **VRF** field, select the VRF that you created earlier.
 - In the **L3 Domain** field, select an L3 domain.
 - Make the appropriate selections for the protocols, then click **Next**.
- Step 7** Make the necessary selections in the next windows, until you get to the **External EPG** window.
You might see the **Nodes and Interfaces** window and the **Protocols** window, depending on the protocol that you selected in the **Identity** window. The last window in the **Create L3Out** wizard is the **External EPG** window.
- Step 8** In the **External EPG** window, perform the following actions:
- In the **Name** field, enter the external network name.
 - Uncheck the **Default EPG for all external networks** checkbox.
The **Subnets** fields appears.
 - Click **+** to access the **Create Subnet** window.
 - In the **Create Subnet** dialog box, in the **IP Address** field, enter the match IP address. Click **OK**.
 - Click **Finish** in the **Create L3Out** wizard.
- Step 9** In the **Navigation** pane, navigate to the **L3Out_name > External EPGs > ExternalEPG_name** that you created.
- Step 10** In the **Work** pane, under **Properties** for the external network, verify that the resolved VRF is displayed in the **Resolved VRF** field.
- Step 11** Double-click the IP address for external subnets to open the **Subnet** dialog box.
- Step 12** In the **Scope** field, check the desired check boxes, and then click **Submit**.
In this scenario, check the following check boxes:
- **External Subnets for the External EPG**
 - **Shared Route Control Subnet**

- **Shared Security Import Subnet**

- Step 13** Navigate to the **L3 Outside** you created earlier.
- Step 14** In the **Provider Label** field, enter the provider name that was created as a prerequisite to starting this task. Click **Submit**.
- Step 15** On the menu bar, click **Tenants > Add Tenant**.
- Step 16** In the **Create Tenant** dialog box, enter a tenant name for the L3Out consumer.
- Step 17** In the **VRF name** field, enter a VRF name for the consumer.
- Step 18** In the **Navigation** pane, under the new tenant name, navigate to **L3Outs** for the consumer.
- Step 19** Right-click on **L3Outs** and select **Create L3Out**.
The **Create L3Out** wizard appears.
- Step 20** In the **Create L3Out** dialog box, perform the following actions:
- In the **Name** field, enter a name for the L3Out.
 - In the **VRF** field, from the drop-down menu, choose the VRF that was created for the consumer.
 - In the **Consumer Label** field, enter the name for the consumer label.
 - In the **L3 Domain** field, select an L3 domain.
 - Make the appropriate selections for the protocols, then click **Next**.
- Step 21** Make the necessary selections in the next windows, until you get to the **External EPG** window.
You might see the **Nodes and Interfaces** window and the **Protocols** window, depending on the protocol that you selected in the **Identity** window. The last window in the **Create L3Out** wizard is the **External EPG** window.
- Step 22** In the **External EPG** window, perform the following actions:
- In the **Name** field, enter the external network name.
 - Uncheck the **Default EPG for all external networks** checkbox.
The **Subnets** fields appears.
 - Click + to access the **Create Subnet** window.
 - In the **Create Subnet** dialog box, in the **IP Address** field, enter the match IP address. Click **OK**.
 - In the **Scope** field, check the desired check boxes, and then click **OK**.
In this scenario, check the check boxes for **Shared Route Control Subnet** and **Shared Security Import Subnet**.
 - Click **Finish** in the **Create L3Out** wizard.

This completes the configuration of shared Layer 3 Outside Inter-VRF leaking.



CHAPTER 25

QoS for L3Outs

This chapter contains the following sections:

- [L3Outs QoS, on page 363](#)
- [L3Outs QoS Guidelines and Limitations, on page 363](#)
- [Configuring QoS Directly on L3Out Using GUI, on page 364](#)
- [Configuring QoS Contracts for L3Outs Using GUI, on page 365](#)

L3Outs QoS

L3Out QoS can be configured using Contracts applied at the external EPG level. Starting with Release 4.0(1), L3Out QoS can also be configured directly on the L3Out interfaces.



Note If you are running Cisco APIC Release 4.0(1) or later, we recommend using the custom QoS policies applied directly to the L3Out to configure QoS for L3Outs.

Packets are classified using the ingress DSCP or CoS value so it is possible to use custom QoS policies to classify the incoming traffic into Cisco ACI QoS queues. A custom QoS policy contains a table mapping the DSCP/CoS values to the user queue and to the new DSCP/CoS value (in case of marking). If there is no mapping for a specific DSCP/CoS value, the user queue is selected by the QoS priority setting of the ingress L3Out interface if configured.

L3Outs QoS Guidelines and Limitations

The following guidelines and limitations apply to configuring QoS for L3Outs:

- A custom QoS policy is not supported for Layer 3 multicast traffic sourced from outside the Cisco Application Centric Infrastructure (ACI) fabric (received from L3Out).
- When configuring the QoS policy by using contracts to be enforced on the border leaf switch where the L3Out is located, the VRF table must be in egress mode (Policy Control Enforcement Direction must be "Egress").

A custom QoS setting can be configured directly on an L3Out and applied for the traffic coming from the border leaf switch, as such, the VRF table does not need to be in egress mode.

- To enable the QoS policy to be enforced, the VRF Policy Control Enforcement Preference must be "Enforced."
- When configuring the contract that controls communication between the L3Out and other EPGs, include the QoS class or target DSCP in the contract or subject.



Note Only configure a QoS class or target DSCP in the contract, not in the external EPG (`l3extInstP`).

- When creating a contract subject, you must choose a QoS priority level. You cannot choose **Unspecified**.



Note The exception is with custom QoS policies, as a custom QoS policy will set the DSCP/CoS value even if the QoS class is set to **Unspecified**. When the QoS level is unspecified, the level is treated as 3 by default.

- On generation 2 switches, QoS supports levels 4, 5, and 6 configured under Global policies, EPG, L3Out, custom QoS, and Contracts. The following limitations apply:
 - The number of classes that can be configured with the strict priority is increased to 5.
 - The 3 new classes are supported only with generation 1 switches.
 - If traffic flows between generation 1 switches and generation 2 switches, the traffic will use QoS level 3.
 - For communicating with FEX for new classes, the traffic carries a Layer 2 CoS value of 0.

Generation 1 switches can be identified by the lack of "EX," "FX," "FX2," "GX," or later suffix at the end of the name. For example, N9K-9312TX. Generation 2 and later switches can be identified by the "EX," "FX," "FX2," "GX," or later suffix at the end of the name. For example N9K-93108TC-EX or N9K-9348GC-FXP.

- You can configure QoS class or create a custom QoS policy to apply on an L3Out interface.

Configuring QoS Directly on L3Out Using GUI

This section describes how to configure QoS directly on an L3Out. This is the preferred way of configuring L3Out QoS starting with Cisco APIC Release 4.0(1).

Procedure

-
- Step 1** From the main menu bar, select **Tenants** > *<tenant-name>* .
- Step 2** In the left-hand navigation pane, expand **Tenant** *<tenant-name>* > **Networking** > **L3Outs** > *<routed-network-name>* > **Logical Node Profiles** > *<node-profile-name>* > **Logical Interface Profiles** > *<interface-profile-name>*.

You may need to create new network, node profile, and interface profile if none exists.

Step 3 In the main window pane, configure custom QoS for your L3Out.

You can choose to configure a standard QoS level priority using the **QoS Priority** drop-down list. Alternatively, you can set an existing or create a new custom QoS policy from the **Custom QoS Policy** dropdown.

Configuring QoS Contracts for L3Outs Using GUI

This section describes how to configure QoS for L3Outs using Contracts.



Note Starting with Release 4.0(1), we recommend using custom QoS policies for L3Out QoS as described in [Configuring QoS Directly on L3Out Using GUI, on page 364](#) instead.

Configuring QoS classification using a contract as described in this section will take priority over any QoS policies configured directly on the L3Out.

Procedure

-
- Step 1** Configure the VRF instance for the tenant consuming the L3Out to support QoS to be enforced on the border leaf switch that is used by the L3Out.
- From the main menu bar, choose **Tenants > <tenant-name>**.
 - In the **Navigation** pane, expand **Networking**, right-click **VRFs**, and choose **Create VRF**.
 - Enter the name of the VRF.
 - In the **Policy Control Enforcement Preference** field, choose **Enforced**.
 - In the **Policy Control Enforcement Direction** choose **Egress**
- VRF enforcement must be set to `Egress` when the QoS classification is done in the contract.
- Complete the VRF configuration according to the requirements for the L3Out.
- Step 2** When configuring filters for contracts to enable communication between the EPGs consuming the L3Out, include a QoS class or target DSCP to enforce the QoS priority in traffic ingressing through the L3Out.
- On the Navigation pane, under the tenant that that will consume the L3Out, expand **Contracts**, right-click **Filters** and choose **Create Filter**.
 - In the **Name** field, enter a filter name.
 - In the **Entries** field, click **+** to add a filter entry.
 - Add the Entry details, click **Update** and **Submit**.
 - Expand the previously created filter and click on a filter entry.
 - Set the **Match DSCP** field to the desired DSCP level for the entry, for example, **EF**.
- Step 3** Add a contract.
- Under **Contracts**, right-click **Standard** and choose **Create Contract**.
 - Enter the name of the contract.

- c) In the **QoS Class** field, choose the QoS priority for the traffic governed by this contract. Alternatively, you can choose a **Target DSCP** value.

Configuring QoS classification using a contract as described in this section will take priority over any QoS policies configured directly on the L3Out.

- d) Click the **+** icon on **Subjects** to add a subject to the contract.
 - e) Enter a name for the subject.
 - f) In the QoS Priority field, choose the desired priority level. You cannot choose **Unspecified**.
 - g) Under **Filter Chain**, click the **+** icon on **Filters** and choose the filter you previously created, from the drop down list.
 - h) Click **Update**.
 - i) On the **Create Contract Subject** dialog box, click **OK**.
-



CHAPTER 26

IP SLAs

This chapter contains the following sections:

- [About ACI IP SLAs, on page 367](#)
- [Guidelines and Limitations for IP SLA, on page 376](#)
- [Configuring and Associating ACI IP SLAs for Static Routes, on page 377](#)
- [Viewing ACI IP SLA Monitoring Information, on page 382](#)

About ACI IP SLAs

Many companies conduct most of their business online and any loss of service can affect their profitability. Internet service providers (ISPs) and even internal IT departments now offer a defined level of service, a service level agreement (SLA), to provide their customers with a degree of predictability.

IP SLA tracking is a common requirement in networks. IP SLA tracking allows a network administrator to collect information about network performance in real time. With the Cisco ACI IP SLA, you can track an IP address using ICMP and TCP probes. Tracking configurations can influence route tables, allowing for routes to be removed when tracking results come in negative and returning the route to the table when the results become positive again.

ACI IP SLAs are available for the following:

- Static routes:
 - New in ACI 4.1
 - Automatically remove or add a static route from/to a route table
 - Track the route using ICMP and TCP probes
- Policy-based redirect (PBR) tracking:
 - Available since ACI 3.1
 - Automatically remove or add a next -hop
 - Track the next-hop IP address using ICMP and TCP probes, or a combination using L2Ping
 - Redirect traffic to the PBR node based on the reachability of the next-hop

For more information about PBR tracking, see *Configuring Policy-Based Redirect in the Cisco APIC Layer 4 to Layer 7 Services Deployment Guide*.



Note For either feature, you can perform a network action based on the results of the probes, including configuration, using APIs, or running scripts.

ACI IP SLA Supported Topologies

The following ACI fabric topologies support IP SLA:

- **Single Fabric:** IP SLA tracking is supported for IP address reachable through both L3out and EPG/BD
- **Multi-Pod**
 - You can define a single object tracking policy across different Pods.
 - A workload can move from one Pod to another. The IP SLA policy continues to check accessibility information and detects if an endpoint has moved.
 - If an endpoint moves to another Pod, IP SLA tracking is moved to the other Pod as well, so that tracking information is not passed through the IP network.
- **Remote Leaf**
 - You can define single object tracking policies across ACI main data center and the remote leaf switch.
 - IP SLA probes on remote leaf switches track IP addresses locally without using the IP network.
 - A workload can move from one local leaf to a remote leaf. The IP SLA policy continues to check accessibility information and detects if an endpoint has moved.
 - IP SLA policies move to the remote leaf switches or ACI main data center, based on the endpoint location, for local tracking, so that tracking traffic is not passed through the IP network.



Note Currently, ACI does not support IP SLA in vPC topology.

Cisco ACI IP SLA Operation

A Cisco ACI IP SLA provides monitoring capabilities on the ACI fabric allowing the SLA probing to occur across the data center network and out to the external network. This is accomplished by configuring an IP SLA monitoring policy which defines the probe type used during monitoring. The monitoring policy is then associated with monitoring probe profiles known as "track members". Once configured, track members define an endpoint or next-hop by IP address, the associated monitoring policy, and the scope (bridge domain or L3Out). One or more track members can be assigned to a "track list". Track lists configure thresholds that, if exceeded, determine if a track list is available (up) or unavailable (down).

The following four examples show the supported use cases for ACI IP SLAs in static routes.

Example 1: Static Route Availability by Tracking the Next-Hop

The following figure shows the network topology and the operation for tracking the static route availability of a router.

Figure 51: Static Route Availability by Tracking the Next-Hop

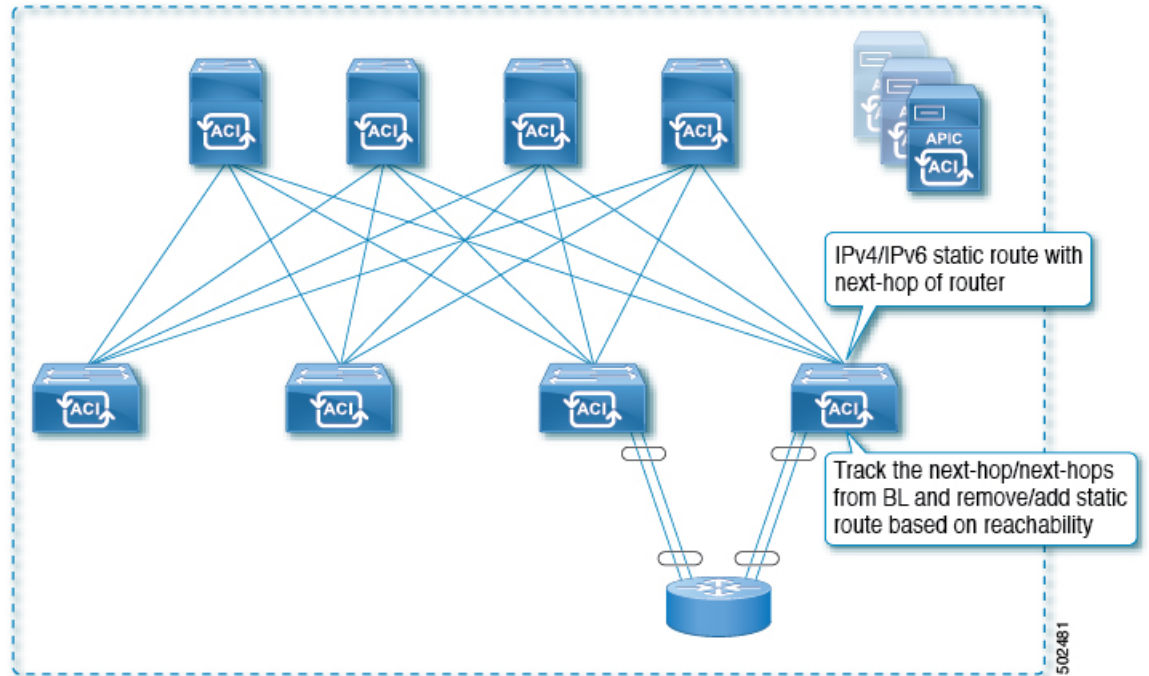

For this use case:

- The next-hop can be direct or indirect meaning that the next-hop can be a loopback IP address of the router.
- The next-hop can be accessed through a physical interface, sub-interface, port channel (PC), PC sub-interface, or switch virtual interface (SVI).
- The static route is configured under the L3out external network and can be removed or added from/to the route table based on the accessibility of the next-hop .

Example 2: Static Route Availability by Tracking an IP Address Through L3Out

The following figure shows the network topology and the operation for tracking the static route availability of a server through an L3Out external route.

Figure 52: Static Route Availability by Tracking an IP Address Through L3Out

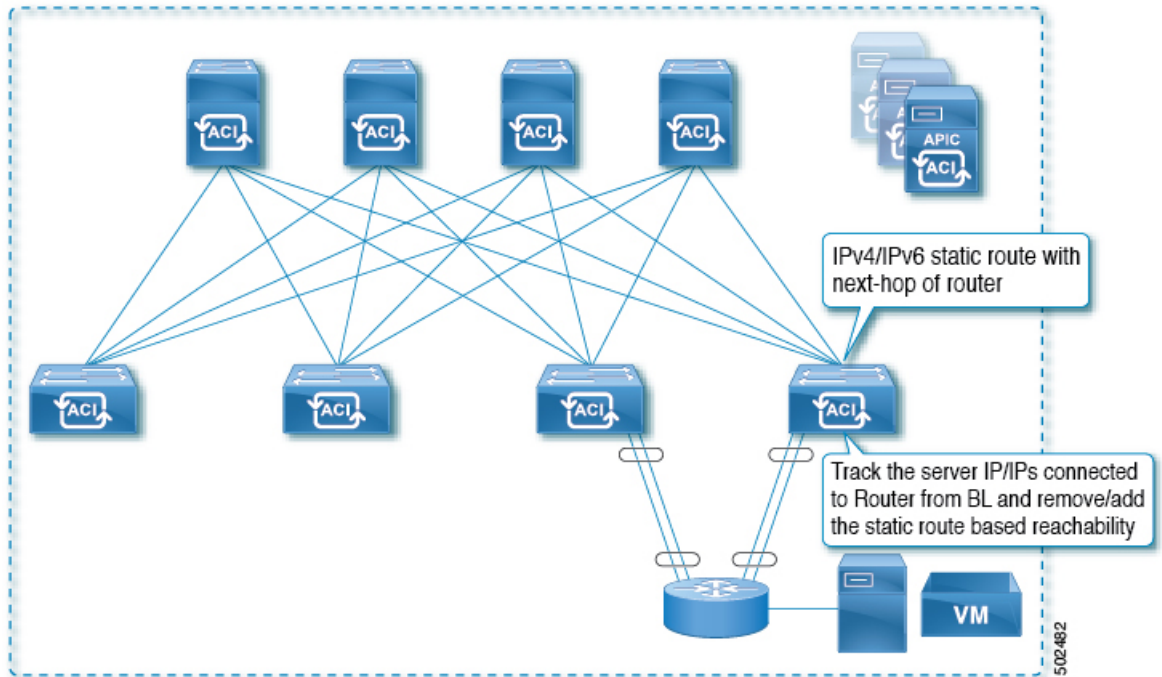

For this use case:

- Track the server IP address connected to the router from the ACI fabric (border leaf) and remove or add the static route based on accessibility of the server.
- The L3Out can be through a port channel (PC), PC sub-interface, switch virtual interface (SVI), L3 interface, or an L3 sub-interface.
- The static route is configured under L3Out and is removed or added based on the accessibility of the IP address.

Example 3: Static Route Removal by Tracking an IP Address Through L3Out

The following figure shows the network topology and the operation for tracking the static route availability of a server through an L3Out external route. The route is removed if it is not accessible through the L3Out/VRF.

Figure 53: Static Route Removal by Tracking an IP Address Through L3Out

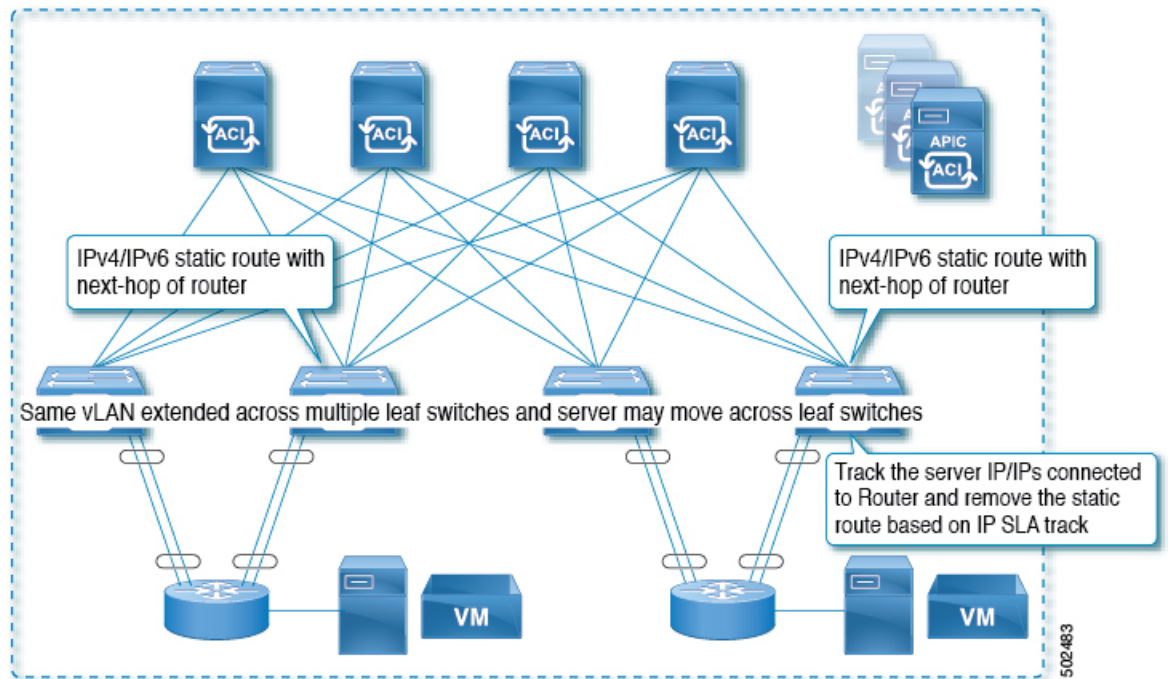

For this use case:

- The L3Out is configured over VLAN/SVI, and that SVI is extended across multiple leaves.
- The server IP address that is accessible through the L3Out can move across leaves.
- Track the server IP address(es) and if they are not accessible through the L3Out/VRF, then remove the static route from the route table.
- The static route is added back to the route table when server is accessible again.

Example 4: Static Route Removal by Tracking an IP Address in the ACI Fabric

Although, as shown in the previous examples, the probe IP of IP SLA for routes is typically the next-hop of the route or an external IP address that should be reachable via the route, you can also use an endpoint IP address in the ACI BD as the probe IP, even if the endpoint does not reside behind the route targeted by the IP SLA. This might be helpful when the static route is to be used solely by certain specific endpoints inside ACI. If such endpoints don't exist, there is no use for the route.

The following figure shows the network topology and the operation for tracking an IP address in the ACI fabric.

Figure 54: Static Route Availability by Tracking an IP Address in the ACI Fabric

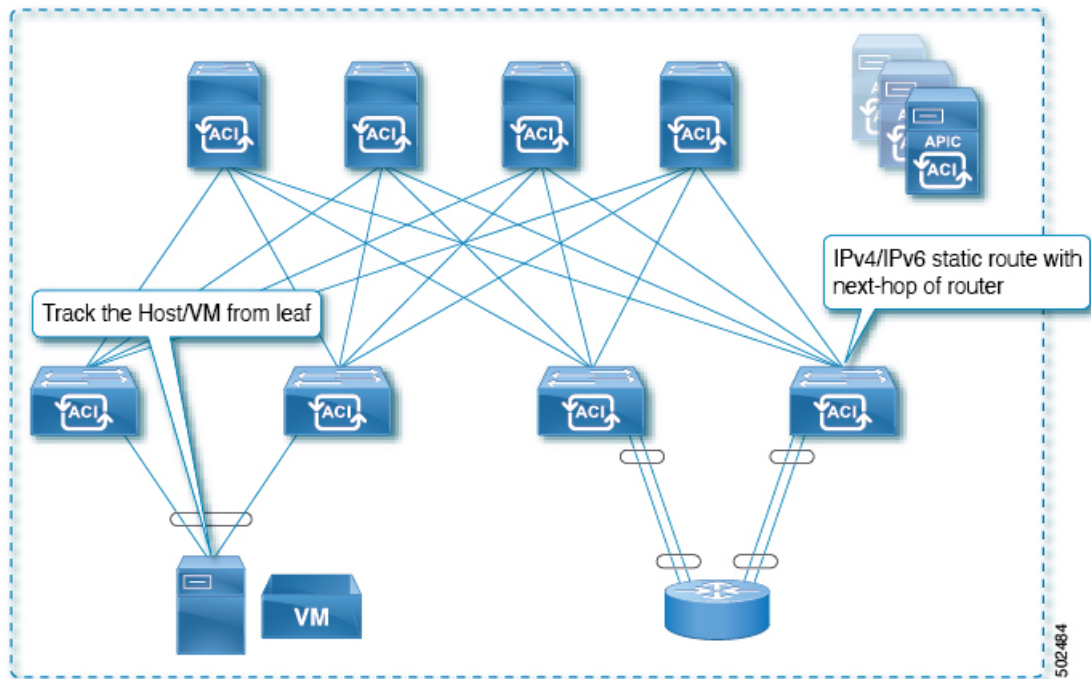

For this use case:

- Track the IP reachability of the endpoints that are connected through the EPG/BD.
- Based on the accessibility of the endpoints, the static route will be removed or added in the L3Out.
- Even if the endpoint moves from one location to another within the fabric, as long as there is the IP reachability to the endpoint from the same BD, IP SLA monitoring considers it accessible and there will be no impact to the validity of the static route.

IP SLA Monitoring Policy

IP Service Level Agreements (SLAs) use active traffic monitoring to generate traffic in a continuous, reliable, and predictable manner, and analyze it to measure the network performance. Measurement statistics that are provided by the IP SLA monitoring policy operations can be used for troubleshooting, problem analysis, and designing network topologies.

With Cisco ACI, the IP SLA monitoring policy is associated with:

- Service Redirect Policies: All the destinations under a service redirect policy are monitored based on the configurations and parameters that are set in the monitoring policy.
- Static Routes: Adding an IP SLA monitoring policy to a track list or track member and associated it with a static route provides the mechanism for monitoring the availability of the next hop segments of the route.

An IP SLA monitoring policy identifies the probe frequency and the type of probe.

ACI IP SLA Monitoring Operation Probe Types

Using ACI IP SLAs, you can monitor the performance between any area in the network: core, distribution, and edge. Monitoring can be done anytime, anywhere, without deploying a physical probe. ACI IP SLAs use generated traffic to measure network performance between two networking devices such as switches. The types of IP SLA operations include:

- ICMP: Echo Probes
- TCP: Connect Probes

TCP Connect Operation

The IP SLAs TCP connect operation measures the response time that is taken to perform a TCP probe between a Cisco switch and an IP device. TCP is a transport layer (Layer 4) Internet Protocol that provides reliable full-duplex data transmission. The destination device can be any device using IP.

In the following figure, Switch B is configured as the source IP SLA device based on the configured static route. A TCP connect operation is configured in the IP SLA monitoring policy (associated with the static route) with the destination device as IP Host 1.

Figure 55: TCP Connection Operation Example

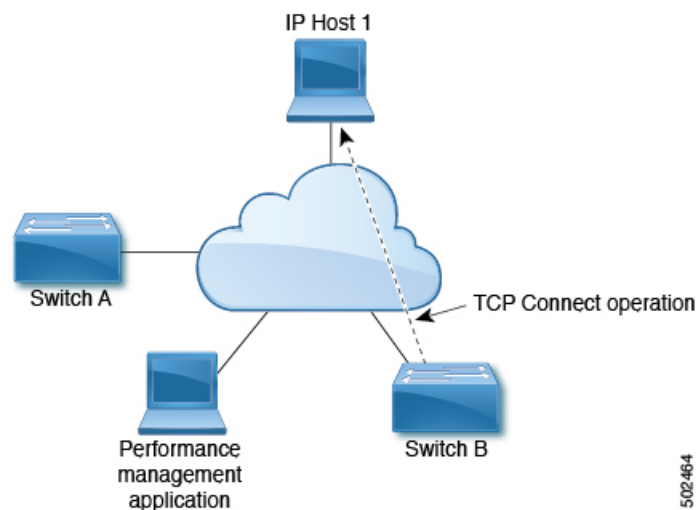

The connection response time is computed by measuring the time that is taken between sending a TCP request message from Switch B to IP Host 1 and receiving a reply from IP Host 1.

ICMP Echo Operation

The Internet Control Message Protocol (ICMP) Echo operation measures the end-to-end response time between two devices that use IPv4 or IPv6. The response time is computed by measuring the time that is taken between sending an ICMP Echo request message to the destination and receiving a reply. An ICMP Echo is useful for troubleshooting network connectivity issues. The results of the ICMP Echo operation can be displayed and analyzed to determine how the network IP connections are performing.

In the following figure, the ICMP Echo operation uses a ping-based probe to measure the response time between the source IP SLAs device and the destination IP device. Many customers use IP SLA ICMP-based operations, in-house ping testing, or ping-based dedicated probes for response time measurements.

Figure 56: ICMP Echo Operation Example

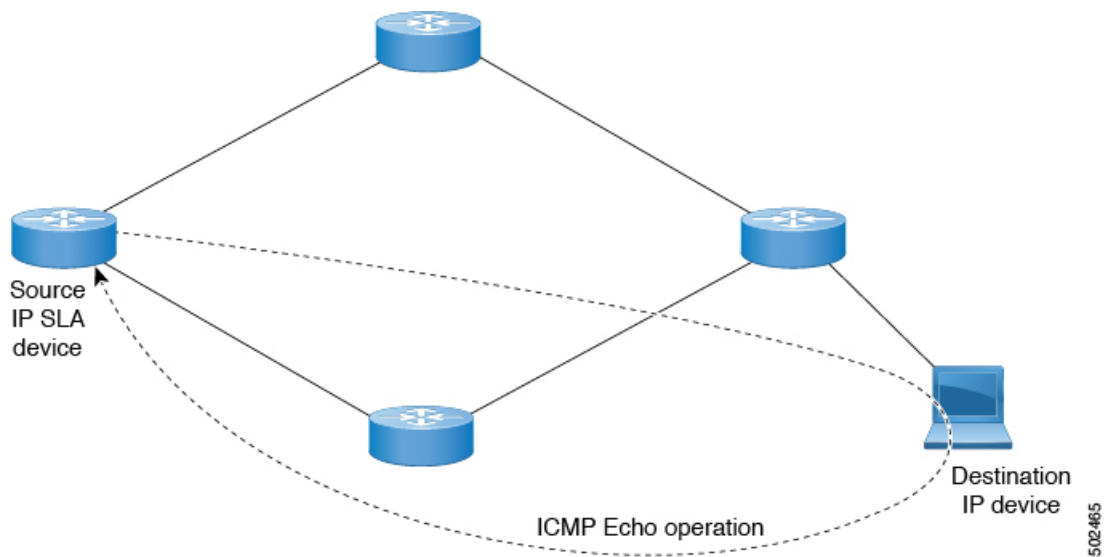

The IP SLA ICMP Echo operation conforms to the same IETF specifications for ICMP ping testing and the two methods result in the same response times.

IP SLA Track Members

An IP SLA track member identifies the:

- IP address to be tracked
- IP SLA monitoring policy (probe frequency and type)
- Scope (bridge domain or L3Out)

IP SLA Track Lists

An IP SLA track list aggregates one or more IP SLA track members representing a network segment to be monitored. The track list determines what percentage or weight of track members must be up or down for the static route to be considered available or unavailable. If the track list is up, based on the threshold percentage or weight, then the static route remains in routing table. If the track list is down, then the static route is removed from the routing table until the track list recovers.

The following is an example of configuring four track members in a track list using the threshold percentage option.

Threshold configuration:

- Set the Percentage Up parameter to 100 (percent)
- Set the Percentage Down parameter to 50 (percent)

In this track list, each of the four track members is assigned 25%. For the track list to become unreachable (down), two of the four track members must be unreachable (50%). For the track list to return to reachable (up), all four track members must be reachable (100%).



Note When a track list is associated with a static route and the track list becomes unreachable (down), the static route is removed from the routing table until the track list becomes reachable again.

Example IP SLA Configuration Component Associations

ACI IP SLAs rely on track members and track lists to identify the types of probes to send and where to send them. Planning the configuration will help make the task easy and fast. This section uses an example to explain how to set up the IP SLA.

Cisco ACI IP SLA L3Out Example

The following figure shows a Cisco ACI IP SLA providing monitoring/probing of a specific configured static route within the ACI fabric and including an external endpoint.

Figure 57: Example ACI L3Out IP SLA

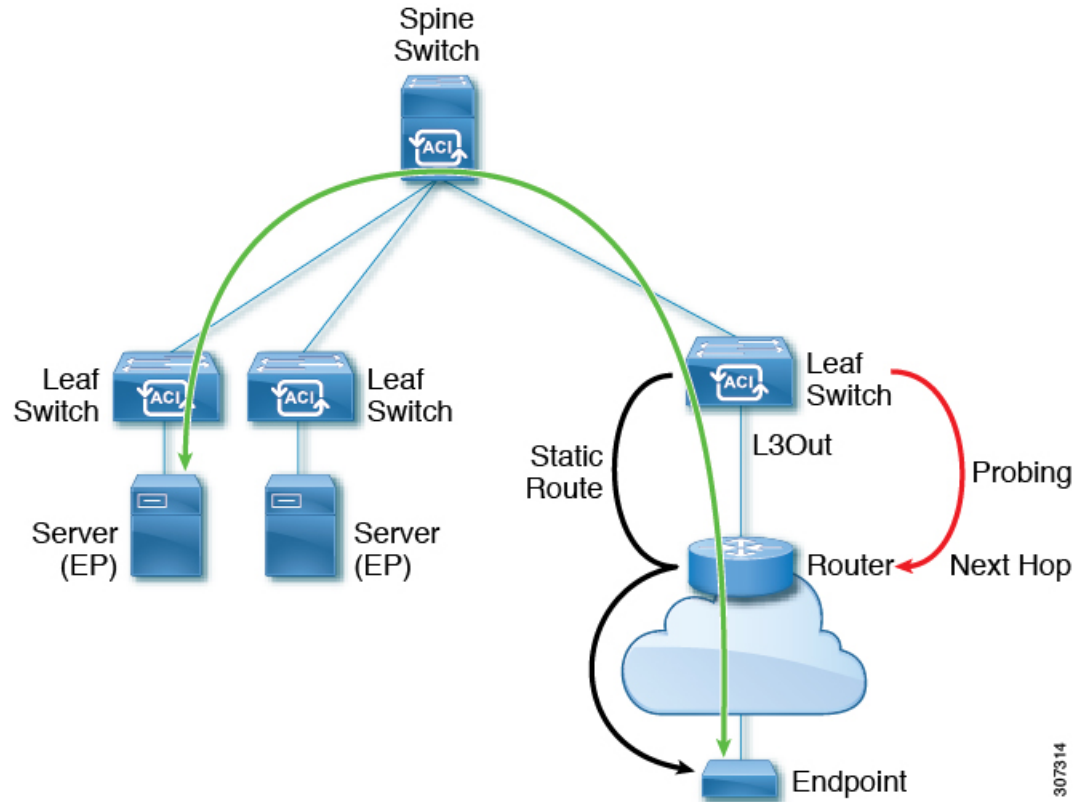

The following image shows a static route for the endpoint prefix of 192.168.13.1/24. It also shows a pair of routers in a static route between an L3Out leaf switch and a consumer endpoint.

Figure 58: Example Static Route

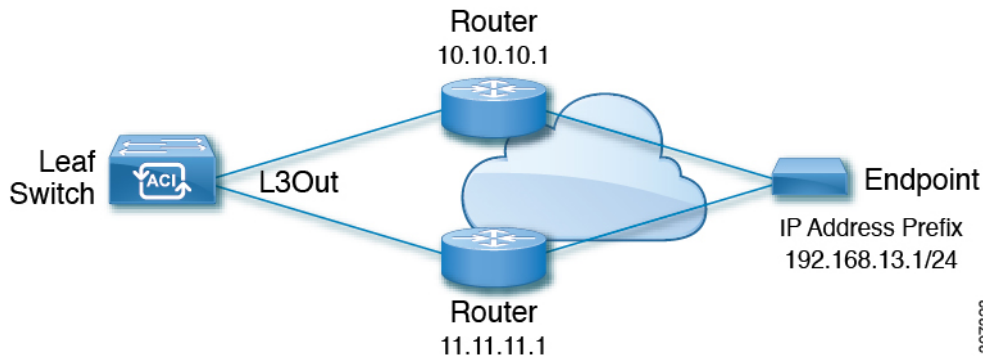

To configure an ACI IP SLA based on the figure above, the router must be monitored to ensure connectivity to the consumer endpoint. This is accomplished by creating a static route, track members, and track lists:

- Static route for 192.168.13.1/24 with next hops of 10.10.10.1 and 11.11.11.1
- Track Member 1 (TM-1) includes the router IP address 10.10.10.1 (this is the next hop probe)
- Track Member 2 (TM-2) includes the router IP address 11.11.11.1 (this is the next hop probe)
- Track List 1 (TL-1) with TM-1 and TM-2 included (track list associated with a static route. The track list contains list of next hops through which configured prefix end points can be reached. Thresholds determining if the track list is reachable or unreachable are also configured.)
- Track List 2 (TL-2) with TM-1 included (associated with a next hop entry included in a static route)
- Track List 3 (TL-3) with TM-2 included (associated with a next hop entry included in a static route)

For a generic static route, you can associate TL-1 with the static route, associate TL-2 with the 10.10.10.1 next hop, and associate TL-3 with the 11.11.11.1 next hop. For a pair of specific static routes (both 192.168.13.1/24), you can associate TL-2 on one and TL-3 on the other. Both should also have TL-2 and TL-3 associated with the router next hops.

These options allow for one router to fail while providing a back-up route in case of the failure. See the following sections to learn more about track members and track lists.

Guidelines and Limitations for IP SLA

Consider the following guidelines and limitations when planning and configuring IP Service Level Agreements:

- IP SLA supports both IPv4 and IPv6 addresses
- IP SLA is supported in all Cisco Nexus second generation switches, which includes the -EX and -FX chassis.
- Beginning in Cisco Application Policy Infrastructure Controller (APIC) release 4.1(1), the IP SLA monitor policy validates the IP SLA port value. Because of the validation, when TCP is configured as the IP SLA type, Cisco APIC no longer accepts an IP SLA port value of 0, which was allowed in previous releases. An IP SLA monitor policy from a previous release that has an IP SLA port value of 0 becomes invalid if the Cisco APIC is upgraded to release 4.1(1) or later. This results in a failure for the configuration import or snapshot rollback.

The workaround is to configure a non-zero IP SLA port value before upgrading the Cisco APIC, and use the snapshot and configuration export that was taken after the IP SLA port change.

- You must enable global GIPo if you are supporting remote leaf switches in an IP SLA:
 1. On the menu bar, click **System > System Settings**.
 2. In the System Settings navigation pane, click **System Global GIPo**.
 3. In the System Global GIPo Policy work pane, click **Enabled**.
 4. In the Policy Usage Warning dialog, review the nodes and policies that may be using the GIPo policy and, if appropriate, click **Submit Changes**.
- Statistics viewed through Fabric > Inventory > Pod *number* > Leaf Node *name* > Protocols > IP SLA > ICMP Echo Operations or TCP Connect Operations can only be gathered in five minute intervals. The interval default is **15 Minute**, but this must be set to **5 Minute**.
- IP SLA policy is not supported for endpoints connected through vPod.
- IP SLA is supported for single pods, Cisco ACI Multi-Pod, and remote leaf switches.
- IP SLA is not supported when the destination IP address to be tracked is connected across Cisco ACI Multi-Site.

For information on verified IP SLA numbers, refer to the appropriate *Verified Scalability Guide for Cisco APIC* on the [Cisco APIC documentation page](#).

Configuring and Associating ACI IP SLAs for Static Routes

This section describes the tasks that are required to configure and associate the following IP SLA policies and profiles:

- IP SLA Monitoring Policies
- IP SLA Track Members
- IP SLA Track Lists

The previous components are applied to either static routes or next hop profiles.

Configuring an IP SLA Monitoring Policy Using the GUI

To enable Cisco Application Policy Infrastructure Controller (APIC) to send monitoring probes for a specific SLA type using the Cisco APIC GUI, perform the following steps:

Procedure

-
- Step 1** On the menu bar, click **Tenant > tenant_name**. In the navigation pane, click **Policies > Protocol > IP SLA**.
 - Step 2** Right-click **IP SLA Monitoring Policies**, and click **Create IP SLA Monitoring Policy**.
 - Step 3** In the **Create IP SLA Monitoring Policy** dialog box, perform the following actions:

- a) In the **Name** field, enter a unique name for the IP SLA Monitoring policy.
- b) In the **SLA Type** field, choose the SLA type.

The SLA type can be **TCP**, **ICMP**, **L2Ping**, or **HTTP**. **ICMP** is the default value.

Note

L2Ping is supported only for Layer 1/Layer 2 policy-based redirect (PBR) tracking.

- c) If you chose **HTTP** for the SLA type, for the **HTTP Version** buttons, choose a version.
- d) If you chose **HTTP** for the SLA type, for the **HTTP URI** field, enter the HTTP URI to use for service node tracking.

The URI must begin with "/", such as "/index.html".

- e) If you chose **TCP** for the SLA type, enter a port number in the **Destination Port** field.
- f) In the **SLA Frequency** field, enter a value, in seconds, to determine the configured frequency to track a packet.

The range is from 1 to 300. The default value is 60. The minimum frequency for HTTP tracking should be 5 seconds.

- g) In the **Detect Multiplier** field, enter a value for the number of missed probes in a row that shows that a failure is detected or a track is down.

By default, failures are detected when three probes are missed in a row. Changing the value in the **Detect Multiplier** field changes the number of missed probes in a row that will determine when failures are detected or when a track is considered to be down.

Used in conjunction with the entry in the **SLA Frequency**, you can determine when a failure will be detected. For example, assume you have the following entries in these fields:

- **SLA Frequency (sec):** 5
- **Detect Multiplier:** 30

A failure would be detected in roughly 150 seconds in this example scenario (5 seconds x 30).

- h) If you chose any SLA type except **TCP**, for the **Request Data Size (bytes)** field, enter the size of the protocol data in the payload of the request packet of the IP SLA operation, in bytes.
- i) For the **Type of Service** field, enter the type of service (ToS) byte for the IPv4 header of the IP SLA operation.
- j) For the **Operation Timeout (milliseconds)** field, enter the amount of time in milliseconds that the IP SLA operation waits for a response from its request packet.
- k) For the **Threshold (milliseconds)** field, enter the upper threshold value for calculating network monitoring statistics created by the IP SLA operation.
- l) For the **Traffic Class Value** field, enter the traffic class byte for the IPv6 header of an IP SLA operation in an IPv6 network.
- m) Click **Submit**.

The IP SLA monitoring policy is configured.

Configuring IP-SLA Track Members Using the GUI

Use this task to create an IP SLA track member which is one of a number added to an IP SLA track list. Track lists are applied to static routes to monitor performance from one defined next hop to another.

Before you begin

You must have created an IP SLA monitoring policy and know the destination IP address for the next hop this track member represents in a static route.

To configure an IP SLA track member using the APIC GUI, perform the following steps:

Procedure

-
- Step 1** On the menu bar, click **Tenants** > *tenant-name*.
 - Step 2** In the Navigation pane, expand **Policies** and then expand **Protocol**.
 - Step 3** Expand **IP SLA**, right-click **Track Members** and choose **Create Track Member**.
 - Step 4** Configure the following parameters:
 - a) In the **Name** field, enter a unique name for the track member.
 - b) In the **Destination IP** field, enter the IP address of the next hop this configuration represents.
 - c) In the **Scope of Track Member** drop-down list, choose an existing bridge domain or external network to which this track member belongs.
 - d) In the **IP SLA Policy** field, select an existing or create a new IP SLA monitoring policy that defines the probe that is used during monitoring.
 - Step 5** Click **Submit**.
-

What to do next

Repeat the preceding steps to create the required number of track members for the static route to be monitored. Once all track members are configured, create a track list and add them to it.

Configuring an IP-SLA Track List Using the GUI

Use this task to create an IP SLA track list which defines a group of track members representing the next hops in a static route. Track lists are applied to static routes to monitor performance from one defined next hop to another.

Before you begin

You must have created one or more IP SLA track members.

To configure an IP SLA track list using the APIC GUI, perform the following steps:

Procedure

-
- Step 1** On the menu bar, click **Tenants** > *tenant-name*.
- Step 2** In the Navigation pane, expand **Policies** and then expand **Protocol**.
- Step 3** Expand **IP SLA**, right-click **Track Lists** and choose **Create Track List**.
The **Create Track List** dialog appears.
- Step 4** Configure the following parameters:
- In the **Name** field, enter a unique name for the track list.
 - In the **Type of Track List** field, choose **Threshold percentage** if you want the route availability to be based on the percentage of track members that are up or down. Choose **Threshold weight** if the route availability is based on a weight value that is assigned to each track member.
 - In the **Track list to track member relation** table, click the + icon in the table head to add a track member to the list. Choose an existing track member and, if the **Type of Track List** is **Threshold weight**, assign a weight value.
- Step 5** Click **Submit**.
-

What to do next

Associate the track list with a static route or next hop IP address.

Associating a Track List with a Static Route Using the GUI

Use this task to associate a track list with a configured static route allowing the system to monitor the performance of a series of next hops.



Note The following task assumes that a next hop configuration already exists for the static route.

Before you begin

A configured routed network with a static route must be available. A configured track list must also be available.

To associate an IP SLA track list with a static route using the APIC GUI, perform the following steps:

Procedure

-
- Step 1** On the menu bar, click **Tenants** > *tenant-name*.
- Step 2** In the Navigation pane, expand **Networking** and then expand **L3Outs**.
- Step 3** Expand the configured routed network (name), **Logical Node Profiles**, a configured logical node profile (name), and **Configured Nodes**.
- Step 4** Click a configured node (name).

The **Node Association** work pane appears.

- Step 5** In the **Static Routes** table, double-click the route entry to which you want to add the track list.
The **Static Route** dialog appears.
- Step 6** In the **Track Policy** drop-down list, choose or create an IP SLA track list to associate with this static route.
- Step 7** Click **Submit**.
- Step 8** The **Policy Usage Warning** dialog appears.
- Step 9** Verify that this change will not impact other nodes or policies using this static route and click **Submit Changes**.
-

Associating a Track List with a Next Hop Profile Using the GUI

Use this task to associate a track list with a configured next hop profile in a static route allowing the system to monitor the next hop performance.

Before you begin

A configured routed network with a static route and next hop profile must be available.

To associate an IP SLA track list with a next hop profile using the APIC GUI, perform the following steps:

Procedure

- Step 1** On the menu bar, click **Tenants** > *tenant-name*.
- Step 2** In the Navigation pane, expand **Networking** and then expand **L3Outs**.
- Step 3** Expand the configured routed network (name), **Logical Node Profiles**, a configured logical node profile (name), and **Configured Nodes**.
- Step 4** Click a configured node (name).
The **Node Association** work pane appears.
- Step 5** In the **Static Routes** table, double-click the route entry to which you want to add the track list.
The **Static Route** dialog appears.
- Step 6** In the **Next Hop Addresses** table, double-click the next hop entry to which you want to add the track list.
The **Next Hop Profile** dialog appears.
- Step 7** In the **Track Policy** drop-down list, choose or create an IP SLA track list to associate with this static route.

Note

If you add an IP SLA Policy to the next hop profile, a track member and track list is automatically created and associated with the profile.

- Step 8** Click **Submit**.
- Step 9** The **Policy Usage Warning** dialog appears.

- Step 10** Verify that this change will not impact other nodes or policies using this static route and click **Submit Changes**.
-

Viewing ACI IP SLA Monitoring Information

This section describes the tasks that are required to view IP SLA statistics, track lists, track members, and associated static routes:

- Viewing ACI IP SLA Probe Statistics Using the GUI
- Viewing Track List and Track Member Status Using the CLI

Viewing IP SLA Probe Statistics Using the GUI

ACI IP SLAs generate the following real-time statistics:

ICMP

- ICMP Echo Round Trip Time (milliseconds)
- Number of Failed ICMP Echo Probes (packets)
- Number of Successful ICMP Echo Probes (packets)
- Number of Transmitted ICMP Echo Probes (packets)

TCP

- Number of Failed TCP Connect Probes (packets)
- Number of Successful TCP Connect Probes (packets)
- Number of Transmitted TCP Connect Probes (packets)
- TCP Connect Round Trip Time (milliseconds)

Use this task to view statistics for an IP SLA track list or member currently monitoring a static route or next hop.

Before you begin

You must have created an IP SLA track list and associated it with a static route before viewing statistics.

Procedure

- Step 1** On the menu bar, click **Tenants** > *tenant-name*.
- Step 2** In the Navigation section, expand **Policies** and then expand **Protocol**.
- Step 3** Expand **IP SLA** and expand either **Track Members** or **Track Lists**.
- Step 4** Click an existing track member or track list you want to view.
- Step 5** Click the **Stats** tab.

- Step 6** Click the **Select Stats** icon to choose the probe statistic types you want to view.
- Step 7** Choose a probe statistic type (chosen statistic types are highlighted in blue) and move it from **Available** to **Selected** with the arrow icon. You can move a probe statistics type from **Selected** back to **Available** with the opposite arrow icon.
- Step 8** When finished selecting the probe statistic type(s) you want to view, click **Submit**.
-

What to do next

The statistics chosen in this task are labeled in the legend above the graph. Lines representing the selected probe statistic types should begin to appear on the graph as the counters begin to accumulate.



CHAPTER 27

HSRP

This chapter contains the following sections:

- [About HSRP, on page 385](#)
- [About Cisco APIC and HSRP, on page 386](#)
- [HSRP Versions, on page 387](#)
- [Guidelines and Limitations, on page 387](#)
- [Default HSRP Settings , on page 389](#)
- [Configuring HSRP Using the GUI, on page 389](#)

About HSRP

HSRP is a first-hop redundancy protocol (FHRP) that allows a transparent failover of the first-hop IP router. HSRP provides first-hop routing redundancy for IP hosts on Ethernet networks configured with a default router IP address. You use HSRP in a group of routers for selecting an active router and a standby router. In a group of routers, the active router is the router that routes packets, and the standby router is the router that takes over when the active router fails or when preset conditions are met.

Many host implementations do not support any dynamic router discovery mechanisms but can be configured with a default router. Running a dynamic router discovery mechanism on every host is not practical for many reasons, including administrative overhead, processing overhead, and security issues. HSRP provides failover services to such hosts.

When you use HSRP, you configure the HSRP virtual IP address as the default router of the host (instead of the IP address of the actual router). The virtual IP address is an IPv4 or IPv6 address that is shared among a group of routers that run HSRP.

When you configure HSRP on a network segment, you provide a virtual MAC address and a virtual IP address for the HSRP group. You configure the same virtual address on each HSRP-enabled interface in the group. You also configure a unique IP address and MAC address on each interface that acts as the real address. HSRP selects one of these interfaces to be the active router. The active router receives and routes packets destined for the virtual MAC address of the group.

HSRP detects when the designated active router fails. At that point, a selected standby router assumes control of the virtual MAC and IP addresses of the HSRP group. HSRP also selects a new standby router at that time.

HSRP uses a priority designator to determine which HSRP-configured interface becomes the default active router. To configure an interface as the active router, you assign it with a priority that is higher than the priority of all the other HSRP-configured interfaces in the group. The default priority is 100, so if you configure just one interface with a higher priority, that interface becomes the default active router.

Interfaces that run HSRP send and receive multicast User Datagram Protocol (UDP)-based hello messages to detect a failure and to designate active and standby routers. When the active router fails to send a hello message within a configurable period of time, the standby router with the highest priority becomes the active router. The transition of packet forwarding functions between the active and standby router is completely transparent to all hosts on the network.

You can configure multiple HSRP groups on an interface. The virtual router does not physically exist but represents the common default router for interfaces that are configured to provide backup to each other. You do not need to configure the hosts on the LAN with the IP address of the active router. Instead, you configure them with the IP address of the virtual router (virtual IP address) as their default router. If the active router fails to send a hello message within the configurable period of time, the standby router takes over, responds to the virtual addresses, and becomes the active router, assuming the active router duties. From the host perspective, the virtual router remains the same.



Note Packets received on a routed port destined for the HSRP virtual IP address terminate on the local router, regardless of whether that router is the active HSRP router or the standby HSRP router. This process includes ping and Telnet traffic. Packets received on a Layer 2 (VLAN) interface destined for the HSRP virtual IP address terminate on the active router.

About Cisco APIC and HSRP

HSRP in Cisco ACI is supported only on routed-interface or sub-interface. Therefore HSRP can only be configured under Layer 3 Out. Also there must be Layer 2 connectivity provided by external device(s) such as a Layer 2 switch between ACI leaf switches running HSRP because HSRP operates on leaf switches by exchanging Hello messages over external Layer 2 connections. An HSRP hello message does not pass through the spine switch.

The following is an example topology of an HSRP deployment in Cisco APIC.

Figure 59: HSRP Deployment Topology

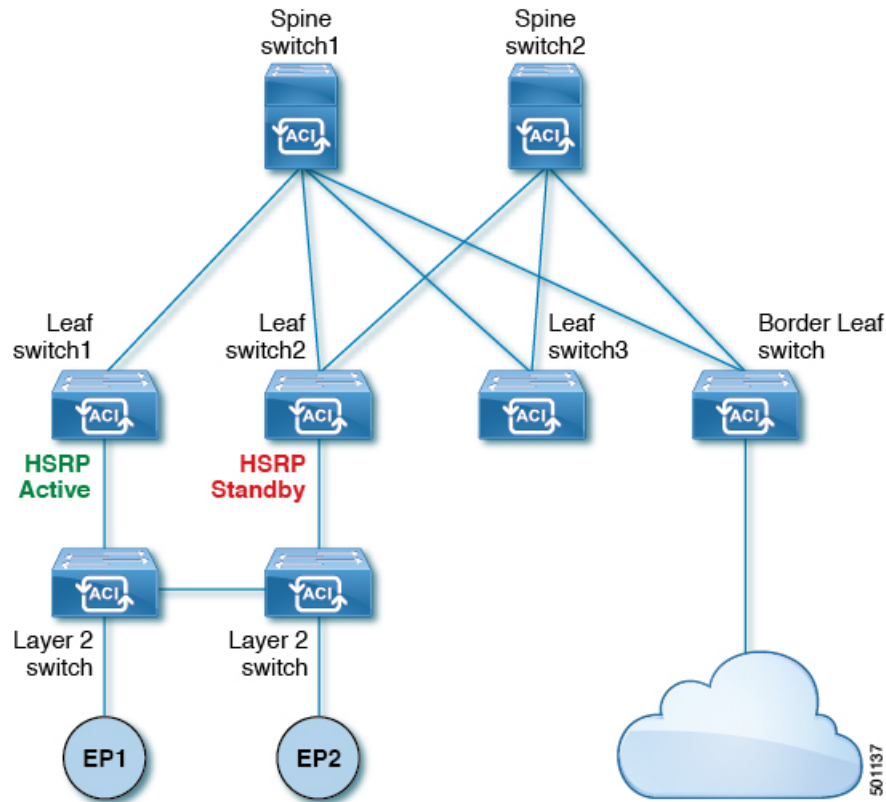

HSRP Versions

Cisco APIC supports HSRP version 1 by default. You can configure an interface to use HSRP version 2.

HSRP version 2 has the following enhancements to HSRP version 1:

- Expands the group number range. HSRP version 1 supports group numbers from 0 to 255. HSRP version 2 supports group numbers from 0 to 4095.
- For IPv4, uses the IPv4 multicast address 224.0.0.102 or the IPv6 multicast address FF02::66 to send hello packets instead of the multicast address of 224.0.0.2, which is used by HSRP version 1.
- Uses the MAC address range from 0000.0C9F.F000 to 0000.0C9F.FFFF for IPv4 and 0005.73A0.0000 through 0005.73A0.0FFF for IPv6 addresses. HSRP version 1 uses the MAC address range 0000.0C07.AC00 to 0000.0C07.ACFF.

Guidelines and Limitations

Follow these guidelines and limitations:

- The HSRP state must be the same for both HSRP IPv4 and IPv6. The priority and preemption must be configured to result in the same state after failovers.

- Currently, only one IPv4 and one IPv6 group is supported on the same sub-interface in Cisco ACI. Even when dual stack is configured, Virtual MAC must be the same in IPv4 and IPv6 HSRP configurations.
- BFD IPv4 and IPv6 is supported when the network connecting the HSRP peers is a pure layer 2 network. You must configure a different router MAC address on the leaf switches. The BFD sessions become active only if you configure different MAC addresses in the leaf interfaces.
- Users must configure the same MAC address for IPv4 and IPv6 HSRP groups for dual stack configurations.
- HSRP VIP must be in the same subnet as the interface IP.
- It is recommended that you configure interface delay for HSRP configurations.
- HSRP is only supported on routed-interface or sub-interface. HSRP is not supported on VLAN interfaces and switched virtual interface (SVI). Therefore, no VPC support for HSRP is available.
- Object tracking on HSRP is not supported.
- HSRP Management Information Base (MIB) for SNMP is not supported.
- Multiple group optimization (MGO) is not supported with HSRP.
- ICMP IPv4 and IPv6 redirects are not supported.
- Cold Standby and Non-Stop Forwarding (NSF) are not supported because HSRP cannot be restarted in the Cisco ACI environment.
- There is no extended hold-down timer support as HSRP is supported only on leaf switches. HSRP is not supported on spine switches.
- HSRP version change is not supported in APIC. You must remove the configuration and reconfigure with the new version.
- HSRP version 2 does not inter-operate with HSRP version 1. An interface cannot operate both version 1 and version 2 because both versions are mutually exclusive. However, the different versions can be run on different physical interfaces of the same router.
- Route Segmentation is programmed in Cisco Nexus 93128TX, Cisco Nexus 9396PX, and Cisco Nexus 9396TX leaf switches when HSRP is active on the interface. Therefore, there is no DMAC=router MAC check conducted for route packets on the interface. This limitation does not apply for Cisco Nexus 93180LC-EX, Cisco Nexus 93180YC-EX, and Cisco Nexus 93108TC-EX leaf switches.
- HSRP configurations are not supported in the Basic GUI mode. The Basic GUI mode has been deprecated starting with APIC release 3.0(1).
- Fabric to Layer 3 Out traffic will always load balance across all the HSRP leaf switches, irrespective of their state. If HSRP leaf switches span multiple pods, the fabric to out traffic will always use leaf switches in the same pod.
- This limitation applies to some of the earlier Cisco Nexus 93128TX, Cisco Nexus 9396PX, and Cisco Nexus 9396TX switches. When using HSRP, the MAC address for one of the routed interfaces or routed sub-interfaces must be modified to prevent MAC address flapping on the Layer 2 external device. This is because Cisco APIC assigns the same MAC address (00:22:BD:F8:19:FF) to every logical interface under the interface logical profiles.

Default HSRP Settings

Parameters	Default Value
Version	1
Delay	0
Reload Delay	0
Interface Control	No Use-Burned-in Address (BIA)
Group ID	0
Group Af	IPv4
IP Obtain Mode	admin
Priority	100
Hello Interval	3000 msec
Hold Interval	10000 msec
Group Control	Preemption disabled
Preempt Delay	0
Authentication Type	Plain Text
Authentication Key Timeout	0
VMAC	Derived (from HSRP groupID)

Configuring HSRP Using the GUI

HSRP is enabled when the leaf switch is configured.

Before you begin

- The tenant and VRF configured.
- VLAN pools must be configured with the appropriate VLAN range defined and the appropriate Layer 3 domain created and attached to the VLAN pool.
- The Attach Entity Profile must also be associated with the Layer 3 domain.
- The interface profile for the leaf switches must be configured as required.

Procedure

Step 1 On the menu bar, click **> Tenants > Tenant_name**. In the **Navigation** pane, click **Networking > L3Outs > L3Out_name > Logical Node Profiles > Logical Interface Profile**.

An HSRP interface profile will be created here.

Step 2 Choose a logical interface profile, and click **Create HSRP Interface Profile**.

Step 3 In the **Create HSRP Interface Profile** dialog box, perform the following actions:

- a) In the **Version** field, choose the desired version.
- b) In the **HSRP Interface Policy** field, from the drop-down, choose **Create HSRP Interface Policy**.
- c) In the **Create HSRP Interface Policy** dialog box, in the **Name** field, enter a name for the policy.
- d) In the **Control** field, choose the desired control.
- e) In the **Delay** field and the **Reload Delay** field, set the desired values. Click **Submit**.

The HSRP interface policy is created and associated with the interface profile.

Step 4 In the **Create HSRP Interface Profile** dialog box, expand **HSRP Interface Groups**.

Step 5 In the **Create HSRP Group Profile** dialog box, perform the following actions:

- a) In the **Name** field, enter an HSRP interface group name.
- b) In the **Group ID** field, choose the appropriate ID.

The values available depend upon whether HSRP version 1 or version 2 was chosen in the interface profile.

- c) In the **IP** field, enter an IP address.

The IP address must be in the same subnet as the interface.

- d) In the **MAC address** field, enter a Mac address.

Note

If you leave this field blank, the HSRP virtual MAC address will be automatically computed based on the group ID.

- e) In the **Group Name** field, enter a group name.

This is the name used in the protocol by HSRP for the HSRP MGO feature.

- f) In the **Group Type** field, choose the desired type.
- g) In the **IP Obtain Mode** field, choose the desired mode.
- h) In the **HSRP Group Policy** field, from the drop-down list, choose **Create HSRP Group Policy**.

Step 6 In the **Create HSRP Group Policy** dialog box, perform the following actions:

- a) In the **Name** field, enter an HSRP group policy name.
- b) The **Key or Password** field is automatically populated.

The default value for authentication type is simple, and the key is "cisco." This is selected by default when a user creates a new policy.

- c) In the **Type** field, choose the level of security desired.
- d) In the **Priority** field choose the priority to define the active router and the standby router.
- e) In the remaining fields, choose the desired values, and click **Submit**.

The HSRP group policy is created.

- f) Create secondary virtual IPs by populating the **Secondary Virtual IPs** field.

This can be used to enable HSRP on each sub-interface with secondary virtual IPs. The IP address that you provide here also must be in the subnet of the interface.

- g) Click **OK**.

Step 7 In the **Create HSRP Interface Profile** dialog box, click **Submit**.
This completes the HSRP configuration.

Step 8 To verify the HSRP interface and group policies created, in the Navigation pane, click **Networking > Protocol Policies > HSRP**.



CHAPTER 28

Cisco ACI GOLF

- [Cisco ACI GOLF](#) , on page 393
- [Distributing BGP EVPN Type-2 Host Routes to a DCIG](#), on page 399
- [Troubleshooting EVPN Type-2 Route Advertisement](#), on page 400

Cisco ACI GOLF

The Cisco ACI GOLF feature (also known as Layer 3 EVPN Services for Fabric WAN) enables much more efficient and scalable ACI fabric WAN connectivity. It uses the BGP EVPN protocol over OSPF for WAN routers that are connected to spine switches.

Figure 60: Cisco ACI GOLF Topology

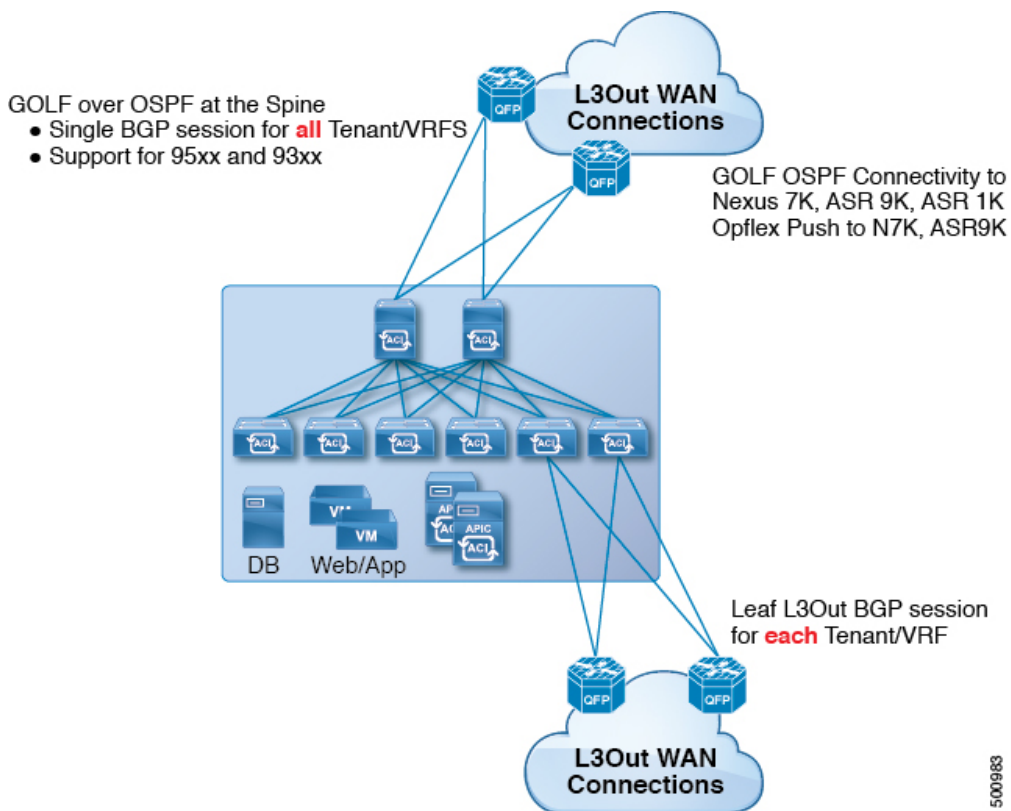

All tenant WAN connections use a single session on the spine switches where the WAN routers are connected. This aggregation of tenant BGP sessions towards the Data Center Interconnect Gateway (DCIG) improves control plane scale by reducing the number of tenant BGP sessions and the amount of configuration required for all of them. The network is extended out using Layer 3 subinterfaces configured on spine fabric ports. Transit routing with shared services using GOLF is not supported.

A Layer 3 external outside network (`L3extOut`) for GOLF physical connectivity for a spine switch is specified under the `infra` tenant, and includes the following:

- `LNodeP` (`L3extInstP` is not required within the `L3Out` in the `infra` tenant.)
- A provider label for the `L3extOut` for GOLF in the `infra` tenant.
- OSPF protocol policies
- BGP protocol policies

All regular tenants use the above-defined physical connectivity. The `L3extOut` defined in regular tenants requires the following:

- An `L3extInstP` (EPG) with subnets and contracts. The scope of the subnet is used to control import/export route control and security policies. The bridge domain subnet must be set to advertise externally and it must be in the same VRF as the application EPG and the GOLF `L3Out` EPG.
- Communication between the application EPG and the GOLF `L3Out` EPG is governed by explicit contracts (not Contract Preferred Groups).

- An `L3extConsLb1` consumer label that must be matched with the same provider label of an `L3Out` for GOLF in the `infra` tenant. Label matching enables application EPGs in other tenants to consume the `LNodeP` external `L3Out` EPG.
- The BGP EVPN session in the matching provider `L3extOut` in the `infra` tenant advertises the tenant routes defined in this `L3Out`.

Guidelines and Limitations for Cisco ACI GOLF

Observe the following Cisco ACI GOLF guidelines and limitations:

- GOLF does not support shared services.
- GOLF does not support transit routing.
- GOLF routers must advertise at least one route to Cisco Application Centric Infrastructure (ACI) to accept traffic. No tunnel is created between leaf switches and the external routers until Cisco ACI receives a route from the external routers.
- All Cisco Nexus 9000 Series Cisco ACI-mode switches and all of the Cisco Nexus 9500 platform Cisco ACI-mode switch line cards and fabric modules support GOLF. With Cisco APIC, release 3.1(x) and higher, this includes the N9K-C9364C switch.
- At this time, only a single GOLF provider policy can be deployed on spine switch interfaces for the whole fabric.
- Up to Cisco APIC release 2.0(2), GOLF is not supported with Cisco ACI Multi-Pod. In release 2.0 (2), the two features are supported in the same fabric only over Cisco Nexus 9000 switches without "EX" on the end of the switch name; for example, N9K-9312TX. Since the 2.1(1) release, the two features can be deployed together over all the switches used in the Cisco ACI Multi-Pod and EVPN topologies.
- When configuring GOLF on a spine switch, wait for the control plane to converge before configuring GOLF on another spine switch.
- A spine switch can be added to multiple provider GOLF outside networks (GOLF L3Outs), but the provider labels have to be different for each GOLF L3Out. Also, in this case, the OSPF Area has to be different on each of the `L3extOuts` and use different loopback addresses.
- The BGP EVPN session in the matching provider `L3Out` in the `infra` tenant advertises the tenant routes defined in this `L3extOut`.
- When deploying three GOLF Outs, if only 1 has a provider/consumer label for GOLF, and 0/0 export aggregation, Cisco APIC will export all routes. This is the same as existing `L3extOut` on leaf switches for tenants.
- If you have an ERSPAN session that has a SPAN destination in a VRF instance, the VRF instance has GOLF enabled, and the ERSPAN source has interfaces on a spine switch, the transit prefix gets sent from a non-GOLF L3Out to the GOLF router with the wrong BGP next-hop.
- If there is direct peering between a spine switch and a data center interconnect (DCI) router, the transit routes from leaf switches to the ASR have the next hop as the PTEP of the leaf switch. In this case, define a static route on the ASR for the TEP range of that Cisco ACI pod. Also, if the DCI is dual-homed to the same pod, then the precedence (administrative distance) of the static route should be the same as the route received through the other link.

- The default `bgpPeerPfxPol` policy restricts routes to 20,000. For Cisco ACI WAN Interconnect peers, increase this as needed.
- In a deployment scenario where there are two `L3extOuts` on one spine switch, and one of them has the provider label `prov1` and peers with the DCI 1, the second `L3extOut` peers with DCI 2 with provider label `prov2`. If the tenant VRF instance has a consumer label pointing to any 1 of the provider labels (either `prov1` or `prov2`), the tenant route will be sent out both DCI 1 and DCI 2.
- When aggregating GOLF OpFlex VRF instances, the leaking of routes cannot occur in the Cisco ACI fabric or on the GOLF device between the GOLF OpFlex VRF instance and any other VRF instance in the system. An external device (not the GOLF router) must be used for the VRF leaking.



Note Cisco ACI does not support IP fragmentation. Therefore, when you configure Layer 3 Outside (L3Out) connections to external routers, or Multi-Pod connections through an Inter-Pod Network (IPN), it is recommended that the interface MTU is set appropriately on both ends of a link. On some platforms, such as Cisco ACI, Cisco NX-OS, and Cisco IOS, the configurable MTU value does not take into account the Ethernet headers (matching IP MTU, and excluding the 14-18 Ethernet header size), while other platforms, such as IOS-XR, include the Ethernet header in the configured MTU value. A configured value of 9000 results in a max IP packet size of 9000 bytes in Cisco ACI, Cisco NX-OS, and Cisco IOS, but results in a max IP packet size of 8986 bytes for an IOS-XR untagged interface.

For the appropriate MTU values for each platform, see the relevant configuration guides.

We highly recommend that you test the MTU using CLI-based commands. For example, on the Cisco NX-OS CLI, use a command such as `ping 1.1.1.1 df-bit packet-size 9000 source-interface ethernet 1/1`.

APIC GOLF Connections Shared by Multi-Site Sites

For APIC Sites in a Multi-Site topology, if stretched VRFs share GOLF connections, follow these guidelines to avoid the risk of cross-VRF traffic issues.

Route Target Configuration between the Spine Switches and the DCI

There are two ways to configure EVPN route targets (RTs) for the GOLF VRFs: Manual RT and Auto RT. The route target is synchronized between ACI spines and DCIs through OpFlex. Auto RT for GOLF VRFs has the Fabric ID embedded in the format: `-ASN: [FabricID] VNID`

If two sites have VRFs deployed as in the following diagram, traffic between the VRFs can be mixed.

Site 1	Site 2
ASN: 100, Fabric ID: 1	ASN: 100, Fabric ID: 1
VRF A: VNID 1000 Import/Export Route Target: 100: [1] 1000	VRF A: VNID 2000 Import/Export Route Target: 100: [1] 2000
VRF B: VNID 2000 Import/Export Route Target: 100: [1] 2000	VRF B: VNID 1000 Import/Export Route Target: 100: [1] 1000

Route Maps Required on the DCI

Since tunnels are not created across sites when transit routes are leaked through the DCI, the churn in the control plane must be reduced as well. EVPN type-5 and type-2 routes sent from GOLF spine in one site towards the DCI should not be sent to GOLF spine in another site. This can happen when the DCI to spine switches have the following types of BGP sessions:

Site1 — IBGP ---- DCI ---- EBGP ---- Site2

Site1 — EBGP ---- DCI ---- IBGP ---- Site2

Site1 — EBGP ---- DCI ---- EBGP ---- Site2

Site1 — IBGP RR client ---- DCI (RR)---- IBGP ---- Site2

To avoid this happening on the DCI, route maps are used with different BGP communities on the inbound and outbound peer policies.

When routes are received from the GOLF spine at one site, the outbound peer policy towards the GOLF spine at another site filters the routes based on the community in the inbound peer policy. A different outbound peer policy strips off the community towards the WAN. All the route-maps are at peer level.

Configuring ACI GOLF Using the GUI

The following steps describe how to configure infra GOLF services that any tenant network can consume.

Procedure

-
- Step 1** On the menu bar, click **Tenants**, then click **infra** to select the infra tenant.
- Step 2** In the **Navigation** pane, expand the **Networking** option and perform the following actions:
- Right-click **L3Outs** and click **Create L3Out** to open the **Create L3Out** wizard.
 - Enter the necessary information in the **Name**, **VRF** and **L3 Domain** fields.
 - In the **Use For:** field, select **Golf**.
The **Provider Label** and **Route Target** fields appear.
 - In the **Provider Label** field, enter a provider label (for example, `golf`).
 - In the **Route Target** field, choose whether to use automatic or explicit policy-governed BGP route target filtering policy:
 - Automatic** - Implements automatic BGP route-target filtering on VRFs associated with this routed outside configuration.
 - Explicit** - Implements route-target filtering through use of explicitly configured BGP route-target policies on VRFs associated with this routed outside configuration.
- Note**
Explicit route target policies are configured in the **BGP Route Target Profiles** table on the **BGP Page** of the **Create VRF Wizard**. If you select the **Automatic** option the in **Route Target** field, configuring explicit route target policies in the **Create VRF Wizard** might cause BGP routing disruptions.
- Leave the remaining fields as-is (BGP selected, and so on), and click **Next**.

The **Nodes and Interfaces** window appears.

Step 3 Enter the necessary information in the **Nodes and Interfaces** window of the **Create L3Out** wizard.

- a) In the **Node ID** drop-down list, choose a spine switch node ID.
- b) In the **Router ID** field, enter the router ID.
- c) (Optional) You can configure another IP address for a loopback address, if necessary.

The **Loopback Address** field is automatically populated with the same entry that you provide in the **Router ID** field. This is the equivalent of the **Use Router ID for Loopback Address** option in previous builds. Enter a different IP address for a loopback address, if you don't want to use route ID for the loopback address. Leave this field empty if you do not want to use the router ID for the loopback address.

- d) Leave the **External Control Peering** field checked.
- e) Enter necessary additional information in the **Nodes and Interfaces** window.

The fields that are shown in this window vary, depending on the options that you select in the **Layer 3** and **Layer 2** areas.

- f) When you have entered the remaining additional information in the **Nodes and Interfaces** window, click **Next**.

The **Protocols** window appears.

Step 4 Enter the necessary information in the **Protocols** window of the **Create L3Out** wizard.

- a) In the **BGP Loopback Policies** and **BGP Interface Policies** areas, enter the following information:
 - **Peer Address**: Enter the peer IP address
 - **EBGP Multihop TTL**: Enter the connection Time To Live (TTL). The range is 1–255 hops; if zero, no TTL is specified. The default is zero.
 - **Remote ASN**: Enter a number that uniquely identifies the neighbor autonomous system. The Autonomous System Number can be in 4 byte as plain format 1–4294967295.

Note

ACI does not support asdot or asdot+ format autonomous system numbers.

- b) In the **OSPF** area, choose the default OSPF policy, a previously created OSPF policy, or **Create OSPF Interface Policy**.
- c) Click **Next**.

The **External EPG** window appears.

Step 5 Enter the necessary information in the **External EPG** window of the **Create L3Out** wizard.

- a) In the **Name** field, enter a name for the external network.
- b) In the **Provided Contract** field, enter the name of a provided contract.
- c) In the **Consumed Contract** field, enter the name of a consumed contract.
- d) In the **Allow All Subnet** field, uncheck if you don't want to advertise all the transit routes out of this L3Out connection.

The Subnets area appears if you uncheck this box. Specify the desired subnets and controls as described in the following steps.

- e) Click **Finish** to complete the necessary configurations in the **Create L3Out** wizard.

- Step 6** In the **Navigation** pane for any tenant, expand the *tenant_name* > **Networking** > **L3Outs** and perform the following actions:
- Right-click **L3Outs** and click **Create L3Out** to open the wizard.
 - Enter the necessary information in the **Name**, **VRF** and **L3 Domain** fields.
 - Check the box next to the **Use for GOLF** field.
 - In the **Label** field, select **Consumer**.
 - Assign a **Consumer Label**. In this example, use *golf* (which was created earlier).
 - Click **Next**, then click **Finish**.
-

Distributing BGP EVPN Type-2 Host Routes to a DCIG

Distributing BGP EVPN Type-2 Host Routes to a DCIG

In APIC up to release 2.0(1f), the fabric control plane did not send EVPN host routes directly, but advertised public bridge domain (BD) subnets in the form of BGP EVPN type-5 (IP Prefix) routes to a Data Center Interconnect Gateway (DCIG). This could result in suboptimal traffic forwarding. To improve forwarding, in APIC release 2.1x, you can enable fabric spines to also advertise host routes using EVPN type-2 (MAC-IP) host routes to the DCIG along with the public BD subnets.

To do so, you must perform the following steps:

- When you configure the BGP Address Family Context Policy, enable Host Route Leak.
- When you leak the host route to BGP EVPN in a GOLF setup:
 - To enable host routes when GOLF is enabled, the BGP Address Family Context Policy must be configured under the application tenant (the application tenant is the consumer tenant that leaks the endpoint to BGP EVPN) rather than under the infrastructure tenant.
 - For a single-pod fabric, the host route feature is not required. The host route feature is required to avoid sub-optimal forwarding in a multi-pod fabric setup. However, if a single-pod fabric is setup, then in order to leak the endpoint to BGP EVPN, a Fabric External Connection Policy must be configured to provide the ETEP IP address. Otherwise, the host route will not leak to BGP EVPN.
- When you configure VRF properties:
 - Add the BGP Address Family Context Policy to the BGP Context Per Address Families for IPv4 and IPv6.
 - Configure BGP Route Target Profiles that identify routes that can be imported or exported from the VRF.

Distributing BGP EVPN Type-2 Host Routes to a DCIG Using the GUI

Enable distributing BGP EVPN type-2 host routes with the following steps:

Before you begin

You must have already configured ACI WAN Interconnect services in the infra tenant, and configured the tenant that will consume the services.

Procedure

-
- Step 1** On the menu bar, click **Tenants > infra**.
- Step 2** In the Navigation pane, navigate to **Policies > Protocol > BGP**.
- Step 3** Right-click **BGP Address Family Context**, select **Create BGP Address Family Context Policy** and perform the following steps:
- Type a name for the policy and optionally add a description.
 - Click the **Enable Host Route Leak** check box.
 - Click **Submit**.
- Step 4** Click **Tenants > tenant-name** (for a tenant that will consume the BGP Address Family Context Policy) and expand **Networking**.
- Step 5** Expand **VRFs** and click the VRF that will include the host routes you want to distribute.
- Step 6** When you configure the VRF properties, add the **BGP Address Family Context Policy** to the **BGP Context Per Address Families** for IPv4 and IPv6.
- Step 7** Click **Submit**.
-

Troubleshooting EVPN Type-2 Route Advertisement

Troubleshooting EVPN Type-2 Route Advertisement

Troubleshooting EVPN Type-2 Route Distribution to a DCIG

For optimal traffic forwarding in an EVPN topology, you can enable fabric spines to distribute host routes to a Data Center Interconnect Gateway (DCIG) using EVPN type-2 (MAC-IP) routes along with the public BD subnets in the form of BGP EVPN type-5 (IP Prefix) routes. This is enabled using the HostLeak object. If you encounter problems with route distribution, use the steps in this topic to troubleshoot.

Procedure

-
- Step 1** Verify that HostLeak object is enabled under the VRF-AF in question, by entering a command such as the following in the spine-switch CLI:

Example:

```
spine1# ls /mit/sys/bgp/inst/dom-apple/af-ipv4-ucast/
ctrl-l2vpn-evpn ctrl-vpnv4-ucast hostleak summary
```

- Step 2** Verify that the config-MO has been successfully processed by BGP, by entering a command such as the following in the spine-switch CLI:

Example:

```
spine1# show bgp process vrf apple
```

Look for output similar to the following:

```
Information for address family IPv4 Unicast in VRF apple
Table Id           : 0
Table state        : UP
Table refcount     : 3
Peers              Active-peers  Routes    Paths    Networks  Aggregates
0                  0          0         0        0         0

Redistribution
  None

Wait for IGP convergence is not configured
GOLF EVPN MAC-IP route is enabled
EVPN network next-hop 192.41.1.1
EVPN network route-map map_pfxleakctrl_v4
Import route-map rtctrlmap-apple-v4
EVPN import route-map rtctrlmap-evpn-apple-v4
```

- Step 3** Verify that the public BD-subnet has been advertised to DCIG as an EVPN type-5 route:

Example:

```
spine1# show bgp l2vpn evpn 10.6.0.0 vrf overlay-1
Route Distinguisher: 192.41.1.5:4123 (L3VNI 2097154)
BGP routing table entry for [5]:[0]:[0]:[16]:[10.6.0.0]:[0.0.0.0]/224, version 2088
Paths: (1 available, best #1)
Flags: (0x000002 00000000) on xmit-list, is not in rib/evpn
Multipath: eBGP iBGP

Advertised path-id 1
Path type: local 0x4000008c 0x0 ref 1, path is valid, is best path
AS-Path: NONE, path locally originated
192.41.1.1 (metric 0) from 0.0.0.0 (192.41.1.5)
  Origin IGP, MED not set, localpref 100, weight 32768
  Received label 2097154
  Community: 1234:444
  Extcommunity:
    RT:1234:5101
    4BYTEAS-GENERIC:T:1234:444

Path-id 1 advertised to peers:
50.41.50.1
```

In the **Path type** entry, **ref 1** indicates that one route was sent.

- Step 4** Verify whether the host route advertised to the EVPN peer was an EVPN type-2 MAC-IP route:

Example:

```
spine1# show bgp l2vpn evpn 10.6.41.1 vrf overlay-1
Route Distinguisher: 10.10.41.2:100 (L2VNI 100)
BGP routing table entry for [2]:[0]:[2097154]:[48]:[0200.0000.0002]:[32]:[10.6.41.1]/272, version 1146
Shared RD: 192.41.1.5:4123 (L3VNI 2097154)
Paths: (1 available, best #1)
Flags: (0x00010a 00000000) on xmit-list, is not in rib/evpn
Multipath: eBGP iBGP
```

```

Advertised path-id 1
Path type: local 0x4000008c 0x0 ref 0, path is valid, is best path
AS-Path: NONE, path locally originated
EVPN network: [5]:[0]:[0]:[16]:[10.6.0.0]:[0.0.0.0] (VRF apple)
  10.10.41.2 (metric 0) from 0.0.0.0 (192.41.1.5)
    Origin IGP, MED not set, localpref 100, weight 32768
    Received label 2097154 2097154
    Extcommunity:
      RT:1234:16777216

Path-id 1 advertised to peers:
  50.41.50.1

```

The **Shared RD** line indicates the RD/VNI shared by the EVPN type-2 route and the BD subnet.

The **EVPN Network** line shows the EVPN type-5 route of the BD-Subnet.

The **Path-id advertised to peers** indicates the path advertised to EVPN peers.

Step 5

Verify that the EVPN peer (a DCIG) received the correct type-2 MAC-IP route and the host route was successfully imported into the given VRF, by entering a command such as the following on the DCIG device (assuming that the DCIG is a Cisco ASR 9000 switch in the example below):

Example:

```

RP/0/RSP0/CPU0:asr9k#show bgp vrf apple-2887482362-8-1 10.6.41.1
Tue Sep  6 23:38:50.034 UTC
BGP routing table entry for 10.6.41.1/32, Route Distinguisher: 44.55.66.77:51
Versions:
  Process          bRIB/RIB  SendTblVer
  Speaker          2088      2088
Last Modified: Feb 21 08:30:36.850 for 28w2d
Paths: (1 available, best #1)
  Not advertised to any peer
  Path #1: Received by speaker 0
  Not advertised to any peer
  Local
    192.41.1.1 (metric 42) from 10.10.41.1 (192.41.1.5)
    Received Label 2097154
    Origin IGP, localpref 100, valid, internal, best, group-best, import-candidate,
imported
    Received Path ID 0, Local Path ID 1, version 2088
    Community: 1234:444
    Extended community: 0x0204:1234:444 Encapsulation Type:8 Router
MAC:0200.c029.0101 RT:1234:5101
  RIB RNH: table_id 0xe0000190, Encap 8, VNI 2097154, MAC Address: 0200.c029.0101,
IP Address: 192.41.1.1, IP table_id 0x00000000
  Source AFI: L2VPN EVPN, Source VRF: default,
Source Route Distinguisher: 192.41.1.5:4123

```

In this output, the received RD, next hop, and attributes are the same for the type-2 route and the BD subnet.



APPENDIX **A**

Guidelines for Layer 3 Networking

- [Guidelines for Layer 3 Networking, on page 403](#)

Guidelines for Layer 3 Networking

Use the following guidelines when creating and maintaining Layer 3 outside connections.

Topic	Caution or Guideline
Traffic gets dropped if you have IPv6 endpoints and the corresponding bridge domain is deployed on a border leaf switch	If the border leaf switch has high utilization of Layer 3 next hops, then the border leaf switch might drop traffic if you have bridge domains with high numbers of IPv6 endpoints deployed on the same border leaf switch.
All leaf switches must be configured with unique IP addresses	The same SVI IPv4 or IPv6 primary or preferred address can be configured across multiple leaf switches within the same L3Out within the management tenant. This can cause network disruptions. To avoid this, ensure that each leaf switch is configured with a unique SVI primary or preferred IP address.
Issue where a border leaf switch in a vPC pair forwards a BGP packet with an incorrect VNID to an on-peer learned endpoint	<p>If the following conditions exist in your configuration:</p> <ul style="list-style-type: none">• Two leaf switches are part of a vPC pair• For the two leaf switches connected behind the L3Out, the destination endpoint is connected to the second (peer) border leaf switch, and the endpoint is on-peer learned on that leaf switch <p>If the endpoint is on-peer learned on the ingress leaf switch that receives a BGP packet that is destined to the on-peer learned endpoint, an issue might arise where the transit BGP connection fails to establish between the first layer 3 switch behind the L3Out and the on-peer learned endpoint on the second leaf switch in the vPC pair. This might happen in this situation because the transit BGP packet with port 179 is forwarded incorrectly using the bridge domain VNID instead of the VRF VNID.</p> <p>To resolve this issue, move the endpoint to any other non-peer leaf switch in the fabric so that it is not learned on the leaf switch.</p>

Topic	Caution or Guideline
Border leaf switches and GIR (maintenance) mode	<p>If a border leaf switch has a static route and is placed in Graceful Insertion and Removal (GIR) mode, or maintenance mode, the route from the border leaf switch might not be removed from the routing table of switches in the ACI fabric, which causes routing issues.</p> <p>To work around this issue, either:</p> <ul style="list-style-type: none"> • Configure the same static route with the same administrative distance on the other border leaf switch, or • Use IP SLA or BFD for track reachability to the next hop of the static route
L3Out aggregate stats do not support egress drop counters	<p>When accessing the Select Stats window through Tenants > tenant_name > Networking > L3Outs > L3Out_name > Stats, you will see that L3Out aggregate stats do not support egress drop counters. This is because there is currently no hardware table in the ASICs that record egress drops from the EPG VLAN, so stats do not populate these counters. There are only ingress drops for the EPG VLAN.</p>
Updates through CLI	<p>For Layer 3 external networks created through the API or GUI and updated through the CLI, protocols need to be enabled globally on the external network through the API or GUI, and the node profile for all the participating nodes needs to be added through the API or GUI before doing any further updates through the CLI.</p>
Loopbacks for Layer 3 networks on same node	<p>When configuring two Layer 3 external networks on the same node, the loopbacks need to be configured separately for both Layer 3 networks.</p>
Ingress-based policy enforcement	<p>Starting with Cisco APIC release 1.2(1), ingress-based policy enforcement enables defining policy enforcement for Layer 3 Outside (L3Out) traffic for both egress and ingress directions. The default is ingress. During an upgrade to release 1.2(1) or higher, existing L3Out configurations are set to egress so that the behavior is consistent with the existing configuration. You do not need any special upgrade sequence. After the upgrade, you change the global property value to ingress. When it has been changed, the system reprograms the rules and prefix entries. Rules are removed from the egress leaf and installed on the ingress leaf, if not already present. If not already configured, an <code>Actrl</code> prefix entry is installed on the ingress leaf. Direct server return (DSR), and attribute EPGs require ingress based policy enforcement. <code>vzAny</code> and <code>taboo</code> contracts ignore ingress based policy enforcement. Transit rules are applied at ingress.</p>
Bridge Domains with L3Outs	<p>A bridge domain in a tenant can contain a public subnet that is advertised through an <code>L3extOut</code> provisioned in the common tenant.</p>
Bridge domain route advertisement For OSPF and EIGRP	<p>When both OSPF and EIGRP are enabled on the same VRF on a node and if the bridge domain subnets are advertised out of one of the L3Outs, it will also get advertised out of the protocol enabled on the other L3Out.</p> <p>For OSPF and EIGRP, the bridge domain route advertisement is per VRF and not per L3Out. The same behavior is expected when multiple OSPF L3Outs (for multiple areas) are enabled on the same VRF and node. In this case, the bridge domain route will be advertised out of all the areas, if it is enabled on one of them.</p>

Topic	Caution or Guideline
BGP Maximum Prefix Limit	<p>Starting with Cisco APIC release 1.2(1x), tenant policies for BGP <code>l3extOut</code> connections can be configured with a maximum prefix limit, that enables monitoring and restricting the number of route prefixes received from a peer. Once the maximum prefix limit has been exceeded, a log entry is recorded, and further prefixes are rejected. The connection can be restarted if the count drops below the threshold in a fixed interval, or the connection is shut down. Only one option can be used at a time. The default setting is a limit of 20,000 prefixes, after which new prefixes are rejected. When the reject option is deployed, BGP accepts one more prefix beyond the configured limit, before the APIC raises a fault.</p>
MTU	<ul style="list-style-type: none"> • Cisco ACI does not support IP fragmentation. Therefore, when you configure Layer 3 Outside (L3Out) connections to external routers, or Multi-Pod connections through an Inter-Pod Network (IPN), it is recommended that the interface MTU is set appropriately on both ends of a link. On some platforms, such as Cisco ACI, Cisco NX-OS, and Cisco IOS, the configurable MTU value does not take into account the Ethernet headers (matching IP MTU, and excluding the 14-18 Ethernet header size), while other platforms, such as IOS-XR, include the Ethernet header in the configured MTU value. A configured value of 9000 results in a max IP packet size of 9000 bytes in Cisco ACI, Cisco NX-OS, and Cisco IOS, but results in a max IP packet size of 8986 bytes for an IOS-XR untagged interface. • The MTU settings for the Cisco ACI physical interfaces vary: <ul style="list-style-type: none"> • For sub-interfaces, the physical interface MTU is fixed and is set to 9216 for the front panel ports on the leaf switches. • For SVI, the physical interface MTU is set based on the fabric MTU policy. For example, if the fabric MTU policy is set to 9000, then the physical interface for the SVI is set to 9000.
QoS for L3Outs	<p>To configure QoS policies for an L3Out and enable the policies to be enforced on the BL switch where the L3Out is located, use the following guidelines:</p> <ul style="list-style-type: none"> • The VRF Policy Control Enforcement Direction must be set to Egress. • The VRF Policy Control Enforcement Preference must be set to Enabled. • When configuring the contract that controls communication between the EPGs using the L3Out, include the QoS class or Target DSCP in the contract or subject of the contract.
ICMP settings	<p>ICMP redirect and ICMP unreachable are disabled by default in Cisco ACI to protect the switch CPU from generating these packets.</p>



APPENDIX **B**

Performing Tasks Using the NX-OS Style CLI

- [Part I: Layer 3 Configuration, on page 407](#)
- [Part II: External Routing \(L3Out\) Configuration, on page 436](#)

Part I: Layer 3 Configuration

Configuring Common Pervasive Gateway Using the NX-OS Style CLI

Configuring Common Pervasive Gateway Using the NX-OS Style CLI

Before you begin

- The tenant, VRF, and bridge domain are created.

Procedure

Configure Common Pervasive Gateway.

Example:

```
apic1#configure
apic1(config)#tenant demo
apic1(config-tenant)#bridge-domain test
apic1(config-tenant-bd)#l2-unknown-unicast flood
apic1(config-tenant-bd)#arp flooding
apic1(config-tenant-bd)#exit

apic1(config-tenant)#interface bridge-domain test
apic1(config-tenant-interface)#multi-site-mac-address 12:34:56:78:9a:bc
apic1(config-tenant-interface)#mac-address 00:CC:CC:CC:C1:01 (Should be unique for each ACI fabric)
apic1(config-tenant-interface)#ip address 192.168.10.1/24 multi-site
apic1(config-tenant-interface)#ip address 192.168.10.254/24 (Should be unique for each ACI fabric)
```

Configuring IP Aging Using the NX-OS Style CLI

Configuring the IP Aging Policy Using the NX-OS-Style CLI

This section explains how to enable and disable the IP Aging policy using the CLI.

Procedure

Step 1 To enable the IP aging policy:

Example:

```
ifc1(config)# endpoint ip aging
```

Step 2 To disable the IP aging policy:

Example:

```
ifav9-ifc1(config)# no endpoint ip aging
```

What to do next

To specify the interval used for tracking IP addresses on endpoints, create an Endpoint Retention policy.

Configuring a Static Route on a Bridge Domain Using the NX-OS Style CLI

Configuring a Static Route on a Bridge Domain Using the NX-OS Style CLI

To configure a static route in a pervasive bridge domain (BD), use the following NX-OS style CLI commands:

Before you begin

The tenant, VRF, BD and EPG are configured.

- When creating the subnet for the static route, it is configured under the EPG (fvSubnet object under fvAEPg), associated with the pervasive BD (fvBD), not the BD itself.
- The subnet mask must be /32 (/128 for IPv6) pointing to one IP address or one endpoint. It is contained in the EPG associated with the pervasive BD.

Procedure

	Command or Action	Purpose
Step 1	configure Example: apic1# configure	Enters configuration mode.

	Command or Action	Purpose
Step 2	tenant <i>tenant-name</i> Example: apicl(config)# tenant t1	Creates a tenant or enters tenant configuration mode.
Step 3	application <i>ap-name</i> Example: apicl(config-tenant)# application ap1	Creates an application profile or enters application profile mode.
Step 4	epg <i>epg-name</i> Example: apicl(config-tenant-app)# epg ep1 ◁ <A.B.C.D> [scope <scope>]	Creates an EPG or enters EPG configuration mode.
Step 5	endpoint ip <i>A.B.C.D/LEN</i> next-hop <i>A.B.C.D</i> [scope <i>scope</i>] Example: apicl(config-tenant-app-epg)# endpoint ip 125.12.1.1/32 next-hop 26.0.14.101	Creates an endpoint behind the EPG. The subnet mask must be /32 (/128 for IPv6) pointing to one IP address or one endpoint.

Example

The following example shows the commands to configure an endpoint behind an EPG.

```
apicl# config
  apicl(config)# tenant t1
  apicl(config-tenant)# application ap1
  apicl(config-tenant-app)# epg ep1
  apicl(config-tenant-app-epg)# endpoint ip 125.12.1.1/32 next-hop 26.0.14.101
```

Configuring Dataplane IP Learning per VRF Using the NX-OS Style CLI

Configuring Dataplane IP Learning Using the NX-OS-Style CLI

This section explains how to disable dataplane IP learning using the NX-OS-style CLI.

To disable dataplane IP learning for a specific VRF:

Procedure

Step 1 Enter the configuration mode.

Example:

```
apicl# config
```

Step 2 Enter the tenant mode for the specific tenant.

Example:

```
apicl(config)# tenant name
```

Step 3 Enter the VRF context mode.

Example:

```
apicl(config-tenant)# vrf context name
```

Step 4 Disable dataplane IP learning for the VRF.

Example:

```
apicl(config-tenant-vrf)# ipdataplanelearning disabled
```

Configuring IPv6 Neighbor Discovery Using the NX-OS Style CLI

Configuring a Tenant, VRF, and Bridge Domain with IPv6 Neighbor Discovery on the Bridge Domain Using the NX-OS Style CLI

Procedure

Step 1 Configure an IPv6 neighbor discovery interface policy and assign it to a bridge domain:

a) Create an IPv6 neighbor discovery interface policy:

Example:

```
apicl(config)# tenant ExampleCorp
apicl(config-tenant)# template ipv6 nd policy NDPol001
apicl(config-tenant-template-ipv6-nd)# ipv6 nd mtu 1500
```

b) Create a VRF and bridge domain:

Example:

```
apicl(config-tenant)# vrf context pvnl
apicl(config-tenant-vrf)# exit
apicl(config-tenant)# bridge-domain bd1
apicl(config-tenant-bd)# vrf member pvnl
apicl(config-tenant-bd)# exit
```

c) Assign an IPv6 neighbor discovery policy to the bridge domain:

Example:

```
apicl(config-tenant)# interface bridge-domain bd1
apicl(config-tenant-interface)# ipv6 nd policy NDPol001
apicl(config-tenant-interface)# exit
```

Step 2 Configure an IPV6 bridge domain subnet and neighbor discovery prefix policy on the subnet:

Example:

```

apic1(config-tenant)# interface bridge-domain bd1
apic1(config-tenant-interface)# ipv6 address 34::1/64
apic1(config-tenant-interface)# ipv6 address 33::1/64
apic1(config-tenant-interface)# ipv6 nd prefix 34::1/64 1000 1000
apic1(config-tenant-interface)# ipv6 nd prefix 33::1/64 4294967295 4294967295

```

Configuring an IPv6 Neighbor Discovery Interface Policy with RA on a Layer 3 Interface Using the NX-OS Style CLI

This example configures an IPv6 neighbor discovery interface policy, and assigns it to a Layer 3 interface. Next, it configures an IPv6 Layer 3 Out interface, neighbor discovery prefix policy, and associates the neighbor discovery policy to the interface.

Procedure

	Command or Action	Purpose
Step 1	configure Example: apic1# configure	Enters configuration mode.
Step 2	tenant <i>tenant_name</i> Example: apic1(config)# tenant ExampleCorp apic1(config-tenant)#	Creates a tenant and enters the tenant mode.
Step 3	template ipv6 nd policy <i>policy_name</i> Example: apic1(config-tenant)# template ipv6 nd policy NDPo1001	Creates an IPv6 ND policy.
Step 4	ipv6 nd mtu <i>mtu value</i> Example: apic1(config-tenant-template-ipv6-nd)# ipv6 nd mtu 1500 apic1(config-tenant-template-ipv6)# exit apic1(config-tenant-template)# exit apic1(config-tenant)#	Assigns an MTU value to the IPv6 ND policy.
Step 5	vrf context <i>VRF_name</i> Example: apic1(config-tenant)# vrf context pvn1	Creates a VRF.

	Command or Action	Purpose
	<code>apicl(config-tenant-vrf)# exit</code>	
Step 6	l3out <i>VRF_name</i> Example: <code>apicl(config-tenant)# l3out l3extOut001</code>	Creates a Layer 3 Out.
Step 7	vrf member <i>VRF_name</i> Example: <code>apicl(config-tenant-l3out)# vrf member pvn1</code> <code>apicl(config-tenant-l3out)# exit</code>	Associates the VRF with the Layer 3 Out.
Step 8	external-l3 epg instp <i>l3out l3extOut001</i> Example: <code>apicl(config-tenant)# external-l3 epg instp l3out l3extOut001</code> <code>apicl(config-tenant-l3ext-epg)# vrf member pvn1</code> <code>apicl(config-tenant-l3ext-epg)# exit</code>	Assigns the Layer 3 Out and the VRF to a Layer 3 interface.
Step 9	leaf <i>2011</i> Example: <code>apicl(config)# leaf 2011</code>	Enters the leaf switch mode.
Step 10	vrf context tenant <i>ExampleCorp vrf pvn1 l3out l3extOut001</i> Example: <code>apicl(config-leaf)# vrf context tenant ExampleCorp vrf pvn1 l3out l3extOut001</code> <code>apicl(config-leaf-vrf)# exit</code>	Associates the VRF to the leaf switch.
Step 11	int <i>eth 1/1</i> Example: <code>apicl(config-leaf)# int eth 1/1</code> <code>apicl(config-leaf-if)#</code>	Enters the interface mode.

	Command or Action	Purpose
Step 12	vrf member tenant <i>ExampleCorp</i> vrf pvn1 l3out l3extOut001 Example: <pre>apic1(config-leaf-if)# vrf member tenant ExampleCorp vrf pvn1 l3out l3extOut001</pre>	Specifies the associated Tenant, VRF, Layer 3 Out in the interface.
Step 13	ipv6 address <i>2001:20:21:22::2/64</i> preferred Example: <pre>apic1(config-leaf-if)# ipv6 address 2001:20:21:22::2/64 preferred</pre>	Specifies the primary or preferred IPv6 address.
Step 14	ipv6 nd prefix <i>2001:20:21:22::2/64 1000</i> <i>1000</i> Example: <pre>apic1(config-leaf-if)# ipv6 nd prefix 2001:20:21:22::2/64 1000 1000</pre>	Configures the IPv6 ND prefix policy under the Layer 3 interface.
Step 15	inherit ipv6 nd <i>NDPo1001</i> Example: <pre>apic1(config-leaf-if)# inherit ipv6 nd NDPo1001 apic1(config-leaf-if)# exit apic1(config-leaf)# exit</pre>	Configures the ND policy under the Layer 3 interface.

The configuration is complete.

Configuring Microsoft NLB Using the NX-OS Style CLI

Configuring Microsoft NLB in Unicast Mode Using the NX-OS Style CLI

This task configures Microsoft NLB to flood all of the ports in the bridge domain.

Before you begin

Have the following information available before proceeding with these procedures:

- Microsoft NLB cluster VIP
- Microsoft NLB cluster MAC address

Procedure

	Command or Action	Purpose
Step 1	configure Example: apicl# configure	Enters configuration mode.
Step 2	tenant <i>tenant-name</i> Example: apicl (config)# tenant tenant1	Creates a tenant if it does not exist or enters tenant configuration mode.
Step 3	application <i>app-profile-name</i> Example: apicl (config-tenant)# application appl	Creates an application profile if it doesn't exist or enters application profile configuration mode.
Step 4	epg <i>epg-name</i> Example: apicl (config-tenant-app)# epg epg1	Creates an EPG if it doesn't exist or enters EPG configuration mode.
Step 5	[no] endpoint {ip ipv6} ip-address epnlb mode mode-uc mac mac-address Example: apicl (config-tenant-app-epg)# endpoint ip 192.0.2.2/32 epnlb mode mode-uc mac 03:BF:01:02:03:04	Configures Microsoft NLB in unicast mode, where: <ul style="list-style-type: none"> • <i>ip-address</i> is the Microsoft NLB cluster VIP. • <i>mac-address</i> is the Microsoft NLB cluster MAC address.

Configuring Microsoft NLB in Multicast Mode Using the NX-OS Style CLI

This task configures Microsoft NLB to flood only on certain ports in the bridge domain.

Before you begin

Have the following information available before proceeding with these procedures:

- Microsoft NLB cluster VIP
- Microsoft NLB cluster MAC address

Procedure

	Command or Action	Purpose
Step 1	configure Example: apicl# configure	Enters configuration mode.

	Command or Action	Purpose
Step 2	tenant <i>tenant-name</i> Example: apicl (config)# tenant tenant1	Creates a tenant if it does not exist or enters tenant configuration mode.
Step 3	application <i>app-profile-name</i> Example: apicl (config-tenant)# application appl	Creates an application profile if it doesn't exist or enters application profile configuration mode.
Step 4	epg <i>epg-name</i> Example: apicl (config-tenant-app)# epg epg1	Creates an EPG if it does not exist or enters EPG configuration mode.
Step 5	[no] endpoint {ip ipv6} ip-address eplb mode mode-mcast--static mac mac-address Example: apicl (config-tenant-app-epg)# endpoint ip 192.0.2.2/32 eplb mode mode-mcast--static mac 03:BF:01:02:03:04	Configures Microsoft NLB in static multicast mode, where: <ul style="list-style-type: none"> • <i>ip-address</i> is the Microsoft NLB cluster VIP. • <i>mac-address</i> is the Microsoft NLB cluster MAC address.
Step 6	[no] nlb static-group mac-address leaf leaf-num interface {ethernet slot/port port-channel port-channel-name} vlan portEncapVlan Example: apicl (config-tenant-app-epg)# nlb static-group 03:BF:01:02:03:04 leaf 102 interface ethernet 1/12 vlan 19	Adds Microsoft NLB multicast VMAC to the EPG ports where the Microsoft NLB servers are connected, where: <ul style="list-style-type: none"> • <i>mac-address</i> is the Microsoft NLB cluster MAC address that you entered in Step 5, on page 415. • <i>leaf-num</i> is the leaf switch that contains the interface to be added or removed. • <i>port-channel-name</i> is the name of the port-channel, when the port-channel option is used. • <i>portEncapVlan</i> is the encapsulation VLAN for the static member of the application EPG.

Configuring Microsoft NLB in IGMP Mode Using the NX-OS Style CLI

This task configures Microsoft NLB to flood only on certain ports in the bridge domain.

Before you begin

Have the following information available before proceeding with these procedures:

- Microsoft NLB cluster VIP
- Microsoft NLB cluster MAC address

Procedure

	Command or Action	Purpose
Step 1	configure Example: apicl# configure	Enters configuration mode.
Step 2	tenant <i>tenant-name</i> Example: apicl (config)# tenant tenant1	Creates a tenant if it does not exist or enters tenant configuration mode.
Step 3	application <i>app-profile-name</i> Example: apicl (config-tenant)# application appl	Creates an application profile if it doesn't exist or enters application profile configuration mode.
Step 4	epg <i>epg-name</i> Example: apicl (config-tenant-app)# epg epg1	Creates an EPG if it doesn't exist or enters EPG configuration mode.
Step 5	[no] endpoint {ip ipv6} ip-address eplb mode mode-mcast-igmp group multicast-IP-address Example: apicl (config-tenant-app-epg)# endpoint ip 192.0.2.2/32 eplb mode mode-mcast-igmp group 1.3.5.7	Configures Microsoft NLB in IGMP mode, where: <ul style="list-style-type: none"> • <i>ip-address</i> is the Microsoft NLB cluster VIP. • <i>multicast-IP-address</i> is the multicast IP for the NLB endpoint group.

Configuring IGMP Snooping Using the NX-OS Style CLI

Configuring and Assigning an IGMP Snooping Policy to a Bridge Domain using the NX-OS Style CLI

Before you begin

- Create the tenant that will consume the IGMP Snooping policy.
- Create the bridge domain for the tenant, where you will attach the IGMP Snooping policy.

Procedure

	Command or Action	Purpose
Step 1	Create a snooping policy based on default values.	The example NX-OS style CLI sequence:

	Command or Action	Purpose
	<p>Example:</p> <pre> apicl(config-tenant)# template ip igmp snoothing policy cookieCut1 apicl(config-tenant-template-ip-igmp-snooping)# show run all # Command: show running -config all tenant foo template ip igmp snooping policy cookieCut1 # Time: Thu Oct 13 18:26:03 2016 tenant t_10 template ip igmp snooping policy cookieCut1 ip igmp snooping no ip igmp snooping fast-leave ip igmp snooping last-member-query-interval 1 no ip igmp snooping querier ip igmp snooping query-interval 125 ip igmp snooping query-max-response-time 10 ip igmp snooping stqrtup-query-count 2 ip igmp snooping startup-query-interval 31 no description exit exit apicl(config-tenant-template-ip-igmp-snooping)# </pre>	<ul style="list-style-type: none"> • Creates an IGMP Snooping policy named cookieCut1 with default values. • Displays the default IGMP Snooping values for the policy cookieCut1.
Step 2	<p>Modify the snooping policy as necessary.</p> <p>Example:</p> <pre> apicl(config-tenant-template-ip-igmp-snooping)# ip igmp snooping query-interval 300 apicl(config-tenant-template-ip-igmp-snooping)# show run all # Command: show running -config all tenant foo template ip igmp snooping policy cookieCut1 #Time: Thu Oct 13 18:26:03 2016 tenant foo template ip igmp snooping policy cookieCut1 ip igmp snooping no ip igmp snooping fast-leave ip igmp snooping last-member-query-interval 1 no ip igmp snooping querier ip igmp snooping query-interval 300 ip igmp snooping query-max-response-time 10 ip igmp snooping stqrtup-query-count 2 ip igmp snooping startup-query-interval 31 </pre>	<p>The example NX-OS style CLI sequence:</p> <ul style="list-style-type: none"> • Specifies a custom value for the query-interval value in the IGMP Snooping policy named cookieCut1. • Confirms the modified IGMP Snooping value for the policy cookieCut1.

	Command or Action	Purpose
	<pre> no description exit exit apicl(config-tenant-template-ip-igmp-snooping)# exit apicl(config--tenant)# </pre>	
Step 3	<p>Modify the snooping policy as necessary.</p> <p>Example:</p> <pre> apicl(config-tenant-template-ip-igmp-snooping)# ip igmp snooping ? <CR> fast-leave Enable IP IGMP Snooping fast leave processing last-member-query-interval Change the IP IGMP snooping last member query interval param querier Enable IP IGMP Snooping querier processing query-interval Change the IP IGMP snooping query interval param query-max-response-time Change the IP IGMP snooping max query response time startup-query-count Change the IP IGMP snooping number of initial queries to send startup-query-interval Change the IP IGMP snooping time for sending initial queries version Change the IP IGMP snooping version param apicl(config-tenant-template-ip-igmp-snooping)# ip igmp snooping version ? v2 version-2 v3 version-3 apicl(config-tenant)# show run # Command: show running-config tenant tenant1 # Time: Mon Jun 1 01:53:53 2020 tenant tenant1 <snipped> interface bridge-domain amit_bd ip address 10.175.31.30/24 secondary ip address 100.175.31.1/32 secondary snooping-querier ip igmp snooping policy igmp_snoop_policy exit template ip igmp snooping policy igmp_snoop_policy ip igmp snooping fast-leave ip igmp snooping last-member-query-interval 2 ip igmp snooping querier v3 ip igmp snooping query-interval 100 </pre>	<p>The example NX-OS style CLI sequence:</p> <ul style="list-style-type: none"> • Specifies a custom value for the query version of the IGMP Snooping policy. • Confirms the modified IGMP Snooping version for the policy.

	Command or Action	Purpose
	<pre> ip igmp snooping startup-query-count 5 ip igmp snooping version v3 exit exit </pre>	
Step 4	<p>Assign the policy to a bridge domain.</p> <p>Example:</p> <pre> apic1(config-tenant)# int bridge-domain bd3 apic1(config-tenant-interface)# ip igmp snooping policy cookieCut1 </pre>	<p>The example NX-OS style CLI sequence:</p> <ul style="list-style-type: none"> • Navigates to bridge domain, BD3. for the query-interval value in the IGMP Snooping policy named cookieCut1. • Assigns the IGMP Snooping policy with a modified IGMP Snooping value for the policy cookieCut1.

What to do next

You can assign the IGMP Snooping policy to multiple bridge domains.

Enabling IGMP Snooping and Multicast on Static Ports in the NX-OS Style CLI

You can enable IGMP snooping and multicast on ports that have been statically assigned to an EPG. Then you can create and assign access groups of users that are permitted or denied access to the IGMP snooping and multicast traffic enabled on those ports.

The steps described in this task assume the pre-configuration of the following entities:

- Tenant: tenant_A
- Application: application_A
- EPG: epg_A
- Bridge Domain: bridge_domain_A
- vrf: vrf_A -- a member of bridge_domain_A
- VLAN Domain: vd_A (configured with a range of 300-310)
- Leaf switch: 101 and interface 1/10

The target interface 1/10 on switch 101 is associated with VLAN 305 and statically linked with tenant_A, application_A, epg_A

- Leaf switch: 101 and interface 1/11

The target interface 1/11 on switch 101 is associated with VLAN 309 and statically linked with tenant_A, application_A, epg_A

Before you begin

Before you begin to enable IGMP snooping and multicasting for an EPG, complete the following tasks.

- Identify the interfaces to enable this function and statically assign them to that EPG



Note For details on static port assignment, see *Deploying an EPG on a Specific Port with APIC Using the NX-OS Style CLI* in the *Cisco APIC Layer 2 Networking Configuration Guide*.

- Identify the IP addresses that you want to be recipients of IGMP snooping multicast traffic.

Procedure

	Command or Action	Purpose
Step 1	<p>On the target interfaces enable IGMP snooping and layer 2 multicasting</p> <p>Example:</p> <pre>apicl# conf t apicl(config)# tenant tenant_A apicl(config-tenant)# application application_A apicl(config-tenant-app)# epg epg_A apicl(config-tenant-app-epg)# ip igmp snooping static-group 225.1.1.1 leaf 101 interface ethernet 1/10 vlan 305 apicl(config-tenant-app-epg)# end apicl# conf t apicl(config)# tenant tenant_A; application application_A; epg epg_A apicl(config-tenant-app-epg)# ip igmp snooping static-group 227.1.1.1 leaf 101 interface ethernet 1/11 vlan 309 apicl(config-tenant-app-epg)# exit apicl(config-tenant-app)# exit</pre>	<p>The example sequences enable:</p> <ul style="list-style-type: none"> • IGMP snooping on the statically-linked target interface 1/10 and associates it with a multicast IP address, 225.1.1.1 • IGMP snooping on the statically-linked target interface 1/11 and associates it with a multicast IP address, 227.1.1.1

Enabling Group Access to IGMP Snooping and Multicast using the NX-OS Style CLI

After you have enabled IGMP snooping and multicast on ports that have been statically assigned to an EPG, you can then create and assign access groups of users that are permitted or denied access to the IGMP snooping and multicast traffic enabled on those ports.

The steps described in this task assume the pre-configuration of the following entities:

- Tenant: tenant_A
- Application: application_A
- EPG: epg_A
- Bridge Domain: bridge_domain_A
- vrf: vrf_A -- a member of bridge_domain_A
- VLAN Domain: vd_A (configured with a range of 300-310)
- Leaf switch: 101 and interface 1/10

The target interface 1/10 on switch 101 is associated with VLAN 305 and statically linked with tenant_A, application_A, epg_A

- Leaf switch: 101 and interface 1/11

The target interface 1/11 on switch 101 is associated with VLAN 309 and statically linked with tenant_A, application_A, epg_A



Note For details on static port assignment, see *Deploying an EPG on a Specific Port with APIC Using the NX-OS Style CLI* in the *Cisco APIC Layer 2 Networking Configuration Guide*.

Procedure

	Command or Action	Purpose
Step 1	Define the route-map "access groups." Example: <pre> apicl# conf t apicl(config)# tenant tenant_A; application application_A; epg epg_A apicl(config-tenant)# route-map fooBroker permit apicl(config-tenant-rtmap)# match ip multicast group 225.1.1.1/24 apicl(config-tenant-rtmap)# exit apicl(config-tenant)# route-map fooBroker deny apicl(config-tenant-rtmap)# match ip multicast group 227.1.1.1/24 apicl(config-tenant-rtmap)# exit </pre>	The example sequences configure: <ul style="list-style-type: none"> • Route-map-access group "foobroker" linked to multicast group 225.1.1.1/24, access permitted • Route-map-access group "foobroker" linked to multicast group 227.1.1.1/24, access denied
Step 2	Verify route map configurations. Example: <pre> apicl(config-tenant)# show running-config tenant test route-map fooBroker # Command: show running-config tenant test route-map fooBroker # Time: Mon Aug 29 14:34:30 2016 tenant test route-map fooBroker permit 10 match ip multicast group 225.1.1.1/24 exit route-map fooBroker deny 20 match ip multicast group 227.1.1.1/24 exit exit </pre>	
Step 3	Specify the access group connection path. Example:	The example sequences configure:

	Command or Action	Purpose
	<pre>apicl(config-tenant)# application application_A apicl(config-tenant-app)# epg epg_A apicl(config-tenant-app-epg)# ip igmp snooping access-group route-map fooBroker leaf 101 interface ethernet 1/10 vlan 305 apicl(config-tenant-app-epg)# ip igmp snooping access-group route-map newBroker leaf 101 interface ethernet 1/10 vlan 305</pre>	<ul style="list-style-type: none"> • Route-map-access group "foobroker" connected through leaf switch 101, interface 1/10, and VLAN 305. • Route-map-access group "newbroker" connected through leaf switch 101, interface 1/10, and VLAN 305.
Step 4	<p>Verify the access group connections.</p> <p>Example:</p> <pre>apicl(config-tenant-app-epg)# show run # Command: show running-config tenant tenant_A application application_A epg epg_A # Time: Mon Aug 29 14:43:02 2016 tenant tenant_A application application_A epg epg_A bridge-domain member bridge_domain_A ip igmp snooping access-group route-map fooBroker leaf 101 interface ethernet 1/10 vlan 305 ip igmp snooping access-group route-map fooBroker leaf 101 interface ethernet 1/11 vlan 309 ip igmp snooping access-group route-map newBroker leaf 101 interface ethernet 1/10 vlan 305 ip igmp snooping static-group 225.1.1.1 leaf 101 interface ethernet 1/10 vlan 305 ip igmp snooping static-group 225.1.1.1 leaf 101 interface ethernet 1/11 vlan 309 exit exit exit</pre>	

Configuring MLD Snooping Using the NX-OS Style CLI

Configuring and Assigning an MLD Snooping Policy to a Bridge Domain using the NX-OS Style CLI

Before you begin

- Create the tenant that will consume the MLD Snooping policy.
- Create the bridge domain for the tenant, where you will attach the MLD Snooping policy.

Procedure

	Command or Action	Purpose
Step 1	configure terminal Example: <pre>apicl# configure terminal apicl(config)#</pre>	Enters configuration mode.
Step 2	tenant <i>tenant-name</i> Example: <pre>apicl(config)# tenant tn1 apicl(config-tenant)#</pre>	Creates a tenant or enters tenant configuration mode.
Step 3	template ipv6 mld snooping policy <i>policy-name</i> Example: <pre>apicl(config-tenant)# template ipv6 mld snooping policy mldPolicy1 apicl(config-tenant-template-ip-mld-snooping)#</pre>	Creates an MLD snooping policy. The example NX-OS style CLI sequence creates an MLD snooping policy named mldPolicy1.
Step 4	[no] ipv6 mld snooping Example: <pre>apicl(config-tenant-template-ip-mld-snooping)# ipv6 mld snooping apicl(config-tenant-template-ip-mld-snooping)# no ipv6 mld snooping</pre>	Enables or disables the admin state of the MLD snoop policy. The default state is disabled.
Step 5	[no] ipv6 mld snooping fast-leave Example: <pre>apicl(config-tenant-template-ip-mld-snooping)# ipv6 mld snooping fast-leave apicl(config-tenant-template-ip-mld-snooping)# no ipv6 mld snooping fast-leave</pre>	Enables or disables IPv6 MLD snooping fast-leave processing.
Step 6	[no] ipv6 mld snooping querier Example: <pre>apicl(config-tenant-template-ip-mld-snooping)# ipv6 mld snooping querier apicl(config-tenant-template-ip-mld-snooping)# no ipv6 mld snooping querier</pre>	Enables or disables IPv6 MLD snooping querier processing. For the enabling querier option to be effectively enabled on the assigned policy, you must also enable the querier option in the subnets assigned to the bridge domains to which the policy is applied, as described in Step 14, on page 425 .
Step 7	ipv6 mld snooping last-member-query-interval <i>parameter</i> Example:	Changes the IPv6 MLD snooping last member query interval parameter. The example NX-OS style CLI sequence changes the IPv6 MLD

	Command or Action	Purpose
	<pre>apicl(config-tenant-template-ip-mld-snooping) # ipv6 mld snooping last-member-query-interval 25</pre>	snooping last member query interval parameter to 25 seconds. Valid options are 1-25. The default is 1 second.
Step 8	<p>ipv6 mld snooping query-interval <i>parameter</i></p> <p>Example:</p> <pre>apicl(config-tenant-template-ip-mld-snooping) # ipv6 mld snooping query-interval 300</pre>	Changes the IPv6 MLD snooping query interval parameter. The example NX-OS style CLI sequence changes the IPv6 MLD snooping query interval parameter to 300 seconds. Valid options are 1-18000. The default is 125 seconds.
Step 9	<p>ipv6 mld snooping query-max-response-time <i>parameter</i></p> <p>Example:</p> <pre>apicl(config-tenant-template-ip-mld-snooping) # ipv6 mld snooping query-max-response-time 25</pre>	Changes the IPv6 MLD snooping max query response time. The example NX-OS style CLI sequence changes the IPv6 MLD snooping max query response time to 25 seconds. Valid options are 1-25. The default is 10 seconds.
Step 10	<p>ipv6 mld snooping startup-query-count <i>parameter</i></p> <p>Example:</p> <pre>apicl(config-tenant-template-ip-mld-snooping) # ipv6 mld snooping startup-query-count 10</pre>	Changes the IPv6 MLD snooping number of initial queries to send. The example NX-OS style CLI sequence changes the IPv6 MLD snooping number of initial queries to send to 10. Valid options are 1-10. The default is 2.
Step 11	<p>ipv6 mld snooping startup-query-interval <i>parameter</i></p> <p>Example:</p> <pre>apicl(config-tenant-template-ip-mld-snooping) # ipv6 mld snooping startup-query-interval 300</pre>	Changes the IPv6 MLD snooping time for sending initial queries. The example NX-OS style CLI sequence changes the IPv6 MLD snooping time for sending initial queries to 300 seconds. Valid options are 1-18000. The default is 31 seconds.
Step 12	<p>exit</p> <p>Example:</p> <pre>apicl(config-tenant-template-ip-mld-snooping) # exit apicl(config-tenant) #</pre>	Returns to configure mode.
Step 13	<p>interface bridge-domain <i>bridge-domain-name</i></p> <p>Example:</p> <pre>apicl(config-tenant) # interface bridge-domain bd1 apicl(config-tenant-interface) #</pre>	Configures the interface bridge-domain. The example NX-OS style CLI sequence configures the interface bridge-domain named bd1.

	Command or Action	Purpose
Step 14	ipv6 address <i>sub-bits/prefix-length</i> snooping-querier Example: <pre>apicl(config-tenant-interface)# ipv6 address 2000::5/64 snooping-querier</pre>	Configures the bridge domain as switch-querier. This will enable the querier option in the subnet assigned to the bridge domain where the policy is applied.
Step 15	ipv6 mld snooping policy <i>policy-name</i> Example: <pre>apicl(config-tenant-interface)# ipv6 mld snooping policy mldPolicy1</pre>	Associates the bridge domain with an MLD snooping policy. The example NX-OS style CLI sequence associates the bridge domain with an MLD snooping policy named mldPolicy1.
Step 16	exit Example: <pre>apicl(config-tenant-interface)# exit apicl(config-tenant)#</pre>	Returns to configure mode.

Configuring IP Multicast Using the NX-OS Style CLI

Configuring Layer 3 Multicast Using the NX-OS Style CLI

Procedure

Step 1 Enter the configure mode.

Example:

```
apicl# configure
```

Step 2 Enter the configure mode for a tenant, the configure mode for the VRF, and configure PIM options.

Example:

```
apicl(config)# tenant tenant1
apicl(config-tenant)# vrf context tenant1_vrf
apicl(config-tenant-vrf)# ip pim
apicl(config-tenant-vrf)# ip pim fast-convergence
apicl(config-tenant-vrf)# ip pim bsr forward
```

Step 3 Configure IGMP and the desired IGMP options for the VRF.

Example:

```
apicl(config-tenant-vrf)# ip igmp
apicl(config-tenant-vrf)# exit
apicl(config-tenant)# interface bridge-domain tenant1_bd
apicl(config-tenant-interface)# ip multicast
apicl(config-tenant-interface)# ip igmp allow-v3-asm
apicl(config-tenant-interface)# ip igmp fast-leave
```

```
apicl(config-tenant-interface)# ip igmp inherit interface-policy igmp_intpoll
apicl(config-tenant-interface)# exit
```

Step 4 Enter the L3 Out mode for the tenant, enable PIM, and enter the leaf interface mode. Then configure PIM for this interface.

Example:

```
apicl(config-tenant)# l3out tenant1_l3out
apicl(config-tenant-l3out)# ip pim
apicl(config-tenant-l3out)# exit
apicl(config-tenant)# exit
apicl(config)#
apicl(config)# leaf 101
apicl(config-leaf)# interface ethernet 1/125
apicl(config-leaf-if) ip pim inherit interface-policy pim_intpoll
```

Step 5 Configure IGMP for the interface using the IGMP commands.

Example:

```
apicl(config-leaf-if)# ip igmp fast-leave
apicl(config-leaf-if)# ip igmp inherit interface-policy igmp_intpoll
apicl(config-leaf-if)# exit
apicl(config-leaf)# exit
```

Step 6 Configure a fabric RP.

Example:

```
apicl(config)# tenant tenant1
apicl(config-tenant)# vrf context tenant1_vrf
apicl(config-tenant-vrf)# ip pim fabric-rp-address 20.1.15.1 route-map intervrf-ctx2
apicl(config-tenant-vrf)# ip pim fabric-rp-address 20.1.15.2 route-map intervrf-ctx1
apicl(config-tenant-vrf)# exit
```

Step 7 Configure a inter-VRF multicast.

Example:

```
apicl(config-tenant)# vrf context tenant1_vrf
apicl(config-tenant-vrf)# ip pim inter-vrf-src ctx2 route-map intervrf-ctx2
apicl(config-tenant-vrf)# route-map intervrf-ctx2 permit 1
apicl(config-tenant-vrf)# match ip multicast group 226.20.0.0/24
apicl(config-tenant-vrf)# exit
apicl(config-tenant)# exit
apicl(config)#
```

This completes the APIC Layer 3 multicast configuration.

Configuring Layer 3 IPv6 Multicast Using the NX-OS Style CLI

Before you begin

- The desired VRF, bridge domains, Layer 3 Out interfaces with IPv6 addresses must be configured to enable PIM6. For Layer 3 Out, for IPv6 multicast to work, an IPv6 loopback address is configured for the node in the logical node profile.

- Basic unicast network must be configured.

Procedure

Step 1 Enable PIM6 on the VRF and configure the Rendezvous Point (RP).

Example:

```
apic1(config)# tenant tenant1
apic1(config-tenant)# vrf context tenant1_vrf
apic1(config-tenant-vrf)# ipv6 pim
apic1(config-tenant-vrf)# ipv6 rp-address 2018::100:100:100:100 route-map ipv6_pim_routemap
```

Step 2 Configure a PIM6 interface policy and apply it on the Layer 3 Out.

Example:

```
apic1(config-tenant)# l3out tenant1_l3out
apic1(config-tenant-l3out)# ipv6 pim
apic1(config-tenant-l3out)# exit
apic1(config-tenant)# exit
apic1(config)#
apic1(config)# leaf 101
apic1(config-leaf)# interface ethernet 1/125
apic1(config-leaf-if) ipv6 pim inherit interface-policy pim6_intpoll
```

Step 3 Enable PIM6 on the BD.

Example:

```
apic1(config-tenant)# interface bridge-domain tenant1_bd
apic1(config-tenant-interface)# ipv6 multicast
apic1(config-tenant)# exit
apic1(config)#
```

Layer 3 IPv6 multicast with PIM6 is enabled.

Configuring Multicast Filtering Using the NX-OS Style CLI

You will be configuring multicast filtering at the bridge domain level. Use the procedures in this topic to configure either source filtering or receiver filtering, or both, at the bridge domain level.

Before you begin

- The bridge domain where you will be configuring multicast filtering is already created.
- The bridge domain is a PIM-enabled bridge domain.
- Layer 3 multicast is enabled at the VRF level.

Procedure

Step 1 Enter the configuration mode.

```
apicl# configure
apicl(config)#
```

Step 2 Access the tenant and enable PIM.

```
apicl(config)# tenant tenant-name
apicl(config-tenant)# vrf context VRF-name
apicl(config-tenant-vrf)# ip pim
apicl(config-tenant-vrf)# exit
apicl(config-tenant)#
```

Example:

```
apicl(config)# tenant t1
apicl(config-tenant)# vrf context v1
apicl(config-tenant-vrf)# ip pim
apicl(config-tenant-vrf)# exit
apicl(config-tenant)#
```

Step 3 Access the bridge domain where you want to configure multicast filtering.

```
apicl(config-tenant)# bridge-domain BD-name
apicl(config-tenant-bd)#
```

Example:

```
apicl(config-tenant)# bridge-domain bd1
apicl(config-tenant-bd)#
```

Step 4 Determine whether you want to enable multicast *source* or *receiver* filtering on this bridge domain.

Note

You can also enable both source and receiver filtering on the same bridge domain.

- If you want to enable multicast source filtering on this bridge domain, enter the following:

```
apicl(config-tenant-bd)# src-filter source-route-map-policy
```

For example:

```
apicl(config-tenant-bd)# src-filter routemap-Mcast-src
```

- If you want to enable multicast receiver filtering on this bridge domain, enter the following:

```
apicl(config-tenant-bd)# dst-filter destination-route-map-policy
```

For example:

```
apic1(config-tenant-bd) # dst-filter routemap-Mcast-dst
```

Step 5 Enable multicasting for IPv4:

```
apic1(config-tenant-bd) # mcast-allow  
apic1(config-tenant-bd) #
```

Step 6 Associate the bridge domain with the VRF.

```
apic1(config-tenant-bd) # vrf member VRF-name  
apic1(config-tenant-bd) # exit  
apic1(config-tenant) #
```

Example:

```
apic1(config-tenant-bd) # vrf member v1  
apic1(config-tenant-bd) # exit  
apic1(config-tenant) #
```

Step 7 Enable multicast on the bridge domain.

```
apic1(config-tenant) # interface bridge-domain BD-name  
apic1(config-tenant-interface) # ip multicast  
apic1(config-tenant-interface) # exit  
apic1(config-tenant) #
```

Example:

```
apic1(config-tenant) # interface bridge-domain bd1  
apic1(config-tenant-interface) # ip multicast  
apic1(config-tenant-interface) # exit  
apic1(config-tenant) #
```

Step 8 Configure the route map.

```
apic1(config-tenant) # route-map destination-route-map-policy <permit/deny> sequence_number  
apic1(config-tenant-rtmap) # match ip multicast <source/group> IP_address_subnet <source/group>  
                                  IP_address_subnet  
apic1(config-tenant-rtmap) # exit  
apic1(config-tenant) # exit  
apic1(config) #
```

Example:

```
apic1(config-tenant) # route-map routemap-Mcast-src permit 1  
apic1(config-tenant-rtmap) # match ip multicast source 10.10.1.1/24 group 192.1.1.1/32  
apic1(config-tenant-rtmap) # exit  
apic1(config-tenant) # route-map routemap-Mcast-dst permit 1  
apic1(config-tenant-rtmap) # match ip multicast group 192.2.2.2/32  
apic1(config-tenant-rtmap) # exit  
apic1(config-tenant) # exit
```

```
apic1(config)#
```

Configuring Multi-Pod Using the NX-OS Style CLI

Setting Up Multi-Pod Fabric Using the NX-OS CLI

Before you begin

- The node group and L3Out policies have already been created.

Procedure

Step 1 Set up the multi-pod, as in the following example:

Example:

```
ifav4-ifc1# show run system
# Command: show running-config system
# Time: Mon Aug 1 21:32:03 2016
system cluster-size 3
system switch-id FOX2016G9DW 204 ifav4-spine4 pod 2
system switch-id SAL1748H56D 201 ifav4-spine1 pod 1
system switch-id SAL1803L25H 102 ifav4-leaf2 pod 1
system switch-id SAL1819RXP4 101 ifav4-leaf1 pod 1
system switch-id SAL1931LA3B 203 ifav4-spine2 pod 2
system switch-id SAL1934MNY0 103 ifav4-leaf3 pod 1
system switch-id SAL1934MNY3 104 ifav4-leaf4 pod 1
system switch-id SAL1938P7A6 202 ifav4-spine3 pod 1
system switch-id SAL1938PHBB 105 ifav4-leaf5 pod 2
system switch-id SAL1942R857 106 ifav4-leaf6 pod 2
system pod 1 tep-pool 10.0.0.0/16
system pod 2 tep-pool 10.1.0.0/16
ifav4-ifc1#
```

Step 2 Configure a VLAN domain, as in the following example:

Example:

```
ifav4-ifc1# show running-config vlan-domain l3Dom
# Command: show running-config vlan-domain l3Dom
# Time: Mon Aug 1 21:32:31 2016
vlan-domain l3Dom
vlan 4
exit
ifav4-ifc1#
```

Step 3 Configure the fabric external connectivity, as in the following example:

Example:

```
ifav4-ifc1# show running-config fabric-external
# Command: show running-config fabric-external
# Time: Mon Aug 1 21:34:17 2016
fabric-external 1
bgp evpn peering
```

```

pod 1
  interpod data hardware-proxy 100.11.1.1/32
  bgp evpn peering
  exit
pod 2
  interpod data hardware-proxy 200.11.1.1/32
  bgp evpn peering
  exit
route-map interpod-import
  ip prefix-list default permit 0.0.0.0/0
  exit
route-target extended 5:16
exit
ifav4-ifc1#

```

Step 4 Configure the spine switch interface and OSPF configuration as in the following example:

Example:

```

# Command: show running-config spine
# Time: Mon Aug  1 21:34:41 2016
spine 201
  vrf context tenant infra vrf overlay-1
    router-id 201.201.201.201
    exit
  interface ethernet 1/1
    vlan-domain member l3Dom
    exit
  interface ethernet 1/1.4
    vrf member tenant infra vrf overlay-1
    ip address 201.1.1.1/30
    ip router ospf default area 1.1.1.1
    ip ospf cost 1
    exit
  interface ethernet 1/2
    vlan-domain member l3Dom
    exit
  interface ethernet 1/2.4
    vrf member tenant infra vrf overlay-1
    ip address 201.2.1.1/30
    ip router ospf default area 1.1.1.1
    ip ospf cost 1
    exit
  router ospf default
    vrf member tenant infra vrf overlay-1
    area 1.1.1.1 loopback 201.201.201.201
    area 1.1.1.1 interpod peering
    exit
  exit
exit
spine 202
  vrf context tenant infra vrf overlay-1
    router-id 202.202.202.202
    exit
  interface ethernet 1/2
    vlan-domain member l3Dom
    exit
  interface ethernet 1/2.4
    vrf member tenant infra vrf overlay-1
    ip address 202.1.1.1/30
    ip router ospf default area 1.1.1.1
    exit
  router ospf default
    vrf member tenant infra vrf overlay-1
    area 1.1.1.1 loopback 202.202.202.202

```

```
        area 1.1.1.1 interpod peering
        exit
    exit
exit
spine 203
vrf context tenant infra vrf overlay-1
    router-id 203.203.203.203
    exit
interface ethernet 1/1
    vlan-domain member l3Dom
    exit
interface ethernet 1/1.4
    vrf member tenant infra vrf overlay-1
    ip address 203.1.1.1/30
    ip router ospf default area 0.0.0.0
    ip ospf cost 1
    exit
interface ethernet 1/2
    vlan-domain member l3Dom
    exit
interface ethernet 1/2.4
    vrf member tenant infra vrf overlay-1
    ip address 203.2.1.1/30
    ip router ospf default area 0.0.0.0
    ip ospf cost 1
    exit
router ospf default
    vrf member tenant infra vrf overlay-1
        area 0.0.0.0 loopback 203.203.203.203
        area 0.0.0.0 interpod peering
    exit
exit
exit
spine 204
vrf context tenant infra vrf overlay-1
    router-id 204.204.204.204
    exit
interface ethernet 1/31
    vlan-domain member l3Dom
    exit
interface ethernet 1/31.4
    vrf member tenant infra vrf overlay-1
    ip address 204.1.1.1/30
    ip router ospf default area 0.0.0.0
    ip ospf cost 1
    exit
router ospf default
    vrf member tenant infra vrf overlay-1
        area 0.0.0.0 loopback 204.204.204.204
        area 0.0.0.0 interpod peering
    exit
exit
exit
ifav4-ifc1#
```

Configuring Remote Leaf Switches Using the NX-OS Style CLI

Configure Remote Leaf Switches Using the NX-OS Style CLI

This example configures a spine switch and a remote leaf switch to enable the leaf switch to communicate with the main fabric pod.

Before you begin

- The IPN router and remote leaf switches are active and configured; see [WAN Router and Remote Leaf Switch Configuration Guidelines, on page 127](#).
- The remote leaf switches are running a switch image of 13.1.x or later (aci-n9000-dk9.13.1.x.x.bin).
- The pod in which you plan to add the remote leaf switches is created and configured.

Procedure

-
- Step 1** Define the TEP pool for a remote location 5, in pod 2.
- The network mask must be /24 or lower.
- Use the following new command: **system remote-leaf-site site-id pod pod-id tep-pool ip-address-and-netmask**
- Example:**
- ```
apic1(config)# system remote-leaf-site 5 pod 2 tep-pool 192.0.0.0/16
```
- Step 2** Add a remote leaf switch to pod 2, remote-leaf-site 5.
- Use the following command: **system switch-id serial-number node-id leaf-switch-name pod pod-id remote-leaf-site remote-leaf-site-id node-type remote-leaf-wan**
- Example:**
- ```
apic1(config)# system switch-id FDO210805SKD 109 ifav4-leaf9 pod 2
remote-leaf-site 5 node-type remote-leaf-wan
```
- Step 3** Configure a VLAN domain with a VLAN that includes VLAN 4.
- Example:**
- ```
apic1(config)# vlan-domain ospfDom
apic1(config-vlan)# vlan 4-5
apic1(config-vlan)# exit
```
- Step 4** Configure two L3Outs for the infra tenant, one for the remote leaf connections and one for the multipod IPN.
- Example:**
- ```
apic1(config)# tenant infra
apic1(config-tenant)# l3out rl-wan
apic1(config-tenant-l3out)# vrf member overlay-1
apic1(config-tenant-l3out)# exit
apic1(config-tenant)# l3out ipn-multipodInternal
apic1(config-tenant-l3out)# vrf member overlay-1
apic1(config-tenant-l3out)# exit
apic1(config-tenant)# exit
apic1(config)#
```

Step 5 Configure the spine switch interfaces and sub-interfaces to be used by the L3Outs.

Example:

```

apicl(config)# spine 201
apicl(config-spine)# vrf context tenant infra vrf overlay-1 l3out rl-wan-test
apicl(config-spine-vrf)# exit
apicl(config-spine)# vrf context tenant infra vrf overlay-1 l3out ipn-multipodInternal
apicl(config-spine-vrf)# exit
apicl(config-spine)#
apicl(config-spine)# interface ethernet 8/36
apicl(config-spine-if)# vlan-domain member ospfDom
apicl(config-spine-if)# exit
apicl(config-spine)# router ospf default
apicl(config-spine-ospf)# vrf member tenant infra vrf overlay-1
apicl(config-spine-ospf-vrf)# area 5 l3out rl-wan-test
apicl(config-spine-ospf-vrf)# exit
apicl(config-spine-ospf)# exit
apicl(config-spine)#
apicl(config-spine)# interface ethernet 8/36.4
apicl(config-spine-if)# vrf member tenant infra vrf overlay-1 l3out rl-wan-test
apicl(config-spine-if)# ip router ospf default area 5
apicl(config-spine-if)# exit
apicl(config-spine)# router ospf multipod-internal
apicl(config-spine-ospf)# vrf member tenant infra vrf overlay-1
apicl(config-spine-ospf-vrf)# area 5 l3out ipn-multipodInternal
apicl(config-spine-ospf-vrf)# exit
apicl(config-spine-ospf)# exit
apicl(config-spine)#
apicl(config-spine)# interface ethernet 8/36.5
apicl(config-spine-if)# vrf member tenant infra vrf overlay-1 l3out ipn-multipodInternal
apicl(config-spine-if)# ip router ospf multipod-internal area 5
apicl(config-spine-if)# exit
apicl(config-spine)# exit
apicl(config)#

```

Step 6 Configure the remote leaf switch interface and sub-interface used for communicating with the main fabric pod.

Example:

```

(config)# leaf 101
apicl(config-leaf)# vrf context tenant infra vrf overlay-1 l3out rl-wan-test
apicl(config-leaf-vrf)# exit
apicl(config-leaf)#
apicl(config-leaf)# interface ethernet 1/49
apicl(config-leaf-if)# vlan-domain member ospfDom
apicl(config-leaf-if)# exit
apicl(config-leaf)# router ospf default
apicl(config-leaf-ospf)# vrf member tenant infra vrf overlay-1
apicl(config-leaf-ospf-vrf)# area 5 l3out rl-wan-test
apicl(config-leaf-ospf-vrf)# exit
apicl(config-leaf-ospf)# exit
apicl(config-leaf)#
apicl(config-leaf)# interface ethernet 1/49.4
apicl(config-leaf-if)# vrf member tenant infra vrf overlay-1 l3out rl-wan-test
apicl(config-leaf-if)# ip router ospf default area 5
apicl(config-leaf-if)# exit

```

Example

The following example provides a downloadable configuration:

```

apic1# configure
apic1(config)# system remote-leaf-site 5 pod 2 tep-pool 192.0.0.0/16
apic1(config)# system switch-id FDO210805SKD 109 ifav4-leaf9 pod 2
remote-leaf-site 5 node-type remote-leaf-wan
apic1(config)# vlan-domain ospfDom
apic1(config-vlan)# vlan 4-5
apic1(config-vlan)# exit
apic1(config)# tenant infra
apic1(config-tenant)# l3out rl-wan-test
apic1(config-tenant-l3out)# vrf member overlay-1
apic1(config-tenant-l3out)# exit
apic1(config-tenant)# l3out ipn-multipodInternal
apic1(config-tenant-l3out)# vrf member overlay-1
apic1(config-tenant-l3out)# exit
apic1(config-tenant)# exit
apic1(config)#
apic1(config)# spine 201
apic1(config-spine)# vrf context tenant infra vrf overlay-1 l3out rl-wan-test
apic1(config-spine-vrf)# exit
apic1(config-spine)# vrf context tenant infra vrf overlay-1 l3out ipn-multipodInternal
apic1(config-spine-vrf)# exit
apic1(config-spine)#
apic1(config-spine)# interface ethernet 8/36
apic1(config-spine-if)# vlan-domain member ospfDom
apic1(config-spine-if)# exit
apic1(config-spine)# router ospf default
apic1(config-spine-ospf)# vrf member tenant infra vrf overlay-1
apic1(config-spine-ospf-vrf)# area 5 l3out rl-wan-test
apic1(config-spine-ospf-vrf)# exit
apic1(config-spine-ospf)# exit
apic1(config-spine)#
apic1(config-spine)# interface ethernet 8/36.4
apic1(config-spine-if)# vrf member tenant infra vrf overlay-1 l3out rl-wan-test
apic1(config-spine-if)# ip router ospf default area 5
apic1(config-spine-if)# exit
apic1(config-spine)# router ospf multipod-internal
apic1(config-spine-ospf)# vrf member tenant infra vrf overlay-1
apic1(config-spine-ospf-vrf)# area 5 l3out ipn-multipodInternal
apic1(config-spine-ospf-vrf)# exit
apic1(config-spine-ospf)# exit
apic1(config-spine)#
apic1(config-spine)# interface ethernet 8/36.5
apic1(config-spine-if)# vrf member tenant infra vrf overlay-1 l3out ipn-multipodInternal
apic1(config-spine-if)# ip router ospf multipod-internal area 5
apic1(config-spine-if)# exit
apic1(config-spine)# exit
apic1(config)#
apic1(config)# leaf 101
apic1(config-leaf)# vrf context tenant infra vrf overlay-1 l3out rl-wan-test
apic1(config-leaf-vrf)# exit
apic1(config-leaf)#
apic1(config-leaf)# interface ethernet 1/49
apic1(config-leaf-if)# vlan-domain member ospfDom
apic1(config-leaf-if)# exit
apic1(config-leaf)# router ospf default
apic1(config-leaf-ospf)# vrf member tenant infra vrf overlay-1
apic1(config-leaf-ospf-vrf)# area 5 l3out rl-wan-test
apic1(config-leaf-ospf-vrf)# exit
apic1(config-leaf-ospf)# exit

```

```

apicl(config-leaf)#
apicl(config-leaf)# interface ethernet 1/49.4
apicl(config-leaf-if)# vrf member tenant infra vrf overlay-1 l3out rl-wan-test
apicl(config-leaf-if)# ip router ospf default area 5
apicl(config-leaf-if)# exit

```

Part II: External Routing (L3Out) Configuration

Routed Connectivity to External Networks

Configuring an MP-BGP Route Reflector Using the NX-OS Style CLI

Configuring an MP-BGP Route Reflector for the ACI Fabric

To distribute routes within the ACI fabric, an MP-BGP process must first be operating, and the spine switches must be configured as BGP route reflectors.

The following is an example of an MP-BGP route reflector configuration:



Note In this example, the BGP fabric ASN is 100. Spine switches 104 and 105 are chosen as MP-BGP route-reflectors.

```

apicl(config)# bgp-fabric
apicl(config-bgp-fabric)# asn 100
apicl(config-bgp-fabric)# route-reflector spine 104,105

```

Node and Interface for L3Out

Configuring Layer 3 Routed and Sub-Interface Port Channels Using the NX-OS Style CLI

Configuring a Layer 3 Routed Port-Channel Using the NX-OS CLI

This procedure configures a Layer 3 routed port channel.

Procedure

	Command or Action	Purpose
Step 1	configure Example: apicl# configure	Enters global configuration mode.
Step 2	leaf <i>node-id</i> Example: apicl(config)# leaf 101	Specifies the leaf switch or leaf switches to be configured. The <i>node-id</i> can be a single node ID or a range of IDs, in the form

	Command or Action	Purpose
		<i>node-id1-node-id2</i> , to which the configuration will be applied.
Step 3	interface port-channel <i>channel-name</i> Example: <pre>apic1(config-leaf)# interface port-channel po1</pre>	Enters the interface configuration mode for the specified port channel.
Step 4	no switchport Example: <pre>apic1(config-leaf-if)# no switchport</pre>	Makes the interface Layer 3 capable.
Step 5	vrf member vrf-name tenant <i>tenant-name</i> Example: <pre>apic1(config-leaf-if)# vrf member v1 tenant t1</pre>	Associates this port channel to this virtual routing and forwarding (VRF) instance and L3 outside policy, where: <ul style="list-style-type: none"> • <i>vrf-name</i> is the VRF name. The name can be any case-sensitive, alphanumeric string up to 32 characters. • <i>tenant-name</i> is the tenant name. The name can be any case-sensitive, alphanumeric string up to 32 characters.
Step 6	vlan-domain member <i>vlan-domain-name</i> Example: <pre>apic1(config-leaf-if)# vlan-domain member dom1</pre>	Associates the port channel template with the previously configured VLAN domain.
Step 7	ip address <i>ip-address/subnet-mask</i> Example: <pre>apic1(config-leaf-if)# ip address 10.1.1.1/24</pre>	Sets the IP address and subnet mask for the specified interface.
Step 8	ipv6 address <i>sub-bits/prefix-length preferred</i> Example: <pre>apic1(config-leaf-if)# ipv6 address 2001::1/64 preferred</pre>	Configures an IPv6 address based on an IPv6 general prefix and enables IPv6 processing on an interface, where: <ul style="list-style-type: none"> • <i>sub-bits</i> is the subprefix bits and host bits of the address to be concatenated with the prefixes provided by the general prefix specified with the prefix-name argument. The sub-bits argument must be in the form documented in RFC 2373 where the address is specified in hexadecimal using 16-bit values between colons. • <i>prefix-length</i> is the length of the IPv6 prefix. A decimal value that indicates how many of the high-order contiguous bits

Configuring a Layer 3 Sub-Interface Port-Channel Using the NX-OS CLI

	Command or Action	Purpose
		of the address comprise the prefix (the network portion of the address). A slash mark must precede the decimal value.
Step 9	ipv6 link-local <i>ipv6-link-local-address</i> Example: apicl(config-leaf-if)# ipv6 link-local fe80::1	Configures an IPv6 link-local address for an interface.
Step 10	mac-address <i>mac-address</i> Example: apicl(config-leaf-if)# mac-address 00:44:55:66:55::01	Manually sets the interface MAC address.
Step 11	mtu <i>mtu-value</i> Example: apicl(config-leaf-if)# mtu 1500	Sets the MTU for this class of service.

Example

This example shows how to configure a basic Layer 3 port channel.

```
apicl# configure
apicl(config)# leaf 101
apicl(config-leaf)# interface port-channel pol
apicl(config-leaf-if)# no switchport
apicl(config-leaf-if)# vrf member vl tenant t1
apicl(config-leaf-if)# vlan-domain member dom1
apicl(config-leaf-if)# ip address 10.1.1.1/24
apicl(config-leaf-if)# ipv6 address 2001::1/64 preferred
apicl(config-leaf-if)# ipv6 link-local fe80::1
apicl(config-leaf-if)# mac-address 00:44:55:66:55::01
apicl(config-leaf-if)# mtu 1500
```

Configuring a Layer 3 Sub-Interface Port-Channel Using the NX-OS CLI

This procedure configures a Layer 3 sub-interface port channel.

Procedure

	Command or Action	Purpose
Step 1	configure Example: apicl# configure	Enters global configuration mode.

	Command or Action	Purpose
Step 2	leaf <i>node-id</i> Example: <pre>apic1(config)# leaf 101</pre>	Specifies the leaf switch or leaf switches to be configured. The <i>node-id</i> can be a single node ID or a range of IDs, in the form <i>node-id1-node-id2</i> , to which the configuration will be applied.
Step 3	vrf member <i>vrf-name</i> tenant <i>tenant-name</i> Example: <pre>apic1(config-leaf-if)# vrf member v1 tenant t1</pre>	Associates this port channel to this virtual routing and forwarding (VRF) instance and L3 outside policy, where: <ul style="list-style-type: none"> <i>vrf-name</i> is the VRF name. The name can be any case-sensitive, alphanumeric string up to 32 characters. <i>tenant-name</i> is the tenant name. The name can be any case-sensitive, alphanumeric string up to 32 characters.
Step 4	vlan-domain member <i>vlan-domain-name</i> Example: <pre>apic1(config-leaf-if)# vlan-domain member dom1</pre>	Associates the port channel template with the previously configured VLAN domain.
Step 5	ip address <i>ip-address / subnet-mask</i> Example: <pre>apic1(config-leaf-if)# ip address 10.1.1.1/24</pre>	Sets the IP address and subnet mask for the specified interface.
Step 6	ipv6 address <i>sub-bits / prefix-length</i> preferred Example: <pre>apic1(config-leaf-if)# ipv6 address 2001::1/64 preferred</pre>	Configures an IPv6 address based on an IPv6 general prefix and enables IPv6 processing on an interface, where: <ul style="list-style-type: none"> <i>sub-bits</i> is the subprefix bits and host bits of the address to be concatenated with the prefixes provided by the general prefix specified with the prefix-name argument. The sub-bits argument must be in the form documented in RFC 2373 where the address is specified in hexadecimal using 16-bit values between colons. <i>prefix-length</i> is the length of the IPv6 prefix. A decimal value that indicates how many of the high-order contiguous bits of the address comprise the prefix (the network portion of the address). A slash mark must precede the decimal value.
Step 7	ipv6 link-local <i>ipv6-link-local-address</i> Example:	Configures an IPv6 link-local address for an interface.

	Command or Action	Purpose
	<code>apic1(config-leaf-if)# ipv6 link-local fe80::1</code>	
Step 8	mac-address <i>mac-address</i> Example: <code>apic1(config-leaf-if)# mac-address 00:44:55:66:55::01</code>	Manually sets the interface MAC address.
Step 9	mtu <i>mtu-value</i> Example: <code>apic1(config-leaf-if)# mtu 1500</code>	Sets the MTU for this class of service.
Step 10	exit Example: <code>apic1(config-leaf-if)# exit</code>	Returns to configure mode.
Step 11	interface port-channel <i>channel-name</i> Example: <code>apic1(config-leaf)# interface port-channel po1</code>	Enters the interface configuration mode for the specified port channel.
Step 12	vlan-domain member <i>vlan-domain-name</i> Example: <code>apic1(config-leaf-if)# vlan-domain member dom1</code>	Associates the port channel template with the previously configured VLAN domain.
Step 13	exit Example: <code>apic1(config-leaf-if)# exit</code>	Returns to configure mode.
Step 14	interface port-channel <i>channel-name.number</i> Example: <code>apic1(config-leaf)# interface port-channel po1.2001</code>	Enters the interface configuration mode for the specified sub-interface port channel.
Step 15	vrf member <i>vrf-name</i> tenant <i>tenant-name</i> Example: <code>apic1(config-leaf-if)# vrf member v1 tenant t1</code>	Associates this port channel to this virtual routing and forwarding (VRF) instance and L3 outside policy, where: <ul style="list-style-type: none"> • <i>vrf-name</i> is the VRF name. The name can be any case-sensitive, alphanumeric string up to 32 characters. • <i>tenant-name</i> is the tenant name. The name can be any case-sensitive, alphanumeric string up to 32 characters.

	Command or Action	Purpose
Step 16	exit Example: apic1(config-leaf-if)# exit	Returns to configure mode.

Example

This example shows how to configure a basic Layer 3 sub-interface port-channel.

```
apic1# configure
apic1(config)# leaf 101
apic1(config-leaf)# interface vlan 2001
apic1(config-leaf-if)# no switchport
apic1(config-leaf-if)# vrf member v1 tenant t1
apic1(config-leaf-if)# vlan-domain member dom1
apic1(config-leaf-if)# ip address 10.1.1.1/24
apic1(config-leaf-if)# ipv6 address 2001::1/64 preferred
apic1(config-leaf-if)# ipv6 link-local fe80::1
apic1(config-leaf-if)# mac-address 00:44:55:66:55::01
apic1(config-leaf-if)# mtu 1500
apic1(config-leaf-if)# exit
apic1(config-leaf)# interface port-channel po1
apic1(config-leaf-if)# vlan-domain member dom1
apic1(config-leaf-if)# exit
apic1(config-leaf)# interface port-channel po1.2001
apic1(config-leaf-if)# vrf member v1 tenant t1
apic1(config-leaf-if)# exit
```

Adding Ports to the Layer 3 Port-Channel Using the NX-OS CLI

This procedure adds ports to a Layer 3 port channel that you configured previously.

Procedure

	Command or Action	Purpose
Step 1	configure Example: apic1# configure	Enters global configuration mode.
Step 2	leaf <i>node-id</i> Example: apic1(config)# leaf 101	Specifies the leaf switch or leaf switches to be configured. The <i>node-id</i> can be a single node ID or a range of IDs, in the form <i>node-id1-node-id2</i> , to which the configuration will be applied.
Step 3	interface Ethernet <i>slot/port</i> Example:	Enters interface configuration mode for the interface you want to configure.

	Command or Action	Purpose
	apic1(config-leaf)# interface Ethernet 1/1-2	
Step 4	channel-group <i>channel-name</i> Example: apic1(config-leaf-if)# channel-group p01	Configures the port in a channel group.

Example

This example shows how to add ports to a Layer 3 port-channel.

```
apic1# configure
apic1(config)# leaf 101
apic1(config-leaf)# interface Ethernet 1/1-2
apic1(config-leaf-if)# channel-group p01
```

Configuring a Switch Virtual Interface Using the NX-OS Style CLI

Configuring SVI Interface Encapsulation Scope Using NX-OS Style CLI

The following example displaying steps for an SVI interface encapsulation scope setting is through a named Layer 3 Out configuration.

Procedure

	Command or Action	Purpose
Step 1	Enter the configure mode. Example: apic1# configure	Enters the configuration mode.
Step 2	Enter the switch mode. Example: apic1(config)# leaf 104	Enters the switch mode.
Step 3	Create the VLAN interface. Example: apic1(config-leaf)# interface vlan 2001	Creates the VLAN interface. The VLAN range is 1-4094.
Step 4	Specify the encapsulation scope. Example: apic1(config-leaf-if)# encap scope vrf context	Specifies the encapsulation scope.

	Command or Action	Purpose
Step 5	Exit the interface mode. Example: apicl(config-leaf-if)# exit	Exits the interface mode.

Configuring SVI Auto State Using NX-OS Style CLI

Before you begin

- The tenant and VRF configured.
- A Layer 3 Out is configured and a logical node profile and a logical interface profile under the Layer 3 Out is configured.

Procedure

	Command or Action	Purpose
Step 1	Enter the configure mode. Example: apicl# configure	Enters the configuration mode.
Step 2	Enter the switch mode. Example: apicl(config)# leaf 104	Enters the switch mode.
Step 3	Create the VLAN interface. Example: apicl(config-leaf)# interface vlan 2001	Creates the VLAN interface. The VLAN range is 1-4094.
Step 4	Enable SVI auto state. Example: apicl(config-leaf-if)# autostate	Enables SVI auto state. By default, the SVI auto state value is not enabled.
Step 5	Exit the interface mode. Example: apicl(config-leaf-if)# exit	Exits the interface mode.

Configuring Routing Protocols Using the NX-OS Style CLI

Configuring BGP External Routed Networks with BFD Support Using the NX-OS Style CLI

Configuring BGP External Routed Network Using the NX-OS Style CLI

Procedure

The following shows how to configure the BGP external routed network using the NX-OS CLI:

Example:

```

apicl(config-leaf)# template route-profile damp_rp tenant t1
This template will be available on all leaves where tenant t1 has a VRF deployment
apicl(config-leaf-template-route-profile)# set dampening 15 750 2000 60
apicl(config-leaf-template-route-profile)# exit
apicl(config-leaf)#
apicl(config-leaf)# router bgp 100
apicl(config-bgp)# vrf member tenant t1 vrf ctx3
apicl(config-leaf-bgp-vrf)# neighbor 32.0.1.0/24 l3out l3out-bgp
apicl(config-leaf-bgp-vrf-neighbor)# update-source ethernet 1/16.401
apicl(config-leaf-bgp-vrf-neighbor)# address-family ipv4 unicast
apicl(config-leaf-bgp-vrf-neighbor-af)# weight 400
apicl(config-leaf-bgp-vrf-neighbor-af)# exit
apicl(config-leaf-bgp-vrf-neighbor)# remote-as 65001
apicl(config-leaf-bgp-vrf-neighbor)# private-as-control remove-exclusive
apicl(config-leaf-bgp-vrf-neighbor)# private-as-control remove-exclusive-all
apicl(config-leaf-bgp-vrf-neighbor)# private-as-control remove-exclusive-all-replace-as
apicl(config-leaf-bgp-vrf-neighbor)# exit
apicl(config-leaf-bgp-vrf)# address-family ipv4 unicast
apicl(config-leaf-bgp-vrf-af)# inherit bgp dampening damp_rp
This template will be inherited on all leaves where VRF ctx3 has been deployed
apicl(config-leaf-bgp-vrf-af)# exit
apicl(config-leaf-bgp-vrf)# address-family ipv6 unicast
apicl(config-leaf-bgp-vrf-af)# inherit bgp dampening damp_rp
This template will be inherited on all leaves where VRF ctx3 has been deployed
apicl(config-leaf-bgp-vrf-af)# exit

```

Configuring BGP Max Path Using the NX-OS Style CLI

Before you begin:

Refer to the *Verified Scalability Guide for Cisco APIC* on the [Cisco APIC documentation page](#) for the acceptable values for the following fields.

The appropriate tenant and the BGP external routed network are created and available.

Use the following commands when logged in to BGP:

- Commands for configuring multipath for eBGP paths:

```

maximum-paths <value>
no maximum-paths <value>

```

- Commands for configuring multipath for iBGP paths:

```
maximum-paths ibgp <value>
no maximum-paths ibgp <value>
```

Example:

```
apic1(config)# leaf 101
apic1(config-leaf)# template bgp address-family newAf tenant t1
This template will be available on all nodes where tenant t1 has a VRF deployment
apic1(config-bgp-af)# maximum-paths ?
<1-64> Number of parallel paths
ibgp Configure multipath for IBGP paths
apic1(config-bgp-af)# maximum-paths 10
apic1(config-bgp-af)# maximum-paths ibgp 8
apic1(config-bgp-af)# end
apic1#
```

Configuring AS Path Prepend Using the NX-OS Style CLI

This section provides information on how to configure the AS Path Prepend feature using the NX-OS style command line interface (CLI).

Before you begin

A configured tenant.

Procedure

To modify the autonomous system path (AS Path) for Border Gateway Protocol (BGP) routes, you can use the `set as-path` command. The `set as-path` command takes the form of

```
apic1(config-leaf-vrf-template-route-profile)# set as-path {'prepend as-num [ ,... as-num ]
| prepend-last-as num}
```

Example:

```
apic1(config)# leaf 103
apic1(config-leaf)# vrf context tenant t1 vrf v1
apic1(config-leaf-vrf)# template route-profile rp1
apic1(config-leaf-vrf-template-route-profile)# set as-path ?
prepend Prepend to the AS-Path
prepend-last-as Prepend last AS to the as-path
apic1(config-leaf-vrf-template-route-profile)# set as-path prepend 100, 101, 102, 103
apic1(config-leaf-vrf-template-route-profile)# set as-path prepend-last-as 8
apic1(config-leaf-vrf-template-route-profile)# exit
apic1(config-leaf-vrf)# exit
apic1(config-leaf)# exit
```

What to do next

To disable AS Path prepend, use the no form of the shown command:

```
apicl(config-leaf-vrf-template-route-profile)# [no] set
as-path { prepend as-num [ ,... as-num ] | prepend-last-as num}
```

Configuring BGP Neighbor Shutdown Using the NX-OS Style CLI*Configuring BGP Neighbor Shutdown Using the NX-OS Style CLI*

The following procedure describes how to use the BGP neighbor shutdown feature using the NX-OS CLI.

Procedure

Step 1 Configure the node and interface for the L3Out.

This example configures VRF `v1` on node 103 (the border leaf switch), which is named `nodep1`, with router ID `11.11.11.103`. It also configures interface `eth1/3` as a routed interface (Layer 3 port), with IP address `12.12.12.3/24` and Layer 3 domain `dom1`.

Example:

```
apicl(config)# leaf 103
apicl(config-leaf)# vrf context tenant t1 vrf v1
apicl(config-leaf-vrf)# router-id 11.11.11.103
apicl(config-leaf-vrf)# exit
apicl(config-leaf)# interface ethernet 1/3
apicl(config-leaf-if)# vlan-domain member dom1
apicl(config-leaf-if)# no switchport
apicl(config-leaf-if)# vrf member tenant t1 vrf v1
apicl(config-leaf-if)# ip address 12.12.12.3/24
apicl(config-leaf-if)# exit
apicl(config-leaf)# exit
```

Step 2 Configure the BGP routing protocol.

This example configures BGP as the primary routing protocol, with a BGP peer address of `15.15.15.2` and ASN 100.

Example:

```
apicl(config)# leaf 103
apicl(config-leaf)# router bgp 100
apicl(config-leaf-bgp)# vrf member tenant t1 vrf v1
apicl(config-leaf-bgp-vrf)# neighbor 15.15.15.2
```

Step 3 Use the BGP neighbor shutdown feature.

Example:

```
apicl(config-leaf-bgp-vrf-neighbor)# shutdown
apicl(config-leaf-bgp-vrf)# exit
apicl(config-leaf-bgp)# exit
apicl(config-leaf)# exit
```

Configuring a Per VRF Per Node BGP Timer Policy Using the NX-OS Style CLI

Procedure

	Command or Action	Purpose
Step 1	<p>Configure BGP ASN and the route reflector before creating a timer policy.</p> <p>Example:</p> <pre>apicl(config)# apicl(config)# bgp-fabric apicl(config-bgp-fabric)# route-reflector spine 102 apicl(config-bgp-fabric)# asn 42 apicl(config-bgp-fabric)# exit apicl(config)# exit apicl#</pre>	
Step 2	<p>Create a timer policy.</p> <p>Example:</p> <pre>apicl# config apicl(config)# leaf 101 apicl(config-leaf)# template bgp timers pol7 tenant tn1 This template will be available on all nodes where tenant tn1 has a VRF deployment apicl(config-bgp-timers)# timers bgp 120 240 apicl(config-bgp-timers)# graceful-restart stalepath-time 500 apicl(config-bgp-timers)# maxas-limit 300 apicl(config-bgp-timers)# exit apicl(config-leaf)# exit apicl(config)# exit apicl#</pre>	The specific values are provided as examples only.
Step 3	<p>Display the configured BGP policy.</p> <p>Example:</p> <pre>apicl# show run leaf 101 template bgp timers pol7 # Command: show running-config leaf 101 template bgp timers pol7 leaf 101 template bgp timers pol7 tenant tn1 timers bgp 120 240 graceful-restart stalepath-time 500 maxas-limit 300 exit exit</pre>	
Step 4	<p>Refer to a specific policy at a node.</p> <p>Example:</p>	

	Command or Action	Purpose
	<pre> apic1# config apic1(config)# leaf 101 apic1(config-leaf)# router bgp 42 apic1(config-leaf-bgp)# vrf member tenant tn1 vrf ctx1 apic1(config-leaf-bgp-vrf)# inherit node-only bgp timer pol7 apic1(config-leaf-bgp-vrf)# exit apic1(config-leaf-bgp)# exit apic1(config-leaf)# exit apic1(config)# exit apic1# </pre>	
Step 5	<p>Display the node specific BGP timer policy.</p> <p>Example:</p> <pre> apic1# show run leaf 101 router bgp 42 vrf member tenant tn1 vrf ctx1 # Command: show running-config leaf 101 router bgp 42 vrf member tenant tn1 vrf ctx1 leaf 101 router bgp 42 vrf member tenant tn1 vrf ctx1 inherit node-only bgp timer pol7 exit exit exit apic1# </pre>	

Configuring Bidirectional Forwarding Detection on a Secondary IP Address Using the NX-OS-Style CLI

This procedure configures bidirectional forwarding detection (BFD) on a secondary IP address using the NX-OS-style CLI. This example configures VRF v1 on node 103 (the border leaf switch), with router ID 1.1.24.24. It also configures interface eth1/3 as a routed interface (Layer 3 port), with IP address 12.12.12.3/24 as primary and 6.11.1.224/24 as secondary address in Layer 3 domain dom1. BFD is enabled on 99.99.99.14/32, which is reachable using the secondary subnet 6.11.1.0/24.

Procedure

-
- Step 1** Enter the configure mode.
- Example:**
- ```
apic1# configure terminal
```
- Step 2** Enter the configure mode for leaf switch 103.
- Example:**
- ```
apic1(config)# leaf 103
```
- Step 3** Enter the configure mode for a VRF instance.

Example:

```
apic1(config-leaf)# vrf context tenant t1 vrf v1
```

- Step 4** Configure a secondary IP address.

Example:

```
apic1(config-leaf-vrf)# router-id 1.1.24.24
apic1(config-leaf-vrf)# exit
apic1(config-leaf)# interface ethernet 1/3
apic1(config-leaf-if)# vlan-domain member dom1
apic1(config-leaf-if)# no switchport
apic1(config-leaf-if)# vrf member tenant t1 vrf v1
apic1(config-leaf-if)# ip address 12.12.12.3/24
apic1(config-leaf-if)# ip address 6.11.1.224/24 secondary
apic1(config-leaf-if)# exit
apic1(config-leaf)# exit
```

- Step 5** Enable BFD.

Example:

```
apic1(config-leaf)# vrf context tenant t1 vrf v1 l3out Routed
apic1(config-leaf-vrf)#router-id 1.1.24.24
apic1(config-leaf-vrf)#ip route 95.95.95.95/32 12.12.12.4 bfd
apic1(config-leaf-vrf)#ip route 99.99.99.14/32 6.11.1.100 bfd
```

Configuring BFD Globally on Leaf Switch Using the NX-OS Style CLI

Procedure

- Step 1** To configure the BFD IPV4 global configuration (bfdIpv4InstPol) using the NX-OS CLI:

Example:

```
apic1# configure
apic1(config)# template bfd ip bfd_ipv4_global_policy
apic1(config-bfd)# [no] echo-address 1.2.3.4
apic1(config-bfd)# [no] slow-timer 2500
apic1(config-bfd)# [no] min-tx 100
apic1(config-bfd)# [no] min-rx 70
apic1(config-bfd)# [no] multiplier 3
apic1(config-bfd)# [no] echo-rx-interval 500
apic1(config-bfd)# exit
```

- Step 2** To configure the BFD IPV6 global configuration (bfdIpv6InstPol) using the NX-OS CLI:

Example:

```
apic1# configure
apic1(config)# template bfd ipv6 bfd_ipv6_global_policy
apic1(config-bfd)# [no] echo-address 34::1/64
apic1(config-bfd)# [no] slow-timer 2500
apic1(config-bfd)# [no] min-tx 100
apic1(config-bfd)# [no] min-rx 70
apic1(config-bfd)# [no] multiplier 3
apic1(config-bfd)# [no] echo-rx-interval 500
apic1(config-bfd)# exit
```

- Step 3** To configure access leaf policy group (infraAccNodePGrp) and inherit the previously created BFD global policies using the NX-OS CLI:

Example:

```
apicl# configure
apicl(config)# template leaf-policy-group test_leaf_policy_group
apicl(config-leaf-policy-group)# [no] inherit bfd ip bfd_ipv4_global_policy
apicl(config-leaf-policy-group)# [no] inherit bfd ipv6 bfd_ipv6_global_policy
apicl(config-leaf-policy-group)# exit
```

- Step 4** To associate the previously created leaf policy group onto a leaf using the NX-OS CLI:

Example:

```
apicl(config)# leaf-profile test_leaf_profile
apicl(config-leaf-profile)# leaf-group test_leaf_group
apicl(config-leaf-group)# leaf-policy-group test_leaf_policy_group
apicl(config-leaf-group)# leaf 101-102
apicl(config-leaf-group)# exit
```

Configuring BFD Globally on Spine Switch Using the NX-OS Style CLI

Use this procedure to configure BFD globally on spine switch using the NX-OS style CLI.

Procedure

- Step 1** To configure the BFD IPV4 global configuration (bfdIpv4InstPol) using the NX-OS CLI:

Example:

```
apicl# configure
apicl(config)# template bfd ip bfd_ipv4_global_policy
apicl(config-bfd)# [no] echo-address 1.2.3.4
apicl(config-bfd)# [no] slow-timer 2500
apicl(config-bfd)# [no] min-tx 100
apicl(config-bfd)# [no] min-rx 70
apicl(config-bfd)# [no] multiplier 3
apicl(config-bfd)# [no] echo-rx-interval 500
apicl(config-bfd)# exit
```

- Step 2** To configure the BFD IPV6 global configuration (bfdIpv6InstPol) using the NX-OS CLI:

Example:

```
apicl# configure
apicl(config)# template bfd ipv6 bfd_ipv6_global_policy
apicl(config-bfd)# [no] echo-address 34::1/64
apicl(config-bfd)# [no] slow-timer 2500
apicl(config-bfd)# [no] min-tx 100
apicl(config-bfd)# [no] min-rx 70
apicl(config-bfd)# [no] multiplier 3
apicl(config-bfd)# [no] echo-rx-interval 500
apicl(config-bfd)# exit
```

- Step 3** To configure spine policy group and inherit the previously created BFD global policies using the NX-OS CLI:

Example:

```
apicl# configure
apicl(config)# template spine-policy-group test_spine_policy_group
apicl(config-spine-policy-group)# [no] inherit bfd ip bfd_ipv4_global_policy
apicl(config-spine-policy-group)# [no] inherit bfd ipv6 bfd_ipv6_global_policy
apicl(config-spine-policy-group)# exit
```

Step 4 To associate the previously created spine policy group onto a spine switch using the NX-OS CLI:

Example:

```
apicl# configure
apicl(config)# spine-profile test_spine_profile
apicl(config-spine-profile)# spine-group test_spine_group
apicl(config-spine-group)# spine-policy-group test_spine_policy_group
apicl(config-spine-group)# spine 103-104
apicl(config-leaf-group)# exit
```

Configuring BFD Interface Override Using the NX-OS Style CLI

Procedure

Step 1 To configure BFD Interface Policy (bfdIfPol) using the NX-OS CLI:

Example:

```
apicl# configure
apicl(config)# tenant t0
apicl(config-tenant)# vrf context v0
apicl(config-tenant-vrf)# exit
apicl(config-tenant)# exit
apicl(config)# leaf 101
apicl(config-leaf)# vrf context tenant t0 vrf v0
apicl(config-leaf-vrf)# exit
apicl(config-leaf)# interface Ethernet 1/18
apicl(config-leaf-if)# vrf member tenant t0 vrf v0
apicl(config-leaf-if)# exit
apicl(config-leaf)# template bfd bfdIfPol1 tenant t0
apicl(config-template-bfd-pol)# [no] echo-mode enable
apicl(config-template-bfd-pol)# [no] echo-rx-interval 500
apicl(config-template-bfd-pol)# [no] min-rx 70
apicl(config-template-bfd-pol)# [no] min-tx 100
apicl(config-template-bfd-pol)# [no] multiplier 5
apicl(config-template-bfd-pol)# [no] optimize subinterface
apicl(config-template-bfd-pol)# exit
```

Step 2 To inherit the previously created BFD interface policy onto a L3 interface with IPv4 address using the NX-OS CLI:

Example:

```
apicl# configure
apicl(config)# leaf 101
apicl(config-leaf)# interface Ethernet 1/15
apicl(config-leaf-if)# bfd ip tenant mode
```

```
apicl(config-leaf-if)# bfd ip inherit interface-policy bfdPoll
apicl(config-leaf-if)# bfd ip authentication keyed-shal key 10 key password
```

Step 3 To inherit the previously created BFD interface policy onto an L3 interface with IPv6 address using the NX-OS CLI:

Example:

```
apicl# configure
apicl(config)# leaf 101
apicl(config-leaf)# interface Ethernet 1/15
apicl(config-leaf-if)# ipv6 address 2001::10:1/64 preferred
apicl(config-leaf-if)# bfd ipv6 tenant mode
apicl(config-leaf-if)# bfd ipv6 inherit interface-policy bfdPoll
apicl(config-leaf-if)# bfd ipv6 authentication keyed-shal key 10 key password
```

Step 4 To configure BFD on a VLAN interface with IPv4 address using the NX-OS CLI:

Example:

```
apicl# configure
apicl(config)# leaf 101
apicl(config-leaf)# interface vlan 15
apicl(config-leaf-if)# vrf member tenant t0 vrf v0
apicl(config-leaf-if)# bfd ip tenant mode
apicl(config-leaf-if)# bfd ip inherit interface-policy bfdPoll
apicl(config-leaf-if)# bfd ip authentication keyed-shal key 10 key password
```

Step 5 To configure BFD on a VLAN interface with IPv6 address using the NX-OS CLI:

Example:

```
apicl# configure
apicl(config)# leaf 101
apicl(config-leaf)# interface vlan 15
apicl(config-leaf-if)# ipv6 address 2001::10:1/64 preferred
apicl(config-leaf-if)# vrf member tenant t0 vrf v0
apicl(config-leaf-if)# bfd ipv6 tenant mode
apicl(config-leaf-if)# bfd ipv6 inherit interface-policy bfdPoll
apicl(config-leaf-if)# bfd ipv6 authentication keyed-shal key 10 key password
```

Configuring BFD Consumer Protocols Using the NX-OS Style CLI

Procedure

Step 1 To enable BFD on the BGP consumer protocol using the NX-OS CLI:

Example:

```
apicl# configure
apicl(config)# bgp-fabric
apicl(config-bgp-fabric)# asn 200
apicl(config-bgp-fabric)# exit
apicl(config)# leaf 101
apicl(config-leaf)# router bgp 200
apicl(config-bgp)# vrf member tenant t0 vrf v0
```



```
apic1(config-leaf-bgp-vrf)# neighbor 1.2.3.4
apic1(config-leaf-bgp-vrf-neighbor)# [no] bfd enable
```

Step 2 To enable BFD on the EIGRP consumer protocol using the NX-OS CLI:

Example:

```
apic1(config-leaf-if)# [no] ip bfd eigrp enable
```

Step 3 To enable BFD on the OSPF consumer protocol using the NX-OS CLI:

Example:

```
apic1(config-leaf-if)# [no] ip ospf bfd enable
```

```
apic1# configure
apic1(config)# spine 103
apic1(config-spine)# interface ethernet 5/3.4
apic1(config-spine-if)# [no] ip ospf bfd enable
```

Step 4 To enable BFD on the Static Route consumer protocol using the NX-OS CLI:

Example:

```
apic1(config-leaf-vrf)# [no] ip route 10.0.0.1/16 10.0.0.5 bfd
```

```
apic1(config)# spine 103
apic1(config-spine)# vrf context tenant infra vrf overlay-1
apic1(config-spine-vrf)# [no] ip route 21.1.1.1/32 32.1.1.1 bfd
```

Step 5 To enable BFD on IS-IS consumer protocol using the NX-OS CLI:

Example:

```
apic1(config)# leaf 101
apic1(config-spine)# interface ethernet 1/49
apic1(config-spine-if)# isis bfd enabled
apic1(config-spine-if)# exit
apic1(config-spine)# exit
```

```
apic1(config)# spine 103
apic1(config-spine)# interface ethernet 5/2
apic1(config-spine-if)# isis bfd enabled
apic1(config-spine-if)# exit
apic1(config-spine)# exit
```

Configuring OSPF External Routed Networks Using the NX-OS Style CLI

Creating an OSPF External Routed Network for a Tenant Using the NX-OS CLI

Configuring external routed network connectivity involves the following steps:

1. Create a VRF under Tenant.

2. Configure L3 networking configuration for the VRF on the border leaf switches, which are connected to the external routed network. This configuration includes interfaces, routing protocols (BGP, OSPF, EIGRP), protocol parameters, route-maps.
3. Configure policies by creating external-L3 EPGs under tenant and deploy these EPGs on the border leaf switches. External routed subnets on a VRF which share the same policy within the ACI fabric form one "External L3 EPG" or one "prefix EPG".

Configuration is realized in two modes:

- Tenant mode: VRF creation and external-L3 EPG configuration
- Leaf mode: L3 networking configuration and external-L3 EPG deployment

The following steps are for creating an OSPF external routed network for a tenant. To create an OSPF external routed network for a tenant, you must choose a tenant and then create a VRF for the tenant.



Note The examples in this section show how to provide external routed connectivity to the "web" epg in the "OnlineStore" application for tenant "exampleCorp".

Procedure

Step 1 Configure the VLAN domain.

Example:

```
apicl(config)# vlan-domain dom_exampleCorp
apicl(config-vlan)# vlan 5-1000
apicl(config-vlan)# exit
```

Step 2 Configure the tenant VRF and enable policy enforcement on the VRF.

Example:

```
apicl(config)# tenant exampleCorp
apicl(config-tenant)# vrf context
    exampleCorp_v1
apicl(config-tenant-vrf)# contract enforce
apicl(config-tenant-vrf)# exit
```

Step 3 Configure the tenant BD and mark the gateway IP as "public". The entry "scope public" makes this gateway address available for advertisement through the routing protocol for external-L3 network.

Example:

```
apicl(config-tenant)# bridge-domain exampleCorp_b1
apicl(config-tenant-bd)# vrf member exampleCorp_v1
apicl(config-tenant-bd)# exit
apicl(config-tenant)# interface bridge-domain exampleCorp_b1
apicl(config-tenant-interface)# ip address 172.1.1.1/24 scope public
apicl(config-tenant-interface)# exit
```

Step 4 Configure the VRF on a leaf.

Example:

```
apic1(config)# leaf 101
apic1(config-leaf)# vrf context tenant exampleCorp vrf exampleCorp_v1
```

Step 5 Configure the OSPF area and add the route map.

Example:

```
apic1(config-leaf)# router ospf default
apic1(config-leaf-ospf)# vrf member tenant exampleCorp vrf exampleCorp_v1
apic1(config-leaf-ospf-vrf)# area 0.0.0.1 route-map map100 out
apic1(config-leaf-ospf-vrf)# exit
apic1(config-leaf-ospf)# exit
```

Step 6 Assign the VRF to the interface (sub-interface in this example) and enable the OSPF area.

Example:**Note**

For the sub-interface configuration, the main interface (ethernet 1/11 in this example) must be converted to an L3 port through “no switchport” and assigned a vlan-domain (dom_exampleCorp in this example) that contains the encapsulation VLAN used by the sub-interface. In the sub-interface ethernet1/11.500, 500 is the encapsulation VLAN.

```
apic1(config-leaf)# interface ethernet 1/11
apic1(config-leaf-if)# no switchport
apic1(config-leaf-if)# vlan-domain member dom_exampleCorp
apic1(config-leaf-if)# exit
apic1(config-leaf)# interface ethernet 1/11.500
apic1(config-leaf-if)# vrf member tenant exampleCorp vrf exampleCorp_v1
apic1(config-leaf-if)# ip address 157.10.1.1/24
apic1(config-leaf-if)# ip router ospf default area 0.0.0.1
```

Step 7 Configure the external-L3 EPG policy. This includes the subnet to match for identifying the external subnet and consuming the contract to connect with the epg "web".

Example:

```
apic1(config)# tenant t100
apic1(config-tenant)# external-l3 epg l3epg100
apic1(config-tenant-l3ext-epg)# vrf member v100
apic1(config-tenant-l3ext-epg)# match ip 145.10.1.0/24
apic1(config-tenant-l3ext-epg)# contract consumer web
apic1(config-tenant-l3ext-epg)# exit
apic1(config-tenant)#exit
```

Step 8 Deploy the external-L3 EPG on the leaf switch.

Example:

```
apic1(config)# leaf 101
apic1(config-leaf)# vrf context tenant t100 vrf v100
apic1(config-leaf-vrf)# external-l3 epg l3epg100
```

Configuring EIGRP External Routed Networks Using the NX-OS Style CLI

Configuring EIGRP Using the NX-OS-Style CLI

Procedure

Step 1 SSH to an Application Policy Infrastructure Controller (APIC) in the fabric:

Example:

```
# ssh admin@node_name
```

Step 2 Enter the configure mode:

Example:

```
apic1# configure
```

Step 3 Enter the configure mode for a tenant:

Example:

```
apic1(config)# tenant tenant1
```

Step 4 Configure the Layer 3 Outside on the tenant:

Example:

```
apic1(config-tenant)# show run
# Command: show running-config tenant tenant1
# Time: Tue Feb 16 09:44:09 2016
tenant tenant1
  vrf context l3out
  exit
  l3out l3out-L1
    vrf member l3out
    exit
  l3out l3out-L3
    vrf member l3out
    exit
  external-13 epg tenant1 l3out l3out-L3
    vrf member l3out
    match ip 0.0.0.0/0
    match ip 3.100.0.0/16
    match ipv6 43:101::/48
    contract consumer default
    exit
  external-13 epg tenant1 l3out l3out-L1
    vrf member l3out
    match ipv6 23:101::/48
    match ipv6 13:101::/48
    contract provider default
    exit
  exit
```

Step 5 Configure a VRF for EIGRP on a leaf:

Example:

```
apic1(config)# leaf 101
apic1(config-leaf)# vrf context tenant tenant1 vrf l3out l3out l3out-L1
apic1(config-leaf-vrf)# show run
# Command: show running-config leaf 101 vrf context tenant tenant1 vrf l3out l3out l3out-L1
```

```
# Time: Tue Feb 16 09:44:45 2016
leaf 101
  vrf context tenant tenant1 vrf l3out l3out l3out-L1
  router-id 3.1.1.1
  route-map l3out-L1_in
  scope global
  ip prefix-list tenant1 permit 1:102::/48
  match prefix-list tenant1
  exit
  exit
  route-map l3out-L1_out
  scope global
  ip prefix-list tenant1 permit 3.102.10.0/23
  ip prefix-list tenant1 permit 3.102.100.0/31
  ip prefix-list tenant1 permit 3.102.20.0/24
  ip prefix-list tenant1 permit 3.102.30.0/25
  ip prefix-list tenant1 permit 3.102.40.0/26
  ip prefix-list tenant1 permit 3.102.50.0/27
  ip prefix-list tenant1 permit 3.102.60.0/28
  ip prefix-list tenant1 permit 3.102.70.0/29
  ip prefix-list tenant1 permit 3.102.80.0/30
  ip prefix-list tenant1 permit 3.102.90.0/32
  <OUTPUT TRUNCATED>
  ip prefix-list tenant1 permit ::/0
  match prefix-list tenant1
  exit
  exit
  route-map l3out-L1_shared
  scope global
  exit
  exit
  exit
  exit
```

Step 6 Configure the EIGRP interface policy:

Example:

```
apic1(config-leaf)# template eigrp interface-policy tenant1 tenant tenant1
This template will be available on all leaves where tenant tenant1 has a VRF deployment
apic1(config-template-eigrp-if-pol)# show run
# Command: show running-config leaf 101 template eigrp interface-policy tenant1 tenant
tenant1
# Time: Tue Feb 16 09:45:50 2016
leaf 101
  template eigrp interface-policy tenant1 tenant tenant1
  ip hello-interval eigrp default 10
  ip hold-interval eigrp default 30
  ip throughput-delay eigrp default 20 tens-of-micro
  ip bandwidth eigrp default 20
  exit
  exit
```

Step 7 Configure the EIGRP VRF policy:

Example:

```
apic1(config-leaf)# template eigrp vrf-policy tenant1 tenant tenant1
This template will be available on all leaves where tenant tenant1 has a VRF deployment
apic1(config-template-eigrp-vrf-pol)# show run
# Command: show running-config leaf 101 template eigrp vrf-policy tenant1 tenant tenant1
# Time: Tue Feb 16 09:46:31 2016
leaf 101
  template eigrp vrf-policy tenant1 tenant tenant1
  metric version 64bit
```

```

    exit
  exit

```

Step 8 Configure the EIGRP VLAN interface and enable EIGRP in the interface:

Example:

```

apic1(config-leaf)# interface vlan 1013
apic1(config-leaf-if)# show run
# Command: show running-config leaf 101 interface vlan 1013
# Time: Tue Feb 16 09:46:59 2016
leaf 101
  interface vlan 1013
    vrf member tenant tenant1 vrf l3out
    ip address 101.13.1.2/24
    ip router eigrp default
    ipv6 address 101:13::1:2/112 preferred
    ipv6 router eigrp default
    ipv6 link-local fe80::101:13:1:2
    inherit eigrp ip interface-policy tenant1
    inherit eigrp ipv6 interface-policy tenant1
    exit
  exit
apic1(config-leaf-if)# ip summary-address ?
  eigrp  Configure route summarization for EIGRP
apic1(config-leaf-if)# ip summary-address eigrp default 11.11.0.0/16 ?
  <CR>
apic1(config-leaf-if)# ip summary-address eigrp default 11.11.0.0/16
apic1(config-leaf-if)# ip summary-address eigrp default 11:11:1::/48
apic1(config-leaf-if)# show run
# Command: show running-config leaf 101 interface vlan 1013
# Time: Tue Feb 16 09:47:34 2016
leaf 101
  interface vlan 1013
    vrf member tenant tenant1 vrf l3out
    ip address 101.13.1.2/24
    ip router eigrp default
    ip summary-address eigrp default 11.11.0.0/16
    ip summary-address eigrp default 11:11:1::/48
    ipv6 address 101:13::1:2/112 preferred
    ipv6 router eigrp default
    ipv6 link-local fe80::101:13:1:2
    inherit eigrp ip interface-policy tenant1
    inherit eigrp ipv6 interface-policy tenant1
    exit
  exit

```

Step 9 Apply the VLAN on the physical interface:

Example:

```

apic1(config-leaf)# interface ethernet 1/5
apic1(config-leaf-if)# show run
# Command: show running-config leaf 101 interface ethernet 1 / 5
# Time: Tue Feb 16 09:48:05 2016
leaf 101
  interface ethernet 1/5
    vlan-domain member cli
    switchport trunk allowed vlan 1213 tenant tenant13 external-svi l3out l3out-L1
    switchport trunk allowed vlan 1613 tenant tenant17 external-svi l3out l3out-L1
    switchport trunk allowed vlan 1013 tenant tenant1 external-svi l3out l3out-L1
    switchport trunk allowed vlan 666 tenant ten_v6_cli external-svi l3out l3out_cli_L1
    switchport trunk allowed vlan 1513 tenant tenant16 external-svi l3out l3out-L1
    switchport trunk allowed vlan 1313 tenant tenant14 external-svi l3out l3out-L1
    switchport trunk allowed vlan 1413 tenant tenant15 external-svi l3out l3out-L1

```

```

switchport trunk allowed vlan 1113 tenant tenant12 external-svi l3out l3out-L1
switchport trunk allowed vlan 712 tenant mgmt external-svi l3out inband_l1
switchport trunk allowed vlan 1913 tenant tenant10 external-svi l3out l3out-L1
switchport trunk allowed vlan 300 tenant tenant1 external-svi l3out l3out-L1
exit
exit

```

Step 10 Enable router EIGRP:

Example:

```

apic1(config-eigrp-vrf)# show run
# Command: show running-config leaf 101 router eigrp default vrf member tenant tenant1 vrf
l3out
# Time: Tue Feb 16 09:49:05 2016
leaf 101
  router eigrp default
  exit
  router eigrp default
  exit
  router eigrp default
  exit
  router eigrp default
  vrf member tenant tenant1 vrf l3out
  autonomous-system 1001 l3out l3out-L1
  address-family ipv6 unicast
  inherit eigrp vrf-policy tenant1
  exit
  address-family ipv4 unicast
  inherit eigrp vrf-policy tenant1
  exit
  exit
  exit

```

Configuring Route Summarization Using the NX-OS Style CLI

Configuring Route Summarization for BGP, OSPF, and EIGRP Using the NX-OS Style CLI

Procedure

Step 1 Configure BGP route summarization using the NX-OS CLI as follows:

a) Enable BGP as follows:

Example:

```

apic1(config)# pod 1
apic1(config-pod)# bgp fabric
apic1(config-pod-bgp)# asn 10
apic1(config-pod)# exit
apic1(config)# leaf 101
apic1(config-leaf)# router bgp 10

```

b) Configure the summary route as follows:

Example:

```
apicl(config-bgp)# vrf member tenant common vrf vrf1
apicl(config-leaf-bgp-vrf)# aggregate-address 10.0.0.0/8
```

Step 2 Configure OSPF external summarization using the NX-OS CLI as follows:

Example:

```
apicl(config-leaf)# router ospf default
apicl(config-leaf-ospf)# vrf member tenant common vrf vrf1
apicl(config-leaf-ospf-vrf)# summary-address 10.0.0.0/8
```

Step 3 Configure OSPF inter-area summarization using the NX-OS CLI as follows:

```
apicl(config-leaf)# router ospf default
apicl(config-leaf-ospf)# vrf member tenant common vrf vrf1
apicl(config-leaf-ospf-vrf)# area 0.0.0.2 range 10.0.0.0/8 cost 20
```

Step 4 Configure EIGRP summarization using the NX-OS CLI as follows:

Example:

```
apicl(config)# leaf 101
apicl(config-leaf)# interface ethernet 1/31 (Or interface vlan <vlan-id>)
apicl(config-leaf-if)# ip summary-address eigrp default 10.0.0.0/8
```

Note

There is no route summarization policy to be configured for EIGRP. The only configuration needed for enabling EIGRP summarization is the summary subnet under the InstP.

Configuring Route Control with Route Maps and Route Profile Using NX-OS Style CLI

Configuring Route Control Per BGP Peer Using the NX-OS Style CLI

The following procedure describes how to configure the route control per BGP peer feature using the NX-OS CLI.

Procedure

Step 1 Create a route group template and add IP prefix to the route group.

This example creates a route group `match-rule1` for tenant `t1`, and adds the IP prefix of `200.3.2.0/24` to the route group.

Example:

```
apicl(config)# leaf 103
apicl(config-leaf)# template route group match-rule1 tenant t1
apicl(config-route-group)# ip prefix permit 200.3.2.0/24
apicl(config-route-group)# exit
apicl(config-leaf)#
```

Step 2 Enter a tenant VRF mode for the node.

This example enters a tenant VRF mode for VRF `v1` for tenant `t1`.

Example:

```
apic1(config-leaf)# vrf context tenant t1 vrf v1
```

Step 3 Create a route-map and enter the route-map configuration mode, then match a route group that has already been created and enter the match mode to configure the route-profile.

This example creates a route-map `rp1`, and matches route group `match-rule1` with an order number 0.

Example:

```
apic1(config-leaf-vrf)# route-map rp1
apic1(config-leaf-vrf-route-map)# match route group match-rule1 order 0
apic1(config-leaf-vrf-route-map-match)# exit
apic1(config-leaf-vrf-route-map)# exit
apic1(config-leaf-vrf)# exit
```

Step 4 Configure the BGP routing protocol.

This example configures BGP as the primary routing protocol, with a BGP peer address of `15.15.15.2` and ASN 100.

Example:

```
apic1(config)# leaf 103
apic1(config-leaf)# router bgp 100
apic1(config-leaf-bgp)# vrf member tenant t1 vrf v1
apic1(config-leaf-bgp-vrf)# neighbor 15.15.15.2
```

Step 5 Configure the route control per BGP peer feature.

Where:

- **in** is the route import policy (routes allowed into the fabric)
- **out** is the route export policy (routes advertised out the external network)

Example:

```
apic1(config-leaf-bgp-vrf-neighbor)# route-map rp1 in
apic1(config-leaf-bgp-vrf-neighbor)# exit
apic1(config-leaf-bgp-vrf)# exit
apic1(config-leaf-bgp)# exit
apic1(config-leaf)# exit
```

Configuring Route Map/Profile with Explicit Prefix List Using NX-OS Style CLI

Before you begin

- Tenant and VRF must be configured through the NX-OS CLI.
- The VRF must be enabled on the leaf switch through the NX-OS CLI.

Procedure

	Command or Action	Purpose
Step 1	configure Example: apicl# configure	Enters configuration mode.
Step 2	leaf <i>node-id</i> Example: apicl(config)# leaf 101	Specifies the leaf to be configured.
Step 3	template route group <i>group-name</i> tenant <i>tenant-name</i> Example: apicl(config-leaf)# template route group g1 tenant exampleCorp	Creates a route group template. Note The route group (match rule) can have one or more of the IP prefixes and one or more match community terms. Across the match types, the AND filter is supported, so all conditions in the route group must match for the route match rule to be accepted. When there are multiple IP prefixes in route group, the OR filter is supported. Any one match prefix is accepted as a route type if it matches.
Step 4	ip prefix permit <i>prefix/masklen</i> [le {32 128 }] Example: apicl(config-route-group)# ip prefix permit 15.15.15.0/24	Add IP prefix to the route group. Note The IP prefix can denote a BD subnet or an external network. Use optional argument le 32 for IPv4 and le 128 for IPv6 if you desire an aggregate prefix.
Step 5	community-list [standard expanded] <i>community-list-name expression</i> Example: apicl(config-route-group)# community-list standard com1 65535:20	This is an optional command. Add match criteria for community if community also needs to be matched along with IP prefix.
Step 6	exit Example: apicl(config-route-group)# exit apicl(config-leaf)#	Exit template mode.
Step 7	vrf context tenant <i>tenant-name</i> vrf <i>vrf-name</i> [I3out { BGP EIGRP OSPF STATIC }] Example: apicl(config-leaf)# vrf context tenant exampleCorp vrf v1	Enters a tenant VRF mode for the node. Note If you enter the optional I3out string, the L3Out must be an L3Out that you configured through the NX-OS CLI.

	Command or Action	Purpose
Step 8	template route-profile <i>profile-name</i> [<i>route-control-context-name order-value</i>] Example: <pre>apic1(config-leaf-vrf) # template route-profile rpl ctx1 1</pre>	Creates a template containing set actions that should be applied to the matched routes.
Step 9	set <i>attribute value</i> Example: <pre>apic1(config-leaf-vrf-template-route-profile) # set metric 128</pre>	Add desired attributes (set actions) to the template.
Step 10	exit Example: <pre>apic1(config-leaf-vrf-template-route-profile) # exit apic1(config-leaf-vrf) #</pre>	Exit template mode.
Step 11	route-map <i>map-name</i> Example: <pre>apic1(config-leaf-vrf) # route-map bgpMap</pre>	Create a route-map and enter the route-map configuration mode.
Step 12	match route group <i>group-name</i> [order <i>number</i>] [deny] Example: <pre>apic1(config-leaf-vrf-route-map) # match route group g1 order 1</pre>	Match a route group that has already been created, and enter the match mode to configure the route-profile. Additionally choose the keyword Deny if routes matching the match criteria defined in route group needs to be denied. The default is Permit .
Step 13	inherit route-profile <i>profile-name</i> Example: <pre>apic1(config-leaf-vrf-route-map-match) # inherit route-profile rpl</pre>	Inherit a route-profile (set actions). Note These actions will be applied to the matched routes. Alternatively, the set actions can be configured inline instead of inheriting a route-profile.
Step 14	exit Example: <pre>apic1(config-leaf-vrf-route-map-match) # exit apic1(config-leaf-vrf-route-map) #</pre>	Exit match mode.
Step 15	exit Example: <pre>apic1(config-leaf-vrf-route-map) # exit apic1(config-leaf-vrf) #</pre>	Exit route map configuration mode.

	Command or Action	Purpose
Step 16	exit Example: apicl(config-leaf-vrf)# exit apicl(config-leaf)#	Exit VRF configuration mode.
Step 17	router bgp fabric-asn Example: apicl(config-leaf)# router bgp 100	Configure the leaf node.
Step 18	vrf member tenant t1 vrf v1 Example: apicl(config-leaf-bgp)# vrf member tenant t1 vrf v1	Set the BGP's VRF membership and the tenant for the BGP policy.
Step 19	neighbor IP-address-of-neighbor Example: apicl(config-leaf-bgp-vrf)# neighbor 15.15.15.2	Configure a BGP neighbor.
Step 20	route-map map-name {in out } Example: apicl(config-leaf-bgp-vrf-neighbor)# route-map bgpMap out	Configure the route map for a BGP neighbor.

Configuring a Route Control Protocol to Use Import and Export Controls, With the NX-OS Style CLI

This example assumes that you have configured the Layer 3 outside network connections using BGP. It is also possible to perform these tasks for a network configured using OSPF.

This section describes how to create a route map using the NX-OS CLI:

Before you begin

- The tenant, private network, and bridge domain are created.
- The Layer 3 outside tenant network is configured.

Procedure

Step 1 Import Route control using match community, match prefix-list

Example:

```
apicl# configure
apicl(config)# leaf 101
      # Create community-list
apicl(config-leaf)# template community-list standard CL_1 65536:20 tenant exampleCorp
apicl(config-leaf)# vrf context tenant exampleCorp vrf v1
```

```

#Create Route-map and use it for BGP import control.
apic1(config-leaf-vrf)# route-map bgpMap
# Match prefix-list and set route-profile actions for the match.
apic1(config-leaf-vrf-route-map)# ip prefix-list list1 permit 13.13.13.0/24
apic1(config-leaf-vrf-route-map)# ip prefix-list list1 permit 14.14.14.0/24
apic1(config-leaf-vrf-route-map)# match prefix-list list1
apic1(config-leaf-vrf-route-map-match)# set tag 200
apic1(config-leaf-vrf-route-map-match)# set local-preference 64
apic1(config-leaf)# router bgp 100
apic1(config-bgp)# vrf member tenant exampleCorp vrf v1
apic1(config-leaf-bgp-vrf)# neighbor 3.3.3.3
apic1(config-leaf-bgp-vrf-neighbor)# route-map bgpMap in

```

Step 2 Export Route Control using match BD, default-export route-profile

Example:

```

# Create custom and "default-export" route-profiles
apic1(config)# leaf 101
apic1(config-leaf)# vrf context tenant exampleCorp vrf v1
apic1(config-leaf-vrf)# template route-profile default-export
apic1(config-leaf-vrf-template-route-profile)# set metric 256
apic1(config-leaf-vrf)# template route-profile bd-rtctrl
apic1(config-leaf-vrf-template-route-profile)# set metric 128

#Create a Route-map and match on BD, prefix-list
apic1(config-leaf-vrf)# route-map bgpMap
apic1(config-leaf-vrf-route-map)# match bridge-domain bd1
apic1(config-leaf-vrf-route-map-match)#exit
apic1(config-leaf-vrf-route-map)# match prefix-list p1
apic1(config-leaf-vrf-route-map-match)#exit
apic1(config-leaf-vrf-route-map)# match bridge-domain bd2
apic1(config-leaf-vrf-route-map-match)# inherit route-profile bd-rtctrl

```

Note

In this case, public-subnets from bd1 and prefixes matching prefix-list p1 are exported out using route-profile “default-export”, while public-subnets from bd2 are exported out using route-profile “bd-rtctrl”.

Configuring Interleak Redistribution Using the NX-OS-Style CLI

The following procedure describes how to configure the interleak redistribution using the NX-OS-style CLI.

Before you begin

Create the tenant, VRF, and L3Out.

Procedure

Step 1 Configure the route map for interleak redistribution for the border leaf node.

Example:

The following example configures the route map `CLI_RP` with an IP prefix-list `CLI_PFX1` for tenant `CLI_TEST` and VRF `VRF1`:

```
apicl# conf t
apicl(config)# leaf 101
apicl(config-leaf)# vrf context tenant CLI_TEST vrf VRF1
apicl(config-leaf-vrf)# route-map CLI_RP
apicl(config-leaf-vrf-route-map)# ip prefix-list CLI_PFX1 permit 192.168.1.0/24
apicl(config-leaf-vrf-route-map)# match prefix-list CLI_PFX1 [deny]
```

Step 2 Configure the interleaf redistribution using the configured route-map.

Example:

The following example configures the redistribution of OSPF routes with the configured route map `CLI_RP`:

```
apicl# conf t
apicl(config)# leaf 101
apicl(config-leaf)# router bgp 65001
apicl(config-leaf-bgp)# vrf member tenant CLI_TEST vrf VRF1
apicl(config-leaf-bgp-vrf)# redistribute ospf route-map CLI_RP
```

Configuring Transit Routing Using the NX-OS Style CLI

Configure Transit Routing Using the NX-OS Style CLI

These steps describe how to configure transit routing for a tenant. This example deploys two L3Outs, in one VRF, on two border leaf switches, that are each connected to separate routers.

Before you begin

- Configure the node, port, functional profile, AEP, and Layer 3 domain.
- Configure a VLAN domain using the `vlan-domain domain` and `vlan vlan-range` commands.
- Configure a BGP route reflector policy to propagate the routed within the fabric.

Procedure

Step 1 Configure the tenant and VRF.

This example configures tenant `t1` with VRF `v1`. The VRF is not yet deployed.

Example:

```
apicl# configure
apicl(config)# tenant t1
apicl(config-tenant)# vrf context v1
apicl(config-tenant-vrf)# exit
apicl(config-tenant)# exit
```

Step 2 Configure the nodes and interfaces.

This example configures two L3Outs for the tenant `t1`, on two border leaf switches:

- The first L3Out is on node 101, which is named `nodep1`. Node 101 is configured with router ID 11.11.11.103. It has a routed interface `ifp1` at `eth1/3`, with the IP address 12.12.12.3/24.
- The second L3Out is on node 102, which is named `nodep2`. Node 102 is configured with router ID 22.22.22.203. It has a routed interface `ifp2` at `eth1/3`, with the IP address, 23.23.23.1/24.

Example:

```

apic1(config)# leaf 101
apic1(config-leaf)# vrf context tenant t1 vrf v1
apic1(config-leaf-vrf)# router-id 11.11.11.103
apic1(config-leaf-vrf)# exit
apic1(config-leaf)# interface ethernet 1/3
apic1(config-leaf-if)# vlan-domain member dom1
apic1(config-leaf-if)# no switchport
apic1(config-leaf-if)# vrf member tenant t1 vrf v1
apic1(config-leaf-if)# ip address 12.12.12.3/24
apic1(config-leaf-if)# exit
apic1(config-leaf)# exit
apic1(config)# leaf 102
apic1(config-leaf)# vrf context tenant t1 vrf v1
apic1(config-leaf-vrf)# router-id 22.22.22.203
apic1(config-leaf-vrf)# exit
apic1(config-leaf)# interface ethernet 1/3
apic1(config-leaf-if)# vlan-domain member dom1
apic1(config-leaf-if)# no switchport
apic1(config-leaf-if)# vrf member tenant t1 vrf v1
apic1(config-leaf-if)# ip address 23.23.23.3/24
apic1(config-leaf-if)# exit
apic1(config-leaf)# exit

```

Step 3 Configure the routing protocol for both leaf switches.

This example configures BGP as the primary routing protocol for both the border leaf switches, both with ASN 100. It also configures Node 101 with BGP peer 15.15.15.2 and node 102 with BGP peer 25.25.25.2.

Example:

```

apic1(config)# leaf 101
apic1(config-leaf)# router bgp 100
apic1(config-leaf-bgp)# vrf member tenant t1 vrf v1
apic1(config-leaf-bgp-vrf)# neighbor 15.15.15.2
apic1(config-leaf-bgp-vrf-neighbor)# exit
apic1(config-leaf-bgp-vrf)# exit
apic1(config-leaf-bgp)# exit
apic1(config-leaf)# exit
apic1(config)# leaf 102
apic1(config-leaf)# router bgp 100
apic1(config-leaf-bgp)# vrf member tenant t1 vrf v1
apic1(config-leaf-bgp-vrf)# neighbor 25.25.25.2
apic1(config-leaf-bgp-vrf-neighbor)# exit
apic1(config-leaf-bgp-vrf)# exit
apic1(config-leaf-bgp)# exit
apic1(config-leaf)# exit

```

Step 4 Configure a connectivity routing protocol.

This example configures OSPF as the communication protocol, for both L3Outs, with regular area ID 0.0.0.0.

Example:

```

apic1(config)# leaf 101
apic1(config-leaf)# router ospf default
apic1(config-leaf-ospf)# vrf member tenant t1 vrf v1

```

```

apicl(config-leaf-ospf-vrf)# area 0.0.0.0 loopback 40.40.40.1
apicl(config-leaf-ospf-vrf)# exit
apicl(config-leaf-ospf)# exit
apicl(config-leaf)# exit
apicl(config)# leaf 102
apicl(config-leaf)# router ospf default
apicl(config-leaf-ospf)# vrf member tenant t1 vrf v1
apicl(config-leaf-ospf-vrf)# area 0.0.0.0 loopback 60.60.60.1
apicl(config-leaf-ospf-vrf)# exit
apicl(config-leaf-ospf)# exit
apicl(config-leaf)# exit

```

Step 5 Configure the external EPGs.

This example configures the network 192.168.1.0/24 as external network `extnw1` on node 101 and the network 192.168.2.0/24 as external network `extnw2` on node 102.

Example:

```

apicl(config)# tenant t1
apicl(config-tenant)# external-l3 epg extnw1
apicl(config-tenant-l3ext-epg)# vrf member v1
apicl(config-tenant-l3ext-epg)# match ip 192.168.1.0/24
apicl(config-tenant-l3ext-epg)# exit
apicl(config-tenant)# external-l3 epg extnw2
apicl(config-tenant-l3ext-epg)# vrf member v1
apicl(config-tenant-l3ext-epg)# match ip 192.168.2.0/24
apicl(config-tenant-l3ext-epg)# exit
apicl(config-tenant)# exit
apicl(config)# leaf 101
apicl(config-leaf)# vrf context tenant t1 vrf v1
apicl(config-leaf-vrf)# external-l3 epg extnw1
apicl(config-leaf-vrf)# exit
apicl(config-leaf)# exit
apicl(config)# leaf 102
apicl(config-leaf)# vrf context tenant t1 vrf v1
apicl(config-leaf-vrf)# external-l3 epg extnw2
apicl(config-leaf-vrf)# exit
apicl(config-leaf)# exit

```

Step 6 Optional. Configure the route maps.

This example configures a route map for each BGP peer in the inbound and outbound directions.

Example:

Example:

```

apicl(config)# leaf 101
apicl(config-leaf)# template route group match-rule1 tenant t1
apicl(config-route-group)# ip prefix permit 192.168.1.0/24
apicl(config-route-group)# exit
apicl(config-leaf)# template route group match-rule2 tenant t1
apicl(config-route-group)# ip prefix permit 192.168.2.0/24
apicl(config-route-group)# exit
apicl(config-leaf)# vrf context tenant t1 vrf v1
apicl(config-leaf-vrf)# route-map rp1
apicl(config-leaf-vrf-route-map)# match route group match-rule1 order 0
apicl(config-leaf-vrf-route-map-match)# exit
apicl(config-leaf-vrf-route-map)# exit
apicl(config-leaf-vrf)# route-map rp2
apicl(config-leaf-vrf-route-map)# match route group match-rule2 order 0
apicl(config-leaf-vrf-route-map-match)# exit
apicl(config-leaf-vrf-route-map)# exit
apicl(config-leaf-vrf)# exit
apicl(config-leaf)# router bgp 100

```



```

apic1(config-leaf-bgp)# vrf member tenant t1 vrf v1
apic1(config-leaf-bgp-vrf)# neighbor 15.15.15.2
apic1(config-leaf-bgp-vrf-neighbor)# route-map rp1 in
apic1(config-leaf-bgp-vrf-neighbor)# route-map rp2 out
apic1(config-leaf-bgp-vrf-neighbor)# exit
apic1(config-leaf-bgp-vrf)# exit
apic1(config-leaf-bgp)# exit
apic1(config-leaf)# exit

apic1(config)# leaf 102
apic1(config-leaf)# template route group match-rule1 tenant t1
apic1(config-route-group)# ip prefix permit 192.168.1.0/24
apic1(config-route-group)# exit
apic1(config-leaf)# template route group match-rule2 tenant t1
apic1(config-route-group)# ip prefix permit 192.168.2.0/24
apic1(config-route-group)# exit
apic1(config-leaf)# vrf context tenant t1 vrf v1
apic1(config-leaf-vrf)# route-map rp1
apic1(config-leaf-vrf-route-map)# match route group match-rule2 order 0
apic1(config-leaf-vrf-route-map-match)# exit
apic1(config-leaf-vrf-route-map)# exit
apic1(config-leaf-vrf)# route-map rp2
apic1(config-leaf-vrf-route-map)# match route group match-rule1 order 0
apic1(config-leaf-vrf-route-map-match)# exit
apic1(config-leaf-vrf-route-map)# exit
apic1(config-leaf-vrf)# exit
apic1(config-leaf)# router bgp 100
apic1(config-leaf-bgp)# vrf member tenant t1 vrf v1
apic1(config-leaf-bgp-vrf)# neighbor 25.25.25.2
apic1(config-leaf-bgp-vrf-neighbor)# route-map rp2 in
apic1(config-leaf-bgp-vrf-neighbor)# route-map rp1 out
apic1(config-leaf-bgp-vrf-neighbor)# exit
apic1(config-leaf-bgp-vrf)# exit
apic1(config-leaf-bgp)# exit
apic1(config-leaf)# exit

```

Step 7 Create filters (access lists) and contracts to enable the EPGs to communicate.

Example:

```

apic1(config)# tenant t1
apic1(config-tenant)# access-list http-filter
apic1(config-tenant-acl)# match ip
apic1(config-tenant-acl)# match tcp dest 80
apic1(config-tenant-acl)# exit
apic1(config-tenant)# contract httpCtrct
apic1(config-tenant-contract)# scope vrf
apic1(config-tenant-contract)# subject subj1
apic1(config-tenant-contract-subj)# access-group http-filter both
apic1(config-tenant-contract-subj)# exit
apic1(config-tenant-contract)# exit
apic1(config-tenant)# exit

```

Step 8 Configure contracts and associate them with EPGs.

Example:

```

apic1(config)# tenant t1
apic1(config-tenant)# external-13 epg extnw1
apic1(config-tenant-13ext-epg)# vrf member v1
apic1(config-tenant-13ext-epg)# contract provider httpCtrct
apic1(config-tenant-13ext-epg)# exit
apic1(config-tenant)# external-13 epg extnw2
apic1(config-tenant-13ext-epg)# vrf member v1
apic1(config-tenant-13ext-epg)# contract consumer httpCtrct

```

```

apicl(config-tenant-l3ext-epg)# exit
apicl(config-tenant)# exit
apicl(config)#

```

Example: Transit Routing

This example provides a merged configuration for transit routing. The configuration is for a single tenant and VRF, with two L3Outs, on two border leaf switches, that are each connected to separate routers.

```

apicl# configure
apicl(config)# tenant t1
apicl(config-tenant)# vrf context v1
apicl(config-tenant-vrf)# exit
apicl(config-tenant)# exit

apicl(config)# leaf 101
apicl(config-leaf)# vrf context tenant t1 vrf v1
apicl(config-leaf-vrf)# router-id 11.11.11.103
apicl(config-leaf-vrf)# exit
apicl(config-leaf)# interface ethernet 1/3
apicl(config-leaf-if)# vlan-domain member dom1
apicl(config-leaf-if)# no switchport
apicl(config-leaf-if)# vrf member tenant t1 vrf v1
apicl(config-leaf-if)# ip address 12.12.12.3/24
apicl(config-leaf-if)# exit
apicl(config-leaf)# router bgp 100
apicl(config-leaf-bgp)# vrf member tenant t1 vrf v1
apicl(config-leaf-bgp-vrf)# neighbor 15.15.15.2
apicl(config-leaf-bgp-vrf-neighbor)# exit
apicl(config-leaf-bgp-vrf)# exit
apicl(config-leaf-bgp)# exit
apicl(config-leaf)# router ospf default
apicl(config-leaf-ospf)# vrf member tenant t1 vrf v1
apicl(config-leaf-ospf-vrf)# area 0.0.0.0 loopback 40.40.40.1
apicl(config-leaf-ospf-vrf)# exit
apicl(config-leaf-ospf)# exit
apicl(config-leaf)# exit

apicl(config)# leaf 102
apicl(config-leaf)# vrf context tenant t1 vrf v1
apicl(config-leaf-vrf)# router-id 22.22.22.203
apicl(config-leaf-vrf)# exit
apicl(config-leaf)# interface ethernet 1/3
apicl(config-leaf-if)# vlan-domain member dom1
apicl(config-leaf-if)# no switchport
apicl(config-leaf-if)# vrf member tenant t1 vrf v1
apicl(config-leaf-if)# ip address 23.23.23.3/24
apicl(config-leaf-if)# exit
apicl(config-leaf)# router bgp 100
apicl(config-leaf-bgp)# vrf member tenant t1 vrf v1
apicl(config-leaf-bgp-vrf)# neighbor 25.25.25.2/24
apicl(config-leaf-bgp-vrf-neighbor)# exit
apicl(config-leaf-bgp-vrf)# exit
apicl(config-leaf-bgp)# exit
apicl(config-leaf)# router ospf default
apicl(config-leaf-ospf)# vrf member tenant t1 vrf v1
apicl(config-leaf-ospf-vrf)# area 0.0.0.0 loopback 60.60.60.3
apicl(config-leaf-ospf-vrf)# exit
apicl(config-leaf-ospf)# exit
apicl(config-leaf)# exit

```

```
apic1(config)# tenant t1
apic1(config-tenant)# external-l3 epg extnw1
apic1(config-tenant-l3ext-epg)# vrf member v1
apic1(config-tenant-l3ext-epg)# match ip 192.168.1.0/24
apic1(config-tenant-l3ext-epg)# exit
apic1(config-tenant)# external-l3 epg extnw2
apic1(config-tenant-l3ext-epg)# vrf member v1
apic1(config-tenant-l3ext-epg)# match ip 192.168.2.0/24
apic1(config-tenant-l3ext-epg)# exit
apic1(config-tenant)# exit

apic1(config)# leaf 101
apic1(config-leaf)# vrf context tenant t1 vrf v1
apic1(config-leaf-vrf)# external-l3 epg extnw1
apic1(config-leaf-vrf)# exit
apic1(config-leaf)# exit
apic1(config)# leaf 102
apic1(config-leaf)# vrf context tenant t1 vrf v1
apic1(config-leaf-vrf)# external-l3 epg extnw2
apic1(config-leaf-vrf)# exit
apic1(config-leaf)# exit

apic1(config)# leaf 101
apic1(config-leaf)# template route group match-rule1 tenant t1
apic1(config-route-group)# ip prefix permit 192.168.1.0/24
apic1(config-route-group)# exit
apic1(config-leaf)# template route group match-rule2 tenant t1
apic1(config-route-group)# ip prefix permit 192.168.2.0/24
apic1(config-route-group)# exit
apic1(config-leaf)# vrf context tenant t1 vrf v1
apic1(config-leaf-vrf)# route-map rp1
apic1(config-leaf-vrf-route-map)# match route group match-rule1 order 0
apic1(config-leaf-vrf-route-map-match)# exit
apic1(config-leaf-vrf-route-map)# exit
apic1(config-leaf-vrf)# route-map rp2
apic1(config-leaf-vrf-route-map)# match route group match-rule2 order 0
apic1(config-leaf-vrf-route-map-match)# exit
apic1(config-leaf-vrf-route-map)# exit
apic1(config-leaf-vrf)# exit
apic1(config-leaf)# router bgp 100
apic1(config-leaf-bgp)# vrf member tenant t1 vrf v1
apic1(config-leaf-bgp-vrf)# neighbor 15.15.15.2
apic1(config-leaf-bgp-vrf-neighbor)# route-map rp1 in
apic1(config-leaf-bgp-vrf-neighbor)# route-map rp2 out
apic1(config-leaf-bgp-vrf-neighbor)# exit
apic1(config-leaf-bgp-vrf)# exit
apic1(config-leaf-bgp)# exit
apic1(config-leaf)# exit

apic1(config)# leaf 102
apic1(config-leaf)# template route group match-rule1 tenant t1
apic1(config-route-group)# ip prefix permit 192.168.1.0/24
apic1(config-route-group)# exit
apic1(config-leaf)# template route group match-rule2 tenant t1
apic1(config-route-group)# ip prefix permit 192.168.2.0/24
apic1(config-route-group)# exit
apic1(config-leaf)# vrf context tenant t1 vrf v1
apic1(config-leaf-vrf)# route-map rp1
apic1(config-leaf-vrf-route-map)# match route group match-rule1 order 0
apic1(config-leaf-vrf-route-map-match)# exit
apic1(config-leaf-vrf-route-map)# exit
apic1(config-leaf-vrf)# route-map rp2
apic1(config-leaf-vrf-route-map)# match route group match-rule2 order 0
apic1(config-leaf-vrf-route-map-match)# exit
```

```

apicl(config-leaf-vrf-route-map)# exit
apicl(config-leaf-vrf)# exit
apicl(config-leaf)# router bgp 100
apicl(config-leaf-bgp)# vrf member tenant t1 vrf v1
apicl(config-leaf-bgp-vrf)# neighbor 25.25.25.2
apicl(config-leaf-bgp-vrf-neighbor)# route-map rp2 in
apicl(config-leaf-bgp-vrf-neighbor)# route-map rp1 out
apicl(config-leaf-bgp-vrf-neighbor)# exit
apicl(config-leaf-bgp-vrf)# exit
apicl(config-leaf-bgp)# exit
apicl(config-leaf)# exit

apicl(config)# tenant t1
apicl(config-tenant)# access-list http-filter
apicl(config-tenant-acl)# match ip
apicl(config-tenant-acl)# match tcp dest 80
apicl(config-tenant-acl)# exit
apicl(config-tenant)# contract httpCtrct
apicl(config-tenant-contract)# scope vrf
apicl(config-tenant-contract)# subject http-subj
apicl(config-tenant-contract-subj)# access-group http-filter both
apicl(config-tenant-contract-subj)# exit
apicl(config-tenant-contract)# exit
apicl(config-tenant)# exit

apicl(config)# tenant t1
apicl(config-tenant)# external-l3 epg extnw1
apicl(config-tenant-l3ext-epg)# vrf member v1
apicl(config-tenant-l3ext-epg)# contract provider httpCtrct
apicl(config-tenant-l3ext-epg)# exit
apicl(config-tenant)# external-l3 epg extnw2
apicl(config-tenant-l3ext-epg)# vrf member v1
apicl(config-tenant-l3ext-epg)# contract consumer httpCtrct
apicl(config-tenant-l3ext-epg)# exit
apicl(config-tenant)# exit
apicl(config)#

```

Configuring Shared Services Using the NX-OS Style CLI

Configuring Shared Layer 3 Out Inter-VRF Leaking Using the NX-OS Style CLI - Named Example

Procedure

	Command or Action	Purpose
Step 1	Enter the configure mode. Example: apicl# configure	
Step 2	Configure the provider Layer 3 Out. Example: apicl(config)# tenant t1_provider apicl(config-tenant)# external-l3 epg l3extInstP-1 l3out T0-o1-L3OUT-1 apicl(config-tenant-l3ext-epg)# vrf member VRF1 apicl(config-tenant-l3ext-epg)# match ip	

	Command or Action	Purpose
	<pre> 192.168.2.0/24 shared apicl(config-tenant-l3ext-epg)# contract provider vzBrCP-1 apicl(config-tenant-l3ext-epg)# exit apicl(config-tenant)# exit apicl(config)# leaf 101 apicl(config-leaf)# vrf context tenant t1_provider vrf VRF1 l3out T0-o1-L3OUT-1 apicl(config-leaf-vrf)# route-map T0-o1-L3OUT-1_shared apicl(config-leaf-vrf-route-map)# ip prefix-list l3extInstP-1 permit 192.168.2.0/24 apicl(config-leaf-vrf-route-map)# match prefix-list l3extInstP-1 apicl(config-leaf-vrf-route-map-match)# exit apicl(config-leaf-vrf-route-map)# exit apicl(config-leaf-vrf)# exit apicl(config-leaf)# exit </pre>	
Step 3	<p>Configure the consumer Layer 3 Out.</p> <p>Example:</p> <pre> apicl(config)# tenant t1_consumer apicl(config-tenant)# external-l3 epg l3extInstP-2 l3out T0-o1-L3OUT-1 apicl(config-tenant-l3ext-epg)# vrf member VRF2 apicl(config-tenant-l3ext-epg)# match ip 199.16.2.0/24 shared apicl(config-tenant-l3ext-epg)# contract consumer vzBrCP-1 imported apicl(config-tenant-l3ext-epg)# exit apicl(config-tenant)# exit apicl(config)# leaf 101 apicl(config-leaf)# vrf context tenant t1_consumer vrf VRF2 l3out T0-o1-L3OUT-1 apicl(config-leaf-vrf)# route-map T0-o1-L3OUT-1_shared apicl(config-leaf-vrf-route-map)# ip prefix-list l3extInstP-2 permit 199.16.2.0/24 apicl(config-leaf-vrf-route-map)# match prefix-list l3extInstP-2 apicl(config-leaf-vrf-route-map-match)# exit apicl(config-leaf-vrf-route-map)# exit apicl(config-leaf-vrf)# exit apicl(config-leaf)# exit apicl(config)# </pre>	

Configuring Shared Layer 3 Out Inter-VRF Leaking Using the NX-OS Style CLI - Implicit Example

Procedure

	Command or Action	Purpose
Step 1	Enter the configure mode. Example: apic1# configure	
Step 2	Configure the provider tenant and VRF. Example: apic1(config)# tenant t1_provider apic1(config-tenant)# vrf context VRF1 apic1(config-tenant-vrf)# exit apic1(config-tenant)# exit	
Step 3	Configure the consumer tenant and VRF. Example: apic1(config)# tenant t1_consumer apic1(config-tenant)# vrf context VRF2 apic1(config-tenant-vrf)# exit apic1(config-tenant)# exit	
Step 4	Configure the contract. Example: apic1(config)# tenant t1_provider apic1(config-tenant)# contract vzBrCP-1 type permit apic1(config-tenant-contract)# scope exportable apic1(config-tenant-contract)# export to tenant t1_consumer apic1(config-tenant-contract)# exit	
Step 5	Configure the provider External Layer 3 EPG. Example: apic1(config-tenant)# external-l3 epg l3extInstP-1 apic1(config-tenant-l3ext-epg)# vrf member VRF1 apic1(config-tenant-l3ext-epg)# match ip 192.168.2.0/24 shared apic1(config-tenant-l3ext-epg)# contract provider vzBrCP-1 apic1(config-tenant-l3ext-epg)# exit apic1(config-tenant)# exit	
Step 6	Configure the provider export map. Example: apic1(config)# leaf 101 apic1(config-leaf)# vrf context tenant	

	Command or Action	Purpose
	<pre>t1_provider vrf VRF1 apicl(config-leaf-vrf)# route-map map1 apicl(config-leaf-vrf-route-map)# ip prefix-list p1 permit 192.168.2.0/24 apicl(config-leaf-vrf-route-map)# match prefix-list p1 apicl(config-leaf-vrf-route-map-match)# exit apicl(config-leaf-vrf-route-map)# exit apicl(config-leaf-vrf)# export map map1 apicl(config-leaf-vrf)# exit apicl(config-leaf)# exit</pre>	
Step 7	<p>Configure the consumer external Layer 3 EPG.</p> <p>Example:</p> <pre>apicl(config)# tenant t1_consumer apicl(config-tenant)# external-l3 epg l3extInstP-2 apicl(config-tenant-l3ext-epg)# vrf member VRF2 apicl(config-tenant-l3ext-epg)# match ip 199.16.2.0/24 shared apicl(config-tenant-l3ext-epg)# contract consumer vzBrCP-1 imported apicl(config-tenant-l3ext-epg)# exit apicl(config-tenant)# exit</pre>	
Step 8	<p>Configure the consumer export map.</p> <p>Example:</p> <pre>apicl(config)# leaf 101 apicl(config-leaf)# vrf context tenant t1_consumer vrf VRF2 apicl(config-leaf-vrf)# route-map map2 apicl(config-leaf-vrf-route-map)# ip prefix-list p2 permit 199.16.2.0/24 apicl(config-leaf-vrf-route-map)# match prefix-list p2 apicl(config-leaf-vrf-route-map-match)# exit apicl(config-leaf-vrf-route-map)# exit apicl(config-leaf-vrf)# export map map2 apicl(config-leaf-vrf)# exit apicl(config-leaf)# exit apicl(config)#</pre>	

Configuring QoS for L3Outs Using the NX-OS Style CLI

Configuring QoS Directly on L3Out Using CLI

This section describes how to configure QoS directly on an L3Out. This is the preferred way of configuring L3Out QoS starting with Cisco APIC Release 4.0(1).

You can configure QoS for L3Out on one of the following objects:

- Switch Virtual Interface (SVI)

- Sub Interface
- Routed Outside

Procedure

Step 1 Configure QoS priorities for a L3Out SVI.

Example:

```
interface vlan 19
  vrf member tenant DT vrf dt-vrf
  ip address 107.2.1.252/24
  description 'SVI19'
  service-policy type qos VrfQos006 // for custom QoS attachment
  set qos-class level6 // for set QoS priority
  exit
```

Step 2 Configure QoS priorities for a sub-interface.

Example:

```
interface ethernet 1/48.10
  vrf member tenant DT vrf inter-tentant-ctx2 l3out L4_E48_inter_tenant
  ip address 210.2.0.254/16
  service-policy type qos vrfQos002
  set qos-class level5
```

Step 3 Configure QoS priorities for a routed outside.

Example:

```
interface ethernet 1/37
  no switchport
  vrf member tenant DT vrf dt-vrf l3out L2E37
  ip address 30.1.1.1/24
  service-policy type qos vrfQos002
  set qos-class level5
  exit
```

Configuring QoS Contract for L3Out Using CLI

This section describes how to configure QoS for L3Outs using Contracts.



Note Starting with Release 4.0(1), we recommend using custom QoS policies for L3Out QoS as described in [Configuring QoS Directly on L3Out Using CLI, on page 475](#) instead.

Procedure

Step 1 Configure the VRF for egress mode and enable policy enforcement to support QoS priority enforcement on the L3Out.

```

apic1# configure
apic1(config)# tenant t1
apic1(config-tenant)# vrf context v1
apic1(config-tenant-vrf)# contract enforce egress
apic1(config-tenant-vrf)# exit
apic1(config-tenant)# exit
apic1(config)#

```

Step 2 Configure QoS.

When creating filters (*access-list*), include the **match dscp** command with target DSCP level.

When configuring contracts, include the QoS class for traffic ingressing on the L3Out. Alternatively, you can define a target DSCP value. QoS policies are supported on either the contract or the subject

VRF enforcement must be ingress, for QoS or custom QoS on L3out interface, VRF enforcement need be egress, only when the QoS classification is going to be done in the contract for traffic between EPG and L3out or L3out to L3out.

Note

If QoS classification is set in the contract and VRF enforcement is egress, then contract QoS classification would override the L3Out interface QoS or Custom QoS classification.

```

apic1(config)# tenant t1
apic1(config-tenant)# access-list http-filter
apic1(config-tenant-acl)# match ip
apic1(config-tenant-acl)# match tcp dest 80
apic1(config-tenant-acl)# match dscp EF
apic1(config-tenant-acl)# exit
apic1(config-tenant)# contract httpCtrct
apic1(config-tenant-contract)# scope vrf
apic1(config-tenant-contract)# qos-class level1
apic1(config-tenant-contract)# subject http-subject
apic1(config-tenant-contract-subj)# access-group http-filter both
apic1(config-tenant-contract-subj)# exit
apic1(config-tenant-contract)# exit
apic1(config-tenant)# exit
apic1(config)#

```

Configuring ACI IP SLAs Using the NX-OS Style CLI

Configuring an IP SLA Monitoring Policy Using the NX-OS-Style CLI

To configure Cisco Application Policy Infrastructure Controller (APIC) to send monitoring probes for a specific SLA type using the NX-OS-style CLI, perform the following steps:

Before you begin

Make sure a tenant is configured.

Procedure

Step 1 Enter the configuration mode.

Example:

```
apicl# configure
```

Step 2 Create a tenant and enter tenant configuration mode, or enter tenant configuration mode for an existing tenant.

Example:

```
apicl(config)# tenant t1
```

Step 3 Create an IP SLA monitoring policy and enter IP SLA policy configuration mode.

Example:

```
apicl(config-tenant)# ipsla-pol ipsla-policy-3
```

Step 4 Configure the monitoring frequency in seconds, which is the interval between sending probes.

Example:

```
apicl(config-ipsla-pol)# sla-frequency 40
```

Step 5 Configure the monitoring probe type.

The possible values for the type are:

- icmp
- l2ping
- tcp sla-port *number*

Only ICMP and TCP are valid for IP SLA in static routes.

Example:

```
apicl(config-ipsla-pol)# sla-type tcp sla-port 90
```

What to do next

To view the IP SLA monitoring policy you just created, enter:

```
show running-config all tenant tenant-name ipsla-pol
```

The following output appears:

```
# Command: show running-config all tenant 99 ipsla-pol
# Time: Tue Mar 19 19:01:06 2019
tenant t1
  ipsla-pol ipsla-policy-3
    sla-detectmultiplier 3
    sla-frequency 40
    sla-type tcp sla-port 90
      sla-port 90
    exit
  exit
exit
```

Configuring an IP-SLA Track Member Using the NX-OS Style CLI

To configure an IP SLA track member using the NX-OS style CLI, perform the following steps:

Before you begin

Make sure a tenant and an IP SLA monitoring policy under the tenant is configured.

Procedure**Step 1** **configure**

Enters configuration mode.

Example:

```
apic1# configure
```

Step 2 **tenant** *tenant-name*

Creates a tenant or enters tenant configuration mode.

Example:

```
apic1(config)# tenant t1
```

Step 3 **track-member** *name* **dst-IPAddr** *ipv4-or-ipv6-address* **l3-out** *name*

Creates a track member with a destination IP address and enters track member configuration mode.

Example:

```
apic1(config-tenant)# )# track-member tm-1 dst-IPAddr 10.10.10.1 l3-out ext-l3-1
```

Step 4 **ipsla-monpol** *name*

Assigns an IP SLA monitoring policy to the track member.

Example:

```
apic1(config-track-member)# ipsla-monpol ipsla-policy-3
```

Example

The following example shows the commands to configure an IP SLA track member.

```
apic1# configure
apic1(config)# tenant t1
apic1(config-tenant)# )# track-member tm-1 dst-IPAddr 10.10.10.1 l3-out ext-l3-1
apic1(config-track-member)# ipsla-monpol ipsla-policy-3
```

What to do next

To view the track member configuration you just created, enter:

```
show running-config all tenant tenant-name track-member name
```

The following output appears:

```
# Command: show running-config all tenant 99 track-member tm-1
# Time: Tue Mar 19 19:01:06 2019
tenant t1
  track-member tm-1 10.10.10.1 l3-out ext-l3-1
```

```

    ipsla-monpol slaICMPProbe
    exit
    exit

```

Configuring an IP-SLA Track List Using the NX-OS Style CLI

To configure an IP SLA track list using the NX-OS style CLI, perform the following steps:

Before you begin

Make sure a tenant, an IP SLA monitoring policy, and at least one track member under the tenant is configured.

Procedure

Step 1 **configure**

Enters configuration mode.

Example:

```
apicl# configure
```

Step 2 **tenant *tenant-name***

Creates a tenant or enters tenant configuration mode.

Example:

```
apicl(config)# tenant t1
```

Step 3 **track-list *name* { percentage [percentage-down | percentage-up] *number* | weight [weight-down | weight-up] *number* }**

Creates a track list with percentage or weight threshold settings and enters track list configuration mode.

Example:

```
apicl(config-tenant)# )# track-list t1-1 percentage percentage-down 50 percentage-up 100
```

Step 4 **track-member *name***

Assigns an existing track member to the track list.

Example:

```
apicl(config-track-list)# track-member tm-1
```

Example

The following example shows the commands to configure an IP SLA track list.

```

apicl# configure
    apicl(config)# tenant t1
    apicl(config-tenant)# )# track-list t1-1 percentage percentage-down 50 percentage-up
100
    apicl(config-track-list)# track-member tm1

```

What to do next

To view the track member configuration you just created, enter:

```
show running-config all tenant tenant-name track-member name
```

The following output appears:

```
# Command: show running-config all tenant 99 track-list t1-1
# Time: Tue Mar 19 19:01:06 2019
tenant t1
  track-list t1-1 percentage percentage-down 50 percentage-up 100
  track-member tm-1 weight 10
  exit
exit
```

Associating a Track List with a Static Route Using the NX-OS Style CLI

To associate an IP SLA track list with a static route using the NX-OS style CLI, perform the following steps:

Before you begin

Make sure a tenant, a VRF, and a track list under the tenant is configured.

Procedure**Step 1** **configure**

Enters configuration mode.

Example:

```
apic1# configure
```

Step 2 **leaf *id* or *leaf-name***

Selects a leaf switch and enter the leaf switch configuration mode.

Example:

```
apic1(config)# leaf 102
```

Step 3 **vrf context *tenant name vrf name***

Selects a VRF context and enters the VRF configuration mode.

Example:

```
apic1(config-leaf)# )# vrf context tenant 99 vrf default
```

Step 4 **ip route *ip-address next-hop-ip-address route-prefix bfd ip-trackList name***

Assigns an existing track list to the static route.

Example:

```
apic1(config-leaf-vrf)# ip route 10.10.10.1/4 20.20.20.8 10 bfd ip-trackList t1-1
```

Example

The following example shows the commands to associate an IP SLA track list with a static route.

```
apicl# configure
  apicl(config)# leaf 102
  apicl(config-leaf)# )# vrf context tenant 99 vrf default
  apicl(config-leaf-vrf)# ip route 10.10.10.1/4 20.20.20.8 10 bfd ip-trackList tl-1
```

Associating a Track List with a Next Hop Profile Using the NX-OS Style CLI

To associate an IP SLA track list with a next hop profile using the NX-OS style CLI, perform the following steps:

Before you begin

Make sure a tenant, a VRF, and a track list under the tenant is configured.

Procedure**Step 1** **configure**

Enters configuration mode.

Example:

```
apicl# configure
```

Step 2 **leaf *id* or *leaf-name***

Selects a leaf switch and enter the leaf switch configuration mode.

Example:

```
apicl(config)# leaf 102
```

Step 3 **vrf context *tenant name* vrf *name***

Selects a VRF context and enters the VRF configuration mode.

Example:

```
apicl(config-leaf)# )# vrf context tenant 99 vrf default
```

Step 4 **ip route *ip-address next-hop-ip-address route-prefix* bfd *nh-ip-trackList name***

Assigns an existing track list to the next hop.

Example:

```
apicl(config-leaf-vrf)# ip route 10.10.10.1/4 20.20.20.8 10 bfd nh-trackList tl-1
```

Example

The following example shows the commands to associate an IP SLA track list with a next hop profile.

```

apic1# configure
  apic1(config)# leaf 102
  apic1(config-leaf)# )# vrf context tenant 99 vrf default
  apic1(config-leaf-vrf)# ip route 10.10.10.1/4 20.20.20.8 10 bfd nh-ip-trackList t1-1

```

Viewing Track List and Track Member Status Using the CLI

You can display IP SLA track list and track member status.

Procedure

	Command or Action	Purpose
Step 1	show track brief Example: switch# show track brief	Displays the status of all track lists and track members.

Example

```

switch# show track brief
TrackId  Type      Instance  Parameter      State  Last Change
97       IP SLA    2034     reachability   up     2019-03-20T14:08:34.127-07:00
98       IP SLA    2160     reachability   up     2019-03-20T14:08:34.252-07:00
99       List      ---      percentage     up     2019-03-20T14:08:45.494-07:00
100      List      ---      percentage     down   2019-03-20T14:08:45.039-07:00
101      List      ---      percentage     down   2019-03-20T14:08:45.040-07:00
102      List      ---      percentage     up     2019-03-20T14:08:45.495-07:00
103      IP SLA    2040     reachability   up     2019-03-20T14:08:45.493-07:00
104      IP SLA    2887     reachability   down   2019-03-20T14:08:45.104-07:00
105      IP SLA    2821     reachability   up     2019-03-20T14:08:45.494-07:00
1        List      ---      percentage     up     2019-03-20T14:08:39.224-07:00
2        List      ---      weight         down   2019-03-20T14:08:33.521-07:00
3        IP SLA    2412     reachability   up     2019-03-20T14:08:33.983-07:00
26       IP SLA    2320     reachability   up     2019-03-20T14:08:33.988-07:00
27       IP SLA    2567     reachability   up     2019-03-20T14:08:33.987-07:00
28       IP SLA    2598     reachability   up     2019-03-20T14:08:33.990-07:00
29       IP SLA    2940     reachability   up     2019-03-20T14:08:33.986-07:00
30       IP SLA    2505     reachability   up     2019-03-20T14:08:38.915-07:00
31       IP SLA    2908     reachability   up     2019-03-20T14:08:33.990-07:00
32       IP SLA    2722     reachability   up     2019-03-20T14:08:33.992-07:00
33       IP SLA    2753     reachability   up     2019-03-20T14:08:38.941-07:00
34       IP SLA    2257     reachability   up     2019-03-20T14:08:33.993-07:00

```

Viewing Track List and Track Member Detail Using the CLI

You can display IP SLA track list and track member detail.

Procedure

	Command or Action	Purpose
Step 1	show track [<i>number</i>] more Example:	Displays the detail of all track lists and track members.

	Command or Action	Purpose
	switch# show track more	

Example

```

switch# show track | more
Track 4
  IP SLA 2758
  reachability is down
  1 changes, last change 2019-03-12T21:41:34.729+00:00
  Tracked by:
    Track List 3
    Track List 5

Track 3
  List Threshold percentage
  Threshold percentage is down
  1 changes, last change 2019-03-12T21:41:34.700+00:00
  Threshold percentage up 1% down 0%
  Tracked List Members:
    Object 4 (50)% down
    Object 6 (50)% down
  Attached to:
    Route prefix 172.16.13.0/24

Track 5
  List Threshold percentage
  Threshold percentage is down
  1 changes, last change 2019-03-12T21:41:34.710+00:00
  Threshold percentage up 1% down 0%
  Tracked List Members:
    Object 4 (100)% down
  Attached to:
    Nexthop Addr 12.12.12.2/32

Track 6
  IP SLA 2788
  reachability is down
  1 changes, last change 2019-03-14T21:34:26.398+00:00
  Tracked by:
    Track List 3
    Track List 7

Track 20
  List Threshold percentage
  Threshold percentage is up
  4 changes, last change 2019-02-21T14:04:21.920-08:00
  Threshold percentage up 100% down 32%
  Tracked List Members:
    Object 4 (20)% up
    Object 5 (20)% up
    Object 6 (20)% up
    Object 3 (20)% up
    Object 9 (20)% up
  Attached to:
    Route prefix 88.88.88.0/24
    Route prefix 5000:8:1:14::/64
    Route prefix 5000:8:1:2::/64
    Route prefix 5000:8:1:1::/64

```

In this example, Track 4 is a track member identified by the IP SLA ID and by the track lists in the **Tracked by:** field.

Track 3 is a track list identified by the threshold information and the track member in the **Track List Members** field.

Track 20 is a track list that is currently reachable (up) and shows the static routes to which it is associated.

Configuring HSRP Using the NX-OS Style CLI

Configuring HSRP in Cisco APIC Using Inline Parameters in NX-OS Style CLI

HSRP is enabled when the leaf switch is configured.

Before you begin

- The tenant and VRF configured.
- VLAN pools must be configured with the appropriate VLAN range defined and the appropriate Layer 3 domain created and attached to the VLAN pool.
- The Attach Entity Profile must also be associated with the Layer 3 domain.
- The interface profile for the leaf switches must be configured as required.

Procedure

	Command or Action	Purpose
Step 1	configure Example: apicl# configure	Enters configuration mode.
Step 2	Configure HSRP by creating inline parameters. Example: apicl(config)# leaf 101 apicl(config-leaf)# interface ethernet 1/17 apicl(config-leaf-if)# hsrp version 1 apicl(config-leaf-if)# hsrp use-bia apicl(config-leaf-if)# hsrp delay minimum 30 apicl(config-leaf-if)# hsrp delay reload 30 apicl(config-leaf-if)# hsrp 10 ipv4 apicl(config-if-hsrp)# ip 182.16.1.2 apicl(config-if-hsrp)# ip 182.16.1.3 secondary apicl(config-if-hsrp)# ip 182.16.1.4 secondary apicl(config-if-hsrp)# mac-address 5000.1000.1060	

	Command or Action	Purpose
	<pre> apic1(config-if-hsrp)# timers 5 18 apic1(config-if-hsrp)# priority 100 apic1(config-if-hsrp)# preempt apic1(config-if-hsrp)# preempt delay minimum 60 apic1(config-if-hsrp)# preempt delay reload 60 apic1(config-if-hsrp)# preempt delay sync 60 apic1(config-if-hsrp)# authentication none apic1(config-if-hsrp)# authentication simple apic1(config-if-hsrp)# authentication md5 apic1(config-if-hsrp)# authentication-key <mypassword> apic1(config-if-hsrp)# authentication-key-timeout <timeout> </pre>	

Configuring HSRP in Cisco APIC Using Template and Policy in NX-OS Style CLI

HSRP is enabled when the leaf switch is configured.

Before you begin

- The tenant and VRF configured.
- VLAN pools must be configured with the appropriate VLAN range defined and the appropriate Layer 3 domain created and attached to the VLAN pool.
- The Attach Entity Profile must also be associated with the Layer 3 domain.
- The interface profile for the leaf switches must be configured as required.

Procedure

	Command or Action	Purpose
Step 1	<p>configure</p> <p>Example:</p> <pre> apic1# configure </pre>	Enters configuration mode.
Step 2	<p>Configure HSRP policy templates.</p> <p>Example:</p> <pre> apic1(config)# leaf 101 apic1(config-leaf)# template hsrp interface-policy hsrp-intfPol1 tenant t9 apic1(config-template-hsrp-if-pol)# hsrp use-bia apic1(config-template-hsrp-if-pol)# hsrp delay minimum 30 apic1(config-template-hsrp-if-pol)# hsrp </pre>	

	Command or Action	Purpose
	<pre> delay reload 30 apicl(config)# leaf 101 apicl(config-leaf)# template hsrp group-policy hsrp-groupPoll tenant t9 apicl(config-template-hsrp-group-pol)# timers 5 18 apicl(config-template-hsrp-group-pol)# priority 100 apicl(config-template-hsrp-group-pol)# preempt apicl(config-template-hsrp-group-pol)# preempt delay minimum 60 apicl(config-template-hsrp-group-pol)# preempt delay reload 60 apicl(config-template-hsrp-group-pol)# preempt delay sync 60 </pre>	
Step 3	<p>Use the configured policy templates</p> <p>Example:</p> <pre> apicl(config)# leaf 101 apicl(config-leaf)# interface ethernet 1/17 apicl(config-leaf-if)# hsrp version 1 apicl(config-leaf-if)# inherit hsrp interface-policy hsrp-intfPoll apicl(config-leaf-if)# hsrp 10 ipv4 apicl(config-if-hsrp)# ip 182.16.1.2 apicl(config-if-hsrp)# ip 182.16.1.3 secondary apicl(config-if-hsrp)# ip 182.16.1.4 secondary apicl(config-if-hsrp)# mac-address 5000.1000.1060 apicl(config-if-hsrp)# inherit hsrp group-policy hsrp-groupPoll </pre>	

Configuring Cisco ACI GOLF Using the NX-OS Style CLI

Recommended Shared GOLF Configuration Using the NX-OS Style CLI

Use the following steps to configure route maps and BGP to avoid cross-VRF traffic issues when sharing GOLF connections with a DCI between multiple APIC sites that are managed by Multi-Site.

Procedure

Step 1 Configure the inbound route map

Example:

Inbound peer policy to attach community:

```
route-map multi-site-in permit 10
  set community 1:1 additive
```

Step 2 Configure the outbound peer policy to filter routes based on the community in the inbound peer policy.

Example:

```
ip community-list standard test-com permit 1:1
route-map multi-site-out deny 10
  match community test-com exact-match
route-map multi-site-out permit 11
```

Step 3 Configure the outbound peer policy to filter the community towards the WAN.

Example:

```
ip community-list standard test-com permit 1:1
route-map multi-site-wan-out permit 11
  set comm-list test-com delete
```

Step 4 Configure BGP.

Example:

```
router bgp 1
  address-family l2vpn evpn
  neighbor 11.11.11.11 remote-as 1
  update-source loopback0
  address-family l2vpn evpn
  send-community both
  route-map multi-site-in in
neighbor 13.0.0.2 remote-as 2
  address-family l2vpn evpn
  send-community both
  route-map multi-site-out out
```

Cisco ACI GOLF Configuration Example, Using the NX-OS Style CLI

These examples show the CLI commands to configure GOLF Services, which uses the BGP EVPN protocol over OSPF for WAN routers that are connected to spine switches.

Configuring the infra Tenant for BGP EVPN

The following example shows how to configure the infra tenant for BGP EVPN, including the VLAN domain, VRF, Interface IP addressing, and OSPF:

```

configure
vlan-domain evpn-dom dynamic
exit
spine 111
    # Configure Tenant Infra VRF overlay-1 on the spine.
    vrf context tenant infra vrf overlay-1
        router-id 10.10.3.3
        exit

    interface ethernet 1/33
        vlan-domain member golf_dom
        exit
    interface ethernet 1/33.4
        vrf member tenant infra vrf overlay-1
        mtu 1500
        ip address 5.0.0.1/24
        ip router ospf default area 0.0.0.150
        exit
    interface ethernet 1/34
        vlan-domain member golf_dom
        exit
    interface ethernet 1/34.4
        vrf member tenant infra vrf overlay-1
        mtu 1500
        ip address 2.0.0.1/24
        ip router ospf default area 0.0.0.200
        exit

    router ospf default
        vrf member tenant infra vrf overlay-1
        area 0.0.0.150 loopback 10.10.5.3
        area 0.0.0.200 loopback 10.10.4.3
        exit
    exit

```

Configuring BGP on the Spine Node

The following example shows how to configure BGP to support BGP EVPN:

```

Configure
spine 111
router bgp 100
    vrf member tenant infra vrf overlay- 1
        neighbor 10.10.4.1 evpn
            label golf_aci
            update-source loopback 10.10.4.3
            remote-as 100
            exit
        neighbor 10.10.5.1 evpn
            label golf_aci2
            update-source loopback 10.10.5.3
            remote-as 100
            exit
    exit
exit

```

Configuring a Tenant for BGP EVPN

The following example shows how to configure a tenant for BGP EVPN, including a gateway subnet which will be advertised through a BGP EVPN session:

```
configure
tenant sky
  vrf context vrf_sky
  exit
  bridge-domain bd_sky
  vrf member vrf_sky
  exit
  interface bridge-domain bd_sky
  ip address 59.10.1.1/24
  exit
  bridge-domain bd_sky2
  vrf member vrf_sky
  exit
  interface bridge-domain bd_sky2
  ip address 59.11.1.1/24
  exit
  exit
```

Configuring the BGP EVPN Route Target, Route Map, and Prefix EPG for the Tenant

The following example shows how to configure a route map to advertise bridge-domain subnets through BGP EVPN.

```
configure
spine 111
  vrf context tenant sky vrf vrf_sky
  address-family ipv4 unicast
  route-target export 100:1
  route-target import 100:1
  exit

  route-map rmap
  ip prefix-list p1 permit 11.10.10.0/24
  match bridge-domain bd_sky
  exit
  match prefix-list p1
  exit

  evpn export map rmap label golf_aci

  route-map rmap2
  match bridge-domain bd_sky
  exit
  match prefix-list p1
  exit
  exit

  evpn export map rmap label golf_aci2

external-l3 epg l3_sky
  vrf member vrf_sky
  match ip 80.10.1.0/24
  exit
```

Enabling Distributing BGP EVPN Type-2 Host Routes to a DCIG Using the NX-OS Style CLI

Procedure

	Command or Action	Purpose
Step 1	<p>Configure distributing EVPN type-2 host routes to a DCIG with the following commands in the BGP address family configuration mode.</p> <p>Example:</p> <pre>apicl(config)# leaf 101 apicl(config-leaf)# template bgp address-family bgpAfl tenant bgp_t1 apicl(config-bgp-af)# distance 250 240 230 apicl(config-bgp-af)# host-rt-enable apicl(config-bgp-af)# exit</pre>	<p>This template will be available on all nodes where tenant bgp_t1 has a VRF deployment. To disable distributing EVPN type-2 host routes, enter the no host-rt-enable command.</p>



APPENDIX **C**

Performing Tasks Using REST API

- [Part I: Layer 3 Configuration, on page 493](#)
- [Part II: External Routing \(L3Out\) Configuration, on page 518](#)

Part I: Layer 3 Configuration

Configuring Common Pervasive Gateway Using REST API

Configuring Common Pervasive Gateway Using the REST API

Before you begin

- The tenant, VRF, and bridge domain are created.

Procedure

Configure common pervasive gateway.

In the following example REST API XML, the bolded text is relevant to configuring a common pervasive gateway.

Example:

```
<?xml version="1.0" encoding="UTF-8"?>
<!-- api/policymgr/mo/.xml -->
<polUni>
  <fvTenant name="test">
    <fvCtx name="test"/>

    <fvBD name="test" vmac="12:34:56:78:9a:bc">
      <fvRsCtx tnFvCtxName="test"/>
      <!-- Primary address -->
      <fvSubnet ip="192.168.15.254/24" preferred="yes"/>
      <!-- Virtual address -->
      <fvSubnet ip="192.168.15.1/24" virtual="yes"/>
    </fvBD>
  </fvTenant>
</polUni>
```

```

    <fvAp name="test">
      <fvAEPg name="web">
        <fvRsBd tnFvBDName="test"/>
        <fvRsPathAtt tDn="topology/pod-1/paths-101/pathep-[eth1/3]" encap="vlan-1002"/>
      </fvAEPg>
    </fvAp>
  </fvTenant>
</polUni>

```

Configuring IP Aging Using REST API

Configuring IP Aging Using the REST API

This section explains how to enable and disable the IP aging policy using the REST API.

Procedure

Step 1 To enable the IP aging policy:

Example:

```

<epIpAgingP adminSt="enabled" descr="" dn="uni/infra/ipAgingP-default" name="default"
ownerKey="" ownerTag=""/>

```

Step 2 To disable the IP aging policy:

Example:

```

<epIpAgingP adminSt="disabled" descr="" dn="uni/infra/ipAgingP-default" name="default"
ownerKey="" ownerTag=""/>

```

What to do next

To specify the interval used for tracking IP addresses on endpoints, create an Endpoint Retention policy by sending a post with XML such as the following example:

```

<fvEpRetPol bounceAgeIntvl="630" bounceTrig="protocol"
holdIntvl="350" lcOwn="local" localEpAgeIntvl="900" moveFreq="256"
name="EndpointPoll" remoteEpAgeIntvl="350"/>

```

Configuring a Static Route on a Bridge Domain Using REST API

Configuring a Static Route on a Bridge Domain Using the REST API

- When creating the subnet for the static route, it is configured under the EPG (fvSubnet object under fvAEPg), associated with the pervasive BD (fvBD), not the BD itself.
- The subnet mask must be /32 (/128 for IPv6) pointing to one IP address or one endpoint. It is contained in the EPG associated with the pervasive BD.

Before you begin

The tenant, VRF, BD, and EPG have been created.

Procedure

To configure a static route for the BD used in a pervasive gateway, enter a post such as the following example:

Example:

```
<fvAEPg name="ep1">
  <fvRsBd tnFvBDName="bd1"/>
    <fvSubnet ip="2002:0db8:85a3:0000:0000:8a2e:0370:7344/128"
ctrl="no-default-gateway" >
      <fvEpReachability>
        <ipNextHopEpP nhAddr="2001:0db8:85a3:0000:0000:8a2e:0370:7343/128" />
      </fvEpReachability>
    </fvSubnet>
  </fvAEPg>
```

Configuring IPv6 Neighbor Discovery Using REST API

Creating the Tenant, VRF, and Bridge Domain with IPv6 Neighbor Discovery on the Bridge Domain Using the REST API

Procedure

Create a tenant, VRF, bridge domain with a neighbor discovery interface policy and a neighbor discovery prefix policy.

Example:

```
<fvTenant descr="" dn="uni/tn-ExampleCorp" name="ExampleCorp" ownerKey="" ownerTag="">
  <ndIfPol name="NDPol001" ctrl="managed-cfg" descr="" hopLimit="64" mtu="1500"
nsIntvl="1000" nsRetries="3" ownerKey="" ownerTag="" raIntvl="600" raLifetime="1800"
reachableTime="0" retransTimer="0"/>
  <fvCtx descr="" knwMcastAct="permit" name="pvn1" ownerKey="" ownerTag=""
pcEnfPref="enforced">
    </fvCtx>
  <fvBD arpFlood="no" descr="" mac="00:22:BD:F8:19:FF" multiDstPktAct="bd-flood" name="bd1"
ownerKey="" ownerTag="" unicastRoute="yes" unkMacUcastAct="proxy" unkMcastAct="flood">
    <fvRsBDToNDP tnNdIfPolName="NDPol001"/>
    <fvRsCtx tnFvCtxName="pvn1"/>
    <fvSubnet ctrl="nd" descr="" ip="34::1/64" name="" preferred="no" scope="private">
      <fvRsNdPfxPol tnNdPfxPolName="NDPfxPol001"/>
    </fvSubnet>
    <fvSubnet ctrl="nd" descr="" ip="33::1/64" name="" preferred="no" scope="private">
      <fvRsNdPfxPol tnNdPfxPolName="NDPfxPol002"/>
    </fvSubnet>
  </fvBD>
  <ndPfxPol ctrl="auto-cfg,on-link" descr="" lifetime="1000" name="NDPfxPol001" ownerKey=""
ownerTag="" prefLifetime="1000"/>
  <ndPfxPol ctrl="auto-cfg,on-link" descr="" lifetime="4294967295" name="NDPfxPol002">
```

```
ownerKey="" ownerTag="" prefLifetime="4294967295"/>
</fvTenant>
```

Note

If you have a public subnet when you configure the routed outside, you must associate the bridge domain with the outside configuration.

Configuring an IPv6 Neighbor Discovery Interface Policy with RA on a Layer 3 Interface Using the REST API

Procedure

Configure an IPv6 neighbor discovery interface policy and associate it with a Layer 3 interface:

The following example displays the configuration in a non-VPC set up.

Example:

```
<fvTenant dn="uni/tn-ExampleCorp" name="ExampleCorp">
  <ndIfPol name="NDPol001" ctrl="managed-cfg" hopLimit="64" mtu="1500" nsIntvl="1000"
  nsRetries="3" raIntvl="600" raLifetime="1800" reachableTime="0" retransTimer="0"/>
  <fvCtx name="pvn1" pcEnfPref="enforced">
    </fvCtx>
    <l3extOut enforceRtctrl="export" name="l3extOut001">
      <l3extRsEctx tnFvCtxName="pvn1"/>
      <l3extLNodeP name="lnodeP001">
        <l3extRsNodeL3OutAtt rtrId="11.11.205.1" rtrIdLoopBack="yes"
        tDn="topology/pod-2/node-2011"/>
        <l3extLIIfP name="lifP001">
          <l3extRsPathL3OutAtt addr="2001:20:21:22::2/64" ifInstT="l3-port" llAddr="::"
          mac="00:22:BD:F8:19:FF" mode="regular" mtu="inherit"
          tDn="topology/pod-2/paths-2011/pathep-[eth1/1]">
            <ndPfxP>
              <ndRsPfxPToNdPfxPol tnNdPfxPolName="NDPfxPol001"/>
            </ndPfxP>
          </l3extRsPathL3OutAtt>
        <l3extRsNdIfPol tnNdIfPolName="NDPol001"/>
      </l3extLIIfP>
    </l3extLNodeP>
  <l3extInstP name="instp"/>
</l3extOut>
<ndPfxPol ctrl="auto-cfg,on-link" descr="" lifetime="1000" name="NDPfxPol001" ownerKey=""
ownerTag="" prefLifetime="1000"/>
</fvTenant>
```

Note

For VPC ports, ndPfxP must be a child of l3extMember instead of l3extRsNodeL3OutAtt. The following code snippet shows the configuration in a VPC setup.

```
<l3extLNodeP name="lnodeP001">
<l3extRsNodeL3OutAtt rtrId="11.11.205.1" rtrIdLoopBack="yes" tDn="topology/pod-2/node-2011"/>
<l3extRsNodeL3OutAtt rtrId="12.12.205.1" rtrIdLoopBack="yes" tDn="topology/pod-2/node-2012"/>
```

```

<l3extLifP name="lifP002">
  <l3extRsPathL3OutAtt addr="0.0.0.0" encap="vlan-205" ifInstT="ext-svi" llAddr="::"
mac="00:22:BD:F8:19:FF" mode="regular" mtu="inherit"
tDn="topology/pod-2/protopaths-2011-2012/pathep-[vpc7]" >
  <l3extMember addr="2001:20:25:1::1/64" descr="" llAddr="::" name="" nameAlias=""
side="A">
    <ndPfxP >
      <ndRsPfxPToNdPfxPol tnNdPfxPolName="NDPfxPol001"/>
    </ndPfxP>
  </l3extMember>
  <l3extMember addr="2001:20:25:1::2/64" descr="" llAddr="::" name="" nameAlias=""
side="B">
    <ndPfxP >
      <ndRsPfxPToNdPfxPol tnNdPfxPolName="NDPfxPol001"/>
    </ndPfxP>
  </l3extMember>
</l3extRsPathL3OutAtt>
<l3extRsNdIfPol tnNdIfPolName="NDPol001"/> </l3extLifP>
</l3extLNodeP>

```

Configuring Neighbor Discovery Duplicate Address Detection Using the REST API

Procedure

- Step 1** Disable the Neighbor Discovery Duplicate Address Detection process for a subnet by changing the value of the `ipv6Dad` entry for that subnet to **disabled**.

The following example shows how to set the Neighbor Discovery Duplicate Address Detection entry for the 2001:DB8:A::11/64 subnet to **disabled**:

Note

In the following REST API example, long single lines of text are broken up with the \ character to improve readability.

Example:

```

<l3extRsPathL3OutAtt addr="2001:DB8:A::2/64" autostate="enabled" \
childAction="" descr="" encap="vlan-1035" encapScope="local" \
ifInstT="ext-svi" ipv6Dad="enabled" llAddr=": : " \
mac="00:22:BD:F8:19:DD" mtu="inherit" \
rn="rspathL3OutAtt-[topology/pod-1/paths-105/pathep-[eth1/1]]" \
status="" tDn="topology/pod-1/paths-105/pathep-[eth1/1]" >
  <l3extIp addr="2001:DB8:A::11/64" childAction="" descr="" \
  ipv6Dad="disabled" name="" nameAlias="" \
  rn="addr-[2001:DB8:A::11/64]" status=""/>
</l3extRsPathL3OutAtt>
</l3extLifP>
</l3extLNodeP>

```

Step 2 Enter the **show ipv6 int** command on the leaf switch to verify that the configuration was pushed out correctly to the leaf switch. For example:

```
swtb23-leaf5# show ipv6 int vrf icmpv6:v1
IPv6 Interface Status for VRF "icmpv6:v1" (9)

vlan2, Interface status: protocol-up/link-up/admin-up, iod: 73
if_mode: ext
IPv6 address:
  2001:DB8:A::2/64 [VALID] [PREFERRED]
  2001:DB8:A::11/64 [VALID] [dad-disabled]
IPv6 subnet: 2001:DB8:A::/64
IPv6 link-local address: fe80::863d:c6ff:fe9f:eb8b/10 (Default) [VALID]
```

Configuring Microsoft NLB Using REST API

Configuring Microsoft NLB in Unicast Mode Using the REST API

Procedure

To configure Microsoft NLB in unicast mode, send a post with XML such as the following example:

Example:

```
https://apic-ip-address/api/node/mo/uni/.xml
<polUni>
  <fvTenant name="tn2" >
    <fvCtx name="ctx1"/>
    <fvBD name="bd2">
      <fvRsCtx tnFvCtxName="ctx1" />
    </fvBD>
    <fvAp name = "ap1">
      <fvAEPg name = "ep1">
        <fvRsBd tnFvBDName = "bd2"/>
        <fvSubnet ip="10.0.1.1/32" scope="public" ctrl="no-default-gateway">
          <fvEpNlb mac="12:21:21:35" mode="mode-uc"/>
        </fvSubnet>
      </fvAEPg>
    </fvAp>
  </fvTenant>
</polUni>
```

Configuring Microsoft NLB in Multicast Mode Using the REST API

Procedure

To configure Microsoft NLB in multicast mode, send a post with XML such as the following example:

Example:

```

https://apic-ip-address/api/node/mo/uni/.xml
<polUni>
  <fvTenant name="tn2" >
    <fvCtx name="ctx1"/>
    <fvBD name="bd2">
      <fvRsCtx tnFvCtxName="ctx1" />
    </fvBD>
    <fvAp name = "ap1">
      <fvAEPg name = "ep1">
        <fvRsBd tnFvBDName = "bd2"/>
        <fvSubnet ip="2001:0db8:85a3:0000:0000:8a2e:0370:7344/128" scope="public"
ctrl="no-default-gateway">
          <fvEpNlb mac="03:21:21:35" mode="mode-mcast--static"/>
        </fvSubnet>
        <fvRsPathAtt tDn="topology/pod-1/paths-101/pathep-[eth1/6]" encap="vlan-911"
>
          <fvNlbStaticGroup mac = "03:21:21:35" />
        </fvRsPathAtt>
      </fvAEPg>
    </fvAp>
  </fvTenant>
</polUni>

```

Configuring Microsoft NLB in IGMP Mode Using the REST API

Procedure

To configure Microsoft NLB in IGMP mode, send a post with XML such as the following example:

Example:

```

https://apic-ip-address/api/node/mo/uni/.xml
<polUni>
  <fvTenant name="tn2" >
    <fvCtx name="ctx1"/>
    <fvBD name="bd2">
      <fvRsCtx tnFvCtxName="ctx1" />
    </fvBD>
    <fvAp name = "ap1">
      <fvAEPg name = "ep1">
        <fvRsBd tnFvBDName = "bd2"/>
        <fvSubnet ip="10.0.1.3/32" scope="public" ctrl="no-default-gateway">
          <fvEpNlb group ="224.132.18.17" mode="mode-mcast-igmp" />
        </fvSubnet>
      </fvAEPg>
    </fvAp>
  </fvTenant>
</polUni>

```

Configuring IGMP Snooping Using REST API

Configuring and Assigning an IGMP Snooping Policy to a Bridge Domain using the REST API

Procedure

To configure an IGMP Snooping policy and assign it to a bridge domain, send a post with XML such as the following example:

Example:

```
https://apic-ip-address/api/node/mo/uni/.xml
<fvTenant name="mcast_tenant1">
<!-- Create an IGMP snooping template, and provide the options -->
<igmpSnoopPol name="igmp_snp_bd_21"
ver="v2"
adminSt="enabled"
lastMbrIntvl="1"
queryIntvl="125"
rspIntvl="10"
startQueryCnt="2"
startQueryIntvl="31"
/>
<fvCtx name="ip_video"/>
<fvBD name="bd_21">
<fvRsCtx tnFvCtxName="ip_video"/>
<!-- Bind IGMP snooping to a BD -->
<fvRsIgmps n tnIgmpSnoopPolName="igmp_snp_bd_21"/>
</fvBD></fvTenant>
```

This example creates and configures the IGMP Snooping policy, `igmp_snp_bd_12` with the following properties, and binds the IGMP policy, `igmp_snp_bd_21`, to bridge domain, `bd_21`:

- Administrative state is enabled
- Last Member Query Interval is the default 1 second.
- Query Interval is the default 125.
- Query Response interval is the default 10 seconds
- The Start Query Count is the default 2 messages
- The Start Query interval is 31 seconds.
- Setting the Querier Version to v2.

Enabling IGMP Snooping and Multicast on Static Ports Using the REST API

You can enable IGMP snooping and multicast processing on ports that have been statically assigned to an EPG. You can create and assign access groups of users that are permitted or denied access to the IGMP snoop and multicast traffic enabled on those ports.

Procedure

To configure application EPGs with static ports, enable those ports to receive and process IGMP snooping and multicast traffic, and assign groups to access or be denied access to that traffic, send a post with XML such as the following example.

In the following example, IGMP snooping is enabled on leaf 102 interface 1/10 on VLAN 202. Multicast IP addresses 224.1.1.1 and 225.1.1.1 are associated with this port.

Example:

```
https://apic-ip-address/api/node/mo/uni/.xml
<fvTenant name="tenant_A">
  <fvAp name="application">
    <fvAEPg name="epg_A">
      <fvRsPathAtt encap="vlan-202" instrImedcy="immediate" mode="regular"
tDn="topology/pod-1/paths-102/pathep-[eth1/10]">
        <!-- IGMP snooping static group case -->
        <igmpSnoopStaticGroup group="224.1.1.1" source="0.0.0.0"/>
        <igmpSnoopStaticGroup group="225.1.1.1" source="2.2.2.2"/>
      </fvRsPathAtt>
    </fvAEPg>
  </fvAp>
</fvTenant>
```

Enabling Group Access to IGMP Snooping and Multicast using the REST API

After you have enabled IGMP snooping and multicast on ports that have been statically assigned to an EPG, you can then create and assign access groups of users that are permitted or denied access to the IGMP snooping and multicast traffic enabled on those ports.

Procedure

To define the access group, F23broker, send a post with XML such as in the following example.

The example configures access group F23broker, associated with tenant_A, Rmap_A, application_A, epg_A, on leaf 102, interface 1/10, VLAN 202. By association with Rmap_A, the access group F23broker has access to multicast traffic received at multicast address 226.1.1.1/24 and is denied access to traffic received at multicast address 227.1.1.1/24.

Example:

```
<!-- api/node/mo/uni/.xml --> <fvTenant name="tenant_A"> <pimRouteMapPol name="Rmap_A">
<pimRouteMapEntry action="permit" grp="226.1.1.1/24" order="10"/> <pimRouteMapEntry action="deny"
grp="227.1.1.1/24" order="20"/> </pimRouteMapPol> <fvAp name="application_A"> <fvAEPg
name="epg_A"> <fvRsPathAtt encap="vlan-202" instrImedcy="immediate" mode="regular"
tDn="topology/pod-1/paths-102/pathep-[eth1/10]"> <!-- IGMP snooping access group case -->
<igmpSnoopAccessGroup name="F23broker"> <igmpRsSnoopAccessGroupFilterRMap
```

```
tnPimRouteMapPolName="Rmap_A"/> </igmpSnoopAccessGroup> </fvRsPathAtt> </fvAEPg> </fvAp>
</fvTenant>
```

Configuring MLD Snooping Using REST API

Configuring and Assigning an MLD Snooping Policy to a Bridge Domain using the REST API

Procedure

To configure an MLD Snooping policy and assign it to a bridge domain, send a post with XML such as the following example:

Example:

```
https://apic-ip-address/api/node/mo/uni/.xml
<fvTenant name="mldsn">
  <mldSnoopPol adminSt="enabled" ctrl="fast-leave,querier"
name="mldsn-it-fabric-querier-policy" queryIntvl="125"
  rspIntvl="10" startQueryCnt="2" startQueryIntvl="31" status=""/>
  <fvBD name="mldsn-bd3">
    <fvRsMldsn status="" tnMldSnoopPolName="mldsn-it-policy"/>
  </fvBD>
</fvTenant>
```

This example creates and configures the MLD Snooping policy `mldsn` with the following properties, and binds the MLD policy `mldsn-it-fabric-querier-policy` to bridge domain `mldsn-bd3`:

- Fast leave processing is enabled
 - Querier processing is enabled
 - Query Interval is set at 125
 - Max query response time is set at 10
 - Number of initial queries to send is set at 2
 - Time for sending initial queries is set at 31
-

Configuring IP Multicast Using REST API

Configuring Layer 3 Multicast Using REST API

Procedure

- Step 1** Configure a tenant and VRF and enable multicast on a VRF.

Example:

```
<fvTenant dn="uni/tn-PIM_Tenant" name="PIM_Tenant">
  <fvCtx knwMcastAct="permit" name="ctx1">
    <pimCtxP mtu="1500">
      </pimCtxP>
    </fvCtx>
  </fvTenant>
```

Step 2 Configure L3 Out and enable multicast (PIM, IGMP) on the L3 Out.

Example:

```
<l3extOut enforceRtctrl="export" name="l3out-pim_l3out1">
  <l3extRsEctx tnFvCtxName="ctx1"/>
  <l3extLNodeP configIssues="" name="bLeaf-CTX1-101">
    <l3extRsNodeL3OutAtt rtrId="200.0.0.1" rtrIdLoopBack="yes"
tDn="topology/pod-1/node-101"/>
    <l3extLIIfP name="if-PIM_Tenant-CTX1" tag="yellow-green">
      <igmpIfP/>
      <pimIfP>
        <pimRsIfPol tDn="uni/tn-PIM_Tenant/pimifpol-pim_poll"/>
      </pimIfP>
      <l3extRsPathL3OutAtt addr="131.1.1.1/24" ifInstT="l3-port" mode="regular"
mtu="1500" tDn="topology/pod-1/paths-101/pathep-[eth1/46]"/>
    </l3extLIIfP>
  </l3extLNodeP>
  <l3extRsL3DomAtt tDn="uni/l3dom-l3outDom"/>
  <l3extInstP name="l3out-PIM_Tenant-CTX1-1topo" >
  </l3extInstP>
  <pimExtP enabledAf="ipv4-mcast" name="pim"/>
</l3extOut>
```

Step 3 Configure a BD under the tenant and enable multicast and IGMP on the BD.

Example:

```
<fvTenant dn="uni/tn-PIM_Tenant" name="PIM_Tenant">
  <fvBD arpFlood="yes" mcastAllow="yes" multiDstPktAct="bd-flood" name="bd2" type="regular"
unicastRoute="yes" unkMacUcastAct="flood" unkMcastAct="flood">
    <igmpIfP/>
    <fvRsBDToOut tnL3extOutName="l3out-pim_l3out1"/>
    <fvRsCtx tnFvCtxName="ctx1"/>
    <fvRsIgmprsn/>
    <fvSubnet ctrl="" ip="41.1.1.254/24" preferred="no" scope="private" virtual="no"/>
  </fvBD>
</fvTenant>
```

Step 4 Configure an IGMP policy and assign it to the BD.

Example:

```
<fvTenant dn="uni/tn-PIM_Tenant" name="PIM_Tenant">
  <igmpIfPol grpTimeout="260" lastMbrCnt="2" lastMbrRespTime="1" name="igmp_pol"
querierTimeout="255" queryIntvl="125" robustFac="2" rspIntvl="10" startQueryCnt="2"
startQueryIntvl="125" ver="v2">
  </igmpIfPol>
  <fvBD arpFlood="yes" mcastAllow="yes" name="bd2">
    <igmpIfP>
      <igmpRsIfPol tDn="uni/tn-PIM_Tenant/igmpIfPol-igmp_pol"/>
    </igmpIfP>
  </fvBD>
</fvTenant>
```

Step 5 Configure a route map, PIM, and RP policy on the VRF.

Note

When configuring a fabric RP using the REST API, first configure a static RP.

Example:

Configuring a static RP:

```
<fvTenant dn="uni/tn-PIM_Tenant" name="PIM_Tenant">
  <pimRouteMapPol name="rootMap">
    <pimRouteMapEntry action="permit" grp="224.0.0.0/4" order="10" rp="0.0.0.0"
src="0.0.0.0/0"/>
  </pimRouteMapPol>
  <fvCtx knwMcastAct="permit" name="ctx1">
    <pimCtxP ctrl="" mtu="1500">
      <pimStaticRPPol>
        <pimStaticRPEntryPol rpIp="131.1.1.2">
          <pimRPGrpRangePol>
            <rtDmcRsFilterToRtMapPol tDn="uni/tn-PIM_Tenant/rtmap-rootMap"/>
          </pimRPGrpRangePol>
        </pimStaticRPEntryPol>
      </pimStaticRPPol>
    </pimCtxP>
  </fvCtx>
</fvTenant>
```

Configuring a fabric RP:

```
<fvTenant name="t0">
  <pimRouteMapPol name="fabricrp-rtmap">
    <pimRouteMapEntry grp="226.20.0.0/24" order="1" />
  </pimRouteMapPol>
  <fvCtx name="ctx1">
    <pimCtxP ctrl="">
      <pimFabricRPPol status="">
        <pimStaticRPEntryPol rpIp="6.6.6.6">
          <pimRPGrpRangePol>
            <rtDmcRsFilterToRtMapPol tDn="uni/tn-t0/rtmap-fabricrp-rtmap" />
          </pimRPGrpRangePol>
        </pimStaticRPEntryPol>
      </pimFabricRPPol>
    </pimCtxP>
  </fvCtx>
</fvTenant>
```

Step 6 Configure a PIM interface policy and apply it on the L3 Out.

Example:

```
<fvTenant dn="uni/tn-PIM_Tenant" name="PIM_Tenant">
  <pimIfPol authKey="" authT="none" ctrl="" drDelay="60" drPrio="1" helloItvl="30000"
itvl="60" name="pim_poll"/>
  <l3extOut enforceRtctrl="export" name="l3out-pim_l3out1" targetDscp="unspecified">
    <l3extRsEctx tnFvCtxName="ctx1"/>
    <l3extLNodeP name="bLeaf-CTX1-101">
      <l3extRsNodeL3OutAtt rtrId="200.0.0.1" rtrIdLoopBack="yes"
tDn="topology/pod-1/node-101"/>
      <l3extLIfP name="if-SIRI_VPC_src_rcv-CTX1" tag="yellow-green">
        <pimIfP>
          <pimRsIfPol tDn="uni/tn-tn-PIM_Tenant/pimifpol-pim_poll"/>
        </pimIfP>
      </l3extLIfP>
    </l3extLNodeP>
  </l3extOut>
</fvTenant>
```

Step 7 Configure inter-VRF multicast.**Example:**

```
<fvTenant name="t0">
  <pimRouteMapPol name="intervrf" status="">
    <pimRouteMapEntry grp="225.0.0.0/24" order="1" status=""/>
    <pimRouteMapEntry grp="226.0.0.0/24" order="2" status=""/>
    <pimRouteMapEntry grp="228.0.0.0/24" order="3" status="deleted"/>
  </pimRouteMapPol>
  <fvCtx name="ctx1">
    <pimCtxP ctrl="">
      <pimInterVRFPol status="">
        <pimInterVRFEntryPol srcVrfDn="uni/tn-t0/ctx-stig_r_ctx" >
          <rtmcRsFilterToRtMapPol tDn="uni/tn-t0/rmap-intervrf" />
        </pimInterVRFEntryPol>
      </pimInterVRFPol>
    </pimCtxP>
  </fvCtx>
</fvTenant>
```

Configuring Layer 3 IPv6 Multicast Using REST API

Before you begin

- The desired VRF, bridge domains, Layer 3 Out interfaces with IPv6 addresses must be configured to enable PIM6. For Layer 3 Out, for IPv6 multicast to work, an IPv6 loopback address is configured for the node in the logical node profile.
- Basic unicast network must be configured.

Procedure**Step 1** Enable PIM6 on the VRF.**Example:**

```
<fvTenant name="t0">
  <fvCtx name="ctx1" pcEnfPref="unenforced" >
    <pimIPv6CtxP ctrl="" mtu="1500" />
  </fvCtx>
</fvTenant>
```

Step 2 Enable PIM6 on the Layer 3 Out.**Example:**

```
<fvTenant dn="uni/tn-t0" name="t0">
  <l3extOut enforceRtctrl="export" name="bl_l3out_1">
    <pimExtP enabledAf="ipv6-mcast" name="pim"/>
  </l3extOut>
</fvTenant>
```

Step 3 Enable PIM6 on the BD.

Example:

```
<fvTenant name="t0" >
  <fvBD name="BD_VPC5" ipv6McastAllow="yes" >
    <fvRsCtx tnFvCtxName="ctx1" />
    <fvSubnet ip="124:1::ffff:ffff:ffff:0/64" scope="public"/>
  </fvBD>
</fvTenant>
```

Step 4 Configure Static Rendezvous Point.**Example:**

```
<fvTenant name="t0">
  <pimRouteMapPol dn="uni/tn-t0/rtmap-static_101_ipv6" name="static_101_ipv6">
    <pimRouteMapEntry action="permit" grp="ff00::/8" order="1"
rp="2001:0:2001:2001:1:1:1:1/128" src="::"/>
  </pimRouteMapPol>
  <fvCtx name="ctx1" pcEnfPref="unenforced">
    <pimIPv6CtxP ctrl="" mtu="1500">
      <pimStaticRPPol>
        <pimStaticRPEntryPol rpIp="2001:0:2001:2001:1:1:1:1">
          <pimRPGrpRangePol>
            <rtDmcsFilterToRtMapPol tDn="uni/tn-t0/rtmap-static_101_ipv6"/>
          </pimRPGrpRangePol>
        </pimStaticRPEntryPol>
      </pimStaticRPPol>
    </pimIPv6CtxP>
  </fvCtx>
</fvTenant>
```

Step 5 Configure a PIM6 interface policy and apply it on the Layer 3 Out.**Example:**

```
<fvTenant dn="uni/tn-t0" name="t0">
  <l3extOut enforceRtctrl="export" name="bl_l3out_1">
    <l3extLNodeP annotation="" configIssues="" descr="" name="common_np1" nameAlias=""
ownerKey="" ownerTag="" tag="yellow-green" targetDscp="unspecified">
      <l3extLIIfP annotation="" descr="" name="common_intpl_v6" nameAlias="" ownerKey=""
ownerTag="" prio="unspecified" tag="yellow-green">
        <pimIPv6IfP annotation="" descr="" name="" nameAlias="">
          <pimRsV6IfPol annotation="" tDn="uni/tn-common/pimifpol-pimv6_policy"/>
        </pimIPv6IfP>
      </l3extLIIfP>
    </l3extLNodeP>
  </l3extOut>
</fvTenant>
```

Layer 3 IPv6 multicast with PIM6 is enabled.

Configuring Multicast Filtering Using the REST API

You will be configuring multicast filtering at the bridge domain level. Use the procedures in this topic to configure either source filtering or receiver filtering, or both, at the bridge domain level.

Before you begin

- The bridge domain where you will be configuring multicast filtering is already created.
- The bridge domain is a PIM-enabled bridge domain.
- Layer 3 multicast is enabled at the VRF level.

Procedure

- Step 1** If you want to enable multicast *source* filtering on the bridge domain, send a post with XML such as the following example:

Example:

```
<fvBD dn="uni/tn-filter/BD-BD1520" ipv6McastAllow="no" mcastAllow="yes">
  <pimBDP annotation="" descr="" name="" nameAlias="" ownerKey="" ownerTag="">
    <pimBDFilterPol annotation="" descr="" name="" nameAlias="">
      <pimBDSrcFilterPol annotation="" descr="" name="" nameAlias="">
        <rtmcsRsFilterToRtMapPol tDn="uni/tn-filter/rmap-test_src_filter"/>
      </pimBDSrcFilterPol>
    </pimBDFilterPol>
  </pimBDP>
</fvBD>
```

- Step 2** If you want to enable multicast *receiver* filtering on the bridge domain, send a post with XML such as the following example:

Example:

```
<fvBD dn="uni/tn-filter/BD-BD1520" ipv6McastAllow="no" mcastAllow="yes">
  <pimBDP annotation="" descr="" name="" nameAlias="" ownerKey="" ownerTag="">
    <pimBDFilterPol annotation="" descr="" name="" nameAlias="">
      <pimBDDestFilterPol annotation="" descr="" name="" nameAlias="">
        <rtmcsRsFilterToRtMapPol tDn="uni/tn-filter/rmap-Recv_filter"/>
      </pimBDDestFilterPol>
    </pimBDFilterPol>
  </pimBDP>
</fvBD>
```

Note

You can also enable both source and receiver filtering on the same bridge domain by sending a post with XML such as the following example:

```
<fvBD dn="uni/tn-filter/BD-BD1520" ipv6McastAllow="no" mcastAllow="yes">
  <pimBDP annotation="" descr="" name="" nameAlias="" ownerKey="" ownerTag="">
    <pimBDFilterPol annotation="" descr="" name="" nameAlias="">
      <pimBDSrcFilterPol annotation="" descr="" name="" nameAlias="">
        <rtmcsRsFilterToRtMapPol tDn="uni/tn-filter/rmap-test_src_filter"/>
      </pimBDSrcFilterPol>
      <pimBDDestFilterPol annotation="" descr="" name="" nameAlias="">
        <rtmcsRsFilterToRtMapPol tDn="uni/tn-filter/rmap-Recv_filter"/>
      </pimBDDestFilterPol>
    </pimBDFilterPol>
  </pimBDP>
</fvBD>
```

```
</pimBDP>
</fvBD>
```

Configuring Multi-Pod Using REST API

Setting Up Multi-Pod Fabric Using the REST API

Procedure

Step 1 Login to Cisco APIC:

Example:

```
http://<apic-name/ip>:80/api/aaaLogin.xml

data: <aaaUser name="admin" pwd="ins3965!" />
```

Step 2 Configure the TEP pool:

Example:

```
http://<apic-name/ip>:80/api/policymgr/mo/uni/controller.xml

<fabricSetupPol status=''>
  <fabricSetupP podId="1" tepPool="10.0.0.0/16" />
  <fabricSetupP podId="2" tepPool="10.1.0.0/16" status='' />
</fabricSetupPol>
```

Step 3 Configure the node ID policy:

Example:

```
http://<apic-name/ip>:80/api/node/mo/uni/controller.xml

<fabricNodeIdentPol>
<fabricNodeIdentP serial="SAL1819RXP4" name="ifav4-leaf1" nodeId="101" podId="1"/>
<fabricNodeIdentP serial="SAL1803L25H" name="ifav4-leaf2" nodeId="102" podId="1"/>
<fabricNodeIdentP serial="SAL1934MNY0" name="ifav4-leaf3" nodeId="103" podId="1"/>
<fabricNodeIdentP serial="SAL1934MNY3" name="ifav4-leaf4" nodeId="104" podId="1"/>
<fabricNodeIdentP serial="SAL1748H56D" name="ifav4-spine1" nodeId="201" podId="1"/>
<fabricNodeIdentP serial="SAL1938P7A6" name="ifav4-spine3" nodeId="202" podId="1"/>
<fabricNodeIdentP serial="SAL1938PHBB" name="ifav4-leaf5" nodeId="105" podId="2"/>
<fabricNodeIdentP serial="SAL1942R857" name="ifav4-leaf6" nodeId="106" podId="2"/>
<fabricNodeIdentP serial="SAL1931LA3B" name="ifav4-spine2" nodeId="203" podId="2"/>
<fabricNodeIdentP serial="FGE173400A9" name="ifav4-spine4" nodeId="204" podId="2"/>
</fabricNodeIdentPol>
```

Step 4 Configure infra L3Out and external connectivity profile:

Example:

```
http://<apic-name/ip>:80/api/node/mo/uni.xml

<polUni>

<fvTenant descr="" dn="uni/tn-infra" name="infra" ownerKey="" ownerTag="">
```



```

    <l3extOut descr="" enforceRtctrl="export" name="multipod" ownerKey="" ownerTag=""
targetDscp="unspecified" status=''>
    <ospfExtP areaId='0' areaType='regular' status=''/>
    <l3extRsEctx tnFvCtxName="overlay-1"/>
    <l3extProvLbl descr="" name="prov_mpl" ownerKey="" ownerTag="" tag="yellow-green"/>

    <l3extLNodeP name="bSpine">
    <l3extRsNodeL3OutAtt rtrId="201.201.201.201" rtrIdLoopBack="no"
tDn="topology/pod-1/node-201">
    <l3extInfraNodeP descr="" fabricExtCtrlPeering="yes" name=""/>
    <l3extLoopBackIfP addr="201::201/128" descr="" name=""/>
    <l3extLoopBackIfP addr="201.201.201.201/32" descr="" name=""/>
    </l3extRsNodeL3OutAtt>

    <l3extRsNodeL3OutAtt rtrId="202.202.202.202" rtrIdLoopBack="no"
tDn="topology/pod-1/node-202">
    <l3extInfraNodeP descr="" fabricExtCtrlPeering="yes" name=""/>
    <l3extLoopBackIfP addr="202::202/128" descr="" name=""/>
    <l3extLoopBackIfP addr="202.202.202.202/32" descr="" name=""/>
    </l3extRsNodeL3OutAtt>

    <l3extRsNodeL3OutAtt rtrId="203.203.203.203" rtrIdLoopBack="no"
tDn="topology/pod-2/node-203">
    <l3extInfraNodeP descr="" fabricExtCtrlPeering="yes" name=""/>
    <l3extLoopBackIfP addr="203::203/128" descr="" name=""/>
    <l3extLoopBackIfP addr="203.203.203.203/32" descr="" name=""/>
    </l3extRsNodeL3OutAtt>

    <l3extRsNodeL3OutAtt rtrId="204.204.204.204" rtrIdLoopBack="no"
tDn="topology/pod-2/node-204">
    <l3extInfraNodeP descr="" fabricExtCtrlPeering="yes" name=""/>
    <l3extLoopBackIfP addr="204::204/128" descr="" name=""/>
    <l3extLoopBackIfP addr="204.204.204.204/32" descr="" name=""/>
    </l3extRsNodeL3OutAtt>

    <l3extLIIfP name='portIf'>
    <l3extRsPathL3OutAtt descr='asr' tDn="topology/pod-1/paths-201/pathep-[eth1/1]"
encap='vlan-4' ifInstT='sub-interface' addr="201.1.1.1/30" />
    <l3extRsPathL3OutAtt descr='asr' tDn="topology/pod-1/paths-201/pathep-[eth1/2]"
encap='vlan-4' ifInstT='sub-interface' addr="201.2.1.1/30" />
    <l3extRsPathL3OutAtt descr='asr' tDn="topology/pod-1/paths-202/pathep-[eth1/2]"
encap='vlan-4' ifInstT='sub-interface' addr="202.1.1.1/30" />
    <l3extRsPathL3OutAtt descr='asr' tDn="topology/pod-2/paths-203/pathep-[eth1/1]"
encap='vlan-4' ifInstT='sub-interface' addr="203.1.1.1/30" />
    <l3extRsPathL3OutAtt descr='asr' tDn="topology/pod-2/paths-203/pathep-[eth1/2]"
encap='vlan-4' ifInstT='sub-interface' addr="203.2.1.1/30" />
    <l3extRsPathL3OutAtt descr='asr' tDn="topology/pod-2/paths-204/pathep-[eth4/31]"
encap='vlan-4' ifInstT='sub-interface' addr="204.1.1.1/30" />

    <ospfIfP>
    <ospfRsIfPol tnOspfIfPolName='ospfIfPol' />
    </ospfIfP>

    </l3extLIIfP>
    </l3extLNodeP>

    <l3extInstP descr="" matchT="AtleastOne" name="instp1" prio="unspecified"
targetDscp="unspecified">
    <fvRsCustQosPol tnQosCustomPolName="" />
    </l3extInstP>
    </l3extOut>

    <fvFabricExtConnP descr="" id="1" name="Fabric_Ext_Conn_Pol1" rt="extended:as2-nn4:5:16"
status=''>

```

```

<fvPodConnP descr="" id="1" name="">
  <fvIp addr="100.11.1.1/32"/>
</fvPodConnP>
<fvPodConnP descr="" id="2" name="">
  <fvIp addr="200.11.1.1/32"/>
</fvPodConnP>
<fvPeeringP descr="" name="" ownerKey="" ownerTag="" type="automatic_with_full_mesh"/>

<l3extFabricExtRoutingP descr="" name="ext_routing_prof_1" ownerKey="" ownerTag="">
  <l3extSubnet aggregate="" descr="" ip="100.0.0.0/8" name="" scope="import-security"/>

  <l3extSubnet aggregate="" descr="" ip="200.0.0.0/8" name="" scope="import-security"/>

  <l3extSubnet aggregate="" descr="" ip="201.1.0.0/16" name=""
scope="import-security"/>
  <l3extSubnet aggregate="" descr="" ip="201.2.0.0/16" name=""
scope="import-security"/>
  <l3extSubnet aggregate="" descr="" ip="202.1.0.0/16" name=""
scope="import-security"/>
  <l3extSubnet aggregate="" descr="" ip="203.1.0.0/16" name=""
scope="import-security"/>
  <l3extSubnet aggregate="" descr="" ip="203.2.0.0/16" name=""
scope="import-security"/>
  <l3extSubnet aggregate="" descr="" ip="204.1.0.0/16" name=""
scope="import-security"/>
  </l3extFabricExtRoutingP>
</fvFabricExtConnP>
</fvTenant>
</polUni>

```

Configuring Remote Leaf Switches Using REST API

Configure Remote Leaf Switches Using the REST API

To enable Cisco APIC to discover and connect the IPN router and remote leaf switches, perform the steps in this topic.

This example assumes that the remote leaf switches are connected to a pod in a multipod topology. It includes two L3Outs configured in the infra tenant, with VRF overlay-1:

- One is configured on VLAN-4, that is required for both the remote leaf switches and the spine switch connected to the WAN router.
- One is the multipod-internal L3Out configured on VLAN-5, that is required for the multipod and Remote Leaf features, when they are deployed together.

Procedure

- Step 1** To define the TEP pool for two remote leaf switches to be connected to a pod, send a post with XML such as the following example:

Example:

```

<fabricSetupPol>
  <fabricSetupP tepPool="10.0.0.0/16" podId="1" >

```

```

        <fabricExtSetupP tepPool="30.0.128.0/20" extPoolId="1"/>
    </fabricSetupP>
    <fabricSetupP tepPool="10.1.0.0/16" podId="2" >
        <fabricExtSetupP tepPool="30.1.128.0/20" extPoolId="1"/>
    </fabricSetupP>
</fabricSetupPol>

```

Step 2 To define the node identity policy, send a post with XML, such as the following example:

Example:

```

<fabricNodeIdentPol>
    <fabricNodeIdentP serial="SAL17267Z7W" name="leaf1" nodeId="101" podId="1"
extPoolId="1" nodeType="remote-leaf-wan"/>
    <fabricNodeIdentP serial="SAL17267Z7X" name="leaf2" nodeId="102" podId="1"
extPoolId="1" nodeType="remote-leaf-wan"/>
    <fabricNodeIdentP serial="SAL17267Z7Y" name="leaf3" nodeId="201" podId="1"
extPoolId="1" nodeType="remote-leaf-wan"/>
    <fabricNodeIdentP serial="SAL17267Z7Z" name="leaf4" nodeId="201" podId="1"
extPoolId="1" nodeType="remote-leaf-wan"/>
</fabricNodeIdentPol>

```

Step 3 To configure the Fabric External Connection Profile, send a post with XML such as the following example:

Example:

```

<?xml version="1.0" encoding="UTF-8"?>
<imdata totalCount="1">
    <fvFabricExtConnP dn="uni/tn-infra/fabricExtConnP-1" id="1" name="Fabric_Ext_Conn_Pol1"
rt="extended:as2-nn4:5:16" siteId="0">
        <l3extFabricExtRoutingP name="test">
            <l3extSubnet ip="150.1.0.0/16" scope="import-security"/>
        </l3extFabricExtRoutingP>
        <l3extFabricExtRoutingP name="ext_routing_prof_1">
            <l3extSubnet ip="204.1.0.0/16" scope="import-security"/>
            <l3extSubnet ip="209.2.0.0/16" scope="import-security"/>
            <l3extSubnet ip="202.1.0.0/16" scope="import-security"/>
            <l3extSubnet ip="207.1.0.0/16" scope="import-security"/>
            <l3extSubnet ip="200.0.0.0/8" scope="import-security"/>
            <l3extSubnet ip="201.2.0.0/16" scope="import-security"/>
            <l3extSubnet ip="210.2.0.0/16" scope="import-security"/>
            <l3extSubnet ip="209.1.0.0/16" scope="import-security"/>
            <l3extSubnet ip="203.2.0.0/16" scope="import-security"/>
            <l3extSubnet ip="208.1.0.0/16" scope="import-security"/>
            <l3extSubnet ip="207.2.0.0/16" scope="import-security"/>
            <l3extSubnet ip="100.0.0.0/8" scope="import-security"/>
            <l3extSubnet ip="201.1.0.0/16" scope="import-security"/>
            <l3extSubnet ip="210.1.0.0/16" scope="import-security"/>
            <l3extSubnet ip="203.1.0.0/16" scope="import-security"/>
            <l3extSubnet ip="208.2.0.0/16" scope="import-security"/>
        </l3extFabricExtRoutingP>
        <fvPodConnP id="1">
            <fvIp addr="100.11.1.1/32"/>
        </fvPodConnP>
        <fvPodConnP id="2">
            <fvIp addr="200.11.1.1/32"/>
        </fvPodConnP>
        <fvPeeringP type="automatic_with_full_mesh"/>
    </fvFabricExtConnP>
</imdata>

```

Step 4 To configure an L3Out on VLAN-4, that is required for both the remote leaf switches and the spine switch connected to the WAN router, enter XML such as the following example:

Example:

```

<?xml version="1.0" encoding="UTF-8"?>
<polUni>
<fvTenant name="infra">
  <l3extOut name="rleaf-wan-test">
    <ospfExtP areaId="0.0.0.5"/>
    <bgpExtP/>
    <l3extRsEctx tnFvCtxName="overlay-1"/>
    <l3extRsL3DomAtt tDn="uni/l3dom-l3extDom1"/>
    <l3extProvLbl descr="" name="prov_mpl" ownerKey="" ownerTag="" tag="yellow-green"/>
    <l3extLNodeP name="rleaf-101">
      <l3extRsNodeL3OutAtt rtrId="202.202.202.202" tDn="topology/pod-1/node-101">
        </l3extRsNodeL3OutAtt>
        <l3extLIIfP name="portIf">
          <l3extRsPathL3OutAtt ifInstT="sub-interface"
tDn="topology/pod-1/paths-101/pathep-[eth1/49]" addr="202.1.1.2/30" mac="AA:11:22:33:44:66"
encap='vlan-4' />
          <ospfIfP>
            <ospfRsIfPol tnOspfIfPolName='ospfIfPol' />
          </ospfIfP>
        </l3extLIIfP>
      </l3extLNodeP>
      <l3extLNodeP name="rlSpine-201">
        <l3extRsNodeL3OutAtt rtrId="201.201.201.201" rtrIdLoopBack="no"
tDn="topology/pod-1/node-201">
          <!--
          <l3extLoopBackIfP addr="201::201/128" descr="" name="" />
          <l3extLoopBackIfP addr="201.201.201.201/32" descr="" name="" />
          -->
          <l3extLoopBackIfP addr="::" />
        </l3extRsNodeL3OutAtt>
        <l3extLIIfP name="portIf">
          <l3extRsPathL3OutAtt ifInstT="sub-interface"
tDn="topology/pod-1/paths-201/pathep-[eth8/36]" addr="201.1.1.1/30" mac="00:11:22:33:77:55"
encap='vlan-4' />
          <ospfIfP>
            <ospfRsIfPol tnOspfIfPolName='ospfIfPol' />
          </ospfIfP>
        </l3extLIIfP>
      </l3extLNodeP>
      <l3extInstP descr="" matchT="AtleastOne" name="instp1" prio="unspecified"
targetDscp="unspecified">
        <fvRsCustQosPol tnQosCustomPolName="" />
      </l3extInstP>
    </l3extOut>
    <ospfIfPol name="ospfIfPol" nwT="bcast"/>
  </fvTenant>
</polUni>

```

Step 5 To configure the multipod L3Out on VLAN-5, that is required for both multipod and the remote leaf topology, send a post such as the following example:

Example:

```

<?xml version="1.0" encoding="UTF-8"?>
<polUni>

  <fvTenant name="infra" >
    <l3extOut name="ipn-multipodInternal">
      <ospfExtP areaCtrl="inherit-ipsec,redistribute,summary" areaId="0.0.0.5"
multipodInternal="yes" />
      <l3extRsEctx tnFvCtxName="overlay-1" />
      <l3extLNodeP name="bLeaf">
        <l3extRsNodeL3OutAtt rtrId="202.202.202.202" rtrIdLoopBack="no"
tDn="topology/pod-2/node-202">
          <l3extLoopBackIfP addr="202.202.202.212"/>

```

```

        </l3extRsNodeL3OutAtt>
        <l3extRsNodeL3OutAtt rtrId="102.102.102.102" rtrIdLoopBack="no"
tDn="topology/pod-1/node-102">
            <l3extLoopBackIfP addr="102.102.102.112"/>
        </l3extRsNodeL3OutAtt>
        <l3extLIIfP name="portIf">
            <ospfIfP authKeyId="1" authType="none">
                <ospfRsIfPol tnOspfIfPolName="ospfIfPol" />
            </ospfIfP>
            <l3extRsPathL3OutAtt addr="10.0.254.233/30" encap="vlan-5" ifInstT="sub-interface"
tDn="topology/pod-2/paths-202/pathep-[eth5/2]"/>
            <l3extRsPathL3OutAtt addr="10.0.255.229/30" encap="vlan-5" ifInstT="sub-interface"
tDn="topology/pod-1/paths-102/pathep-[eth5/2]"/>
        </l3extLIIfP>
        </l3extLNodeP>
        <l3extInstP matchT="AtleastOne" name="ipnInstP" />
    </l3extOut>
</fvTenant>
</polUni>

```

Configuring SR-MPLS Handoff Using REST API

Configuring an SR-MPLS Infra L3Out Using the REST API

- The SR-MPLS infra L3Out is configured on the border leaf switch, which is used to set up the underlay BGP-LU and overlay MP-BGP EVPN sessions that are needed for the SR-MPLS handoff.
- An SR-MPLS infra L3Out will be scoped to a pod or a remote leaf switch site.
- Border leaf switches or remote leaf switches in one SR-MPLS infra L3Out can connect to one or more provider edge (PE) routers in one or more routing domains.
- A pod or remote leaf switch site can have one or more SR-MPLS infra L3Outs.
- Each SR-MPLS infra L3Out should have a unique provider label and one provider label only. Each SR-MPLS infra L3Out is identified by the provider label.

You will configure the following pieces when configuring the SR-MPLS infra L3Out:

• Nodes

- Only leaf switches are allowed to be configured as nodes in the SR-MPLS infra L3Out (border leaf switches and remote leaf switches).
- Each SR-MPLS infra L3Out can have border leaf switches from one pod or remote leaf switch from the same site.
- Each border leaf switch or remote leaf switch can be configured in multiple SR-MPLS infra L3Outs if it connects to multiple SR-MPLS domains.
- You will also configure the loopback interface underneath the node, and a node SID policy underneath the loopback interface.

• Interfaces

- Supported types of interfaces are:

- Routed interface or sub-interface
- Routed port channel or port channel sub-interface

For sub-interfaces, any VLAN tag is supported.

- You will also configure the underlay BGP peer policy underneath the interfaces area in the SR-MPLS infra L3Out.

• QoS rules

- You can configure the MPLS ingress rule and MPLS egress rule through the MPLS QoS policy in the SR-MPLS infra L3Out.
- If you do not create an MPLS QoS policy, any ingressing MPLS traffic is assigned the default QoS level.

You will also configure the underlay and overlay through the SR-MPLS infra L3Out:

- **Underlay:** BGP peer IP (BGP LU peer) configuration as part of the interface configuration.
- **Overlay:** MP-BGP EVPN remote IPv4 address (MP-BGP EVPN peer) configuration as part of the logical node profile configuration.

Before you begin

- Review the SR-MPLS guidelines and limitations provided in [Guidelines and Limitations for SR-MPLS, on page 164](#), especially the guidelines and limitations provided in [Guidelines and Limitations for the SR-MPLS Infra L3Out, on page 166](#).
- (Optional) If necessary, configure an MPLS custom QoS policy using the procedures provided in [Creating SR-MPLS Custom QoS Policy Using REST API, on page 517](#).

Procedure

Post with information similar to the following:

```
<polUni>
<fvTenant name="infra">
  <mplsIfPol name="default"/>
  <mplsLabelPol name="default" >
    <mplsSrgbLabelPol minSrgbLabel="16000" maxSrgbLabel="17000" localId="1" status="" />
  </mplsLabelPol>

  <l3extOut name="mplsOut" status="" descr="b1" mplsEnabled="yes">
    <l3extRsEctx tnFvCtxName="overlay-1"/>
    <l3extProvLbl name="mpls" />
    <mplsExtP status="" >
      <mplsRsLabelPol tDn="uni/tn-infra/mplslabelpol-default"/>
    </mplsExtP>
    <l3extLNodeP name="mplsLNP" status="">
      <l3extRsNodeL3OutAtt rtrId="100.1.1.1" rtrIdLoopBack="no"
tDn="topology/pod-1/node-101" status="">
        <l3extLoopBackIfP addr="10.10.10.11" status="">
```

```

        <mplsNodeSidP sidoffset="2" loopbackAddr="10.1.3.11" status="" />
    </l3extLoopBackIfP>
</l3extRsNodeL3OutAtt>

    <l3extLIIfP name="mplsLIIfP1" status="">
        <mplsIfP status="">
            <mplsRsIfPol tnMplsIfPolName="default" />
        </mplsIfP>
        <l3extRsPathL3OutAtt addr="34.1.2.3/30" ifInstT="l3-port"
tDn="topology/pod-1/paths-101/pathep-[eth1/8]">
            <bgpPeerP addr="9.9.9.7" addrTCtrl="af-ucast,af-label-ucast"
ctrl="send-ext-com" ttl="1" status="">
                <bgpAsP asn="100"/>
            </bgpPeerP>
        </l3extRsPathL3OutAtt>
    </l3extLIIfP>
    <bgpInfraPeerP addr="20.1.1.1" ctrl="send-com,send-ext-com" peerT="sr-mpls" ttl="3"
status="" >
        <bgpAsP asn="100"/>
    </bgpInfraPeerP>
</l3extLNodeP>

    <l3extInstP name="mplsInstP">
        <l3extSubnet aggregate="" descr="" ip="11.11.11.0/24" name=""
scope="import-security"/>
    </l3extInstP>
    <bgpExtP/>
    <l3extRsL3DomAtt tDn="uni/l3dom-l3extDom1" />
</l3extOut>

</fvTenant>
</polUni>

```

Configuring an SR-MPLS VRF L3Out Using the REST API

Using the procedures in this section, you will configure a SR-MPLS VRF L3Out, which will be used to forward traffic from the SR-MPLS infra L3Out that you configured in the previous set of procedures.

- User tenant VRFs are mapped to the SR-MPLS infra L3Outs to advertise tenant bridge domain subnets to the DC-PE routers and import the MPLS VPN routes received from the DC-PE.
- You must specify routing and security policies in the SR-MPLS VRF L3Out for each VRF. These policies point to one or more SR-MPLS infra L3Outs.
- One SR-MPLS VRF L3Out is supported for each VRF.
- You can configure multiple consumer labels in one SR-MPLS VRF L3Out, with each consumer label identifying one SR-MPLS infra L3Out. A consumer label identifies the entry and exit point for traffic to and from one SR-MPLS VRF L3Out, which is a particular MPLS domain for a particular pod or remote leaf switch.

Before you begin

- Review the SR-MPLS guidelines and limitations provided in [Guidelines and Limitations for SR-MPLS, on page 164](#), especially the guidelines and limitations provided in [Guidelines and Limitations for the SR-MPLS VRF L3Out, on page 166](#).

- Configure an SR-MPLS infra L3Out using the procedures provided in [Configuring an SR-MPLS Infra L3Out Using the REST API, on page 513](#).

Procedure

Post with information similar to the following:

```
<polUni>
<fvTenant name="t1">
  <fvCtx name="v1">
    <!-- specify bgp evpn route-target -->
    <bgpRtTargetP af="ipv4-ucast">
      <bgpRtTarget rt="route-target:as4-nn2:100:1259" type="import"/>
      <bgpRtTarget rt="route-target:as4-nn2:100:1259" type="export"/>
    </bgpRtTargetP>
  </fvCtx>

  <!-- MPLS L3out -->
  <l3extOut name="out1" mplsEnabled="yes">
    <l3extRsEctx tnFvCtxName="v1" />

    <!-- MPLS consumer label -->
    <l3extConsLbl name="mpls1">
      <!-- route profile association -->
      <l3extRsLblToProfile tDn="uni/tn-t1/prof-rp1" direction="export" />
      <!-- InstP association -->
      <l3extRsLblToInstP tDn="uni/tn-t1/out-out1/instP-epgMpls1" />
    </l3extConsLbl>

    <!-- External-EPG -->
    <l3extInstP name="epgMpls1">
      <fvRsProv tnVzBrCPName="cp1"/>
      <l3extSubnet ip="55.1.1.1/28"/>
    </l3extInstP>
    <bgpExtP/>
  </l3extOut>

  <!-- route control profile -->
  <rtctrlProfile descr="" name="rp1" type="global" status="">
    <rtctrlCtxP action="permit" descr="" name="ctx1" order="0">
      <rtctrlRsCtxPToSubjP status="" tnRtctrlSubjPName="subj1"/>
    </rtctrlCtxP>
  </rtctrlProfile>
  <rtctrlSubjP descr="" name="subj1" status="" >
    <rtctrlMatchRtDest ip="101.1.1.1/32"/>
    <rtctrlMatchRtDest ip="102.1.1.0/24" aggregate="yes"/>
  </rtctrlSubjP>

  <!-- Filter and Contract (global) -->
  <vzBrCP name="cp1" scope="global">
    <vzSubj name="allow-all">
      <vzRsSubjFiltAtt action="permit" tnVzFilterName="default" />
    </vzSubj>
  </vzBrCP>
</fvTenant>
</polUni>
```

Creating SR-MPLS Custom QoS Policy Using REST API

SR-MPLS Custom QoS policy defines the priority of the packets coming from an SR-MPLS network while they are inside the ACI fabric based on the incoming MPLS EXP values defined in the MPLS QoS ingress policy. It also marks the CoS and MPLS EXP values of the packets leaving the ACI fabric through an MPLS interface based on IPv4 DSCP values defined in MPLS QoS egress policy.

If no custom ingress policy is defined, the default QoS Level (`Level13`) is assigned to packets inside the fabric. If no custom egress policy is defined, the default EXP value of 0 will be marked on packets leaving the fabric.

Procedure

Step 1 Create SR-MPLS QoS policy.

In the following POST:

- Replace `customqos1` with the name of the SR-MPLS QoS policy you want to create.
- For the `qosMplsIngressRule`:
 - Replace `from="2" to="3"` with the EXP range you want the policy to match.
 - Replace `prio="level15"` with the ACI QoS Level for the packet while it's inside the ACI fabric.
 - Replace `target="CS5"` with the DSCP value you want to set on the packet when it's matched.
 - Replace `targetCos="4"` with the CoS value you want to set on the packet when it's matched.
- For the `qosMplsEgressRule`:
 - Replace `from="CS2" to="CS4"` with the DSCP range you want the policy to match.
 - Replace `targetExp="5"` with the EXP value you want to set on the packet when it's leaving the fabric.
 - Replace `targetCos="3"` with the CoS value you want to set on the packet when it's leaving the fabric.

```
<polUni>
  <fvTenant name="infra">
    <qosMplsCustomPol descr="" dn="uni/tn-infra/qosmplscustom-customqos1" name="customqos1"
      status="" >
      <qosMplsIngressRule from="2" to="3" prio="level15" target="CS5" targetCos="4" status=""
    />
      <qosMplsEgressRule from="CS2" to="CS4" targetExp="5" targetCos="3" status=""/>
    </qosMplsCustomPol>
  </fvTenant>
</polUni>
```

Step 2 Applying SR-MPLS QoS policy.

In the following POST, replace `customqos1` with the name of the SR-MPLS QoS policy you created in the previous step.

```
<polUni>
  <fvTenant name="infra">
    <l3extOut name="mplsOut" status="" descr="b1">
      <l3extLNodeP name="mplsLNP" status="">
```

```

        <l3extRsLNodePMplsCustQosPol tDn="uni/tn-infra/qosmplscustom-customqos1"/>
    </l3extLNodeP>
</l3extOut>
</fvTenant>
</polUni>

```

Part II: External Routing (L3Out) Configuration

Routed Connectivity to External Networks

Configuring an MP-BGP Route Reflector Using REST API

Configuring an MP-BGP Route Reflector Using the REST API

Procedure

Step 1 Mark the spine switches as route reflectors.

Example:

```
POST https://apic-ip-address/api/policymgr/mo/uni/fabric.xml
```

```

<bgpInstPol name="default">
  <bgpAsP asn="1" />
  <bgpRRP>
    <bgpRRNodePEp id="<spine_id1>" />
    <bgpRRNodePEp id="<spine_id2>" />
  </bgpRRP>
</bgpInstPol>

```

Step 2 Set up the pod selector using the following post.

Example:

For the FuncP setup—

```
POST https://apic-ip-address/api/policymgr/mo/uni.xml
```

```

<fabricFuncP>
  <fabricPodPGrp name="bgpRRPodGrp">
    <fabricRsPodPGrpBGPRRP tnBgpInstPolName="default" />
  </fabricPodPGrp>
</fabricFuncP>

```

Example:

For the PodP setup—

```
POST https://apic-ip-address/api/policymgr/mo/uni.xml
```

```

<fabricPodP name="default">
  <fabricPodS name="default" type="ALL">
    <fabricRsPodPGrp tDn="uni/fabric/funcprof/podgrp-bgpRRPodGrp"/>
  </fabricPodS>
</fabricPodP>

```

```
</fabricPodS>  
</fabricPodP>
```

Configuring the BGP Domain-Path Feature for Loop Prevention Using the REST API

Before you begin

Become familiar with the BGP Domain-Path feature using the information provided in [About the BGP Domain-Path Feature for Loop Prevention, on page 196](#).

Procedure

- Step 1** If you want to use the BGP Domain-Path feature for loop prevention, set the global `DomainIdBase`.

```
<polUni>  
  <fabricInst>  
    <bgpInstPol name="default">  
      <bgpDomainIdBase domainIdBase="12346" />  
    </bgpInstPol>  
  </fabricInst>  
</polUni>
```

- Step 2** Enable `send-domain-path` in the appropriate L3Out.

```
<bgpPeerP addr="22.22.3.5" addrTCtrl="af-ucast" allowedSelfAsCnt="3" ttl="2"  
  ctrlExt="send-domain-path" ctrl="send-ext-com">  
</bgpPeerP>
```

Node and Interface for L3Out

Configuring Layer 3 Routed and Sub-Interface Port Channels Using REST API

Configuring a Layer 3 Routed Port Channel Using the REST API

Before you begin

- The ACI fabric is installed, APIC controllers are online, and the APIC cluster is formed and healthy.
- An APIC fabric administrator account is available that will enable creating the necessary fabric infrastructure configurations.
- The target leaf switches are registered in the ACI fabric and available.
- Port channels are configured when port channels are used for L3Out interfaces.



Note In the following REST API example, long single lines of text are broken up with the \ character to improve readability.

Procedure

To configure a Layer 3 route to the port channels that you created previously using the REST API, send a post with XML such as the following:

Example:

```
<polUni>
<fvTenant name=pep9>
  <l3extOut descr="" dn="uni/tn-pep9/out-routAccounting" enforceRtctrl="export" \
    name="routAccounting" nameAlias="" ownerKey="" ownerTag="" \
    targetDscp="unspecified">
    <l3extRsL3DomAtt tDn="uni/l3dom-Dom1"/>
    <l3extRsEctx tnFvCtxName="ctx9"/>
    <l3extLNodeP configIssues="" descr="" name="node101" nameAlias="" ownerKey="" \
      ownerTag="" tag="yellow-green" targetDscp="unspecified">
      <l3extRsNodeL3OutAtt rtrId="10.1.0.101" rtrIdLoopBack="yes" \
        tDn="topology/pod-1/node-101">
        <l3extInfraNodeP descr="" fabricExtCtrlPeering="no" \
          fabricExtIntersiteCtrlPeering="no" name="" nameAlias="" spineRole=""/>
      </l3extRsNodeL3OutAtt>
      <l3extLIIFP descr="" name="lifp17" nameAlias="" ownerKey="" ownerTag="" \
        tag="yellow-green">
        <ospfIfP authKeyId="1" authType="none" descr="" name="" nameAlias="">
          <ospfRsIfPol tnOspfIfPolName=""/>
        </ospfIfP>
        <l3extRsPathL3OutAtt addr="10.1.5.3/24" autostate="disabled" descr="" \
          encap="unknown" encapScope="local" ifInstT="l3-port" llAddr="::" \
          mac="00:22:BD:F8:19:FF" mode="regular" mtu="inherit" \
          tDn="topology/pod-1/paths-101/pathep-[pol17_PolGrp]" \
          targetDscp="unspecified"/>
        <l3extRsNdIfPol tnNdIfPolName=""/>
        <l3extRsIngressQosDppPol tnQosDppPolName=""/>
        <l3extRsEgressQosDppPol tnQosDppPolName=""/>
      </l3extLIIFP>
    </l3extLNodeP>
    <l3extInstP descr="" floodOnEncap="disabled" matchT="AtleastOne" \
      name="accountingInst" nameAlias="" prefGrMemb="exclude" prio="unspecified" \
      targetDscp="unspecified">
      <fvRsProv matchT="AtleastOne" prio="unspecified" tnVzBrCPName="webCtrct"/>
      <l3extSubnet aggregate="export-rtctrl,import-rtctrl" descr="" ip="0.0.0.0/0" \
        name="" nameAlias="" scope="export-rtctrl,import-rtctrl,import-security"/>
      <l3extSubnet aggregate="export-rtctrl,import-rtctrl" descr="" ip="::/0" \
        name="" nameAlias="" scope="export-rtctrl,import-rtctrl,import-security"/>
      <fvRsCustQosPol tnQosCustomPolName=""/>
    </l3extInstP>
    <l3extConsLbl descr="" name="golf" nameAlias="" owner="infra" ownerKey="" \
      ownerTag="" tag="yellow-green"/>
  </l3extOut>
</fvTenant>
</polUni>
```

Configuring a Layer 3 Sub-Interface Port Channel Using the REST API

Before you begin

- The ACI fabric is installed, APIC controllers are online, and the APIC cluster is formed and healthy.
- An APIC fabric administrator account is available that will enable creating the necessary fabric infrastructure configurations.
- The target leaf switches are registered in the ACI fabric and available.
- Port channels are configured using the procedures in "Configuring Port Channels Using the REST API".



Note In the following REST API example, long single lines of text are broken up with the \ character to improve readability.

Procedure

To configure a Layer 3 sub-interface route to the port channels that you created previously using the REST API, send a post with XML such as the following:

Example:

```
<polUni>
<fvTenant name=pep9>
  <l3extOut descr="" dn="uni/tn-pep9/out-routAccounting" enforceRtctrl="export" \
    name="routAccounting" nameAlias="" ownerKey="" ownerTag="" targetDscp="unspecified">
    <l3extRsL3DomAtt tDn="uni/l3dom-Dom1"/>
    <l3extRsEctx tnFvCtxName="ctx9"/>
    <l3extLNodeP configIssues="" descr="" name="node101" nameAlias="" ownerKey="" \
      ownerTag="" tag="yellow-green" targetDscp="unspecified">
      <l3extRsNodeL3OutAtt rtrId="10.1.0.101" rtrIdLoopBack="yes" \
        tDn="topology/pod-1/node-101">
        <l3extInfraNodeP descr="" fabricExtCtrlPeering="no" \
          fabricExtIntersiteCtrlPeering="no" name="" nameAlias="" spineRole=""/>
      </l3extRsNodeL3OutAtt>
    <l3extLIIfP descr="" name="lifp27" nameAlias="" ownerKey="" ownerTag="" \
      tag="yellow-green">
      <ospfIfP authKeyId="1" authType="none" descr="" name="" nameAlias="">
        <ospfRsIfPol tnOspfIfPolName=""/>
      </ospfIfP>
      <l3extRsPathL3OutAtt addr="11.1.5.3/24" autostate="disabled" descr="" \
        encap="vlan-2001" encapScope="local" ifInstT="sub-interface" \
        llAddr="::" mac="00:22:BD:F8:19:FF" mode="regular" mtu="inherit" \
        tDn="topology/pod-1/paths-101/pathep-[po27_PolGrp]" \
        targetDscp="unspecified"/>
      <l3extRsNdIfPol tnNdIfPolName=""/>
      <l3extRsIngressQosDppPol tnQosDppPolName=""/>
      <l3extRsEgressQosDppPol tnQosDppPolName=""/>
    </l3extLIIfP>
  </l3extLNodeP>
  <l3extInstP descr="" floodOnEncap="disabled" matchT="AtleastOne" \
    name="accountingInst" nameAlias="" prefGrMemb="exclude" prio="unspecified" \
    targetDscp="unspecified">
    <fvRsProv matchT="AtleastOne" prio="unspecified" tnVzBrCPName="webCtrct"/>
    <l3extSubnet aggregate="export-rtctrl,import-rtctrl" descr="" ip="0.0.0.0/0" \
```

```

        name="" nameAlias="" scope="export-rtctrl,import-rtctrl,import-security"/>
<l3extSubnet aggregate="export-rtctrl,import-rtctrl" descr="" ip="::/0" \
name="" nameAlias="" scope="export-rtctrl,import-rtctrl,import-security"/>
<fvRsCustQosPol tnQosCustomPolName=""/>
</l3extInstP>
<l3extConsLbl descr="" name="golf" nameAlias="" owner="infra" ownerKey="" \
ownerTag="" tag="yellow-green"/>
</l3extOut>
</fvTenant>
</polUni>

```

Configuring a Switch Virtual Interface Using REST API

Configuring SVI Interface Encapsulation Scope Using the REST API

Before you begin

The interface selector is configured.

Procedure

Configure the SVI interface encapsulation scope.

Example:

```

<?xml version="1.0" encoding="UTF-8"?>
<!-- /api/node/mo/.xml -->
<polUni>
  <fvTenant name="coke">
    <l3extOut descr="" dn="uni/tn-coke/out-l3out1" enforceRtctrl="export" name="l3out1"
nameAlias="" ownerKey="" ownerTag="" targetDscp="unspecified">
      <l3extRsL3DomAtt tDn="uni/l3dom-Dom1"/>
      <l3extRsEctx tnFvCtxName="vrf0"/>
      <l3extLNodeP configIssues="" descr="" name="__ui_node_101" nameAlias="" ownerKey=""
ownerTag="" tag="yellow-green" targetDscp="unspecified">
        <l3extRsNodeL3OutAtt rtrId="1.1.1.1" rtrIdLoopBack="no" tDn="topology/pod-1/node-101"/>

        <l3extLIIfP descr="" name="int1_11" nameAlias="" ownerKey="" ownerTag=""
tag="yellow-green">
          <l3extRsPathL3OutAtt addr="1.2.3.4/24" descr="" encap="vlan-2001" encapScope="ctx"
ifInstT="ext-svi" llAddr="0.0.0.0" mac="00:22:BD:F8:19:FF" mode="regular" mtu="inherit"
tDn="topology/pod-1/paths-101/pathep-[eth1/5]" targetDscp="unspecified"/>
          <l3extRsNdIfPol tnNdIfPolName=""/>
          <l3extRsIngressQosDppPol tnQosDppPolName=""/>
          <l3extRsEgressQosDppPol tnQosDppPolName=""/>
        </l3extLIIfP>
      </l3extLNodeP>
      <l3extInstP descr="" matchT="AtleastOne" name="epg1" nameAlias="" prefGrMemb="exclude"
prio="unspecified" targetDscp="unspecified">
        <l3extSubnet aggregate="" descr="" ip="101.10.10.1/24" name="" nameAlias=""
scope="import-security"/>
        <fvRsCustQosPol tnQosCustomPolName=""/>
      </l3extInstP>
    </l3extOut>
  </fvTenant>
</polUni>

```

```
</fvTenant>
</polUni>
```

Configuring SVI Auto State Using the REST API

Before you begin

- The tenant and VRF configured.
- A Layer 3 Out is configured and a logical node profile and a logical interface profile under the Layer 3 Out is configured.

Procedure

Enable the SVI auto state value.

Example:

```
<fvTenant name="t1" >
  <l3extOut name="out1">
    <l3extLNodeP name="__ui_node_101" >
      <l3extLIIfP descr="" name="__ui_eth1_10_vlan_99_af_ipv4" >
        <l3extRsPathL3OutAtt addr="19.1.1.1/24" autostate="enabled" descr=""
          encap="vlan-100" encapScope="local" ifInstT="ext-svi" llAddr="::" mac="00:22:BD:F8:19:FF"
          mode="regular" mtu="inherit" tDn="topology/pod-1/paths-101/pathep-[eth1/10]"
          targetDscp="unspecified" />
        </l3extLIIfP>
      </l3extLNodeP>
    </l3extOut>
  </fvTenant>
```

To disable the autostate, you must change the value to disabled in the above example. For example, autostate="disabled".

Configuring Routing Protocols Using REST API

Configuring BGP External Routed Networks with BFD Support Using REST API

Configuring BGP External Routed Network Using the REST API

Before you begin

The tenant where you configure the BGP external routed network is already created.

The following shows how to configure the BGP external routed network using the REST API:

For Example:

Procedure

Example:

```

<l3extOut descr="" dn="uni/tn-t1/out-l3out-bgp" enforceRtctrl="export" name="l3out-bgp"
ownerKey="" ownerTag="" targetDscp="unspecified">
  <l3extRsEctx tnFvCtxName="ctx3"/>
  <l3extLNodeP configIssues="" descr="" name="l3extLNodeP_1" ownerKey="" ownerTag=""
tag="yellow-green" targetDscp="unspecified">
    <l3extRsNodeL3OutAtt rtrId="1.1.1.1" rtrIdLoopBack="no" tDn="topology/pod-1/node-101"/>
    <l3extLIFP descr="" name="l3extLIFP_2" ownerKey="" ownerTag="" tag="yellow-green">
      <l3extRsNdIfPol tnNdIfPolName=""/>
      <l3extRsIngressQosDppPol tnQosDppPolName=""/>
      <l3extRsEgressQosDppPol tnQosDppPolName=""/>
      <l3extRsPathL3OutAtt addr="3001::31:0:1:2/120" descr="" encap="vlan-3001"
encapScope="local" ifInstT="sub-interface" llAddr="::" mac="00:22:BD:F8:19:FF" mode="regular"
mtu="inherit" tDn="topology/pod-1/paths-101/pathep-[eth1/8]" targetDscp="unspecified">
        <bgpPeerP addr="3001::31:0:1:0/120" allowedSelfAsCnt="3" ctrl="send-com,send-ext-com"
descr="" name="" peerCtrl="bfd" privateASctrl="remove-all,remove-exclusive,replace-as"
ttl="1" weight="1000">
          <bgpRsPeerPfxPol tnBgpPeerPfxPolName=""/>
          <bgpAsP asn="3001" descr="" name=""/>
        </bgpPeerP>
      </l3extRsPathL3OutAtt>
    </l3extLIFP>
    <l3extLIFP descr="" name="l3extLIFP_1" ownerKey="" ownerTag="" tag="yellow-green">
      <l3extRsNdIfPol tnNdIfPolName=""/>
      <l3extRsIngressQosDppPol tnQosDppPolName=""/>
      <l3extRsEgressQosDppPol tnQosDppPolName=""/>
      <l3extRsPathL3OutAtt addr="31.0.1.2/24" descr="" encap="vlan-3001" encapScope="local"
ifInstT="sub-interface" llAddr="::" mac="00:22:BD:F8:19:FF" mode="regular" mtu="inherit"
tDn="topology/pod-1/paths-101/pathep-[eth1/8]" targetDscp="unspecified">
        <bgpPeerP addr="31.0.1.0/24" allowedSelfAsCnt="3" ctrl="send-com,send-ext-com" descr=""
name="" peerCtrl="" privateASctrl="remove-all,remove-exclusive,replace-as" ttl="1"
weight="100">
          <bgpRsPeerPfxPol tnBgpPeerPfxPolName=""/>
          <bgpLocalAsnP asnPropagate="none" descr="" localAsn="200" name=""/>
          <bgpAsP asn="3001" descr="" name=""/>
        </bgpPeerP>
      </l3extRsPathL3OutAtt>
    </l3extLIFP>
  </l3extLNodeP>
  <l3extRsL3DomAtt tDn="uni/l3dom-l3-dom"/>
  <l3extRsDampeningPol af="ipv6-ucast" tnRtctrlProfileName="damp_rp"/>
  <l3extRsDampeningPol af="ipv4-ucast" tnRtctrlProfileName="damp_rp"/>
  <l3extInstP descr="" matchT="AtleastOne" name="l3extInstP_1" prio="unspecified"
targetDscp="unspecified">
    <l3extSubnet aggregate="" descr="" ip="130.130.130.0/24" name=""
scope="import-rtctrl"></l3extSubnet>
    <l3extSubnet aggregate="" descr="" ip="130.130.131.0/24" name="" scope="import-rtctrl"/>
    <l3extSubnet aggregate="" descr="" ip="120.120.120.120/32" name=""
scope="export-rtctrl,import-security"/>
    <l3extSubnet aggregate="" descr="" ip="3001::130:130:130:100/120" name=""
scope="import-rtctrl"/>
  </l3extInstP>
  <bgpExtP descr=""/>
</l3extOut>
<rtctrlProfile descr="" dn="uni/tn-t1/prof-damp_rp" name="damp_rp" ownerKey="" ownerTag=""
type="combinable">
  <rtctrlCtxP descr="" name="ipv4_rpc" order="0">

```



```

<rtctrlScope descr="" name="">
  <rtctrlRsScopeToAttrP tnRtctrlAttrPName="act_rule"/>
</rtctrlScope>
</rtctrlCtxP>
</rtctrlProfile>
<rtctrlAttrP descr="" dn="uni/tn-t1/attr-act_rule" name="act_rule">
  <rtctrlSetDamp descr="" halfLife="15" maxSuppressTime="60" name="" reuse="750"
suppress="2000" type="dampening-pol"/>
</rtctrlAttrP>

```

Configuring BGP Max Path Using the REST API

Refer to the *Verified Scalability Guide for Cisco APIC* on the [Cisco APIC documentation page](#) for the acceptable values for the following fields.

The two properties that enable you to configure more paths are `maxEcmp` and `maxEcmpIbgp` in the `bgpCtxAfPol` object. After you configure these two properties, they are propagated to the rest of your implementation. The ECMP policy is applied at the VRF level.

The following example provides information on how to configure the BGP Max Path feature using the REST API:

```

<fvTenant descr="" dn="uni/tn-t1" name="t1">
  <fvCtx name="v1">
    <fvRsCtxToBgpCtxAfPol af="ipv4-ucast" tnBgpCtxAfPolName="bgpCtxPol1"/>
  </fvCtx>
  <bgpCtxAfPol name="bgpCtxPol1" maxEcmp="64" maxEcmpIbgp="64"/>
</fvTenant>

```

Configuring AS Path Prepend Using the REST API

This following example provides information on how to configure the AS Path Prepend feature using the REST API:

```

<?xml version="1.0" encoding="UTF-8"?>
<fvTenant name="coke">
  <rtctrlAttrP name="attrp1">
    <rtctrlSetASPath criteria="prepend">
      <rtctrlSetASPathASN asn="100" order="1"/>
      <rtctrlSetASPathASN asn="200" order="10"/>
      <rtctrlSetASPathASN asn="300" order="5"/>
    </rtctrlSetASPath/>
    <rtctrlSetASPath criteria="prepend-last-as" lastnum="9" />
  </rtctrlAttrP>

  <l3extOut name="out1">
    <rtctrlProfile name="rp1">
      <rtctrlCtxP name="ctxp1" order="1">
        <rtctrlScope>
          <rtctrlRsScopeToAttrP tnRtctrlAttrPName="attrp1"/>
        </rtctrlScope>
      </rtctrlCtxP>
    </rtctrlProfile>
  </l3extOut>
</fvTenant>

```

Configuring BGP External Routed Network with Autonomous System Override Enabled Using the REST API

Procedure

Configure the BGP External Routed Network with Autonomous override enabled.

Note

The line of code that is in bold displays the BGP AS override portion of the configuration. This feature was introduced in the Cisco APIC Release 3.1(2m).

Example:

```
<fvTenant name="coke">
  <fvCtx name="coke" status="">
    <bgpRtTargetP af="ipv4-ucast">
      <bgpRtTarget type="import" rt="route-target:as4-nn2:1234:1300" />
      <bgpRtTarget type="export" rt="route-target:as4-nn2:1234:1300" />
    </bgpRtTargetP>
    <bgpRtTargetP af="ipv6-ucast">
      <bgpRtTarget type="import" rt="route-target:as4-nn2:1234:1300" />
      <bgpRtTarget type="export" rt="route-target:as4-nn2:1234:1300" />
    </bgpRtTargetP>
  </fvCtx>

  <fvBD name="cokeBD">
    <!-- Association from Bridge Doamin to Private Network -->
    <fvRsCtx tnFvCtxName="coke" />
    <fvRsBDToOut tnL3extOutName="routAccounting" />
    <!-- Subnet behind the bridge domain-->
    <fvSubnet ip="20.1.1.1/16" scope="public"/>
    <fvSubnet ip="2000:1::1/64" scope="public"/>
  </fvBD>
  <fvBD name="cokeBD2">
    <!-- Association from Bridge Doamin to Private Network -->
    <fvRsCtx tnFvCtxName="coke" />
    <fvRsBDToOut tnL3extOutName="routAccounting" />
    <!-- Subnet behind the bridge domain-->
    <fvSubnet ip="30.1.1.1/16" scope="public"/>
  </fvBD>

  <vzBrCP name="webCtrct" scope="global">
    <vzSubj name="http">
      <vzRsSubjFiltAtt tnVzFilterName="default"/>
    </vzSubj>
  </vzBrCP>

  <!-- GOLF L3Out -->
  <l3extOut name="routAccounting">
    <l3extConsLbl name="golf_transit" owner="infra" status="" />
    <bgpExtP/>
    <l3extInstP name="accountingInst">
      <!--
      <l3extSubnet ip="192.2.2.0/24" scope="import-security,import-rtctrl" />
      <l3extSubnet ip="192.3.2.0/24" scope="export-rtctrl"/>
      <l3extSubnet ip="192.5.2.0/24" scope="export-rtctrl"/>
      <l3extSubnet ip="64:ff9b::c007:200/120" scope="export-rtctrl" />
      -->
      <l3extSubnet ip="0.0.0.0/0"

```

```

scope="export-rtctrl,import-security"
aggregate="export-rtctrl"

/>
<fvRsProv tnVzBrCPName="webCtrct"/>
</l3extInstP>

<l3extRsEctx tnFvCtxName="coke"/>
</l3extOut>

<fvAp name="cokeAp">
  <fvAEPg name="cokeEPg" >
    <fvRsBd tnFvBDName="cokeBD" />
    <fvRsPathAtt tDn="topology/pod-1/paths-103/pathep-[eth1/20]" encap="vlan-100"
instrImedcy="immediate" mode="regular"/>
    <fvRsCons tnVzBrCPName="webCtrct"/>
  </fvAEPg>
  <fvAEPg name="cokeEPg2" >
    <fvRsBd tnFvBDName="cokeBD2" />
    <fvRsPathAtt tDn="topology/pod-1/paths-103/pathep-[eth1/20]" encap="vlan-110"
instrImedcy="immediate" mode="regular"/>
    <fvRsCons tnVzBrCPName="webCtrct"/>
  </fvAEPg>
</fvAp>

<!-- Non GOLF L3Out-->
<l3extOut name="NonGolfOut">
  <bgpExtP/>
  <l3extLNodeP name="bLeaf">
    <!--
    <l3extRsNodeL3OutAtt tDn="topology/pod-1/node-101" rtrId="20.1.13.1"/>
    -->
    <l3extRsNodeL3OutAtt tDn="topology/pod-1/node-101" rtrId="20.1.13.1">
    <l3extLoopBackIfP addr="1.1.1.1"/>

    <ipRouteP ip="2.2.2.2/32" >
      <ipNextHopP nhAddr="20.1.12.3"/>
    </ipRouteP>

    </l3extRsNodeL3OutAtt>
    <l3extLIIfP name='portIfV4'>
      <l3extRsPathL3OutAtt tDn="topology/pod-1/paths-101/pathep-[eth1/17]"
encap='vlan-1010' ifInstT='sub-interface' addr="20.1.12.2/24">

      </l3extRsPathL3OutAtt>
    </l3extLIIfP>
    <l3extLIIfP name='portIfV6'>
      <l3extRsPathL3OutAtt tDn="topology/pod-1/paths-101/pathep-[eth1/17]"
encap='vlan-1010' ifInstT='sub-interface' addr="64:ff9b::1401:302/120">
      <bgpPeerP addr="64:ff9b::1401:d03" ctrl="send-com,send-ext-com" />
    </l3extRsPathL3OutAtt>
    </l3extLIIfP>
    <bgpPeerP addr="2.2.2.2" ctrl="as-override,disable-peer-as-check,
send-com,send-ext-com" status=""/>
  </l3extLNodeP>
  <!--
  <bgpPeerP addr="2.2.2.2" ctrl="send-com,send-ext-com" status=""/>
  -->
<l3extInstP name="accountingInst">
  <l3extSubnet ip="192.10.0.0/16" scope="import-security,import-rtctrl" />
  <l3extSubnet ip="192.3.3.0/24" scope="import-security,import-rtctrl" />
  <l3extSubnet ip="192.4.2.0/24" scope="import-security,import-rtctrl" />
  <l3extSubnet ip="64:ff9b::c007:200/120" scope="import-security,import-rtctrl"

```

```

/>
    <l3extSubnet ip="192.2.2.0/24" scope="export-rtctrl" />
    <l3extSubnet ip="0.0.0.0/0"
        scope="export-rtctrl,import-rtctrl,import-security"
        aggregate="export-rtctrl,import-rtctrl"
    />
  </l3extInstP>
  <l3extRsEctx tnFvCtxName="coke"/>
</l3extOut>

</fvTenant>

```

Configuring BGP Neighbor Shutdown and Soft Reset Using the REST API

Configuring BGP Neighbor Shutdown Using the REST API

The following procedure describes how to use the BGP neighbor shutdown feature using the REST API.

Procedure

Step 1 Configure the node and interface.

This example configures VRF `v1` on node 103 (the border leaf switch), with the node profile, `nodep1`, and router ID `11.11.11.103`. It also configures interface `eth1/3` as a routed interface (Layer 3 port), with IP address `12.12.12.1/24` and Layer 3 domain `dom1`.

Example:

```

<l3extOut name="l3out1">
  <l3extRsEctx tnFvCtxName="v1"/>
  <l3extLNodeP name="nodep1">
    <l3extRsNodeL3OutAtt rtrId="11.11.11.103" tDn="topology/pod-1/node-103"/>
    <l3extLIIfP name="ifp1"/>
    <l3extRsPathL3OutAtt addr="12.12.12.3/24" ifInstT="l3-port"
tDn="topology/pod-1/paths-103/pathep-[eth1/3]"/>
  </l3extLIIfP>
</l3extLNodeP>
  <l3extRsL3DomAtt tDn="uni/l3dom-dom1"/>
</l3extOut>

```

Step 2 Configure the BGP routing protocol and configure the BGP neighbor shutdown feature.

This example configures BGP as the primary routing protocol, with a BGP peer with the IP address, `15.15.15.2` and ASN 100.

The `adminSt` variable can be set to one of the following:

- **enabled:** Enables the BGP neighbor shutdown feature.
- **disabled:** Disables the BGP neighbor shutdown feature.

In the following example, the BGP neighbor shutdown feature is enabled.

Example:

```
<l3extOut name="l3out1">
  <l3extLNodeP name="nodep1">
    <bgpPeerP addr="15.15.15.2"> adminSt="enabled"
      <bgpAsP asn="100"/>
    </bgpPeerP>
  </l3extLNodeP>
  <bgpExtP/>
</l3extOut>
```

Configuring BGP Neighbor Soft Reset Using the REST API

The following procedure describes how to use the BGP neighbor soft reset feature using the REST API.

Procedure

Step 1 Configure the node and interface.

This example configures VRF `v1` on node 103 (the border leaf switch), with the node profile, `nodep1`, and router ID `11.11.11.103`. It also configures interface `eth1/3` as a routed interface (Layer 3 port), with IP address `12.12.12.1/24` and Layer 3 domain `dom1`.

Example:

```
<l3extOut name="l3out1">
  <l3extRsEctx tnFvCtxName="v1"/>
  <l3extLNodeP name="nodep1">
    <l3extRsNodeL3OutAtt rtrId="11.11.11.103" tDn="topology/pod-1/node-103"/>
    <l3extLIIfP name="ifp1"/>
    <l3extRsPathL3OutAtt addr="12.12.12.3/24" ifInstT="l3-port"
tDn="topology/pod-1/paths-103/pathep-[eth1/3]"/>
  </l3extLIIfP>
  </l3extLNodeP>
  <l3extRsL3DomAtt tDn="uni/l3dom-dom1"/>
</l3extOut>
```

Step 2 Configure the BGP routing protocol and configure the BGP neighbor soft reset feature.

This example configures BGP as the primary routing protocol, with a BGP peer with the IP address, `15.15.15.2` and ASN `100`.

The **dir** variable can be set to one of the following:

- **in**: Enables the soft dynamic inbound reset.
- **out**: Enables the soft outbound reset.

In the following example, the soft dynamic inbound reset is enabled.

Example:

```
<l3extOut name="l3out1">
  <l3extLNodeP name="nodep1">
    <bgpPeerP addr="15.15.15.2">
      <bgpAsP asn="100"/>
      <bgpPeerEntryClearPeerLTask>
        <attributes>
          <mode>soft</mode>
        </attributes>
      </bgpPeerEntryClearPeerLTask>
    </bgpPeerP>
  </l3extLNodeP>
</l3extOut>
```

```

        <dir>in</dir>
        <adminSt>start</adminSt>
      </attributes>
    </children/>
  </bgpPeerEntryClearPeerLTask>
</bgpPeerP>
</l3extLNodeP>
<bgpExtP/>
</l3extOut>

```

Configuring a Per VRF Per Node BGP Timer Using the REST API

The following example shows how to configure Per VRF Per node BGP timer in a node. Configure `bgpProtP` under `l3extLNodeP` configuration. Under `bgpProtP`, configure a relation (`bgpRsBgpNodeCtxPol`) to the desired BGP Context Policy (`bgpCtxPol`).

Procedure

Configure a node specific BGP timer policy on `node1`, and configure `node2` with a BGP timer policy that is not node specific.

Example:

POST `https://apic-ip-address/mo.xml`

```

<fvTenant name="tn1" >
  <bgpCtxPol name="pol1" staleIntvl="25" />
  <bgpCtxPol name="pol2" staleIntvl="35" />
  <fvCtx name="ctx1" >
    <fvRsBgpCtxPol tnBgpCtxPolName="pol1"/>
  </fvCtx>
  <l3extout name="out1" >
    <l3extRsEctx toFvCtxName="ctx1" />
    <l3extLNodeP name="node1" >
      <bgpProtP name="protpl" >
        <bgpRsBgpNodeCtxPol tnBgpCtxPolName="pol2" />
      </bgpProtP>
    </l3extLNodeP>
    <l3extLNodeP name="node2" >
    </l3extLNodeP>

```

In this example, `node1` gets BGP timer values from policy `pol2`, and `node2` gets BGP timer values from `pol1`. The timer values are applied to the `bgpDom` corresponding to VRF `tn1:ctx1`. This is based upon the BGP timer policy that is chosen following the algorithm described in the *Per VRF Per Node BGP Timer Values* section.

Deleting a Per VRF Per Node BGP Timer Using the REST API

The following example shows how to delete an existing Per VRF Per node BGP timer in a node.

Procedure

Delete the node specific BGP timer policy on `node1`.

Example:

POST `https://apic-ip-address/mo.xml`

```
<fvTenant name="tn1" >
  <bgpCtxPol name="pol1" staleIntvl="25" />
  <bgpCtxPol name="pol2" staleIntvl="35" />
  <fvCtx name="ctx1" >
    <fvRsBgpCtxPol tnBgpCtxPolName="pol1"/>
  </fvCtx>
  <l3extout name="out1" >
    <l3extRsEctx toFvCtxName="ctx1" />
    <l3extLNodeP name="node1" >
      <bgpProtP name="protp1" status="deleted" >
        <bgpRsBgpNodeCtxPol tnBgpCtxPolName="pol2" />
      </bgpProtP>
    </l3extLNodeP>
    <l3extLNodeP name="node2" >
      </l3extLNodeP>
  </l3extout>
</fvTenant>
```

The code phrase `<bgpProtP name="protp1" status="deleted" >` in the example above, deletes the BGP timer policy. After the deletion, `node1` defaults to the BGP timer policy for the VRF with which `node1` is associated, which is `pol1` in the above example.

Configuring Bidirectional Forwarding Detection on a Secondary IP Address Using the REST API

The following example configures bidirectional forwarding detection (BFD) on a secondary IP address using the REST API:

```
<l3extLIIfP
  dn="uni/tn-sec-ip-bfd/out-secip-bfd-l3out/lnodep-secip-bfd-l3out_nodeProfile/
  lifp-secip-bfd-l3out_interfaceProfile" name="secip-bfd-l3out_interfaceProfile"
  prio="unspecified" tag="yellow-green" userdom=":all:">
  <l3extRsPathL3OutAtt addr="50.50.50.200/24" autostate="disabled"
    encap="vlan-2" encapScope="local" ifInstT="ext-svi" ipv6Dad="enabled"
    isMultiPodDirect="no" llAddr="::" mac="00:22:BD:F8:19:FF" mode="regular"
    mtu="inherit" tDn="topology/pod-1/paths-101/pathep-[eth1/3]"
    targetDscp="unspecified" userdom=":all:">
    <l3extIp addr="9.9.9.1/24" ipv6Dad="enabled" userdom=":all:"/>
    <l3extIp addr="6.6.6.1/24" ipv6Dad="enabled" userdom=":all:"/>
  </l3extRsPathL3OutAtt>
  <l3extRsNdIfPol userdom="all"/>
  <l3extRsLIfPCustQosPol userdom="all"/>
  <l3extRsIngressQosDppPol userdom="all"/>
  <l3extRsEgressQosDppPol userdom="all"/>
  <l3extRsArpIfPol userdom="all"/>
</l3extLIIfP>
<ipRouteP aggregate="no"
  dn="uni/tn-sec-ip-bfd/out-secip-bfd-l3out/lnodep-secip-bfd-l3out_nodeProfile/
  rsnodeL3OutAtt-[topology/pod-1/node-101]/rt-[6.0.0.1/24]"
  fromPfxLen="0" ip="6.0.0.1/24" pref="1" rtCtrl="bfd" toPfxLen="0" userdom=":all:">
  <ipNextHopP nhAddr="6.6.6.2" pref="unspecified" type="prefix" userdom=":all:"/>
</ipRouteP>
```

Configuring BFD Globally Using the REST API

Procedure

The following REST API shows the global configuration for bidirectional forwarding detection (BFD):

Example:

```
<polUni>
  <infraInfra>
    <bfdIpv4InstPol name="default" echoSrcAddr="1.2.3.4" slowIntvl="1000" minTxIntvl="150"
minRxIntvl="250" detectMult="5" echoRxIntvl="200"/>
    <bfdIpv6InstPol name="default" echoSrcAddr="34::1/64" slowIntvl="1000" minTxIntvl="150"
minRxIntvl="250" detectMult="5" echoRxIntvl="200"/>
  </infraInfra>
</polUni>
```

Configuring BFD Interface Override Using the REST API

Procedure

The following REST API shows the interface override configuration for bidirectional forwarding detection (BFD):

Example:

```
<fvTenant name="ExampleCorp">
  <bfdIfPol name="bfdIfPol" minTxIntvl="400" minRxIntvl="400" detectMult="5" echoRxIntvl="400"
echoAdminSt="disabled"/>
  <l3extOut name="l3-out">
    <l3extLNodeP name="leaf1">
      <l3extRsNodeL3OutAtt tDn="topology/pod-1/node-101" rtrId="2.2.2.2"/>
      <l3extLIIFP name='portIpv4'>
        <l3extRsPathL3OutAtt tDn="topology/pod-1/paths-101/pathep-[eth1/11]"
ifInstT='l3-port' addr="10.0.0.1/24" mtu="1500"/>
        <bfdIfP type="sha1" key="password">
          <bfdRsIfPol tnBfdIfPolName='bfdIfPol' />
        </bfdIfP>
      </l3extLIIFP>
    </l3extLNodeP>
  </l3extOut>
</fvTenant>
```

Configuring BFD Consumer Protocols Using the REST API

Procedure

Step 1 The following example shows the interface configuration for bidirectional forwarding detection (BFD):

Example:

```
<fvTenant name="ExampleCorp">
  <bfdIfPol name="bfdIfPol" minTxIntvl="400" minRxIntvl="400" detectMult="5" echoRxIntvl="400"
  echoAdminSt="disabled"/>
  <l3extOut name="l3-out">
    <l3extLNodeP name="leaf1">
      <l3extRsNodeL3OutAtt tDn="topology/pod-1/node-101" rtrId="2.2.2.2"/>

      <l3extLIIfP name='portIpv4'>
        <l3extRsPathL3OutAtt tDn="topology/pod-1/paths-101/pathep-[eth1/11]"
        ifInstT='l3-port' addr="10.0.0.1/24" mtu="1500"/>
        <bfdIfP type="sha1" key="password">
          <bfdRsIfPol tnBfdIfPolName='bfdIfPol' />
        </bfdIfP>
      </l3extLIIfP>
    </l3extLNodeP>
  </l3extOut>
</fvTenant>
```

Step 2 The following example shows the interface configuration for enabling BFD on OSPF and EIGRP:

Example:

BFD on leaf switch

```
<fvTenant name="ExampleCorp">
  <ospfIfPol name="ospf_intf_pol" cost="10" ctrl="bfd"/>
  <eigrpIfPol ctrl="nh-self,split-horizon,bfd"
  dn="uni/tn-Coke/eigrpIfPol-eigrp_if_default"
</fvTenant>
```

Example:

BFD on spine switch

```
<l3extLNodeP name="bSpine">

  <l3extRsNodeL3OutAtt tDn="topology/pod-1/node-103" rtrId="192.3.1.8">
    <l3extLoopBackIfP addr="10.10.3.1" />
    <l3extInfraNodeP fabricExtCtrlPeering="false" />
  </l3extRsNodeL3OutAtt>

  <l3extLIIfP name='portIf'>
    <l3extRsPathL3OutAtt tDn="topology/pod-1/paths-103/pathep-[eth5/10]"
    encap='vlan-4' ifInstT='sub-interface' addr="20.3.10.1/24"/>
    <ospfIfP>
      <ospfRsIfPol tnOspfIfPolName='ospf_intf_pol' />
    </ospfIfP>
    <bfdIfP name="test" type="sha1" key="hello" status="created,modified">
      <bfdRsIfPol tnBfdIfPolName='default' status="created,modified"/>
    </bfdIfP>
  </l3extLIIfP>
```

```
</l3extLNodeP>
```

Step 3 The following example shows the interface configuration for enabling BFD on BGP:

Example:

```
<fvTenant name="ExampleCorp">
  <l3extOut name="l3-out">
    <l3extLNodeP name="leaf1">
      <l3extRsNodeL3OutAtt tDn="topology/pod-1/node-101" rtrId="2.2.2.2"/>

      <l3extLIIF name='portIpv4'>
        <l3extRsPathL3OutAtt tDn="topology/pod-1/paths-101/pathep-[eth1/11]"
ifInstT='l3-port' addr="10.0.0.1/24" mtu="1500">
          <bgpPeerP addr="4.4.4.4/24" allowedSelfAsCnt="3" ctrl="bfd" descr=""
name="" peerCtrl="" ttl="1">
            <bgpRsPeerPfxPol tnBgpPeerPfxPolName=""/>
            <bgpAsP asn="3" descr="" name=""/>
          </bgpPeerP>
        </l3extRsPathL3OutAtt>
      </l3extLIIF>

    </l3extLNodeP>
  </l3extOut>
</fvTenant>
```

Step 4 The following example shows the interface configuration for enabling BFD on Static Routes:

Example:

BFD on leaf switch

```
<fvTenant name="ExampleCorp">
  <l3extOut name="l3-out">
    <l3extLNodeP name="leaf1">
      <l3extRsNodeL3OutAtt tDn="topology/pod-1/node-101" rtrId="2.2.2.2">
        <ipRouteP ip="192.168.3.4" rtCtrl="bfd">
          <ipNextHopP nhAddr="192.168.62.2"/>
        </ipRouteP>
      </l3extRsNodeL3OutAtt>
    <l3extLIIF name='portIpv4'>
      <l3extRsPathL3OutAtt tDn="topology/pod-1/paths-101/pathep-[eth1/3]"
ifInstT='l3-port' addr="10.10.10.2/24" mtu="1500" status="created,modified" />
    </l3extLIIF>

  </l3extLNodeP>

</l3extOut>
</fvTenant>
```

Example:

BFD on spine switch

```
<l3extLNodeP name="bSpine">

  <l3extRsNodeL3OutAtt tDn="topology/pod-1/node-103" rtrId="192.3.1.8">
    <ipRouteP ip="0.0.0.0" rtCtrl="bfd">
      <ipNextHopP nhAddr="192.168.62.2"/>
    </ipRouteP>
  </l3extRsNodeL3OutAtt>
```

```

    <l3extLIfP name='portIf'>
      <l3extRsPathL3OutAtt tDn="topology/pod-1/paths-103/pathep-[eth5/10]"
encap='vlan-4' ifInstT='sub-interface' addr="20.3.10.1/24"/>

      <bfdIfP name="test" type="sha1" key="hello" status="created,modified">
        <bfdRsIfPol tnBfdIfPolName='default' status="created,modified"/>
      </bfdIfP>
    </l3extLIfP>
  </l3extLNodeP>

```

Step 5 The following example shows the interface configuration for enabling BFD on IS-IS:

Example:

```

<fabricInst>
  <l3IfPol name="testL3IfPol" bfdIisis="enabled"/>
  <fabricLeafP name="LeNode" >
    <fabricRsLePortP tDn="uni/fabric/leportp-leaf_profile" />
    <fabricLeafS name="spsw" type="range">
    <fabricNodeBlk name="node101" to_"=102" from_"="101" />
  </fabricLeafS>
  </fabricLeafP>

  <fabricSpineP name="SpNode" >
  <fabricRsSpPortP tDn="uni/fabric/spportp-spine_profile" />
  <fabricSpineS name="spsw" type="range">
    <fabricNodeBlk name="node103" to_"=103" from_"="103" />
  </fabricSpineS>
  </fabricSpineP>

  <fabricLePortP name="leaf_profile">
  <fabricLFPortS name="leafIf" type="range">
  <fabricPortBlk name="spBlk" fromCard="1" fromPort="49" toCard="1" toPort="49" />
  <fabricRsLePortPGrp tDn="uni/fabric/funcprof/leportgrp-LeTestPGrp" />
  </fabricLFPortS>
  </fabricLePortP>

  <fabricSpPortP name="spine_profile">
  <fabricSFPortS name="spineIf" type="range">
    <fabricPortBlk name="spBlk" fromCard="5" fromPort="1" toCard="5" toPort="2" />
    <fabricRsSpPortPGrp tDn="uni/fabric/funcprof/spportgrp-SpTestPGrp" />
  </fabricSFPortS>
  </fabricSpPortP>

  <fabricFuncP>
    <fabricLePortPGrp name = "LeTestPGrp">
  <fabricRsL3IfPol tnL3IfPolName="testL3IfPol"/>
  </fabricLePortPGrp>

    <fabricSpPortPGrp name = "SpTestPGrp">
  <fabricRsL3IfPol tnL3IfPolName="testL3IfPol"/>
  </fabricSpPortPGrp>

</fabricFuncP>
</fabricInst>

```

Configuring OSPF External Routed Networks Using REST API

Creating OSPF External Routed Network for Management Tenant Using REST API

- You must verify that the router ID and the logical interface profile IP address are different and do not overlap.
- The following steps are for creating an OSPF external routed network for a management tenant. To create an OSPF external routed network for a tenant, you must choose a tenant and create a VRF for the tenant.
- For more details, see *Cisco APIC and Transit Routing*.

Procedure

Create an OSPF external routed network for management tenant.

Example:

POST: `https://apic-ip-address/api/mo/uni/tn-mgmt.xml`

```
<fvTenant name="mgmt">
  <fvBD name="bd1">
    <fvRsBDToOut tnL3extOutName="RtdOut" />
    <fvSubnet ip="1.1.1.1/16" />
    <fvSubnet ip="1.2.1.1/16" />
    <fvSubnet ip="40.1.1.1/24" scope="public" />
    <fvRsCtx tnFvCtxName="inb" />
  </fvBD>
  <fvCtx name="inb" />

  <l3extOut name="RtdOut">
    <l3extRsL3DomAtt tDn="uni/l3dom-extdom"/>
    <l3extInstP name="extMgmt">
      </l3extInstP>
      <l3extLNodeP name="borderLeaf">
        <l3extRsNodeL3OutAtt tDn="topology/pod-1/node-101" rtrId="10.10.10.10"/>
        <l3extRsNodeL3OutAtt tDn="topology/pod-1/node-102" rtrId="10.10.10.11"/>
        <l3extLIfP name='portProfile'>
          <l3extRsPathL3OutAtt tDn="topology/pod-1/paths-101/pathep-[eth1/40]"
ifInstT='l3-port' addr="192.168.62.1/24"/>
          <l3extRsPathL3OutAtt tDn="topology/pod-1/paths-102/pathep-[eth1/40]"
ifInstT='l3-port' addr="192.168.62.5/24"/>
          <ospfIfP/>
        </l3extLIfP>
      </l3extLNodeP>
      <l3extRsEctx tnFvCtxName="inb"/>
      <ospfExtP areaId="57" />
    </l3extOut>
  </fvTenant>
```

Configuring EIGRP External Routed Networks Using REST API

Configuring EIGRP Using the REST API

Procedure

Step 1 Configure an EIGRP context policy.

Example:

```
<polUni>
  <fvTenant name="cisco_6">
    <eigrpCtxAfPol actIntvl="3" descr="" dn="uni/tn-cisco_6/eigrpCtxAfP-eigrp_default_pol"
    extDist="170"
      intDist="90" maxPaths="8" metricStyle="narrow" name="eigrp_default_pol" ownerKey=""
    ownerTag=""/>
  </fvTenant>
</polUni>
```

Step 2 Configure an EIGRP interface policy.

Example:

```
<polUni>
  <fvTenant name="cisco_6">
    <eigrpIfPol bw="10" ctrl="nh-self,split-horizon" delay="10" delayUnit="tens-of-micro"
    descr="" dn="uni/tn-cisco_6/eigrpIfPol-eigrp_if_default"
      helloIntvl="5" holdIntvl="15" name="eigrp_if_default" ownerKey="" ownerTag=""/>
  </fvTenant>
</polUni>
```

Step 3 Configure an EIGRP VRF.

Example:

IPv4:

```
<polUni>
  <fvTenant name="cisco_6">
    <fvCtx name="dev">
      <fvRsCtxToEigrpCtxAfPol tnEigrpCtxAfPolName="eigrp_ctx_pol_v4" af="1"/>
    </fvCtx>
  </fvTenant>
</polUni>
```

IPv6:

```
<polUni>
  <fvTenant name="cisco_6">
    <fvCtx name="dev">
      <fvRsCtxToEigrpCtxAfPol tnEigrpCtxAfPolName="eigrp_ctx_pol_v6" af="ipv6-ucast"/>
    </fvCtx>
  </fvTenant>
</polUni>
```

Step 4 Configure an EIGRP Layer3 Outside.

Example:

IPv4

```
<polUni>
  <fvTenant name="cisco_6">
```

```

    <l3extOut name="ext">
      <eigrpExtP asn="4001"/>
      <l3extLNodeP name="node1">
        <l3extLIIfP name="intf_v4">
          <l3extRsPathL3OutAtt addr="201.1.1.1/24" ifInstT="l3-port"
            tDn="topology/pod-1/paths-101/pathep-[eth1/4]"/>
          <eigrpIfP name="eigrp_ifp_v4">
            <eigrpRsIfPol tnEigrpIfPolName="eigrp_if_pol_v4"/>
          </eigrpIfP>
        </l3extLIIfP>
      </l3extLNodeP>
    </l3extOut>
  </fvTenant>
</polUni>

```

IPv6

```

<polUni>
  <fvTenant name="cisco_6">
    <l3extOut name="ext">
      <eigrpExtP asn="4001"/>
      <l3extLNodeP name="node1">
        <l3extLIIfP name="intf_v6">
          <l3extRsPathL3OutAtt addr="2001::1/64" ifInstT="l3-port"
            tDn="topology/pod-1/paths-101/pathep-[eth1/4]"/>
          <eigrpIfP name="eigrp_ifp_v6">
            <eigrpRsIfPol tnEigrpIfPolName="eigrp_if_pol_v6"/>
          </eigrpIfP>
        </l3extLIIfP>
      </l3extLNodeP>
    </l3extOut>
  </fvTenant>
</polUni>

```

IPv4 and IPv6

```

<polUni>
  <fvTenant name="cisco_6">
    <l3extOut name="ext">
      <eigrpExtP asn="4001"/>
      <l3extLNodeP name="node1">
        <l3extLIIfP name="intf_v4">
          <l3extRsPathL3OutAtt addr="201.1.1.1/24" ifInstT="l3-port"
            tDn="topology/pod-1/paths-101/pathep-[eth1/4]"/>
          <eigrpIfP name="eigrp_ifp_v4">
            <eigrpRsIfPol tnEigrpIfPolName="eigrp_if_pol_v4"/>
          </eigrpIfP>
        </l3extLIIfP>

        <l3extLIIfP name="intf_v6">
          <l3extRsPathL3OutAtt addr="2001::1/64" ifInstT="l3-port"
            tDn="topology/pod-1/paths-101/pathep-[eth1/4]"/>
          <eigrpIfP name="eigrp_ifp_v6">
            <eigrpRsIfPol tnEigrpIfPolName="eigrp_if_pol_v6"/>
          </eigrpIfP>
        </l3extLIIfP>
      </l3extLNodeP>
    </l3extOut>
  </fvTenant>
</polUni>

```

Step 5 (Optional) Configure the interface policy knobs.

Example:

```

<polUni>
  <fvTenant name="cisco_6">
    <eigrpIfPol bw="1000000" ctrl="nh-self,split-horizon" delay="10"
      delayUnit="tens-of-micro" helloIntvl="5" holdIntvl="15" name="default"/>
  </fvTenant>
</polUni>

```

The `bandwidth (bw)` attribute is defined in Kbps. The `delayUnit` attribute can be "tens of micro" or "pico".

Configuring Route Summarization Using REST API

Configuring Route Summarization for BGP, OSPF, and EIGRP Using the REST API

Procedure

Step 1 Configure BGP route summarization using the REST API as follows:

Example:

```

<fvTenant name="common">
  <fvCtx name="vrf1"/>
  <bgpRtSummPol name="bgp_rt_summ" cntrl='as-set'/>
  <l3extOut name="l3_ext_pol" >
    <l3extLNodeP name="bLeaf">
      <l3extRsNodeL3OutAtt tDn="topology/pod-1/node-101" rtrId="20.10.1.1"/>
      <l3extLIfP name='portIf'>
        <l3extRsPathL3OutAtt tDn="topology/pod-1/paths-101/pathep-[eth1/31]"
ifInstT='l3-port' addr="10.20.1.3/24"/>
      </l3extLIfP>
    </l3extLNodeP>
  <bgpExtP />
  <l3extInstP name="InstP" >
    <l3extSubnet ip="10.0.0.0/8" scope="export-rtctrl">
      <l3extRsSubnetToRtSumm tDn="uni/tn-common/bgpsum-bgp_rt_summ"/>
      <l3extRsSubnetToProfile tnRtctrlProfileName="rtprof"/>
    </l3extSubnet>
  </l3extInstP>
  <l3extRsEctx tnFvCtxName="vrf1"/>
</l3extOut>
</fvTenant>

```

Step 2 Configure OSPF inter-area and external summarization using the following REST API:

Example:

```

<?xml version="1.0" encoding="utf-8"?>
<fvTenant name="t20">
  <!--Ospf Inter External route summarization Policy-->
  <ospfRtSummPol cost="unspecified" interAreaEnabled="no" name="ospfext"/>
  <!--Ospf Inter Area route summarization Policy-->
  <ospfRtSummPol cost="16777215" interAreaEnabled="yes" name="interArea"/>
  <fvCtx name="ctx0" pcEnfDir="ingress" pcEnfPref="enforced"/>
  <!-- L3OUT backbone Area-->
  <l3extOut enforceRtctrl="export" name="l3_1" ownerKey="" ownerTag=""

```

```

targetDscp="unspecified">
  <l3extRsEctx tnFvCtxName="ctx0"/>
  <l3extLNodeP name="node-101">
    <l3extRsNodeL3OutAtt rtrId="20.1.3.2" rtrIdLoopBack="no" tDn="topology/pod-1/node-101"/>

    <l3extLIIfP name="intf-1">
      <l3extRsPathL3OutAtt addr="20.1.5.2/24" encap="vlan-1001" ifInstT="sub-interface"
tDn="topology/pod-1/paths-101/pathep-[eth1/33]"/>
    </l3extLIIfP>
  </l3extLNodeP>
  <l3extInstP name="l3InstP1">
    <fvRsProv tnVzBrCPName="default"/>
    <!--Ospf External Area route summarization-->
    <l3extSubnet aggregate="" ip="193.0.0.0/8" name="" scope="export-rtctrl">
      <l3extRsSubnetToRtSumm tDn="uni/tn-t20/ospfsumm-ospfext"/>
    </l3extSubnet>
  </l3extInstP>
  <ospfExtP areaCost="1" areaCtrl="redistribute,summary" areaId="backbone"
areaType="regular"/>
</l3extOut>
<!-- L3OUT Regular Area-->
<l3extOut enforceRtctrl="export" name="l3_2">
  <l3extRsEctx tnFvCtxName="ctx0"/>
  <l3extLNodeP name="node-101">
    <l3extRsNodeL3OutAtt rtrId="20.1.3.2" rtrIdLoopBack="no" tDn="topology/pod-1/node-101"/>

    <l3extLIIfP name="intf-2">
      <l3extRsPathL3OutAtt addr="20.1.2.2/24" encap="vlan-1014" ifInstT="sub-interface"
tDn="topology/pod-1/paths-101/pathep-[eth1/11]"/>
    </l3extLIIfP>
  </l3extLNodeP>
  <l3extInstP matchT="AtleastOne" name="l3InstP2">
    <fvRsCons tnVzBrCPName="default"/>
    <!--Ospf Inter Area route summarization-->
    <l3extSubnet aggregate="" ip="197.0.0.0/8" name="" scope="export-rtctrl">
      <l3extRsSubnetToRtSumm tDn="uni/tn-t20/ospfsumm-interArea"/>
    </l3extSubnet>
  </l3extInstP>
  <ospfExtP areaCost="1" areaCtrl="redistribute,summary" areaId="0.0.0.57"
areaType="regular"/>
</l3extOut>
</fvTenant>

```

Step 3 Configure EIGRP summarization using the following REST API:

Example:

```

<fvTenant name="exampleCorp">
  <l3extOut name="out1">
    <l3extInstP name="eigrpSummInstp" >
      <l3extSubnet aggregate="" descr="" ip="197.0.0.0/8" name="" scope="export-rtctrl">
        <l3extRsSubnetToRtSumm/>
      </l3extSubnet>
    </l3extInstP>
  </l3extOut>
  <eigrpRtSummPol name="pol1" />

```

Note

There is no route summarization policy to be configured for EIGRP. The only configuration needed for enabling EIGRP summarization is the summary subnet under the InstP.

Configuring Route Control with Route Maps and Route Profile Using REST API

Configuring Route Control Per BGP Peer Using the REST API

The following procedure describes how to configure the route control per BGP peer feature using the REST API.

Procedure

Configure the route control per BGP peer feature.

Where:

- **direction="import"** is the route import policy (routes allowed into the fabric)
- **direction="export"** is the route export policy (routes advertised out the external network)

Example:

```
<polUni>
  <fvTenant name="t1">
    <fvCtx name="v1"/>
    <l3extOut name="l3out1">
      <l3extRsEctx tnFvCtxName="v1"/>
      <l3extLNodeP name="nodep1">
        <l3extRsNodeL3OutAtt rtrId="11.11.11.103" tDn="topology/pod-1/node-103"/>
        <l3extLIIfP name="ifp1">
          <l3extRsPathL3OutAtt addr="12.12.12.3/24" ifInstT="l3-port"
tDn="topology/pod-1/paths-103/pathep-[eth1/3]"/>
        </l3extLIIfP>
        <bgpPeerP addr="15.15.15.2">
          <bgpAsP asn="100"/>
          <bgpRsPeerToProfile direction="export" tnRtctrlProfileName="rp1"/>
        </bgpPeerP>
      </l3extLNodeP>
      <l3extRsL3DomAtt tDn="uni/l3dom-dom1"/>
      <bgpExtP/>
      <ospfExtP areaId="0.0.0.0" areaType="regular"/>
      <l3extInstP name="extnw1" >
        <l3extSubnet ip="20.20.20.0/24" scope="import-security"/>
      </l3extInstP>
    </l3extOut>
  <rtctrlProfile name="rp1">
    <rtctrlCtxP name="ctxp1" action="permit" order="0">
      <rtctrlScope>
        <rtctrlRsScopeToAttrP tnRtctrlAttrPName="attrp1"/>
      </rtctrlScope>
      <rtctrlRsCtxPToSubjP tnRtctrlSubjPName="match-rule1"/>
    </rtctrlCtxP>
  </rtctrlProfile>
  <rtctrlSubjP name="match-rule1">
```

```

        <rtctrlMatchRtDest ip="200.3.2.0/24"/>
      </rtctrlSubjP>
    <rtctrlAttrP name="attrp1">
      <rtctrlSetASPath criteria="prepend">
        <rtctrlSetASPathASN asn="100" order="2"/>
        <rtctrlSetASPathASN asn="200" order="1"/>
      </rtctrlSetASPath>
    </rtctrlAttrP>
  </fvTenant>
</polUni>

```

Configuring Route Map/Profile with Explicit Prefix List Using REST API

Before you begin

- Tenant and VRF must be configured.

Procedure

Configure the route map/profile using explicit prefix list.

Note

The entries shown in **bold** below are enhancements for match prefix that are available for APIC releases 4.2(3) and later. For more information on these fields, see [Enhancements for Match Prefix, on page 313](#).

Example:

```

<?xml version="1.0" encoding="UTF-8"?>
<fvTenant name="PM" status="">
  <rtctrlAttrP name="set_dest">
    <rtctrlSetComm community="regular:as2-nn2:5:24" />
  </rtctrlAttrP>
  <rtctrlSubjP name="allow_dest">
    <rtctrlMatchRtDest ip="192.169.0.0/24" aggregate="yes" fromPfxLen="26" toPfxLen="30"
  />
    <rtctrlMatchCommTerm name="term1">
      <rtctrlMatchCommFactor community="regular:as2-nn2:5:24" status="" />
      <rtctrlMatchCommFactor community="regular:as2-nn2:5:25" status="" />
    </rtctrlMatchCommTerm>
    <rtctrlMatchCommRegexTerm commType="regular" regex="200:*" status="" />
  </rtctrlSubjP>
  <rtctrlSubjP name="deny_dest">
    <rtctrlMatchRtDest ip="192.168.0.0/24" />
  </rtctrlSubjP>
</fvTenant>
<fvCtx name="ctx" />
<l3extOut name="L3Out_1" enforceRtctrl="import,export" status="">
  <l3extRsEctx tnFvCtxName="ctx" />
  <l3extLNodeP name="bLeaf">
    <l3extRsNodeL3OutAtt tDn="topology/pod-1/node-101" rtrId="1.2.3.4" />
    <l3extLIIfP name="portIf">
      <l3extRsPathL3OutAtt tDn="topology/pod-1/paths-101/pathep-[eth1/25]"
ifInstT="sub-interface" encap="vlan-1503" addr="10.11.12.11/24" />
      <ospfIfP />
    </l3extLIIfP>
    <bgpPeerP addr="5.16.57.18/32" ctrl="send-com" />
    <bgpPeerP addr="6.16.57.18/32" ctrl="send-com" />
  </l3extLNodeP>
</l3extOut>

```

```

</l3extLNodeP>
<bgpExtP />
<ospfExtP areaId="0.0.0.59" areaType="nssa" status="" />
<l3extInstP name="l3extInstP_1" status="">
  <l3extSubnet ip="17.11.1.11/24" scope="import-security" />
</l3extInstP>
<rtctrlProfile name="default-export" type="global" status="">
  <rtctrlCtxP name="ctx_deny" action="deny" order="1">
    <rtctrlRsCtxPToSubjP tnRtctrlSubjPName="deny_dest" status="" />
  </rtctrlCtxP>
  <rtctrlCtxP name="ctx_allow" order="2">
    <rtctrlRsCtxPToSubjP tnRtctrlSubjPName="allow_dest" status="" />
  </rtctrlCtxP>
  <rtctrlScope name="scope" status="">
    <rtctrlRsScopeToAttrP tnRtctrlAttrPName="set_dest" status="" />
  </rtctrlScope>
</rtctrlProfile>
</l3extOut>
<fvBD name="testBD">
  <fvRsBDToOut tnL3extOutName="L3Out_1" />
  <fvRsCtx tnFvCtxName="ctx" />
  <fvSubnet ip="40.1.1.12/24" scope="public" />
  <fvSubnet ip="40.1.1.2/24" scope="private" />
  <fvSubnet ip="2003::4/64" scope="public" />
</fvBD>
</fvTenant>

```

Configuring a Route Control Protocol to Use Import and Export Controls, With the REST API

This example assumes that you have configured the Layer 3 outside network connections using BGP. It is also possible to perform these tasks for a network using OSPF.

Before you begin

- The tenant, private network, and bridge domain are created.
- The Layer 3 outside tenant network is configured.

Procedure

Configure the route control protocol using import and export controls.

Example:

```

<l3extOut descr="" dn="uni/tn-Ten_ND/out-L3Out1" enforceRtctrl="export" name="L3Out1"
ownerKey="" ownerTag="" targetDscp="unspecified">
  <l3extLNodeP descr="" name="LNodeP1" ownerKey="" ownerTag="" tag="yellow-green"
targetDscp="unspecified">
    <l3extRsNodeL3OutAtt rtrId="1.2.3.4" rtrIdLoopBack="yes"
tDn="topology/pod-1/node-101">
      <l3extLoopBackIfP addr="2000::3" descr="" name="" />
    </l3extRsNodeL3OutAtt>
  <l3extLIIfP descr="" name="IFP1" ownerKey="" ownerTag="" tag="yellow-green">
    <ospfIfP authKeyId="1" authType="none" descr="" name="">
      <ospfRsIfPol tnOspfIfPolName="" />
    </ospfIfP>
  </l3extLNodeP>
</l3extOut>

```

```

        <l3extRsNdIfPol tnNdIfPolName=""/>
        <l3extRsPathL3OutAtt addr="10.11.12.10/24" descr="" encap="unknown"
ifInstT="l3-port"
llAddr="::" mac="00:22:BD:F8:19:FF" mtu="1500" tDn="topology/pod-1/paths-101/pathep-[eth1/17]"
targetDscp="unspecified"/>
    </l3extLIIfP>
    </l3extLNodeP>
    <l3extRsEctx tnFvCtxName="PVN1"/>
    <l3extInstP descr="" matchT="AtleastOne" name="InstP1" prio="unspecified"
targetDscp="unspecified">
        <fvRsCustQosPol tnQosCustomPolName=""/>
        <l3extSubnet aggregate="" descr="" ip="192.168.1.0/24" name="" scope=""/>
    </l3extInstP>
    <ospfExtP areaCost="1" areaCtrl="redistribute,summary" areaId="0.0.0.1"
areaType="nssa" descr=""/>
    <rtctrlProfile descr="" name="default-export" ownerKey="" ownerTag="">
        <rtctrlCtxP descr="" name="routecontrolpvtw" order="3">
            <rtctrlScope descr="" name="">
                <rtctrlRsScopeToAttrP tnRtctrlAttrPName="actionruleprofile2"/>
            </rtctrlScope>
        </rtctrlCtxP>
    </rtctrlProfile>
</l3extOut>

```

Configuring Interleak Redistribution Using the REST API

The following procedure describes how to configure the interleak redistribution using the REST API.

Before you begin

Create the tenant, VRF, and L3Out.

Procedure

Step 1 Configure the route-map for interleak redistribution.

Example:

The following example configures a route map `INTERLEAK_RP` with two contexts (`ROUTES_A` and `ROUTES_ALL`). The first context `ROUTES_A` matches with an IP prefix-list `10.0.0.0/24 le 32` to set a community attribute via set rule `COM_A`. The second context matches with all routes.

```

POST: https://<APIC IP>/api/mo/uni.xml
BODY:
<fvTenant dn="uni/tn-SAMPLE">
    <!-- route map with two contexts (ROUTES_A and ROUTES_ALL)-->
    <rtctrlProfile type="global" name="INTERLEAK_RP">
        <rtctrlCtxP name="ROUTES_A" order="0" action="permit">
            <rtctrlRsCtxPToSubjP tnRtctrlSubjPName="PFX_10-0-0-0_24"/>
            <rtctrlScope>
                <rtctrlRsScopeToAttrP tnRtctrlAttrPName="COM_A"/>
            </rtctrlScope>
        </rtctrlCtxP>
        <rtctrlCtxP name="ROUTES_ALL" order="9" action="permit">
            <rtctrlRsCtxPToSubjP tnRtctrlSubjPName="ALL_PREFIX"/>
        </rtctrlCtxP>
    </rtctrlProfile>

```

```

<!-- match rule with an IP prefix-list -->
<rtctrlSubjP name="ALL_PREFIX">
  <rtctrlMatchRtDest ip="0.0.0.0/0" aggregate="yes"/>
</rtctrlSubjP>

<!-- match rule with an IP prefix-list -->
<rtctrlSubjP name="PFX_10-0-0-0_24">
  <rtctrlMatchRtDest ip="10.0.0.0/24" aggregate="yes"/>
</rtctrlSubjP>

<!-- setu rule for community attribute -->
<rtctrlAttrP name="COM_A">
  <rtctrlSetComm type="community" setCriteria="append"
community="regular:as2-nn2:100:200"/>
</rtctrlAttrP>
</fvTenant>

```

Step 2 Apply the configured route map to an L3Out.

The following example applies the route map from Step 1 to L3Out `l3out1` to customize interleaf redistribution of routes from the given L3Out.

`L3extRsInterleakPol` is applied for dynamic routing protocol (OSPF/EIGRP) routes used by the given L3Out. `L3extRsRedistributePol` is applied for static routes, as specified by the `src` attribute (`static`).

Example:

```

POST: https://<APIC IP>/api/mo/uni.xml
BODY:
<fvTenant dn="uni/tn-SAMPLE">
  <l3extOut name="l3out1">
    <!-- interleaf redistribution for OSPF/EIGRP routes -->
    <l3extRsInterleakPol tnRtctrlProfileName="INTERLEAK_RP"/>
    <!-- interleaf redistribution for static routes -->
    <l3extRsRedistributePol tnRtctrlProfileName="INTERLEAK_RP" src="static"/>
  </l3extOut>
</fvTenant>

```

Configuring Transit Routing Using REST API

Configuring Transit Routing Using the REST API

These steps describe how to configure transit routing for a tenant. This example deploys two L3Outs, in one VRF, on two border leaf switches, that are each connected to a separate router.

Before you begin

- Configure the node, port, functional profile, AEP, and Layer 3 domain.
- Create the external routed domain and associate it to the interface for the L3Out.
- Configure a BGP route reflector policy to propagate the routes within the fabric.

Procedure

Step 1 Configure the tenant and VRF.

This example configures tenant `t1` and VRF `v1`. The VRF is not yet deployed.

Example:

```
<fvTenant name="t1">
  <fvCtx name="v1"/>
</fvTenant>
```

Step 2 Configure the nodes and interfaces.

This example configures two L3Outs for the tenant `t1` and VRF `v1`, on two border leaf switches. The VRF has a Layer 3 domain, `dom1`.

- The first L3Out is on node 101, which is named `nodep1`. Node 101 is configured with router ID `11.11.11.103`. It has a routed interface `ifp1` at `eth1/3`, with the IP address `12.12.12.3/24`.
- The second L3Out is on node 102, which is named `nodep2`. Node 102 is configured with router ID `22.22.22.203`. It has a routed interface `ifp2` at `eth1/3`, with the IP address, `23.23.23.1/24`.

Example:

```
<l3extOut name="l3out1">
  <l3extRsEctx tnFvCtxName="v1"/>
  <l3extLNodeP name="nodep1">
    <l3extRsNodeL3OutAtt rtrId="11.11.11.103" tDn="topology/pod-1/node-101"/>
    <l3extLIIfP name="ifp1"/>
    <l3extRsPathL3OutAtt addr="12.12.12.3/24" ifInstT="l3-port"
tDn="topology/pod-1/paths-101/pathep-[eth1/3]"/>
  </l3extLIIfP>
</l3extLNodeP>
  <l3extRsL3DomAtt tDn="uni/l3dom-dom1"/>
</l3extOut>

<l3extOut name="l3out2">
  <l3extRsEctx tnFvCtxName="v1"/>
  <l3extLNodeP name="nodep2">
    <l3extRsNodeL3OutAtt rtrId="22.22.22.203" tDn="topology/pod-1/node-102"/>
    <l3extLIIfP name="ifp2"/>
    <l3extRsPathL3OutAtt addr="23.23.23.3/24" ifInstT="l3-port"
tDn="topology/pod-1/paths-102/pathep-[eth1/3]"/>
  </l3extLIIfP>
</l3extLNodeP>
  <l3extRsL3DomAtt tDn="uni/l3dom-dom1"/>
</l3extOut>
```

Step 3 Configure the routing protocol for both border leaf switches.

This example configures BGP as the primary routing protocol for both the border leaf switches, both with ASN 100. It also configures Node 101 with BGP peer `15.15.15.2` and node 102 with BGP peer `25.25.25.2`.

Example:

```
<l3extOut name="l3out1">
  <l3extLNodeP name="nodep1">
    <bgpPeerP addr="15.15.15.2/24"
  <bgpAsP asn="100"/>
    </bgpPeerP>
  </l3extLNodeP>
```

```

</l3extOut>

<l3extOut name="l3out2">
  <l3extLNodeP name="nodep2">
    <bgpPeerP addr="25.25.25.2/24"
      <bgpAsP asn="100"/>
    </bgpPeerP>
  </l3extLNodeP>
</l3extOut>

```

Step 4 Configure a connectivity routing protocol.

This example configures OSPF as the communication protocol, for both L3Outs, with regular area ID 0.0.0.0.

Example:

```

<l3extOut name="l3out1">
  <ospfExtP areaId="0.0.0.0" areaType="regular"/>
  <l3extLNodeP name="nodep1">
    <l3extLIIfP name="ifp1">
      <ospfIfP/>
    <l3extIfP>
  </l3extLNodeP>
</l3extOut>
<l3extOut name="l3out2">
  <ospfExtP areaId="0.0.0.0" areaType="regular"/>
  <l3extLNodeP name="nodep2">
    <l3extLIIfP name="ifp2">
      <ospfIfP/>
    <l3extIfP>
  </l3extLNodeP>
</l3extOut>

```

Step 5 Configure the external EPGs.

This example configures the network 192.168.1.0/24 as external network `extnw1` on node 101 and 192.168.2.0/24 as external network `extnw2` on node 102. It also associates the external EPGs with the route control profiles `rp1` and `rp2`.

Example:

```

<l3extOut name="l3out1">
  <l3extInstP name="extnw1">
    <l3extSubnet ip="192.168.1.0/24" scope="import-security"/>
    <l3extRsInstPToProfile direction="export" tnRtctrlProfileName="rp1"/>
  </l3extInstP>
</l3extOut>
<l3extOut name="l3out2">
  <l3extInstP name="extnw2">
    <l3extSubnet ip="192.168.2.0/24" scope="import-security"/>
    <l3extRsInstPToProfile direction="export" tnRtctrlProfileName="rp2"/>
  </l3extInstP>
</l3extOut>

```

Step 6 Optional. Configure a route map.

This example configures a route map for each BGP peer in the inbound and outbound directions. For `l3out1`, the route map `rp1` is applied for routes that match an import destination of 192.168.1.0/24 and the route map `rp2` is applied for routes that match an export destination of 192.168.2.0/24. For `l3out2`, the direction of the route maps is reversed.

Example:

```

<fvTenant name="t1">
  <rtctrlSubjP name="match-rule1">
    <rtctrlMatchRtDest ip="192.168.1.0/24" />
  </rtctrlSubjP>
  <rtctrlSubjP name="match-rule2">
    <rtctrlMatchRtDest ip="192.168.2.0/24" />
  </rtctrlSubjP>
  <l3extOut name="l3out1">
    <rtctrlProfile name="rp1">
      <rtctrlCtxP name="ctxp1" action="permit" order="0">
        <rtctrlRsCtxPToSubjP tnRtctrlSubjPName="match-rule1" />
      </rtctrlCtxP>
    </rtctrlProfile>
    <rtctrlProfile name="rp2">
      <rtctrlCtxP name="ctxp1" action="permit" order="0">
        <rtctrlRsCtxPToSubjP tnRtctrlSubjPName="match-rule2" />
      </rtctrlCtxP>
    </rtctrlProfile>
    <l3extInstP name="extnw1">
      <l3extRsInstPToProfile direction="import" tnRtctrlProfileName="rp1" />
      <l3extRsInstPToProfile direction="export" tnRtctrlProfileName="rp2" />
    </l3extInstP>
  </l3extOut>
  <l3extOut name="l3out2">
    <rtctrlProfile name="rp1">
      <rtctrlCtxP name="ctxp1" action="permit" order="0">
        <rtctrlRsCtxPToSubjP tnRtctrlSubjPName="match-rule1" />
      </rtctrlCtxP>
    </rtctrlProfile>
    <rtctrlProfile name="rp2">
      <rtctrlCtxP name="ctxp1" action="permit" order="0">
        <rtctrlRsCtxPToSubjP tnRtctrlSubjPName="match-rule2" />
      </rtctrlCtxP>
    </rtctrlProfile>
    <l3extInstP name="extnw2">
      <l3extRsInstPToProfile direction="import" tnRtctrlProfileName="rp2" />
      <l3extRsInstPToProfile direction="export" tnRtctrlProfileName="rp1" />
    </l3extInstP>
  </l3extOut>
</fvTenant>

```

Step 7 Create the filter and contract to enable the EPGs to communicate.

This example configures the filter `http-filter` and the contract `httpCtrct`. The external EPGs and the application EPGs are already associated with the contract `httpCtrct` as providers and consumers respectively.

Example:

```

<vzFilter name="http-filter">
  <vzEntry name="http-e" etherT="ip" prot="tcp"/>
</vzFilter>
<vzBrCP name="httpCtrct" scope="context">
  <vzSubj name="subj1">
    <vzRsSubjFiltAtt tnVzFilterName="http-filter"/>
  </vzSubj>
</vzBrCP>

```

Step 8 Associate the external EPGs with the contract.

This example associates the external EPG `extnw1` as provider and external EPG `extnw2` as consumer of the contract `httpCtrct`.

```

<l3extOut name="l3out1">
  <l3extInstP name="extnw1">
    <fvRsProv tnVzBrCPName="httpCtrct"/>

```



```

    </l3extInstP>
  </l3extOut>
  <l3extOut name="l3out2">
    <l3extInstP name="extnw2">
      <fvRsCons tnVzBrCPName="httpCtrct"/>
    </l3extInstP>
  </l3extOut>

```

REST API Example: Transit Routing

The following example configures two L3Outs on two border leaf switches, using the REST API.

```

<?xml version="1.0" encoding="UTF-8"?>
<!-- api/policymgr/mo/.xml -->
<polUni>
  <fvTenant name="t1">
    <fvCtx name="v1"/>
    <l3extOut name="l3out1">
      <l3extRsEctx tnFvCtxName="v1"/>
      <l3extLNodeP name="nodep1">
        <bgpPeerP addr="15.15.15.2/24">
          <bgpAsP asn="100"/>
        </bgpPeerP>
        <l3extRsNodeL3OutAtt rtrId="11.11.11.103" tDn="topology/pod-1/node-101"/>
        <l3extLIIfP name="ifp1">
          <l3extRsPathL3OutAtt addr="12.12.12.3/24" ifInstT="l3-port"
tDn="topology/pod-1/paths-101/pathep-[eth1/3]" />
          <ospfIfP/>
        </l3extLIIfP>
      </l3extLNodeP>
      <l3extInstP name="extnw1">
        <l3extSubnet ip="192.168.1.0/24" scope="import-security"/>
        <l3extRsInstPToProfile direction="import" tnRtctrlProfileName="rp1"/>
        <l3extRsInstPToProfile direction="export" tnRtctrlProfileName="rp2"/>
        <fvRsProv tnVzBrCPName="httpCtrct"/>
      </l3extInstP>
      <bgpExtP/>
      <ospfExtP areaId="0.0.0.0" areaType="regular"/>
      <l3extRsL3DomAtt tDn="uni/l3dom-dom1"/>
      <rtctrlProfile name="rp1">
        <rtctrlCtxP name="ctxp1" action="permit" order="0">
          <rtctrlRsCtxPToSubjP tnRtctrlSubjPName="match-rule1"/>
        </rtctrlCtxP>
      </rtctrlProfile>
      <rtctrlProfile name="rp2">
        <rtctrlCtxP name="ctxp1" action="permit" order="0">
          <rtctrlRsCtxPToSubjP tnRtctrlSubjPName="match-rule2"/>
        </rtctrlCtxP>
      </rtctrlProfile>
    </l3extOut>
    <l3extOut name="l3out2">
      <l3extRsEctx tnFvCtxName="v1"/>
      <l3extLNodeP name="nodep2">
        <bgpPeerP addr="25.25.25.2/24">
          <bgpAsP asn="100"/>
        </bgpPeerP>
        <l3extRsNodeL3OutAtt rtrId="22.22.22.203" tDn="topology/pod-1/node-102" />
        <l3extLIIfP name="ifp2">
          <l3extRsPathL3OutAtt addr="23.23.23.3/24" ifInstT="l3-port"
tDn="topology/pod-1/paths-102/pathep-[eth1/3]" />
          <ospfIfP/>
        </l3extLIIfP>
      </l3extLNodeP>
    </l3extOut>
  </fvTenant>
</polUni>

```

```

        </l3extLIFP>
    </l3extLNodeP>
    <l3extInstP name="extnw2">
        <l3extSubnet ip="192.168.2.0/24" scope="import-security"/>
        <l3extRsInstPToProfile direction="import" tnRtctrlProfileName="rp2"/>
        <l3extRsInstPToProfile direction="export" tnRtctrlProfileName="rp1"/>
        <fvRsCons tnVzBrCPName="httpCtrct"/>
    </l3extInstP>
    <bgpExtP/>
    <ospfExtP areaId="0.0.0.0" areaType="regular"/>
    <l3extRsL3DomAtt tDn="uni/l3dom-dom1"/>
    <rtctrlProfile name="rp1">
        <rtctrlCtxP name="ctxp1" action="permit" order="0">
            <rtctrlRsCtxPToSubjP tnRtctrlSubjPName="match-rule1"/>
        </rtctrlCtxP>
    </rtctrlProfile>
    <rtctrlProfile name="rp2">
        <rtctrlCtxP name="ctxp1" action="permit" order="0">
            <rtctrlRsCtxPToSubjP tnRtctrlSubjPName="match-rule2"/>
        </rtctrlCtxP>
    </rtctrlProfile>
</l3extOut>
<rtctrlSubjP name="match-rule1">
    <rtctrlMatchRtDest ip="192.168.1.0/24"/>
</rtctrlSubjP>
<rtctrlSubjP name="match-rule2">
    <rtctrlMatchRtDest ip="192.168.2.0/24"/>
</rtctrlSubjP>
<vzFilter name="http-filter">
    <vzEntry name="http-e" etherT="ip" prot="tcp"/>
</vzFilter>
<vzBrCP name="httpCtrct" scope="context">
    <vzSubj name="subj1">
        <vzRsSubjFiltAtt tnVzFilterName="http-filter"/>
    </vzSubj>
</vzBrCP>
</fvTenant>
</polUni>

```

Shared L3Out

Configuring Shared Services Using REST API

Configuring Two Shared Layer 3 Outs in Two VRFs Using REST API

The following REST API configuration example that displays how two shared Layer 3 Outs in two VRFs communicate.

Procedure

Step 1 Configure the provider Layer 3 Out.

Example:

```

<tenant name="t1_provider">
<fvCtx name="VRF1">
<l3extOut name="T0-o1-L3OUT-1">
    <l3extRsEctx tnFvCtxName="o1"/>

```

```

        <ospfExtP areaId='60' />
        <l3extInstP name="l3extInstP-1">
        <fvRsProv tnVzBrCPName="vzBrCP-1">
        </fvRsProv>
        <l3extSubnet ip="192.168.2.0/24" scope="shared-rtctrl, shared-security"
aggregate="" />
        </l3extInstP>
    </l3extOut>
</tenant>

```

Step 2 Configure the consumer Layer 3 Out.

Example:

```

<tenant name="t1_consumer">
<fvCtx name="VRF2">
<l3extOut name="T0-o1-L3OUT-1">
    <l3extRsEctx tnFvCtxName="o1" />
    <ospfExtP areaId='70' />
    <l3extInstP name="l3extInstP-2">
    <fvRsCons tnVzBrCPName="vzBrCP-1">
    </fvRsCons>
    <l3extSubnet ip="199.16.2.0/24" scope="shared-rtctrl, shared-security"
aggregate="" />
    </l3extInstP>
</l3extOut>
</tenant>

```

Configuring QoS for L3Outs Using REST API

Configuring QoS Directly on L3Out Using REST API

This section describes how to configure QoS directly on an L3Out. This is the preferred way of configuring L3Out QoS starting with Cisco APIC Release 4.0(1).

You can configure QoS for L3Out on one of the following objects:

- Switch Virtual Interface (SVI)
- Sub Interface
- Routed Outside

Procedure

Step 1 Configure QoS priorities for a L3Out SVI.

Example:

```

<l3extLIfP descr=""
dn="uni/tn-DT/out-L3_4_2_24_SVI17/lndep-L3_4_E2_24/lifp-L3_4_E2_24_SVI_19"
    name="L3_4_E2_24_SVI_19" prio="level6" tag="yellow-green">
    <l3extRsPathL3OutAtt addr="0.0.0.0" autostate="disabled" descr="SVI19" encap="vlan-19"
encapScope="local" ifInstT="ext-svi" ipv6Dad="enabled" llAddr=":"
        mac="00:22:BD:F8:19:FF" mode="regular" mtu="inherit"

```

```

        tDn="topology/pod-1/protopaths-103-104/pathep-[V_L3_l4_2-24]"
        targetDscp="unspecified">
    <l3extMember addr="107.2.1.253/24" ipv6Dad="enabled" llAddr="::" side="B"/>
    <l3extMember addr="107.2.1.252/24" ipv6Dad="enabled" llAddr="::" side="A"/>
</l3extRsPathL3OutAtt>
<l3extRsLIFPCustQoSPol tnQoSCustomPolName="VrfQoS006"/>
</l3extLIFP>

```

Step 2 Configure QoS priorities for a sub-interface.

Example:

```

<l3extLIFP dn="uni/tn-DT/out-L4E48_inter_tenant/lnodep-L4E48_inter_tenant/lifp-L4E48"
  name="L4E48" prio="level4" tag="yellow-green">
  <l3extRsPathL3OutAtt addr="210.1.0.254/16" autostate="disabled" encap="vlan-20"
    encapScope="local" ifInstT="sub-interface" ipv6Dad="enabled"
llAddr="::"
    mac="00:22:BD:F8:19:FF" mode="regular" mtu="inherit"
    tDn="topology/pod-1/paths-104/pathep-[eth1/48]"
targetDscp="unspecified"/>
  <l3extRsNdIfPol annotation="" tnNdIfPolName=""/>
  <l3extRsLIFPCustQoSPol annotation="" tnQoSCustomPolName=" vrfQoS002"/>
</l3extLIFP>

```

Step 3 Configure QoS priorities for a routed outside.

Example:

```

<l3extLIFP dn="uni/tn-DT/out-L2E37/lnodep-L2E37/lifp-L2E37OUT"
  name="L2E37OUT" prio="level5" tag="yellow-green">
  <l3extRsPathL3OutAtt addr="30.1.1.1/24" autostate="disabled" encap="unknown"
    encapScope="local" ifInstT="l3-port" ipv6Dad="enabled"
llAddr="::" mac="00:22:BD:F8:19:FF" mode="regular"
    mtu="inherit" targetDscp="unspecified"
    tDn="topology/pod-1/paths-102/pathep-[eth1/37]"/>
  <l3extRsNdIfPol annotation="" tnNdIfPolName=""/>
  <l3extRsLIFPCustQoSPol tnQoSCustomPolName="vrfQoS002"/>
</l3extLIFP>

```

Configuring QoS Contract for L3Out Using REST API

This section describes how to configure QoS for L3Outs using Contracts.



Note Starting with Release 4.0(1), we recommend using custom QoS policies for L3Out QoS as described in [Configuring QoS Directly on L3Out Using REST API, on page 551](#) instead.

Procedure

Step 1 When configuring the tenant, VRF, and bridge domain, configure the VRF for egress mode (`pcEnfDir="egress"`) with policy enforcement enabled (`pcEnfPref="enforced"`). Send a post with XML similar to the following example:

Example:

```

<fvTenant name="t1">
  <fvCtx name="v1" pcEnfPref="enforced" pcEnfDir="egress"/>
  <fvBD name="bd1">
    <fvRsCtx tnFvCtxName="v1"/>
    <fvSubnet ip="44.44.44.1/24" scope="public"/>
    <fvRsBDToOut tnL3extOutName="l3out1"/>
  </fvBD>/>
</fvTenant>

```

Step 2 When creating the filters and contracts to enable the EPGs participating in the L3Out to communicate, configure the QoS priority.

The contract in this example includes the QoS priority, `level1`, for traffic ingressing on the L3Out. Alternatively, it could define a target DSCP value. QoS policies are supported on either the contract or the subject.

The filter also has the `matchDscp="EF"` criteria, so that traffic with this specific TAG received by the L3out processes through the queue specified in the contract subject.

Note

VRF enforcement should be ingress, for QoS or custom QoS on L3out interface, VRF enforcement need be egress, only when the QoS classification is going to be done in the contract for traffic between EPG and L3out or L3out to L3out.

Note

If QoS classification is set in the contract and VRF enforcement is egress, then contract QoS classification would override the L3out interface QoS or Custom QoS classification, So either we need to configure this one or the new one.

Example:

```

<vzFilter name="http-filter">
  <vzEntry name="http-e" etherT="ip" prot="tcp" matchDscp="EF"/>
</vzFilter>
<vzBrCP name="httpCtrct" prio="level1" scope="context">
  <vzSubj name="subj1">
    <vzRsSubjFiltAtt tnVzFilterName="http-filter"/>
  </vzSubj>
</vzBrCP>

```

Creating SR-MPLS Custom QoS Policy Using REST API

SR-MPLS Custom QoS policy defines the priority of the packets coming from an SR-MPLS network while they are inside the ACI fabric based on the incoming MPLS EXP values defined in the MPLS QoS ingress policy. It also marks the CoS and MPLS EXP values of the packets leaving the ACI fabric through an MPLS interface based on IPv4 DSCP values defined in MPLS QoS egress policy.

If no custom ingress policy is defined, the default QoS Level (`Level3`) is assigned to packets inside the fabric. If no custom egress policy is defined, the default EXP value of 0 will be marked on packets leaving the fabric.

Procedure

Step 1 Create SR-MPLS QoS policy.

In the following POST:

- Replace *customqos1* with the name of the SR-MPLS QoS policy you want to create.
- For the `qosMplsIngressRule`:
 - Replace `from="2" to="3"` with the EXP range you want the policy to match.
 - Replace `prio="level5"` with the ACI QoS Level for the packet while it's inside the ACI fabric.
 - Replace `target="CS5"` with the DSCP value you want to set on the packet when it's matched.
 - Replace `targetCos="4"` with the CoS value you want to set on the packet when it's matched.
- For the `qosMplsEgressRule`:
 - Replace `from="CS2" to="CS4"` with the DSCP range you want the policy to match.
 - Replace `targetExp="5"` with the EXP value you want to set on the packet when it's leaving the fabric.
 - Replace `targetCos="3"` with the CoS value you want to set on the packet when it's leaving the fabric.

```
<polUni>
  <fvTenant name="infra">
    <qosMplsCustomPol descr="" dn="uni/tn-infra/qosmplscustom-customqos1" name="customqos1"
      status="" >
      <qosMplsIngressRule from="2" to="3" prio="level5" target="CS5" targetCos="4" status=""
    />
      <qosMplsEgressRule from="CS2" to="CS4" targetExp="5" targetCos="3" status=""/>
    </qosMplsCustomPol>
  </fvTenant>
</polUni>
```

Step 2 Applying SR-MPLS QoS policy.

In the following POST, replace *customqos1* with the name of the SR-MPLS QoS policy you created in the previous step.

```
<polUni>
  <fvTenant name="infra">
    <l3extOut name="mplsOut" status="" descr="bl">
      <l3extLNodeP name="mplsLNP" status="">
        <l3extRsLNodePMplsCustQosPol tDn="uni/tn-infra/qosmplscustom-customqos1"/>
      </l3extLNodeP>
    </l3extOut>
  </fvTenant>
</polUni>
```

Configuring ACI IP SLAs Using REST API

Configuring an IP SLA Monitoring Policy Using the REST API

To enable Cisco APIC to send monitoring probes for a specific SLA type using REST API, perform the following steps:

Procedure

Configure an IP SLA monitoring policy.

Example:

```
<?xml version="1.0" encoding="utf-8"?>
<imdata totalCount="1">
    <fvIPSLAMonitoringPol annotation="" descr=""
dn="uni/tn-t8/ipslaMonitoringPol-ICMP-Probe"
    name="ICMP-Probe" nameAlias="" ownerKey="" ownerTag=""
slaDetectMultiplier="3" slaFrequency="5"
    slaPort="0" slaType="icmp"/>
</imdata>
```

Configuring an IP-SLA Track Member Using the REST API

To configure an IP SLA track member using REST API, perform the following steps:

Procedure

Configure an IP SLA track member.

Example:

```
<?xml version="1.0" encoding="utf-8"?>
<imdata totalCount="1">
    <fvTrackMember annotation="" descr="" dn="uni/tn-t8/trackmember-TM_pc_sub"
dstIpAddr="52.52.52.1" name="TM_pc_sub" nameAlias="" ownerKey="" ownerTag=""
    scopeDn="uni/tn-t8/out-t8_13">
        <fvRsIpslaMonPol annotation=""
tDn="uni/tn-t8/ipslaMonitoringPol-TCP-Telnet"/>
    </fvTrackMember>
</imdata>
```

Configuring an IP-SLA Track List Using the REST API

To configure an IP SLA track list using REST API, perform the following steps:

Procedure

Configure an IP SLA track list.

Example:

```
<?xml version="1.0" encoding="utf-8"?>
<imdata totalCount="1">
    <fvTrackList annotation="" descr="" dn="uni/tn-t8/tracklist-T8_pc_sub1">
```

```

        name="T8_pc_sub1" nameAlias="" ownerKey="" ownerTag="" percentageDown="0"
        percentageUp="1" type="weight" weightDown="5" weightUp="10">
        <fvRsOtmListMember annotation=""
tDn="uni/tn-t8/trackmember-TM_pc_sub"
        weight="10"/>
    </fvTrackList>
</imdata>

```

Associating a Track List with a Static Route Using the REST API

To associate an IP SLA track list with a static route using REST API, perform the following steps:

Procedure

Associate an IP SLA track list with a static route.

Example:

```

<?xml version="1.0" encoding="utf-8"?>
<imdata totalCount="1">
    <ipRouteP aggregate="no" annotation="" descr=""
dn="uni/tn-t8/out-t8_l3/lnodep-t8_l3_vpcl/rsnodeL3OutAtt-[topology/pod-2/node-108]/rt-[88.88.88.2/24]"
        ip="88.88.88.2/24" name="" nameAlias="" pref="1" rtCtrl="">
        <ipRsRouteTrack annotation=""
tDn="uni/tn-t8/tracklist-T8_TL1_Static"/>
        <ipNexthopP annotation="" descr="" name="" nameAlias=""
nhAddr="23.23.2.3"
        pref="1" type="prefix"/>
    </ipRouteP>
</imdata>

```

Associating a Track List with a Next Hop Profile Using the REST API

To associate an IP SLA track list with a next hop profile using REST API, perform the following steps:

Procedure

Associate an IP SLA track list with a next hop profile.

Example:

```

<?xml version="1.0" encoding="utf-8"?>
<imdata totalCount="1">
    <ipRouteP aggregate="no" annotation="" descr=""
dn="uni/tn-t8/out-t8_l3/lnodep-t8_l3_vpcl/rsnodeL3OutAtt-[topology/pod-2/node-109]/rt-[86.86.86.2/24]"
        ip="86.86.86.2/24" name="" nameAlias="" pref="1" rtCtrl="">
        <ipNexthopP annotation="" descr="" name="" nameAlias=""
nhAddr="25.25.25.3" pref="1" type="prefix">

```



```

                                <ipRsNextHopRouteTrack annotation=""
tDn="uni/tn-t8/tracklist-ctx0_25.25.25.3"/>
                                <ipRsNHTrackMember annotation=""
tDn="uni/tn-t8/trackmember-ctx0_25.25.25.3"/>
                                </ipNextHopP>
                                </ipRouteP>
</imdata>

```

Configuring HSRP Using REST API

Configuring HSRP in APIC Using REST API

HSRP is enabled when the leaf switch is configured.

Before you begin

- The tenant and VRF must be configured.
- VLAN pools must be configured with the appropriate VLAN range defined and the appropriate Layer 3 domain created and attached to the VLAN pool.
- The Attach Entity Profile must also be associated with the Layer 3 domain.
- The interface profile for the leaf switches must be configured as required.

Procedure

Step 1 Create port selectors.

Example:

```

<polUni>
  <infraInfra dn="uni/infra">
    <infraNodeP name="TenantNode_101">
      <infraLeafS name="leafselector" type="range">
        <infraNodeBlk name="nodeblk" from_"101" to_"101">
          </infraNodeBlk>
        </infraLeafS>
      <infraRsAccPortP tDn="uni/infra/accportprof-TenantPorts_101"/>
    </infraNodeP>
    <infraAccPortP name="TenantPorts_101">
      <infraHPortS name="portselector" type="range">
        <infraPortBlk name="portblk" fromCard="1" toCard="1" fromPort="41" toPort="41">
          </infraPortBlk>
        <infraRsAccBaseGrp tDn="uni/infra/funcprof/accportgrp-TenantPortGrp_101"/>
      </infraHPortS>
    </infraAccPortP>
    <infraFuncP>
      <infraAccPortGrp name="TenantPortGrp_101">
        <infraRsAttEntP tDn="uni/infra/attentp-AttEntityProfTenant"/>
        <infraRsHIfPol tnFabricHIfPolName="default"/>
      </infraAccPortGrp>
    </infraFuncP>
  </infraInfra>

```

```
</polUni>
```

Step 2 Create a tenant policy.

Example:

```
<polUni>
  <fvTenant name="t9" dn="uni/tn-t9" descr="">
    <fvCtx name="t9_ctx1" pcEnfPref="unenforced">
      </fvCtx>
    <fvBD name="t9_bd1" unkMacUcastAct="flood" arpFlood="yes">
      <fvRsCtx tnFvCtxName="t9_ctx1"/>
      <fvSubnet ip="101.9.1.1/24" scope="shared"/>
    </fvBD>
    <l3extOut dn="uni/tn-t9/out-l3extOut1" enforceRtctrl="export" name="l3extOut1">
      <l3extLNodeP name="Node101">
        <l3extRsNodeL3OutAtt rtrId="210.210.121.121" rtrIdLoopBack="no"
tDn="topology/pod-1/node-101"/>
      </l3extLNodeP>
      <l3extRsEctx tnFvCtxName="t9_ctx1"/>
      <l3extRsL3DomAtt tDn="uni/l3dom-dom1"/>
      <l3extInstP matchT="AtleastOne" name="extEpg" prio="unspecified"
targetDscp="unspecified">
        <l3extSubnet aggregate="" descr="" ip="176.21.21.21/21" name=""
scope="import-security"/>
      </l3extInstP>
    </l3extOut>
  </fvTenant>
</polUni>
```

Step 3 Create an HSRP interface policy.

Example:

```
<polUni>
  <fvTenant name="t9" dn="uni/tn-t9" descr="">
    <hsrpIfPol name="hsrpIfPol" ctrl="bfd" delay="4" reloadDelay="11"/>
  </fvTenant>
</polUni>
```

Step 4 Create an HSRP group policy.

Example:

```
<polUni>
  <fvTenant name="t9" dn="uni/tn-t9" descr="">
    <hsrpIfPol name="hsrpIfPol" ctrl="bfd" delay="4" reloadDelay="11"/>
  </fvTenant>
</polUni>
```

Step 5 Create an HSRP interface profile and an HSRP group profile.

Example:

```
<polUni>
  <fvTenant name="t9" dn="uni/tn-t9" descr="">
    <l3extOut dn="uni/tn-t9/out-l3extOut1" enforceRtctrl="export" name="l3extOut1">
      <l3extLNodeP name="Node101">
        <l3extLIfP name="eth1-41-v6" ownerKey="" ownerTag="" tag="yellow-green">
          <hsrpIfP name="eth1-41-v6" version="v2">
            <hsrpRsIfPol tnHsrpIfPolName="hsrpIfPol"/>
            <hsrpGroupP descr="" name="HSRPV6-2" groupId="330" groupAf="ipv6" ip="fe80::3"
mac="00:00:0C:18:AC:01" ipObtainMode="admin">
              <hsrpRsGroupPol tnHsrpGroupPolName="G1"/>
            </hsrpGroupP>
          </l3extLIfP>
        </l3extLNodeP>
      </l3extOut>
    </fvTenant>
  </polUni>
```

```

        </hsrpGroupP>
        </hsrpIfP>
        <l3extRsPathL3OutAtt addr="2002::100/64" descr="" encap="unknown" encapScope="local"
ifInstT="l3-port" llAddr=":" mac="00:22:BD:F8:19:FF" mode="regular" mtu="inherit"
tDn="topology/pod-1/paths-101/pathep-[eth1/41]" targetDscp="unspecified">
        <l3extIp addr="2004::100/64"/>
        </l3extRsPathL3OutAtt>
    </l3extLIIfP>
    <l3extLIIfP name="eth1-41-v4" ownerKey="" ownerTag="" tag="yellow-green">
        <hsrpIfP name="eth1-41-v4" version="v1">
            <hsrpRsIfPol tnHsrpIfPolName="hsrpIfPol"/>
            <hsrpGroupP descr="" name="HSRPV4-2" groupId="51" groupAf="ipv4" ip="177.21.21.21"
mac="00:00:0C:18:AC:01" ipObtainMode="admin">
                <hsrpRsGroupPol tnHsrpGroupPolName="G1"/>
            </hsrpGroupP>
        </hsrpIfP>
        <l3extRsPathL3OutAtt addr="177.21.21.11/24" descr="" encap="unknown"
encapScope="local" ifInstT="l3-port" llAddr=":" mac="00:22:BD:F8:19:FF" mode="regular"
mtu="inherit" tDn="topology/pod-1/paths-101/pathep-[eth1/41]" targetDscp="unspecified">
            <l3extIp addr="177.21.23.11/24"/>
        </l3extRsPathL3OutAtt>
    </l3extLIIfP>
    </l3extLNodeP>
</l3extOut>
</fvTenant>
</polUni>

```

Configuring Cisco ACI GOLF Using REST API

Configuring GOLF Using the REST API

Procedure

- Step 1** The following example shows how to deploy nodes and spine switch interfaces for GOLF, using the REST API:

Example:

```

POST
https://192.0.20.123/api/mo/uni/golf.xml

```

- Step 2** The XML below configures the spine switch interfaces and infra tenant provider of the GOLF service. Include this XML structure in the body of the POST message.

Example:

```

<l3extOut descr="" dn="uni/tn-infra/out-golf" enforceRtctrl="export,import"
name="golf"
ownerKey="" ownerTag="" targetDscp="unspecified">
    <l3extRsEctx tnFvCtxName="overlay-1"/>
    <l3extProvLbl descr="" name="golf"
ownerKey="" ownerTag="" tag="yellow-green"/>
    <l3extLNodeP configIssues="" descr=""
name="bLeaf" ownerKey="" ownerTag=""
tag="yellow-green" targetDscp="unspecified">
        <l3extRsNodeL3OutAtt rtrId="10.10.3.3" rtrIdLoopBack="no"

```

```

        tDn="topology/pod-1/node-111">
        <l3extInfraNodeP descr="" fabricExtCtrlPeering="yes" name=""/>
        <l3extLoopBackIfP addr="10.10.3.3" descr="" name=""/>
    </l3extRsNodeL3OutAtt>
    <l3extRsNodeL3OutAtt rtrId="10.10.3.4" rtrIdLoopBack="no"
        tDn="topology/pod-1/node-112">
        <l3extInfraNodeP descr="" fabricExtCtrlPeering="yes" name=""/>
        <l3extLoopBackIfP addr="10.10.3.4" descr="" name=""/>
    </l3extRsNodeL3OutAtt>
    <l3extLIIfP descr="" name="portIf-spine1-3"
        ownerKey="" ownerTag="" tag="yellow-green">
        <ospfIfP authKeyId="1" authType="none" descr="" name="">
            <ospfRsIfPol tnOspfIfPolName="ospfIfPol"/>
        </ospfIfP>
        <l3extRsNdIfPol tnNdIfPolName=""/>
        <l3extRsIngressQosDppPol tnQosDppPolName=""/>
        <l3extRsEgressQosDppPol tnQosDppPolName=""/>
        <l3extRsPathL3OutAtt addr="7.2.1.1/24" descr=""
            encap="vlan-4"
            encapScope="local"
            ifInstT="sub-interface"
            llAddr="::" mac="00:22:BD:F8:19:FF"
            mode="regular"
            mtu="1500"
            tDn="topology/pod-1/paths-111/pathep-[eth1/12]"
            targetDscp="unspecified"/>
    </l3extLIIfP>
    <l3extLIIfP descr="" name="portIf-spine2-1"
        ownerKey=""
        ownerTag=""
        tag="yellow-green">
        <ospfIfP authKeyId="1"
            authType="none"
            descr=""
            name="">
            <ospfRsIfPol tnOspfIfPolName="ospfIfPol"/>
        </ospfIfP>
        <l3extRsNdIfPol tnNdIfPolName=""/>
        <l3extRsIngressQosDppPol tnQosDppPolName=""/>
        <l3extRsEgressQosDppPol tnQosDppPolName=""/>
        <l3extRsPathL3OutAtt addr="7.1.0.1/24" descr=""
            encap="vlan-4"
            encapScope="local"
            ifInstT="sub-interface"
            llAddr="::" mac="00:22:BD:F8:19:FF"
            mode="regular"
            mtu="9000"
            tDn="topology/pod-1/paths-112/pathep-[eth1/11]"
            targetDscp="unspecified"/>
    </l3extLIIfP>
    <l3extLIIfP descr="" name="portif-spine2-2"
        ownerKey=""
        ownerTag=""
        tag="yellow-green">
        <ospfIfP authKeyId="1"
            authType="none" descr=""
            name="">
            <ospfRsIfPol tnOspfIfPolName="ospfIfPol"/>
        </ospfIfP>
        <l3extRsNdIfPol tnNdIfPolName=""/>
        <l3extRsIngressQosDppPol tnQosDppPolName=""/>
        <l3extRsEgressQosDppPol tnQosDppPolName=""/>
        <l3extRsPathL3OutAtt addr="7.2.2.1/24" descr=""
            encap="vlan-4"

```

```

        encapScope="local"
        ifInstT="sub-interface"
            llAddr="::" mac="00:22:BD:F8:19:FF"
            mode="regular"
            mtu="1500"
            tDn="topology/pod-1/paths-112/pathep-[eth1/12]"
            targetDscp="unspecified"/>
    </l3extLIIFP>
<l3extLIIFP descr="" name="portIf-spine1-2"
  ownerKey="" ownerTag="" tag="yellow-green">
  <ospfIfP authKeyId="1" authType="none" descr="" name="">
    <ospfRsIfPol tnOspfIfPolName="ospfIfPol"/>
  </ospfIfP>
  <l3extRsNdIfPol tnNdIfPolName=""/>
  <l3extRsIngressQosDppPol tnQosDppPolName=""/>
  <l3extRsEgressQosDppPol tnQosDppPolName=""/>
  <l3extRsPathL3OutAtt addr="9.0.0.1/24" descr=""
    encap="vlan-4"
    encapScope="local"
    ifInstT="sub-interface"
        llAddr="::" mac="00:22:BD:F8:19:FF"
        mode="regular"
        mtu="9000"
        tDn="topology/pod-1/paths-111/pathep-[eth1/11]"
        targetDscp="unspecified"/>
  </l3extLIIFP>
<l3extLIIFP descr="" name="portIf-spine1-1"
  ownerKey="" ownerTag="" tag="yellow-green">
  <ospfIfP authKeyId="1" authType="none" descr="" name="">
    <ospfRsIfPol tnOspfIfPolName="ospfIfPol"/>
  </ospfIfP>
  <l3extRsNdIfPol tnNdIfPolName=""/>
  <l3extRsIngressQosDppPol tnQosDppPolName=""/>
  <l3extRsEgressQosDppPol tnQosDppPolName=""/>
  <l3extRsPathL3OutAtt addr="7.0.0.1/24" descr=""
    encap="vlan-4"
    encapScope="local"
    ifInstT="sub-interface"
        llAddr="::" mac="00:22:BD:F8:19:FF"
        mode="regular"
        mtu="1500"
        tDn="topology/pod-1/paths-111/pathep-[eth1/10]"
        targetDscp="unspecified"/>
  </l3extLIIFP>
<bgpInfraPeerP addr="10.10.3.2"
  allowedSelfAsCnt="3"
  ctrl="send-com,send-ext-com"
  descr="" name="" peerCtrl=""
  peerT="wan"
  privateASctrl="" ttl="2" weight="0">
  <bgpRsPeerPfxPol tnBgpPeerPfxPolName=""/>
  <bgpAsP asn="150" descr="" name="aspn"/>
</bgpInfraPeerP>
<bgpInfraPeerP addr="10.10.4.1"
  allowedSelfAsCnt="3"
  ctrl="send-com,send-ext-com" descr="" name="" peerCtrl=""
  peerT="wan"
  privateASctrl="" ttl="1" weight="0">
  <bgpRsPeerPfxPol tnBgpPeerPfxPolName=""/>
  <bgpAsP asn="100" descr="" name=""/>
</bgpInfraPeerP>
<bgpInfraPeerP addr="10.10.3.1"
  allowedSelfAsCnt="3"
  ctrl="send-com,send-ext-com" descr="" name="" peerCtrl=""

```

```

        peerT="wan"
        privateASctrl="" ttl="1" weight="0">
        <bgpRsPeerPfxPol tnBgpPeerPfxPolName=""/>
        <bgpAsP asn="100" descr="" name=""/>
    </bgpInfraPeerP>
</l3extLNodeP>
<bgpRtTargetInstrP descr="" name="" ownerKey="" ownerTag="" rtTargetT="explicit"/>
<l3extRsL3DomAtt tDn="uni/l3dom-l3dom"/>
<l3extInstP descr="" matchT="AtleastOne" name="golfInstP"
    prio="unspecified"
    targetDscp="unspecified">
    <fvRsCustQosPol tnQosCustomPolName=""/>
</l3extInstP>
<bgpExtP descr=""/>
<ospfExtP areaCost="1"
    areaCtrl="redistribute,summary"
    areaId="0.0.0.1"
    areaType="regular" descr=""/>
</l3extOut>

```

Step 3 The XML below configures the tenant consumer of the infra part of the GOLF service. Include this XML structure in the body of the POST message.

Example:

```

<fvTenant descr="" dn="uni/tn-pep6" name="pep6" ownerKey="" ownerTag="">
    <vzBrCP descr="" name="webCtrct"
        ownerKey="" ownerTag="" prio="unspecified"
        scope="global" targetDscp="unspecified">
        <vzSubj consMatchT="AtleastOne" descr=""
            name="http" prio="unspecified" provMatchT="AtleastOne"
            revFltPorts="yes" targetDscp="unspecified">
            <vzRsSubjFiltAtt directives="" tnVzFilterName="default"/>
        </vzSubj>
    </vzBrCP>
    <vzBrCP descr="" name="webCtrct-pod2"
        ownerKey="" ownerTag="" prio="unspecified"
        scope="global" targetDscp="unspecified">
        <vzSubj consMatchT="AtleastOne" descr=""
            name="http" prio="unspecified"
            provMatchT="AtleastOne" revFltPorts="yes"
            targetDscp="unspecified">
            <vzRsSubjFiltAtt directives=""
                tnVzFilterName="default"/>
        </vzSubj>
    </vzBrCP>
    <fvCtx descr="" knwMcastAct="permit"
        name="ctx6" ownerKey="" ownerTag=""
        pcEnfDir="ingress" pcEnfPref="enforced">
        <bgpRtTargetP af="ipv6-ucast"
            descr="" name="" ownerKey="" ownerTag="">
            <bgpRtTarget descr="" name="" ownerKey="" ownerTag=""
                rt="route-target:as4-nn2:100:1256"
                type="export"/>
            <bgpRtTarget descr="" name="" ownerKey="" ownerTag=""
                rt="route-target:as4-nn2:100:1256"
                type="import"/>
        </bgpRtTargetP>
        <bgpRtTargetP af="ipv4-ucast"
            descr="" name="" ownerKey="" ownerTag="">
            <bgpRtTarget descr="" name="" ownerKey="" ownerTag=""
                rt="route-target:as4-nn2:100:1256"
                type="export"/>
            <bgpRtTarget descr="" name="" ownerKey="" ownerTag=""

```

```

        rt="route-target:as4-nn2:100:1256"
        type="import"/>
    </bgpRtTargetP>
    <fvRsCtxToExtRouteTagPol tnL3extRouteTagPolName=""/>
    <fvRsBgpCtxPol tnBgpCtxPolName=""/>
    <vzAny descr="" matchT="AtleastOne" name=""/>
    <fvRsOspfCtxPol tnOspfCtxPolName=""/>
    <fvRsCtxToEpRet tnFvEpRetPolName=""/>
    <l3extGlobalCtxName descr="" name="dci-pep6"/>
</fvCtx>
<fvBD arpFlood="no" descr="" epMoveDetectMode=""
  ipLearning="yes"
  limitIpLearnToSubnets="no"
  llAddr="::" mac="00:22:BD:F8:19:FF"
  mcastAllow="no"
  multiDstPktAct="bd-flood"
  name="bd107" ownerKey="" ownerTag="" type="regular"
  unicastRoute="yes"
  unkMacUcastAct="proxy"
  unkMcastAct="flood"
  vmac="not-applicable">
  <fvRsBDToNdP tnNdIfPolName=""/>
  <fvRsBDToOut tnL3extOutName="routAccounting-pod2"/>
  <fvRsCtx tnFvCtxName="ctx6"/>
  <fvRsIgmprn tnIgmprnSnoopPolName=""/>
  <fvSubnet ctrl="" descr="" ip="27.6.1.1/24"
    name="" preferred="no"
    scope="public"
    virtual="no"/>
    <fvSubnet ctrl="nd" descr="" ip="2001:27:6:1::1/64"
      name="" preferred="no"
      scope="public"
      virtual="no">
      <fvRsNdPfxPol tnNdPfxPolName=""/>
    </fvSubnet>
  <fvRsBdToEpRet resolveAct="resolve" tnFvEpRetPolName=""/>
</fvBD>
<fvBD arpFlood="no" descr="" epMoveDetectMode=""
  ipLearning="yes"
  limitIpLearnToSubnets="no"
  llAddr="::" mac="00:22:BD:F8:19:FF"
  mcastAllow="no"
  multiDstPktAct="bd-flood"
  name="bd103" ownerKey="" ownerTag="" type="regular"
  unicastRoute="yes"
  unkMacUcastAct="proxy"
  unkMcastAct="flood"
  vmac="not-applicable">
  <fvRsBDToNdP tnNdIfPolName=""/>
  <fvRsBDToOut tnL3extOutName="routAccounting"/>
  <fvRsCtx tnFvCtxName="ctx6"/>
  <fvRsIgmprn tnIgmprnSnoopPolName=""/>
  <fvSubnet ctrl="" descr="" ip="23.6.1.1/24"
    name="" preferred="no"
    scope="public"
    virtual="no"/>
    <fvSubnet ctrl="nd" descr="" ip="2001:23:6:1::1/64"
      name="" preferred="no"
      scope="public" virtual="no">
      <fvRsNdPfxPol tnNdPfxPolName=""/>
    </fvSubnet>
  <fvRsBdToEpRet resolveAct="resolve" tnFvEpRetPolName=""/>
</fvBD>
</vnsSvcCont/>

```

```

<fvRsTenantMonPol tnMonEPGPolName=""/>
<fvAp descr="" name="AP1"
  ownerKey="" ownerTag="" prio="unspecified">
  <fvAEPg descr=""
    isAttrBasedEPg="no"
    matchT="AtleastOne"
    name="epg107"
    pcEnfPref="unenforced" prio="unspecified">
    <fvRsCons prio="unspecified"
      tnVzBrCPName="webCtrct-pod2"/>
    <fvRsPathAtt descr=""
      encap="vlan-1256"
      instrImedcy="immediate"
      mode="regular" primaryEncap="unknown"
      tDn="topology/pod-2/paths-107/pathep-[eth1/48]"/>
    <fvRsDomAtt classPref="encap" delimiter=""
      encap="unknown"
      instrImedcy="immediate"
      primaryEncap="unknown"
      resImedcy="lazy" tDn="uni/phys-phys"/>
    <fvRsCustQosPol tnQosCustomPolName=""/>
    <fvRsBd tnFvBDName="bd107"/>
    <fvRsProv matchT="AtleastOne"
      prio="unspecified"
      tnVzBrCPName="default"/>
  </fvAEPg>
  <fvAEPg descr=""
    isAttrBasedEPg="no"
    matchT="AtleastOne"
    name="epg103"
    pcEnfPref="unenforced" prio="unspecified">
    <fvRsCons prio="unspecified" tnVzBrCPName="default"/>
    <fvRsCons prio="unspecified" tnVzBrCPName="webCtrct"/>
    <fvRsPathAtt descr="" encap="vlan-1256"
      instrImedcy="immediate"
      mode="regular" primaryEncap="unknown"
      tDn="topology/pod-1/paths-103/pathep-[eth1/48]"/>
    <fvRsDomAtt classPref="encap" delimiter=""
      encap="unknown"
      instrImedcy="immediate"
      primaryEncap="unknown"
      resImedcy="lazy" tDn="uni/phys-phys"/>
    <fvRsCustQosPol tnQosCustomPolName=""/>
    <fvRsBd tnFvBDName="bd103"/>
  </fvAEPg>
</fvAp>
<l3extOut descr=""
  enforceRtctrl="export"
  name="routAccounting-pod2"
  ownerKey="" ownerTag="" targetDscp="unspecified">
  <l3extRsEctx tnFvCtxName="ctx6"/>
  <l3extInstP descr=""
    matchT="AtleastOne"
    name="accountingInst-pod2"
    prio="unspecified" targetDscp="unspecified">
  <l3extSubnet aggregate="export-rtctrl,import-rtctrl"
    descr="" ip="::/0" name=""
    scope="export-rtctrl,import-rtctrl,import-security"/>
  <l3extSubnet aggregate="export-rtctrl,import-rtctrl"
    descr=""
    ip="0.0.0.0/0" name=""
    scope="export-rtctrl,import-rtctrl,import-security"/>
  <fvRsCustQosPol tnQosCustomPolName=""/>
  <fvRsProv matchT="AtleastOne"

```



```

        prio="unspecified" tnVzBrCPName="webCtrct-pod2"/>
    </l3extInstP>
    <l3extConsLbl descr=""
        name="golf2"
        owner="infra"
        ownerKey="" ownerTag="" tag="yellow-green"/>
</l3extOut>
<l3extOut descr=""
    enforceRtctrl="export"
    name="routAccounting"
    ownerKey="" ownerTag="" targetDscp="unspecified">
<l3extRsEctx tnFvCtxName="ctx6"/>
<l3extInstP descr=""
    matchT="AtleastOne"
    name="accountingInst"
    prio="unspecified" targetDscp="unspecified">
<l3extSubnet aggregate="export-rtctrl,import-rtctrl" descr=""
    ip="0.0.0.0/0" name=""
    scope="export-rtctrl,import-rtctrl,import-security"/>
<fvRsCustQosPol tnQosCustomPolName=""/>
<fvRsProv matchT="AtleastOne" prio="unspecified" tnVzBrCPName="webCtrct"/>
</l3extInstP>
    <l3extConsLbl descr=""
        name="golf"
        owner="infra"
        ownerKey="" ownerTag="" tag="yellow-green"/>
</l3extOut>
</fvTenant>

```

Enabling Distributing BGP EVPN Type-2 Host Routes to a DCIG Using the REST API

Enable distributing BGP EVPN type-2 host routes using the REST API, as follows:

Before you begin

EVPN services must be configured.

Procedure

- Step 1** Configure the Host Route Leak policy, with a POST containing XML such as in the following example:

Example:

```
<bgpCtxAfPol descr="" ctrl="host-rt-leak" name="bgpCtxPol_0 status=""/>
```

- Step 2** Apply the policy to the VRF BGP Address Family Context Policy for one or both of the address families using a POST containing XML such as in the following example:

Example:

```
<fvCtx name="vni-10001">
<fvRsCtxToBgpCtxAfPol af="ipv4-ucast" tnBgpCtxAfPolName="bgpCtxPol_0"/>
<fvRsCtxToBgpCtxAfPol af="ipv6-ucast" tnBgpCtxAfPolName="bgpCtxPol_0"/>
</fvCtx>
```

