



## Configuring vPCs

---

- [Information About vPCs, on page 1](#)
- [Guidelines and Limitations, on page 29](#)
- [Best Practices for Layer 3 and vPC Configuration, on page 35](#)
- [Layer 3 over vPC Supported Topologies, on page 45](#)
- [Default Settings, on page 47](#)
- [Configuring vPCs, on page 47](#)
- [Verifying the vPC Configuration, on page 78](#)
- [Monitoring vPCs, on page 79](#)
- [Configuration Examples for vPCs, on page 79](#)
- [Related Documents, on page 81](#)

## Information About vPCs

### vPC Overview

A virtual port channel (vPC) allows links that are physically connected to two Cisco Nexus 9000 Series devices to appear as a single port channel by a third device (see figure). The third device can be a switch, server, or any other networking device that supports port channels. A vPC can provide Layer 2 multipathing, which allows you to create redundancy and increase the bisectional bandwidth by enabling multiple parallel paths between nodes and allowing load balancing traffic.

Figure 1: vPC Architecture

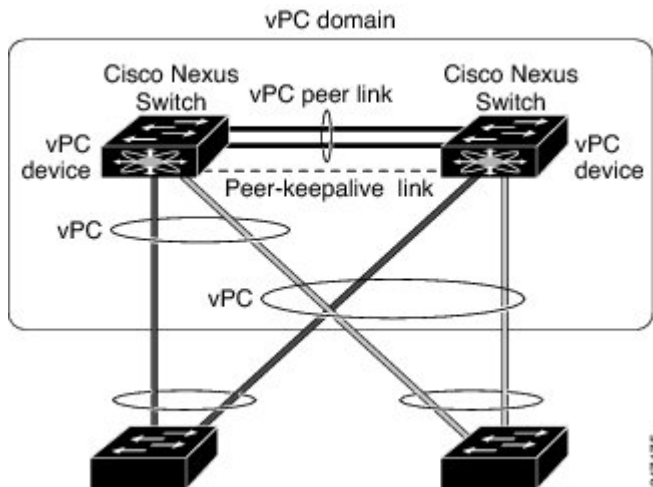

You can use only Layer 2 port channels in the vPC. You configure the port channels by using one of the following:

- No protocol
- Link Aggregation Control Protocol (LACP)

When you configure the port channels in a vPC—including the vPC Peer-Link channel—without using LACP, each device can have up to 32 active links in a single port channel. When you configure the port channels in a vPC—including the vPC Peer-Link channels—using LACP, each device can have 32 active links and eight standby links in a single port channel. (See the “vPC Interactions with Other Features” section for more information on using LACP and vPCs.)



**Note** You must enable the vPC feature before you can configure or run the vPC functionality.

The system automatically takes a checkpoint prior to disabling the feature, and you can roll back to this checkpoint.

After you enable the vPC functionality, you create the peer-keepalive link, which sends heartbeat messages between the two vPC peer devices.

You can create a vPC Peer-Link by configuring a port channel on one Cisco Nexus 9000 Series chassis by using two or more Ethernet ports higher speed than 1-Gigabit Ethernet. To ensure that you have the correct hardware to enable and run a vPC, enter the **show hardware feature-capability** command. If you see an X across from the vPC in your command output, your hardware cannot enable the vPC feature.

We recommend that you configure the vPC Peer-Link Layer 2 port channels as trunks. On another Cisco Nexus 9000 Series chassis, you configure another port channel again using two or more Ethernet ports with speed higher than 1-Gigabit in the dedicated port mode. Connecting these two port channels creates a vPC Peer-Link in which the two linked Cisco Nexus devices appear as one device to a third device. The third device, or downstream device, can be a switch, server, or any other networking device that uses a regular port channel to connect to the vPC.

If you are not using the correct module, the system displays an error message.

For modular Cisco Nexus 9500 switches, we recommend that you configure the vPC Peer-Links on dedicated ports of different modules to reduce the possibility of a failure. For the best resiliency scenario, use at least two modules.

You can use any of the interfaces of the Nexus 9000 device for the vPC Peer-Link. If you must configure all the vPC Peer-Links and core-facing interfaces on a single module, you should configure a track object that is associated with the Layer 3 link to the core and on all the links on the vPC Peer-Link on both vPC peer devices.

Once you configure this feature and if the primary vPC peer device fails, the system automatically suspends all the vPC links on the primary vPC peer device. This action forces all the vPC traffic to the secondary vPC peer device until the system stabilizes.

You can create a track object and apply that object to all links on the primary vPC peer device that connect to the core and to the vPC Peer-Link. See the *Cisco Nexus 9000 Series NX-OS Unicast Routing Configuration Guide* for information about the **track interface** command.

The vPC domain includes both vPC peer devices, the vPC peer-keepalive link, the vPC Peer-Link, and all of the port channels in the vPC domain connected to the downstream device. You can have only one vPC domain ID on each device.

In this version, you can connect each downstream device to a single vPC domain ID using a single port channel.



---

**Note** Devices attached to a vPC domain using port channels should be connected to both of vPC peers.

---

A vPC (see figure) provides the following benefits:

- Allows a single device to use a port channel across two upstream devices
- Eliminates Spanning Tree Protocol (STP) blocked ports
- Provides a loop-free topology
- Uses all available uplink bandwidth
- Provides fast convergence if either the link or a device fails
- Provides link-level resiliency
- Assures high availability

Figure 2: vPC Interfaces

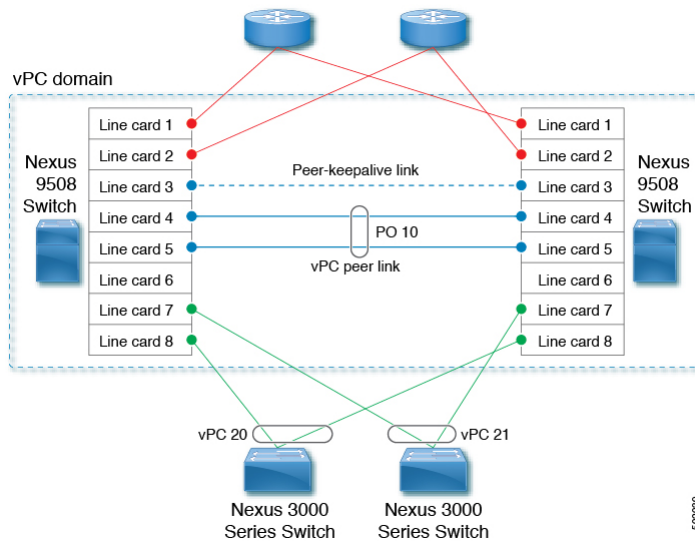

## vPC Terminology

The terminology used in vPCs is as follows:

- vPC—The combined port channel between the vPC peer devices and the downstream device.
- vPC peer device—One of a pair of devices that are connected with the special port channel known as the vPC Peer-Link.
- vPC Peer-Link—The link used to synchronize state between the vPC peer devices. This link must use a 10-Gigabit Ethernet interface at a minimum. Higher-bandwidth interfaces (such as 25-Gigabit Ethernet, 40-Gigabit Ethernet, 100-Gigabit Ethernet, and so on) may also be used.
- vPC member port—An interface that belongs to a vPC.
- Host vPC port—A Fabric Extender host interfaces that belongs to a vPC.
- vPC domain—This domain includes both vPC peer devices, the vPC peer-keepalive link, and all of the port channels in the vPC connected to the downstream devices. It is also associated to the configuration mode that you must use to assign vPC global parameters.
- vPC peer-keepalive link—The peer-keepalive link monitors the vitality of a vPC peer Cisco Nexus 9000 Series device. The peer-keepalive link sends configurable, periodic keepalive messages between vPC peer devices.

We recommend that you associate a peer-keepalive link to a separate virtual routing and forwarding (VRF) instance that is mapped to a Layer 3 interface in each vPC peer device. If you do not configure a separate VRF, the system uses the management VRF by default. However, if you use the management interfaces for the peer-keepalive link, you must put a management switch connected to both the active and standby management ports on each vPC peer device (see figure).

Figure 3: Separate Switch Required to Connect Management Ports for vPC Peer-Keepalive Link

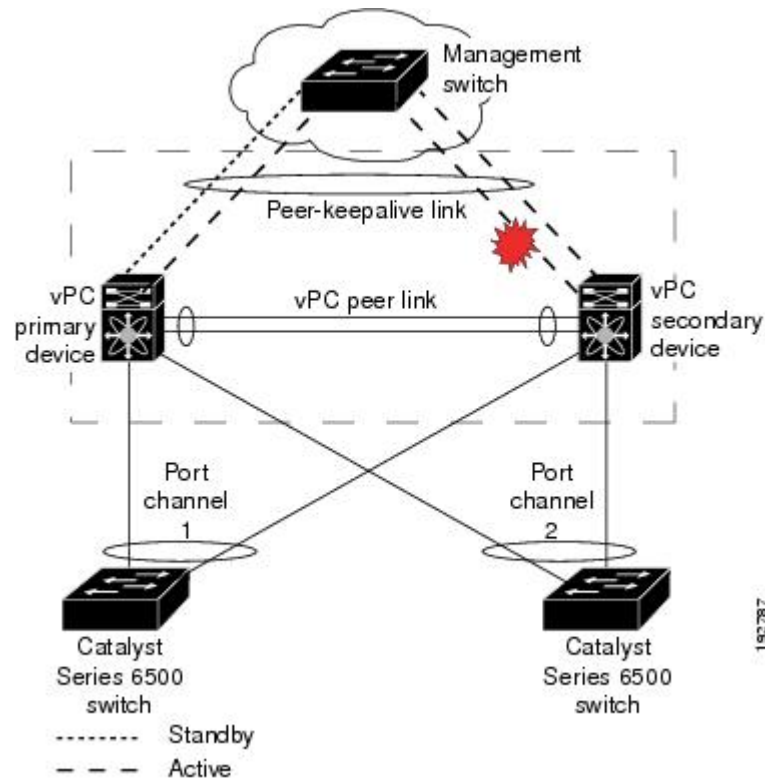

No data or synchronization traffic moves over the vPC peer-keepalive link; the only traffic on this link is a message that indicates that the originating switch is operating and running a vPC.

- vPC member port—Interfaces that belong to the vPCs.
- Dual-active— Both vPC peers act as primary. This situation occurs when the peer-keepalive and vPC Peer-Link go down when both the peers are still active. In this case, the secondary vPC assumes that the primary vPC is inactive and acts as the primary vPC.
- Recovery—When the peer-keepalive and the vPC Peer-Link come up, one switch becomes the secondary vPC. On the switch that becomes the secondary vPC, the vPC links go down and come back up.

## vPC Peer-Link Overview

You can have only two devices as vPC peers; each device can serve as a vPC peer to only one other vPC peer. The vPC peer devices can also have non-vPC links to other devices.

See the following figure for invalid vPC peer configurations.

Figure 4: vPC Peer Configurations That Are Not Allowed

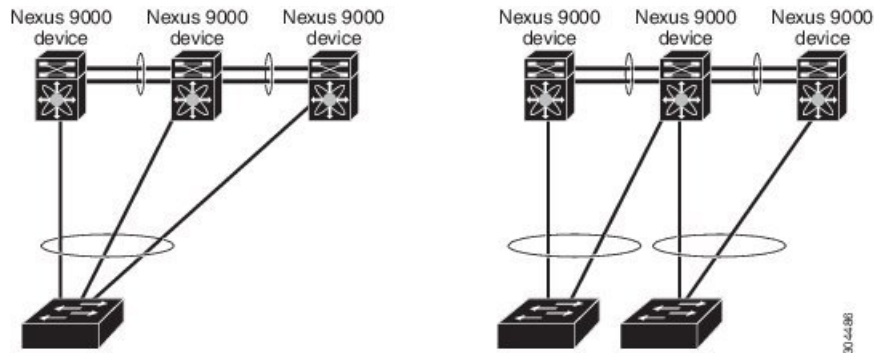

To make a valid configuration, you first configure a port channel on each device and then configure the vPC domain. You assign the port channel on each device as a vPC Peer-Link, using the same vPC domain ID. For redundancy, we recommend that you should configure at least two of the dedicated ports into the port channel because if one of the interfaces in the vPC Peer-Link fails, the device automatically falls back to use another interface in the vPC Peer-Link.



**Note** We recommend that you configure the Layer 2 port channels in trunk mode.

Many operational parameters and configuration parameters must be the same in each device connected by a vPC Peer-Link (see the [Compatibility Parameters for vPC Interfaces](#) section). Because each device is completely independent on the management plane, you must ensure that the devices are compatible on the critical parameters. vPC peer devices have separate control planes. After configuring the vPC Peer-Link, you should display the configuration on each vPC peer device to ensure that the configurations are compatible.



**Note** You must ensure that the two devices connected by the vPC Peer-Link have certain identical operational and configuration parameters. For more information on required configuration consistency, see the [Compatibility Parameters for vPC Interfaces](#) section.

When you configure the vPC Peer-Link, the vPC peer devices negotiate that one of the connected devices is the primary device and the other connected device is the secondary device (see the “Configuring vPCs” section). By default, the Cisco NX-OS software uses the lowest MAC address to elect the primary device. However, if the role priority is set, then the device with the lowest priority will be elected as the primary device. The software takes different actions on each device—that is, the primary and secondary—only in certain failover conditions. If the primary device fails, the secondary device becomes the new primary device when the system recovers, and the previously primary device is now the secondary device.

You can also configure which of the vPC devices is the primary device. Changing the priority of the vPC peer devices can cause the interfaces in your network to go up and down. If you want to configure the role priority again to make one vPC device the primary device, configure the role priority on both the primary vPC device with a lower priority value and the secondary vPC device with the higher value. Then, shut down the port channel that is the vPC Peer-Link on both devices by entering the **shutdown** command, and finally reenables the port channel on both devices by entering the **no shutdown** command.



---

**Note** We recommend that you use two different modules for redundancy on each vPC peer device on each vPC Peer-Link.

---

The software keeps all traffic that forwards across the vPC peer devices as local traffic. A packet that ingresses the port channel uses one of the local links rather than moving across the vPC Peer-Link. Unknown unicast, multicast, and broadcast traffic (including STP BPDUs) are flooded across the vPC Peer-Link. The software keeps the multicast forwarding state synchronized on both of the vPC peer devices.

You can configure any of the standard load-balancing schemes on both the vPC Peer-Link devices and the downstream device (see the *Configuring Port Channels* chapter for information about load balancing).

Configuration information flows across the vPC Peer-Links using the Cisco Fabric Services over Ethernet (CFSOE) protocol. (See the [CFSOE, on page 24](#) section for more information about CFSOE.)

All MAC addresses for those VLANs configured on both devices are synchronized between vPC peer devices. The software uses CFSOE for this synchronization. (See the [CFSOE, on page 24](#) section for information about CFSOE.)

If the vPC Peer-Link fails, the software checks the status of the remote vPC peer device using the peer-keepalive link, which is a link between vPC peer devices that ensures that both devices are up. If the vPC peer device is up, the secondary vPC device disables all vPC ports on its device, to prevent loops and disappearing or flooding traffic. The data then forwards down the remaining active links of the port channel.



---

**Note** We recommend that you create and configure a separate VRF and configure a Layer 3 port on each vPC peer device in that VRF for the vPC peer-keepalive link. The default ports and VRF for the peer-keepalive are the management ports and VRF.

---

The software learns of a vPC peer device failure when the keepalive messages are not returned over the peer-keepalive link.

Use a separate link (vPC peer-keepalive link) to send configurable keepalive messages between the vPC peer devices. The keepalive messages on the vPC peer-keepalive link determines whether a failure is on the vPC Peer-Link only or on the vPC peer device. The keepalive messages are used only when all the links in the vPC Peer-Link fail. See the “Peer-Keepalive Link and Messages” section for information about the keepalive message.

## Features That You Must Manually Configure on the Primary and Secondary Devices

You must manually configure the following features to conform to the primary/secondary mapping of each of the vPC peer devices:

- STP root—Configure the primary vPC peer device as the STP primary root device and configure the vPC secondary device to be the STP secondary root device. See the “vPC Peer-Links and STP” section for more information about vPCs and STP.
  - We recommend that you configure the vPC Peer-Link interfaces as STP network ports so that Bridge Assurance is enabled on all vPC Peer-Links.
  - We recommend that you configure Rapid per VLAN Spanning Tree plus (PVST+) so that the primary device is the root for all VLANs and configure Multiple Spanning Tree (MST) so that the primary device is the root for all instances.

- Layer 3 VLAN network interface—Configure Layer 3 connectivity from each vPC peer device by configuring a VLAN network interface for the same VLAN from both devices.
- HSRP active—If you want to use Hot Standby Router Protocol (HSRP) and VLAN interfaces on the vPC peer devices, configure the primary vPC peer device with the HSRP active highest priority. Configure the secondary device to be the HSRP standby and ensure that you have VLAN interfaces on each vPC device that are in the same administrative and operational mode. (See the “vPC Peer-Links and Routing” section for more information on vPC and HSRP.)

While you configure Unidirectional Link Detection (UDLD), note the following recommendations:

- If LACP is used as port-channel aggregation protocol, UDLD is not required in a vPC domain.
- If LACP is not used as the port-channel aggregation protocol (static port-channel), use UDLD in normal mode on vPC member ports.
- If STP is used without Bridge Assurance and if LACP is not used, use UDLD in normal mode on vPC orphan ports.

## Peer-Keepalive Link and Messages

The Cisco NX-OS software uses the peer-keepalive link between the vPC peers to transmit periodic, configurable keepalive messages. You must have Layer 3 connectivity between the peer devices to transmit these messages; the system cannot bring up the vPC Peer-Link unless the peer-keepalive link is already up and running.



---

**Note** We recommend that you associate the vPC peer-keepalive link to a separate VRF mapped to a Layer 3 interface in each vPC peer device. If you do not configure a separate VRF, the system uses the management VRF and management ports by default. Do not use the vPC Peer-Link itself to send and receive vPC peer-keepalive messages.

---

If one of the vPC peer devices fails, the vPC peer device on the other side of the vPC Peer-Link senses the failure by not receiving any peer-keepalive messages. The default interval time for the vPC peer-keepalive message is 1 second, and you can configure the interval between 400 milliseconds and 10 seconds.

You can configure a hold-timeout value with a range of 3 to 10 seconds; the default hold-timeout value is 3 seconds. This timer starts when the vPC Peer-Link goes down. During this hold-timeout period, the secondary vPC peer device ignores vPC peer-keepalive messages, which ensures that network convergence occurs before a vPC action takes place. The purpose of the hold-timeout period is to prevent false-positive cases.

You can also configure a timeout value with a range of 3 to 20 seconds; the default timeout value is 5 seconds. This timer starts at the end of the hold-timeout interval. During the timeout period, the secondary vPC peer device checks for vPC peer-keepalive hello messages from the primary vPC peer device. If the secondary vPC peer device receives a single hello message, that device disables all vPC interfaces on the secondary vPC peer device.

The difference between the hold-timeout and the timeout parameters is as follows:

- During the hold-timeout, the vPC secondary device does not take any action based on any keepalive messages received, which prevents the system taking action when the keepalive might be received just temporarily, such as if a supervisor fails a few seconds after the vPC Peer-Link goes down.



- During the timeout, the vPC secondary device takes action to become the vPC primary device if no keepalive message is received by the end of the configured interval.

See the “Configuring vPC Keepalive Link and Messages” section for information about configuring the timer for the keepalive messages.



**Note** Ensure that both the source and destination IP addresses used for the peer-keepalive messages are unique in your network and these IP addresses are reachable from the VRF associated with the vPC peer-keepalive link. Peer-keepalive IP addresses must be global unicast addresses. Link-local addresses are not supported.

Use the command-line interface (CLI) to configure the interfaces you are using the vPC peer-keepalive messages as trusted ports. Leave the precedence at the default (6) or configure it higher. The following is an example of configuring an interface as a trusted port:

```
(config)# class-map type qos match-all trust-map
(config-cmap-qos)# match cos 4-7
(config)# policy-map type qos ingresspolicy
(config-pmap-qos)# class trust-map
(config)# interface Ethernet 8/11
(config-if)# service-policy type qos input ingresspolicy
```

## vPC Domain

You can use the vPC domain ID to identify the vPC Peer-Links and the ports that are connected to the vPC downstream devices.

The vPC domain is also a configuration mode that you use to configure the keepalive messages and other vPC Peer-Link parameters rather than accept the default values. See the “Configuring vPCs” section for more information about configuring these parameters.

To create a vPC domain, you must first create a vPC domain ID on each vPC peer device using a number from 1 to 1000. You can have only one vPC domain per vPC peer.

You must explicitly configure the port channel that you want to act as the vPC Peer-Link on each device. You associate the port channel that you made a vPC Peer-Link on each device with the same vPC domain ID to form a single vPC domain. Within this domain, the system provides a loop-free topology and Layer 2 multipathing.

You can only configure these port channels and vPC Peer-Links statically. All ports in the vPC on each of the vPC peer devices must be in the same VDC. You can configure the port channels and vPC Peer-Links either using LACP or no protocol. We recommend that you use LACP with the interfaces in active mode to configure port channels in each vPC, which ensures an optimized, graceful recovery in a port-channel failover scenario and provides configuration checks against configuration mismatches among the port channels themselves.

The vPC peer devices use the vPC domain ID that you configure to automatically assign a unique vPC system MAC address. Each vPC domain has a unique MAC address that is used as a unique identifier for the specific vPC-related operations, although the devices use the vPC system MAC addresses only for link-scope operations, such as LACP. We recommend that you create each vPC domain within the contiguous Layer 2 network with a unique domain ID. You can also configure a specific MAC address for the vPC domain, rather than having the Cisco NX-OS software assign the address.

See the “vPC and Orphan Ports” section for more information about displaying the vPC MAC table.

After you create a vPC domain, the Cisco NX-OS software creates a system priority for the vPC domain. You can also configure a specific system priority for the vPC domain.



**Note** When manually configuring the system priority, you must ensure that you assign the same priority value on both vPC peer devices. If the vPC peer devices have different system priority values, vPC does not come up.

## vPC Topology

The following figure shows a basic configuration in which the Cisco Nexus 9000 Series device ports are directly connected to another switch or host and are configured as part of a port channel that becomes part of a vPC.

*Figure 5: Switch vPC Topology*

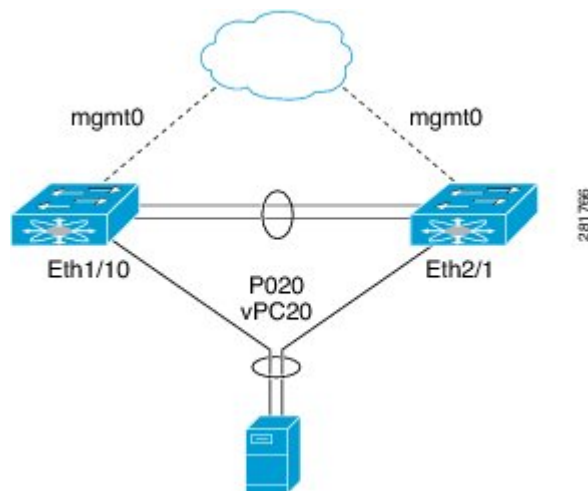

In the figure, vPC 20 is configured on port channel 20, which has Eth1/10 on the first device and Eth2/1 on the second as member ports.

You can configure a vPC from the peer devices through Fabric Extenders (FEXs) as shown in the figure.

Figure 6: FEX Straight-Through Topology (Host vPC)

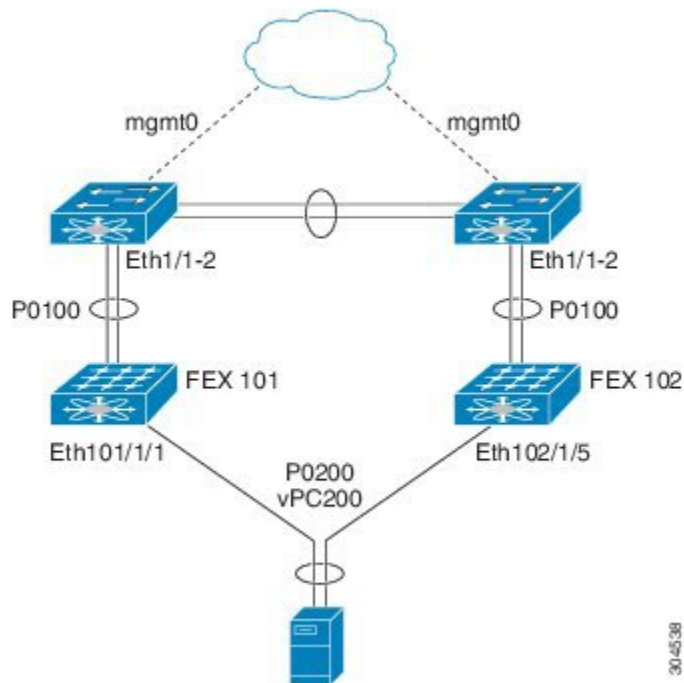

In the figure, each FEX is single-homed (straight-through FEX topology) with a Cisco Nexus 9000 Series device. The host interfaces on this FEX are configured as port channels and those port channels are configured as vPCs. Eth101/1/1 and Eth102/1/5 are configured as members of PO200, and PO200 is configured for vPC 200.

In both topologies, port channels P020 and P0200 must be configured identically on the peer switches and configuration synchronization is used to synchronize the configurations of the vPC switches.

See the [Cisco Nexus 2000 Series NX-OS Fabric Extender Configuration Guide for Cisco Nexus 9000 Series Switches](#) for more information about configuring FEX ports.

## Compatibility Parameters for vPC Interfaces

Many configuration and operational parameters must be identical on all interfaces in the vPC. We recommend that you configure the Layer 2 port channels that you use for the vPC Peer-Link in trunk mode.

After you enable the vPC feature and configure the vPC Peer-Link on both vPC peer devices, Cisco Fabric Services (CFS) messages provide a copy of the configuration on the local vPC peer device configuration to the remote vPC peer device. The system then determines whether any of the crucial configuration parameters differ on the two devices. (See the “vPC and Orphan Ports” section for more information about CFS.)



**Note** Enter the `show vpc consistency-parameters` command to display the configured values on all interfaces in the vPC. The displayed configurations are only those configurations that would limit the vPC Peer-Link and vPC from coming up.



---

**Note** The port channel compatibility parameters must be the same for all the port channel members on the physical switch. You cannot configure shared interfaces to be part of a vPC.

---

The compatibility check process for vPCs differs from the compatibility check for regular port channels.

See the “Configuring Port Channels” chapter for information about regular port channels.

## Configuration Parameters That Must Be Identical

The configuration parameters in this section must be configured identically on both devices of the vPC Peer-Link; otherwise, the vPC moves fully or partially into a suspended mode.



---

**Note** You must ensure that all interfaces in the vPC have the identical operational and configuration parameters listed in this section.

---



---

**Note** Enter the **show vpc consistency-parameters** command to display the configured values on all interfaces in the vPC. The displayed configurations are only those configurations that would limit the vPC Peer-Link and vPC from coming up.

---

The devices automatically check for compatibility for some of these parameters on the vPC interfaces. The per-interface parameters must be consistent per interface, and the global parameters must be consistent globally:

- Port-channel mode: on, off, or active (port-channel mode can, however, be active/passive on each side of the vPC peer)
- The **[no] lacp suspend-individual pxe** configuration must be the same on both the sides of the vPC.
- Link speed per channel
- Duplex mode per channel
- Trunk mode per channel:
  - Native VLAN
  - VLANs allowed on trunk
  - Tagging of native VLAN traffic
- Spanning Tree Protocol (STP) mode
- STP region configuration for Multiple Spanning Tree
- Enable/disable state per VLAN
- STP global settings:
  - Bridge Assurance setting
  - Port type setting

- Loop Guard settings
- STP interface settings:
  - Port type setting
  - Loop Guard
  - Root Guard
- Maximum Transmission Unit (MTU)

If any of these parameters are not enabled or defined on either device, the vPC consistency check ignores those parameters.



**Note** To ensure that none of the vPC interfaces are in the suspend mode, enter the **show vpc brief** and **show vpc consistency-parameters** commands and check the syslog messages.

In the output of **show vpc** or **show vpc brief** command, after every 50th configured vPC port-channel the following message will be displayed:

```
Please check "show vpc consistency-parameters vpc <vpc-num>" for the consistency reason of down vpc and for type-2 consistency reasons for any vpc.
```

## Configuration Parameters That Should Be Identical

When any of the following parameters are not configured identically on both vPC peer devices, a misconfiguration might cause undesirable behavior in the traffic flow:

- MAC aging timers
- Static MAC entries
- VLAN interface—Each device on the end of the vPC Peer-Link must have a VLAN interface configured for the same VLAN on both ends and they must be in the same administrative and operational mode. Those VLANs configured on only one device of the vPC Peer-Link do not pass traffic using the vPC or vPC Peer-Link. You must create all VLANs on both the primary and secondary vPC devices, or the VLAN will be suspended.
- All ACL configurations and parameters
- Quality of Service (QoS) configuration and parameters
- STP interface settings:
  - BPDU Filter
  - BPDU Guard
  - Cost
  - Link type
  - Priority

- VLANs (Rapid PVST+)
- Port security
- Cisco Trusted Security (CTS)
- Dynamic Host Configuration Protocol (DHCP) snooping
- Network Access Control (NAC)
- Dynamic ARP Inspection (DAI)
- IP source guard (IPSG)
- Internet Group Management Protocol (IGMP) snooping
- Hot Standby Routing Protocol (HSRP)
- Protocol Independent Multicast (PIM)
- Gateway Load-Balancing Protocol (GLBP)
- All routing protocol configurations

To ensure that all the configuration parameters are compatible, we recommend that you display the configurations for each vPC peer device once you configure the vPC.

## Consequences of Parameter Mismatches

You can configure the graceful consistency check feature, which suspends only the links on the secondary peer device when a mismatch is introduced in a working vPC. This feature is configurable only in the CLI and is enabled by default.

The graceful consistency-check command is configured by default.

As part of the consistency check of all parameters from the list of parameters that must be identical, the system checks the consistency of all VLANs.

The vPC remains operational, and only the inconsistent VLANs are brought down. This per-VLAN consistency check feature cannot be disabled and does not apply to Multiple Spanning Tree (MST) VLANs.

## vPC Number

Once you have created the vPC domain ID and the vPC Peer-Link, you create port channels to attach the downstream device to each vPC peer device. That is, you create one port channel to the downstream device from the primary vPC peer device and you create another port channel to the downstream device from the secondary peer device.



---

**Note** We recommend that you configure the ports on the downstream devices that connect to a host or a network device that is not functioning as a switch or a bridge as STP edge ports.

---

On each vPC peer device, you assign a vPC number to the port channel that connects to the downstream device. You will experience minimal traffic disruption when you are creating vPCs. To simplify the

configuration, you can assign the vPC ID number to every port channel to be the same as the port channel itself (that is, vPC ID 10 for port channel 10).



---

**Note** The vPC number that you assign to the port channel that connects to the downstream device from the vPC peer device must be identical on both vPC peer devices.

---

## Hitless vPC Role Change

A virtual port channel (vPC) allows links that are physically connected to two different Cisco Nexus 9000 Series devices to appear as a single port channel. The vPC role change feature enables you switch vPC roles between vPC peers without impacting traffic flow. The vPC role switching is done based on the role priority value of the device under the vPC domain. A vPC peer device with lower role priority is selected as the primary vPC device during the vPC Role switch. You can use the `vpc role preempt` command to switch vPC role between peers.

For information about how to configure Hitless vPC Role Change, see [Configuring Hitless vPC Role Change, on page 70](#).

## Moving Other Port Channels into a vPC



---

**Note** You must attach a downstream device using a port channel to both vPC peer devices.

---

To connect to the downstream device, you create a port channel to the downstream device from the primary vPC peer device and you create another port channel to the downstream device from the secondary peer device. On each vPC peer device, you assign a vPC number to the port channel that connects to the downstream device. You will experience minimal traffic disruption when you are creating vPCs.

## vPC Object Tracking



---

**Note** We recommend that you configure the vPC Peer-Links on dedicated ports of different modules on Cisco Nexus 9500 devices. This is recommended to reduce the possibility of a failure. For the best resiliency scenario, use at least two modules.

---

vPC object tracking is used to prevent traffic black-holing in case of failure of a module where both vPC Peer-Link and uplinks to the core resides. By tracking interface feature can suspend vPC on affected switch and prevent traffic black-holing.

If you must configure all the vPC Peer-Links and core-facing interfaces on a single module, you should configure, using the command-line interface, a track object and a track list that is associated with the Layer 3 link to the core and on all vPC Peer-Links on both vPC peer devices. You use this configuration to avoid dropping traffic if that particular module goes down because when all the tracked objects on the track list go down, the system does the following:

- Stops the vPC primary peer device sending peer-keepalive messages, which forces the vPC secondary peer device to take over.
- Brings down all the downstream vPCs on that vPC peer device, which forces all the traffic to be rerouted in the access switch toward the other vPC peer device.

Once you configure this feature and if the module fails, the system automatically suspends all the vPC links on the primary vPC peer device and stops the peer-keepalive messages. This action forces the vPC secondary device to take over the primary role and all the vPC traffic to go to this new vPC primary device until the system stabilizes.

You should create a track list that contains all the links to the core and all the vPC Peer-Links as its object. Enable tracking for the specified vPC domain for this track list. Apply this same configuration to the other vPC peer device. See the [Cisco Nexus 9000 Series NX-OS Unicast Routing Configuration Guide](#) for information about configuring object tracking and track lists.



---

**Note** This example uses Boolean OR in the track list and forces all traffic to the vPC peer device only for a complete module failure. If you want to trigger a switchover when any core interface or vPC Peer-Link goes down, use a Boolean AND in the track list below.

---

To configure a track list to switch over a vPC to the remote peer when all related interfaces on a single module fail, follow these steps:

1. Configure track objects on an interface (Layer 3 to core) and on a port channel (vPC Peer-Link).

```
switch(config-if)# track 35 interface ethernet 8/35 line-protocol
switch(config-track)# track 23 interface ethernet 8/33 line-protocol
switch(config)# track 55 interface port-channel 100 line-protocol
```

2. Create a track list that contains all the interfaces in the track list using the Boolean OR to trigger when all objects fail.

```
switch(config)# track 44 list boolean OR
switch(config-track)# object 23
switch(config-track)# object 35
switch(config-track)# object 55
switch(config-track)# end
```

3. Add this track object to the vPC domain:

```
switch(config)# vpc domain 1
switch(config-vpc-domain)# track 44
```

4. Display the track object:

```
switch# show vpc brief
Legend:
(*) - local vPC is down, forwarding via vPC peer-link
vPC domain id : 1
Peer status : peer adjacency formed ok
vPC keep-alive status : peer is alive
```



```

Configuration consistency status: success
vPC role : secondary
Number of vPCs configured : 52
Track object : 44
vPC Peer-link status
-----
id Port Status Active vlans
-----
1 Po100 up 1-5,140
vPC status
-----
id Port Status Consistency Reason Active vlans
-----
1 Po1 up success success 1-5,140

```

This example shows how to display information about the track objects:

```

switch# show track brief
Track Type Instance Parameter State Last
Change
23 Interface Ethernet8/33 Line Protocol UP 00:03:05
35 Interface Ethernet8/35 Line Protocol UP 00:03:15
44 List ----- Boolean
or UP 00:01:19
55 Interface port-channel100 Line Protocol UP 00:00:34

```

## vPC Interactions with Other Features

### vPC and LACP

LACP uses the system MAC address of the vPC domain to form the LACP Aggregation Group (LAG) ID for the vPC. (See the “Configuring Port Channels” chapter for information about LAG-ID and LACP.)

You can use LACP on all the vPC port channels, including those channels from the downstream device. We recommend that you configure LACP with active mode on the interfaces on each port channel on the vPC peer devices. This configuration allows you to more easily detect compatibility between devices, unidirectional links, and multihop connection, and provides dynamic reaction to run-time changes and link failures.

We recommend that you manually configure the system priority on the vPC Peer-Link devices to ensure that the vPC Peer-Link devices have a higher LACP priority than the downstream connected devices. A lower numerical value system priority means a higher LACP priority.



---

**Note** When manually configuring the system priority, you must ensure that you assign the same priority value on both vPC peer devices. If the vPC peer devices have different system priority values, vPC does not come up.

---

### vPC Peer-Links and STP

Although vPCs provide a loop-free Layer 2 topology, STP is still required to provide a fail-safe mechanism to protect against any incorrect or defective cabling or possible misconfiguration. When you first bring up a vPC, STP reconverges. STP treats the vPC Peer-Link as a special link and always includes the vPC Peer-Link in the STP active topology.

We recommend that you set all the vPC Peer-Link interfaces to the STP network port type so that Bridge Assurance is automatically enabled on all vPC Peer-Links. We also recommend that you do not enable any of the STP enhancement features on vPC Peer-Links. If the STP enhancements are already configured, they do not cause any problems for the vPC Peer-Links..

When you are running both MST and Rapid PVST+, ensure that the PVST simulation feature is correctly configured.

See the [Cisco Nexus 9000 Series NX-OS Layer 2 Switching Configuration Guide](#) for information about STP enhancement features and PVST simulation.



---

**Note** You must configure a list of parameters to be identical on the vPC peer devices on both sides of the vPC Peer-Link. See the “Compatibility Parameters for vPC Interfaces” section for information about these required matched settings.

---

STP is distributed; that is, the protocol continues running on both vPC peer devices. However, the configuration on the vPC peer device elected as the primary device controls the STP process for the vPC interfaces on the secondary vPC peer device.

The primary vPC device synchronizes the STP state on the vPC secondary peer device using Cisco Fabric Services over Ethernet (CFS over E). See the “vPC and Orphan Ports” section for information about CFS over E.

The STP process for vPC also relies on the periodic keepalive messages to determine when one of the connected devices on the vPC Peer-Link fails. See the “Peer-Keepalive Link and Messages” section for information about these messages.

The vPC manager performs a proposal/handshake agreement between the vPC peer devices that set the primary and secondary devices and coordinates the two devices for STP. The primary vPC peer device then controls the STP protocol on both the primary and secondary devices. We recommend that you configure the primary vPC peer device as the STP primary root device and configure the secondary vPC device to be the STP secondary root device.

If the primary vPC peer device fails over to the secondary vPC peer device, there is no change in the STP topology.

The BPDUs use the MAC address set for the vPC for the STP bridge ID in the designated bridge ID field. The vPC primary device sends these BPDUs on the vPC interfaces.

You must configure both ends of vPC Peer-Link with the identical STP configuration for the following parameters:

- STP global settings:
  - STP mode
  - STP region configuration for MST
  - Enable/disable state per VLAN
  - Bridge Assurance setting
  - Port type setting
  - Loop Guard settings
- STP interface settings:

- Port type setting
- Loop Guard
- Root Guard



---

**Note** If any of these parameters are misconfigured, the Cisco NX-OS software suspends all interfaces in the vPC. Check the syslog and enter the **show vpc brief** command to see if the vPC interfaces are suspended.

---

Ensure that the following STP interface configurations are identical on both sides of the vPC Peer-Links or you may see unpredictable behavior in the traffic flow:

- BPDU Filter
- BPDU Guard
- Cost
- Link type
- Priority
- VLANs (PVRST+)



---

**Note** Display the configuration on both sides of the vPC Peer-Link to ensure that the settings are identical.

---

You can use the **show spanning-tree** command to display information about the vPC when that feature is enabled. See the [Cisco Nexus 9000 Series NX-OS Layer 2 Switching Configuration Guide](#) for an example.



---

**Note** We recommend that you configure the ports on the downstream devices as STP edge ports. You should configure all host ports connected to a switch as STP edge ports. See the [Cisco Nexus 9000 Series NX-OS Layer 2 Switching Configuration Guide](#) for more information about STP port types.

---

## vPC Peer Switch

The vPC peer switch feature was added to Cisco NX-OS to address performance concerns around STP convergence. This feature allows a pair of Cisco Nexus 9000 Series devices to appear as a single STP root in the Layer 2 topology. This feature eliminates the need to pin the STP root to the vPC primary switch and improves vPC convergence if the vPC primary switch fails.

To avoid loops, the vPC Peer-Link is excluded from the STP computation. In vPC peer switch mode, STP BPDUs are sent from both vPC peer devices to avoid issues related to STP BPDU timeout on the downstream switches, which can cause traffic disruption.

This feature can be used with the pure peer switch topology in which the devices all belong to the vPC.



---

**Note** Peer-switch feature is supported on networks that use vPC and STP-based redundancy is not supported. If the vPC Peer-Link fail in a hybrid peer-switch configuration, you can lose traffic. In this scenario, the vPC peers use the same STP root ID as well as the same bridge ID. The access switch traffic is split in two with half going to the first vPC peer and the other half to the second vPC peer. With vPC Peer-Link failure, there is no impact to the north/south traffic but the east/west traffic is lost.

---

See the [Cisco Nexus 9000 Series NX-OS Layer 2 Switching Configuration Guide](#) for information about STP enhancement features and Rapid PVST+.

## vPC Peer-Gateway

You can configure vPC peer devices to act as the gateway even for packets that are destined to the vPC peer device's MAC address.

Use the **peer-gateway** command to configure this feature.



---

**Note** You can use the mode auto command to automatically enable this feature. See the “Enabling Certain vPC Commands Automatically” section for more information about using this command.

---



---

**Note** The **peer-gateway exclude-vlan** variation of the command that specifies VLANs to be excluded from peer-gateway functionality is not supported.

The **peer-gateway exclude-vlan** command that is used when configuring a VLAN interface for Layer 3 backup routing on vPC peer devices is not supported.

---

Some network-attached storage (NAS) devices or load balancers might have features that help to optimize the performances of particular applications. These features enable the device to avoid a routing-table lookup when responding to a request that originated from a host that is not locally attached to the same subnet. Such devices might reply to traffic using the MAC address of the sender Cisco Nexus 9000 Series device rather than the common HSRP gateway. This behavior is noncompliant with some basic Ethernet RFC standards. Packets that reach a vPC device for the nonlocal router MAC address are sent across the vPC Peer-Link and could be dropped by the built in vPC loop avoidance mechanism if the final destination is behind another vPC.

The vPC peer-gateway capability allows a vPC switch to act as the active gateway for packets that are addressed to the router MAC address of the vPC peer. This feature enables local forwarding of packets without the need to cross the vPC Peer-Link. In this scenario, the feature optimizes use of the vPC Peer-Link and avoids potential traffic loss.

Configuring the peer-gateway feature must be done on both primary and secondary vPC peers and is nondisruptive to the operations of the device or to the vPC traffic. The vPC peer-gateway feature can be configured globally under the vPC domain submode.

When you enable this feature, Cisco NX-OS automatically disables IP redirects on all interface VLANs mapped over a vPC VLAN to avoid generation of IP redirect messages for packets switched through the peer gateway router.

Packets that arrive at the peer-gateway vPC device have their Time to Live (TTL) decremented, so that packets carrying a TTL of 1 might get dropped in transit due to TTL expiration. You should take this situation into account when the peer-gateway feature is enabled and particular network protocols that source packets with a TTL of 1 operate on a vPC VLAN.

## vPC and ARP or ND

A feature was added to Cisco NX-OS to address table synchronization across vPC peers using the reliable transport mechanism of the Cisco Fabric Service over Ethernet (CFS over E) protocol. You must enable the **ip arp synchronize** and **ipv6 nd synchronize** commands to support faster convergence of address tables between the vPC peers. This convergence overcomes the delay that occurs in ARP table restoration for IPv4 or ND table restoration for IPv6 when the vPC Peer-Link port channel flaps or when a vPC peer comes back online.



---

**Note** You can use the **mode auto** command to automatically enable this feature. See the “Enabling Certain vPC Commands Automatically” section for information about using this command.

---

## vPC Multicast—PIM, IGMP, and IGMP Snooping

The Cisco NX-OS software for the Nexus 9000 Series devices supports the following on a vPC:

- PIM Any Source Multicast (ASM).
- PIM Source-Specific Multicast (SSM) (7.0(3)I4(1) and later).



---

**Note** The Cisco NX-OS software does not support Product Independent Multicast (PIM), Source-Specific Multicast (SSM) or Bidirectional (BIDR) on a vPC.

---

The software keeps the multicast forwarding state synchronized on both of the vPC peer devices. The IGMP snooping process on a vPC peer device shares the learned group information with the other vPC peer device through the vPC Peer-Link; the multicast states are always synchronized on both vPC peer devices. The PIM process in vPC mode ensures that only one of the vPC peer devices forwards the multicast traffic to the receivers.

Each vPC peer is a Layer 2 or Layer 3 device. Multicast traffic flows from only one of the vPC peer devices. You might see duplicate packets in the following scenarios:

- Orphan hosts
- When the source and receivers are in the Layer 2 vPC cloud in different VLANs with multicast routing enabled and a vPC member link goes down.

You might see negligible traffic loss in the following scenarios:

- When you reload the vPC peer device that is forwarding the traffic.
- When you restart PIM on the vPC peer device that is forwarding the traffic.

Overall multicast convergence times are scale and vPC role change / PIM restart duration dependent.

Ensure that you dual-attach all Layer 3 devices to both vPC peer devices. If one vPC peer device goes down, the other vPC peer device continues to forward all multicast traffic normally.

The following outlines vPC PIM and vPC IGMP/IGMP snooping:

- vPC PIM—The PIM process in vPC mode ensures that only one vPC peer device forwards multicast traffic. The PIM process in vPC mode synchronizes the source state with both vPC peer devices and elects which vPC peer device forwards the traffic.
- vPC IGMP/IGMP snooping—The IGMP process in vPC mode synchronizes the designated router (DR) information on both vPC peer devices. Dual DRs are available for IGMP when you are in vPC mode. Dual DRs are not available when you are not in vPC mode, because both vPC peer devices maintain the multicast group information between the peers.



---

**Note** A PIM adjacency between a Switched Virtual Interface (SVI) on a vPC VLAN (a VLAN that is carried on a vPC Peer-Link) and a downstream device is not supported; this configuration can result in dropped multicast packets. If a PIM neighbor relationship is required with a downstream device, a physical Layer 3 interface must be used on the Nexus switches instead of a vPC SVI.

For SVIs on vPC VLANs, only one PIM adjacency is supported, which is with the vPC peer switch. PIM adjacencies over the vPC Peer-Link with devices other than the vPC peer switch for the vPC-SVI are not supported.

---

You should enable or disable IGMP snooping identically on both vPC peer devices, and all the feature configurations should be identical. IGMP snooping is on by default.



---

**Note** The following commands are not supported in vPC mode:

- **ip pim spt-threshold infinity**
  - **ip pim use-shared-tree-only**
- 

See the *Cisco Nexus 9000 Series NX-OS Multicast Routing Configuration Guide* for more information about multicasting.

## Multicast PIM Dual DR (Proxy DR)

By default, a multicast router sends PIM joins upstream only if it has interested receivers. These interested receivers can either be IGMP hosts (they communicate through IGMP reports) or other multicast routers (they communicate through PIM joins).

In the Cisco NX-OS vPC implementation, PIM works in dual designated router (DR) mode. That is, if a vPC device is a DR on a vPC SVI outgoing interface (OIF), its peer automatically assumes the proxy DR role. IGMP adds an OIF (the report is learned on that OIF) to the forwarding if the OIF is a DR. With dual DRs, both vPC devices have an identical (\*,G) entry with respect to the vPC SVI OIFs as shown in this example:

```
VPC Device1:
-----
(*,G)
oif1 (igmp)
VPC Device2:
-----
(*,G)
```

```
oif1 (igmp)
```

## IP PIM PRE-BUILD SPT

When the multicast source is in a Layer 3 cloud (outside the vPC domain), one vPC peer is elected as the forwarder for the source. This forwarder election is based on the metrics to reach the source. If there is a tie, the vPC primary is chosen as the forwarder. Only the forwarder has the vPC OIFs in its associated (S,G) and the nonforwarder (S,G) has 0 OIFs. Therefore, only the forwarder sends PIM (S,G) joins toward the source as shown in this example:

```
VPC Device1 (say this is Forwarder for Source 'S'):
-----
(*,G)
oif1 (igmp)
(S,G)
oif1 (mrib)
VPC Device2:
-----
(*,G)
oif1 (igmp)
(S,G)
NULL
```

In the case of a failure (for example, a Layer 3 Reverse Path Forwarding (RPF) link on the forwarder becomes inoperable or the forwarder gets reloaded), if the current nonforwarder ends up becoming the forwarder, it has to start sending PIM joins for (S,G) toward the source to pull the traffic. Depending upon the number of hops to reach the source, this operation might take some time (PIM is a hop-by-hop protocol).

To eliminate this issue and get better convergence, use the **ip pim pre-build-spt** command. This command enables PIM send joins even if the multicast route has 0 OIFs. In a vPC device, the nonforwarder sends PIM (S,G) joins upstream toward the source. The downside is that the link bandwidth upstream from the nonforwarder gets used for the traffic that is ultimately dropped by it. The benefits that result with better convergence far outweigh the link bandwidth usage. Therefore, we recommend that you use this command if you use vPCs.

## vPC Peer-Links and Routing

The First Hop Redundancy Protocols (FHRPs) interoperate with vPCs. The Hot Standby Routing Protocol (HSRP), Gateway Load Balancing Protocol (GLBP), and Virtual Router Redundancy Protocol (VRRP) all interoperate with vPCs. We recommend that you dual-attach all Layer 3 devices to both vPC peer devices.

The primary FHRP device responds to ARP requests, even though the secondary vPC device forwards the data traffic.

To simplify initial configuration verification and vPC/HSRP troubleshooting, you can configure the primary vPC peer device with the FHRP active router highest priority.

In addition, you can use the priority command in the if-hsrp configuration mode to configure failover thresholds for when a group state enabled on a vPC Peer-Link is in standby or in listen state. You can configure lower and upper thresholds to prevent the interface from going up and down.

VRRP acts similarly to HSRP when running on vPC peer devices. You should configure VRRP the same way that you configure HSRP. For GLBP, the forwarders on both vPC peer devices forward traffic.

When the primary vPC peer device fails over to the secondary vPC peer device, the FHRP traffic continues to flow seamlessly.

We recommend that you configure routing adjacency between the two vPC peer devices to act as a backup routing path. If one vPC peer device loses Layer 3 uplinks, the vPC can redirect the routed traffic to the other vPC peer device and leverage its active Layer 3 uplinks.

You can configure the inter-switch link for a backup routing path in the following ways:

- Create a Layer 3 link between the two vPC peer devices.
- Use the non-VPC VLAN trunk with a dedicated VLAN interface.
- Use a vPC Peer-Link with a dedicated VLAN interface.

We do not recommend that you configure the burnt-in MAC address option (use-bia) for HSRP or manually configure virtual MAC addresses for any FHRP protocol in a vPC environment because these configurations can adversely affect vPC load balancing. The HSRP use-bia option is not supported on vPCs. When you are configuring custom MAC addresses, you must configure the same MAC address on both vPC peer devices.

You can use the **delay restore** command to configure a restore timer that delays the vPC coming back up until after the peer adjacency forms and the VLAN interfaces are back up. This feature enables you to avoid packet drops when the routing tables might not be converged before the vPC is once again passing traffic. Use the **delay restore** command to configure this feature.

To delay the VLAN interfaces on the restored vPC peer device from coming up, use the **interfaces-vlan** option of the **delay restore** command.

See the [Cisco Nexus 9000 Series NX-OS Unicast Routing Configuration Guide](#) for more information about FHRPs and routing.

## Configuring Layer 3 Backup Routes on a vPC Peer-Link

You can use VLAN network interfaces on the vPC peer devices to link to Layer 3 of the network for such applications as HSRP and PIM. Ensure that you have a VLAN network interface configured on each peer device and that the interface is connected to the same VLAN on each device. Also, each VLAN interface must be in the same administrative and operational mode. For more information about configuring VLAN network interfaces, see the “Configuring Layer 3 Interfaces” chapter.

If a failover occurs on the vPC Peer-Link, the VLAN interfaces on the vPC peer devices are also affected. If a vPC Peer-Link fails, the system brings down associated VLAN interfaces on the secondary vPC peer device.

You can ensure that specified VLAN interfaces do not go down on the vPC secondary device when the vPC Peer-Link fails.

Use the **dual-active exclude interface-vlan** command to configure this feature.

## CFSoS

The Cisco Fabric Services over Ethernet (CFSoS) is a reliable state transport mechanism that is used to synchronize the actions of the vPC peer devices. CFSoS carries messages and packets for many features linked with vPC, such as STP and IGMP. Information is carried in CFS/CFSoS protocol data units (PDUs).

When you enable the vPC feature, the device automatically enables CFSoS, and you do not have to configure anything. CFSoS distributions for vPCs do not need the capabilities to distribute over IP or the CFS regions. You do not need to configure anything for the CFSoS feature to work correctly on vPCs.

The CFSoS transport is local to each VDC.

You can use the **show mac address-table** command to display the MAC addresses that CFSoS synchronizes for the vPC Peer-Link.





---

**Note** Do not enter the **no cfs eth distribute** or the **no cfs distribute** command. You must enable CFSoE for vPC functionality. If you do enter either of these commands with vPC enabled, the system displays an error message.

---

When you enter the **show cfs application** command, the output displays “Physical-eth,” which shows the applications that are using CFSoE.

CFS also transports data over TCP/IP. See the [Cisco Nexus 9000 Series NX-OS System Management Configuration Guide](#) for more information about CFS over IP.



---

**Note** The software does not support CFS regions.

---

## vPC and Orphan Ports

When a device that is not vPC-capable connects to each peer, the connected ports are known as orphan ports because they are not members of a vPC. The device’s link to one peer will be active (forwarding) and the other link will be standby (blocking) due to STP.

If a vPC Peer-Link failure or restoration occurs, an orphan port’s connectivity might be bound to the vPC failure or restoration process. For example, if a device’s active orphan port connects to the secondary vPC peer, the device loses any connections through the primary peer if a vPC Peer-Link failure occurs and the vPC ports are suspended by the secondary peer. If the secondary peer were to also suspend the active orphan port, the device’s standby port becomes active, provides a connection to the primary peer, and restores connectivity. You can configure in the CLI that specific orphan ports are suspended by the secondary peer when it suspends its vPC ports and are restored when the vPC is restored.

## Virtualization Support

All ports in a given vPC must be in the same VDC. This version of the software supports only one vPC domain per VDC. You can use the numbers from 1 to 4096 in each VDC to number the vPC.

## vPC Recovery After an Outage

In a data center outage, both the vPC peer in vPC domain get reloaded. Occasionally only one peer can be restored. With no functioning peer-keepalive or vPC Peer-Link, the vPC cannot function normally, a method might be available to allow vPC services to use only the local ports of the functional peer.

## Autorecovery

You can configure the Cisco Nexus 9000 Series device to restore vPC services when its peer fails to come online by using the **auto-recovery** command. You must save this setting in the startup configuration. On reload, if the vPC Peer-Link is down and three consecutive peer-keepalive messages are lost, the secondary device assumes the primary STP role and the primary LACP role. The software reinitializes the vPCs, bringing up its local ports. Because there are no peers, the consistency check is bypassed for the local vPC ports. The device elects itself to be the STP primary regardless of its role priority and also acts as the primary device for LACP port roles.



---

**Note** You can use the **mode auto** command to automatically enable this feature. See the “Enabling Certain vPC Commands Automatically” section for information about using this command.

---

## Autorecovery reload-delay

vPC peer auto recovery can be delayed using **auto-recovery reload-delay** command. Auto-recovery reload-delay time is used on peer that comes up first. The **reload-delay time** command is used to wait for both peers to recover and to keep existing roles before auto recovery starts. The device then resumes primary role to recovered switch.

## vPC Peer Roles After a Recovery

When the other peer device completes its reload and adjacency forms, the following process occurs:

1. The first vPC peer maintains its current role to avoid any transition reset to other protocols. The peer accepts the other available role.
2. When an adjacency forms, consistency checks are performed and appropriate actions are taken.

## High Availability

During an In-Service Software Upgrade (ISSU), the software reload process on the first vPC device locks its vPC peer device by using CFS messaging over the vPC communications channel. Only one device at a time is upgraded. When the first device completes its upgrade, it unlocks its peer device. The second device then performs the upgrade process, locking the first device as it does so. During the upgrade, the two vPC devices temporarily run different releases of Cisco NX-OS, however the system functions correctly because of its backward compatibility support.



---

**Note** See the [Cisco Nexus 9000 Series NX-OS High Availability and Redundancy Guide](#) for complete information about high-availability features.

---

## vPC Forklift Upgrade Scenario

The following procedure describes a scenario of migrating pair of Cisco Nexus 9500 switches in a vPC domain to a different pair of Cisco Nexus 9500 switches with a same type of line cards. Migrating from Cisco Nexus 9504 switches to Cisco Nexus 9508 switches for the need of more interfaces is a typical example of such migration. The following migration scenarios are not supported:

- Migration of Cisco Nexus 9500 switches with a different set of line cards. For example, from a Cisco Nexus 9500 switches with N9K-X94xx line card to Cisco Nexus 9500 switches with N9K-X97xx line card.
- Migration between different generations of Cisco Nexus 9300 switches. For example, migration from Cisco Nexus N9K-C9372PX to Cisco Nexus N9K-93180YC-EX switches
- Having different generations of Cisco Nexus 9000 switches in a vPC domain is not supported

Considerations for a vPC forklift upgrade:

- vPC Role Election and Sticky-bit

By default, the Cisco NX-OS software uses the lowest MAC address to elect the primary device. However, if the role priority is set, then the device with the lowest priority will be elected as the primary device. When the primary device is reloaded, the system comes back online and connectivity to the vPC secondary device (now the operational primary) is restored. The operational role of the secondary device (operational primary) does not change (to avoid unnecessary disruptions). This behavior is achieved with a sticky-bit, where the sticky information is not saved in the startup configuration. This method makes the device that is up and running win over the reloaded device. Hence, the vPC primary becomes the vPC operational secondary. Sticky-bit is also set when a vPC node comes up with vPC Peer-Link and peer-keepalive down and it becomes primary after the auto recovery period.

- vPC Delay Restore

The delay restore timer is used to delay the vPC from coming up on the restored vPC peer device after a reload when the peer adjacency is already established.

To delay the VLAN interfaces on the restored vPC peer device from coming up, use the **interfaces-vlan** option of the **delay restore** command.

- vPC Auto-Recovery

During a data center power outage when both vPC peer switches go down, if only one switch is restored, the auto-recovery feature allows that switch to assume the role of the primary switch and the vPC links come up after the auto-recovery time period. The default auto-recovery period is 240 seconds.

The following example is a migration scenario that replaces vPC peer nodes Node1 and Node2 with New\_Node1 and New\_Node2.

	Migration Step	Expected Behavior	Node1 Configured role ( Ex: role priority 100)	Node1 Operational role	Node2 Configured role (Ex: role priority 200)	Node2 Operational role
1	Initial state	Traffic is forwarded by both vPC peers – Node1 and Node2.  Node1 is primary and Node2 is secondary.	primary	Primary  Sticky bit: False	secondary	Secondary  Sticky bit: False
2	Node2 replacement – Shut all vPCs and uplinks on Node2. vPC Peer-Link and vPC peer-keepalive are in administrative up state.	Traffic converged on Primary vPC peer Node1.	primary	Primary  Sticky bit: False	secondary	Secondary  Sticky bit: False

	<b>Migration Step</b>	<b>Expected Behavior</b>	<b>Node1 Configured role ( Ex: role priority 100)</b>	<b>Node1 Operational role</b>	<b>Node2 Configured role (Ex: role priority 200)</b>	<b>Node2 Operational role</b>
3	Remove Node2.	Node1 will continue to forward traffic.	primary	Primary Sticky bit: False	n/a	n/a
4	Configure New_Node2. Copy the configuration to startup config. vPC vPC Peer-Link and peer-keepalive in administrative up state.  Power off New_Node2.  Make all connections.  Power on New_Node2.	New_Node2 will come up as secondary. Node1 continue to be primary.  Traffic will continue to be forwarded on Node01.	primary	Primary Sticky bit: False	secondary	Secondary Sticky bit: False
5	Bring up all vPCs and uplink ports on New_Node2.	Traffic will be forwarded by both Node 1 and New_Node2.	primary	Primary Sticky bit: False	secondary	Secondary Sticky bit: False
6	Node1 replacement - Shut vPCs and uplinks on Node1.	Traffic will converge on New_Node2.	primary	Primary Sticky bit: False	secondary	Secondary Sticky bit: False
7	Remove Node1.	New_Node2 will become secondary, operational primary and sticky bit will be set to True.	n/a	n/a	secondary	Primary Sticky bit: True
8	Configure New_Node1. Copy running to startup.  Power off the new Node1. Make all connections. Power on New_Node1.	New_Node1 will come up as primary, operational secondary.	primary	Secondary Sticky bit: False	secondary	Primary Sticky bit: True

	Migration Step	Expected Behavior	Node1 Configured role ( Ex: role priority 100)	Node1 Operational role	Node2 Configured role (Ex: role priority 200)	Node2 Operational role
9	Bring up all vPCs and uplink ports on New_Node1.	Traffic will be forwarded by both New Node1 and new Node2.	primary	Secondary Sticky bit: False	secondary	Primary Sticky bit: True



**Note** If you prefer to have the configured secondary node as the operational secondary and the configured primary as the operational primary, then Node2 can be reloaded at the end of the migration. This is optional and does not have any functional impact.

## Guidelines and Limitations

vPCs have the following configuration guidelines and limitations:

- When forming a vPC domain between two Cisco Nexus 9300 Series switches, both switches must be the exact same model to form a supported vPC domain. When forming a vPC domain between two Cisco Nexus 9500 Series switches, both switches must consist of the same models of line cards, fabric modules, supervisor modules, and system controllers inserted in the same slots of the chassis to form a supported vPC domain.
- You must configure the peer-keepalive link and adjacency between peers must be formed before the system can establish the vPC Peer-Link.
- You must configure both vPC peer devices; the configuration is not sent from one device to the other.
- Only Layer 2 port channels can be in vPCs.
- We recommend that you configure all the port channels in the vPC using LACP with the interfaces in active mode.
- All the devices that are attached to a vPC domain through a vPC must be dual homed.
- You must ensure that all the necessary configuration parameters are compatible on both sides of the vPC Peer-Link. See the *Compatibility Parameters for vPC Interfaces* section for information about compatibility recommendations.
- You may experience minimal traffic disruption while configuring vPCs on existing port-channels.
- The software does not support CFS regions.
- vPC Peer-Link by default has set MTU of 9216.
- The STP port cost is fixed to 200 in a vPC environment.
- To configure multilayer (back-to-back) vPCs, you must assign unique vPC domain ID for each respective vPC.

- To accommodate increased traffic when the vPC goes down and traffic needs to cross the vPC Peer-Link, the best practice is to use multiple high bandwidth interfaces (such as the 40G interfaces for the Cisco Nexus 9000 switches) across linecards for the vPC Peer-Link.
- There might be duplicate multicast streams with L3 links and with the back-to-back vPC when:
  - SVI is configured on all four switches that are part of a back-to-back vPC.
  - There are additional L3 links connecting the four switches which are part of vPC.
  - PIM is enabled on all SVIs and on the L3 links between switches.

To prevent the duplicate streams, remove SVIs or the PIM configuration from one of the vPC switch pairs.

- Beginning with Cisco NX-OS Release 7.0(3)I5(1), Layer 3 over vPC is supported on Cisco Nexus 9000 Series switches for Layer 3 unicast communication only. Layer 3 over vPC is not supported for Layer 3 multicast traffic. For more information please refer to the *Best Practices for Layer 3 and vPC Configuration* section
- By default Layer 3 vPC forwards all the packets (with TTL=1) destined for the peer vPC node. OSPF/BGP can flap due to this forwarding. You need to carve the ing-sup TCAM to size 768 in order to make the switch hardware forward. Make sure to reload the switch after the TCAM carving. An example is listed below.

```
show hardware access-list tcam region | gr ing-sup
      Ingress SUP [ing-sup] size = 768
```

- Beginning with Cisco NX-OS Release 7.0(3)I4(1), the spanning-tree pseudo-information command is not available on Cisco Nexus 92160 and Cisco Nexus 93180 switches.
- Cisco Nexus 9000 Series switches do not support NAT on vPC topology.
- vPC peers must run the same Cisco NX-OS release. During a software upgrade, you must upgrade the primary vPC peer first.
- Before performing a non-disruptive upgrade, you must make sure that both vPC peers are in the same mode (regular ISSU mode or enhance ISSU mode).



---

**Note** vPCpeering between an enhanced ISSU mode (boot mode lxc) configured switch and a non-enhanced ISSU mode switch is not supported.

---

- The **vpc orphan-ports suspend** command is recommended to be used on interfaces with vPC VLANs. This command also can be applied to ports in non-vPC VLANs and Layer 3 ports.
- The software does not support BIDR PIM on vPCs.
- The software does not support DHCP snooping, DAI, or IPSG in a vPC environment; DHCP Relay is supported.
- When **peer-switch** features are configured under **vpc domain** configuration mode on two Cisco Nexus 9000 Series switches, the spanning-tree root changes even for VLANs that are not enabled on the vPC Peer-Link. Both the switches act as one system with one MAC address as the bridge address. This is true

even for non-vPC mst-instance or VLANs. Therefore, a non vPC Peer-Link between the two switches gets blocked as a backup link. This is an expected behavior.

- Having the same Hot Standby Router Protocol (HSRP)/Virtual Router Redundancy Protocol (VRRP) group on all nodes on a double sided vPC is supported on Cisco NX-OS 7.0(3)I2(1) and later releases
- When migrating from a pair of spine nodes to a pair of Cisco Nexus 9000 devices, the HSRP priority should be configured so that the Cisco Nexus 9000 vPC peers are in Active/Standby state. There is no support for Cisco Nexus 9000 vPC peers in HSRP state to be in Active/Listen state, or Standby/Listen state (7.(0)I2(2) or later) .
- Beginning with Cisco NX-OS Release 7.0(3)I2(2), when configuring vPCs, the behavior previously provided by using the **ip pim pre-build-spt** command has now been enabled automatically by default and cannot be disabled.
- Beginning with Cisco NX-OS Release NX-OS 7.0(3)I2(2), a vPC port channel member link that is operating in Individual state will be flapped while checking for VLAN inconsistencies. To avoid having the link flapped during server provisioning, disable the VPC graceful consistency check with the **no gracefulconsistency-check** command.
- When using vPCs, we recommend that you use default timers for FHRP (HSRP, VRRP), and PIM configurations. Using aggressive timers in vPC configurations has no advantage in convergence times.
- If you configure open shortest path first (OSPF) in a vPC environment, use the following timer commands in router configuration mode on the core switch to ensure fast OSPF convergence when a vPC Peer-Link is shut down:

```
switch (config-router)# timers throttle spf 1 50 50
switch (config-router)# timers lsa-arrival 10
```

See the *Cisco Nexus 9000 Series NX-OS Unicast Routing Configuration Guide* for further details about OSPF.

- BFD for VRRP/HSRP is not supported in a vPC environment.
- Beginning with Cisco Nexus 9000 Release 7.0(3)I7(1), vPC STP hitless role change feature is supported.
- vPC role change can be performed from either of the peer devices.
- If the original secondary device has higher role priority value than the original primary device, role swapping cannot be performed. Change the role priority on either vPC device so that the value of the original secondary device is lower than the original primary one. To view the existing role of a device, use the show vpc role command on local and peer switch.
- Always check the existing configured role priority before configuring vPC hitless role change feature. In a vPC domain, enable the peer-switch command, where both vPC peers have same STP priorities, and ensure it is operational before issuing a role change. If you do not enable the peer-switch command, it can lead to convergence issues. Use **show spanning-tree summary | grep peer** command to verify whether the peer vPC switch is operational or not.
- Beginning with Cisco NX-OS Release 7.0(3)I5(2), FEX-AA (dual-homed FEX) and FEX-ST (FEX straight-thru) topologies (FEX-AA and FEX-ST) are supported. The following parent switch combinations are not supported:
  - Cisco Nexus 9300-EX and 9300 switches.
  - Cisco Nexus 9300 and 9500 switches.

- Cisco Nexus 9300-EX and 9500 switches.
- The first generation Broadcom based Nexus 9300 series switches and Nexus 9500 series line-cards does not support policy based routing route map with a set ip next-hop statement where the egress interface is the vPC Peer-Link while the vPC convergence TCAM region is allocated. This limitation does not apply to cloud scale based Nexus 9000 series devices such as Cisco Nexus 9200 switches, 9300 switches with EX/FX/FX2 line-cards and Nexus 9500 platform switches with 9700-EX/FX line-cards.
- **show** commands with the **internal** keyword are not supported
- Layer 3 over vPC is supported on Cisco Nexus 9000 Series switches for Layer 3 unicast communication only. Layer 3 over vPC is not supported for Layer 3 multicast traffic. For more information see the *Best Practices for Layer 3 and vPC Configuration* section.
- The default behavior with Layer 3 peer-router and TTL=1 packet destined to IP of vPC peer is to punt packet to CPU and then forward the software to vPC peer. This is applicable to the Cloud Scale based EOR switches.
- Starting with Cisco NX-OS Release 7.0(3)I7(9) and Cisco NX-OS Release 9.3(5) Cloud Scale based TOR switches can forward TTL=1 packet destined to vPC peer in hardware/data plane. It is recommended to use one of these releases or later releases for a seamless operation of the feature.
  - Cisco NX-OS Release 9.3(4) has this default behavior though a TCAM re-carving option is available for the hardware redirect of the packets to vPC peer for Cloud Scale based TOR switches. This requires allocating at least 768 space for ing-sup region and requires reload and has operational overhead.
- When you configure a vPC pair for STP priority, you must set the same priority level for both the vPC peer switches in order to get both vPC peers to work as STP root.
- You may see the following behavior with unicast packets when you configure Layer 3 peer-router with Cloud Scale ASIC based switches:
  - Unicast packets with TTL=0 destined to vPC peer node, will be forwarded to the peer.
  - Unicast packets with TTL=0 are not dropped by the peer, it gets punted to SUP instead.
  - Unicast packets with TTL=1 and TTL=0 destined to VPC peer node can be software forwarded and hardware forwarded. So duplicate packets are seen in the peer node.
- Beginning with Cisco NX-OS Release 9.3(9), a syslog is created when peer-gateway and layer 3 peer-router commands are not configured on both the vPC peers in the vPC domain.
- LACP configuration on the vPC port-channel must be consistent on both the Cisco Nexus switches across a vPC Peer-Link.
- Make sure that both vPC peers are in the same mode (regular mode or enhanced mode) before performing a nondisruptive upgrade.



---

**Note** vPC peering between an enhanced ISSU mode (boot mode lxc) configured switch and a non-enhanced ISSU mode switch is not supported.

---

- **show** commands with the **internal** keyword are not supported.



- Cisco Nexus 9000 Series switches do not support NAT on vPC topology.
- The **spanning-tree pseudo-information** command is not available on Cisco Nexus 92160 and Cisco Nexus 93180 switches.
- The **show vpc consistency-checker** command is not available on Cisco Nexus 9000 switches starting from Cisco NX-OS Release 9.2(1).
- The **delay restore interface-bridge-domain** and **peer-gateway exclude-bridge-domain** commands are not available on Cisco Nexus 9500-R platform switches starting from Cisco NX-OS Release 9.2(1).
- vPC peers must run the same Cisco NX-OS release. During a software upgrade, make sure to upgrade the primary vPC peer first.
- All ports for a given vPC must be in the same VDC.
- You must enable vPCs before you can configure them.
- You must configure the peer-keepalive link and messages before the system can form the vPC Peer-Link.
- Only Layer 2 port channels can be in vPCs.
- You must configure both vPC peer devices; the configuration is not sent from one device to the other.
- To configure multilayer (back-to-back) vPCs, you must assign unique vPC domain ID for each respective vPC.
- Check that the necessary configuration parameters are compatible on both sides of the vPC Peer-Link. See the “Compatibility Parameters for vPC Interfaces” section for information about compatibility recommendations.
- You may experience minimal traffic disruption while configuring vPCs.
- The software does not support BIDR PIM or SSM on vPCs.
- The software does not support CFS regions.
- When **peer-switch** features are configured under **vpc domain** configuration mode on two Cisco Nexus 9000 Series switches, the spanning-tree root changes even for VLANs that are not enabled on the vPC Peer-Link. Both the switches act as one system with one MAC address as the bridge address. This is true even for non-vPC mst-instance or VLANs. Therefore, a non vPC Peer-Link between the two switches gets blocked as a backup link. This is an expected behavior.
- We recommend that you configure all the port channels in the vPC using LACP with the interfaces in active mode.
- Back-to-back, multilayer vPC topologies require unique domain IDs on each respective vPC.
- Having the same Hot Standby Router Protocol (HSRP)/Virtual Router Redundancy Protocol (VRRP) group on all nodes on a double sided vPC is supported..
- When migrating from a pair of spine nodes to a pair of Cisco Nexus 9000 devices, the HSRP priority should be configured so that the Cisco Nexus 9000 vPC peers are in Active/Standby state. There is no support for Cisco Nexus 9000 vPC peers in HSRP state to be in Active/Listen state, Standby/Listen state, or Listen/Listen state.

When migrating from a pair of spine nodes to a pair of Cisco Nexus 9000 devices, the HSRP priority should be configured so that the Cisco Nexus 9000 vPC peers are in Active/Standby state. There is no

support for Cisco Nexus 9000 vPC peers in HSRP state to be in Active/Listen state, or Standby/Listen state.

- When using vPCs, we recommend that you use default timers for FHRP (HSRP, VRRP, GLBP), and PIM configurations. There is no advantage in convergence times when using aggressive timers in vPC configurations.
- If you configure open shortest path first (OSPF) in a vPC environment, use the following timer commands in router configuration mode on the core switch to ensure fast OSPF convergence when a vPC Peer-Link is shut down:

```
switch (config-router)# timers throttle spf 1 50 50
switch (config-router)# timers lsa-arrival 10
```

See the *Cisco Nexus 9000 Series NX-OS Unicast Routing Configuration Guide* for further details about OSPF.

- BFD for VRRP/HSRP is not supported in a vPC environment.
- The STP port cost is fixed to 200 in a vPC environment.
- Jumbo frames are enabled by default on the vPC Peer-Link.
- To accommodate increased traffic when the vPC goes down and traffic needs to cross the vPC Peer-Link, it is a best practice to use multiple high bandwidth interfaces (such as the 40G interfaces for the Cisco Nexus 9000) across linecards for the vPC Peer-Link.
- The **vpc orphan-ports suspend** command also applies to ports in non-vPC VLANs and Layer 3 ports. However, it is recommended to be used with ports in VPC VLANs.
- FEX vPC is not supported between FEX (any model) and the Cisco Nexus 9300 (TOR) and Cisco Nexus 9500 (EOR) Series switches as the parent switches.

FEX-AA (dual-homed FEX) and FEX-ST (FEX straight-thru) topologies (FEX-AA and FEX-ST) are supported. The following mixing is not supported as the parent switches:

- Cisco Nexus 9300-EX and 9300 switches
  - Cisco Nexus 9300 and 9500 switches
  - Cisco Nexus 9300-EX and 9500 switches
- When configuring vPCs, the behavior previously provided by using the `ip pim pre-build-spt` command has now been enabled automatically by default and cannot be disabled.
  - A vPC port channel member link that is operating in Individual state will be flapped while checking for VLAN inconsistencies. To avoid having the link flapped during server provisioning, disable the VPC graceful consistency check with the **no graceful consistency-check** command.

The following example disables the VPC graceful consistency check:

```
switch# conf t
Enter configuration commands, one per line. End with CNTL/Z.

switch(config)# vpc domain 1
switch(config-vpc-domain)# no graceful consistency-check
```

- vPC STP hitless role change feature is supported.

- vPC role change can be performed from either of the peer devices.
- If the original secondary device has higher role priority value than the original primary device, role swapping cannot be performed. Change the role priority on either vPC device so that the value of the original secondary device is lower than the original primary one. To view the existing role of a device, use the `show vpc role` command on local and peer switch.
- To form a supported vPC domain, ensure that the following is taken care:
  - For Cisco Nexus 9300 Series switches, both switches must be of the exact same model.
  - For Cisco Nexus 9500 Series switches, both switches must consist of the same models of line cards, fabric modules, supervisor modules, and system controllers inserted in the same slots of the chassis.
- Always check the existing configured role priority before configuring vPC hitless role change feature
- In a vPC domain, enable the `peer-switch` command, where both vPC peers have same STP priorities, and ensure it is operational before issuing a role change. If you do not enable the `peer-switch` command, it can lead to convergence issues. Use `show spanning-tree summary | grep peer` command to verify whether the peer vPC switch is operational or not.
- All the devices that are attached to a vPC domain through a vPC must be dual homed.
- The first generation Broadcom based Nexus 9300 series switches and Nexus 9500 series line-cards does not support policy based routing route map with a `set ip next-hop` statement where the egress interface is the vPC Peer-Link while the vPC convergence TCAM region is allocated. This limitation does not apply to cloud scale based Nexus 9000 series devices such as Cisco Nexus 9200 switches, 9300 switches with EX/FX/FX2 line-cards and Nexus 9500 platform switches with 9700-EX/FX line-cards.
- You must run the commands `lacp suspend-individual` and `lacp mode delay` to PXE boot the servers that are connected Cisco Nexus 9000 switches via vPC.

## Best Practices for Layer 3 and vPC Configuration

This section describes best practices for using and configuring Layer 3 with vPC.

### Layer 3 and vPC Configuration Overview

When a Layer 3 device is connected to a vPC domain through a vPC, it has the following views:

- At Layer 2, the Layer 3 device sees a unique Layer 2 switch presented by the vPC peer devices.
- At Layer 3, the Layer 3 device sees two distinct Layer 3 devices (one for each vPC peer device).

vPC is a Layer 2 virtualization technology, so at Layer 2, both vPC peer devices present themselves as a unique logical device to the rest of the network.

There is no virtualization technology at Layer 3, so each vPC peer device is seen as a distinct Layer 3 device by the rest of the network.

The following figure illustrates the two different Layer 2 and Layer 3 views with vPC.

Figure 7: Different Views for vPC Peer Devices

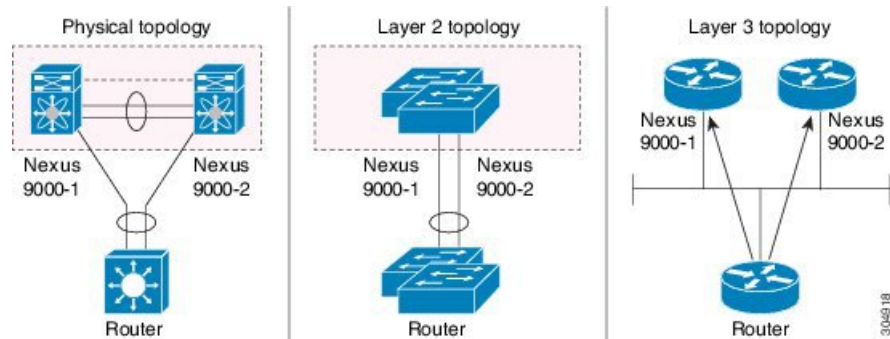

## Guidelines for Layer 3 and vPC Configurations

To connect Layer 3 devices to a vPC domain, use Layer 3 links from Layer 3 devices to connect each vPC peer device.



**Note** The vPC loop avoidance rule does not allow the attachment of a Layer 3 device to a vPC domain using a vPC.

Layer 3 devices are able to initiate Layer 3 routing protocol adjacencies with both vPC peer devices.

One or multiple Layer 3 links can be used to connect a Layer 3 device to each vPC peer device. Cisco Nexus 9000 series devices support Layer 3 Equal Cost Multipathing (ECMP) with up to 16 hardware load-sharing paths per prefix. Traffic from a vPC peer device to a Layer 3 device can be load-balanced across all the Layer 3 links interconnecting the two devices together.

Using Layer 3 ECMP on the Layer 3 device can effectively use all Layer 3 links from the device to the vPC domain. Traffic from a Layer 3 device to the vPC domain can be load-balanced across all the Layer 3 links interconnecting the two entities together.

The supported connection model for a Layer 3 device to the vPC domain is illustrated in the following figure.

Figure 8: Using Separate Layer 3 Links to Connect L3 Device to a vPC Domain

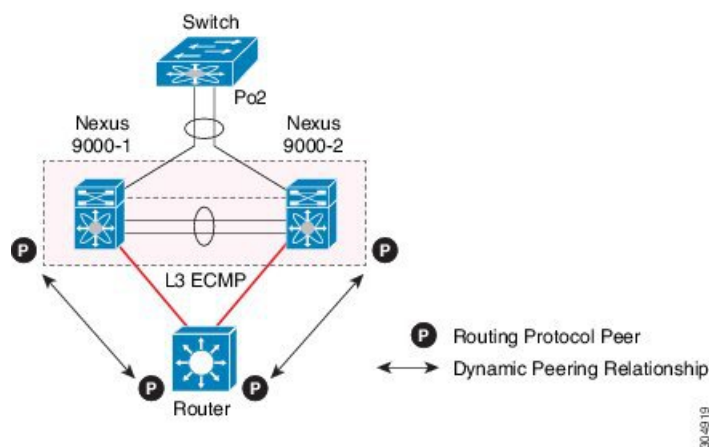

Follow these guidelines when connecting a Layer 3 device to the vPC domain:

- Use separate Layer 3 links to connect Layer 3 devices to the vPC domain.
- Do not use a Layer 2 vPC to attach a Layer 3 device to a vPC domain unless the Layer 3 device can statically route to the HSRP address configured on the vPC peer devices.
- When both routed and bridged traffic are required, use individual Layer 3 links for routed traffic and a separate Layer 2 port-channel for bridged traffic when both routed and bridged traffic are required.
- Enable Layer 3 connectivity between vPC peer device by configuring a VLAN network interface for the same VLAN from both devices or by using a dedicated Layer 3 link between the two peer devices (for Layer 3 backup routing path purposes).

## Supported Topologies for Layer 3 and vPC

This section contains examples of Layer 3 and vPC network topologies.

There are two approaches for Layer 3 and vPC interactions. The first one is by using dedicated Layer 3 links to connect the Layer 3 devices to each vPC peer device. The second one is by allowing the Layer 3 devices to peer with the SVIs defined on each of the vPC peer device, on a dedicated VLAN that is carried on the vPC connection. The following sections describe all the supported topologies leveraging the elements that are described in the legends in the following figure.

**Figure 9: Legend**

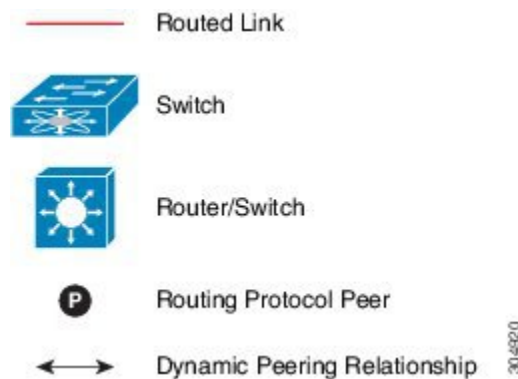

### Peering with an External Router Using Layer 3 Links

This example shows a topology that uses Layer 3 links to connect a Layer 3 device to the Cisco Nexus 9000 switches that are part of the a vPC domain



**Note** Interconnecting the two entities together in this way allows to support Layer 3 unicast and multicast communication.

Figure 10: Peering with an External Router Using Layer 3 Links

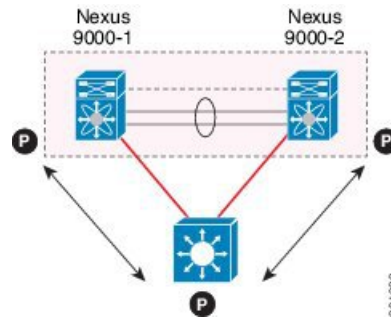

Layer 3 devices can initiate Layer 3 routing protocol adjacencies with both vPC peer devices.

One or multiple Layer 3 links can be used to connect a Layer 3 device to each vPC peer device. Cisco Nexus 9000 series devices support Layer 3 Equal Cost Multipathing (ECMP) with up to 16 hardware load-sharing paths per prefix. Traffic from a vPC peer device to a Layer 3 device can be load-balanced across all the Layer 3 links interconnecting the two devices together.

Using Layer 3 ECMP on the Layer 3 device can effectively use all Layer 3 links from the device to the vPC domain. Traffic from a Layer 3 device to the vPC domain can be load-balanced across all the Layer 3 links interconnecting the two entities together.

Follow these guidelines when connecting a Layer 3 device to the vPC domain using Layer 3 links:

- Use separate Layer 3 links to connect Layer 3 devices to the vPC domain. Each link represents a point-to-point Layer 3 connection and should get assigned an IP address taken from a small IP subnet (/30 or /31).
- If the Layer 3 peering is required for multiple VRFs, it is recommended to define multiple sub-interfaces, each mapped to an individual VRF.

## Peering Between vPC Devices for a Backup Routing Path

This example shows peering between the two vPC peer devices with a Layer 3 backup routed path. If the Layer 3 uplinks on vPC peer device 1 or vPC peer device 2 fail, the path between the two peer devices is used to redirect traffic to the switch that has the Layer 3 uplinks in the up state.

The Layer 3 backup routing path can be implemented using a dedicated interface VLAN (such as SVI) over the vPC Peer-Link or by using dedicated Layer 2 or Layer 3 links across the two vPC peer devices.

Figure 11: Peering Between vPC Devices for a Backup Routing Path

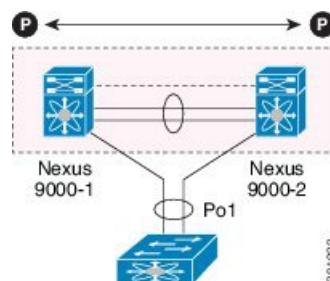

## Direct Layer 3 Peering Between Routers

In this scenario, the Nexus 9000 devices part of the vPC domain are simply used as a Layer 2 transit path to allow the routers connected to them to establish Layer 3 peering and communication.

**Figure 12: Peering Between Routers**

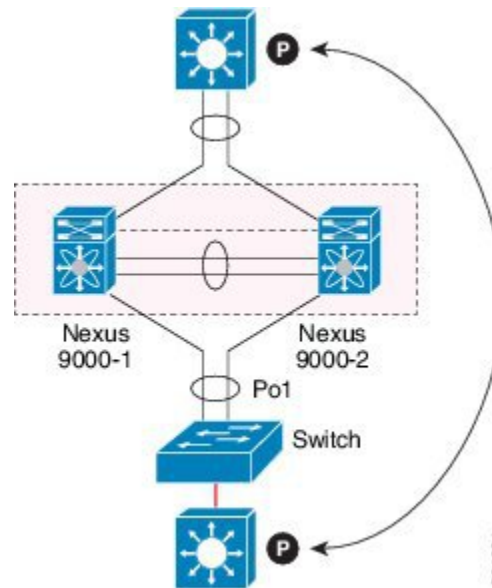

The Layer 3 devices can peer with each other in following two methods. Peering also depends on the specific device deployed for this role.

- Defining a VLAN network interface (SVI) for a VLAN that is extended between the Layer 3 devices through the intermediate Cisco Nexus 9000 vPC peer switches.
- Defining a Layer 3 port-channel interface on each Layer 3 device and establishing a point-to-point Layer 3 peering.



**Note** In deployments where the Layer 3 peering must be established for multiple VRFs, the first method require the definition on the Layer 3 devices of a VLAN (and SVI) per VRF. For the second method, it is possible to create a Layer 3 port-channel subinterface per VRF

## Peering Between Two Routers with vPC Devices as Transit Switches

This example is similar to the peering between routers topology. In this case also, the Cisco Nexus 9000 devices that are part of the same vPC domain are only used as Layer 2 transit paths. The difference here is that there are two pairs of Cisco Nexus 9000 switches. Each switch that is connected with a Layer 3 device using a vPC connection, also establishes a back-to-back vPC connection between them. The difference is that the vPC domains are only used as Layer 2 transit paths.

**Figure 13: Peering Between Two Routers with vPC Devices as Transit Switches**

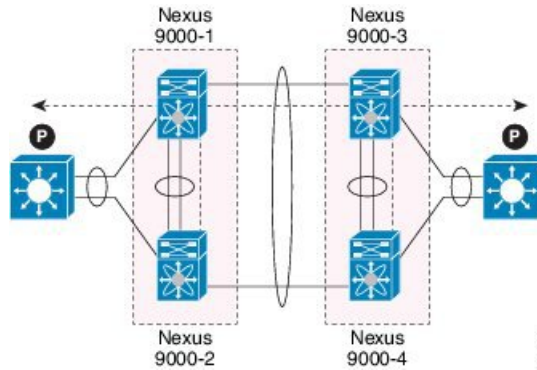

This topology is commonly used when you want to establish connectivity between separate data centers that are interconnected with direct links (dark fibers or DWDM circuits). The two pairs of Cisco Nexus 9000 switches, in this case, provide only Layer 2 extension services, allowing the Layer 3 devices to peer with each other at Layer 3.

## Peering with an External Router on Parallel Interconnected Routed Ports

This example shows the Layer 3 device attached to the vPC domain through two different types of links, Layer 2 links and Layer 3 links.

When you require both routed and bridged traffic, use individual Layer 3 links for routed traffic and a separate Layer 2 port-channel for bridged traffic, as shown in following figure.

The Layer 2 links are used for bridged traffic (traffic staying in the same VLAN) or inter-VLAN traffic (assuming vPC domain hosts the interface VLAN and associated HSRP configuration).

The Layer 3 links are used for routing protocol peering adjacency with each vPC peer device.

The purpose of this topology is to attract specific traffic to go through the Layer 3 device. Layer 3 links are also used to carry routed traffic from a Layer 3 device to the vPC domain.

**Figure 14: Peering with an External Router on Parallel Interconnected Routed Ports**

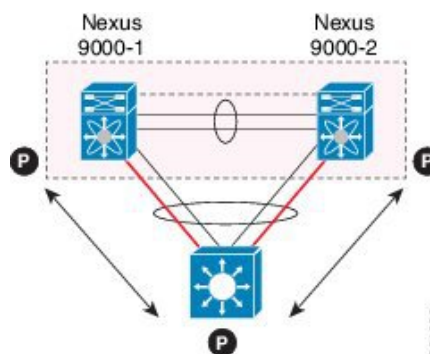

## Peering between vPC Switch Pairs on Parallel Interconnected Routed Ports

When routing protocol peering adjacency is required to be established between the two data centers, a best practice is to add dedicated Layer 3 links between the two sites as shown in this example.



An alternative design to what is shown in the previous section (Peering Between Two Routers with vPC Devices as Transit Switches), uses two pairs of Cisco Nexus 9000 switches that are deployed in each data center for providing both Layer 2 and Layer 3 extension services. When routing protocol peering adjacency is required to be established between the two pairs of Cisco Nexus 9000 devices, the best practice is to add dedicated Layer 3 links between the two sites as shown in the following example.

The vPC link between the two data centers carry bridged traffic or inter-VLAN traffic while the dedicated Layer 3 links carry the routed traffic across the two sites.

**Figure 15: Peering Over a vPC Interconnection on Parallel Interconnected Routed Ports**

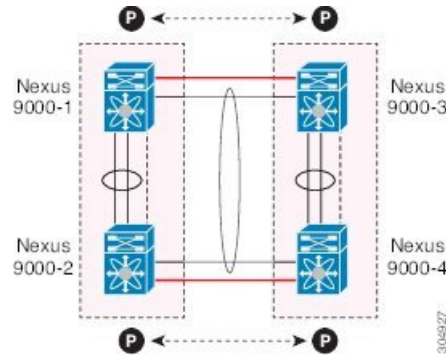

The back-to-back vPC connection between the two data centers carry bridged traffic or inter-VLAN traffic while the dedicated Layer 3 links carry the routed traffic across the two sites.

## Peering Over a PC Interconnection and Dedicated Interswitch Link Using non-vPC VLAN

This example shows when the Layer 3 device is single-attached to the vPC domain, you can use a non-vPC VLAN with a dedicated inter-switch link to establish the routing protocol peering adjacency between the Layer 3 device and each vPC peer device. However, the non-vPC VLAN must be configured to use a static MAC that is different than the vPC VLAN.



**Note** Configuring the vPC VLAN (and vPC Peer-Link) for this purpose is not supported.

**Figure 16: Peering Over a PC Interconnection and Dedicated Interswitch Link Using non-vPC VLAN**

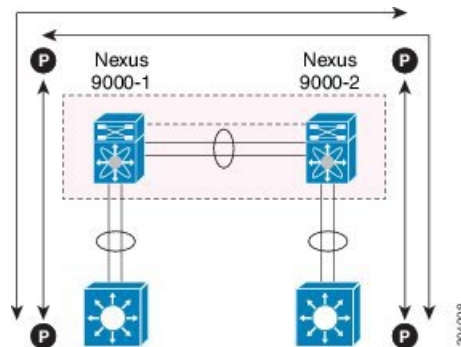

## Peering Directly Over a vPC Connection

Beginning with Cisco NX-OS Release 7.0(3)I5(1), an alternative method has been introduced to establish Layer 3 peering between a Layer 3 router and a pair of Cisco Nexus 9000 vPC switches.



**Note** Peering directly over a vPC connection is supported only for Layer 3 unicast communication but not for Layer 3 multicast traffic. If you require Layer 3 multicast, you must establish peering over dedicated Layer 3 links

*Figure 17: Supported: Peering Over a vPC Interconnection Where the Router Peers with Both the vPC Peers.*

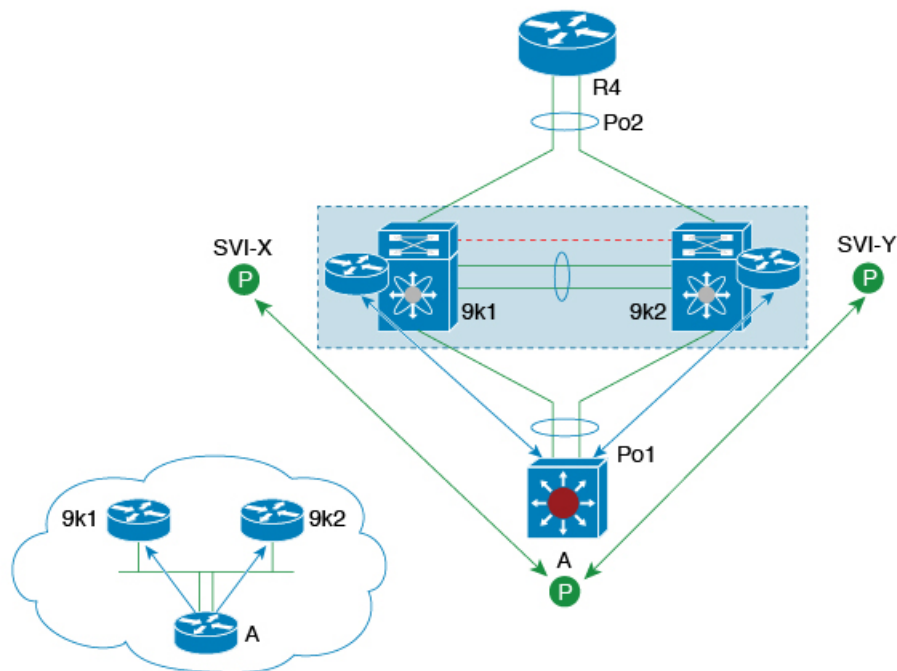

501182

In this scenario, the Layer 3 peering between the external router and the Cisco Nexus 9000 switches that are part of a same vPC domain is established directly on a VLAN carried on the vPC connection. The external router in this case peers with SVI interfaces defined on each vPC device. As for the scenario shown in previous figure 12, the external router could use an SVI or a Layer 3 Port-Channel to peer with the vPC devices (multiple SVIs or Port-Channel subinterfaces could be used for a multi-VRF deployment).

This deployment model requires configuring **layer3 peer-router** command as part of the vPC domain. You can adopt the same approach for establishing Layer 2 and Layer 3 connectivity on a vPC back-to-back connection established between two separate pairs of vPC switches.

Figure 18: Supported: Peering Over a vPC Interconnection Where Each Nexus Device Peers with Two vPC Peers.

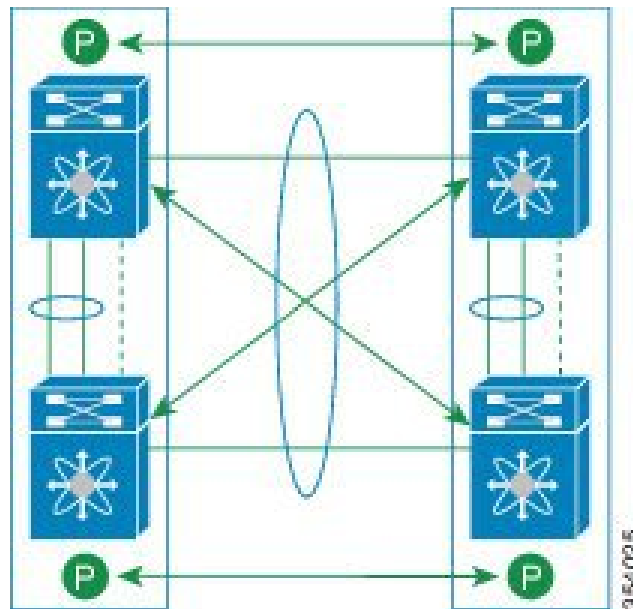

In this deployment model, SVI interfaces in the same VLAN is configured on all the four Cisco Nexus 9000 switches to establish routing peering and connectivity between them.

## Configuring Layer 3 over vPC

Beginning with Cisco NX-OS Release 7.0(3)I5(1), Layer 3 over vPC is supported on Cisco Nexus 9000 Series switches.

### Before you begin

Ensure that the peer-gateway feature is enabled and it is configured on both the peers and both the peers run an image that supports Layer 3 over vPC. If you enter the **layer3 peer-router** command without enabling the peer-gateway feature, a syslog message is displayed recommending you to enable the peer-gateway feature.

Ensure that the vPC Peer-Link is up.

### SUMMARY STEPS

1. switch# **configure terminal**
2. switch(config)# **vpc domain** *domain-id*
3. switch(config-vpc-domain)#**layer3 peer-router**
4. switch(config-vpc-domain)# **exit**
5. (Optional) switch#**show vpc brief**
6. (Optional) switch#**copy running-config startup-config**

## DETAILED STEPS

	Command or Action	Purpose
<b>Step 1</b>	<b>switch# configure terminal</b> <b>Example:</b> switch# <b>configure terminal</b> switch(config) #	Enters global configuration mode.
<b>Step 2</b>	<b>switch(config)# vpc domain domain-id</b> <b>Example:</b> switch(config) # <b>vpc domain 5</b> switch(config-vpc-domain) #	Creates a vPC domain if it does not already exist, and enters the vpc-domain configuration mode. There is no default; the range is from <1 to 1000>.
<b>Step 3</b>	<b>switch(config-vpc-domain)#layer3 peer-router</b>	Enables the Layer 3 device to form peering adjacency with both the peers.  <b>Note</b> Configure this command in both the peers. If you configure this command only on one of the peers or you disable it on one peer, the operational state of layer 3 peer-router gets disabled. You get a notification when there is a change in the operational state.
<b>Step 4</b>	<b>switch(config-vpc-domain)# exit</b>	Exits the vpc-domain configuration mode.
<b>Step 5</b>	(Optional) <b>switch#show vpc brief</b>	Displays brief information about each vPC domain.
<b>Step 6</b>	(Optional) <b>switch#copy running-config startup-config</b>	Copies the running configuration to the startup configuration.

**Example**

The following example shows how to configure Layer 3 over vPC feature:

```
switch# configure terminal
switch(config)# vpc domain 5
switch(config-vpc-domain)# layer3 peer-router
```

```
switch(config-vpc-domain)# exit
```

```
switch(config)#
```

This example shows how to verify if the Layer 3 over vPC feature is configured. The **Operational Layer3 Peer** is enabled or disabled depending up on how the operational state of Layer 3 over vPC is configured.

```
switch# show vpc brief
```

```
vPC domain id : 5
Peer status : peer adjacency formed ok
vPC keep-alive status : peer is alive
Configuration consistency status : success
Per-vlan consistency status : failed
```

```

Type-2 consistency status : success
vPC role : secondary
Number of vPCs configured : 2
Peer Gateway : Enabled
Peer gateway excluded VLANs : -
Dual-active excluded VLANs : -
Graceful Consistency Check : Enabled
Auto-recovery status : Enabled (timeout = 240 seconds)
Operational Layer3 Peer : Enabled
    
```

## Layer 3 over vPC Supported Topologies

See the following Layer 3 over vPC supported topologies:

**Figure 19: Supported: Peering Over a vPC Interconnection Where the Router Peers with Both the vPC Peers.**

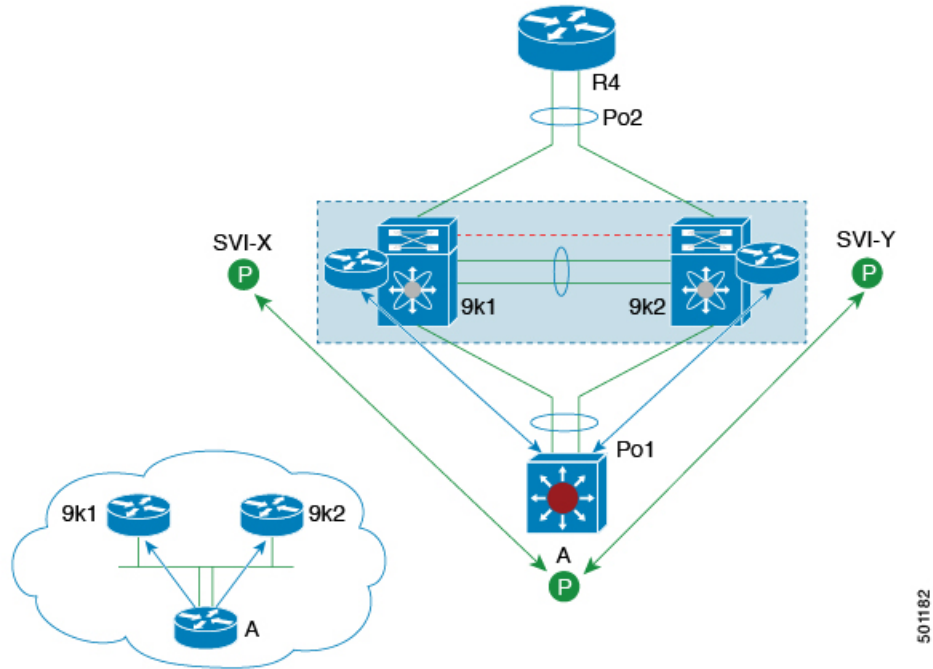

Figure 20: Supported: Peering Over an STP Interconnection Using a vPC VLAN Where the Router Peers with Both the vPC Peers.

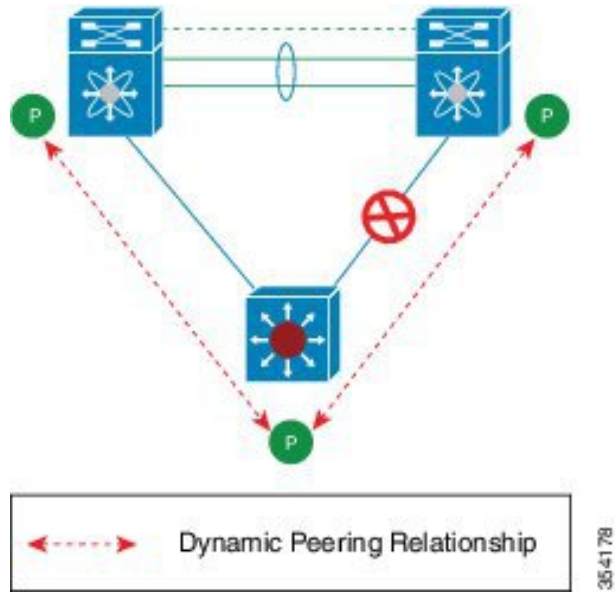

Figure 21: Supported: Peering Over an Orphan Device with Both the vPC Peers.

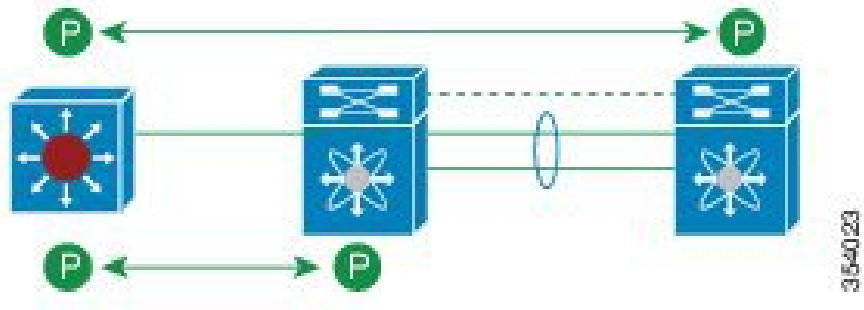
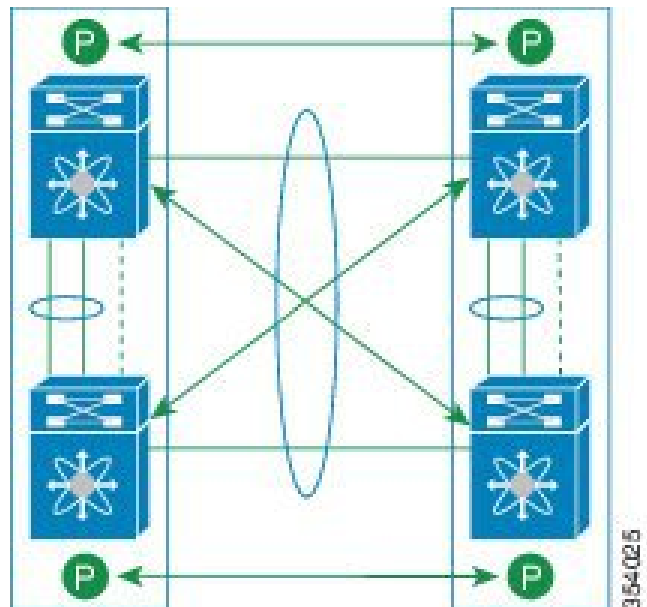

Figure 22: Supported: Peering Over a vPC Interconnection Where Each Nexus Device Peers with Two vPC Peers.



## Default Settings

The following table lists the default settings for vPC parameters.

Table 1: Default vPC Parameters

Parameters	Default
vPC system priority	32667
vPC peer-keepalive message	Disabled
vPC peer-keepalive interval	1 second
vPC peer-keepalive timeout	5 seconds
vPC peer-keepalive UDP port	3200

## Configuring vPCs



**Note** You must use these procedures on both devices on both sides of the vPC Peer-Link. You configure both of the vPC peer devices using these procedures.

This section describes how to configure vPCs using the command-line interface (CLI).



**Note** If you are familiar with the Cisco IOS CLI, be aware that the Cisco NX-OS commands for this feature might differ from the Cisco IOS commands that you would use.

## Enabling vPCs

You must enable the feature vPC before you can configure and use vPCs.

### SUMMARY STEPS

1. **configure terminal**
2. **feature vpc**
3. **exit**
4. **show feature**
5. **copy running-config startup-config**

### DETAILED STEPS

	Command or Action	Purpose
<b>Step 1</b>	<b>configure terminal</b> <b>Example:</b> switch# <b>configure terminal</b> switch(config)#	Enters global configuration mode.
<b>Step 2</b>	<b>feature vpc</b> <b>Example:</b> switch(config)# <b>feature vpc</b>	Enables vPCs on the device.
<b>Step 3</b>	<b>exit</b> <b>Example:</b> switch(config)# <b>exit</b> switch#	Exits global configuration mode.
<b>Step 4</b>	<b>show feature</b> <b>Example:</b> switch# <b>show feature</b>	(Optional) Displays which features are enabled on the device.
<b>Step 5</b>	<b>copy running-config startup-config</b> <b>Example:</b> switch# <b>copy running-config startup-config</b>	(Optional) Copies the running configuration to the startup configuration.

### Example

This example shows how to enable the vPC feature:



```
switch# configure terminal
switch(config)# feature vpc
switch(config)# exit
switch(config)#
```

## Disabling vPCs



**Note** When you disable the vPC functionality, the device clears all the vPC configurations.

### SUMMARY STEPS

1. `configure terminal`
2. `no feature vpc`
3. `exit`
4. `show feature`
5. `copy running-config startup-config`

### DETAILED STEPS

	Command or Action	Purpose
Step 1	<b>configure terminal</b> <b>Example:</b> <pre>switch# configure terminal switch(config)#</pre>	Enters global configuration mode.
Step 2	<b>no feature vpc</b> <b>Example:</b> <pre>switch(config)# no feature vpc</pre>	Disables vPCs on the device.
Step 3	<b>exit</b> <b>Example:</b> <pre>switch(config)# exit switch#</pre>	Exits global configuration mode.
Step 4	<b>show feature</b> <b>Example:</b> <pre>switch# show feature</pre>	(Optional) Displays which features are enabled on the device.
Step 5	<b>copy running-config startup-config</b> <b>Example:</b> <pre>switch# copy running-config startup-config</pre>	(Optional) Copies the running configuration to the startup configuration.

**Example**

This example shows how to disable the vPC feature:

```
switch# configure terminal
switch(config)# no feature vpc
switch(config)# exit
switch#
```

## Creating a vPC Domain and Entering vpc-domain Mode

You can create a vPC domain and put the vPC Peer-Link port channels into the identical vPC domain on both vPC peer devices. Use a unique vPC domain number throughout a single vPC domain . This domain ID is used to automatically to form the vPC system MAC address.

You can also use this command to enter vpc-domain command mode.

**SUMMARY STEPS**

1. **configure terminal**
2. **vpc domain *domain-id* [shut | no shut]**
3. **exit**
4. **show vpc brief**
5. **copy running-config startup-config**

**DETAILED STEPS**

	Command or Action	Purpose
<b>Step 1</b>	<b>configure terminal</b>  <b>Example:</b> switch# <b>configure terminal</b> switch(config)#	Enters global configuration mode.
<b>Step 2</b>	<b>vpc domain <i>domain-id</i> [shut   no shut]</b>  <b>Example:</b> switch(config)# <b>vpc domain 5</b> switch(config-vpc-domain)#	Creates a vPC domain on the device, and enters vpc-domain configuration mode for configuration purposes. There is no default; the range is from 1 to 1000.
<b>Step 3</b>	<b>exit</b>  <b>Example:</b> switch(config)# <b>exit</b> switch#	Exits vpc-domain configuration mode.
<b>Step 4</b>	<b>show vpc brief</b>  <b>Example:</b> switch# <b>show vpc brief</b>	(Optional) Displays brief information about each vPC domain.

	Command or Action	Purpose
Step 5	<b>copy running-config startup-config</b> <b>Example:</b> <pre>switch# copy running-config startup-config</pre>	(Optional) Copies the running configuration to the startup configuration.

### Example

This example shows how to enter the vpc-domain command mode to configure an existing vPC domain:

```
switch# configure terminal
switch(config)# vpc domain 5
switch(config-vpc-domain)# exit
switch(config)#
```

## Configuring a vPC Keepalive Link and Messages

You can configure the destination IP for the peer-keepalive link that carries the keepalive messages. Optionally, you can configure other parameters for the keepalive messages.



**Note** You must configure the vPC peer-keepalive link before the system can form the vPC Peer-Link.



**Note** We recommend that you configure a separate VRF instance and put a Layer 3 port from each vPC peer device into that VRF for the vPC peer-keepalive link. Do not use the vPC Peer-Link itself to send vPC peer-keepalive messages. For information about creating and configuring VRFs, see the [Cisco Nexus 9000 Series NX-OS Unicast Routing Configuration Guide](#). Ensure that both the source and destination IP addresses use for the peer-keepalive message are unique in your network. The management port and management VRF are the defaults for these keepalive messages.

### Before you begin

Ensure that you have enabled the vPC feature.

### SUMMARY STEPS

1. **configure terminal**
2. **vpc domain** *domain-id* [**shut** | **no shut**]
3. **peer-keepalive destination** *ipaddress* [**hold-timeout secs** | **interval msec** {**timeout secs**} | {**precedence** {*prec-value* | **network** | **internet** | **critical** | **flash-override** | **flash** | **immediate** | **priority** | **routine**}} | **tos** {*tos-value* | **max-reliability** | **max-throughput** | **min-delay** | **min-monetary-cost** | **normal**}} | **tos-byte** *tos-byte-value*} | **source ipaddress** | **vrf** {*name* | **management vpc-keepalive**}]
4. **exit**

5. show vpc statistics
6. copy running-config startup-config

## DETAILED STEPS

	Command or Action	Purpose
Step 1	<b>configure terminal</b> <b>Example:</b> <pre>switch# configure terminal switch(config)#</pre>	Enters global configuration mode.
Step 2	<b>vpc domain <i>domain-id</i> [shut   no shut]</b> <b>Example:</b> <pre>switch(config)# vpc domain 5 switch(config-vpc-domain)#</pre>	Creates a vPC domain on the device, and enters vpc-domain configuration mode.
Step 3	<b>peer-keepalive destination <i>ipaddress</i> [hold-timeout <i>secs</i>   interval <i>msecs</i> {timeout <i>secs</i>}   {precedence {<i>prec-value</i>   network   internet   critical   flash-override   flash   immediate priority   routine}}   tos {<i>tos-value</i>   max-reliability   max-throughput   min-delay   min-monetary-cost   normal}   tos-byte <i>tos-byte-value</i>}   source <i>ipaddress</i>   vrf {<i>name</i>   management vpc-keepalive}]</b> <b>Example:</b> <pre>switch(config-vpc-domain)# peer-keepalive destination 172.28.230.85 switch(config-vpc-domain)#</pre>	<p>Configures the IPv4 and IPv6 addresses for the remote end of the vPC peer-keepalive link.</p> <p><b>Note</b> The system does not form the vPC Peer-Link until you configure a vPC peer-keepalive link.</p> <p><b>Note</b> You may get the following error message if you do not specify the source IP address when you configure an IPv6 address for the remote end of the vPC peer-keepalive link.</p> <pre>Cannot configure IPV6 peer-keepalive without source IPV6 address</pre> <p>The management ports and VRF are the defaults.</p> <p><b>Note</b> We recommend that you configure a separate VRF and use a Layer 3 port from each vPC peer device in that VRF for the vPC peer-keepalive link. For more information about creating and configuring VRFs, see the <a href="#">Cisco Nexus 9000 Series NX-OS Unicast Routing Configuration Guide</a>.</p>
Step 4	<b>exit</b> <b>Example:</b> <pre>switch(config)# exit switch#</pre>	Exits global configuration mode.
Step 5	<b>show vpc statistics</b> <b>Example:</b> <pre>switch# show vpc statistics</pre>	(Optional) Displays information about the configuration for the keepalive messages.
Step 6	<b>copy running-config startup-config</b> <b>Example:</b>	(Optional) Copies the running configuration to the startup configuration.

	Command or Action	Purpose
	switch# <code>copy running-config startup-config</code>	

### Example

For more information about configuring VRFs, see the [Cisco Nexus 9000 Series NX-OS Unicast Routing Configuration Guide](#).

This example shows how to configure the destination and source IP address and VRF for the vPC-peer-keepalive link:

```
switch# configure terminal
switch(config)# vpc domain 100
switch(config-vpc-domain)# peer-keepalive destination 172.168.1.2 source 172.168.1.1 vrf
vpc-keepalive
switch(config-vpc-domain)# exit
switch#
```

## Creating a vPC Peer-Link

You create the vPC Peer-Link by designating the port channel that you want on each device as the vPC Peer-Link for the specified vPC domain. We recommend that you configure the Layer 2 port channels that you are designating as the vPC Peer-Link in trunk mode and that you use two ports on separate modules on each vPC peer device for redundancy.

### Before you begin

Ensure that you have enabled the vPC feature.

### SUMMARY STEPS

1. `configure terminal`
2. `interface port-channel` *channel-number*
3. `switchport mode trunk`
4. `switchport trunk allowed vlan` *vlan-list*
5. `vpc peer-link`
6. `exit`
7. `show vpc brief`
8. `copy running-config startup-config`

### DETAILED STEPS

	Command or Action	Purpose
Step 1	<b>configure terminal</b>  <b>Example:</b> <pre>switch# configure terminal switch(config)#</pre>	Enters global configuration mode.

	Command or Action	Purpose
<b>Step 2</b>	<b>interface port-channel</b> <i>channel-number</i> <b>Example:</b> <pre>switch(config)# interface port-channel 20 switch(config-if)#</pre>	Selects the port channel that you want to use as the vPC Peer-Link for this device, and enters interface configuration mode.
<b>Step 3</b>	<b>switchport mode trunk</b> <b>Example:</b> <pre>switch(config-if)# switchport mode trunk</pre>	(Optional) Configures this interface in trunk mode.
<b>Step 4</b>	<b>switchport trunk allowed vlan</b> <i>vlan-list</i> <b>Example:</b> <pre>switch(config-if)# switchport trunk allowed vlan 1-120,201-3967</pre>	(Optional) Configures the permitted VLAN list.
<b>Step 5</b>	<b>vpc peer-link</b> <b>Example:</b> <pre>switch(config-if)# vpc peer-link switch(config-vpc-domain)#</pre>	Configures the selected port channel as the vPC Peer-Link, and enters vpc-domain configuration mode.
<b>Step 6</b>	<b>exit</b> <b>Example:</b> <pre>switch(config)# exit switch#</pre>	Exits vpc-domain configuration mode.
<b>Step 7</b>	<b>show vpc brief</b> <b>Example:</b> <pre>switch# show vpc brief</pre>	(Optional) Displays information about each vPC, including information about the vPC Peer-Link.
<b>Step 8</b>	<b>copy running-config startup-config</b> <b>Example:</b> <pre>switch# copy running-config startup-config</pre>	(Optional) Copies the running configuration to the startup configuration.

### Example

This example shows how to configure a vPC Peer-Link:

```
switch# configure terminal
switch(config)# interface port-channel 20
switch(config-if)# switchport mode
switch(config-if)# switchport mode trunk
switch(config-if)# switchport trunk allowed vlan 1-120,201-3967
switch(config-if)# vpc peer-link
switch(config-vpc-domain)# exit
switch(config)#
```

## Moving Other Port Channels into a vPC

We recommend that you attach the vPC domain downstream port channel to two devices for redundancy.

To connect to the downstream device, you create a port channel from the downstream device to the primary vPC peer device and you create another port channel from the downstream device to the secondary peer device. On each vPC peer device, you assign a vPC number to the port channel that connects to the downstream device. You will experience minimal traffic disruption when you are creating vPCs.

### Before you begin

Ensure that you have enabled the vPC feature.

Ensure that you are using a Layer 2 port channel.

### SUMMARY STEPS

1. **configure terminal**
2. **interface port-channel** *channel-number*
3. **vpc** *number*
4. **exit**
5. **show vpc brief**
6. **copy running-config startup-config**

### DETAILED STEPS

	Command or Action	Purpose
Step 1	<b>configure terminal</b> <b>Example:</b> <pre>switch# configure terminal switch(config)#</pre>	Enters global configuration mode.
Step 2	<b>interface port-channel</b> <i>channel-number</i> <b>Example:</b> <pre>switch(config)# interface port-channel 20 switch(config-if)#</pre>	Selects the port channel that you want to put into the vPC to connect to the downstream device, and enters interface configuration mode.
Step 3	<b>vpc</b> <i>number</i> <b>Example:</b> <pre>switch(config-if)# vpc 5 switch(config-vpc-domain)#</pre>	Configures the selected port channel into the vPC to connect to the downstream device. You can use any module in the device for these port channels. The range is from 1 and 4096.  <b>Note</b> The vPC number that you assign to the port channel connecting to the downstream device from the vPC peer device must be identical on both vPC peer devices.
Step 4	<b>exit</b> <b>Example:</b>	Exits vpc-domain configuration mode.

	Command or Action	Purpose
	switch(config)# <b>exit</b> switch#	
<b>Step 5</b>	<b>show vpc brief</b>  <b>Example:</b> switch# <b>show vpc brief</b>	(Optional) Displays information on the vPCs.
<b>Step 6</b>	<b>copy running-config startup-config</b>  <b>Example:</b> switch# <b>copy running-config startup-config</b>	(Optional) Copies the running configuration to the startup configuration.

### Example

This example shows how to configure a port channel to connect to the downstream device:

```
switch# configure terminal
switch(config)# interface port-channel 20
switch(config-if)# vpc 5
switch(config-if)# exit
switch(config)#
```

## Checking the Configuration Compatibility on a vPC Peer-Link

After you have configured the vPC Peer-Link on both vPC peer devices, check that the configurations are consistent on all vPC interfaces. See the “Compatibility Parameters for vPC Interfaces” section for information about consistent configurations on the vPCs.

### SUMMARY STEPS

1. **configure terminal**
2. **show vpc consistency-parameters {global | interface port-channel *channel-number*}**

### DETAILED STEPS

	Command or Action	Purpose
<b>Step 1</b>	<b>configure terminal</b>  <b>Example:</b> switch# <b>configure terminal</b> switch(config)#	Enters global configuration mode.
<b>Step 2</b>	<b>show vpc consistency-parameters {global   interface port-channel <i>channel-number</i>}</b>  <b>Example:</b> switch(config)# <b>show vpc consistency-parameters global</b> switch(config)#	(Optional) Displays the status of those parameters that must be consistent across all vPC interfaces.



**Example**

This example shows how to check that the required configurations are compatible across all the vPC interfaces:

```
switch# configure terminal
switch(config)# show vpc consistency-parameters global
switch(config)#
```



**Note** Messages regarding the vPC interface configuration compatibility are also logged to the syslog.

## Configuring a Graceful Consistency Check

You can configure the graceful consistency check feature, which is enabled by default. Unless this feature is enabled, the vPC is completely suspended when a mismatch in a mandatory compatibility parameter is introduced in a working vPC. When this feature is enabled, only the links on the secondary peer device are suspended. See the “Compatibility Parameters for vPC Interfaces” section for information about consistent configurations on the vPCs.

### SUMMARY STEPS

1. **configure terminal**
2. **vpc domain** *domain-id* [**shut** | **no shut**]
3. **graceful consistency-check**
4. **exit**
5. **show vpc brief**

### DETAILED STEPS

	Command or Action	Purpose
Step 1	<b>configure terminal</b> <b>Example:</b> <pre>switch# configure terminal switch(config)#</pre>	Enters global configuration mode.
Step 2	<b>vpc domain</b> <i>domain-id</i> [ <b>shut</b>   <b>no shut</b> ] <b>Example:</b> <pre>switch(config-if)# vpc domain 5 switch(config-vpc-domain)#</pre>	Creates a vPC domain if it does not already exist, and enters vpc-domain configuration mode.
Step 3	<b>graceful consistency-check</b> <b>Example:</b> <pre>switch(config-vpc-domain)# graceful consistency-check</pre>	<p>Specifies that only the links on the secondary peer device are suspended when a mismatch is detected in a mandatory compatibility parameter.</p> <p>Use the <b>no</b> form of this command to disable the feature.</p>

	Command or Action	Purpose
<b>Step 4</b>	<b>exit</b> <b>Example:</b> <pre>switch(config)# exit switch#</pre>	Exits vpc-domain configuration mode.
<b>Step 5</b>	<b>show vpc brief</b> <b>Example:</b> <pre>switch# show vpc brief</pre>	(Optional) Displays information on the vPCs.

### Example

This example shows how to enable the graceful consistency check feature:

```
switch# configure terminal
switch(config)# vpc domain 5
switch(config-vpc-domain)# graceful consistency-check
switch(config-vpc-domain)# exit
switch(config)#
```

## Configuring a vPC Peer-Gateway

You can configure vPC peer devices to act as the gateway for packets that are destined to the vPC peer device's MAC address.

### Before you begin

Ensure that you have enabled the vPC feature.

### SUMMARY STEPS

1. **configure terminal**
2. **vpc domain** *domain-id* [**shut** | **no shut**]
3. **peer-gateway**
4. **exit**
5. **show vpc brief**
6. **copy running-config startup-config**

### DETAILED STEPS

	Command or Action	Purpose
<b>Step 1</b>	<b>configure terminal</b> <b>Example:</b> <pre>switch# configure terminal switch(config)#</pre>	Enters global configuration mode.

	Command or Action	Purpose
Step 2	<b>vpc domain</b> <i>domain-id</i> [ <b>shut</b>   <b>no shut</b> ] <b>Example:</b> <pre>switch(config-if) # vpc domain 5 switch(config-vpc-domain) #</pre>	Creates a vPC domain if it does not already exist, and enters vpc-domain configuration mode.
Step 3	<b>peer-gateway</b> <b>Example:</b> <pre>switch(config-vpc-domain) # peer-gateway</pre> <b>Note</b> Disable IP redirects on all interface-vlans of this vPC domain for correct operation of this feature.	Enables Layer 3 forwarding for packets destined to the peer's gateway MAC address.
Step 4	<b>exit</b> <b>Example:</b> <pre>switch(config) # exit switch#</pre>	Exits vpc-domain configuration mode.
Step 5	<b>show vpc brief</b> <b>Example:</b> <pre>switch# show vpc brief</pre>	(Optional) Displays information about each vPC, including information about the vPC Peer-Link.
Step 6	<b>copy running-config startup-config</b> <b>Example:</b> <pre>switch# copy running-config startup-config</pre>	(Optional) Copies the running configuration to the startup configuration.

## Configuring the vPC Peer Switch

You can configure the Cisco Nexus 9000 Series device to make a pair of vPC devices appear as a single STP root in the Layer 2 topology.

### Configuring a Pure vPC Peer Switch Topology

You can configure a pure vPC peer switch topology by using the peer-switch command and then setting the best possible (lowest) spanning tree bridge priority value.

#### Before you begin

Ensure that you have enabled the vPC feature.



**Note** When using a non-VPC dedicated trunk link between the VPC peers, the non-VPC VLANs should have a different global priority on the peers to prevent STP from blocking the VLANs.

#### SUMMARY STEPS

1. configure terminal

2. **vpc domain** *domain-id* [**shut** | **no shut**]
3. **peer-switch**
4. **spanning-tree vlan** *vlan-range* **priority** *value*
5. **exit**
6. **show spanning-tree summary**
7. **copy running-config startup-config**

## DETAILED STEPS

	Command or Action	Purpose
<b>Step 1</b>	<b>configure terminal</b> <b>Example:</b> switch# <b>configure terminal</b> switch(config)#	Enters global configuration mode.
<b>Step 2</b>	<b>vpc domain</b> <i>domain-id</i> [ <b>shut</b>   <b>no shut</b> ] <b>Example:</b> switch(config)# <b>vpc domain</b> 5 switch(config-vpc-domain)#	Enters the vPC domain number that you want to configure, and enters vpc-domain configuration mode.
<b>Step 3</b>	<b>peer-switch</b> <b>Example:</b> switch(config-vpc-domain)# <b>peer-switch</b>	Enables the vPC switch pair to appear as a single STP root in the Layer 2 topology.  Use the <b>no</b> form of the command to disable the peer switch vPC topology.
<b>Step 4</b>	<b>spanning-tree vlan</b> <i>vlan-range</i> <b>priority</b> <i>value</i> <b>Example:</b> switch(config)# <b>spanning-tree vlan</b> 1 <b>priority</b> 8192	Configures the bridge priority of the VLAN. Valid values are multiples of 4096. The default value is 32768.
<b>Step 5</b>	<b>exit</b> <b>Example:</b> switch(config-vpc-domain)# <b>exit</b> switch#	Exits vpc-domain configuration mode.
<b>Step 6</b>	<b>show spanning-tree summary</b> <b>Example:</b> switch# <b>show spanning-tree summary</b>	(Optional) Displays a summary of the spanning tree port states including the vPC peer switch.
<b>Step 7</b>	<b>copy running-config startup-config</b> <b>Example:</b> switch# <b>copy running-config startup-config</b>	(Optional) Copies the running configuration to the startup configuration.

### Example

This example shows how to configure a pure vPC peer switch topology:

```

switch# configure terminal
Enter configuration commands, one per line. End with CNTL/Z.
switch(config)# vpc domain 5
switch(config-vpc-domain)# peer-switch

2010 Apr 28 14:44:44 switch %STP-2-VPC_PEERSWITCH_CONFIG_ENABLED: vPC peer-switch
configuration is enabled. Please make sure to configure spanning tree "bridge" priority as
per recommended guidelines to make vPC peer-switch operational.

switch(config-vpc-domain)# spanning-tree vlan 1 priority 8192
switch(config-vpc-domain)# exit
switch(config)#

```

## Configuring a Hybrid vPC Peer Switch Topology

You can configure a hybrid vPC and non-vPC peer switch topology by using the spanning-tree pseudo-information command to change the designated bridge ID so that it meets the STP VLAN-based load-balancing criteria and then change the root bridge ID priority to a value that is better than the best bridge priority. You then enable the peer switch.

### Before you begin

Ensure that you have enabled the vPC feature.

When using a non-VPC dedicated trunk link between the VPC peers, the non-VPC VLANs should have a different pseudo root priority on the peers to prevent STP from blocking the VLANs.

### SUMMARY STEPS

1. **configure terminal**
2. **spanning-tree pseudo-information**
3. **vlan *vlan-id* designated priority *priority***
4. **vlan *vlan-id* root priority *priority***
5. **vpc domain *domain-id* [shut | no shut]**
6. **peer-switch**
7. **exit**
8. **show spanning-tree summary**
9. **copy running-config startup-config**

### DETAILED STEPS

	Command or Action	Purpose
Step 1	<b>configure terminal</b> <b>Example:</b> <pre>switch# <b>configure terminal</b> switch(config)#</pre>	Enters global configuration mode.
Step 2	<b>spanning-tree pseudo-information</b> <b>Example:</b> <pre>switch(config)# <b>spanning-tree pseudo-information</b> switch(config-pseudo)#</pre>	Configures the spanning tree pseudo information.

	Command or Action	Purpose
<b>Step 3</b>	<b>vlan</b> <i>vlan-id</i> <b>designated</b> <i>priority</i> <i>priority</i> <b>Example:</b> <pre>switch(config-pseudo)# vlan 1 designated priority 8192</pre>	Configures the designated bridge priority of the VLAN. Valid values are multiples of 4096 from 0 to 61440.
<b>Step 4</b>	<b>vlan</b> <i>vlan-id</i> <b>root</b> <i>priority</i> <i>priority</i> <b>Example:</b> <pre>switch(config-pseudo)# vlan 1 root priority 4096</pre>	Configures the root bridge priority of the VLAN. Valid values are multiples of 4096 from 0 to 61440.
<b>Step 5</b>	<b>vpc domain</b> <i>domain-id</i> [ <b>shut</b>   <b>no shut</b> ] <b>Example:</b> <pre>switch(config)# vpc domain 5 switch(config-vpc-domain)#</pre>	Enters the vPC domain number that you want to configure, and enters vpc-domain configuration mode.
<b>Step 6</b>	<b>peer-switch</b> <b>Example:</b> <pre>switch(config-vpc-domain)# peer-switch</pre>	<p>Enables the vPC switch pair to appear as a single STP root in the Layer 2 topology.</p> <p>Use the <b>no</b> form of the command to disable the peer switch vPC topology.</p>
<b>Step 7</b>	<b>exit</b> <b>Example:</b> <pre>switch(config-vpc-domain)# exit switch#</pre>	Exits vpc-domain configuration mode.
<b>Step 8</b>	<b>show spanning-tree summary</b> <b>Example:</b> <pre>switch# show spanning-tree summary</pre>	(Optional) Displays a summary of the spanning tree port states including the vPC peer switch.
<b>Step 9</b>	<b>copy running-config startup-config</b> <b>Example:</b> <pre>switch# copy running-config startup-config</pre>	(Optional) Copies the running configuration to the startup configuration.

### Example

This example shows how to configure a hybrid vPC peer switch topology:

```
switch# configure terminal
Enter configuration commands, one per line. End with CNTL/Z.
switch(config)# spanning-tree pseudo-information
switch(config-pseudo)# vlan 1 designated priority 8192
switch(config-pseudo)# vlan 1 root priority 4096
switch(config-pseudo)# vpc domain 5
switch(config-vpc-domain)# peer-switch
switch(config-vpc-domain)# exit
switch(config)#
```

## Configuring the Suspension of Orphan Ports

When a device that is not vPC-capable connects to each peer, the connected ports are known as orphan ports because they are not members of a vPC. You can explicitly declare physical interfaces as orphan ports to be suspended (shut down) by the secondary peer when it suspends its vPC ports in response to a vPC Peer-Link or peer-keepalive failure. The orphan ports are restored when the vPC is restored.



**Note** You can configure vPC orphan port suspension only on physical ports, portchannels. However, you cannot configure the same on individual port channel member ports.

vPC orphan port suspend is not supported under vPC member ports.

### Before you begin

Ensure that you have enabled the vPC feature.

### SUMMARY STEPS

1. **configure terminal**
2. **show vpc orphan-ports**
3. **interface** *type slot/port*
4. **vpc orphan-port suspend**
5. **exit**
6. **copy running-config startup-config**

### DETAILED STEPS

	Command or Action	Purpose
Step 1	<b>configure terminal</b> <b>Example:</b> <pre>switch# configure terminal switch(config)#</pre>	Enters global configuration mode.
Step 2	<b>show vpc orphan-ports</b> <b>Example:</b> <pre>switch# show vpc orphan-ports</pre>	(Optional) Displays a list of the orphan ports.
Step 3	<b>interface</b> <i>type slot/port</i> <b>Example:</b> <pre>switch(config)# interface ethernet 3/1 switch(config-if)#</pre>	Specifies an interface to configure, and enters interface configuration mode.
Step 4	<b>vpc orphan-port suspend</b> <b>Example:</b> <pre>switch(config-if)# vpc orphan-ports suspend</pre>	Configures the selected interface as a vPC orphan port to be suspended by the secondary peer in the case of a vPC failure.

	Command or Action	Purpose
<b>Step 5</b>	<b>exit</b> <b>Example:</b> <pre>switch(config-if)# exit switch#</pre>	Exits interface configuration mode.
<b>Step 6</b>	<b>copy running-config startup-config</b> <b>Example:</b> <pre>switch# copy running-config startup-config</pre>	(Optional) Copies the running configuration to the startup configuration.

### Example

This example shows how to configure an interface as a vPC orphan port to be suspended by the secondary peer in the case of a vPC failure:

```
switch# configure terminal
switch(config)# interface ethernet 3/1
switch(config-if)# vpc orphan-ports suspend
switch(config-if)# exit
switch(config)#
```

Beginning Cisco NX-OS Release 9.2(1), the output of the **show vpc orphan-ports** command is slightly different from that of the earlier releases. This example shows the output of **show vpc orphan-ports** command:

```
switch# show vpc orphan-ports
-----:Going through port database. Please be patient.:-----
VLAN          Orphan Ports
-----
1              Eth1/18, Eth3/23
2              Eth3/23
3              Eth3/23
4              Eth3/23
5              Eth3/23
```

## Configuring vPC Object Tracking Tracking Feature on a Single-Module vPC

If you must configure all the vPC Peer-Links and core-facing interfaces on a single module, you should configure a track object and a track list that is associated with the Layer 3 link to the core and on all the links on the vPC Peer-Link on both primary vPC peer devices. Once you configure this feature and if the primary vPC peer device fails, the system automatically suspends all the vPC links on the primary vPC peer device. This action forces all the vPC traffic to the secondary vPC peer device until the system stabilizes.

You must put this configuration on both vPC peer devices. Additionally, you should put the identical configuration on both vPC peer devices because either device can become the operationally primary vPC peer device.



**Before you begin**

Ensure that you have enabled the vPC feature.

Ensure that you have configured the track object and the track list. Ensure that you assign all interfaces that connect to the core and to the vPC Peer-Link to the track-list object on both vPC peer devices.

**SUMMARY STEPS**

1. **configure terminal**
2. **vpc domain** *domain-id* [**shut** | **no shut**]
3. **track** *track-object-id*
4. **exit**
5. **show vpc brief**
6. **copy running-config startup-config**

**DETAILED STEPS**

	Command or Action	Purpose
<b>Step 1</b>	<b>configure terminal</b> <b>Example:</b> switch# <b>configure terminal</b> switch(config)#	Enters global configuration mode.
<b>Step 2</b>	<b>vpc domain</b> <i>domain-id</i> [ <b>shut</b>   <b>no shut</b> ] <b>Example:</b> switch(config)# <b>vpc domain</b> 5 switch(config-vpc-domain)#	Enters the vPC domain number that you want to configure, and enters vpc-domain configuration mode.
<b>Step 3</b>	<b>track</b> <i>track-object-id</i> <b>Example:</b> switch(config-vpc-domain)# <b>track object</b> 23 switch(config-vpc-domain)#	Adds the previously configured track-list object with its associated interfaces to the vPC domain. See the <a href="#">Cisco Nexus 9000 Series NX-OS Unicast Routing Configuration Guide</a> for information about configuring object tracking and track lists.
<b>Step 4</b>	<b>exit</b> <b>Example:</b> switch(config-vpc-domain)# <b>exit</b> switch#	Exits vpc-domain configuration mode.
<b>Step 5</b>	<b>show vpc brief</b> <b>Example:</b> switch# <b>show vpc brief</b>	(Optional) Displays information about the tracked objects.
<b>Step 6</b>	<b>copy running-config startup-config</b> <b>Example:</b> switch# <b>copy running-config startup-config</b>	(Optional) Copies the running configuration to the startup configuration.

**Example**

This example shows how to put the previously configured track-list object into the vPC domain on the vPC peer device:

```
switch# configure terminal
switch(config)# vpc domain 5
switch(config-vpc-domain)# track object 5
switch(config-vpc-domain)# exit
switch(config)#
```

## Configuring for Recovery After an Outage

If an outage occurs, the vPC waits for a peer adjacency to form on a switch reload. This situation can result in an unacceptably long service disruption. You can configure the Cisco Nexus 9000 Series device to restore vPC services when its peer fails to come on line.

### Configuring Reload Restore

The **reload restore** command and procedure described in this section is deprecated. We recommend that you use the **auto-recovery** command and procedure described in the “Configuring an Autorecovery” section.

You can configure the Cisco Nexus 9000 Series device to restore vPC services when its peer fails to come online by using the **reload restore** command.

**Before you begin**

Ensure that you have enabled the vPC feature.

**SUMMARY STEPS**

1. **configure terminal**
2. **vpc domain** *domain-id* [**shut** | **no shut**]
3. **reload restore** [**delay** *time-out*]
4. **exit**
5. **show running-config vpc**
6. **show vpc consistency-parameters interface port-channel** *number*
7. **copy running-config startup-config**

**DETAILED STEPS**

	Command or Action	Purpose
<b>Step 1</b>	<b>configure terminal</b> <b>Example:</b> <pre>switch# <b>configure terminal</b> switch(config)#</pre>	Enters global configuration mode.
<b>Step 2</b>	<b>vpc domain</b> <i>domain-id</i> [ <b>shut</b>   <b>no shut</b> ] <b>Example:</b>	Enters the vPC domain number that you want to configure, and enters vpc-domain configuration mode.

	Command or Action	Purpose
	switch(config)# <b>vpc domain 5</b> switch(config-vpc-domain)#	
<b>Step 3</b>	<b>reload restore [delay time-out]</b>  <b>Example:</b> switch(config-vpc-domain)# <b>reload restore</b>	Configures the vPC to assume its peer is not functional and to bring up the vPC. The default delay is 240 seconds. You can configure a time-out delay from 240 to 3600 seconds.  Use the <b>no</b> form of the command to reset the vPC to its default settings.
<b>Step 4</b>	<b>exit</b>  <b>Example:</b> switch(config-vpc-domain)# <b>exit</b> switch#	Exits vpc-domain configuration mode.
<b>Step 5</b>	<b>show running-config vpc</b>  <b>Example:</b> switch# <b>show running-config vpc</b>	(Optional) Displays information about the vPC, specifically the reload status.
<b>Step 6</b>	<b>show vpc consistency-parameters interface port-channel number</b>  <b>Example:</b> switch# <b>show vpc consistency-parameters interface port-channel 1</b>	(Optional) Displays information about the vPC consistency parameters for the specified interface.
<b>Step 7</b>	<b>copy running-config startup-config</b>  <b>Example:</b> switch# <b>copy running-config startup-config</b>	(Optional) Copies the running configuration to the startup configuration.  <b>Note</b> To ensure the reload feature is enabled, you should perform this step.

### Example

This example shows how to set the vPC reload restore feature and save it in the switch startup configuration:

```
switch# configure terminal
Enter configuration commands, one per line. End with CNTL/Z.
switch(config)# vpc domain 5
switch(config-vpc-domain)# reload restore
```

Warning:  
Enables restoring of vPCs in a peer-detached state after reload, will wait for 240 seconds (by default) to determine if peer is un-reachable

```
switch(config-vpc-domain)# exit
switch(config)# exit
switch# copy running-config startup-config
switch# show running-config vpc
```

```
!Command: show running-config vpc
!Time: Wed Mar 24 18:43:54 2010
version 5.0(2)
```

```
feature vpc
logging level vpc 6
vpc domain 5
reload restore
```

This example shows how to examine the consistency parameters:

```
switch# show vpc consistency-parameters interface port-channel 1
```

Legend:

Type 1 : vPC will be suspended in case of mismatch

Name Type Local Value Peer Value

-----

```
STP Port Type 1 Default -
STP Port Guard 1 None -
STP MST Simulate PVST 1 Default -
mode 1 on -
Speed 1 1000 Mb/s -
Duplex 1 full -
Port Mode 1 trunk -
Native Vlan 1 1 -
MTU 1 1500 -
Allowed VLANs - 1-3967,4048-4093
Local suspended VLANs
```

## Configuring an Autorecovery

You can configure the Cisco Nexus 9000 Series device to restore vPC services when its peer fails to come online by using the auto-recovery command.

You can configure the Cisco Nexus 9000 Series device to restore vPC services on the secondary vPC peer when its vPC primary peer fails and bringing down peer-keepalive and vPC Peer-Link, by using the **auto-recovery** command. In case of failure of primary switch where both peer-keepalive and vPC Peer-Links are down secondary switch will suspend vPC member. However, after 3 missed keepalive heartbeats secondary switch resumes the role of a primary switch and bring up vPC member ports. The **auto-recovery reload restore** command can be used in scenarios when vPC primary switch reloads, where secondary switch resumes the role of the vPC primary and bring ip VPC member ports.



---

**Note** The auto-recovery feature is not enabled by default on Cisco Nexus 9000 Switches. When the object tracking is triggered, the vPC secondary peer device does not change its role to that primary device and it reinitializes the vPC legs. You must manually configure auto-recovery on the vPC secondary peer device so that it can take over the primary role and reinitialize its vPC legs.

---

### Before you begin

Ensure that you have enabled the vPC feature.

### SUMMARY STEPS

1. **configure terminal**
2. **vpc domain** *domain-id* [**shut** | **no shut**]
3. **auto-recovery** [**reload-delay** *time*]
4. **exit**
5. **show running-config vpc**

6. `show vpc consistency-parameters interface port-channel number`
7. `copy running-config startup-config`

## DETAILED STEPS

	Command or Action	Purpose
Step 1	<b>configure terminal</b> <b>Example:</b> <pre>switch# configure terminal switch(config)#</pre>	Enters global configuration mode.
Step 2	<b>vpc domain <i>domain-id</i> [shut   no shut]</b> <b>Example:</b> <pre>switch(config)# vpc domain 5 switch(config-vpc-domain)#</pre>	Enters the vPC domain number that you want to configure, and enters vpc-domain configuration mode.
Step 3	<b>auto-recovery [reload-delay <i>time</i>]</b> <b>Example:</b> <pre>switch(config-vpc-domain)# auto-recovery</pre>	<p>Configures the vPC to assume its peer is not functional and to bring up the vPC, and specifies the time to wait after a reload to restore the vPC. The default delay is 240 seconds. You can configure a delay from 240 to 3600 seconds.</p> <p>Use the <b>no</b> form of the command to reset the vPC to its default settings.</p>
Step 4	<b>exit</b> <b>Example:</b> <pre>switch(config-vpc-domain)# exit switch#</pre>	Exits vpc-domain configuration mode.
Step 5	<b>show running-config vpc</b> <b>Example:</b> <pre>switch# show running-config vpc</pre>	(Optional) Displays information about the vPC, specifically the reload status.
Step 6	<b>show vpc consistency-parameters interface port-channel <i>number</i></b> <b>Example:</b> <pre>switch# show vpc consistency-parameters interface port-channel 1</pre>	(Optional) Displays information about the vPC consistency parameters for the specified interface.
Step 7	<b>copy running-config startup-config</b> <b>Example:</b> <pre>switch# copy running-config startup-config</pre>	<p>(Optional) Copies the running configuration to the startup configuration.</p> <p><b>Note</b> To ensure the autorecovery feature is enabled, you should perform this step.</p>

### Example

This example shows how to set the vPC autorecovery feature and save it in the switch startup configuration:

```

switch# configure terminal
Enter configuration commands, one per line. End with CNTL/Z.
switch(config)# vpc domain 5
switch(config-vpc-domain)# auto-recovery
switch(config-vpc-domain)# auto-recovery auto-recovery reload-delay 100

Warning:
Enables restoring of vPCs in a peer-detached state after reload, will wait for 240
seconds to determine if peer is un-reachable

switch(config-vpc-domain)# exit
switch(config)# exit
switch# copy running-config startup-config

```

## Configuring Hitless vPC Role Change

Complete these steps to enable hitless vPC role change.

### Before you begin

- Ensure that the vPC feature is enabled.
- Ensure that the vPC Peer-Link is up
- Verify the role priority of devices

### SUMMARY STEPS

1. **vpc role preempt**
2. **show vpc role**

### DETAILED STEPS

	Command or Action	Purpose
<b>Step 1</b>	<b>vpc role preempt</b> <b>Example:</b> switch# <b>vpc role preempt</b> switch(config)#	Enable hitless vPC role change.
<b>Step 2</b>	<b>show vpc role</b> <b>Example:</b> switch(config)# <b>show vpc role</b>	(Optional) Verify hitless vPC role change feature.

### Example

This example on how to configure hitless vPC role change:

```

switch# show vpc rolevPC Role status
-----
vPC role                : secondary
vPC system-mac          : 00:23:04:ee:be:01
vPC system-priority     : 32667

```

```

vPC local system-mac          : 8c:60:4f:03:84:41
vPC local role-priority       : 32668
vPC peer system-mac          : 8c:60:4f:03:84:43
vPC peer role-priority        : 32667

! Configure vPC hitless role change on the device!

switch(config)# vpc role preempt
! The following is an output from the show vpc role command after the
vPC hitless feature is configured
switch(config)# show vpc role
vPC Role status
-----
vPC role                      : primary
vPC system-mac                : 00:00:00:00:00:00
vPC system-priority           : 32667
vPC local system-mac          : 8c:60:4f:03:84:41
vPC local role-priority       : 32666
vPC peer system-mac           : 8c:60:4f:03:84:43
vPC peer role-priority        : 32667

switch(config)#

```

## Use Case Scenario for vPC Role Change

The hitless vPC role change feature can be used in the following scenarios:

- Role change request—When you want to change the roles of the peer devices in a vPC domain.
- Primary switch reload—When the devices comes up after a reload and roles are defined, you can use the hitless vPC role change feature to restore the roles. For example, after a reload if the primary device takes the role of operational secondary and the secondary device takes the role of primary operational, you can change the vPC peer roles to their original defined roles using the **vpc role preempt** command.



---

**Note** Always check the existing device role priority before switching vPC role.

---

- Dual-active recovery—In a dual-active recovery scenario, the vPC primary switch continues to be (operational) primary, but the vPC secondary switch becomes the targeted primary switch and keeps its vPC member ports up. You can use the vPC hitless feature and restore the device roles. After the Dual-active recovery, if one side is operational primary and the other side operational secondary, then you can use the **vpc role preempt** command to restore the device roles to be primary and secondary

## Enabling Certain vPC Commands Automatically

You can automatically and simultaneously enable the following commands using the **mode auto** command: **peer-gateway**, **auto-recovery**, **ip arp synchronize**, and **ipv6 nd synchronize**

### Before you begin

Ensure that you have enabled the vPC feature.

## SUMMARY STEPS

1. **configure terminal**
2. **feature vpc**
3. **vpc domain *domain-id* [shut | no shut]**
4. **[no] mode auto**
5. **exit**
6. **exit**
7. **show running-config vpc**
8. **copy running-config startup-config**

## DETAILED STEPS

	Command or Action	Purpose
<b>Step 1</b>	<b>configure terminal</b>  <b>Example:</b> switch# <b>configure terminal</b> switch(config)#	Enters global configuration mode.
<b>Step 2</b>	<b>feature vpc</b>  <b>Example:</b> switch(config)# <b>feature vpc</b>	Enables vPCs on the device.
<b>Step 3</b>	<b>vpc domain <i>domain-id</i> [shut   no shut]</b>  <b>Example:</b> switch# <b>vpc domain 1</b> switch(config-vpc-domain)#	Creates a vPC domain on the device and enters vpc-domain configuration mode. The range is from 1 to 1000.
<b>Step 4</b>	<b>[no] mode auto</b>  <b>Example:</b> switch(config-vpc-domain)# <b>mode auto</b>	Enables the following commands simultaneously: <b>peer-gateway</b> , <b>auto-recovery</b> , <b>ip arp synchronize</b> , and <b>ipv6 nd synchronize</b> .  Use the <b>no</b> form of this command to disable the feature.
<b>Step 5</b>	<b>exit</b>  <b>Example:</b> switch(config-vpc-domain)# <b>exit</b> switch#	Exits vpc-domain configuration mode.
<b>Step 6</b>	<b>exit</b>  <b>Example:</b> switch(config)# <b>exit</b> switch#	Exits global configuration mode.
<b>Step 7</b>	<b>show running-config vpc</b>  <b>Example:</b> switch# <b>show running-config vpc</b>	(Optional) Displays information about the vPC, including the commands that are enabled.



	Command or Action	Purpose
Step 8	<b>copy running-config startup-config</b> <b>Example:</b> <pre>switch# copy running-config startup-config</pre>	(Optional) Copies the running configuration to the startup configuration.

### Example

This example shows how to simultaneously enable the following commands: **peer-gateway**, **auto-recovery**, **ip arp synchronize**, and **ipv6 nd synchronize**.

```
switch# configure terminal
switch# feature vpc
switch(config)# vpc domain 1
switch(config-vpc-domain)# mode auto
```

The following commands are executed:

```
peer-gateway ;
auto-recovery ;
ip arp synchronize ;
ipv6 nd synchronize ;
```

Warning:

Enables restoring of vPCs in a peer-detached state after reload, will wait for 240 seconds to determine if peer is un-reachable

```
switch(config-vpc-domain)# exit
switch(config)# exit
switch# show running-config vpc
```

```
!Command: show running-config vpc
!Time: Thu Feb 18 12:31:42 2013
version 6.2(2)
feature vpc
vpc domain 1
peer-gateway
auto-recovery
ip arp synchronize
ipv6 nd synchronize
```

## Manually Configuring a vPC Domain MAC Address

When you create a vPC domain, the Cisco NX-OS software automatically creates a vPC system MAC address, which is used for operations that are confined to the link-scope, such as LACP. However, you might choose to configure the vPC domain MAC address manually.

### Before you begin

Ensure that you have enabled the vPC feature.

### SUMMARY STEPS

1. **configure terminal**
2. **vpc domain *domain-id* [shut | no shut]**
3. **system-mac *mac-address***

4. **exit**
5. **show vpc role**
6. **copy running-config startup-config**

## DETAILED STEPS

	Command or Action	Purpose
<b>Step 1</b>	<b>configure terminal</b> <b>Example:</b> <pre>switch# configure terminal switch(config)#</pre>	Enters global configuration mode.
<b>Step 2</b>	<b>vpc domain <i>domain-id</i> [shut   no shut]</b> <b>Example:</b> <pre>switch(config)# vpc domain 5 switch(config-vpc-domain)#</pre>	Enters the vPC domain number that you want to configure. The system enters vpc-domain configuration mode.
<b>Step 3</b>	<b>system-mac <i>mac-address</i></b> <b>Example:</b> <pre>switch(config-vpc-domain)# system-mac 23fb.4ab5.4c4e switch(config-vpc-domain)#</pre>	Enters the MAC address that you want for the specified vPC domain in the following format: <code>aaaa.bbbb.cccc</code> .
<b>Step 4</b>	<b>exit</b> <b>Example:</b> <pre>switch(config-vpc-domain)# exit switch#</pre>	Exits vpc-domain configuration mode.
<b>Step 5</b>	<b>show vpc role</b> <b>Example:</b> <pre>switch# show vpc brief</pre>	(Optional) Displays the vPC system MAC address.
<b>Step 6</b>	<b>copy running-config startup-config</b> <b>Example:</b> <pre>switch# copy running-config startup-config</pre>	(Optional) Copies the running configuration to the startup configuration.

### Example

This example shows how to manually configure a vPC domain MAC address:

```
switch# configure terminal
switch(config)# vpc domain 5
switch(config-vpc-domain)# system-mac 13gb.4ab5.4c4e
switch(config-vpc-domain)# exit
switch(config)#
```

## Manually Configuring the System Priority

When you create a vPC domain, the system automatically creates a vPC system priority. However, you can also manually configure a system priority for the vPC domain.



**Note** We recommend that you manually configure the vPC system priority when you are running LACP to ensure that the vPC peer devices are the primary devices on LACP. When you manually configure the system priority, ensure that you configure the same priority value on both vPC peer devices. If these values do not match, vPC does not come up.

### Before you begin

Ensure that you have enabled the vPC feature.

### SUMMARY STEPS

1. **configure terminal**
2. **vpc domain** *domain-id* [**shut** | **no shut**]
3. **system-priority** *priority*
4. **exit**
5. **show vpc role**
6. **copy running-config startup-config**

### DETAILED STEPS

	Command or Action	Purpose
Step 1	<b>configure terminal</b> <b>Example:</b> <pre>switch# configure terminal switch(config)#</pre>	Enters global configuration mode.
Step 2	<b>vpc domain</b> <i>domain-id</i> [ <b>shut</b>   <b>no shut</b> ] <b>Example:</b> <pre>switch(config)# vpc domain 5 switch(config-vpc-domain)#</pre>	Enters the vPC domain number that you want to configure. The system enters vpc-domain configuration mode.
Step 3	<b>system-priority</b> <i>priority</i> <b>Example:</b> <pre>switch(config-vpc-domain)# system-priority 4000 switch(config-vpc-domain)#</pre>	Enters the system priority that you want for the specified vPC domain. The range of values is from 1 to 65535. The default value is 32667.
Step 4	<b>exit</b> <b>Example:</b> <pre>switch(config-vpc-domain)# exit switch#</pre>	Exits vpc-domain configuration mode.

	Command or Action	Purpose
<b>Step 5</b>	<b>show vpc role</b> <b>Example:</b> switch# show vpc role	(Optional) Displays the vPC system priority.
<b>Step 6</b>	<b>copy running-config startup-config</b> <b>Example:</b> switch# copy running-config startup-config	(Optional) Copies the running configuration to the startup configuration.

### Example

This example shows how to manually configure the vPC domain system priority:

```
switch# configure terminal
switch(config)# vpc domain 5
switch(config-vpc-domain)# system-priority 4000
switch(config-vpc-domain)# exit
switch(config)#
```

## Manually Configuring the vPC Peer Device Role

By default, the Cisco NX-OS software elects a primary and secondary vPC peer device after you configure the vPC domain and both sides of the vPC Peer-Link. However, you might want to elect a specific vPC peer device as the primary device for the vPC. Then, you would manually configure the role value for the vPC peer device that you want as the primary device to be lower than the other vPC peer device.

vPCs do not support role preemption. If the primary vPC peer device fails, the secondary vPC peer device takes over to become operationally the vPC primary device. However, the original operational roles are not restored if the formerly primary vPC comes up again.

### Before you begin

Ensure that you have enabled the vPC feature.

### SUMMARY STEPS

1. **configure terminal**
2. **vpc domain** *domain-id* [**shut** | **no shut**]
3. **role priority** *priority*
4. **exit**
5. **show vpc role**
6. **copy running-config startup-config**

### DETAILED STEPS

	Command or Action	Purpose
<b>Step 1</b>	<b>configure terminal</b> <b>Example:</b>	Enters global configuration mode.

	Command or Action	Purpose
	<code>switch# configure terminal</code> <code>switch(config)#</code>	
<b>Step 2</b>	<b>vpc domain</b> <i>domain-id</i> [ <b>shut</b>   <b>no shut</b> ]  <b>Example:</b> <code>switch(config)# vpc domain 5</code> <code>switch(config-vpc-domain)#</code>	Enters the vPC domain number that you want to configure. The system enters vpc-domain configuration mode.
<b>Step 3</b>	<b>role priority</b> <i>priority</i>  <b>Example:</b> <code>switch(config-vpc-domain)# role priority 4</code> <code>switch(config-vpc-domain)#</code>	Enters the role priority that you want for the vPC system priority. The range of values is from 1 to 65636, and the default value is 32667. A lower value means that this switch has a better chance of being the primary vPC.
<b>Step 4</b>	<b>exit</b>  <b>Example:</b> <code>switch(config)# exit</code> <code>switch#</code>	Exits vpc-domain configuration mode.
<b>Step 5</b>	<b>show vpc role</b>  <b>Example:</b> <code>switch# show vpc role</code>	(Optional) Displays the vPC system priority.
<b>Step 6</b>	<b>copy running-config startup-config</b>  <b>Example:</b> <code>switch# copy running-config startup-config</code>	(Optional) Copies the running configuration to the startup configuration.

### Example

This example shows how to manually configure the role priority of the vPC peer device:

```
switch# configure terminal
switch(config)# vpc domain 5
switch(config-vpc-domain)# role priority 4
switch(config-vpc-domain)# exit
switch(config)#
```

## Enabling STP to Use the Cisco MAC Address

This procedure enables STP to use the Cisco MAC address (00:26:0b:xx:xx:xx).

### Before you begin

Ensure that you have enabled the vPC feature.

### SUMMARY STEPS

1. **configure terminal**
2. **vpc domain** *domain-id*

3. `[no] mac-address bpdu source version 2`
4. `exit`
5. (Optional) `copy running-config startup-config`

## DETAILED STEPS

	Command or Action	Purpose
<b>Step 1</b>	<b>configure terminal</b> <b>Example:</b> <code>switch# configure terminal</code>	Enters global configuration mode.
<b>Step 2</b>	<b>vpc domain <i>domain-id</i></b> <b>Example:</b> <code>switch(config)# vpc domain 5</code>	Creates a vPC domain if it does not already exist, and enters vpc-domain configuration mode.
<b>Step 3</b>	<b>[no] mac-address bpdu source version 2</b> <b>Example:</b> <code>switch(config-vpc-domain)# mac-address bpdu source version 2</code>	Enables STP to use the Cisco MAC address (00:26:0b:xx:xx:xx) as the source address of BPDUs generated on vPC ports.
<b>Step 4</b>	<b>exit</b> <b>Example:</b> <code>switch(config-vpc-domain)# exit</code>	Exits vpc-domain configuration mode.
<b>Step 5</b>	(Optional) <b>copy running-config startup-config</b> <b>Example:</b> <code>switch(config)# copy running-config startup-config</code>	Copies the running configuration to the startup configuration.

## Verifying the vPC Configuration

To display vPC configuration information, perform one of the following tasks:

Command	Purpose
<code>show feature</code>	Displays whether the vPC is enabled or not.
<code>show vpc brief</code>	Displays brief information about the vPCs.
<code>show vpc consistency-parameters</code>	Displays the status of those parameters that must be consistent across all vPC interfaces.
<code>show running-config vpc</code>	Displays running configuration information for vPCs.
<code>show port-channel capacity</code>	Displays how many port channels are configured and how many are still available on the device.
<code>show vpc statistics</code>	Displays statistics about the vPCs.

Command	Purpose
<code>show vpc peer-keepalive</code>	Displays information about the peer-keepalive messages.
<code>show vpc role</code>	Displays the peer status, the role of the local device, the vPC system MAC address and system priority, and the MAC address and priority for the local vPC device.

## Monitoring vPCs

Use the `show vpc statistics` command to display vPC statistics.



**Note** This command displays the vPC statistics only for the vPC peer device that you are working on.

## Configuration Examples for vPCs

The following example shows how to configure vPC on device A as shown in the figure:

*Figure 23: vPC Configuration Example*

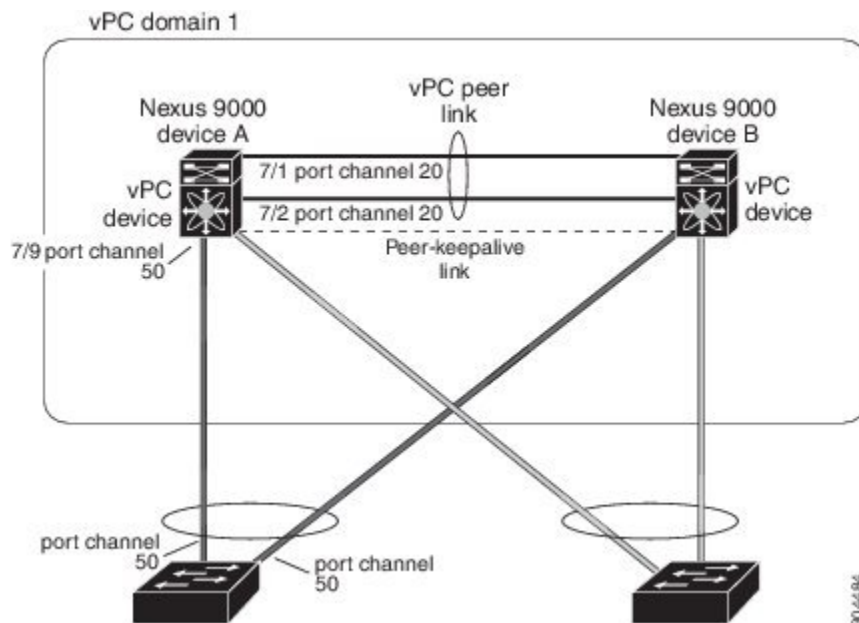

1. Enable vPC and LACP.
 

```
switch# configure terminal
switch(config)# feature vPC
switch(config)# feature lacp
```

2. (Optional) Configure one of the interfaces that you want to be a vPC Peer-Link in the dedicated port mode.

```
switch(config)# interface ethernet 7/1,
ethernet 7/3, ethernet 7/5. ethernet 7/7
switch(config-if)# shutdown
switch(config-if)# exit
switch(config)# interface ethernet 7/1
switch(config-if)# rate-mode dedicated
switch(config-if)# no shutdown
switch(config-if)# exit
switch(config)#
```

3. (Optional) Configure the second, redundant interface that you want to be a vPC Peer-Link in the dedicated port mode.

```
switch(config)# interface ethernet 7/2, ethernet 7/4,
ethernet 7/6. ethernet 7/8
switch(config-if)# shutdown
switch(config-if)# exit
switch(config)# interface ethernet 7/2
switch(config-if)# rate-mode dedicated
switch(config-if)# no shutdown
switch(config-if)# exit
switch(config)#
```

4. Configure the two interfaces (for redundancy) that you want to be in the vPC Peer-Link to be an active Layer 2 LACP port channel.

```
switch(config)# interface ethernet 7/1-2
switch(config-if)# switchport
switch(config-if)# switchport mode trunk
switch(config-if)# switchport trunk allowed vlan 1-50
switch(config-if)# switchport trunk native vlan 20
switch(config-if)# channel-group 20 mode active
switch(config-if)# exit
```

5. Create and enable the VLANs.

```
switch(config)# vlan 1-50
switch(config-vlan)# no shutdown
switch(config-vlan)# exit
```

6. Create a separate VRF for the vPC peer-keepalive link and add a Layer 3 interface to that VRF.

```
switch(config)# vrf context pkal
switch(config-vrf)# exit
switch(config)# interface ethernet 8/1
switch(config-if)# vrf member pkal
switch(config-if)# ip address 172.23.145.218/24
switch(config-if)# no shutdown
switch(config-if)# exit
```

7. Create the vPC domain and add the vPC peer-keepalive link.

```
switch(config)# vpc domain 1
switch(config-vpc-domain)# peer-keepalive
destination 172.23.145.217 source 172.23.145.218 vrf pkal
switch(config-vpc-domain)# exit
```

8. Configure the vPC vPC Peer-Link.

```
switch(config)# interface port-channel 20
switch(config-if)# switchport mode trunk
```



```
switch(config-if)# switchport trunk allowed vlan 1-50
switch(config-if)# vpc peer-link
switch(config-if)# exit
switch(config)#
```

9. Configure the interface for the port channel to the downstream device of the vPC.

```
switch(config)# interface ethernet 7/9
switch(config-if)# switchport mode trunk
switch(config-if)# allowed vlan 1-50
switch(config-if)# native vlan 20
switch(config-if)# channel-group 50 mode active
switch(config-if)# exit
switch(config)# interface port-channel 50
switch(config-if)# vpc 50
switch(config-if)# exit
switch(config)#
```

10. Save the configuration.

```
switch(config)# copy running-config startup-config
```



---

**Note** If you configure the port channel first, ensure that it is a Layer 2 port channel.

---

## Related Documents

Related Topic	Related Topic
System management	System management
High availability	High availability
Release Notes	Release Notes

