



# Implementing IP Service Level Agreements

IP Service Level Agreements (IP SLAs) is a portfolio of technology embedded in most devices that run Cisco IOS XR Software, which allows you to analyze IP service levels for IP applications and services, increase productivity, lower operational costs, and reduce the frequency of network outages.

Using IP SLA, service provider customers can measure and provide service level agreements. IP SLA can perform network assessments, verify quality of service (QoS), ease the deployment of new services, and assist administrators with network troubleshooting.



---

**Note** For a complete description of the IP SLA commands used in this chapter, refer to the *IP Service Level Agreement Commands on the Cisco ASR 9000 Series Router* module of *System Management Command Reference for Cisco ASR 9000 Series Routers*.

---

## Feature History for Implementing IP Service Level Agreements

Release	Modification
Release 3.7.2	This feature was introduced.
Release 6.0.1	The TWAMP accuracy enhancement was introduced.

- [Prerequisites for Implementing IP Service Level Agreements, on page 1](#)
- [Restrictions for Implementing IP Service Level Agreements, on page 2](#)
- [Information About Implementing IP Service Level Agreements, on page 3](#)
- [How to Implement IP Service Level Agreements, on page 17](#)
- [Configuration Examples for Implementing IP Service Level Agreements, on page 91](#)
- [Additional References, on page 94](#)

## Prerequisites for Implementing IP Service Level Agreements

Knowledge of general networking protocols and your specific network design is assumed. Familiarity with network management applications is helpful. We do not recommend scheduling all the operations at the same time as this could negatively affect your performance.

You must be in a user group associated with a task group that includes the proper task IDs. The command reference guides include the task IDs required for each command. If you suspect user group assignment is preventing you from using a command, contact your AAA administrator for assistance.

## Restrictions for Implementing IP Service Level Agreements

- The maximum number of IP SLA configurable operations that is supported by Cisco IOS XR Software is 2000.
- The current validated scale numbers for scheduling operations are as follows:
  - The number of UDP echo operations is 1000 operations with default frequency.
  - The number of UDP jitter operations is 1000 operations with default frequency.
  - The number of ICMP echo operations is 1000 operations with default frequency.
  - The number of ICMP echo-path operations is 400 operations with default frequency.
  - The ICMP jitter operations that can be configured with default frequency without packet loss is 75.
  - The MPLS LSP ping operations that can be configured with default frequency without packet loss is 100.
  - The MPLS LSP trace operations that can be configured with default frequency without packet loss is 100.
- We do not recommend scheduling all the operations at the same start time as this may affect the performance. At the same start time, not more than 10 operations per second should be scheduled. We recommend using the `start after` configuration.



---

**Note** Setting the frequency to less than 60 seconds will increase the number of packets sent. But this could negatively impact the performance of IP SLA operation when scheduled operations have same start time.

---

- IP SLA is not HA capable.
- Consider the following guidelines before configuring the frequency, timeout, and threshold commands.
  - For the UDP and ICMP jitter operation, the following guidelines are recommended:
    - $\text{frequency} > \text{timeout} + 2 \text{ seconds} + \text{num\_packets} * \text{packet\_interval}$
    - $\text{timeout} > \text{rtt\_threshold}$
    - $\text{num\_packet} > \text{loss\_threshold}$
  - For all other IP SLAs operations, the following configuration guideline is recommended:
    - $\text{frequency} > \text{timeout} > \text{rtt\_threshold}$

# Information About Implementing IP Service Level Agreements

## About IP Service Level Agreements Technology

IP SLA uses active traffic monitoring, which generates traffic in a continuous, reliable, and predictable manner to measure network performance. IP SLA sends data across the network to measure performance between multiple network locations or across multiple network paths. It simulates network data and IP services, and collects network performance information in real time. This information is collected:

- Response times
- One-way latency, jitter (interpacket delay variance)
- Packet loss
- Network resource availability

IP SLA originated from the technology previously known as Service Assurance Agent (SAA). IP SLA performs active monitoring by generating and analyzing traffic to measure performance, either between the router or from a router to a remote IP device such as a network application server. Measurement statistics, which are provided by the various IP SLA operations, are used for troubleshooting, problem analysis, and designing network topologies.

Depending on the specific IP SLA operation, statistics of delay, packet loss, jitter, packet sequence, connectivity, and path are monitored by and stored in the router and provided through command-line interface (CLI), Extensive Markup Language (XML), and SNMP MIBs. IP SLA uses the Cisco RTTMON Management Information Base (MIB) to interact between external Network Management System (NMS) applications and the IP SLA operations that are running on Cisco devices.

For a complete description of the object variables that are referenced by IP SLA, see the text of the CISCO-RTTMON-MIB.my file that is available from the Cisco MIB Locator.

## Service Level Agreements

Internet commerce has grown significantly in the past few years as the technology has advanced to provide faster, more reliable access to the Internet. Many companies need online access and conduct most of their business on line and any loss of service can affect the profitability of the company. Internet service providers (ISPs) and even internal IT departments now offer a defined level of service—a service level agreement—to provide their customers with a degree of predictability.

Network administrators are required to support service level agreements that support application solutions. [Figure 1: Scope of Traditional Service Level Agreement Versus IP SLA, on page 4](#) shows how IP SLA has taken the traditional concept of Layer 2 service level agreements and applied a broader scope to support end-to-end performance measurement, including support of applications.



---

**Note**

- Provided that the application and the IP-SLA processing rates support it, you can specify the flow rate for IP-SLA flow entries to up to 1500.
  - To enable high performance for IP-SLA operations, avoid reuse of same source and destination ports for multiple IP SLA operations on the same device, especially when the scale is huge
-

Figure 1: Scope of Traditional Service Level Agreement Versus IP SLA

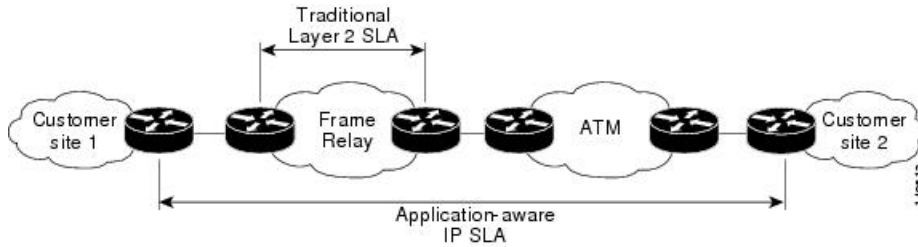

This table lists the improvements with IP SLA over a traditional service level agreement.

Table 1: IP SLA Improvements over a Traditional Service Level Agreement

Type of Improvement	Description
End-to-end measurements	The ability to measure performance from one end of the network to the other allows a broader reach and more accurate representation of the end-user experience.
Sophistication	Statistics, such as delay, jitter, packet sequence, Layer 3 connectivity, and path and download time, that are divided into bidirectional and round-trip numbers provide more data than just the bandwidth of a Layer 2 link.
Accuracy	Applications that are sensitive to slight changes in network performance require the precision of the submillisecond measurement of IP SLA.
Ease of deployment	Leveraging the existing Cisco devices in a large network makes IP SLA easier to implement than the physical operations that are often required with traditional service level agreements.
Application-aware monitoring	IP SLA can simulate and measure performance statistics generated by applications running over Layer 3 through Layer 7. Traditional service level agreements can measure only Layer 2 performance.
Pervasiveness	IP SLA support exists in Cisco networking devices ranging from low-end to high-end routers and switches. This wide range of deployment gives IP SLA more flexibility over traditional service level agreements.

## Benefits of IP Service Level Agreements

This table lists the benefits of implementing IP SLA.

Table 2: List of Benefits for IP SLA

Benefit	Description
IP SLA monitoring	Provides service level agreement monitoring, measurement, and verification.

Benefit	Description
Network performance monitoring	Measure the jitter, latency, or packet loss in the network. In addition, IP SLA provides continuous, reliable, and predictable measurements along with proactive notification.
IP service network health assessment	Verifies that the existing QoS is sufficient for the new IP services.
Troubleshooting of network operation	Provides consistent, reliable measurement that immediately identifies problems and saves troubleshooting time.

## Measuring Network Performance with IP Service Level Agreements

IP SLA uses generated traffic to measure network performance between two networking devices, such as routers. [Figure 2: IP SLA Operations, on page 5](#) shows how IP SLA starts when the IP SLA device sends a generated packet to the destination device. After the destination device receives the packet and if the operation uses an IP SLA component at the receiving end (for example, IP SLA Responder), the reply packet includes information about the delay at the target device. The source device uses this information to improve the accuracy of the measurements. An IP SLA operation is a network measurement to a destination in the network from the source device using a specific protocol, such as User Datagram Protocol (UDP) for the operation.

**Figure 2: IP SLA Operations**

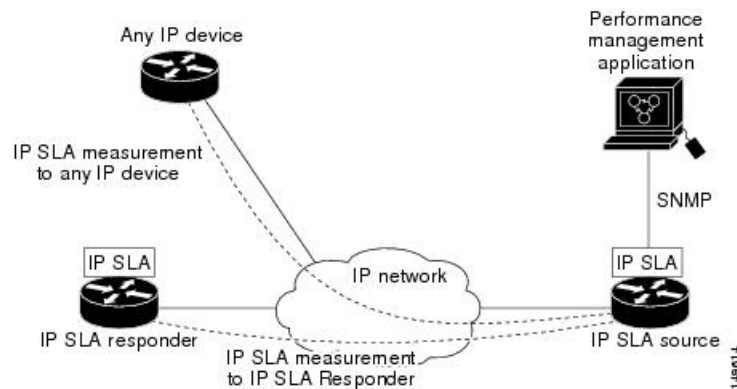

Operations are divided into two classes, which depend on whether they rely on the IP SLA Responder component to be running at the target device or not. The former is used only with Cisco devices; whereas, the latter is used with any device that has IP connectivity. Operations that are based on Internet Control Message Protocol (ICMP) are examples of the second class; whereas, UDP-based operations are examples of the first.

In responder-based operations, the IP SLA Responder is enabled in the destination device and provides information such as the processing delays of IP SLA packets. The responder-based operation has improved accuracy over the ICMP operation discussed above, and offers the capability of unidirectional measurements. In replies to the IP SLA source device, the responder includes information about processing delays. The IP SLA source device removes the delays in its final performance calculation. Use of the responder is optional for the UDP echo operation, but it is required for the UDP jitter operation. If no IP SLA Responder is used, the target device should support the UDP echo operation.

In ICMP operations, the source IP SLA device sends several ICMP packets to the destination. The destination device, which is any IP device, echoes with replies. The source IP SLA device uses the sent and received ping time stamps to calculate the response time. The ICMP echo operation resembles the traditional extended ping

utility, and it measures only the response time between the source device and the destination device. ICMP path-echo and path-jitter operations use the traceroute mechanism to identify the whole path. Subsequent ICMP packets are sent to each path node, and the measurements are correlated to provide hop-by-hop round-trip delay and jitter information.

To implement IP SLA network performance measurement, perform these tasks:

1. Enable the IP SLA Responder, if appropriate.
2. Configure the required IP SLA operation type.
3. Configure any options available for the specified IP SLA operation type.
4. Configure reaction conditions, if required.
5. Schedule the operation to run. Then, let the operation run for a period of time to gather statistics.
6. Display and interpret the results of the operation using Cisco IOS XR Software CLI, XML, or an NMS system with SNMP.

## Operation Types for IP Service Level Agreements

IP SLA configures various types of operations to measure response times, jitter, throughput, and packet loss. Also, each operation maps to multiple applications.

This table lists the various types of operations.

**Table 3: Types of Operations for IP SLA**

Operation	Description
UDP echo	Measures round-trip delay and helps in accurate measurement of response time of UDP traffic.
UDP jitter	Measures round-trip delay, one-way delay, one-way jitter, two-way jitter, and one-way packet loss.
ICMP echo	Measures round-trip delay for the full path.
ICMP path-echo	Calculates the hop-by-hop response time between the router and any IP device on the network. The path is discovered using the traceroute algorithm and then by measuring the response time between the source router and each intermediate hop in the path. If there are multiple equal-cost routes between source and destination devices, the ICMP path-echo operation can select one of the paths by using the Loose Source Routing (LSR) option, which is configurable.
ICMP path-jitter	Measures hop-by-hop jitter, packet loss, and delay measurement statistics in an IP network.

Operation	Description
MPLS LSP ping	<p>Tests the connectivity of a label switched paths (LSP) and measures round-trip delay of the LSP in an MPLS network. The following Forwarding Equivalence Classes (FECs) are supported:</p> <ul style="list-style-type: none"> <li>• IPv4 Label Distribution Protocol (LDP)</li> <li>• Traffic engineering (TE) tunnels</li> <li>• Pseudowire</li> </ul> <p>An echo request is sent along the same data path as other packets belonging to the FEC. When the echo request packet reaches the end of the path, it is sent to the control plane of the egress label switching router (LSR). The LSR verifies that it is indeed an egress for the FEC and sends an echo reply packet that contains information about the FEC whose MPLS path is being verified. Only a default VRF table is supported.</p>
MPLS LSP trace	<p>Traces the hop-by-hop route of an LSP path and measures the hop-by-hop round-trip delay for IPv4 LDP prefixes and TE tunnel FECs in an MPLS network.</p> <p>An echo request packet is sent data to the control plane of each transit LSR, which checks if it is a transit LSR for this path. Each transit LSR also returns information related to the label bound to the FEC that is being tested. Only a default VRF table is supported.</p>

## IP SLA Responder and IP SLA Control Protocol

The IP SLA Responder is a component embedded in the destination Cisco routing device that allows the system to anticipate and respond to IP SLA request packets. The IP SLA Responder provides enhanced accuracy for measurements. Additional statistics are also provided, which are not otherwise available through standard ICMP-based measurements. The patented IP SLA Control Protocol is used by the IP SLA Responder, providing a mechanism through which the responder is notified on which port it should listen and respond. Only a Cisco IOS XR Software device or other Cisco platforms can be a source for a destination IP SLA Responder.

[Figure 2: IP SLA Operations, on page 5](#) shows where the IP SLA Responder fits relative to the IP network. The IP SLA Responder listens on a specific port for control protocol messages sent by an IP SLA operation. Upon receipt of the control message, the responder enables the UDP port specified in the control message for the specified duration. During this time, the responder accepts the requests and responds to them. The responder disables the port after it responds to the IP SLA packet or packets, or when the specified time expires. For added security, MD5 authentication for control messages is available.



**Note** The IP SLA responder needs at least one second to open a socket and program Local Packet Transport Services (LPTS). Therefore, configure the IP SLA timeout to at least 2000 milli seconds.

The IP SLA Responder must be used with the UDP jitter operation, but it is optional for UDP echo operation. If services that are already provided by the target router are chosen, the IP SLA Responder need not be enabled. For devices that are not Cisco devices, the IP SLA Responder cannot be configured, and the IP SLA can send operational packets only to services native to those devices.

## Response Time Computation for IP SLA

T3 is the time the reply packet is sent at the IP SLA Responder node, and T1 is the time the request is sent at the source node. Because of other high-priority processes, routers can take tens of milliseconds to process incoming packets. The delay affects the response times, because the reply to test packets might be sitting in a queue while waiting to be processed. In this situation, the response times would not accurately represent true network delays. IP SLA minimizes these processing delays on the source router and on the target router (if IP SLA Responder is being used) to determine true round-trip times. Some IP SLA probe packets contain delay information that are used in the final computation to make measurements more accurate.

When enabled, the IP SLA Responder allows the target device to take two time stamps, both when the packet arrives on the interface and again just as it is leaving, and accounts for it when calculating the statistics. This time stamping is made with a granularity of submilliseconds. At times of high network activity, an ICMP ping test often shows a long and inaccurate response time, while an IP SLA-based responder shows an accurate response time.

Figure 2: IP SLA Operations, on page 5 shows how the responder works. Four time stamps are taken to make the calculation for round-trip time. At the target router, with the responder functionality enabled, time stamp 2 (TS2) is subtracted from time stamp 3 (TS3) to produce the time spent processing the test packet as represented by delta. This delta value is then subtracted from the overall round-trip time. Notice that the same principle is applied by IP SLA on the source router on which the incoming time stamp 4 (TS4) is taken in a high-priority path to allow for greater accuracy.

Figure 3: IP SLA Responder Time Stamping

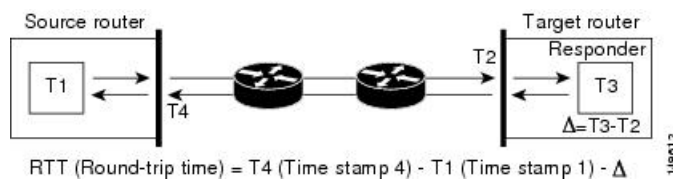

## IP SLA VRF Support

Service providers need to monitor and measure network performance from both the perspective of the core network and a customer's network. To do so, it is necessary to use nondefault VPN routing and forwarding (VRF) tables for IP SLA operations in addition to the default VRF table. Table 3: Types of Operations for IP SLA, on page 6 describes the different IP SLA operations, including information about whether or not an operation supports the use of nondefault VRF tables.

## IP SLA Operation Scheduling

After an IP SLA operation is configured, you must schedule the operation to begin capturing statistics and collecting error information. When scheduling an operation, the operation starts immediately or starts at a certain month and day. In addition, an operation can be scheduled to be in pending state, which is used when the operation is a reaction (threshold) operation waiting to be triggered. Normal scheduling of IP SLA operations lets you schedule one operation at a time.



**Note** Multiple SLA probes with the same configuration (source and port number) must not be scheduled to run simultaneously.



## IP SLA—Proactive Threshold Monitoring

This section describes the proactive monitoring capabilities for IP SLA that use thresholds and reaction triggering. IP SLA allows you to monitor, analyze, and verify IP service levels for IP applications and services to increase productivity, lower operational costs, and reduce occurrences of network congestion or outages. IP SLA uses active traffic monitoring to measure network performance.

To perform the tasks that are required to configure proactive threshold monitoring using IP SLA, you must understand these concepts:

### IP SLA Reaction Configuration

IP SLA is configured to react to certain measured network conditions. For example, if IP SLA measures too much jitter on a connection, IP SLA can generate a notification to a network management application or trigger another IP SLA operation to gather more data.

IP SLA reaction configuration is performed by using the **ipsla reaction operation** command.

### IP SLA Threshold Monitoring and Notifications

IP SLA supports threshold monitoring for performance parameters, such as jitter-average, bidirectional round-trip time, and connectivity. For packet loss and jitter, notifications can be generated for violations in either direction (for example, the source to the destination and the destination to the source) or for round-trip values.

Notifications are not issued for every occurrence of a threshold violation. An event is sent and a notification is issued when the rising threshold is exceeded for the first time. Subsequent threshold-exceeded notifications are issued only after the monitored value falls below the falling threshold before exceeding the rising threshold again.

The following figure illustrates the sequence for a triggered reaction that occurs when the monitored element exceeds the upper threshold.

**Figure 4: IP SLAs Triggered Reaction Condition and Notifications for Threshold Exceeded**

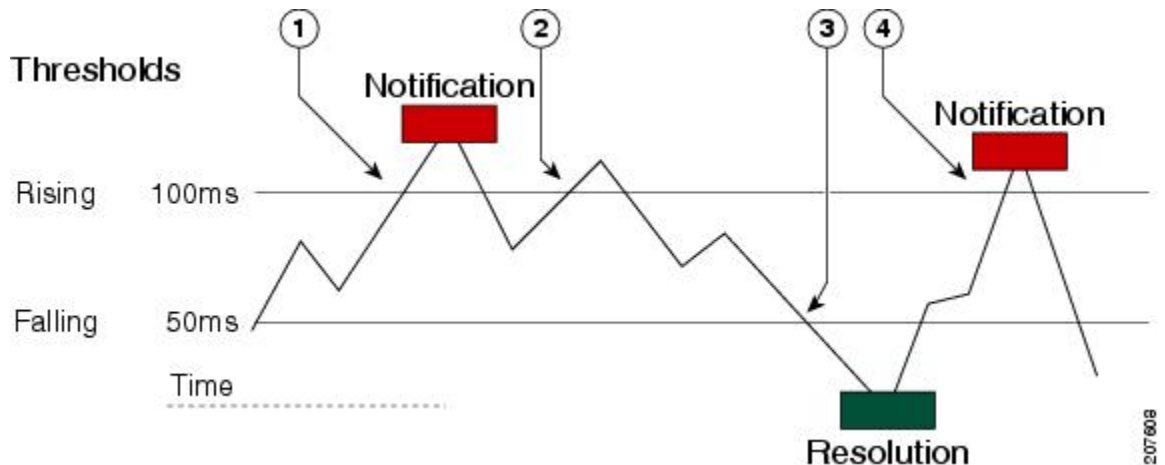

1	An event is sent and a threshold-exceeded notification is issued when the rising threshold is exceeded for the first time.
---	--

2	Consecutive over-rising threshold violations occur without issuing additional notifications.
3	The monitored value goes below the falling threshold.
4	Another threshold-exceeded notification is issued when the rising threshold is exceeded only after the monitored value first fell below the falling threshold.

Similarly, a lower-threshold notification is also issued the first time that the monitored element falls below the falling threshold. Subsequent notifications for lower-threshold violations are issued only after the rising threshold is exceeded before the monitored value falls below the falling threshold again.

## Two-Way Active Measurement Protocol (TWAMP)

The Two-Way Active Measurement Protocol (TWAMP) defines a flexible method for measuring round-trip IP performance between any two devices.

### Advantages of TWAMP

- TWAMP enables complete IP performance measurement.
- TWAMP provides a flexible choice of solutions as it supports all devices deployed in the network.

### The TWAMP entities

The TWAMP system consists of 4 logical entities:

- server - manages one or more TWAMP sessions and also configures per-session ports in the end-points.
- session-reflector - reflects a measurement packet as soon as it receives a TWAMP test packet.
- control-client - initiates the start and stop of TWAMP test sessions.
- session-sender - instantiates the TWAMP test packets sent to the session reflector.

Figure 5: TWAMP System

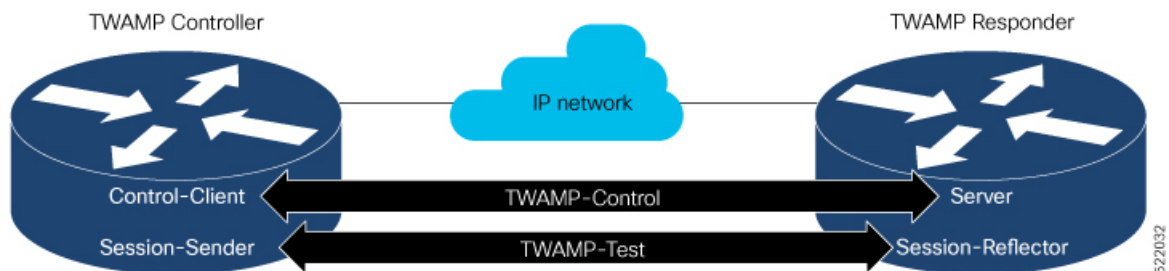

### The TWAMP protocols

The TWAMP protocol includes three distinct message exchange categories, they are:

- Connection set-up exchange: Messages establish a session connection between the Control-Client and the Server. First the identities of the communicating peers are established via a challenge response mechanism. The Server sends a randomly generated challenge, to which the Control-Client then sends a response by encrypting the challenge using a key derived from the shared secret. Once the identities

are established, the next step negotiates a security mode that is binding for the subsequent TWAMP-Control commands as well as the TWAMP-Test stream packets.



---

**Note** A server can accept connection requests from multiple control clients.

---

- TWAMP-control exchange: The TWAMP-Control protocol runs over TCP and is used to instantiate and control measurement sessions. The sequence of commands is as follows, but unlike, the Connection setup exchanges, the TWAMP-Control commands can be sent multiple times. However, the messages cannot occur out of sequence although multiple request-session commands can be sent before a session-start command.
  - request-session
  - start-session
  - stop-session
- TWAMP-test stream exchange: The TWAMP-Test runs over UDP and exchanges TWAMP-Test packets between Session-Sender and Session-Reflector. These packets include timestamp fields that contain the instant of packet egress and ingress. In addition, each packet includes an error-estimate that indicates the synchronization skew of the sender (session-sender or session-reflector) with an external time source (e.g. GPS or NTP). The packet also includes a Sequence Number.

TWAMP-Control and TWAMP-test stream, have three security modes: unauthenticated, authenticated, and encrypted.

## TWAMP Accuracy Enhancement

The TWAMP (Two-Way Active Measurement Protocol) accuracy enhancement provides microsecond granularity in TWAMP measurements. This enhancement allows the collection of ingress and egress time stamps as closely as possible to the wire to achieve more accuracy. The granularity also depends on the synchronization mechanism used. The TWAMP accuracy enhancement uses the NTP RP ( Network Time Protocol Route Processor) to LC (Line Card) synchronization.

### Hardware Time Stamp

The hardware time stamp feature provides greater accuracy than other time synchronization protocols. This feature is enabled by default and requires no configuration.

The objective of using the LC clock for hardware time stamp is to provide timing signals to the connected servers, so that the system clocks can be synchronized accurately.

#### Benefits of Hardware Time Stamping

Hardware time stamping achieves microsecond precision, better accuracy (closer to wire) and better performance at scale.

### Hardware Time Stamp Disable

Some platforms may rely on a certain configuration or deployment to provide hardware time stamping. In particular, the Cisco ASR9000 series routers need PTP synchronization as a clock source. Such a solution may not be available in all user scenarios. To allow the use of other sources of time stamping (NTP clock source, through a daemon running on RP) a new configuration - **ipsla hw-timestamp disable** is introduced

to ignore the time stamp values provided by other platform dependent layers and revert back to platform independent time stamps.

Use the **hw-timestamp disable** command in IP SLA configuration to disable hardware time stamping.

## Limitations

The TWAMP accuracy enhancement has the following limitations:

- It may be required to configure PTP or GPS interface to provide a clock source for hardware time stamping
- TWAMP reflector does not support IPv6
- TWAMP does not support SNMP or XML

## Recommendations

TWAMP Sender must not use port values already assigned by IANA organization for other applications. See <http://www.iana.org/assignments/service-names-port-numbers/service-names-port-numbers.xhtml>.

To avoid conflict and consequently unexpected behavior, it is highly recommended for TWAMP Sender applications to use port values in the range of the Dynamic Ports (also known as the Private or Ephemeral Ports) from 49152 to 65535 (never assigned by IANA, as per RFC 6335).

## One-Way Delay Measurement

The UDP (User Datagram Protocol) jitter operation is capable of measuring one-way delay for packets. The NTP synchronization of the LC hardware clock to the RP clock supports one-way delay measurement. One-way delay measurement is also possible with PTP and GPS synchronization.



---

**Note** The round-trip time (RTT) and jitter measurements are validated with both NTP and PTP clock synchronizations.

---

## TWAMP-Light

TWAMP-light is a light-weight model of TWAMP which eliminates the need for a control session. Unlike the TWAMP feature, you need to configure the parameters of the TWAMP-light test-session at both end devices. So this removes the overhead of establishing and terminating the control session. In addition, the server entity is not required on the reflector device thereby reducing the overhead of maintaining the server.





---

**Note** TWAMP-Light v4 and v6 are supported.

---

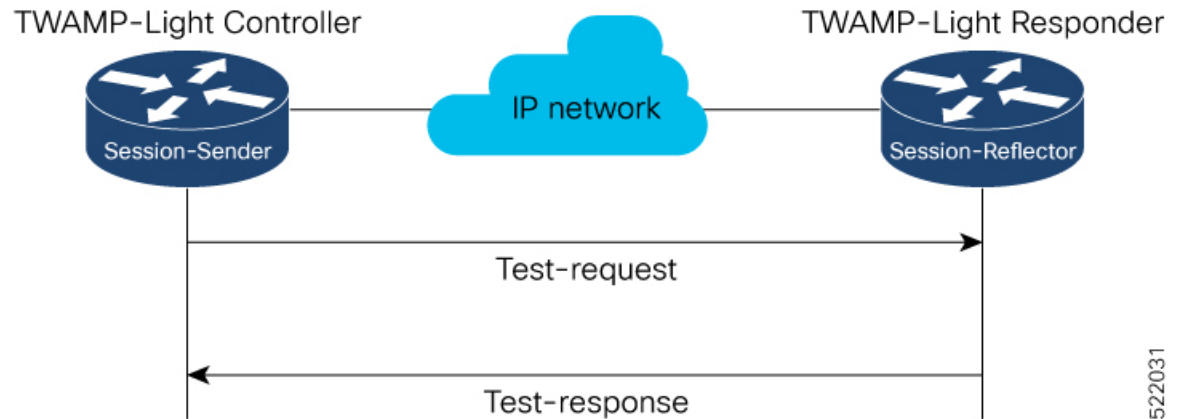
Figure 6: TWAMP-Light test-session



522031

## Restrictions of TWAMP-Light

- If the TWAMP-light test-session runs on a Virtual Routing and Forwarding (VRF) instance, then the session will work only when the same VRF is also configured on the interface.
- Once you configure a TWAMP-light test-session on a device, it opens a permanent port, which will remain open until you delete the configuration for TWAMP-light. If you do not prefer this behaviour, then you should configure a timeout for the TWAMP-light test-session so that the session will be inactive after the timeout period.
- When there are two clients with two different test-sessions with the same local IP address and local port under the same VRF, there will be only one underlying socket at the responder. In such a scenario, due to UDP restrictions it is not possible to support the maximum number of packets for these two clients. This causes the performance to be impacted. Therefore, any two test-sessions cannot have the same local IP address and local port under the same VRF.

## Configuring TWAMP-Light

This example shows you how to configure TWAMP-Light and the timeout value:

```
Router# configure
Router(config)# ipsla
Router(config-ipsla)# responder twamp-light test-session 1 local-ip 192.0.2.10 local-port
13001 remote-ip 192.0.2.186 remote-port 13002 vrf default
Router(config-ipsla)# responder twamp-light test-session 1 timeout 60
Router(config-ipsla)# commit
```

### Running Configuration

This is a sample running configuration of twamp-light responder:

```
ipsla
 responder
  twamp-light test-session 1
  local-ip 192.0.2.10 local-port 13001 remote-ip 192.0.2.186 remote-port 13002 vrf default
  timeout 60
  !
  !
  !
```

## Verification of TWAMP-Light

The TWAMP-light session can be verified using the command **show ipsla twamp session**. The output of the command shows the state of the session using the **Session status** field as shown below:

```
Router# show ipsla twamp session
***** TWAMP Sessions *****
No records matching query found
***** TWAMP-LIGHT Sessions *****
Session status: Active
Recv Addr: any (IPV4)
Recv Port: 2345
Sender Addr: any (IPV4)
Sender Port: any
Sender VRF Name: any
Session ID: 10
Mode: Unauthenticated
Number of Packets Received: 0
Session timeout: 0
Number of Packets Sent: 0
```

## MPLS LSP Monitoring

The IP Service Level Agreements (SLAs) label switched path (LSP) monitor feature provides the capability to proactively monitor Layer 3 Multiprotocol Label Switching (MPLS) Virtual Private Networks (VPNs). This feature is useful for determining network availability or testing network connectivity between provider edge (PE) routers in an MPLS VPN. When configured, MPLS LSP monitor automatically creates and deletes IP SLA LSP ping or LSP traceroute operations based on network topology.

The MPLS LSP monitor feature also allows you to perform multi-operation scheduling of IP SLA operations and supports proactive threshold violation monitoring through SNMP trap notifications and syslog messages.

To use the MPLS LSP monitor feature, you must understand these concepts:

### How MPLS LSP Monitoring Works

The MPLS LSP monitor feature provides the capability to proactively monitor Layer 3 MPLS VPNs. The general process for how the MPLS LSP monitor works is as follows:

1. The user configures an MPLS LSP monitor instance.

Configuring an MPLS LSP monitor instance is similar to configuring a standard IP SLA operation. To illustrate, all operation parameters for an MPLS LSP monitor instance are configured after an identification number for the operation is specified. However, unlike standard IP SLA operations, these configured parameters are then used as the base configuration for the individual IP SLA LSP ping and LSP traceroute operations that will be created by the MPLS LSP monitor instance.

When the first MPLS LSP monitor instance is configured and scheduled to begin, BGP next-hop neighbor discovery is enabled. See the [BGP Next-hop Neighbor Discovery](#), on page 15.

2. The user configures proactive threshold violation monitoring for the MPLS LSP monitor instance.
3. The user configures multioperation scheduling parameters for the MPLS LSP monitor instance.
4. Depending on the configuration options chosen, the MPLS LSP monitor instance automatically creates individual IP SLA LSP ping or LSP traceroute operations for each applicable BGP next-hop neighbor.

For any given MPLS LSP monitor operation, only one IP SLA LSP ping or LSP traceroute operation is configured per BGP next-hop neighbor. However, more than one MPLS LSP monitor instance can be running on a particular PE router at the same time. (For more details, see the note at the end of this section.)

5. Each IP SLA LSP ping or LSP traceroute operation measures network connectivity between the source PE router and the discovered destination PE router.

**Note**

More than one MPLS LSP monitor instance can be running on a particular PE router at the same time. For example, one MPLS LSP monitor instance can be configured to discover BGP next-hop neighbors belonging to the VRF named VPN1. On the same PE router, another MPLS LSP monitor instance can be configured to discover neighbors belonging to the VRF named VPN2. In this case, if a BGP next-hop neighbor belongs to both VPN1 and VPN2, then the PE router would create two IP SLA operations for this neighbor—one for VPN1 and one for VPN2.

### Adding and Deleting IP SLA Operations from the MPLS LSP Monitor Database

The MPLS LSP monitor instance receives periodic notifications about BGP next-hop neighbors that have been added to or removed from a particular VPN. This information is stored in a queue maintained by the MPLS LSP monitor instance. Based on the information in the queue and user-specified time intervals, new IP SLA operations are automatically created for newly discovered PE routers and existing IP SLA operations are automatically deleted for any PE routers that are no longer valid.

## BGP Next-hop Neighbor Discovery

BGP next-hop neighbor discovery is used to find the BGP next-hop neighbors in use by any VRF associated with the source provider edge (PE) router. In most cases, these neighbors are PE routers.

When BGP next-hop neighbor discovery is enabled, a database of BGP next-hop neighbors in use by any VRF associated with the source PE router is generated, based on information from the local VRF and global routing tables. As routing updates are received, new BGP next-hop neighbors are added immediately to the database. However, BGP next-hop neighbors that are no longer valid are removed from the database only periodically, as defined by the user.

**Figure 7: BGP Next-hop Neighbor Discovery for a Simple VPN, on page 16** shows how BGP next-hop neighbor discovery works for a simple VPN scenario for an Internet service provider (ISP). In this example, there are three VPNs associated with router PE1: red, blue, and green. From the perspective of router PE1, these VPNs are reachable remotely through BGP next-hop neighbors PE2 (router ID: 12.12.12.12) and PE3 (router ID: 13.13.13.13). When the BGP next-hop neighbor discovery process is enabled on router PE1, a database is generated based on the local VRF and global routing tables. The database in this example contains two BGP next-hop router entries, PE2 12.12.12.12 and PE3 13.13.13.13. The routing entries are maintained per next-hop router to distinguish which next-hop routers belong within which particular VRF. For each next-hop router entry, the IPv4 Forward Equivalence Class (FEC) of the BGP next-hop router in the global routing table is provided so that it can be used by the MPLS LSP ping operation.

Figure 7: BGP Next-hop Neighbor Discovery for a Simple VPN

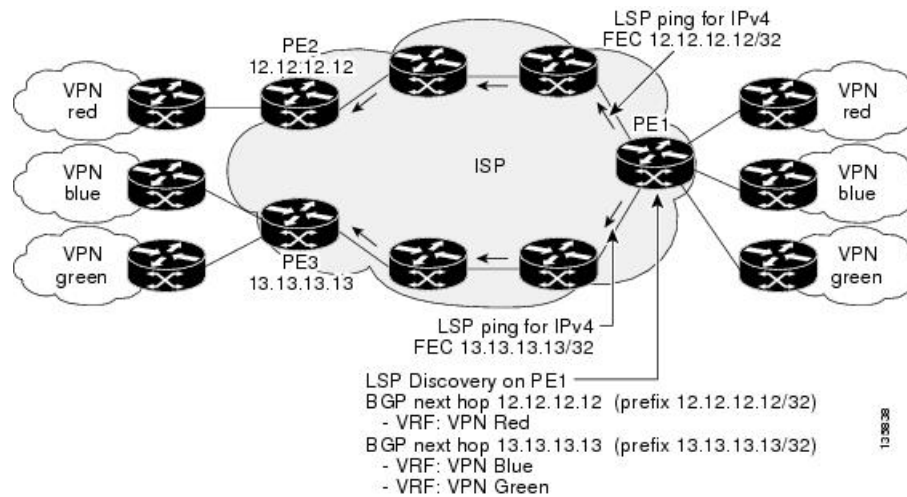

## IP SLA LSP Ping and LSP Traceroute Operations

This feature introduces support for the IP SLA LSP ping and IP SLA LSP traceroute operations. These operations are useful for troubleshooting network connectivity issues and determining network availability in an MPLS VPN. When using MPLS LSP monitoring, IP SLA LSP ping and LSP traceroute operations are automatically created to measure network connectivity between the source PE router and the discovered destination PE routers. Individual IP SLA LSP ping and LSP traceroute operations can also be manually configured. Manual configuration of these operations can be useful for troubleshooting a connectivity issue.

For more information about how to configure IP SLA LSP ping or LSP traceroute operations using MPLS LSP monitoring, see the [Configuring an MPLS LSP Monitoring Ping Instance, on page 77](#) and the [Configuring an MPLS LSP Monitoring Trace Instance, on page 81](#).

The IP SLA LSP ping and IP SLA LSP traceroute operations are based on the same infrastructure used by the MPLS LSP Ping and MPLS LSP Traceroute features, respectively, for sending and receiving echo reply and request packets to test LSPs.

## Proactive Threshold Monitoring for MPLS LSP Monitoring

Proactive threshold monitoring support for the MPLS LSP Monitor feature provides the capability for triggering SNMP trap notifications and syslog messages when user-defined reaction conditions (such as a connection loss or timeout) are met. Configuring threshold monitoring for an MPLS LSP monitor instance is similar to configuring threshold monitoring for a standard IP SLAs operation.

## Multi-operation Scheduling for the LSP Health Monitor

Multioperation scheduling support for the MPLS LSP Monitor feature provides the capability to easily schedule the automatically created IP SLA operations (for a given MPLS LSP monitor instance) to begin at intervals equally distributed over a specified duration of time (schedule period) and to restart at a specified frequency. Multioperation scheduling is particularly useful in cases where MPLS LSP monitoring is enabled on a source PE router that has a large number of PE neighbors and, therefore, a large number of IP SLAs operations running at the same time.





---

**Note** Newly created IP SLA operations (for newly discovered BGP next-hop neighbors) are added to the same schedule period as the operations that are currently running. To prevent too many operations from starting at the same time, the multioperation scheduling feature schedules the operations to begin at random intervals uniformly distributed over the schedule period.

---

## LSP Path Discovery

LSP Path Discovery (LPD) is an enhancement to MPLS LSP monitor (MPLSLM) that allows operations that are part of an MPLSLM instance to initiate the path discovery process and to process the results. This feature relies on the tree trace capabilities provided by the MPLS OAM infrastructure through the LSPV server.

When multiple paths with equal cost exist between two PE routers, also known as equal cost multipath (ECMP), routers between these PE routers perform load balancing on the traffic, based on characteristics of the traffic being forwarded (for example, the destination address in the packet). In network topologies such as this, monitoring only one (or some) of the available paths among PE routers does not provide any guarantee that traffic will be forwarded correctly.

LPD is configured using the **path discover** command.



---

**Note** LPD functionality may create considerable CPU demands when large numbers of path discovery requests are received by the LSPV server at one time.

---

# How to Implement IP Service Level Agreements

## Configuring IP Service Levels Using the UDP Jitter Operation

The IP SLA UDP jitter monitoring operation is designed to diagnose network suitability for real-time traffic applications such as VoIP, Video over IP, or real-time conferencing.

Jitter means interpacket delay variance. When multiple packets are sent consecutively from source to destination—for example, 10 ms apart—and if the network is behaving ideally, the destination can receive them 10 ms apart. But if there are delays in the network (for example, queuing, arriving through alternate routes, and so on), the arrival delay between packets can be greater than or less than 10 ms. Using this example, a positive jitter value indicates that the packets arrived more than 10 ms apart. If the packets arrive 12 ms apart, positive jitter is 2 ms; if the packets arrive 8 ms apart, negative jitter is 2 ms. For delay-sensitive networks like VoIP, positive jitter values are undesirable, and a jitter value of 0 is ideal.

However, the IP SLA UDP jitter operation does more than just monitor jitter. The packets that IP SLA generates carry sending sequence and receiving sequence information for the packets, and sending and receiving time stamps from the source and the operational target. Based on these, UDP jitter operations are capable of measuring the following functions:

- Per-direction jitter (source to destination and destination to source)
- Per-direction packet-loss

- Per-direction delay (one-way delay)
- Round-trip delay (average round-trip time)

As the paths for the sending and receiving of data may be different (asymmetric), the per-direction data allows you to more readily identify where congestion or other problems are occurring in the network.

The UDP jitter operation functions by generating synthetic (simulated) UDP traffic. By default, ten packet-frames (N), each with a payload size of 32 bytes (S) are generated every 20 ms (T), and the operation is repeated every 60 seconds (F). Each of these parameters is user-configurable, so as to best simulate the IP service you are providing, or want to provide.

This section contains these procedures:

## Enabling the IP SLA Responder on the Destination Device

The IP SLA Responder must be enabled on the target device, which is the operational target.

By configuring the **ipsla responder** command, you make the IP SLA Responder open a UDP port 1967 and wait for a control request (not for probes). You can open or close a port dynamically through the IP SLA control protocol (through UDP port 1967). In addition, you can configure permanent ports.

Permanent ports are open until the configuration is removed. Agents can send IP SLA probe packets to the permanent port directly without a control request packet because the port can be opened by the configuration.

If you do not use permanent ports, you have to configure only the **ipsla responder** command.

To use a dynamic port, use the **ipsla responder** command, as shown in this example:

```
configure
ipsla responder
```

The dynamic port is opened through the IP SLA control protocol on the responder side when you start an operation on the agent side.

The example is configured as a permanent port on the responder. UDP echo and UDP jitter can use a dynamic port or a permanent port. If you use a permanent port for UDP jitter, there is no check performed for duplicated or out-of-sequence packets. This is because there is no control packet to indicate the start or end of the probe sequence. Therefore, the verification for sequence numbers are skipped when using permanent ports.

### SUMMARY STEPS

1. **configure**
2. **ipsla responder**
3. **type udp ipv4 address** *ip-address* **port** *port*
4. Use the **commit** or **end** command.

### DETAILED STEPS

	Command or Action	Purpose
Step 1	<b>configure</b> <b>Example:</b> RP/0/RSP0/CPU0:router# configure	Enters global configuration mode.

	Command or Action	Purpose
Step 2	<b>ipsla responder</b> <b>Example:</b> <pre>RP/0/RSP0/CPU0:router(config)# ipsla responder RP/0/RSP0/CPU0:router(config-ipsla-resp)#</pre>	Enables the IP SLA Responder for UDP echo or jitter operations.
Step 3	<b>type udp ipv4 address <i>ip-address</i> port <i>port</i></b> <b>Example:</b> <pre>RP/0/RSP0/CPU0:router(config-ipsla-resp)# type udp   ipv4 address 12.25.26.10 port 10001</pre>	Enables the permanent address and port on the IP SLA Responder.
Step 4	Use the <b>commit</b> or <b>end</b> command.	<b>commit</b> —Saves the configuration changes and remains within the configuration session. <b>end</b> —Prompts user to take one of these actions: <ul style="list-style-type: none"> <li>• <b>Yes</b> — Saves configuration changes and exits the configuration session.</li> <li>• <b>No</b> —Exits the configuration session without committing the configuration changes.</li> <li>• <b>Cancel</b> —Remains in the configuration session, without committing the configuration changes.</li> </ul>

### What to do next

After enabling the IP SLA Responder, see the [Configuring and Scheduling a UDP Jitter Operation on the Source Device, on page 19](#) section.

## Configuring and Scheduling a UDP Jitter Operation on the Source Device

The IP SLA operations function by generating synthetic (simulated) network traffic. A single IP SLA operation (for example, IP SLA operation 10) repeats at a given frequency for the lifetime of the operation.

A single UDP jitter operation consists of N UDP packets, each of size S, sent T milliseconds apart, from a source router to a target router, at a given frequency of F. By default, ten packets (N), each with a payload size of 32 bytes (S), are generated every 20 ms (T), and the operation is repeated every 60 seconds (F). Each of these parameters is user configurable, as shown in [Table 4: UDP Jitter Operation Parameters, on page 19](#).

**Table 4: UDP Jitter Operation Parameters**

UDP Jitter Operation Parameter	Default	Configured Using
Number of packets (N)	10 packets	<ul style="list-style-type: none"> <li>• <b>ipsla operation</b> command with the <i>operation-number</i> argument</li> <li>• <b>type udp jitter</b> command</li> <li>• <b>packet count</b> command with the <i>count</i> argument</li> </ul>

UDP Jitter Operation Parameter	Default	Configured Using
Payload size per packet (S)	32 bytes	<ul style="list-style-type: none"> <li>• <b>ipsla operation</b> command with the <i>operation-number</i> argument</li> <li>• <b>type udp jitter</b> command</li> <li>• <b>datasize request</b> command with the <i>size</i> argument</li> </ul>
Time between packets, in milliseconds (T)	20 ms	<ul style="list-style-type: none"> <li>• <b>ipsla operation</b> command with the <i>operation-number</i> argument</li> <li>• <b>type udp jitter</b> command</li> <li>• <b>packet interval</b> command with the <i>interval</i> argument</li> </ul>
Elapsed time before the operation repeats, in seconds (F)	60 seconds	<ul style="list-style-type: none"> <li>• <b>ipsla operation</b> command with the <i>operation-number</i> argument</li> <li>• <b>type udp jitter</b> command</li> <li>• <b>frequency</b> command with the <i>seconds</i> argument</li> </ul>



**Note** If the **control disable** command is used to disable control packets while configuring IP SLA, the packets sent out from sender do not have sequence numbers. To calculate jitter, sequence number and time stamp values are required. So, jitter is not calculated when you use the **control disable** command.

## Prerequisites for Configuring a UDP Jitter Operation on the Source Device

Use of the UDP jitter operation requires that the IP SLA Responder be enabled on the target Cisco device. To enable the IP SLA Responder, perform the task in the [Enabling the IP SLA Responder on the Destination Device, on page 18](#) section.

## Configuring and Scheduling a Basic UDP Jitter Operation on the Source Device

You can configure and schedule a UDP jitter operation.

### SUMMARY STEPS

1. **configure**
2. **ipsla operation** *operation-number*
3. **type udp jitter**
4. **destination address** *ipv4address*
5. **destination port** *port*
6. **packet count** *count*
7. **packet interval** *interval*
8. **frequency** *seconds*
9. **exit**
10. **ipsla schedule operation** *op-num*

11. **life** { **forever** | *seconds*}
12. **ageout** *seconds*
13. **recurring**
14. **start-time** [*hh:mm:ss* {*day* | *month day*} | **now** | **pending** | **after** *hh:mm:ss*]
15. Use the **commit** or **end** command.

## DETAILED STEPS

	Command or Action	Purpose
<b>Step 1</b>	<b>configure</b> <b>Example:</b> RP/0/RSP0/CPU0:router# configure	Enters global configuration mode.
<b>Step 2</b>	<b>ipsla operation</b> <i>operation-number</i> <b>Example:</b> RP/0/RSP0/CPU0:router(config)# ipsla operation 432	Specifies the operation number. The range is from 1 to 2048.
<b>Step 3</b>	<b>type udp jitter</b> <b>Example:</b> RP/0/RSP0/CPU0:router(config-ipsla-op)# type udp jitter	Configures the operation as a UDP jitter operation, and configures characteristics for the operation.
<b>Step 4</b>	<b>destination address</b> <i>ipv4address</i> <b>Example:</b> RP/0/RSP0/CPU0:router(config-ipsla-udp-jitter)# destination address 12.25.26.10	Specifies the IP address of the destination for the UDP jitter operation.
<b>Step 5</b>	<b>destination port</b> <i>port</i> <b>Example:</b> RP/0/RSP0/CPU0:router(config-ipsla-udp-jitter)# destination port 11111	Specifies the destination port number, in the range from 1 to 65535.
<b>Step 6</b>	<b>packet count</b> <i>count</i> <b>Example:</b> RP/0/RSP0/CPU0:router(config-ipsla-udp-jitter)# packet count 30	(Optional) Specifies the number of packets to be transmitted during a probe. For UDP jitter operation, the range is 1 to 60000. For ICMP path-jitter operation, the range is 1 to 100.  The default number of packets sent is 10.
<b>Step 7</b>	<b>packet interval</b> <i>interval</i> <b>Example:</b> RP/0/RSP0/CPU0:router(config-ipsla-udp-jitter)# packet interval 30	(Optional) Specifies the time between packets. The default interval between packets is 20 milliseconds.

	Command or Action	Purpose
<b>Step 8</b>	<p><b>frequency</b> <i>seconds</i></p> <p><b>Example:</b></p> <pre>RP/0/RSP0/CPU0:router(config-ipsla-udp-jitter)# frequency 300</pre>	<p>(Optional) Sets the rate at which a specified IP SLA operation is sent into the network.</p> <ul style="list-style-type: none"> <li>(Optional) Use the <i>seconds</i> argument to specify the number of seconds between the IP SLA operations. Valid values are in the range from 1 to 12604800 seconds. The default is 60 seconds.</li> </ul>
<b>Step 9</b>	<p><b>exit</b></p> <p><b>Example:</b></p> <pre>RP/0/RSP0/CPU0:router(config-ipsla-udp-jitter)# exit RP/0/RSP0/CPU0:router(config-ipsla-op)# exit RP/0/RSP0/CPU0:router(config-ipsla)# exit RP/0/RSP0/CPU0:router(config)#</pre>	Exits from IP SLA configuration mode and operational mode, and returns the CLI to global configuration mode.
<b>Step 10</b>	<p><b>ipsla schedule operation</b> <i>op-num</i></p> <p><b>Example:</b></p> <pre>RP/0/RSP0/CPU0:router(config)# ipsla schedule operation 432 RP/0/RSP0/CPU0:router(config-ipsla-sched)#</pre>	Schedules the start time of the operation. You can configure a basic schedule.
<b>Step 11</b>	<p><b>life</b> { <b>forever</b>   <i>seconds</i> }</p> <p><b>Example:</b></p> <pre>RP/0/RSP0/CPU0:router(config-ipsla-sched)# life 30</pre>	The <b>forever</b> keyword schedules the operation to run indefinitely. The <i>seconds</i> argument schedules the lifetime of the operation, in seconds. The default lifetime of an operation is 3600 seconds (one hour).
<b>Step 12</b>	<p><b>ageout</b> <i>seconds</i></p> <p><b>Example:</b></p> <pre>RP/0/RSP0/CPU0:router(config-ipsla-sched)# ageout 3600</pre>	(Optional) Specifies the number of seconds to keep the operation in memory when it is not actively collecting information. The default value of 0 seconds means that the operation never times out.
<b>Step 13</b>	<p><b>recurring</b></p> <p><b>Example:</b></p> <pre>RP/0/RSP0/CPU0:router(config-ipsla-sched)# recurring</pre>	(Optional) Specifies that the operation starts automatically at the specified time and for the specified duration every day.
<b>Step 14</b>	<p><b>start-time</b> [<i>hh:mm:ss</i> {<i>day</i>   <i>month day</i>}]   <b>now</b>   <b>pending</b>   <b>after</b> <i>hh:mm:ss</i>]</p> <p><b>Example:</b></p> <pre>RP/0/RSP0/CPU0:router(config-ipsla-sched)# start-time 01:00:00</pre>	<p>Specifies a time for the operation to start. The following keywords are described:</p> <ul style="list-style-type: none"> <li>(Optional) Use the <b>pending</b> keyword to configure the operation to remain in a pending (unstarted) state. The default is inactive. If the <b>start-time</b> command is not specified, no information is collected until the start time is configured or a trigger occurs that performs an immediate start.</li> </ul>

	Command or Action	Purpose
		<ul style="list-style-type: none"> <li>• (Optional) Use the <b>now</b> keyword to indicate that the operation should start immediately.</li> <li>• (Optional) Use the <b>after</b> keyword and associated arguments to specify the time after which the operation starts collecting information.</li> </ul>
<b>Step 15</b>	Use the <b>commit</b> or <b>end</b> command.	<p><b>commit</b> —Saves the configuration changes and remains within the configuration session.</p> <p><b>end</b> —Prompts user to take one of these actions:</p> <ul style="list-style-type: none"> <li>• <b>Yes</b> — Saves configuration changes and exits the configuration session.</li> <li>• <b>No</b> —Exits the configuration session without committing the configuration changes.</li> <li>• <b>Cancel</b> —Remains in the configuration session, without committing the configuration changes.</li> </ul>

## Configuring and Scheduling a UDP Jitter Operation with Additional Characteristics

You can configure and schedule a UDP jitter operation.

### SUMMARY STEPS

1. **configure**
2. **ipsla operation** *operation-number*
3. **type udp jitter**
4. **vrf** *vrf-name*
5. **destination address** *ipv4address*
6. **destination port** *port*
7. **frequency** *seconds*
8. **statistics** [**hourly** | **interval** *seconds*]
9. **buckets** *hours*
10. **distribution count** *slot*
11. **distribution interval** *interval*
12. **exit**
13. **datasize request** *size*
14. **timeout** *milliseconds*
15. **tos** *number*
16. **exit**
17. **ipsla schedule operation** *op-num*
18. **life** {**forever** | *seconds*}
19. **ageout** *seconds*
20. **recurring**
21. **start-time** [*hh:mm:ss* {*day* | *month day*} | **now** | **pending** | **after** *hh:mm:ss* ]

22. Use the **commit** or **end** command.
23. **show ipsla statistics** [*operation-number* ]
24. **show ipsla statistics aggregated** [*operation-number* ]

## DETAILED STEPS

	Command or Action	Purpose
<b>Step 1</b>	<b>configure</b> <b>Example:</b> RP/0/RSP0/CPU0:router# configure	Enters global configuration mode.
<b>Step 2</b>	<b>ipsla operation</b> <i>operation-number</i> <b>Example:</b> RP/0/RSP0/CPU0:router(config)# ipsla operation 432	Specifies the operation number. The range is from 1 to 2048.
<b>Step 3</b>	<b>type udp jitter</b> <b>Example:</b> RP/0/RSP0/CPU0:router(config-ipsla-op)# type udp jitter	Configures the operation as a UDP jitter operation, and configures characteristics for the operation.
<b>Step 4</b>	<b>vrf</b> <i>vrf-name</i> <b>Example:</b> RP/0/RSP0/CPU0:router(config-ipsla-udp-jitter)# vrf VPN-A	(Optional) Enables the monitoring of a VPN (using a nondefault routing table) in a UDP jitter operation. Maximum length is 32 alphanumeric characters.
<b>Step 5</b>	<b>destination address</b> <i>ipv4address</i> <b>Example:</b> RP/0/RSP0/CPU0:router(config-ipsla-udp-jitter)# destination address 12.25.26.10	Specifies the IP address of the destination for the proper operation type.
<b>Step 6</b>	<b>destination port</b> <i>port</i> <b>Example:</b> RP/0/RSP0/CPU0:router(config-ipsla-udp-jitter)# destination port 11111	Specifies the destination port number, in the range from 1 to 65535.
<b>Step 7</b>	<b>frequency</b> <i>seconds</i> <b>Example:</b> RP/0/RSP0/CPU0:router(config-ipsla-udp-jitter)# frequency 300	(Optional) Sets the rate at which a specified IP SLA operation is sent into the network. <ul style="list-style-type: none"> <li>• (Optional) Use the <i>seconds</i> argument to specify the number of seconds between the IP SLA operations. Valid values are in the range from 1 to 12604800 seconds. The default is 60 seconds.</li> </ul>



	Command or Action	Purpose
Step 8	<b>statistics</b> [ <i>hourly</i>   <i>interval seconds</i> ] <b>Example:</b> <pre>RP/0/RSP0/CPU0:router(config-ipsla-udp-jitter)# statistics hourly RP/0/RSP0/CPU0:router(config-ipsla-op-stats)#</pre>	(Optional) Specifies the statistics collection parameters for UDP jitter operation.
Step 9	<b>buckets</b> <i>hours</i> <b>Example:</b> <pre>RP/0/RSP0/CPU0:router(config-ipsla-op-stats)# buckets 10</pre>	(Optional) Sets the number of hours in which statistics are maintained for the IP SLA operations. This command is valid only with the <b>statistics</b> command with <b>hourly</b> keyword. The range is 0 to 25 hours. The default value is 2 hours.
Step 10	<b>distribution count</b> <i>slot</i> <b>Example:</b> <pre>RP/0/RSP0/CPU0:router(config-ipsla-op-stats)# distribution count 15</pre>	(Optional) Sets the number of statistic distributions that are kept for each hop during the lifetime of the IP SLA operation. The range is 1 to 20. The default value is 1 distribution.
Step 11	<b>distribution interval</b> <i>interval</i> <b>Example:</b> <pre>RP/0/RSP0/CPU0:router(config-ipsla-op-stats)# distribution interval 20</pre>	(Optional) Sets the time interval for each statistical distribution. The range is 1 to 100 ms. The default value is 20 ms.
Step 12	<b>exit</b> <b>Example:</b> <pre>RP/0/RSP0/CPU0:router(config-ipsla-op-stats)# exit</pre>	Exits from IP SLA statistics configuration mode.
Step 13	<b>datasize request</b> <i>size</i> <b>Example:</b> <pre>RP/0/RSP0/CPU0:router(config-ipsla-udp-jitter)# datasize request 512</pre>	(Optional) Sets the data size in the payload of the operation's request packets. For UDP jitter, the range is from 16 to 1500 bytes.
Step 14	<b>timeout</b> <i>milliseconds</i> <b>Example:</b> <pre>RP/0/RSP0/CPU0:router(config-ipsla-udp-jitter)# timeout 10000</pre>	Sets the time that the specified IP SLA operation waits for a response from its request packet. <ul style="list-style-type: none"> <li>(Optional) Use the <i>milliseconds</i> argument to specify the number of milliseconds that the operation waits to receive a response.</li> </ul>
Step 15	<b>tos</b> <i>number</i> <b>Example:</b> <pre>RP/0/RSP0/CPU0:router(config-ipsla-udp-jitter)# tos 255</pre>	Specifies the type of service number.

	Command or Action	Purpose
<b>Step 16</b>	<p><b>exit</b></p> <p><b>Example:</b></p> <pre>RP/0/RSP0/CPU0:router(config-ipsla-udp-jitter)# exit RP/0/RSP0/CPU0:router(config-ipsla-op)# exit RP/0/RSP0/CPU0:router(config-ipsla)# exit RP/0/RSP0/CPU0:router(config)#</pre>	Exits from IP SLA configuration mode and operational mode, and returns the CLI to global configuration mode.
<b>Step 17</b>	<p><b>ipsla schedule operation <i>op-num</i></b></p> <p><b>Example:</b></p> <pre>RP/0/RSP0/CPU0:router(config)# ipsla schedule operation 432 RP/0/RSP0/CPU0:router(config-ipsla-sched)#</pre>	Schedules the start time of the operation. You can configure a basic schedule.
<b>Step 18</b>	<p><b>life {<i>forever</i>   <i>seconds</i>}</b></p> <p><b>Example:</b></p> <pre>RP/0/RSP0/CPU0:router(config-ipsla-sched)# life 30</pre>	The <b>forever</b> keyword schedules the operation to run indefinitely. The <i>seconds</i> argument schedules the lifetime of the operation, in seconds. The default lifetime of an operation is 3600 seconds (one hour).
<b>Step 19</b>	<p><b>ageout <i>seconds</i></b></p> <p><b>Example:</b></p> <pre>RP/0/RSP0/CPU0:router(config-ipsla-sched)# ageout 3600</pre>	(Optional) Specifies the number of seconds to keep the operation in memory when it is not actively collecting information. The default value of 0 seconds means that the operation never times out.
<b>Step 20</b>	<p><b>recurring</b></p> <p><b>Example:</b></p> <pre>RP/0/RSP0/CPU0:router(config-ipsla-sched)# recurring</pre>	(Optional) Specifies that the operation starts automatically at the specified time and for the specified duration every day.
<b>Step 21</b>	<p><b>start-time [<i>hh:mm:ss</i> {<i>day</i>   <i>month day</i>}   <b>now</b>   <b>pending</b>   <b>after</b> <i>hh:mm:ss</i> ]</b></p> <p><b>Example:</b></p> <pre>RP/0/RSP0/CPU0:router(config-ipsla-sched)# start-time 01:00:00</pre>	<p>(Optional) Specifies a time for the operation to start. The following keywords are described:</p> <ul style="list-style-type: none"> <li>• (Optional) Use the <b>pending</b> keyword to configure the operation to remain in a pending (unstarted) state. The default is inactive. If the <b>start-time</b> command is not specified, no information is collected until the start time is configured or a trigger occurs that performs an immediate start.</li> <li>• (Optional) Use the <b>now</b> keyword to indicate that the operation should start immediately.</li> <li>• (Optional) Use the <b>after</b> keyword and associated arguments to specify the time after which the operation starts collecting information.</li> </ul>

	Command or Action	Purpose
Step 22	Use the <b>commit</b> or <b>end</b> command.	<p><b>commit</b> —Saves the configuration changes and remains within the configuration session.</p> <p><b>end</b> —Prompts user to take one of these actions:</p> <ul style="list-style-type: none"> <li>• <b>Yes</b> — Saves configuration changes and exits the configuration session.</li> <li>• <b>No</b> —Exits the configuration session without committing the configuration changes.</li> <li>• <b>Cancel</b> —Remains in the configuration session, without committing the configuration changes.</li> </ul>
Step 23	<p><b>show ipsla statistics</b> [<i>operation-number</i> ]</p> <p><b>Example:</b></p> <pre>RP/0/RSP0/CPU0:router # show ipsla statistics 432</pre>	Displays the current statistics.
Step 24	<p><b>show ipsla statistics aggregated</b> [<i>operation-number</i> ]</p> <p><b>Example:</b></p> <pre>RP/0/RSP0/CPU0:router # show ipsla statistics aggregated 432</pre>	<p>Returns the hourly statistics (aggregated data) on the performance of the network.</p> <p>The UDP jitter operation provides the following hourly statistics:</p> <ul style="list-style-type: none"> <li>• Jitter statistics—Interprets telephony and multimedia conferencing requirements.</li> <li>• Packet loss and packet sequencing statistics—Interprets telephony, multimedia conferencing, streaming media, and other low-latency data requirements.</li> <li>• One-way latency and delay statistics—Interprets telephony, multimedia conferencing, and streaming media requirements.</li> </ul>

## Configuring the IP SLA for a UDP Echo Operation

To measure UDP performance on a network, use the IP SLA UDP echo operation. A UDP echo operation measures round-trip delay times and tests connectivity to Cisco devices and devices that are not Cisco devices. The results of a UDP echo operation can be useful in troubleshooting issues with business-critical applications.



**Note** The UDP echo operation requires a Cisco device that is running the IP SLA Responder or a non-Cisco device that is running the UDP echo service.

Depending on whether you want to configure a basic UDP echo operation or to configure a UDP echo operation with optional parameters, perform one of the following tasks:

## Prerequisites for Configuring a UDP Echo Operation on the Source Device

If you are using the IP SLA Responder, ensure that you have completed the [Enabling the IP SLA Responder on the Destination Device](#), on page 18 section.

## Configuring and Scheduling a UDP Echo Operation on the Source Device

You can enable a UDP echo operation without any optional parameters.

### SUMMARY STEPS

1. **configure**
2. **ipsla operation** *operation-number*
3. **type udp echo**
4. **destination address** *ipv4address*
5. **destination port** *port*
6. **frequency** *seconds*
7. **exit**
8. **ipsla schedule operation** *op-num*
9. **life** [**forever** | *seconds*]
10. **ageout** *seconds*
11. **recurring**
12. **start-time** [*hh:mm:ss {day | month day}* | **now** | **pending** | **after** *hh:mm:ss* ]
13. Use the **commit** or **end** command.
14. **show ipsla statistics** [*operation-number*]
15. **show ipsla statistics aggregated** [*operation-number*]

### DETAILED STEPS

	Command or Action	Purpose
<b>Step 1</b>	<b>configure</b> <b>Example:</b> RP/0/RSP0/CPU0:router# configure	Enters global configuration mode.
<b>Step 2</b>	<b>ipsla operation</b> <i>operation-number</i> <b>Example:</b> RP/0/RSP0/CPU0:router(config)# ipsla operation 432	Specifies the operation number. The range is from 1 to 2048.
<b>Step 3</b>	<b>type udp echo</b> <b>Example:</b> RP/0/RSP0/CPU0:router(config-ipsla-op)# type udp echo	Configures the operation as a UDP echo operation, and configures characteristics for the operation.

	Command or Action	Purpose
Step 4	<p><b>destination address</b> <i>ipv4address</i></p> <p><b>Example:</b></p> <pre>RP/0/RSP0/CPU0:router(config-ipsla-udp-echo)# destination address 12.25.26.10</pre>	Specifies the IP address of the destination for the proper operation type. You can configure a permanent port on the IP SLA Responder side, or you can use an UDP echo server.
Step 5	<p><b>destination port</b> <i>port</i></p> <p><b>Example:</b></p> <pre>RP/0/RSP0/CPU0:router(config-ipsla-udp-echo)# destination port 11111</pre>	Specifies the destination port number, in the range from 1 to 65535.
Step 6	<p><b>frequency</b> <i>seconds</i></p> <p><b>Example:</b></p> <pre>RP/0/RSP0/CPU0:router(config-ipsla-udp-echo)# frequency 300</pre>	<p>(Optional) Sets the rate at which a specified IP SLA operation is sent into the network.</p> <ul style="list-style-type: none"> <li>(Optional) Use the <i>seconds</i> argument to specify the number of seconds between the IP SLA operations. Valid values are in the range from 1 to 12604800 seconds. The default is 60 seconds.</li> </ul>
Step 7	<p><b>exit</b></p> <p><b>Example:</b></p> <pre>RP/0/RSP0/CPU0:router(config-ipsla-udp-echo)# exit RP/0/RSP0/CPU0:router(config-ipsla-op)# exit RP/0/RSP0/CPU0:router(config-ipsla)# exit RP/0/RSP0/CPU0:router(config)#</pre>	Exits IP SLA operation configuration mode and IP SLA configuration mode. Returns to global configuration mode.
Step 8	<p><b>ipsla schedule operation</b> <i>op-num</i></p> <p><b>Example:</b></p> <pre>RP/0/RSP0/CPU0:router(config)# ipsla schedule operation 432 RP/0/RSP0/CPU0:router(config-ipsla-sched)#</pre>	Schedules the start time of the operation. You can configure a basic schedule.
Step 9	<p><b>life</b> [<b>forever</b>   <i>seconds</i>]</p> <p><b>Example:</b></p> <pre>RP/0/RSP0/CPU0:router(config-ipsla-sched)# life 1</pre>	The <b>forever</b> keyword schedules the operation to run indefinitely. The <i>seconds</i> argument schedules the lifetime of the operation, in seconds. The default lifetime of an operation is 3600 seconds (one hour).
Step 10	<p><b>ageout</b> <i>seconds</i></p> <p><b>Example:</b></p> <pre>RP/0/RSP0/CPU0:router(config-ipsla-sched)# ageout 3600</pre>	(Optional) Specifies the number of seconds to keep the operation in memory when it is not actively collecting information. The default value of 0 seconds means that the operation never times out.

	Command or Action	Purpose
<b>Step 11</b>	<p><b>recurring</b></p> <p><b>Example:</b></p> <pre>RP/0/RSP0/CPU0:router(config-ipsla-sched)# recurring</pre>	(Optional) Specifies that the operation starts automatically at the specified time and for the specified duration every day.
<b>Step 12</b>	<p><b>start-time</b> [<i>hh:mm:ss {day   month day}</i>]   <b>now</b>   <b>pending</b>   <b>after</b> <i>hh:mm:ss</i> ]</p> <p><b>Example:</b></p> <pre>RP/0/RSP0/CPU0:router(config-ipsla-sched)# start-time 01:00:00</pre>	<p>(Optional) Specifies a time for the operation to start. The following keywords are described:</p> <ul style="list-style-type: none"> <li>• (Optional) Use the <b>pending</b> keyword to configure the operation to remain in a pending (unstarted) state. This is the default value. If the <b>start-time</b> command is not specified, no information is collected until the start time is configured or a trigger occurs that performs an immediate start.</li> <li>• (Optional) Use the <b>now</b> keyword to indicate that the operation should start immediately.</li> <li>• (Optional) Use the <b>after</b> keyword and associated arguments to specify the time after which the operation starts collecting information.</li> </ul>
<b>Step 13</b>	Use the <b>commit</b> or <b>end</b> command.	<p><b>commit</b> —Saves the configuration changes and remains within the configuration session.</p> <p><b>end</b> —Prompts user to take one of these actions:</p> <ul style="list-style-type: none"> <li>• <b>Yes</b> — Saves configuration changes and exits the configuration session.</li> <li>• <b>No</b> —Exits the configuration session without committing the configuration changes.</li> <li>• <b>Cancel</b> —Remains in the configuration session, without committing the configuration changes.</li> </ul>
<b>Step 14</b>	<p><b>show ipsla statistics</b> [<i>operation-number</i>]</p> <p><b>Example:</b></p> <pre>RP/0/RSP0/CPU0:router# show ipsla statistics 432</pre>	Displays the current statistics.
<b>Step 15</b>	<p><b>show ipsla statistics aggregated</b> [<i>operation-number</i>]</p> <p><b>Example:</b></p> <pre>RP/0/RSP0/CPU0:router# show ipsla statistics aggregated 1</pre>	Displays the hourly statistical errors and the hourly statistics for all the IP SLA operations or specified operation.

## Configuring and Scheduling a UDP Echo Operation with Optional Parameters on the Source Device

You can enable a UDP echo operation on the source device and configure some optional IP SLA parameters. The source device is the location at which the measurement statistics are stored.

### SUMMARY STEPS

1. **configure**
2. **ipsla operation** *operation-number*
3. **type udp echo**
4. **vrf** *vrf-name*
5. **destination address** *ipv4address*
6. **destination port** *port*
7. **frequency** *seconds*
8. **datasize request** *size*
9. **tos** *number*
10. **timeout** *milliseconds*
11. **tag** *text*
12. **exit**
13. **ipsla schedule operation** *op-num*
14. **life** {**forever** | *seconds*}
15. **ageout** *seconds*
16. **recurring**
17. **start-time** [*hh:mm:ss {day | month day}*] | **now** | **pending** | **after** *hh:mm:ss*]
18. Use the **commit** or **end** command.
19. **show ipsla statistics enhanced aggregated** [*operation-number*] **interval** *seconds*
20. **show ipsla statistics** [*operation-number*]

### DETAILED STEPS

	Command or Action	Purpose
<b>Step 1</b>	<b>configure</b> <b>Example:</b> RP/0/RSP0/CPU0:router# <code>configure</code>	Enters global configuration mode.
<b>Step 2</b>	<b>ipsla operation</b> <i>operation-number</i> <b>Example:</b> RP/0/RSP0/CPU0:router(config)# <code>ipsla operation 432</code>	Specifies the operation number. The range is from 1 to 2048.
<b>Step 3</b>	<b>type udp echo</b> <b>Example:</b> RP/0/RSP0/CPU0:router(config-ipsla-op)# <code>type udp echo</code>	Configures the operation as a UDP echo operation, and configures characteristics for the operation.

	Command or Action	Purpose
<b>Step 4</b>	<b>vrf</b> <i>vrf-name</i> <b>Example:</b> RP/0/RSP0/CPU0:router(config-ipsla-udp-echo)# vrf VPN-A	(Optional) Enables the monitoring of a VPN (using a nondefault routing table) in a UDP echo operation. Maximum length is 32 alphanumeric characters.
<b>Step 5</b>	<b>destination address</b> <i>ipv4address</i> <b>Example:</b> RP/0/RSP0/CPU0:router(config-ipsla-udp-echo)# destination address 12.25.26.10	Specifies the IP address of the destination for the proper operation type.
<b>Step 6</b>	<b>destination port</b> <i>port</i> <b>Example:</b> RP/0/RSP0/CPU0:router(config-ipsla-udp-echo)# destination port 11111	Specifies the destination port number, in the range from 1 to 65535.
<b>Step 7</b>	<b>frequency</b> <i>seconds</i> <b>Example:</b> RP/0/RSP0/CPU0:router(config-ipsla-udp-echo)# frequency 300	(Optional) Sets the rate at which a specified IP SLA operation is sent into the network. <ul style="list-style-type: none"> <li>• (Optional) Use the <i>seconds</i> argument to specify the number of seconds between the IP SLA operations. Valid values are in the range from 1 to 12604800 seconds. The default is 60 seconds.</li> </ul>
<b>Step 8</b>	<b>datasize request</b> <i>size</i> <b>Example:</b> RP/0/RSP0/CPU0:router(config-ipsla-udp-echo)# datasize request 512	(Optional) Sets the protocol data size in the payload of the IP SLA operation's request packet. <ul style="list-style-type: none"> <li>• Use the <i>size</i> argument to specify the protocol data size in bytes. The range is from 0 to the maximum of the protocol. The default is 1 byte.</li> </ul>
<b>Step 9</b>	<b>tos</b> <i>number</i> <b>Example:</b> RP/0/RSP0/CPU0:router(config-ipsla-udp-echo)# tos 255	Defines a type of service (ToS) byte in the IP header of IP SLA operations. <p><b>Note</b> The ToS byte is converted to a Differentiated Services Code Point (DSCP) value, but you cannot enter the DSCP value directly. To use a DSCP value, multiply it by 4 and enter the result as the value of the <i>number</i> argument.</p>
<b>Step 10</b>	<b>timeout</b> <i>milliseconds</i> <b>Example:</b> RP/0/RSP0/CPU0:router(config-ipsla-udp-echo)# timeout 10000	Sets the time that the specified IP SLA operation waits for a response from its request packet. <ul style="list-style-type: none"> <li>• Use the <i>milliseconds</i> argument to specify the number of milliseconds that the operation waits to receive a response.</li> </ul>



	Command or Action	Purpose
Step 11	<p><b>tag</b> <i>text</i></p> <p><b>Example:</b></p> <pre>RP/0/RSP0/CPU0:router(config-ipsla-udp-echo)# type udp echo tag ipsla</pre>	(Optional) Creates a user-specified identifier for an IP SLA operation.
Step 12	<p><b>exit</b></p> <p><b>Example:</b></p> <pre>RP/0/RSP0/CPU0:router(config-ipsla-udp-echo)# exit RP/0/RSP0/CPU0:router(config-ipsla-op)# exit RP/0/RSP0/CPU0:router(config-ipsla)# exit RP/0/RSP0/CPU0:router(config)#</pre>	Exits IP SLA operation configuration mode and IPSLA configuration mode. Returns to global configuration mode.
Step 13	<p><b>ipsla schedule operation</b> <i>op-num</i></p> <p><b>Example:</b></p> <pre>RP/0/RSP0/CPU0:router(config)# ipsla schedule operation 432 RP/0/RSP0/CPU0:router(config-ipsla-sched)#</pre>	Schedules the start time of the operation. You can configure a basic schedule or schedule multiple operations using group scheduling.
Step 14	<p><b>life</b> {<b>forever</b>   <i>seconds</i>}</p> <p><b>Example:</b></p> <pre>RP/0/RSP0/CPU0:router(config-ipsla-sched)# life 30</pre>	The <b>forever</b> keyword schedules the operation to run indefinitely. The <i>seconds</i> argument schedules the lifetime of the operation, in seconds. The default lifetime of an operation is 3600 seconds (one hour).
Step 15	<p><b>ageout</b> <i>seconds</i></p> <p><b>Example:</b></p> <pre>RP/0/RSP0/CPU0:router(config-ipsla-sched)# ageout 3600</pre>	(Optional) Specifies the number of seconds to keep the operation in memory when it is not actively collecting information. The default value of 0 seconds means that the operation never times out.
Step 16	<p><b>recurring</b></p> <p><b>Example:</b></p> <pre>RP/0/RSP0/CPU0:router(config-ipsla-sched)# recurring</pre>	(Optional) Specifies that the operation starts automatically at the specified time and for the specified duration every day.
Step 17	<p><b>start-time</b> [<i>hh:mm:ss</i> {<i>day</i>   <i>month day</i>}   <b>now</b>   <b>pending</b>   <b>after</b> <i>hh:mm:ss</i>]</p> <p><b>Example:</b></p> <pre>RP/0/RSP0/CPU0:router(config-ipsla-sched)# start-time 01:00:00</pre>	<p>Specifies a time for the operation to start. The following keywords are described:</p> <ul style="list-style-type: none"> <li>(Optional) Use the <b>pending</b> keyword to configure the operation to remain in a pending (unstarted) state. The default value is inactive. If the <b>start-time</b> command is not specified, no information is collected until the start time is configured or a trigger occurs that performs an immediate start.</li> <li>(Optional) Use the <b>now</b> keyword to indicate that the operation should start immediately.</li> </ul>

	Command or Action	Purpose
		<ul style="list-style-type: none"> <li>• (Optional) Use the <b>after</b> keyword and associated arguments to specify the time after which the operation starts collecting information.</li> </ul>
<b>Step 18</b>	Use the <b>commit</b> or <b>end</b> command.	<p><b>commit</b> —Saves the configuration changes and remains within the configuration session.</p> <p><b>end</b> —Prompts user to take one of these actions:</p> <ul style="list-style-type: none"> <li>• <b>Yes</b> — Saves configuration changes and exits the configuration session.</li> <li>• <b>No</b> —Exits the configuration session without committing the configuration changes.</li> <li>• <b>Cancel</b> —Remains in the configuration session, without committing the configuration changes.</li> </ul>
<b>Step 19</b>	<p><b>show ipsla statistics enhanced aggregated</b> [<i>operation-number</i>] <i>interval seconds</i></p> <p><b>Example:</b></p> <pre>RP/0/RSP0/CPU0:router# show ipsla statistics enhanced aggregated 432</pre>	Displays the enhanced history statistics. You must configure the enhanced history statistics to display the sample output.
<b>Step 20</b>	<p><b>show ipsla statistics</b> [<i>operation-number</i>]</p> <p><b>Example:</b></p> <pre>RP/0/RSP0/CPU0:router# show ipsla statistics 432</pre>	Displays the current statistics.

## Configuring an ICMP Echo Operation

To monitor IP connections on a device, use the IP SLA ICMP echo operation. An ICMP echo operation measures end-to-end response times between a Cisco router and devices using IP. ICMP echo is used to troubleshoot network connectivity issues.



**Note** The ICMP echo operation does not require the IP SLA Responder to be enabled.

Depending on whether you want to configure and schedule a basic ICMP echo operation or configure and schedule an ICMP echo operation with optional parameters, perform one of the following procedures:

### Configuring and Scheduling a Basic ICMP Echo Operation on the Source Device

You can enable and schedule an ICMP echo operation without any optional parameters.

#### SUMMARY STEPS

1. **configure**

2. **ipsla operation** *operation-number*
3. **type icmp echo**
4. **destination address** *ipv4address*
5. **frequency** *seconds*
6. **exit**
7. **ipsla schedule operation** *op-num*
8. **life** {**forever** | *seconds*}
9. **ageout** *seconds*
10. **recurring**
11. **start-time** [*hh:mm:ss {day | month day}*] | **now** | **pending** | **after** *hh:mm:ss*]
12. Use the **commit** or **end** command.
13. **show ipsla statistics** [*operation-number*]

## DETAILED STEPS

	Command or Action	Purpose
<b>Step 1</b>	<b>configure</b> <b>Example:</b> RP/0/RSP0/CPU0:router# configure	Enters global configuration mode.
<b>Step 2</b>	<b>ipsla operation</b> <i>operation-number</i> <b>Example:</b> RP/0/RSP0/CPU0:router(config)# ipsla operation 432	Specifies the operation number. The range is from 1 to 2048.
<b>Step 3</b>	<b>type icmp echo</b> <b>Example:</b> RP/0/RSP0/CPU0:router(config-ipsla-op)# type icmp echo	Defines an ICMP echo operation type.
<b>Step 4</b>	<b>destination address</b> <i>ipv4address</i> <b>Example:</b> RP/0/RSP0/CPU0:router(config-ipsla-icmp-echo)# destination address 12.25.26.10	Specifies the IP address of the destination for the proper operation type.
<b>Step 5</b>	<b>frequency</b> <i>seconds</i> <b>Example:</b> RP/0/RSP0/CPU0:router(config-ipsla-icmp-echo) frequency 300	(Optional) Sets the rate at which a specified IP SLA operation is sent into the network. <ul style="list-style-type: none"> <li>• (Optional) Use the <i>seconds</i> argument to specify the number of seconds between the IP SLA operations. Valid values are in the range from 1 to 12604800 seconds. The default is 60 seconds.</li> </ul>

	Command or Action	Purpose
<b>Step 6</b>	<b>exit</b> <b>Example:</b> <pre>RP/0/RSP0/CPU0:router(config-ipsla-icmp-echo)# exit RP/0/RSP0/CPU0:router(config-ipsla-op)# exit RP/0/RSP0/CPU0:router(config-ipsla)# exit RP/0/RSP0/CPU0:router(config)#</pre>	Exits IP SLA operation configuration mode and IP SLA configuration mode. Returns to global configuration mode.
<b>Step 7</b>	<b>ipsla schedule operation <i>op-num</i></b> <b>Example:</b> <pre>RP/0/RSP0/CPU0:router(config)# ipsla schedule operation 432 RP/0/RSP0/CPU0:router(config-ipsla-sched)#</pre>	Schedules the start time of the operation. You can configure a basic schedule.
<b>Step 8</b>	<b>life {forever   <i>seconds</i>}</b> <b>Example:</b> <pre>RP/0/RSP0/CPU0:router(config-ipsla-sched)# life 30</pre>	The <b>forever</b> keyword schedules the operation to run indefinitely. The <i>seconds</i> argument schedules the lifetime of the operation, in seconds. The default lifetime of an operation is 3600 seconds (one hour).
<b>Step 9</b>	<b>ageout <i>seconds</i></b> <b>Example:</b> <pre>RP/0/RSP0/CPU0:router(config-ipsla-sched)# ageout 3600</pre>	(Optional) Specifies the number of seconds to keep the operation in memory when it is not actively collecting information. The default value of 0 seconds means that the operation never times out.
<b>Step 10</b>	<b>recurring</b> <b>Example:</b> <pre>RP/0/RSP0/CPU0:router(config-ipsla-sched)# recurring</pre>	(Optional) Specifies that the operation starts automatically at the specified time and for the specified duration every day.
<b>Step 11</b>	<b>start-time [<i>hh:mm:ss</i> {<i>day</i>   <i>month day</i>}   <b>now</b>   <b>pending</b>   <b>after</b> <i>hh:mm:ss</i>]</b> <b>Example:</b> <pre>RP/0/RSP0/CPU0:router(config-ipsla-sched)# start-time 01:00:00</pre>	<p>Specifies a time for the operation to start. The following keywords are described:</p> <ul style="list-style-type: none"> <li>• (Optional) Use the <b>pending</b> keyword to configure the operation to remain in a pending (unstarted) state. The default value is inactive. If the <b>start-time</b> command is not specified, no information is collected until the start time is configured or a trigger occurs that performs an immediate start.</li> <li>• (Optional) Use the <b>now</b> keyword to indicate that the operation should start immediately.</li> <li>• (Optional) Use the <b>after</b> keyword and associated arguments to specify the time after which the operation starts collecting information.</li> </ul>

	Command or Action	Purpose
Step 12	Use the <b>commit</b> or <b>end</b> command.	<p><b>commit</b> —Saves the configuration changes and remains within the configuration session.</p> <p><b>end</b> —Prompts user to take one of these actions:</p> <ul style="list-style-type: none"> <li>• <b>Yes</b> — Saves configuration changes and exits the configuration session.</li> <li>• <b>No</b> —Exits the configuration session without committing the configuration changes.</li> <li>• <b>Cancel</b> —Remains in the configuration session, without committing the configuration changes.</li> </ul>
Step 13	<p><b>show ipsla statistics</b> [<i>operation-number</i>]</p> <p><b>Example:</b></p> <pre>RP/0/RSP0/CPU0:router # show ipsla statistics 432</pre>	Displays the current statistics.

## Configuring and Scheduling an ICMP Echo Operation with Optional Parameters on the Source Device

You can enable an ICMP echo operation on the source device and configure some optional IP SLA parameters.

### SUMMARY STEPS

1. **configure**
2. **ipsla operation** *operation-number*
3. **type icmp echo**
4. **vrf** *vrf-name*
5. **destination address** *ipv4address*
6. **frequency** *seconds*
7. **datasize request** *size*
8. **tos** *number*
9. **timeout** *milliseconds*
10. **tag** *text*
11. **exit**
12. **ipsla schedule operation** *op-num*
13. **life** {**forever** | *seconds*}
14. **ageout** *seconds*
15. **recurring**
16. **start-time** [*hh:mm:ss* {*day* | *month day*} | **now** | **pending** | **after** *hh:mm:ss*]
17. Use the **commit** or **end** command.
18. **show ipsla statistics** [*operation-number*]

## DETAILED STEPS

	Command or Action	Purpose
<b>Step 1</b>	<b>configure</b> <b>Example:</b>  RP/0/RSP0/CPU0:router# configure	Enters global configuration mode.
<b>Step 2</b>	<b>ipsla operation operation-number</b> <b>Example:</b>  RP/0/RSP0/CPU0:router(config)# ipsla operation 432	Specifies the operation number. The range is from 1 to 2048.
<b>Step 3</b>	<b>type icmp echo</b> <b>Example:</b>  RP/0/RSP0/CPU0:router(config-ipsla-op)# type icmp echo	Defines an ICMP echo operation type.
<b>Step 4</b>	<b>vrf vrf-name</b> <b>Example:</b>  RP/0/RSP0/CPU0:router(config-ipsla-icmp-echo)# vrf VPN-A	(Optional) Enables the monitoring of a VPN (using a nondefault routing table) in an ICMP echo operation. Maximum length is 32 alphanumeric characters.
<b>Step 5</b>	<b>destination address ipv4address</b> <b>Example:</b>  RP/0/RSP0/CPU0:router(config-ipsla-icmp-echo)# destination address 12.25.26.10	Specifies the IP address of the destination for the proper operation type.
<b>Step 6</b>	<b>frequency seconds</b> <b>Example:</b>  RP/0/RSP0/CPU0:router(config-ipsla-icmp-echo)# frequency 300	(Optional) Sets the rate at which a specified IP SLA operation is sent into the network. <ul style="list-style-type: none"> <li>(Optional) Use the <i>seconds</i> argument to specify the number of seconds between the IP SLA operations. Valid values are in the range from 1 to 12604800 seconds. The default is 60 seconds.</li> </ul>
<b>Step 7</b>	<b>datsize request size</b> <b>Example:</b>  RP/0/RSP0/CPU0:router(config-ipsla-icmp-echo)# datsize request 512	(Optional) Sets the protocol data size in the payload of the request packet for the specified IP SLA operation. <ul style="list-style-type: none"> <li>Use the <i>bytes</i> argument to specify the protocol data size in bytes. The range is from 0 to 16384. The default is 36 bytes for ICMP echo operation.</li> </ul>
<b>Step 8</b>	<b>tos number</b> <b>Example:</b>	Defines a type of service (ToS) byte in the IP header of IP SLA operations.

	Command or Action	Purpose
	RP/0/RSP0/CPU0:router(config-ipsla-icmp-echo)# tos 1	<b>Note</b> The ToS byte can be converted to a Differentiated Services Code Point (DSCP) value, but you cannot enter the DSCP value directly. To use a DSCP value, multiply it by 4 and enter the result as the value of the <i>number</i> argument.
<b>Step 9</b>	<b>timeout</b> <i>milliseconds</i>  <b>Example:</b>  RP/0/RSP0/CPU0:router(config-ipsla-icmp-echo)# timeout 10000	Sets the time that the IP SLA operation waits for a response from its request packet.  <ul style="list-style-type: none"> <li>Use the <i>milliseconds</i> argument to specify the number of milliseconds that the operation waits to receive a response.</li> </ul>
<b>Step 10</b>	<b>tag</b> <i>text</i>  <b>Example:</b>  RP/0/RSP0/CPU0:router(config-ipsla-icmp-echo)# tag ipsla	(Optional) Creates a user-specified identifier for an IP SLA operation.
<b>Step 11</b>	exit  <b>Example:</b>  RP/0/RSP0/CPU0:router(config-ipsla-icmp-echo)# exit RP/0/RSP0/CPU0:router(config-ipsla-op)# exit RP/0/RSP0/CPU0:router(config-ipsla)# exit RP/0/RSP0/CPU0:router(config)#	Exits IP SLA operation configuration mode and IP SLA configuration mode. Returns to global configuration mode.
<b>Step 12</b>	<b>ipsla schedule operation</b> <i>op-num</i>  <b>Example:</b>  RP/0/RSP0/CPU0:router(config)# ipsla schedule operation 432 RP/0/RSP0/CPU0:router(config-ipsla-sched)#	Schedules the start time of the operation. You can configure a basic schedule.
<b>Step 13</b>	<b>life</b> { <b>forever</b>   <i>seconds</i> }  <b>Example:</b>  RP/0/RSP0/CPU0:router(config-ipsla-sched)# life 30	The <b>forever</b> keyword schedules the operation to run indefinitely. The <i>seconds</i> argument schedules the lifetime of the operation, in seconds. The default lifetime of an operation is 3600 seconds (one hour).
<b>Step 14</b>	<b>ageout</b> <i>seconds</i>  <b>Example:</b>  RP/0/RSP0/CPU0:router(config-ipsla-sched)# ageout 3600	(Optional) Specifies the number of seconds to keep the operation in memory when it is not actively collecting information. The default value of 0 seconds means that the operation never times out.

	Command or Action	Purpose
<b>Step 15</b>	<p><b>recurring</b></p> <p><b>Example:</b></p> <pre>RP/0/RSP0/CPU0:router(config-ipsla-sched)# recurring</pre>	(Optional) Specifies that the operation starts automatically at the specified time and for the specified duration every day.
<b>Step 16</b>	<p><b>start-time</b> [<i>hh:mm:ss</i> {<i>day</i>   <i>month day</i>}   <b>now</b>   <b>pending</b>   <b>after</b> <i>hh:mm:ss</i>]</p> <p><b>Example:</b></p> <pre>RP/0/RSP0/CPU0:router(config-ipsla-sched)# start-time 01:00:00</pre>	<p>Specifies a time for the operation to start. The following keywords are described:</p> <ul style="list-style-type: none"> <li>• (Optional) Use the <b>pending</b> keyword to configure the operation to remain in a pending (unstarted) state. The default value is inactive. If the <b>start-time</b> command is not specified, no information is collected until the start time is configured or a trigger occurs that performs an immediate start.</li> <li>• (Optional) Use the <b>now</b> keyword to indicate that the operation should start immediately.</li> <li>• (Optional) Use the <b>after</b> keyword and associated arguments to specify the time after which the operation starts collecting information.</li> </ul>
<b>Step 17</b>	Use the <b>commit</b> or <b>end</b> command.	<p><b>commit</b> —Saves the configuration changes and remains within the configuration session.</p> <p><b>end</b> —Prompts user to take one of these actions:</p> <ul style="list-style-type: none"> <li>• <b>Yes</b> — Saves configuration changes and exits the configuration session.</li> <li>• <b>No</b> —Exits the configuration session without committing the configuration changes.</li> <li>• <b>Cancel</b> —Remains in the configuration session, without committing the configuration changes.</li> </ul>
<b>Step 18</b>	<p><b>show ipsla statistics</b> [<i>operation-number</i>]</p> <p><b>Example:</b></p> <pre>RP/0/RSP0/CPU0:router # show ipsla statistics 432</pre>	Displays the current statistics.

## Configuring the ICMP Path-echo Operation

The IP SLA ICMP path-echo operation records statistics for each hop along the path that the IP SLA operation takes to reach its destination. The ICMP path-echo operation determines the hop-by-hop response time between a Cisco router and any IP device on the network by discovering the path using the traceroute facility.



The source IP SLA device uses traceroute to discover the path to the destination IP device. A ping is then used to measure the response time between the source IP SLA device and each subsequent hop in the path to the destination IP device.



**Note** The ICMP path-echo operation does not require the IP SLA Responder to be enabled.

Depending on whether you want to configure and schedule a basic ICMP path-echo operation or configure and schedule an ICMP path-echo operation with optional parameters, perform one of the following procedures:

## Configuring and Scheduling a Basic ICMP Path-echo Operation on the Source Device

You can enable and schedule an ICMP path-echo operation without any optional parameters.

### SUMMARY STEPS

1. **configure**
2. **ipsla operation** *operation-number*
3. **type icmp path-echo**
4. **destination address** *ipv4address*
5. **frequency** *seconds*
6. **exit**
7. **ipsla schedule operation** *op-num*
8. **life** {**forever** | *seconds*}
9. **ageout** *seconds*
10. **recurring**
11. **start-time** [*hh:mm:ss {day | month day}*] | **now** | **pending** | **after** *hh:mm:ss*]
12. Use the **commit** or **end** command.
13. **show ipsla statistics** [*operation-number*]

### DETAILED STEPS

	Command or Action	Purpose
<b>Step 1</b>	<b>configure</b> <b>Example:</b> RP/0/RSP0/CPU0:router# configure	Enters global configuration mode.
<b>Step 2</b>	<b>ipsla operation</b> <i>operation-number</i> <b>Example:</b> RP/0/RSP0/CPU0:router(config)# ipsla operation 432	Specifies the operation number. The range is from 1 to 2048.
<b>Step 3</b>	<b>type icmp path-echo</b> <b>Example:</b> RP/0/RSP0/CPU0:router(config-ipsla-op)# type icmp	Defines an ICMP path-echo operation type.

	Command or Action	Purpose
	<pre>path-echo RP/0/RSP0/CPU0:router(config-ipsla-icmp-path-echo)#</pre>	
<b>Step 4</b>	<p><b>destination address</b> <i>ipv4address</i></p> <p><b>Example:</b></p> <pre>RP/0/RSP0/CPU0:router(config-ipsla-icmp-path-echo)# destination address 12.25.26.10</pre>	Specifies the IP address of the destination for the proper operation type.
<b>Step 5</b>	<p><b>frequency</b> <i>seconds</i></p> <p><b>Example:</b></p> <pre>RP/0/RSP0/CPU0:router(config-ipsla-icmp-path-echo)# frequency 300</pre>	<p>(Optional) Sets the rate at which a specified IP SLA operation is sent into the network.</p> <ul style="list-style-type: none"> <li>(Optional) Use the <i>seconds</i> argument to specify the number of seconds between the IP SLA operations. Valid values are in the range from 1 to 12604800 seconds. The default is 60 seconds.</li> </ul>
<b>Step 6</b>	<p><b>exit</b></p> <p><b>Example:</b></p> <pre>RP/0/RSP0/CPU0:router(config-ipsla-icmp-path-echo)# exit RP/0/RSP0/CPU0:router(config-ipsla-op)# exit RP/0/RSP0/CPU0:router(config-ipsla)# exit RP/0/RSP0/CPU0:router(config)#</pre>	Exits IP SLA operation configuration mode and IP SLA configuration mode. Returns to global configuration mode.
<b>Step 7</b>	<p><b>ipsla schedule operation</b> <i>op-num</i></p> <p><b>Example:</b></p> <pre>RP/0/RSP0/CPU0:router(config)# ipsla schedule operation 432 RP/0/RSP0/CPU0:router(config-ipsla-sched)#</pre>	Schedules the start time of the operation. You can configure a basic schedule.
<b>Step 8</b>	<p><b>life</b> {<b>forever</b>   <i>seconds</i>}</p> <p><b>Example:</b></p> <pre>RP/0/RSP0/CPU0:router(config-ipsla-sched)# life 30</pre>	The <b>forever</b> keyword schedules the operation to run indefinitely. The <i>seconds</i> argument schedules the lifetime of the operation, in seconds. The default lifetime of an operation is 3600 seconds (one hour).
<b>Step 9</b>	<p><b>ageout</b> <i>seconds</i></p> <p><b>Example:</b></p> <pre>RP/0/RSP0/CPU0:router(config-ipsla-sched)# ageout 3600</pre>	(Optional) Specifies the number of seconds to keep the operation in memory when it is not actively collecting information. The default value of 0 seconds means that the operation never times out.
<b>Step 10</b>	<p><b>recurring</b></p> <p><b>Example:</b></p> <pre>RP/0/RSP0/CPU0:router(config-ipsla-sched)# recurring</pre>	(Optional) Specifies that the operation starts automatically at the specified time and for the specified duration every day.

	Command or Action	Purpose
Step 11	<p><b>start-time</b> [<i>hh:mm:ss</i> {<i>day</i>   <i>month day</i>}   <b>now</b>   <b>pending</b>   <b>after</b> <i>hh:mm:ss</i>]</p> <p><b>Example:</b></p> <pre>RP/0/RSP0/CPU0:router(config-ipsla-sched)# start-time 01:00:00</pre>	<p>Specifies a time for the operation to start. The following keywords are described:</p> <ul style="list-style-type: none"> <li>• (Optional) Use the <b>pending</b> keyword to configure the operation to remain in a pending (unstarted) state. The default value is inactive. If the <b>start-time</b> command is not specified, no information is collected until the start time is configured or a trigger occurs that performs an immediate start.</li> <li>• (Optional) Use the <b>now</b> keyword to indicate that the operation should start immediately.</li> <li>• (Optional) Use the <b>after</b> keyword and associated arguments to specify the time after which the operation starts collecting information.</li> </ul>
Step 12	Use the <b>commit</b> or <b>end</b> command.	<p><b>commit</b> —Saves the configuration changes and remains within the configuration session.</p> <p><b>end</b> —Prompts user to take one of these actions:</p> <ul style="list-style-type: none"> <li>• <b>Yes</b> — Saves configuration changes and exits the configuration session.</li> <li>• <b>No</b> —Exits the configuration session without committing the configuration changes.</li> <li>• <b>Cancel</b> —Remains in the configuration session, without committing the configuration changes.</li> </ul>
Step 13	<p><b>show ipsla statistics</b> [<i>operation-number</i>]</p> <p><b>Example:</b></p> <pre>RP/0/RSP0/CPU0:router# show ipsla statistics 432</pre>	Displays the current statistics.

## Configuring and Scheduling an ICMP Path-echo Operation with Optional Parameters on the Source Device

You can enable an ICMP path-echo operation on the source device and configure some optional IP SLA parameters.

### SUMMARY STEPS

1. **configure**
2. **ipsla operation** *operation-number*
3. **type icmp path-echo**
4. **vrf** *vrf-name*
5. **lsr-path** *ip-address*
6. **destination address** *ipv4address*

7. **frequency** *seconds*
8. **datasize request** *size*
9. **tos** *number*
10. **timeout** *milliseconds*
11. **tag** *text*
12. **lsr-path** *ipaddress1 {ipaddress2 {... {ipaddress8}}*
13. **exit**
14. **ipsla schedule operation** *op-num*
15. **life** {**forever** | *seconds*}
16. **ageout** *seconds*
17. **recurring**
18. **start-time** [*hh:mm:ss {day | month day}*] | **now** | **pending** | **after** *hh:mm:ss*]
19. Use the **commit** or **end** command.
20. **show ipsla statistics** [*operation-number*]

## DETAILED STEPS

	Command or Action	Purpose
<b>Step 1</b>	<b>configure</b> <b>Example:</b>  RP/0/RSP0/CPU0:router# configure	Enters global configuration mode.
<b>Step 2</b>	<b>ipsla operation</b> <i>operation-number</i> <b>Example:</b>  RP/0/RSP0/CPU0:router(config)# ipsla operation 432	Specifies the operation number. The range is from 1 to 2048.
<b>Step 3</b>	<b>type icmp path-echo</b> <b>Example:</b>  RP/0/RSP0/CPU0:router(config-ipsla-op)# type icmp path-echo RP/0/RSP0/CPU0:router(config-ipsla-icmp-path-echo)#	Defines an ICMP path-echo operation type.
<b>Step 4</b>	<b>vrf</b> <i>vrf-name</i> <b>Example:</b>  RP/0/RSP0/CPU0:router(config-ipsla-icmp-path-echo)# vrf VPN-A	(Optional) Enables the monitoring of a VPN (using a nondefault routing table) in an ICMP path-echo operation. Maximum length is 32 alphanumeric characters.
<b>Step 5</b>	<b>lsr-path</b> <i>ip-address</i> <b>Example:</b>  RP/0/RSP0/CPU0:router(config-ipsla-icmp-path-echo)# lsr-path 20.25.22.1	Specifies that a loose source routing path is to be used.

	Command or Action	Purpose
Step 6	<p><b>destination address</b> <i>ipv4address</i></p> <p><b>Example:</b></p> <pre>RP/0/RSP0/CPU0:router(config-ipsla-icmp-path-echo)# destination address 12.25.26.10</pre>	Specifies the IP address of the destination for the proper operation type.
Step 7	<p><b>frequency</b> <i>seconds</i></p> <p><b>Example:</b></p> <pre>RP/0/RSP0/CPU0:router(config-ipsla-icmp-path-echo)# frequency 300</pre>	<p>(Optional) Sets the rate at which a specified IP SLA operation is sent into the network.</p> <ul style="list-style-type: none"> <li>(Optional) Use the <i>seconds</i> argument to specify the number of seconds between the IP SLA operations. Valid values are in the range from 1 to 12604800 seconds. The default is 60 seconds.</li> </ul>
Step 8	<p><b>datasize request size</b></p> <p><b>Example:</b></p> <pre>RP/0/RSP0/CPU0:router(config-ipsla-icmp-path-echo)# datasize request 512</pre>	<p>(Optional) Sets the protocol data size in the payload of the request packet for the specified IP SLA operation.</p> <ul style="list-style-type: none"> <li>Use the <i>bytes</i> argument to specify the protocol data size in bytes. The range is from 0 to 16384. The default is 36 bytes.</li> </ul>
Step 9	<p><b>tos number</b></p> <p><b>Example:</b></p> <pre>RP/0/RSP0/CPU0:router(config-ipsla-icmp-path-echo)# tos 5</pre>	<p>Defines a type of service (ToS) byte in the IP header of IP SLA operations.</p> <p><b>Note</b> The ToS byte can be converted to a Differentiated Services Code Point (DSCP) value, but you cannot enter the DSCP value directly. To use a DSCP value, multiply it by 4 and enter the result as the <i>number</i> argument.</p>
Step 10	<p><b>timeout milliseconds</b></p> <p><b>Example:</b></p> <pre>RP/0/RSP0/CPU0:router(config-ipsla-icmp-path-echo)# timeout 10000</pre>	<p>Sets the time that the IP SLA operation waits for a response from its request packet.</p> <ul style="list-style-type: none"> <li>Use the <i>milliseconds</i> argument to specify the number of milliseconds that the operation waits to receive a response.</li> </ul>
Step 11	<p><b>tag text</b></p> <p><b>Example:</b></p> <pre>RP/0/RSP0/CPU0:router(config-ipsla-icmp-path-echo)# tag ipsla</pre>	(Optional) Creates a user-specified identifier for an IP SLA operation.
Step 12	<p><b>lsr-path</b> <i>ipaddress1 {ipaddress2 {... {ipaddress8}}</i></p> <p><b>Example:</b></p> <pre>RP/0/RSP0/CPU0:router(config-ipsla-icmp-path-echo)# lsr-path 20.25.22.1</pre>	<p>Specifies the path in which to measure the ICMP echo response time.</p> <ul style="list-style-type: none"> <li>(Optional) Use the <i>ip address</i> argument of the intermediate node or nodes in a path to the destination.</li> </ul>

	Command or Action	Purpose
<b>Step 13</b>	<b>exit</b> <b>Example:</b> <pre>RP/0/RSP0/CPU0:router(config-ipsla-icmp-path-echo)#   exit RP/0/RSP0/CPU0:router(config-ipsla-op)# exit RP/0/RSP0/CPU0:router(config-ipsla)# exit RP/0/RSP0/CPU0:router(config)#</pre>	Exits IP SLA operation configuration mode and IP SLA configuration mode. Returns to global configuration mode.
<b>Step 14</b>	<b>ipsla schedule operation <i>op-num</i></b> <b>Example:</b> <pre>RP/0/RSP0/CPU0:router(config)# ipsla schedule   operation 432 RP/0/RSP0/CPU0:router(config-ipsla-sched)#</pre>	Schedules the start time of the operation. You can configure a basic schedule.
<b>Step 15</b>	<b>life {forever   <i>seconds</i>}</b> <b>Example:</b> <pre>RP/0/RSP0/CPU0:router(config-ipsla-sched)# life   1</pre>	The <b>forever</b> keyword schedules the operation to run indefinitely. The <i>seconds</i> argument schedules the lifetime of the operation, in seconds. The default lifetime of an operation is 3600 seconds (one hour).
<b>Step 16</b>	<b>ageout <i>seconds</i></b> <b>Example:</b> <pre>RP/0/RSP0/CPU0:router(config-ipsla-sched)# ageout   3600</pre>	(Optional) Specifies the number of seconds to keep the operation in memory when it is not actively collecting information. The default value of 0 seconds means that the operation never times out.
<b>Step 17</b>	<b>recurring</b> <b>Example:</b> <pre>RP/0/RSP0/CPU0:router(config-ipsla-sched)#   recurring</pre>	(Optional) Specifies that the operation starts automatically at the specified time and for the specified duration every day.
<b>Step 18</b>	<b>start-time [<i>hh:mm:ss</i> {<i>day</i>   <i>month day</i>}   <b>now</b>   <b>pending</b>   <b>after</b> <i>hh:mm:ss</i>]</b> <b>Example:</b> <pre>RP/0/RSP0/CPU0:router(config-ipsla-sched)#   start-time 01:00:00</pre>	<p>Specifies a time for the operation to start. The following keywords are described:</p> <ul style="list-style-type: none"> <li>• (Optional) Use the <b>pending</b> keyword to configure the operation to remain in a pending (unstarted) state. The default value is inactive. If the <b>start-time</b> command is not specified, no information is collected until the start time is configured or a trigger occurs that performs an immediate start.</li> <li>• (Optional) Use the <b>now</b> keyword to indicate that the operation should start immediately.</li> <li>• (Optional) Use the <b>after</b> keyword and associated arguments to specify the time after which the operation starts collecting information.</li> </ul>

	Command or Action	Purpose
Step 19	Use the <b>commit</b> or <b>end</b> command.	<p><b>commit</b> —Saves the configuration changes and remains within the configuration session.</p> <p><b>end</b> —Prompts user to take one of these actions:</p> <ul style="list-style-type: none"> <li>• <b>Yes</b> — Saves configuration changes and exits the configuration session.</li> <li>• <b>No</b> —Exits the configuration session without committing the configuration changes.</li> <li>• <b>Cancel</b> —Remains in the configuration session, without committing the configuration changes.</li> </ul>
Step 20	<p><b>show ipsla statistics</b> [<i>operation-number</i>]</p> <p><b>Example:</b></p> <pre>RP/0/RSP0/CPU0:router# show ipsla statistics 432</pre>	Displays the current statistics.

## Configuring the ICMP Path-jitter Operation

The IP SLA ICMP path-jitter operation provides hop-by-hop jitter, packet loss, and delay measurement statistics in an IP network. The path-jitter operation functions differently than the standard UDP jitter operation, which provides total one-way data and total round-trip data.

The ICMP path-jitter operation can be used as a supplement to the standard UDP jitter operation. For example, results from the UDP jitter operation can indicate unexpected delays or high jitter values; the ICMP path-jitter operation can then be used to troubleshoot the network path and determine if traffic is bottlenecking in a particular segment along the transmission path.

The operation first discovers the hop-by-hop IP route from the source to the destination using a traceroute utility, and uses ICMP echoes to determine the response times, packet loss and approximate jitter values for each hop along the path. The jitter values obtained using the ICMP path-jitter operation are approximate because they do not account for delays at the target nodes.

The ICMP path-jitter operation functions by tracing the IP path from a source device to a specified destination device, then sending N number of Echo probes to each hop along the traced path, with a time interval of T milliseconds between each Echo probe. The operation as a whole is repeated at a frequency of once every F seconds. The attributes are user-configurable, as described in this table.

**Table 5: ICMP Path-jitter Operation Parameters**

ICMP Path-jitter Operation Parameter	Default	Configured Using
Number of echo probes (N)	10 echoes	<ul style="list-style-type: none"> <li>• <b>ipsla operation</b> command with the <i>operation-number</i> argument</li> <li>• <b>packet count</b> command with the <i>count</i> argument</li> </ul>

ICMP Path-jitter Operation Parameter	Default	Configured Using
Time between Echo probes, in milliseconds (T)	20 ms	<ul style="list-style-type: none"> <li>• <b>ipsla operation</b> command with the <i>operation-number</i> argument</li> <li>• <b>packet interval</b> command with the <i>interval</i> argument</li> </ul>
The frequency of how often the operation is repeated (F)	once every 60 seconds	<ul style="list-style-type: none"> <li>• <b>ipsla operation</b> command with the <i>operation-number</i> argument</li> <li>• <b>frequency</b> command with the <i>seconds</i> argument</li> </ul>

Depending on whether you want to configure and schedule a basic ICMP path-jitter operation or configure and schedule an ICMP jitter operation with additional parameters, perform one of the following procedures:

## Configuring and Scheduling a Basic ICMP Path-jitter Operation

You can configure and schedule an ICMP path-jitter operation using the general default characteristics for the operation.

### SUMMARY STEPS

1. **configure**
2. **ipsla operation** *operation-number*
3. **type icmp path-jitter**
4. **destination address** *ipv4address*
5. **packet count** *count*
6. **packet interval** *interval*
7. **frequency** *seconds*
8. **exit**
9. **ipsla schedule operation** *op-num*
10. **life** {**forever** | *seconds*}
11. **ageout** *seconds*
12. **recurring**
13. **start-time** [*hh:mm:ss* {*day* | *month day*} | **now** | **pending** | **after** *hh:mm:ss*]
14. Use the **commit** or **end** command.
15. **show ipsla statistics** [*operation-number*]

### DETAILED STEPS

	Command or Action	Purpose
<b>Step 1</b>	<b>configure</b> <b>Example:</b> <pre>RP/0/RSP0/CPU0:router# configure</pre>	Enters global configuration mode.



	Command or Action	Purpose
Step 2	<p><b>ipsla operation</b> <i>operation-number</i></p> <p><b>Example:</b></p> <pre>RP/0/RSP0/CPU0:router(config)# ipsla operation 432</pre>	Specifies the operation number. The range is from 1 to 2048.
Step 3	<p><b>type icmp path-jitter</b></p> <p><b>Example:</b></p> <pre>RP/0/RSP0/CPU0:router(config-ipsla-op)# type icmp path-jitter</pre>	Defines an ICMP path-jitter operation type.
Step 4	<p><b>destination address</b> <i>ipv4address</i></p> <p><b>Example:</b></p> <pre>RP/0/RSP0/CPU0:router(config-ipsla-icmp-path-jitter)# destination address 12.25.26.10</pre>	Specifies the IP address of the destination for the proper operation type.
Step 5	<p><b>packet count</b> <i>count</i></p> <p><b>Example:</b></p> <pre>RP/0/RSP0/CPU0:router(config-ipsla-icmp-path-jitter)# packet count 30</pre>	<p>(Optional) Specifies the number of packets to be transmitted during a probe. For UDP jitter operation, the range is 1 to 60000. For ICMP path-jitter operation, the range is 1 to 100.</p> <p>The default number of packets sent is 10.</p>
Step 6	<p><b>packet interval</b> <i>interval</i></p> <p><b>Example:</b></p> <pre>RP/0/RSP0/CPU0:router(config-ipsla-icmp-path-jitter)# packet interval 30</pre>	(Optional) Specifies the time between packets. The default interval between packets is 20 milliseconds.
Step 7	<p><b>frequency</b> <i>seconds</i></p> <p><b>Example:</b></p> <pre>RP/0/RSP0/CPU0:router(config-ipsla-icmp-path-jitter)# frequency 300</pre>	<p>(Optional) Sets the rate at which a specified IP SLA operation is sent into the network.</p> <ul style="list-style-type: none"> <li>(Optional) Use the <i>seconds</i> argument to specify the number of seconds between the IP SLA operations. Valid values are in the range from 1 to 12604800 seconds. The default is 60 seconds.</li> </ul>
Step 8	<p><b>exit</b></p> <p><b>Example:</b></p> <pre>RP/0/RSP0/CPU0:router(config-ipsla-icmp-path-jitter)# exit RP/0/RSP0/CPU0:router(config-ipsla-op)# exit RP/0/RSP0/CPU0:router(config-ipsla)# exit RP/0/RSP0/CPU0:router(config)#</pre>	Exits IP SLA operation configuration mode and IP SLA configuration mode. Returns to global configuration mode.
Step 9	<p><b>ipsla schedule operation</b> <i>op-num</i></p> <p><b>Example:</b></p>	Schedules the start time of the operation. You can configure a basic schedule.

	Command or Action	Purpose
	<pre>RP/0/RSP0/CPU0:router(config)# ipsla schedule operation 432 RP/0/RSP0/CPU0:router(config-ipsla-sched)#</pre>	
<b>Step 10</b>	<p><b>life</b> {<b>forever</b>   <i>seconds</i>}</p> <p><b>Example:</b></p> <pre>RP/0/RSP0/CPU0:router(config-ipsla-sched)# life 30</pre>	The <b>forever</b> keyword schedules the operation to run indefinitely. The <i>seconds</i> argument schedules the lifetime of the operation, in seconds. The default lifetime of an operation is 3600 seconds (one hour).
<b>Step 11</b>	<p><b>ageout</b> <i>seconds</i></p> <p><b>Example:</b></p> <pre>RP/0/RSP0/CPU0:router(config-ipsla-sched)# ageout 3600</pre>	(Optional) Specifies the number of seconds to keep the operation in memory when it is not actively collecting information. The default value of 0 seconds means that the operation never times out.
<b>Step 12</b>	<p><b>recurring</b></p> <p><b>Example:</b></p> <pre>RP/0/RSP0/CPU0:router(config-ipsla-sched)# recurring</pre>	(Optional) Specifies that the operation starts automatically at the specified time and for the specified duration every day.
<b>Step 13</b>	<p><b>start-time</b> [<i>hh:mm:ss</i> {<i>day</i>   <i>month day</i>}]   <b>now</b>   <b>pending</b>   <b>after</b> <i>hh:mm:ss</i>]</p> <p><b>Example:</b></p> <pre>RP/0/RSP0/CPU0:router(config-ipsla-sched)# start-time 01:00:00</pre>	<p>(Optional) Specifies a time for the operation to start. The following keywords are described:</p> <ul style="list-style-type: none"> <li>• (Optional) Use the <b>pending</b> keyword to configure the operation to remain in a pending (unstarted) state. The default value is inactive. If the <b>start-time</b> command is not specified, no information is collected until the start time is configured or a trigger occurs that performs an immediate start.</li> <li>• (Optional) Use the <b>now</b> keyword to indicate that the operation should start immediately.</li> <li>• (Optional) Use the <b>after</b> keyword and associated arguments to specify the time after which the operation starts collecting information.</li> </ul>
<b>Step 14</b>	Use the <b>commit</b> or <b>end</b> command.	<p><b>commit</b> —Saves the configuration changes and remains within the configuration session.</p> <p><b>end</b> —Prompts user to take one of these actions:</p> <ul style="list-style-type: none"> <li>• <b>Yes</b> — Saves configuration changes and exits the configuration session.</li> <li>• <b>No</b> —Exits the configuration session without committing the configuration changes.</li> <li>• <b>Cancel</b> —Remains in the configuration session, without committing the configuration changes.</li> </ul>

	Command or Action	Purpose
Step 15	<b>show ipsla statistics</b> [ <i>operation-number</i> ] <b>Example:</b> RP/0/RSP0/CPU0:router# show ipsla statistics 432	Displays the current statistics.

## Configuring and Scheduling an ICMP Path-jitter Operation with Additional Parameters

You can enable an ICMP path-echo operation on the source device and configure some optional IP SLA parameters.

### SUMMARY STEPS

1. **configure**
2. **ipsla operation** *operation-number*
3. **type icmp path-jitter**
4. **vrf** *vrf-name*
5. **lsr-path** *ip-address*
6. **destination address** *ipv4address*
7. **packet count** *count*
8. **packet interval** *interval*
9. **frequency** *seconds*
10. **datasize request** *size*
11. **tos** *number*
12. **timeout** *milliseconds*
13. **tag** *text*
14. **exit**
15. **ipsla schedule operation** *op-num*
16. **life** {*forever* | *seconds*}
17. **ageout** *seconds*
18. **recurring**
19. **start-time** [*hh:mm:ss* {*day* | *month day*} | **now** | **pending** | **after** *hh:mm:ss*]
20. Use the **commit** or **end** command.
21. **show ipsla statistics** [*operation-number*]

### DETAILED STEPS

	Command or Action	Purpose
Step 1	<b>configure</b> <b>Example:</b> RP/0/RSP0/CPU0:router# configure	Enters global configuration mode.
Step 2	<b>ipsla operation</b> <i>operation-number</i> <b>Example:</b>	Specifies the operation number. The range is from 1 to 2048.

	Command or Action	Purpose
	RP/0/RSP0/CPU0:router(config)# ipsla operation 432	
<b>Step 3</b>	<b>type icmp path-jitter</b> <b>Example:</b> RP/0/RSP0/CPU0:router(config-ipsla-op)# type icmp path-jitter	Defines an ICMP path-jitter operation type.
<b>Step 4</b>	<b>vrf vrf-name</b> <b>Example:</b> RP/0/RSP0/CPU0:router(config-ipsla-icmp-path-jitter)# vrf VPN-A	(Optional) Enables the monitoring of a VPN (using a nondefault routing table) in an ICMP path-jitter operation. Maximum length is 32 alphanumeric characters.
<b>Step 5</b>	<b>lsr-path ip-address</b> <b>Example:</b> RP/0/RSP0/CPU0:router(config-ipsla-icmp-path-jitter)# lsr-path 20.25.22.1	Specifies that a loose source routing path is to be used.
<b>Step 6</b>	<b>destination address ipv4address</b> <b>Example:</b> RP/0/RSP0/CPU0:router(config-ipsla-icmp-path-jitter)# destination address 12.25.26.10	Specifies the IP address of the destination for the proper operation type.
<b>Step 7</b>	<b>packet count count</b> <b>Example:</b> RP/0/RSP0/CPU0:router(config-ipsla-icmp-path-jitter)# packet count 30	(Optional) Specifies the number of packets to be transmitted during a probe. For UDP jitter operation, the range is 1 to 60000. For ICMP path-jitter operation, the range is 1 to 100.  The default number of packets sent is 10.
<b>Step 8</b>	<b>packet interval interval</b> <b>Example:</b> RP/0/RSP0/CPU0:router(config-ipsla-icmp-path-jitter)# packet interval 30	(Optional) Specifies the time between packets. The default interval between packets is 20 milliseconds
<b>Step 9</b>	<b>frequency seconds</b> <b>Example:</b> RP/0/RSP0/CPU0:router(config-ipsla-icmp-path-jitter)# frequency 300	(Optional) Sets the rate at which a specified IP SLA operation is sent into the network.  • (Optional) Use the <i>seconds</i> argument to specify the number of seconds between the IP SLA operations. Valid values are in the range from 1 to 12604800 seconds. The default is 60 seconds.
<b>Step 10</b>	<b>datsize request size</b> <b>Example:</b>	(Optional) Sets the protocol data size in the payload of the request packet for the specified IP SLA operation.

	Command or Action	Purpose
	RP/0/RSP0/CPU0:router(config-ipsla-icmp-path-jitter)# datasize request 512	<ul style="list-style-type: none"> <li>Use the <i>size</i> argument to specify the protocol data size in bytes. The default for jitter is 36 bytes. The range is 0 to 16384 bytes.</li> </ul>
<b>Step 11</b>	<b>tos number</b> <b>Example:</b> RP/0/RSP0/CPU0:router(config-ipsla-icmp-path-jitter)# tos 1	<p>Defines a type of service (ToS) byte in the IP header of IP SLA operations.</p> <p><b>Note</b> The ToS byte can be converted to a Differentiated Services Code Point (DSCP) value, but you cannot enter the DSCP value directly. To use a DSCP value, multiply it by 4 and enter the result as the <i>number</i> argument.</p>
<b>Step 12</b>	<b>timeout milliseconds</b> <b>Example:</b> RP/0/RSP0/CPU0:router(config-ipsla-icmp-path-jitter)# timeout 10000	<p>Sets the time that the IP SLA operation waits for a response from its request packet.</p> <ul style="list-style-type: none"> <li>Use the <i>milliseconds</i> argument to specify the number of milliseconds that the operation waits to receive a response.</li> </ul>
<b>Step 13</b>	<b>tag text</b> <b>Example:</b> RP/0/RSP0/CPU0:router(config-ipsla-icmp-path-jitter)# tag ipsla	(Optional) Creates a user-specified identifier for an IP SLA operation.
<b>Step 14</b>	<b>exit</b> <b>Example:</b> RP/0/RSP0/CPU0:router(config-ipsla-icmp-path-jitter)# exit RP/0/RSP0/CPU0:router(config-ipsla-op)# exit RP/0/RSP0/CPU0:router(config-ipsla)# exit RP/0/RSP0/CPU0:router(config)#	Exits IP SLA operation configuration mode and IP SLA configuration mode. Returns to global configuration mode.
<b>Step 15</b>	<b>ipsla schedule operation op-num</b> <b>Example:</b> RP/0/RSP0/CPU0:router(config)# ipsla schedule operation 432 RP/0/RSP0/CPU0:router(config-ipsla-sched)#	Schedules the start time of the operation. You can configure a basic schedule.
<b>Step 16</b>	<b>life {forever   seconds}</b> <b>Example:</b> RP/0/RSP0/CPU0:router(config-ipsla-sched)# life 30	The <b>forever</b> keyword schedules the operation to run indefinitely. The <i>seconds</i> argument schedules the lifetime of the operation, in seconds. The default lifetime of an operation is 3600 seconds (one hour).
<b>Step 17</b>	<b>ageout seconds</b> <b>Example:</b>	(Optional) Specifies the number of seconds to keep the operation in memory when it is not actively collecting

	Command or Action	Purpose
	RP/0/RSP0/CPU0:router(config-ipsla-sched)# ageout 3600	information. The default value of 0 seconds means that the operation never times out.
<b>Step 18</b>	<b>recurring</b> <b>Example:</b>  RP/0/RSP0/CPU0:router(config-ipsla-sched)# recurring	(Optional) Specifies that the operation starts automatically at the specified time and for the specified duration every day.
<b>Step 19</b>	<b>start-time</b> [ <i>hh:mm:ss {day   month day}</i> ]   <b>now</b>   <b>pending</b>   <b>after</b> <i>hh:mm:ss</i> <b>Example:</b>  RP/0/RSP0/CPU0:router(config-ipsla-sched)# start-time 01:00:00	Specifies a time for the operation to start. The following keywords are described: <ul style="list-style-type: none"> <li>• (Optional) Use the <b>pending</b> keyword to configure the operation to remain in a pending (unstarted) state. The default value is inactive. If the <b>start-time</b> command is not specified, no information is collected until the start time is configured or a trigger occurs that performs an immediate start.</li> <li>• (Optional) Use the <b>now</b> keyword to indicate that the operation should start immediately.</li> <li>• (Optional) Use the <b>after</b> keyword and associated arguments to specify the time after which the operation starts collecting information.</li> </ul>
<b>Step 20</b>	Use the <b>commit</b> or <b>end</b> command.	<b>commit</b> —Saves the configuration changes and remains within the configuration session. <b>end</b> —Prompts user to take one of these actions: <ul style="list-style-type: none"> <li>• <b>Yes</b> — Saves configuration changes and exits the configuration session.</li> <li>• <b>No</b> —Exits the configuration session without committing the configuration changes.</li> <li>• <b>Cancel</b> —Remains in the configuration session, without committing the configuration changes.</li> </ul>
<b>Step 21</b>	<b>show ipsla statistics</b> [ <i>operation-number</i> ] <b>Example:</b>  RP/0/RSP0/CPU0:router# show ipsla statistics 432	Displays the current statistics.

## Configuring IP SLA MPLS LSP Ping and Trace Operations

The MPLS LSP ping and trace operations allow service providers to monitor label switched paths (LSPs) and quickly isolate MPLS forwarding problems. Use these IP SLA operations to troubleshoot network connectivity

between a source router and a target router. To test LSPs, the MPLS LSP ping and trace operations send echo request packets and receive echo reply packets.

To configure and schedule an MPLS LSP ping or trace operation, perform one of the following tasks:

## Configuring and Scheduling an MPLS LSP Ping Operation

An MPLS LSP ping operation tests connectivity between routers along an LSP path in an MPLS network by sending an echo request (User Datagram Protocol (UDP) packet) to the end of the LSP, and receiving an echo reply back that contains diagnostic data.

The MPLS echo request packet is sent to a target router through the use of the appropriate label stack associated with the LSP to be validated. Use of the label stack causes the packet to be forwarded over the LSP itself.

The destination IP address of the MPLS echo request packet is different from the address used to select the label stack. The destination IP address is defined as a 127.x.y.z/8 address. The 127.x.y.z/8 address prevents the IP packet from being IP switched to its destination if the LSP is broken.

An MPLS echo reply is sent in response to an MPLS echo request. The reply is sent as an IP packet and it is forwarded using IP, MPLS, or a combination of both types of switching. The source address of the MPLS echo reply packet is an address obtained from the router generating the echo reply. The destination address is the source address of the router that originated the MPLS echo request packet. The MPLS echo reply destination port is set to the echo request source port.

The MPLS LSP ping operation verifies LSP connectivity by using one of the supported Forwarding Equivalence Class (FEC) entities between the ping origin and egress node of each FEC. The following FEC types are supported for an MPLS LSP ping operation:

- LDP IPv4 prefixes (configured with the **target ipv4** command)
- MPLS TE tunnels (configured with the **target traffic-eng tunnel** command)
- Pseudowire (configured with the **target pseudowire** command)

### SUMMARY STEPS

1. **configure**
2. **ipsla operation** *operation-number*
3. **type mpls lsp ping**
4. **output interface** *type interface-path-id*
5. **target** {**ipv4** *destination-address destination-mask* | **traffic-eng tunnel** *tunnel-interface* | **pseudowire** *destination-address circuit-id*}
6. **lsp selector ipv4** *ip-address*
7. **force explicit-null**
8. **reply dscp** *dscp-bits*
9. **reply mode** {**control-channel** | **router-alert**}
10. **exp** *exp-bits*
11. **ttl** *time-to-live*
12. **exit**
13. **ipsla schedule operation** *operation-number*
14. **start-time** [*hh:mm:ss {day | month day}*] | **now** | **pending** | **after** *hh:mm:ss*]
15. Use the **commit** or **end** command.
16. **show ipsla statistics** [*operation-number*]

## DETAILED STEPS

	Command or Action	Purpose
<b>Step 1</b>	<b>configure</b> <b>Example:</b>  RP/0/RSP0/CPU0:router# configure	Enters global configuration mode.
<b>Step 2</b>	<b>ipsla operation operation-number</b> <b>Example:</b>  RP/0/RSP0/CPU0:router(config)# ipsla operation 432	Configures an IP SLA operation and specifies the operation number. The range is from 1 to 2048.
<b>Step 3</b>	<b>type mpls lsp ping</b> <b>Example:</b>  RP/0/RSP0/CPU0:router(config-ipsla-op)# type mpls lsp ping	Configures an MPLS LSP ping operation and enters IP SLA MPLS LSP Ping configuration mode.
<b>Step 4</b>	<b>output interface type interface-path-id</b> <b>Example:</b>  RP/0/RSP0/CPU0:router(config-ipsla-mpls-lsp-ping)# output interface pos 0/1/0/0	(Optional) Configures the echo request output interface to be used for LSP ping operations.  <b>Note</b> You cannot use the <b>output interface</b> command if pseudowire is specified as the target to be used in an MPLS LSP ping operation
<b>Step 5</b>	<b>target {ipv4 destination-address destination-mask   traffic-eng tunnel tunnel-interface   pseudowire destination-address circuit-id}</b> <b>Example:</b>  RP/0/RSP0/CPU0:router(config-ipsla-mpls-lsp-ping)# target ipv4 10.25.26.10 255.255.255.255  or  RP/0/RSP0/CPU0:router(config-ipsla-mpls-lsp-ping)# target ipv4 10.25.26.10/32  or  RP/0/RSP0/CPU0:router(config-ipsla-mpls-lsp-ping)# target traffic-eng tunnel 12  or  RP/0/RSP0/CPU0:router(config-ipsla-mpls-lsp-trace)# target pseudowire 192.168.1.4 4211	Specifies the target destination of the MPLS LSP ping operation as a LDP IPv4 address, MPLS traffic engineering tunnel, or pseudowire.
<b>Step 6</b>	<b>lsp selector ipv4 ip-address</b> <b>Example:</b>	(Optional) Specifies the local host IPv4 address used to select the LSP in an MPLS LSP ping operation.



	Command or Action	Purpose
	RP/0/RSP0/CPU0:router(config-ipsla-mpls-lsp-ping)# lsp selector ipv4 127.0.0.2	
<b>Step 7</b>	<b>force explicit-null</b> <b>Example:</b>  RP/0/RSP0/CPU0:router(config-ipsla-mpls-lsp-ping)# force explicit-null	(Optional) Adds an explicit null label to the label stack of an LSP when an echo request is sent.
<b>Step 8</b>	<b>reply dscp dscp-bits</b> <b>Example:</b>  RP/0/RSP0/CPU0:router(config-ipsla-mpls-lsp-ping)# reply dscp 2	(Optional) Specifies the differentiated services codepoint (DSCP) value to be used in echo reply packets. Valid values are from 0 to 63.  Reserved keywords such as EF (expedited forwarding) and AF11 (assured forwarding class AF11) can be specified instead of numeric values.
<b>Step 9</b>	<b>reply mode {control-channel   router-alert}</b> <b>Example:</b>  RP/0/RSP0/CPU0:router(config-ipsla-mpls-lsp-ping)# reply mode router-alert  or  RP/0/RSP0/CPU0:router(config-ipsla-mpls-lsp-ping)# reply mode control-channel	(Optional) Sets echo requests to send echo reply packets by way of a control channel in an MPLS LSP ping operation, or to reply as an IPv4 UDP packet with IP router alert. The router-alert reply mode forces an echo reply packet to be specially handled by the transit LSR router at each intermediate hop as it moves back to the destination.  <b>Note</b> The <b>control-channel</b> keyword can be used only if the target is set to pseudowire.
<b>Step 10</b>	<b>exp exp-bits</b> <b>Example:</b>  RP/0/RSP0/CPU0:router(config-ipsla-mpls-lsp-ping)# exp 5	(Optional) Specifies the MPLS experimental field (EXP) value to be used in the header of echo reply packets. Valid values are from 0 to 7.
<b>Step 11</b>	<b>ttl time-to-live</b> <b>Example:</b>  RP/0/RSP0/CPU0:router(config-ipsla-mpls-lsp-ping)# ttl 200	(Optional) Specifies the time-to-live (TTL) value used in the MPLS label of echo request packets. Valid values are from 1 to 255.
<b>Step 12</b>	<b>exit</b> <b>Example:</b>  RP/0/RSP0/CPU0:router(config-ipsla-mpls-lsp-ping)# exit RP/0/RSP0/CPU0:router(config-ipsla-op)# exit RP/0/RSP0/CPU0:router(config-ipsla)# exit RP/0/RSP0/CPU0:router(config)#	Exits IP SLA MPLS LSP Ping configuration mode and IP SLA configuration mode. Returns to global configuration mode.
<b>Step 13</b>	<b>ipsla schedule operation operation-number</b> <b>Example:</b>	Schedules the start time of the operation. You can configure a basic schedule.

	Command or Action	Purpose
	<pre>RP/0/RSP0/CPU0:router(config)# ipsla schedule operation 432 RP/0/RSP0/CPU0:router(config-ipsla-sched)#</pre>	
<b>Step 14</b>	<p><b>start-time</b> [<i>hh:mm:ss {day   month day}</i>]   <b>now</b>   <b>pending</b>   <b>after</b> <i>hh:mm:ss</i>]</p> <p><b>Example:</b></p> <pre>RP/0/RSP0/CPU0:router(config-ipsla-sched)# start-time 01:00:00</pre>	<p>Specifies a time for the operation to start. The following keywords are described:</p> <ul style="list-style-type: none"> <li>• (Optional) Use the <b>pending</b> keyword to configure the operation to remain in a pending (unstarted) state. The default value is inactive. If the <b>start-time</b> command is not specified, no information is collected until the start time is configured or a trigger occurs that performs an immediate start.</li> <li>• (Optional) Use the <b>now</b> keyword to indicate that the operation should start immediately.</li> <li>• (Optional) Use the <b>after</b> keyword and associated arguments to specify the time after which the operation starts collecting information.</li> </ul>
<b>Step 15</b>	Use the <b>commit</b> or <b>end</b> command.	<p><b>commit</b> —Saves the configuration changes and remains within the configuration session.</p> <p><b>end</b> —Prompts user to take one of these actions:</p> <ul style="list-style-type: none"> <li>• <b>Yes</b> — Saves configuration changes and exits the configuration session.</li> <li>• <b>No</b> —Exits the configuration session without committing the configuration changes.</li> <li>• <b>Cancel</b> —Remains in the configuration session, without committing the configuration changes.</li> </ul>
<b>Step 16</b>	<p><b>show ipsla statistics</b> [<i>operation-number</i>]</p> <p><b>Example:</b></p> <pre>RP/0/RSP0/CPU0:router# show ipsla statistics 432</pre>	Displays IP SLA statistics for the current MPLS LSP ping operation.

## Configuring and Scheduling an MPLS LSP Trace Operation

An MPLS LSP trace operation traces the hop-by-hop route of LSP paths to a target router in an MPLS network by sending echo requests (UDP packets) to the control plane of each transit label switching router (LSR). A transit LSR performs various checks to determine if it is a transit LSR for the LSP path. A trace operation allows you to troubleshoot network connectivity and localize faults hop-by-hop.

Echo request and reply packets validate the LSP. The success of an MPLS LSP trace operation depends on the transit router processing the MPLS echo request when it receives a labeled packet.

The transit router returns an MPLS echo reply containing information about the transit hop in response to any time-to-live (TTL)-expired MPLS packet or LSP breakage. The destination port of the MPLS echo reply is set to the echo request source port.

In an MPLS LSP trace operation, each transit LSR returns information related to the type of Forwarding Equivalence Class (FEC) entity that is being traced. This information allows the trace operation to check if the local forwarding information matches what the routing protocols determine as the LSP path.

An MPLS label is bound to a packet according to the type of FEC used for the LSP. The following FEC types are supported for an MPLS LSP trace operation:

- LDP IPv4 prefixes (configured with the **target ipv4** command)
- MPLS TE tunnels (configured with the **target traffic-eng tunnel** command)

## SUMMARY STEPS

1. **configure**
2. **ipsla operation** *operation-number*
3. **type mpls lsp trace**
4. **output interface** *type interface-path-id*
5. Do one of the following:
  - **target ipv4** *destination-address destination-mask*
  - **target traffic-eng tunnel** *tunnel-interface*
6. **lsp selector ipv4** *ip-address*
7. **force explicit-null**
8. **reply dscp** *dscp-bits*
9. **reply mode router-alert**
10. **exp** *exp-bits*
11. **ttl** *time-to-live*
12. **exit**
13. **ipsla schedule operation** *operation-number*
14. **start-time** [*hh:mm:ss {day | month day}*] | **now** | **pending** | **after** *hh:mm:ss*
15. Use the **commit** or **end** command.
16. **show ipsla statistics** [*operation-number*]

## DETAILED STEPS

	Command or Action	Purpose
Step 1	<b>configure</b> <b>Example:</b> RP/0/RSP0/CPU0:router# <code>configure</code>	Enters global configuration mode.
Step 2	<b>ipsla operation</b> <i>operation-number</i> <b>Example:</b>	Configures an IP SLA operation and specifies the operation number. The range is from 1 to 2048.

	Command or Action	Purpose
	RP/0/RSP0/CPU0:router(config)# ipsla operation 432	
<b>Step 3</b>	<b>type mpls lsp trace</b> <b>Example:</b> RP/0/RSP0/CPU0:router(config-ipsla-op)# type mpls lsp trace	Configures an MPLS LSP trace operation and enters IP SLA MPLS LSP Trace configuration mode.
<b>Step 4</b>	<b>output interface <i>type interface-path-id</i></b> <b>Example:</b> RP/0/RSP0/CPU0:router(config-ipsla-mpls-lsp-ping)# output interface pos 0/1/0/0	(Optional) Configures the echo request output interface to be used for LSP trace operations.
<b>Step 5</b>	Do one of the following: <ul style="list-style-type: none"> <li>• <b>target ipv4 <i>destination-address destination-mask</i></b></li> <li>• <b>target traffic-eng tunnel <i>tunnel-interface</i></b></li> </ul> <b>Example:</b> RP/0/RSP0/CPU0:router(config-ipsla-mpls-lsp-trace)# target ipv4 10.25.26.10 255.255.255.255 RP/0/RSP0/CPU0:router(config-ipsla-mpls-lsp-trace)# target ipv4 10.25.26.10/32 or RP/0/RSP0/CPU0:router(config-ipsla-mpls-lsp-trace)# target traffic-eng tunnel 12	Specifies the target destination of the MPLS LSP trace operation as an LDP IPv4 address or MPLS traffic engineering tunnel.
<b>Step 6</b>	<b>lsp selector ipv4 <i>ip-address</i></b> <b>Example:</b> RP/0/RSP0/CPU0:router(config-ipsla-mpls-lsp-trace)# lsp selector ipv4 127.0.0.2	(Optional) Specifies the local host IPv4 address used to select the LSP in the MPLS LSP ping operation.
<b>Step 7</b>	<b>force explicit-null</b> <b>Example:</b> RP/0/RSP0/CPU0:router(config-ipsla-mpls-lsp-trace)# force explicit-null	(Optional) Adds an explicit null label to the label stack of an LSP when an echo request is sent.
<b>Step 8</b>	<b>reply dscp <i>dscp-bits</i></b> <b>Example:</b> RP/0/RSP0/CPU0:router(config-ipsla-mpls-lsp-trace)# reply dscp 2	(Optional) Specifies the differentiated services codepoint (DSCP) value to be used in echo reply packets. Valid values are from 0 to 63. Reserved keywords such as EF (expedited forwarding) and AF11 (assured forwarding class AF11) can be specified instead of numeric values.

	Command or Action	Purpose
Step 9	<p><b>reply mode router-alert</b></p> <p><b>Example:</b></p> <pre>RP/0/RSP0/CPU0:router(config-ipsla-mpls-lsp-trace)# reply mode router-alert</pre>	(Optional) Sets echo requests to reply as an IPv4 UDP packet with IP router alert. The router-alert reply mode forces an echo reply packet to be specially handled by the transit LSR router at each intermediate hop as it moves back to the destination.
Step 10	<p><b>exp <i>exp-bits</i></b></p> <p><b>Example:</b></p> <pre>RP/0/RSP0/CPU0:router(config-ipsla-mpls-lsp-trace)# exp 5</pre>	(Optional) Specifies the MPLS experimental field (EXP) value to be used in the header of echo reply packets. Valid values are from 0 to 7.
Step 11	<p><b>ttl <i>time-to-live</i></b></p> <p><b>Example:</b></p> <pre>RP/0/RSP0/CPU0:router(config-ipsla-mpls-lsp-trace)# ttl 20</pre>	(Optional) Specifies the time-to-live (TTL) value used in the MPLS label of echo request packets. Valid values are from 1 to 255.
Step 12	<p><b>exit</b></p> <p><b>Example:</b></p> <pre>RP/0/RSP0/CPU0:router(config-ipsla-mpls-lsp-trace)# exit RP/0/RSP0/CPU0:router(config-ipsla-op)# exit RP/0/RSP0/CPU0:router(config-ipsla)# exit RP/0/RSP0/CPU0:router(config)#</pre>	Exits IP SLA MPLS LSP Trace configuration mode and IP SLA configuration mode. Returns to global configuration mode.
Step 13	<p><b>ipsla schedule operation <i>operation-number</i></b></p> <p><b>Example:</b></p> <pre>RP/0/RSP0/CPU0:router(config)# ipsla schedule operation 432 RP/0/RSP0/CPU0:router(config-ipsla-sched)#</pre>	Schedules the start time of the operation. You can configure a basic schedule.
Step 14	<p><b>start-time [hh:mm:ss {day   month day}   now   pending   after hh:mm:ss]</b></p> <p><b>Example:</b></p> <pre>RP/0/RSP0/CPU0:router(config-ipsla-sched)# start-time 01:00:00</pre>	<p>Specifies a time for the operation to start. The following keywords are described:</p> <ul style="list-style-type: none"> <li>• (Optional) Use the <b>pending</b> keyword to configure the operation to remain in a pending (unstarted) state. The default value is inactive. If the <b>start-time</b> command is not specified, no information is collected until the start time is configured or a trigger occurs that performs an immediate start.</li> <li>• (Optional) Use the <b>now</b> keyword to indicate that the operation should start immediately.</li> <li>• (Optional) Use the <b>after</b> keyword and associated arguments to specify the time after which the operation starts collecting information.</li> </ul>

	Command or Action	Purpose
<b>Step 15</b>	Use the <b>commit</b> or <b>end</b> command.	<p><b>commit</b> —Saves the configuration changes and remains within the configuration session.</p> <p><b>end</b> —Prompts user to take one of these actions:</p> <ul style="list-style-type: none"> <li>• <b>Yes</b> — Saves configuration changes and exits the configuration session.</li> <li>• <b>No</b> —Exits the configuration session without committing the configuration changes.</li> <li>• <b>Cancel</b> —Remains in the configuration session, without committing the configuration changes.</li> </ul>
<b>Step 16</b>	<p><b>show ipsla statistics</b> [<i>operation-number</i>]</p> <p><b>Example:</b></p> <pre>RP/0/RSP0/CPU0:router # show ipsla statistics 432</pre>	Displays the current IP SLA statistics for the trace operation.

## Configuring IP SLA Reactions and Threshold Monitoring

If you want IP SLA to set some threshold and inform you of a threshold violation, the **ipsla reaction operation** command and the **ipsla reaction trigger** command are required. Perform the following procedures to configure IP SLA reactions and threshold monitoring:

### Configuring Monitored Elements for IP SLA Reactions

IP SLA reactions are configured to be triggered when a monitored value exceeds or falls below a specified level or a monitored event (for example, timeout or connection-loss) occurs. These monitored values and events are called monitored elements. You can configure the conditions for a reaction to occur in a particular operation.

The types of monitored elements that are available are presented in the following sections:

#### Configuring Triggers for Connection-Loss Violations

You can configure a reaction if there is a connection-loss for the monitored operation.

#### SUMMARY STEPS

1. **configure**
2. **ipsla reaction operation** *operation-number*
3. **react** [**connection-loss**]
4. Use the **commit** or **end** command.

## DETAILED STEPS

	Command or Action	Purpose
Step 1	<b>configure</b> <b>Example:</b> RP/0/RSP0/CPU0:router# configure	Enters global configuration mode.
Step 2	<b>ipsla reaction operation <i>operation-number</i></b> <b>Example:</b> RP/0/RSP0/CPU0:router(config)# ipsla reaction operation 432	Configures certain actions that are based on events under the control of the IP SLA agent. The <i>operation-number</i> argument is the number of the IP SLA operations for the reactions that are configured. The range is from 1 to 2048.
Step 3	<b>react [connection-loss]</b> <b>Example:</b> RP/0/RSP0/CPU0:router(config-ipsla-react)# react connection-loss RP/0/RSP0/CPU0:router(config-ipsla-react-cond)#	Specifies an element to be monitored for a reaction.  Use the <b>connection-loss</b> keyword to specify a reaction that occurs if there is a connection-loss for the monitored operation.
Step 4	Use the <b>commit</b> or <b>end</b> command.	<b>commit</b> —Saves the configuration changes and remains within the configuration session.  <b>end</b> —Prompts user to take one of these actions: <ul style="list-style-type: none"> <li>• <b>Yes</b> — Saves configuration changes and exits the configuration session.</li> <li>• <b>No</b> —Exits the configuration session without committing the configuration changes.</li> <li>• <b>Cancel</b> —Remains in the configuration session, without committing the configuration changes.</li> </ul>

## Configuring Triggers for Jitter Violations

Jitter values are computed as source-to-destination and destination-to-source values. Events, for example, traps, can be triggered when the jitter value in either direction or both directions rises above a specified threshold or falls below a specified threshold. You can configure jitter-average as a monitored element.

## SUMMARY STEPS

1. **configure**
2. **ipsla reaction operation *operation-number***
3. **react [jitter-average {dest-to-source | source-to-dest}]**
4. Use the **commit** or **end** command.

## DETAILED STEPS

	Command or Action	Purpose
<b>Step 1</b>	<b>configure</b> <b>Example:</b> RP/0/RSP0/CPU0:router# configure	Enters global configuration mode.
<b>Step 2</b>	<b>ipsla reaction operation <i>operation-number</i></b> <b>Example:</b> RP/0/RSP0/CPU0:router(config)# ipsla reaction operation 432	Configures certain actions that are based on events under the control of the IP SLA agent. The <i>operation-number</i> argument is the number of the IP SLA operations for the reactions that are configured. The range is from 1 to 2048.
<b>Step 3</b>	<b>react [jitter-average {dest-to-source   source-to-dest}]</b> <b>Example:</b> RP/0/RSP0/CPU0:router(config-ipsla-react)# react jitter-average RP/0/RSP0/CPU0:router(config-ipsla-react-cond)#	Specifies an element to be monitored for a reaction. A reaction occurs if the average round-trip jitter value violates the upper threshold or lower threshold. The following options are listed for the <b>jitter-average</b> keyword: <ul style="list-style-type: none"> <li>• <b>dest-to-source</b>—Specifies the jitter average destination to source (DS).</li> <li>• <b>source-to-dest</b>—Specifies the jitter average source to destination (SD).</li> </ul>
<b>Step 4</b>	Use the <b>commit</b> or <b>end</b> command.	<b>commit</b> —Saves the configuration changes and remains within the configuration session. <b>end</b> —Prompts user to take one of these actions: <ul style="list-style-type: none"> <li>• <b>Yes</b> — Saves configuration changes and exits the configuration session.</li> <li>• <b>No</b> —Exits the configuration session without committing the configuration changes.</li> <li>• <b>Cancel</b> —Remains in the configuration session, without committing the configuration changes.</li> </ul>

## Configuring Triggers for Packet Loss Violations

Packet-loss values are computed as source-to-destination and destination-to-source values. Events, for example, traps, can be triggered when the packet-loss values in either direction rise above a specified threshold or fall below a specified threshold. Perform this task to configure packet-loss as a monitored element.

## SUMMARY STEPS

1. **configure**
2. **ipsla reaction operation *operation-number***
3. **react [packet-loss [dest-to-source | source-to-dest]]**
4. Use the **commit** or **end** command.



## DETAILED STEPS

	Command or Action	Purpose
<b>Step 1</b>	<b>configure</b> <b>Example:</b> RP/0/RSP0/CPU0:router# configure	Enters global configuration mode.
<b>Step 2</b>	<b>ipsla reaction operation <i>operation-number</i></b> <b>Example:</b> RP/0/RSP0/CPU0:router(config)# ipsla reaction operation 432	Configures certain actions that are based on events under the control of the IP SLA agent. The <i>operation-number</i> argument is the number of the IP SLA operations for the reactions that are configured. The range is from 1 to 2048.
<b>Step 3</b>	<b>react [packet-loss [dest-to-source   source-to-dest]]</b> <b>Example:</b> RP/0/RSP0/CPU0:router(config-ipsla-react)# react packet-loss dest-to-source RP/0/RSP0/CPU0:router(config-ipsla-react-cond)#	Specifies an element to be monitored for a reaction. The reaction on packet loss value violation is specified. The following options are listed for the <b>packet-loss</b> keyword: <ul style="list-style-type: none"> <li>• <b>dest-to-source</b>—Specifies the packet loss destination to source (DS) violation.</li> <li>• <b>source-to-dest</b>—Specifies the packet loss source to destination (SD) violation.</li> </ul>
<b>Step 4</b>	Use the <b>commit</b> or <b>end</b> command.	<b>commit</b> —Saves the configuration changes and remains within the configuration session. <b>end</b> —Prompts user to take one of these actions: <ul style="list-style-type: none"> <li>• <b>Yes</b> — Saves configuration changes and exits the configuration session.</li> <li>• <b>No</b> —Exits the configuration session without committing the configuration changes.</li> <li>• <b>Cancel</b> —Remains in the configuration session, without committing the configuration changes.</li> </ul>

## Configuring Triggers for Round-Trip Violations

Round-trip time (RTT) is a monitored value of all IP SLA operations. Events, for example, traps, can be triggered when the rtt value rises above a specified threshold or falls below a specified threshold. You can configure rtt as a monitored element.

## SUMMARY STEPS

1. **configure**
2. **ipsla reaction operation *operation-number***
3. **react [rtt]**
4. Use the **commit** or **end** command.

## DETAILED STEPS

	Command or Action	Purpose
<b>Step 1</b>	<b>configure</b> <b>Example:</b> RP/0/RSP0/CPU0:router# configure	Enters global configuration mode.
<b>Step 2</b>	<b>ipsla reaction operation <i>operation-number</i></b> <b>Example:</b> RP/0/RSP0/CPU0:router(config)# ipsla reaction operation 432	Configures certain actions that are based on events under the control of the IP SLA agent. The <i>operation-number</i> argument is the number of the IP SLA operations for the reactions that are configured. The range is from 1 to 2048.
<b>Step 3</b>	<b>react [rtt]</b> <b>Example:</b> RP/0/RSP0/CPU0:router(config-ipsla-react)# react rtt RP/0/RSP0/CPU0:router(config-ipsla-react-cond)#	Specifies an element to be monitored for a reaction.  Use the <b>rtt</b> keyword to specify a reaction that occurs if the round-trip value violates the upper threshold or lower threshold.
<b>Step 4</b>	Use the <b>commit</b> or <b>end</b> command.	<b>commit</b> —Saves the configuration changes and remains within the configuration session.  <b>end</b> —Prompts user to take one of these actions: <ul style="list-style-type: none"> <li>• <b>Yes</b> — Saves configuration changes and exits the configuration session.</li> <li>• <b>No</b> —Exits the configuration session without committing the configuration changes.</li> <li>• <b>Cancel</b> —Remains in the configuration session, without committing the configuration changes.</li> </ul>

## Configuring Triggers for Timeout Violations

You can configure triggers for timeout violations.

## SUMMARY STEPS

1. **configure**
2. **ipsla reaction operation *operation-number***
3. **react [timeout]**
4. Use the **commit** or **end** command.

## DETAILED STEPS

	Command or Action	Purpose
<b>Step 1</b>	<b>configure</b> <b>Example:</b>	Enters global configuration mode.

	Command or Action	Purpose
	RP/0/RSP0/CPU0:router# configure	
<b>Step 2</b>	<p><b>ipsla reaction operation</b> <i>operation-number</i></p> <p><b>Example:</b></p> <pre>RP/0/RSP0/CPU0:router(config)# ipsla reaction operation 432</pre>	Configures certain actions that are based on events under the control of the IP SLA agent. The <i>operation-number</i> argument is the number of the IP SLA operations for the reactions that are configured. The range is from 1 to 2048.
<b>Step 3</b>	<p><b>react</b> [<b>timeout</b>]</p> <p><b>Example:</b></p> <pre>RP/0/RSP0/CPU0:router(config-ipsla-react)# react timeout RP/0/RSP0/CPU0:router(config-ipsla-react-cond)#</pre>	<p>Specifies an element to be monitored for a reaction.</p> <p>Use the <b>timeout</b> keyword to specify a reaction that occurs if there is a timeout for the monitored operation.</p>
<b>Step 4</b>	Use the <b>commit</b> or <b>end</b> command.	<p><b>commit</b> —Saves the configuration changes and remains within the configuration session.</p> <p><b>end</b> —Prompts user to take one of these actions:</p> <ul style="list-style-type: none"> <li>• <b>Yes</b> — Saves configuration changes and exits the configuration session.</li> <li>• <b>No</b> —Exits the configuration session without committing the configuration changes.</li> <li>• <b>Cancel</b> —Remains in the configuration session, without committing the configuration changes.</li> </ul>

### Configuring Triggers for Verify Error Violations

You can specify a reaction if there is an error verification violation.

#### SUMMARY STEPS

1. **configure**
2. **ipsla reaction operation** *operation-number*
3. **react** [**verify-error**]
4. Use the **commit** or **end** command.

#### DETAILED STEPS

	Command or Action	Purpose
<b>Step 1</b>	<p><b>configure</b></p> <p><b>Example:</b></p> <pre>RP/0/RSP0/CPU0:router# configure</pre>	Enters global configuration mode.

	Command or Action	Purpose
<b>Step 2</b>	<p><b>ipsla reaction operation</b> <i>operation-number</i></p> <p><b>Example:</b></p> <pre>RP/0/RSP0/CPU0:router(config)# ipsla reaction operation 432</pre>	Configures certain actions that are based on events under the control of the IP SLA agent. The <i>operation-number</i> argument is the number of the IP SLA operations for the reactions that are configured. The range is from 1 to 2048.
<b>Step 3</b>	<p><b>react</b> [<b>verify-error</b>]</p> <p><b>Example:</b></p> <pre>RP/0/RSP0/CPU0:router(config-ipsla-react)# react verify-error RP/0/RSP0/CPU0:router(config-ipsla-react-cond)#</pre>	<p>Specifies an element to be monitored for a reaction.</p> <p>Use the <b>verify-error</b> keyword to specify a reaction that occurs if there is an error verification violation.</p>
<b>Step 4</b>	Use the <b>commit</b> or <b>end</b> command.	<p><b>commit</b> —Saves the configuration changes and remains within the configuration session.</p> <p><b>end</b> —Prompts user to take one of these actions:</p> <ul style="list-style-type: none"> <li>• <b>Yes</b> — Saves configuration changes and exits the configuration session.</li> <li>• <b>No</b> —Exits the configuration session without committing the configuration changes.</li> <li>• <b>Cancel</b> —Remains in the configuration session, without committing the configuration changes.</li> </ul>

## Configuring Threshold Violation Types for IP SLA Reactions

For each monitored element, you can specify:

- Condition to check for the threshold value.
- Pattern of occurrences of the condition that can generate the reaction, such as a threshold type.

For example, you can specify that a reaction can occur for a particular element as soon as you observe the condition of interest by using the **threshold type immediate** command or when you observe the condition for three consecutive times by using the **threshold type consecutive** command.

The type of threshold defines the type of threshold violation (or combination of threshold violations) that triggers an event.

This table lists the threshold violation types.

**Table 6: Threshold Violation Types for IP SLA Reactions**

Type of Threshold Violation	Description
consecutive	Triggers an event only after a violation occurs a number of times consecutively. For example, the consecutive violation type can be used to configure an action to occur after a timeout occurs five times in a row or when the round-trip time exceeds the upper threshold value five times in a row. For more information, see <a href="#">Generating Events for Consecutive Violations, on page 70</a> .
immediate	Triggers an event immediately when the value for a reaction type (such as response time) exceeds the upper threshold value or falls below the lower threshold value or when a timeout, connection-loss, or verify-error event occurs. For more information, see <a href="#">Generating Events for Each Violation, on page 69</a> .
X of Y	Triggers an event after some number (X) of violations within some other number (Y) of probe operations (X of Y). For more information, see <a href="#">Generating Events for X of Y Violations, on page 71</a> .
averaged	Triggers an event when the averaged totals of a value for X number of probe operations exceeds the specified upper-threshold value or falls below the lower-threshold value. For more information, see <a href="#">Generating Events for Averaged Violations, on page 73</a> .

## Generating Events for Each Violation

You can generate a trap or trigger another operation each time a specified condition is met.

### SUMMARY STEPS

1. **configure**
2. **ipsla reaction operation** *operation-number*
3. **react** [**connection-loss** | **jitter-average** {**dest-to-source** | **source-to-dest**} | **packet-loss** [**dest-to-source** | **source-to-dest**] | **rtt** | **timeout** | **verify-error**]
4. **threshold type immediate**
5. Use the **commit** or **end** command.

### DETAILED STEPS

	Command or Action	Purpose
Step 1	<b>configure</b> <b>Example:</b> RP/0/RSP0/CPU0:router# <code>configure</code>	Enters global configuration mode.
Step 2	<b>ipsla reaction operation</b> <i>operation-number</i> <b>Example:</b>	Configures certain actions that are based on events under the control of the IP SLA agent. The <i>operation-number</i> argument is the number of the IP SLA operations for the reactions that are configured. The range is from 1 to 2048.

	Command or Action	Purpose
	RP/0/RSP0/CPU0:router(config)# ipsla reaction operation 432	
<b>Step 3</b>	<p><b>react</b> [connection-loss   jitter-average {dest-to-source   source-to-dest}   packet-loss [dest-to-source   source-to-dest]   rtt   timeout   verify-error]</p> <p><b>Example:</b></p> <pre>RP/0/RSP0/CPU0:router(config-ipsla-react)# react timeout RP/0/RSP0/CPU0:router(config-ipsla-react-cond)#</pre>	<p>Specifies an element to be monitored for a reaction.</p> <p>A reaction is specified if there is a timeout for the monitored operation.</p>
<b>Step 4</b>	<p><b>threshold type immediate</b></p> <p><b>Example:</b></p> <pre>RP/0/RSP0/CPU0:router(config-ipsla-react-cond)# threshold type immediate</pre>	Takes action immediately upon a threshold violation.
<b>Step 5</b>	Use the <b>commit</b> or <b>end</b> command.	<p><b>commit</b> —Saves the configuration changes and remains within the configuration session.</p> <p><b>end</b> —Prompts user to take one of these actions:</p> <ul style="list-style-type: none"> <li>• <b>Yes</b> — Saves configuration changes and exits the configuration session.</li> <li>• <b>No</b> —Exits the configuration session without committing the configuration changes.</li> <li>• <b>Cancel</b> —Remains in the configuration session, without committing the configuration changes.</li> </ul>

## Generating Events for Consecutive Violations

You can generate a trap or trigger another operation after a certain number of consecutive violations.

### SUMMARY STEPS

1. **configure**
2. **ipsla reaction operation** *operation-number*
3. **react** [connection-loss | jitter-average {dest-to-source | source-to-dest} | packet-loss [dest-to-source | source-to-dest] | rtt | timeout | verify-error]
4. **threshold type consecutive** *occurrences*
5. Use the **commit** or **end** command.

## DETAILED STEPS

	Command or Action	Purpose
Step 1	<b>configure</b> <b>Example:</b> RP/0/RSP0/CPU0:router# configure	Enters global configuration mode.
Step 2	<b>ipsla reaction operation <i>operation-number</i></b> <b>Example:</b> RP/0/RSP0/CPU0:router(config)# ipsla reaction operation 432	Configures certain actions that are based on events under the control of the IP SLA agent. The <i>operation-number</i> argument is the number of the IP SLA operations for the reactions that are configured. The range is from 1 to 2048.
Step 3	<b>react [connection-loss   jitter-average {dest-to-source   source-to-dest}   packet-loss [dest-to-source   source-to-dest]   rtt   timeout   verify-error]</b> <b>Example:</b> RP/0/RSP0/CPU0:router(config-ipsla-react)# react connection-loss RP/0/RSP0/CPU0:router(config-ipsla-react-cond)#	Specifies an element to be monitored for a reaction. A reaction is specified if there is a connection-loss for the monitored operation.
Step 4	<b>threshold type consecutive <i>occurrences</i></b> <b>Example:</b> RP/0/RSP0/CPU0:router(config-ipsla-react-cond)# threshold type consecutive 8	Takes action after a number of consecutive violations. When the reaction condition is set for a consecutive number of occurrences, there is no default value. The number of occurrences is set when specifying the threshold type. The number of consecutive violations is from 1 to 16.
Step 5	Use the <b>commit</b> or <b>end</b> command.	<b>commit</b> —Saves the configuration changes and remains within the configuration session. <b>end</b> —Prompts user to take one of these actions: <ul style="list-style-type: none"> <li>• <b>Yes</b> — Saves configuration changes and exits the configuration session.</li> <li>• <b>No</b> —Exits the configuration session without committing the configuration changes.</li> <li>• <b>Cancel</b> —Remains in the configuration session, without committing the configuration changes.</li> </ul>

## Generating Events for X of Y Violations

You can generate a trap or trigger another operation after some number (X) of violations within some other number (Y) of probe operations (X of Y). The **react** command with the **rtt** keyword is used as an example.

## SUMMARY STEPS

1. **configure**
2. **ipsla reaction operation *operation-number***

3. **react** [**connection-loss** | **jitter-average** {**dest-to-source** | **source-to-dest**} | **packet-loss** [**dest-to-source** | **source-to-dest**] | **rtt** | **timeout** | **verify-error**]
4. **threshold type xofy** *X value Y value*
5. Use the **commit** or **end** command.

## DETAILED STEPS

	Command or Action	Purpose
<b>Step 1</b>	<b>configure</b> <b>Example:</b> <pre>RP/0/RSP0/CPU0:router# configure</pre>	Enters global configuration mode.
<b>Step 2</b>	<b>ipsla reaction operation</b> <i>operation-number</i> <b>Example:</b> <pre>RP/0/RSP0/CPU0:router(config)# ipsla reaction operation 432</pre>	Configures certain actions that are based on events under the control of the IP SLA agent. The <i>operation-number</i> argument is the number of the IP SLA operations for the reactions that are configured. The range is from 1 to 2048.
<b>Step 3</b>	<b>react</b> [ <b>connection-loss</b>   <b>jitter-average</b> { <b>dest-to-source</b>   <b>source-to-dest</b> }   <b>packet-loss</b> [ <b>dest-to-source</b>   <b>source-to-dest</b> ]   <b>rtt</b>   <b>timeout</b>   <b>verify-error</b> ] <b>Example:</b> <pre>RP/0/RSP0/CPU0:router(config-ipsla-react)# react rtt RP/0/RSP0/CPU0:router(config-ipsla-react-cond)#</pre>	Specifies that a reaction occurs if the round-trip value violates the upper threshold or lower threshold.
<b>Step 4</b>	<b>threshold type xofy</b> <i>X value Y value</i> <b>Example:</b> <pre>RP/0/RSP0/CPU0:router(config-ipsla-react-cond)# threshold type xofy 7 7</pre>	When the reaction condition, such as threshold violations, are met for the monitored element after some <i>x</i> number of violations within some other <i>y</i> number of probe operations (for example, <i>x</i> of <i>y</i> ), the action is performed as defined by the <b>action</b> command. The default is 5 for both <i>x value</i> and <i>y value</i> ; for example, <b>xofy 5 5</b> . The valid range for each value is from 1 to 16.
<b>Step 5</b>	Use the <b>commit</b> or <b>end</b> command.	<b>commit</b> —Saves the configuration changes and remains within the configuration session. <b>end</b> —Prompts user to take one of these actions: <ul style="list-style-type: none"> <li>• <b>Yes</b> — Saves configuration changes and exits the configuration session.</li> <li>• <b>No</b> —Exits the configuration session without committing the configuration changes.</li> <li>• <b>Cancel</b> —Remains in the configuration session, without committing the configuration changes.</li> </ul>



## Generating Events for Averaged Violations

You can generate a trap or trigger another operation when the averaged totals of X number of probe operations violate a falling threshold or rising threshold.

### SUMMARY STEPS

1. **configure**
2. **ipsla reaction operation** *operation-number*
3. **react** [**connection-loss** | **jitter-average** {**dest-to-source** | **source-to-dest**} | **packet-loss** [**dest-to-source** | **source-to-dest**] | **rtt** | **timeout** | **verify-error**]
4. **threshold type average** *number-of-probes*
5. Use the **commit** or **end** command.

### DETAILED STEPS

	Command or Action	Purpose
<b>Step 1</b>	<b>configure</b> <b>Example:</b> <pre>RP/0/RSP0/CPU0:router# configure</pre>	Enters global configuration mode.
<b>Step 2</b>	<b>ipsla reaction operation</b> <i>operation-number</i> <b>Example:</b> <pre>RP/0/RSP0/CPU0:router(config)# ipsla reaction operation 432</pre>	Configures certain actions that are based on events under the control of the IP SLA agent. The <i>operation-number</i> argument is the number of the IP SLA operations for the reactions that are configured. The range is from 1 to 2048.
<b>Step 3</b>	<b>react</b> [ <b>connection-loss</b>   <b>jitter-average</b> { <b>dest-to-source</b>   <b>source-to-dest</b> }   <b>packet-loss</b> [ <b>dest-to-source</b>   <b>source-to-dest</b> ]   <b>rtt</b>   <b>timeout</b>   <b>verify-error</b> ] <b>Example:</b> <pre>RP/0/RSP0/CPU0:router(config-ipsla-react)# react packet-loss dest-to-source RP/0/RSP0/CPU0:router(config-ipsla-react-cond)#</pre>	Specifies an element to be monitored for a reaction. The reaction on packet loss value violation is specified. The following options are listed for the <b>packet-loss</b> keyword: <ul style="list-style-type: none"> <li>• <b>dest-to-source</b>—Specifies the packet loss destination to source (DS) violation.</li> <li>• <b>source-to-dest</b>—Specifies the packet loss source to destination (SD) violation.</li> </ul>
<b>Step 4</b>	<b>threshold type average</b> <i>number-of-probes</i> <b>Example:</b> <pre>RP/0/RSP0/CPU0:router(config-ipsla-react-cond)# threshold type average 8</pre>	Takes action on average values to violate a threshold.
<b>Step 5</b>	Use the <b>commit</b> or <b>end</b> command.	<b>commit</b> —Saves the configuration changes and remains within the configuration session. <b>end</b> —Prompts user to take one of these actions: <ul style="list-style-type: none"> <li>• <b>Yes</b> — Saves configuration changes and exits the configuration session.</li> </ul>

	Command or Action	Purpose
		<ul style="list-style-type: none"> <li>• <b>No</b> —Exits the configuration session without committing the configuration changes.</li> <li>• <b>Cancel</b> —Remains in the configuration session, without committing the configuration changes.</li> </ul>

## Specifying Reaction Events

When a reaction condition is detected, you can configure the type of action that occurs by using the **action** command. The following types of actions are configured:

- **logging**—When the **logging** keyword is configured, a message is generated to the console to indicate that a reaction has occurred.
- **trigger**—When the **trigger** keyword is configured, one or more other operations can be started. As a result, you can control which operations can be started with the **ipsla reaction trigger op1 op2** command. This command indicates when *op1* generates an action type trigger and operation *op2* can be started.

You can specify reaction events. The **react** command with the **connection-loss** keyword is used as an example.

### SUMMARY STEPS

1. **configure**
2. **ipsla reaction operation** *operation-number*
3. **react** [**connection-loss** | **jitter-average** {**dest-to-source** | **source-to-dest**} | **packet-loss** [**dest-to-source** | **source-to-dest**] | **rtt** | **timeout** | **verify-error**]
4. **action** [**logging** | **trigger**]
5. Use the **commit** or **end** command.

### DETAILED STEPS

	Command or Action	Purpose
<b>Step 1</b>	<b>configure</b> <b>Example:</b> RP/0/RSP0/CPU0:router# configure	Enters global configuration mode.
<b>Step 2</b>	<b>ipsla reaction operation</b> <i>operation-number</i> <b>Example:</b> RP/0/RSP0/CPU0:router(config)# ipsla reaction operation 432	Configures certain actions that are based on events under the control of the IP SLA agent. The <i>operation-number</i> argument is the number of the IP SLA operations for the reactions that are configured. The range is from 1 to 2048.
<b>Step 3</b>	<b>react</b> [ <b>connection-loss</b>   <b>jitter-average</b> { <b>dest-to-source</b>   <b>source-to-dest</b> }   <b>packet-loss</b> [ <b>dest-to-source</b>   <b>source-to-dest</b> ]   <b>rtt</b>   <b>timeout</b>   <b>verify-error</b> ] <b>Example:</b>	Specifies a reaction if there is a connection-loss for the monitored operation.

	Command or Action	Purpose
	<pre>RP/0/RSP0/CPU0:router(config-ipsla-react)# react connection-loss RP/0/RSP0/CPU0:router(config-ipsla-react-cond)#</pre>	
<b>Step 4</b>	<p><b>action [logging   trigger]</b></p> <p><b>Example:</b></p> <pre>RP/0/RSP0/CPU0:router(config-ipsla-react-cond)# action logging</pre>	<p>Specifies what action or combination of actions the operation performs when you configure the <b>react</b> command or when threshold events occur. The following action types are described:</p> <ul style="list-style-type: none"> <li>• <b>logging</b>—Sends a logging message when the specified violation type occurs for the monitored element. The IP SLA agent generates a syslog and informs SNMP. Then, it is up to the SNMP agent to generate a trap or not.</li> <li>• <b>trigger</b>—Determines that the operational state of one or more operations makes the transition from pending to active when the violation conditions are met. The target operations to be triggered are specified using the <b>ipsla reaction trigger</b> command. A target operation continues until its life expires, as specified by lifetime value of the target operation. A triggered target operation must finish its life before it can be triggered again.</li> </ul>
<b>Step 5</b>	Use the <b>commit</b> or <b>end</b> command.	<p><b>commit</b> —Saves the configuration changes and remains within the configuration session.</p> <p><b>end</b> —Prompts user to take one of these actions:</p> <ul style="list-style-type: none"> <li>• <b>Yes</b> — Saves configuration changes and exits the configuration session.</li> <li>• <b>No</b> —Exits the configuration session without committing the configuration changes.</li> <li>• <b>Cancel</b> —Remains in the configuration session, without committing the configuration changes.</li> </ul>

## Configuring server twamp

Perform this task to configure server twamp.

### SUMMARY STEPS

1. **configure**
2. **ipsla**
3. **server twamp**
4. **port** *number*
5. **timer inactivity** *value*

## DETAILED STEPS

	Command or Action	Purpose
<b>Step 1</b>	<b>configure</b> <b>Example:</b>  RP/0/RSP0/CPU0:router# <b>configure</b>	Enters global configuration mode.
<b>Step 2</b>	<b>ipsla</b> <b>Example:</b>  RP/0/RSP0/CPU0:router(config)# <b>ipsla</b>	Enters the IPSLA configuration mode.
<b>Step 3</b>	<b>server twamp</b> <b>Example:</b>  RP/0/RSP0/CPU0:router(config-ipsla)# <b>server twamp</b>	Enables the server twamp configuration mode. The port and timer details for the server can be configured.
<b>Step 4</b>	<b>port</b> <i>number</i> <b>Example:</b>  RP/0/RSP0/CPU0:router(config-ipsla)# <b>port 80</b>	The port details for the server.
<b>Step 5</b>	<b>timer inactivity</b> <i>value</i> <b>Example:</b>  RP/0/RSP0/CPU0:router(config-ipsla)# <b>timer inactivity 100</b>	The timer details for the server. The server can remain inactive for the set time.

## Configuring responder twamp

Perform this task to configure responder twamp.

## SUMMARY STEPS

1. **configure**
2. **ipsla**
3. **responder twamp**
4. **timeout** *value*

## DETAILED STEPS

	Command or Action	Purpose
<b>Step 1</b>	<b>configure</b> <b>Example:</b>  RP/0/RSP0/CPU0:router# <b>configure</b>	Enters global configuration mode.

	Command or Action	Purpose
Step 2	<b>ipsla</b> <b>Example:</b> RP/0/RSP0/CPU0:router(config)# <b>ipsla</b>	Enters the IPSLA configuration mode.
Step 3	<b>responder twamp</b> <b>Example:</b> RP/0/RSP0/CPU0:router(config-ipsla)# <b>responder twamp</b>	Enables the responder twamp configuration mode. The timer details for the responder can be configured.
Step 4	<b>timeout value</b> <b>Example:</b> RP/0/RSP0/CPU0:router(config-ipsla)# <b>timeout 100</b>	The timer details for the responder. The responder can remain inactive for the set time.

## Verification of TWAMP Session

The TWAMP session can be verified using the command: **show ipsla twamp session**

```
Router# show ipsla twamp session
IP SLAs Responder TWAMP is: Enabled
Recv Addr: 10.5.139.11
Recv Port: 7222
Sender Addr: 172.27.111.233
Sender Port: 33243
Session Id: 10.5.139.11:70929508:88F7A620
Connection Id: 0
```

## Configuring the MPLS LSP Monitoring Instance on a Source PE Router

Perform this task to configure the operation parameters for an MPLS LSP monitor (MPLSLM) instance. The IP SLA measurement statistics are stored on the source PE router.

To configure an MPLS LSP monitor ping or trace instance, perform one of the following tasks:

### Configuring an MPLS LSP Monitoring Ping Instance

#### Before you begin



**Note** MPLS LSP monitoring is configured on a PE router.

#### SUMMARY STEPS

1. **configure**
2. **ipsla**

3. **mpls discovery vpn**
4. **interval** *minutes*
5. **exit**
6. **mpls lsp-monitor**
7. **monitor** *monitor-id*
8. **type mpls lsp ping**
9. **vrf** *vrf-name*
10. **scan interval** *scan-interval*
11. **scan delete-factor** *factor-value*
12. **timeout** *milliseconds*
13. **datasize request** *size*
14. **lsp selector ipv4** *ip-address*
15. **force explicit-null**
16. **reply dscp** *dscp-bits*
17. **reply mode router-alert**
18. **ttl** *time-to-live*
19. **tag** *text*
20. **exp** *exp-bits*
21. **statistics hourly** [**buckets** *hours*]
22. Use the **commit** or **end** command.

## DETAILED STEPS

	Command or Action	Purpose
<b>Step 1</b>	<b>configure</b> <b>Example:</b> RP/0/RSP0/CPU0:router# configure	Enters global configuration mode.
<b>Step 2</b>	<b>ipsla</b> <b>Example:</b> RP/0/RSP0/CPU0:router(config)# ipsla	Enters IP SLA configuration mode and configures IP service level agreements.
<b>Step 3</b>	<b>mpls discovery vpn</b> <b>Example:</b> RP/0/RSP0/CPU0:router(config-ipsla)# mpls discovery vpn	(Optional) Enters MPLS VPN BGP next-hop neighbor discovery configuration mode.
<b>Step 4</b>	<b>interval</b> <i>minutes</i> <b>Example:</b> RP/0/RSP0/CPU0:router(config-ipsla-mpls-discovery-vpn)# interval 120	(Optional) Specifies the time interval at which routing entries that are no longer valid are removed from the BGP next-hop neighbor discovery database of an MPLS VPN. The default time interval is 60 minutes.

	Command or Action	Purpose
Step 5	<b>exit</b> <b>Example:</b> <pre>RP/0/RSP0/CPU0:router(config-ipsla-mpls-discovery-vpn)# exit</pre>	Exits MPLS discovery VPN configuration mode.
Step 6	<b>mpls lsp-monitor</b> <b>Example:</b> <pre>RP/0/RSP0/CPU0:router(config-ipsla)# mpls lsp-monitor RP/0/RSP0/CPU0:router(config-ipsla-mplsmlm)#</pre>	Enters MPLS LSP monitor mode. From this mode you can configure an LSP monitor instance, configure a reaction for an LSP monitor instance, or schedule an LSP monitor instance.
Step 7	<b>monitor <i>monitor-id</i></b> <b>Example:</b> <pre>RP/0/RSP0/CPU0:router(config-ipsla-mplsmlm)# monitor 1 RP/0/RSP0/CPU0:router(config-ipsla-mplsmlm-def)#</pre>	Configures an MPLS LSP monitor instance and enters IP SLA MPLS LSP monitor configuration mode.
Step 8	<b>type mpls lsp ping</b> <b>Example:</b> <pre>RP/0/RSP0/CPU0:router(config-ipsla-mplsmlm-def)# type mpls lsp ping</pre>	Automatically creates an MPLS LSP ping operation for each discovered BGP next-hop address and enters the corresponding configuration mode to configure the parameters.
Step 9	<b>vrf <i>vrf-name</i></b> <b>Example:</b> <pre>RP/0/RSP0/CPU0:router(config-ipsla-mplsmlm-lsp-ping)# vrf SANJOSE</pre>	(Optional) Enables the monitoring of a specific Virtual Private Network (VPN) routing and forwarding (VRF) instance in the ping operation. If no VRF is specified, the MPLS LSP monitoring instance monitors all VRFs.
Step 10	<b>scan interval <i>scan-interval</i></b> <b>Example:</b> <pre>RP/0/RSP0/CPU0:router(config-ipsla-mplsmlm-lsp-ping)# scan interval 300</pre>	<p>(Optional) Specifies the time interval (in minutes) at which the MPLS LSP monitor instance checks the scan queue for BGP next-hop neighbor updates. The default time interval is 240 minutes.</p> <p>At each interval, a new IP SLA operation is automatically created for each newly discovered BGP next-hop neighbor listed in the MPLS LSP monitor instance scan queue.</p>
Step 11	<b>scan delete-factor <i>factor-value</i></b> <b>Example:</b> <pre>RP/0/RSP0/CPU0:router(config-ipsla-mplsmlm-lsp-ping)# scan delete-factor 2</pre>	<p>(Optional) Specifies the number of times the MPLS LSP monitor instance should check the scan queue before automatically deleting IP SLA operations for BGP next-hop neighbors that are no longer valid.</p> <p>The default scan factor is 1. In other words, each time the MPLS LSP monitor instance checks the scan queue for updates, it deletes IP SLA operations for BGP next-hop neighbors that are no longer valid.</p>

	Command or Action	Purpose
		If the scan factor is set to 0, IP SLA operations are never deleted by the MPLS LSP monitor instance. We do not recommend this configuration.
<b>Step 12</b>	<b>timeout</b> <i>milliseconds</i> <b>Example:</b> <pre>RP/0/RSP0/CPU0:router (config-ipsla-mpls-lm-lsp-ping) #   timeout 50000</pre>	(Optional) Specifies the amount of time that each MPLS LSP operation waits for a response from the LSP verification (LSPV) server. The default value is 5000 milliseconds.
<b>Step 13</b>	<b>datasize request</b> <i>size</i> <b>Example:</b> <pre>RP/0/RSP0/CPU0:router (config-ipsla-mpls-lm-lsp-ping) #   datasize request 512</pre>	(Optional) Specifies the payload size of the MPLS LSP echo request packets. The default value is 100 bytes.  <b>Note</b> This command is available in MPLS LSP ping mode only.
<b>Step 14</b>	<b>lsp selector ipv4</b> <i>ip-address</i> <b>Example:</b> <pre>RP/0/RSP0/CPU0:router (config-ipsla-mpls-lm-lsp-ping) #   lsp selector ipv4 127.10.10.1</pre>	(Optional) Specifies a local host IP address (127.x.x.x) that is used to select the label switched path (LSP) from among multiple LSPs. The default value is 127.0.0.1.
<b>Step 15</b>	<b>force explicit-null</b> <b>Example:</b> <pre>RP/0/RSP0/CPU0:router (config-ipsla-mpls-lm-lsp-ping) #   force explicit-null</pre>	(Optional) Specifies whether an explicit null label is added to the label stack of MPLS LSP echo request packets. This is disabled by default.
<b>Step 16</b>	<b>reply dscp</b> <i>dscp-bits</i> <b>Example:</b> <pre>RP/0/RSP0/CPU0:router (config-ipsla-mpls-lm-lsp-ping) #   reply dscp 5</pre>	(Optional) Specifies the differentiated services codepoint (DSCP) value to be used in the IP header of MPLS LSP echo reply packets.
<b>Step 17</b>	<b>reply mode router-alert</b> <b>Example:</b> <pre>RP/0/RSP0/CPU0:router (config-ipsla-mpls-lm-lsp-ping) #   reply mode router-alert</pre>	(Optional) Enables the use of the router alert option in MPLS LSP echo reply packets. This is disabled by default.
<b>Step 18</b>	<b>ttl</b> <i>time-to-live</i> <b>Example:</b> <pre>RP/0/RSP0/CPU0:router (config-ipsla-mpls-lm-lsp-ping) #   ttl 200</pre>	(Optional) Specifies the maximum hop count for an echo request packet to be used for MPLS LSP operations. The default value is 255.
<b>Step 19</b>	<b>tag</b> <i>text</i> <b>Example:</b>	(Optional) Creates a user-specified identifier for MPLS LSP operations.



	Command or Action	Purpose
	RP/0/RSP0/CPU0:router(config-ipsla-mplsml-lsp-ping)# tag <i>mplsml-tag</i>	
<b>Step 20</b>	<b>exp</b> <i>exp-bits</i> <b>Example:</b> RP/0/RSP0/CPU0:router(config-ipsla-mplsml-lsp-ping)# exp 7	(Optional) Specifies the experimental field value to be used in the MPLS header of MPLS LSP echo request packets. The default value is 0.
<b>Step 21</b>	<b>statistics hourly</b> [ <i>buckets hours</i> ] <b>Example:</b> RP/0/RSP0/CPU0:router(config-ipsla-mplsml-lsp-ping)# statistics hourly buckets 2	(Optional) Specifies the statistics collection parameters for the operations in the MPLS LSP monitoring instance. The default number of hours is 2.
<b>Step 22</b>	Use the <b>commit</b> or <b>end</b> command.	<b>commit</b> —Saves the configuration changes and remains within the configuration session. <b>end</b> —Prompts user to take one of these actions: <ul style="list-style-type: none"> <li>• <b>Yes</b> — Saves configuration changes and exits the configuration session.</li> <li>• <b>No</b> —Exits the configuration session without committing the configuration changes.</li> <li>• <b>Cancel</b> —Remains in the configuration session, without committing the configuration changes.</li> </ul>

**What to do next**

- Configure the reaction conditions.
- Schedule the MPLS LSP monitoring instance operations.

## Configuring an MPLS LSP Monitoring Trace Instance

**Before you begin**



**Note** MPLS LSP monitoring is configured on a PE router.

**SUMMARY STEPS**

1. **configure**
2. **ipsla**
3. **mpls discovery vpn**
4. **interval** *minutes*

5. **exit**
6. **mpls lsp-monitor**
7. **monitor** *monitor-id*
8. **type mpls lsp trace**
9. **vrf** *vrf-name*
10. **scan interval** *scan-interval*
11. **scan delete-factor** *factor-value*
12. **timeout** *milliseconds*
13. **lsp selector ipv4** *ip-address*
14. **force explicit-null**
15. **reply dscp** *dscp-bits*
16. **reply mode router-alert**
17. **ttl** *time-to-live*
18. **tag** *text*
19. **exp** *exp-bits*
20. **statistics hourly** [**buckets** *hours*]
21. Use the **commit** or **end** command.

## DETAILED STEPS

	Command or Action	Purpose
<b>Step 1</b>	<b>configure</b> <b>Example:</b> RP/0/RSP0/CPU0:router# configure	Enters global configuration mode.
<b>Step 2</b>	<b>ipsla</b> <b>Example:</b> RP/0/RSP0/CPU0:router(config)# ipsla	Enters IP SLA configuration mode and configures IP service level agreements.
<b>Step 3</b>	<b>mpls discovery vpn</b> <b>Example:</b> RP/0/RSP0/CPU0:router(config-ipsla)# mpls discovery vpn	(Optional) Enables MPLS VPN BGP next-hop neighbor discovery.
<b>Step 4</b>	<b>interval</b> <i>minutes</i> <b>Example:</b> RP/0/RSP0/CPU0:router(config-ipsla-mpls-discovery-vpn)# interval 120	(Optional) Specifies the time interval at which routing entries that are no longer valid are removed from the BGP next-hop neighbor discovery database of an MPLS VPN. The default time interval is 60 minutes.
<b>Step 5</b>	<b>exit</b> <b>Example:</b> RP/0/RSP0/CPU0:router(config-ipsla-mpls-discovery-vpn)# exit	Exits MPLS discovery VPN configuration mode.

	Command or Action	Purpose
Step 6	<b>mpls lsp-monitor</b> <b>Example:</b> <pre>RP/0/RSP0/CPU0:router(config-ipsla) # mpls lsp-monitor RP/0/RSP0/CPU0:router(config-ipsla-mplslm) #</pre>	Enters MPLS LSP monitor mode. From this mode you can configure an LSP monitor instance, configure a reaction for an LSP monitor instance, or schedule an LSP monitor instance.
Step 7	<b>monitor <i>monitor-id</i></b> <b>Example:</b> <pre>RP/0/RSP0/CPU0:router(config-ipsla-mplslm) # monitor 1 RP/0/RSP0/CPU0:router(config-ipsla-mplslm-def) #</pre>	Configures an MPLS LSP monitor instance and enters IP SLA MPLS LSP monitor configuration mode.
Step 8	<b>type mpls lsp trace</b> <b>Example:</b> <pre>RP/0/RSP0/CPU0:router(config-ipsla-mplslm-def) # type mpls lsp trace</pre>	Automatically creates an MPLS LSP trace operation for each discovered BGP next-hop address and enters the corresponding configuration mode to configure the parameters.
Step 9	<b>vrf <i>vrf-name</i></b> <b>Example:</b> <pre>RP/0/RSP0/CPU0:router(config-ipsla-mplslm-lsp-trace) # vrf SANJOSE</pre>	(Optional) Enables the monitoring of a specific Virtual Private Network (VPN) routing and forwarding (VRF) instance in the traceroute operation. If no VRF is specified, the MPLS LSP monitoring instance monitors all VRFs.
Step 10	<b>scan interval <i>scan-interval</i></b> <b>Example:</b> <pre>RP/0/RSP0/CPU0:router(config-ipsla-mplslm-lsp-trace) # scan interval 300</pre>	<p>(Optional) Specifies the time interval (in minutes) at which the MPLS LSP monitor instance checks the scan queue for BGP next-hop neighbor updates. The default time interval is 240 minutes.</p> <p>At each interval, a new IP SLA operation is automatically created for each newly discovered BGP next-hop neighbor listed in the MPLS LSP monitor instance scan queue.</p>
Step 11	<b>scan delete-factor <i>factor-value</i></b> <b>Example:</b> <pre>RP/0/RSP0/CPU0:router(config-ipsla-mplslm-lsp-trace) # scan delete-factor 2</pre>	<p>(Optional) Specifies the number of times the MPLS LSP monitor instance should check the scan queue before automatically deleting IP SLA operations for BGP next-hop neighbors that are no longer valid.</p> <p>The default scan factor is 1. In other words, each time the MPLS LSP monitor instance checks the scan queue for updates, it deletes IP SLA operations for BGP next-hop neighbors that are no longer valid.</p> <p>If the scan factor is set to 0, IP SLA operations are never deleted by the MPLS LSP monitor instance. We do not recommend this configuration.</p>
Step 12	<b>timeout <i>milliseconds</i></b> <b>Example:</b>	(Optional) Specifies the amount of time that each MPLS LSP operation waits for a response from the LSP

	Command or Action	Purpose
	RP/0/RSP0/CPU0:router (config-ipsla-mplsml-lsp-trace) # timeout 50000	verification (LSPV) server. The default value is 5000 milliseconds.
<b>Step 13</b>	<b>lsp selector ipv4 ip-address</b> <b>Example:</b>  RP/0/RSP0/CPU0:router (config-ipsla-mplsml-lsp-trace) # lsp selector ipv4 127.10.10.1	(Optional) Specifies a local host IP address (127.x.x.x) that is used to select the label switched path (LSP) from among multiple LSPs. The default value is 127.0.0.1.
<b>Step 14</b>	<b>force explicit-null</b> <b>Example:</b>  RP/0/RSP0/CPU0:router (config-ipsla-mplsml-lsp-trace) # force explicit-null	(Optional) Specifies whether an explicit null label is added to the label stack of MPLS LSP echo request packets. This is disabled by default.
<b>Step 15</b>	<b>reply dscp dscp-bits</b> <b>Example:</b>  RP/0/RSP0/CPU0:router (config-ipsla-mplsml-lsp-trace) # reply dscp 5	(Optional) Specifies the differentiated services codepoint (DSCP) value to be used in the IP header of MPLS LSP echo reply packets.
<b>Step 16</b>	<b>reply mode router-alert</b> <b>Example:</b>  RP/0/RSP0/CPU0:router (config-ipsla-mplsml-lsp-trace) # reply mode router-alert	(Optional) Enables the use of the router alert option in MPLS LSP echo reply packets. This is disabled by default.
<b>Step 17</b>	<b>ttl time-to-live</b> <b>Example:</b>  RP/0/RSP0/CPU0:router (config-ipsla-mplsml-lsp-trace) # ttl 40	(Optional) Specifies the maximum hop count for an echo request packet to be used for MPLS LSP operations. The default value is 30.
<b>Step 18</b>	<b>tag text</b> <b>Example:</b>  RP/0/RSP0/CPU0:router (config-ipsla-mplsml-lsp-trace) # tag mplsml-tag	(Optional) Creates a user-specified identifier for MPLS LSP operations.
<b>Step 19</b>	<b>exp exp-bits</b> <b>Example:</b>  RP/0/RSP0/CPU0:router (config-ipsla-mplsml-lsp-trace) # exp 7	(Optional) Specifies the experimental field value to be used in the MPLS header of MPLS LSP echo request packets. The default value is 0.

	Command or Action	Purpose
Step 20	<b>statistics hourly</b> [buckets <i>hours</i> ] <b>Example:</b> <pre>RP/0/RSP0/CPU0:router(config-ipsla-mpls-lsp-trace)# statistics hourly buckets 2</pre>	(Optional) Specifies the statistics collection parameters for the operations in the MPLS LSP monitoring instance. The default number of hours is 2.
Step 21	Use the <b>commit</b> or <b>end</b> command.	<b>commit</b> —Saves the configuration changes and remains within the configuration session. <b>end</b> —Prompts user to take one of these actions: <ul style="list-style-type: none"> <li>• <b>Yes</b> — Saves configuration changes and exits the configuration session.</li> <li>• <b>No</b> —Exits the configuration session without committing the configuration changes.</li> <li>• <b>Cancel</b> —Remains in the configuration session, without committing the configuration changes.</li> </ul>

**What to do next**

- Configure the reaction conditions.
- Schedule the MPLS LSP monitoring instance operations.

## Configuring the Reaction Conditions for an MPLS LSP Monitoring Instance on a Source PE Router

Perform this task to configure the reaction conditions for an MPLS LSP monitoring instance.

**Before you begin**

The MPLS LSP monitoring instance should be defined before you configure the reaction conditions.

**SUMMARY STEPS**

1. **configure**
2. **ipsla**
3. **mpls lsp-monitor**
4. **reaction monitor** *monitor-id*
5. **react** {**connection-loss** | **timeout**}
6. **action logging**
7. **threshold type** {**consecutive** *occurrences* | **immediate**}
8. Use the **commit** or **end** command.

## DETAILED STEPS

	Command or Action	Purpose
<b>Step 1</b>	<b>configure</b> <b>Example:</b>  RP/0/RSP0/CPU0:router# configure	Enters global configuration mode.
<b>Step 2</b>	<b>ipsla</b> <b>Example:</b>  RP/0/RSP0/CPU0:router(config)# ipsla	Enters IP SLA configuration mode and configures IP service level agreements.
<b>Step 3</b>	<b>mpls lsp-monitor</b> <b>Example:</b>  RP/0/RSP0/CPU0:router(config-ipsla)# mpls lsp-monitor RP/0/RSP0/CPU0:router(config-ipsla-mplsmlm)#	Enters MPLS LSP monitor mode. From this mode you can configure an LSP monitor instance, configure a reaction for an LSP monitor instance, or schedule an LSP monitor instance.
<b>Step 4</b>	<b>reaction monitor <i>monitor-id</i></b> <b>Example:</b>  RP/0/RSP0/CPU0:router(config-ipsla-mplsmlm)# reaction monitor 2 RP/0/RSP0/CPU0:router(config-ipsla-mplsmlm-react)#	Configures an MPLS LSP monitor instance reaction and enters IP SLA MPLS LSP monitor reaction configuration mode.
<b>Step 5</b>	<b>react {connection-loss   timeout}</b> <b>Example:</b>  RP/0/RSP0/CPU0:router(config-ipsla-mplsmlm-react)# react connection-loss	Specifies that a reaction occurs if there is a one-way connection loss or timeout for the monitored operation. The reaction applies when the condition comes up for any of the automatically created operations.
<b>Step 6</b>	<b>action logging</b> <b>Example:</b>  RP/0/RSP0/CPU0:router(config-ipsla-mplsmlm-react-cond)# action logging	Specifies that an event be logged as a result of the reaction condition and threshold.
<b>Step 7</b>	<b>threshold type {consecutive <i>occurrences</i>   immediate}</b> <b>Example:</b>  RP/0/RSP0/CPU0:router(config-ipsla-mplsmlm-react-cond)# threshold type consecutive	Specifies that the designated action is taken after the specified number of consecutive violations or immediately. The valid range of <i>occurrences</i> is 1 to 16.
<b>Step 8</b>	Use the <b>commit</b> or <b>end</b> command.	<b>commit</b> —Saves the configuration changes and remains within the configuration session.  <b>end</b> —Prompts user to take one of these actions: <ul style="list-style-type: none"><li>• <b>Yes</b> — Saves configuration changes and exits the configuration session.</li></ul>

	Command or Action	Purpose
		<ul style="list-style-type: none"> <li>• <b>No</b> —Exits the configuration session without committing the configuration changes.</li> <li>• <b>Cancel</b> —Remains in the configuration session, without committing the configuration changes.</li> </ul>

#### What to do next

- Schedule the MPLS LSP monitoring instance operations.

## Scheduling an MPLS LSP Monitoring Instance on a Source PE Router

Perform this task to schedule the operations in an MPLS LSP monitoring instance.

### SUMMARY STEPS

1. **configure**
2. **ipsla**
3. **mpls lsp-monitor**
4. **schedule monitor** *monitor-id*
5. **frequency** *seconds*
6. **schedule period** *seconds*
7. **start-time** *hh:mm:ss [day | month day]*
8. Use the **commit** or **end** command.

### DETAILED STEPS

	Command or Action	Purpose
<b>Step 1</b>	<b>configure</b> <b>Example:</b> RP/0/RSP0/CPU0:router# configure	Enters global configuration mode.
<b>Step 2</b>	<b>ipsla</b> <b>Example:</b> RP/0/RSP0/CPU0:router(config)# ipsla	Enters IP SLA configuration mode and configures IP service level agreements.
<b>Step 3</b>	<b>mpls lsp-monitor</b> <b>Example:</b> RP/0/RSP0/CPU0:router(config-ipsla)# mpls lsp-monitor RP/0/RSP0/CPU0:router(config-ipsla-mplslm)#	Enters MPLS LSP monitor mode. From this mode you can configure an LSP monitor instance, configure a reaction for an LSP monitor instance, or schedule an LSP monitor instance.

	Command or Action	Purpose
<b>Step 4</b>	<b>schedule monitor</b> <i>monitor-id</i> <b>Example:</b> <pre>RP/0/RSP0/CPU0:router(config-ipsla-mplsmlm)# schedule monitor 2 RP/0/RSP0/CPU0:router(config-ipsla-mplsmlm-sched)#</pre>	Enters IP SLA MPLS LSP monitor schedule configuration mode to schedule the MPLS LSP monitor instance.
<b>Step 5</b>	<b>frequency</b> <i>seconds</i> <b>Example:</b> <pre>RP/0/RSP0/CPU0:router(config-ipsla-mplsmlm-sched)# frequency 600</pre>	(Optional) Specifies the frequency at which the schedule period is run. The default value is same as schedule period. The schedule period is specified using the <b>schedule period</b> command. You must specify this value before scheduling an MPLS LSP monitor instance start time.
<b>Step 6</b>	<b>schedule period</b> <i>seconds</i> <b>Example:</b> <pre>RP/0/RSP0/CPU0:router(config-ipsla-mplsmlm-sched)# schedule period 300</pre>	<p>Specifies the amount of time, in seconds, during which all of the operations are scheduled to run. All operations are scheduled equally spaced throughout the schedule period.</p> <p>Use the <b>frequency</b> command to specify how often the entire set of operations is performed. The frequency value must be greater than or equal to the schedule period.</p> <p>You must specify this value before scheduling an MPLS LSP monitor instance start time.</p>
<b>Step 7</b>	<b>start-time</b> <i>hh:mm:ss [day   month day]</i> <b>Example:</b> <pre>RP/0/RSP0/CPU0:router(config-ipsla-mplsmlm-sched)# start-time 11:45:00 July 4</pre>	Specifies the time when the MPLS LSP monitor instance starts collecting information. You must specify the scheduled time; otherwise, no information is collected.
<b>Step 8</b>	Use the <b>commit</b> or <b>end</b> command.	<p><b>commit</b> —Saves the configuration changes and remains within the configuration session.</p> <p><b>end</b> —Prompts user to take one of these actions:</p> <ul style="list-style-type: none"> <li>• <b>Yes</b> — Saves configuration changes and exits the configuration session.</li> <li>• <b>No</b> —Exits the configuration session without committing the configuration changes.</li> <li>• <b>Cancel</b> —Remains in the configuration session, without committing the configuration changes.</li> </ul>

## LSP Path Discovery

Perform this task to configure the LSP Path Discovery (LPD) and its required parameters, including echo interval, path, and scan.



## SUMMARY STEPS

1. **configure**
2. **ipsla**
3. **mpls lsp-monitor**
4. **monitor** *monitor-id*
5. **type mpls lsp ping**
6. **path discover**
7. **echo interval** *time*
8. **echo maximum lsp selector ipv4** *host address*
9. **echo multipath bitmap-size** *size*
10. **echo retry** *count*
11. **echo timeout** *value*
12. **path retry** *range*
13. **path secondary frequency** {**both** | **connection-loss** | **timeout**} *value*}
14. **scan period** *value*
15. Use the **commit** or **end** command.

## DETAILED STEPS

	Command or Action	Purpose
Step 1	<b>configure</b> <b>Example:</b> RP/0/RSP0/CPU0:router# configure	Enters global configuration mode.
Step 2	<b>ipsla</b> <b>Example:</b> RP/0/RSP0/CPU0:router(config)# ipsla	Enters IP SLA configuration mode and configures IP service level agreements.
Step 3	<b>mpls lsp-monitor</b> <b>Example:</b> RP/0/RSP0/CPU0:router(config-ipsla)# mpls lsp-monitor	Enters MPLS LSP monitor mode. From this mode you can configure an LSP monitor instance, configure a reaction for an LSP monitor instance, or schedule an LSP monitor instance.
Step 4	<b>monitor</b> <i>monitor-id</i> <b>Example:</b> RP/0/RSP0/CPU0:router(config-ipsla-mplsml)# monitor 2	Configures an MPLS LSP monitor instance.
Step 5	<b>type mpls lsp ping</b> <b>Example:</b> RP/0/RSP0/CPU0:router(config-ipsla-mplsml-def)# type mpls lsp ping	Verifies the end-to-end connectivity of a label switched path (LSP) and the integrity of an MPLS network.

	Command or Action	Purpose
<b>Step 6</b>	<b>path discover</b> <b>Example:</b> <pre>RP/0/RSP0/CPU0:router(config-ipsla-mpls-lsp-ping)# path discover</pre>	Enables LSP path discovery.
<b>Step 7</b>	<b>echo interval <i>time</i></b> <b>Example:</b> <pre>RP/0/RSP0/CPU0:router(config-ipsla-mpls-lsp-lpd)# echo interval 777</pre>	Configures the interval (in milliseconds) between MPLS LSP echo requests sent during path discovery. Range is 0 to 3600000. Default is 0.
<b>Step 8</b>	<b>echo maximum lsp selector ipv4 host address</b> <b>Example:</b> <pre>RP/0/RSP0/CPU0:router(config-ipsla-mpls-lsp-lpd)# echo maximum lsp selector ipv4 host_one 127.100.100.100</pre>	Configures a local host IP address (127.x.x.x) that is the maximum selector value to be used during path discovery. Default is 127.255.255.255.
<b>Step 9</b>	<b>echo multipath bitmap-size <i>size</i></b> <b>Example:</b> <pre>RP/0/RSP0/CPU0:router(config-ipsla-mpls-lsp-lpd)# echo multipath bitmap-size 50</pre>	Configures the maximum number of selectors sent in the downstream mapping of an MPLS LSP echo request during path discovery. Range is 1 to 256. Default is 32.
<b>Step 10</b>	<b>echo retry count</b> <b>Example:</b> <pre>RP/0/RSP0/CPU0:router(config-ipsla-mpls-lsp-lpd)# echo retry 3</pre>	Configures the number of timeout retry attempts for MPLS LSP echo requests sent during path discovery. Range is 0 to 10. Default is 3.
<b>Step 11</b>	<b>echo timeout <i>value</i></b> <b>Example:</b> <pre>RP/0/RSP0/CPU0:router(config-ipsla-mpls-lsp-lpd)# echo timeout 300</pre>	Configures the timeout value for echo requests during path discovery. Range is 0 to 3600 in milliseconds. Default is 5.
<b>Step 12</b>	<b>path retry range</b> <b>Example:</b> <pre>RP/0/RSP0/CPU0:router(config-ipsla-mpls-lsp-lpd)# path retry 12</pre>	Configures MPLS LSP path retry range. Range is 1 to 16. Default is 1.
<b>Step 13</b>	<b>path secondary frequency {both   connection-loss   timeout} <i>value</i></b> <b>Example:</b> <pre>RP/0/RSP0/CPU0:router(config-ipsla-mpls-lsp-lpd)# path secondary frequency both 600</pre>	Enables secondary frequency for: <ul style="list-style-type: none"> <li>• Both timeout and connection loss</li> <li>• Only connection loss</li> <li>• Only timeout</li> </ul>

	Command or Action	Purpose
		<b>Note</b> There is no default value.
<b>Step 14</b>	<p><b>scan period</b> <i>value</i></p> <p><b>Example:</b></p> <pre>RP/0/RSP0/CPU0:router(config-ipsla-mpls-lsp-lpd)# scan period 60</pre>	Configures MPLS LSP scan time period value. Range is 0 to 7200 minutes. Default is 5.
<b>Step 15</b>	Use the <b>commit</b> or <b>end</b> command.	<p><b>commit</b> —Saves the configuration changes and remains within the configuration session.</p> <p><b>end</b> —Prompts user to take one of these actions:</p> <ul style="list-style-type: none"> <li>• <b>Yes</b> — Saves configuration changes and exits the configuration session.</li> <li>• <b>No</b> —Exits the configuration session without committing the configuration changes.</li> <li>• <b>Cancel</b> —Remains in the configuration session, without committing the configuration changes.</li> </ul>

## Configuration Examples for Implementing IP Service Level Agreements

This section provides these configuration examples:

### Configuring IP Service Level Agreements: Example

The following example shows how to configure and schedule a UDP jitter operation:

```
configure
ipsla
operation 101
type udp jitter
destination address 12.2.0.2
statistics hourly
buckets 5
distribution count 5
distribution interval 1
!
destination port 400
statistics interval 120
buckets 5
!
!
!
schedule operation 101
start-time now
life forever
```

```

!
!

show ipsla statistics
Fri Nov 28 16:48:48.286 GMT
Entry number: 101
Modification time: 16:39:36.608 GMT Fri Nov 28 2014
Start time       : 16:39:36.633 GMT Fri Nov 28 2014
Number of operations attempted: 10
Number of operations skipped : 0
Current seconds left in Life : Forever
Operational state of entry   : Active
Operational frequency(seconds): 60
Connection loss occurred     : FALSE
Timeout occurred             : FALSE
Latest RTT (milliseconds)    : 3
Latest operation start time   : 16:48:37.653 GMT Fri Nov 28 2014
Next operation start time     : 16:49:37.653 GMT Fri Nov 28 2014
Latest operation return code  : OK
RTT Values:
  RTTAvg  : 3          RTTMin: 3          RTTMax : 4
  NumOfRTT: 10        RTTSum: 33         RTTSum2: 111
Packet Loss Values:
  PacketLossSD      : 0          PacketLossDS : 0
  PacketOutOfSequence: 0        PacketMIA    : 0
  PacketLateArrival : 0          PacketSkipped: 0
  Errors            : 0          Busies       : 0
  InvalidTimestamp  : 0
Jitter Values :
  MinOfPositivesSD: 1          MaxOfPositivesSD: 1
  NumOfPositivesSD: 2          SumOfPositivesSD: 2
  Sum2PositivesSD : 2
  MinOfNegativesSD: 1          MaxOfNegativesSD: 1
  NumOfNegativesSD: 1          SumOfNegativesSD: 1
  Sum2NegativesSD : 1
  MinOfPositivesDS: 1          MaxOfPositivesDS: 1
  NumOfPositivesDS: 1          SumOfPositivesDS: 1
  Sum2PositivesDS : 1
  MinOfNegativesDS: 1          MaxOfNegativesDS: 1
  NumOfNegativesDS: 1          SumOfNegativesDS: 1
  Sum2NegativesDS : 1
  JitterAve: 1          JitterSDAve: 1          JitterDSAve: 1
  Interarrival jitterout: 0          Interarrival jitterin: 0
One Way Values :
  NumOfOW: 0
  OWMinSD : 0          OWMaxSD: 0          OWSumSD: 0
  OWSum2SD: 0          OWAveSD: 0
  OWMinDS : 0          OWMaxDS: 0          OWSumDS: 0
  OWSum2DS: 0          OWAveDS: 0

```

## Configuring IP SLA Reactions and Threshold Monitoring: Example

The following examples show how to configure IP SLA reactions and threshold monitoring. You can:

- Configure a reaction for attributes that activate a true or false condition, for example, 1, 5, or 6.
- Configure a reaction for attributes that accept a threshold value.
- Configure additional threshold type options.
- Configure either the logging or triggering of action types.

```

configure
ipsla operation 1
  type icmp echo
  timeout 5000
  destination address 223.255.254.254
  frequency 10
  statistics interval 30
  buckets 3
end

configure
ipsla operation 2
  type icmp path-echo
  destination address 223.255.254.254
  frequency 5
end

configure
ipsla reaction operation 1
  react timeout
  action trigger
  threshold type immediate
  exit
exit
  react rtt
  action logging
  threshold lower-limit 4 upper-limit 5
end

```

Operation 1 checks for timeout occurrence. If applicable, operation 1 generates a trigger event. If the **rtt** keyword exceeds 5, an error is logged.

If operation 1 generates a trigger event, operation 2 is started. The following example shows how to configure a reaction trigger operation by using the **ipsla reaction trigger** command:

```

configure
ipsla reaction trigger 1 2
end

```

## Configuring IP SLA MPLS LSP Monitoring: Example

The following example illustrates how to configure IP SLA MPLS LSP monitoring:

```

ipsla
mpls lsp-monitor
monitor 1
  type mpls lsp ping
  vrf SANJOSE
  scan interval 300
  scan delete-factor 2
  timeout 10000
  datasize request 256
  lsp selector ipv4 127.0.0.10
  force explicit-null
  reply dscp af
  reply mode router-alert
  ttl 30
  exp 1
  statistics hourly
  buckets 1

```

```

!
!
!
reaction monitor 1
  react timeout
  action logging
  threshold type immediate
!
  react connection-loss
  action logging
  threshold type immediate
!
!
schedule monitor 1
  frequency 300
  schedule period 120
  start-time 11:45:00 July 4
!
!
mpls discovery vpn
  interval 600
!
!

```

## Configuring LSP Path Discovery: Example

The following example illustrates how to configure LSP Path Discovery:

```

configure
ipsla
mpls lsp-monitor
  monitor 1
  type mpls lsp ping
  path discover
  path retry 12
  path secondary frequency both 12

```

## Additional References

The following sections provide references related to IP Service Level Agreements.

### Related Documents

Related Topic	Document Title
IP Service Level Agreement commands	<i>IP Service Level Agreement Commands</i> module in the <i>System Monitoring Command Reference for Cisco ASR 9000 Series Routers</i>
Information about user groups and task IDs	<i>Configuring AAA Services</i> module in the <i>System Security Configuration Guide for Cisco ASR 9000 Series Routers</i>

Standards	Title
No new or modified standards are supported by this feature, and support for existing standards has not been modified by this feature.	—

MIBs	MIBs Link
—	To locate and download MIBs using Cisco IOS XR software, use the Cisco MIB Locator found at the following URL and choose a platform under the Cisco Access Products menu: <a href="http://cisco.com/public/sw-center/netmgmt/cmtk/mibs.shtml">http://cisco.com/public/sw-center/netmgmt/cmtk/mibs.shtml</a>

**RFCs**

RFCs	Title
No new or modified RFCs are supported by this feature, and support for existing RFCs has not been modified by this feature.	—

**Technical Assistance**

Description	Link
The Cisco Technical Support website contains thousands of pages of searchable technical content, including links to products, technologies, solutions, technical tips, and tools. Registered Cisco.com users can log in from this page to access even more content.	<a href="http://www.cisco.com/cisco/web/support/index.html">http://www.cisco.com/cisco/web/support/index.html</a>

