



## **T3 or E3 CEM Interface Module Configuration Guide, Cisco IOS XE 17 (Cisco NCS 4200 Series)**

**First Published:** 2021-11-30

### **Americas Headquarters**

Cisco Systems, Inc.  
170 West Tasman Drive  
San Jose, CA 95134-1706  
USA  
<http://www.cisco.com>  
Tel: 408 526-4000  
800 553-NETS (6387)  
Fax: 408 527-0883

THE SPECIFICATIONS AND INFORMATION REGARDING THE PRODUCTS IN THIS MANUAL ARE SUBJECT TO CHANGE WITHOUT NOTICE. ALL STATEMENTS, INFORMATION, AND RECOMMENDATIONS IN THIS MANUAL ARE BELIEVED TO BE ACCURATE BUT ARE PRESENTED WITHOUT WARRANTY OF ANY KIND, EXPRESS OR IMPLIED. USERS MUST TAKE FULL RESPONSIBILITY FOR THEIR APPLICATION OF ANY PRODUCTS.

THE SOFTWARE LICENSE AND LIMITED WARRANTY FOR THE ACCOMPANYING PRODUCT ARE SET FORTH IN THE INFORMATION PACKET THAT SHIPPED WITH THE PRODUCT AND ARE INCORPORATED HEREIN BY THIS REFERENCE. IF YOU ARE UNABLE TO LOCATE THE SOFTWARE LICENSE OR LIMITED WARRANTY, CONTACT YOUR CISCO REPRESENTATIVE FOR A COPY.

The Cisco implementation of TCP header compression is an adaptation of a program developed by the University of California, Berkeley (UCB) as part of UCB's public domain version of the UNIX operating system. All rights reserved. Copyright © 1981, Regents of the University of California.

NOTWITHSTANDING ANY OTHER WARRANTY HEREIN, ALL DOCUMENT FILES AND SOFTWARE OF THESE SUPPLIERS ARE PROVIDED "AS IS" WITH ALL FAULTS. CISCO AND THE ABOVE-NAMED SUPPLIERS DISCLAIM ALL WARRANTIES, EXPRESSED OR IMPLIED, INCLUDING, WITHOUT LIMITATION, THOSE OF MERCHANTABILITY, FITNESS FOR A PARTICULAR PURPOSE AND NON-INFRINGEMENT OR ARISING FROM A COURSE OF DEALING, USAGE, OR TRADE PRACTICE.

IN NO EVENT SHALL CISCO OR ITS SUPPLIERS BE LIABLE FOR ANY INDIRECT, SPECIAL, CONSEQUENTIAL, OR INCIDENTAL DAMAGES, INCLUDING, WITHOUT LIMITATION, LOST PROFITS OR LOSS OR DAMAGE TO DATA ARISING OUT OF THE USE OR INABILITY TO USE THIS MANUAL, EVEN IF CISCO OR ITS SUPPLIERS HAVE BEEN ADVISED OF THE POSSIBILITY OF SUCH DAMAGES.

Any Internet Protocol (IP) addresses and phone numbers used in this document are not intended to be actual addresses and phone numbers. Any examples, command display output, network topology diagrams, and other figures included in the document are shown for illustrative purposes only. Any use of actual IP addresses or phone numbers in illustrative content is unintentional and coincidental.

All printed copies and duplicate soft copies of this document are considered uncontrolled. See the current online version for the latest version.

Cisco has more than 200 offices worldwide. Addresses and phone numbers are listed on the Cisco website at [www.cisco.com/go/offices](http://www.cisco.com/go/offices).

Cisco and the Cisco logo are trademarks or registered trademarks of Cisco and/or its affiliates in the U.S. and other countries. To view a list of Cisco trademarks, go to this URL: <https://www.cisco.com/c/en/us/about/legal/trademarks.html>. Third-party trademarks mentioned are the property of their respective owners. The use of the word partner does not imply a partnership relationship between Cisco and any other company. (1721R)

© 2021 Cisco Systems, Inc. All rights reserved.



## CONTENTS

---

<b>CHAPTER 1</b>	<b>Preface</b>	<b>1</b>
	Document Organization	1
	Related Documentation	2

---

<b>CHAPTER 2</b>	<b>Feature History</b>	<b>3</b>
------------------	------------------------	----------

---

<b>CHAPTER 3</b>	<b>Overview of the T3 or E3 Interface Module</b>	<b>5</b>
	Benefits of T3 or E3 Interfaces	7
	Restrictions for Configuring T3 or E3 Interfaces	7
	Circuit Emulation	7
	Overview of CEM Pseudowire	8
	Configuring Pseudowire	8
	Structure-Agnostic TDM over Packet	8
	Circuit Emulation Service over Packet-Switched Network	8
	Restrictions for CESoPSN on T3 or E3 Controller	8
	Circuit Emulation over Packet (CEP)	9
	Restrictions	9
	STS-1 Electricals	9
	Prerequisites for Configuring STS-1e	10
	Restrictions for STS-1e	10

---

<b>CHAPTER 4</b>	<b>Configuring T3 or E3 Interfaces</b>	<b>11</b>
	Configuring the Mode	11
	Configuring the Controller	11
	Configuring the Controller - Clear Channel T3 or E3 Interfaces	11
	Configuring the Controller - Channelized T3 or E3 Interfaces	12

<b>SATOP</b>	<b>13</b>
Configuring SAToP - Clear Channel T3 or E3 Interfaces	13
Configuring SAToP - Channelized T3 Interfaces	14
Configuring SAToP - Channelized E3 Interfaces	14
Configuring Framed SAToP - Channelized T3 Interfaces	15
Configuring Framed SAToP - Channelized E3 Interfaces	15
<b>CESoPN</b>	<b>15</b>
Configuring CESoPSN - Channelized T3 or E3 Interfaces	15
Verifying CESoPSN Configurations - Channelized E3 Interface	16
Configuring CEM Group for CESoPSN - Channelized T3 Interface	19
Verifying CEM for CESoPSN - Channelized T3 Interface	19
Configuring DS1 Local Connect on T3/E3 Interface	22
Configuring T3 or E3 CEP	22
Verifying T3 or E3 CEP Configuration	23
<b>STS-1 Electricals</b>	<b>24</b>
Configuring STS-1e Modes	24
Configuring VT-15 Mode of STS-1e	25
Configuring T1 CT3 mode of STS-1e	25
Configuring T3 mode of STS-1e	26
Configuring Unframed Mode of STS-1e	26
Configuring Line and Section Overhead	27
Configuring Line Loopback	27
Configuring AIS Shut	27
Configuring Shut	27
Configuring Clock	28
Configuring Clock Recovery on STS-1e Controller for Framed SAToP	29
Verifying STS-1e Configuration	30

**CHAPTER 5****Monitoring the T3 or E3 Interface Module 47**

MDL Messages	47
Configuring MDL for Path Transmission	48
Verifying MDL for Path Transmission Configuration	48
Configuring MDL for Test Signal	51
Verifying MDL for Test Signal Configuration	51

Configuring MDL for Idle Signal	55
Verifying MDL for Idle Signal Configuration	55
Performance Monitoring	58

---

<b>CHAPTER 6</b>	<b>Troubleshooting the T3 or E3 Interface Module</b>	<b>73</b>
	Overview of BERT	73
	BERT Restrictions	74
	BERT Patterns on T3/E3 Interface Module	74
	BERT for CESoPSN	76
	Configuring BERT - T3 or E3 Interfaces for SAToP	76
	Verifying the BERT for T3/E3 Interfaces	77
	Configuring BERT - T3 or E3 Interfaces for CESoPSN	78
	Verifying BERT for CESoPSN on T3 or E3 Interface	78
	Loopback on T3 or E3 Interfaces	80
	Restrictions for Loopback Remote	81
	Loopback Remote on T1 and T3 Interfaces	81
	Configuring Loopback for T3 or E3 Interfaces	81
	Configuring Loopback Remote on T1 and T3 Interface	82

---

<b>CHAPTER 7</b>	<b>Providing Redundancy Support At the Interface Module</b>	<b>87</b>
	Card Protection for T3 or E3 Interface Module	87
	Card Protection	87
	Y Cable	88
	Card Protection Switchover	88
	Restrictions	89
	Supported Features on Interface Module	89
	How to Configure Card Protection for T3 or E3	90
	Configuring T3/E3 Card Protection	90
	Configuring Maintenance Commands	92
	Associated Commands	93
	Card Protection for STS-1e	93
	Restrictions for STS-1 Electricals Card Protection	94
	How to Configure Card Protection for STS-1 Electricals	94
	Configuring Card Protection	94

Provisioning Card Protection	94
Configuring STS-1 Electrical Mode for SONET	96
Configuring STS-1e for VT1.5-T1 Mode	96
Configuring STS-1e for T3 Mode	96
Configuring STS-1e for VT1.5-VT Mode	97
Configuring STS-1e for CEP Mode	97
Configuring STS-1e for CT3 Mode	97
Verifying Card Protection Configuration for STS-1 Electricals	98

---

**CHAPTER 8****Additional References** 99

STS-1 Frame	99
STS-1 Overhead	100
Asynchronous Mapping for T3 or E3 CEP	100
Alarms for T3 or E3 CEP	101



# CHAPTER 1

## Preface

This guide provides an overview and explains how to configure the various features for the T3 or E3 CEM Interface Module.

This document is applicable for the following interface modules:

**Table 1: Supported Interface Module**

Interface Module	Part Number
48-port T3/E3 Interface module	• NCS4200-48T3E3-CE
1-port OC48/ STM-16 or 4-port OC-12/OC-3 / STM-1/STM-4 + 12-Port T1/E1 + 4-Port T3/E3 CEM Interface Module	• NCS4200-3GMS

Circuit Emulation (CEM) is a technology that provides a protocol-independent transport over IP/MPLS networks. It enables proprietary or legacy applications to be carried transparently to the destination, similar to a leased line.

- [Document Organization, on page 1](#)
- [Related Documentation, on page 2](#)

## Document Organization

Chapter	Description
Overview of the T3/E3 Interface Module	Provides a high-level overview of the interface module. Also provides additional information such as restrictions, benefits etc..
Configuring the T3/E3 Interface Module	Provides information about how to configure the interface module.
Monitoring the Interface Module	Provides information on monitoring features for the interface module.
Troubleshooting the Interface Module	Describes features that you can use to troubleshoot the operation of interface module.

Chapter	Description
Providing Redundancy Support at the Interface Module	Describes how to configure redundancy on the interface module.
Additional References	Provides information on additional features, technical details.

## Related Documentation

- Alarm Configuring and Monitoring Guide
- CEM Generic Guide
- T1 or E1 CEM Interface Module Configuration Guide





## CHAPTER 2

# Feature History

The following table lists the new and modified features supported in the 48-Port T3/E3 CEM Interface Module Configuration Guide in Cisco IOS XE 17 releases., on Cisco NCS 4206 and Cisco NCS 4216 routers.

Feature	Description
<b>Cisco IOS XE Bengaluru 17.5.1</b>	
<a href="#">GR-820-CORE Performance Monitoring</a>	The <b>show controller tabular</b> command enables you to view the performance monitoring details in tabular form as per GR-820-Core standards.
<b>Cisco IOS XE Bengaluru 17.4.1</b>	
<a href="#">STS1E Framed SAToP Support on IMA3G</a>	Support on clock recovery on STS-1e controller for framed SAToP on the following modes: <ul style="list-style-type: none"> <li>• T3</li> <li>• CT3</li> <li>• VT-15</li> </ul>
<a href="#">Support for all 0s and 1s BERT Patterns</a>	Support for all 0s and 1s BERT patterns on T3 or E3 interfaces.





# CHAPTER 3

## Overview of the T3 or E3 Interface Module

The T3 or E3 interface module delivers T3 or E3 connectivity on the router with the RSP3 module. The module can be software configured as either T3 mode or E3 mode per interface module. The module provides physical connectivity using a single high-density connector and requires a breakout cable and patch panel for individual port connections.

The T3 or E3 interface module supports the following modes:

- T3
- E3
- STS-1

Each mode supports clear channel and channelized mode.



**Note** Mixing T3 and E3 ports on the same interface module is not supported.

CEM configurations are supported on different modes on the interface module. The troubleshooting, monitoring and redundancy features are supported on the module. The module can be clocked from a line or from an internal clock source. The table describes the configurations and features for the modes supported on the T3 or E3 interface module.

*Table 2: Configurations on T3 or E3 Interface Module*

	T3		E3		STS-1	
	Clear Channel	Channelized	Clear Channel	Channelized	Clear Channel - STS1c, T3	Channelized (Vt1.5, CT3)
<b>Required Configurations</b>						
<b>Mode</b>	Yes	Yes	Yes	Yes	Yes	Yes
<b>Internal/Line Clock Source</b>	Yes	Yes	Yes	Yes	Yes	Yes
<b>ACR/DCR Clock</b>	Yes	Yes	Yes	Yes	NA	Yes

	T3		E3		STS-1	
	Clear Channel	Channelized	Clear Channel	Channelized	Clear Channel - STS1c, T3	Channelized (Vt1.5, CT3)
<b>Line and Section Overhead</b>	NA	NA	NA	NA	Yes	Yes
<b>CEM Configurations</b>						
<b>Structure- Agnostic TDM over Packet (SATOP) (Framed/Unframed)</b>	Yes	Yes	Yes	Yes	NA	Yes
<b>Circuit Emulation over Packet-Switched Network (CESoPSN)</b>	NA	Yes	NA	Yes	NA	Yes
<b>Circuit Emulation over Packet (CEP)</b>	Yes	NA	Yes	NA	Yes	NA
<b>Troubleshooting Features</b>						
<b>Bit Error Rate Testing (BERT)</b>	Yes	Yes	Yes	Yes	Yes	Yes
<b>Loopback</b>	Yes	Yes	Yes	Yes	Yes	Yes
<b>Monitoring Features</b>						
<b>Maintenance Data Link (MDL)</b>	Yes	NA	Yes	NA	Yes (only on T3 mode)	Yes
<b>Performance Monitoring</b>	Yes	Yes	Yes	NA	Yes	Yes
<b>Redundancy Support</b>						
<b>Card Protection Switchover</b>	Yes	Yes	Yes	Yes	Yes	Yes
<b>Alarm Based Switchover</b>	Yes	Yes	Yes	Yes	Yes	Yes

- [Benefits of T3 or E3 Interfaces, on page 7](#)
- [Restrictions for Configuring T3 or E3 Interfaces, on page 7](#)
- [Circuit Emulation, on page 7](#)
- [Overview of CEM Pseudowire, on page 8](#)
- [Structure-Agnostic TDM over Packet , on page 8](#)
- [Circuit Emulation Service over Packet-Switched Network, on page 8](#)
- [Circuit Emulation over Packet \(CEP\), on page 9](#)

- [STS-1 Electricals, on page 9](#)

## Benefits of T3 or E3 Interfaces

The following are the benefits of T3/E3 interfaces:

- Higher bandwidth
- Flexibility by channelization

## Restrictions for Configuring T3 or E3 Interfaces

- You can configure CEM to support serial interface configuration.
- DS0 level Channelization is *not* supported.
- The G.832 framing mode is *not* supported.
- Synchronization Status Message (SSM) is not supported on T3 ports.
- The interoperability of Maintenance Data Link (MDL) is not supported with earlier version interface modules.
- The T3 or E3 port does not support sending Alarm Indication Signal (AIS) when local loopback is configured.

## Circuit Emulation

Circuit Emulation (CEM) is a technology that provides a protocol-independent transport over IP/MPLS networks. It enables proprietary or legacy applications to be carried transparently to the destination, similar to a leased line.

CEM provides a bridge between a Time-Division Multiplexing (TDM) network and Multiprotocol Label Switching (MPLS) network. The router encapsulates the TDM data in the MPLS packets and sends the data over a CEM pseudowire to the remote Provider Edge (PE) router. As a result, CEM functions as a physical communication link across the packet network.

The router supports the pseudowire type that utilizes CEM transport: Structure-Agnostic TDM over Packet (SAToP) and Circuit Emulation Service over Packet-Switched Network (CESoPSN).

L2VPN over IP/MPLS is supported on the interface modules.



---

**Note** We recommend that you configure the controller in the administratively up mode. Configuration under the administratively down mode is not recommended and it might cause configuration errors.

---

## Overview of CEM Pseudowire

Pseudowires manage encapsulation, timing, order, and other operations in order to make it transparent to users. The pseudowire tunnel acts as an unshared link or circuit of the emulated service. CEM is a way to carry TDM circuits over packet switched network. CEM embeds the TDM circuits into packets, encapsulates them into an appropriate header, and then sends that through Packet Switched Network. The receiver side of CEM restores the TDM circuits from packets.

## Configuring Pseudowire

Cisco Pseudowire Emulation Edge-to-Edge (PWE3) allows you to transport traffic by using traditional services such as T1/E1 over a packet-based backhaul technology such as MPLS or IP. A pseudowire (PW) consists of a connection between two provider edge (PE) chassis that connects two attachment circuits (ACs), such as T1/E1 or T3 /E3 links.

## Structure-Agnostic TDM over Packet

Structure-Agnostic TDM over Packet (SAToP) encapsulates Time Division Multiplexing (TDM) bit-streams as pseudowires over public switched networks. It disregards any structure that may be imposed on streams, in particular the structure imposed by the standard TDM framing.

The protocol used for emulation of these services does not depend on the method in which attachment circuits are delivered to the Provider Edge (PE) chassis. For example, a T1 attachment circuit is treated the same way for all delivery methods, including copper, multiplex in a T3 circuit, a virtual tributary of a SONET circuit, or unstructured Circuit Emulation Service (CES).

In SAToP mode, the interface is considered as a continuous framed bit stream. The packetization of the stream is done according to IETF RFC 4553. All signaling is carried out transparently as a part of a bit stream.

## Circuit Emulation Service over Packet-Switched Network

CESoPSN is a method for encapsulating structured (NxDS0) TDM signals as pseudowires over packet switching networks.

## Restrictions for CESoPSN on T3 or E3 Controller

- The maximum number of CEM interface supported is 1344.
- M13 framing isn't supported on the T3 interface for the clear channel configuration, and it's only supported for the T3 channelized configuration.  
G832 framing isn't supported on the E3 interface for the clear channel configuration, and it's only supported for the E3 channelized configuration.
- CT3-E1 and CE3-T1 are not supported and only CT3-T1 and CE3-E1 are supported.
- DS0 loopback isn't supported on the T3 interface.
- Alarm forwarding isn't supported on the T3 interface.

- Card protection isn't supported on the T3 interface.

## Circuit Emulation over Packet (CEP)

Effective Cisco IOS XE Fuji 16.8.1, CEP feature is introduced to achieve STS-1 or VC4 CEP configuration on the interface module. Here, T3 or E3 is mapped to STS-1 or VC4 that is emulated on a packet network.

**Figure 1: Network Reference Model and Protocol Layers for TDM-MPLS User Plane Interworking**

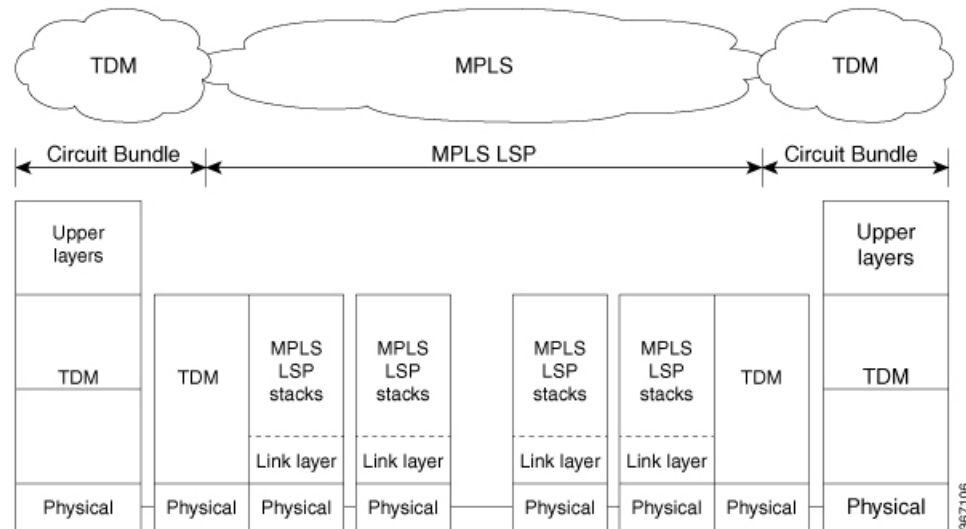

For more information on CEP, see [Asynchronous Mapping for T3 or E3 CEP, on page 100](#) and [Alarms for T3 or E3 CEP, on page 101](#).

## Restrictions

- BERT for both line and system directions is *not* supported until Cisco IOS XE Fuji 16.9.5 release.
- Card Protection is *not* supported.
- E3 CEP is not supported on optical or SDH controller.

## STS-1 Electricals

STS-1 structure or frame format enables STS-1 mode on the Electrical T3 or E3 ports in the 48-Port T3 or E3 CEM interface module and 1 port OC-48/STM-16 or 4 port OC-12/OC-3 / STM-1/STM-4 + 12 port T1/E1 + 4 port T3/E3 CEM interface module. STS-1E provides facility to have STS-1 and its modes transmission on the Electrical T3 or E3 ports. Thus, the STS-1 signal coded for electrical transmission is also termed as Electrical Carrier-1 (EC-1).

STS-1E supports SAToP and CEP support configurations on the T3 or E3 ports.

For information on STS-1 frame, see [STS-1 Frame, on page 99](#) and [STS-1 Overhead, on page 100](#).

## Prerequisites for Configuring STS-1e

You must select the MediaType controller to configure and enter the controller configuration mode.

You must configure the controller as a STS-1e port.

## Restrictions for STS-1e

- Only 16 BERT patterns can be configured at a time.
- PMON fields are not supported for VT1.5 VT and T3.
- PMON far-end parameters are not supported.
- APS and card-protection are not supported for STS-1e port.
- In the unframed mode, ACR and DCR are not supported.
- CESoPSN is not supported.
- Framed SAToP is not supported for releases until Cisco IOS XE Amsterdam 17.3.1. Starting with Cisco IOS XE Bengaluru 17.4.1 framed SAToP is supported.
- For framed SAToP with SF framing, RAI is asserted and cleared continuously.

### Restrictions for Clock Source Configuration

- Only 4 ports can be configured in STS-1e line for clock source configuration per chassis.
- You should configure the clock source line and network-clock sync together to receive the clock from a remote port that is connected to the STS-1e port.





## CHAPTER 4

# Configuring T3 or E3 Interfaces

This section provides the information about how to configure a T3 or E3 interface. The T3 or E3 interface can be configured as clear channel mode or channelized mode.

- [Configuring the Mode, on page 11](#)
- [Configuring the Controller, on page 11](#)
- [SATOP, on page 13](#)
- [CESoPN, on page 15](#)
- [STS-1 Electricals, on page 24](#)

## Configuring the Mode

To enable the mode on the T3/E3 interface module, follow these steps:

```
enable
configure terminal
controller mediatype 0/4/0
mode t3
exit
```

To disable the mode use the **no mode** command.

## Configuring the Controller

### Configuring the Controller - Clear Channel T3 or E3 Interfaces

#### Before You Begin

When the clear channel T3 or E3 interface is used for the first time, the running configuration does not show the T3 or E3 controller. You can use the **show platform** command to check whether the chassis recognizes the T3 or E3 port and initializes the card correctly. After the port is configured for the slot, the respective controller appears in the running configuration and you can configure the clear channel T3 or E3 interface.

Perform this task to configure clear channel controller as T3.

```
enable
```

```

configure terminal
controller t3 0/4/40
no channelized
clock source line
no shut
exit

```



---

**Note** By default, the T3 controller is in C-Bit framing mode. To configure CEM, the framing mode must be set to unframed.

---

Perform this task to configure clear channel controller as E3.

```

enable
configure terminal
controller e3 0/4/40
clock source line
no shut
exit

```

## Configuring the Controller - Channelized T3 or E3 Interfaces

### Before You Begin

When the channelized T3 or E3 interface is used for the first time, the running configuration does not show the T3 or E3 controller. You can use the **show platform** command to check if the chassis recognizes the T3 or E3 port and initializes the card properly. After the port is configured for the slot, the respective controller appears in the running configuration and you can configure the channelized T3 or E3 interface.

Perform this task to configure channelized controller as T3.

```

enable
configure terminal
controller t3 0/4/46
channelized
clock source line
no shut
exit

```



---

**Note** The channelized mode is the default mode for T3 interface.

---

Perform this task to configure channelized controller as E3.

```

enable
configure terminal
controller e3 0/4/46
channelized mode e1
framing g751
exit

```



**Note** The clear channel mode is the default mode for E3 interface.

**Table 3: Feature History**

Feature Name	Release Information	Description
Channelize the T3 interface into E1 lines	Cisco IOS XE Bengaluru 17.6.2	Support for the T3 interface to be channelized into 21 E1 lines.

Starting with Cisco IOS XE Bengaluru 17.6.2, T3 interface can be channelized to 21 E1 lines.

To channelize the T3 interface into E1 lines, use the following commands:

```
enable
configure terminal
controller MediaType0/1/1
mode t3
controller t30/1/1
channelized mode e1
framing c-bit
exit
```

## SATOP

### Configuring SAToP - Clear Channel T3 or E3 Interfaces

#### Before You Begin

Before Structure-Agnostic TDM over Packet (SAToP) is configured, the controller of clear channel T3 interface must be configured.

```
enable
configure terminal
controller t3 0/4/40
no channelized
cem-group 0 unframed
interface CEM 0/4/40
cem 0
xconnect 10.10.2.2 204 encapsulation mpls
exit
```

#### Before You Begin

Before SAToP is configured, the controller of clear channel E3 interface must be configured.

```
enable
configure terminal
controller e3 0/4/40
no channelized
cem-group 0 unframed
```

```
interface CEM 0/4/40
cem 0
xconnect 10.10.2.2 204 encapsulation mpls
exit
```

### Verifying the configuration



**Note** The **no channelize** is displayed in show running-configuration when cem-group 0 unframed is configured.

```
Router(config-controller)# show run
controller MediaType 0/4/40
mode e3
controller 0/4/40
threshold sd-ber 6
threshold sf-ber 3
no channelized
framing g751
cablelength short
cem-group 0 framed
controller MediaType 0/4/40
interface CEM8/1/10/4/40
no ip address
cem 0
!
```

## Configuring SAToP - Channelized T3 Interfaces

### Before You Begin

Before SAToP is configured, the controller of channelized T3 interface must be configured.

```
enable
configure terminal
controller t3 0/4/12
channelized
t1 1 cem-group 0 unframed
interface CEM 0/4/12
cem 0
xconnect 10.10.2.2 204 encapsulation mpls
exit
```

## Configuring SAToP - Channelized E3 Interfaces

### Before You Begin

Before SAToP is configured, the controller of channelized E3 interfaces must be configured.

```
enable
configure terminal
controller e3 0/4/46
channelized
e1 1 cem-group 0 unframed
interface CEM 0/4/46
```

```

cem 0
xconnect 10.10.2.2 204 encapsulation mpls
exit

```

## Configuring Framed SAToP - Channelized T3 Interfaces



**Note** Framing type should be maintained same in all routers end to end.

To configure the controller of channelized T3 interface for framed SAToP:

```

enable
configure terminal
controller t3 0/4/46
channelized mode
framing c-bit
t1 1 cem-group 0 framed
interface CEM 0/4/46
cem 0
xconnect 10.10.2.2 204 encapsulation mpls
exit

```

## Configuring Framed SAToP - Channelized E3 Interfaces

To configure the controller of channelized E3 interfaces for Framed SAToP:

```

enable
configure terminal
controller e3 0/4/46
channelized mode e1
framing g751
e1 1 cem-group 0 framed
interface CEM 0/4/46
cem 0
xconnect 10.10.2.2 204 encapsulation mpls
exit

```

## CESoPN

### Configuring CESoPSN - Channelized T3 or E3 Interfaces

Before You Begin

Create CEM group for channelized T3 interface, use the following commands:

```

enable
configure terminal
controller MediaType 0/5/1
mode t3
channelized
controller T3 0/5/1
framing c-bit

```

```

cablelength short
t1 1 cem-group 1 timeslots 10
exit

```

Create CEM group for channelized E3 interface, use the following commands:

```

enable
configure terminal
controller MediaType 0/5/1
  mode e3
channelized mode e1
controller e3 0/14/0
channelized
  cablelength short
  e1 1 cem-group 0 timeslots 10
exit

```

Configure xconnect:

```

int cem 0/14/0
cem 0
xconnect 10.1.1.1 9999 encapsulation mpls

```

Verify the xconnect status:

```

sh xconnect all | i 9999
UP pri ac CE0/14/0:0(CESoPSN Basic) UP mpls 10.1.1.1:9999 UP

```

## Verifying CESoPSN Configurations - Channelized E3 Interface

This section includes show commands for CESoPSN:

```

Router# show controllers e3 0/14/2
E3 0/14/2 is up.
Hardware is ASR903-48T3E3-CE
Applique type is Channelized E3
No alarms detected.
Framing is E3 G751, Line Code is HDB3, Cablelength Short less than 225ft
BER thresholds: SF = 10e-10 SD = 10e-10
Clock Source is internal, National Bit 0
Equipment customer loopback
Data in current interval (240 seconds elapsed):
Near End
  0 Line Code Violations, 0 P-bit Coding Violations
  0 C-bit Coding Violations, 0 P-bit Err Secs
  0 P-bit Severely Err Secs, 0 Severely Err Framing Secs
  0 Unavailable Secs, 0 Line Errored Secs
  0 C-bit Errored Secs, 0 C-bit Severely Errored Secs
  0 Severely Errored Line Secs, 0 Path Failures
  0 AIS Defect Secs, 0 LOS Defect Secs
Far End
  0 Errored Secs, 0 Severely Errored Secs
  0 C-bit Unavailable Secs, 0 Path Failures
  0 Code Violations, 0 Service Affecting Secs
Data in Interval 1:
Near End
  0 Line Code Violations, 0 P-bit Coding Violations
  0 C-bit Coding Violations, 0 P-bit Err Secs
  0 P-bit Severely Err Secs, 0 Severely Err Framing Secs
  20 Unavailable Secs, 20 Line Errored Secs
  0 C-bit Errored Secs, 0 C-bit Severely Errored Secs
  20 Severely Errored Line Secs, 1 Path Failures

```

```

    0 AIS Defect Secs, 20 LOS Defect Secs
  Far End
    0 Errored Secs, 0 Severely Errored Secs
    0 C-bit Unavailable Secs, 0 Path Failures
    0 Code Violations, 0 Service Affecting Secs
Total Data (last 1 15 minute intervals):
  Near End
    0 Line Code Violations, 0 P-bit Coding Violations,
    0 C-bit Coding Violations, 0 P-bit Err Secs,
    0 P-bit Severely Err Secs, 0 Severely Err Framing Secs,
    20 Unavailable Secs, 20 Line Errored Secs,
    0 C-bit Errored Secs, 0 C-bit Severely Errored Secs
    20 Severely Errored Line Secs, 1 path failures
    0 AIS Defect Secs, 20 LOS Defect Secs
  Far End
    0 Errored Secs, 0 Severely Errored Secs
    0 C-bit Unavailable Secs, 0 Path Failures
    0 Code Violations, 0 Service Affecting Secs

E1 1 is up
timeslots:
FDL per AT&T 54016 spec.
No alarms detected.
Framing is crc4, Clock Source is Internal, National bits are 0x1F.
Data in current interval (250 seconds elapsed):
  Near End
    0 Line Code Violations, 0 Path Code Violations
    0 Slip Secs, 0 Fr Loss Secs, 0 Line Err Secs, 0 Degraded Mins
    0 Errored Secs, 0 Bursty Err Secs, 0 Severely Err Secs
    0 Unavailable Secs, 0 Stuffed Secs
    0 Path Failures, 0 SEF/AIS Secs
  Far End
    0 Line Code Violations, 0 Path Code Violations
    0 Slip Secs, 0 Fr Loss Secs, 0 Line Err Secs, 0 Degraded Mins
    0 Errored Secs, 0 Bursty Err Secs, 0 Severely Err Secs
    0 Unavailable Secs 0 Path Failures
Data in Interval 1:
  Near End
    0 Line Code Violations, 0 Path Code Violations
    0 Slip Secs, 2 Fr Loss Secs, 0 Line Err Secs, 0 Degraded Mins
    2 Errored Secs, 0 Bursty Err Secs, 2 Severely Err Secs
    0 Unavailable Secs, 0 Stuffed Secs
    1 Path Failures, 2 SEF/AIS Secs
  Far End
    0 Line Code Violations, 0 Path Code Violations
    0 Slip Secs, 2 Fr Loss Secs, 0 Line Err Secs, 0 Degraded Mins
    3 Errored Secs, 0 Bursty Err Secs, 3 Severely Err Secs
    0 Unavailable Secs 0 Path Failures
Total Data (last 1 15 minute intervals):
  Near End
    0 Line Code Violations,0 Path Code Violations,
    0 Slip Secs, 2 Fr Loss Secs, 0 Line Err Secs, 0 Degraded Mins,
    2 Errored Secs, 0 Bursty Err Secs, 2 Severely Err Secs
    0 Unavailable Secs, 0 Stuffed Secs
    1 Path Failures, 2 SEF/AIS Secs
  Far End
    0 Line Code Violations,0 Path Code Violations
    0 Slip Secs, 2 Fr Loss Secs, 0 Line Err Secs, 0 Degraded Mins,
    3 Errored Secs, 0 Bursty Err Secs, 3 Severely Err Secs
    0 Unavailable Secs, 0 Path Failures

```

```

router# sh mpls l2 vc interface cem 0/14/0 0
-----
Local intf      Local circuit      Dest address      VC ID      Status
-----
CE0/14/0       CESoPSN Basic 0    10.1.1.1         9999       UP

```

```

router# sh mpls l2transport vc 9090 detail
Local interface: CE0/14/2 up, line protocol up, CESoPSN Basic 0 up
Destination address: 10.1.1.1, VC ID: 9090, VC status: up
Output interface: Te0/12/0, imposed label stack {130}
Preferred path: not configured
Default path: active
Next hop: 209.165.202.129
Create time: 00:18:44, last status change time: 00:18:30
Last label FSM state change time: 00:18:30
Signaling protocol: LDP, peer 10.1.1.1:0 up
Targeted Hello: 10.2.2.2(LDP Id) -> 10.1.1.1, LDP is UP
Graceful restart: not configured and not enabled
Non stop routing: configured and not enabled
Status TLV support (local/remote) : enabled/supported
LDP route watch : enabled
Label/status state machine : established, LruRru
Last local dataplane status rcvd: No fault
Last BFD dataplane status rcvd: Not sent
Last BFD peer monitor status rcvd: No fault
Last local AC circuit status rcvd: No fault
Last local AC circuit status sent: No fault
Last local PW i/f circ status rcvd: No fault
Last local LDP TLV status sent: No fault
Last remote LDP TLV status rcvd: No fault
Last remote LDP ADJ status rcvd: No fault
MPLS VC labels: local 130, remote 130
Group ID: local 207, remote 220
MTU: local 0, remote 0
Remote interface description:
Sequencing: receive disabled, send disabled
Control Word: On (configured: autosense)
SSO Descriptor: 10.1.1.1/9090, local label: 130
Dataplane:
SSM segment/switch IDs: 1237749/557811 (used), PWID: 114
VC statistics:
transit packet totals: receive 0, send 0
transit byte totals: receive 0, send 0
transit packet drops: receive 0, seq error 0, send 0
ASR907# sh cem circuit interface cem 0/14/2 0
CEM0/14/2, ID: 0, Line: UP, Admin: UP, Ckt: ACTIVE
Mode :Channelized-E1, E1: 1, CEM Mode: E1-CESoP
Controller state: up, T1 state: up
Idle Pattern: 0xFF, Idle CAS: 0x8
Dejitter: 5 (In use: 0)
Payload Size: 160
Framing: Framed (DS0 channels: 1-20)
CEM Defects Set
None
Signalling: No CAS
RTP: No RTP
Ingress Pkts: 24005 Dropped: 0
Egress Pkts: 24005 Dropped: 0
CEM Counter Details
Input Errors: 0 Output Errors: 0
Pkts Missing: 0 Pkts Reordered: 0
Misorder Drops: 0 JitterBuf Underrun: 0
Error Sec: 0 Severly Errored Sec: 0
Unavailable Sec: 0 Failure Counts: 0

```



```

Pkts Malformed: 0          JitterBuf Overrun: 0
Generated Lbits: 0         Received Lbits: 0
Generated Rbits: 0         Received Rbits: 0
Generated Mbits: 0         Received Mbits: 0

```

## Configuring CEM Group for CESoPSN - Channelized T3 Interface

The following section describes how to configure a CEM group for CESoPSN on the channelized T3 interface:

```

controller MediaType 0/5/1
 mode t3
 channelized
controller T3 0/5/1
 framing c-bit
 cablelength short
 t1 1 cem-group 1 timeslots 1-10

```

## Verifying CEM for CESoPSN - Channelized T3 Interface

Use the following commands to verify the pseudowire configuration for CESoPSN:

- **show cem circuit**—Displays information about the circuit state, administrative state, the CEM ID of the circuit, and the interface on which it is configured. If cross connect is configured under the circuit, the command output also includes information about the attachment circuit status.
- **show mpls 12 vc**—Displays information about the MPLS VC.
- **show mpls 12 vc detail**—Displays detailed information about the MPLS VC.

```

Router# show controllers e3 0/14/2
E3 0/14/2 is up.
Hardware is ASR903-48T3E3-CE
Applique type is Channelized E3
No alarms detected.
Framing is E3 G751, Line Code is HDB3, Cablelength Short less than 225ft
BER thresholds: SF = 10e-10 SD = 10e-10
Clock Source is internal, National Bit 0
Equipment customer loopback
Data in current interval (240 seconds elapsed):
Near End
 0 Line Code Violations, 0 P-bit Coding Violations
 0 C-bit Coding Violations, 0 P-bit Err Secs
 0 P-bit Severely Err Secs, 0 Severely Err Framing Secs
 0 Unavailable Secs, 0 Line Errored Secs
 0 C-bit Errored Secs, 0 C-bit Severely Errored Secs
 0 Severely Errored Line Secs, 0 Path Failures
 0 AIS Defect Secs, 0 LOS Defect Secs
Far End
 0 Errored Secs, 0 Severely Errored Secs
 0 C-bit Unavailable Secs, 0 Path Failures
 0 Code Violations, 0 Service Affecting Secs
Data in Interval 1:
Near End
 0 Line Code Violations, 0 P-bit Coding Violations
 0 C-bit Coding Violations, 0 P-bit Err Secs
 0 P-bit Severely Err Secs, 0 Severely Err Framing Secs
 20 Unavailable Secs, 20 Line Errored Secs
 0 C-bit Errored Secs, 0 C-bit Severely Errored Secs

```

```

    20 Severely Errored Line Secs, 1 Path Failures
    0 AIS Defect Secs, 20 LOS Defect Secs
Far End
    0 Errored Secs, 0 Severely Errored Secs
    0 C-bit Unavailable Secs, 0 Path Failures
    0 Code Violations, 0 Service Affecting Secs
Total Data (last 1 15 minute intervals):
Near End
    0 Line Code Violations, 0 P-bit Coding Violations,
    0 C-bit Coding Violations, 0 P-bit Err Secs,
    0 P-bit Severely Err Secs, 0 Severely Err Framing Secs,
    20 Unavailable Secs, 20 Line Errored Secs,
    0 C-bit Errored Secs, 0 C-bit Severely Errored Secs
    20 Severely Errored Line Secs, 1 path failures
    0 AIS Defect Secs, 20 LOS Defect Secs
Far End
    0 Errored Secs, 0 Severely Errored Secs
    0 C-bit Unavailable Secs, 0 Path Failures
    0 Code Violations, 0 Service Affecting Secs

E1 1 is up
timeslots: 1-20
No alarms detected.
Framing is crc4, Clock Source is Internal, National bits are 0x1F.
Data in current interval (250 seconds elapsed):
Near End
    0 Line Code Violations, 0 Path Code Violations
    0 Slip Secs, 0 Fr Loss Secs, 0 Line Err Secs, 0 Degraded Mins
    0 Errored Secs, 0 Bursty Err Secs, 0 Severely Err Secs
    0 Unavailable Secs, 0 Stuffed Secs
    0 Path Failures, 0 SEF/AIS Secs
Far End
    0 Line Code Violations, 0 Path Code Violations
    0 Slip Secs, 0 Fr Loss Secs, 0 Line Err Secs, 0 Degraded Mins
    0 Errored Secs, 0 Bursty Err Secs, 0 Severely Err Secs
    0 Unavailable Secs 0 Path Failures
Data in Interval 1:
Near End
    0 Line Code Violations, 0 Path Code Violations
    0 Slip Secs, 2 Fr Loss Secs, 0 Line Err Secs, 0 Degraded Mins
    2 Errored Secs, 0 Bursty Err Secs, 2 Severely Err Secs
    0 Unavailable Secs, 0 Stuffed Secs
    1 Path Failures, 2 SEF/AIS Secs
Far End
    0 Line Code Violations, 0 Path Code Violations
    0 Slip Secs, 2 Fr Loss Secs, 0 Line Err Secs, 0 Degraded Mins
    3 Errored Secs, 0 Bursty Err Secs, 3 Severely Err Secs
    0 Unavailable Secs 0 Path Failures
Total Data (last 1 15 minute intervals):
Near End
    0 Line Code Violations,0 Path Code Violations,
    0 Slip Secs, 2 Fr Loss Secs, 0 Line Err Secs, 0 Degraded Mins,
    2 Errored Secs, 0 Bursty Err Secs, 2 Severely Err Secs
    0 Unavailable Secs, 0 Stuffed Secs
    1 Path Failures, 2 SEF/AIS Secs
Far End
    0 Line Code Violations,0 Path Code Violations
    0 Slip Secs, 2 Fr Loss Secs, 0 Line Err Secs, 0 Degraded Mins,
    3 Errored Secs, 0 Bursty Err Secs, 3 Severely Err Secs
    0 Unavailable Secs, 0 Path Failures

```

```
router# sh mpls 12 vc interface cem 0/14/0 0
```

Local intf	Local circuit	Dest address	VC ID	Status
CE0/14/0	CESoPSN Basic 0	10.1.1.1	9999	UP

Router# **sh mpls l2transport vc 9090 detail**

```

Local interface: CE0/14/2 up, line protocol up, CESoPSN Basic 0 up
  Destination address: 10.1.1.1, VC ID: 9090, VC status: up
  Output interface: Te0/12/0, imposed label stack {130}
  Preferred path: not configured
  Default path: active
  Next hop: 209.165.202.129
Create time: 00:18:44, last status change time: 00:18:30
Last label FSM state change time: 00:18:30
Signaling protocol: LDP, peer 10.1.1.1:0 up
  Targeted Hello: 10.2.2.2(LDP Id) -> 10.1.1.1, LDP is UP
  Graceful restart: not configured and not enabled
  Non stop routing: configured and not enabled
  Status TLV support (local/remote) : enabled/supported
  LDP route watch : enabled
  Label/status state machine : established, LruRru
  Last local dataplane status rcvd: No fault
  Last BFD dataplane status rcvd: Not sent
  Last BFD peer monitor status rcvd: No fault
  Last local AC circuit status rcvd: No fault
  Last local AC circuit status sent: No fault
  Last local PW i/f circ status rcvd: No fault
  Last local LDP TLV status sent: No fault
  Last remote LDP TLV status rcvd: No fault
  Last remote LDP ADJ status rcvd: No fault
MPLS VC labels: local 130, remote 130
Group ID: local 207, remote 220
MTU: local 0, remote 0
Remote interface description:
Sequencing: receive disabled, send disabled
Control Word: On (configured: autosense)
SSO Descriptor: 10.1.1.1/9090, local label: 130
Dataplane:
  SSM segment/switch IDs: 1237749/557811 (used), PWID: 114
VC statistics:
  transit packet totals: receive 0, send 0
  transit byte totals: receive 0, send 0
  transit packet drops: receive 0, seq error 0, send 0

```

Router# **sh cem circuit interface cem 0/14/2 0**

```

CEM0/14/2, ID: 0, Line: UP, Admin: UP, Ckt: ACTIVE
Mode :Channelized-E1, E1: 1, CEM Mode: E1-CESoP
Controller state: up, T1 state: up
Idle Pattern: 0xFF, Idle CAS: 0x8
Dejitter: 5 (In use: 0)
Payload Size: 160
Framing: Framed (DS0 channels: 1-20)
CEM Defects Set
None

Signalling: No CAS
RTP: No RTP

Ingress Pkts: 24005 Dropped: 0
Egress Pkts: 24005 Dropped: 0

CEM Counter Details

```

```

Input Errors:      0          Output Errors:      0
Pkts Missing:     0          Pkts Reordered:    0
Misorder Drops:   0          JitterBuf Underrun: 0
Error Sec:        0          Severly Errored Sec: 0
Unavailable Sec:  0          Failure Counts:     0
Pkts Malformed:  0          JitterBuf Overrun:  0
Generated Lbits:  0          Received Lbits:     0
Generated Rbits:  0          Received Rbits:     0
Generated Mbits:  0          Received Mbits:     0

```

## Configuring DS1 Local Connect on T3/E3 Interface

The following section describes how to configure the first segment for DS1 local connection:

```

enable
configure terminal
controller MediaType 0/5/7
  mode e3
channelized mode e1
controller E3 0/5/7
  e1 2 cem-group 1 timeslots 1-10

```

The following section describes how to configure the second segment for DS1 local connection:

```

enable
configure terminal
controller MediaType 0/5/2
  mode e3
channelized mode e1
controller E3 0/5/2
  e1 2 cem-group 1 timeslots 1-10

```

The following section describes how to create a DS1 local connection:

```

enable
configure terminal
connect ds1_connect CEM0/5/7 1 CEM CEM0/5/2 1

```

## Verifying DS1 Local Connect on T3 Interface

Use the following commands to verify the DS1 local connection:

- **show connection name**—Displays information about the connection state and segment state.

```

ASR907# sh xconnect all | i 0/14/7
UP pri ac CE0/14/2:2(CESoPSN Basic) UP ac CE0/14/7:2(CESoPSN Basic) UP

ASR907# sh connection all | i 0/14/7
38 local_t3 CE0/14/2 CESP 2 CE0/14/7 CESP 2 UP

```

## Configuring T3 or E3 CEP

### Pre-requisites:

The default mode is channelized mode. Use **no channelized** command to change to non-channelized mode.

To configure T3 or E3 CEP for mode T3:

```

enable
controller MediaType 0/3/0
mode t3
controller t3 0/3/0
no channelized
cem-group 0 cep

```

To configure T3 or E3 CEP for mode E3:

```

enable
controller MediaType 0/3/0
mode e3
controller e3 0/3/0
no channelized
cem-group 0 cep

```

### Configuration of Overhead C2 and J1 Bytes:

You can configure overhead C2 and J1 bytes after you configure T3 or E3 CEP.

```

enable
controller MediaType 0/14/44
mode e3
controller e3 0/14/44
threshold sd-ber 6
threshold sf-ber 3
no channelized
framing g751
cablelength short
cem group 0 cep
overhead j1 tx length 16
overhead j1 expected length 16

```

For loopback configuration, see *Loopback on T3 or E3 Interfaces* section.

## Verifying T3 or E3 CEP Configuration

Use **show controller t3 0/1/20 path** to verify T3 or E3 CEP configuration:

```

router#show controller t3 0/1/20 path

T3 0/1/20 PATH 1.

Asynchronous Mapping for DS3 into STS-1

TX : TDM to PSN direction
RX : PSN to TDM direction

Clock Source is internal

      AIS = 0          RDI = 0          REI = 349          BIP(B3) = 22
      LOP = 0          PSE = 0          NSE = 0           NEWPTR = 0
      LOM = 0          PLM = 0          UNEQ = 0

Active Defects: None
Detected Alarms: None
Asserted/Active Alarms: None
Alarm reporting enabled for: None

TCA threshold:  B3 = 10e-6
Rx: C2 = FF
Tx: C2 = 01

Tx J1 Length : 64
Tx J1 Trace

```

```

72 74 72 32 20 30 2F 31 2F 32 30 2E 31 00 00 00      rtr2 0/1/20.1...
00 00 00 00 00 00 00 00 00 00 00 00 00 00 00 00      .....
00 00 00 00 00 00 00 00 00 00 00 00 00 00 00 00      .....
00 00 00 00 00 00 00 00 00 00 00 00 00 00 00 00      .....

Expected J1 Length : 64
Expected J1 Trace

72 74 72 32 20 30 2F 31 2F 32 30 2E 31 00 00 00      rtr2 0/1/20.1...
00 00 00 00 00 00 00 00 00 00 00 00 00 00 00 00      .....
00 00 00 00 00 00 00 00 00 00 00 00 00 00 00 00      .....
00 00 00 00 00 00 00 00 00 00 00 00 00 00 00 00      .....

PATH TRACE BUFFER : UNSTABLE

Rx J1 Length : 64
Rx J1 Trace

72 73 70 32 20 30 2F 35 2F 31 32 2E 31 00 00 00      rsp2 0/5/12.1...
00 00 00 00 00 00 00 00 00 00 00 00 00 00 00 00      .....
00 00 00 00 00 00 00 00 00 00 00 00 00 00 00 00      .....
00 00 00 00 00 00 00 00 00 00 00 00 00 00 00 00      .....

rtr2#

```



---

**Note** The verification output does not provide the alarm details.

---

## STS-1 Electricals

### Configuring STS-1e Modes

#### Configuring STS-1e Modes for Unframed SAToP

STS-1e supports unframed SAToP and you can configure STS-1e under VT-15, CT3, T3, and unframed modes. There is no default mode for STS-1e.

To configure STS-1e modes for unframed SAToP, use the following commands:

```

enable
configure terminal
controller sts-1e 0/0/16
sts-1 1
mode {vt-15 | ct3 | t3 | unframed}
end

```



---

**Note** To restore the system to its default condition, use the **no** form of the command.

---

### Configuring STS-1e Modes for Framed SAToP

Starting from Cisco IOS XE Bengaluru 17.4.1, STS-1e supports framed SAToP. You can configure STS-1e under VT-15, CT3, and T3 modes for framed SAToP:

To configure STS-1e modes for framed SAToP, use the following commands:

```
enable
configure terminal
controller sts-1e 0/0/16
sts-1 1
mode {vt-15 | ct3 | t3}
end
```

## Configuring VT-15 Mode of STS-1e

### Configuring VT-15 Mode of STS-1e for Unframed SAToP

To configure VT-15 mode of STS-1e for unframed SAToP, enter the following commands:

```
enable
configure terminal
controller STS1E 0/3/14
no ais-shut
alarm-report all
clock source internal
!
sts-1 1
clock source internal
mode vt-15
vtg 1 t1 1 framing unframed
vtg 1 t1 1 cem-group 0 unframed
```

### Configuring VT-15 Mode of STS-1e for Framed SAToP

To configure VT-15 mode of STS-1e for framed SAToP, enter the following commands:

```
enable
configure terminal
controller STS1E 0/3/14
no ais-shut
alarm-report all
clock source internal
!
sts-1 1
clock source internal
mode vt-15
vtg 1 t1 1 cem-group 0 framed
```

## Configuring T1 CT3 mode of STS-1e

### Configuring T1 CT3 mode of STS-1e for Unframed SAToP

To configure T1 CT3 mode of STS-1, you can configure the T1 link using the following steps:

```
enable
configure terminal
controller sts-1e 0/0/16
sts-1 1
mode ct3
```

```
t1 1 clock source internal
t1 1 framing unframed
end
```



---

**Note** To restore the system to its default condition, use the **no** form of the command.

---

### Configuring T1 CT3 mode of STS-1e for Framed SAToP

To configure T1 CT3 mode of STS-1 for framed SAToP, you can configure the T1 link using the following steps:

```
enable
configure terminal
controller sts-1e 0/0/16
sts-1 1
mode ct3
t1 1 clock source internal
t1 1 cem-group 0 framed
end
```

## Configuring T3 mode of STS-1e

### Configuring T3 mode of STS-1e for Unframed SAToP

```
controller STS1E 0/3/14
no ais-shut
alarm-report all
clock source internal
!
sts-1 1
clock source internal
mode t3
cem-group 0 unframed
t3 clock source internal
```

### Configuring T3 mode of STS-1e for Framed SAToP

```
controller STS1E 0/3/14
no ais-shut
alarm-report all
clock source internal
!
sts-1 1
clock source internal
mode t3
cem-group 0 framed
t3 clock source internal
```

## Configuring Unframed Mode of STS-1e

```
controller STS1E 0/3/14
no ais-shut
alarm-report all
clock source internal
!
sts-1 1
clock source internal
```



```
mode unframed
cem-group 0 cep
```

## Configuring Line and Section Overhead

To configure line and section overhead, use the following commands:

```
enable
configure terminal
controller MediaType 0/0/16
mode sts-1e
controller sts-1e 0/0/16
overhead s1s0 2
overhead j0 tx length 1-byte
end
```



---

**Note** To restore the system to its default condition, use the **no** form of the command.

---

## Configuring Line Loopback

To configure loopback, use the following commands:

```
enable
configure terminal
controller sts-1e 0/0/16
loopback local
end
```



---

**Note** To restore the system to its default condition, use the **no** form of the command.

---

## Configuring AIS Shut

Alarm Indication Signal (AIS) shut when enabled on the STS-1e controller results in sending AIS alarm to peer node.

To configure AIS-Shut, use the following commands:

```
enable
configure terminal
controller sts-1e 0/0/16
ais-shut
end
```



---

**Note** The **no ais-shut** command will not send AIS.

---

## Configuring Shut

To configure Shut, use the following commands:

```
enable
configure terminal
controller sts-1e 0/0/16
shutdown
end
```



---

**Note** Use the **no shutdown** command to disable the interface.

---

## Configuring Clock

To configure clock, use the following commands:

```
enable
configure terminal
controller MediaType 0/0/16
mode sts-1e
controller sts-1e 0/0/16
clock source line
end
```



---

**Note** The default mode is internal.

---



---

**Note** ACR and DCR clock recovery are also supported.

---

### Configuring Clock Recovery on STS-1e for Framed SAToP

Starting from Cisco IOS XE Bengaluru 17.4.1, ACR and DCR is supported on STS-1e for framed SAToP.

For more information, see *Configuring Clock Recovery on STS-1e Controller for Framed SAToP*.

### Configuring Network-Clock STS-1e

To configure network-clock STS-1e, use the following commands:

```
enable
configure terminal
network-clock input-source 1 controller STS-1e 0/0/16
end
```

## Configuring Clock Recovery on STS-1e Controller for Framed SAToP

Table 4: Feature History

Feature Name	Release Information	Description
STS1E Framed SAToP Support on IMA3G	Cisco IOS XE Bengaluru 17.4.1	Support on clock recovery on STS-1e controller for framed SAToP on the following modes: <ul style="list-style-type: none"> <li>• T3</li> <li>• CT3</li> <li>• VT-15</li> </ul>

Starting from Cisco IOS XE Bengaluru 17.4.1, ACR and DCR are supported on STS-1e controller for framed SAToP.

To configure the clock on STS-1e controller for framed SAToP on the T3 mode, enter the following commands:

```
enable
configure terminal
controller STS-1e slot/bay/port
sts-1 1
mode t3
t3 framing c-bit
cem-group 0 framed
t3 clock source recovered 1
```

To configure the clock on STS-1e controller for framed SAToP on the CT3 mode, enter the following commands:

```
enable
configure terminal
controller STS-1e slot/bay/port
sts-1 1
clock source internal
mode ct3
t3 framing c-bit
t1 1 cem-group 0 framed
t1 1 clock source recovered 1
```

To configure the clock on STS-1e controller for framed SAToP on the VT-15 mode, enter the following commands:

```
enable
configure terminal
controller STS-1e slot/bay/port
sts-1 1
mode vt-15
vtg 1 t1 1 cem-group 0 framed
vtg 1 t1 1 clock source recovered 2
```

The following example shows how to configure the clock on STS-1e controller for framed SAToP on the T3 mode:

```

enable
configure terminal
controller STS-1e 0/8/12
sts-1 1
mode t3
t3 framing c-bit
cem-group 0 framed
t3 clock source recovered 1

```

The following example shows how to configure the clock on STS-1e controller for framed SAToP on the CT3 mode:

```

enable
configure terminal
controller STS-1e 0/8/12
sts-1 1
clock source internal
mode ct3
t3 framing c-bit
t1 1 cem-group 0 framed
t1 1 clock source recovered 1

```

The following example shows how to configure the clock on STS-1e controller for framed SAToP on the VT-15 mode:

```

enable
configure terminal
controller STS-1e 0/8/12
sts-1 1
mode vt-15
vtg 1 t1 1 cem-group 0 framed
vtg 1t1 1 clock source recovered 2

```

## Verifying STS-1e Configuration

The following sample output shows the verification of STS-1e configuration in unframed mode:

```

router#show controllers sts1e 0/3/14
STS1E 0/3/14 is up.                    =====> this is the controller/port status.

    Hardware is A900-IMA3G-IMSG

    Port configured rate: OC3            =====> this is the rate the port is
    configured on it.

    Applique type is Channelized STS1E
    Clock Source is Internal            ===> the clocking config
Medium info:
    Type: STS1E, Line Coding: NRZ,
    Alarm Throttling: OFF
SECTION:
    LOS = 0          LOF = 0          BIP(B1) = 0          =====> the section level
    alarm counter (from last clear counters)

STS1E Section Tables
    INTERVAL      CV      ES      SES      SEFS

```

```

05:26-05:28      0    49    49    49

LINE:
  AIS = 0          RDI = 0          REI = 0          BIP(B2) = 0          =====> the line
  level alarm counter (from last clear counters)
Active Defects: None
Detected Alarms: None
Asserted/Active Alarms: None          =====> present active
  alarms on the port.
Alarm reporting enabled for: SLOS SLOF LAIS SF SD LRDI B1-TCA B2-TCA
BER thresholds:  SF = 10e-3  SD = 10e-6          =====> ber thresholds
TCA thresholds:  B1 = 10e-6  B2 = 10e-6
Rx: S1S0 = 00
   J0 = 00

   RX S1 = 00

Tx: S1S0 = 00
   J0 = 04

Tx J0 Length : 64
Tx J0 Trace :

 52 53 50 32 20 20 20 20 20 20 20 20 20 20 20 20 20 20 20 20  RSP2
 20 20 20 20 20 20 20 20 20 20 20 20 20 20 20 20 20 20 20 20
 20 20 20 20 20 20 20 20 20 20 20 20 20 20 20 20 20 20 20 20
 20 20 20 20 20 20 20 20 20 20 20 20 20 20 20 20 00 00          ..

Expected J0 Length : 64
Expected J0 Trace :

 52 53 50 32 20 20 20 20 20 20 20 20 20 20 20 20 20 20 20 20  RSP2
 20 20 20 20 20 20 20 20 20 20 20 20 20 20 20 20 20 20 20 20
 20 20 20 20 20 20 20 20 20 20 20 20 20 20 20 20 20 20 20 20
 20 20 20 20 20 20 20 20 20 20 20 20 20 20 20 20 00 00          ..

Rx J0 Length : 16
Rx J0 Trace :
CRC-7: 0xD8 ERROR

BC 4B 69 CC 79 24 1B 01 E8 EB 9C 36 FC 29 A9 00      .Ki.y$......6.)..

STS1e Line Tables
INTERVAL      CV      ES      SES      UAS      CVFE      ESFE      SESFE      UASFE
05:26-05:28   0        0        0        50       0         0         0         0

High Order Path:

PATH 1:
Clock Source is internal

  AIS = 0          RDI = 0          REI = 0          BIP(B3) = 0
  LOP = 0          PSE = 0          NSE = 0          NEWPTR = 0
  LOM = 0          PLM = 0          UNEQ = 0

Active Defects: None
Detected Alarms: None
Asserted/Active Alarms: None
Alarm reporting enabled for: PAIS PRDI PUNEQ PLOP PPLM LOM B3-TCA

TCA threshold:  B3 = 10e-6
Rx: C2 = 04
Tx: C2 = 01

```

```
Tx J1 Length : 64
Tx J1 Trace

 52 53 50 32 20 30 2F 33 2F 31 34 2E 31 00 00 00   RSP2 0/3/14.1...
00 00 00 00 00 00 00 00 00 00 00 00 00 00 00 00   .....
00 00 00 00 00 00 00 00 00 00 00 00 00 00 00 00   .....
00 00 00 00 00 00 00 00 00 00 00 00 00 00 00 00   .....
```

```
Expected J1 Length : 64
Expected J1 Trace

 52 53 50 32 20 30 2F 33 2F 31 34 2E 31 00 00 00   RSP2 0/3/14.1...
00 00 00 00 00 00 00 00 00 00 00 00 00 00 00 00   .....
00 00 00 00 00 00 00 00 00 00 00 00 00 00 00 00   .....
00 00 00 00 00 00 00 00 00 00 00 00 00 00 00 00   .....
```

PATH TRACE BUFFER : UNSTABLE

```
Rx J1 Length : 64
Rx J1 Trace

00 00 00 00 00 00 00 00 00 00 00 00 00 00 00 00   .....
00 00 00 00 00 00 00 00 00 00 00 00 00 00 00 00   .....
00 00 00 00 00 00 00 00 00 00 00 00 00 00 00 00   .....
00 00 00 00 00 00 00 00 00 00 00 00 00 00 00 00   .....
```

```
SONET Path Tables
INTERVAL      CV      ES      SES      UAS      CVFE      ESFE      SESFE      UASFE
05:26-05:28   0       0       0       48       0         0         0         0
```

```
STS1E 0/3/14.1 PATH mode UNFRAMED is up
cep is configured: TRUE cem_id :0
clock source internal
```

The following sample output shows the verification of STS-1e configuration in VT-15 mode:

```
router#show controllers sts1e 0/3/14
STS1E 0/3/14 is up.
  Hardware is A900-IMA3G-IMSG

  Port configured rate: OC1
  Applique type is Channelized STS1E
  Clock Source is Internal
Medium info:
  Type: STS1E, Line Coding: NRZ,
  Alarm Throttling: OFF
SECTION:
  LOS = 0          LOF = 0          BIP(B1) = 0

STS1E Section Tables
INTERVAL      CV      ES      SES      SEFS
05:33-05:33   0       0       0       0

LINE:
  AIS = 0          RDI = 0          REI = 0          BIP(B2) = 0
Active Defects: None
Detected Alarms: None
Asserted/Active Alarms: None
Alarm reporting enabled for: SLOS SLOF LAIS SF SD LRDI B1-TCA B2-TCA
BER thresholds: SF = 10e-3 SD = 10e-6
TCA thresholds: B1 = 10e-6 B2 = 10e-6
Rx: SISO = 00
    JO = 00
```

RX S1 = 00

Tx: S1S0 = 00  
J0 = 04

Tx J0 Length : 64  
Tx J0 Trace :

52 53 50 32 20 20 20 20 20 20 20 20 20 20 20 RSP2  
20 20 20 20 20 20 20 20 20 20 20 20 20 20 20  
20 20 20 20 20 20 20 20 20 20 20 20 20 20 20  
20 20 20 20 20 20 20 20 20 20 20 20 20 00 00 ..

Expected J0 Length : 64  
Expected J0 Trace :

52 53 50 32 20 20 20 20 20 20 20 20 20 20 20 RSP2  
20 20 20 20 20 20 20 20 20 20 20 20 20 20 20  
20 20 20 20 20 20 20 20 20 20 20 20 20 20 20  
20 20 20 20 20 20 20 20 20 20 20 20 20 00 00 ..

Rx J0 Length : 16  
Rx J0 Trace :

CRC-7: 0xD8 ERROR  
  
BC 4B 69 CC 79 24 1B 01 E8 EB 9C 36 FC 29 A9 00 .Ki.y\$. ....6.)..

STS1E Line Tables

INTERVAL	CV	ES	SES	UAS	CVFE	ESFE	SESFE	UASFE
05:33-05:33	0	0	0	0	0	0	0	0

High Order Path:

PATH 1:  
Clock Source is internal

AIS = 0                 RDI = 0                 REI = 0                 BIP(B3) = 0  
LOP = 0                 PSE = 0                 NSE = 0                 NEWPTR = 0  
LOM = 0                 PLM = 0                 UNEQ = 0

Active Defects: None  
Detected Alarms: None  
Asserted/Active Alarms: None  
Alarm reporting enabled for: PAIS PRDI PUNEQ PLOP PPLM LOM B3-TCA

TCA threshold: B3 = 10e-6  
Rx: C2 = 02  
Tx: C2 = 02

Tx J1 Length : 64  
Tx J1 Trace

52 53 50 32 20 30 2F 33 2F 31 34 2E 31 00 00 00 RSP2 0/3/14.1...  
00 00 00 00 00 00 00 00 00 00 00 00 00 00 00 .....  
00 00 00 00 00 00 00 00 00 00 00 00 00 00 00 .....  
00 00 00 00 00 00 00 00 00 00 00 00 00 00 00 .....

Expected J1 Length : 64  
Expected J1 Trace

52 53 50 32 20 30 2F 33 2F 31 34 2E 31 00 00 00 RSP2 0/3/14.1...  
00 00 00 00 00 00 00 00 00 00 00 00 00 00 00 .....

```
00 00 00 00 00 00 00 00 00 00 00 00 00 00 00 00 .....
00 00 00 00 00 00 00 00 00 00 00 00 00 00 00 00 .....
```

PATH TRACE BUFFER : UNSTABLE

Rx J1 Length : 64

Rx J1 Trace

```
00 00 00 00 00 00 00 00 00 00 00 00 00 00 00 00 .....
00 00 00 00 00 00 00 00 00 00 00 00 00 00 00 00 .....
00 00 00 00 00 00 00 00 00 00 00 00 00 00 00 00 .....
00 00 00 00 00 00 00 00 00 00 00 00 00 00 00 00 .....
```

SONET Path Tables

INTERVAL	CV	ES	SES	UAS	CVFE	ESFE	SESFE	UASF
05:33-05:33	0	0	0	0	0	0	0	0

STS1E 0/3/14.1 PATH is up.  
Hardware is A900-IMA3G-IMSG

Applique type is VT1.5

STS-1 1, VTG 1, VT 1 (STS1E 0/3/14.1/1/1 VT) is up  
No VT alarms detected.

cep is configured: FALSE cem\_id (0)  
fwd\_alarm\_ais :0 fwd\_alarm\_rai :0  
Framing is unframed, Clock Source is Internal  
BIP2-tca:6, BIP2-sf:3, BIP2-sd:6

Tx V5:1

Rx V5:2

Tx J2 Length=64

TX J2 Trace Buffer:

```
00 00 00 00 00 00 00 00 00 00 00 00 00 00 00 00 .....
00 00 00 00 00 00 00 00 00 00 00 00 00 00 00 00 .....
00 00 00 00 00 00 00 00 00 00 00 00 00 00 00 00 .....
00 00 00 00 00 00 00 00 00 00 00 00 00 00 00 00 .....
```

Expected J2 Length=64

Expected J2 Trace Buffer:

```
00 00 00 00 00 00 00 00 00 00 00 00 00 00 00 00 .....
00 00 00 00 00 00 00 00 00 00 00 00 00 00 00 00 .....
00 00 00 00 00 00 00 00 00 00 00 00 00 00 00 00 .....
00 00 00 00 00 00 00 00 00 00 00 00 00 00 00 00 .....
```

Rx J2 Length=16

RX J2 Trace Buffer:

CRC-7: 0x80 OK

4A 44 53 55 00 00 00 00 00 00 00 00 00 00 00 00 JDSU.....

Data in current interval (1 seconds elapsed)

Near End  
0 CodeViolations, 0 ErrorSecs, 0 Severly Err Secs, 0 Unavailable Secs  
Far End  
0 CodeViolations, 0 ErrorSecs, 0 Severly Err Secs, 0 Unavailable Secs

STS-1 1, VTG 1, T1 1 (STS1E 0/3/14.1/1/1 T1) is up  
No alarms detected.

Framing is unframed, Clock Source is Internal  
Data in current interval (0 seconds elapsed):  
Near End  
0 Line Code Violations, 0 Path Code Violations  
0 Slip Secs, 0 Fr Loss Secs, 0 Line Err Secs, 0 Degraded Mins



0 Errored Secs, 0 Bursty Err Secs, 0 Severely Err Secs
0 Unavail Secs, 0 Stuffed Secs
Far End
0 Line Code Violations, 0 Path Code Violations
0 Slip Secs, 0 Fr Loss Secs, 0 Line Err Secs, 0 Degraded Mins
0 Errored Secs, 0 Bursty Err Secs, 0 Severely Err Secs
0 Unavail Secs

The following sample output shows the verification of STS-1e configuration in T3 mode:

```
router#show controllers sts1e 0/3/14
STS1E 0/3/14 is up.
Hardware is A900-IMA3G-IMSG

Port configured rate: OC1
Applique type is Channelized STS1E
Clock Source is Internal
Medium info:
Type: STS1E, Line Coding: NRZ,
Alarm Throttling: OFF
SECTION:
LOS = 0          LOF = 0          BIP(B1) = 0

STS1E Section Tables
INTERVAL       CV      ES   SES SEFS
05:35-05:35   0       0    0    0

LINE:
AIS = 0         RDI = 0         REI = 0         BIP(B2) = 0
Active Defects: None
Detected Alarms: None
Asserted/Active Alarms: None
Alarm reporting enabled for: SLOS SLOF LAIS SF SD LRDI B1-TCA B2-TCA
BER thresholds: SF = 10e-3 SD = 10e-6
TCA thresholds: B1 = 10e-6 B2 = 10e-6
Rx: S1S0 = 00
   J0 = 00

   RX S1 = 00

Tx: S1S0 = 00
   J0 = 04

Tx J0 Length : 64
Tx J0 Trace :

52 53 50 32 20 20 20 20 20 20 20 20 20 20 20 20 20 20 RSP2
20 20 20 20 20 20 20 20 20 20 20 20 20 20 20 20 20 20
20 20 20 20 20 20 20 20 20 20 20 20 20 20 20 20 20 20
20 20 20 20 20 20 20 20 20 20 20 20 20 20 20 00 00 ..

Expected J0 Length : 64
Expected J0 Trace :

52 53 50 32 20 20 20 20 20 20 20 20 20 20 20 20 20 20 RSP2
20 20 20 20 20 20 20 20 20 20 20 20 20 20 20 20 20 20
20 20 20 20 20 20 20 20 20 20 20 20 20 20 20 20 20 20
20 20 20 20 20 20 20 20 20 20 20 20 20 20 20 00 00 ..

Rx J0 Length : 16
Rx J0 Trace :
CRC-7: 0xD8 ERROR

BC 4B 69 CC 79 24 1B 01 E8 EB 9C 36 FC 29 A9 00 .Ki.y$.6.)..
```

```

STS1E Line Tables
INTERVAL      CV    ES    SES    UAS    CVFE    ESFE    SESFE    UASFE
05:35-05:35    0    0    0     73     0     0     0     0
    
```

High Order Path:

PATH 1:

Clock Source is internal

```

AIS = 0          RDI = 0          REI = 0          BIP(B3) = 0
LOP = 0          PSE = 0          NSE = 0          NEWPTR = 0
LOM = 0          PLM = 0          UNEQ = 0
    
```

Active Defects: None

Detected Alarms: None

Asserted/Active Alarms: None

Alarm reporting enabled for: PAIS PRDI PUNEQ PLOP PPLM LOM B3-TCA

TCA threshold: B3 = 10e-6

Rx: C2 = 04

Tx: C2 = 04

Tx J1 Length : 64

Tx J1 Trace

```

52 53 50 32 20 30 2F 33 2F 31 34 2E 31 00 00 00    RSP2 0/3/14.1...
00 00 00 00 00 00 00 00 00 00 00 00 00 00 00 00    .....
00 00 00 00 00 00 00 00 00 00 00 00 00 00 00 00    .....
00 00 00 00 00 00 00 00 00 00 00 00 00 00 00 00    .....
    
```

Expected J1 Length : 64

Expected J1 Trace

```

52 53 50 32 20 30 2F 33 2F 31 34 2E 31 00 00 00    RSP2 0/3/14.1...
00 00 00 00 00 00 00 00 00 00 00 00 00 00 00 00    .....
00 00 00 00 00 00 00 00 00 00 00 00 00 00 00 00    .....
00 00 00 00 00 00 00 00 00 00 00 00 00 00 00 00    .....
    
```

PATH TRACE BUFFER : UNSTABLE

Rx J1 Length : 64

Rx J1 Trace

```

00 00 00 00 00 00 00 00 00 00 00 00 00 00 00 00    .....
00 00 00 00 00 00 00 00 00 00 00 00 00 00 00 00    .....
00 00 00 00 00 00 00 00 00 00 00 00 00 00 00 00    .....
00 00 00 00 00 00 00 00 00 00 00 00 00 00 00 00    .....
    
```

SONET Path Tables

```

INTERVAL      CV    ES    SES    UAS    CVFE    ESFE    SESFE    UASFE
05:26-05:36    0    0    0     12     0     0     0     0
    
```

STS1E 0/3/14.1 T3 is up.

Hardware is A900-IMA3G-IMSG

Applique type is T3

No alarms detected.

Framing is Unframed, Cablelength is 224

BER thresholds: SF = 10e-3 SD = 10e-6

Clock Source is internal

Equipment customer loopback

Data in current interval (560 seconds elapsed):

```
Near End
 0 Line Code Violations, 0 P-bit Coding Violation
 0 C-bit Coding Violation, 0 P-bit Err Secs
 0 P-bit Severely Err Secs, 0 Severely Err Framing Secs
275 Unavailable Secs, 0 Line Errored Secs
 0 C-bit Errored Secs, 0 C-bit Severely Errored Secs
 0 Severely Errored Line Secs, 3 Path Failures
 0 AIS Defect Secs, 0 LOS Defect Secs
Far End
 0 Errored Secs, 0 Severely Errored Secs
 0 C-bit Unavailable Secs, 0 Path Failures
 0 Code Violations, 0 Service Affecting Secs
```

The following sample output shows the verification of STS-1e configuration in CT3 mode:

```
router#show controllers sts1e 0/3/14
STS1E 0/3/14 is up.
  Hardware is A900-IMA3G-IMSG

  Port configured rate: OC1
  Applique type is Channelized STS1E
  Clock Source is Internal
Medium info:
  Type: STS1E, Line Coding: NRZ,
  Alarm Throttling: OFF
SECTION:
  LOS = 0           LOF = 0           BIP(B1) = 0

STS1E Section Tables
INTERVAL          CV      ES      SES  SEFS
05:41-05:42      0      10     10   10

LINE:
  AIS = 0           RDI = 0           REI = 0           BIP(B2) = 0
Active Defects: None
Detected Alarms: None
Asserted/Active Alarms: None
Alarm reporting enabled for: SLOS SLOF LAIS SF SD LRDI B1-TCA B2-TCA
BER thresholds:   SF = 10e-3   SD = 10e-6
TCA thresholds:  B1 = 10e-6   B2 = 10e-6
Rx: S1S0 = 00
    J0 = 00

    RX S1 = 00

Tx: S1S0 = 00
    J0 = 04

Tx J0 Length : 64
Tx J0 Trace :

52 53 50 32 20 20 20 20 20 20 20 20 20 20 20 20      RSP2
20 20 20 20 20 20 20 20 20 20 20 20 20 20 20 20
20 20 20 20 20 20 20 20 20 20 20 20 20 20 20 20
20 20 20 20 20 20 20 20 20 20 20 20 20 20 00 00      ..

Expected J0 Length : 64
Expected J0 Trace :

52 53 50 32 20 20 20 20 20 20 20 20 20 20 20 20      RSP2
20 20 20 20 20 20 20 20 20 20 20 20 20 20 20 20
20 20 20 20 20 20 20 20 20 20 20 20 20 20 20 20
20 20 20 20 20 20 20 20 20 20 20 20 20 20 00 00      ..

Rx J0 Length : 16
```

```

Rx J0 Trace :
CRC-7: 0xD8 ERROR

BC 4B 69 CC 79 24 1B 01 E8 EB 9C 36 FC 29 A9 00      .Ki.y$.....6.)..

STS1E Line Tables
INTERVAL      CV    ES    SES    UAS    CVFE    ESFE    SESFE    UASFE
05:41-05:42   0     0     0     10     0     0     0     0

High Order Path:

PATH 1:
Clock Source is internal

AIS = 0          RDI = 0          REI = 0          BIP(B3) = 0
LOP = 0          PSE = 0          NSE = 0          NEWPTR = 0
LOM = 0          PLM = 0          UNEQ = 0

Active Defects: None
Detected Alarms: None
Asserted/Active Alarms: None
Alarm reporting enabled for: PAIS PRDI PUNEQ PLOP PPLM LOM B3-TCA

TCA threshold: B3 = 10e-6
Rx: C2 = 04
Tx: C2 = 04

Tx J1 Length : 64
Tx J1 Trace

52 53 50 32 20 30 2F 33 2F 31 34 2E 31 00 00 00      RSP2 0/3/14.1...
00 00 00 00 00 00 00 00 00 00 00 00 00 00 00 00      .....
00 00 00 00 00 00 00 00 00 00 00 00 00 00 00 00      .....
00 00 00 00 00 00 00 00 00 00 00 00 00 00 00 00      .....

Expected J1 Length : 64
Expected J1 Trace

52 53 50 32 20 30 2F 33 2F 31 34 2E 31 00 00 00      RSP2 0/3/14.1...
00 00 00 00 00 00 00 00 00 00 00 00 00 00 00 00      .....
00 00 00 00 00 00 00 00 00 00 00 00 00 00 00 00      .....
00 00 00 00 00 00 00 00 00 00 00 00 00 00 00 00      .....

PATH TRACE BUFFER : UNSTABLE

Rx J1 Length : 64
Rx J1 Trace

00 00 00 00 00 00 00 00 00 00 00 00 00 00 00 00      .....
00 00 00 00 00 00 00 00 00 00 00 00 00 00 00 00      .....
00 00 00 00 00 00 00 00 00 00 00 00 00 00 00 00      .....
00 00 00 00 00 00 00 00 00 00 00 00 00 00 00 00      .....

SONET Path Tables
INTERVAL      CV    ES    SES    UAS    CVFE    ESFE    SESFE    UASFE
05:42-05:42   0     0     0     0     0     0     0     0

STS1E 0/3/14.1 T3 is up.
Hardware is A900-IMA3G-IMSG

Applique type is Channelized T3 to T1
No alarms detected.
MDL transmission is disabled
    
```

```

FEAC code received: No code is being received
Framing is C-BIT Parity, Cablelength is 224
BER thresholds: SF = 10e-3 SD = 10e-6
Clock Source is internal
Equipment customer loopback
Data in current interval (60 seconds elapsed):
Near End
  0 Line Code Violations, 0 P-bit Coding Violation
  0 C-bit Coding Violation, 0 P-bit Err Secs
  0 P-bit Severely Err Secs, 0 Severely Err Framing Secs
  25 Unavailable Secs, 0 Line Errored Secs
  0 C-bit Errored Secs, 0 C-bit Severely Errored Secs
  0 Severely Errored Line Secs, 0 Path Failures
  0 AIS Defect Secs, 0 LOS Defect Secs
Far End
  0 Errored Secs, 0 Severely Errored Secs
  0 C-bit Unavailable Secs, 0 Path Failures
  0 Code Violations, 0 Service Affecting Secs

STS-1 1, T1 1 (STS1E 0/3/14.1/1 T1) is up
No alarms detected.
Framing is unframed, Clock Source is Internal
Data in current interval (60 seconds elapsed):
Near End
  0 Line Code Violations, 0 Path Code Violations
  0 Slip Secs, 0 Fr Loss Secs, 0 Line Err Secs, 0 Degraded Mins
  0 Errored Secs, 0 Bursty Err Secs, 0 Severely Err Secs
  25 Unavail Secs, 0 Stuffed Secs
Far End
  0 Line Code Violations, 0 Path Code Violations
  0 Slip Secs, 0 Fr Loss Secs, 0 Line Err Secs, 0 Degraded Mins
  0 Errored Secs, 0 Bursty Err Secs, 0 Severely Err Secs
  0 Unavail Secs

STS-1 1, T1 2 (STS1E 0/3/14.1/2 T1) is up
timeslots:
FDL per AT&T 54016 spec.
No alarms detected.
Framing is ESF, Clock Source is Internal
Data in current interval (60 seconds elapsed):
Near End
  0 Line Code Violations, 0 Path Code Violations
  0 Slip Secs, 0 Fr Loss Secs, 0 Line Err Secs, 0 Degraded Mins
  0 Errored Secs, 0 Bursty Err Secs, 0 Severely Err Secs
  26 Unavail Secs, 0 Stuffed Secs
Far End
  0 Line Code Violations, 0 Path Code Violations
  0 Slip Secs, 0 Fr Loss Secs, 0 Line Err Secs, 0 Degraded Mins
  0 Errored Secs, 0 Bursty Err Secs, 0 Severely Err Secs
  0 Unavail Secs

```

Starting with Cisco IOS XE 17.11.1, you can view the previous day performance monitoring details using the following **show controller** commands for the STS-1e controllers.

- show controller sts1e
- show controller sts1e tabular
- show controller sts1e remote performance
- show controller sts1e remote performance tabular

```

router#show controllers sts1e 0/3/0

sts1e 0/3/0 is down.
  Hardware is NCS4200-1T8S-10CS

  Port configured rate: OC3
  Applique type is Channelized Sonet
  Clock Source is Internal
Medium info:
  Type: sts1e, Line Coding: NRZ,
  Alarm Throttling: OFF
SECTION:
  LOS = 1          LOF = 0          BIP(B1) = 0

sts1e Section Tables
  INTERVAL      CV    ES    SES  SEFS
  06:14-06:24   0    611  611  611
  05:59-06:14   0    901  901  901
  .....
  06:29-06:44   0    901  901  901
  06:14-06:29   0    901  901  901
Total of Data in Current and Previous Intervals
  06:14-06:24   0 87107 87107 87107
Total (Previous Day)
  05:29-05:29   0 86494 86494 86494

LINE:
  AIS = 0          RDI = 0          REI = 0          BIP(B2) = 0
Active Defects: None
Detected Alarms: SLOS SLOF LAIS
Asserted/Active Alarms: SLOS
.....
sts1e Line Tables
  INTERVAL      CV    ES    SES  UAS  CVFE  ESFE  SESFE  UASFE
  06:14-06:24   0    0    0    611  0    0    0    0
  05:59-06:14   0    0    0    901  0    0    0    0
  05:44-05:59   0    0    0    901  0    0    0    0
  05:29-05:44   0    0    0    901  0    0    0    0
  .....
  06:14-06:29   0    0    0    901  0    0    0    0
Total of Data in Current and Previous Intervals
  06:14-06:24   0    0    0 87107 0    0    0    0
Total (Previous Day)
  05:29-05:29   0    0    0 86494 0    0    0    0

PATH 1:
Clock Source is internal

  AIS = 0          RDI = 0          REI = 0          BIP(B3) = 8
  LOM = 0          PLM = 0          UNEQ = 0         LOP = 0
  .....

SONET Path Tables
  INTERVAL      CV    ES    SES  UAS  CVFE  ESFE  SESFE  UASFE
  06:14-06:24   0    0    0    609  0    0    0    0
  05:59-06:14   0    0    0    901  0    0    0    0
  05:44-05:59   0    0    0    900  0    0    0    0
  05:29-05:44   0    0    0    901  0    0    0    0
  .....
  06:29-06:44   0    0    0    900  0    0    0    0
  06:14-06:29   0    0    0    900  0    0    0    0
Total of Data in Current and Previous Intervals

```

```

06:14-06:24      0      0      0 87045      0      0      0      0
Total (Previous Day)
05:29-05:29      0      0      0 86435      0      0      0      0

PATH 2:
Clock Source is internal
.....

sts1e 0/3/0.1 PATH is down.
  Hardware is A900-IMA1Z8S-CX

Applique type is VT1.5

STS-1 1, VTG 1, VT 1 (sts1e 0/3/0.1/1/1 VT) is down
VT Receiver has LP_AIS.
cep is configured: FALSE cem_id (0)
fwd_alarm_ais :0   fwd_alarm_rai :0, Clock Source is Internal
BIP2-tca:6, BIP2-sf:3, BIP2-sd:6
Tx V5:2
Rx V5:0
Tx J2 Length=64
TX J2 Trace Buffer:
00 00 00 00 00 00 00 00 00 00 00 00 00 00 00 00 .....
00 00 00 00 00 00 00 00 00 00 00 00 00 00 00 00 .....
00 00 00 00 00 00 00 00 00 00 00 00 00 00 00 00 .....
00 00 00 00 00 00 00 00 00 00 00 00 00 00 00 00 .....

Expected J2 Length=64
Expected J2 Trace Buffer:
00 00 00 00 00 00 00 00 00 00 00 00 00 00 00 00 .....
00 00 00 00 00 00 00 00 00 00 00 00 00 00 00 00 .....
00 00 00 00 00 00 00 00 00 00 00 00 00 00 00 00 .....
00 00 00 00 00 00 00 00 00 00 00 00 00 00 00 00 .....

Rx J2 Length=16
RX J2 Trace Buffer:
CRC-7: 0x60 ERROR

C9 79 F7 0F 5F D8 5D D2 D2 7C F6 0E 53 B2 0E 00   .y.._]..|..S...

Data in curerent interval (610 seconds elapsed)
  Near End
    0 CodeViolations, 0 ErrorSecs, 0 Severly Err Secs, 609 Unavailable Secs
  Far End
    0 CodeViolations, 0 ErrorSecs, 0 Severly Err Secs, 0 Unavailable Secs
Data in Interval 1:
  Near End
    0 CodeViolations, 0 ErrorSecs, 0 Severly Err Secs, 901 Unavailable Secs
  Far End
    0 CodeViolations, 0 ErrorSecs, 0 Severly Err Secs, 0 Unavailable Secs
.....
Data in Interval 96:
  Near End
    0 CodeViolations, 0 ErrorSecs, 0 Severly Err Secs, 900 Unavailable Secs
  Far End
    0 CodeViolations, 0 ErrorSecs, 0 Severly Err Secs, 0 Unavailable Secs
Total Data (last 96 fifteen minute intervals):
  Near End
    0 CodeViolations, 0 ErrorSecs, 0 Severly Err Secs, 86436 Unavailable Secs
  Far End
    0 CodeViolations, 0 ErrorSecs, 0 Severly Err Secs, 0 Unavailable Secs
Total (Previous Day):
  Near End
    0 CodeViolations, 0 ErrorSecs, 0 Severly Err Secs, 86435 Unavailable Secs

```

```

Far End
  0 CodeViolations, 0 ErrorSecs, 0 Severly Err Secs, 0 Unavailable Secs

STS-1 1, VTG 1, T1 1 (sts1e 0/3/0.1/1/1 T1) is down
timeslots: 1-4
FDL per AT&T 54016 spec.
Receiver is getting AIS.
Framing is ESF, Clock Source is Internal
Data in current interval (610 seconds elapsed):
  Near End
    0 Line Code Violations, 0 Path Code Violations
    0 Slip Secs, 0 Fr Loss Secs, 0 Line Err Secs, 0 Degraded Mins
    0 Errored Secs, 0 Bursty Err Secs, 0 Severly Err Secs
    609 Unavail Secs, 0 Stuffed Secs
  Far End
    0 Line Code Violations, 0 Path Code Violations
    0 Slip Secs, 0 Fr Loss Secs, 0 Line Err Secs, 0 Degraded Mins
    0 Errored Secs, 0 Bursty Err Secs, 0 Severly Err Secs
    0 Unavail Secs
Data in Interval 1:
  Near End
    0 Line Code Violations, 0 Path Code Violations
.....
  Far End
    0 Line Code Violations, 0 Path Code Violations
    0 Slip Secs, 0 Fr Loss Secs, 0 Line Err Secs, 0 Degraded Mins
    0 Errored Secs, 0 Bursty Err Secs, 0 Severly Err Secs
    0 Unavail Secs
Data in Interval 96:
  Near End
    0 Line Code Violations, 0 Path Code Violations
    0 Slip Secs, 0 Fr Loss Secs, 0 Line Err Secs, 0 Degraded Mins
    0 Errored Secs, 0 Bursty Err Secs, 0 Severly Err Secs
    900 Unavail Secs, 0 Stuffed Secs
  Far End
    0 Line Code Violations, 0 Path Code Violations
    0 Slip Secs, 0 Fr Loss Secs, 0 Line Err Secs, 0 Degraded Mins
    0 Errored Secs, 0 Bursty Err Secs, 0 Severly Err Secs
    0 Unavail Secs
Total Data (last 24 hours)
  Near End
    0 Line Code Violations,0 Path Code Violations,
    0 Slip Secs, 0 Fr Loss Secs, 0 Line Err Secs, 0 Degraded Mins,
    0 Errored Secs, 0 Bursty Err Secs, 0 Severly Err Secs
    86436 Unavail Secs, 0 Stuffed Secs
  Far End
    0 Line Code Violations,0 Path Code Violations
    0 Slip Secs, 0 Fr Loss Secs, 0 Line Err Secs, 0 Degraded Mins,
    0 Errored Secs, 0 Bursty Err Secs, 0 Severly Err Secs
    0 Unavailable Secs
Total (Previous Day)
  Near End
    0 Line Code Violations,0 Path Code Violations,
    0 Slip Secs, 0 Fr Loss Secs, 0 Line Err Secs, 0 Degraded Mins,
    0 Errored Secs, 0 Bursty Err Secs, 0 Severly Err Secs
    86435 Unavail Secs, 0 Stuffed Secs
  Far End
    0 Line Code Violations,0 Path Code Violations
    0 Slip Secs, 0 Fr Loss Secs, 0 Line Err Secs, 0 Degraded Mins,
    0 Errored Secs, 0 Bursty Err Secs, 0 Severly Err Secs
    0 Unavailable Secs

```



STS-1 1, VTG 1, VT 2 (SONET 0/3/0.1/1/2 VT) is down  
 VT Receiver has LP\_AIS.

router#show controllers sts1e 0/3/0 tabular

Section/Line/Path same as previous.

sts1e 0/3/0.1 PATH is down.  
 Hardware is NCS4200-1T8S-10CS

Applique type is VT1.5

STS-1 1, VTG 1, VT 1 (SONET 0/3/0.1/1/1 VT) is down  
 VT Receiver has LP\_AIS.  
 cep is configured: FALSE cem\_id (0)  
 fwd\_alarm\_ais :0 fwd\_alarm\_rai :0, Clock Source is Internal  
 BIP2-tca:6, BIP2-sf:3, BIP2-sd:6

Tx V5:2  
 Rx V5:0  
 Tx J2 Length=64  
 TX J2 Trace Buffer:  
 00 00 00 00 00 00 00 00 00 00 00 00 00 00 00 00 .....  
 00 00 00 00 00 00 00 00 00 00 00 00 00 00 00 00 .....  
 00 00 00 00 00 00 00 00 00 00 00 00 00 00 00 00 .....  
 00 00 00 00 00 00 00 00 00 00 00 00 00 00 00 00 .....

Expected J2 Length=64  
 Expected J2 Trace Buffer:  
 00 00 00 00 00 00 00 00 00 00 00 00 00 00 00 00 .....  
 00 00 00 00 00 00 00 00 00 00 00 00 00 00 00 00 .....  
 00 00 00 00 00 00 00 00 00 00 00 00 00 00 00 00 .....  
 00 00 00 00 00 00 00 00 00 00 00 00 00 00 00 00 .....

Rx J2 Length=16  
 RX J2 Trace Buffer:  
 CRC-7: 0x60 ERROR  
  
 C9 79 F7 0F 5F D8 5D D2 D2 7C F6 0E 53 B2 0E 00 .y..\_]...|..S...

INTERVAL	CV-V	ES-V	SES-V	UAS-V	CV-VFE	ES-VFE	SES-VFE	UAS-VFE
06:14-06:24	0	0	0	619	0	0	0	0
05:59-06:14	0	0	0	901	0	0	0	0
05:44-05:59	0	0	0	900	0	0	0	0
05:29-05:44	0	0	0	901	0	0	0	0
05:14-05:29	0	0	0	900	0	0	0	0
04:59-05:14	0	0	0	900	0	0	0	0
.....								
06:44-06:59	0	0	0	901	0	0	0	0
06:29-06:44	0	0	0	900	0	0	0	0
06:14-06:29	0	0	0	900	0	0	0	0
Total	0	0	0	86436	0	0	0	0
Total (Previous Day):								
05:29-05:29	0	0	0	86435	0	0	0	0

STS-1 1, VTG 1, T1 1 (SONET 0/3/0.1/1/1 T1) is down  
 timeslots: 1-4  
 FDL per AT&T 54016 spec.  
 Receiver is getting AIS.  
 Framing is ESF, Clock Source is Internal

Near End Data

INTERVAL	CV-L	ES-L	CV-P	ES-P	SES-P	CSS-P	SAS-P	UAS-P	FC-P
06:14-06:24	0	0	0	0	0	0	0	619	0
05:59-06:14	0	0	0	0	0	0	0	901	0

```

.....
06:44-06:59      0      0      0      0      0      0      0      901      0
06:29-06:44      0      0      0      0      0      0      900      0
06:14-06:29      0      0      0      0      0      0      900      0
Total            0      0      0      0      0      0      86436     0
Total (Previous Day):
05:29-05:29      0      0      0      0      0      0      86435     0
Far End Data
INTERVAL      ES-LFE  ES-PFE  SES-PFE  SEFS-PFE  CSS-PFE  UAS-PFE  FC-PFE
06:14-06:24      0      0      0      0      0      0      0
05:59-06:14      0      0      0      0      0      0      0
.....
06:29-06:44      0      0      0      0      0      0      0
06:14-06:29      0      0      0      0      0      0      0
Total            0      0      0      0      0      0      0
Total (Previous Day):
05:29-05:29      0      0      0      0      0      0      0

```

```

STS-1 1, VTG 1, VT 2 (SONET 0/3/0.1/1/2 VT) is down
VT Receiver has LP_AIS.
cep is configured: FALSE cem_id (0)
fwd_alarm_ais :0   fwd_alarm_rai :0, Clock Source is Internal

```

```
router#show controllers sts1e 0/3/0 remote performance
```

```
Section/Line/Path same as previous.
```

```
sts1e 0/3/0.1 PATH is down.
Hardware is NCS4200-1T8S-10CS
```

```

STS-1 1, VTG 1, VT 1 (VT1.5 1/1/1) - Remote Performance Data
Far end MIB Data:
Data in current interval (630 seconds elapsed)
0 CodeViolations , 0 ErrorSecs,0 Severly Err Secs, 0 Unavail Secs
FarEnd VT Interval data:
Total Data (last 96 15 minute intervals):
0 CodeViolations, 0 ErrorSec, 0 Severly Err Secs, 0 Unavail Secs

Total (Previous Day):
0 CodeViolations, 0 ErrorSec, 0 Severly Err Secs, 0 Unavail Secs

```

```

STS-1 1, VTG 1, T1 1 (SONET 0/3/0.1/1/1 T1) - Remote Performance Data
Data in current interval (630 seconds elapsed):
0 Line Code Violations, 0 Path Code Violations
0 Slip Secs, 0 Fr Loss Secs, 0 Line Err Secs, 0 Degraded Mins
0 Errored Secs, 0 Bursty Err Secs, 0 Severly Err Secs
0 Unavail Secs
Data in Interval 1:
.....
Data in Interval 96:
0 Line Code Violations, 0 Path Code Violations
0 Slip Secs, 0 Fr Loss Secs, 0 Line Err Secs, 0 Degraded Mins
0 Errored Secs, 0 Bursty Err Secs, 0 Severly Err Secs
0 Unavail Secs
Total Data (last 24 hours)
0 Path Code Violations
0 Slip Secs, 0 Fr Loss Secs, 0 Line Err Secs, 0 Degraded Mins,
0 Errored Secs, 0 Bursty Err Secs, 0 Severly Err Secs
0 Unavail Secs
Total (Previous Day)
0 Path Code Violations
0 Slip Secs, 0 Fr Loss Secs, 0 Line Err Secs, 0 Degraded Mins,

```

```

0 Errored Secs, 0 Bursty Err Secs, 0 Severly Err Secs
0 Unavail Secs

STS-1 1, VTG 1, VT 2 (VT1.5 1/1/2) - Remote Performance Data
Far end MIB Data:
Data in curerent interval (630 seconds elapsed)
0 CodeViolations , 0 ErrorSecs,0 Severly Err Secs, 0 Unavail Secs
FarEnd VT Interval data:
Total Data (last 96 15 minute intervals):
0 CodeViolations, 0 ErrorSec, 0 Severly Err Secs, 0 Unavail Secs

Total (Previous Day):
0 CodeViolations, 0 ErrorSec, 0 Severly Err Secs, 0 Unavail Secs
    
```

router#show controllers stsl e 0/3/0 remote performance tabular

Section/Line/Path same as previous.

stsl e 0/3/0.1 PATH is down.  
Hardware is NCS4200-1T8S-10CS

```

STS-1 1, VTG 1, VT 1 (VT1.5 1/1/1) - Remote Performance Data
Far end MIB Data:
INTERVAL      CV      ES      SES      UAS
06:14-06:24   0      0      0      0
FarEnd VT Interval data:
INTERVAL      CV      ES      SES      UAS
05:59-06:14   0      0      0      0

05:44-05:59   0      0      0      0
05:29-05:44   0      0      0      0
05:14-05:29   0      0      0      0
.....
06:29-06:44   0      0      0      0
06:14-06:29   0      0      0      0

Total
CV      ES      SES      UAS      0      0      0      0

Total (Previous Day)
CV      ES      SES      UAS      0      0      0      0
    
```

```

STS-1 1, VTG 1, T1 1 (SONET 0/3/0.1/1/1 T1) - Remote Performance Data
INTERVAL      LCV      PCV      CSS      SELS      LES      DM      ES      BES      SES      UAS
06:14-06:24   0      0      0      0      0      0      0      0      0      0
05:59-06:14   0      0      0      0      0      0      0      0      0      0
05:44-05:59   0      0      0      0      0      0      0      0      0      0
.....
06:44-06:59   0      0      0      0      0      0      0      0      0      0
06:29-06:44   0      0      0      0      0      0      0      0      0      0
06:14-06:29   0      0      0      0      0      0      0      0      0      0
Total         0      0      0      0      0      0      0      0      0      0
Total (Previous Day)
05:29-05:29   0      0      0      0      0      0      0      0      0      0
    
```

```

STS-1 1, VTG 1, VT 2 (VT1.5 1/1/2) - Remote Performance Data
Far end MIB Data:
INTERVAL      CV      ES      SES      UAS
    
```

```
06:14-06:24      0      0      0      0
FarEnd VT Interval data:
INTERVAL      CV      ES      SES      UAS
05:59-06:14      0      0      0      0
```



## CHAPTER 5

# Monitoring the T3 or E3 Interface Module

This chapter provides information on monitoring the T3 or E3 interface module. Some of monitoring tools available are:

- Maintenance Data Link (MDL) messages
- Performance Monitoring
- [MDL Messages, on page 47](#)
- [Performance Monitoring , on page 58](#)

## MDL Messages

MDL messages are used to communicate identification information between local and remote ports. The MDL message includes:

- Equipment Identification Code (EIC)
- Location Identification Code (LIC)
- Frame Identification Code (FIC)
- Unit
- Path Facility Identification (PFI)
- Port Number
- Generator Identification Number



---

**Note** MDL messages are only supported when the T3 framing is set for C-bit parity.

---

The **no mdl** command removes the configuration of mdl messages.



---

**Note** MDL configuration is *not* supported for E3 interfaces.

---

## Configuring MDL for Path Transmission

To configure MDL path transmission messages on T3 controller configuration mode, use the following commands:

```
enable
configure terminal
controller t3 0/0/17
framing c-bit
mdl string eic beic
mdl string lic beic
mdl string fic bfix
mdl string unit bunit
mdl string pfi bphi
mdl transmit path
```

## Verifying MDL for Path Transmission Configuration

For PE1 Configuration:

Use the **show controller** command to display the verification of MDL path transmission configuration.

```
Router# show controllers t3 0/0/17
```

```
T3 0/0/17 is up.
Hardware is ASR903-48T3E3-CE

Applique type is Channelized T3
No alarms detected.
MDL transmission is disabled

FEAC code received: No code is being received
Framing is C-BIT Parity, Line Code is B3ZS, Cablelength Short less than 225ft
BER thresholds: SF = 10e-10 SD = 10e-10
Clock Source is internal
Equipment customer loopback
Data in current interval (240 seconds elapsed):
Near End
  0 Line Code Violations, 0 P-bit Coding Violations
  0 C-bit Coding Violations, 0 P-bit Err Secs
  0 P-bit Severely Err Secs, 0 Severely Err Framing Secs
  0 Unavailable Secs, 0 Line Errored Secs
  0 C-bit Errored Secs, 0 C-bit Severely Errored Secs
  0 Severely Errored Line Secs, 0 Path Failures
  0 AIS Defect Secs, 0 LOS Defect Secs
Far End
  0 Errored Secs, 0 Severely Errored Secs
  0 C-bit Unavailable Secs, 0 Path Failures
  0 Code Violations, 0 Service Affecting Secs
Data in Interval 1:
Near End
  0 Line Code Violations, 0 P-bit Coding Violations
  0 C-bit Coding Violations, 0 P-bit Err Secs
  0 P-bit Severely Err Secs, 0 Severely Err Framing Secs
  20 Unavailable Secs, 20 Line Errored Secs
  0 C-bit Errored Secs, 0 C-bit Severely Errored Secs
  20 Severely Errored Line Secs, 1 Path Failures
  0 AIS Defect Secs, 20 LOS Defect Secs
Far End
  0 Errored Secs, 0 Severely Errored Secs
  0 C-bit Unavailable Secs, 0 Path Failures
```

```

    0 Code Violations, 0 Service Affecting Secs
Total Data (last 1 15 minute intervals):
Near End
    0 Line Code Violations, 0 P-bit Coding Violations,
    0 C-bit Coding Violations, 0 P-bit Err Secs,
    0 P-bit Severely Err Secs, 0 Severely Err Framing Secs,
    20 Unavailable Secs, 20 Line Errored Secs,
    0 C-bit Errored Secs, 0 C-bit Severely Errored Secs
    20 Severely Errored Line Secs, 1 path failures
    0 AIS Defect Secs, 20 LOS Defect Secs
Far End
    0 Errored Secs, 0 Severely Errored Secs
    0 C-bit Unavailable Secs, 0 Path Failures
    0 Code Violations, 0 Service Affecting Secs

T1 1 is up
timeslots:
FDL per AT&T 54016 spec.
No alarms detected.
Framing is ESF, Clock Source is Internal
Data in current interval (250 seconds elapsed):
Near End
    0 Line Code Violations, 0 Path Code Violations
    0 Slip Secs, 0 Fr Loss Secs, 0 Line Err Secs, 0 Degraded Mins
    0 Errored Secs, 0 Bursty Err Secs, 0 Severely Err Secs
    0 Unavailable Secs, 0 Stuffed Secs
    0 Path Failures, 0 SEF/AIS Secs
Far End
    0 Line Code Violations, 0 Path Code Violations
    0 Slip Secs, 0 Fr Loss Secs, 0 Line Err Secs, 0 Degraded Mins
    0 Errored Secs, 0 Bursty Err Secs, 0 Severely Err Secs
    0 Unavailable Secs 0 Path Failures
Data in Interval 1:
Near End
    0 Line Code Violations, 0 Path Code Violations
    0 Slip Secs, 2 Fr Loss Secs, 0 Line Err Secs, 0 Degraded Mins
    2 Errored Secs, 0 Bursty Err Secs, 2 Severely Err Secs
    0 Unavailable Secs, 0 Stuffed Secs
    1 Path Failures, 2 SEF/AIS Secs
Far End
    0 Line Code Violations, 0 Path Code Violations
    0 Slip Secs, 2 Fr Loss Secs, 0 Line Err Secs, 0 Degraded Mins
    3 Errored Secs, 0 Bursty Err Secs, 3 Severely Err Secs
    0 Unavailable Secs 0 Path Failures
Total Data (last 1 15 minute intervals):
Near End
    0 Line Code Violations,0 Path Code Violations,
    0 Slip Secs, 2 Fr Loss Secs, 0 Line Err Secs, 0 Degraded Mins,
    2 Errored Secs, 0 Bursty Err Secs, 2 Severely Err Secs
    0 Unavailable Secs, 0 Stuffed Secs
    1 Path Failures, 2 SEF/AIS Secs
Far End
    0 Line Code Violations,0 Path Code Violations
    0 Slip Secs, 2 Fr Loss Secs, 0 Line Err Secs, 0 Degraded Mins,
    3 Errored Secs, 0 Bursty Err Secs, 3 Severely Err Secs
    0 Unavailable Secs, 0 Path Failures

```

For PE2 Configuration:

Use the **show controller** command to display the verification of MDL path transmission configuration.

```
Router# show controllers t3 0/0/18
```

```
T3 0/0/18 is up.
```

## Verifying MDL for Path Transmission Configuration

```

Hardware is ASR903-48T3E3-CE

Applique type is Channelized T3
No alarms detected.
MDL transmission is enabled

Far-End MDL Information Received
  EIC: beic, LIC: beic, FIC: bfix, UNIT: bunit
  Idle Signal PORT_NO: bport
FEAC code received: DS3 Out-Of-Frame
Framing is C-BIT Parity, Line Code is B3ZS, Cablelength Short less than 225ft
Clock Source is internal
Equipment customer loopback

Data in current interval (240 seconds elapsed):
Near End
  0 Line Code Violations, 0 P-bit Coding Violations
  0 C-bit Coding Violations, 0 P-bit Err Secs
  0 P-bit Severely Err Secs, 0 Severely Err Framing Secs
  0 Unavailable Secs, 0 Line Errored Secs
  0 C-bit Errored Secs, 0 C-bit Severely Errored Secs
  0 Severely Errored Line Secs, 0 Path Failures
  0 AIS Defect Secs, 0 LOS Defect Secs
Far End
  0 Errored Secs, 0 Severely Errored Secs
  0 C-bit Unavailable Secs, 0 Path Failures
  0 Code Violations, 0 Service Affecting Secs
Data in Interval 1:
Near End
  0 Line Code Violations, 0 P-bit Coding Violations
  0 C-bit Coding Violations, 0 P-bit Err Secs
  0 P-bit Severely Err Secs, 0 Severely Err Framing Secs
  20 Unavailable Secs, 20 Line Errored Secs
  0 C-bit Errored Secs, 0 C-bit Severely Errored Secs
  20 Severely Errored Line Secs, 1 Path Failures
  0 AIS Defect Secs, 20 LOS Defect Secs
Far End
  0 Errored Secs, 0 Severely Errored Secs
  0 C-bit Unavailable Secs, 0 Path Failures
  0 Code Violations, 0 Service Affecting Secs
Total Data (last 1 15 minute intervals):
Near End
  0 Line Code Violations, 0 P-bit Coding Violations,
  0 C-bit Coding Violations, 0 P-bit Err Secs,
  0 P-bit Severely Err Secs, 0 Severely Err Framing Secs,
  20 Unavailable Secs, 20 Line Errored Secs,
  0 C-bit Errored Secs, 0 C-bit Severely Errored Secs
  20 Severely Errored Line Secs, 1 path failures
  0 AIS Defect Secs, 20 LOS Defect Secs
Far End
  0 Errored Secs, 0 Severely Errored Secs
  0 C-bit Unavailable Secs, 0 Path Failures
  0 Code Violations, 0 Service Affecting Secs

T1 1 is up
timeslots:
FDL per AT&T 54016 spec.
No alarms detected.
Framing is ESF, Clock Source is Internal
Data in current interval (250 seconds elapsed):
Near End
  0 Line Code Violations, 0 Path Code Violations
  0 Slip Secs, 0 Fr Loss Secs, 0 Line Err Secs, 0 Degraded Mins
  0 Errored Secs, 0 Bursty Err Secs, 0 Severely Err Secs

```



```

    0 Unavailable Secs, 0 Stuffed Secs
    0 Path Failures, 0 SEF/AIS Secs
Far End
    0 Line Code Violations, 0 Path Code Violations
    0 Slip Secs, 0 Fr Loss Secs, 0 Line Err Secs, 0 Degraded Mins
    0 Errored Secs, 0 Bursty Err Secs, 0 Severely Err Secs
    0 Unavailable Secs 0 Path Failures
Data in Interval 1:
Near End
    0 Line Code Violations, 0 Path Code Violations
    0 Slip Secs, 2 Fr Loss Secs, 0 Line Err Secs, 0 Degraded Mins
    2 Errored Secs, 0 Bursty Err Secs, 2 Severely Err Secs
    0 Unavailable Secs, 0 Stuffed Secs
    1 Path Failures, 2 SEF/AIS Secs
Far End
    0 Line Code Violations, 0 Path Code Violations
    0 Slip Secs, 2 Fr Loss Secs, 0 Line Err Secs, 0 Degraded Mins
    3 Errored Secs, 0 Bursty Err Secs, 3 Severely Err Secs
    0 Unavailable Secs 0 Path Failures
Total Data (last 1 15 minute intervals):
Near End
    0 Line Code Violations,0 Path Code Violations,
    0 Slip Secs, 2 Fr Loss Secs, 0 Line Err Secs, 0 Degraded Mins,
    2 Errored Secs, 0 Bursty Err Secs, 2 Severely Err Secs
    0 Unavailable Secs, 0 Stuffed Secs
    1 Path Failures, 2 SEF/AIS Secs
Far End
    0 Line Code Violations,0 Path Code Violations
    0 Slip Secs, 2 Fr Loss Secs, 0 Line Err Secs, 0 Degraded Mins,
    3 Errored Secs, 0 Bursty Err Secs, 3 Severely Err Secs
    0 Unavailable Secs, 0 Path Failures

```

## Configuring MDL for Test Signal

To configure MDL test signal messages on T3 controller configuration mode, use the following commands:

```

enable
configure terminal
controller t3 0/0/17
framing c-bit
mdl string eic beic
mdl string lic beic
mdl string fic bfix
mdl string unit bunit
mdl string generator bgen
mdl transmit test-signal

```

## Verifying MDL for Test Signal Configuration

For PE1 Configuration:

Use the **show controller** command to display the verification of MDL for test signal configuration.

```

Router# show controllers t3 0/0/17
T3 0/0/17 is up.
Hardware is ASR903-48T3E3-CE

Applique type is Channelized T3
No alarms detected.
MDL transmission is enabled

```

```

    EIC: beic, LIC: beic, FIC: bfix, UNIT: bunit
    Test Signal GEN_NO: bgen
FEAC code received: DS3 Out-Of-Frame
Framing is C-BIT Parity, Line Code is B3ZS, Cablelength Short less than 225ft
Clock Source is internal
Equipment customer loopback
Data in current interval (240 seconds elapsed):
  Near End
    0 Line Code Violations, 0 P-bit Coding Violations
    0 C-bit Coding Violations, 0 P-bit Err Secs
    0 P-bit Severely Err Secs, 0 Severely Err Framing Secs
    0 Unavailable Secs, 0 Line Errored Secs
    0 C-bit Errored Secs, 0 C-bit Severely Errored Secs
    0 Severely Errored Line Secs, 0 Path Failures
    0 AIS Defect Secs, 0 LOS Defect Secs
  Far End
    0 Errored Secs, 0 Severely Errored Secs
    0 C-bit Unavailable Secs, 0 Path Failures
    0 Code Violations, 0 Service Affecting Secs
Data in Interval 1:
  Near End
    0 Line Code Violations, 0 P-bit Coding Violations
    0 C-bit Coding Violations, 0 P-bit Err Secs
    0 P-bit Severely Err Secs, 0 Severely Err Framing Secs
    20 Unavailable Secs, 20 Line Errored Secs
    0 C-bit Errored Secs, 0 C-bit Severely Errored Secs
    20 Severely Errored Line Secs, 1 Path Failures
    0 AIS Defect Secs, 20 LOS Defect Secs
  Far End
    0 Errored Secs, 0 Severely Errored Secs
    0 C-bit Unavailable Secs, 0 Path Failures
    0 Code Violations, 0 Service Affecting Secs
Total Data (last 1 15 minute intervals):
  Near End
    0 Line Code Violations, 0 P-bit Coding Violations,
    0 C-bit Coding Violations, 0 P-bit Err Secs,
    0 P-bit Severely Err Secs, 0 Severely Err Framing Secs,
    20 Unavailable Secs, 20 Line Errored Secs,
    0 C-bit Errored Secs, 0 C-bit Severely Errored Secs
    20 Severely Errored Line Secs, 1 path failures
    0 AIS Defect Secs, 20 LOS Defect Secs
  Far End
    0 Errored Secs, 0 Severely Errored Secs
    0 C-bit Unavailable Secs, 0 Path Failures
    0 Code Violations, 0 Service Affecting Secs

T1 1 is up
timeslots:
FDL per AT&T 54016 spec.
No alarms detected.
Framing is ESF, Clock Source is Internal
Data in current interval (250 seconds elapsed):
  Near End
    0 Line Code Violations, 0 Path Code Violations
    0 Slip Secs, 0 Fr Loss Secs, 0 Line Err Secs, 0 Degraded Mins
    0 Errored Secs, 0 Bursty Err Secs, 0 Severely Err Secs
    0 Unavailable Secs, 0 Stuffed Secs
    0 Path Failures, 0 SEF/AIS Secs
  Far End
    0 Line Code Violations, 0 Path Code Violations
    0 Slip Secs, 0 Fr Loss Secs, 0 Line Err Secs, 0 Degraded Mins
    0 Errored Secs, 0 Bursty Err Secs, 0 Severely Err Secs
    0 Unavailable Secs 0 Path Failures
Data in Interval 1:

```

```

Near End
  0 Line Code Violations, 0 Path Code Violations
  0 Slip Secs, 2 Fr Loss Secs, 0 Line Err Secs, 0 Degraded Mins
  2 Errored Secs, 0 Bursty Err Secs, 2 Severely Err Secs
  0 Unavailable Secs, 0 Stuffed Secs
  1 Path Failures, 2 SEF/AIS Secs
Far End
  0 Line Code Violations, 0 Path Code Violations
  0 Slip Secs, 2 Fr Loss Secs, 0 Line Err Secs, 0 Degraded Mins
  3 Errored Secs, 0 Bursty Err Secs, 3 Severely Err Secs
  0 Unavailable Secs 0 Path Failures
Total Data (last 1 15 minute intervals):
Near End
  0 Line Code Violations,0 Path Code Violations,
  0 Slip Secs, 2 Fr Loss Secs, 0 Line Err Secs, 0 Degraded Mins,
  2 Errored Secs, 0 Bursty Err Secs, 2 Severely Err Secs
  0 Unavailable Secs, 0 Stuffed Secs
  1 Path Failures, 2 SEF/AIS Secs
Far End
  0 Line Code Violations,0 Path Code Violations
  0 Slip Secs, 2 Fr Loss Secs, 0 Line Err Secs, 0 Degraded Mins,
  3 Errored Secs, 0 Bursty Err Secs, 3 Severely Err Secs
  0 Unavailable Secs, 0 Path Failures

```

For PE2 Configuration:

Use the **show controller** command to display the verification of MDL for test signal configuration.

```

Router# show controllers t3 0/0/18
T3 0/0/18 is up.
  Hardware is ASR903-48T3E3-CE

  Applique type is Channelized T3
  No alarms detected.
  MDL transmission is disabled

  Far-End MDL Information Received
    EIC: beic, LIC: beic, FIC: bfix, UNIT: bunit
    Test Signal GEN_NO: bgen
  FEAC code received: DS3 Out-Of-Frame
  Framing is C-BIT Parity, Line Code is B3ZS, Cablelength Short less than 225ft
  Clock Source is internal
  Equipment customer loopback
  Data in current interval (240 seconds elapsed):
    Near End
      0 Line Code Violations, 0 P-bit Coding Violations
      0 C-bit Coding Violations, 0 P-bit Err Secs
      0 P-bit Severely Err Secs, 0 Severely Err Framing Secs
      0 Unavailable Secs, 0 Line Errored Secs
      0 C-bit Errored Secs, 0 C-bit Severely Errored Secs
      0 Severely Errored Line Secs, 0 Path Failures
      0 AIS Defect Secs, 0 LOS Defect Secs
    Far End
      0 Errored Secs, 0 Severely Errored Secs
      0 C-bit Unavailable Secs, 0 Path Failures
      0 Code Violations, 0 Service Affecting Secs
  Data in Interval 1:
    Near End
      0 Line Code Violations, 0 P-bit Coding Violations
      0 C-bit Coding Violations, 0 P-bit Err Secs
      0 P-bit Severely Err Secs, 0 Severely Err Framing Secs
      20 Unavailable Secs, 20 Line Errored Secs
      0 C-bit Errored Secs, 0 C-bit Severely Errored Secs
      20 Severely Errored Line Secs, 1 Path Failures

```

```

    0 AIS Defect Secs, 20 LOS Defect Secs
Far End
    0 Errored Secs, 0 Severely Errored Secs
    0 C-bit Unavailable Secs, 0 Path Failures
    0 Code Violations, 0 Service Affecting Secs
Total Data (last 1 15 minute intervals):
Near End
    0 Line Code Violations, 0 P-bit Coding Violations,
    0 C-bit Coding Violations, 0 P-bit Err Secs,
    0 P-bit Severely Err Secs, 0 Severely Err Framing Secs,
    20 Unavailable Secs, 20 Line Errored Secs,
    0 C-bit Errored Secs, 0 C-bit Severely Errored Secs
    20 Severely Errored Line Secs, 1 path failures
    0 AIS Defect Secs, 20 LOS Defect Secs
Far End
    0 Errored Secs, 0 Severely Errored Secs
    0 C-bit Unavailable Secs, 0 Path Failures
    0 Code Violations, 0 Service Affecting Secs

Tl 1 is up
timeslots:
FDL per AT&T 54016 spec.
No alarms detected.
Framing is ESF, Clock Source is Internal
Data in current interval (250 seconds elapsed):
Near End
    0 Line Code Violations, 0 Path Code Violations
    0 Slip Secs, 0 Fr Loss Secs, 0 Line Err Secs, 0 Degraded Mins
    0 Errored Secs, 0 Bursty Err Secs, 0 Severely Err Secs
    0 Unavailable Secs, 0 Stuffed Secs
    0 Path Failures, 0 SEF/AIS Secs
Far End
    0 Line Code Violations, 0 Path Code Violations
    0 Slip Secs, 0 Fr Loss Secs, 0 Line Err Secs, 0 Degraded Mins
    0 Errored Secs, 0 Bursty Err Secs, 0 Severely Err Secs
    0 Unavailable Secs 0 Path Failures
Data in Interval 1:
Near End
    0 Line Code Violations, 0 Path Code Violations
    0 Slip Secs, 2 Fr Loss Secs, 0 Line Err Secs, 0 Degraded Mins
    2 Errored Secs, 0 Bursty Err Secs, 2 Severely Err Secs
    0 Unavailable Secs, 0 Stuffed Secs
    1 Path Failures, 2 SEF/AIS Secs
Far End
    0 Line Code Violations, 0 Path Code Violations
    0 Slip Secs, 2 Fr Loss Secs, 0 Line Err Secs, 0 Degraded Mins
    3 Errored Secs, 0 Bursty Err Secs, 3 Severely Err Secs
    0 Unavailable Secs 0 Path Failures
Total Data (last 1 15 minute intervals):
Near End
    0 Line Code Violations,0 Path Code Violations,
    0 Slip Secs, 2 Fr Loss Secs, 0 Line Err Secs, 0 Degraded Mins,
    2 Errored Secs, 0 Bursty Err Secs, 2 Severely Err Secs
    0 Unavailable Secs, 0 Stuffed Secs
    1 Path Failures, 2 SEF/AIS Secs
Far End
    0 Line Code Violations,0 Path Code Violations
    0 Slip Secs, 2 Fr Loss Secs, 0 Line Err Secs, 0 Degraded Mins,
    3 Errored Secs, 0 Bursty Err Secs, 3 Severely Err Secs
    0 Unavailable Secs, 0 Path Failures

```

## Configuring MDL for Idle Signal

To configure MDL idle signal messages on T3 controller configuration mode, use the following commands:

```
enable
configure terminal
controller T3 0/0/17
framing c-bit
mdl string eic beic
mdl string lic beic
mdl string fic bfix
mdl string unit bunit
mdl string port bport
mdl transmit idle-signal
```

## Verifying MDL for Idle Signal Configuration

For PE1 Configuration:

Use the **show controller** command to display the verification of MDL for idle signal configuration.

```
Router# show controllers t3 0/0/17

T3 0/0/17 is up.
Hardware is ASR903-48T3E3-CE

Applique type is Channelized T3
No alarms detected.
MDL transmission is disabled

FEAC code received: No code is being received
Framing is C-BIT Parity, Line Code is B3ZS, Cablelength Short less than 225ft
BER thresholds: SF = 10e-10 SD = 10e-10
Clock Source is internal
Equipment customer loopback
Data in current interval (240 seconds elapsed):
Near End
  0 Line Code Violations, 0 P-bit Coding Violations
  0 C-bit Coding Violations, 0 P-bit Err Secs
  0 P-bit Severely Err Secs, 0 Severely Err Framing Secs
  0 Unavailable Secs, 0 Line Errored Secs
  0 C-bit Errored Secs, 0 C-bit Severely Errored Secs
  0 Severely Errored Line Secs, 0 Path Failures
  0 AIS Defect Secs, 0 LOS Defect Secs
Far End
  0 Errored Secs, 0 Severely Errored Secs
  0 C-bit Unavailable Secs, 0 Path Failures
  0 Code Violations, 0 Service Affecting Secs
Data in Interval 1:
Near End
  0 Line Code Violations, 0 P-bit Coding Violations
  0 C-bit Coding Violations, 0 P-bit Err Secs
  0 P-bit Severely Err Secs, 0 Severely Err Framing Secs
  20 Unavailable Secs, 20 Line Errored Secs
  0 C-bit Errored Secs, 0 C-bit Severely Errored Secs
  20 Severely Errored Line Secs, 1 Path Failures
  0 AIS Defect Secs, 20 LOS Defect Secs
Far End
  0 Errored Secs, 0 Severely Errored Secs
  0 C-bit Unavailable Secs, 0 Path Failures
  0 Code Violations, 0 Service Affecting Secs
```

```

Total Data (last 1 15 minute intervals):
Near End
  0 Line Code Violations, 0 P-bit Coding Violations,
  0 C-bit Coding Violations, 0 P-bit Err Secs,
  0 P-bit Severely Err Secs, 0 Severely Err Framing Secs,
  20 Unavailable Secs, 20 Line Errored Secs,
  0 C-bit Errored Secs, 0 C-bit Severely Errored Secs
  20 Severely Errored Line Secs, 1 path failures
  0 AIS Defect Secs, 20 LOS Defect Secs
Far End
  0 Errored Secs, 0 Severely Errored Secs
  0 C-bit Unavailable Secs, 0 Path Failures
  0 Code Violations, 0 Service Affecting Secs

Tl 1 is up
timeslots:
FDL per AT&T 54016 spec.
No alarms detected.
Framing is ESF, Clock Source is Internal
Data in current interval (250 seconds elapsed):
Near End
  0 Line Code Violations, 0 Path Code Violations
  0 Slip Secs, 0 Fr Loss Secs, 0 Line Err Secs, 0 Degraded Mins
  0 Errored Secs, 0 Bursty Err Secs, 0 Severely Err Secs
  0 Unavailable Secs, 0 Stuffed Secs
  0 Path Failures, 0 SEF/AIS Secs
Far End
  0 Line Code Violations, 0 Path Code Violations
  0 Slip Secs, 0 Fr Loss Secs, 0 Line Err Secs, 0 Degraded Mins
  0 Errored Secs, 0 Bursty Err Secs, 0 Severely Err Secs
  0 Unavailable Secs 0 Path Failures
Data in Interval 1:
Near End
  0 Line Code Violations, 0 Path Code Violations
  0 Slip Secs, 2 Fr Loss Secs, 0 Line Err Secs, 0 Degraded Mins
  2 Errored Secs, 0 Bursty Err Secs, 2 Severely Err Secs
  0 Unavailable Secs, 0 Stuffed Secs
  1 Path Failures, 2 SEF/AIS Secs
Far End
  0 Line Code Violations, 0 Path Code Violations
  0 Slip Secs, 2 Fr Loss Secs, 0 Line Err Secs, 0 Degraded Mins
  3 Errored Secs, 0 Bursty Err Secs, 3 Severely Err Secs
  0 Unavailable Secs 0 Path Failures
Total Data (last 1 15 minute intervals):
Near End
  0 Line Code Violations,0 Path Code Violations,
  0 Slip Secs, 2 Fr Loss Secs, 0 Line Err Secs, 0 Degraded Mins,
  2 Errored Secs, 0 Bursty Err Secs, 2 Severely Err Secs
  0 Unavailable Secs, 0 Stuffed Secs
  1 Path Failures, 2 SEF/AIS Secs
Far End
  0 Line Code Violations,0 Path Code Violations
  0 Slip Secs, 2 Fr Loss Secs, 0 Line Err Secs, 0 Degraded Mins,
  3 Errored Secs, 0 Bursty Err Secs, 3 Severely Err Secs
  0 Unavailable Secs, 0 Path Failures

```

#### For PE2 Configuration:

Use the **show controller** command to display the verification of MDL for idle signal configuration.

```
Router# show controllers t3 0/0/18
```

```
T3 0/0/18 is up.
Hardware is ASR903-48T3E3-CE
```

```

Applique type is Channelized T3
No alarms detected.
MDL transmission is enabled

Far-End MDL Information Received
  EIC: beic, LIC: beic, FIC: bfix, UNIT: bunit
  Idle Signal PORT_NO: bport
FEAC code received: DS3 Out-Of-Frame
Framing is C-BIT Parity, Line Code is B3ZS, Cablelength Short less than 225ft
Clock Source is internal
Equipment customer loopback

Data in current interval (240 seconds elapsed):
Near End
  0 Line Code Violations, 0 P-bit Coding Violations
  0 C-bit Coding Violations, 0 P-bit Err Secs
  0 P-bit Severely Err Secs, 0 Severely Err Framing Secs
  0 Unavailable Secs, 0 Line Errored Secs
  0 C-bit Errored Secs, 0 C-bit Severely Errored Secs
  0 Severely Errored Line Secs, 0 Path Failures
  0 AIS Defect Secs, 0 LOS Defect Secs
Far End
  0 Errored Secs, 0 Severely Errored Secs
  0 C-bit Unavailable Secs, 0 Path Failures
  0 Code Violations, 0 Service Affecting Secs
Data in Interval 1:
Near End
  0 Line Code Violations, 0 P-bit Coding Violations
  0 C-bit Coding Violations, 0 P-bit Err Secs
  0 P-bit Severely Err Secs, 0 Severely Err Framing Secs
  20 Unavailable Secs, 20 Line Errored Secs
  0 C-bit Errored Secs, 0 C-bit Severely Errored Secs
  20 Severely Errored Line Secs, 1 Path Failures
  0 AIS Defect Secs, 20 LOS Defect Secs
Far End
  0 Errored Secs, 0 Severely Errored Secs
  0 C-bit Unavailable Secs, 0 Path Failures
  0 Code Violations, 0 Service Affecting Secs
Total Data (last 1 15 minute intervals):
Near End
  0 Line Code Violations, 0 P-bit Coding Violations,
  0 C-bit Coding Violations, 0 P-bit Err Secs,
  0 P-bit Severely Err Secs, 0 Severely Err Framing Secs,
  20 Unavailable Secs, 20 Line Errored Secs,
  0 C-bit Errored Secs, 0 C-bit Severely Errored Secs
  20 Severely Errored Line Secs, 1 path failures
  0 AIS Defect Secs, 20 LOS Defect Secs
Far End
  0 Errored Secs, 0 Severely Errored Secs
  0 C-bit Unavailable Secs, 0 Path Failures
  0 Code Violations, 0 Service Affecting Secs

T1 1 is up
timeslots:
FDL per AT&T 54016 spec.
No alarms detected.
Framing is ESF, Clock Source is Internal
Data in current interval (250 seconds elapsed):
Near End
  0 Line Code Violations, 0 Path Code Violations
  0 Slip Secs, 0 Fr Loss Secs, 0 Line Err Secs, 0 Degraded Mins
  0 Errored Secs, 0 Bursty Err Secs, 0 Severely Err Secs
  0 Unavailable Secs, 0 Stuffed Secs

```

```

    0 Path Failures, 0 SEF/AIS Secs
  Far End
    0 Line Code Violations, 0 Path Code Violations
    0 Slip Secs, 0 Fr Loss Secs, 0 Line Err Secs, 0 Degraded Mins
    0 Errored Secs, 0 Bursty Err Secs, 0 Severely Err Secs
    0 Unavailable Secs 0 Path Failures
Data in Interval 1:
  Near End
    0 Line Code Violations, 0 Path Code Violations
    0 Slip Secs, 2 Fr Loss Secs, 0 Line Err Secs, 0 Degraded Mins
    2 Errored Secs, 0 Bursty Err Secs, 2 Severely Err Secs
    0 Unavailable Secs, 0 Stuffed Secs
    1 Path Failures, 2 SEF/AIS Secs
  Far End
    0 Line Code Violations, 0 Path Code Violations
    0 Slip Secs, 2 Fr Loss Secs, 0 Line Err Secs, 0 Degraded Mins
    3 Errored Secs, 0 Bursty Err Secs, 3 Severely Err Secs
    0 Unavailable Secs 0 Path Failures
Total Data (last 1 15 minute intervals):
  Near End
    0 Line Code Violations,0 Path Code Violations,
    0 Slip Secs, 2 Fr Loss Secs, 0 Line Err Secs, 0 Degraded Mins,
    2 Errored Secs, 0 Bursty Err Secs, 2 Severely Err Secs
    0 Unavailable Secs, 0 Stuffed Secs
    1 Path Failures, 2 SEF/AIS Secs
  Far End
    0 Line Code Violations,0 Path Code Violations
    0 Slip Secs, 2 Fr Loss Secs, 0 Line Err Secs, 0 Degraded Mins,
    3 Errored Secs, 0 Bursty Err Secs, 3 Severely Err Secs
    0 Unavailable Secs, 0 Path Failures

```

## Performance Monitoring

You can view the statistics or error count generated on the TDM lines for T3 interfaces.

```

enable
configure terminal
controller MediaType 0/0/0
mode t3
controller t3 0/0/0
framing c-bit
cablelength
long 224-450 ft
short 0-224 ft
controller MediaType 0/0/15
mode t3
controller T3 0/0/15
framing c-bit
cablelength short

```

To view the statistics or error count generated on the TDM lines for T3 interfaces, use the **show controller** command:

```

Router# show controller T3 0/0/0
T3 0/0/0 is up.
  Hardware is ASR900-48T3E3-CE

  Applique type is Channelized T3
  No alarms detected.
  MDL transmission is disabled

  FEAC code received: No code is being received

```



```

Framing is C-BIT Parity, Line Code is B3ZS, Cablelength Short less than 225ft
BER thresholds: SF = 10e-10 SD = 10e-10
Clock Source is internal
Equipment customer loopback
Data in current interval (240 seconds elapsed):
Near End
  0 Line Code Violations, 0 P-bit Coding Violations
  0 C-bit Coding Violations, 0 P-bit Err Secs
  0 P-bit Severely Err Secs, 0 Severely Err Framing Secs
  0 Unavailable Secs, 0 Line Errored Secs
  0 C-bit Errored Secs, 0 C-bit Severely Errored Secs
  0 Severely Errored Line Secs, 0 Path Failures
  0 AIS Defect Secs, 0 LOS Defect Secs
Far End
  0 Errored Secs, 0 Severely Errored Secs
  0 C-bit Unavailable Secs, 0 Path Failures
  0 Code Violations, 0 Service Affecting Secs
Data in Interval 1:
Near End
  0 Line Code Violations, 0 P-bit Coding Violations
  0 C-bit Coding Violations, 0 P-bit Err Secs
  0 P-bit Severely Err Secs, 0 Severely Err Framing Secs
  20 Unavailable Secs, 20 Line Errored Secs
  0 C-bit Errored Secs, 0 C-bit Severely Errored Secs
  20 Severely Errored Line Secs, 1 Path Failures
  0 AIS Defect Secs, 20 LOS Defect Secs
Far End
  0 Errored Secs, 0 Severely Errored Secs
  0 C-bit Unavailable Secs, 0 Path Failures
  0 Code Violations, 0 Service Affecting Secs
Total Data (last 1 15 minute intervals):
Near End
  0 Line Code Violations, 0 P-bit Coding Violations,
  0 C-bit Coding Violations, 0 P-bit Err Secs,
  0 P-bit Severely Err Secs, 0 Severely Err Framing Secs,
  20 Unavailable Secs, 20 Line Errored Secs,
  0 C-bit Errored Secs, 0 C-bit Severely Errored Secs
  20 Severely Errored Line Secs, 1 path failures
  0 AIS Defect Secs, 20 LOS Defect Secs
Far End
  0 Errored Secs, 0 Severely Errored Secs
  0 C-bit Unavailable Secs, 0 Path Failures
  0 Code Violations, 0 Service Affecting Secs

T1 1 is up
timeslots:
FDL per AT&T 54016 spec.
No alarms detected.
Framing is ESF, Clock Source is Internal
Data in current interval (250 seconds elapsed):
Near End
  0 Line Code Violations, 0 Path Code Violations
  0 Slip Secs, 0 Fr Loss Secs, 0 Line Err Secs, 0 Degraded Mins
  0 Errored Secs, 0 Bursty Err Secs, 0 Severely Err Secs
  0 Unavailable Secs, 0 Stuffed Secs
  0 Path Failures, 0 SEF/AIS Secs
Far End
  0 Line Code Violations, 0 Path Code Violations
  0 Slip Secs, 0 Fr Loss Secs, 0 Line Err Secs, 0 Degraded Mins
  0 Errored Secs, 0 Bursty Err Secs, 0 Severely Err Secs
  0 Unavailable Secs 0 Path Failures
Data in Interval 1:
Near End
  0 Line Code Violations, 0 Path Code Violations

```

```

    0 Slip Secs, 2 Fr Loss Secs, 0 Line Err Secs, 0 Degraded Mins
    2 Errored Secs, 0 Bursty Err Secs, 2 Severely Err Secs
    0 Unavailable Secs, 0 Stuffed Secs
    1 Path Failures, 2 SEF/AIS Secs
Far End
    0 Line Code Violations, 0 Path Code Violations
    0 Slip Secs, 2 Fr Loss Secs, 0 Line Err Secs, 0 Degraded Mins
    3 Errored Secs, 0 Bursty Err Secs, 3 Severely Err Secs
    0 Unavailable Secs 0 Path Failures
Total Data (last 1 15 minute intervals):
Near End
    0 Line Code Violations,0 Path Code Violations,
    0 Slip Secs, 2 Fr Loss Secs, 0 Line Err Secs, 0 Degraded Mins,
    2 Errored Secs, 0 Bursty Err Secs, 2 Severely Err Secs
    0 Unavailable Secs, 0 Stuffed Secs
    1 Path Failures, 2 SEF/AIS Secs
Far End
    0 Line Code Violations,0 Path Code Violations
    0 Slip Secs, 2 Fr Loss Secs, 0 Line Err Secs, 0 Degraded Mins,
    3 Errored Secs, 0 Bursty Err Secs, 3 Severely Err Secs
    0 Unavailable Secs, 0 Path Failures

```

### Use Case 1

If your configuration is as follows:

- T3 is up
- No Alarms
- Framing is unframed
- Clock Source is Internal

This performance monitoring result is displayed:

```

T3 is up
No alarms detected.
Framing is unframed, Clock Source is Internal
Data in current interval (240 seconds elapsed):
Near End
    0 Line Code Violations, 0 P-bit Coding Violations
    0 C-bit Coding Violations, 0 P-bit Err Secs
    0 P-bit Severely Err Secs, 0 Severely Err Framing Secs
    0 Unavailable Secs, 0 Line Errored Secs
    0 C-bit Errored Secs, 0 C-bit Severely Errored Secs
    0 Severely Errored Line Secs, 0 Path Failures
    0 AIS Defect Secs, 0 LOS Defect Secs
Far End
    0 Errored Secs, 0 Severely Errored Secs
    0 C-bit Unavailable Secs, 0 Path Failures
    0 Code Violations, 0 Service Affecting Secs
Data in Interval 1:
Near End
    0 Line Code Violations, 0 P-bit Coding Violations
    0 C-bit Coding Violations, 0 P-bit Err Secs
    0 P-bit Severely Err Secs, 0 Severely Err Framing Secs
    20 Unavailable Secs, 20 Line Errored Secs
    0 C-bit Errored Secs, 0 C-bit Severely Errored Secs
    20 Severely Errored Line Secs, 1 Path Failures
    0 AIS Defect Secs, 20 LOS Defect Secs
Far End
    0 Errored Secs, 0 Severely Errored Secs
    0 C-bit Unavailable Secs, 0 Path Failures

```

```

    0 Code Violations, 0 Service Affecting Secs
Total Data (last 1 15 minute intervals):
Near End
    0 Line Code Violations, 0 P-bit Coding Violations,
    0 C-bit Coding Violations, 0 P-bit Err Secs,
    0 P-bit Severely Err Secs, 0 Severely Err Framing Secs,
    20 Unavailable Secs, 20 Line Errored Secs,
    0 C-bit Errored Secs, 0 C-bit Severely Errored Secs
    20 Severely Errored Line Secs, 1 path failures
    0 AIS Defect Secs, 20 LOS Defect Secs
Far End
    0 Errored Secs, 0 Severely Errored Secs
    0 C-bit Unavailable Secs, 0 Path Failures
    0 Code Violations, 0 Service Affecting Secs

T1 1 is up
timeslots:
FDL per AT&T 54016 spec.
No alarms detected.
Framing is ESF, Clock Source is Internal
Data in current interval (250 seconds elapsed):
Near End
    0 Line Code Violations, 0 Path Code Violations
    0 Slip Secs, 0 Fr Loss Secs, 0 Line Err Secs, 0 Degraded Mins
    0 Errored Secs, 0 Bursty Err Secs, 0 Severely Err Secs
    0 Unavailable Secs, 0 Stuffed Secs
    0 Path Failures, 0 SEF/AIS Secs
Far End
    0 Line Code Violations, 0 Path Code Violations
    0 Slip Secs, 0 Fr Loss Secs, 0 Line Err Secs, 0 Degraded Mins
    0 Errored Secs, 0 Bursty Err Secs, 0 Severely Err Secs
    0 Unavailable Secs 0 Path Failures
Data in Interval 1:
Near End
    0 Line Code Violations, 0 Path Code Violations
    0 Slip Secs, 2 Fr Loss Secs, 0 Line Err Secs, 0 Degraded Mins
    2 Errored Secs, 0 Bursty Err Secs, 2 Severely Err Secs
    0 Unavailable Secs, 0 Stuffed Secs
    1 Path Failures, 2 SEF/AIS Secs
Far End
    0 Line Code Violations, 0 Path Code Violations
    0 Slip Secs, 2 Fr Loss Secs, 0 Line Err Secs, 0 Degraded Mins
    3 Errored Secs, 0 Bursty Err Secs, 3 Severely Err Secs
    0 Unavailable Secs 0 Path Failures
Total Data (last 1 15 minute intervals):
Near End
    0 Line Code Violations,0 Path Code Violations,
    0 Slip Secs, 2 Fr Loss Secs, 0 Line Err Secs, 0 Degraded Mins,
    2 Errored Secs, 0 Bursty Err Secs, 2 Severely Err Secs
    0 Unavailable Secs, 0 Stuffed Secs
    1 Path Failures, 2 SEF/AIS Secs
Far End
    0 Line Code Violations,0 Path Code Violations
    0 Slip Secs, 2 Fr Loss Secs, 0 Line Err Secs, 0 Degraded Mins,
    3 Errored Secs, 0 Bursty Err Secs, 3 Severely Err Secs
    0 Unavailable Secs, 0 Path Failures

```

## Use Case 2

If your configuration is as follows:

- T1 28 is up or E1 16 is up
- No alarm received

- Framing is unframed
- Clock Source is Internal

This performance monitoring result is displayed:

```
T1 28 is up
No alarms detected.
Framing is unframed, Clock Source is Internal
Data in current interval (240 seconds elapsed):
  Near End
    0 Line Code Violations, 0 P-bit Coding Violations
    0 C-bit Coding Violations, 0 P-bit Err Secs
    0 P-bit Severely Err Secs, 0 Severely Err Framing Secs
    0 Unavailable Secs, 0 Line Errored Secs
    0 C-bit Errored Secs, 0 C-bit Severely Errored Secs
    0 Severely Errored Line Secs, 0 Path Failures
    0 AIS Defect Secs, 0 LOS Defect Secs
  Far End
    0 Errored Secs, 0 Severely Errored Secs
    0 C-bit Unavailable Secs, 0 Path Failures
    0 Code Violations, 0 Service Affecting Secs
Data in Interval 1:
  Near End
    0 Line Code Violations, 0 P-bit Coding Violations
    0 C-bit Coding Violations, 0 P-bit Err Secs
    0 P-bit Severely Err Secs, 0 Severely Err Framing Secs
    20 Unavailable Secs, 20 Line Errored Secs
    0 C-bit Errored Secs, 0 C-bit Severely Errored Secs
    20 Severely Errored Line Secs, 1 Path Failures
    0 AIS Defect Secs, 20 LOS Defect Secs
  Far End
    0 Errored Secs, 0 Severely Errored Secs
    0 C-bit Unavailable Secs, 0 Path Failures
    0 Code Violations, 0 Service Affecting Secs
Total Data (last 1 15 minute intervals):
  Near End
    0 Line Code Violations, 0 P-bit Coding Violations,
    0 C-bit Coding Violations, 0 P-bit Err Secs,
    0 P-bit Severely Err Secs, 0 Severely Err Framing Secs,
    20 Unavailable Secs, 20 Line Errored Secs,
    0 C-bit Errored Secs, 0 C-bit Severely Errored Secs
    20 Severely Errored Line Secs, 1 path failures
    0 AIS Defect Secs, 20 LOS Defect Secs
  Far End
    0 Errored Secs, 0 Severely Errored Secs
    0 C-bit Unavailable Secs, 0 Path Failures
    0 Code Violations, 0 Service Affecting Secs

T1 1 is up
timeslots:
FDL per AT&T 54016 spec.
No alarms detected.
Framing is ESF, Clock Source is Internal
Data in current interval (250 seconds elapsed):
  Near End
    0 Line Code Violations, 0 Path Code Violations
    0 Slip Secs, 0 Fr Loss Secs, 0 Line Err Secs, 0 Degraded Mins
    0 Errored Secs, 0 Bursty Err Secs, 0 Severely Err Secs
    0 Unavailable Secs, 0 Stuffed Secs
    0 Path Failures, 0 SEF/AIS Secs
  Far End
    0 Line Code Violations, 0 Path Code Violations
    0 Slip Secs, 0 Fr Loss Secs, 0 Line Err Secs, 0 Degraded Mins
```

```

    0 Errored Secs, 0 Bursty Err Secs, 0 Severely Err Secs
    0 Unavailable Secs 0 Path Failures
Data in Interval 1:
Near End
    0 Line Code Violations, 0 Path Code Violations
    0 Slip Secs, 2 Fr Loss Secs, 0 Line Err Secs, 0 Degraded Mins
    2 Errored Secs, 0 Bursty Err Secs, 2 Severely Err Secs
    0 Unavailable Secs, 0 Stuffed Secs
    1 Path Failures, 2 SEF/AIS Secs
Far End
    0 Line Code Violations, 0 Path Code Violations
    0 Slip Secs, 2 Fr Loss Secs, 0 Line Err Secs, 0 Degraded Mins
    3 Errored Secs, 0 Bursty Err Secs, 3 Severely Err Secs
    0 Unavailable Secs 0 Path Failures
Total Data (last 1 15 minute intervals):
Near End
    0 Line Code Violations,0 Path Code Violations,
    0 Slip Secs, 2 Fr Loss Secs, 0 Line Err Secs, 0 Degraded Mins,
    2 Errored Secs, 0 Bursty Err Secs, 2 Severely Err Secs
    0 Unavailable Secs, 0 Stuffed Secs
    1 Path Failures, 2 SEF/AIS Secs
Far End
    0 Line Code Violations,0 Path Code Violations
    0 Slip Secs, 2 Fr Loss Secs, 0 Line Err Secs, 0 Degraded Mins,
    3 Errored Secs, 0 Bursty Err Secs, 3 Severely Err Secs
    0 Unavailable Secs, 0 Path Failures

```

To view the statistics or error count generated on the TDM lines for T3 interfaces, use the **show controller** command is:

```

Router# show controllers t3 0/0/0
T3 0/0/0 is down.
Hardware is ASR900-48T3E3-CE

Applique type is Channelized T3
Receiver has loss of signal.
Framing is Unknown, Line Code is B3ZS, Cablelength Short less than 225ft
Clock Source is internal
Equipment customer loopback
Data in current interval (240 seconds elapsed):
Near End
    0 Line Code Violations, 0 P-bit Coding Violations
    0 C-bit Coding Violations, 0 P-bit Err Secs
    0 P-bit Severely Err Secs, 0 Severely Err Framing Secs
    0 Unavailable Secs, 0 Line Errored Secs
    0 C-bit Errored Secs, 0 C-bit Severely Errored Secs
    0 Severely Errored Line Secs, 0 Path Failures
    0 AIS Defect Secs, 0 LOS Defect Secs
Far End
    0 Errored Secs, 0 Severely Errored Secs
    0 C-bit Unavailable Secs, 0 Path Failures
    0 Code Violations, 0 Service Affecting Secs
Data in Interval 1:
Near End
    0 Line Code Violations, 0 P-bit Coding Violations
    0 C-bit Coding Violations, 0 P-bit Err Secs
    0 P-bit Severely Err Secs, 0 Severely Err Framing Secs
    20 Unavailable Secs, 20 Line Errored Secs
    0 C-bit Errored Secs, 0 C-bit Severely Errored Secs
    20 Severely Errored Line Secs, 1 Path Failures
    0 AIS Defect Secs, 20 LOS Defect Secs
Far End
    0 Errored Secs, 0 Severely Errored Secs
    0 C-bit Unavailable Secs, 0 Path Failures

```

```

    0 Code Violations, 0 Service Affecting Secs
Total Data (last 1 15 minute intervals):
Near End
    0 Line Code Violations, 0 P-bit Coding Violations,
    0 C-bit Coding Violations, 0 P-bit Err Secs,
    0 P-bit Severely Err Secs, 0 Severely Err Framing Secs,
    20 Unavailable Secs, 20 Line Errored Secs,
    0 C-bit Errored Secs, 0 C-bit Severely Errored Secs
    20 Severely Errored Line Secs, 1 path failures
    0 AIS Defect Secs, 20 LOS Defect Secs
Far End
    0 Errored Secs, 0 Severely Errored Secs
    0 C-bit Unavailable Secs, 0 Path Failures
    0 Code Violations, 0 Service Affecting Secs

T1 1 is up
timeslots:
FDL per AT&T 54016 spec.
No alarms detected.
Framing is ESF, Clock Source is Internal
Data in current interval (250 seconds elapsed):
Near End
    0 Line Code Violations, 0 Path Code Violations
    0 Slip Secs, 0 Fr Loss Secs, 0 Line Err Secs, 0 Degraded Mins
    0 Errored Secs, 0 Bursty Err Secs, 0 Severely Err Secs
    0 Unavailable Secs, 0 Stuffed Secs
    0 Path Failures, 0 SEF/AIS Secs
Far End
    0 Line Code Violations, 0 Path Code Violations
    0 Slip Secs, 0 Fr Loss Secs, 0 Line Err Secs, 0 Degraded Mins
    0 Errored Secs, 0 Bursty Err Secs, 0 Severely Err Secs
    0 Unavailable Secs 0 Path Failures
Data in Interval 1:
Near End
    0 Line Code Violations, 0 Path Code Violations
    0 Slip Secs, 2 Fr Loss Secs, 0 Line Err Secs, 0 Degraded Mins
    2 Errored Secs, 0 Bursty Err Secs, 2 Severely Err Secs
    0 Unavailable Secs, 0 Stuffed Secs
    1 Path Failures, 2 SEF/AIS Secs
Far End
    0 Line Code Violations, 0 Path Code Violations
    0 Slip Secs, 2 Fr Loss Secs, 0 Line Err Secs, 0 Degraded Mins
    3 Errored Secs, 0 Bursty Err Secs, 3 Severely Err Secs
    0 Unavailable Secs 0 Path Failures
Total Data (last 1 15 minute intervals):
Near End
    0 Line Code Violations,0 Path Code Violations,
    0 Slip Secs, 2 Fr Loss Secs, 0 Line Err Secs, 0 Degraded Mins,
    2 Errored Secs, 0 Bursty Err Secs, 2 Severely Err Secs
    0 Unavailable Secs, 0 Stuffed Secs
    1 Path Failures, 2 SEF/AIS Secs
Far End
    0 Line Code Violations,0 Path Code Violations
    0 Slip Secs, 2 Fr Loss Secs, 0 Line Err Secs, 0 Degraded Mins,
    3 Errored Secs, 0 Bursty Err Secs, 3 Severely Err Secs
    0 Unavailable Secs, 0 Path Failures

```

The performance monitoring result displays the statistics TDM lines for DS1.

Table 5: Feature History Table

Feature Name	Release Information	Description
GR-820-CORE Performance Monitoring	Cisco IOS XE Bengaluru 17.5.1	The <b>show controller tabular</b> command enables you to view the performance monitoring details in tabular form as per GR-820-Core standards.

To view the performance monitoring details on T3 controller, use the **show controller t3 tabular** command:

```
Router#show controllers t3 0/2/0 tabular
T3 0/2/0 is up.
  Hardware is ASR900-48T3E3-CE

  Applique type is Subrate T3
  No alarms detected.
  MDL transmission is disabled

  FEAC code received: No code is being received
  Framing is C-BIT Parity, Line Code is B3ZS, Cablelength Short less than 225ft
  BER thresholds: SF = 10e-3 SD = 10e-6
  Clock Source is internal
  Equipment customer loopback
  Near End Data
  INTERVAL      CV-L  ES-L  SES-L  LOSS-L  CVP-P  CVCP-P  ESP-P  ESCP-P  SESP-P  SESCP-P  SAS-P
  AISS-P  FC-P  UASP-P  UASCP-P
  19:03-19:11      0    0    0    0    0    0    0    0    0    0    0
    0    0    0    0
  18:48-19:03      0    0    0    0    0    0    0    0    0    0    0
    0    0    0    0
  Total            0    0    0    0    0    0    0    0    0    0    0
    0    0    0    0
  Far End Data
  INTERVAL      CVCP-PFE  ESCP-PFE  SESP-PFE  UASCP-PFE  FCCP-PFE  SASCP-PFE
  19:03-19:11      0    0    0    0    0    0
  18:48-19:03      0    0    0    0    0    0
  Total            0    0    0    0    0    0
```

To view the performance monitoring details on channelised T1-T3 controller, use the **show controller t3 tabular** command:

```
Router#show controllers t3 0/2/4 tabular
T3 0/2/4 is down.
  Hardware is ASR900-48T3E3-CE

  Applique type is Channelized T3/T1
  Receiver has loss of signal.
  MDL transmission is disabled

  FEAC code received: No code is being received
  Framing is C-BIT Parity, Line Code is B3ZS, Cablelength Short less than 225ft
  BER thresholds: SF = 10e-3 SD = 10e-6
  Clock Source is internal
  Equipment customer loopback
  Near End Data
  INTERVAL      CV-L  ES-L  SES-L  LOSS-L  CVP-P  CVCP-P  ESP-P  ESCP-P  SESP-P  SESCP-P  SAS-P
  AISS-P  FC-P  UASP-P  UASCP-P
  19:02-19:09      0  459  459  459    0    0    0    0    0    0    0
    0    1  459  459
  Far End Data
  INTERVAL      CVCP-PFE  ESCP-PFE  SESP-PFE  UASCP-PFE  FCCP-PFE  SASCP-PFE
  19:02-19:09      0    0    0    0    0    0
```

```

T3 0/2/4.1 T1 is down
timeslots:
FDL per AT&T 54016 spec.
Receiver is getting AIS.
Framing is ESF, Clock Source is Internal
Near End Data
INTERVAL      CV-L   ES-L   CV-P   ES-P   SES-P   CSS-P   SAS-P   UAS-P   FC-P
19:02-19:09   0     0     0     0     0     0     0     0     1
Far End Data
INTERVAL      ES-LFE ES-PFE  SES-PFE SEFS-PFE CSS-PFE  UAS-PFE  FC-PFE
19:02-19:09   0     0     0     0     0     0     0     0

```

Starting with Cisco IOS XE 17.11.1, you can view the previous day performance monitoring details using the following **show controller** commands for the T1 or E1, and T3 or E3 controllers.

- `show controllers { t1 | e1 | t3 | e3 }`
- `show controllers { t1 | e1 | t3 | e3 } tabular`
- `show controllers { t1 | e1 | t3 | e3 } remote performance`
- `show controllers { t1 | e1 | t3 | e3 } remote performance tabular`

```

router#show controllers t3 0/9/1
T3 0/9/1 is down.
Hardware is NCS4200-48T3E3-CE
Applique type is Channelized T3/T1
Receiver has loss of signal.
MDL transmission is disabled

FEAC code received: No code is being received
Framing is C-BIT Parity, Line Code is B3ZS, Cablelength Short less than 225ft
BER thresholds: SF = 10e-3 SD = 10e-6
Clock Source is internal
Equipment customer loopback
Data in current interval (220 seconds elapsed):
.....
  0 Code Violations, 0 Service Affecting Secs
Total Data (last 24 hours)
Near End
  0 Line Code Violations, 0 P-bit Coding Violation,
  0 C-bit Coding Violation, 0 P-bit Err Secs,
  0 P-bit Severely Err Secs, 0 Severely Err Framing Secs,
  86423 Unavailable Secs, 86423 Line Errored Secs,
  0 C-bit Errored Secs, 0 C-bit Severely Errored Secs
  86423 Severely Errored Line Secs, 0 path failures
  0 AIS Defect Secs, 86423 LOS Defect Secs
Far End
  0 Errored Secs, 0 Severely Errored Secs
  0 C-bit Unavailable Secs, 0 Path Failures
  0 Code Violations, 0 Service Affecting Secs
Total (Previous Day)
Near End
  0 Line Code Violations, 0 P-bit Coding Violation,
  0 C-bit Coding Violation, 0 P-bit Err Secs,
  0 P-bit Severely Err Secs, 0 Severely Err Framing Secs,
  86440 Unavailable Secs, 86440 Line Errored Secs,
  0 C-bit Errored Secs, 0 C-bit Severely Errored Secs
  86440 Severely Errored Line Secs, 2 path failures
  0 AIS Defect Secs, 86440 LOS Defect Secs
Far End
  0 Errored Secs, 0 Severely Errored Secs
  0 C-bit Unavailable Secs, 0 Path Failures

```



```

    0 Code Violations, 0 Service Affecting Secs

T3 0/9/1.1 T1 is down
timeslots: 1-3
FDL per AT&T 54016 spec.
Receiver is getting AIS.
Framing is ESF, Clock Source is Internal
Data in current interval (220 seconds elapsed):
Near End
  0 Line Code Violations, 0 Path Code Violations
  0 Slip Secs, 0 Fr Loss Secs, 0 Line Err Secs, 0 Degraded Mins
  0 Errored Secs, 0 Bursty Err Secs, 0 Severely Err Secs
  219 Unavail Secs, 0 Stuffed Secs
  0 Path Failures, 0 SEF/AIS Secs
Far End
  0 Line Code Violations, 0 Path Code Violations
.....
  0 Errored Secs, 0 Bursty Err Secs, 0 Severely Err Secs
  0 Unavail Secs 0 Path Failures
Total Data (last 24 hours)
Near End
  0 Line Code Violations,0 Path Code Violations,
  0 Slip Secs, 0 Fr Loss Secs, 0 Line Err Secs, 0 Degraded Mins,
  0 Errored Secs, 0 Bursty Err Secs, 0 Severely Err Secs
  86423 Unavail Secs, 0 Stuffed Secs
  0 Path Failures, 0 SEF/AIS Secs
Far End
  0 Line Code Violations,0 Path Code Violations
  0 Slip Secs, 0 Fr Loss Secs, 0 Line Err Secs, 0 Degraded Mins,
  0 Errored Secs, 0 Bursty Err Secs, 0 Severely Err Secs
  0 Unavailable Secs, 0 Path Failures
Total (Previous Day)
Near End
  0 Line Code Violations,0 Path Code Violations,
  0 Slip Secs, 0 Fr Loss Secs, 0 Line Err Secs, 0 Degraded Mins,
  0 Errored Secs, 0 Bursty Err Secs, 0 Severely Err Secs
  86415 Unavail Secs, 0 Stuffed Secs
  0 Path Failures, 0 SEF/AIS Secs
Far End
  0 Line Code Violations,0 Path Code Violations
  0 Slip Secs, 0 Fr Loss Secs, 0 Line Err Secs, 0 Degraded Mins,
  0 Errored Secs, 0 Bursty Err Secs, 0 Severely Err Secs
  0 Unavailable Secs, 0 Path Failures

router#show controllers t3 0/9/1 tabular
T3 0/9/1 is down.
Hardware is NCS4200-48T3E3-CE
Applique type is Channelized T3/T1
Receiver has loss of signal.
MDL transmission is disabled

FEAC code received: No code is being received
Framing is C-BIT Parity, Line Code is B3ZS, Cablelength Short less than 225ft
BER thresholds: SF = 10e-3 SD = 10e-6
Clock Source is internal
Equipment customer loopback
Near End Data
INTERVAL      CV-L  ES-L  SES-L  LOSS-L  CVP-P  CVCP-P  ESP-P  ESCP-P  SESP-P  SESP-P  SAS-P
AISS-P  FC-P  UASP-P  UASCP-P
06:11-06:15    0   249   249   249     0     0     0     0     0     0     0
              0    0   249   249
05:56-06:11    0   900   900   900     0     0     0     0     0     0     0
              0    0   900   900
05:41-05:56    0   900   900   900     0     0     0     0     0     0     0

```

```

      0      0      900      900
.....
06:26-06:41      0      900      900      900      900      0      0      0      0      0      0      0
      0      0      900      900
06:11-06:26      0      901      901      901      0      0      0      0      0      0      0
      0      0      901      901
Total              0 86423 86423 86423      0      0      0      0      0      0      0
      0      0 86423 86423
Total (Previous Day)
05:26-05:26      0 86440 86440 86440      0      0      0      0      0      0      0
      0      2 86440 86440

Far End Data
INTERVAL      CVCP-PFE  ESCP-PFE  SESCP-PFE  UASCP-PFE  FCCP-PFE  SASCP-PFE
06:11-06:15      0          0          0          0          0          0
05:56-06:11      0          0          0          0          0          0
.....
06:11-06:26      0          0          0          0          0          0
Total              0          0          0          0          0          0
Total (Previous Day)
05:26-05:26      0          0          0          0          0          0

T3 0/9/1.1 T1 is down
timeslots: 1-3
FDL per AT&T 54016 spec.
Receiver is getting AIS.
Framing is ESF, Clock Source is Internal
Near End Data
INTERVAL      CV-L      ES-L      CV-P      ES-P      SES-P      CSS-P      SAS-P      UAS-P      FC-P
06:11-06:15      0          0          0          0          0          0          0      249      0
05:56-06:11      0          0          0          0          0          0          0      900      0
05:41-05:56      0          0          0          0          0          0          0      900      0
.....
06:26-06:41      0          0          0          0          0          0          0      900      0
06:11-06:26      0          0          0          0          0          0          0      901      0
Total              0          0          0          0          0          0          0 86423      0
Total (Previous Day)
05:26-05:26      0          0          0          0          0          0          0 86415      0

Far End Data
INTERVAL      ES-LFE  ES-PFE  SES-PFE  SEFS-PFE  CSS-PFE  UAS-PFE  FC-PFE
06:11-06:15      0          0          0          0          0          0          0
.....
06:56-07:11      0          0          0          0          0          0          0
06:41-06:56      0          0          0          0          0          0          0
06:26-06:41      0          0          0          0          0          0          0
06:11-06:26      0          0          0          0          0          0          0
Total              0          0          0          0          0          0          0
Total (Previous Day)
05:26-05:26      0          0          0          0          0          0          0

T3 0/9/1.2 T1 is down
timeslots:
FDL per AT&T 54016 spec.
Receiver is getting AIS.
Framing is ESF, Clock Source is Internal
Near End Data
INTERVAL      CV-L      ES-L      CV-P      ES-P      SES-P      CSS-P      SAS-P      UAS-P      FC-P
06:11-06:15      0          0          0          0          0          0          0      249      0
05:56-06:11      0          0          0          0          0          0          0      900      0

router#show controllers t3 0/9/1 remote performance

T3 0/9/1 is down.
Hardware is NCS4200-48T3E3-CE

```

```

Applique type is Channelized T3/T1
Receiver has loss of signal.
MDL transmission is disabled

FEAC code received: No code is being received
Framing is C-BIT Parity, Line Code is B3ZS, Cablelength Short less than 225ft
BER thresholds: SF = 10e-3 SD = 10e-6
Clock Source is internal
Equipment customer loopback
Data in current interval (250 seconds elapsed):
Near End
  0 Line Code Violations, 0 P-bit Coding Violation
  0 C-bit Coding Violation, 0 P-bit Err Secs
.....
  901 Severely Errored Line Secs, 0 Path Failures
  0 AIS Defect Secs, 901 LOS Defect Secs
Far End
  0 Errored Secs, 0 Severely Errored Secs
  0 C-bit Unavailable Secs, 0 Path Failures
  0 Code Violations, 0 Service Affecting Secs
Total Data (last 24 hours)
Near End
  0 Line Code Violations, 0 P-bit Coding Violation,
  0 C-bit Coding Violation, 0 P-bit Err Secs,
  0 P-bit Severely Err Secs, 0 Severely Err Framing Secs,
  86423 Unavailable Secs, 86423 Line Errored Secs,
  0 C-bit Errored Secs, 0 C-bit Severely Errored Secs
  86423 Severely Errored Line Secs, 0 path failures
  0 AIS Defect Secs, 86423 LOS Defect Secs
Far End
  0 Errored Secs, 0 Severely Errored Secs
  0 C-bit Unavailable Secs, 0 Path Failures
  0 Code Violations, 0 Service Affecting Secs
Total (Previous Day)
Near End
  0 Line Code Violations, 0 P-bit Coding Violation,
  0 C-bit Coding Violation, 0 P-bit Err Secs,
  0 P-bit Severely Err Secs, 0 Severely Err Framing Secs,
  86440 Unavailable Secs, 86440 Line Errored Secs,
  0 C-bit Errored Secs, 0 C-bit Severely Errored Secs
  86440 Severely Errored Line Secs, 2 path failures
  0 AIS Defect Secs, 86440 LOS Defect Secs
Far End
  0 Errored Secs, 0 Severely Errored Secs
  0 C-bit Unavailable Secs, 0 Path Failures
  0 Code Violations, 0 Service Affecting Secs

T1 1 - Remote Performance Data
Data in current interval (260 seconds elapsed):
  0 Line Code Violations, 0 Path Code Violations
  0 Slip Secs, 0 Fr Loss Secs, 0 Line Err Secs, 0 Degraded Mins
  0 Errored Secs, 0 Bursty Err Secs, 0 Severely Err Secs
  0 Unavail Secs
Data in Interval 1:
  0 Line Code Violations, 0 Path Code Violations
  0 Slip Secs, 0 Fr Loss Secs, 0 Line Err Secs, 0 Degraded Mins
  0 Errored Secs, 0 Bursty Err Secs, 0 Severely Err Secs
  0 Unavail Secs
Data in Interval 2:
  0 Line Code Violations, 0 Path Code Violations
.....
Data in Interval 96:
  0 Line Code Violations, 0 Path Code Violations
  0 Slip Secs, 0 Fr Loss Secs, 0 Line Err Secs, 0 Degraded Mins

```

```

    0 Errored Secs, 0 Bursty Err Secs, 0 Severely Err Secs
    0 Unavail Secs
Total Data (last 24 hours)
    0 Path Code Violations
    0 Slip Secs, 0 Fr Loss Secs, 0 Line Err Secs, 0 Degraded Mins,
    0 Errored Secs, 0 Bursty Err Secs, 0 Severely Err Secs
    0 Unavail Secs
Total (Previous Day)
    0 Path Code Violations
    0 Slip Secs, 0 Fr Loss Secs, 0 Line Err Secs, 0 Degraded Mins,
    0 Errored Secs, 0 Bursty Err Secs, 0 Severely Err Secs
    0 Unavail Secs

```

```

T1 2 - Remote Performance Data
Data in current interval (260 seconds elapsed):
    0 Line Code Violations, 0 Path Code Violations

```

```
router#show controllers t3 0/9/1 remote performance tabular
```

```
T3 0/9/1 is down.
```

```
Hardware is NCS4200-48T3E3-CE
```

```

Applique type is Channelized T3/T1
Receiver has loss of signal.
MDL transmission is disabled

```

```

FEAC code received: No code is being received
Framing is C-BIT Parity, Line Code is B3ZS, Cablelength Short less than 225ft
BER thresholds: SF = 10e-3 SD = 10e-6
Clock Source is internal
Equipment customer loopback

```

```
Near End Data
```

INTERVAL	CV-L	ES-L	SES-L	LOSS-L	CVP-P	CVCP-P	ESP-P	ESCP-P	SESP-P	SESCP-P	SAS-P
AISS-P	FC-P	UASP-P	UASCP-P								
06:11-06:16	0	279	279	279	0	0	0	0	0	0	0
	0	279	279								
05:56-06:11	0	900	900	900	0	0	0	0	0	0	0
	0	900	900								
05:41-05:56	0	900	900	900	0	0	0	0	0	0	0
	0	900	900								
.....											
06:11-06:26	0	901	901	901	0	0	0	0	0	0	0
	0	901	901								
Total	0	86423	86423	86423	0	0	0	0	0	0	0
	0	86423	86423								
Total (Previous Day)											
05:26-05:26	0	86440	86440	86440	0	0	0	0	0	0	0
	0	2 86440	86440								

```
Far End Data
```

INTERVAL	CVCP-PFE	ESCP-PFE	SESCP-PFE	UASCP-PFE	FCCP-PFE	SASCP-PFE
06:11-06:16	0	0	0	0	0	0
05:56-06:11	0	0	0	0	0	0
05:41-05:56	0	0	0	0	0	0
.....						
06:11-06:26	0	0	0	0	0	0
Total	0	0	0	0	0	0
Total (Previous Day)						
05:26-05:26	0	0	0	0	0	0

```
T1 1 - Remote Performance Data
```

INTERVAL	LCV	PCV	CSS	SELS	LES	DM	ES	BES	SES	UAS
06:11-06:16	0	0	0	0	0	0	0	0	0	0
05:56-06:11	0	0	0	0	0	0	0	0	0	0
05:41-05:56	0	0	0	0	0	0	0	0	0	0

```

.....
06:56-07:11      0      0      0      0      0      0      0      0      0      0
06:41-06:56      0      0      0      0      0      0      0      0      0      0
06:26-06:41      0      0      0      0      0      0      0      0      0      0
06:11-06:26      0      0      0      0      0      0      0      0      0      0
Total            0      0      0      0      0      0      0      0      0      0
Total (Previous Day)
05:26-05:26      0      0      0      0      0      0      0      0      0      0

Tl 2 - Remote Performance Data
INTERVAL      LCV   PCV   CSS  SELS   LES   DM   ES   BES   SES   UAS
06:11-06:16      0     0     0    0     0     0   0   0     0     0
05:56-06:11      0     0     0    0     0     0   0   0     0     0
05:41-05:56      0     0     0    0     0     0   0   0     0     0

```





## CHAPTER 6

# Troubleshooting the T3 or E3 Interface Module

To troubleshoot T3 or E3, you must configure the following:

- Bit Error Rate Testing (BERT)
- Loopback
- [Overview of BERT, on page 73](#)
- [Loopback on T3 or E3 Interfaces, on page 80](#)

## Overview of BERT

Bit Error Rate Testing (BERT) is used to test the integrity of the physical line.

The interface contains on board BERT circuitry. With this circuitry, the interface software can send and detect a programmable pattern that is compliant with CCITT/ITU O.151, O.152, O.153 pseudo-random, and repetitive test patterns. BERTs allow you to test cables and signal problems in the field.

The bit error rate (BER) is determined by comparing the erroneous bits received with the total number of bits received. You can display and analyze the total number of error bits transmitted and the total number of bits received on the link. You can retrieve error statistics anytime during the BERT.

Both the total number of bits and the error bits received are available for analysis. You can select the testing period from 1 minute to 24 hours and you can also retrieve the error statistics anytime during the BERT test.

### Running a BERT Test

When running a BERT test, the system expects to receive the same pattern that it transmits. To help ensure this, two common options are available:

- Use a loopback somewhere in the link or network
- Configure remote testing equipment to transmit the same BERT test pattern at the same time.

The BERT runtime engine can be kept running until the interval completes or can be stopped by unconfiguring it anytime.

### Types of BERT

BERT is supported in two directions:

- Line - supports BERT in TDM direction

- System - supports BERT in PSN direction

BERT engines uses different BERT patterns for transmission for each mode. The supported BERT patterns on each card is described.

## BERT Restrictions

- BERT is not supported on the following modes:
  - T3—Framing M-13, non-channelized
  - E3—Framing G832, channelized
- When the BERT is initiated with pattern 0s and 1s from the local end and the loopback local is applied from the far end, then the BERT syncing does not happen. Since the BERT process is asserted as LOS alarms for all 0s and AIS alarms for all 1s BERT patterns. Whereas the BERT syncing behaves properly when the BERT is initiated from both the local and the far end.

For all 1s on T3 or E3, the BERT behaviour is not asserted as AIS and the BERT syncing happens as usual.

- In the unframed mode, BERT sync is not stable and may generate alarms until Cisco IOS XE Fuji 16.9.4.



---

**Note** Framing type should be similar in all routers end to end.

---

- System BERT is not supported for any pattern in framed SATOP.
- System BERT is not configurable, without cem-group configuration.
- Path modes, unframed modes, and concatenation modes are not supported.

### BERT Restrictions for Cisco IOS XE Bengaluru 17.4.1 release

- When the BERT is initiated from the local end and the loopback local is applied from the far end, then BERT syncing does not happen. Since the BERT process is asserted as LOS alarms for all 0s and AIS alarms for all 1s BERT patterns. Whereas the BERT syncing behaves properly when the BERT is initiated from both the local and the far end.

## BERT Patterns on T3/E3 Interface Module

Bit error rate testing (BERT) is supported on T3/E3 interfaces.

- You can run 16 BERTs at a time.
- The test can be either of the T1/E1 or the T3/E3 interface.



**Table 6: Feature History**

Feature Name	Release Information	Description
Support for all 0s and 1s BERT Patterns	Cisco IOS XE Bengaluru 17.4.1	Support for all 0s and 1s BERT patterns on T3 or E3 interfaces.
Support for 3-in-24 BERT Patterns	Cisco IOS XE Dublin 17.11.1	Support for 3-in-24 BERT patterns on T3 or E3 interfaces.

The BERT patterns on the 48-port T3/E3 interface module are:

**Table 7: BERT Pattern Descriptions**

Keyword	Description
<b>All 1s</b> <a href="#">1</a>	Pseudo-random binary test pattern consisting of all 1's that is used to test alternating line volt and repeaters.
<b>All 0s</b>	Pseudo-random binary test pattern consisting of all 0's that is used for test line coding.
<b>2^15-1 O.151</b>	Pseudo-random O.151 test pattern consisting of a maximum of 14 consecutive zeros and 15 consecutive ones. The length of this pattern is 32,768 bits.
<b>2^20-O.151</b>	Pseudo-random O.151 test pattern consisting of a maximum of 19 consecutive zeros and 20 consecutive ones. The length of this pattern is 1,048,575 bits.
<b>2^20-O.153</b>	Pseudo-random O.153 test pattern consisting of a maximum of 19 consecutive zeros and 20 consecutive ones. The length of this pattern is 1,048,575 bits.
<b>2^23-1 O.151</b>	Pseudo-random O.151 test pattern consisting of a maximum of 22 consecutive zeros and 23 consecutive ones. The length of this pattern is 8,388,607 bits.
<b>2^9</b> <a href="#">2</a>	Pseudo-random binary test pattern consisting of a maximum of eight consecutive zeros and nine consecutive ones. The length of this pattern is 511 bits.
<b>2^11</b> <a href="#">3</a>	Pseudo-random binary test pattern consisting of a maximum of ten consecutive zeros and eleven consecutive ones. The length of this pattern is 2048 bits.
<b>3-in-24</b> <a href="#">4</a>	Pseudo-random binary test pattern consisting of repeating 24-bit sequence that contains three ones, fifteen consecutive zeros, and 12.5 percent average one's density.

- <sup>1</sup> Starting with Cisco IOS XE Bengaluru 17.4.1, All Is are supported on all modes.
- <sup>2</sup> Starting with Cisco IOS XE Gibraltar 16.12.1, 2^9 is supported on both T3 and T1 modes.
- <sup>3</sup> Starting with Cisco IOS XE Fuji 16.9.5, 2^11 is supported on both T3 and T1 modes.
- <sup>4</sup> Starting with Cisco IOS XE Dublin 17.11.1, 3-in-24 pattern is supported on the T1, T3, E1, and E3 modes.



**Note** If All 1's BERT pattern is tested on the system side, then ensure that you need to start all 1's pattern from both sides of the end points.

Configuring BERT on one side and loopback on other side of the end points is not supported. The router treats all 1's pattern as AIS alarm and BERT will not come in sync with the other side configuration of the end point.

## BERT for CESoPSN

BERT is supported at the TDM side and pseudowire side. BERT can be used either at NxDS0 or DS1 but not together.

BERT is supported on following controllers:

- T1—NxDS0, DS1
- T3—NxDS0, DS1 (channelised), clear channel DS3.
- OCX—NxDS0, DS1 (channelised), DS3(channelised), clear channel DS3, STS1, STS-nc, VT-1.5, VT1.5 T1

## Configuring BERT - T3 or E3 Interfaces for SAToP

### Before You Begin

Before you configure BERT for clear channel T3 or E3 interfaces, ensure that controller and CEM are configured.

To run a BERT on clear channel T3 or E3 interface, perform the following tasks in global configuration mode.

```
enable
configure terminal
controller t3 0/0/1
no channelized
bert pattern 0s interval 30 direction line
exit
```

To run a BERT on channelized T3 interface or channelized E3 interface, perform the following tasks in global configuration mode.

```
enable
configure terminal
controller t3 0/0/1
channelized
t1 1 bert pattern 0s interval 30 direction line
exit
```



**Note** To terminate a BERT test during the specified test period, use the **no bert** command.

You can view the results of a BERT test at the following points of time:

- After you terminate the test using the **no bert** command
- After the test runs completely
- Anytime during the test (in real time)

## Verifying the BERT for T3/E3 Interfaces

Use the **show controller** command to verify the BERT configuration for clear channel T3/E3 interfaces:

```
Router# show controllers t3 0/4/40 | sec BERT
BERT test result (running)
  Test Pattern : 2^15, Status : Not Sync, Sync Detected : 0
  DSX3 BERT direction : Line
  Interval : 5 minute(s), Time Remain : 3 minute(s)
  Bit Errors (since BERT started): 0 bits,
  Bits Received (since BERT started): 0 Kbits
  Bit Errors (since last sync): 0 bits
  Bits Received (since last sync): 0 Kbits
```

Use the **show controller** command to verify the BERT configuration of channelized T3/T1 interfaces or channelized E3/E1 interfaces:

```
Router# sh controller t3 0/3/0 | be T1 1
T1 1 is up
  timeslots:
  FDL per AT&T 54016 spec.
  Receiver is getting AIS.
  Framing is ESF, Clock Source is Internal
  BERT test result (running)
    Test Pattern : 2^23, Status : Not Sync, Sync Detected : 0
    Interval : 5 minute(s), Time Remain : 00:01:44
    Bit Errors (since BERT started): 299 Mbits,
    Bits Received (since BERT started): 299 Mbits
    Bit Errors (since last sync): 0 bits
    Bits Received (since last sync): 0 Kbits
    Direction : Line
  Data in current interval (250 seconds elapsed):
    Near End
      0 Line Code Violations, 0 Path Code Violations
      0 Slip Secs, 0 Fr Loss Secs, 0 Line Err Secs, 0 Degraded Mins
      0 Errored Secs, 0 Bursty Err Secs, 0 Severely Err Secs
      0 Unavailable Secs, 0 Stuffed Secs
      0 Path Failures, 0 SEF/AIS Secs
    Far End
      0 Line Code Violations, 0 Path Code Violations
      0 Slip Secs, 0 Fr Loss Secs, 0 Line Err Secs, 0 Degraded Mins
      0 Errored Secs, 0 Bursty Err Secs, 0 Severely Err Secs
      0 Unavailable Secs 0 Path Failures
  Data in Interval 1:
    Near End
      0 Line Code Violations, 0 Path Code Violations
      0 Slip Secs, 2 Fr Loss Secs, 0 Line Err Secs, 0 Degraded Mins
```

```

2 Errored Secs, 0 Bursty Err Secs, 2 Severely Err Secs
0 Unavailable Secs, 0 Stuffed Secs
1 Path Failures, 2 SEF/AIS Secs
Far End
0 Line Code Violations, 0 Path Code Violations
0 Slip Secs, 2 Fr Loss Secs, 0 Line Err Secs, 0 Degraded Mins
3 Errored Secs, 0 Bursty Err Secs, 3 Severely Err Secs
0 Unavailable Secs 0 Path Failures
Total Data (last 1 15 minute intervals):
Near End
0 Line Code Violations,0 Path Code Violations,
0 Slip Secs, 2 Fr Loss Secs, 0 Line Err Secs, 0 Degraded Mins,
2 Errored Secs, 0 Bursty Err Secs, 2 Severely Err Secs
0 Unavailable Secs, 0 Stuffed Secs
1 Path Failures, 2 SEF/AIS Secs
Far End
0 Line Code Violations,0 Path Code Violations
0 Slip Secs, 2 Fr Loss Secs, 0 Line Err Secs, 0 Degraded Mins,
3 Errored Secs, 0 Bursty Err Secs, 3 Severely Err Secs
0 Unavailable Secs, 0 Path Failures

```

## Configuring BERT - T3 or E3 Interfaces for CESoPSN

### Before You Begin

Before you configure BERT for clear channel T3 or E3 interfaces, ensure that the controller and CEM are configured.

To run a BERT on the T3 interface, use the following commands:

```

configure terminal
controller t3 0/5/0
t1 1 bert timeslots 1 pattern 2^15 interval 1

```

To run a BERT on the E3 interface, use the following commands:

```

config terminal
controller e3 0/5/0
e1 1 bert timeslots 1 pattern 2^15 interval 1

```



---

**Note** To terminate a BERT test during the specified test period, use the **no bert** command.

---

You can view the results of a BERT test at the following points of time:

- After you terminate the test using the **no bert** command
- After the test runs completely
- Anytime during the test (in real time)

## Verifying BERT for CESoPSN on T3 or E3 Interface

Use the following command to verify the BERT configuration for CESoPSN on T3 interfaces:

```

Router# show controllers t3 0/5/0
T3 0/5/0 is up.
  Hardware is ASR903-48T3E3-CE

  Applique type is Channelized T3
  No alarms detected.
  MDL transmission is disabled

  FEAC code received: No code is being received
  Framing is C-BIT Parity, Line Code is B3ZS, Cablelength Short less than 225ft
  BER thresholds: SF = 10e-3 SD = 10e-6
  Clock Source is internal
  Equipment customer loopback
  Data in current interval (240 seconds elapsed):
    Near End
      0 Line Code Violations, 0 P-bit Coding Violations
      0 C-bit Coding Violations, 0 P-bit Err Secs
      0 P-bit Severely Err Secs, 0 Severely Err Framing Secs
      0 Unavailable Secs, 0 Line Errored Secs
      0 C-bit Errored Secs, 0 C-bit Severely Errored Secs
      0 Severely Errored Line Secs, 0 Path Failures
      0 AIS Defect Secs, 0 LOS Defect Secs
    Far End
      0 Errored Secs, 0 Severely Errored Secs
      0 C-bit Unavailable Secs, 0 Path Failures
      0 Code Violations, 0 Service Affecting Secs
  Data in Interval 1:
    Near End
      0 Line Code Violations, 0 P-bit Coding Violations
      0 C-bit Coding Violations, 0 P-bit Err Secs
      0 P-bit Severely Err Secs, 0 Severely Err Framing Secs
      20 Unavailable Secs, 20 Line Errored Secs
      0 C-bit Errored Secs, 0 C-bit Severely Errored Secs
      20 Severely Errored Line Secs, 1 Path Failures
      0 AIS Defect Secs, 20 LOS Defect Secs
    Far End
      0 Errored Secs, 0 Severely Errored Secs
      0 C-bit Unavailable Secs, 0 Path Failures
      0 Code Violations, 0 Service Affecting Secs
  Total Data (last 1 15 minute intervals):
    Near End
      0 Line Code Violations, 0 P-bit Coding Violations,
      0 C-bit Coding Violations, 0 P-bit Err Secs,
      0 P-bit Severely Err Secs, 0 Severely Err Framing Secs,
      20 Unavailable Secs, 20 Line Errored Secs,
      0 C-bit Errored Secs, 0 C-bit Severely Errored Secs
      20 Severely Errored Line Secs, 1 path failures
      0 AIS Defect Secs, 20 LOS Defect Secs
    Far End
      0 Errored Secs, 0 Severely Errored Secs
      0 C-bit Unavailable Secs, 0 Path Failures
      0 Code Violations, 0 Service Affecting Secs

T1 1 is down
timeslots: 1-24
FDL per AT&T 54016 spec.
Receiver has remote alarm.
Framing is ESF, Clock Source is Recovered 1
BERT running on timeslots 1,
BERT test result (running)
  Test Pattern : 2^15, Status : Sync, Sync Detected : 0
  Interval : 0 minute(s), Time Remain : 00:00:37
  Bit Errors (since BERT started): 0 bits,
    
```

```

Bits Received (since BERT started): 137 Kbits
Bit Errors (since last sync): 0 bits
Bits Received (since last sync): 137 Kbits
Direction   : Line
Near End
  0 Line Code Violations, 0 Path Code Violations
  0 Slip Secs, 0 Fr Loss Secs, 0 Line Err Secs, 0 Degraded Mins
  0 Errored Secs, 0 Bursty Err Secs, 0 Severely Err Secs
  0 Unavailable Secs, 0 Stuffed Secs
  0 Path Failures, 0 SEF/AIS Secs
Far End
  0 Line Code Violations, 0 Path Code Violations
  0 Slip Secs, 0 Fr Loss Secs, 0 Line Err Secs, 0 Degraded Mins
  0 Errored Secs, 0 Bursty Err Secs, 0 Severely Err Secs
  0 Unavailable Secs 0 Path Failures
Data in Interval 1:
Near End
  0 Line Code Violations, 0 Path Code Violations
  0 Slip Secs, 2 Fr Loss Secs, 0 Line Err Secs, 0 Degraded Mins
  2 Errored Secs, 0 Bursty Err Secs, 2 Severely Err Secs
  0 Unavailable Secs, 0 Stuffed Secs
  1 Path Failures, 2 SEF/AIS Secs
Far End
  0 Line Code Violations, 0 Path Code Violations
  0 Slip Secs, 2 Fr Loss Secs, 0 Line Err Secs, 0 Degraded Mins
  3 Errored Secs, 0 Bursty Err Secs, 3 Severely Err Secs
  0 Unavailable Secs 0 Path Failures
Total Data (last 1 15 minute intervals):
Near End
  0 Line Code Violations,0 Path Code Violations,
  0 Slip Secs, 2 Fr Loss Secs, 0 Line Err Secs, 0 Degraded Mins,
  2 Errored Secs, 0 Bursty Err Secs, 2 Severely Err Secs
  0 Unavailable Secs, 0 Stuffed Secs
  1 Path Failures, 2 SEF/AIS Secs
Far End
  0 Line Code Violations,0 Path Code Violations
  0 Slip Secs, 2 Fr Loss Secs, 0 Line Err Secs, 0 Degraded Mins,
  3 Errored Secs, 0 Bursty Err Secs, 3 Severely Err Secs
  0 Unavailable Secs, 0 Path Failures
    
```

You can view the results of a BERT test at the following times:

- After you terminate the test using the **no bert** command
- After the test runs completely
- Anytime during the test (in real time)

## Loopback on T3 or E3 Interfaces

### Loopback Description

You can use the following loopback on the clear and channelized T3 or E3 interfaces.

Loopback	Description
loopback local	Loops the transmitting signal back to the receiver.

Loopback	Description
loopback network line	Loops the incoming signal back to the interface using the line loopback mode of the framer. The framer does not reclock or reframe the incoming data. All incoming data is received by the interface driver.

## Restrictions for Loopback Remote

- E1 and E3 loopback remote are not supported until Cisco IOS XE Fuji 16.9.4 release. Starting from Cisco IOS XE Fuji 16.9.5 release, E1 and E3 loopback remote are supported.
- IBOC loopcode configuration is not supported when CESoP or SATOP (framed or unframed) is configured.
- ESF loopcode configuration is not supported when SAToP is configured.

## Loopback Remote on T1 and T3 Interfaces

The remote loopback configuration attempts to put the far-end T1 or T3 into a loopback.

The remote loopback setting loops back the far-end at line or payload, using IBOC (inband bit-orientated CDE) or the ESF loopback codes to communicate the request to the far-end.

## Configuring Loopback for T3 or E3 Interfaces

To set a loopback local on the clear channel T3 or E3 interface, perform the following tasks in global configuration mode:

```
enable
configure terminal
controller t3 0/0/1
loopback local
exit
```

To set a loopback network on the clear channel T3 or E3 interface, perform the following tasks in global configuration mode:

```
enable
configure terminal
controller t3 0/0/1
loopback network line
exit
```

To set a loopback local on the channelized channel T3 or E3 interface, perform the following tasks in global configuration mode:

```
enable
configure terminal
controller t3 0/0/1
channelized
t1 1 loopback local
exit
```

To set a loopback network on the channelized channel T3 or E3 interface, perform the following tasks in global configuration mode:

```
enable
configure terminal
controller t3 0/0/1
channelized
t1 1 loopback network line
exit
```



---

**Note** To remove a loopback, use the **no loopback** command.

---



---

**Note** Network payload configuration is not supported on the port configured with SAToP. To configure loopback network payload when SAToP is configured, you need to remove the CEM configuration and then configure the loopback.

---

## Configuring Loopback Remote on T1 and T3 Interface

To set T3 loopback remote line or payload for T3 or E3 interface, perform the following tasks in global configuration mode:

```
enable
configure terminal
controller t3 0/0/1
loopback remote {line | payload}
exit
```

To set T1 loopback remote iboc fac1/fac2/csu for T3 or E3 interface, perform the following tasks in global configuration mode:

```
enable
configure terminal
controller t3 0/0/1
t1 1 loopback remote iboc {fac1 | fac2 | csu}
exit
```

To set T1 loopback remote iboc esf line csu/esf payload for T3 or E3 interface, perform the following tasks in global configuration mode:

```
enable
configure terminal
controller t3 0/0/1
t1 1 loopback remote iboc esf {line csu | payload}
```

## Verifying the Loopback Remote Configuration on T1 or T3 Interfaces

Use the following command to check the loopback remote configuration on a T3 interface module:

```
router# show running-config | sec 0/0/1
controller MediaType 0/0/1
mode t3
controller T3 0/0/1
```



```

threshold sd-ber 6
threshold sf-ber 3
no channelized
framing c-bit
cablelength short
loopback remote line

```

Use the following command to verify the loopback remote configuration on a T3 interface module:

```

router(config-controller)# do show controller t3 0/0/1
T3 0/0/1 is up. (Configured for Remotely Looped)
  Currently in Remotely Line Looped
  Hardware is A900-48T3E3-CE
  Applique type is Subrate T3
  Receiver has no alarms.
  MDL transmission is disabled
  FEAC code received: No code is being received
  Framing is C-BIT Parity, Line Code is B3ZS, Cablelength Short less than 225ft
  BER thresholds: SF = 10e-10 SD = 10e-10
  Clock Source is internal
  Equipment customer loopback
  Data in current interval (240 seconds elapsed):
    Near End
      0 Line Code Violations, 0 P-bit Coding Violations
      0 C-bit Coding Violations, 0 P-bit Err Secs
      0 P-bit Severely Err Secs, 0 Severely Err Framing Secs
      0 Unavailable Secs, 0 Line Errored Secs
      0 C-bit Errored Secs, 0 C-bit Severely Errored Secs
      0 Severely Errored Line Secs, 0 Path Failures
      0 AIS Defect Secs, 0 LOS Defect Secs
    Far End
      0 Errored Secs, 0 Severely Errored Secs
      0 C-bit Unavailable Secs, 0 Path Failures
      0 Code Violations, 0 Service Affecting Secs
  Data in Interval 1:
    Near End
      0 Line Code Violations, 0 P-bit Coding Violations
      0 C-bit Coding Violations, 0 P-bit Err Secs
      0 P-bit Severely Err Secs, 0 Severely Err Framing Secs
      20 Unavailable Secs, 20 Line Errored Secs
      0 C-bit Errored Secs, 0 C-bit Severely Errored Secs
      20 Severely Errored Line Secs, 1 Path Failures
      0 AIS Defect Secs, 20 LOS Defect Secs
    Far End
      0 Errored Secs, 0 Severely Errored Secs
      0 C-bit Unavailable Secs, 0 Path Failures
      0 Code Violations, 0 Service Affecting Secs
  Total Data (last 1 15 minute intervals):
    Near End
      0 Line Code Violations, 0 P-bit Coding Violations,
      0 C-bit Coding Violations, 0 P-bit Err Secs,
      0 P-bit Severely Err Secs, 0 Severely Err Framing Secs,
      20 Unavailable Secs, 20 Line Errored Secs,
      0 C-bit Errored Secs, 0 C-bit Severely Errored Secs
      20 Severely Errored Line Secs, 1 path failures
      0 AIS Defect Secs, 20 LOS Defect Secs
    Far End
      0 Errored Secs, 0 Severely Errored Secs
      0 C-bit Unavailable Secs, 0 Path Failures
      0 Code Violations, 0 Service Affecting Secs

T1 1 is up
timeslots:
FDL per AT&T 54016 spec.

```

```

No alarms detected.
Framing is ESF, Clock Source is Internal
Data in current interval (250 seconds elapsed):
  Near End
    0 Line Code Violations, 0 Path Code Violations
    0 Slip Secs, 0 Fr Loss Secs, 0 Line Err Secs, 0 Degraded Mins
    0 Errored Secs, 0 Bursty Err Secs, 0 Severely Err Secs
    0 Unavailable Secs, 0 Stuffed Secs
    0 Path Failures, 0 SEF/AIS Secs
  Far End
    0 Line Code Violations, 0 Path Code Violations
    0 Slip Secs, 0 Fr Loss Secs, 0 Line Err Secs, 0 Degraded Mins
    0 Errored Secs, 0 Bursty Err Secs, 0 Severely Err Secs
    0 Unavailable Secs 0 Path Failures
Data in Interval 1:
  Near End
    0 Line Code Violations, 0 Path Code Violations
    0 Slip Secs, 2 Fr Loss Secs, 0 Line Err Secs, 0 Degraded Mins
    2 Errored Secs, 0 Bursty Err Secs, 2 Severely Err Secs
    0 Unavailable Secs, 0 Stuffed Secs
    1 Path Failures, 2 SEF/AIS Secs
  Far End
    0 Line Code Violations, 0 Path Code Violations
    0 Slip Secs, 2 Fr Loss Secs, 0 Line Err Secs, 0 Degraded Mins
    3 Errored Secs, 0 Bursty Err Secs, 3 Severely Err Secs
    0 Unavailable Secs 0 Path Failures
Total Data (last 1 15 minute intervals):
  Near End
    0 Line Code Violations,0 Path Code Violations,
    0 Slip Secs, 2 Fr Loss Secs, 0 Line Err Secs, 0 Degraded Mins,
    2 Errored Secs, 0 Bursty Err Secs, 2 Severely Err Secs
    0 Unavailable Secs, 0 Stuffed Secs
    1 Path Failures, 2 SEF/AIS Secs
  Far End
    0 Line Code Violations,0 Path Code Violations
    0 Slip Secs, 2 Fr Loss Secs, 0 Line Err Secs, 0 Degraded Mins,
    3 Errored Secs, 0 Bursty Err Secs, 3 Severely Err Secs
    0 Unavailable Secs, 0 Path Failures

```

Use the following command to check the loopback remote configuration on a T1 interface module:

```

Router#show run | sec 0/4/15
controller MediaType 0/4/15
mode t3
controller T3 0/4/15
threshold sd-ber 6
threshold sf-ber 3
framing c-bit
cablelength short
t1 1 Loopback remote iboc fac1

```

Use the following command to verify the loopback remote configuration on a T1 interface module:

```

Router#show controller t3 0/4/15 | be T1 1
T1 1 is up
timeslots:
FDL per AT&T 54016 spec.
Configured for NIU FAC1 Line Loopback with IBOC
Currently in Inband Remotely Line Looped
Receiver has no alarms.
Framing is ESF, Clock Source is Internal
Data in current interval (250 seconds elapsed):
  Near End

```

```

0 Line Code Violations, 0 Path Code Violations
0 Slip Secs, 0 Fr Loss Secs, 0 Line Err Secs, 0 Degraded Mins
0 Errored Secs, 0 Bursty Err Secs, 0 Severely Err Secs
0 Unavailable Secs, 0 Stuffed Secs
0 Path Failures, 0 SEF/AIS Secs
Far End
0 Line Code Violations, 0 Path Code Violations
0 Slip Secs, 0 Fr Loss Secs, 0 Line Err Secs, 0 Degraded Mins
0 Errored Secs, 0 Bursty Err Secs, 0 Severely Err Secs
0 Unavailable Secs 0 Path Failures
Data in Interval 1:
Near End
0 Line Code Violations, 0 Path Code Violations
0 Slip Secs, 2 Fr Loss Secs, 0 Line Err Secs, 0 Degraded Mins
2 Errored Secs, 0 Bursty Err Secs, 2 Severely Err Secs
0 Unavailable Secs, 0 Stuffed Secs
1 Path Failures, 2 SEF/AIS Secs
Far End
0 Line Code Violations, 0 Path Code Violations
0 Slip Secs, 2 Fr Loss Secs, 0 Line Err Secs, 0 Degraded Mins
3 Errored Secs, 0 Bursty Err Secs, 3 Severely Err Secs
0 Unavailable Secs 0 Path Failures
Total Data (last 1 15 minute intervals):
Near End
0 Line Code Violations,0 Path Code Violations,
0 Slip Secs, 2 Fr Loss Secs, 0 Line Err Secs, 0 Degraded Mins,
2 Errored Secs, 0 Bursty Err Secs, 2 Severely Err Secs
0 Unavailable Secs, 0 Stuffed Secs
1 Path Failures, 2 SEF/AIS Secs
Far End
0 Line Code Violations,0 Path Code Violations
0 Slip Secs, 2 Fr Loss Secs, 0 Line Err Secs, 0 Degraded Mins,
3 Errored Secs, 0 Bursty Err Secs, 3 Severely Err Secs
0 Unavailable Secs, 0 Path Failures

```





## CHAPTER 7

# Providing Redundancy Support At the Interface Module

Use the following procedures to provide redundancy for the interface module.

**Table 8: Supported Interface Module**

Interface Module	Part Number	Mode
48-port T3/E3 Interface module	• NCS4200-48T3E3-CE	• T3/E3
1-port OC48/ STM-16 or 4-port OC-12/OC-3 / STM-1/STM-4 + 12-Port T1/E1 + 4-Port T3/E3 CEM Interface Module	• NCS4200-3GMS	• STS-1

- [Card Protection for T3 or E3 Interface Module, on page 87](#)
- [Card Protection for STS-1e, on page 93](#)

## Card Protection for T3 or E3 Interface Module

The Card Protection feature is introduced for the 48-port T3 or E3 interface module. In this feature, the interface module bay is protected by another interface module of the same type.

### Card Protection

The Card Protection feature is required to protect traffic flow either when an interface module is out of service, when the software fails or a hardware component has issues. Because card protection is supported only on redundant interface modules, traffic is switched to the protect interface module when the active interface module does not respond, and vice-versa.



**Note** This feature does not require any change in the patch panel of the interface modules.

In card protection, a Y Cable is used to multiplex the signal from the patch panel to both the ports of active and protect interface modules. Both ports receive the signal, but only the active interface module transmits the signal from its port.

Figure 2: Y Cable

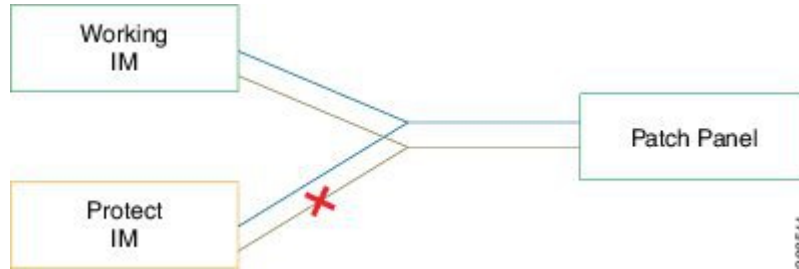

To support the Card Protection feature, the configuration on the active and protect interface module must be same. To achieve this, a virtual interface module is created with the same interface module type as the active interface module. A virtual controller is also created, which broadcasts the configuration to both the interface modules. The configuration on the physical controllers is then blocked and you can make configuration changes only on the virtual controller. The user configuration can only be performed on the virtual controller.

The virtual controller supports CEM level configuration and all other configurations. These configurations are blocked on physical controllers.

Figure 3: Card Protection Topology

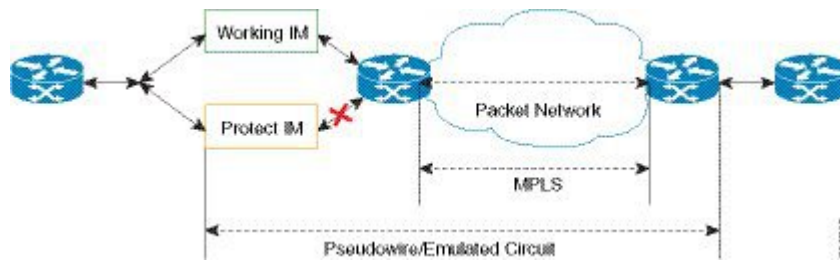

**Note** DS3 (T3) channelized into T1 and E3 channelized into E1s are supported in card protection. For more information on configuration, see the [Configuring the Controller of Channelized T3/T1 Interfaces](#) section.

## Y Cable

In card protection, a Y cable is used to multiplex the signal from the patch panel to both the ports of active and standby interface modules. Both the active and protect ports receive the signal, but only the active port transmits the signal from its port. Protect port transmitter is disabled.

## Card Protection Switchover

The following table shows the card protection switchover trigger and time to complete the switchover between the working and protect interface module.

Trigger	Time
Interface Module Reload with CLI OIR	Less than 50 millisecond
Non-responsive Interface Module Process (interface module reloads on its own, the reload is initiated due to software error)	100 millisecond to 200 millisecond
Interface Module shuts down due to high temperature	Less than 50 millisecond
Interface Module shuts down using CLI	Less than 50 millisecond
Interface Module stops using CLI	Less than 50 millisecond
Serializer/Deserializer (SerDes) Failures	250 millisecond to 1 second
Alarm Based Switchover	Based on Hold Over Time or Soak Time
Card Protection Commands	20 millisecond to 30 millisecond
Non-responsive Interface Module Process (interface module reloads on its own, the reload is initiated due to software error)	200 millisecond to 1 second
Card Physical Jackout	200 millisecond to 1 second

### Alarm Based Switchover

Alarm based switchover is only applicable for Loss Of Signal (LOS) alarm. Switchover happens only when the number of ports with LOS alarm in working interface module is greater than that on the protect interface module.

Each card protection group maintains a weight for each working and protect interface module. This weight is updated when the LOS alarms are asserted or cleared. The switchover happens only if the weight of working interface module and protect interface module stays same for a certain amount of time called soak time.

When there is any issue with the Patch Panel, both working interface module and protect interface module have the same number of LOS alarms (weights are same). Hence, switchover does not happen.

## Restrictions

- Card physical jack out convergence time for card protection switchover is more than 50 milliseconds.
- The time taken to restart the interface module due to any software error is more than 50 milliseconds.
- Alarm toggle on active or backup card causes at least one card protection switch.
- When BERT is started from the virtual controllers, the syslog displays the physical controllers instead of the virtual controller port.

## Supported Features on Interface Module

The supported features are:

- Switching Mode
  - Non-revertive mode
  - Revertive mode
- Alarm Based Switchover
- SerDes Based Switchover
- Adaptive Clock Recovery (ACR) on virtual CEM
- Differential Clock Recovery (DCR) on virtual CEM
- Maintenance Commands
  - Lockout
  - Force
  - Manual



---

**Note** All controller configurations are performed on the virtual controller.

---

You can create card protection with one slot (either primary or backup) and the remaining slots can be added later.

## How to Configure Card Protection for T3 or E3

### Configuring T3/E3 Card Protection

#### Pre-requisites

The interface module should be free from any configuration.

#### Configuring Card Protection Group:

```
enable
configure terminal
card-protection [1-16]
primary slot 0 bay 0
backup slot 0 bay 5
end
```



---

**Note** The card protection number 1 to 16 refers to the Card Protection Group Number (CPGN).

---



---

**Note** This is a non-revertive mode.

---

#### Configuring Virtual Card and Virtual Controller:



When card protection group is configured, it creates virtual card for card protection object, denoted by 8/x/port. Slot 8 is a fixed slot number for all card protection-created virtual card. Bay number 'x' is derived from the CPGN, where x=CPGN-1. Since card protection group number ranges from 1 to 16, bay number ranges from 0 to 15. Virtual controllers can be configured from 8/x/0 to 8/x/47.

#### Physical Card Configuration:

Configures mode T3/E3 on physical controllers of both primary (0/0) and backup (0/5) card.

```
enable
configure terminal
controller mediatype 8/0/0
mode t3
end
```

#### Virtual Card Configuration:

- Configures mode T3/E3 on virtual controllers.
- Configures CEM on virtual controller (8/x/port).
- Configures xconnect and local connect on CEM interface.

```
enable
configure terminal
controller t3 8/0/0
cem 0 unframed
interface cem 8/0/0
cem 0
xconnect 10.1.1.1 112 encapsulation mpls
end
```



---

**Note** This is a non-revertive mode.

---



---

**Note** To un-configure a CEM group under a virtual controller, first perform shutdown of the virtual controller and then un-configure the CEM group.

---

### Configuring Revertive Mode

To configure revertive mode:

```
enable
configure terminal
card-protection 4
primary slot 0 bay 0
backup slot 0 bay 5
end
card-protection 4
revertive time [30-720]
end
```



---

**Note** The revertive time ranges from 30 to 720 seconds.

---

## Verifying T3/E3 Card Protection Configuration

Use **show card-protection detail** command to verify card protection group configuration.

```
#show card-protection 2 detail
Working(0/1:A900-IMA48T-C NCS4200-48T3E3-CE):
  Number of LOS Alarms:7
  ok,Active
  1:1, Revertive

  Protect(0/2:A900-IMA48T-C NCS4200-48T3E3-CE):
  Number of LOS Alarms:7
  ok,Inactive
  1:1, Revertive

Revert Timer : (Not Started)
Last switchover reason :None
```

```
#show card-protection 4
CPGN   Primary Card                Backup Card                Active
-----
4      0/1                          0/2                        Primary
```

```
#show running-configuration | b 8/0/
controller mediatype 8/0/0
!
controller mediatype 8/0/1
!
controller mediatype 8/0/2
#
```

Use **show xconnect all** command to verify xconnect configuration.

```
#show xconnect all
XC ST=Xconnect      State  S1=Segment1 State  S2=Segment2 State
UP=Up  DN=Down      AD=Admin Down  IA=Inactive
SB=Standby HS=Hot Standby  RV=Recovering  NH=No Hardware
XC  ST   Segment 1                S1 Segment 2                S2
-----
UP  pri  ac CE8/0/0:(SATOP T3)          UP mpls 10.1.1.1:112        UP
#
```

## Configuring Maintenance Commands

To configure maintenance commands:

```
enable
configure terminal
card-protection 4
primary slot 0 bay 0
backup slot 0 bay 5
end
card-protection 4
card-protection [manual {backup|primary} | force {backup|primary} | lockout]
end
```



**Note** Maintenance commands are not synced in the standby environment. After Redundancy Force Switchover (SSO), maintenance commands must be executed again on the new active environment.

## Priority Table

The following table shows the priority of the actions:

Priority	Configurations
1	Lockout
2	Force
3	Alarm or Card Failure
4	Manual Switch
5	Revert

## Associated Commands

The following table shows the commands for the IM configuration:

Command	Link
<b>Card Protection Creation Commands:</b> <b>card-protection</b> <i>CPGN</i> <b>card-protection</b> { <i>primary</i>   <i>backup</i> } <b>card-protection</b> <i>revertive time</i>	<a href="https://www.cisco.com/c/en/us/td/docs/ios-xml/ios/interface/command/ir-cr-book/ir-c1.html#wp1208639895">https://www.cisco.com/c/en/us/td/docs/ios-xml/ios/interface/command/ir-cr-book/ir-c1.html#wp1208639895</a>
<b>Card Protection Maintenance Commands:</b> <b>card-protection</b> <i>CPGN</i> [ <b>manual</b> { <i>primary</i>   <i>backup</i> }   <b>force</b> { <i>primary</i>   <i>backup</i> }   <b>lockout</b> ]	
<b>show card-protection</b> <i>CPGN</i> <b>detail</b>	<a href="https://www.cisco.com/c/en/us/td/docs/ios-xml/ios/interface/command/ir-cr-book/ir-s2.html#wp1628614402">https://www.cisco.com/c/en/us/td/docs/ios-xml/ios/interface/command/ir-cr-book/ir-s2.html#wp1628614402</a>

## Card Protection for STS-1e

The router supports electrical card protection feature with 1:1 protection, where the feature functions during events such as when interface module stops responding, software stops responding, and issues in other hardware components.

In card protection, the Y Cable multiplexes the signal from the patch panel to both the ports of Active and Standby interface module. Both the Active and Protect ports receive the signal, but only the Active transmits the signal from its port. Protect port transmitter is disabled.

To support card protection, the configuration in the Active and Protect interface must be same. To achieve this, a virtual controller is created. The virtual controller must be of the same interface module type. Once the virtual controller is created, it broadcasts the configuration to both active and protect interfaces, and configuration on the physical controller is blocked. The user can perform configuration only on this virtual controller.

In 1:1 protection, a working interface is paired with a protect interface of the same type. If the working interface fails, the traffic from the working interface switches to the protect interface. When the failure on the working interface is resolved, traffic automatically reverts to the working interface.

## Restrictions for STS-1 Electricals Card Protection

- The advanced detection mechanism for chip failures such as LIU, FMEA, cable failure between patch panel and Card, XFI going out of synchronization is not supported for card protection.
- The card protection is supported only on the NCS4200-48T3E3-CE CEM interface module.
- The card protection is supported only on the following modes:

**Table 9: Card Protection Supported Modes**

Mode	Type
T3	Unframed
VT 1.5 - T1	Unframed
VT 1.5 - VTG	CEP
CT-3 - T1	Unframed
STS-1	Unframed CEP

## How to Configure Card Protection for STS-1 Electricals

### Configuring Card Protection

To configure card protection, enter the following commands:

```
router(config)#card-protection 1
router(config-card-protection)#primary slot <slot-no> bay <bay-no>
router(config-card-protection)#backup slot <slot-no> bay <bay-no>
```

The following example explains on how to configure card protection:

```
router(config)#card-protection 1
router(config-card-protection)#primary slot 0 bay 0
router(config-card-protection)#backup slot 0 bay 1
```

### Provisioning Card Protection

To provision card protection for the primary card in a protection group, enter the following commands:

```
router(config)# card-protection 1
router(config-card-protection)#primary slot <slot-no> bay <bay-no>
```

To provision card protection for the backup card in a protect, enter the following commands:

```
router(config)# card-protection 1
router(config-card-protection)#backup slot <slot-no> bay <bay-no>
```

The following example details on how to provision card on a primary card in slot 0 and bay 0 for a card protection group 1:

```
router(config)# card-protection 1
router(config-card-protection)#primary slot 0 bay 0
```

The following example details on how to provision card on backup card in slot 0 and bay 5 for a card protection group 1:

```
router(config)# card-protection 1
router(config-card-protection)#backup slot 0 bay 5
```

You can verify the card protection using the **show card-protection <protection-group>** command.

Once card protection group is configured, a virtual controller is created for the card protection object and is denoted as 8/x/port.

The slot 8 is fixed slot number for all card protection created virtual controller. The bay number 'x' is derived from Card Protection Group Number (CPGN), and is calculated using the following equation:

$$x = \text{CPGN} - 1$$

The card protection group number ranges from 1 through 16 and the bay number ranges from 0 through 15. The virtual controllers can be referred from 8/x/0 to 8/x/47.

The following are few examples denoting virtual controllers:

- If the card protection number is 1 and the port is 15, then the logical controller is represented as: **controller sts1e 8/0/15**
- If the card protection number is 10 and the port is 25, then the logical controller is represented as: **controller sts1e 8/9/25**

You can verify the controller information using the **show controllers sts1e 8/x/port** command:

```
router#show controllers sts1e 8/0/16
STS1E 8/0/16 is up.
  Hardware is N/A

  Port configured rate: OC1
  Applique type is Channelized STS1E
  Clock Source is Internal
Medium info:
  Type: STS1E, Line Coding: NRZ,
  Alarm Throttling: OFF
SECTION:
  LOS = 0          LOF = 0          BIP(B1) = 0

STS1E Section Tables
  INTERVAL      CV      ES      SES      SEFS
  09:42-09:54   0       0       0       0

LINE:
  AIS = 0          RDI = 0          REI = 0          BIP(B2) = 0
```

```

Active Defects: None
Detected Alarms: None
Asserted/Active Alarms: None
Alarm reporting enabled for: SLOS SLOF LAIS SF SD LRDI B1-TCA B2-TCA
BER thresholds: SF = 10e-3 SD = 10e-6

```

## Configuring STS-1 Electrical Mode for SONET

```

config terminal
controller MediaType 8/0/0
mode sts-1e
controller STS-1E 8/0/0
sts-1 1

```

## Configuring STS-1e for VT1.5-T1 Mode

To configure STS-1e for VT1.5-T1 mode, enter the following commands:

```

config terminal
controller MediaType 8/0/16
mode sts1e
controller STS1E 8/0/16
no snmp trap link-status
no ais-shut
clock source internal
cablelength short
overhead j0 tx length 64-byte
overhead j0 expected length 64-byte

sts-1 1
clock source internal
mode vt-15
vtg 1 t1 1 cem-group 1 unframed

```

## Configuring STS-1e for T3 Mode

To configure STS-1e for T3 mode, enter the following commands:

```

config terminal
controller MediaType 8/0/17
mode sts1e
controller STS1E 8/0/17
no snmp trap link-status
no ais-shut
clock source internal
cablelength short
overhead j0 tx length 64-byte
overhead j0 expected length 64-byte

sts-1 1
clock source internal
mode t3
cem-group 100 unframed
t3 clock source internal
interface CEM8/0/17
no ip address

```

```
cem 100
```

## Configuring STS-1e for VT1.5-VT Mode

To configure STS-1e for VT1.5-VT mode, enter the following commands:

```
config terminal
controller MediaType 8/0/18
 mode sts1e
controller STS1E 8/0/18
 no snmp trap link-status
 no ais-shut
 clock source internal
 cablelength short
 overhead j0 tx length 64-byte
 overhead j0 expected length 64-byte

sts-1 1
 clock source internal
 mode vt-15
 vtg 1 vt 1 cem-group 200 cep
```

## Configuring STS-1e for CEP Mode

```
config terminal
controller MediaType 8/0/20
 mode sts1e
controller STS1E 8/0/20
 no snmp trap link-status
 no ais-shut
 clock source internal
 cablelength short
 overhead j0 tx length 64-byte
 overhead j0 expected length 64-byte

sts-1 1
 clock source internal
 mode unframed
 cem-group 500 cep
interface CEM8/0/20
 no ip address
 cem 500
```

## Configuring STS-1e for CT3 Mode

To configure STS-1e for CT3 mode, enter the following commands:

```
config terminal
controller MediaType 8/0/19
 mode sts1e
controller STS1E 8/0/19
 no snmp trap link-status
 no ais-shut
 clock source internal
 cablelength short
 overhead j0 tx length 64-byte
```

```

overhead j0 expected length 64-byte

sts-1 1
  clock source internal
  mode ct3
  t3 clock source internal
  t1 1 cem-group 300 unframed

```

## Verifying Card Protection Configuration for STS-1 Electricals

Use the following commands to verify the card protection configuration:

- **show card-protection <protection-group>**—Displays Card Protection Group Number (CPGN), primary and backup card slots, and the active card.
- **show card-protection <protection-group> detail**—Displays the detailed information of the card protection group.
- **show controllers sts1e**—Displays the STS-1e configuration.

```

router#show card-protection 1
CPGN          Primary Card          Backup Card
Active
-----
1              0/0                  0/5
Primary
-----

```

```

router#show card-protection 1 detail
Card Protection Group 1:
  Working(0/0:NCS4200-48T3E3-CE):
  Number of LOS Alarms:0
  ok,Active
  1:1, non-revertive
  Protect(0/5:NCS4200-48T3E3-CE):
  Number of LOS Alarms:0
  ok,Inactive
  1:1, non-revertive
Revert Timer : (Not Started)
Last switchover reason :Serdes

```

```

router#show controllers sts1e 8/0/16
STS1E 8/0/16 is up.
Hardware is N/A

Port configured rate: OC1
Applique type is Channelized STS1E
Clock Source is Internal
Medium info:
Type: STS1E, Line Coding: NRZ,
Alarm Throttling: OFF
SECTION:
LOS = 0 LOF = 0 BIP(B1) = 0

STS1E Section Tables
INTERVAL CV ES SES SEFS
14:20-14:31 0 0 0 0

```





# CHAPTER 8

## Additional References

This appendix describes additional CEM features that are used on the router. This appendix describes the following topics:

- [STS-1 Frame](#), on page 99
- [STS-1 Overhead](#), on page 100
- [Asynchronous Mapping for T3 or E3 CEP](#), on page 100
- [Alarms for T3 or E3 CEP](#), on page 101

## STS-1 Frame

A standard STS-1 frame is nine rows by 90 bytes. The first three bytes of each row represent the Section and Line overhead. These overhead bits comprise framing bits and pointers to different parts of the STS-1 frame.

**Figure 4: STS-1 Frame Structure**

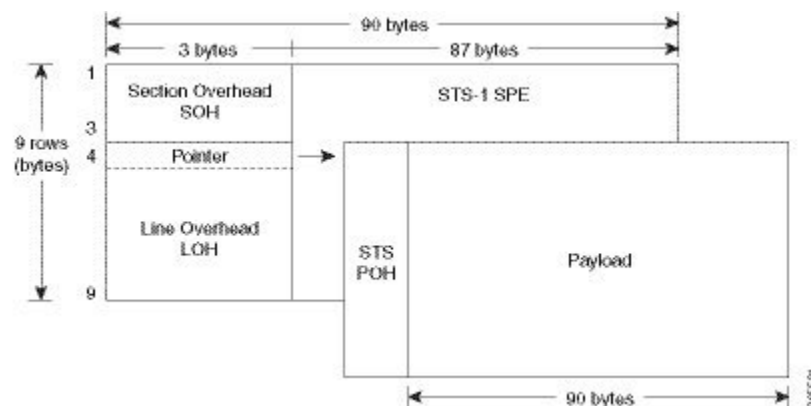

There is one column of bytes in the payload that represents the STS path overhead. This column frequently "floats" throughout the frame. Its location in the frame is determined by a pointer in the Section and Line overhead.

The combination of the Section and Line overhead comprises the transport overhead, and the remainder is the SPE.

# STS-1 Overhead

Figure 5: STS-1 Overhead

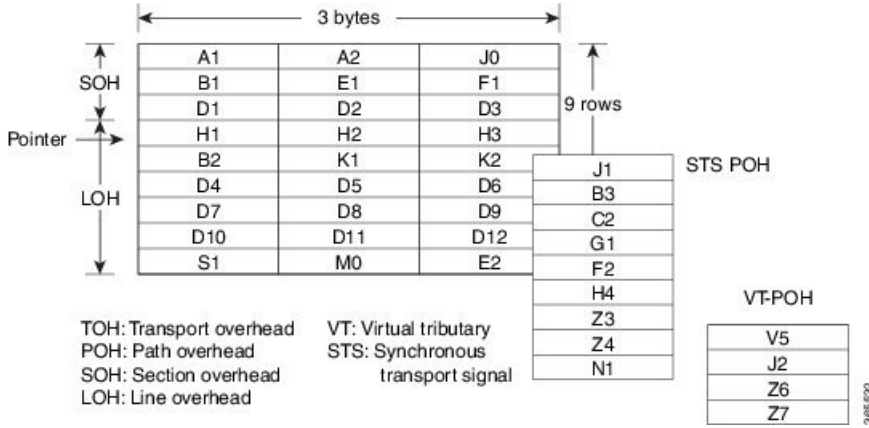

For STS-1, a single frame is transmitted in 125 microseconds, or 8000 frames per second.  $8000 \text{ fps} * 810 \text{ B/frame} = 51.84 \text{ Mbs}$ , of which the payload is roughly 49.5 Mbs, enough to encapsulate 28 DS-1s, a full DS-3, or 21 CEPT-1s.

STS-1 electrical ports are also supported. 48 STS-1 electrical ports are supported per card. Each port operates at 51.840 Mbps over a single 75-ohm, 728A or equivalent coaxial span. All the ports are supported.

## Asynchronous Mapping for T3 or E3 CEP

An asynchronous mapping for a T3 or E3 in the payload capacity of an STS-1 signal is defined for clear-channel transport of T3 or E3 signals that meet the T3 or E3 requirements in GR-499-CORE. The asynchronous T3 or E3 mapping consists of nine subframes each of 125  $\mu\text{s}$ . Each subframe contains 621 information (I) bits, a set of five stuff control (C) bits, one stuff opportunity (S) bit, and two overhead communication channel (O) bits. The remaining bits of the STS-1 payload capacity are fixed stuff (R) bits. The O-bits are reserved for future overhead communication purposes. The values of the R and O bits are undefined. In each subframe, the set of five C-bits are used to control the S-bit. CCCCC = 00000 is used to indicate that the S-bit is an information bit, while CCCCC = 11111 is used to indicate that the S-bit is a stuff bit. The value of the S-bit (if it is stuff bit) is undefined.

Figure 6: Asynchronous Mapping for T3 or E3 CEP

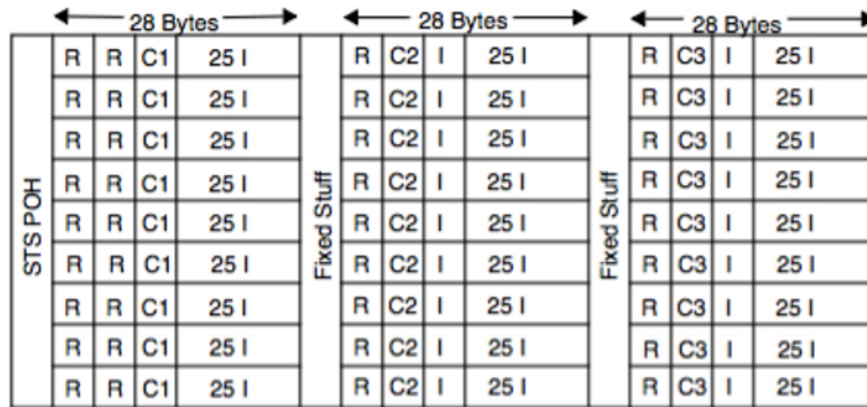

Bytes

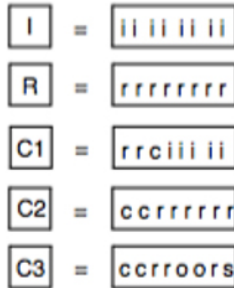

bits

- i: information (payload) bit
- r: fixed stuff bit
- c: stuff control bit
- s: stuff opportunity bit
- o: overhead communications channel bit

367135

## Alarms for T3 or E3 CEP

If an alarm is detected in the DS3 end, the C2 bytes are used to inform the remote Provider Edge (PE). For this, the alarm mapping table has to be followed as shown in the figure below.

Figure 7: Alarm Mapping Table

