



Logical Devices

- [About Logical Devices, on page 1](#)
- [Requirements and Prerequisites for Logical Devices, on page 9](#)
- [Guidelines and Limitations for Logical Devices, on page 17](#)
- [Add a Standalone Logical Device, on page 23](#)
- [Add a High Availability Pair, on page 57](#)
- [Add a Cluster, on page 58](#)
- [Configure Radware DefensePro, on page 92](#)
- [Configure TLS Crypto Acceleration, on page 101](#)
- [Manage Logical Devices, on page 105](#)
- [Monitoring Logical Devices, on page 115](#)
- [Examples for Inter-Site Clustering, on page 117](#)
- [History for Logical Devices, on page 120](#)

About Logical Devices

A logical device lets you run one application instance (either ASA or Firepower Threat Defense) and also one optional decorator application (Radware DefensePro) to form a service chain.

When you add a logical device, you also define the application instance type and version, assign interfaces, and configure bootstrap settings that are pushed to the application configuration.



Note For the Firepower 9300, you can install different application types (ASA and Firepower Threat Defense) on separate modules in the chassis. You can also run different versions of an application instance type on separate modules.

Standalone and Clustered Logical Devices

You can add the following logical device types:

- **Standalone**—A standalone logical device operates as a standalone unit or as a unit in a High Availability pair.

- Cluster—A clustered logical device lets you group multiple units together, providing all the convenience of a single device (management, integration into a network) while achieving the increased throughput and redundancy of multiple devices. Multiple module devices, like the Firepower 9300, support intra-chassis clustering. For the Firepower 9300, all three modules must participate in the cluster, for both native and container instances. The FDM does not support clustering.

Logical Device Application Instances: Container and Native

Application instances run in the following deployment types:

- Native instance—A native instance uses all of the resources (CPU, RAM, and disk space) of the security module/engine, so you can only install one native instance.
- Container instance—A container instance uses a subset of resources of the security module/engine, so you can install multiple container instances. Multi-instance capability is only supported for the Firepower Threat Defense using FMC; it is not supported for the ASA or the Firepower Threat Defense using FDM.



Note Multi-instance capability is similar to ASA multiple context mode, although the implementation is different. Multiple context mode partitions a single application instance, while multi-instance capability allows independent container instances. Container instances allow hard resource separation, separate configuration management, separate reloads, separate software updates, and full Firepower Threat Defense feature support. Multiple context mode, due to shared resources, supports more contexts on a given platform. Multiple context mode is not available on the Firepower Threat Defense.

For the Firepower 9300, you can use a native instance on some modules, and container instances on the other module(s).

Container Instance Interfaces

To provide flexible physical interface use for container instances, you can create VLAN subinterfaces in FXOS and also share interfaces (VLAN or physical) between multiple instances. Native instances cannot use VLAN subinterfaces or shared interfaces. A multi-instance cluster cannot use VLAN subinterfaces or shared interfaces. An exception is made for the cluster control link, which can use a subinterface of the Cluster EtherChannel. See [Shared Interface Scalability](#) and [Add a VLAN Subinterface for Container Instances](#).



Note This document discusses *FXOS* VLAN subinterfaces only. You can separately create subinterfaces within the FTD application. See [FXOS Interfaces vs. Application Interfaces](#) for more information.

How the Chassis Classifies Packets

Each packet that enters the chassis must be classified, so that the chassis can determine to which instance to send a packet.

- **Unique Interfaces**—If only one instance is associated with the ingress interface, the chassis classifies the packet into that instance. For bridge group member interfaces (in transparent mode or routed mode), inline sets, or passive interfaces, this method is used to classify packets at all times.
- **Unique MAC Addresses**—The chassis automatically generates unique MAC addresses for all interfaces, including shared interfaces. If multiple instances share an interface, then the classifier uses unique MAC addresses assigned to the interface in each instance. An upstream router cannot route directly to an instance without unique MAC addresses. You can also set the MAC addresses manually when you configure each interface within the application.



Note If the destination MAC address is a multicast or broadcast MAC address, the packet is duplicated and delivered to each instance.

Classification Examples

Packet Classification with a Shared Interface Using MAC Addresses

The following figure shows multiple instances sharing an outside interface. The classifier assigns the packet to Instance C because Instance C includes the MAC address to which the router sends the packet.

Figure 1: Packet Classification with a Shared Interface Using MAC Addresses

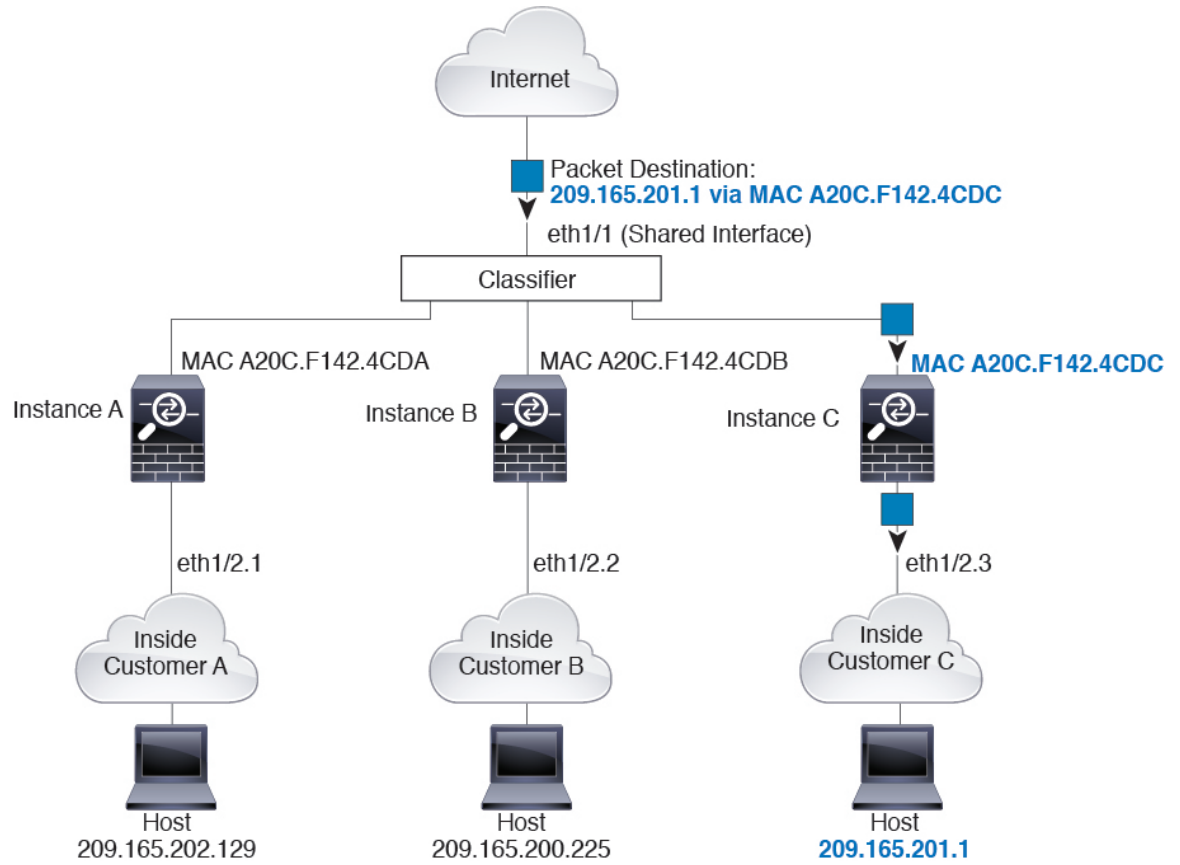

Incoming Traffic from Inside Networks

Note that all new incoming traffic must be classified, even from inside networks. The following figure shows a host on the Instance C inside network accessing the internet. The classifier assigns the packet to Instance C because the ingress interface is Ethernet 1/2.3, which is assigned to Instance C.

Figure 2: Incoming Traffic from Inside Networks

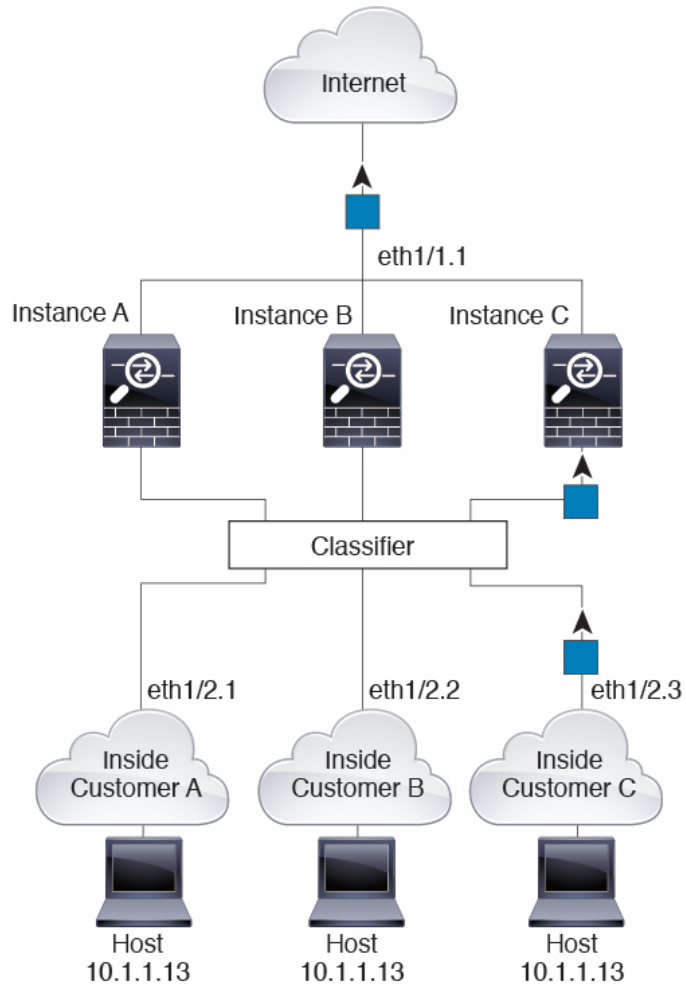

Transparent Firewall Instances

For transparent firewalls, you must use unique interfaces. The following figure shows a packet destined to a host on the Instance C inside network from the internet. The classifier assigns the packet to Instance C because the ingress interface is Ethernet 1/2.3, which is assigned to Instance C.

Figure 3: Transparent Firewall Instances

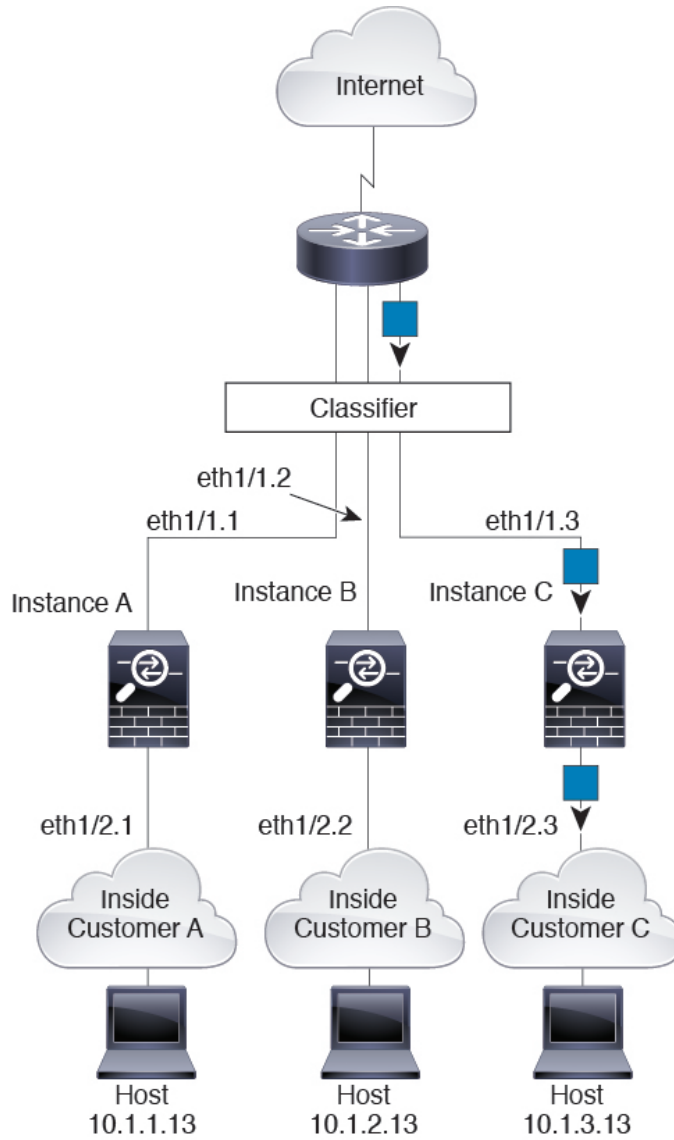

Inline Sets

For inline sets, you must use unique interfaces and they must be physical interfaces or EtherChannels. The following figure shows a packet destined to a host on the Instance C inside network from the internet. The classifier assigns the packet to Instance C because the ingress interface is Ethernet 1/5, which is assigned to Instance C.

Figure 4: Inline Sets

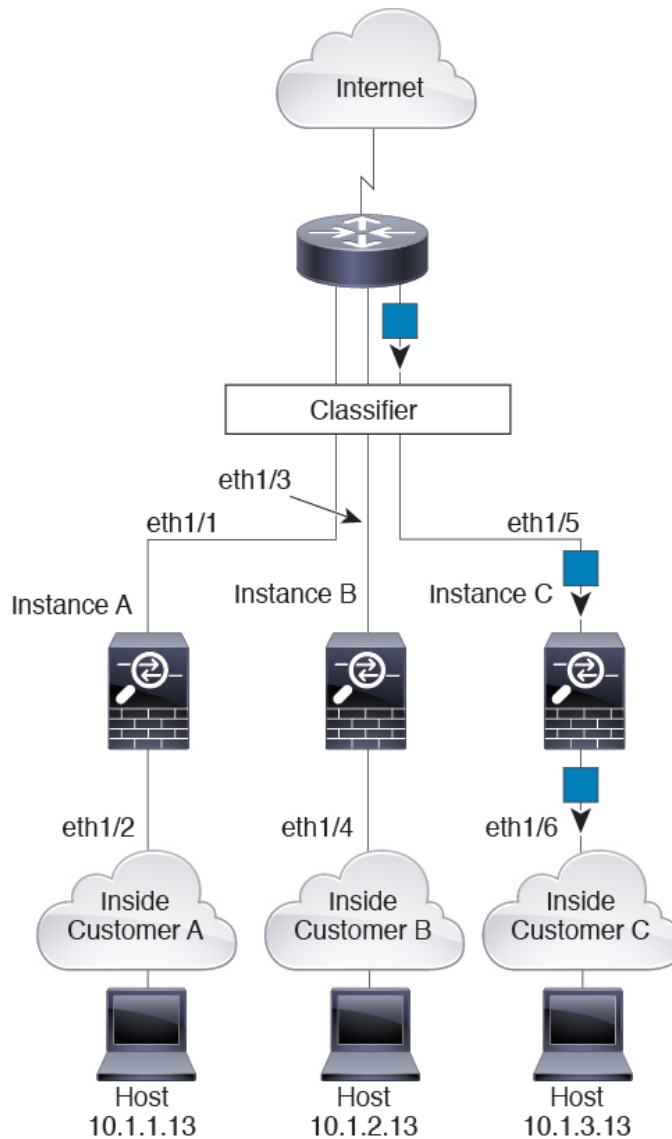

Cascading Container Instances

Placing an instance directly in front of another instance is called *cascading instances*; the outside interface of one instance is the same interface as the inside interface of another instance. You might want to cascade instances if you want to simplify the configuration of some instances by configuring shared parameters in the top instance.

The following figure shows a gateway instance with two instances behind the gateway.

Figure 5: Cascading Instances

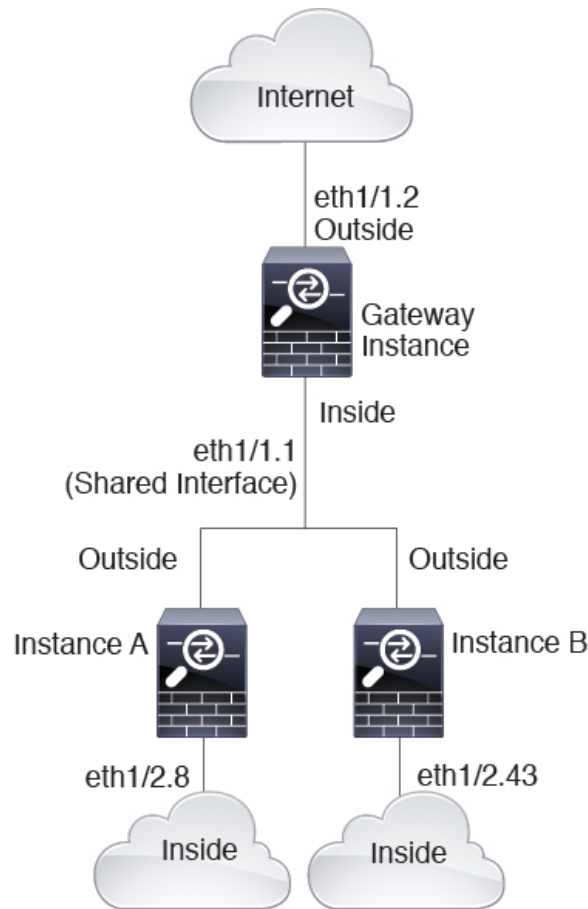

Note Do not use cascading instances (using a shared interface) with High Availability. After a failover occurs and the standby unit rejoins, MAC addresses can overlap temporarily and cause an outage. You should instead use unique interfaces for the gateway instance and inside instance using an external switch to pass traffic between the instances.

Typical Multi-Instance Deployment

The following example includes three container instances in routed firewall mode. They include the following interfaces:

- **Management**—All instances use the Port-Channel1 interface (management type). This EtherChannel includes two 10 Gigabit Ethernet interfaces. Within each application, the interface uses a unique IP address on the same management network.
- **Inside**—Each instance uses a subinterface on Port-Channel2 (data type). This EtherChannel includes two 10 Gigabit Ethernet interfaces. Each subinterface is on a separate network.

- Outside—All instances use the Port-Channel3 interface (data-sharing type). This EtherChannel includes two 10 Gigabit Ethernet interfaces. Within each application, the interface uses a unique IP address on the same outside network.
- Failover—Each instance uses a subinterface on Port-Channel4 (data type). This EtherChannel includes two 10 Gigabit Ethernet interfaces. Each subinterface is on a separate network.

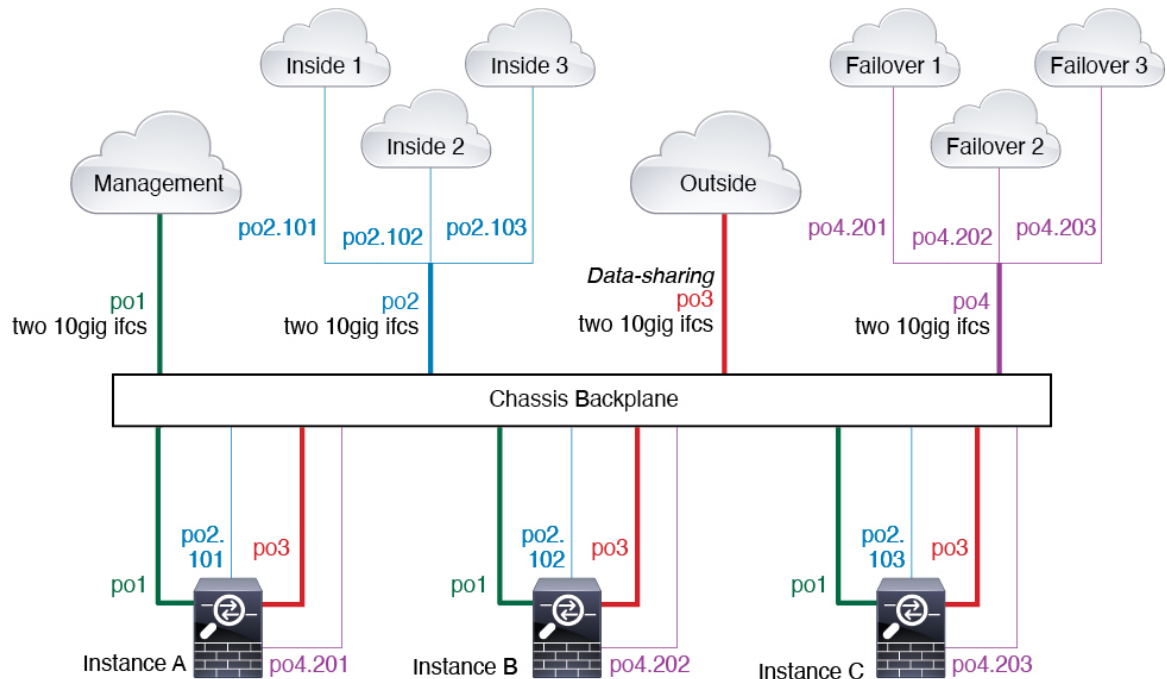

Automatic MAC Addresses for Container Instance Interfaces

The chassis automatically generates MAC addresses for instance interfaces, and guarantees that a shared interface in each instance uses a unique MAC address.

If you manually assign a MAC address to a shared interface within the instance, then the manually-assigned MAC address is used. If you later remove the manual MAC address, the autogenerated address is used. In the rare circumstance that the generated MAC address conflicts with another private MAC address in your network, we suggest that you manually set the MAC address for the interface within the instance.

Because autogenerated addresses start with A2, you should not start manual MAC addresses with A2 due to the risk of overlapping addresses.

The chassis generates the MAC address using the following format:

A2xx.yyyz.zzzz

Where xx.yy is a user-defined prefix or a system-defined prefix, and zz.zzzz is an internal counter generated by the chassis. The system-defined prefix matches the lower 2 bytes of the first MAC address in the burned-in MAC address pool that is programmed into the IDPROM. Use **connect fxos**, then **show module** to view the MAC address pool. For example, if the range of MAC addresses shown for module 1 is b0aa.772f.f0b0 to b0aa.772f.f0bf, then the system prefix will be f0b0.

The user-defined prefix is an integer that is converted into hexadecimal. For an example of how the user-defined prefix is used, if you set a prefix of 77, then the chassis converts 77 into the hexadecimal value 004D (yyxx). When used in the MAC address, the prefix is reversed (xxyy) to match the chassis native form:

A2**4D.00**zz.zzzz

For a prefix of 1009 (03F1), the MAC address is:

A2**F1.03**zz.zzzz

Container Instance Resource Management

To specify resource usage per container instance, create one or more resource profiles in FXOS. When you deploy the logical device/application instance, you specify the resource profile that you want to use. The resource profile sets the number of CPU cores; RAM is dynamically allocated according to the number of cores, and disk space is set to 40 GB per instance. To view the available resources per model, see [Requirements and Prerequisites for Container Instances, on page 16](#). To add a resource profile, see [Add a Resource Profile for Container Instances](#).

Performance Scaling Factor for Multi-Instance Capability

The maximum throughput (connections, VPN sessions, and TLS proxy sessions) for a platform is calculated for a native instance's use of memory and CPU (and this value is shown in **show resource usage**). If you use multiple instances, then you need to calculate the throughput based on the percentage of CPU cores that you assign to the instance. For example, if you use a container instance with 50% of the cores, then you should initially calculate 50% of the throughput. Moreover, the throughput available to a container instance may be less than that available to a native instance.

For detailed instructions on calculating the throughput for instances, see <https://www.cisco.com/c/en/us/products/collateral/security/firewalls/white-paper-c11-744750.html>.

Container Instances and High Availability

You can use High Availability using a container instance on 2 separate chassis; for example, if you have 2 chassis, each with 10 instances, you can create 10 High Availability pairs. Note that High Availability is not configured in FXOS; configure each High Availability pair in the application manager.

For detailed requirements, see [Requirements and Prerequisites for High Availability, on page 16](#) and [Add a High Availability Pair, on page 57](#).

Container Instances and Clustering

You can create a cluster of container instances using one container instance per security module/engine. See [Requirements and Prerequisites for Clustering, on page 11](#) for detailed requirements.

Requirements and Prerequisites for Logical Devices

See the following sections for requirements and prerequisites.

Requirements and Prerequisites for Hardware and Software Combinations

The Firepower 4100/9300 supports multiple models, security modules, application types, and high availability and scalability features. See the following requirements for allowed combinations.

Firepower 9300 Requirements

The Firepower 9300 includes 3 security module slots and multiple types of security modules. See the following requirements:

- Security Module Types—You can install modules of different types in the Firepower 9300. For example, you can install the SM-48 as module 1, SM-40 as module 2, and SM-56 as module 3.
- Native and Container instances—When you install a container instance on a security module, that module can only support other container instances. A native instance uses all of the resources for a module, so you can only install a single native instance on a module. You can use native instances on some modules, and container instances on the other module. For example, you can install a native instance on module 1 and module 2, but container instances on module 3.
- Native instance Clustering—All security modules in the cluster, whether it is intra-chassis or inter-chassis, must be the same type. You can have different quantities of installed security modules in each chassis, although all modules present in the chassis must belong to the cluster including any empty slots. For example, you can install 2 SM-40s in chassis 1, and 3 SM-40s in chassis 2. You cannot use clustering if you install 1 SM-48 and 2 SM-40s in the same chassis.
- Container instance Clustering—You can create a cluster using instances on different model types. For example, you can create a cluster using an instance on a Firepower 9300 SM-56, SM-48, and SM-40. You *cannot* mix the Firepower 9300 and the Firepower 4100 in the same cluster, however.

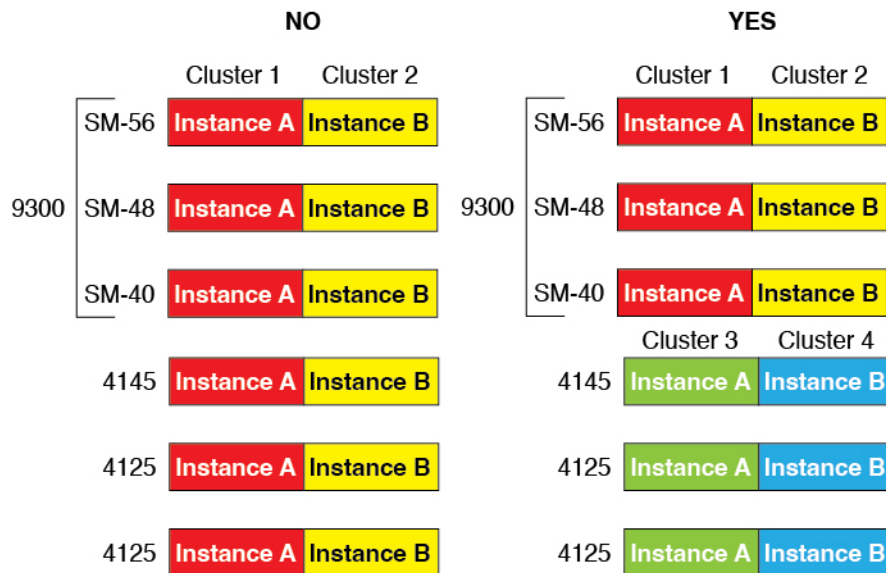

- High Availability—High Availability is only supported between same-type modules on the Firepower 9300. However, the two chassis can include mixed modules. For example, each chassis has an SM-40, SM-48, and SM-56. You can create High Availability pairs between the SM-40 modules, between the SM-48 modules, and between the SM-56 modules.
- ASA and FTD application types—You can install different application types on separate modules in the chassis. For example, you can install ASA on module 1 and module 2, and FTD on module 3.

- ASA or FTD versions—You can run different versions of an application instance type on separate modules, or as separate container instances on the same module. For example, you can install the FTD 6.3 on module 1, FTD 6.4 on module 2, and FTD 6.5 on module 3.

Firepower 4100 Requirements

The Firepower 4100 comes in multiple models. See the following requirements:

- Native and Container instances—When you install a container instance on a Firepower 4100, that device can only support other container instances. A native instance uses all of the resources for a device, so you can only install a single native instance on the device.
- Native instance Clustering—All chassis in the cluster must be the same model.
- Container instance Clustering—You can create a cluster using instances on different model types. For example, you can create a cluster using an instance on a Firepower 4145 and a 4125. You *cannot* mix the Firepower 9300 and the Firepower 4100 in the same cluster, however.

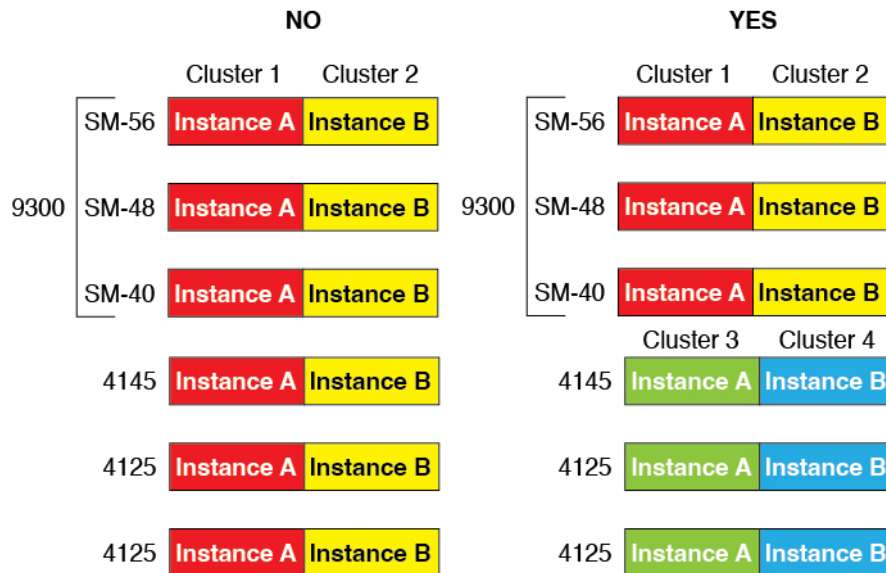

- High Availability—High Availability is only supported between same-type models.
- ASA and FTD application types—The Firepower 4100 can only run a single application type.
- The FTD container instance versions—You can run different versions of Firepower Threat Defense as separate container instances on the same module.

Requirements and Prerequisites for Clustering

Cluster Model Support

- ASA on the Firepower 9300—Maximum 16 modules. For example, you can use 1 module in 16 chassis, or 2 modules in 8 chassis, or any combination that provides a maximum of 16 modules. Note that all modules in a chassis must belong to the cluster. Supported for intra-chassis, inter-chassis, and inter-site clustering.

- ASA on the Firepower 4100 series—Maximum 16 chassis. Supported for inter-chassis and inter-site clustering.
- FTD on the Firepower 9300 using FMC—Maximum 16 modules. For example, you can use 1 module in 16 chassis, or 2 modules in 8 chassis, or any combination that provides a maximum of 16 modules. Note that all modules in a chassis must belong to the cluster. Supported for intra-chassis and inter-chassis clustering.
- FTD on the Firepower 4100 series using FMC—Maximum 16 chassis. Supported for inter-chassis clustering.
- Radware DefensePro—Supported for intra-chassis clustering with the ASA.
- Radware DefensePro—Supported for intra-chassis clustering with the Firepower Threat Defense. Not supported for multi-instance clustering.

Clustering Hardware and Software Requirements

All chassis in a cluster:

- Native instance clustering—For the Firepower 4100: All chassis must be the same model. For the Firepower 9300: All security modules must be the same type. For example, if you use clustering, all modules in the Firepower 9300 must be SM-40s. You can have different quantities of installed security modules in each chassis, although all modules present in the chassis must belong to the cluster including any empty slots.
- Container instance clustering—We recommend that you use the same security module or chassis model for each cluster instance. However, you can mix and match container instances on different Firepower 9300 security module types or Firepower 4100 models in the same cluster if required. You cannot mix Firepower 9300 and 4100 instances in the same cluster. For example, you can create a cluster using an instance on a Firepower 9300 SM-56, SM-48, and SM-40. Or you can create a cluster on a Firepower 4145 and a 4125.

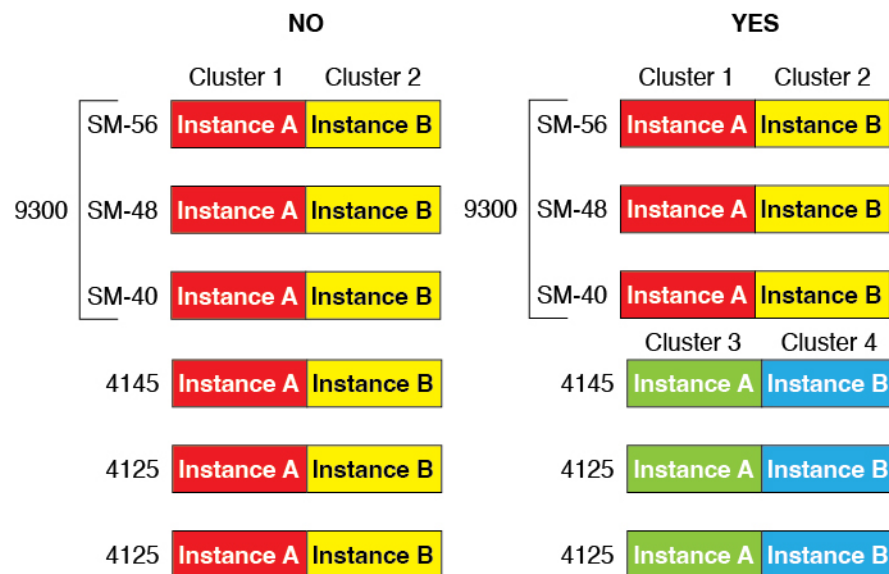

- Must run the identical FXOS and application software except at the time of an image upgrade. Mismatched software versions can lead to poor performance, so be sure to upgrade all nodes in the same maintenance window.

- Must include the same interface configuration for interfaces you assign to the cluster, such as the same Management interface, EtherChannels, active interfaces, speed and duplex, and so on. You can use different network module types on the chassis as long as the capacity matches for the same interface IDs and interfaces can successfully bundle in the same spanned EtherChannel. Note that all data interfaces must be EtherChannels in clusters with multiple chassis. If you change the interfaces in FXOS after you enable clustering (by adding or removing interface modules, or configuring EtherChannels, for example), then perform the same changes on each chassis, starting with the data nodes, and ending with the control node.
- Must use the same NTP server. For Firepower Threat Defense, the FMC must also use the same NTP server. Do not set the time manually.
- ASA: Each FXOS chassis must be registered with the License Authority or satellite server. There is no extra cost for data nodes. For permanent license reservation, you must purchase separate licenses for each chassis. For Firepower Threat Defense, all licensing is handled by the FMC.

Multi-Instance Clustering Requirements

- No intra-security-module/engine clustering—For a given cluster, you can only use a single container instance per security module/engine. You cannot add 2 container instances to the same cluster if they are running on the same module.

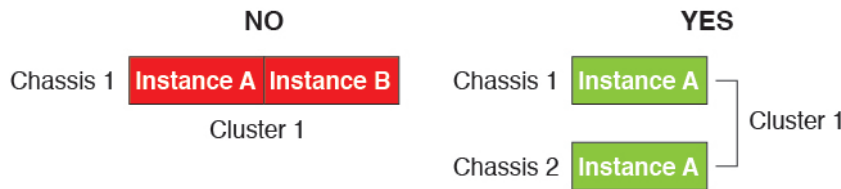

- Mix and match clusters and standalone instances—Not all container instances on a security module/engine need to belong to a cluster. You can use some instances as standalone or High Availability nodes. You can also create multiple clusters using separate instances on the same security module/engine.

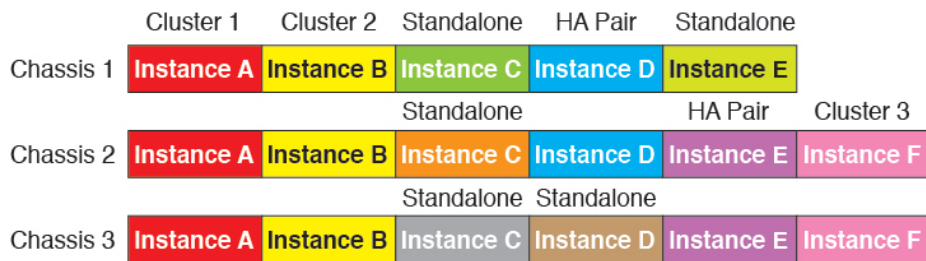

- All 3 modules in a Firepower 9300 must belong to the cluster—For the Firepower 9300, a cluster requires a single container instance on all 3 modules. You cannot create a cluster using instances on module 1 and 2, and then use a native instance on module 3, or example.

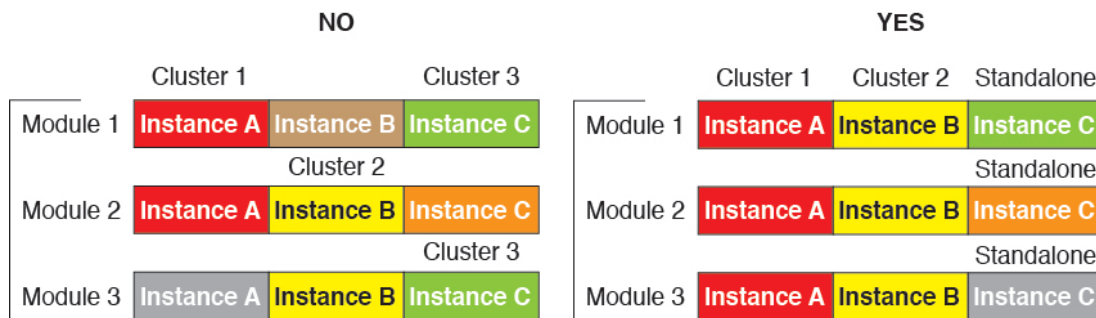

- Match resource profiles—We recommend that each node in the cluster use the same resource profile attributes; however, mismatched resources are allowed when changing cluster nodes to a different resource profile, or when using different models.
- Dedicated cluster control link—For clusters with multiple chassis, each cluster needs a dedicated cluster control link. For example, each cluster can use a separate subinterface on the same cluster-type EtherChannel, or use separate EtherChannels.

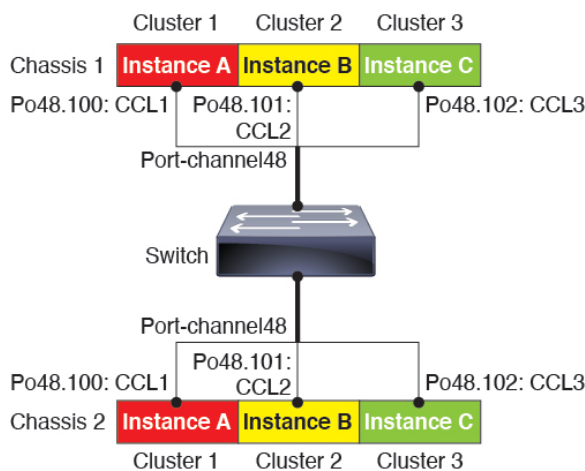

- No shared interfaces—Shared-type interfaces are not supported with clustering. However, the same Management and Eventing interfaces can be used by multiple clusters.
- No subinterfaces—A multi-instance cluster cannot use FXOS-defined VLAN subinterfaces. An exception is made for the cluster control link, which can use a subinterface of the Cluster EtherChannel.
- Mix chassis models—We recommend that you use the same security module or chassis model for each cluster instance. However, you can mix and match container instances on different Firepower 9300 security module types or Firepower 4100 models in the same cluster if required. You cannot mix Firepower 9300 and 4100 instances in the same cluster. For example, you can create a cluster using an instance on a Firepower 9300 SM-56, SM-48, and SM-40. Or you can create a cluster on a Firepower 4145 and a 4125.

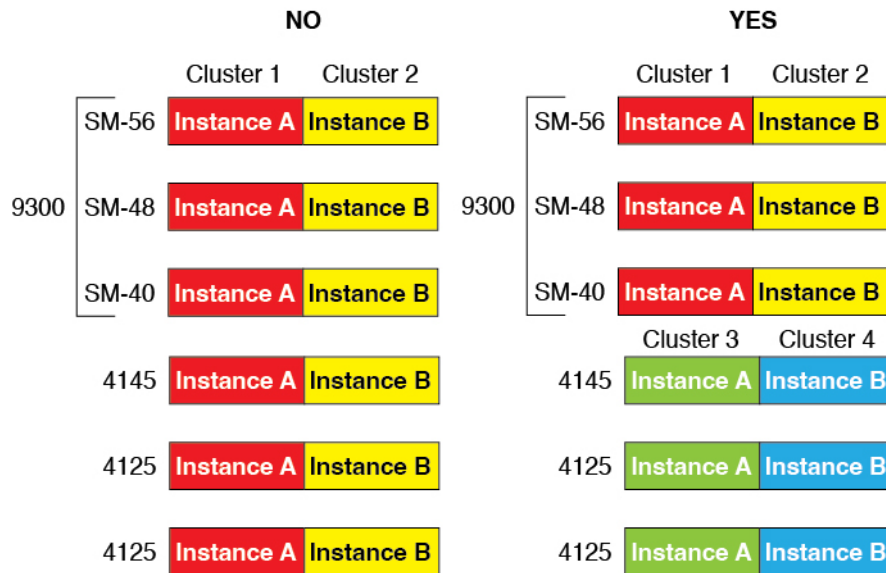

- Maximum 6 nodes—You can use up to six container instances in a cluster.

Switch Requirements for Inter-Chassis Clustering

- Be sure to complete the switch configuration and successfully connect all the EtherChannels from the chassis to the switch(es) before you configure clustering on the Firepower 4100/9300 chassis.
- For supported switch characteristics, see [Cisco FXOS Compatibility](#).

Sizing the Data Center Interconnect for Inter-Site Clustering

You should reserve bandwidth on the data center interconnect (DCI) for cluster control link traffic equivalent to the following calculation:

$$\frac{\text{\# of cluster members per site}}{2} \times \text{cluster control link size per member}$$

If the number of members differs at each site, use the larger number for your calculation. The minimum bandwidth for the DCI should not be less than the size of the cluster control link for one member.

For example:

- For 4 members at 2 sites:
 - 4 cluster members total
 - 2 members at each site
 - 5 Gbps cluster control link per member

Reserved DCI bandwidth = 5 Gbps (2/2 x 5 Gbps).

- For 6 members at 3 sites, the size increases:
 - 6 cluster members total
 - 3 members at site 1, 2 members at site 2, and 1 member at site 3

- 10 Gbps cluster control link per member

Reserved DCI bandwidth = 15 Gbps ($3/2 \times 10$ Gbps).

- For 2 members at 2 sites:
 - 2 cluster members total
 - 1 member at each site
 - 10 Gbps cluster control link per member

Reserved DCI bandwidth = 10 Gbps ($1/2 \times 10$ Gbps = 5 Gbps; but the minimum bandwidth should not be less than the size of the cluster control link (10 Gbps)).

Requirements and Prerequisites for High Availability

- The two units in a High Availability Failover configuration must:
 - Be on a separate chassis; intra-chassis High Availability for the Firepower 9300 is not supported.
 - Be the same model.
 - Have the same interfaces assigned to the High Availability logical devices.
 - Have the same number and types of interfaces. All interfaces must be preconfigured in FXOS identically before you enable High Availability.
- High Availability is only supported between same-type modules on the Firepower 9300; but the two chassis can include mixed modules. For example, each chassis has an SM-56, SM-48, and SM-40. You can create High Availability pairs between the SM-56 modules, between the SM-48 modules, and between the SM-40 modules.
- For container instances, each unit must use the same resource profile attributes.
- For container instances: Do not use cascading instances (using a shared interface) with High Availability. After a failover occurs and the standby unit rejoins, MAC addresses can overlap temporarily and cause an outage. You should instead use unique interfaces for the gateway instance and inside instance using an external switch to pass traffic between the instances.
- For other High Availability system requirements, see the application configuration guide chapter for High Availability.

Requirements and Prerequisites for Container Instances

For information about high-availability or clustering requirements with multi-instance, see [Requirements and Prerequisites for High Availability, on page 16](#) and see [Requirements and Prerequisites for Clustering, on page 11](#).

Supported Application Types

- The FTD using FMC

Maximum Container Instances and Resources per Model

For each container instance, you can specify the number of CPU cores to assign to the instance. RAM is dynamically allocated according to the number of cores, and disk space is set to 40 GB per instance.

Table 1: Maximum Container Instances and Resources per Model

Model	Max. Container Instances	Available CPU Cores	Available RAM	Available Disk Space
Firepower 4112	3	22	78 GB	308 GB
Firepower 4115	7	46	162 GB	308 GB
Firepower 4125	10	62	162 GB	644 GB
Firepower 4145	14	86	344 GB	608 GB
Firepower 9300 SM-40 security module	13	78	334 GB	1359 GB
Firepower 9300 SM-48 security module	15	94	334 GB	1341 GB
Firepower 9300 SM-56 security module	18	110	334 GB	1314 GB

FMC Requirements

For all instances on a Firepower 4100 chassis or Firepower 9300 module, you must use the same FMC due to the licensing implementation.

Guidelines and Limitations for Logical Devices

See the following sections for guidelines and limitations.

General Guidelines and Limitations

Firewall Mode

You can set the firewall mode to routed or transparent in the bootstrap configuration for the Firepower Threat Defense and ASA.

High Availability

- Configure high availability within the application configuration.
- You can use any data interfaces as the failover and state links. Data-sharing interfaces are not supported.

Multi-Instance and Context Mode

- Multiple context mode is only supported on the ASA.
- Enable multiple context mode in the ASA after you deploy.
- Multi-instance capability with container instances is only available for the Firepower Threat Defense using FMC.
- For Firepower Threat Defense container instances, a single FMC must manage all instances on a security module/engine.
- You can enable TLS crypto acceleration on up to 16 container instances.
- For Firepower Threat Defense container instances, the following features are not supported:
 - Radware DefensePro link decorator
 - FMC UCAPL/CC mode
 - Flow offload to hardware

Clustering Guidelines and Limitations

Switches for Clustering

- Make sure connected switches match the MTU for both cluster data interfaces and the cluster control link interface. You should configure the cluster control link interface MTU to be at least 100 bytes higher than the data interface MTU, so make sure to configure the cluster control link connecting switch appropriately. Because the cluster control link traffic includes data packet forwarding, the cluster control link needs to accommodate the entire size of a data packet plus cluster traffic overhead. In addition, we do not recommend setting the cluster control link MTU between 2561 and 8362; due to block pool handling, this MTU size is not optimal for system operation.
- For Cisco IOS XR systems, if you want to set a non-default MTU, set the IOS XR interface MTU to be 14 bytes higher than the cluster device MTU. Otherwise, OSPF adjacency peering attempts may fail unless the **mtu-ignore** option is used. Note that the cluster device MTU should match the IOS XR *IPv4* MTU. This adjustment is not required for Cisco Catalyst and Cisco Nexus switches.
- On the switch(es) for the cluster control link interfaces, you can optionally enable Spanning Tree PortFast on the switch ports connected to the cluster unit to speed up the join process for new units.
- On the switch, we recommend that you use one of the following EtherChannel load-balancing algorithms: **source-dest-ip** or **source-dest-ip-port** (see the Cisco Nexus OS and Cisco IOS-XE **port-channel load-balance** command). Do not use a **vlan** keyword in the load-balance algorithm because it can cause unevenly distributed traffic to the devices in a cluster.
- If you change the load-balancing algorithm of the EtherChannel on the switch, the EtherChannel interface on the switch temporarily stops forwarding traffic, and the Spanning Tree Protocol restarts. There will be a delay before traffic starts flowing again.
- Switches on the cluster control link path should not verify the L4 checksum. Redirected traffic over the cluster control link does not have a correct L4 checksum. Switches that verify the L4 checksum could cause traffic to be dropped.

- Port-channel bundling downtime should not exceed the configured keepalive interval.
- On Supervisor 2T EtherChannels, the default hash distribution algorithm is adaptive. To avoid asymmetric traffic in a VSS design, change the hash algorithm on the port-channel connected to the cluster device to fixed:

```
router(config)# port-channel id hash-distribution fixed
```

Do not change the algorithm globally; you may want to take advantage of the adaptive algorithm for the VSS peer link.

- Firepower 4100/9300 clusters support LACP graceful convergence. So you can leave LACP graceful convergence enabled on connected Cisco Nexus switches.
- When you see slow bundling of a Spanned EtherChannel on the switch, you can enable LACP rate fast for an individual interface on the switch. FXOS EtherChannels have the LACP rate set to fast by default. Note that some switches, such as the Nexus series, do not support LACP rate fast when performing in-service software upgrades (ISSUs), so we do not recommend using ISSUs with clustering.

EtherChannels for Clustering

- In Catalyst 3750-X Cisco IOS software versions earlier than 15.1(1)S2, the cluster unit did not support connecting an EtherChannel to a switch stack. With default switch settings, if the cluster unit EtherChannel is connected cross stack, and if the control unit switch is powered down, then the EtherChannel connected to the remaining switch will not come up. To improve compatibility, set the **stack-mac persistent timer** command to a large enough value to account for reload time; for example, 8 minutes or 0 for indefinite. Or, you can upgrade to more a more stable switch software version, such as 15.1(1)S2.
- Spanned vs. Device-Local EtherChannel Configuration—Be sure to configure the switch appropriately for Spanned EtherChannels vs. Device-local EtherChannels.
 - Spanned EtherChannels—For cluster unit *Spanned* EtherChannels, which span across all members of the cluster, the interfaces are combined into a single EtherChannel on the switch. Make sure each interface is in the same channel group on the switch.

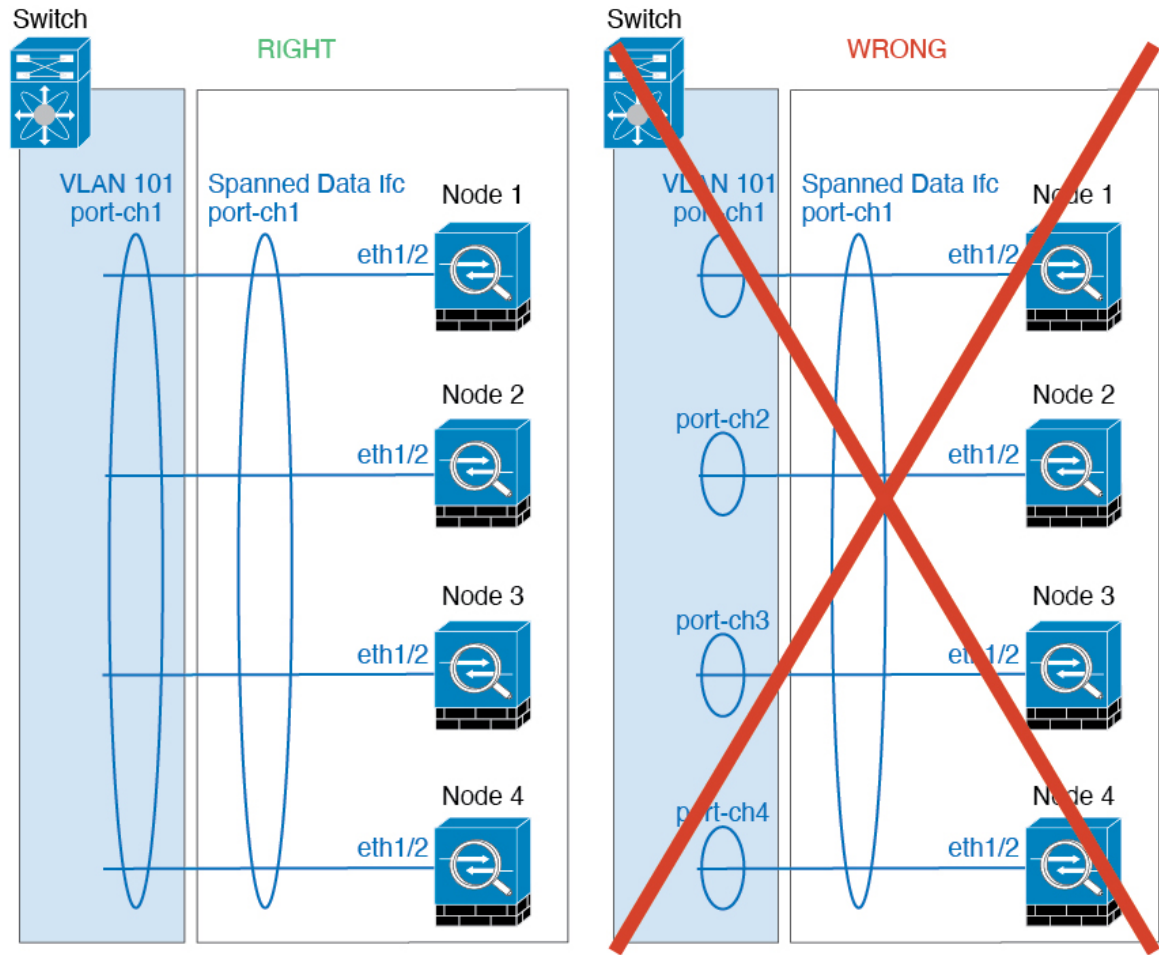

- Device-local EtherChannels—For cluster unit *Device-local* EtherChannels including any EtherChannels configured for the cluster control link, be sure to configure discrete EtherChannels on the switch; do not combine multiple cluster unit EtherChannels into one EtherChannel on the switch.

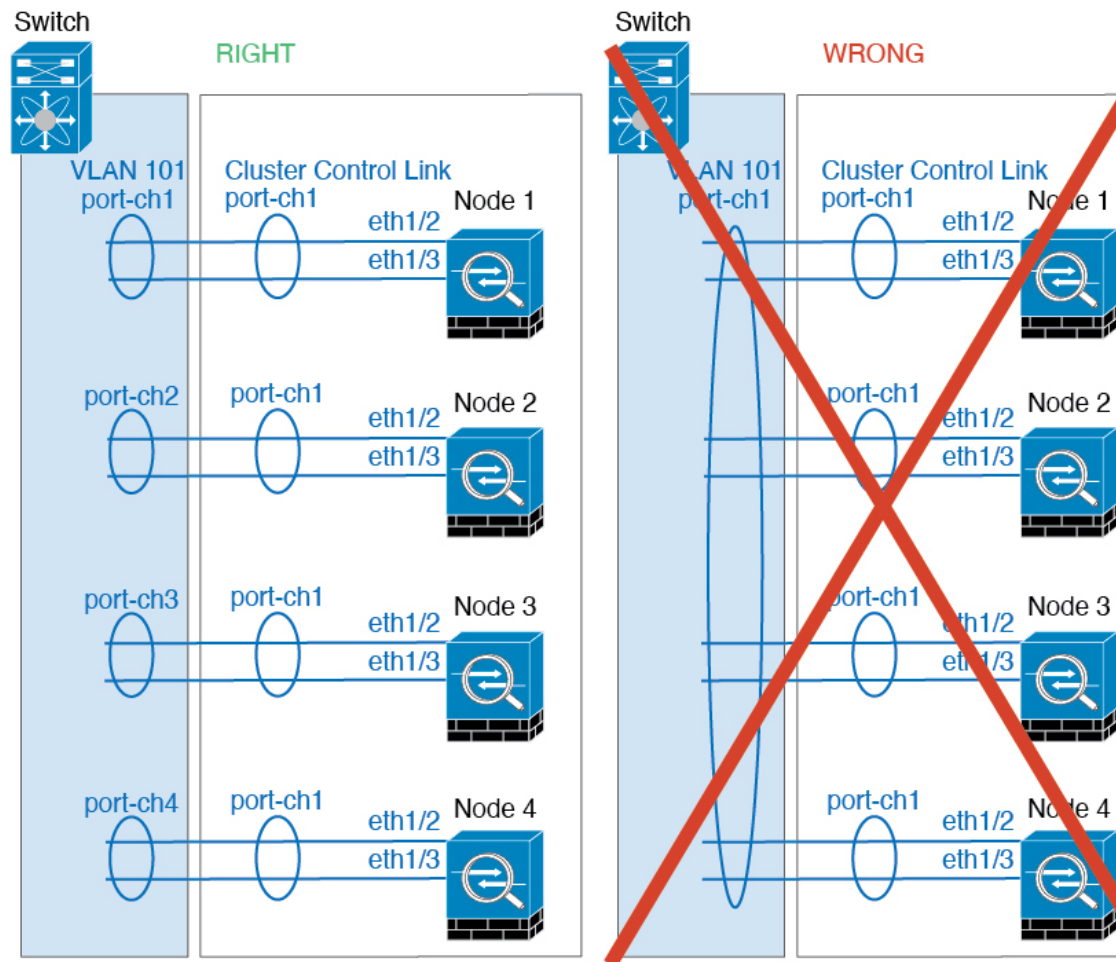

Inter-Site Clustering

See the following guidelines for inter-site clustering:

- The cluster control link latency must be less than 20 ms round-trip time (RTT).
- The cluster control link must be reliable, with no out-of-order or dropped packets; for example, you should use a dedicated link.
- Do not configure connection rebalancing; you do not want connections rebalanced to cluster members at a different site.
- The does not encrypt forwarded data traffic on the cluster control link because it is a dedicated link, even when used on a Data Center Interconnect (DCI). If you use Overlay Transport Virtualization (OTV), or are otherwise extending the cluster control link outside of the local administrative domain, you can configure encryption on your border routers such as 802.1AE MacSec over OTV.
- The cluster implementation does not differentiate between members at multiple sites for incoming connections; therefore, connection roles for a given connection may span across sites. This is expected behavior. However, if you enable director localization, the local director role is always chosen from the same site as the connection owner (according to site ID). Also, the local director chooses a new owner

at the same site if the original owner fails (Note: if the traffic is asymmetric across sites, and there is continuous traffic from the remote site after the original owner fails, then a node from the remote site might become the new owner if it receives a data packet within the re-hosting window.).

- For director localization, the following traffic types do not support localization: NAT or PAT traffic; SCTP-inspected traffic; Fragmentation owner query.
- For transparent mode, if the cluster is placed between a pair of inside and outside routers (AKA North-South insertion), you must ensure that both inside routers share a MAC address, and also that both outside routers share a MAC address. When a cluster member at site 1 forwards a connection to a member at site 2, the destination MAC address is preserved. The packet will only reach the router at site 2 if the MAC address is the same as the router at site 1.
- For transparent mode, if the cluster is placed between data networks and the gateway router at each site for firewalling between internal networks (AKA East-West insertion), then each gateway router should use a First Hop Redundancy Protocol (FHRP) such as HSRP to provide identical virtual IP and MAC address destinations at each site. The data VLANs are extended across the sites using Overlay Transport Virtualization (OTV), or something similar. You need to create filters to prevent traffic that is destined to the local gateway router from being sent over the DCI to the other site. If the gateway router becomes unreachable at one site, you need to remove any filters so traffic can successfully reach the other site's gateway.
- For transparent mode, if the cluster is connected to an HSRP router, you must add the router HSRP MAC address as a static MAC address table entry on the . When adjacent routers use HSRP, traffic destined to the HSRP IP address will be sent to the HSRP MAC Address, but return traffic will be sourced from the MAC address of a particular router's interface in the HSRP pair. Therefore, the MAC address table is typically only updated when the ARP table entry for the HSRP IP address expires, and the sends an ARP request and receives a reply. Because the 's ARP table entries expire after 14400 seconds by default, but the MAC address table entry expires after 300 seconds by default, a static MAC address entry is required to avoid MAC address table expiration traffic drops.
- For routed mode using Spanned EtherChannel, configure site-specific MAC addresses. Extend the data VLANs across the sites using OTV, or something similar. You need to create filters to prevent traffic that is destined to the global MAC address from being sent over the DCI to the other site. If the cluster becomes unreachable at one site, you need to remove any filters so traffic can successfully reach the other site's cluster nodes. Dynamic routing is not supported when an inter-site cluster acts as the first hop router for an extended segment.

Additional Guidelines

- When adding a unit to an existing cluster, or when reloading a unit, there will be a temporary, limited packet/connection drop; this is expected behavior. In some cases, the dropped packets can hang connections; for example, dropping a FIN/ACK packet for an FTP connection will make the FTP client hang. In this case, you need to reestablish the FTP connection.
- If you use a Windows 2003 server connected to a Spanned EtherChannel interface, when the syslog server port is down, and the server does not throttle ICMP error messages, then large numbers of ICMP messages are sent back to the cluster. These messages can result in some units of the cluster experiencing high CPU, which can affect performance. We recommend that you throttle ICMP error messages.
- We recommend connecting EtherChannels to a VSS, vPC, StackWise, or StackWise Virtual for redundancy.

- Within a chassis, you cannot cluster some security modules and run other security modules in standalone mode; you must include all security modules in the cluster.
- For decrypted TLS/SSL connections, the decryption states are not synchronized, and if the connection owner fails, then decrypted connections will be reset. New connections will need to be established to a new unit. Connections that are not decrypted (they match a do-not-decrypt rule) are not affected and are replicated correctly.

Defaults

- The cluster health check feature is enabled by default with the holdtime of 3 seconds. Interface health monitoring is enabled on all interfaces by default.
- The cluster auto-rejoin feature for a failed cluster control link is set to unlimited attempts every 5 minutes.
- The cluster auto-rejoin feature for a failed data interface is set to 3 attempts every 5 minutes, with the increasing interval set to 2.
- Connection replication delay of 5 seconds is enabled by default for HTTP traffic.

Add a Standalone Logical Device

Standalone logical devices can be used alone or as high availability units. For more information about high availability usage, see [Add a High Availability Pair, on page 57](#).

Add a Standalone ASA

Standalone logical devices work either alone or in a High Availability pair. On the Firepower 9300 with multiple security modules, you can deploy either a cluster or standalone devices. The cluster must use all modules, so you cannot mix and match a 2-module cluster plus a single standalone device, for example.

You can deploy a routed or transparent firewall mode ASA from the Firepower 4100/9300 chassis.

For multiple context mode, you must first deploy the logical device, and then enable multiple context mode in the ASA application.

Before you begin

- Download the application image you want to use for the logical device from Cisco.com, and then download that image to the Firepower 4100/9300 chassis.



Note For the Firepower 9300, you can install different application types (ASA and FTD) on separate modules in the chassis. You can also run different versions of an application instance type on separate modules.

- Configure a management interface to use with the logical device. The management interface is required. Note that this management interface is not the same as the chassis management port that is used only for chassis management (in FXOS, you might see it displayed as MGMT, management0, or other similar names).

- Gather the following information:
 - Interface IDs for this device
 - Management interface IP address and network mask
 - Gateway IP address

Procedure

Step 1 Enter security services mode.

scope ssa

Example:

```
Firepower# scope ssa
Firepower /ssa #
```

Step 2 Set the application instance image version.

- a) View available images. Note the Version number that you want to use.

show app

Example:

```
Firepower /ssa # show app
  Name      Version      Author      Supported Deploy Types CSP Type      Is Default
  App
  -----
  asa       9.9.1        cisco       Native      Application No
  asa       9.10.1       cisco       Native      Application Yes
  ftd       6.2.3        cisco       Native      Application Yes
  ftd       6.3.0        cisco       Native,Container Application Yes
```

- b) Set the scope to the security module/engine slot.

scope slot *slot_id*

The *slot_id* is always 1 for the Firepower 4100, and 1, 2, or 3 for the Firepower 9300.

Example:

```
Firepower /ssa # scope slot 1
Firepower /ssa/slot #
```

- c) Create the application instance.

enter app-instance asa *device_name*

The *device_name* can be between 1 and 64 characters. You will use this device name when you create the logical device for this instance.

Example:

```
Firepower /ssa/slot # enter app-instance asa ASA1
Firepower /ssa/slot/app-instance* #
```

- d) Set the ASA image version.

set startup-version *version*

Example:

```
Firepower /ssa/slot/app-instance* # set startup-version 9.10.1
```

- e) Exit to slot mode.

exit

Example:

```
Firepower /ssa/slot/app-instance* # exit
Firepower /ssa/slot* #
```

- f) Exit to ssa mode.

exit

Example:

```
Firepower /ssa/slot* # exit
Firepower /ssa* #
```

Example:

```
Firepower /ssa # scope slot 1
Firepower /ssa/slot # enter app-instance asa ASA1
Firepower /ssa/slot/app-instance* # set startup-version 9.10.1
Firepower /ssa/slot/app-instance* # exit
Firepower /ssa/slot* # exit
Firepower /ssa* #
```

- Step 3** Create the logical device.

enter logical-device *device_name* **asa** *slot_id* **standalone**

Use the same *device_name* as the application instance you added earlier.

Example:

```
Firepower /ssa # enter logical-device ASA1 asa 1 standalone
Firepower /ssa/logical-device* #
```

- Step 4** Assign the management and data interfaces to the logical device. Repeat for each interface.

create external-port-link *name* *interface_id* **asa**

set description *description*

exit

- *name*—The name is used by the Firepower 4100/9300 chassis supervisor; it is not the interface name used in the ASA configuration.
- *description*—Use quotes (") around phrases with spaces.

The management interface is not the same as the chassis management port. You will later enable and configure the data interfaces on the ASA, including setting the IP addresses.

Example:

```
Firepower /ssa/logical-device* # create external-port-link inside Ethernet1/1 asa
Firepower /ssa/logical-device/external-port-link* # set description "inside link"
Firepower /ssa/logical-device/external-port-link* # exit
Firepower /ssa/logical-device* # create external-port-link management Ethernet1/7 asa
Firepower /ssa/logical-device/external-port-link* # set description "management link"
Firepower /ssa/logical-device/external-port-link* # exit
Firepower /ssa/logical-device* # create external-port-link outside Ethernet1/2 asa
Firepower /ssa/logical-device/external-port-link* # set description "external link"
Firepower /ssa/logical-device/external-port-link* # exit
```

Step 5 Configure the management bootstrap information.

- a) Create the bootstrap object.

create mgmt-bootstrap asa

Example:

```
Firepower /ssa/logical-device* # create mgmt-bootstrap asa
Firepower /ssa/logical-device/mgmt-bootstrap* #
```

- b) Specify the firewall mode, routed or transparent.

create bootstrap-key FIREWALL_MODE

set value {routed | transparent}

exit

In routed mode, the device is considered to be a router hop in the network. Each interface that you want to route between is on a different subnet. A transparent firewall, on the other hand, is a Layer 2 firewall that acts like a “bump in the wire,” or a “stealth firewall,” and is not seen as a router hop to connected devices.

The firewall mode is only set at initial deployment. If you re-apply the bootstrap settings, this setting is not used.

Example:

```
Firepower /ssa/logical-device/mgmt-bootstrap* # create bootstrap-key FIREWALL_MODE
Firepower /ssa/logical-device/mgmt-bootstrap/bootstrap-key* # set value routed
Firepower /ssa/logical-device/mgmt-bootstrap/bootstrap-key* # exit
Firepower /ssa/logical-device/mgmt-bootstrap* #
```

- c) Specify the admin and enable password.

create bootstrap-key-secret PASSWORD

set value

Enter a value: *password*

Confirm the value: *password*

exit**Example:**

The pre-configured ASA admin user and enable password is useful for password recovery; if you have FXOS access, you can reset the admin user password if you forget it.

Example:

```
Firepower /ssa/logical-device/mgmt-bootstrap* # create bootstrap-key-secret PASSWORD
Firepower /ssa/logical-device/mgmt-bootstrap/bootstrap-key-secret* # set value
Enter a value: floppylampshade
Confirm the value: floppylampshade
Firepower /ssa/logical-device/mgmt-bootstrap/bootstrap-key-secret* # exit
Firepower /ssa/logical-device/mgmt-bootstrap* #
```

- d) Configure the IPv4 management interface settings.

create ipv4 slot_id default

set ip ip_address mask network_mask

set gateway gateway_address

exit**Example:**

```
Firepower /ssa/logical-device/mgmt-bootstrap* # create ipv4 1 default
Firepower /ssa/logical-device/mgmt-bootstrap/ipv4* # set ip 10.10.10.34 mask 255.255.255.0
Firepower /ssa/logical-device/mgmt-bootstrap/ipv4* # set gateway 10.10.10.1
Firepower /ssa/logical-device/mgmt-bootstrap/ipv4* # exit
Firepower /ssa/logical-device/mgmt-bootstrap* #
```

- e) Configure the IPv6 management interface settings.

create ipv6 slot_id default

set ip ip_address prefix-length prefix

set gateway gateway_address

exit**Example:**

```
Firepower /ssa/logical-device/mgmt-bootstrap* # create ipv6 1 default
Firepower /ssa/logical-device/mgmt-bootstrap/ipv6* # set ip 2001:0DB8:BA98::3210
prefix-length 64
Firepower /ssa/logical-device/mgmt-bootstrap/ipv6* # set gateway 2001:0DB8:BA98::3211
Firepower /ssa/logical-device/mgmt-bootstrap/ipv6* # exit
Firepower /ssa/logical-device/mgmt-bootstrap* #
```

- f) Exit the management bootstrap mode.

exit

Example:

```
Firepower /ssa/logical-device/mgmt-bootstrap* # exit
Firepower /ssa/logical-device* #
```

Step 6 Save the configuration.

commit-buffer

The chassis deploys the logical device by downloading the specified software version and pushing the bootstrap configuration and management interface settings to the application instance. Check the status of the deployment using the **show app-instance** command. The application instance is running and ready to use when the **Admin State is Enabled** and the **Oper State is Online**.

Example:

```
Firepower /ssa/logical-device* # commit-buffer
Firepower /ssa/logical-device # exit
Firepower /ssa # show app-instance
```

App Name	Identifier	Slot	ID	Admin State	Oper State	Running Version	Startup Version
Deploy Type	Profile Name	Cluster	State	Cluster	Role		
asa	asal	2		Disabled	Not Installed		9.12.1
	Native			Not Applicable	None		
ftd	ftdl	1		Enabled	Online	6.4.0.49	6.4.0.49
	Container	Default-Small		Not Applicable	None		

Step 7 See the ASA configuration guide to start configuring your security policy.

Example

```
Firepower# scope ssa
Firepower /ssa # scope slot 1
Firepower /ssa/slot # enter app-instance asa MyDevice1
Firepower /ssa/slot/app-instance* # set startup-version 9.10.1
Firepower /ssa/slot/app-instance* # exit
Firepower /ssa/slot* # exit
Firepower /ssa* # create logical-device MyDevice1 asa 1 standalone
Firepower /ssa/logical-device* # create external-port-link inside Ethernet1/1 asa
Firepower /ssa/logical-device/external-port-link* # set description "inside link"
Firepower /ssa/logical-device/external-port-link* # exit
Firepower /ssa/logical-device* # create external-port-link management Ethernet1/7 asa
Firepower /ssa/logical-device/external-port-link* # set description "management link"
Firepower /ssa/logical-device/external-port-link* # exit
Firepower /ssa/logical-device* # create external-port-link outside Ethernet1/2 asa
Firepower /ssa/logical-device/external-port-link* # set description "external link"
Firepower /ssa/logical-device/external-port-link* # exit
Firepower /ssa/logical-device* # create mgmt-bootstrap asa
Firepower /ssa/logical-device/mgmt-bootstrap* # enter bootstrap-key FIREWALL_MODE
Firepower /ssa/logical-device/mgmt-bootstrap/bootstrap-key* # set value transparent
Firepower /ssa/logical-device/mgmt-bootstrap/bootstrap-key* # exit
Firepower /ssa/logical-device/mgmt-bootstrap* # create bootstrap-key-secret PASSWORD
Firepower /ssa/logical-device/mgmt-bootstrap/bootstrap-key-secret* # set value
Enter a value: secretglassine
Confirm the value: secretglassine
```

```
Firepower /ssa/logical-device/mgmt-bootstrap/bootstrap-key-secret* # exit
Firepower /ssa/logical-device/mgmt-bootstrap* # create ipv4 1 default
Firepower /ssa/logical-device/mgmt-bootstrap/ipv4* # set gateway 10.0.0.1
Firepower /ssa/logical-device/mgmt-bootstrap/ipv4* # set ip 10.0.0.31 mask 255.255.255.0
Firepower /ssa/logical-device/mgmt-bootstrap/ipv4* # exit
Firepower /ssa/logical-device/mgmt-bootstrap/bootstrap-key* # commit-buffer
Firepower /ssa/logical-device/mgmt-bootstrap/bootstrap-key #
```

Add a Standalone FTD for the FMC

Standalone logical devices work either alone or in a High Availability pair. On the Firepower 9300 with multiple security modules, you can deploy either a cluster or standalone devices. The cluster must use all modules, so you cannot mix and match a 2-module cluster plus a single standalone device, for example.

You can use native instances on some modules, and container instances on the other module(s).

Before you begin

- Download the application image you want to use for the logical device from Cisco.com, and then download that image to the Firepower 4100/9300 chassis.



Note For the Firepower 9300, you can install different application types (ASA and FTD) on separate modules in the chassis. You can also run different versions of an application instance type on separate modules.

- Configure a management interface to use with the logical device. The management interface is required. Note that this management interface is not the same as the chassis management port that is used only for chassis management (in FXOS, you might see it displayed as MGMT, management0, or other similar names).
- You can later enable management from a data interface; but you must assign a Management interface to the logical device even if you don't intend to use it after you enable data management. See the **configure network management-data-interface** command in the [FTD command reference](#) for more information.
- You must also configure at least one Data type interface. Optionally, you can also create a firepower-eventing interface to carry all event traffic (such as web events). See [Interface Types](#) for more information.
- For container instances, if you do not want to use the default profile, add a resource profile according to [Add a Resource Profile for Container Instances](#).
- For container instances, before you can install a container instance for the first time, you must reinitialize the security module/engine so that the disk has the correct formatting. An existing logical device will be deleted and then reinstalled as a new device, losing any local application configuration. If you are replacing a native instance with container instances, you will need to delete the native instance in any case. You cannot automatically migrate a native instance to a container instance. See [Reinitializing a Security Module/Engine](#) for more information.
- Gather the following information:
 - Interface IDs for this device

- Management interface IP address and network mask
- Gateway IP address
- FMC IP address and/or NAT ID of your choosing
- DNS server IP address
- Firepower Threat Defense hostname and domain name

Procedure

Step 1 Enter security services mode.

scope ssa

Example:

```
Firepower# scope ssa
Firepower /ssa #
```

Step 2 Accept the end-user license agreement for the Firepower Threat Defense version you want to use. You only need to perform this step if you have not already accepted the EULA for this version.

a) View available images. Note the Version number that you want to use.

show app

Example:

```
Firepower /ssa # show app
  Name          Version      Author      Supported Deploy Types CSP Type      Is Default
  App
  -----
  asa           9.9.1       cisco       Native          Application No
  asa           9.10.1      cisco       Native          Application Yes
  ftd           6.2.3       cisco       Native          Application Yes
  ftd           6.3.0       cisco       Native,Container Application Yes
```

b) Set the scope to the image version.

scope app ftd *application_version*

Example:

```
Firepower /ssa # scope app ftd 6.2.3
Firepower /ssa/app #
```

c) Accept the license agreement.

accept-license-agreement

Example:

```
Firepower /ssa/app # accept-license-agreement
```

End User License Agreement: End User License Agreement

Effective: May 22, 2017

This is an agreement between You and Cisco Systems, Inc. or its affiliates ("Cisco") and governs your Use of Cisco Software. "You" and "Your" means the individual or legal entity licensing the Software under this EULA. "Use" or "Using" means to download, install, activate, access or otherwise use the Software. "Software" means the Cisco computer programs and any Upgrades made available to You by an Approved Source and licensed to You by Cisco. "Documentation" is the Cisco user or technical manuals, training materials, specifications or other documentation applicable to the Software and made available to You by an Approved Source. "Approved Source" means (i) Cisco or (ii) the Cisco authorized reseller, distributor or systems integrator from whom you acquired the Software. "Entitlement" means the license detail; including license metric, duration, and quantity provided in a product ID (PID) published on Cisco's price list, claim certificate or right to use notification. "Upgrades" means all updates, upgrades, bug fixes, error corrections, enhancements and other modifications to the Software and backup copies thereof.

[...]

Please "commit-buffer" if you accept the license agreement, otherwise "discard-buffer".

```
Firepower /ssa/app* #
```

- d) Save the configuration.

commit-buffer

Example:

```
Firepower /ssa/app* # commit-buffer
Firepower /ssa/app #
```

- e) Exit to security services mode.

exit

Example:

```
Firepower /ssa/app # exit
Firepower /ssa #
```

Step 3 Set the application instance parameters, including the image version.

- a) For container instances, view available resource profiles. To add a profile, see [Add a Resource Profile for Container Instances](#).

show resource-profile

Note the profile name you want to use.

Example:

```
Firepower /ssa # show resource-profile
```

Profile Name	App Name	App Version	Is In Use	Security Model	CPU Logical Core
Count	RAM Size (MB)	Default Profile	Profile Type	Description	

bronze	N/A	N/A	No	all
6	N/A	No	Custom	low end device
silver 1	N/A	N/A	No	all
8	N/A	No	Custom	mid-level

- b) Set the scope to the security module/engine slot.

scope slot *slot_id*

The *slot_id* is always 1 for the Firepower 4100, and 1, 2, or 3 for the Firepower 9300.

Example:

```
Firepower /ssa # scope slot 1
Firepower /ssa/slot #
```

- c) Create the application instance.

enter app-instance *ftd device_name*

The *device_name* can be between 1 and 64 characters. You will use this device name when you create the logical device for this instance.

Example:

```
Firepower /ssa/slot # enter app-instance ftd FTD1
Firepower /ssa/slot/app-instance* #
```

- d) For a container instance, set the application instance type to container.

set deploy-type **container**

A container instance uses a subset of resources of the security module/engine, so you can install multiple container instances. A native instance uses all of the resources (CPU, RAM, and disk space) of the security module/engine, so you can only install one native instance.

You cannot change the instance type after you save the configuration. The default type is **native**.

Example:

```
Firepower /ssa/slot/app-instance* # set deploy-type container
```

- e) For a container instance, set the resource profile.

set resource-profile-name *name*

This profile name must already exist.

If you later assign a different resource profile, then the instance will reload, which can take approximately 5 minutes. Note that for established High Availability pairs, if you assign a different-sized resource profile, be sure to make all members the same size as soon as possible.

Example:

```
Firepower /ssa/slot/app-instance* # set resource-profile-name bronze
```

- f) Set the Firepower Threat Defense image version.

set startup-version *version*

Enter the version number that you noted earlier in this procedure when you accepted the EULA.

Example:

```
Firepower /ssa/slot/app-instance* # set startup-version 6.3.0
```

- g) For a container instance, enable or disable TLS crypto acceleration.

enter hw-crypto

set admin-state {**enabled** | **disabled**}

exit

This setting enables TLS crypto acceleration in hardware, and improves performance for certain types of traffic. This feature is enabled by default. You can enable TLS crypto acceleration for up to 16 instances per security module. This feature is not supported for native instances. To view the percentage of hardware crypto resources allocated to this instance, enter the **show hw-crypto** command. Note that Version 2 refers to the TLS crypto acceleration type used in FXOS 2.7 and later.

Example:

```
Firepower /ssa/slot/app-instance* # enter hw-crypto
Firepower /ssa/slot/app-instance/hw-crypto* # set admin-state enabled
Firepower /ssa/slot/app-instance/hw-crypto* # exit
Firepower /ssa/slot/app-instance* # commit-buffer
Firepower /ssa/slot/app-instance # show hw-crypto
Hardware Crypto:
```

Admin State	Hardware Crypto Size	Hardware Crypto Version
enabled	40%	2

- h) Exit to slot mode.

exit**Example:**

```
Firepower /ssa/slot/app-instance* # exit
Firepower /ssa/slot* #
```

- i) (Optional) Create the Radware DefensePro instance for the Firepower 4110 or 4120, which require you to create the application instance before you create the logical device (Radware DefensePro is not supported with container instances).

enter app-instance vdp *device_name*

exit

Set the *device_name* to match the Firepower Threat Defense application instance. After you complete the logical device configuration, you must continue configuring the Radware DefensePro decorator in a service chain with the Firepower Threat Defense logical device. See [Configure Radware DefensePro on a Standalone Logical Device, on page 93](#), starting with step 4.

Example:

```
Firepower /ssa/slot* # enter app-instance vdp FTD1
Firepower /ssa/slot/app-instance* # exit
Firepower /ssa/slot* #
```

j) Exit to ssa mode.

exit

Example:

```
Firepower /ssa/slot* # exit
Firepower /ssa* #
```

Example:

```
Firepower /ssa # scope slot 1
Firepower /ssa/slot # enter app-instance ftd MyDevice1
Firepower /ssa/slot/app-instance* # set deploy-type container
Firepower /ssa/slot/app-instance* # set resource-profile-name silver 1
Firepower /ssa/slot/app-instance* # set startup-version 6.3.0
Firepower /ssa/slot/app-instance* # exit
Firepower /ssa/slot* # exit
Firepower /ssa* #
```

Step 4 Create the logical device.

enter logical-device *device_name* **ftd** *slot_id* **standalone**

Use the same *device_name* as the application instance you added earlier.

Example:

```
Firepower /ssa # enter logical-device FTD1 ftd 1 standalone
Firepower /ssa/logical-device* #
```

Step 5 Assign the management and data interfaces to the logical device. Repeat for each interface.

create external-port-link *name* *interface_id* **ftd**

set description *description*

exit

- *name*—The name is used by the Firepower 4100/9300 chassis supervisor; it is not the interface name used in the Firepower Threat Defense configuration.
- *description*—Use quotes (") around phrases with spaces.

The management interface is not the same as the chassis management port. You will later enable and configure the data interfaces in FMC, including setting the IP addresses.

You can only assign up to 10 data-sharing interfaces to a container instance. Also, each data-sharing interface can be assigned to at most 14 container instances.

Example:

```

Firepower /ssa/logical-device* # create external-port-link inside Ethernet1/1 ftd
Firepower /ssa/logical-device/external-port-link* # set description "inside link"
Firepower /ssa/logical-device/external-port-link* # exit
Firepower /ssa/logical-device* # create external-port-link management Ethernet1/7 ftd
Firepower /ssa/logical-device/external-port-link* # set description "management link"
Firepower /ssa/logical-device/external-port-link* # exit
Firepower /ssa/logical-device* # create external-port-link outside Ethernet1/2 ftd
Firepower /ssa/logical-device/external-port-link* # set description "external link"
Firepower /ssa/logical-device/external-port-link* # exit

```

Step 6 Enable link state synchronization.

set link state sync enabled

The chassis can now synchronize the Firepower Threat Defense operational link state with the physical link state for data interfaces. Currently, interfaces will be in an Up state as long as the FXOS admin state is up and the physical link state is up. The Firepower Threat Defense application interface admin state is not considered. Without synchronization from Firepower Threat Defense, data interfaces can be in an Up state physically before the Firepower Threat Defense application has completely come online, for example, or can stay Up for a period of time after you initiate an Firepower Threat Defense shutdown. For inline sets, this state mismatch can result in dropped packets because external routers may start sending traffic to the Firepower Threat Defense before the Firepower Threat Defense can handle it.

This feature is disabled by default, and can be enabled per logical device in FXOS. This feature does not affect non-data interfaces such as Management or Cluster.

When you enable Firepower Threat Defense link state synchronization, the **Service State** of an interface in FXOS will be synced with the administrative state of this interface in Firepower Threat Defense. For example, if you shut down an interface in Firepower Threat Defense, the Service State will show as Disabled. If you shut down the Firepower Threat Defense application, all interfaces will show as Disabled. For Hardware Bypass interfaces, administratively shutting down the interface in Firepower Threat Defense will set the Service State to Disabled; but shutting down the Firepower Threat Defense application or other chassis-level shutdowns, including powering off, keeps the interface pair Enabled.

If you disable Firepower Threat Defense link state synchronization, the Service State will always show as Enabled.

Note This feature is not supported for clustering, container instances, or an Firepower Threat Defense with a Radware vDP decorator. It is also not supported for the ASA.

To view the current Service State of an interface, as well as the last down reason, enter the **show interface expand detail** command.

Example:

```

Firepower /ssa/logical-device* # set link state sync enabled
Firepower /ssa/logical-device* # scope eth-uplink
Firepower /eth-uplink* # scope fabric a
Firepower /eth-uplink/fabric* # show interface expand detail
Interface:
  Port Name: Ethernet1/2
  User Label:
  Port Type: Data
  Admin State: Enabled
  Oper State: Up
  State Reason:
  flow control policy: default
  Auto negotiation: Yes
  Admin Speed: 1 Gbps

```

```

Oper Speed: 1 Gbps
Admin Duplex: Full Duplex
Oper Duplex: Full Duplex
Ethernet Link Profile name: default
Oper Ethernet Link Profile name: fabric/lan/eth-link-prof-default
Ulld Oper State: Admin Disabled
Inline Pair Admin State: Enabled
Inline Pair Peer Port Name:
Service State: Enabled
Last Service State Down Reason: None
Allowed Vlan: All
Network Control Policy: default
Current Task:
<...>

```

Step 7 Configure the management bootstrap parameters.

These settings are meant for initial deployment only, or for disaster recovery. For normal operation, you can later change most values in the application CLI configuration.

- a) Create the bootstrap object.

create mgmt-bootstrap ftd

Example:

```

Firepower /ssa/logical-device* # create mgmt-bootstrap ftd
Firepower /ssa/logical-device/mgmt-bootstrap* #

```

- b) For a native instance, set the manager to FMC.

enter bootstrap-key MANAGEMENT_TYPE

set value FMC

exit

Native instances also support FDM as a manager. After you deploy the logical device, you cannot change the manager type.

Example:

```

Firepower /ssa/logical-device/mgmt-bootstrap* # enter bootstrap-key MANAGEMENT_TYPE
Firepower /ssa/logical-device/mgmt-bootstrap/bootstrap-key* # set value FMC
Firepower /ssa/logical-device/mgmt-bootstrap/bootstrap-key* # exit
Firepower /ssa/logical-device/mgmt-bootstrap* #

```

- c) Specify the IP address or hostname or NAT ID of the managing FMC:

Set one of the following:

- **enter bootstrap-key FIREPOWER_MANAGER_IP**

set value *IP_address*

exit

- **enter bootstrap-key FQDN**

set value *fmc_hostname*

exit

• **enter bootstrap-key NAT_ID**

set value *nat_id*

exit

Normally, you need both IP addresses (along with a registration key) for both routing purposes and for authentication: the FMC specifies the device IP address, and the device specifies the FMC IP address. However, if you only know one of the IP addresses, which is the minimum requirement for routing purposes, then you must also specify a unique NAT ID on both sides of the connection to establish trust for the initial communication and to look up the correct registration key. You can specify any text string as the NAT ID, from 1 to 37 characters. The FMC and device use the registration key and NAT ID (instead of IP addresses) to authenticate and authorize for initial registration.

Example:

```
Firepower /ssa/logical-device/mgmt-bootstrap* # create bootstrap-key FIREPOWER_MANAGER_IP
Firepower /ssa/logical-device/mgmt-bootstrap/bootstrap-key* # set value 10.10.10.7
Firepower /ssa/logical-device/mgmt-bootstrap/bootstrap-key* # exit
Firepower /ssa/logical-device/mgmt-bootstrap* #
```

- d) Specify the firewall mode, routed or transparent.

create bootstrap-key FIREWALL_MODE

set value {**routed** | **transparent**}

exit

In routed mode, the device is considered to be a router hop in the network. Each interface that you want to route between is on a different subnet. A transparent firewall, on the other hand, is a Layer 2 firewall that acts like a “bump in the wire,” or a “stealth firewall,” and is not seen as a router hop to connected devices.

The firewall mode is only set at initial deployment. If you re-apply the bootstrap settings, this setting is not used.

Example:

```
Firepower /ssa/logical-device/mgmt-bootstrap* # create bootstrap-key FIREWALL_MODE
Firepower /ssa/logical-device/mgmt-bootstrap/bootstrap-key* # set value routed
Firepower /ssa/logical-device/mgmt-bootstrap/bootstrap-key* # exit
Firepower /ssa/logical-device/mgmt-bootstrap* #
```

- e) Specify the key to be shared between the device and the FMC. You can choose any passphrase for this key between 1 and 37 characters; you will enter the same key on the FMC when you add the Firepower Threat Defense.

create bootstrap-key-secret REGISTRATION_KEY

set value

Enter a value: *registration_key*

Confirm the value: *registration_key*

exit

Example:

```
Firepower /ssa/logical-device/mgmt-bootstrap* # create bootstrap-key-secret
REGISTRATION_KEY
Firepower /ssa/logical-device/mgmt-bootstrap/bootstrap-key-secret* # set value
Enter a value: gratuitousapples
Confirm the value: gratuitousapples
Firepower /ssa/logical-device/mgmt-bootstrap/bootstrap-key-secret* # exit
Firepower /ssa/logical-device/mgmt-bootstrap* #
```

- f) Specify the admin password. This password is used for the admin user for CLI access.

create bootstrap-key-secret PASSWORD**set value**

Enter a value: *password*

Confirm the value: *password*

exit**Example:**

```
Firepower /ssa/logical-device/mgmt-bootstrap* # create bootstrap-key-secret PASSWORD
Firepower /ssa/logical-device/mgmt-bootstrap/bootstrap-key-secret* # set value
Enter a value: floppylampshade
Confirm the value: floppylampshade
Firepower /ssa/logical-device/mgmt-bootstrap/bootstrap-key-secret* # exit
Firepower /ssa/logical-device/mgmt-bootstrap* #
```

- g) Specify the fully qualified hostname.

create bootstrap-key FQDN**set value fqdn****exit****Example:**

```
Firepower /ssa/logical-device/mgmt-bootstrap* # create bootstrap-key FQDN
Firepower /ssa/logical-device/mgmt-bootstrap/bootstrap-key* # set value ftd1.cisco.com
Firepower /ssa/logical-device/mgmt-bootstrap/bootstrap-key* # exit
Firepower /ssa/logical-device/mgmt-bootstrap* #
```

- h) Specify a comma-separated list of DNS servers.

create bootstrap-key DNS_SERVERS**set value dns_servers****exit**

The Firepower Threat Defense uses DNS if you specify a hostname for the FMC, for example.

Example:

```
Firepower /ssa/logical-device/mgmt-bootstrap* # create bootstrap-key DNS_SERVERS
Firepower /ssa/logical-device/mgmt-bootstrap/bootstrap-key* # set value 10.9.8.7,10.9.6.5
Firepower /ssa/logical-device/mgmt-bootstrap/bootstrap-key* # exit
```

```
Firepower /ssa/logical-device/mgmt-bootstrap* #
```

- i) Specify a comma-separated list of search domains.

```
create bootstrap-key SEARCH_DOMAINS
```

```
set value search_domains
```

```
exit
```

Example:

```
Firepower /ssa/logical-device/mgmt-bootstrap* # create bootstrap-key SEARCH_DOMAINS
Firepower /ssa/logical-device/mgmt-bootstrap/bootstrap-key* # set value
cisco.com,example.com
Firepower /ssa/logical-device/mgmt-bootstrap/bootstrap-key* # exit
Firepower /ssa/logical-device/mgmt-bootstrap* #
```

- j) (Optional) For a container instance, permit Expert Mode from Firepower Threat Defense SSH sessions. Expert Mode provides Firepower Threat Defense shell access for advanced troubleshooting.

```
create bootstrap-key PERMIT_EXPERT_MODE
```

```
set value {yes | no}
```

```
exit
```

- **yes**—Users who access this container instance directly from an SSH session can enter Expert Mode.
- **no**—Only users who access the container instance from the FXOS CLI can enter Expert Mode.

By default for container instances, Expert Mode is only available to users who access the Firepower Threat Defense CLI from the FXOS CLI. This limitation is only applied to container instances to increase isolation between instances. Use Expert Mode only if a documented procedure tells you it is required, or if the Cisco Technical Assistance Center asks you to use it. To enter this mode, use the **expert** command in the Firepower Threat Defense CLI.

Example:

```
Firepower /ssa/logical-device/mgmt-bootstrap* # create bootstrap-key PERMIT_EXPERT_MODE
Firepower /ssa/logical-device/mgmt-bootstrap/bootstrap-key* # set value yes
Firepower /ssa/logical-device/mgmt-bootstrap/bootstrap-key* # exit
Firepower /ssa/logical-device/mgmt-bootstrap* #
```

- k) Configure the IPv4 management interface settings.

```
create ipv4 slot_id firepower
```

```
set ip ip_address mask network_mask
```

```
set gateway gateway_address
```

```
exit
```

Example:

```
Firepower /ssa/logical-device/mgmt-bootstrap* # create ipv4 1 firepower
Firepower /ssa/logical-device/mgmt-bootstrap/ipv4* # set ip 10.10.10.34 mask 255.255.255.0
Firepower /ssa/logical-device/mgmt-bootstrap/ipv4* # set gateway 10.10.10.1
Firepower /ssa/logical-device/mgmt-bootstrap/ipv4* # exit
```

```
Firepower /ssa/logical-device/mgmt-bootstrap* #
```

- l) Configure the IPv6 management interface settings.

create ipv6 slot_id firepower

set ip ip_address prefix-length prefix

set gateway gateway_address

exit

Example:

```
Firepower /ssa/logical-device/mgmt-bootstrap* # create ipv6 1 firepower
Firepower /ssa/logical-device/mgmt-bootstrap/ipv6* # set ip 2001:0DB8:BA98::3210
prefix-length 64
Firepower /ssa/logical-device/mgmt-bootstrap/ipv6* # set gateway 2001:0DB8:BA98::3211
Firepower /ssa/logical-device/mgmt-bootstrap/ipv6* # exit
Firepower /ssa/logical-device/mgmt-bootstrap* #
```

- m) Exit the management bootstrap mode.

exit

Example:

```
Firepower /ssa/logical-device/mgmt-bootstrap* # exit
Firepower /ssa/logical-device* #
```

- Step 8** Save the configuration.

commit-buffer

The chassis deploys the logical device by downloading the specified software version and pushing the bootstrap configuration and management interface settings to the application instance. Check the status of the deployment using the **show app-instance** command. The application instance is running and ready to use when the **Admin State** is **Enabled** and the **Oper State** is **Online**.

Example:

```
Firepower /ssa/logical-device* # commit-buffer
Firepower /ssa/logical-device # exit
Firepower /ssa # show app-instance
```

App Name	Identifier	Slot ID	Admin State	Oper State	Running Version	Startup Version
Deploy Type	Profile Name	Cluster	State	Cluster Role		
asa	asa1	2	Disabled	Not Installed		9.12.1
	Native		Not Applicable	None		
ftd	ftd1	1	Enabled	Online	6.4.0.49	6.4.0.49
	Container	Default-Small	Not Applicable	None		

- Step 9** See the FMC configuration guide to add the Firepower Threat Defense as a managed device and start configuring your security policy.

Example

```

Firepower# scope ssa
Firepower /ssa* # scope app ftd 6.3.0
Firepower /ssa/app* # accept-license-agreement
Firepower /ssa/app* # commit-buffer
Firepower /ssa/app # exit
Firepower /ssa # scope slot 1
Firepower /ssa/slot # enter app-instance ftd MyDevice1
Firepower /ssa/slot/app-instance* # set deploy-type container
Firepower /ssa/slot/app-instance* # set resource-profile-name silver 1
Firepower /ssa/slot/app-instance* # set startup-version 6.3.0
Firepower /ssa/slot/app-instance* # exit
Firepower /ssa/slot* # exit
Firepower /ssa* # create logical-device MyDevice1 ftd 1 standalone
Firepower /ssa/logical-device* # create external-port-link inside Ethernet1/1 ftd
Firepower /ssa/logical-device/external-port-link* # set description "inside link"
Firepower /ssa/logical-device/external-port-link* # exit
Firepower /ssa/logical-device* # create external-port-link management Ethernet1/7 ftd
Firepower /ssa/logical-device/external-port-link* # set description "management link"
Firepower /ssa/logical-device/external-port-link* # exit
Firepower /ssa/logical-device* # create external-port-link outside Ethernet1/2 ftd
Firepower /ssa/logical-device/external-port-link* # set description "external link"
Firepower /ssa/logical-device/external-port-link* # exit
Firepower /ssa/logical-device* # create mgmt-bootstrap ftd
Firepower /ssa/logical-device/mgmt-bootstrap* # create bootstrap-key FIREPOWER_MANAGER_IP
Firepower /ssa/logical-device/mgmt-bootstrap/bootstrap-key* # set value 10.0.0.100
Firepower /ssa/logical-device/mgmt-bootstrap/bootstrap-key* # exit
Firepower /ssa/logical-device/mgmt-bootstrap* # create bootstrap-key FIREWALL_MODE
Firepower /ssa/logical-device/mgmt-bootstrap/bootstrap-key* # set value routed
Firepower /ssa/logical-device/mgmt-bootstrap/bootstrap-key* # exit
Firepower /ssa/logical-device/mgmt-bootstrap* # create bootstrap-key-secret REGISTRATION_KEY
Firepower /ssa/logical-device/mgmt-bootstrap/bootstrap-key-secret* # set value
Enter a value: juniorwindowpane
Confirm the value: juniorwindowpane
Firepower /ssa/logical-device/mgmt-bootstrap/bootstrap-key-secret* # exit
Firepower /ssa/logical-device/mgmt-bootstrap* # create bootstrap-key-secret PASSWORD
Firepower /ssa/logical-device/mgmt-bootstrap/bootstrap-key-secret* # set value
Enter a value: secretglassine
Confirm the value: secretglassine
Firepower /ssa/logical-device/mgmt-bootstrap/bootstrap-key-secret* # exit
Firepower /ssa/logical-device/mgmt-bootstrap* # create ipv4 1 firepower
Firepower /ssa/logical-device/mgmt-bootstrap/ipv4* # set gateway 10.0.0.1
Firepower /ssa/logical-device/mgmt-bootstrap/ipv4* # set ip 10.0.0.31 mask 255.255.255.0
Firepower /ssa/logical-device/mgmt-bootstrap/ipv4* # exit
Firepower /ssa/logical-device/mgmt-bootstrap* # create bootstrap-key FQDN
Firepower /ssa/logical-device/mgmt-bootstrap/bootstrap-key* # set value ftd.cisco.com
Firepower /ssa/logical-device/mgmt-bootstrap/bootstrap-key* # exit
Firepower /ssa/logical-device/mgmt-bootstrap* # create bootstrap-key DNS_SERVERS
Firepower /ssa/logical-device/mgmt-bootstrap/bootstrap-key* # set value 192.168.1.1
Firepower /ssa/logical-device/mgmt-bootstrap/bootstrap-key* # exit
Firepower /ssa/logical-device/mgmt-bootstrap* # create bootstrap-key SEARCH_DOMAINS
Firepower /ssa/logical-device/mgmt-bootstrap/bootstrap-key* # set value search.com
Firepower /ssa/logical-device/mgmt-bootstrap/bootstrap-key* # commit-buffer
Firepower /ssa/logical-device/mgmt-bootstrap/bootstrap-key #

```

Add a Standalone FTD for the FDM

You can use the FDM with a native instance. Container instances are not supported. Standalone logical devices work either alone or in a High Availability pair.

Before you begin

- Download the application image you want to use for the logical device from Cisco.com, and then download that image to the Firepower 4100/9300 chassis.



Note For the Firepower 9300, you can install different application types (ASA and FTD) on separate modules in the chassis. You can also run different versions of an application instance type on separate modules.

- Configure a management interface to use with the logical device. The management interface is required. Note that this management interface is not the same as the chassis management port that is used only for chassis management (in FXOS, you might see it displayed as MGMT, management0, or other similar names).
- You must also configure at least one Data type interface.
- Gather the following information:
 - Interface IDs for this device
 - Management interface IP address and network mask
 - Gateway IP address
 - DNS server IP address
 - FTD hostname and domain name

Procedure

Step 1 Enter security services mode.

scope ssa

Example:

```
Firepower# scope ssa
Firepower /ssa #
```

Step 2 Accept the end-user license agreement for the Firepower Threat Defense version you want to use. You only need to perform this step if you have not already accepted the EULA for this version.

- a) View available images. Note the Version number that you want to use.

show app

Example:

```

Firepower /ssa # show app
Name          Version      Author      Supported Deploy Types CSP Type      Is Default
App
-----
asa           9.9.1        cisco       Native          Application No
asa           9.10.1       cisco       Native          Application Yes
ftd           6.2.3        cisco       Native          Application Yes
ftd           6.3.0        cisco       Native,Container Application Yes

```

- b) Set the scope to the image version.

scope app ftd *application_version*

Example:

```

Firepower /ssa # scope app ftd 6.5.0
Firepower /ssa/app #

```

- c) Accept the license agreement.

accept-license-agreement

Example:

```

Firepower /ssa/app # accept-license-agreement

```

```

End User License Agreement: End User License Agreement

```

```

Effective: May 22, 2017

```

```

This is an agreement between You and Cisco Systems, Inc. or its affiliates
("Cisco") and governs your Use of Cisco Software. "You" and "Your" means the
individual or legal entity licensing the Software under this EULA. "Use" or
"Using" means to download, install, activate, access or otherwise use the
Software. "Software" means the Cisco computer programs and any Upgrades made
available to You by an Approved Source and licensed to You by Cisco.
"Documentation" is the Cisco user or technical manuals, training materials,
specifications or other documentation applicable to the Software and made
available to You by an Approved Source. "Approved Source" means (i) Cisco or
(ii) the Cisco authorized reseller, distributor or systems integrator from whom
you acquired the Software. "Entitlement" means the license detail; including
license metric, duration, and quantity provided in a product ID (PID) published
on Cisco's price list, claim certificate or right to use notification.
"Upgrades" means all updates, upgrades, bug fixes, error corrections,
enhancements and other modifications to the Software and backup copies thereof.

```

```

[...]

```

```

Please "commit-buffer" if you accept the license agreement, otherwise "discard-buffer".

```

```

Firepower /ssa/app* #

```

- d) Save the configuration.

commit-buffer

Example:

```

Firepower /ssa/app* # commit-buffer

```

```
Firepower /ssa/app #
```

- e) Exit to security services mode.

exit

Example:

```
Firepower /ssa/app # exit
Firepower /ssa #
```

Step 3 Set the application instance image version.

- a) Set the scope to the security module/engine slot.

scope slot *slot_id*

The *slot_id* is always 1 for the Firepower 4100, and 1, 2, or 3 for the Firepower 9300.

Example:

```
Firepower /ssa # scope slot 1
Firepower /ssa/slot #
```

- b) Create the application instance.

enter app-instance ftd *device_name*

The *device_name* can be between 1 and 64 characters. You will use this device name when you create the logical device for this instance.

Example:

```
Firepower /ssa/slot # enter app-instance ftd FTD1
Firepower /ssa/slot/app-instance* #
```

- c) Set the Firepower Threat Defense image version.

set startup-version *version*

Enter the version number that you noted earlier in this procedure when you accepted the EULA.

Example:

```
Firepower /ssa/slot/app-instance* # set startup-version 6.5.0
```

- d) Exit to slot mode.

exit

Example:

```
Firepower /ssa/slot/app-instance* # exit
Firepower /ssa/slot* #
```

- e) (Optional) Create the Radware DefensePro instance for the Firepower 4110 or 4120, which require you to create the application instance before you create the logical device.

```
enter app-instance vdp device_name
```

```
exit
```

Set the *device_name* to match the Firepower Threat Defense application instance. After you complete the logical device configuration, you must continue configuring the Radware DefensePro decorator in a service chain with the Firepower Threat Defense logical device. See [Configure Radware DefensePro on a Standalone Logical Device, on page 93](#), starting with step 4.

Example:

```
Firepower /ssa/slot* # enter app-instance vdp FTD1
Firepower /ssa/slot/app-instance* # exit
Firepower /ssa/slot* #
```

- f) Exit to ssa mode.

```
exit
```

Example:

```
Firepower /ssa/slot* # exit
Firepower /ssa* #
```

Example:

```
Firepower /ssa # scope slot 1
Firepower /ssa/slot # enter app-instance ftd MyDevice1
Firepower /ssa/slot/app-instance* # set startup-version 6.5.0
Firepower /ssa/slot/app-instance* # exit
Firepower /ssa/slot* # exit
Firepower /ssa* #
```

- Step 4** Create the logical device.

```
enter logical-device device_name ftd slot_id standalone
```

Use the same *device_name* as the application instance you added earlier.

Example:

```
Firepower /ssa # enter logical-device FTD1 ftd 1 standalone
Firepower /ssa/logical-device* #
```

- Step 5** Assign the management and data interfaces to the logical device. Repeat for each interface.

```
create external-port-link name interface_id ftd
```

```
set description description
```

```
exit
```

- *name*—The name is used by the Firepower 4100/9300 chassis supervisor; it is not the interface name used in the Firepower Threat Defense configuration.
- *description*—Use quotes (") around phrases with spaces.

The management interface is not the same as the chassis management port. You will later enable and configure the data interfaces in the FDM, including setting the IP addresses.

Example:

```
Firepower /ssa/logical-device* # create external-port-link inside Ethernet1/1 ftd
Firepower /ssa/logical-device/external-port-link* # set description "inside link"
Firepower /ssa/logical-device/external-port-link* # exit
Firepower /ssa/logical-device* # create external-port-link management Ethernet1/7 ftd
Firepower /ssa/logical-device/external-port-link* # set description "management link"
Firepower /ssa/logical-device/external-port-link* # exit
Firepower /ssa/logical-device* # create external-port-link outside Ethernet1/2 ftd
Firepower /ssa/logical-device/external-port-link* # set description "external link"
Firepower /ssa/logical-device/external-port-link* # exit
```

Step 6 Enable link state synchronization.

set link state sync enabled

The chassis can now synchronize the FTD operational link state with the physical link state for data interfaces. Currently, interfaces will be in an Up state as long as the FXOS admin state is up and the physical link state is up. The FTD application interface admin state is not considered. Without synchronization from the FTD, data interfaces can be in an Up state physically before the FTD application has completely come online, for example, or can stay Up for a period of time after you initiate the FTD shutdown. For inline sets, this state mismatch can result in dropped packets because external routers may start sending traffic to the FTD device before the device can handle it.

This feature is disabled by default, and can be enabled per logical device in FXOS. This feature does not affect non-data interfaces such as Management or Cluster.

When you enable the FTD link state synchronization, the **Service State** of an interface in FXOS will be synced with the administrative state of this interface in the FTD. For example, if you shut down an interface in the FTD, the Service State will show as Disabled. If you shut down the FTD application, all interfaces will show as Disabled. For Hardware Bypass interfaces, administratively shutting down the interface in the FTD will set the Service State to Disabled; but shutting down the FTD application or other chassis-level shutdowns, including powering off, keeps the interface pair Enabled.

If you disable the FTD link state synchronization, the Service State will always show as Enabled.

Note This feature is not supported for clustering, container instances, or an FTD with a Radware vDP decorator. It is also not supported for the ASA.

To view the current Service State of an interface, as well as the last down reason, enter the **show interface expand detail** command.

Example:

```
Firepower /ssa/logical-device* # set link state sync enabled
Firepower /ssa/logical-device* # scope eth-uplink
Firepower /eth-uplink* # scope fabric a
Firepower /eth-uplink/fabric* # show interface expand detail
Interface:
  Port Name: Ethernet1/2
  User Label:
  Port Type: Data
  Admin State: Enabled
  Oper State: Up
  State Reason:
```

```

flow control policy: default
Auto negotiation: Yes
Admin Speed: 1 Gbps
Oper Speed: 1 Gbps
Admin Duplex: Full Duplex
Oper Duplex: Full Duplex
Ethernet Link Profile name: default
Oper Ethernet Link Profile name: fabric/lan/eth-link-prof-default
Uddld Oper State: Admin Disabled
Inline Pair Admin State: Enabled
Inline Pair Peer Port Name:
Service State: Enabled
Last Service State Down Reason: None
Allowed Vlan: All
Network Control Policy: default
Current Task:
<...>

```

Step 7 Configure the management bootstrap parameters.

These settings are meant for initial deployment only, or for disaster recovery. For normal operation, you can later change most values in the application CLI configuration.

- a) Create the bootstrap object.

```
create mgmt-bootstrap ftd
```

Example:

```

Firepower /ssa/logical-device* # create mgmt-bootstrap ftd
Firepower /ssa/logical-device/mgmt-bootstrap* #

```

- b) For a native instance, set the manager to the FDM.

```
enter bootstrap-key MANAGEMENT_TYPE
```

```
set value LOCALLY_MANAGED
```

```
exit
```

Native instances also support the FMC as a manager. After you deploy the logical device, you cannot change the manager type.

Example:

```

Firepower /ssa/logical-device/mgmt-bootstrap* # enter bootstrap-key MANAGEMENT_TYPE
Firepower /ssa/logical-device/mgmt-bootstrap/bootstrap-key* # set value LOCALLY_MANAGED
Firepower /ssa/logical-device/mgmt-bootstrap/bootstrap-key* # exit
Firepower /ssa/logical-device/mgmt-bootstrap* #

```

- c) Specify the admin password. This password is used for the admin user for CLI access.

```
create bootstrap-key-secret PASSWORD
```

```
set value
```

Enter a value: *password*

Confirm the value: *password*

```
exit
```

Example:

```
Firepower /ssa/logical-device/mgmt-bootstrap* # create bootstrap-key-secret PASSWORD
Firepower /ssa/logical-device/mgmt-bootstrap/bootstrap-key-secret* # set value
Enter a value: floppylampshade
Confirm the value: floppylampshade
Firepower /ssa/logical-device/mgmt-bootstrap/bootstrap-key-secret* # exit
Firepower /ssa/logical-device/mgmt-bootstrap* #
```

- d) Specify the fully qualified hostname.

create bootstrap-key FQDN

set value *fqdn*

exit

Example:

```
Firepower /ssa/logical-device/mgmt-bootstrap* # create bootstrap-key FQDN
Firepower /ssa/logical-device/mgmt-bootstrap/bootstrap-key* # set value ftd1.cisco.com
Firepower /ssa/logical-device/mgmt-bootstrap/bootstrap-key* # exit
Firepower /ssa/logical-device/mgmt-bootstrap* #
```

- e) Specify a comma-separated list of DNS servers.

create bootstrap-key DNS_SERVERS

set value *dns_servers*

exit

Example:

```
Firepower /ssa/logical-device/mgmt-bootstrap* # create bootstrap-key DNS_SERVERS
Firepower /ssa/logical-device/mgmt-bootstrap/bootstrap-key* # set value 10.9.8.7,10.9.6.5
Firepower /ssa/logical-device/mgmt-bootstrap/bootstrap-key* # exit
Firepower /ssa/logical-device/mgmt-bootstrap* #
```

- f) Specify a comma-separated list of search domains.

create bootstrap-key SEARCH_DOMAINS

set value *search_domains*

exit

Example:

```
Firepower /ssa/logical-device/mgmt-bootstrap* # create bootstrap-key SEARCH_DOMAINS
Firepower /ssa/logical-device/mgmt-bootstrap/bootstrap-key* # set value
cisco.com,example.com
Firepower /ssa/logical-device/mgmt-bootstrap/bootstrap-key* # exit
Firepower /ssa/logical-device/mgmt-bootstrap* #
```

- g) Configure the IPv4 management interface settings.

create ipv4 slot_id firepower

set ip_address mask network_mask

```
set gateway gateway_address
```

```
exit
```

Example:

```
Firepower /ssa/logical-device/mgmt-bootstrap* # create ipv4 1 firepower
Firepower /ssa/logical-device/mgmt-bootstrap/ipv4* # set ip 10.10.10.34 mask 255.255.255.0
Firepower /ssa/logical-device/mgmt-bootstrap/ipv4* # set gateway 10.10.10.1
Firepower /ssa/logical-device/mgmt-bootstrap/ipv4* # exit
Firepower /ssa/logical-device/mgmt-bootstrap* #
```

- h) Configure the IPv6 management interface settings.

```
create ipv6 slot_id firepower
```

```
set ip ip_address prefix-length prefix
```

```
set gateway gateway_address
```

```
exit
```

Example:

```
Firepower /ssa/logical-device/mgmt-bootstrap* # create ipv6 1 firepower
Firepower /ssa/logical-device/mgmt-bootstrap/ipv6* # set ip 2001:0DB8:BA98::3210
prefix-length 64
Firepower /ssa/logical-device/mgmt-bootstrap/ipv6* # set gateway 2001:0DB8:BA98::3211
Firepower /ssa/logical-device/mgmt-bootstrap/ipv6* # exit
Firepower /ssa/logical-device/mgmt-bootstrap* #
```

- i) Exit the management bootstrap mode.

```
exit
```

Example:

```
Firepower /ssa/logical-device/mgmt-bootstrap* # exit
Firepower /ssa/logical-device* #
```

- Step 8** Save the configuration.

commit-buffer

The chassis deploys the logical device by downloading the specified software version and pushing the bootstrap configuration and management interface settings to the application instance. Check the status of the deployment using the **show app-instance** command. The application instance is running and ready to use when the **Admin State is Enabled** and the **Oper State is Online**.

Example:

```
Firepower /ssa/logical-device* # commit-buffer
Firepower /ssa/logical-device # exit
Firepower /ssa # show app-instance
```

App Name	Identifier	Slot ID	Admin State	Oper State	Running Version	Startup Version
Deploy Type	Profile Name	Cluster	State	Cluster Role		
asa	asal	2	Disabled	Not Installed		9.12.1
	Native		Not Applicable	None		

ftd	ftd1	1	Enabled	Online	6.4.0.49	6.4.0.49
Container	Default-Small	Not	Applicable	None		

Step 9 See the FDM configuration guide to start configuring your security policy.

Example

```

Firepower# scope ssa
Firepower /ssa* # scope app ftd 6.5.0
Firepower /ssa/app* # accept-license-agreement
Firepower /ssa/app* # commit-buffer
Firepower /ssa/app # exit
Firepower /ssa # scope slot 1
Firepower /ssa/slot # enter app-instance ftd
Firepower /ssa/slot/app-instance* # set startup-version 6.5.0
Firepower /ssa/slot/app-instance* # exit
Firepower /ssa/slot* # exit
Firepower /ssa* # create logical-device MyDevice1 ftd 1 standalone
Firepower /ssa/logical-device* # create external-port-link inside Ethernet1/1 ftd
Firepower /ssa/logical-device/external-port-link* # set description "inside link"
Firepower /ssa/logical-device/external-port-link* # exit
Firepower /ssa/logical-device* # create external-port-link management Ethernet1/7 ftd
Firepower /ssa/logical-device/external-port-link* # set description "management link"
Firepower /ssa/logical-device/external-port-link* # exit
Firepower /ssa/logical-device* # create external-port-link outside Ethernet1/2 ftd
Firepower /ssa/logical-device/external-port-link* # set description "external link"
Firepower /ssa/logical-device/external-port-link* # exit
Firepower /ssa/logical-device* # create mgmt-bootstrap ftd
Firepower /ssa/logical-device/mgmt-bootstrap* # create bootstrap-key MANAGEMENT_TYPE
Firepower /ssa/logical-device/mgmt-bootstrap/bootstrap-key* # set value LOCALLY_MANAGED
Firepower /ssa/logical-device/mgmt-bootstrap/bootstrap-key* # exit
Firepower /ssa/logical-device/mgmt-bootstrap* # create bootstrap-key-secret PASSWORD
Firepower /ssa/logical-device/mgmt-bootstrap/bootstrap-key-secret* # set value
Enter a value: secretglassine
Confirm the value: secretglassine
Firepower /ssa/logical-device/mgmt-bootstrap/bootstrap-key-secret* # exit
Firepower /ssa/logical-device/mgmt-bootstrap* # create ipv4 1 firepower
Firepower /ssa/logical-device/mgmt-bootstrap/ipv4* # set gateway 10.0.0.1
Firepower /ssa/logical-device/mgmt-bootstrap/ipv4* # set ip 10.0.0.31 mask 255.255.255.0
Firepower /ssa/logical-device/mgmt-bootstrap/ipv4* # exit
Firepower /ssa/logical-device/mgmt-bootstrap* # create bootstrap-key FQDN
Firepower /ssa/logical-device/mgmt-bootstrap/bootstrap-key* # set value ftd.cisco.com
Firepower /ssa/logical-device/mgmt-bootstrap/bootstrap-key* # exit
Firepower /ssa/logical-device/mgmt-bootstrap* # create bootstrap-key DNS_SERVERS
Firepower /ssa/logical-device/mgmt-bootstrap/bootstrap-key* # set value 192.168.1.1
Firepower /ssa/logical-device/mgmt-bootstrap/bootstrap-key* # exit
Firepower /ssa/logical-device/mgmt-bootstrap* # create bootstrap-key SEARCH_DOMAINS
Firepower /ssa/logical-device/mgmt-bootstrap/bootstrap-key* # set value search.com
Firepower /ssa/logical-device/mgmt-bootstrap/bootstrap-key* # commit-buffer
Firepower /ssa/logical-device/mgmt-bootstrap/bootstrap-key #

```

Add a Standalone Threat Defense for the Cisco Defense Orchestrator

You can use CDO with both native and container instances. Standalone logical devices work either alone or in a High Availability pair.

Before you begin

- Download the application image you want to use for the logical device from Cisco.com, and then download that image to the Firepower 4100/9300 chassis.



Note For the Firepower 9300, you can install different application types (ASA and FTD) on separate modules in the chassis. You can also run different versions of an application instance type on separate modules.

- Configure a management interface to use with the logical device. The management interface is required. Note that this management interface is not the same as the chassis management port that is used only for chassis management (in FXOS, you might see it displayed as MGMT, management0, or other similar names).
- You must also configure at least one Data type interface.
- You must onboard the FTD device in CDO.
- Gather the following information:
 - Interface IDs for this device
 - Management interface IP address and network mask
 - Gateway IP address
 - DNS server IP address
 - Threat Defense hostname and domain name
 - CDO onboard string
 - FTD hostname and domain name

Procedure

Step 1 Enter security services mode.

scope ssa

Example:

```
Firepower# scope ssa
Firepower /ssa #
```

Step 2 Set the scope to the security module/engine slot.

scope slot *slot_id*

Example:

Example:

```
Firepower /ssa # scope slot 1
```

Step 3 Create the application instance.

enter app-instance ftd *device_name*

The *device_name* can be between 1 and 64 characters. You will use this device name when you create the logical device for this instance.

Example:

```
Firepower /ssa/slot # enter app-instance ftd FTD1
Firepower /ssa/slot/app-instance* #
```

Step 4 For a container instance, set the application instance type to container.

set deploy-type container

A container instance uses a subset of resources of the security module/engine, so you can install multiple container instances. A native instance uses all of the resources (CPU, RAM, and disk space) of the security module/engine, so you can only install one native instance.

You cannot change the instance type after you save the configuration. The default type is **native**.

Example:

```
Firepower /ssa/slot/app-instance* # set deploy-type container
```

Step 5 For a container instance, set the resource profile.

set resource-profile-name *name*

This profile name must already exist.

If you later assign a different resource profile, then the instance will reload, which can take approximately 5 minutes. Note that for established High Availability pairs or clusters, if you assign a different-sized resource profile, be sure to make all members the same size as soon as possible.

Example:

```
Firepower /ssa/slot/app-instance* # set resource-profile-name bronze
```

Step 6 Exit to slot mode.

exit

Example:

```
Firepower /ssa/slot/app-instance* # exit
Firepower /ssa/slot* #
```

Step 7 Create the logical device.

enter logical-device *device_name* **ftd** *slot_id* **standalone**

Use the same *device_name* as the application instance you added earlier.

Example:

```
Firepower /ssa # enter logical-device FTD1 ftd 1 standalone
```

```
Firepower /ssa/logical-device* #
```

Step 8 Assign the management and data interfaces to the logical device. Repeat for each interface.

```
create external-port-link name interface_id ftd
```

```
set description description
```

```
exit
```

- *name*—The name is used by the Firepower 4100/9300 chassis supervisor; it is not the interface name used in the Firepower Threat Defense configuration.
- *description*—Use quotes (") around phrases with spaces.

You can only assign up to 10 data-sharing interfaces to a container instance. Also, each data-sharing interface can be assigned to at most 14 container instances.

Example:

```
Firepower /ssa/logical-device* # create external-port-link inside Ethernet1/1 ftd
Firepower /ssa/logical-device/external-port-link* # set description "inside link"
Firepower /ssa/logical-device/external-port-link* # exit
Firepower /ssa/logical-device* # create external-port-link management Ethernet1/7 ftd
Firepower /ssa/logical-device/external-port-link* # set description "management link"
Firepower /ssa/logical-device/external-port-link* # exit
Firepower /ssa/logical-device* # create external-port-link outside Ethernet1/2 ftd
Firepower /ssa/logical-device/external-port-link* # set description "external link"
Firepower /ssa/logical-device/external-port-link* # exit
```

Step 9 Configure the management bootstrap parameters.

These settings are meant for initial deployment only, or for disaster recovery. For normal operation, you can later change most values in the application CLI configuration.

a) Create the bootstrap object.

```
create mgmt-bootstrap ftd
```

Example:

```
Firepower /ssa/logical-device* # create mgmt-bootstrap ftd
Firepower /ssa/logical-device/mgmt-bootstrap* #
```

b) Specify a comma-separated list of DNS servers.

```
create bootstrap-key DNS_SERVERS
```

```
set value dns_servers
```

```
exit
```

The Firepower Threat Defense uses DNS if you specify a hostname for the CDO, for example.

Example:

```
Firepower /ssa/logical-device/mgmt-bootstrap* # create bootstrap-key DNS_SERVERS
Firepower /ssa/logical-device/mgmt-bootstrap/bootstrap-key* # set value 10.9.8.7,10.9.6.5
Firepower /ssa/logical-device/mgmt-bootstrap/bootstrap-key* # exit
```

```
Firepower /ssa/logical-device/mgmt-bootstrap* #
```

- c) Specify a comma-separated list of search domains.

create bootstrap-key SEARCH_DOMAINS

set value *search_domains*

exit

Example:

```
Firepower /ssa/logical-device/mgmt-bootstrap* # create bootstrap-key SEARCH_DOMAINS
Firepower /ssa/logical-device/mgmt-bootstrap/bootstrap-key* # set value
cisco.com,example.com
Firepower /ssa/logical-device/mgmt-bootstrap/bootstrap-key* # exit
Firepower /ssa/logical-device/mgmt-bootstrap* #
```

- d) Specify the firewall mode, routed or transparent.

create bootstrap-key FIREWALL_MODE

set value {**routed** | **transparent**}

exit

In routed mode, the device is considered to be a router hop in the network. Each interface that you want to route between is on a different subnet. A transparent firewall, on the other hand, is a Layer 2 firewall that acts like a “bump in the wire,” or a “stealth firewall,” and is not seen as a router hop to connected devices.

The firewall mode is only set at initial deployment. If you re-apply the bootstrap settings, this setting is not used.

Example:

```
Firepower /ssa/logical-device/mgmt-bootstrap* # create bootstrap-key FIREWALL_MODE
Firepower /ssa/logical-device/mgmt-bootstrap/bootstrap-key* # set value routed
Firepower /ssa/logical-device/mgmt-bootstrap/bootstrap-key* # exit
Firepower /ssa/logical-device/mgmt-bootstrap* #
```

- e) (Optional) For a container instance, permit Expert Mode from Firepower Threat Defense SSH sessions. Expert Mode provides Firepower Threat Defense shell access for advanced troubleshooting.

create bootstrap-key PERMIT_EXPERT_MODE

set value {**yes** | **no**}

exit

- **yes**—Users who access this container instance directly from an SSH session can enter Expert Mode.
- **no**—Only users who access the container instance from the FXOS CLI can enter Expert Mode.

By default for container instances, Expert Mode is only available to users who access the Firepower Threat Defense CLI from the FXOS CLI. This limitation is only applied to container instances to increase isolation between instances. Use Expert Mode only if a documented procedure tells you it is required, or if the Cisco Technical Assistance Center asks you to use it. To enter this mode, use the **expert** command in the Firepower Threat Defense CLI.

Example:

```
Firepower /ssa/logical-device/mgmt-bootstrap* # create bootstrap-key PERMIT_EXPERT_MODE
Firepower /ssa/logical-device/mgmt-bootstrap/bootstrap-key* # set value yes
Firepower /ssa/logical-device/mgmt-bootstrap/bootstrap-key* # exit
Firepower /ssa/logical-device/mgmt-bootstrap* #
```

- f) For a native instance, set the manager to CDO.

```
enter bootstrap-key MANAGEMENT_TYPE
```

```
set value CDO
```

```
exit
```

Native instances also support CDO as a manager. After you deploy the logical device, you cannot change the manager type.

Example:

```
Firepower /ssa/logical-device/mgmt-bootstrap* # enter bootstrap-key MANAGEMENT_TYPE
Firepower /ssa/logical-device/mgmt-bootstrap/bootstrap-key* # set value CDO
Firepower /ssa/logical-device/mgmt-bootstrap/bootstrap-key* # exit
Firepower /ssa/logical-device/mgmt-bootstrap* #
```

- g) Specify the key to be shared between the device and the CDO.

```
create bootstrap-key-secret CDO_ONBOARD
```

```
set value
```

Enter a key: *registration_key*

Confirm the key: *registration_key*

```
exit
```

Example:

```
Firepower /SSA-5 /ssa/logical-device/mgmt-bootstrap* # create bootstrap-key-secret
CDO_ONBOARD
Firepower /SSA-5 /ssa/logical-device/mgmt-bootstrap/bootstrap-key* # set value
Firepower /SSA-5 /ssa/logical-device/mgmt-bootstrap/bootstrap-key* #
Enter a value: configure manager add cisco-sapphire.app.staging.cdo.cisco.com
TuNDBm6peReVDbUkOpZCgtJ1GqWKbD30 o9B064UXEwmr3AYAEpuflf4qE2E3JKY5
cisco-sapphire.app.staging.cdo.cisco.com
Confirm the value: configure manager add cisco-sapphire.app.staging.cdo.cisco.com
TuNDBm6peReVDbUkOpZCgtJ1GqWKbD30 o9B064UXEwmr3AYAEpuflf4qE2E3JKY5
cisco-sapphire.app.staging.cdo.cisco.com
Firepower /SSA-5 /ssa/logical-device/mgmt-bootstrap/bootstrap-key* # commit-buffer
```

Note CDO generates an onboarding command string once you onboard your FTD. Copy that string and use it for value input.

- h) Specify the admin password. This password is used for the admin user for CLI access.

```
create bootstrap-key-secret PASSWORD
```

```
set value
```

Enter a value: *password*

Confirm the value: *password*

exit

Example:

```
Firepower /ssa/logical-device/mgmt-bootstrap* # create bootstrap-key-secret PASSWORD
Firepower /ssa/logical-device/mgmt-bootstrap/bootstrap-key-secret* # set value
Enter a value: floppylampshade
Confirm the value: floppylampshade
Firepower /ssa/logical-device/mgmt-bootstrap/bootstrap-key-secret* # exit
Firepower /ssa/logical-device/mgmt-bootstrap* #
```

- i) Configure the IPv4 management interface settings.

create ipv4 slot_id firepower

set ip ip_address mask network_mask

set gateway gateway_address

exit

Example:

```
Firepower /ssa/logical-device/mgmt-bootstrap* # create ipv4 1 firepower
Firepower /ssa/logical-device/mgmt-bootstrap/ipv4* # set ip 10.10.10.34 mask 255.255.255.0
Firepower /ssa/logical-device/mgmt-bootstrap/ipv4* # set gateway 10.10.10.1
Firepower /ssa/logical-device/mgmt-bootstrap/ipv4* # exit
Firepower /ssa/logical-device/mgmt-bootstrap* #
```

- j) Exit the management bootstrap mode.

exit

Example:

```
Firepower /ssa/logical-device/mgmt-bootstrap* # exit
Firepower /ssa/logical-device* #
```

- Step 10** Save the configuration.

commit-buffer

The chassis deploys the logical device by downloading the specified software version and pushing the bootstrap configuration and management interface settings to the application instance. Check the status of the deployment using the **show app-instance** command. The application instance is running and ready to use when the **Admin State is Enabled** and the **Oper State is Online**.

Example:

```
Firepower /ssa/logical-device* # commit-buffer
Firepower /ssa/logical-device # exit
Firepower /ssa # show app-instance
App Name Identifier Slot ID Admin State Oper State Running Version Startup Version
Deploy Type Profile Name Cluster State Cluster Role
-----
asa asa1 2 Disabled Not Installed 9.12.1
Native Not Applicable None
```

ftd	ftd1	1	Enabled	Online	7.3.0	7.3.0
Container	Default-Small	Not	Applicable	None		

Step 11 See the CDO configuration guide to start configuring your security policy.

Add a High Availability Pair

FTD or ASA High Availability (also known as failover) is configured within the application, not in FXOS. However, to prepare your chassis for high availability, see the following steps.

Before you begin

See [Requirements and Prerequisites for High Availability, on page 16](#).

Procedure

Step 1 Allocate the same interfaces to each logical device.

Step 2 Allocate 1 or 2 data interfaces for the failover and state link(s).

These interfaces exchange high availability traffic between the 2 chassis. We recommend that you use a 10 GB data interface for a combined failover and state link. If you have available interfaces, you can use separate failover and state links; the state link requires the most bandwidth. You cannot use the management-type interface for the failover or state link. We recommend that you use a switch between the chassis, with no other device on the same network segment as the failover interfaces.

For container instances, data-sharing interfaces are not supported for the failover link. We recommend that you create subinterfaces on a parent interface or EtherChannel, and assign a subinterface for each instance to use as a failover link. Note that you must use all subinterfaces on the same parent as failover links. You cannot use one subinterface as a failover link and then use other subinterfaces (or the parent interface) as regular data interfaces.

Step 3 Enable High Availability on the logical devices.

Step 4 If you need to make interface changes after you enable High Availability, perform the changes on the standby unit first, and then perform the changes on the active unit.

Note For the ASA, if you remove an interface in FXOS (for example, if you remove a network module, remove an EtherChannel, or reassign an interface to an EtherChannel), then the ASA configuration retains the original commands so that you can make any necessary adjustments; removing an interface from the configuration can have wide effects. You can manually remove the old interface configuration in the ASA OS.

Add a Cluster

Clustering lets you group multiple devices together as a single logical device. A cluster provides all the convenience of a single device (management, integration into a network) while achieving the increased throughput and redundancy of multiple devices. The Firepower 9300, which includes multiple modules, supports intra-chassis clustering where you group all modules within a single chassis into a cluster. You can also use inter-chassis clustering, where multiple chassis are grouped together; inter-chassis clustering is the only option for single module devices like the Firepower 4100 series.

About Clustering on the Firepower 4100/9300 Chassis

When you deploy a cluster on the Firepower 4100/9300 chassis, it does the following:

- For native instance clustering: Creates a *cluster-control link* (by default, port-channel 48) for node-to-node communication.

For multi-instance clustering: You should pre-configure subinterfaces on one or more cluster-type EtherChannels; each instance needs its own cluster control link.

For a cluster isolated to security modules within one Firepower 9300 chassis, this link utilizes the Firepower 9300 backplane for cluster communications.

For clustering with multiple chassis, you need to manually assign physical interface(s) to this EtherChannel for communications between chassis.

- Creates the cluster bootstrap configuration within the application.

When you deploy the cluster, the chassis supervisor pushes a minimal bootstrap configuration to each unit that includes the cluster name, cluster control link interface, and other cluster settings. Some parts of the bootstrap configuration may be user-configurable within the application if you want to customize your clustering environment.

- Assigns data interfaces to the cluster as *Spanned* interfaces.

For a cluster isolated to security modules within one Firepower 9300 chassis, spanned interfaces are not limited to EtherChannels, like it is for clustering with multiple chassis. The Firepower 9300 supervisor uses EtherChannel technology internally to load-balance traffic to multiple modules on a shared interface, so any data interface type works for Spanned mode. For clustering with multiple chassis, you must use Spanned EtherChannels for all data interfaces.



Note Individual interfaces are not supported, with the exception of a management interface.

- Assigns a management interface to all units in the cluster.

See the following sections for more information about clustering.

Primary and Secondary Unit Roles

One member of the cluster is the primary unit. The primary unit is determined automatically. All other members are secondary units.

You must perform all configuration on the primary unit only; the configuration is then replicated to the secondary units.

Cluster Control Link

For native instance clustering: The cluster control link is automatically created using the Port-channel 48 interface.

For multi-instance clustering: You should pre-configure subinterfaces on one or more cluster-type EtherChannels; each instance needs its own cluster control link.

For a cluster isolated to security modules within one Firepower 9300 chassis, this interface has no member interfaces. This Cluster type EtherChannel utilizes the Firepower 9300 backplane for cluster communications. For clustering with multiple chassis, you must add one or more interfaces to the EtherChannel.

For a cluster with two chassis, do not directly connect the cluster control link from one chassis to the other chassis. If you directly connect the interfaces, then when one unit fails, the cluster control link fails, and thus the remaining healthy unit fails. If you connect the cluster control link through a switch, then the cluster control link remains up for the healthy unit.

Cluster control link traffic includes both control and data traffic.

Size the Cluster Control Link

If possible, you should size the cluster control link to match the expected throughput of each chassis so the cluster control link can handle the worst-case scenarios.

Cluster control link traffic is comprised mainly of state update and forwarded packets. The amount of traffic at any given time on the cluster control link varies. The amount of forwarded traffic depends on the load-balancing efficacy or whether there is a lot of traffic for centralized features. For example:

- NAT results in poor load balancing of connections, and the need to rebalance all returning traffic to the correct units.
- When membership changes, the cluster needs to rebalance a large number of connections, thus temporarily using a large amount of cluster control link bandwidth.

A higher-bandwidth cluster control link helps the cluster to converge faster when there are membership changes and prevents throughput bottlenecks.



Note If your cluster has large amounts of asymmetric (rebalanced) traffic, then you should increase the cluster control link size.

Cluster Control Link Redundancy

The following diagram shows how to use an EtherChannel as a cluster control link in a Virtual Switching System (VSS), Virtual Port Channel (vPC), StackWise, or StackWise Virtual environment. All links in the EtherChannel are active. When the switch is part of a redundant system, then you can connect firewall interfaces within the same EtherChannel to separate switches in the redundant system. The switch interfaces are members of the same EtherChannel port-channel interface, because the separate switches act like a single switch. Note that this EtherChannel is device-local, not a Spanned EtherChannel.

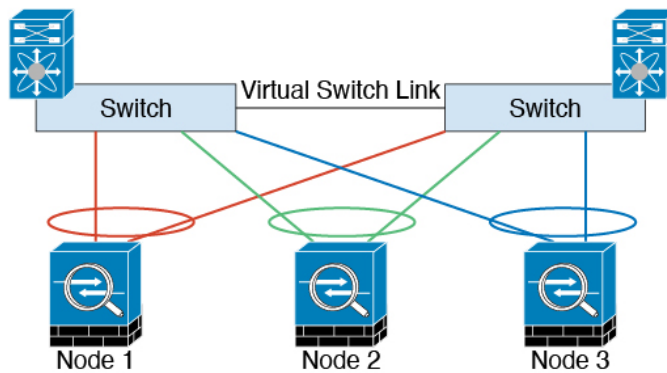

Cluster Control Link Reliability for Inter-Chassis Clustering

To ensure cluster control link functionality, be sure the round-trip time (RTT) between units is less than 20 ms. This maximum latency enhances compatibility with cluster members installed at different geographical sites. To check your latency, perform a ping on the cluster control link between units.

The cluster control link must be reliable, with no out-of-order or dropped packets; for example, for inter-site deployment, you should use a dedicated link.

Cluster Control Link Network

The Firepower 4100/9300 chassis auto-generates the cluster control link interface IP address for each unit based on the chassis ID and slot ID: $127.2.chassis_id.slot_id$. For multi-instance clusters, which typically use different VLAN subinterfaces of the same EtherChannel, the same IP address can be used for different clusters because of VLAN separation. You can customize this IP address when you deploy the cluster. The cluster control link network cannot include any routers between units; only Layer 2 switching is allowed. For inter-site traffic, Cisco recommends using Overlay Transport Virtualization (OTV).

Management Network

We recommend connecting all units to a single management network. This network is separate from the cluster control link.

Management Interface

You must assign a Management type interface to the cluster. This interface is a special *individual* interface as opposed to a Spanned interface. The management interface lets you connect directly to each unit.

For the ASA, the Main cluster IP address is a fixed address for the cluster that always belongs to the current primary unit. You must configure a range of addresses so that each unit, including the current primary unit, can use a Local address from the range. The Main cluster IP address provides consistent management access to an address; when a primary unit changes, the Main cluster IP address moves to the new primary unit, so management of the cluster continues seamlessly. The Local IP address is used for routing, and is also useful for troubleshooting. For example, you can manage the cluster by connecting to the Main cluster IP address, which is always attached to the current primary unit. To manage an individual member, you can connect to the Local IP address. For outbound management traffic such as TFTP or syslog, each unit, including the primary unit, uses the Local IP address to connect to the server.

For the Firepower Threat Defense, assign a management IP address to each unit on the same network. Use these IP addresses when you add each unit to the FMC.

Spanned EtherChannels

You can group one or more interfaces per chassis into an EtherChannel that spans all chassis in the cluster. The EtherChannel aggregates the traffic across all the available active interfaces in the channel.

A Spanned EtherChannel can be configured in both routed and transparent firewall modes. In routed mode, the EtherChannel is configured as a routed interface with a single IP address. In transparent mode, the IP address is assigned to the BVI, not to the bridge group member interface.

The EtherChannel inherently provides load balancing as part of basic operation.

For multi-instance clusters, each cluster requires dedicated data EtherChannels; you cannot use shared interfaces or VLAN subinterfaces.

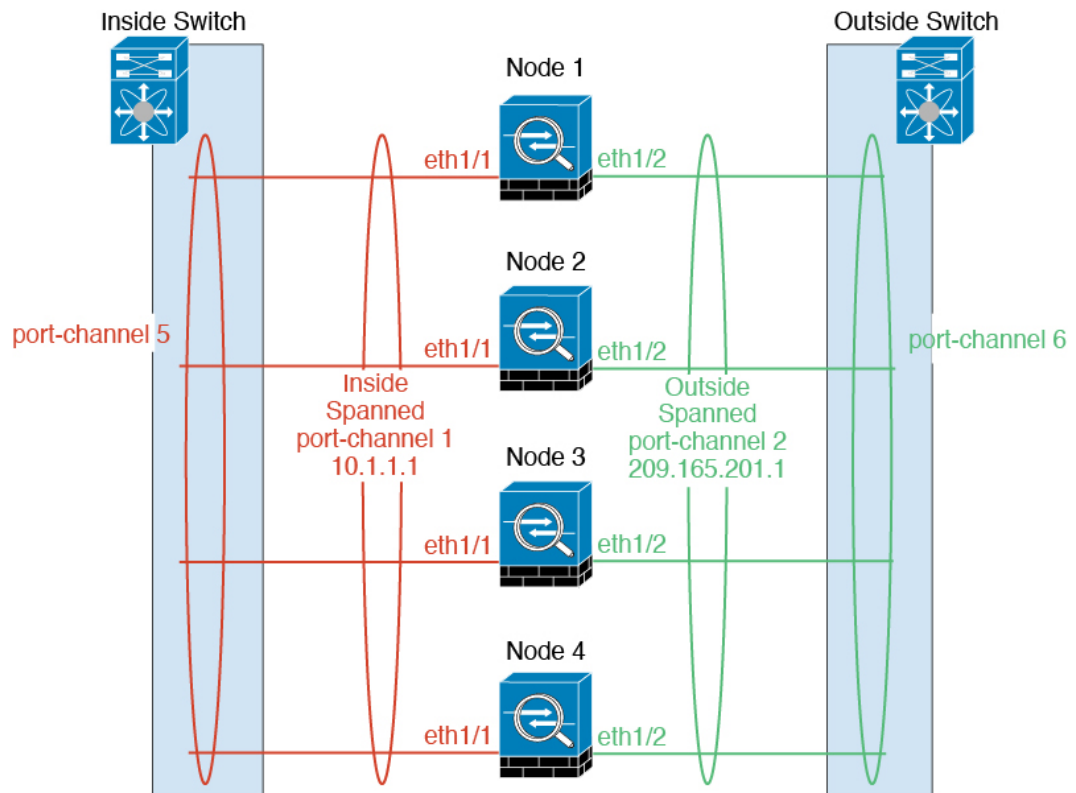

Inter-Site Clustering

For inter-site installations, you can take advantage of clustering as long as you follow the recommended guidelines.

You can configure each cluster chassis to belong to a separate site ID.

Site IDs work with site-specific MAC addresses and IP addresses. Packets egressing the cluster use a site-specific MAC address and IP address, while packets received by the cluster use a global MAC address and IP address. This feature prevents the switches from learning the same global MAC address from both sites on two different ports, which causes MAC flapping; instead, they only learn the site MAC address. Site-specific MAC addresses and IP address are supported for routed mode using Spanned EtherChannels only.

Site IDs are also used to enable flow mobility using LISP inspection, director localization to improve performance and reduce round-trip time latency for inter-site clustering for data centers, and site redundancy for connections where a backup owner of a traffic flow is always at a different site from the owner.

See the following sections for more information about inter-site clustering:

- Sizing the Data Center Interconnect—[Requirements and Prerequisites for Clustering, on page 11](#)
- Inter-Site Guidelines—[Clustering Guidelines and Limitations, on page 18](#)
- Inter-Site Examples—[Examples for Inter-Site Clustering, on page 117](#)

Add an ASA Cluster

You can add a single Firepower 9300 chassis as an intra-chassis cluster, or add multiple chassis for inter-chassis clustering. For inter-chassis clustering, you must configure each chassis separately. Add the cluster on one chassis; you can then enter most of the same settings on the next chassis.

Create an ASA Cluster

Set the scope to the image version.

You can easily deploy the cluster from the Firepower 4100/9300 chassis supervisor. All initial configuration is automatically generated for each unit.

For clustering on multiple chassis, you must configure each chassis separately. Deploy the cluster on one chassis; you can then copy the bootstrap configuration from the first chassis to the next chassis for ease of deployment.

In a Firepower 9300 chassis, you must enable clustering for all 3 module slots, or for container instances, a container instance in each slot, even if you do not have a module installed. If you do not configure all 3 modules, the cluster will not come up.

For multiple context mode, you must first deploy the logical device, and then enable multiple context mode in the ASA application.

Before you begin

- Download the application image you want to use for the logical device from Cisco.com, and then upload that image to the Firepower 4100/9300 chassis.
- Gather the following information:
 - Management interface ID, IP address, and network mask
 - Gateway IP address

Procedure

- Step 1** Configure interfaces.
- Step 2** Enter security services mode.
- ```
scope ssa
```

**Example:**

```
Firepower# scope ssa
Firepower /ssa #
```

**Step 3** Set the application instance parameters, including the image version.

- a) View available images. Note the Version number that you want to use.

**show app****Example:**

```
Firepower /ssa # show app
 Name Version Author Supported Deploy Types CSP Type Is Default
App

asa 9.9.1 cisco Native Application No
asa 9.10.1 cisco Native Application Yes
ftd 6.2.3 cisco Native Application Yes
ftd 6.3.0 cisco Native,Container Application Yes
```

- b) Set the scope to the image version.

**scope app asa *application\_version*****Example:**

```
Firepower /ssa # scope app asa 9.10.1
Firepower /ssa/app #
```

- c) Set this version as the default.

**set-default****Example:**

```
Firepower /ssa/app # set-default
Firepower /ssa/app* #
```

- d) Exit to ssa mode.

**exit****Example:**

```
Firepower /ssa/app* # exit
Firepower /ssa* #
```

**Example:**

```
Firepower /ssa # scope app asa 9.12.1
Firepower /ssa/app # set-default
Firepower /ssa/app* # exit
Firepower /ssa* #
```

**Step 4** Create the cluster.

**enter logical-device** *device\_name* **asa slots clustered**

- *device\_name*—Used by the Firepower 4100/9300 chassis supervisor to configure clustering settings and assign interfaces; it is not the cluster name used in the security module configuration. You must specify all three security modules, even if you have not yet installed the hardware.
- *slots*—Assigns the chassis modules to the cluster. For the Firepower 4100, specify **1**. For the Firepower 9300, specify **1,2,3**. You must enable clustering for all 3 module slots in a Firepower 9300 chassis, even if you do not have a module installed. If you do not configure all 3 modules, the cluster will not come up.

**Example:**

```
Firepower /ssa # enter logical-device ASA1 asa 1,2,3 clustered
Firepower /ssa/logical-device* #
```

**Step 5** Configure the cluster bootstrap parameters.

These settings are meant for initial deployment only, or for disaster recovery. For normal operation, you can later change most values in the application CLI configuration.

a) Create the cluster bootstrap object.

**enter cluster-bootstrap**

**Example:**

```
Firepower /ssa/logical-device* # enter cluster-bootstrap
Firepower /ssa/logical-device/cluster-bootstrap* #
```

b) Set the chassis ID.

**set chassis-id** *id*

Each chassis in the cluster needs a unique ID.

c) For inter-site clustering, set the site ID between 1 and 8.

**set site-id** *number*.

To remove the site ID, set the value to **0**.

**Example:**

```
Firepower /ssa/logical-device/cluster-bootstrap* # set site-id 1
Firepower /ssa/logical-device/cluster-bootstrap* #
```

d) Configure an authentication key for control traffic on the cluster control link.

**set key**

**Example:**

```
Firepower /ssa/logical-device/cluster-bootstrap* # set key
Key: diamonddogs
```



You are prompted to enter the shared secret.

The shared secret is an ASCII string from 1 to 63 characters. The shared secret is used to generate the key. This option does not affect datapath traffic, including connection state update and forwarded packets, which are always sent in the clear.

- e) Set the cluster interface mode.

**set mode spanned-etherchannel**

Spanned EtherChannel mode is the only supported mode.

**Example:**

```
Firepower /ssa/logical-device/cluster-bootstrap* # set mode spanned-etherchannel
Firepower /ssa/logical-device/cluster-bootstrap* #
```

- f) Set the cluster group name in the security module configuration.

**set service-type cluster\_name**

The name must be an ASCII string from 1 to 38 characters.

**Example:**

```
Firepower /ssa/logical-device/cluster-bootstrap* # set service-type cluster1
Firepower /ssa/logical-device/cluster-bootstrap* #
```

- g) (Optional) Set the cluster control link IP network.

**set cluster-control-link network a.b.0.0**

By default, the cluster control link uses the 127.2.0.0/16 network. However, some networking deployments do not allow 127.2.0.0/16 traffic to pass. In this case, you can specify a /16 address on a unique network for the cluster.

- **a.b.0.0**—Specify any /16 network address, except for loopback (127.0.0.0/8) and multicast (224.0.0.0/4) addresses. If you set the value to 0.0.0.0, then the default network is used: 127.2.0.0.

The chassis auto-generates the cluster control link interface IP address for each unit based on the chassis ID and slot ID: *a.b.chassis\_id.slot\_id*.

**Example:**

```
Firepower /ssa/logical-device/cluster-bootstrap* # set cluster-control-link network
10.10.0.0
```

- h) Configure the management IP address information.

This information is used to configure a management interface in the security module configuration.

1. Configure a pool of Local IP addresses, one of which will be assigned to each cluster unit for the interface.

**set ipv4 pool start\_ip end\_ip**

**set ipv6 pool start\_ip end\_ip**

Include at least as many addresses as there are units in the cluster. Note that for the Firepower 9300, you must include 3 addresses per chassis, even if you do not have all module slots filled. If you plan to expand the cluster, include additional addresses. The Virtual IP address (known as the Main cluster IP address) that belongs to the current control unit is *not* a part of this pool; be sure to reserve an IP address on the same network for the Main cluster IP address. You can use IPv4 and/or IPv6 addresses.

2. Configure the Main cluster IP address for the management interface.

```
set virtual ipv4 ip_address mask mask
```

```
set virtual ipv6 ip_address prefix-length prefix
```

This IP address must be on the same network as the cluster pool addresses, but not be part of the pool.

3. Enter the network gateway address.

```
set ipv4 gateway ip_address
```

```
set ipv6 gateway ip_address
```

#### Example:

```
Firepower /ssa/logical-device/cluster-bootstrap* # set ipv4 gateway 10.1.1.254
Firepower /ssa/logical-device/cluster-bootstrap* # set ipv4 pool 10.1.1.11 10.1.1.27
Firepower /ssa/logical-device/cluster-bootstrap* # set ipv6 gateway 2001:DB8::AA
Firepower /ssa/logical-device/cluster-bootstrap* # set ipv6 pool 2001:DB8::11 2001:DB8::27
Firepower /ssa/logical-device/cluster-bootstrap* # set virtual ipv4 10.1.1.1 mask
255.255.255.0
Firepower /ssa/logical-device/cluster-bootstrap* # set virtual ipv6 2001:DB8::1
prefix-length 64
```

- i) Exit the cluster bootstrap mode.

```
exit
```

#### Example:

```
Firepower /ssa/logical-device* # enter cluster-bootstrap
Firepower /ssa/logical-device/cluster-bootstrap* # set chassis-id 1
Firepower /ssa/logical-device/cluster-bootstrap* # set key
Key: f@arscape
Firepower /ssa/logical-device/cluster-bootstrap* # set mode spanned-etherchannel
Firepower /ssa/logical-device/cluster-bootstrap* # set service-type cluster1
Firepower /ssa/logical-device/cluster-bootstrap* # exit
Firepower /ssa/logical-device/* #
```

### Step 6 Configure the management bootstrap parameters.

These settings are meant for initial deployment only, or for disaster recovery. For normal operation, you can later change most values in the application CLI configuration.

- a) Create the management bootstrap object.

```
enter mgmt-bootstrap asa
```

#### Example:

```
Firepower /ssa/logical-device* # enter mgmt-bootstrap asa
```

```
Firepower /ssa/logical-device/mgmt-bootstrap* #
```

- b) Specify the admin and enable password.

**create bootstrap-key-secret PASSWORD**

**set value**

Enter a value: *password*

Confirm the value: *password*

**exit**

**Example:**

The pre-configured ASA admin user and enable password is useful for password recovery; if you have FXOS access, you can reset the admin user password if you forget it.

**Example:**

```
Firepower /ssa/logical-device/mgmt-bootstrap* # create bootstrap-key-secret PASSWORD
Firepower /ssa/logical-device/mgmt-bootstrap/bootstrap-key-secret* # set value
Enter a value: floppylampshade
Confirm the value: floppylampshade
Firepower /ssa/logical-device/mgmt-bootstrap/bootstrap-key-secret* # exit
Firepower /ssa/logical-device/mgmt-bootstrap* #
```

- c) Specify the firewall mode, routed or transparent.

**create bootstrap-key FIREWALL\_MODE**

**set value {routed | transparent}**

**exit**

In routed mode, the device is considered to be a router hop in the network. Each interface that you want to route between is on a different subnet. A transparent firewall, on the other hand, is a Layer 2 firewall that acts like a “bump in the wire,” or a “stealth firewall,” and is not seen as a router hop to connected devices.

The firewall mode is only set at initial deployment. If you re-apply the bootstrap settings, this setting is not used.

**Example:**

```
Firepower /ssa/logical-device/mgmt-bootstrap* # create bootstrap-key FIREWALL_MODE
Firepower /ssa/logical-device/mgmt-bootstrap/bootstrap-key* # set value routed
Firepower /ssa/logical-device/mgmt-bootstrap/bootstrap-key* # exit
Firepower /ssa/logical-device/mgmt-bootstrap* #
```

- d) Exit the management bootstrap mode.

**exit**

**Example:**

```
Firepower /ssa/logical-device/mgmt-bootstrap* # exit
Firepower /ssa/logical-device* #
```

**Step 7** Save the configuration.

#### **commit-buffer**

The chassis deploys the logical device by downloading the specified software version and pushing the bootstrap configuration and management interface settings to the application instance. Check the status of the deployment using the **show app-instance** command. The application instance is running and ready to use when the **Admin State** is **Enabled** and the **Oper State** is **Online**.

#### **Example:**

```
Firepower /ssa/logical-device* # commit-buffer
Firepower /ssa/logical-device # exit
Firepower /ssa # show app-instance
```

| App Name    | Identifier   | Slot ID | Admin State    | Oper State    | Running Version | Startup Version |
|-------------|--------------|---------|----------------|---------------|-----------------|-----------------|
| Deploy Type | Profile Name | Cluster | State          | Cluster Role  |                 |                 |
| ftd         | cluster1     | 1       | Enabled        | Online        | 7.3.0.49        | 7.3.0.49        |
| Native      |              |         | In Cluster     | Data Node     |                 |                 |
| ftd         | cluster1     | 2       | Enabled        | Online        | 7.3.0.49        | 7.3.0.49        |
| Native      |              |         | In Cluster     | Control Node  |                 |                 |
| ftd         | cluster1     | 3       | Disabled       | Not Available |                 | 7.3.0.49        |
| Native      |              |         | Not Applicable | None          |                 |                 |

**Step 8** To add another chassis to the cluster, repeat this procedure except you must configure a unique **chassis-id** and the correct **site-id**; otherwise, use the same configuration for both chassis.

Make sure the interface configuration is the same on the new chassis. You can export and import FXOS chassis configuration to make this process easier.

**Step 9** Connect to the control unit ASA to customize your clustering configuration.

#### **Example**

For chassis 1:

```
scope eth-uplink
 scope fabric a
 enter port-channel 1
 set port-type data
 enable
 enter member-port Ethernet1/1
 exit
 enter member-port Ethernet1/2
 exit
 exit
 enter port-channel 2
 set port-type data
 enable
 enter member-port Ethernet1/3
 exit
 enter member-port Ethernet1/4
 exit
 exit
 enter port-channel 3
 set port-type data
 enable
```

```

 enter member-port Ethernet1/5
 exit
 enter member-port Ethernet1/6
 exit
 exit
enter port-channel 4
 set port-type mgmt
 enable
 enter member-port Ethernet2/1
 exit
 enter member-port Ethernet2/2
 exit
 exit
enter port-channel 48
 set port-type cluster
 enable
 enter member-port Ethernet2/3
 exit
 exit
exit
commit-buffer

scope ssa
 enter logical-device ASA1 asa "1,2,3" clustered
 enter cluster-bootstrap
 set chassis-id 1
 set ipv4 gateway 10.1.1.254
 set ipv4 pool 10.1.1.11 10.1.1.27
 set ipv6 gateway 2001:DB8::AA
 set ipv6 pool 2001:DB8::11 2001:DB8::27
 set key
 Key: f@arscape
 set mode spanned-etherchannel
 set service-type cluster1
 set virtual ipv4 10.1.1.1 mask 255.255.255.0
 set virtual ipv6 2001:DB8::1 prefix-length 64
 exit
scope app asa 9.5.2.1
 set-default
 exit
commit-buffer

```

For chassis 2:

```

scope eth-uplink
 scope fabric a
 create port-channel 1
 set port-type data
 enable
 create member-port Ethernet1/1
 exit
 create member-port Ethernet1/2
 exit
 exit
 create port-channel 2
 set port-type data
 enable
 create member-port Ethernet1/3
 exit
 create member-port Ethernet1/4
 exit

```

```

 exit
 create port-channel 3
 set port-type data
 enable
 create member-port Ethernet1/5
 exit
 create member-port Ethernet1/6
 exit
 exit
 create port-channel 4
 set port-type mgmt
 enable
 create member-port Ethernet2/1
 exit
 create member-port Ethernet2/2
 exit
 exit
 create port-channel 48
 set port-type cluster
 enable
 create member-port Ethernet2/3
 exit
 exit
 exit
exit
commit-buffer

scope ssa
 enter logical-device ASA1 asa "1,2,3" clustered
 enter cluster-bootstrap
 set chassis-id 2
 set ipv4 gateway 10.1.1.254
 set ipv4 pool 10.1.1.11 10.1.1.15
 set ipv6 gateway 2001:DB8::AA
 set ipv6 pool 2001:DB8::11 2001:DB8::19
 set key
 Key: f@rscape
 set mode spanned-etherchannel
 set service-type cluster1
 set virtual ipv4 10.1.1.1 mask 255.255.255.0
 set virtual ipv6 2001:DB8::1 prefix-length 64
 exit
 exit
scope app asa 9.5.2.1
 set-default
 exit
commit-buffer

```

## Add More Cluster Members

Add or replace the ASA cluster member.



---

**Note** This procedure only applies to adding or replacing a *chassis*; if you are adding or replacing a module to a Firepower 9300 where clustering is already enabled, the module will be added automatically.

---

### Before you begin

- Make sure your existing cluster has enough IP addresses in the management IP address pool for this new member. If not, you need to edit the existing cluster bootstrap configuration on each chassis before you add this new member. This change causes a restart of the logical device.
- The interface configuration must be the same on the new chassis. You can export and import FXOS chassis configuration to make this process easier.
- For multiple context mode, enable multiple context mode in the ASA application on the first cluster member; additional cluster members will inherit the multiple context mode configuration automatically.

### Procedure

---

- Step 1** Click **OK**.
- Step 2** To add another chassis to the cluster, repeat the procedure in [Create an ASA Cluster, on page 62](#) except you must configure a unique **chassis-id** and the correct **site-id**; otherwise, use the same configuration for the new chassis.
- 

## Add a FTD Cluster

In native mode: You can add a cluster to a single Firepower 9300 chassis that is isolated to security modules within the chassis, or you can use multiple chassis.

In multi-instance mode: You can add one or more clusters to a single Firepower 9300 chassis that are isolated to security modules within the chassis (you must include an instance on each module), or add one or more clusters on multiple chassis.

For clusters on multiple chassis, you must configure each chassis separately. Add the cluster on one chassis; you can then enter most of the same settings on the next chassis.

## Create a FTD Cluster

You can easily deploy the cluster from the Firepower 4100/9300 chassis supervisor. All initial configuration is automatically generated for each unit.

For clustering on multiple chassis, you must configure each chassis separately. Deploy the cluster on one chassis; you can then copy the bootstrap configuration from the first chassis to the next chassis for ease of deployment.

In a Firepower 9300 chassis, you must enable clustering for all 3 module slots, or for container instances, a container instance in each slot, even if you do not have a module installed. If you do not configure all 3 modules, the cluster will not come up.

### Before you begin

- Download the application image you want to use for the logical device from Cisco.com, and then upload that image to the Firepower 4100/9300 chassis.
- For container instances, if you do not want to use the default profile, add a resource profile according to [Add a Resource Profile for Container Instances](#).

- For container instances, before you can install a container instance for the first time, you must reinitialize the security module/engine so that the disk has the correct formatting. An existing logical device will be deleted and then reinstalled as a new device, losing any local application configuration. If you are replacing a native instance with container instances, you will need to delete the native instance in any case. You cannot automatically migrate a native instance to a container instance. See [Reinitializing a Security Module/Engine](#) for more information.
- Gather the following information:
  - Management interface ID, IP addresses, and network mask
  - Gateway IP address
  - FMC IP address and/or NAT ID of your choosing
  - DNS server IP address
  - FTD hostname and domain name

## Procedure

---

**Step 1** Configure interfaces.

**Step 2** Enter security services mode.

**scope ssa**

**Example:**

```
Firepower# scope ssa
Firepower /ssa #
```

**Step 3** Accept the end-user license agreement for the Firepower Threat Defense version you want to use. You only need to perform this step if you have not already accepted the EULA for this version.

a) View available images. Note the Version number that you want to use.

**show app**

**Example:**

```
Firepower /ssa # show app
 Name Version Author Supported Deploy Types CSP Type Is Default
 ---- -
 asa 9.9.1 cisco Native Application No
 asa 9.10.1 cisco Native Application Yes
 ftd 6.2.3 cisco Native Application Yes
 ftd 6.3.0 cisco Native,Container Application Yes
```

b) Set the scope to the image version.

**scope app ftd *application\_version***

**Example:**



```
Firepower /ssa # scope app ftd 6.2.3
Firepower /ssa/app #
```

- c) Accept the license agreement.

#### **accept-license-agreement**

##### **Example:**

```
Firepower /ssa/app # accept-license-agreement
```

```
End User License Agreement: End User License Agreement
```

```
Effective: May 22, 2017
```

This is an agreement between You and Cisco Systems, Inc. or its affiliates ("Cisco") and governs your Use of Cisco Software. "You" and "Your" means the individual or legal entity licensing the Software under this EULA. "Use" or "Using" means to download, install, activate, access or otherwise use the Software. "Software" means the Cisco computer programs and any Upgrades made available to You by an Approved Source and licensed to You by Cisco.

"Documentation" is the Cisco user or technical manuals, training materials, specifications or other documentation applicable to the Software and made available to You by an Approved Source. "Approved Source" means (i) Cisco or (ii) the Cisco authorized reseller, distributor or systems integrator from whom you acquired the Software. "Entitlement" means the license detail; including license metric, duration, and quantity provided in a product ID (PID) published on Cisco's price list, claim certificate or right to use notification.

"Upgrades" means all updates, upgrades, bug fixes, error corrections, enhancements and other modifications to the Software and backup copies thereof.

```
[...]
```

Please "commit-buffer" if you accept the license agreement, otherwise "discard-buffer".

```
Firepower /ssa/app* #
```

- d) Save the configuration.

#### **commit-buffer**

##### **Example:**

```
Firepower /ssa/app* # commit-buffer
Firepower /ssa/app #
```

- e) Exit to ssa mode.

#### **exit**

##### **Example:**

```
Firepower /ssa/app* # exit
Firepower /ssa* #
```

##### **Example:**

```
Firepower /ssa # scope app ftd 6.3.0.21
Firepower /ssa/app* # accept-license-agreement
```

```
Firepower /ssa/app* # exit
Firepower /ssa* #
```

**Step 4**

Set the application instance parameters, including the image version.

- a) For container instances, view available resource profiles. To add a profile, see [Add a Resource Profile for Container Instances](#).

**show resource-profile**

Note the profile name you want to use.

**Example:**

```
Firepower /ssa # show resource-profile
```

| Profile Name | App Name      | App Version     | Is In Use    | Security Model | CPU Logical Core |
|--------------|---------------|-----------------|--------------|----------------|------------------|
| Count        | RAM Size (MB) | Default Profile | Profile Type | Description    |                  |
| bronze       | N/A           | N/A             | No           | all            |                  |
| 6            | N/A           | No              | Custom       | low end device |                  |
| silver 1     | N/A           | N/A             | No           | all            |                  |
| 8            | N/A           | No              | Custom       | mid-level      |                  |

- b) Set the scope to the security module/engine slot.

**scope slot slot\_id**

The *slot\_id* is always 1 for the Firepower 4100, and 1, 2, or 3 for the Firepower 9300.

**Example:**

```
Firepower /ssa # scope slot 1
Firepower /ssa/slot #
```

- c) Create the application instance.

**enter app-instance ftd device\_name**

The *device\_name* can be between 1 and 64 characters. You will use this device name when you create the logical device for this instance.

**Example:**

```
Firepower /ssa/slot # enter app-instance ftd FTD1
Firepower /ssa/slot/app-instance* #
```

- d) For a container instance, set the application instance type to container.

**set deploy-type container**

A container instance uses a subset of resources of the security module/engine, so you can install multiple container instances. A native instance uses all of the resources (CPU, RAM, and disk space) of the security module/engine, so you can only install one native instance.

You cannot change the instance type after you save the configuration. The default type is **native**.

**Example:**

```
Firepower /ssa/slot/app-instance* # set deploy-type container
```

- e) For a container instance, set the resource profile.

**set resource-profile-name** *name*

This profile name must already exist.

If you later assign a different resource profile, then the instance will reload, which can take approximately 5 minutes. Note that for established High Availability pairs or clusters, if you assign a different-sized resource profile, be sure to make all members the same size as soon as possible.

**Example:**

```
Firepower /ssa/slot/app-instance* # set resource-profile-name bronze
```

- f) Set the image version.

**set startup-version** *version*

Enter the version number that you noted earlier in this procedure.

**Example:**

```
Firepower /ssa/slot/app-instance* # set startup-version 6.6.0
```

- g) (Optional) For a container instance, enable or disable TLS crypto acceleration.

**enter hw-crypto**

**set admin-state** {**enabled** | **disabled**}

**exit**

This setting enables TLS crypto acceleration in hardware, and improves performance for certain types of traffic. This feature is enabled by default. You can enable TLS crypto acceleration for up to 16 instances per security module. This feature is not supported for native instances. To view the percentage of hardware crypto resources allocated to this instance, enter the **show hw-crypto** command. Note that Version 2 refers to the TLS crypto acceleration type used in FXOS 2.7 and later.

**Example:**

```
Firepower /ssa/slot/app-instance* # enter hw-crypto
Firepower /ssa/slot/app-instance/hw-crypto* # set admin-state enabled
Firepower /ssa/slot/app-instance/hw-crypto* # exit
Firepower /ssa/slot/app-instance* # commit-buffer
Firepower /ssa/slot/app-instance # show hw-crypto
Hardware Crypto:
```

| Admin State | Hardware Crypto Size | Hardware Crypto Version |
|-------------|----------------------|-------------------------|
| enabled     | 40%                  | 2                       |

- h) Exit to slot mode.

**exit**

**Example:**

```
Firepower /ssa/slot/app-instance* # exit
Firepower /ssa/slot* #
```

- i) For container instances on the Firepower 9300, repeat these steps to create a container instance on each security module.
- j) Exit to ssa mode.

**exit**

**Example:**

```
Firepower /ssa/slot* # exit
Firepower /ssa* #
```

**Example:**

```
Firepower /ssa # scope slot 1
Firepower /ssa/slot # enter app-instance ftd MyDevice1
Firepower /ssa/slot/app-instance* # set deploy-type container
Firepower /ssa/slot/app-instance* # set resource-profile-name silver 1
Firepower /ssa/slot/app-instance* # set startup-version 6.6.0
Firepower /ssa/slot/app-instance* # exit
Firepower /ssa/slot* # exit
Firepower /ssa # scope slot 2
Firepower /ssa/slot # enter app-instance ftd MyDevice1
Firepower /ssa/slot/app-instance* # set deploy-type container
Firepower /ssa/slot/app-instance* # set resource-profile-name silver 1
Firepower /ssa/slot/app-instance* # set startup-version 6.6.0
Firepower /ssa/slot/app-instance* # exit
Firepower /ssa/slot* # exit
Firepower /ssa # scope slot 3
Firepower /ssa/slot # enter app-instance ftd MyDevice1
Firepower /ssa/slot/app-instance* # set deploy-type container
Firepower /ssa/slot/app-instance* # set resource-profile-name silver 1
Firepower /ssa/slot/app-instance* # set startup-version 6.6.0
Firepower /ssa/slot/app-instance* # exit
Firepower /ssa/slot* # exit
Firepower /ssa* #
```

**Step 5**

Create the cluster:

**enter logical-device *device\_name* ftd *slots* clustered**

- *device\_name*—Use the same *device\_name* as the application instance you added earlier.
- *slots*—Assigns the chassis modules to the cluster. For the Firepower 4100, specify **1**. For the Firepower 9300, specify **1,2,3**. You must enable clustering for all 3 module slots in a Firepower 9300 chassis, even if you do not have a module installed. If you do not configure all 3 modules, the cluster will not come up.

**Example:**

```
Firepower /ssa # enter logical-device FTD1 ftd 1,2,3 clustered
Firepower /ssa/logical-device* #
```

**Step 6**

Configure the cluster bootstrap parameters.

These settings are meant for initial deployment only, or for disaster recovery. For normal operation, you can later change most values in the application CLI configuration.

- a) Create the cluster bootstrap object.

**enter cluster-bootstrap**

**Example:**

```
Firepower /ssa/logical-device* # enter cluster-bootstrap
Firepower /ssa/logical-device/cluster-bootstrap* #
```

- b) Set the chassis ID.

**set chassis-id *id***

Each chassis in the cluster needs a unique ID.

- c) For inter-site clustering, set the site ID between 1 and 8.

**set site-id *number***

To remove the site ID, set the value to **0**.

**Example:**

```
Firepower /ssa/logical-device/cluster-bootstrap* # set site-id 1
Firepower /ssa/logical-device/cluster-bootstrap* #
```

- d) Configure an authentication key for control traffic on the cluster control link.

**set key**

**Example:**

```
Firepower /ssa/logical-device/cluster-bootstrap* # set key
Key: diamonddogs
```

You are prompted to enter the shared secret.

The shared secret is an ASCII string from 1 to 63 characters. The shared secret is used to generate the key. This option does not affect datapath traffic, including connection state update and forwarded packets, which are always sent in the clear.

- e) Set the cluster interface mode.

**set mode spanned-etherchannel**

Spanned EtherChannel mode is the only supported mode.

**Example:**

```
Firepower /ssa/logical-device/cluster-bootstrap* # set mode spanned-etherchannel
Firepower /ssa/logical-device/cluster-bootstrap* #
```

- f) Set the cluster group name in the security module configuration.

**set service-type *cluster\_name***

The name must be an ASCII string from 1 to 38 characters.

**Example:**

```
Firepower /ssa/logical-device/cluster-bootstrap* # set service-type cluster1
Firepower /ssa/logical-device/cluster-bootstrap* #
```

- g) (Optional) Set the cluster control link IP network.

**set cluster-control-link network *a.b.0.0***

By default, the cluster control link uses the 127.2.0.0/16 network. However, some networking deployments do not allow 127.2.0.0/16 traffic to pass. In this case, you can specify a /16 address on a unique network for the cluster.

- ***a.b.0.0***—Specify any /16 network address, except for loopback (127.0.0.0/8) and multicast (224.0.0.0/4) addresses. If you set the value to 0.0.0.0, then the default network is used: 127.2.0.0.

The chassis auto-generates the cluster control link interface IP address for each unit based on the chassis ID and slot ID: *a.b.chassis\_id.slot\_id*.

**Example:**

```
Firepower /ssa/logical-device/cluster-bootstrap* # set cluster-control-link network
10.10.0.0
```

- h) Exit the cluster bootstrap mode.

**exit****Example:**

```
Firepower /ssa/logical-device* # enter cluster-bootstrap
Firepower /ssa/logical-device/cluster-bootstrap* # set chassis-id 1
Firepower /ssa/logical-device/cluster-bootstrap* # set key
Key: f@arscape
Firepower /ssa/logical-device/cluster-bootstrap* # set mode spanned-etherchannel
Firepower /ssa/logical-device/cluster-bootstrap* # set service-type cluster1
Firepower /ssa/logical-device/cluster-bootstrap* # exit
Firepower /ssa/logical-device/* #
```

**Step 7**

Configure the management bootstrap parameters.

These settings are meant for initial deployment only, or for disaster recovery. For normal operation, you can later change most values in the application CLI configuration.

- a) Create the management bootstrap object.

**enter mgmt-bootstrap *ftd*****Example:**

```
Firepower /ssa/logical-device* # enter mgmt-bootstrap ftd
Firepower /ssa/logical-device/mgmt-bootstrap* #
```

- b) Specify the IP address or hostname or NAT ID of the managing FMC.

Set one of the following:

- **enter bootstrap-key FIREPOWER\_MANAGER\_IP**

**set value** *IP\_address*

**exit**

- **enter bootstrap-key FQDN**

**set value** *fmc\_hostname*

**exit**

- **enter bootstrap-key NAT\_ID**

**set value** *nat\_id*

**exit**

Normally, you need both IP addresses (along with a registration key) for both routing purposes and for authentication: the FMC specifies the device IP address, and the device specifies the FMC IP address. However, if you only know one of the IP addresses, which is the minimum requirement for routing purposes, then you must also specify a unique NAT ID on both sides of the connection to establish trust for the initial communication and to look up the correct registration key. You can specify any text string as the NAT ID, from 1 to 37 characters. The FMC and device use the registration key and NAT ID (instead of IP addresses) to authenticate and authorize for initial registration.

**Example:**

```
Firepower /ssa/logical-device/mgmt-bootstrap* # enter bootstrap-key NAT_ID
Firepower /ssa/logical-device/mgmt-bootstrap/bootstrap-key* # set value sc0rpius15
Firepower /ssa/logical-device/mgmt-bootstrap/bootstrap-key* # exit
Firepower /ssa/logical-device/mgmt-bootstrap* #
```

- c) Specify the firewall mode, routed or transparent.

**create bootstrap-key FIREWALL\_MODE**

**set value** {**routed** | **transparent**}

**exit**

In routed mode, the device is considered to be a router hop in the network. Each interface that you want to route between is on a different subnet. A transparent firewall, on the other hand, is a Layer 2 firewall that acts like a “bump in the wire,” or a “stealth firewall,” and is not seen as a router hop to connected devices.

The firewall mode is only set at initial deployment. If you re-apply the bootstrap settings, this setting is not used.

**Example:**

```
Firepower /ssa/logical-device/mgmt-bootstrap* # create bootstrap-key FIREWALL_MODE
Firepower /ssa/logical-device/mgmt-bootstrap/bootstrap-key* # set value routed
Firepower /ssa/logical-device/mgmt-bootstrap/bootstrap-key* # exit
Firepower /ssa/logical-device/mgmt-bootstrap* #
```

- d) Specify the key to be shared between the device and the FMC.

**enter bootstrap-key-secret REGISTRATION\_KEY**

**set value**

Enter a value: *registration\_key*

Confirm the value: *registration\_key*

**exit**

You can choose any text string for this key between 1 and 37 characters; you will enter the same key on the FMC when you add the Firepower Threat Defense.

**Example:**

```
Firepower /ssa/logical-device/mgmt-bootstrap* # create bootstrap-key-secret
REGISTRATION_KEY
Firepower /ssa/logical-device/mgmt-bootstrap/bootstrap-key-secret* # set value
Enter a value: gratuitousapples
Confirm the value: gratuitousapples
Firepower /ssa/logical-device/mgmt-bootstrap/bootstrap-key-secret* # exit
Firepower /ssa/logical-device/mgmt-bootstrap* #
```

- e) Specify a password for the Firepower Threat Defense admin user for CLI access.

**enter bootstrap-key-secret PASSWORD****set value**

Enter a value: *password*

Confirm the value: *password*

**exit****Example:**

```
Firepower /ssa/logical-device/mgmt-bootstrap* # create bootstrap-key-secret PASSWORD
Firepower /ssa/logical-device/mgmt-bootstrap/bootstrap-key-secret* # set value
Enter a value: floppylampshade
Confirm the value: floppylampshade
Firepower /ssa/logical-device/mgmt-bootstrap/bootstrap-key-secret* # exit
Firepower /ssa/logical-device/mgmt-bootstrap* #
```

- f) Specify the fully qualified hostname.

**enter bootstrap-key FQDN****set value fqdn****exit**

Valid characters are the letters from a to z, the digits from 0 to 9, the dot (.), and the hyphen (-); maximum number of characters is 253.

**Example:**

```
Firepower /ssa/logical-device/mgmt-bootstrap* # create bootstrap-key FQDN
Firepower /ssa/logical-device/mgmt-bootstrap/bootstrap-key* # set value
ftdcluster1.example.com
Firepower /ssa/logical-device/mgmt-bootstrap/bootstrap-key* # exit
Firepower /ssa/logical-device/mgmt-bootstrap* #
```



- g) Specify a comma-separated list of DNS servers.

```
enter bootstrap-key DNS_SERVERS
```

```
set value dns_servers
```

```
exit
```

The Firepower Threat Defense uses DNS if you specify a hostname for the FMC, for example.

**Example:**

```
Firepower /ssa/logical-device/mgmt-bootstrap* # create bootstrap-key DNS_SERVERS
Firepower /ssa/logical-device/mgmt-bootstrap/bootstrap-key* # set value 10.9.8.7,10.9.6.5
Firepower /ssa/logical-device/mgmt-bootstrap/bootstrap-key* # exit
Firepower /ssa/logical-device/mgmt-bootstrap* #
```

- h) Specify a comma-separated list of search domains.

```
enter bootstrap-key SEARCH_DOMAINS
```

```
set value search_domains
```

```
exit
```

**Example:**

```
Firepower /ssa/logical-device/mgmt-bootstrap* # create bootstrap-key SEARCH_DOMAINS
Firepower /ssa/logical-device/mgmt-bootstrap/bootstrap-key* # set value
cisco.com,example.com
Firepower /ssa/logical-device/mgmt-bootstrap/bootstrap-key* # exit
Firepower /ssa/logical-device/mgmt-bootstrap* #
```

- i) (Optional) For a container instance, permit Expert Mode from Firepower Threat Defense SSH sessions. Expert Mode provides Firepower Threat Defense shell access for advanced troubleshooting.

```
create bootstrap-key PERMIT_EXPERT_MODE
```

```
set value {yes | no}
```

```
exit
```

- **yes**—Users who access this container instance directly from an SSH session can enter Expert Mode.
- **no**—Only users who access the container instance from the FXOS CLI can enter Expert Mode.

By default for container instances, Expert Mode is only available to users who access the Firepower Threat Defense CLI from the FXOS CLI. This limitation is only applied to container instances to increase isolation between instances. Use Expert Mode only if a documented procedure tells you it is required, or if the Cisco Technical Assistance Center asks you to use it. To enter this mode, use the **expert** command in the Firepower Threat Defense CLI.

**Example:**

```
Firepower /ssa/logical-device/mgmt-bootstrap* # create bootstrap-key PERMIT_EXPERT_MODE
Firepower /ssa/logical-device/mgmt-bootstrap/bootstrap-key* # set value yes
Firepower /ssa/logical-device/mgmt-bootstrap/bootstrap-key* # exit
Firepower /ssa/logical-device/mgmt-bootstrap* #
```

- j) Configure the management IP addresses for each security module in the cluster.

**Note** For the Firepower 9300, you must set the IP address for all 3 module slots in a chassis, even if you do not have a module installed. If you do not configure all 3 modules, the cluster will not come up.

To create an IPv4 management interface object:

1. Create the management interface object.  
**enter ipv4 slot\_id firepower**
2. Set the gateway address.  
**set gateway gateway\_address**
3. Set the IP address and mask.  
**set ip ip\_address mask network\_mask**
4. Exit the management IP mode.  
**exit**
5. Repeat for the remaining modules in the chassis.

To create an IPv6 management interface object:

1. Create the management interface object.  
**enter ipv6 slot\_id firepower**
2. Set the gateway address.  
**set gateway gateway\_address**
3. Set the IP address and prefix.  
**set ip ip\_address prefix-length prefix**
4. Exit the management IP mode.  
**exit**
5. Repeat for the remaining modules in the chassis.

**Example:**

```
Firepower /ssa/logical-device/mgmt-bootstrap* # create ipv4 1 firepower
Firepower /ssa/logical-device/mgmt-bootstrap/ipv4* # set ip 10.10.10.34 mask 255.255.255.0
Firepower /ssa/logical-device/mgmt-bootstrap/ipv4* # set gateway 10.10.10.1
Firepower /ssa/logical-device/mgmt-bootstrap/ipv4* # exit
Firepower /ssa/logical-device/mgmt-bootstrap* # create ipv4 2 firepower
Firepower /ssa/logical-device/mgmt-bootstrap/ipv4* # set ip 10.10.10.35 mask 255.255.255.0
Firepower /ssa/logical-device/mgmt-bootstrap/ipv4* # set gateway 10.10.10.1
Firepower /ssa/logical-device/mgmt-bootstrap/ipv4* # exit
Firepower /ssa/logical-device/mgmt-bootstrap* # create ipv4 3 firepower
Firepower /ssa/logical-device/mgmt-bootstrap/ipv4* # set ip 10.10.10.36 mask 255.255.255.0
Firepower /ssa/logical-device/mgmt-bootstrap/ipv4* # set gateway 10.10.10.1
Firepower /ssa/logical-device/mgmt-bootstrap/ipv4* # exit
Firepower /ssa/logical-device/mgmt-bootstrap* # create ipv6 1 firepower
Firepower /ssa/logical-device/mgmt-bootstrap/ipv6* # set ip 2001:0DB8:BA98::3210
prefix-length 64
Firepower /ssa/logical-device/mgmt-bootstrap/ipv6* # set gateway 2001:0DB8:BA98::3211
Firepower /ssa/logical-device/mgmt-bootstrap/ipv6* # exit
```

```

Firepower /ssa/logical-device/mgmt-bootstrap* # create ipv6 1 firepower
Firepower /ssa/logical-device/mgmt-bootstrap/ipv6* # set ip 2001:0DB8:BA98::3210
prefix-length 64
Firepower /ssa/logical-device/mgmt-bootstrap/ipv6* # set gateway 2001:0DB8:BA98::3211
Firepower /ssa/logical-device/mgmt-bootstrap/ipv6* # exit
Firepower /ssa/logical-device/mgmt-bootstrap* # create ipv6 2 firepower
Firepower /ssa/logical-device/mgmt-bootstrap/ipv6* # set ip 2001:0DB8:BA98::3211
prefix-length 64
Firepower /ssa/logical-device/mgmt-bootstrap/ipv6* # set gateway 2001:0DB8:BA98::3211
Firepower /ssa/logical-device/mgmt-bootstrap/ipv6* # exit
Firepower /ssa/logical-device/mgmt-bootstrap* # create ipv6 3 firepower
Firepower /ssa/logical-device/mgmt-bootstrap/ipv6* # set ip 2001:0DB8:BA98::3212
prefix-length 64
Firepower /ssa/logical-device/mgmt-bootstrap/ipv6* # set gateway 2001:0DB8:BA98::3211
Firepower /ssa/logical-device/mgmt-bootstrap/ipv6* # exit
Firepower /ssa/logical-device/mgmt-bootstrap* #

```

k) Exit the management bootstrap mode.

**exit**

**Example:**

```

Firepower /ssa/logical-device/mgmt-bootstrap* # exit
Firepower /ssa/logical-device* #

```

**Example:**

```

Firepower /ssa/logical-device* # enter mgmt-bootstrap ftd
Firepower /ssa/logical-device/mgmt-bootstrap* # enter bootstrap-key FIREPOWER_MANAGER_IP
Firepower /ssa/logical-device/mgmt-bootstrap/bootstrap-key* # set value 10.0.0.100
Firepower /ssa/logical-device/mgmt-bootstrap/bootstrap-key* # exit
Firepower /ssa/logical-device/mgmt-bootstrap* # enter bootstrap-key FIREWALL_MODE
Firepower /ssa/logical-device/mgmt-bootstrap/bootstrap-key* # set value routed
Firepower /ssa/logical-device/mgmt-bootstrap/bootstrap-key* # exit
Firepower /ssa/logical-device/mgmt-bootstrap* # enter bootstrap-key-secret REGISTRATION_KEY
Firepower /ssa/logical-device/mgmt-bootstrap/bootstrap-key-secret* # set value
Value: ziggy$stardust
Firepower /ssa/logical-device/mgmt-bootstrap/bootstrap-key-secret* # exit
Firepower /ssa/logical-device/mgmt-bootstrap* # enter bootstrap-key-secret PASSWORD
Firepower /ssa/logical-device/mgmt-bootstrap/bootstrap-key-secret* # set value
Value: $pidersfrommars
Firepower /ssa/logical-device/mgmt-bootstrap/bootstrap-key-secret* # exit
Firepower /ssa/logical-device/mgmt-bootstrap* # enter bootstrap-key FQDN
Firepower /ssa/logical-device/mgmt-bootstrap/bootstrap-key* # set value example.cisco.com
Firepower /ssa/logical-device/mgmt-bootstrap/bootstrap-key* # exit
Firepower /ssa/logical-device/mgmt-bootstrap* # enter bootstrap-key DNS_SERVERS
Firepower /ssa/logical-device/mgmt-bootstrap/bootstrap-key* # set value 192.168.1.1
Firepower /ssa/logical-device/mgmt-bootstrap/bootstrap-key* # exit
Firepower /ssa/logical-device/mgmt-bootstrap* # enter bootstrap-key SEARCH_DOMAINS
Firepower /ssa/logical-device/mgmt-bootstrap/bootstrap-key* # set value example.com
Firepower /ssa/logical-device/mgmt-bootstrap/bootstrap-key* # exit
Firepower /ssa/logical-device/mgmt-bootstrap* # enter ipv4 1 firepower
Firepower /ssa/logical-device/mgmt-bootstrap/ipv4* # set gateway 10.0.0.1
Firepower /ssa/logical-device/mgmt-bootstrap/ipv4* # set ip 10.0.0.31 mask 255.255.255.0
Firepower /ssa/logical-device/mgmt-bootstrap/ipv4* # exit
Firepower /ssa/logical-device/mgmt-bootstrap* # enter ipv4 2 firepower
Firepower /ssa/logical-device/mgmt-bootstrap/ipv4* # set gateway 10.0.0.1
Firepower /ssa/logical-device/mgmt-bootstrap/ipv4* # set ip 10.0.0.32 mask 255.255.255.0
Firepower /ssa/logical-device/mgmt-bootstrap/ipv4* # exit
Firepower /ssa/logical-device/mgmt-bootstrap* # enter ipv4 3 firepower

```

```
Firepower /ssa/logical-device/mgmt-bootstrap/ipv4* # set gateway 10.0.0.1
Firepower /ssa/logical-device/mgmt-bootstrap/ipv4* # set ip 10.0.0.33 mask 255.255.255.0
Firepower /ssa/logical-device/mgmt-bootstrap/ipv4* # exit
Firepower /ssa/logical-device/mgmt-bootstrap* # exit
Firepower /ssa/logical-device* #
```

**Step 8** Save the configuration.

#### commit-buffer

The chassis deploys the logical device by downloading the specified software version and pushing the bootstrap configuration and management interface settings to the application instance. Check the status of the deployment using the **show app-instance** command. The application instance is running and ready to use when the **Admin State is Enabled** and the **Oper State is Online**.

#### Example:

```
Firepower /ssa/logical-device* # commit-buffer
Firepower /ssa/logical-device # exit
Firepower /ssa # show app-instance
```

| App Name    | Identifier   | Slot ID | Admin State    | Oper State    | Running Version | Startup Version |
|-------------|--------------|---------|----------------|---------------|-----------------|-----------------|
| Deploy Type | Profile Name | Cluster | State          | Cluster Role  |                 |                 |
| ftd         | cluster1     | 1       | Enabled        | Online        | 7.3.0.49        | 7.3.0.49        |
| Native      |              |         | In Cluster     | Data Node     |                 |                 |
| ftd         | cluster1     | 2       | Enabled        | Online        | 7.3.0.49        | 7.3.0.49        |
| Native      |              |         | In Cluster     | Control Node  |                 |                 |
| ftd         | cluster1     | 3       | Disabled       | Not Available |                 | 7.3.0.49        |
| Native      |              |         | Not Applicable | None          |                 |                 |

**Step 9** To add another chassis to the cluster, repeat this procedure except you must configure unique **chassis-id** and management IP addresses, as well as the correct **site-id**; otherwise, use the same configuration for both chassis.

Make sure the interface configuration is the same on the new chassis. You can export and import FXOS chassis configuration to make this process easier.

**Step 10** Add the control unit to the FMC using the management IP address.

All cluster units must be in a successfully-formed cluster on FXOS prior to adding them to FMC.

The FMC then automatically detects the data units.

#### Native Cluster Example

```
scope eth-uplink
 scope fabric a
 enter port-channel 1
 set port-type data
 enable
 create member-port Ethernet1/1
 exit
 create member-port Ethernet1/2
 exit
 exit
 enter port-channel 2
```

```
 set port-type data
 enable
 create member-port Ethernet1/3
 exit
 create member-port Ethernet1/4
 exit
 exit
enter port-channel 3
 set port-type firepower-eventing
 enable
 create member-port Ethernet1/5
 exit
 create member-port Ethernet1/6
 exit
 exit
enter port-channel 4
 set port-type mgmt
 enable
 create member-port Ethernet2/1
 exit
 enter member-port Ethernet2/2
 exit
 exit
enter port-channel 48
 set port-type cluster
 enable
 enter member-port Ethernet2/3
 exit
 exit
exit
commit-buffer

scope ssa
 enter logical-device FTD1 ftd "1,2,3" clustered
 enter cluster-bootstrap
 set chassis-id 1
 set key cluster_key
 set mode spanned-etherchannel
 set service-type ftd-cluster
 exit
 enter mgmt-bootstrap ftd
 enter bootstrap-key FIREPOWER_MANAGER_IP
 set value 10.0.0.100
 exit
 enter bootstrap-key FIREWALL_MODE
 set value transparent
 exit
 enter bootstrap-key-secret REGISTRATION_KEY
 set value
 Value: alladinsane
 exit
 enter bootstrap-key-secret PASSWORD
 set value
 Value: widthofacircle
 exit
 enter bootstrap-key FQDN
 set value ftd.cisco.com
 exit
 enter bootstrap-key DNS_SERVERS
 set value 192.168.1.1
 exit
 enter bootstrap-key SEARCH_DOMAINS
 set value search.com
```

```

 exit
 enter ipv4 1 firepower
 set gateway 10.0.0.1
 set ip 10.0.0.31 mask 255.255.255.0
 exit
 enter ipv4 2 firepower
 set gateway 10.0.0.1
 set ip 10.0.0.32 mask 255.255.255.0
 exit
 enter ipv4 3 firepower
 set gateway 10.0.0.1
 set ip 10.0.0.33 mask 255.255.255.0
 exit
 exit
 exit
scope app ftd 6.0.0.837
 accept-license-agreement
 set-default
 exit
commit-buffer

```

For chassis 2:

```

scope eth-uplink
 scope fabric a
 enter port-channel 1
 set port-type data
 enable
 create member-port Ethernet1/1
 exit
 create member-port Ethernet1/2
 exit
 exit
 enter port-channel 2
 set port-type data
 enable
 create member-port Ethernet1/3
 exit
 create member-port Ethernet1/4
 exit
 exit
 enter port-channel 3
 set port-type firepower-eventing
 enable
 create member-port Ethernet1/5
 exit
 create member-port Ethernet1/6
 exit
 exit
 enter port-channel 4
 set port-type mgmt
 enable
 create member-port Ethernet2/1
 exit
 enter member-port Ethernet2/2
 exit
 exit
 enter port-channel 48
 set port-type cluster
 enable
 enter member-port Ethernet2/3
 exit
 exit
 exit

```

```

 exit
 exit
commit-buffer

scope ssa
 enter logical-device FTD1 ftd "1,2,3" clustered
 enter cluster-bootstrap
 set chassis-id 2
 set key cluster_key
 set mode spanned-etherchannel
 set service-type ftd-cluster
 exit
 enter mgmt-bootstrap ftd
 bootstrap-key FIREPOWER_MANAGER_IP
 set value 10.0.0.100
 exit
 enter bootstrap-key FIREWALL_MODE
 set value transparent
 exit
 enter bootstrap-key-secret REGISTRATION_KEY
 set value
 Value: alladinsane
 exit
 enter bootstrap-key-secret PASSWORD
 set value
 Value: widthofacircle
 exit
 enter bootstrap-key FQDN
 set value ftd.cisco.com
 exit
 enter bootstrap-key DNS_SERVERS
 set value 192.168.1.1
 exit
 enter bootstrap-key SEARCH_DOMAINS
 set value search.com
 exit
 enter ipv4 1 firepower
 set gateway 10.0.0.1
 set ip 10.0.0.31 mask 255.255.255.0
 exit
 enter ipv4 2 firepower
 set gateway 10.0.0.1
 set ip 10.0.0.32 mask 255.255.255.0
 exit
 enter ipv4 3 firepower
 set gateway 10.0.0.1
 set ip 10.0.0.33 mask 255.255.255.0
 exit
 exit
scope app ftd 6.0.0.837
 set-default
 accept-license-agreement
 exit
commit-buffer

```

### Multi-Instance Clustering Example

```

scope eth-uplink
 scope fabric a
 enter port-channel 1
 set port-type data
 enable

```

```

 create member-port Ethernet1/1
 exit
 create member-port Ethernet1/2
 exit
 exit
 enter port-channel 2
 set port-type data
 enable
 create member-port Ethernet1/3
 exit
 create member-port Ethernet1/4
 exit
 exit
 enter interface Ethernet1/8
 set port-type mgmt
 enable
 exit
 enter port-channel 48
 set port-type cluster
 enable
 enter member-port Ethernet2/3
 exit
 enter subinterface 100
 set vlan 100
 set port-type cluster
 exit
 exit
 exit
commit-buffer

scope ssa
 scope slot 1
 enter app-instance ftd FTD1
 set deploy-type container
 set resource-profile-name medium
 set startup-version 6.6.0
 exit
 exit
 scope slot 2
 enter app-instance ftd FTD1
 set deploy-type container
 set resource-profile-name medium
 set startup-version 6.6.0
 exit
 exit
 enter app-instance ftd FTD1
 set deploy-type container
 set resource-profile-name medium
 set startup-version 6.6.0
 exit
 exit
 enter logical-device FTD1 ftd "1,2,3" clustered
 enter cluster-bootstrap
 set chassis-id 1
 set key cluster_key
 set mode spanned-etherchannel
 set service-type ftd-cluster
 exit
 enter mgmt-bootstrap ftd
 enter bootstrap-key FIREPOWER_MANAGER_IP
 set value 10.0.0.100
 exit
 enter bootstrap-key FIREWALL_MODE
 set value transparent

```



```
 exit
 enter bootstrap-key-secret REGISTRATION_KEY
 set value
 Value: alladinsane
 exit
 enter bootstrap-key-secret PASSWORD
 set value
 Value: widthofacircle
 exit
 enter bootstrap-key FQDN
 set value ftd.cisco.com
 exit
 enter bootstrap-key DNS_SERVERS
 set value 192.168.1.1
 exit
 enter bootstrap-key SEARCH_DOMAINS
 set value search.com
 exit
 enter ipv4 1 firepower
 set gateway 10.0.0.1
 set ip 10.0.0.31 mask 255.255.255.0
 exit
 enter ipv4 2 firepower
 set gateway 10.0.0.1
 set ip 10.0.0.32 mask 255.255.255.0
 exit
 enter ipv4 3 firepower
 set gateway 10.0.0.1
 set ip 10.0.0.33 mask 255.255.255.0
 exit
 enter bootstrap-key PERMIT_EXPERT_MODE
 set value yes
 exit
 exit
exit
scope app ftd 6.6.0
 accept-license-agreement
 exit
commit-buffer
```

For chassis 2:

```
scope eth-uplink
 scope fabric a
 enter port-channel 1
 set port-type data
 enable
 create member-port Ethernet1/1
 exit
 create member-port Ethernet1/2
 exit
 exit
 enter port-channel 2
 set port-type data
 enable
 create member-port Ethernet1/3
 exit
 create member-port Ethernet1/4
 exit
 exit
 enter interface Ethernet1/8
 set port-type mgmt
 enable
```

```

 exit
 enter port-channel 48
 set port-type cluster
 enable
 enter member-port Ethernet2/3
 exit
 enter subinterface 100
 set vlan 100
 set port-type cluster
 exit
 exit
exit
commit-buffer

scope ssa
 scope slot 1
 enter app-instance ftd FTD1
 set deploy-type container
 set resource-profile-name medium
 set startup-version 6.6.0
 exit
 exit
 scope slot 2
 enter app-instance ftd FTD1
 set deploy-type container
 set resource-profile-name medium
 set startup-version 6.6.0
 exit
 exit
 enter app-instance ftd FTD1
 set deploy-type container
 set resource-profile-name medium
 set startup-version 6.6.0
 exit
 exit
enter logical-device FTD1 ftd "1,2,3" clustered
enter cluster-bootstrap
 set chassis-id 2
 set key cluster_key
 set mode spanned-etherchannel
 set service-type ftd-cluster
 exit
enter mgmt-bootstrap ftd
 enter bootstrap-key FIREPOWER_MANAGER_IP
 set value 10.0.0.100
 exit
 enter bootstrap-key FIREWALL_MODE
 set value transparent
 exit
 enter bootstrap-key-secret REGISTRATION_KEY
 set value
 Value: alladinsane
 exit
 enter bootstrap-key-secret PASSWORD
 set value
 Value: widthofacircle
 exit
 enter bootstrap-key FQDN
 set value ftd.cisco.com
 exit
 enter bootstrap-key DNS_SERVERS
 set value 192.168.1.1
 exit
 enter bootstrap-key SEARCH_DOMAINS

```

```
 set value search.com
 exit
enter ipv4 1 firepower
 set gateway 10.0.0.1
 set ip 10.0.0.31 mask 255.255.255.0
 exit
enter ipv4 2 firepower
 set gateway 10.0.0.1
 set ip 10.0.0.32 mask 255.255.255.0
 exit
enter ipv4 3 firepower
 set gateway 10.0.0.1
 set ip 10.0.0.33 mask 255.255.255.0
 exit
enter bootstrap-key PERMIT_EXPERT_MODE
 set value yes
 exit
exit
scope app ftd 6.6.0
 accept-license-agreement
 exit
commit-buffer
```

## Add More Cluster Nodes

Add or replace the Firepower Threat Defense cluster node in an existing cluster. When you add a new cluster node in FXOS, the FMC adds the node automatically.



---

**Note** The FXOS steps in this procedure only apply to adding a new *chassis*; if you are adding a new module to a Firepower 9300 where clustering is already enabled, the module will be added automatically.

---

### Before you begin

- In the case of a replacement, you must delete the old cluster node from the FMC. When you replace it with a new node, it is considered to be a new device on the FMC.
- The interface configuration must be the same on the new chassis. You can export and import FXOS chassis configuration to make this process easier.

### Procedure

---

To add another chassis to the cluster, repeat the procedure in [Create a FTD Cluster, on page 71](#) except you must configure the following settings to be unique; otherwise, use the same configuration for both chassis.

- Chassis ID
- Management IP addresses

Also be sure to set the startup version to the currently running version on the cluster nodes.

---

# Configure Radware DefensePro

The Cisco Firepower 4100/9300 chassis can support multiple services (for example, a firewall and a third-party DDoS application) on a single blade. These applications and services can be linked together to form a Service Chain.

## About Radware DefensePro

In the current supported Service Chaining configuration, the third-party Radware DefensePro virtual platform can be installed to run in front of the ASA firewall, or in front of Firepower Threat Defense. Radware DefensePro is a KVM-based virtual platform that provides distributed denial-of-service (DDoS) detection and mitigation capabilities on the Firepower 4100/9300 chassis. When Service Chaining is enabled on your Firepower 4100/9300 chassis, traffic from the network must first pass through the DefensePro virtual platform before reaching the main ASA or Firepower Threat Defense firewall.

**Note**

- The Radware DefensePro virtual platform may be referred to as *Radware vDP* (virtual DefensePro), or simply *vDP*.
- The Radware DefensePro virtual platform may occasionally be referred to as a Link Decorator.
- Radware (vDP) is not supported on logical device instance type setup as container instance.

## Prerequisites for Radware DefensePro

Prior to deploying Radware DefensePro on your Firepower 4100/9300 chassis, you must configure the Firepower 4100/9300 chassis to use an NTP Server with the **etc/UTC** Time Zone. For more information about setting the date and time in your Firepower 4100/9300 chassis, see [Setting the Date and Time](#).

## Guidelines for Service Chaining

**Models**

- ASA—The Radware DefensePro (vDP) platform is supported with ASA on the following models:
  - Firepower 9300
  - Firepower 4110
  - Firepower 4115
  - Firepower 4120
  - Firepower 4125
  - Firepower 4140
  - Firepower 4145
  - Firepower 4150

- FTD—The Radware DefensePro platform is supported with Firepower Threat Defense on the following models:
  - Firepower 9300
  - Firepower 4110—Note you must deploy the decorator at the same time as the logical device. You cannot install the decorator after the logical device is already configured on the device.
  - Firepower 4112
  - Firepower 4115
  - Firepower 4120—Note you must deploy the decorator at the same time as the logical device. You cannot install the decorator after the logical device is already configured on the device.
  - Firepower 4125
  - Firepower 4140
  - Firepower 4145
  - Firepower 4150

#### Additional Guidelines

- Service Chaining is not supported in an inter-chassis cluster configuration. However, the Radware DefensePro (vDP) application can be deployed in a standalone configuration in an inter-chassis cluster scenario.

## Configure Radware DefensePro on a Standalone Logical Device

The following procedure shows how to install Radware DefensePro in a single Service Chain in front of a standalone ASA or Firepower Threat Defense logical device.

#### Before you begin

- Download the vDP image from Cisco.com (see [Downloading Images from Cisco.com](#)) and then download that image to the Firepower 4100/9300 chassis (see [Downloading a Logical Device Software Image to the Firepower 4100/9300 chassis](#)).
- You can deploy the Radware DefensePro application in a standalone configuration on an intra-chassis cluster; for intra-chassis clustering, see [Configure Radware DefensePro on an Intra-Chassis Cluster](#), on page 96.

#### Procedure

- 
- Step 1** If you want to use a separate management interface for vDP, enable the interface and set it to be the mgmt type according to [Configure a Physical Interface](#). Otherwise, you can share the application management interface.
- Step 2** Create an ASA or Firepower Threat Defense logical device in standalone configuration (see [Add a Standalone ASA](#), on page 23 or [Add a Standalone FTD for the FMC](#), on page 29). Note that if you are installing the

images on a Firepower 4110 or 4120 security appliance, you must install vDP along with the Firepower Threat Defense image before you commit your configuration.

**Step 3** Enter security services mode:

```
Firepower# scope ssa
```

**Step 4** Create the Radware vDP instance:

```
Firepower /ssa # scope slot slot_id
```

```
Firepower /ssa/slot # create app-instance vdp logical_device_identifier
```

```
Firepower /ssa/slot/app-instance* # exit
```

```
Firepower /ssa/slot/* # exit
```

**Step 5** Commit the configuration:

```
commit-buffer
```

**Step 6** Verify the installation and provisioning of vDP on the security module:

```
Firepower /ssa # show app-instance
```

**Example:**

```
Firepower /ssa # show app-instance
App Name Slot ID Admin State Oper State Running Version Startup Version Cluster
State Cluster Role

ftd 1 Enabled Online 6.2.1.62 6.2.1.62 Not
Applicable None
vdp 1 Disabled Installing 8.10.01.16-5 Not
Applicable None
```

**Step 7** (Optional) Show the available supported resource profiles:

```
Firepower /ssa/app # show resource-profile system
```

**Example:**

```
Firepower /ssa # show resource-profile system
Profile Name App Name App Version Is In Use Security Model CPU Logical Core Count
RAM Size (MB) Default Profile Profile Type Description

DEFAULT-4110-RESOURCE
 vdp 8.13.01.09-2 No FPR4K-SM-12
4 16384 Yes System
DEFAULT-RESOURCE vdp 8.13.01.09-2 No FPR9K-SM-56, FPR9K-SM-44, FPR9K-SM-36,
FPR9K-SM-24, FPR4K-SM-44, FPR4K-SM-36, FPR4K-SM-24
6 24576 Yes System
VDP-10-CORES vdp 8.13.01.09-2 No FPR9K-SM-56, FPR9K-SM-44, FPR9K-SM-36,
FPR9K-SM-24, FPR4K-SM-44, FPR4K-SM-36, FPR4K-SM-24
10 40960 No System
VDP-2-CORES vdp 8.13.01.09-2 No all
2 8192 No System
VDP-4-CORES vdp 8.13.01.09-2 No all
4 16384 No System
VDP-8-CORES vdp 8.13.01.09-2 No FPR9K-SM-56, FPR9K-SM-44, FPR9K-SM-36,
FPR9K-SM-24, FPR4K-SM-44, FPR4K-SM-36, FPR4K-SM-24
```

```
8 32768 No System
```

**Step 8** (Optional) Set the resource profile, using one of the available profiles from the previous step:

a) Scope to slot 1:

```
Firepower /ssa*# scope slot 1
```

b) Enter the DefensePro application instance:

```
Firepower /ssa/slot* # enter app-instance vdp
```

c) Set the resource profile:

```
Firepower /ssa/slot/app-instance* # set resource-profile-name resource_profile_name
```

d) Commit the configuration:

```
Firepower /ssa/slot/app-instance* # commit-buffer
```

**Step 9** Once the vDP application is installed, access the logical device:

```
Firepower /ssa # scope logical-device device_name
```

**Step 10** Assign the management interface to vDP. You can use the same physical interface as for the logical device, or you can use a separate interface.

```
Firepower /ssa/logical-device # enter external-port-link name interface_id vdp
```

```
Firepower /ssa/logical-device/external-port-link* # exit
```

**Step 11** Configure the external management interface settings for vDP.

a) Create the bootstrap object:

```
Firepower /ssa/logical-device* # create mgmt-bootstrap vdp
```

b) Configure the management IP address:

```
Firepower /ssa/logical-device/mgmt-bootstrap* #create ipv4 slot_id default
```

c) Set the gateway address:

```
Firepower /ssa/logical-device/mgmt-bootstrap/ipv4* #set gateway gateway_address
```

d) Set the IP address and mask:

```
Firepower /ssa/logical-device/mgmt-bootstrap/ipv4* #set ip ip_address mask network_mask
```

e) Exit the management IP configuration scope:

```
Firepower /ssa/logical-device/mgmt-bootstrap/ipv4* #exit
```

f) Exit the management bootstrap configuration scope:

```
Firepower /ssa/logical-device/mgmt-bootstrap* #exit
```

**Step 12** Edit the data interface where you want to place the vDP in front of the ASA or Firepower Threat Defense flow:

```
Firepower /ssa/logical-device* # scope external-port-link name
```

Enter the **show external-port-link** command to view interface names.

**Step 13** Add the vDP to the logical device:

```
Firepower /ssa/logical-device/external-port-link* # set decorator vdp
```

Repeat for each interface where you want to use vDP.

**Note** To view the updated vDP interfaces in ASA, you must reload the ASA after adding or deleting a vDP interface.

**Step 14** Commit the configuration:

```
commit-buffer
```

**Step 15** Verify that the third-party app is set for the interface:

```
Firepower /ssa/logical-device/external-port-link* # show detail
```

**Example:**

```
Firepower /ssa/logical-device/external-port-link # show detail

External-Port Link:
 Name: Ethernet11_ftd
 Port or Port Channel Name: Ethernet1/1
 App Name: ftd
 Description:
 Link Decorator: vdp
```

---

### What to do next

Set a password for the DefensePro application. Note that the application does not come online until you set a password. For more information, see the Radware DefensePro DDoS Mitigation User Guide on [cisco.com](http://cisco.com).

## Configure Radware DefensePro on an Intra-Chassis Cluster



---

**Note** Service Chaining is not supported in an inter-chassis cluster configuration. However, the Radware DefensePro application can be deployed in a standalone configuration in an inter-chassis cluster scenario.

---

### Before you begin

- Download the vDP image from [Cisco.com](http://Cisco.com) (see [Downloading Images from Cisco.com](#)) and then download that image to the Firepower 4100/9300 chassis (see [Downloading a Logical Device Software Image to the Firepower 4100/9300 chassis](#)).

### Procedure

---

**Step 1** If you want to use a separate management interface for vDP, enable the interface and set it to be the mgmt type according to [Configure a Physical Interface](#). Otherwise, you can share the application management interface.



**Step 2** Configure an ASA intra-chassis cluster (see [Create an ASA Cluster, on page 62](#)) or a Firepower Threat Defense intra-chassis cluster (see [Create a FTD Cluster, on page 71](#)).

**Step 3** Decorate the external (client-facing) port with Radware DefensePro:

```
enter external-port-link name interface_name { asa | ftd }
set decorator vdp
set description ""
exit
```

**Step 4** Assign the external management port for the logical device:

```
enter external-port-link { mgmt_asa | mgmt_ftd } interface_id { asa | ftd }
set decorator ""
set description ""
exit
```

**Step 5** Assign the external management port for DefensePro:

```
enter external-port-link mgmt_vdp interface_name { asa | ftd }
set decorator ""
set description ""
```

**Step 6** (Optional) Show the available supported resource profiles:

```
show resource-profile system
```

**Example:**

```
Firepower /ssa # show resource-profile system
Profile Name App Name App Version Is In Use Security Model CPU Logical Core Count
RAM Size (MB) Default Profile Profile Type Description

DEFAULT-4110-RESOURCE
 vdp 8.13.01.09-2 No FPR4K-SM-12
4 16384 Yes System
DEFAULT-RESOURCE vdp 8.13.01.09-2 No FPR9K-SM-56, FPR9K-SM-44, FPR9K-SM-36,
FPR9K-SM-24, FPR4K-SM-44, FPR4K-SM-36, FPR4K-SM-24
6 24576 Yes System
VDP-10-CORES vdp 8.13.01.09-2 No FPR9K-SM-56, FPR9K-SM-44, FPR9K-SM-36,
FPR9K-SM-24, FPR4K-SM-44, FPR4K-SM-36, FPR4K-SM-24
10 40960 No System
VDP-2-CORES vdp 8.13.01.09-2 No all
2 8192 No System
VDP-4-CORES vdp 8.13.01.09-2 No all
4 16384 No System
VDP-8-CORES vdp 8.13.01.09-2 No FPR9K-SM-56, FPR9K-SM-44, FPR9K-SM-36,
FPR9K-SM-24, FPR4K-SM-44, FPR4K-SM-36, FPR4K-SM-24
8 32768 No System
```

**Step 7** (Optional) Set the resource profile using one of the available profiles from the previous step:

**Note** After committing this change, the FXOS chassis reboots.

- a) Scope to slot 1:  
Firepower /ssa\*# **scope slot 1**
- b) Enter the DefensePro application instance:  
Firepower /ssa/slot\* # **enter app-instance vdp**
- c) Set the resource profile:  
Firepower /ssa/slot/app-instance\* # **set resource-profile-name resource\_profile\_name**
- d) Commit the configuration:  
Firepower /ssa/slot/app-instance\* # **commit-buffer**

**Step 8** Configure cluster port channel:  
 enter **external-port-link** port-channel48 Port-channel48 { asa | ftd }  
 set **decorator** ""  
 set **description** ""  
**exit**

**Step 9** Configure management bootstrap for all three DefensePro instances:  
 enter **mgmt-bootstrap vdp**  
 enter **ipv4 slot\_id default**  
**set gateway gateway\_address**  
**set ip ip\_address mask network\_mask**  
**exit**

**Example:**

```

enter mgmt-bootstrap vdp
 enter ipv4 1 default
 set gateway 172.16.0.1
 set ip 172.16.4.219 mask 255.255.0.0
 exit

 enter ipv4 2 default
 set gateway 172.16.0.1
 set ip 172.16.4.220 mask 255.255.0.0
 exit

 enter ipv4 3 default
 set gateway 172.16.0.1
 set ip 172.16.4.221 mask 255.255.0.0
 exit

```

**Step 10** Exit management bootstrap configuration scope:  
**exit**

**Step 11** Enter the DefensePro application instance on the Control blade:  
**connect module slot console**

**connect vdp**

- Step 12** On the Control blade, set the management IP:  
**device clustering management-channel ip**
- Step 13** Using the IP found in the previous step, set the Control IP:  
**device clustering master set *management-channel ip***
- Step 14** Enable the cluster:  
**device clustering state set enable**
- Step 15** Exit the application console and return to the FXOS module CLI:  
**Ctrl ]**
- Step 16** Repeat steps 10, 12, 13, and 14 to set the Control blade IP found in step 11 and enable the cluster for each blade application instance.
- Step 17** Commit the configuration:  
**commit-buffer**
- Note** After completing this procedure, you must verify whether the DefensePro instances are configured in a cluster.
- Step 18** Validate that all DefensePro applications have joined the cluster:  
**device cluster show**
- Step 19** Use either of the following methods to verify which DefensePro instance is primary, and which one is secondary.
- Scope the DefensePro instance and show application attributes for DefensePro only:  
**scope ssa**  
**scope slot *slot\_number***  
**scope app-instance vdp**  
**show app-attri**
  - Scope the slot and show the DefensePro instance in expanded detail. This approach displays information for both logical device and vDP application instances on the slot.  
**scope ssa**  
**scope *slot\_number***  
**show app-instance expand detail**

---

If the DefensePro application is online but not yet formed in a cluster, the CLI displays:

```
App Attribute:
App Attribute Key: cluster-role
Value: unknown
```

If the system displays this "unknown" value, you must enter the DefensePro application and configure the Control blade IP address to create the vDP cluster.

If the DefensePro application is online and formed in a cluster, the CLI displays:

```
App Attribute:
App Attribute Key: cluster-role
Value: primary/secondary
```

### Example

```
scope ssa
 enter logical-device ld asa "1,2,3" clustered
 enter cluster-bootstrap
 set chassis-id 1
 set ipv4 gateway 172.16.0.1
 set ipv4 pool 172.16.4.216 172.16.4.218
 set ipv6 gateway 2010::2
 set ipv6 pool 2010::21 2010::26
 set key secret
 set mode spanned-etherchannel
 set name cisco
 set virtual ipv4 172.16.4.222 mask 255.255.0.0
 set virtual ipv6 2010::134 prefix-length 64
 exit
 enter external-port-link Ethernet1-2 Ethernet1/2 asa
 set decorator vdp
 set description ""
 exit
 enter external-port-link Ethernet1-3_asa Ethernet1/3 asa
 set decorator ""
 set description ""
 exit
 enter external-port-link mgmt_asa Ethernet1/1 asa
 set decorator ""
 set description ""
 exit
 enter external-port-link mgmt_vdp Ethernet1/1 vdp
 set decorator ""
 set description ""
 exit
 enter external-port-link port-channel48 Port-channel48 asa
 set decorator ""
 set description ""
 exit
 enter mgmt-bootstrap vdp
 enter ipv4 1 default
 set gateway 172.16.0.1
 set ip 172.16.4.219 mask 255.255.0.0
 exit

 enter ipv4 2 default
 set gateway 172.16.0.1
 set ip 172.16.4.220 mask 255.255.0.0
 exit

 enter ipv4 3 default
 set gateway 172.16.0.1
 set ip 172.16.4.221 mask 255.255.0.0
 exit
 exit
commit-buffer
scope ssa
 scope slot 1
 scope app-instance vdp
```

```
show app-attri
App Attribute:
App Attribute Key: cluster-role
Value: unknown
```

### What to do next

Set a password for the DefensePro application. Note that the application does not come online until you set a password. For more information, see the Radware DefensePro DDoS Mitigation User Guide on [cisco.com](http://cisco.com).

## Open UDP/TCP Ports and Enable vDP Web Services

The Radware APSolute Vision Manager interfaces communicate with the Radware vDP application using various UDP/TCP ports. In order for the vDP application to communicate with the APSolute Vision Manager, you must ensure that these ports are accessible and not blocked by your firewall. For more information on which specific ports to open, see the following tables in the APSolute Vision User Guide:

- **Ports for APSolute Vision Server-WBM Communication and Operating System**
- **Communication Ports for APSolute Vision Server with Radware Devices**

In order for Radware APSolute Vision to manage the Virtual DefensePro application deployed on the FXOS chassis, you must enable the vDP web service using the FXOS CLI.

### Procedure

- 
- Step 1** From the FXOS CLI, connect to the vDP application instance.
- ```
connect module slot console
connect vdp
```
- Step 2** Enable vDP web services.
- ```
manage secure-web status set enable
```
- Step 3** Exit the vDP application console and return to the FXOS module CLI.
- ```
Ctrl ]
```
-

Configure TLS Crypto Acceleration

The following topics discuss TLS crypto acceleration, how to enable it, and how to view its status using the FMCr.

The following table maps the Firepower Threat Defense and the FXOS version with the required TSL Crypto:



Note When FXOS 2.6.1 is upgraded to FXOS 2.7.x and above, FTD 6.4 does not automatically enable crypto as 6.4 is not compatible with TLS crypto.

FTD	FXOS	Crypto
6.4	2.6	Support for only one container instance (Phase 1)
6.4	2.7 and above	NA
6.5 and above	2.7 and above	Support for upto 16 container instances (Phase 2)

About TLS Crypto Acceleration

The Firepower 4100/9300 support Transport Layer Security cryptographic acceleration, which performs Transport Layer Security/Secure Sockets Layer (TLS/SSL) encryption and decryption in hardware, which greatly accelerates the following:

- TLS/SSL encryption and decryption
- VPN, including TLS/SSL and IPsec

TLS cryptographic acceleration is automatically enabled on native instances and cannot be disabled. You can enable TLS crypto acceleration on up to 16 FTD container instances per security engine/module as well.

Guidelines and Limitations for TLS Crypto Acceleration

Keep the following in mind if your Firepower Threat Defense has TLS crypto acceleration enabled.

Inspection engine failure

If the inspection engine is configured to preserve connections and the inspection engine fails unexpectedly, TLS/SSL traffic is dropped until the engine restarts.

This behavior is controlled by the Firepower Threat Defense command **configure snort preserve-connection {enable | disable}** command.

HTTP-only performance

Using TLS crypto acceleration on an FTD container instance that is not decrypting traffic can affect performance. We recommend you enable TLS crypto acceleration *only* on FTD container instances that decrypt TLS/SSL traffic.

Federal Information Processing Standards (FIPS)

If TLS crypto acceleration and Federal Information Processing Standards (FIPS) are both enabled, connections with the following options fail:

- RSA keys less than 2048 bytes in size

- Rivest cipher 4 (RC4)
- Single Data Encryption Standard (single DES)
- Merkle–Damgard 5 (MD5)
- SSL v3

FIPS is enabled when you configure the FMC and Firepower Threat Defenses to operate in a security certifications compliance mode. To allow connections when operating in those modes, you can either disable TLS crypto acceleration on the FTD container instance or you can configure web browsers to accept more secure options.

For more information:

- [Common Criteria](#).

High Availability (HA) and clustering

If you have high availability (HA) or clustered Firepower Threat Defenses, you must enable TLS crypto acceleration on each Firepower Threat Defense individually. One device's TLS crypto acceleration configuration is not shared with the other devices in the HA pair or cluster.

TLS heartbeat

Some applications use the *TLS heartbeat* extension to the Transport Layer Security (TLS) and Datagram Transport Layer Security (DTLS) protocols defined by [RFC6520](#). TLS heartbeat provides a way to confirm the connection is still alive—either the client or server sends a specified number of bytes of data and requests the other party echo the response. If this is successful, encrypted data is sent.

When an Firepower Threat Defense managed by FMC with TLS crypto acceleration enabled encounters a packet that uses the TLS heartbeat extension, the Firepower Threat Defense takes the action specified by the FMC setting for **Decryption Errors** in the SSL policy's **Undecryptable Actions**:

- Block
- Block with reset

To determine whether applications are using TLS heartbeat, see the chapter on troubleshooting TLS/SSL rules in the *Firepower Management Center Configuration Guide*.

If TLS crypto acceleration is disabled on an FTD container instance, you can configure a **Max Heartbeat Length** in a Network Analysis Policy (NAP) in the FMC to determine how to handle TLS heartbeats.

For more information about TLS heartbeat, see the chapter on troubleshooting TLS/SSL rules in the *Firepower Management Center Configuration Guide*.

TLS/SSL oversubscription

TLS/SSL oversubscription is a state where an Firepower Threat Defense is overloaded with TLS/SSL traffic. Any Firepower Threat Defense can experience TLS/SSL oversubscription but only the Firepower Threat Defenses that support TLS crypto acceleration provide a configurable way to handle it.

When an Firepower Threat Defense managed by an FMC with TLS crypto acceleration enabled is oversubscribed, any packet received by the Firepower Threat Defense is acted on according to the setting for **Handshake Errors** in the SSL policy's **Undecryptable Actions**:

- Inherit default action
- Do not decrypt
- Block
- Block with reset

If the setting for **Handshake Errors** in the SSL policy's **Undecryptable Actions** is **Do Not decrypt** and the associated access control policy is configured to inspect the traffic, inspection occurs; decryption does *not* occur.

If a significant amount of oversubscription is occurring, you have the following options:

- Upgrade to an Firepower Threat Defense with more TLS/SSL processing capacity.
- Change your SSL policies to add **Do Not Decrypt** rules for traffic that is not a high priority to decrypt.

For more information about TLS oversubscription, see the chapter on troubleshooting TLS/SSL rules in the *Firepower Management Center Configuration Guide*.

Passive and inline tap sets not supported

TLS/SSL traffic cannot be decrypted on passive or inline tap set interfaces when TLS crypto acceleration is enabled.

Enable TLS Crypto Acceleration for Container Instances

TLS crypto acceleration is automatically enabled when you deploy a logical instance as discussed in [Add a Standalone FTD for the FMC, on page 29](#).

TLS crypto acceleration is enabled on all native instances and cannot be disabled.

View the Status of TLS Crypto Acceleration

This topic discusses how you can determine if TLS crypto acceleration is enabled.

Perform the following task in the FMC.

Procedure

-
- Step 1** Log in to the FMC.
 - Step 2** Click **Devices > Device Management**.
 - Step 3** Click **Edit** () to edit a managed device.
 - Step 4** Click **Device** page. TLS crypto acceleration status is displayed in the General section.
-

Manage Logical Devices

You can delete a logical device, convert an ASA to transparent mode, change the interface configuration, and perform other tasks on existing logical devices.

Connect to the Console of the Application

Use the following procedure to connect to the console of the application.

Procedure

Step 1 Connect to the module CLI using a console connection or a Telnet connection.

connect module *slot_number* { **console** | **telnet** }

To connect to the security engine of a device that does not support multiple security modules, always use **1** as the *slot_number*.

The benefits of using a Telnet connection is that you can have multiple sessions to the module at the same time, and the connection speed is faster.

Example:

```
Firepower# connect module 1 console
Telnet escape character is '~'.
Trying 127.5.1.1...
Connected to 127.5.1.1.
Escape character is '~'.
```

```
CISCO Serial Over LAN:
Close Network Connection to Exit
```

```
Firepower-module1>
```

Step 2 Connect to the application console. Enter the appropriate command for your device.

connect asa *name*

connect ftd *name*

connect vdp *name*

To view the instance names, enter the command without a name.

Example:

```
Firepower-module1> connect asa asal
Connecting to asa(asal) console... hit Ctrl + A + D to return to bootCLI
[...]
asa>
```

Example:

```
Firepower-module1> connect ftd ftd1
```

```
Connecting to ftd(ftd-native) console... enter exit to return to bootCLI
[...]  
>
```

Step 3 Exit the application console to the FXOS module CLI.

- ASA—Enter **Ctrl-a, d**
- FTD—Enter **exit**
- vDP—Enter **Ctrl-], .**

Step 4 Return to the supervisor level of the FXOS CLI.

Exit the console:

- a) Enter `~`
You exit to the Telnet application.
- b) To exit the Telnet application, enter:
telnet>**quit**

Exit the Telnet session:

- a) Enter **Ctrl-], .**

Example

The following example connects to an ASA on security module 1 and then exits back to the supervisor level of the FXOS CLI.

```
Firepower# connect module 1 console  
Telnet escape character is '~'.  
Trying 127.5.1.1...  
Connected to 127.5.1.1.  
Escape character is '~'.  
  
CISCO Serial Over LAN:  
Close Network Connection to Exit  
  
Firepower-module1>connect asa asa1  
asa> ~  
telnet> quit  
Connection closed.  
Firepower#
```

Delete a Logical Device

Procedure

Step 1 Enter security services mode:

```
Firepower# scope ssa
```

Step 2 View details for the logical devices on the chassis:

```
Firepower /ssa # show logical-device
```

Step 3 For each logical device that you want to delete, enter the following command:

```
Firepower /ssa # delete logical-device device_name
```

Step 4 View details for the applications installed on the logical devices:

```
Firepower /ssa # show app-instance
```

Step 5 For each application that you want to delete, enter the following commands:

- a) Firepower /ssa # **scope slot** *slot_number*
- b) Firepower /ssa/slot # **delete app-instance** *application_name*
- c) Firepower /ssa/slot # **exit**

Step 6 Commit the configuration:

```
commit-buffer
```

Commits the transaction to the system configuration.

Example

```
Firepower# scope ssa
Firepower /ssa # show logical-device

Logical Device:
  Name          Description Slot ID    Mode      Operational State    Template Name
  -----
  FTD           1,2,3      Clustered  Ok                  ftd
Firepower /ssa # delete logical-device FTD
Firepower /ssa* # show app-instance
Application Name    Slot ID    Admin State    Operational State    Running Version Startup
Version Cluster Oper State
-----
ftd                1 Disabled    Stopping         6.0.0.837
6.0.0.837         Not Applicable
ftd                2 Disabled    Offline          6.0.0.837
6.0.0.837         Not Applicable
ftd                3 Disabled    Not Available
6.0.0.837         Not Applicable
Firepower /ssa* # scope slot 1
Firepower /ssa/slot # delete app-instance ftd
Firepower /ssa/slot* # exit
Firepower /ssa* # scope slot 2
Firepower /ssa/slot # delete app-instance ftd
Firepower /ssa/slot* # exit
Firepower /ssa* # scope slot 3
Firepower /ssa/slot # delete app-instance ftd
Firepower /ssa/slot* # exit
Firepower /ssa* # commit-buffer
```

Remove a Cluster Node

The following sections describe how to remove nodes temporarily or permanently from the cluster.

Temporary Removal

A cluster node will be automatically removed from the cluster due to a hardware or network failure, for example. This removal is temporary until the conditions are rectified, and it can rejoin the cluster. You can also manually disable clustering.

To check whether a device is currently in the cluster, check the cluster status within the application using the **show cluster info** command:

```
ciscoasa# show cluster info
Clustering is not enabled
```

For FTD using the FMC, you should leave the device in the FMC device list so that it can resume full functionality after you reenable clustering.

- **Disable clustering in the application**—You can disable clustering using the application CLI. Enter the **cluster remove unit name** command to remove any node other than the one you are logged into. The bootstrap configuration remains intact, as well as the last configuration synced from the control node, so you can later re-add the node without losing your configuration. If you enter this command on a data node to remove the control node, a new control node is elected.

When a device becomes inactive, all data interfaces are shut down; only the Management interface can send and receive traffic. To resume traffic flow, re-enable clustering. The Management interface remains up using the IP address the node received from the bootstrap configuration. However if you reload, and the node is still inactive in the cluster, the Management interface is disabled.

To reenable clustering, on the ASA enter **cluster group name** and then **enable**. To reenable clustering, on the FTD enter **cluster enable**.

- **Disable the application instance**—At the FXOS CLI, see the following example:

```
Firepower-chassis# scope ssa
Firepower-chassis /ssa # scope slot 1
Firepower-chassis /ssa/slot # scope app-instance asa asal
Firepower-chassis /ssa/slot/app-instance # disable
Firepower-chassis /ssa/slot/app-instance* # commit-buffer
Firepower-chassis /ssa/slot/app-instance #
```

To reenable:

```
Firepower-chassis /ssa/slot/app-instance # enable
Firepower-chassis /ssa/slot/app-instance* # commit-buffer
Firepower-chassis /ssa/slot/app-instance #
```

- **Shut down the security module/engine**—At the FXOS CLI, see the following example:

```
Firepower-chassis# scope service-profile server 1/1
Firepower-chassis /org/service-profile # power down soft-shut-down
Firepower-chassis /org/service-profile* # commit-buffer
Firepower-chassis /org/service-profile #
```

To power up:

```
Firepower-chassis /org/service-profile # power up
Firepower-chassis /org/service-profile* # commit-buffer
Firepower-chassis /org/service-profile #
```

- Shut down the chassis—At the FXOS CLI, see the following example:

```
Firepower-chassis# scope chassis 1
Firepower-chassis /chassis # shutdown no-prompt
```

Permanent Removal

You can permanently remove a cluster node using the following methods.

For FTD using the FMC, be sure to remove the node from the FMC device list after you disable clustering on the chassis.

- Delete the logical device—At the FXOS CLI, see the following example:

```
Firepower-chassis# scope ssa
Firepower-chassis /ssa # delete logical-device cluster1
Firepower-chassis /ssa* # commit-buffer
Firepower-chassis /ssa #
```

- Remove the chassis or security module from service—If you remove a device from service, you can add replacement hardware as a new node of the cluster.

Delete an Application Instance that is not Associated with a Logical Device

When you delete a logical device, you are prompted as to whether you want to also delete the application configuration for the logical device. If you do not delete the application configuration, you will not be able to create a logical device using a different application until that application instance is deleted. You can use the following procedure to delete an application instance from a security module/engine when it is no longer associated with a logical device.

Procedure

-
- Step 1** Enter security services mode:
- ```
Firepower# scope ssa
```
- Step 2** View details for the installed applications:
- ```
Firepower /ssa # show app-instance
```
- Step 3** For each application that you want to delete, enter the following commands:
- Firepower /ssa # **scope slot slot_number**
 - Firepower /ssa/slot # **delete app-instance application_name**
 - Firepower /ssa/slot # **exit**

Step 4 Commit the configuration:

commit-buffer

Commits the transaction to the system configuration.

Example

```
Firepower# scope ssa
Firepower /ssa* # show app-instance
Application Name      Slot ID      Admin State      Operational State      Running Version Startup
Version Cluster Oper State
-----
ftd                   1 Disabled      Stopping          6.0.0.837
6.0.0.837             Not Applicable
ftd                   2 Disabled      Offline           6.0.0.837
6.0.0.837             Not Applicable
ftd                   3 Disabled      Not Available
6.0.0.837             Not Applicable
Firepower /ssa* # scope slot 1
Firepower /ssa/slot # delete app-instance ftd
Firepower /ssa/slot* # exit
Firepower /ssa* # scope slot 2
Firepower /ssa/slot # delete app-instance ftd
Firepower /ssa/slot* # exit
Firepower /ssa* # scope slot 3
Firepower /ssa/slot # delete app-instance ftd
Firepower /ssa/slot* # exit
Firepower /ssa* # commit-buffer
```

Change an Interface on a FTD Logical Device

You can allocate or unallocate an interface on the Firepower Threat Defense logical device. You can then sync the interface configuration in the FMC or the FDM.

Adding a new interface, or deleting an unused interface has minimal impact on the Firepower Threat Defense configuration. However, deleting an interface that is used in your security policy will impact the configuration. Interfaces can be referenced directly in many places in the Firepower Threat Defense configuration, including access rules, NAT, SSL, identity rules, VPN, DHCP server, and so on. Policies that refer to security zones are not affected. You can also edit the membership of an allocated EtherChannel without affecting the logical device or requiring a sync on the FMC or the FDM.

For the FMC: Deleting an interface will delete any configuration associated with that interface.

For the FDM: You can migrate the configuration from one interface to another interface before you delete the old interface.

Before you begin

- Configure your interfaces, and add any EtherChannels according to [Configure a Physical Interface](#) and [Add an EtherChannel \(Port Channel\)](#).
- If you want to add an already-allocated interface to an EtherChannel (for example, all interfaces are allocated by default to a cluster), you need to unallocate the interface from the logical device first, then

add the interface to the EtherChannel. For a new EtherChannel, you can then allocate the EtherChannel to the device.

- For clustering or High Availability, make sure you add or remove the interface on all units before you sync the configuration in the FMC or the FDM. We recommend that you make the interface changes on the data/standby unit(s) first, and then on the control/active unit. Note that new interfaces are added in an administratively down state, so they do not affect interface monitoring.
- In mult-instance mode, for changing a sub-interface with another sub-interface with the same vlan tag, you must first remove all the configuration (including nameif config) of the interface and then unallocate the interface from Firepower Chassis Manager. Once unallocated, add the new interface and then use sync interfaces from the FMC.

Procedure

- Step 1** Enter security services mode:
Firepower# **scope ssa**
- Step 2** Edit the logical device:
Firepower /ssa # **scope logical-device device_name**
- Step 3** Allocate a new interface to the logical device:
Firepower /ssa/logical-device* # **create external-port-link name interface_id ftd**
Do not delete any interfaces yet.
- Step 4** Commit the configuration:
commit-buffer
Commits the transaction to the system configuration.
- Step 5** Sync the interfaces in the FMC.
- Log into the FMC.
 - Select **Devices > Device Management** and click **Edit** () for your Firepower Threat Defense device. The **Interfaces** page is selected by default.
 - Click the **Sync Device** button on the top left of the **Interfaces** page.
 - After the changes are detected, you will see a red banner on the **Interfaces** page indicating that the interface configuration has changed. Click the **Click to know more** link to view the interface changes.
 - If you plan to delete an interface, manually transfer any interface configuration from the old interface to the new interface.

Because you have not yet deleted any interfaces, you can refer to the existing configuration. You will have additional opportunity to fix the configuration after you delete the old interface and re-run the validation. The validation will show you all locations in which the old interface is still used.
 - Click **Validate Changes** to make sure your policy will still work with the interface changes.
If there are any errors, you need to change your policy and rerun the validation.
 - Click **Save**.

- h) Select the devices and click **Deploy** to deploy the policy to the assigned devices. The changes are not active until you deploy them.

Step 6 Sync and migrate the interfaces in the FDM.

- a) Log into the FDM.
b) Click **Device**, then click the **View All Interfaces** link in the **Interfaces** summary.

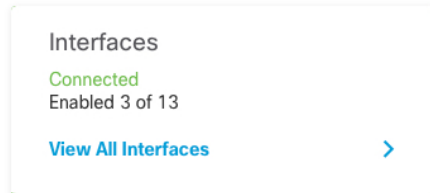

- c) Click the **Scan Interfaces icon**.
d) Wait for the interfaces to scan, and then click **OK**.

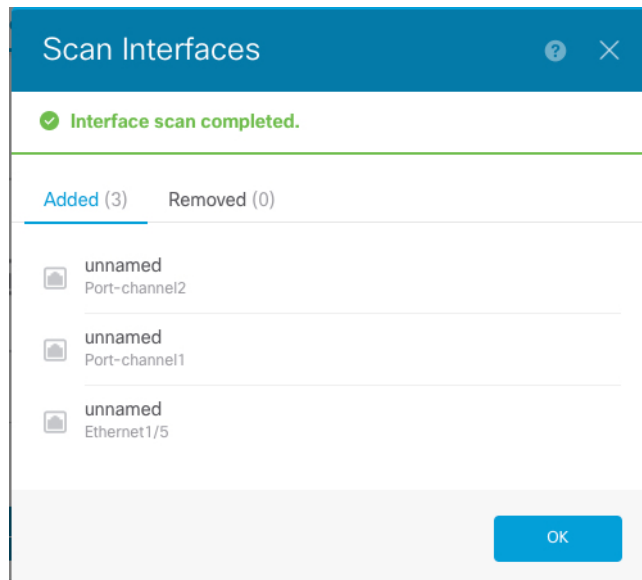

- e) Configure the new interfaces with names, IP addresses, and so on.

If you want to use the existing IP address and name of an interface that you want to delete, then you need to reconfigure the old interface with a dummy name and IP address so that you can use those settings on the new interface.

- f) To replace an old interface with a new interface, click the Replace icon for the old interface.

Replace icon

This process replaces the old interface with the new interface in all configuration settings that refer to the interface.

- g) Choose the new interface from the **Replacement Interface** drop-down list.

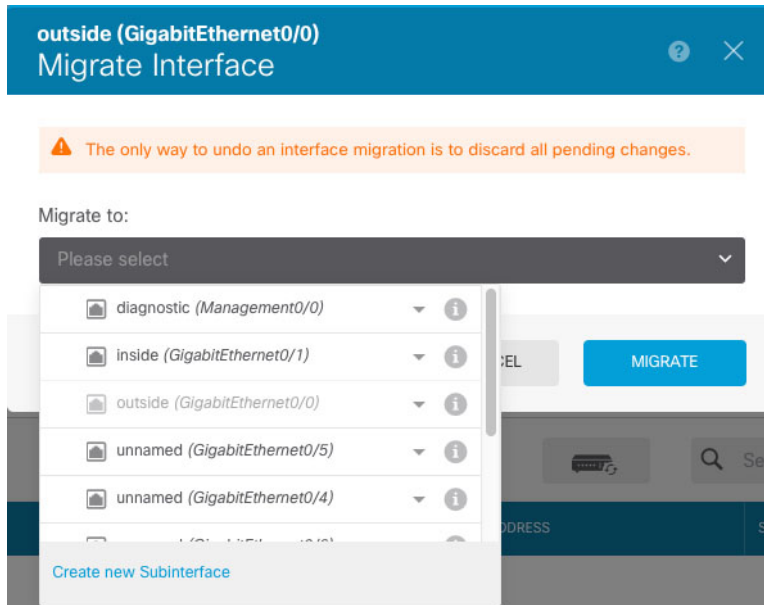

h) A message appears on the **Interfaces** page. Click the link in the message.

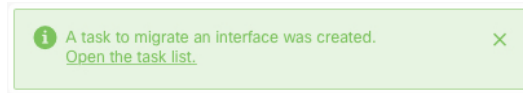

i) Check the **Task List** to ensure that the migration was successful.

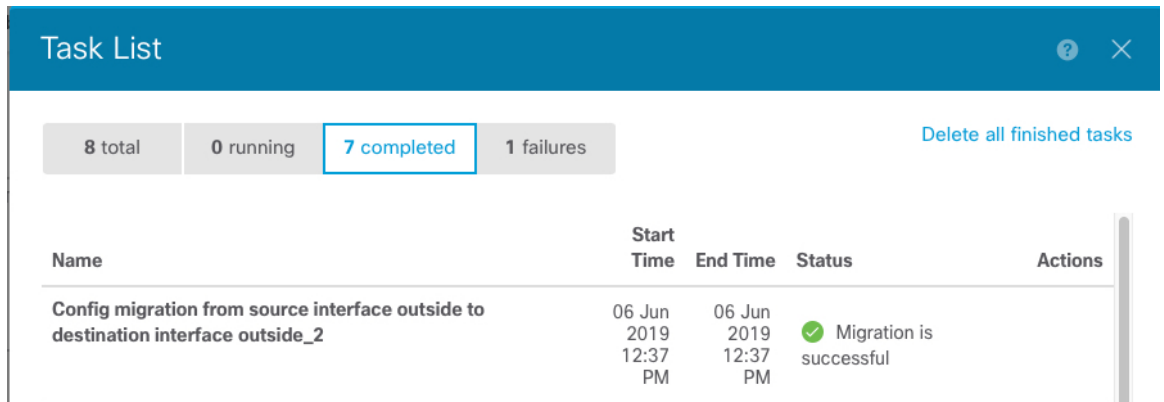

Step 7 In FXOS, unallocate an interface from the logical device:
 Firepower /ssa/logical-device # **delete external-port-link** *name*
 Enter the **show external-port-link** command to view interface names.

Step 8 Commit the configuration:
commit-buffer
 Commits the transaction to the system configuration.

Step 9 Sync the interfaces again in the FMC or the FDM.

Figure 6: FDM Scan Interfaces

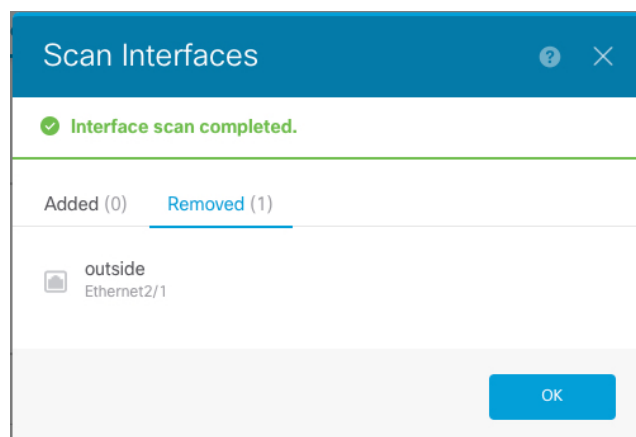

Change an Interface on an ASA Logical Device

You can allocate, unallocate, or replace a management interface on an ASA logical device. ASDM discovers the new interfaces automatically.

Adding a new interface, or deleting an unused interface has minimal impact on the ASA configuration. However, if you remove an allocated interface in FXOS (for example, if you remove a network module, remove an EtherChannel, or reassign an allocated interface to an EtherChannel), and the interface is used in your security policy, removal will impact the ASA configuration. In this case, the ASA configuration retains the original commands so that you can make any necessary adjustments. You can manually remove the old interface configuration in the ASA OS.



Note You can edit the membership of an allocated EtherChannel without impacting the logical device.

Before you begin

- Configure your interfaces and add any EtherChannels according to [Configure a Physical Interface](#) and [Add an EtherChannel \(Port Channel\)](#).
- If you want to add an already-allocated interface to an EtherChannel (for example, all interfaces are allocated by default to a cluster), you need to unallocate the interface from the logical device first, then add the interface to the EtherChannel. For a new EtherChannel, you can then allocate the EtherChannel to the device.
- For clustering or failover, make sure you add or remove the interface on all units. We recommend that you make the interface changes on the data/standby unit(s) first, and then on the control/active unit. New interfaces are added in an administratively down state, so they do not affect interface monitoring.

Procedure

-
- Step 1** Enter security services mode:
Firepower# **scope ssa**
- Step 2** Edit the logical device:
Firepower /ssa # **scope logical-device** *device_name*
- Step 3** Unallocate an interface from the logical device:
Firepower /ssa/logical-device # **delete external-port-link** *name*
Enter the **show external-port-link** command to view interface names.
For a management interface, delete the current interface then commit your change using the **commit-buffer** command before you add the new management interface.
- Step 4** Allocate a new interface to the logical device:
Firepower /ssa/logical-device* # **create external-port-link** *name interface_id asa*
- Step 5** Commit the configuration:
commit-buffer
Commits the transaction to the system configuration.
-

Monitoring Logical Devices

- **show app**

View available images.

```
Firepower# scope ssa
Firepower /ssa # show app
  Name          Version          Author          Supported Deploy Types CSP Type      Is Default
  App
-----
  asa           9.10.1           cisco          Native          Application Yes
  ftd           6.3.0           cisco          Native,Container Application Yes
  ftd           6.2.3           cisco          Native          Application Yes
  vdp           8.13.01.09-2    radware        Vm              Application Yes
```

- **show app-instance**

View the application instance status and information.

```
firepower# scope ssa
firepower /ssa # show app-instance
App Name  Identifier Slot ID  Admin State Oper State  Running Version Startup
Version Deploy Type Profile Name Cluster State Cluster Role
-----
```

```

-----
ftd      LD1      1      Enabled   Online    6.4.0.10353  6.4.0.10353
  Container Default-Small Not Applicable None
ftd      LD2      1      Enabled   Online    6.4.0.10353  6.4.0.10353
  Container Default-Small Not Applicable None
ftd      LD3      1      Enabled   Online    6.4.0.10353  6.4.0.10353
  Container Default-Small Not Applicable None
ftd      LD4      1      Enabled   Online    6.4.0.10353  6.4.0.1056
  Container Default-Small Not Applicable None

```

- **show logical-device**

View details for logical devices.

```

Firepower# scope ssa
Firepower /ssa # show logical-device

```

```

Logical Device:
  Name          Description Slot ID   Mode      Oper State      Template Name
-----
  asa1          1           Standalone Ok      asa

```

- **show resource-profile system**

Show resource profiles for vDP.

```

Firepower# scope ssa
Firepower /ssa # show resource-profile system
Profile Name      App Name  App Version  Is In Use  Security Model  CPU Logical Core
Count RAM Size (MB)  Default Profile Profile Type Description
-----
DEFAULT-4110-RESOURCE
      vdp      8.13.01.09-2 No      FPR4K-SM-12
4      16384 Yes      System
DEFAULT-RESOURCE  vdp      8.13.01.09-2 No      FPR9K-SM-56, FPR9K-SM-44,
FPR9K-SM-36, FPR9K-SM-24, FPR4K-SM-44, FPR4K-SM-36, FPR4K-SM-24
6      24576 Yes      System
VDP-10-CORES      vdp      8.13.01.09-2 No      FPR9K-SM-56, FPR9K-SM-44,
FPR9K-SM-36, FPR9K-SM-24, FPR4K-SM-44, FPR4K-SM-36, FPR4K-SM-24
10     40960 No      System
VDP-2-CORES      vdp      8.13.01.09-2 No      all
2      8192 No      System
VDP-4-CORES      vdp      8.13.01.09-2 No      all
4      16384 No      System
VDP-8-CORES      vdp      8.13.01.09-2 No      FPR9K-SM-56, FPR9K-SM-44,
FPR9K-SM-36, FPR9K-SM-24, FPR4K-SM-44, FPR4K-SM-36, FPR4K-SM-24
8      32768 No      System

```

- **show resource-profile user-defined**

View container instance resource profile assignments.

```

Firepower# scope ssa
Firepower /ssa # show resource-profile user-defined
Profile Name      Is In Use  CPU Logical Core Count Description

```

```

-----
bronze                No                6                low end device
gold                  No                14               highest
silver                No                8                mid-level

```

- **show resource detail**

View resource allocation for the application instance.

```

Firepower# scope ssa
Firepower /ssa # scope slot 1
Firepower /ssa/slot # enter app-instance ftd ftdl
Firepower /ssa/slot/app-instance # show resource detail
Resource:
  Allocated Core NR: 10
  Allocated RAM (MB): 32413
  Allocated Data Disk (MB): 49152
  Allocated Binary Disk (MB): 3907
  Allocated Secondary Disk (MB): 0

```

Examples for Inter-Site Clustering

The following examples show supported cluster deployments.

Spanned EtherChannel Routed Mode Example with Site-Specific MAC Addresses

The following example shows 2 cluster members at each of 2 data centers placed between the gateway router and an inside network at each site (East-West insertion). The cluster members are connected by the cluster control link over the DCI. The cluster members at each site connect to the local switches using spanned EtherChannels for both the inside and outside networks. Each EtherChannel is spanned across all chassis in the cluster.

The data VLANs are extended between the sites using Overlay Transport Virtualization (OTV) (or something similar). You must add filters blocking the global MAC address to prevent traffic from traversing the DCI to the other site when the traffic is destined for the cluster. If the cluster nodes at one site become unreachable, you must remove the filters so traffic can be sent to the other site's cluster nodes. You should use VACLs to filter the global MAC address. Be sure to disable ARP inspection.

The cluster acts as the gateway for the inside networks. The global virtual MAC, which is shared across all cluster nodes, is used only to receive packets. Outgoing packets use a site-specific MAC address from each DC cluster. This feature prevents the switches from learning the same global MAC address from both sites on two different ports, which causes MAC flapping; instead, they only learn the site MAC address.

In this scenario:

- All egress packets sent from the cluster use the site MAC address and are localized at the data center.
- All ingress packets to the cluster are sent using the global MAC address, so they can be received by any of the nodes at both sites; filters at the OTV localize the traffic within the data center.

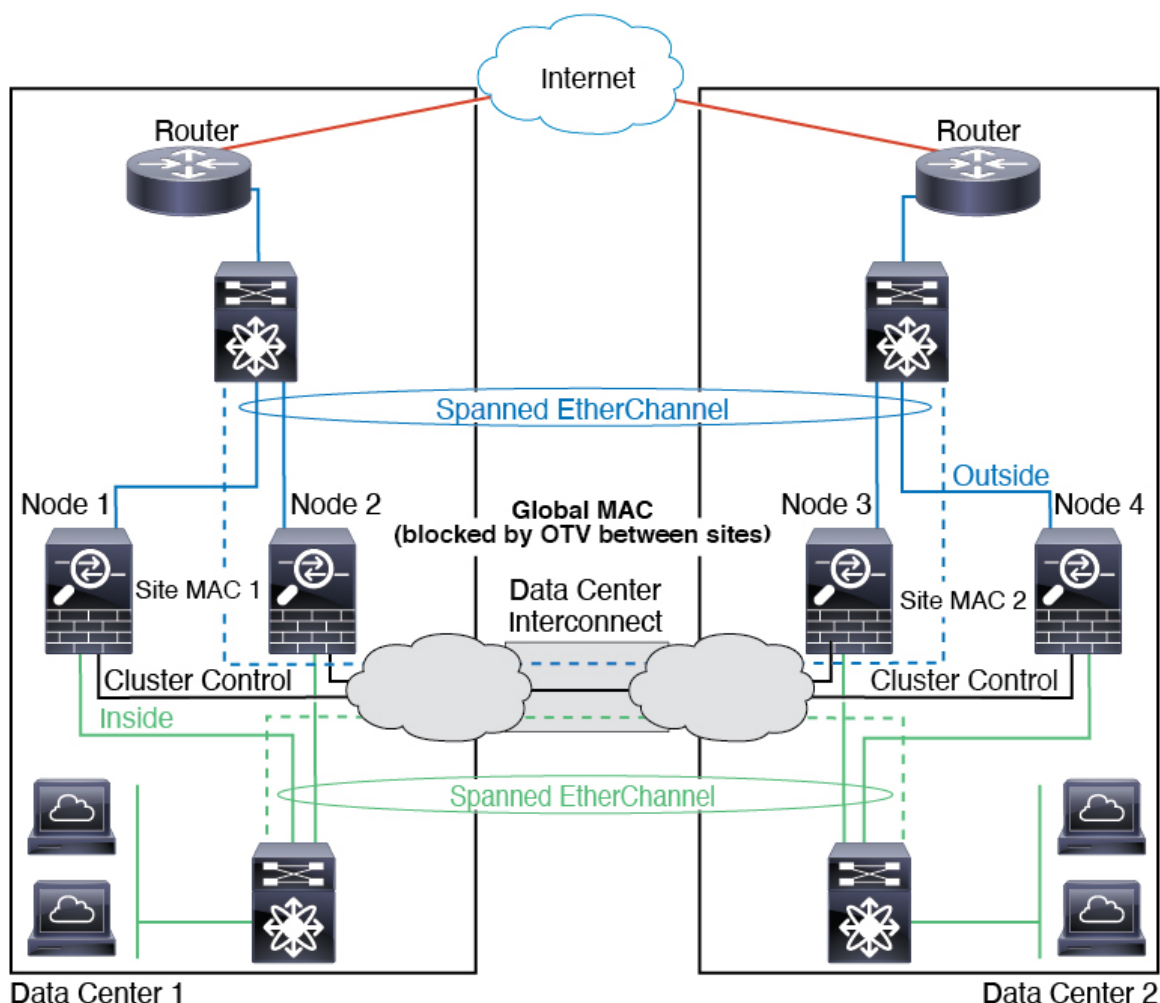

Spanned EtherChannel Transparent Mode North-South Inter-Site Example

The following example shows 2 cluster members at each of 2 data centers placed between inside and outside routers (North-South insertion). The cluster members are connected by the cluster control link over the DCI. The cluster members at each site connect to the local switches using spanned EtherChannels for the inside and outside. Each EtherChannel is spanned across all chassis in the cluster.

The inside and outside routers at each data center use OSPF, which is passed through the transparent ASAs. Unlike MACs, router IPs are unique on all routers. By assigning a higher cost route across the DCI, traffic stays within each data center unless all cluster members at a given site go down. The lower cost route through the ASAs must traverse the same bridge group at each site for the cluster to maintain asymmetric connections. In the event of a failure of all cluster members at one site, traffic goes from each router over the DCI to the cluster members at the other site.

The implementation of the switches at each site can include:

- Inter-site VSS, vPC, StackWise, or StackWise Virtual—In this scenario, you install one switch at Data Center 1, and the other at Data Center 2. One option is for the cluster nodes at each Data Center to only connect to the local switch, while the redundant switch traffic goes across the DCI. In this case, connections

are for the most part kept local to each datacenter. You can optionally connect each node to both switches across the DCI if the DCI can handle the extra traffic. In this case, traffic is distributed across the data centers, so it is essential for the DCI to be very robust.

- Local VSS, vPC, StackWise, or StackWise Virtual at each site—For better switch redundancy, you can install 2 separate redundant switch pairs at each site. In this case, although the cluster nodes still have a spanned EtherChannel with Data Center 1 chassis connected only to both local switches, and Data Center 2 chassis connected to those local switches, the spanned EtherChannel is essentially “split.” Each local redundant switch system sees the spanned EtherChannel as a site-local EtherChannel.

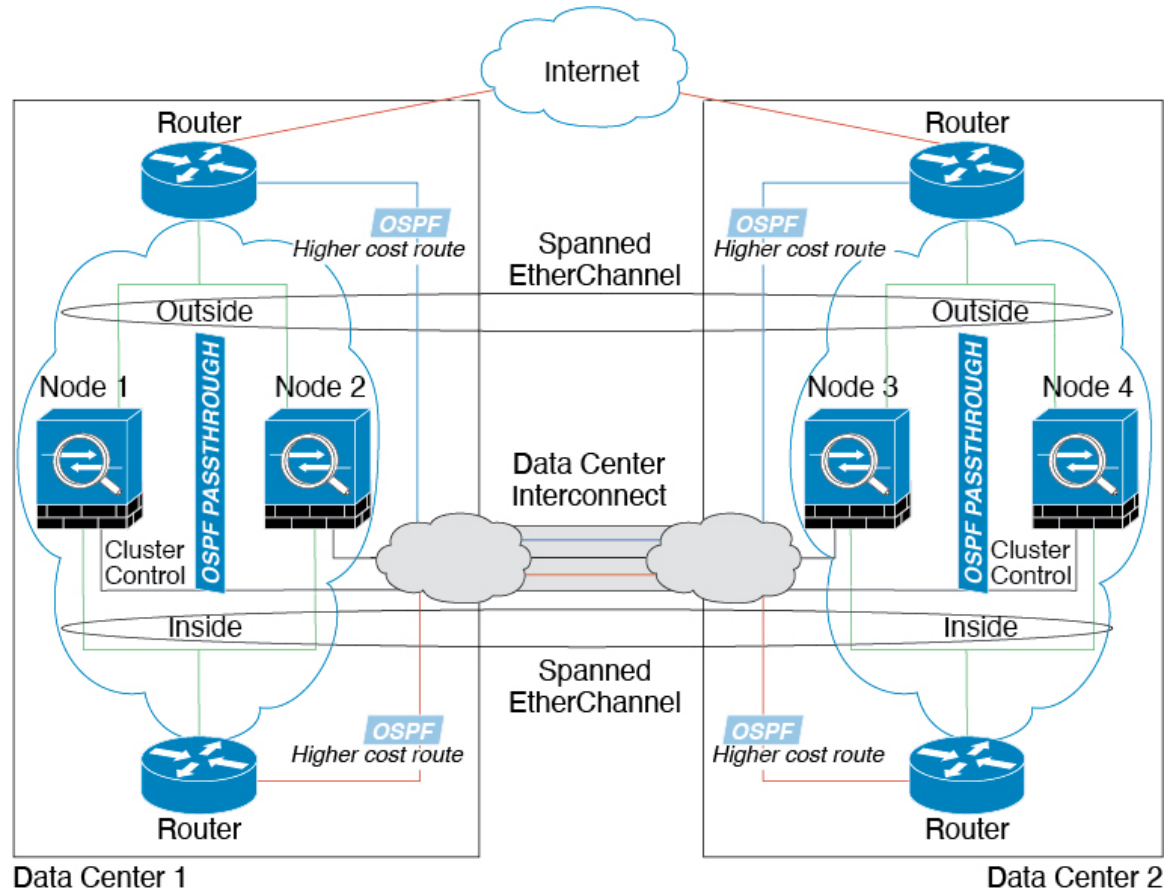

Spanned EtherChannel Transparent Mode East-West Inter-Site Example

The following example shows 2 cluster members at each of 2 data centers placed between the gateway router and two inside networks at each site, the App network and the DB network (East-West insertion). The cluster members are connected by the cluster control link over the DCI. The cluster members at each site connect to the local switches using spanned EtherChannels for both the App and DB networks on the inside and outside. Each EtherChannel is spanned across all chassis in the cluster.

The gateway router at each site uses an FHRP such as HSRP to provide the same destination virtual MAC and IP addresses at each site. A good practice to avoid unintended MAC address flapping is to statically add the gateway routers real MAC addresses to the ASA MAC address table using the `mac-address-table static outside_interface mac_address` command. Without these entries, if the gateway at site 1 communicates with

the gateway at site 2, that traffic might pass through the ASA and attempt to reach site 2 from the inside interface and cause problems. The data VLANs are extended between the sites using Overlay Transport Virtualization (OTV) (or something similar). You must add filters to prevent traffic from traversing the DCI to the other site when the traffic is destined for the gateway router. If the gateway router at one site becomes unreachable, you must remove the filters so traffic can be sent to the other site's gateway router.

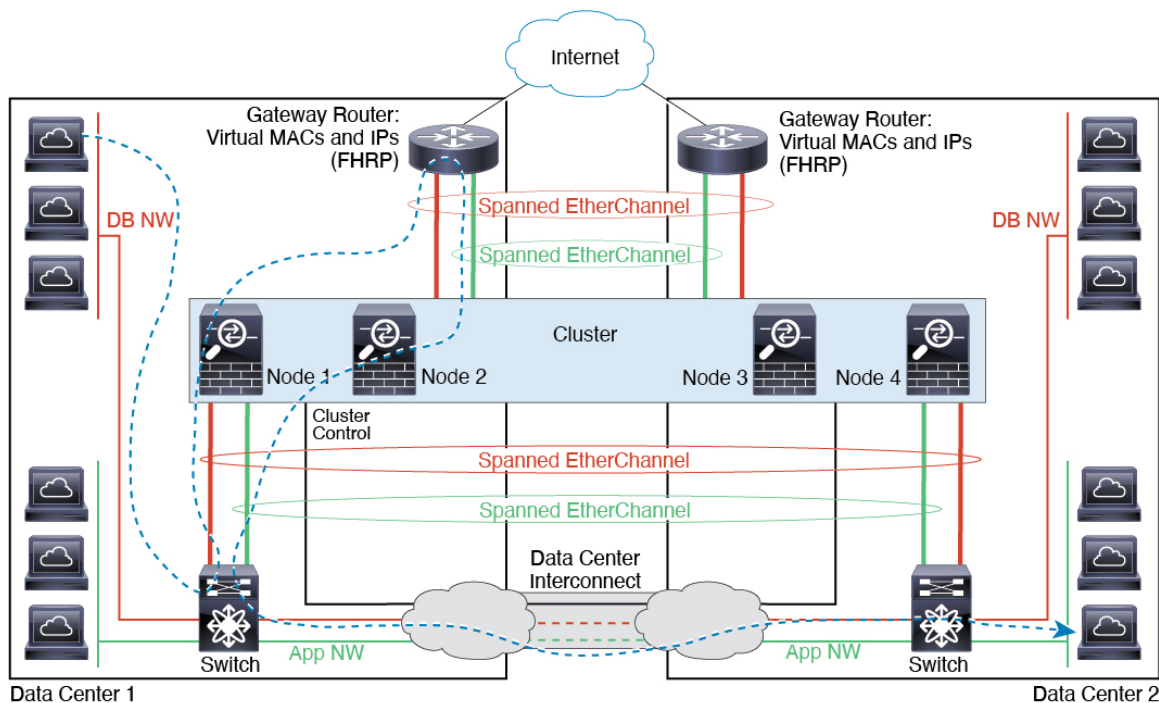

History for Logical Devices

Feature Name	Platform Releases	Feature Information
Support for 16 nodes in the FTD cluster.	2.12.1	You can now use up to 16 nodes for a FTD cluster. Note Requires FTD 7.2.

Feature Name	Platform Releases	Feature Information
Synchronization between the Firepower Threat Defense operational link state and the physical link state	2.9.1	<p>The chassis can now synchronize the Firepower Threat Defense operational link state with the physical link state for data interfaces. Currently, interfaces will be in an Up state as long as the FXOS admin state is up and the physical link state is up. The Firepower Threat Defense application interface admin state is not considered. Without synchronization from Firepower Threat Defense, data interfaces can be in an Up state physically before the Firepower Threat Defense application has completely come online, for example, or can stay Up for a period of time after you initiate an Firepower Threat Defense shutdown. For inline sets, this state mismatch can result in dropped packets because external routers may start sending traffic to the Firepower Threat Defense before the Firepower Threat Defense can handle it. This feature is disabled by default, and can be enabled per logical device in FXOS.</p> <p>Note This feature is not supported for clustering, container instances, or an Firepower Threat Defense with a Radware vDP decorator. It is also not supported for the ASA.</p> <p>New/Modified Firepower Chassis Manager screens: Logical Devices > Enable Link State</p> <p>New/Modified FXOS commands: set link-state-sync enabled, show interface expand detail</p>
Firepower Threat Defense configuration backup and restore using FMC for container instances	2.9.1	<p>You can now use the FMC backup/restore tool on an Firepower Threat Defense container instance.</p> <p>New/Modified FMC screens: System > Tools > Backup/Restore > Managed Device Backup</p> <p>New/Modified Firepower Threat Defense CLI commands: restore</p> <p>Supported platforms: Firepower 4100/9300</p> <p>Note Requires Firepower 6.7.</p>
Multi-instance clustering	2.8.1	<p>You can now create a cluster using container instances. On the Firepower 9300, you must include one container instance on each module in the cluster. You cannot add more than one container instance to the cluster per security engine/module. We recommend that you use the same security module or chassis model for each cluster instance. However, you can mix and match container instances on different Firepower 9300 security module types or Firepower 4100 models in the same cluster if required. You cannot mix Firepower 9300 and 4100 instances in the same cluster.</p> <p>New/Modified commands: set port-type cluster</p> <p>Note Requires Firepower 6.6 or later.</p>
Support for Firepower Threat Defense with FDM	2.7.1	<p>You can now deploy a native Firepower Threat Defense instance and specify FDM management. Container instances are not supported.</p> <p>New/Modified commands: enter bootstrap-key MANAGEMENT_TYPE, set value LOCALLY_MANAGED</p> <p>Note Requires Firepower Threat Defense 6.5 or later.</p>

Feature Name	Platform Releases	Feature Information
TLS crypto acceleration for multiple container instances	2.7.1	<p>TLS crypto acceleration is now supported on multiple container instances (up to 16) on a Firepower 4100/9300 chassis. Previously, you could enable TLS crypto acceleration for only <i>one</i> container instance per module/security engine.</p> <p>New instances have this feature enabled by default. However, the upgrade does <i>not</i> enable acceleration on existing instances. Instead, use the enter hw-crypto and then the set admin-state enabled FXOS commands.</p> <p>New FXOS CLI commands: enter hw-crypto, set admin-state</p> <p>Removed FXOS CLI commands: show hwCrypto, config hwCrypto</p> <p>Removed Firepower Threat Defense CLI commands: show crypto accelerator status</p> <p>Note Requires Firepower Threat Defense 6.5 or later.</p>
Firepower 4115, 4125, and 4145	2.6.1	<p>We introduced the Firepower 4115, 4125, and 4145.</p> <p>Note Requires ASA 9.12(1). Firepower 6.4.0 requires FXOS 2.6.1.157.</p> <p>No modified commands.</p>
Firepower 9300 SM-40, SM-48, and SM-56 support	2.6.1	<p>We introduced the following three security modules: SM-40, SM-48, and SM-56.</p> <p>Note The SM-40 and SM-48 require ASA 9.12(1). The SM-56 requires ASA 9.12(2) and FXOS 2.6.1.157.</p> <p>All modules require Firepower Threat Defense 6.4 and FXOS 2.6.1.157.</p> <p>No modified commands.</p>
Support for ASA and Firepower Threat Defense on separate modules of the same Firepower 9300	2.6.1	<p>You can now deploy ASA and Firepower Threat Defense logical devices on the same Firepower 9300.</p> <p>Note Requires ASA 9.12(1). Firepower 6.4.0 requires FXOS 2.6.1.157.</p> <p>No modified commands.</p>
For the Firepower Threat Defense bootstrap configuration, you can now set the NAT ID for the FMC in the Firepower Chassis Manager	2.6.1	<p>You can now set the FMC NAT ID in the Firepower Chassis Manager. Previously, you could only set the NAT ID within the FXOS CLI or Firepower Threat Defense CLI. Normally, you need both IP addresses (along with a registration key) for both routing purposes and for authentication: the FMC specifies the device IP address, and the device specifies the FMC IP address. However, if you only know one of the IP addresses, which is the minimum requirement for routing purposes, then you must also specify a unique NAT ID on both sides of the connection to establish trust for the initial communication and to look up the correct registration key. The FMC and device use the registration key and NAT ID (instead of IP addresses) to authenticate and authorize for initial registration.</p> <p>New/Modified screens:</p> <p>Logical Devices > Add Device > Settings > Firepower Management Center NAT ID field</p>

Feature Name	Platform Releases	Feature Information
Support for SSL hardware acceleration on one Firepower Threat Defense container instance on a module/security engine	2.6.1	<p>You can now enable SSL hardware acceleration for one container instance on a module/security engine. SSL hardware acceleration is disabled for other container instances, but enabled for native instances. See the FMC configuration guide for more information.</p> <p>New/Modified commands: config hwCrypto enable, show hwCrypto</p>
Multi-instance capability for Firepower Threat Defense	2.4.1	<p>You can now deploy multiple logical devices, each with a Firepower Threat Defense container instance, on a single security engine/module. Formerly, you could only deploy a single native application instance. Native instances are still also supported. For the Firepower 9300, you can use a native instance on some modules, and container instances on the other module(s).</p> <p>To provide flexible physical interface use, you can create VLAN subinterfaces in FXOS and also share interfaces between multiple instances. When you deploy a container instance, you must specify the number of CPU cores assigned; RAM is dynamically allocated according to the number of cores, and disk space is set to 40 GB per instance. This resource management lets you customize performance capabilities for each instance.</p> <p>You can use High Availability using a container instance on 2 separate chassis; for example, if you have 2 chassis, each with 10 instances, you can create 10 High Availability pairs. Clustering is not supported.</p> <p>Note Multi-instance capability is similar to ASA multiple context mode, although the implementation is different. Multiple context mode partitions a single application instance, while multi-instance capability allows independent container instances. Container instances allow hard resource separation, separate configuration management, separate reloads, separate software updates, and full Firepower Threat Defense feature support. Multiple context mode, due to shared resources, supports more contexts on a given platform. Multiple context mode is not available on the Firepower Threat Defense.</p> <p>Note Requires Firepower Threat Defense Version 6.3 or later.</p> <p>New/Modified FXOS commands: connect Firepower Threat Defense name, connect module telnet, create bootstrap-key PERMIT_EXPERT_MODE, create resource-profile, create subinterface, scope auto-macpool, set cpu-core-count, set deploy-type, set port-type data-sharing, set prefix, set resource-profile-name, set vlan, scope app-instance Firepower Threat Defense name, show cgroups container, show interface, show mac-address, show subinterface, show tech-support module app-instance, show version</p> <p>New/Modified FMC screens:</p> <p>Devices > Device Management > Edit icon > Interfaces tab</p>
Support for transparent mode deployment for an ASA logical device	2.4.1	<p>You can now specify transparent or routed mode when you deploy the ASA.</p> <p>New/Modified commands: enter bootstrap-key FIREWALL_MODE, set value routed, set value transparent</p>

Feature Name	Platform Releases	Feature Information
Cluster control link customizable IP Address	2.4.1	<p>By default, the cluster control link uses the 127.2.0.0/16 network. You can now set the network when you deploy the cluster in FXOS. The chassis auto-generates the cluster control link interface IP address for each unit based on the chassis ID and slot ID: <code>127.2.chassis_id.slot_id</code>. However, some networking deployments do not allow 127.2.0.0/16 traffic to pass. Therefore, you can now set a custom /16 subnet for the cluster control link in FXOS except for loopback (127.0.0.0/8) and multicast (224.0.0.0/4) addresses.</p> <p>New/Modified commands: set cluster-control-link network</p>
For the Firepower Threat Defense bootstrap configuration, you can now set the NAT ID for the FMC at the FXOS CLI	2.4.1	<p>You can now set the FMC NAT ID at the FXOS CLI. Previously, you could only set the NAT ID within the Firepower Threat Defense CLI. Normally, you need both IP addresses (along with a registration key) for both routing purposes and for authentication: the FMC specifies the device IP address, and the device specifies the FMC IP address. However, if you only know one of the IP addresses, which is the minimum requirement for routing purposes, then you must also specify a unique NAT ID on both sides of the connection to establish trust for the initial communication and to look up the correct registration key. The FMC and device use the registration key and NAT ID (instead of IP addresses) to authenticate and authorize for initial registration.</p> <p>New/Modified commands: enter bootstrap-key NAT_ID</p>
Inter-site clustering improvement for the ASA	2.1.1	<p>You can now configure the site ID for each Firepower 4100/9300 chassis when you deploy the ASA cluster. Previously, you had to configure the site ID within the ASA application; this new feature eases initial deployment. Note that you can no longer set the site ID within the ASA configuration. Also, for best compatibility with inter-site clustering, we recommend that you upgrade to ASA 9.7(1) and FXOS 2.1.1, which includes several improvements to stability and performance.</p> <p>We modified the following command: set site-id</p>
Inter-chassis clustering for 6 Firepower Threat Defense modules on the Firepower 9300	2.1.1	<p>You can now enable inter-chassis clustering for the Firepower Threat Defense on the Firepower 9300. You can include up to 6 modules. For example, you can use 1 module in 6 chassis, or 2 modules in 3 chassis, or any combination that provides a maximum of 6 modules.</p>
Support for Firepower Threat Defense clustering on the Firepower 4100	2.1.1	<p>You can cluster up to 6 chassis in an Firepower Threat Defense cluster.</p>
Support for 16 Firepower 4100 chassis in an ASA cluster	2.0.1	<p>You can cluster up to 16 chassis in an ASA cluster.</p>
Support for ASA clustering on the Firepower 4100	1.1.4	<p>You can cluster up to 6 chassis in an ASA cluster.</p>

Feature Name	Platform Releases	Feature Information
Support for intra-chassis clustering on the Firepower Threat Defense on the Firepower 9300	1.1.4	<p>The Firepower 9300 supports intra-chassis clustering with the Firepower Threat Defense application.</p> <p>We introduced the following commands: enter mgmt-bootstrap Firepower Threat Defense, enter bootstrap-key FIREPOWER_MANAGER_IP, enter bootstrap-key FIREWALL_MODE, enter bootstrap-key-secret REGISTRATION_KEY, enter bootstrap-key-secret PASSWORD, enter bootstrap-key FQDN, enter bootstrap-key DNS_SERVERS, enter bootstrap-key SEARCH_DOMAINS, enter ipv4 firepower, enter ipv6 firepower, set value, set gateway, set ip, accept-license-agreement</p>
Inter-chassis clustering for 16 ASA modules on the Firepower 9300	1.1.3	<p>You can now enable inter-chassis clustering for the ASA. You can include up to 16 modules. For example, you can use 1 module in 16 chassis, or 2 modules in 8 chassis, or any combination that provides a maximum of 16 modules.</p>
Intra-chassis Clustering for the ASA on the Firepower 9300	1.1.1	<p>You can cluster all ASA security modules within the Firepower 9300 chassis.</p> <p>We introduced the following commands: enter cluster-bootstrap, enter logical-device clustered, set chassis-id, set ipv4 gateway, set ipv4 pool, set ipv6 gateway, set ipv6 pool, set key, set mode spanned-etherchannel, set port-type cluster, set service-type, set virtual ipv4, set virtual ipv6</p>

