



## **VLAN Configuration Guide, Cisco IOS XE Dublin 17.10.x (Catalyst 9200 Switches)**

**First Published:** 2022-11-30

### **Americas Headquarters**

Cisco Systems, Inc.  
170 West Tasman Drive  
San Jose, CA 95134-1706  
USA  
<http://www.cisco.com>  
Tel: 408 526-4000  
800 553-NETS (6387)  
Fax: 408 527-0883

THE SPECIFICATIONS AND INFORMATION REGARDING THE PRODUCTS IN THIS MANUAL ARE SUBJECT TO CHANGE WITHOUT NOTICE. ALL STATEMENTS, INFORMATION, AND RECOMMENDATIONS IN THIS MANUAL ARE BELIEVED TO BE ACCURATE BUT ARE PRESENTED WITHOUT WARRANTY OF ANY KIND, EXPRESS OR IMPLIED. USERS MUST TAKE FULL RESPONSIBILITY FOR THEIR APPLICATION OF ANY PRODUCTS.

THE SOFTWARE LICENSE AND LIMITED WARRANTY FOR THE ACCOMPANYING PRODUCT ARE SET FORTH IN THE INFORMATION PACKET THAT SHIPPED WITH THE PRODUCT AND ARE INCORPORATED HEREIN BY THIS REFERENCE. IF YOU ARE UNABLE TO LOCATE THE SOFTWARE LICENSE OR LIMITED WARRANTY, CONTACT YOUR CISCO REPRESENTATIVE FOR A COPY.

The Cisco implementation of TCP header compression is an adaptation of a program developed by the University of California, Berkeley (UCB) as part of UCB's public domain version of the UNIX operating system. All rights reserved. Copyright © 1981, Regents of the University of California.

NOTWITHSTANDING ANY OTHER WARRANTY HEREIN, ALL DOCUMENT FILES AND SOFTWARE OF THESE SUPPLIERS ARE PROVIDED "AS IS" WITH ALL FAULTS. CISCO AND THE ABOVE-NAMED SUPPLIERS DISCLAIM ALL WARRANTIES, EXPRESSED OR IMPLIED, INCLUDING, WITHOUT LIMITATION, THOSE OF MERCHANTABILITY, FITNESS FOR A PARTICULAR PURPOSE AND NON-INFRINGEMENT OR ARISING FROM A COURSE OF DEALING, USAGE, OR TRADE PRACTICE.

IN NO EVENT SHALL CISCO OR ITS SUPPLIERS BE LIABLE FOR ANY INDIRECT, SPECIAL, CONSEQUENTIAL, OR INCIDENTAL DAMAGES, INCLUDING, WITHOUT LIMITATION, LOST PROFITS OR LOSS OR DAMAGE TO DATA ARISING OUT OF THE USE OR INABILITY TO USE THIS MANUAL, EVEN IF CISCO OR ITS SUPPLIERS HAVE BEEN ADVISED OF THE POSSIBILITY OF SUCH DAMAGES.

Any Internet Protocol (IP) addresses and phone numbers used in this document are not intended to be actual addresses and phone numbers. Any examples, command display output, network topology diagrams, and other figures included in the document are shown for illustrative purposes only. Any use of actual IP addresses or phone numbers in illustrative content is unintentional and coincidental.

All printed copies and duplicate soft copies of this document are considered uncontrolled. See the current online version for the latest version.

Cisco has more than 200 offices worldwide. Addresses and phone numbers are listed on the Cisco website at [www.cisco.com/go/offices](http://www.cisco.com/go/offices).

The documentation set for this product strives to use bias-free language. For purposes of this documentation set, bias-free is defined as language that does not imply discrimination based on age, disability, gender, racial identity, ethnic identity, sexual orientation, socioeconomic status, and intersectionality. Exceptions may be present in the documentation due to language that is hardcoded in the user interfaces of the product software, language used based on standards documentation, or language that is used by a referenced third-party product.

Cisco and the Cisco logo are trademarks or registered trademarks of Cisco and/or its affiliates in the U.S. and other countries. To view a list of Cisco trademarks, go to this URL: <https://www.cisco.com/c/en/us/about/legal/trademarks.html>. Third-party trademarks mentioned are the property of their respective owners. The use of the word partner does not imply a partnership relationship between Cisco and any other company. (1721R)

© 2022 Cisco Systems, Inc. All rights reserved.



## CONTENTS

---

### CHAPTER 1

#### Configuring VTP 1

Prerequisites for VTP	1
Restrictions for VTP	1
Information About VTP	2
VTP	2
VTP Domain	2
VTP Modes	3
VTP Advertisements	3
VTP Version 2	4
VTP Version 3	4
VTP Pruning	5
VTP and Device Stacks	6
VTP Configuration Guidelines	7
VTP Configuration Requirements	7
VTP Settings	7
Domain Names for Configuring VTP	7
Passwords for the VTP Domain	8
VTP Version	8
How to Configure VTP	9
Configuring VTP Mode	9
Configuring a VTP Version 3 Password	11
Configuring a VTP Version 3 Primary Server	12
Enabling the VTP Version	13
Enabling VTP Pruning	14
Configuring VTP on a Per-Port Basis	15
Adding a VTP Client to a VTP Domain	16

Monitoring VTP	18
Configuration Examples for VTP	19
Example: Configuring a Device as the Primary Server	19
Where to Go Next	19
Feature History for VTP	19

---

**CHAPTER 2****Configuring VLANs 21**

Prerequisites for VLANs	21
Restrictions for VLANs	21
Information About VLANs	22
Logical Networks	22
Supported VLANs	23
VLAN Port Membership Modes	23
VLAN Configuration Files	24
Normal-Range VLAN Configuration Guidelines	25
Extended-Range VLAN Configuration Guidelines	26
How to Configure VLANs	26
How to Configure Normal-Range VLANs	26
Creating or Modifying an Ethernet VLAN	27
Deleting a VLAN	28
Assigning Static-Access Ports to a VLAN	29
How to Configure Extended-Range VLANs	31
Creating an Extended-Range VLAN	31
Monitoring VLANs	32
Where to Go Next	33
Feature History for VLAN	33

---

**CHAPTER 3****Configuring Voice VLANs 35**

Prerequisites for Voice VLANs	35
Restrictions for Voice VLANs	35
Information About Voice VLAN	36
Voice VLANs	36
Cisco IP Phone Voice Traffic	36
Cisco IP Phone Data Traffic	36

Voice VLAN Configuration Guidelines	37
How to Configure Voice VLANs	38
Configuring Cisco IP Phone Voice Traffic	38
Configuring the Priority of Incoming Data Frames	40
Monitoring Voice VLAN	41
Where to Go Next	41
Feature History for Voice VLAN	41

**CHAPTER 4****Configuring VLAN Trunks 43**

Information About VLAN Trunks	43
Trunking Overview	43
Trunking Modes	43
Layer 2 Interface Modes	44
Allowed VLANs on a Trunk	44
Load Sharing on Trunk Ports	45
Network Load Sharing Using STP Priorities	45
Network Load Sharing Using STP Path Cost	45
Feature Interactions	45
Prerequisites for VLAN Trunks	46
Restrictions for VLAN Trunks	46
How to Configure VLAN Trunks	47
Configuring an Ethernet Interface as a Trunk Port	47
Configuring a Trunk Port	47
Defining the Allowed VLANs on a Trunk	49
Changing the Pruning-Eligible List	50
Configuring the Native VLAN for Untagged Traffic	52
Configuring Trunk Ports for Load Sharing	53
Configuring Load Sharing Using STP Port Priorities	53
Configuring Load Sharing Using STP Path Cost	56
Feature History for VLAN Trunks	58

**CHAPTER 5****Configuring Private VLANs 61**

Prerequisites for Private VLANs	61
Restrictions for Private VLANs	61

Information About Private VLANs	62
Private VLAN Domains	62
Secondary VLANs	63
Private VLANs Ports	63
Private VLANs in Networks	64
IP Addressing Scheme with Private VLANs	64
Private VLANs Across Multiple Devices	65
Private-VLAN Interaction with Other Features	65
Private VLANs and Unicast, Broadcast, and Multicast Traffic	65
Private VLANs and SVIs	66
Private VLANs and Switch Stacks	66
Private VLAN with Dynamic MAC Address	67
Private VLAN with Static MAC Address	67
Private VLAN Interaction with VACL/QOS	67
Private VLANs and HA Support	68
Private-VLAN Configuration Guidelines	68
Default Private-VLAN Configurations	68
Secondary and Primary VLAN Configuration	68
Private VLAN Port Configuration	70
How to Configure Private VLANs	71
Configuring Private VLANs	71
Configuring and Associating VLANs in a Private VLAN	71
Configuring a Layer 2 Interface as a Private VLAN Host Port	74
Configuring a Layer 2 Interface as a Private VLAN Promiscuous Port	76
Mapping Secondary VLANs to a Primary VLAN Layer 3 VLAN Interface	77
Monitoring Private VLANs	79
Configuration Examples for Private VLANs	79
Example: Configuring and Associating VLANs in a Private VLAN	80
Example: Configuring an Interface as a Host Port	80
Example: Configuring an Interface as a Private VLAN Promiscuous Port	81
Example: Mapping Secondary VLANs to a Primary VLAN Interface	81
Example: Monitoring Private VLANs	81
Where to Go Next	82
Additional References	82

Feature History for Private VLANs 83

---

**CHAPTER 6**

**Configuring Wired Dynamic PVLAN 85**

Restrictions for Wired Dynamic PVLAN 85

Information About Wired Dynamic PVLAN 85

Configuring Wired Dynamic PVLAN 87

Feature History for Wired Dynamic PVLAN 92







# CHAPTER 1

## Configuring VTP

- [Prerequisites for VTP, on page 1](#)
- [Restrictions for VTP, on page 1](#)
- [Information About VTP, on page 2](#)
- [How to Configure VTP, on page 9](#)
- [Monitoring VTP, on page 18](#)
- [Configuration Examples for VTP, on page 19](#)
- [Where to Go Next, on page 19](#)
- [Feature History for VTP, on page 19](#)

### Prerequisites for VTP

Before you create VLANs, you must decide whether to use the VLAN Trunking Protocol (VTP) in your network. Using VTP, you can make configuration changes centrally on one or more devices and have those changes automatically communicated to all the other devices in the network. Without VTP, you cannot send information about VLANs to other devices.

VTP is designed to work in an environment where updates are made on a single device and are sent through VTP to other devices in the domain. It does not work well in a situation where multiple updates to the VLAN database occur simultaneously on devices in the same domain, which would result in an inconsistency in the VLAN database.

You can enable or disable VTP per port by entering the **[no] vtp** interface configuration command. When you disable VTP on trunking ports, all VTP instances for that port are disabled. You cannot set VTP to *off* for the MST database and *on* for the VLAN database on the same port.

When you globally set VTP mode to *off*, it applies to all the trunking ports in the system. However, you can specify *on* or *off* on a per-VTP instance basis. For example, you can configure the device as a VTP server for the VLAN database but with VTP *off* for the MST database.

Because trunk ports send and receive VTP advertisements, you must ensure that at least one trunk port is configured on the device or device stack and that this trunk port is connected to the trunk port of another device. Otherwise, the device cannot receive any VTP advertisements.

### Restrictions for VTP

The following are restrictions for a VTP:

**Caution**

Before adding a VTP client device to a VTP domain, always verify that its VTP configuration revision number is lower than the configuration revision number of the other devices in the VTP domain. Devices in a VTP domain always use the VLAN configuration of the device with the highest VTP configuration revision number. If you add a device that has a revision number higher than the revision number in the VTP domain, it can erase all VLAN information from the VTP server and VTP domain.

## Information About VTP

The following sections provide information about VTP and VTP configuration:

### VTP

VTP is a Layer 2 messaging protocol that maintains VLAN configuration consistency by managing the addition, deletion, and renaming of VLANs on a network-wide basis. VTP minimizes misconfigurations and configuration inconsistencies that can cause several problems, such as duplicate VLAN names, incorrect VLAN-type specifications, and security violations.

VTP functionality is supported across the stack, and all devices in the stack maintain the same VLAN and VTP configuration inherited from the active device. When a device learns of a new VLAN through VTP messages or when a new VLAN is configured by the user, the new VLAN information is communicated to all devices in the stack.

When a device joins the stack or when stacks merge, the new devices get VTP information from the active device.

### VTP Domain

A VTP domain (also called a VLAN management domain) consists of one device or several interconnected devices under the same administrative responsibility sharing the same VTP domain name. A device can be in only one VTP domain. You make global VLAN configuration changes for the domain.

By default, the device is in the VTP no-management-domain state until it receives an advertisement for a domain over a trunk link (a link that carries the traffic of multiple VLANs) or until you configure a domain name. You can create or modify VLANs on a VTP server without specifying the domain name. However, when the management domain name is not specified VLAN information is not propagated over the network.

If the device receives a VTP advertisement over a trunk link, it inherits the management domain name and the VTP configuration revision number. The device then ignores advertisements with a different domain name or an earlier configuration revision number.

When you make a change to the VLAN configuration on a VTP server, the change is propagated to all devices in the VTP domain. VTP advertisements are sent over all IEEE trunk connections, including IEEE 802.1Q. VTP dynamically maps VLANs with unique names and internal index associates across multiple LAN types. Mapping eliminates excessive device administration required from network administrators.

If you configure a device for VTP transparent mode, you can create and modify VLANs, but the changes are not sent to other devices in the domain, and they affect only the individual device. However, configuration changes made when the device is in this mode are saved in the device running configuration and can be saved to the device startup configuration file.

## VTP Modes

Table 1: VTP Modes

VTP Mode	Description
VTP server	<p>In VTP server mode, you can create, modify, and delete VLANs, and specify other configuration (such as the VTP version) for the entire VTP domain. VTP servers advertise their VLAN configurations to other devices in the same VTP domain and synchronize their VLAN configurations with other devices through advertisements received over trunk links.</p> <p>VTP server is the default mode.</p> <p>In VTP server mode, VLAN configurations are saved in NVRAM. If the device detects a failure to save a configuration to NVRAM, VTP mode automatically changes from server mode to client mode. In this mode, the device cannot be returned to VTP server mode until the NVRAM is functioning.</p>
VTP client	<p>A VTP client functions like a VTP server and transmits and receives VTP updates on its trunks, but does not create, change, or delete VLANs on a VTP client. VLANs are configured on another device in the same VTP domain that is in server mode.</p> <p>In VTP versions 1 and 2 in VTP client mode, VLAN configurations are not saved in NVRAM. In VTP version 3, VLAN configurations are saved in NVRAM in client mode.</p>
VTP transparent	<p>VTP transparent devices do not participate in VTP. A VTP transparent device does not advertise its VLAN configuration and does not synchronize its VLAN configuration based on received advertisements. In VTP version 2 or version 3, transparent devices do forward VTP advertisements that they receive to other devices through their trunk interfaces. You can create, modify, and delete VLANs on a device in VTP transparent mode.</p> <p>In VTP versions 1 and 2, the device must be in VTP transparent mode when you create private VLANs. When private VLANs are configured, you should not change the VTP mode from transparent to client or server mode. VTP version 3 also supports private VLANs in client and server modes. When private VLANs are configured, you should not change the VTP mode from transparent to client or server mode.</p> <p>When the device is in VTP transparent mode, the VTP and VLAN configurations are saved in NVRAM. However, they are not advertised to other devices. In this mode, VTP mode and domain name are saved in the running configuration, and you can save this information in the device startup configuration file by using the <b>copy running-config startup-config</b> privileged EXEC command.</p> <p>In a device stack, the running configuration and the saved configuration are the same for all devices.</p>
VTP off	<p>A device in VTP off mode functions in the same manner as a VTP transparent device, except that it does not forward VTP advertisements on trunks.</p>

## VTP Advertisements

Each device in the VTP domain sends periodic global configuration advertisements from each trunk port to a reserved multicast address. Neighboring devices receive these advertisements and update their VTP and VLAN configurations as necessary.

Because trunk ports send and receive VTP advertisements, you must ensure that at least one trunk port is configured on the switch stack and that this trunk port is connected to the trunk port of another switch. Otherwise, the switch cannot receive any VTP advertisements.

VTP advertisements distribute this global domain information:

- VTP domain name
- VTP configuration revision number
- Update identity and update timestamp
- MD5 digest VLAN configuration, including maximum transmission unit (MTU) size for each VLAN
- Frame format

VTP advertisements distribute this VLAN information for each configured VLAN:

- VLAN IDs (including IEEE 802.1Q)
- VLAN name
- VLAN type
- VLAN state
- Additional VLAN configuration information specific to the VLAN type

In VTP version 3, VTP advertisements also include the primary server ID, an instance number, and a start index.

## VTP Version 2

If you use VTP in your network, you must decide which version of VTP to use. By default, VTP operates in version 1.

VTP version 2 supports these features that are not supported in version 1:

- Token Ring support—VTP version 2 supports Token Ring Bridge Relay Function (TrBRF) and Token Ring Concentrator Relay Function (TrCRF) VLANs.
- Unrecognized Type-Length-Value (TLV) support—A VTP server or client propagates configuration changes to its other trunks, even for TLVs it is not able to parse. The unrecognized TLV is saved in NVRAM when the device is operating in VTP server mode.
- Version-Dependent Transparent Mode—In VTP version 1, a VTP transparent device inspects VTP messages for the domain name and version and forwards a message only if the version and domain name match. Although VTP version 2 supports only one domain, a VTP version 2 transparent device forwards a message only when the domain name matches.
- Consistency Checks—In VTP version 2, VLAN consistency checks (such as VLAN names and values) are performed only when you enter new information through the CLI or SNMP. Consistency checks are not performed when new information is obtained from a VTP message or when information is read from NVRAM. If the MD5 digest on a received VTP message is correct, its information is accepted.

## VTP Version 3

VTP version 3 supports these features that are not supported in version 1 or version 2:

- Enhanced authentication—You can configure the authentication as **hidden** or **secret**. When **hidden**, the secret key from the password string is saved in the VLAN database file, but it does not appear in plain text in the configuration. Instead, the key associated with the password is saved in hexadecimal format in the running configuration. You must reenter the password if you enter a takeover command in the domain. When you enter the **secret** keyword, you can directly configure the password secret key.
- Support for extended range VLAN (VLANs 1006 to 4094) database propagation—VTP versions 1 and 2 propagate only VLANs 1 to 1005.



---

**Note** VTP pruning still applies only to VLANs 1 to 1005, and VLANs 1002 to 1005 are still reserved and cannot be modified.

---

- Private VLAN support.
- Support for any database in a domain—In addition to propagating VTP information, version 3 can propagate Multiple Spanning Tree (MST) protocol database information. A separate instance of the VTP protocol runs for each application that uses VTP.
- VTP primary server and VTP secondary servers—A VTP primary server updates the database information and sends updates that are honored by all devices in the system. A VTP secondary server can only back up the updated VTP configurations received from the primary server to its NVRAM.

By default, all devices come up as secondary servers. You can enter the **vtp primary** privileged EXEC command to specify a primary server. Primary server status is only needed for database updates when the administrator issues a takeover message in the domain. You can have a working VTP domain without any primary servers. Primary server status is lost if the device reloads, after a switchover, or domain parameters change, even when a password is configured on the device.

## VTP Pruning

VTP pruning increases network available bandwidth by restricting flooded traffic to those trunk links that the traffic must use to reach the destination devices. Without VTP pruning, a device floods broadcast, multicast, and unknown unicast traffic across all trunk links within a VTP domain even though receiving devices might discard them. VTP pruning is disabled by default.

VTP pruning blocks unneeded flooded traffic to VLANs on trunk ports that are included in the pruning-eligible list. Only VLANs included in the pruning-eligible list can be pruned. By default, VLANs 2 through 1001 are pruning eligible device trunk ports. If the VLANs are configured as pruning-ineligible, the flooding continues. VTP pruning is supported in all VTP versions.

### *Figure 1: Flooding Traffic without VTP Pruning*

VTP pruning is disabled in the switched network. Port 1 on Device A and Port 2 on Device D are assigned to the Red VLAN. If a broadcast is sent from the host connected to Device A, Device A floods the broadcast and every device in the network receives it, even though Devices C, E, and F have no ports in the Red VLAN.

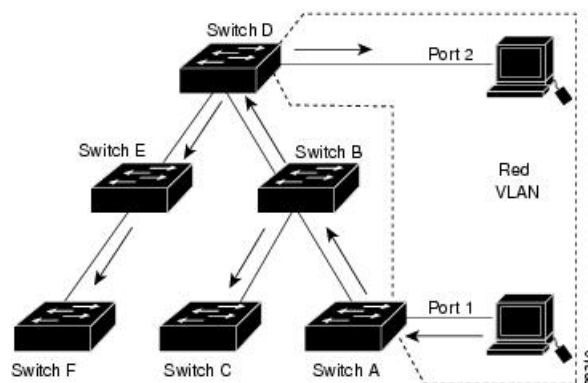
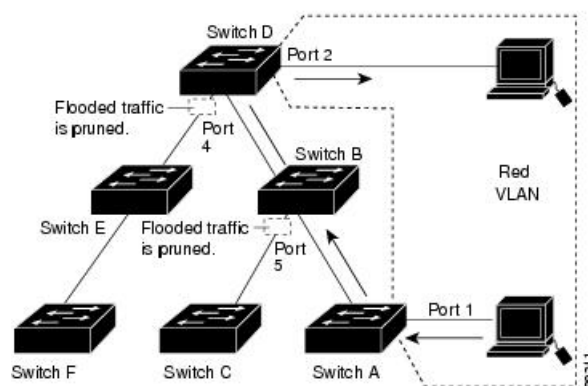

Figure 2: Optimized Flooded Traffic VTP Pruning

VTP pruning is enabled in the switched network. The broadcast traffic from Device A is not forwarded to Devices C, E, and F because traffic for the Red VLAN has been pruned on the links shown (Port 5 on Device B and Port 4 on Device D).



With VTP versions 1 and 2, when you enable pruning on the VTP server, it is enabled for the entire VTP domain. In VTP version 3, you must manually enable pruning on each device in the domain. Making VLANs pruning-eligible or pruning-ineligible affects pruning eligibility for those VLANs on that trunk only (not on all devices in the VTP domain).

VTP pruning takes effect several seconds after you enable it. VTP pruning does not prune traffic from VLANs that are pruning-ineligible. VLAN 1 and VLANs 1002 to 1005 are always pruning-ineligible; traffic from these VLANs cannot be pruned. Extended-range VLANs (VLAN IDs higher than 1005) are also pruning-ineligible.

## VTP and Device Stacks

VTP configuration is the same in all members of a device stack. When the device stack is in VTP server or client mode, all devices in the stack carry the same VTP configuration. When VTP mode is transparent, the stack is not taking part in VTP.

- When a device joins the stack, it inherits the VTP and VLAN properties of the active device.
- All VTP updates are carried across the stack.
- When VTP mode is changed in a device in the stack, the other devices in the stack also change VTP mode, and the device VLAN database remains consistent.

VTP version 3 functions the same on a standalone device or a stack except when the switch stack is the primary server for the VTP database. In this case, the MAC address of the active device is used as the primary server ID. If the active device reloads or is powered off, a new active device is elected.

- If you do not configure the persistent MAC address feature, when the new active device is elected, it sends a takeover message with the new active MAC address as the primary server.
- If a persistent MAC address is configured, the new active device waits for the configured timer value. If the previous active device does not rejoin the stack during this time, then the new active device issues the takeover message.

## VTP Configuration Guidelines

This section provides information about VTP configuration guidelines:

### VTP Configuration Requirements

When you configure VTP, you must configure a trunk port so that the device can send and receive VTP advertisements to and from other devices in the domain.

VTP versions 1 and 2 do not support private VLANs. VTP version 3 does support private VLANs. If you configure private VLANs, the device must be in VTP transparent mode. When private VLANs are configured on the device, do not change the VTP mode from transparent to client or server mode.

### VTP Settings

The VTP information is saved in the VTP VLAN database. When VTP mode is transparent, the VTP domain name and mode are also saved in the device running configuration file, and you can save it in the device startup configuration file by entering the **copy running-config startup-config** privileged EXEC command. You must use this command if you want to save VTP mode as transparent, even if the device resets.

When you save VTP information in the device startup configuration file and reboot the device, the device configuration is selected as follows:

- If the VTP mode is transparent in the startup configuration and the VLAN database and the VTP domain name from the VLAN database matches that in the startup configuration file, the VLAN database is ignored (cleared), and the VTP and VLAN configurations in the startup configuration file are used. The VLAN database revision number remains unchanged in the VLAN database.
- If the VTP mode or domain name in the startup configuration do not match the VLAN database, the domain name and VTP mode and configuration for VLAN IDs 1 to 1005 use the VLAN database information.

### Domain Names for Configuring VTP

When configuring VTP for the first time, you must always assign a domain name. You must configure all devices in the VTP domain with the same domain name. Devices in VTP transparent mode do not exchange VTP messages with other devices, and you do not need to configure a VTP domain name for them.



---

**Note** If the NVRAM and DRAM storage is sufficient, all devices in a VTP domain should be in VTP server mode.

---



---

**Caution** Do not configure a VTP domain if all devices are operating in VTP client mode. If you configure the domain, it is impossible to make changes to the VLAN configuration of that domain. Make sure that you configure at least one device in the VTP domain for VTP server mode.

---

## Passwords for the VTP Domain

You can configure a password for the VTP domain, but it is not required. If you do configure a domain password, all domain devices must share the same password and you must configure the password on each device in the management domain. Devices without a password or with the wrong password reject VTP advertisements.

If you configure a VTP password for a domain, a device that is booted without a VTP configuration does not accept VTP advertisements until you configure it with the correct password. After the configuration, the device accepts the next VTP advertisement that uses the same password and domain name in the advertisement.

If you are adding a new device to an existing network with VTP capability, the new device learns the domain name only after the applicable password has been configured on it.



---

**Caution** When you configure a VTP domain password, the management domain does not function properly if you do not assign a management domain password to each device in the domain.

---

## VTP Version

Follow these guidelines when deciding which VTP version to implement:

- All devices in a VTP domain must have the same domain name, but they do not need to run the same VTP version.
- A VTP version 2-capable device can operate in the same VTP domain as a device running VTP version 1 if version 2 is disabled on the version 2-capable device (version 2 is disabled by default).
- If a device running VTP version 1, but capable of running VTP version 2, receives VTP version 3 advertisements, it automatically moves to VTP version 2.
- If a device running VTP version 3 is connected to a device running VTP version 1, the VTP version 1 device moves to VTP version 2, and the VTP version 3 device sends scaled-down versions of the VTP packets so that the VTP version 2 device can update its database.
- A device running VTP version 3 cannot move to version 1 or 2 if it has extended VLANs.
- Do not enable VTP version 2 on a device unless all of the devices in the same VTP domain are version-2-capable. When you enable version 2 on a device, all of the version-2-capable devices in the domain enable version 2. If there is a version 1-only device, it does not exchange VTP information with device that have version 2 enabled.
- Cisco recommends placing VTP version 1 and 2 device at the edge of the network because they do not forward VTP version 3 advertisements.
- If there are TrBRF and TrCRF Token Ring networks in your environment, you must enable VTP version 2 or version 3 for Token Ring VLAN switching to function properly. To run Token Ring and Token Ring-Net, disable VTP version 2.



- For VTP version 1 and version 2, the device must be in VTP transparent mode when you create extended-range VLANs. VTP version 3 also supports creating extended-range VLANs in client or server mode.
- When a VTP version 3 device trunk port receives messages from a VTP version 2 device, it sends a scaled-down version of the VLAN database on that particular trunk in VTP version 2 format. A VTP version 3 device does not send VTP version 2-formatted packets on a trunk unless it first receives VTP version 2 packets on that trunk port.
- When a VTP version 3 device detects a VTP version 2 device on a trunk port, it continues to send VTP version 3 packets, in addition to VTP version 2 packets, to allow both kinds of neighbors to coexist on the same trunk.
- A VTP version 3 device does not accept configuration information from a VTP version 2 or version 1 device.
- Two VTP version 3 regions can only communicate in transparent mode over a VTP version 1 or version 2 region.
- Devices that are only VTP version 1 capable cannot interoperate with VTP version 3 devices.

## How to Configure VTP

The following sections provide information about Configuring VTP:

### Configuring VTP Mode

You can configure VTP mode as one of these:

- VTP server mode—In VTP server mode, you can change the VLAN configuration and have it propagated throughout the network.
- VTP client mode—In VTP client mode, you cannot change its VLAN configuration. The client device receives VTP updates from a VTP server in the VTP domain and then modifies its configuration accordingly.
- VTP transparent mode—In VTP transparent mode, VTP is disabled on the device. The device does not send VTP updates and does not act on VTP updates received from other devices. However, a VTP transparent device running VTP version 2 does forward received VTP advertisements on its trunk links.
- VTP off mode—VTP off mode is the same as VTP transparent mode except that VTP advertisements are not forwarded.

When you configure a domain name, it cannot be removed; you can only reassign a device to a different domain.

#### Procedure

	Command or Action	Purpose
Step 1	<b>enable</b> <b>Example:</b>	Enables privileged EXEC mode. Enter your password if prompted.

	Command or Action	Purpose
	Device> <b>enable</b>	
<b>Step 2</b>	<b>configure terminal</b> <b>Example:</b> Device# <b>configure terminal</b>	Enters global configuration mode.
<b>Step 3</b>	<b>vtp domain</b> <i>domain-name</i> <b>Example:</b> Device(config)# <b>vtp domain eng_group</b>	<p>Configures the VTP administrative-domain name. The name can be 1 to 32 characters. All devices operating in VTP server or client mode under the same administrative responsibility must be configured with the same domain name.</p> <p>This command is optional for modes other than server mode. VTP server mode requires a domain name. If the device has a trunk connection to a VTP domain, the device learns the domain name from the VTP server in the domain.</p> <p>You should configure the VTP domain before configuring other VTP parameters.</p>
<b>Step 4</b>	<b>vtp mode</b> { <b>client</b>   <b>server</b>   <b>transparent</b>   <b>off</b> } { <b>vlan</b>   <b>mst</b>   <b>unknown</b> } <b>Example:</b> Device(config)# <b>vtp mode server</b>	<p>Configures the device for VTP mode (client, server, transparent, or off).</p> <ul style="list-style-type: none"> <li>• <b>vlan</b>—The VLAN database is the default if none are configured.</li> <li>• <b>mst</b>—The multiple spanning tree (MST) database.</li> <li>• <b>unknown</b>—An unknown database type.</li> </ul>
<b>Step 5</b>	<b>vtp password</b> <i>password</i> <b>Example:</b> Device(config)# <b>vtp password mypassword</b>	<p>(Optional) Sets the password for the VTP domain. The password can be 8 to 64 characters. If you configure a VTP password, the VTP domain does not function properly if you do not assign the same password to each device in the domain.</p>
<b>Step 6</b>	<b>end</b> <b>Example:</b> Device(config)# <b>end</b>	Returns to privileged EXEC mode.

	Command or Action	Purpose
<b>Step 7</b>	<b>show vtp status</b> <b>Example:</b> <pre>Device# show vtp status</pre>	Verifies your entries in the <i>VTP Operating Mode</i> and the <i>VTP Domain Name</i> fields of the display.
<b>Step 8</b>	<b>copy running-config startup-config</b> <b>Example:</b> <pre>Device# copy running-config startup-config</pre>	(Optional) Saves the configuration in the startup configuration file.  Only VTP mode and domain name are saved in the device running configuration and can be copied to the startup configuration file.

## Configuring a VTP Version 3 Password

You can configure a VTP version 3 password on the device.

### Procedure

	Command or Action	Purpose
<b>Step 1</b>	<b>enable</b> <b>Example:</b> <pre>Device&gt; enable</pre>	Enables privileged EXEC mode.  Enter your password if prompted.
<b>Step 2</b>	<b>configure terminal</b> <b>Example:</b> <pre>Device# configure terminal</pre>	Enters global configuration mode.
<b>Step 3</b>	<b>vtp version 3</b> <b>Example:</b> <pre>Device(config)# vtp version 3</pre>	Enables VTP version 3 on the device. The default is VTP version 1.
<b>Step 4</b>	<b>vtp password <i>password</i> [hidden   secret]</b> <b>Example:</b> <pre>Device(config)# vtp password mypassword hidden</pre>	(Optional) Sets the password for the VTP domain. The password can be 8 to 64 characters. <ul style="list-style-type: none"> <li>(Optional) <b>hidden</b>: Saves the secret key generated from the password string in the <code>nvrn:vlan.dat</code> file. If you configure a takeover by configuring a VTP primary server, you are prompted to reenter the password.</li> </ul>

	Command or Action	Purpose
		<ul style="list-style-type: none"> <li>(Optional) <b>secret</b>: Directly configures the password. The secret password must contain 32 hexadecimal characters.</li> </ul>
<b>Step 5</b>	<b>end</b> <b>Example:</b> <pre>Device(config)# end</pre>	Returns to privileged EXEC mode.
<b>Step 6</b>	<b>show vtp password</b> <b>Example:</b> <pre>Device# show vtp password</pre>	Verifies whether the VTP password is configured or not.
<b>Step 7</b>	<b>copy running-config startup-config</b> <b>Example:</b> <pre>Device# copy running-config startup-config</pre>	(Optional) Saves your entries in the configuration file.

## Configuring a VTP Version 3 Primary Server

When you configure a VTP server as a VTP primary server, the takeover operation starts.

### Procedure

	Command or Action	Purpose
<b>Step 1</b>	<b>vtp version 3</b> <b>Example:</b> <pre>Device(config)# vtp version 3</pre>	Enables VTP version 3 on the device. The default is VTP version 1.
<b>Step 2</b>	<b>vtp primary [vlan   mst] [force]</b> <b>Example:</b> <pre>Device# vtp primary vlan force</pre>	<p>Changes the operational state of a device from a secondary server (the default) to a primary server and advertises the configuration to the domain. If the device password is configured as <b>hidden</b>, you are prompted to reenter the password.</p> <ul style="list-style-type: none"> <li>(Optional) <b>vlan</b>—Selects the VLAN database as the takeover feature. This is the default.</li> </ul>

	Command or Action	Purpose
		<ul style="list-style-type: none"> <li>• (Optional) <b>mst</b>—Selects the multiple spanning tree (MST) database as the takeover feature.</li> <li>• (Optional) <b>force</b>—Overwrites the configuration of any conflicting servers. If you do not enter <b>force</b>, you are prompted for confirmation before the takeover.</li> </ul>

## Enabling the VTP Version

VTP version 2 and version 3 are disabled by default.

- When you enable VTP version 2 on a device, every VTP version 2-capable device in the VTP domain enables version 2. To enable VTP version 3, you must manually configure it on each device.
- With VTP versions 1 and 2, you can configure the version only on devices in VTP server or transparent mode. If a device is running VTP version 3, you can change to version 2 when the device is in client mode if no extended VLANs exist, no private VLANs exist, and no hidden password was configured.



**Caution** VTP version 1 and VTP version 2 are not interoperable on devices in the same VTP domain. Do not enable VTP version 2 unless every device in the VTP domain supports version 2.

- In TrCRF and TrBRF Token Ring environments, you must enable VTP version 2 or VTP version 3 for Token Ring VLAN switching to function properly. For Token Ring and Token Ring-Net media, disable VTP version 2.



**Caution** In VTP version 3, both the primary and secondary servers can exist on an instance in the domain.

### Procedure

	Command or Action	Purpose
<b>Step 1</b>	<b>enable</b> <b>Example:</b> Device> <b>enable</b>	Enables privileged EXEC mode. Enter your password if prompted.
<b>Step 2</b>	<b>configure terminal</b> <b>Example:</b>	Enters global configuration mode.

	Command or Action	Purpose
	Device# <code>configure terminal</code>	
<b>Step 3</b>	<b>vtp version {1   2   3}</b> <b>Example:</b> Device(config)# <code>vtp version 2</code>	Enables the VTP version on the device. The default is VTP version 1.
<b>Step 4</b>	<b>end</b> <b>Example:</b> Device(config)# <code>end</code>	Returns to privileged EXEC mode.
<b>Step 5</b>	<b>show vtp status</b> <b>Example:</b> Device# <code>show vtp status</code>	Verifies that the configured VTP version is enabled.
<b>Step 6</b>	<b>copy running-config startup-config</b> <b>Example:</b> Device# <code>copy running-config startup-config</code>	(Optional) Saves your entries in the configuration file.

## Enabling VTP Pruning

### Before you begin

VTP pruning is not designed to function in VTP transparent mode. If one or more devices in the network are in VTP transparent mode, you should do one of these actions:

- Turn off VTP pruning in the entire network.
- Turn off VTP pruning by making all VLANs on the trunk of the device upstream to the VTP transparent device pruning ineligible.

To configure VTP pruning on an interface, use the **switchport trunk pruning vlan** interface configuration command. VTP pruning operates when an interface is trunking. You can set VLAN pruning-eligibility, whether or not VTP pruning is enabled for the VTP domain, whether or not any given VLAN exists, and whether or not the interface is currently trunking.

**Procedure**

	<b>Command or Action</b>	<b>Purpose</b>
<b>Step 1</b>	<b>enable</b> <b>Example:</b> Device> <b>enable</b>	Enables privileged EXEC mode. Enter your password if prompted.
<b>Step 2</b>	<b>configure terminal</b> <b>Example:</b> Device# <b>configure terminal</b>	Enters global configuration mode.
<b>Step 3</b>	<b>vtp pruning</b> <b>Example:</b> Device(config)# <b>vtp pruning</b>	Enables pruning in the VTP administrative domain.  By default, pruning is disabled. You need to enable pruning on only one device in VTP server mode.
<b>Step 4</b>	<b>end</b> <b>Example:</b> Device(config)# <b>end</b>	Returns to privileged EXEC mode.
<b>Step 5</b>	<b>show vtp status</b> <b>Example:</b> Device# <b>show vtp status</b>	Verifies your entries in the <i>VTP Pruning Mode</i> field of the display.

## Configuring VTP on a Per-Port Basis

With VTP version 3, you can enable or disable VTP on a per-port basis. You can enable VTP only on ports that are in trunk mode. Incoming and outgoing VTP traffic are blocked, not forwarded.

**Procedure**

	<b>Command or Action</b>	<b>Purpose</b>
<b>Step 1</b>	<b>enable</b> <b>Example:</b> Device> <b>enable</b>	Enables privileged EXEC mode. Enter your password if prompted.

	Command or Action	Purpose
<b>Step 2</b>	<b>configure terminal</b> <b>Example:</b> Device# <code>configure terminal</code>	Enters global configuration mode.
<b>Step 3</b>	<b>interface <i>interface-id</i></b> <b>Example:</b> Device(config)# <code>interface gigabitethernet0/1</code>	Identifies an interface, and enters interface configuration mode.
<b>Step 4</b>	<b>vtp</b> <b>Example:</b> Device(config-if)# <code>vtp</code>	Enables VTP on the specified port.
<b>Step 5</b>	<b>end</b> <b>Example:</b> Device(config)# <code>end</code>	Returns to privileged EXEC mode.
<b>Step 6</b>	<b>show running-config interface <i>interface-id</i></b> <b>Example:</b> Device# <code>show running-config interface gigabitethernet 1/0/1</code>	Verifies the change to the port.
<b>Step 7</b>	<b>show vtp status</b> <b>Example:</b> Device# <code>show vtp status</code>	Verifies the configuration.

## Adding a VTP Client to a VTP Domain

Follow these steps to verify and reset the VTP configuration revision number on a device *before* adding it to a VTP domain.

### Before you begin

Before adding a VTP client to a VTP domain, always verify that its VTP configuration revision number is *lower* than the configuration revision number of the other devices in the VTP domain. Devices in a VTP domain always use the VLAN configuration of the device with the highest VTP configuration revision number.



With VTP versions 1 and 2, adding a device that has a revision number higher than the revision number in the VTP domain can erase all VLAN information from the VTP server and VTP domain. With VTP version 3, the VLAN information is not erased.

You can use the **vtp mode transparent** global configuration command to disable VTP on the device and then to change its VLAN information without affecting the other devices in the VTP domain.

### Procedure

	Command or Action	Purpose
<b>Step 1</b>	<b>enable</b> <b>Example:</b> Device> <b>enable</b>	Enables privileged EXEC mode. Enter your password if prompted.
<b>Step 2</b>	<b>show vtp status</b> <b>Example:</b> Device# <b>show vtp status</b>	Checks the VTP configuration revision number. If the number is 0, add the device to the VTP domain. If the number is greater than 0, follow these substeps: <ul style="list-style-type: none"> <li>• Write down the domain name.</li> <li>• Write down the configuration revision number.</li> <li>• Continue with the next steps to reset the device configuration revision number.</li> </ul>
<b>Step 3</b>	<b>configure terminal</b> <b>Example:</b> Device# <b>configure terminal</b>	Enters global configuration mode.
<b>Step 4</b>	<b>vtp domain <i>domain-name</i></b> <b>Example:</b> Device(config)# <b>vtp domain domain123</b>	Changes the domain name from the original one displayed in Step 1 to a new name.
<b>Step 5</b>	<b>end</b> <b>Example:</b> Device(config)# <b>end</b>	Returns to privileged EXEC mode. The VLAN information on the device is updated and the configuration revision number is reset to 0.

	Command or Action	Purpose
<b>Step 6</b>	<b>show vtp status</b> <b>Example:</b>  Device# <code>show vtp status</code>	Verifies that the configuration revision number has been reset to 0.
<b>Step 7</b>	<b>configure terminal</b> <b>Example:</b>  Device# <code>configure terminal</code>	Enters global configuration mode.
<b>Step 8</b>	<b>vtp domain <i>domain-name</i></b> <b>Example:</b>  Device (config)# <code>vtp domain domain012</code>	Enters the original domain name on the device.
<b>Step 9</b>	<b>end</b> <b>Example:</b>  Device (config)# <code>end</code>	Returns to privileged EXEC mode. The VLAN information on the device is updated.
<b>Step 10</b>	<b>show vtp status</b> <b>Example:</b>  Device# <code>show vtp status</code>	(Optional) Verifies that the domain name is the same as in Step 1 and that the configuration revision number is 0.

## Monitoring VTP

This section describes commands used to display and monitor the VTP configuration.

You monitor VTP by displaying VTP configuration information: the domain name, the current VTP revision, and the number of VLANs. You can also display statistics about the advertisements sent and received by the device.

**Table 2: VTP Monitoring Commands**

Command	Purpose
<code>show vtp counters</code>	Displays counters about VTP messages th
<code>show vtp devices [conflict]</code>	Displays information about all VTP versi version 3 devices with conflicting primar not display information when the device i

Command	Purpose
<code>show vtp interface [interface-id]</code>	Displays VTP status and configuration
<code>show vtp password</code>	Displays whether the VTP password is
<code>show vtp status</code>	Displays the VTP device configuration

## Configuration Examples for VTP

The following section shows a VTP configuration example:

### Example: Configuring a Device as the Primary Server

This example shows how to configure a device as the primary server for the VLAN database (the default) when a hidden or secret password was configured:

```
Device# vtp primary vlan
Enter VTP password: mypassword
This switch is becoming Primary server for vlan feature in the VTP domain

VTP Database Conf Switch ID      Primary Server Revision System Name
-----
VLANDB          Yes  00d0.00b8.1400=00d0.00b8.1400 1      stp7

Do you want to continue (y/n) [n]? y
```

## Where to Go Next

After configuring VTP, you can configure the following:

- VLANs
- VLAN trunking
- Voice VLANs
- Private VLANs

## Feature History for VTP

This table provides release and related information for features explained in this module.

These features are available on all releases subsequent to the one they were introduced in, unless noted otherwise.

Release	Feature	Feature Information
Cisco IOS XE Fuji 16.9.1	VLAN Trunking Protocol (VTP)	VTP is a Layer 2 messaging protocol that maintains VLAN configuration consistency by managing the addition, deletion, and renaming of VLANs on a network-wide basis. VTP minimizes misconfigurations and configuration inconsistencies that can cause several problems, such as duplicate VLAN names, incorrect VLAN-type specifications, and security violations.
Cisco IOS XE Gibraltar 16.12.4	VTP <b>show vtp password</b> command output modification	The <b>show vtp password</b> command output now displays whether the password is or is not configured.
Cisco IOS XE Cupertino 17.9.1	VLAN Trunking Protocol (VTP)	This feature was implemented on C9200CX-12P-2X2G, C9200CX-8P-2X2G, and C9200CX-12T-2X2G models of the Cisco Catalyst 9200CX Series Switches, which were introduced in this release.

Use Cisco Feature Navigator to find information about platform and software image support. To access Cisco Feature Navigator, go to <http://www.cisco.com/go/cfn>.



## CHAPTER 2

# Configuring VLANs

---

- [Prerequisites for VLANs, on page 21](#)
- [Restrictions for VLANs, on page 21](#)
- [Information About VLANs, on page 22](#)
- [How to Configure VLANs, on page 26](#)
- [Monitoring VLANs, on page 32](#)
- [Where to Go Next, on page 33](#)
- [Feature History for VLAN, on page 33](#)

## Prerequisites for VLANs

The following are prerequisites and considerations for configuring VLANs:

- Before you create VLANs, you must decide whether to use VLAN Trunking Protocol (VTP) to maintain global VLAN configuration for your network.
- If you plan to configure many VLANs on the device and to not enable routing, you can set the Switch Database Management (SDM) feature to the VLAN template, which configures system resources to support the maximum number of unicast MAC addresses.
- A VLAN should be present in the device to be able to add it to the VLAN group.

## Restrictions for VLANs

The following are restrictions for VLANs:

- The number of Spanning Tree Protocol (STP) virtual ports in the per-VLAN spanning-tree (PVST) or rapid PVST mode is based on the number of trunks, multiplied by the number of active VLANs, plus the number of access ports.

STP virtual ports = trunks \* active VLANs on trunk + number of non-trunk ports.

Consider the following examples:

- If a switch has 40 trunk ports (100 active VLANs on each trunk) and 8 access ports, the number of STP virtual ports on this switch would be:  $40 * 100 + 8 = 4,008$ .

- If a switch has 8 trunk ports (200 active VLANs on each trunk) and 40 access ports, the number of STP virtual ports on this switch would be:  $8 * 200 + 40 = 1,640$

For information about the supported scalability of STP virtual ports, see the [Cisco Catalyst 9200 Series Switches Data Sheet](#).

- The device supports IEEE 802.1Q trunking methods for sending VLAN traffic over Ethernet ports.
- The interface VLAN already has a MAC address assigned by default. You can override the interface VLAN MAC address by using the **mac-address** command. If this command is configured on a single SVI or router port that requires Layer 3 injected packets, all other SVIs or routed ports on the device also must be configured with the same first four most significant bits (4MSB) of the MAC address. For example, if you set the MAC address of any SVI to `xxxx.yyyy.zzzz`, set the MAC address of all other SVIs to start with `xxxx.yyyy`. If Layer 3 injected packets are not used, this restriction does not apply.



---

**Note** This applies to all Layer 3 ports, SVIs, and routed ports. This does not apply to GigabitEthernet0/0 port.

---

- Once a range of interfaces has been bundled, any VLAN interface configuration change must be done only on a port channel. Otherwise, the interfaces will get suspended.

## Information About VLANs

The following sections provides information about VLANs:

### Logical Networks

A VLAN is a switched network that is logically segmented by function, project team, or application, without regard to the physical locations of the users. VLANs have the same attributes as physical LANs, but you can group end stations even if they are not physically located on the same LAN segment. Any device port can belong to a VLAN, and unicast, broadcast, and multicast packets are forwarded and flooded only to end stations in the VLAN. Each VLAN is considered a logical network, and packets destined for stations that do not belong to the VLAN must be forwarded through a router or a device supporting fallback bridging. In a switch stack, VLANs can be formed with ports across the stack. Because a VLAN is considered a separate logical network, it contains its own bridge Management Information Base (MIB) information and can support its own implementation of spanning tree.

Figure 3: VLANs as Logically Defined Networks

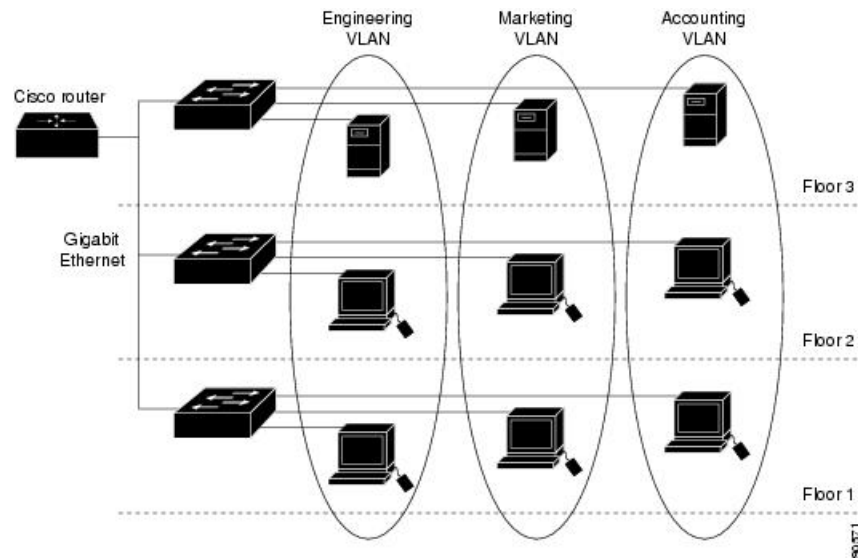

VLANs are often associated with IP subnetworks. For example, all the end stations in a particular IP subnet belong to the same VLAN. Interface VLAN membership on the device is assigned manually on an interface-by-interface basis. When you assign device interfaces to VLANs by using this method, it is known as interface-based, or static, VLAN membership.

Traffic between VLANs must be routed.

The device can route traffic between VLANs by using device virtual interfaces (SVIs). An SVI must be explicitly configured and assigned an IP address to route traffic between VLANs.

## Supported VLANs

The device supports VLANs in VTP client, server, and transparent modes. VLANs are identified by a number from 1 to 4094. VLAN 1 is the default VLAN and is created during system initialization.

You can configure up to 1024 VLANs on the C9200L and Cisco Catalyst 9200 Series Switches.

With STP enabled, you can configure up to 128 VLANs on all the models of Cisco Catalyst 9200 Series Switches. With STP disabled, you can configure up to 512 VLANs on the Cisco Catalyst 9200 and Cisco Catalyst 9200L Series Switches.

VLAN IDs 1002 through 1005 are reserved for Token Ring and FDDI VLANs. All of the VLANs except 1002 to 1005 are available for user configuration.

## VLAN Port Membership Modes

You configure a port to belong to a VLAN by assigning a membership mode that specifies the kind of traffic the port carries and the number of VLANs to which it can belong.

When a port belongs to a VLAN, the device learns and manages the addresses associated with the port on a per-VLAN basis.

Table 3: Port Membership Modes and Characteristics

Membership Mode	VLAN Membership Characteristics	VTP Characteristics
Static-access	A static-access port can belong to one VLAN and is manually assigned to that VLAN.	VTP is not required. If you do not want VTP to globally propagate information, set the VTP mode to transparent. To participate in VTP, there must be at least one trunk port on the device or the device stack connected to a trunk port of a second device or device stack.
Trunk (IEEE 802.1Q) : <ul style="list-style-type: none"> <li>IEEE 802.1Q— Industry-standard trunking encapsulation.</li> </ul>	A trunk port is a member of all VLANs by default, including extended-range VLANs, but membership can be limited by configuring the allowed-VLAN list. You can also modify the pruning-eligible list to block flooded traffic to VLANs on trunk ports that are included in the list.	VTP is recommended but not required. VTP maintains VLAN configuration consistency by managing the addition, deletion, and renaming of VLANs on a network-wide basis. VTP exchanges VLAN configuration messages with other devices over trunk links.
Voice VLAN	A voice VLAN port is an access port attached to a Cisco IP Phone, configured to use one VLAN for voice traffic and another VLAN for data traffic from a device attached to the phone.	VTP is not required; it has no effect on a voice VLAN.

## VLAN Configuration Files

Configurations for VLAN IDs 1 to 1005 are written to the `vlan.dat` file (VLAN database), and you can display them by entering the **show vlan** privileged EXEC command. The `vlan.dat` file is stored in flash memory. If the VTP mode is transparent, they are also saved in the device running configuration file.

In a device stack, the whole stack uses the same `vlan.dat` file and running configuration. On some devices, the `vlan.dat` file is stored in flash memory on the active device.

You use the interface configuration mode to define the port membership mode and to add and remove ports from VLANs. The results of these commands are written to the running-configuration file, and you can display the file by entering the **show running-config** privileged EXEC command.

When you save VLAN and VTP information (including extended-range VLAN configuration information) in the startup configuration file and reboot the device, the device configuration is selected as follows:

- If the VTP mode is transparent in the startup configuration, and the VLAN database and the VTP domain name from the VLAN database matches that in the startup configuration file, the VLAN database is ignored (cleared), and the VTP and VLAN configurations in the startup configuration file are used. The VLAN database revision number remains unchanged in the VLAN database.



- If the VTP mode or domain name in the startup configuration does not match the VLAN database, the domain name and VTP mode and configuration for the VLAN IDs 1 to 1005 use the VLAN database information.
- In VTP versions 1 and 2, if VTP mode is server, the domain name and VLAN configuration for VLAN IDs 1 to 1005 use the VLAN database information. VTP version 3 also supports VLANs 1006 to 4094.



---

**Note** Ensure that you delete the `vlan.dat` file along with the configuration files before you reset the switch configuration using `write erase` command. This ensures that the switch reboots correctly on a reset.

---

## Normal-Range VLAN Configuration Guidelines

Normal-range VLANs are VLANs with IDs from 1 to 1005.

Follow these guidelines when creating and modifying normal-range VLANs in your network:

- Normal-range VLANs are identified with a number between 1 and 1001. VLAN numbers 1002 through 1005 are reserved for Token Ring and FDDI VLANs.
- VLAN configurations for VLANs 1 to 1005 are always saved in the VLAN database. If the VTP mode is transparent, VTP and VLAN configurations are also saved in the device running configuration file.
- If the device is in VTP server or VTP transparent mode, you can add, modify or remove configurations for VLANs 2 to 1001 in the VLAN database. (VLAN IDs 1 and 1002 to 1005 are automatically created and cannot be removed.)
- Before you can create a VLAN, the device must be in VTP server mode or VTP transparent mode. If the device is a VTP server, you must define a VTP domain or VTP will not function.
- The device does not support Token Ring or FDDI media. The device does not forward FDDI, FDDI-Net, TrCRF, or TrBRF traffic, but it does propagate the VLAN configuration through VTP.
- A fixed number of spanning tree instances are supported on the device (See the Cisco Catalyst 9200 Series Switches Data Sheet for the latest information). If the device has more than the supported number of spanning tree instances, spanning tree is still enabled only on the supported number of VLANs and disabled on all remaining VLANs.

If you have already used all available spanning-tree instances on a device, adding another VLAN anywhere in the VTP domain creates a VLAN on that device that is not running spanning-tree. If you have the default allowed list on the trunk ports of that device (which is to allow all VLANs), the new VLAN is carried on all trunk ports. Depending on the topology of the network, this could create a loop in the new VLAN that would not be broken, particularly if there are several adjacent devices that all have run out of spanning-tree instances. You can prevent this possibility by setting allowed lists on the trunk ports of devices that have used up their allocation of spanning-tree instances.

If the number of VLANs on the device exceeds the number of supported spanning-tree instances, we recommend that you configure the IEEE 802.1s Multiple STP (MSTP) on your device to map multiple VLANs to a single spanning-tree instance.

## Extended-Range VLAN Configuration Guidelines

Extended-range VLANs are VLANs with IDs from 1006 to 4094.

Follow these guidelines when creating extended-range VLANs:

- VLAN IDs in the extended range are not saved in the VLAN database and are not recognized by VTP unless the device is running VTP version 3.
- You cannot include extended-range VLANs in the pruning eligible range.
- For VTP version 1 or 2, you can set the VTP mode to transparent in global configuration mode. You should save this configuration to the startup configuration so that the device boots up in VTP transparent mode. Otherwise, you lose the extended-range VLAN configuration if the device resets. If you create extended-range VLANs in VTP version 3, you cannot convert to VTP version 1 or 2.
- In a switch stack, the whole stack uses the same running configuration and saved configuration, and extended-range VLAN information is shared across the stack.

## How to Configure VLANs

The following sections provide information about configuring Normal-Range VLANs and Extended-Range VLANs:

### How to Configure Normal-Range VLANs

You can set these parameters when you create a new normal-range VLAN or modify an existing VLAN in the VLAN database:

- VLAN ID
- VLAN name
- VLAN type
  - Ethernet
  - Fiber Distributed Data Interface [FDDI]
  - FDDI network entity title [NET]
  - TrBRF or TrCRF
  - Token Ring
  - Token Ring-Net
- VLAN state (active or suspended)
- Security Association Identifier (SAID)
- Bridge identification number for TrBRF VLANs
- Ring number for FDDI and TrCRF VLANs
- Parent VLAN number for TrCRF VLANs

- Spanning Tree Protocol (STP) type for TrCRF VLANs
- VLAN number to use when translating from one VLAN type to another

You can cause inconsistency in the VLAN database if you attempt to manually delete the `vlan.dat` file. If you want to modify the VLAN configuration, follow the procedures in this section.

## Creating or Modifying an Ethernet VLAN

### Before you begin

With VTP version 1 and 2, if the device is in VTP transparent mode, you can assign VLAN IDs greater than 1006, but they are not added to the VLAN database.

The device supports only Ethernet interfaces. Because FDDI and Token Ring VLANs are not locally supported, you only configure FDDI and Token Ring media-specific characteristics for VTP global advertisements to other devices.

Although the device does not support Token Ring connections, a remote device with Token Ring connections could be managed from one of the supported devices. Devices running VTP Version 2 advertise information about these Token Ring VLANs:

- Token Ring TrBRF VLANs
- Token Ring TrCRF VLANs

### Procedure

	Command or Action	Purpose
<b>Step 1</b>	<b>configure terminal</b> <b>Example:</b> Device# <b>configure terminal</b>	Enters global configuration mode.
<b>Step 2</b>	<b>vlan <i>vlan-id</i></b> <b>Example:</b> Device(config)# <b>vlan 20</b>	Enters a VLAN ID, and enters VLAN configuration mode. Enter a new VLAN ID to create a VLAN, or enter an existing VLAN ID to modify that VLAN.  <b>Note</b> The available VLAN ID range for this command is 1 to 4094.
<b>Step 3</b>	<b>name <i>vlan-name</i></b> <b>Example:</b> Device(config-vlan)# <b>name test20</b>	(Optional) Enters a name for the VLAN. If no name is entered for the VLAN, the default is to append the <i>vlan-id</i> value with leading zeros to the word VLAN. For example, VLAN0004 is a default VLAN name for VLAN 4.
<b>Step 4</b>	<b>media { ethernet   fd-net   fddi   tokenring   trn-net }</b> <b>Example:</b>	Configures the VLAN media type. Command options include:

	Command or Action	Purpose
	Device(config-vlan)# <b>media ethernet</b>	<ul style="list-style-type: none"> <li>• <b>ethernet</b>—Sets the VLAN media type as Ethernet.</li> <li>• <b>fd-net</b>—Sets the VLAN media type as FDDI net.</li> <li>• <b>fdi</b>—Sets the VLAN media type as FDDI.</li> <li>• <b>tokenring</b>—Sets the VLAN media type as Token Ring.</li> <li>• <b>trn-net</b>—Sets the VLAN media type as Token Ring net.</li> </ul>
<b>Step 5</b>	<b>end</b> <b>Example:</b> Device(config)# <b>end</b>	Returns to privileged EXEC mode.
<b>Step 6</b>	<b>end</b> <b>Example:</b> Device(config)# <b>end</b>	Returns to privileged EXEC mode.
<b>Step 7</b>	<b>show vlan {name <i>vlan-name</i>   id <i>vlan-id</i>}</b> <b>Example:</b> Device# <b>show vlan name test20</b> or Device# <b>show vlan id 20</b>	Verifies your entries.

## Deleting a VLAN

When you delete a VLAN from a device that is in VTP server mode, the VLAN is removed from the VLAN database for all devices in the VTP domain. When you delete a VLAN from a device that is in VTP transparent mode, the VLAN is deleted only on that specific device .

You cannot delete the default VLANs for the different media types: Ethernet VLAN 1 and FDDI or Token Ring VLANs 1002 to 1005.



**Caution** When you delete a VLAN, any ports assigned to that VLAN become inactive. They remain associated with the VLAN (and thus inactive) until you assign them to a new VLAN.

**Procedure**

	<b>Command or Action</b>	<b>Purpose</b>
<b>Step 1</b>	<b>enable</b> <b>Example:</b> Device> <b>enable</b>	Enables privileged EXEC mode. Enter your password if prompted.
<b>Step 2</b>	<b>configure terminal</b> <b>Example:</b> Device# <b>configure terminal</b>	Enters global configuration mode.
<b>Step 3</b>	<b>no vlan <i>vlan-id</i></b> <b>Example:</b> Device(config)# <b>no vlan 4</b>	Removes the VLAN by entering the VLAN ID.
<b>Step 4</b>	<b>end</b> <b>Example:</b> Device(config)# <b>end</b>	Returns to privileged EXEC mode.
<b>Step 5</b>	<b>show vlan brief</b> <b>Example:</b> Device# <b>show vlan brief</b>	Verifies the VLAN removal.
<b>Step 6</b>	<b>copy running-config startup-config</b> <b>Example:</b> Device# <b>copy running-config startup-config</b>	(Optional) Saves your entries in the configuration file.

**Assigning Static-Access Ports to a VLAN**

You can assign a static-access port to a VLAN without having VTP globally propagate VLAN configuration information by disabling VTP (VTP transparent mode).

If you assign an interface to a VLAN that does not exist, the new VLAN is created.

## Procedure

	Command or Action	Purpose
<b>Step 1</b>	<b>enable</b> <b>Example:</b> Device> <b>enable</b>	Enables privileged EXEC mode. Enter your password if prompted.
<b>Step 2</b>	<b>configure terminal</b> <b>Example:</b> Device# <b>configure terminal</b>	Enters global configuration mode
<b>Step 3</b>	<b>interface <i>interface-id</i></b> <b>Example:</b> Device(config)# <b>interface</b> <b>gigabitethernet2/0/1</b>	Enters the interface to be added to the VLAN.
<b>Step 4</b>	<b>switchport mode access</b> <b>Example:</b> Device(config-if)# <b>switchport mode access</b>	Defines the VLAN membership mode for the port (Layer 2 access port).
<b>Step 5</b>	<b>switchport access vlan <i>vlan-id</i></b> <b>Example:</b> Device(config-if)# <b>switchport access vlan</b> <b>2</b>	Assigns the port to a VLAN. Valid VLAN IDs are 1 to 4094.
<b>Step 6</b>	<b>end</b> <b>Example:</b> Device(config-if)# <b>end</b>	Returns to privileged EXEC mode.
<b>Step 7</b>	<b>show running-config interface <i>interface-id</i></b> <b>Example:</b> Device# <b>show running-config interface</b> <b>gigabitethernet2/0/1</b>	Verifies the VLAN membership mode of the interface.

	Command or Action	Purpose
<b>Step 8</b>	<b>show interfaces <i>interface-id</i> switchport</b> <b>Example:</b> <pre>Device# show interfaces gigabitethernet2/0/1 switchport</pre>	Verifies your entries in the <i>Administrative Mode</i> and the <i>Access Mode VLAN</i> fields of the display.
<b>Step 9</b>	<b>copy running-config startup-config</b> <b>Example:</b> <pre>Device# copy running-config startup-config</pre>	(Optional) Saves your entries in the configuration file.

## How to Configure Extended-Range VLANs

Extended-range VLANs enable service providers to extend their infrastructure to a greater number of customers. The extended-range VLAN IDs are allowed for any **switchport** commands that allow VLAN IDs.

With VTP version 1 or 2, extended-range VLAN configurations are not stored in the VLAN database, but because VTP mode is transparent, they are stored in the device running configuration file, and you can save the configuration in the startup configuration file. Extended-range VLANs created in VTP version 3 are stored in the VLAN database.

### Creating an Extended-Range VLAN

#### Procedure

	Command or Action	Purpose
<b>Step 1</b>	<b>enable</b> <b>Example:</b> <pre>Device&gt; enable</pre>	Enables privileged EXEC mode. Enter your password if prompted.
<b>Step 2</b>	<b>configure terminal</b> <b>Example:</b> <pre>Device# configure terminal</pre>	Enters global configuration mode.
<b>Step 3</b>	<b>vlan <i>vlan-id</i></b> <b>Example:</b> <pre>Device(config)# vlan 2000 Device(config-vlan)#</pre>	Enters an extended-range VLAN ID and enters VLAN configuration mode. The range is 1006 to 4094.

	Command or Action	Purpose
<b>Step 4</b>	<b>remote-span</b> <b>Example:</b> Device(config-vlan)# <b>remote-span</b>	(Optional) Configures the VLAN as the RSPAN VLAN.
<b>Step 5</b>	<b>exit</b> <b>Example:</b> Device(config-vlan)# <b>exit</b> Device(config)#	Returns to configuration mode.
<b>Step 6</b>	<b>end</b> <b>Example:</b> Device(config)# <b>end</b>	Returns to privileged EXEC mode.
<b>Step 7</b>	<b>show vlan id <i>vlan-id</i></b> <b>Example:</b> Device# <b>show vlan id 2000</b>	Verifies that the VLAN has been created.
<b>Step 8</b>	<b>copy running-config startup-config</b> <b>Example:</b> Device# <b>copy running-config startup-config</b>	(Optional) Saves your entries in the configuration file.

## Monitoring VLANs

Table 4: Privileged EXEC show Commands

Command	Purpose
<b>show interfaces [vlan <i>vlan-id</i>]</b>	Displays characteristics for all interfaces or for the specified VLAN configured on the device .



Command	Purpose
<b>show vlan</b> [ <b>access-map</b> <i>name</i>   <b>brief</b>   <b>dot1q</b> { <b>tag native</b> }   <b>filter</b> [ <b>access-map</b>   <b>vlan</b> ]   <b>group</b> [ <b>group-name</b> <i>name</i> ]   <b>id</b> <i>vlan-id</i>   <b>ifindex</b>   <b>mtu</b>   <b>name</b> <i>name</i>   <b>private-vlan</b> <b>remote-span</b>   <b>summary</b> ]	Displays parameters for all VLANs or the specified VLAN on the device. The following command options are available: <ul style="list-style-type: none"> <li>• <b>access-map</b>—Displays the VLAN access-maps.</li> <li>• <b>brief</b>—Displays VTP VLAN status in brief.</li> <li>• <b>dot1q</b>—Displays the dot1q parameters.</li> <li>• <b>filter</b>—Displays VLAN filter information.</li> <li>• <b>group</b>—Displays the VLAN group with its name and the connected VLANs that are available.</li> <li>• <b>id</b>—Displays VTP VLAN status by identification number.</li> <li>• <b>ifindex</b>—Displays SNMP ifIndex.</li> <li>• <b>mtu</b>—Displays VLAN MTU information.</li> <li>• <b>name</b>—Displays the VTP VLAN information by specified name.</li> <li>• <b>private-vlan</b>—Displays private VLAN information.</li> <li>• <b>remote-span</b>—Displays the remote SPAN VLANs.</li> <li>• <b>summary</b>—Displays a summary of VLAN information.</li> </ul>

## Where to Go Next

After configuring VLANs, you can configure the following:

- VLAN Trunking Protocol (VTP)
- VLAN trunks
- Private VLANs
- Voice VLANs

## Feature History for VLAN

This table provides release and related information for features explained in this module.

These features are available on all releases subsequent to the one they were introduced in, unless noted otherwise.

Release	Feature	Feature Information
Cisco IOS XE Fuji 16.9.1	VLAN	A VLAN is a switched network that is logically segmented by function, project team, or application, without regard to the physical locations of the users. VLANs have the same attributes as physical LANs, but you can group end stations even if they are not physically located on the same LAN segment.
Cisco IOS XE Cupertino 17.9.1	VLAN	This feature was implemented on C9200CX-12P-2X2G, C9200CX-8P-2X2G, and C9200CX-12T-2X2G models of the Cisco Catalyst 9200CX Series Switches, which were introduced in this release.

Use Cisco Feature Navigator to find information about platform and software image support. To access Cisco Feature Navigator, go to <https://cfnng.cisco.com/>.



## CHAPTER 3

# Configuring Voice VLANs

---

- [Prerequisites for Voice VLANs, on page 35](#)
- [Restrictions for Voice VLANs, on page 35](#)
- [Information About Voice VLAN, on page 36](#)
- [How to Configure Voice VLANs, on page 38](#)
- [Monitoring Voice VLAN, on page 41](#)
- [Where to Go Next, on page 41](#)
- [Feature History for Voice VLAN, on page 41](#)

## Prerequisites for Voice VLANs

The following are the prerequisites for voice VLANs:

- Voice VLAN configuration is only supported on device access ports; voice VLAN configuration is not supported on trunk ports.



---

**Note** Trunk ports can carry any number of voice VLANs, similar to regular VLANs. The configuration of voice VLANs is not supported on trunk ports.

---

- Before you enable voice VLAN, enable QoS on the device by entering the **trust device cisco-phone** interface configuration command. If you use the auto QoS feature, these settings are automatically configured.
- You must enable CDP on the device port connected to the Cisco IP Phone to send the configuration to the phone. (CDP is globally enabled by default on all device interfaces.)

## Restrictions for Voice VLANs

You cannot configure static secure MAC addresses in the voice VLAN.

# Information About Voice VLAN

The following sections provide information about Voice VLAN:

## Voice VLANs

The voice VLAN feature enables access ports to carry IP voice traffic from an IP phone. When the device is connected to a Cisco 7960 IP Phone, the phone sends voice traffic with Layer 3 IP precedence and Layer 2 class of service (CoS) values, which are both set to 5 by default. Because the sound quality of an IP phone call can deteriorate if the data is unevenly sent, the device supports quality of service (QoS) based on IEEE 802.1p CoS. QoS uses classification and scheduling to send network traffic from the device in a predictable manner.

The Cisco 7960 IP Phone is a configurable device, and you can configure it to forward traffic with an IEEE 802.1p priority. You can configure the device to trust or override the traffic priority assigned by a Cisco IP Phone.

## Cisco IP Phone Voice Traffic

You can configure an access port with an attached Cisco IP Phone to use one VLAN for voice traffic and another VLAN for data traffic from a device attached to the phone. You can configure access ports on the device to send Cisco Discovery Protocol (CDP) packets that instruct an attached phone to send voice traffic to the device in any of these ways:

- In the voice VLAN tagged with a Layer 2 CoS priority value
- In the access VLAN tagged with a Layer 2 CoS priority value
- In the access VLAN, untagged (no Layer 2 CoS priority value)



---

**Note** In all configurations, the voice traffic carries a Layer 3 IP precedence value (the default is 5 for voice traffic and 3 for voice control traffic).

---

## Cisco IP Phone Data Traffic

The device can also process tagged data traffic (traffic in IEEE 802.1Q or IEEE 802.1p frame types) from the device attached to the access port on the Cisco IP Phone. You can configure Layer 2 access ports on the device to send CDP packets that instruct the attached phone to configure the phone access port in one of these modes:

- In trusted mode, all traffic received through the access port on the Cisco IP Phone passes through the phone unchanged.
- In untrusted mode, all traffic in IEEE 802.1Q or IEEE 802.1p frames received through the access port on the Cisco IP Phone receive a configured Layer 2 CoS value. The default Layer 2 CoS value is 0. Untrusted mode is the default.



---

**Note** Untagged traffic from the device attached to the Cisco IP Phone passes through the phone unchanged, regardless of the trust state of the access port on the phone.

---

## Voice VLAN Configuration Guidelines

- Because a Cisco 7960 IP Phone also supports a connection to a PC or other device, a port connecting the device to a Cisco IP Phone can carry mixed traffic. You can configure a port to decide how the Cisco IP Phone carries voice traffic and data traffic.
- The voice VLAN should be present and active on the device for the IP phone to correctly communicate on the voice VLAN. Use the **show vlan** privileged EXEC command to see if the VLAN is present (listed in the display). If the VLAN is not listed, create the voice VLAN.
- The Power over Ethernet (PoE) devices are capable of automatically providing power to Cisco pre-standard and IEEE 802.3af-compliant powered devices if they are not being powered by an AC power source.
- The Port Fast feature is automatically enabled when voice VLAN is configured. When you disable voice VLAN, the Port Fast feature is not automatically disabled.
- If the Cisco IP Phone and a device attached to the phone are in the same VLAN, they must be in the same IP subnet. These conditions indicate that they are in the same VLAN:
  - They both use IEEE 802.1p or untagged frames.
  - The Cisco IP Phone uses IEEE 802.1p frames, and the device uses untagged frames.
  - The Cisco IP Phone uses untagged frames, and the device uses IEEE 802.1p frames.
  - The Cisco IP Phone uses IEEE 802.1Q frames, and the voice VLAN is the same as the access VLAN.
- The Cisco IP Phone and a device attached to the phone cannot communicate if they are in the same VLAN and subnet but use different frame types because traffic in the same subnet is not routed (routing would eliminate the frame type difference).
- Voice VLAN ports can also be these port types:
  - Dynamic access port.
  - IEEE 802.1x authenticated port.



---

**Note** If you enable IEEE 802.1x on an access port on which a voice VLAN is configured and to which a Cisco IP Phone is connected, the phone loses connectivity to the device for up to 30 seconds.

---

- Protected port.
- A source or destination port for a SPAN or RSPAN session.
- Secure port.



**Note** When you enable port security on an interface that is also configured with a voice VLAN, you must set the maximum allowed secure addresses on the port to two plus the maximum number of secure addresses allowed on the access VLAN. When the port is connected to a Cisco IP Phone, the phone requires up to two MAC addresses. The phone address is learned on the voice VLAN and might also be learned on the access VLAN. Connecting a PC to the phone requires additional MAC addresses.

## How to Configure Voice VLANs

The following sections provide information about configuring Voice VLANs:

### Configuring Cisco IP Phone Voice Traffic

You can configure a port connected to the Cisco IP Phone to send CDP packets to the phone to configure the way in which the phone sends voice traffic. The phone can carry voice traffic in IEEE 802.1Q frames for a specified voice VLAN with a Layer 2 CoS value. It can use IEEE 802.1p priority tagging to give voice traffic a higher priority and forward all voice traffic through the native (access) VLAN. The Cisco IP Phone can also send untagged voice traffic or use its own configuration to send voice traffic in the access VLAN. In all configurations, the voice traffic carries a Layer 3 IP precedence value (the default is 5).

#### Procedure

	Command or Action	Purpose
<b>Step 1</b>	<b>configure terminal</b> <b>Example:</b> Device# <b>configure terminal</b>	Enters global configuration mode.
<b>Step 2</b>	<b>interface <i>interface-id</i></b> <b>Example:</b> Device(config)# <b>interface</b> <b>gigabitethernet1/0/1</b>	Specifies the interface connected to the phone, and enters interface configuration mode.
<b>Step 3</b>	<b>trust device cisco-phone</b> <b>Example:</b> Device(config-if)# <b>trust device</b> <b>cisco-phone</b>	Configures the interface to trust incoming traffic packets for the Cisco IP phone.
<b>Step 4</b>	<b>switchport voice vlan {<i>vlan-id</i>   dot1p   none</b> <b>  untagged}</b>	Configures the voice VLAN.

	Command or Action	Purpose
	<p><b>Example:</b></p> <pre>Device(config-if)# switchport voice vlan dot1p</pre>	<ul style="list-style-type: none"> <li>• <b>vlan-id</b>—Configures the phone to forward all voice traffic through the specified VLAN. By default, the Cisco IP Phone forwards the voice traffic with an IEEE 802.1Q priority of 5. Valid VLAN IDs are 1 to 4094.</li> <li>• <b>dot1p</b>—Configures the device to accept voice and data IEEE 802.1p priority frames tagged with VLAN ID 0 (the native VLAN). By default, the device drops all voice and data traffic tagged with VLAN 0. If configured for 802.1p the Cisco IP Phone forwards the traffic with an IEEE 802.1p priority of 5.</li> <li>• <b>none</b>—Allows the phone to use its own configuration to send untagged voice traffic.</li> <li>• <b>untagged</b>—Configures the phone to send untagged voice traffic.</li> </ul>
<b>Step 5</b>	<p><b>end</b></p> <p><b>Example:</b></p> <pre>Device(config-if)# end</pre>	Returns to privileged EXEC mode.
<b>Step 6</b>	<p>Use one of the following:</p> <ul style="list-style-type: none"> <li>• <b>show interfaces interface-id switchport</b></li> <li>• <b>show running-config interface interface-id</b></li> </ul> <p><b>Example:</b></p> <pre>Device# show interfaces gigabitethernet1/0/1 switchport</pre> <p>or</p> <pre>Device# show running-config interface gigabitethernet1/0/1</pre>	Verifies your voice VLAN entries or your QoS and voice VLAN entries.
<b>Step 7</b>	<p><b>copy running-config startup-config</b></p> <p><b>Example:</b></p> <pre>Device# copy running-config startup-config</pre>	(Optional) Saves your entries in the configuration file.

## Configuring the Priority of Incoming Data Frames

You can connect a PC or other data device to a Cisco IP Phone port. To process tagged data traffic (in IEEE 802.1Q or IEEE 802.1p frames), you can configure the device to send CDP packets to instruct the phone how to send data packets from the device attached to the access port on the Cisco IP Phone. The PC can generate packets with an assigned CoS value. You can configure the phone to not change (trust) or to override (not trust) the priority of frames arriving on the phone port from connected devices.

Follow these steps to set the priority of data traffic received from the non-voice port on the Cisco IP Phone:

### Procedure

	Command or Action	Purpose
<b>Step 1</b>	<b>enable</b> <b>Example:</b> Device> <b>enable</b>	Enables privileged EXEC mode. Enter your password if prompted.
<b>Step 2</b>	<b>configure terminal</b> <b>Example:</b> Device# <b>configure terminal</b>	Enters global configuration mode.
<b>Step 3</b>	<b>interface <i>interface-id</i></b> <b>Example:</b> Device(config)# <b>interface</b> <b>gigabitethernet1/0/1</b>	Specifies the interface connected to the Cisco IP Phone, and enters interface configuration mode.
<b>Step 4</b>	<b>switchport priority extend {<i>cos value</i>   trust}</b> <b>Example:</b> Device(config-if)# <b>switchport priority</b> <b>extend trust</b>	Sets the priority of data traffic received from the Cisco IP Phone access port: <ul style="list-style-type: none"> <li>• <b>cos value</b>—Configures the phone to override the priority received from the PC or the attached device with the specified CoS value. The value is a number from 0 to 7, with 7 as the highest priority. The default priority is <b>cos 0</b>.</li> <li>• <b>trust</b>—Configures the phone access port to trust the priority received from the PC or the attached device.</li> </ul>
<b>Step 5</b>	<b>end</b> <b>Example:</b> Device(config-if)# <b>end</b>	Returns to privileged EXEC mode.



	Command or Action	Purpose
<b>Step 6</b>	<b>show interfaces <i>interface-id</i> switchport</b> <b>Example:</b> <pre>Device# show interfaces gigabitethernet1/0/1 switchport</pre>	Verifies your entries.
<b>Step 7</b>	<b>copy running-config startup-config</b> <b>Example:</b> <pre>Device# copy running-config startup-config</pre>	(Optional) Saves your entries in the configuration file.

## Monitoring Voice VLAN

To display voice VLAN configuration for an interface, use the **show interfaces *interface-id* switchport** privileged EXEC command.

## Where to Go Next

After configuring voice VLANs, you can configure the following:

- VLANs
- VLAN Trunking
- VTP

## Feature History for Voice VLAN

This table provides release and related information for features explained in this module.

These features are available on all releases subsequent to the one they were introduced in, unless noted otherwise.

Release	Feature	Feature Information
Cisco IOS XE Fuji 16.9.1	Voice VLAN	The voice VLAN feature enables access ports to carry IP voice traffic from an IP phone. You can configure a port connected to the Cisco IP Phone to send CDP packets to the phone to configure the way in which the phone sends voice traffic. The phone can carry voice traffic in IEEE 802.1Q frames for a specified voice VLAN with a Layer 2 CoS value.

Release	Feature	Feature Information
Cisco IOS XE Cupertino 17.9.1	Voice VLAN	This feature was implemented on C9200CX-12P-2X2G, C9200CX-8P-2X2G, and C9200CX-12T-2X2G models of the Cisco Catalyst 9200CX Series Switches, which were introduced in this release.

Use Cisco Feature Navigator to find information about platform and software image support. To access Cisco Feature Navigator, go to <https://cfng.cisco.com/>.



## CHAPTER 4

# Configuring VLAN Trunks

---

- [Information About VLAN Trunks, on page 43](#)
- [Prerequisites for VLAN Trunks, on page 46](#)
- [Restrictions for VLAN Trunks, on page 46](#)
- [How to Configure VLAN Trunks, on page 47](#)
- [Feature History for VLAN Trunks, on page 58](#)

## Information About VLAN Trunks

The following sections provide information about VLAN Trunks:

### Trunking Overview

A trunk is a point-to-point link between one or more Ethernet interfaces and another networking device such as a router or a controller. Ethernet trunks carry the traffic of multiple VLANs over a single link, and you can extend the VLANs across an entire network.

IEEE 802.1Q— Industry-standard trunking encapsulation is available on all Ethernet interfaces.

### Trunking Modes

Ethernet trunk interfaces support different trunking modes. You can set an interface as trunking or nontrunking or to negotiate trunking with the neighboring interface. To autonegotiate trunking, the interfaces must be in the same VTP domain.

Trunk negotiation is managed by the Dynamic Trunking Protocol (DTP), which is a Point-to-Point Protocol (PPP). However, some internetworking devices might forward DTP frames improperly, which could cause misconfigurations.

## Layer 2 Interface Modes

Table 5: Layer 2 Interface Modes

Mode	Function
<b>switchport mode access</b>	Puts the interface (access port) into permanent nontrunking mode and negotiates to convert the link into a nontrunk link. The interface becomes a nontrunk interface regardless of whether or not the neighboring interface is a trunk interface.
<b>switchport mode dynamic auto</b>	Makes the interface able to convert the link to a trunk link. The interface becomes a trunk interface if the neighboring interface is set to <b>trunk</b> or <b>desirable</b> mode. The default switchport mode for all Ethernet interfaces is <b>dynamic auto</b> .
<b>switchport mode dynamic desirable</b>	Makes the interface actively attempt to convert the link to a trunk link. The interface becomes a trunk interface if the neighboring interface is set to <b>trunk</b> , <b>desirable</b> , or <b>auto</b> mode.
<b>switchport mode trunk</b>	Puts the interface into permanent trunking mode and negotiates to convert the neighboring link into a trunk link. The interface becomes a trunk interface even if the neighboring interface is not a trunk interface.
<b>switchport nonegotiate</b>	Prevents the interface from generating DTP frames. You can use this command only when the interface switchport mode is <b>access</b> or <b>trunk</b> . You must manually configure the neighboring interface as a trunk interface to establish a trunk link.
<b>switchport mode private-vlan</b>	Configures the private VLAN mode.

## Allowed VLANs on a Trunk

By default, a trunk port sends traffic to and receives traffic from all VLANs. All VLAN IDs, 1 to 4094, are allowed on each trunk. However, you can remove VLANs from the allowed list, preventing traffic from those VLANs from passing over the trunk.

To reduce the risk of spanning-tree loops or storms, you can disable VLAN 1 on any individual VLAN trunk port by removing VLAN 1 from the allowed list. When you remove VLAN 1 from a trunk port, the interface continues to send and receive management traffic, for example, Cisco Discovery Protocol (CDP), Port Aggregation Protocol (PAgP), Link Aggregation Control Protocol (LACP), DTP, and VTP in VLAN 1.

If a trunk port with VLAN 1 disabled is converted to a nontrunk port, it is added to the access VLAN. If the access VLAN is set to 1, the port will be added to VLAN 1, regardless of the **switchport trunk allowed** setting. The same is true for any VLAN that has been disabled on the port.

A trunk port can become a member of a VLAN if the VLAN is enabled, if VTP knows of the VLAN, and if the VLAN is in the allowed list for the port. When VTP detects a newly enabled VLAN and the VLAN is in the allowed list for a trunk port, the trunk port automatically becomes a member of the enabled VLAN. When VTP detects a new VLAN and the VLAN is not in the allowed list for a trunk port, the trunk port does not become a member of the new VLAN.

## Load Sharing on Trunk Ports

Load sharing divides the bandwidth supplied by parallel trunks connecting devices. To avoid loops, STP normally blocks all but one parallel link between the devices. Using load sharing, you divide the traffic between the links according to which VLAN the traffic belongs.

You configure load sharing on trunk ports by using STP port priorities or STP path costs. For load sharing using STP port priorities, both load-sharing links must be connected to the same device. For load sharing using STP path costs, each load-sharing link can be connected to the same device or to two different devices.

### Network Load Sharing Using STP Priorities

When two ports on the same device form a loop, the device uses the STP port priority to decide which port is enabled and which port is in a blocking state. You can set the priorities on a parallel trunk port so that the port carries all the traffic for a given VLAN. The trunk port with the higher priority (lower values) for a VLAN is forwarding traffic for that VLAN. The trunk port with the lower priority (higher values) for the same VLAN remains in a blocking state for that VLAN. One trunk port sends or receives all traffic for the VLAN.

### Network Load Sharing Using STP Path Cost

You can configure parallel trunks to share VLAN traffic by setting different path costs on a trunk and associating the path costs with different sets of VLANs, blocking different ports for different VLANs. The VLANs keep the traffic separate and maintain redundancy in the event of a lost link.

## Feature Interactions

Trunking interacts with other features in these ways:

- A trunk port cannot be a secure port.
- Trunk ports can be grouped into EtherChannel port groups, but all trunks in the group must have the same configuration. When a group is first created, all ports follow the parameters set for the first port to be added to the group. If you change the configuration of one of these parameters, the device propagates the setting that you entered to all ports in the group:
  - Allowed-VLAN list.
  - STP port priority for each VLAN.
  - STP Port Fast setting.
  - Trunk status:

If one port in a port group ceases to be a trunk, all ports cease to be trunks.

- If you try to enable IEEE 802.1x on a trunk port, an error message appears, and IEEE 802.1x is not enabled. If you try to change the mode of an IEEE 802.1x-enabled port to trunk, the port mode is not changed.
- A port in dynamic mode can negotiate with its neighbor to become a trunk port. If you try to enable IEEE 802.1x on a dynamic port, an error message appears, and IEEE 802.1x is not enabled. If you try to change the mode of an IEEE 802.1x-enabled port to dynamic, the port mode is not changed.

## Prerequisites for VLAN Trunks

The IEEE 802.1Q trunks impose these limitations on the trunking strategy for a network:

- In a network of Cisco devices connected through IEEE 802.1Q trunks, the devices maintain one spanning-tree instance for each VLAN allowed on the trunks. Non-Cisco devices might support one spanning-tree instance for all VLANs.

When you connect a Cisco device to a non-Cisco device through an IEEE 802.1Q trunk, the Cisco device combines the spanning-tree instance of the VLAN of the trunk with the spanning-tree instance of the non-Cisco IEEE 802.1Q device. However, spanning-tree information for each VLAN is maintained by Cisco devices separated by a cloud of non-Cisco IEEE 802.1Q devices. The non-Cisco IEEE 802.1Q cloud separating the Cisco device is treated as a single trunk link between the devices.

- Make sure the native VLAN for an IEEE 802.1Q trunk is the same on both ends of the trunk link. If the native VLAN on one end of the trunk is different from the native VLAN on the other end, spanning-tree loops might result.
- Disabling spanning tree on the native VLAN of an IEEE 802.1Q trunk without disabling spanning tree on every VLAN in the network can potentially cause spanning-tree loops. We recommend that you leave spanning tree enabled on the native VLAN of an IEEE 802.1Q trunk or disable spanning tree on every VLAN in the network. Make sure your network is loop-free before disabling spanning tree.

## Restrictions for VLAN Trunks

The following are restrictions for VLAN trunks:

- A trunk port cannot be a secure port.
- Trunk ports can be grouped into EtherChannel port groups, but all trunks in the group must have the same configuration. When a group is first created, all ports follow the parameters set for the first port to be added to the group. If you change the configuration of one of these parameters, the device propagates the setting that you entered to all ports in the group:
  - Allowed-VLAN list.
  - STP port priority for each VLAN.
  - STP Port Fast setting.
  - Trunk status:
    - If one port in a port group ceases to be a trunk, all ports cease to be trunks.
- If you try to enable IEEE 802.1x on a trunk port, an error message appears, and IEEE 802.1x is not enabled. If you try to change the mode of an IEEE 802.1x-enabled port to trunk, the port mode is not changed.
- A port in dynamic mode can negotiate with its neighbor to become a trunk port. If you try to enable IEEE 802.1x on a dynamic port, an error message appears, and IEEE 802.1x is not enabled. If you try to change the mode of an IEEE 802.1x-enabled port to dynamic, the port mode is not changed.
- Dynamic Trunking Protocol (DTP) is not supported on tunnel ports.

- The device does not support Layer 3 trunks; you cannot configure subinterfaces or use the **encapsulation** keyword on Layer 3 interfaces. The device does support Layer 2 trunks and Layer 3 VLAN interfaces, which provide equivalent capabilities.
- When native VLAN and management VLAN is configured with the same VLAN ID and a new VLAN is added as trunk port, both the new VLAN and native VLAN shifts between active and suspend state for a duration of 15 seconds. This duration is the time taken for STP to resolve all inconsistencies.

## How to Configure VLAN Trunks

To avoid trunking misconfigurations, configure interfaces connected to devices that do not support DTP to not forward DTP frames, that is, to turn off DTP.

- If you do not intend to trunk across those links, use the **switchport mode access** interface configuration command to disable trunking.
- To enable trunking to a device that does not support DTP, use the **switchport mode trunk** and **switchport nonegotiate** interface configuration commands to cause the interface to become a trunk but to not generate DTP frames.

## Configuring an Ethernet Interface as a Trunk Port

This section provides information about configuring an Ethernet Interface as a trunk port:

### Configuring a Trunk Port

Because trunk ports send and receive VTP advertisements, to use VTP you must ensure that at least one trunk port is configured on the device and that this trunk port is connected to the trunk port of a second device. Otherwise, the device cannot receive any VTP advertisements.

#### Before you begin

By default, an interface is in Layer 2 mode. The default mode for Layer 2 interfaces is **switchport mode dynamic auto**. If the neighboring interface supports trunking and is configured to allow trunking, the link is a Layer 2 trunk or, if the interface is in Layer 3 mode, it becomes a Layer 2 trunk when you enter the **switchport** interface configuration command.

#### Procedure

	Command or Action	Purpose
Step 1	<b>enable</b> <b>Example:</b> Device> <b>enable</b>	Enables privileged EXEC mode. Enter your password if prompted.
Step 2	<b>configure terminal</b> <b>Example:</b>	Enters global configuration mode.

	Command or Action	Purpose
	Device# <code>configure terminal</code>	
<b>Step 3</b>	<b>interface</b> <i>interface-id</i> <b>Example:</b> Device(config)# <code>interface gigabitethernet 1/0/2</code>	Specifies the port to be configured for trunking, and enters interface configuration mode.
<b>Step 4</b>	<b>switchport mode</b> {dynamic {auto   desirable}   trunk} <b>Example:</b> Device(config-if)# <code>switchport mode dynamic desirable</code>	Configures the interface as a Layer 2 trunk (required only if the interface is a Layer 2 access port or tunnel port or to specify the trunking mode). <ul style="list-style-type: none"> <li>• <b>dynamic auto</b>—Sets the interface to a trunk link if the neighboring interface is set to trunk or desirable mode. This is the default.</li> <li>• <b>dynamic desirable</b>—Sets the interface to a trunk link if the neighboring interface is set to trunk, desirable, or auto mode.</li> <li>• <b>trunk</b>—Sets the interface in permanent trunking mode and negotiate to convert the link to a trunk link even if the neighboring interface is not a trunk interface.</li> </ul>
<b>Step 5</b>	<b>switchport access vlan</b> <i>vlan-id</i> <b>Example:</b> Device(config-if)# <code>switchport access vlan 200</code>	(Optional) Specifies the default VLAN, which is used if the interface stops trunking.
<b>Step 6</b>	<b>switchport trunk native vlan</b> <i>vlan-id</i> <b>Example:</b> Device(config-if)# <code>switchport trunk native vlan 200</code>	Specifies the native VLAN for IEEE 802.1Q trunks.
<b>Step 7</b>	<b>end</b> <b>Example:</b> Device(config)# <code>end</code>	Returns to privileged EXEC mode.



	Command or Action	Purpose
<b>Step 8</b>	<b>show interfaces <i>interface-id</i> switchport</b> <b>Example:</b> <pre>Device# show interfaces gigabitethernet 1/0/2 switchport</pre>	Displays the switch port configuration of the interface in the <i>Administrative Mode</i> and the <i>Administrative Trunking Encapsulation</i> fields of the display.
<b>Step 9</b>	<b>show interfaces <i>interface-id</i> trunk</b> <b>Example:</b> <pre>Device# show interfaces gigabitethernet 1/0/2 trunk</pre>	Displays the trunk configuration of the interface.
<b>Step 10</b>	<b>copy running-config startup-config</b> <b>Example:</b> <pre>Device# copy running-config startup-config</pre>	(Optional) Saves your entries in the configuration file.

## Defining the Allowed VLANs on a Trunk

VLAN 1 is the default VLAN on all trunk ports in all Cisco devices, and it has previously been a requirement that VLAN 1 always be enabled on every trunk link. You can use the VLAN 1 minimization feature to disable VLAN 1 on any individual VLAN trunk link so that no user traffic (including spanning-tree advertisements) is sent or received on VLAN 1.

### Procedure

	Command or Action	Purpose
<b>Step 1</b>	<b>enable</b> <b>Example:</b> <pre>Device&gt; enable</pre>	Enables privileged EXEC mode. Enter your password if prompted.
<b>Step 2</b>	<b>configure terminal</b> <b>Example:</b> <pre>Device# configure terminal</pre>	Enters global configuration mode.
<b>Step 3</b>	<b>interface <i>interface-id</i></b> <b>Example:</b> <pre>Device(config)# interface gigabitethernet</pre>	Specifies the port to be configured, and enters interface configuration mode.

	Command or Action	Purpose
	1/0/1	
<b>Step 4</b>	<b>switchport mode trunk</b> <b>Example:</b> <pre>Device(config-if)# switchport mode trunk</pre>	Configures the interface as a VLAN trunk port.
<b>Step 5</b>	<b>switchport trunk allowed vlan { word   add   all   except   none   remove } vlan-list</b> <b>Example:</b> <pre>Device(config-if)# switchport trunk allowed vlan remove 2</pre>	(Optional) Configures the list of VLANs allowed on the trunk.  The <i>vlan-list</i> parameter is either a single VLAN number from 1 to 4094 or a range of VLANs described by two VLAN numbers, the lower one first, separated by a hyphen. Do not enter any spaces between comma-separated VLAN parameters or in hyphen-specified ranges.  All VLANs are allowed by default.
<b>Step 6</b>	<b>end</b> <b>Example:</b> <pre>Device(config)# end</pre>	Returns to privileged EXEC mode.
<b>Step 7</b>	<b>show interfaces interface-id switchport</b> <b>Example:</b> <pre>Device# show interfaces gigabitethernet 1/0/1 switchport</pre>	Verifies your entries in the <i>Trunking VLANs Enabled</i> field of the display.
<b>Step 8</b>	<b>copy running-config startup-config</b> <b>Example:</b> <pre>Device# copy running-config startup-config</pre>	(Optional) Saves your entries in the configuration file.

## Changing the Pruning-Eligible List

The pruning-eligible list applies only to trunk ports. Each trunk port has its own eligibility list. VTP pruning must be enabled for this procedure to take effect.

### Procedure

	Command or Action	Purpose
<b>Step 1</b>	<b>enable</b>	Enables privileged EXEC mode.

	Command or Action	Purpose
	<b>Example:</b>  Device> <b>enable</b>	Enter your password if prompted.
<b>Step 2</b>	<b>configure terminal</b>  <b>Example:</b>  Device# <b>configure terminal</b>	Enters global configuration mode.
<b>Step 3</b>	<b>interface</b> <i>interface-id</i>  <b>Example:</b>  Device(config)# <b>interface</b> <b>gigabitethernet0/1</b>	Selects the trunk port for which VLANs should be pruned, and enters interface configuration mode.
<b>Step 4</b>	<b>switchport trunk pruning vlan</b> { <b>add</b>   <b>except</b>   <b>none</b>   <b>remove</b> } <i>vlan-list</i> [, <i>vlan</i> [, <i>vlan</i> [,...]]]	<p>Configures the list of VLANs allowed to be pruned from the trunk.</p> <p>For explanations about using the <b>add</b>, <b>except</b>, <b>none</b>, and <b>remove</b> keywords, see the command reference for this release.</p> <p>Separate non-consecutive VLAN IDs with a comma and no spaces; use a hyphen to designate a range of IDs. Valid IDs are 2 to 1001. Extended-range VLANs (VLAN IDs 1006 to 4094) cannot be pruned.</p> <p>VLANs that are pruning-ineligible receive flooded traffic.</p> <p>The default list of VLANs allowed to be pruned contains VLANs 2 to 1001.</p>
<b>Step 5</b>	<b>end</b>  <b>Example:</b>  Device(config)# <b>end</b>	Returns to privileged EXEC mode.
<b>Step 6</b>	<b>show interfaces</b> <i>interface-id</i> <b>switchport</b>  <b>Example:</b>  Device# <b>show interfaces</b> <b>gigabitethernet</b> <b>1/0/1</b> <b>switchport</b>	Verifies your entries in the <i>Pruning VLANs Enabled</i> field of the display.
<b>Step 7</b>	<b>copy running-config startup-config</b>  <b>Example:</b>	(Optional) Saves your entries in the configuration file.

	Command or Action	Purpose
	Device# <code>copy running-config startup-config</code>	

## Configuring the Native VLAN for Untagged Traffic

A trunk port configured with IEEE 802.1Q tagging can receive both tagged and untagged traffic. By default, the device forwards untagged traffic in the native VLAN configured for the port. The native VLAN is VLAN 1 by default.

The native VLAN can be assigned any VLAN ID.

If a packet has a VLAN ID that is the same as the outgoing port native VLAN ID, the packet is sent untagged; otherwise, the device sends the packet with a tag.

### Procedure

	Command or Action	Purpose
<b>Step 1</b>	<b>enable</b> <b>Example:</b> Device> <code>enable</code>	Enables privileged EXEC mode. Enter your password if prompted.
<b>Step 2</b>	<b>configure terminal</b> <b>Example:</b> Device# <code>configure terminal</code>	Enters global configuration mode.
<b>Step 3</b>	<b>interface <i>interface-id</i></b> <b>Example:</b> Device(config)# <code>interface gigabitethernet 1/0/2</code>	Defines the interface that is configured as the IEEE 802.1Q trunk, and enters interface configuration mode.
<b>Step 4</b>	<b>switchport trunk native vlan <i>vlan-id</i></b> <b>Example:</b> Device(config-if)# <code>switchport trunk native vlan 12</code>	Configures the VLAN that is sending and receiving untagged traffic on the trunk port. For <i>vlan-id</i> , the range is 1 to 4094.
<b>Step 5</b>	<b>end</b> <b>Example:</b> Device(config-if)# <code>end</code>	Returns to privileged EXEC mode.

	Command or Action	Purpose
<b>Step 6</b>	<b>show interfaces <i>interface-id</i> switchport</b> <b>Example:</b> <pre>Device# show interfaces gigabitethernet 1/0/2 switchport</pre>	Verifies your entries in the <i>Trunking Native Mode VLAN</i> field.
<b>Step 7</b>	<b>copy running-config startup-config</b> <b>Example:</b> <pre>Device# copy running-config startup-config</pre>	(Optional) Saves your entries in the configuration file.

## Configuring Trunk Ports for Load Sharing

The following sections provide information about configuring trunk ports for load sharing:

### Configuring Load Sharing Using STP Port Priorities

If your switch is a member of a switch stack, you must use the **spanning-tree [vlan *vlan-id*] cost *cost*** interface configuration command instead of the **spanning-tree [vlan *vlan-id*] port-priority *priority*** interface configuration command to select an interface to put in the forwarding state. Assign lower cost values to interfaces that you want selected first and higher cost values that you want selected last.

These steps describe how to configure a network with load sharing using STP port priorities.

#### Procedure

	Command or Action	Purpose
<b>Step 1</b>	<b>enable</b> <b>Example:</b> <pre>Device&gt; enable</pre>	Enables privileged EXEC mode. Enter your password if prompted.
<b>Step 2</b>	<b>configure terminal</b> <b>Example:</b> <pre>Device# configure terminal</pre>	Enters global configuration mode on Device A.
<b>Step 3</b>	<b>vtp domain <i>domain-name</i></b> <b>Example:</b> <pre>Device(config)# vtp domain workdomain</pre>	Configures a VTP administrative domain. The domain name can be 1 to 32 characters.

	Command or Action	Purpose
<b>Step 4</b>	<b>vtp mode server</b> <b>Example:</b>  Device(config)# <b>vtp mode server</b>	Configures Device A as the VTP server.
<b>Step 5</b>	<b>end</b> <b>Example:</b>  Device(config)# <b>end</b>	Returns to privileged EXEC mode.
<b>Step 6</b>	<b>show vtp status</b> <b>Example:</b>  Device# <b>show vtp status</b>	Verifies the VTP configuration on both Device A and Device B.  In the display, check the <i>VTP Operating Mode</i> and the <i>VTP Domain Name</i> fields.
<b>Step 7</b>	<b>show vlan</b> <b>Example:</b>  Device# <b>show vlan</b>	Verifies that the VLANs exist in the database on Device A.
<b>Step 8</b>	<b>configure terminal</b> <b>Example:</b>  Device# <b>configure terminal</b>	Enters global configuration mode.
<b>Step 9</b>	<b>interface interface-id</b> <b>Example:</b>  Device(config)# <b>interface</b> <b>gigabitethernet1/0/1</b>	Defines the interface to be configured as a trunk, and enters interface configuration mode.
<b>Step 10</b>	<b>switchport mode trunk</b> <b>Example:</b>  Device(config-if)# <b>switchport mode trunk</b>	Configures the port as a trunk port.
<b>Step 11</b>	<b>end</b> <b>Example:</b>  Device(config-if)# <b>end</b>	Returns to privileged EXEC mode.

	Command or Action	Purpose
<b>Step 12</b>	<p><b>show interfaces</b> <i>interface-id</i> <b>switchport</b></p> <p><b>Example:</b></p> <pre>Device# show interfaces gigabitethernet 1/0/1 switchport</pre>	Verifies the VLAN configuration.
<b>Step 13</b>	Repeat the above steps on Device A for a second port in the device.	
<b>Step 14</b>	Repeat the above steps on Device B to configure the trunk ports that connect to the trunk ports configured on Device A.	
<b>Step 15</b>	<p><b>show vlan</b></p> <p><b>Example:</b></p> <pre>Device# show vlan</pre>	When the trunk links come up, VTP passes the VTP and VLAN information to Device B. This command verifies that Device B has learned the VLAN configuration.
<b>Step 16</b>	<p><b>configure terminal</b></p> <p><b>Example:</b></p> <pre>Device# configure terminal</pre>	Enters global configuration mode on Device A.
<b>Step 17</b>	<p><b>interface</b> <i>interface-id</i></p> <p><b>Example:</b></p> <pre>Device(config)# interface gigabitethernet 1/0/1</pre>	Defines the interface to set the STP port priority, and enters interface configuration mode.
<b>Step 18</b>	<p><b>spanning-tree vlan</b> <i>vlan-range</i> <b>port-priority</b> <i>priority-value</i></p> <p><b>Example:</b></p> <pre>Device(config-if)# spanning-tree vlan 8-10 port-priority 16</pre>	Assigns the port priority for the VLAN range specified. Enter a port priority value from 0 to 240. Port priority values increment by 16.
<b>Step 19</b>	<p><b>exit</b></p> <p><b>Example:</b></p> <pre>Device(config-if)# exit</pre>	Returns to global configuration mode.
<b>Step 20</b>	<p><b>interface</b> <i>interface-id</i></p> <p><b>Example:</b></p> <pre>Device(config)# interface</pre>	Defines the interface to set the STP port priority, and enters interface configuration mode.

	Command or Action	Purpose
	<code>gigabitethernet 1/0/2</code>	
<b>Step 21</b>	<b>spanning-tree vlan <i>vlan-range</i> port-priority <i>priority-value</i></b> <b>Example:</b> <pre>Device(config-if)# spanning-tree vlan 3-6 port-priority 16</pre>	Assigns the port priority for the VLAN range specified. Enter a port priority value from 0 to 240. Port priority values increment by 16.
<b>Step 22</b>	<b>end</b> <b>Example:</b> <pre>Device(config-if)# end</pre>	Returns to privileged EXEC mode.
<b>Step 23</b>	<b>show running-config</b> <b>Example:</b> <pre>Device# show running-config</pre>	Verifies your entries.
<b>Step 24</b>	<b>copy running-config startup-config</b> <b>Example:</b> <pre>Device# copy running-config startup-config</pre>	(Optional) Saves your entries in the configuration file.

## Configuring Load Sharing Using STP Path Cost

These steps describe how to configure a network with load sharing using STP path costs.

### Procedure

	Command or Action	Purpose
<b>Step 1</b>	<b>enable</b> <b>Example:</b> <pre>Device&gt; enable</pre>	Enables privileged EXEC mode. Enter your password if prompted.
<b>Step 2</b>	<b>configure terminal</b> <b>Example:</b> <pre>Device# configure terminal</pre>	Enters global configuration mode on Device A.



	Command or Action	Purpose
<b>Step 3</b>	<b>interface</b> <i>interface-id</i> <b>Example:</b> <pre>Device(config)# interface gigabitethernet 1/0/1</pre>	Defines the interface to be configured as a trunk, and enters interface configuration mode.
<b>Step 4</b>	<b>switchport mode trunk</b> <b>Example:</b> <pre>Device(config-if)# switchport mode trunk</pre>	Configures the port as a trunk port.
<b>Step 5</b>	<b>exit</b> <b>Example:</b> <pre>Device(config-if)# exit</pre>	Returns to global configuration mode.
<b>Step 6</b>	Repeat Steps 2 through 4 on a second interface in Device A or in Device A stack.	
<b>Step 7</b>	<b>end</b> <b>Example:</b> <pre>Device(config)# end</pre>	Returns to privileged EXEC mode.
<b>Step 8</b>	<b>show running-config</b> <b>Example:</b> <pre>Device# show running-config</pre>	Verifies your entries. In the display, make sure that the interfaces are configured as trunk ports.
<b>Step 9</b>	<b>show vlan</b> <b>Example:</b> <pre>Device# show vlan</pre>	When the trunk links come up, Device A receives the VTP information from the other devices. This command verifies that Device A has learned the VLAN configuration.
<b>Step 10</b>	<b>configure terminal</b> <b>Example:</b> <pre>Device# configure terminal</pre>	Enters global configuration mode.
<b>Step 11</b>	<b>interface</b> <i>interface-id</i> <b>Example:</b>	Defines the interface on which to set the STP cost, and enters interface configuration mode.

	Command or Action	Purpose
	Device (config) # <b>interface</b> <b>gigabitethernet 1/0/1</b>	
<b>Step 12</b>	<b>spanning-tree vlan</b> <i>vlan-range</i> <b>cost</b> <i>cost-value</i> <b>Example:</b> Device (config-if) # <b>spanning-tree vlan</b> <b>2-4 cost 30</b>	Sets the spanning-tree path cost to 30 for VLANs 2 through 4.
<b>Step 13</b>	<b>end</b> <b>Example:</b> Device (config-if) # <b>end</b>	Returns to global configuration mode.
<b>Step 14</b>	Repeat Steps 9 through 13 on the other configured trunk interface on Device A, and set the spanning-tree path cost to 30 for VLANs 8, 9, and 10.	
<b>Step 15</b>	<b>exit</b> <b>Example:</b> Device (config) # <b>exit</b>	Returns to privileged EXEC mode.
<b>Step 16</b>	<b>show running-config</b> <b>Example:</b> Device# <b>show running-config</b>	Verifies your entries. In the display, verify that the path costs are set correctly for both trunk interfaces.
<b>Step 17</b>	<b>copy running-config startup-config</b> <b>Example:</b> Device# <b>copy running-config</b> <b>startup-config</b>	(Optional) Saves your entries in the configuration file.

## Feature History for VLAN Trunks

This table provides release and related information for features explained in this module.

These features are available on all releases subsequent to the one they were introduced in, unless noted otherwise.

Release	Feature	Feature Information
Cisco IOS XE Fuji 16.9.2	VLAN Trunks	A trunk is a point-to-point link between one or more Ethernet interfaces and another networking device such as a router or a controller. Ethernet trunks carry the traffic of multiple VLANs over a single link, and you can extend the VLANs across an entire network.
Cisco IOS XE Cupertino 17.9.1	VLAN Trunks	This feature was implemented on C9200CX-12P-2X2G, C9200CX-8P-2X2G, and C9200CX-12T-2X2G models of the Cisco Catalyst 9200CX Series Switches, which were introduced in this release.

Use Cisco Feature Navigator to find information about platform and software image support. To access Cisco Feature Navigator, go to <https://cfng.cisco.com/>.





## CHAPTER 5

# Configuring Private VLANs

---

- [Prerequisites for Private VLANs, on page 61](#)
- [Restrictions for Private VLANs, on page 61](#)
- [Information About Private VLANs, on page 62](#)
- [How to Configure Private VLANs, on page 71](#)
- [Monitoring Private VLANs, on page 79](#)
- [Configuration Examples for Private VLANs, on page 79](#)
- [Where to Go Next, on page 82](#)
- [Additional References, on page 82](#)
- [Feature History for Private VLANs, on page 83](#)

## Prerequisites for Private VLANs

When configuring private VLANs on the device, always use the default Switch Database Management (SDM) template to balance system resources between unicast routes and Layer 2 entries. If another SDM template is configured, use the **sdm prefer default** global configuration command to set the default template.



---

**Note** Private VLANs are supported in transparent mode for VTP 1, 2 and 3. Private VLANs are also supported on server mode with VTP 3.

---

## Restrictions for Private VLANs



---

**Note** In some cases, the configuration is accepted with no error messages, but the commands have no effect.

---

- Do not configure fallback bridging on the device with private VLANs.
- Do not configure a remote SPAN (RSPAN) VLAN as a primary or a secondary VLAN of a private-VLAN.
- Do not configure private VLAN ports on interfaces configured for these other features:
  - Dynamic-access port VLAN membership

- Dynamic Trunking Protocol (DTP)
  - IP Source Guard
  - IPv6 First Hop Security (FHS)
  - IPv6 Security Group (SG)
  - Multicast VLAN Registration (MVR)
  - Voice VLAN
  - Web Cache Communication Protocol (WCCP)
- Port Aggregation Protocol (PAgP) and Link Aggregation Control Protocol (LACP) are supported only for Private VLAN promiscuous trunk ports and Private VLAN isolated trunk ports.
  - You can configure IEEE 802.1x port-based authentication on a private-VLAN port, but do not configure 802.1x with port security, voice VLAN, or per-user ACL on private-VLAN ports.
  - A private-VLAN host or promiscuous port cannot be a SPAN destination port. If you configure a SPAN destination port as a private-VLAN port, the port becomes inactive.
  - If you configure a static MAC address on a promiscuous port in the primary VLAN, you need not add the same static address to all associated secondary VLANs. Similarly, if you configure a static MAC address on a host port in a secondary VLAN, you need not add the same static MAC address to the associated primary VLAN. Also, when you delete a static MAC address from a private-VLAN port, you do not have to remove all instances of the configured MAC address from the private VLAN.



---

**Note** Dynamic MAC addresses learned in the secondary VLAN of a private VLAN are replicated to the primary VLANs. All MAC entries are learnt on secondary VLANs, even if the traffic ingresses from primary VLAN. If a MAC address is dynamically learnt in the primary VLAN, it is not replicated in the associated secondary VLANs.

---

- Configure Layer 3 VLAN interfaces (switch value interfaces) only for primary VLANs.
- Private VLAN configured with MACsec or Virtual Private LAN Services (VPLS) or Cisco Software-Defined Access solution on the same VLAN does not work.

## Information About Private VLANs

The following sections provide information about Private VLANs:

### Private VLAN Domains

The private VLAN feature addresses two problems that service providers face when using VLANs:

- To enable IP routing, each VLAN is assigned a subnet address space or a block of addresses, which can result in wasting the unused IP addresses, and cause IP address management problems.

**Figure 4: Private VLAN Domain**

Using private VLANs addresses the scalability problem and provides IP address management benefits for service providers and Layer 2 security for customers. Private VLANs partition a regular VLAN domain into subdomains. A subdomain is represented by a pair of VLANs: a *primary* VLAN and a *secondary* VLAN. A private VLAN can have multiple VLAN pairs, one pair for each subdomain. All VLAN pairs in a private VLAN share the same primary VLAN. The secondary VLAN ID differentiates one subdomain from another.

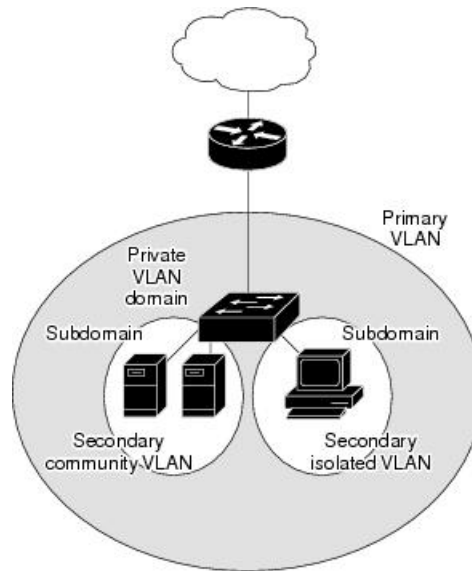

## Secondary VLANs

There are two types of secondary VLANs:

- Isolated VLANs—Ports within an isolated VLAN cannot communicate with each other at the Layer 2 level.
- Community VLANs—Ports within a community VLAN can communicate with each other but cannot communicate with ports in other communities at the Layer 2 level.

## Private VLANs Ports

Private VLANs provide Layer 2 isolation between ports within the same private VLAN. Private VLAN ports are access ports that are one of these types:

- Promiscuous—A promiscuous port belongs to the primary VLAN and can communicate with all interfaces, including the community and isolated host ports that belong to the secondary VLANs associated with the primary VLAN.
- Isolated—An isolated port is a host port that belongs to an isolated secondary VLAN. It has complete Layer 2 separation from other ports within the same private VLAN, except for the promiscuous ports. Private VLANs block all traffic to isolated ports except traffic from promiscuous ports. Traffic received from an isolated port is forwarded only to promiscuous ports.
- Community—A community port is a host port that belongs to a community secondary VLAN. Community ports communicate with other ports in the same community VLAN and with promiscuous ports. These

interfaces are isolated at Layer 2 from all other interfaces in other communities and from isolated ports within their private VLAN.



---

**Note** Trunk ports carry traffic from regular VLANs and also from primary, isolated, and community VLANs.

---

Primary and secondary VLANs have these characteristics:

- **Primary VLAN**—A private VLAN has only one primary VLAN. Every port in a private VLAN is a member of the primary VLAN. The primary VLAN carries unidirectional traffic downstream from the promiscuous ports to the (isolated and community) host ports and to other promiscuous ports.
- **Isolated VLAN**—A private VLAN has only one isolated VLAN. An isolated VLAN is a secondary VLAN that carries unidirectional traffic upstream from the hosts toward the promiscuous ports and the gateway.
- **Community VLAN**—A community VLAN is a secondary VLAN that carries upstream traffic from the community ports to the promiscuous port gateways and to other host ports in the same community. You can configure multiple community VLANs in a private VLAN.

A promiscuous port can serve only one primary VLAN, one isolated VLAN, and multiple community VLANs. Layer 3 gateways are typically connected to the device through a promiscuous port. With a promiscuous port, you can connect a wide range of devices as access points to a private VLAN. For example, you can use a promiscuous port to monitor or back up all the private VLAN servers from an administration workstation.

## Private VLANs in Networks

In a switched environment, you can assign an individual private VLAN and associated IP subnet to each individual or common group of end stations. The end stations need to communicate only with a default gateway to communicate outside the private VLAN.

You can use private VLANs to control access to end stations in these ways:

- Configure selected interfaces connected to end stations as isolated ports to prevent any communication at Layer 2. For example, if the end stations are servers, this configuration prevents Layer 2 communication between the servers.
- Configure interfaces connected to default gateways and selected end stations (for example, backup servers) as promiscuous ports to allow all end stations access to a default gateway.

You can extend private VLANs across multiple devices by trunking the primary, isolated, and community VLANs to other devices that support private VLANs. To maintain the security of your private VLAN configuration and to avoid other use of the VLANs configured as private VLANs, configure private VLANs on all intermediate devices, including devices that have no private VLAN ports.

## IP Addressing Scheme with Private VLANs

Assigning a separate VLAN to each customer creates an inefficient IP addressing scheme:

- Assigning a block of addresses to a customer VLAN can result in unused IP addresses.



- If the number of devices in the VLAN increases, the number of assigned address might not be large enough to accommodate them.

These problems are reduced by using private VLANs, where all members in the private VLAN share a common address space, which is allocated to the primary VLAN. Hosts are connected to secondary VLANs and the DHCP server assigns them IP addresses from the block of addresses allocated to the primary VLAN. Subsequent IP addresses can be assigned to customer devices in different secondary VLANs, but in the same primary VLAN. When new devices are added, the DHCP server assigns them the next available address from a large pool of subnet addresses.

## Private VLANs Across Multiple Devices

*Figure 5: Private VLANs Across Switches*

As with regular VLANs, private VLANs can span multiple switches. A trunk port carries the primary VLAN and secondary VLANs to a neighboring switch. The trunk port treats the private VLAN as any other VLAN. A feature of private VLANs across multiple switches is that traffic from an isolated port in the Switch A does not reach an isolated port on Switch B.

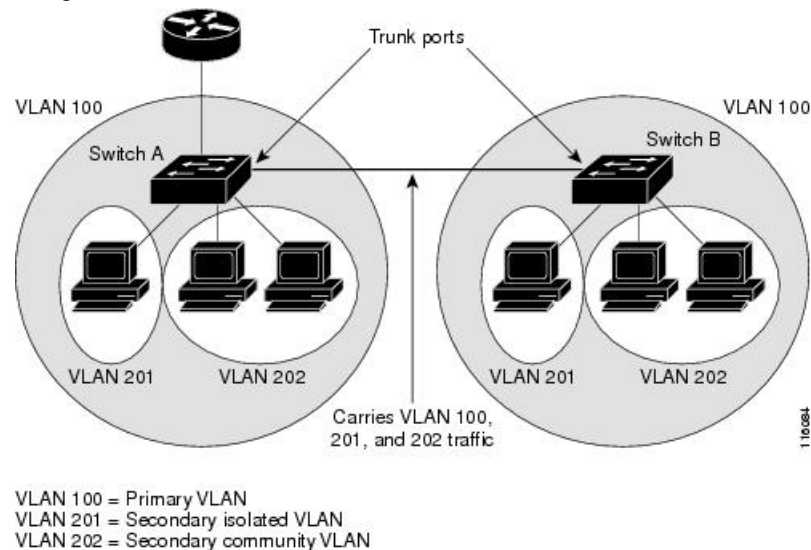

Private VLANs are supported in transparent mode for VTP 1, 2 and 3. Private VLAN is also supported on server mode for VTP 3. If you have a server client setup using VTP 3, private VLANs configured on the server should be reflected on the client.

## Private-VLAN Interaction with Other Features

The following sections provide information about Private-VLAN interaction with other features:

### Private VLANs and Unicast, Broadcast, and Multicast Traffic

In regular VLANs, devices in the same VLAN can communicate with each other at the Layer 2 level, but devices connected to interfaces in different VLANs must communicate at the Layer 3 level. In private VLANs, the promiscuous ports are members of the primary VLAN, while the host ports belong to secondary VLANs. Because the secondary VLAN is associated with the primary VLAN, members of these VLANs can communicate with each other at the Layer 2 level.

In a regular VLAN, broadcasts are forwarded to all ports in that VLAN. Private VLAN broadcast forwarding depends on the port sending the broadcast:

- An isolated port sends a broadcast only to the promiscuous ports or trunk ports.
- A community port sends a broadcast to all promiscuous ports, trunk ports, and ports in the same community VLAN.
- A promiscuous port sends a broadcast to all ports in the private VLAN (other promiscuous ports, trunk ports, isolated ports, and community ports).

Multicast traffic is routed or bridged across private VLAN boundaries and within a single community VLAN. Multicast traffic is not forwarded between ports in the same isolated VLAN or between ports in different secondary VLANs.

Private VLAN multicast forwarding supports the following:

- Sender can be outside the VLAN and the Receivers can be inside the VLAN domain.
- Sender can be inside the VLAN and the Receivers can be outside the VLAN domain.
- Sender and Receiver can both be in the same community VLAN.

## Private VLANs and SVIs

A switch virtual interface (SVI) represents the Layer 3 interface of a VLAN. Layer 3 devices communicate with a private VLAN only through the primary VLAN and not through secondary VLANs. Configure Layer 3 VLAN interfaces (SVIs) only for primary VLANs. You cannot configure Layer 3 VLAN interfaces for secondary VLANs. SVIs for secondary VLANs are inactive while the VLAN is configured as a secondary VLAN.

- If you try to configure a VLAN with an active SVI as a secondary VLAN, the configuration is not allowed until you disable the SVI.
- If you try to create an SVI on a VLAN that is configured as a secondary VLAN and the secondary VLAN is already mapped at Layer 3, the SVI is not created, and an error is returned. If the SVI is not mapped at Layer 3, the SVI is created, but it is automatically shut down.

When the primary VLAN is associated with and mapped to the secondary VLAN, any configuration on the primary VLAN is propagated to the secondary VLAN SVIs. For example, if you assign an IP subnet to the primary VLAN SVI, this subnet is the IP subnet address of the entire private VLAN.

## Private VLANs and Switch Stacks

Private VLANs can operate within the switch stack, and private-VLAN ports can reside on different member switches in the stack. However, the following changes to the stack can impact private-VLAN operation:

- If a stack contains only one private-VLAN promiscuous port and the member switch that contains that port is removed from the stack, host ports in that private VLAN lose connectivity outside the private VLAN.
- If an active switch that contains the only private-VLAN promiscuous port in the stack fails or leaves the stack and a new active switch is elected, host ports in a private VLAN that had its promiscuous port on the old active switch lose connectivity outside of the private VLAN.

- If two stacks merge, private VLANs on the winning stack are not affected, but private-VLAN configuration on the losing switch is lost when that switch reboots.

## Private VLAN with Dynamic MAC Address

The MAC addresses learnt in the secondary VLAN are replicated to the primary VLAN and not vice-versa. This saves the hardware l2 cam space. The primary VLAN is always used for forwarding lookups in both directions.

Dynamic MAC addresses learned in Primary VLAN of a private VLAN are then, if required, replicated in the secondary VLANs. For example, if a MAC-address is dynamically received on the secondary VLAN, it will be learnt as part of primary VLAN. In case of isolated VLANs, a blocked entry for the same mac will be added to secondary VLAN in the mac address table. So, MAC learnt on host ports in secondary domain are installed as blocked type entries. All mac entries are learnt on secondary VLANs, even if the traffic ingresses from primary VLAN.

However, if a MAC-address is dynamically learnt in the primary VLAN it will not get replicated in the associated secondary VLANs.

## Private VLAN with Static MAC Address

Users are not required to replicate the Static MAC Address CLI for private VLAN hosts as compare to legacy model.

Example:

- In the legacy model, if the user configures a static MAC address, they need to add the same static MAC address in the associated VLAN too. For example, if MAC address A is user configured on port 1/0/1 in VLAN 101, where VLAN 101 is a secondary VLAN and VLAN 100 is a primary VLAN, then the user has to configure

```
mac-address static A vlan 101 interface G1/0/1
mac-address static A vlan 100 interface G1/0/1
```

- In this device, the user does not need to replicate the mac address to the associated VLAN. For the above example, user has to configure only

```
mac-address static A vlan 101 interface G1/0/1
```

## Private VLAN Interaction with VACL/QOS

Private VLANs are bidirectional in case of this device, as compared to “Unidirectional” in other platforms.

After layer-2 forward lookup, proper egress VLAN mapping happens and all the egress VLAN based feature processing happens in the egress VLAN context.

When a frame in Layer-2 is forwarded within a private VLAN, the VLAN map is applied at the ingress side and at the egress side. When a frame is routed from inside a private VLAN to an external port, the private-VLAN map is applied at the ingress side. Similarly, when the frame is routed from an external port to a Private VLAN, the private-VLAN is applied at the egress side. This is applicable to both bridged and routed traffic.

### Bridging:

- For upstream traffic from secondary VLAN to primary VLAN, the MAP of the secondary VLAN is applied on the ingress side and the MAP of the primary VLAN is applied on the egress side.

- For downstream traffic from primary VLAN to secondary VLAN, the MAP of the primary VLAN is applied in the ingress direction and the MAP of the secondary VLAN is applied in the egress direction.

### Routing

If we have two private VLAN domains - PV1 (sec1, prim1) and PV2 (sec2, prim2). For frames routed from PV1 to PV2:

- The MAP of sec1 and L3 ACL of prim1 is applied in the ingress port.
- The MAP of sec2 and L3 ACL of prim2 is applied in the egress port.

For packets going upstream or downstream from isolated host port to promiscuous port, the isolated VLAN's VACL is applied in the ingress direction and primary VLAN's VACL is applied in the egress direction. This allows user to configure different VACL for different secondary VLAN in a same primary VLAN domain.



---

**Note** 2-way community VLAN is now not required as the private VLANs on this device are always bi-directional.

---

## Private VLANs and HA Support

PVLAN will work seamlessly with High Availability (HA) feature. The Private VLAN existing on the active switch before changeover should be the same after changeover (new active switch should have similar PVLAN configuration both on IOS side and FED side as that of the old active switch).

## Private-VLAN Configuration Guidelines

The following sections provide information about Private-VLAN configuration guidelines:

### Default Private-VLAN Configurations

No private VLANs are configured.

### Secondary and Primary VLAN Configuration

Follow these guidelines when configuring private VLANs:

- Private VLANs are supported in transparent mode for VTP 1, 2 and 3. If the device is running VTP version 1 or 2, you must set VTP to transparent mode. After you configure a private VLAN, you should not change the VTP mode to client or server. VTP version 3 supports private VLANs in all modes.
- With VTP version 1 or 2, after you have configured private VLANs, use the **copy running-config startup config** privileged EXEC command to save the VTP transparent mode configuration and private-VLAN configuration in the device startup configuration file. Otherwise, if the device resets, it defaults to VTP server mode, which does not support private VLANs. VTP version 3 does support private VLANs.
- VTP version 1 and 2 do not propagate private-VLAN configuration. You must configure private VLANs on each device where you want private-VLAN ports unless the devices are running VTP version 3, as VTP3 propagate private vlans.
- You cannot configure VLAN 1 or VLANs 1002 to 1005 as primary or secondary VLANs. Extended VLANs (VLAN IDs 1006 to 4094) can belong to private VLANs.

- A primary VLAN can have one isolated VLAN and multiple community VLANs associated with it. An isolated or community VLAN can have only one primary VLAN associated with it.
- Although a private VLAN contains more than one VLAN, only one Spanning Tree Protocol (STP) instance runs for the entire private VLAN. When a secondary VLAN is associated with the primary VLAN, the STP parameters of the primary VLAN are propagated to the secondary VLAN.
- When copying a PVLAN configuration from a tftp server and applying it on a running-config, the PVLAN association will not be formed. You will need to check and ensure that the primary VLAN is associated to all the secondary VLANs.

You can also use **configure replace flash:config\_file force** instead of **copy flash:config\_file running-config**.

- You can enable DHCP snooping on private VLANs. When you enable DHCP snooping on the primary VLAN, it is propagated to the secondary VLANs. If you configure DHCP on a secondary VLAN, the configuration does not take effect if the primary VLAN is already configured.
- When you enable IP source guard on private-VLAN ports, you must enable DHCP snooping on the primary VLAN.
- We recommend that you prune the private VLANs from the trunks on devices that carry no traffic in the private VLANs.
- You can apply different quality of service (QoS) configurations to primary, isolated, and community VLANs.
- Note the following considerations for sticky ARP:
  - Sticky ARP entries are those learned on SVIs and Layer 3 interfaces. These entries do not age out.
  - The **ip sticky-arp** global configuration command is supported only on SVIs belonging to private VLANs.
  - The **ip sticky-arp** interface configuration command is only supported on:
    - Layer 3 interfaces
    - SVIs belonging to normal VLANs
    - SVIs belonging to private VLANs

For more information about using the **ip sticky-arp global** configuration and the **ip sticky-arp interface** configuration commands, see the command reference for this release.

- You can configure VLAN maps on primary and secondary VLANs. However, we recommend that you configure the same VLAN maps on private-VLAN primary and secondary VLANs.
- PVLANs are bidirectional. They can be applied at both the ingress and egress sides.

When a frame in Layer-2 is forwarded within a private VLAN, the VLAN map is applied at the ingress side and at the egress side. When a frame is routed from inside a private VLAN to an external port, the private-VLAN map is applied at the ingress side. Similarly, when the frame is routed from an external port to a Private VLAN, the private-VLAN is applied at the egress side.

#### Bridging

- For upstream traffic from secondary VLAN to primary VLAN, the MAP of the secondary VLAN is applied on the ingress side and the MAP of the primary VLAN is applied on the egress side.

- For downstream traffic from primary VLAN to secondary VLAN, the MAP of the primary VLAN is applied in the ingress direction and the MAP of the secondary VLAN is applied in the egress direction.

### Routing

If we have two private VLAN domains - PV1 (sec1, prim1) and PV2 (sec2, prim2). For frames routed from PV1 to PV2:

- The MAP of sec1 and L3 ACL of prim1 is applied in the ingress port .
- The MAP of sec1 and L3 ACL of prim2 is applied in the egress port.
- For packets going upstream or downstream from isolated host port to promiscuous port, the isolated VLAN's VACL is applied in the ingress direction and primary VLAN'S VACL is applied in the egress direction. This allows user to configure different VACL for different secondary VLAN in a same primary VLAN domain.

To filter out specific IP traffic for a private VLAN, you should apply the VLAN map to both the primary and secondary VLANs.

- You can apply router ACLs only on the primary-VLAN SVIs. The ACL is applied to both primary and secondary VLAN Layer 3 traffic.
- Although private VLANs provide host isolation at Layer 2, hosts can communicate with each other at Layer 3.
- Private VLANs support these Switched Port Analyzer (SPAN) features:
  - You can configure a private-VLAN port as a SPAN source port.
  - You can use VLAN-based SPAN (VSPAN) on primary, isolated, and community VLANs or use SPAN on only one VLAN to separately monitor egress or ingress traffic.

## Private VLAN Port Configuration

Follow these guidelines when configuring private VLAN ports:

- Use only the private VLAN configuration commands to assign ports to primary, isolated, or community VLANs. Layer 2 access ports assigned to the VLANs that you configure as primary, isolated, or community VLANs are inactive while the VLAN is part of the private VLAN configuration. Layer 2 trunk interfaces remain in the STP forwarding state.
- Do not configure ports that belong to a PAgP or LACP EtherChannel as private VLAN ports. While a port is part of the private VLAN configuration, any EtherChannel configuration for it is inactive.
- Enable Port Fast and BPDU guard on isolated and community host ports to prevent STP loops due to misconfigurations and to speed up STP convergence. When enabled, STP applies the BPDU guard feature to all Port Fast-configured Layer 2 LAN ports. Do not enable Port Fast and BPDU guard on promiscuous ports.
- If you delete a VLAN used in the private VLAN configuration, the private VLAN ports associated with the VLAN become inactive.
- Private VLAN ports can be on different network devices if the devices are trunk-connected and the primary and secondary VLANs have not been removed from the trunk.

# How to Configure Private VLANs

The following sections provide information about configuring Private VLANs:

## Configuring Private VLANs

To configure a private VLAN, perform these steps:



---

**Note** Private vlans are supported in transparent mode for VTP 1, 2 and 3. Private VLANs are also supported on server mode with VTP 3.

---

### Procedure

- 
- Step 1** Set VTP mode to **transparent**
- Note** Note: For VTP3, you can set mode to either server or transparent mode.
- Step 2** Create the primary and secondary VLANs and associate them.  
See [Configuring and Associating VLANs in a Private VLAN](#)
- Note** If the VLAN is not created already, the private-VLAN configuration process creates it.
- Step 3** Configure interfaces to be isolated or community host ports, and assign VLAN membership to the host port.  
See [Configuring a Layer 2 Interface as a Private VLAN Host Port](#)
- Step 4** Configure interfaces as promiscuous ports, and map the promiscuous ports to the primary-secondary VLAN pair.  
See [Configuring a Layer 2 Interface as a Private VLAN Promiscuous Port](#)
- Step 5** If inter-VLAN routing will be used, configure the primary SVI, and map secondary VLANs to the primary.  
See [Mapping Secondary VLANs to a Primary VLAN Layer 3 VLAN Interface](#)
- Step 6** Verify private-VLAN configuration.
- 

## Configuring and Associating VLANs in a Private VLAN

The **private-vlan** commands do not take effect until you exit VLAN configuration mode.

To configure and associate VLANs in a Private VLAN, perform these steps:

### Procedure

	Command or Action	Purpose
<b>Step 1</b>	<b>enable</b> <b>Example:</b>	Enables privileged EXEC mode. Enter your password if prompted.

	Command or Action	Purpose
	Device> <b>enable</b>	
<b>Step 2</b>	<b>configure terminal</b> <b>Example:</b> Device# <b>configure terminal</b>	Enters global configuration mode.
<b>Step 3</b>	<b>vtp mode transparent</b> <b>Example:</b> Device(config)# <b>vtp mode transparent</b>	Sets VTP mode to transparent (disable VTP). <b>Note</b> For VTP3, you can set mode to either server or transparent mode
<b>Step 4</b>	<b>vlan <i>vlan-id</i></b> <b>Example:</b> Device(config)# <b>vlan 20</b>	Enters VLAN configuration mode and designates or creates a VLAN that will be the primary VLAN. The VLAN ID range is 2 to 1001 and 1006 to 4094.
<b>Step 5</b>	<b>private-vlan primary</b> <b>Example:</b> Device(config-vlan)# <b>private-vlan primary</b>	Designates the VLAN as the primary VLAN.
<b>Step 6</b>	<b>exit</b> <b>Example:</b> Device(config-vlan)# <b>exit</b>	Returns to global configuration mode.
<b>Step 7</b>	<b>vlan <i>vlan-id</i></b> <b>Example:</b> Device(config)# <b>vlan 501</b>	(Optional) Enters VLAN configuration mode and designates or creates a VLAN that will be an isolated VLAN. The VLAN ID range is 2 to 1001 and 1006 to 4094.
<b>Step 8</b>	<b>private-vlan isolated</b> <b>Example:</b> Device(config-vlan)# <b>private-vlan isolated</b>	Designates the VLAN as an isolated VLAN.
<b>Step 9</b>	<b>exit</b> <b>Example:</b>	Returns to global configuration mode.



	Command or Action	Purpose
	Device (config-vlan) # <b>exit</b>	
<b>Step 10</b>	<b>vlan <i>vlan-id</i></b> <b>Example:</b> Device (config) # <b>vlan 502</b>	(Optional) Enters VLAN configuration mode and designates or creates a VLAN that will be a community VLAN. The VLAN ID range is 2 to 1001 and 1006 to 4094.
<b>Step 11</b>	<b>private-vlan community</b> <b>Example:</b> Device (config-vlan) # <b>private-vlan community</b>	Designates the VLAN as a community VLAN.
<b>Step 12</b>	<b>exit</b> <b>Example:</b> Device (config-vlan) # <b>exit</b>	Returns to global configuration mode.
<b>Step 13</b>	<b>vlan <i>vlan-id</i></b> <b>Example:</b> Device (config) # <b>vlan 503</b>	(Optional) Enters VLAN configuration mode and designates or creates a VLAN that will be a community VLAN. The VLAN ID range is 2 to 1001 and 1006 to 4094.
<b>Step 14</b>	<b>private-vlan community</b> <b>Example:</b> Device (config-vlan) # <b>private-vlan community</b>	Designates the VLAN as a community VLAN.
<b>Step 15</b>	<b>exit</b> <b>Example:</b> Device (config-vlan) # <b>exit</b>	Returns to global configuration mode.
<b>Step 16</b>	<b>vlan <i>vlan-id</i></b> <b>Example:</b> Device (config) # <b>vlan 20</b>	Enters VLAN configuration mode for the primary VLAN designated in Step 4.
<b>Step 17</b>	<b>private-vlan association [add   remove] <i>secondary_vlan_list</i></b>	Associates the secondary VLANs with the primary VLAN. It can be a single

	Command or Action	Purpose
	<p><b>Example:</b></p> <pre>Device (config-vlan) # private-vlan association 501-503</pre>	<p>private-VLAN ID or a hyphenated range of private-VLAN IDs.</p> <ul style="list-style-type: none"> <li>• The <i>secondary_vlan_list</i> parameter cannot contain spaces. It can contain multiple comma-separated items. Each item can be a single private-VLAN ID or a hyphenated range of private-VLAN IDs.</li> <li>• The <i>secondary_vlan_list</i> parameter can contain multiple community VLAN IDs but only one isolated VLAN ID.</li> <li>• Enter a <i>secondary_vlan_list</i>, or use the <b>add</b> keyword with a <i>secondary_vlan_list</i> to associate secondary VLANs with a primary VLAN.</li> <li>• Use the <b>remove</b> keyword with a <i>secondary_vlan_list</i> to clear the association between secondary VLANs and a primary VLAN.</li> <li>• The command does not take effect until you exit VLAN configuration mode.</li> </ul>
<b>Step 18</b>	<p><b>end</b></p> <p><b>Example:</b></p> <pre>Device (config) # end</pre>	Returns to privileged EXEC mode.
<b>Step 19</b>	<p><b>show vlan private-vlan [type] or show interfaces status</b></p> <p><b>Example:</b></p> <pre>Device# show vlan private-vlan</pre>	Verifies the configuration.
<b>Step 20</b>	<p><b>copy running-config startup config</b></p> <p><b>Example:</b></p> <pre>Device# copy running-config startup-config</pre>	Saves your entries in the device startup configuration file.

## Configuring a Layer 2 Interface as a Private VLAN Host Port

Follow these steps to configure a Layer 2 interface as a private-VLAN host port and to associate it with primary and secondary VLANs:



**Note** Isolated and community VLANs are both secondary VLANs.

### Procedure

	Command or Action	Purpose
<b>Step 1</b>	<b>enable</b> <b>Example:</b> Device> <b>enable</b>	Enables privileged EXEC mode. Enter your password if prompted.
<b>Step 2</b>	<b>configure terminal</b> <b>Example:</b> Device# <b>configure terminal</b>	Enters global configuration mode.
<b>Step 3</b>	<b>interface <i>interface-id</i></b> <b>Example:</b> Device(config)# <b>interface</b> <b>gigabitethernet1/0/22</b>	Enters interface configuration mode for the Layer 2 interface to be configured.
<b>Step 4</b>	<b>switchport mode private-vlan host</b> <b>Example:</b> Device(config-if)# <b>switchport mode</b> <b>private-vlan host</b>	Configures the Layer 2 port as a private-VLAN host port.
<b>Step 5</b>	<b>switchport private-vlan host-association</b> <i>primary_vlan_id secondary_vlan_id</i> <b>Example:</b> Device(config-if)# <b>switchport</b> <b>private-vlan host-association 20 501</b>	Associates the Layer 2 port with a private VLAN.  <b>Note</b> This is a required step to associate the PVLAN to a Layer 2 interface.
<b>Step 6</b>	<b>end</b> <b>Example:</b> Device(config)# <b>end</b>	Returns to privileged EXEC mode.
<b>Step 7</b>	<b>show interfaces [<i>interface-id</i>] switchport</b> <b>Example:</b>	Verifies the configuration.

	Command or Action	Purpose
	Device# <code>show interfaces gigabitethernet1/0/22 switchport</code>	
<b>Step 8</b>	<b>copy running-config startup-config</b>  <b>Example:</b>  Device# <code>copy running-config startup-config</code>	(Optional) Saves your entries in the configuration file.

## Configuring a Layer 2 Interface as a Private VLAN Promiscuous Port

Follow these steps to configure a Layer 2 interface as a private VLAN promiscuous port and map it to primary and secondary VLANs:



**Note** Isolated and community VLANs are both secondary VLANs.

### Procedure

	Command or Action	Purpose
<b>Step 1</b>	<b>enable</b>  <b>Example:</b>  Device> <code>enable</code>	Enables privileged EXEC mode.  Enter your password if prompted.
<b>Step 2</b>	<b>configure terminal</b>  <b>Example:</b>  Device# <code>configure terminal</code>	Enters global configuration mode.
<b>Step 3</b>	<b>interface <i>interface-id</i></b>  <b>Example:</b>  Device(config)# <code>interface gigabitethernet1/0/2</code>	Enters interface configuration mode for the Layer 2 interface to be configured.
<b>Step 4</b>	<b>switchport mode private-vlan promiscuous</b>  <b>Example:</b>  Device(config-if)# <code>switchport mode</code>	Configures the Layer 2 port as a private VLAN promiscuous port.

	Command or Action	Purpose
	<code>private-vlan promiscuous</code>	
<b>Step 5</b>	<p><b>switchport private-vlan mapping</b>  <code>primary_vlan_id {add   remove}</code>  <code>secondary_vlan_list</code></p> <p><b>Example:</b></p> <pre>Device(config-if)# switchport private-vlan mapping 20 add 501-503</pre>	<p>Maps the private VLAN promiscuous port to a primary VLAN and to selected secondary VLANs.</p> <ul style="list-style-type: none"> <li>• The <code>secondary_vlan_list</code> parameter cannot contain spaces. It can contain multiple comma-separated items. Each item can be a single private VLAN ID or a hyphenated range of private VLAN IDs.</li> <li>• Enter a <code>secondary_vlan_list</code>, or use the <b>add</b> keyword with a <code>secondary_vlan_list</code> to map the secondary VLANs to the private VLAN promiscuous port.</li> <li>• Use the <b>remove</b> keyword with a <code>secondary_vlan_list</code> to clear the mapping between secondary VLANs and the private VLAN promiscuous port.</li> </ul>
<b>Step 6</b>	<p><b>end</b></p> <p><b>Example:</b></p> <pre>Device(config)# end</pre>	Returns to privileged EXEC mode.
<b>Step 7</b>	<p><b>show interfaces [interface-id] switchport</b></p> <p><b>Example:</b></p> <pre>Device# show interfaces gigabitethernet1/0/2 switchport</pre>	Verifies the configuration.
<b>Step 8</b>	<p><b>copy running-config startup config</b></p> <p><b>Example:</b></p> <pre>Device# copy running-config startup-config</pre>	Saves your entries in the device startup configuration file.

## Mapping Secondary VLANs to a Primary VLAN Layer 3 VLAN Interface

If the private VLAN will be used for inter-VLAN routing, you configure an SVI for the primary VLAN and map secondary VLANs to the SVI.



**Note** Isolated and community VLANs are both secondary VLANs.

Follow these steps to map secondary VLANs to the SVI of a primary VLAN to allow Layer 3 switching of private VLAN traffic:

### Procedure

	Command or Action	Purpose
<b>Step 1</b>	<b>enable</b> <b>Example:</b> Device> <b>enable</b>	Enables privileged EXEC mode. Enter your password if prompted.
<b>Step 2</b>	<b>configure terminal</b> <b>Example:</b> Device# <b>configure terminal</b>	Enters global configuration mode.
<b>Step 3</b>	<b>interface vlan</b> <i>primary_vlan_id</i> <b>Example:</b> Device(config)# <b>interface vlan 20</b>	Enters interface configuration mode for the primary VLAN, and configures the VLAN as an SVI. The VLAN ID range is 2 to 1001 and 1006 to 4094.
<b>Step 4</b>	<b>private-vlan mapping</b> [add   remove] <i>secondary_vlan_list</i> <b>Example:</b> Device(config-if)# <b>private-vlan mapping 501-503</b>	Maps the secondary VLANs to the Layer 3 VLAN interface of a primary VLAN to allow Layer 3 switching of private VLAN ingress traffic. <b>Note</b> The <b>private-vlan mapping</b> interface configuration command only affects private VLAN traffic that is Layer 3 switched. <ul style="list-style-type: none"> <li>• The <i>secondary_vlan_list</i> parameter cannot contain spaces. It can contain multiple comma-separated items. Each item can be a single private-VLAN ID or a hyphenated range of private-VLAN IDs.</li> <li>• Enter a <i>secondary_vlan_list</i>, or use the <b>add</b> keyword with a <i>secondary_vlan_list</i> to map the secondary VLANs to a primary VLAN.</li> <li>• Use the <b>remove</b> keyword with a <i>secondary_vlan_list</i> to clear the mapping</li> </ul>

	Command or Action	Purpose
		between secondary VLANs and a primary VLAN.
<b>Step 5</b>	<b>end</b> <b>Example:</b> Device(config)# <b>end</b>	Returns to privileged EXEC mode.
<b>Step 6</b>	<b>show interfaces private-vlan mapping</b> <b>Example:</b> Device# <b>show interfaces private-vlan mapping</b>	Verifies the configuration.
<b>Step 7</b>	<b>copy running-config startup config</b> <b>Example:</b> Device# <b>copy running-config startup-config</b>	Saves your entries in the device startup configuration file.

## Monitoring Private VLANs

The following table displays the commands used to monitor private VLANs.

*Table 6: Private VLAN Monitoring Commands*

Command	Purpose
<b>show interfaces status</b>	Displays the status of interfaces, including
<b>show vlan private-vlan [type]</b>	
<b>show interface switchport</b>	Displays private VLAN configuration on
<b>show interface private-vlan mapping</b>	Displays information about the private

## Configuration Examples for Private VLANs

The following sections provide configuration examples for Private VLANs:

## Example: Configuring and Associating VLANs in a Private VLAN

This example shows how to configure VLAN 20 as a primary VLAN, VLAN 501 as an isolated VLAN, and VLANs 502 and 503 as community VLANs, to associate them in a private VLAN, and to verify the configuration:

```
Device# configure terminal
Device(config)# vlan 20
Device(config-vlan)# private-vlan primary
Device(config-vlan)# exit
Device(config)# vlan 501
Device(config-vlan)# private-vlan isolated
Device(config-vlan)# exit
Device(config)# vlan 502
Device(config-vlan)# private-vlan community
Device(config-vlan)# exit
Device(config)# vlan 503
Device(config-vlan)# private-vlan community
Device(config-vlan)# exit
Device(config)# vlan 20
Device(config-vlan)# private-vlan association 501-503
Device(config-vlan)# end
Device# show vlan private-vlan
Primary   Secondary   Type
-----
20        501         isolated
20        502         community
20        503         community
```

## Example: Configuring an Interface as a Host Port

This example shows how to configure an interface as a private VLAN host port, associate it with a private VLAN pair, and verify the configuration:

```
Device# configure terminal
Device(config)# interface gigabitethernet1/0/22
Device(config-if)# switchport mode private-vlan host
Device(config-if)# switchport private-vlan host-association 20 501
Device(config-if)# end
Device# show interfaces gigabitethernet1/0/22 switchport
Name: Gi1/0/22
Switchport: Enabled
Administrative Mode: private-vlan host
Operational Mode: private-vlan host
Administrative Trunking Encapsulation: negotiate
Operational Trunking Encapsulation: native
Negotiation of Trunking: Off
Access Mode VLAN: 1 (default)
Trunking Native Mode VLAN: 1 (default)
Administrative Native VLAN tagging: enabled
Voice VLAN: none
Administrative private-vlan host-association: 20 501
Administrative private-vlan mapping: none
Administrative private-vlan trunk native VLAN: none
Administrative private-vlan trunk Native VLAN tagging: enabled
Administrative private-vlan trunk encapsulation: dot1q
Administrative private-vlan trunk normal VLANs: none
```



```
Administrative private-vlan trunk private VLANs: none
Operational private-vlan:
20 501

<output truncated>
```

## Example: Configuring an Interface as a Private VLAN Promiscuous Port

This example shows how to configure an interface as a private VLAN promiscuous port and map it to a private VLAN. The interface is a member of primary VLAN 20 and secondary VLANs 501 to 503 are mapped to it.

```
Device# configure terminal
Device(config)# interface gigabitethernet1/0/2
Device(config-if)# switchport mode private-vlan promiscuous
Device(config-if)# switchport private-vlan mapping 20 add 501-503
Device(config-if)# end
```

Use the **show vlan private-vlan** or the **show interface status** privileged EXEC command to display primary and secondary VLANs and private-VLAN ports on the device.

## Example: Mapping Secondary VLANs to a Primary VLAN Interface

This example shows how to map the interfaces for VLANs 501 and 502 to primary VLAN 10, which permits routing of secondary VLAN ingress traffic from private VLANs 501 and 502:

```
Device# configure terminal
Device(config)# interface vlan 20
Device(config-if)# private-vlan mapping 501-503
Device(config-if)# end
Device# show interfaces private-vlan mapping
Interface Secondary VLAN Type
-----
vlan20      501          isolated
vlan20      502          community
vlan20      503          community
```

## Example: Monitoring Private VLANs

This example shows output from the **show vlan private-vlan** command:

```
Device# show vlan private-vlan
Primary Secondary Type Ports
-----
20      501      isolated  Gi1/0/22, Gi1/0/2
20      502      community Gi1/0/2
20      503      community Gi1/0/2
```

## Where to Go Next

You can configure the following:

- VTP
- VLANs
- VLAN trunking
- VLAN Membership Policy Server (VMPS)
- Voice VLANs

## Additional References

### Related Documents

Related Topic	Document Title
For complete syntax and usage information for the commands used in this chapter.	<i>Command Reference (Catalyst 9200 Series Switches)</i>

### Standards and RFCs

Standard/RFC	Title
RFC 1573	Evolution of the Interfaces Group of MIB-II
RFC 1757	Remote Network Monitoring Management Information Base
RFC 2021	Remote Network Monitoring Management Information Base Version 2 using SMIV2

**MIBs**

MIB	MIBs Link
<p>All the supported MIBs for this release.</p> <ul style="list-style-type: none"> <li>• BRIDGE-MIB (RFC1493)</li> <li>• CISCO-BRIDGE-EXT-MIB</li> <li>• CISCO-CDP-MIB</li> <li>• CISCO-PAGP-MIB</li> <li>• CISCO-PRIVATE-VLAN-MIB</li> <li>• CISCO-LAG-MIB</li> <li>• CISCO-L2L3-INTERFACE-CONFIG-MIB</li> <li>• CISCO-MAC-NOTIFICATION-MIB</li> <li>• CISCO-STP-EXTENSIONS-MIB</li> <li>• CISCO-VLAN-IFTABLE-RELATIONSHIP-MIB</li> <li>• CISCO-VLAN-MEMBERSHIP-MIB</li> <li>• CISCO-VTP-MIB</li> <li>• IEEE8023-LAG-MIB</li> <li>• IF-MIB (RFC 1573)</li> <li>• RMON-MIB (RFC 1757)</li> <li>• RMON2-MIB (RFC 2021)</li> </ul>	<p>To locate and download MIBs for selected platforms, Cisco IOS releases, and feature sets, use Cisco MIB Locator found at the following URL:</p> <p><a href="http://www.cisco.com/go/mibs">http://www.cisco.com/go/mibs</a></p>

## Feature History for Private VLANs

This table provides release and related information for features explained in this module.

These features are available on all releases subsequent to the one they were introduced in, unless noted otherwise.

Release	Feature	Feature Information
Cisco IOS XE Fuji 16.9.2	Private VLANs	<p>The private VLAN feature addresses the problem that service providers face when using VLANs:</p> <ul style="list-style-type: none"> <li>• When running the Network Essentials or Network Advantage license, the device supports up to 4094 active VLANs. If a service provider assigns one VLAN per customer, this limits the numbers of customers the service provider can support.</li> <li>• To enable IP routing, each VLAN is assigned a subnet address space or a block of addresses, which can result in wasting the unused IP addresses, and cause IP address management problems.</li> </ul>
Cisco IOS XE Cupertino 17.9.1	Private VLANs	<p>This feature was implemented on C9200CX-12P-2X2G, C9200CX-8P-2X2G, and C9200CX-12T-2X2G models of the Cisco Catalyst 9200CX Series Switches, which were introduced in this release.</p>

Use Cisco Feature Navigator to find information about platform and software image support. To access Cisco Feature Navigator, go to <https://cfng.cisco.com/>.



## CHAPTER 6

# Configuring Wired Dynamic PVLAN

---

The following sections provide information about configuring wired dynamic PVLAN:

- [Restrictions for Wired Dynamic PVLAN, on page 85](#)
- [Information About Wired Dynamic PVLAN, on page 85](#)
- [Configuring Wired Dynamic PVLAN, on page 87](#)
- [Feature History for Wired Dynamic PVLAN, on page 92](#)

## Restrictions for Wired Dynamic PVLAN

- High availability is not supported with Wired Dynamic PVLAN.
- Voice VLAN configuration cannot co-exist with this feature.
- Local Web Authentication (LWA) and Central Web Authentication (CWA) cannot be used with this feature.
- All wired clients using the dynamic PVLAN interface template will be programmed as data clients.
- Only interfaces with existing Access or PVLAN Host switchport mode support PVLAN template.
- Identity Based Networking Services 2.0 (IBNS 2.0) must be used for dynamic template support.

## Information About Wired Dynamic PVLAN

Wired Dynamic PVLAN is a feature that uses a private VLAN with AAA authorization to isolate clients and provide Zero-Trust. It is a method to block peer to peer communications within a subnet/VLAN. Here, the client is assigned to a PVLAN which isolates a wired client connected on one port from all other ports on Layer 2 while the Layer 3 communication occurs via the promiscuous port. In this feature, a single wired data client is supported per port interface, to ensure point-to-point blocking.



---

**Note** Traffic from multiple clients on the same interface will not be blocked.

---

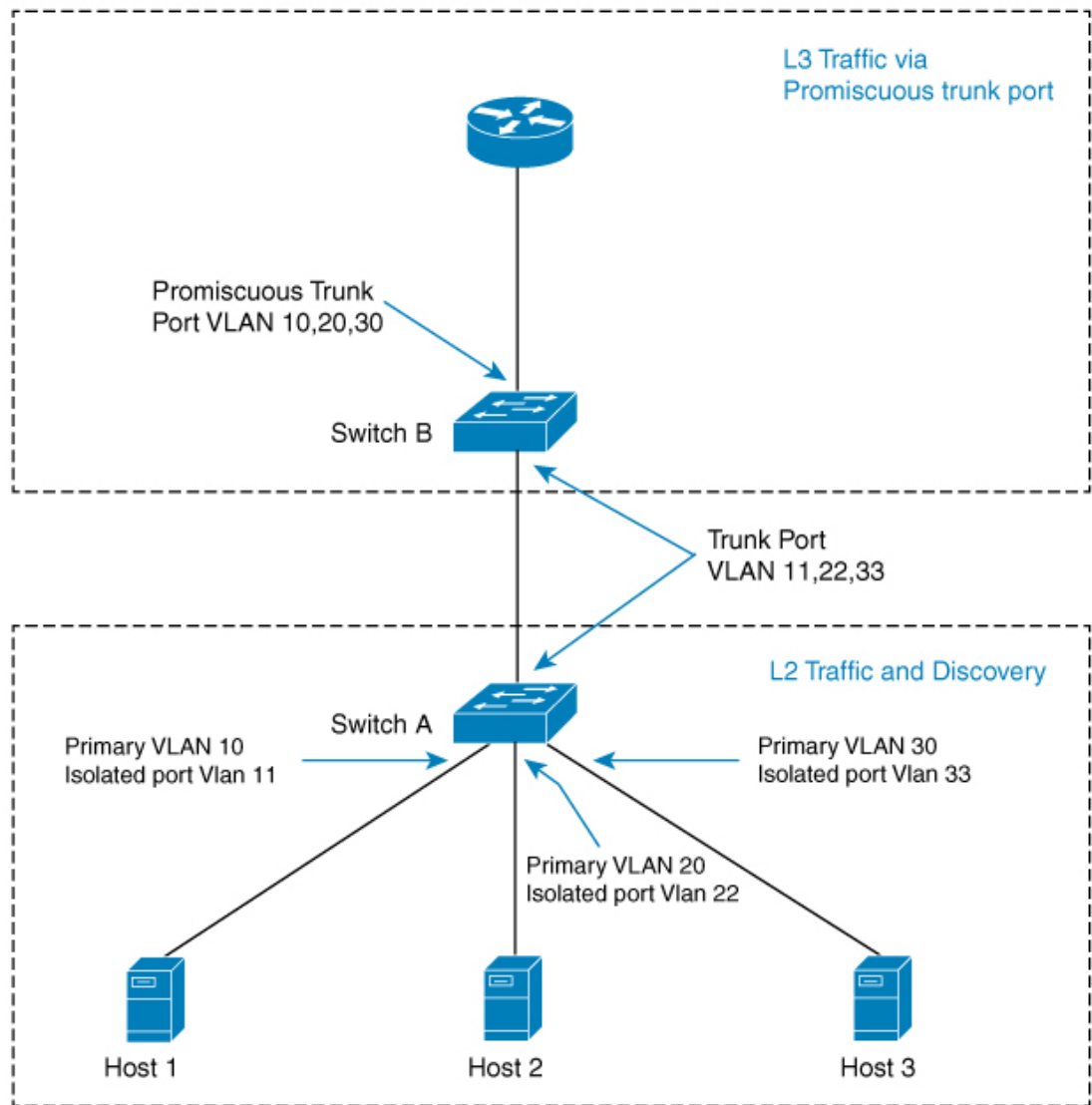

In this topology, the hosts are connected to Switch A and they can communicate only with the promiscuous trunk port on the switch. The PVLAN can be extended to span across multiple switches by adding intermediate switches. If there is a switch (Switch C) between Switch A and Switch B in the above topology, then layer 2 trunk ports need to be configured on the intermediate links. In case of a community VLAN, it allows packets to be seen on other hosts within the same community VLAN.

When a host is connected to a switch port with a cable, it is placed into an Isolated PVLAN where it cannot discover any other hosts. The host is then authenticated by the RADIUS server. Another scenario is when the port is placed in closed mode, and if the port is not authenticated, only Extensible Authentication Protocol over LAN (EAPoL) packets are allowed. Once the port is authenticated it is placed into an Isolated VLAN dynamically. As the host first authenticates with the RADIUS server, it sends the name of a dynamic interface template to be applied to the host's port. This interface template contains the configurations to enable the PVLAN Primary and Secondary VLANs on the port. With the template applied to the host, the switchport mode will be changed which will cause the port to flap from access mode to PVLAN mode.



**Note** The interface template with the same name as referred by AAA Authorization needs to be configured on the switch.

When the interface template is being applied, the port will physically go down for a time period set by the sticky timer and come up again. When the RADIUS server sends the interface template a second time, it is ignored as the conversion has been completed. The port is then assigned to a PVLAN which keeps it isolated. The host completes authorization and comes up to ready state.

Configure the keep time for which the interface template information is retained before it is removed from the port using the **access-session interface-template sticky timer** *time* command.

## Configuring Wired Dynamic PVLAN

To configure Wired Dynamic PVLAN, perform these steps on the user device (Switch A in the above topology):

### Before you begin

Ensure that the dot1x aaa is configured on the user device.

### Procedure

	Command or Action	Purpose
<b>Step 1</b>	<b>enable</b> <b>Example:</b> Device> <b>enable</b>	Enables privileged EXEC mode. Enter your password if prompted.
<b>Step 2</b>	<b>configure terminal</b> <b>Example:</b> Device# <b>configure terminal</b>	Enters global configuration mode.
<b>Step 3</b>	<b>vlan</b> <i>vlan-id</i> <b>Example:</b> Device(config)# <b>vlan 200</b>	(Optional) Enters VLAN configuration mode and designates or creates a VLAN that will be an isolated VLAN. The VLAN ID range is 2 to 1001 and 1006 to 4094.
<b>Step 4</b>	<b>private-vlan isolated</b> <b>Example:</b> Device(config-vlan)# <b>private-vlan isolated</b>	Designates the VLAN as an isolated VLAN.

	Command or Action	Purpose
Step 5	<b>exit</b> <b>Example:</b> Device(config-vlan)# <b>exit</b>	Returns to global configuration mode.
Step 6	<b>vlan <i>vlan-id</i></b> <b>Example:</b> Device(config)# <b>vlan 100</b>	Enters VLAN configuration mode and designates or creates a VLAN that will be the primary VLAN. The VLAN ID range is 2 to 1001 and 1006 to 4094.
Step 7	<b>private-vlan primary</b> <b>Example:</b> Device(config-vlan)# <b>private-vlan primary</b>	Designates the VLAN as the primary VLAN.
Step 8	<b>private-vlan association [add   remove] <i>secondary_vlan_list</i></b> <b>Example:</b> Device(config-vlan)# <b>private-vlan association 200</b>	<p>Associates the secondary VLANs with the primary VLAN. It can be a single private-VLAN ID or a hyphenated range of private-VLAN IDs.</p> <ul style="list-style-type: none"> <li>• The <i>secondary_vlan_list</i> parameter cannot contain spaces. It can contain multiple comma-separated items. Each item can be a single private-VLAN ID or a hyphenated range of private-VLAN IDs.</li> <li>• The <i>secondary_vlan_list</i> parameter can contain multiple community VLAN IDs but only one isolated VLAN ID.</li> <li>• Enter a <i>secondary_vlan_list</i>, or use the <b>add</b> keyword with a <i>secondary_vlan_list</i> to associate secondary VLANs with a primary VLAN.</li> <li>• Use the <b>remove</b> keyword with a <i>secondary_vlan_list</i> to clear the association between secondary VLANs and a primary VLAN.</li> <li>• The command does not take effect until you exit VLAN configuration mode.</li> </ul>
Step 9	<b>exit</b> <b>Example:</b>	Returns to global configuration mode.



	Command or Action	Purpose
	Device (config-vlan) # <b>exit</b>	
<b>Step 10</b>	<b>template</b> <i>template-name</i> <b>Example:</b> Device (config) # <b>template</b> <b>PVLAN100_200_CFG</b>	Creates a user template and enters template configuration mode.
<b>Step 11</b>	<b>switchport mode private-vlan host</b> <b>Example:</b> Device (config-template) # <b>switchport mode</b> <b>private-vlan host</b>	Configures a Layer 2 port as a PVLAN host port on the template.
<b>Step 12</b>	<b>switchport private-vlan host-association</b> <i>primary_vlan_id secondary_vlan_id</i> <b>Example:</b> Device (config-template) # <b>switchport</b> <b>private-vlan host-association 100 200</b>	Configures the association of a Layer 2 port with a PVLAN on the template.
<b>Step 13</b>	<b>exit</b> <b>Example:</b> Device (config-template) # <b>exit</b>	Returns to global configuration mode.
<b>Step 14</b>	<b>access-session interface-template sticky</b> <b>timer</b> <i>time</i> <b>Example:</b> Device (config) # <b>access-session</b> <b>interface-template sticky timer 60</b>	Configures the keep time of the template globally. Once the last client leaves, the template will be removed from the port after the configured keep time.  <b>Note</b> It is recommended that you set the sticky timer to 60 seconds.
<b>Step 15</b>	<b>interface</b> <i>interface-id</i> <b>Example:</b> Device (config) # <b>interface</b> <b>GigabitEthernet1/0/1</b>	Enters interface configuration mode and specifies the interface.
<b>Step 16</b>	<b>access-session interface-template sticky</b> <b>timer</b> <i>time</i> <b>Example:</b>	Configures the keep time of the template on the interface. Once the last client leaves, the template will be removed from the port after the configured keep time.

	Command or Action	Purpose
	Device (config-if) # <code>access-session interface-template sticky timer 60</code>	<b>Note</b> It is recommended that you set the sticky timer to 60 seconds.
<b>Step 17</b>	<b>end</b> <b>Example:</b> Device (config-if) # <code>end</code>	Returns to privileged EXEC mode.

### What to do next

After the above steps, configure the Identity Services Engine (ISE) or any other RADIUS server to assign the template to the client's port interface after the client has been authenticated successfully.

*Figure 6: Configuring the ISE to Assign the Interface Template*

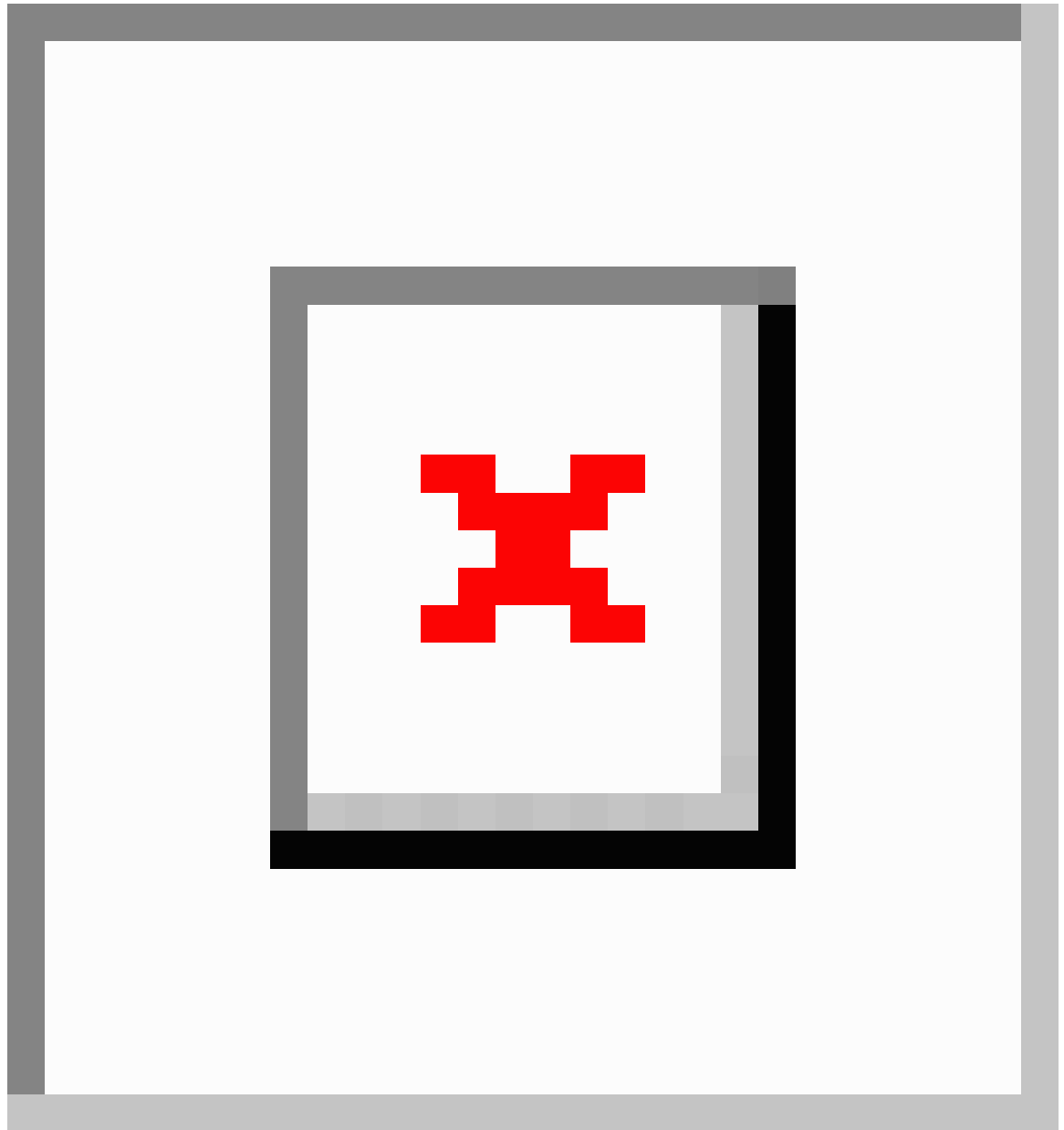

If you are using the ISE, go to the **Policy > Policy Elements > Authorization > Authorization Profile** page. Check the **Interface Template** check box and enter the name of the template to be assigned to the client interface.

If you are using a different RADIUS server, the attribute **Cisco-AVpair="interface:template=name"** must be pushed to the switch after the initial client authentication has been completed.

## Feature History for Wired Dynamic PVLAN

This table provides release and related information for features explained in this module.

These features are available on all releases subsequent to the one they were introduced in, unless noted otherwise.

Release	Feature	Feature Information
Cisco IOS XE Bengaluru 17.5.1	Wired Dynamic PVLAN (Whitelist P2P Blocking)	Wired Dynamic PVLAN feature uses a private VLAN to isolate the clients and provide Zero-Trust. This methods blocks peer to peer communication within a subnet/VLAN. The client is assigned to a PVLAN which isolates a single wired client connected on a port from other ports.
Cisco IOS XE Cupertino 17.9.1	Wired Dynamic PVLAN	This feature was implemented on C9200CX-12P-2X2G, C9200CX-8P-2X2G, and C9200CX-12T-2X2G models of the Cisco Catalyst 9200CX Series Switches, which were introduced in this release.

Use Cisco Feature Navigator to find information about platform and software image support. To access Cisco Feature Navigator, go to <https://cfng.cisco.com/>.