



High Availability Configuration Guide, Cisco IOS XE 17.14.x (Catalyst 9600 Switches)

First Published: 2024-03-29

Americas Headquarters

Cisco Systems, Inc.
170 West Tasman Drive
San Jose, CA 95134-1706
USA
<http://www.cisco.com>
Tel: 408 526-4000
800 553-NETS (6387)
Fax: 408 527-0883

THE SPECIFICATIONS AND INFORMATION REGARDING THE PRODUCTS IN THIS MANUAL ARE SUBJECT TO CHANGE WITHOUT NOTICE. ALL STATEMENTS, INFORMATION, AND RECOMMENDATIONS IN THIS MANUAL ARE BELIEVED TO BE ACCURATE BUT ARE PRESENTED WITHOUT WARRANTY OF ANY KIND, EXPRESS OR IMPLIED. USERS MUST TAKE FULL RESPONSIBILITY FOR THEIR APPLICATION OF ANY PRODUCTS.

THE SOFTWARE LICENSE AND LIMITED WARRANTY FOR THE ACCOMPANYING PRODUCT ARE SET FORTH IN THE INFORMATION PACKET THAT SHIPPED WITH THE PRODUCT AND ARE INCORPORATED HEREIN BY THIS REFERENCE. IF YOU ARE UNABLE TO LOCATE THE SOFTWARE LICENSE OR LIMITED WARRANTY, CONTACT YOUR CISCO REPRESENTATIVE FOR A COPY.

The Cisco implementation of TCP header compression is an adaptation of a program developed by the University of California, Berkeley (UCB) as part of UCB's public domain version of the UNIX operating system. All rights reserved. Copyright © 1981, Regents of the University of California.

NOTWITHSTANDING ANY OTHER WARRANTY HEREIN, ALL DOCUMENT FILES AND SOFTWARE OF THESE SUPPLIERS ARE PROVIDED "AS IS" WITH ALL FAULTS. CISCO AND THE ABOVE-NAMED SUPPLIERS DISCLAIM ALL WARRANTIES, EXPRESSED OR IMPLIED, INCLUDING, WITHOUT LIMITATION, THOSE OF MERCHANTABILITY, FITNESS FOR A PARTICULAR PURPOSE AND NON-INFRINGEMENT OR ARISING FROM A COURSE OF DEALING, USAGE, OR TRADE PRACTICE.

IN NO EVENT SHALL CISCO OR ITS SUPPLIERS BE LIABLE FOR ANY INDIRECT, SPECIAL, CONSEQUENTIAL, OR INCIDENTAL DAMAGES, INCLUDING, WITHOUT LIMITATION, LOST PROFITS OR LOSS OR DAMAGE TO DATA ARISING OUT OF THE USE OR INABILITY TO USE THIS MANUAL, EVEN IF CISCO OR ITS SUPPLIERS HAVE BEEN ADVISED OF THE POSSIBILITY OF SUCH DAMAGES.

Any Internet Protocol (IP) addresses and phone numbers used in this document are not intended to be actual addresses and phone numbers. Any examples, command display output, network topology diagrams, and other figures included in the document are shown for illustrative purposes only. Any use of actual IP addresses or phone numbers in illustrative content is unintentional and coincidental.

All printed copies and duplicate soft copies of this document are considered uncontrolled. See the current online version for the latest version.

Cisco has more than 200 offices worldwide. Addresses and phone numbers are listed on the Cisco website at www.cisco.com/go/offices.

Cisco and the Cisco logo are trademarks or registered trademarks of Cisco and/or its affiliates in the U.S. and other countries. To view a list of Cisco trademarks, go to this URL: <https://www.cisco.com/c/en/us/about/legal/trademarks.html>. Third-party trademarks mentioned are the property of their respective owners. The use of the word partner does not imply a partnership relationship between Cisco and any other company. (1721R)

© 2024 Cisco Systems, Inc. All rights reserved.



CONTENTS

CHAPTER 1

Configuring Nonstop Forwarding with Stateful Switchover 1

- Prerequisites for Cisco Nonstop Forwarding with Stateful Switchover 1
- Restrictions for Cisco Nonstop Forwarding with Stateful Switchover 2
- Information About Cisco Nonstop Forwarding with Stateful Switchover 2
 - Overview of Cisco Nonstop Forwarding with Stateful Switchover 2
 - SSO Operation 3
 - Cisco Nonstop Forwarding Operation 3
 - Cisco Express Forwarding 4
 - Routing Protocols 4
 - BGP Operation 5
 - EIGRP Operation 5
 - OSPF Operation 6
- How to Configure Cisco Nonstop Forwarding with Stateful Switchover 7
 - Configuring Stateful Switchover 7
- Verifying Cisco Express Forwarding with Cisco Nonstop Forwarding 8
- Configuration Examples for Cisco Nonstop Forwarding with Stateful Switchover 9
 - Example: Configuring Stateful Switchover 9
- Additional References for Cisco Nonstop Forwarding with Stateful Switchover 9
- Feature History for Cisco Nonstop Forwarding with Stateful Switchover 9

CHAPTER 2

Configuring Cisco StackWise Virtual 11

- Prerequisites for Cisco StackWise Virtual 11
- Restrictions for Cisco StackWise Virtual 11
- Information About Cisco StackWise Virtual 14
 - Overview of Cisco StackWise Virtual 14
 - Cisco StackWise Virtual Topology 14

Cisco StackWise Virtual Redundancy	16
SSO Redundancy	16
Nonstop Forwarding	17
Multichassis EtherChannels	17
MEC Minimum Latency Load Balancing	17
MEC Failure Scenarios	18
Cisco StackWise Virtual Packet Handling	18
Traffic on StackWise Virtual Link	19
Layer 2 Protocols	19
Layer 3 Protocols	21
Dual-Active Detection	23
Dual-Active-Detection Link with Fast Hello	23
Dual-Active Detection with enhanced PAgP	23
Recovery Actions	24
Implementing Cisco StackWise Virtual	24
How to Configure Cisco StackWise Virtual	25
Configuring Cisco StackWise Virtual Settings	25
Configuring Cisco StackWise Virtual Link	27
Configuring Secure StackWise Virtual	31
Configuring BUM Traffic Optimization	32
Configuring StackWise Virtual Fast Hello Dual-Active-Detection Link	33
Enabling ePAgP Dual-Active-Detection	34
Disabling Recovery Reload	36
Disabling Cisco StackWise Virtual	37
Disabling Secure StackWise Virtual	38
Configuration Examples for StackWise Virtual	39
Example: Configuring StackWise Virtual Link	39
Example: Configuring Secure StackWise Virtual	40
Example: Displaying Secure StackWise Virtual Authorization Key and Status	40
Example: Disabling Secure StackWise Virtual	40
Example: Configuring StackWise Virtual Fast Hello Dual-Active-Detection Link	41
Example: Displaying StackWise Virtual Link Information	42
Example: Displaying StackWise Virtual Dual-Active-Detection Link Information	43
Verifying Cisco StackWise Virtual Configuration	44

	Additional References for StackWise Virtual	44
	Feature History for Cisco StackWise Virtual	44
CHAPTER 3	Quad-Supervisor with Route Processor Redundancy	47
	Prerequisites for Quad-Supervisor with RPR	47
	Restrictions for Quad-Supervisor with RPR	48
	Information About Quad-Supervisor with RPR	48
	Understanding Quad-Supervisor with RPR	48
	SSO and RPR Operations in a Quad-Supervisor Setup	48
	Switchovers in Quad-Supervisor with RPR	49
	Quad-Supervisor with RPR with One ICS	49
	Quad-Supervisor with RPR with Two ICS	49
	Interaction with Other Features	50
	Performing ISSU in a Quad-Supervisor with RPR	50
	Upgrading in Install Mode in Quad-Supervisor with RPR	51
	How to Implement Quad-Supervisor with RPR	51
	Implementing Quad-Supervisor with RPR on Two Chassis	51
	Implementing Quad-Supervisor with RPR on an Existing Cisco StackWise Virtual Setup	52
	Upgrading the Software Version	52
	Upgrading the Software Version Using a Spare Chassis	53
	Upgrading the Software Version Without Using a Spare Chassis	53
	Upgrading the Software Version Using a USB Flash	54
	Manually Initiating a Switchover	56
	Monitoring Quad-Supervisor with RPR	56
	Implementation Examples for Quad-Supervisor with RPR	58
	Example: Quad-Supervisor with RPR with One ICS	58
	Example: Quad-Supervisor with RPR with Two ICS	59
	Example: Performing ISSU in a Quad-Supervisor with RPR	59
	Command Outputs with Information About Quad-Supervisor with RPR	60
	Additional References for Quad-Supervisor with RPR	61
	Feature History for Quad-Supervisor with RPR	62
CHAPTER 4	Configuring Graceful Insertion and Removal	63
	Restrictions for Graceful Insertion and Removal	63

Information About Graceful Insertion and Removal	63
Overview	63
Layer 2 Interface Shutdown	64
Custom Template	64
System Mode Maintenance Counters	65
How to Configure Graceful Insertion and Removal	66
Creating a Maintenance Template	66
Configuring System Mode Maintenance	66
Starting and Stopping Maintenance Mode	67
Monitoring Graceful Insertion and Removal	68
Configuration Examples for Graceful Removal and Insertion	68
Example: Configuring Maintenance Templates	68
Example: Configuring System Mode Maintenance	69
Example: Starting and Stopping the Maintenance Mode	69
Example: Displaying System Mode Settings	69
Additional References for Graceful Insertion and Removal	70
Feature History for Graceful Insertion and Removal	70

CHAPTER 5**Troubleshooting High Availability** 71

Overview	71
Support Articles	71
Feedback Request	72
Disclaimer and Caution	72



CHAPTER 1

Configuring Nonstop Forwarding with Stateful Switchover

Cisco nonstop forwarding (NSF) works with the stateful switchover (SSO) feature. NSF works with SSO to minimize the amount of time a network is unavailable to users following a switchover. The main objective of NSF SSO is to continue forwarding IP packets following a Route Processor (RP) switchover.

- [Prerequisites for Cisco Nonstop Forwarding with Stateful Switchover, on page 1](#)
- [Restrictions for Cisco Nonstop Forwarding with Stateful Switchover, on page 2](#)
- [Information About Cisco Nonstop Forwarding with Stateful Switchover, on page 2](#)
- [How to Configure Cisco Nonstop Forwarding with Stateful Switchover, on page 7](#)
- [Verifying Cisco Express Forwarding with Cisco Nonstop Forwarding, on page 8](#)
- [Configuration Examples for Cisco Nonstop Forwarding with Stateful Switchover, on page 9](#)
- [Additional References for Cisco Nonstop Forwarding with Stateful Switchover, on page 9](#)
- [Feature History for Cisco Nonstop Forwarding with Stateful Switchover, on page 9](#)

Prerequisites for Cisco Nonstop Forwarding with Stateful Switchover

- Cisco NSF must be configured on a networking device that has been configured for SSO.
- Border Gateway Protocol (BGP) support in NSF requires that neighbor networking devices be NSF-aware; that is, devices must have the graceful restart capability and advertise that capability in their OPEN message during session establishment. If an NSF-capable device discovers that a particular BGP neighbor does not have graceful restart capability, it does not establish an NSF-capable session with that neighbor. All other neighbors that have graceful restart capability continue to have NSF-capable sessions with this NSF-capable networking device.
- Open Shortest Path First (OSPF) support in NSF requires that all neighbor networking devices be NSF-aware. If an NSF-capable device discovers that it has non-NSF-aware neighbors on a particular network segment, it disables NSF capabilities for that segment. Other network segments composed entirely of NSF-capable or NSF-aware devices continue to provide NSF capabilities.

Restrictions for Cisco Nonstop Forwarding with Stateful Switchover

The following are restrictions for configuring NSF with SSO:

- For NSF operation, you must have SSO configured on the device.
- All Layer 3 neighboring devices must be an NSF helper or NSF-capable to support graceful restart capability.
- For IETF, all neighboring devices must be running an NSF-aware software image.
- The Hot Standby Routing Protocol (HSRP) is not supported with NSF SSO.
- An NSF-aware device cannot support two NSF-capable peers performing an NSF restart operation at the same time. However, both neighbors can reestablish peering sessions after the NSF restart operation is complete.
- For SSO operation, ensure that both active and standby devices run the same version of the Cisco IOS XE image. If the active and standby devices are operating different images, SSO failover might cause an outage.
- If the sensitive timer is set in milliseconds during SSO for Fast UniDirectional Link Detection (UDLD) and Bidirectional Forwarding Detection (BFD) protocols, the port could be disabled and is displayed as err-disabled state.

Information About Cisco Nonstop Forwarding with Stateful Switchover

Overview of Cisco Nonstop Forwarding with Stateful Switchover

Cisco NSF works with the SSO feature. The device supports fault resistance by allowing a standby supervisor module to take over if the active supervisor module becomes unavailable. NSF works with SSO to minimize the amount of time a network is unavailable.

Usually, when a networking device restarts, all routing peers of that device detect that the device went down and then came back up. This transition results in what is called a routing flap, which could spread across multiple routing domains. Routing flaps caused by routing restarts create routing instabilities, which are detrimental to the overall network performance. Cisco NSF helps to suppress routing flaps in SSO-enabled devices, thus reducing network instability.

Cisco NSF with SSO allows for the forwarding of data packets to continue along known routes while the routing protocol information is being restored following a switchover. With NSF/SSO, peer networking devices do not experience routing flaps. Data traffic is forwarded through intelligent line cards or dual forwarding processors (FPs) while the standby router processor (RP) assumes control from the failed active RP during a switchover. NSF with SSO operation provides the ability of line cards and FPs to remain active through a switchover and to be kept current with the Forwarding Information Base (FIB) on the active RP.

NSF provides the following benefits:

- Improved network availability—NSF continues forwarding network traffic and application state information so that user session information is maintained after a switchover.
- Overall network stability—Network stability can be improved with the reduction in the number of route flaps that are created when devices in the network fail, and lose their routing tables.
- Neighboring devices do not detect a link flap—Because interfaces remain active during a switchover, neighboring devices do not detect a link flap (the link does not go down and come back up).
- Prevents routing flaps—Because SSO continues forwarding network traffic during a switchover, routing flaps are avoided.
- Maintains user sessions established prior to the switchover.
- When the active supervisor module is down, the standby supervisor module takes the active role

SSO Operation

When a standby supervisor module runs in SSO mode, it starts up in a fully-initialized state and synchronizes with the persistent configuration and the running configuration on the active supervisor module. It subsequently maintains the state of the protocols, and all changes in hardware and software states for features that support SSO are kept in synchronization. Consequently, it offers minimum interruption to Layer 2 sessions in a redundant active supervisor module configuration.

If the active supervisor module fails, the standby supervisor module becomes the active supervisor module. This new active supervisor module uses existing Layer 2 switching information to continue forwarding traffic. Layer 3 forwarding is delayed until routing tables are repopulated in the newly active supervisor module.



Note The routing tables require around 80 seconds for repopulation. You can use the **show ip bgp ip-address** command, in privileged EXEC mode, to check whether the routing tables are repopulated or not.

Cisco Nonstop Forwarding Operation

NSF always runs with SSO, and provides redundancy for Layer 3 traffic. NSF is supported by BGP, Enhanced Interior Gateway Routing Protocol (EIGRP), and OSPF routing protocols and also by Cisco Express Forwarding for forwarding. These routing protocols have been enhanced with NSF-capability and awareness, which means that devices running these protocols can detect a switchover and take necessary actions to continue forwarding network traffic and to recover route information from peer devices.

Each protocol depends on Cisco Express Forwarding to continue forwarding packets during switchover while routing protocols rebuild the Routing Information Base (RIB) tables. After the convergence of routing protocols, Cisco Express Forwarding updates the FIB table and removes stale route entries. Cisco Express Forwarding then updates the hardware with the new FIB information.

If the active supervisor module is configured (with the **graceful-restart** command) for BGP, OSPF, or EIGRP routing protocols, routing updates are automatically sent during the active supervisor module election.

NSF has two primary components:

- NSF-aware: A networking device is NSF-aware if it is running NSF-compatible software. If neighboring devices detect that an NSF device can still forward packets when an active supervisor module election

happens, this capability is referred to as NSF-awareness. Enhancements to the Layer 3 routing protocols (BGP, OSPF, and EIGRP) are designed to prevent route-flapping so that the Cisco Express Forwarding routing table does not time out or the NSF device does not drop routes. An NSF-aware device helps to send routing protocol information to the neighboring NSF device. NSF-awareness is enabled by default for EIGRP-stub, EIGRP, and OSPF protocols. NSF-awareness is disabled by default for BGP.

- **NSF-capability:** A device is NSF-capable if it is configured to support NSF; it rebuilds routing information from NSF-aware or NSF-capable neighbors. NSF works with SSO to minimize the amount of time that a Layer 3 network is unavailable following an active device election by continuing to forward IP packets. Reconvergence of Layer 3 routing protocols (BGP, OSPFv2, and EIGRP) is transparent to the user and happens automatically in the background. Routing protocols recover routing information from neighbor devices and rebuild the Cisco Express Forwarding table.

Cisco Express Forwarding

A key element of NSF is packet forwarding. In a Cisco networking device, packet forwarding is provided by Cisco Express Forwarding. Cisco Express Forwarding maintains the Forwarding Information Base (FIB), and uses the FIB information that is current at the time of a switchover to continue forwarding packets during a switchover, to reduce traffic interruption during the switchover.

During normal NSF operation, Cisco Express Forwarding on the active supervisor module synchronizes its current FIB and adjacency databases with the FIB and adjacency databases on the standby supervisor module. Upon switchover, the standby supervisor module initially has FIB and adjacency databases that are mirror images of those that were current on the active supervisor module. Cisco Express Forwarding keeps the forwarding engine on the standby supervisor module current with changes that are sent to it by Cisco Express Forwarding on the active supervisor module. The forwarding engine can continue forwarding after a switchover as soon as the interfaces and a data path are available.

As the routing protocols start to repopulate the RIB on a prefix-by-prefix basis, the updates cause prefix-by-prefix updates to Cisco Express Forwarding, which it uses to update the FIB and adjacency databases. Existing and new entries receive the new version (“epoch”) number, indicating that they have been refreshed. The forwarding information is updated on the forwarding engine during convergence. The device signals when the RIB has converged. The software removes all FIB and adjacency entries that have an epoch older than the current switchover epoch. The FIB now represents the newest routing protocol forwarding information.

Routing Protocols

Routing protocols run only on the active RP, and receive routing updates from neighbor devices. Routing protocols do not run on the standby RP. Following a switchover, routing protocols request that the NSF-aware neighbor devices send state information to help rebuild routing tables. Alternately, the Intermediate System-to-Intermediate System (IS-IS) protocol can be configured to synchronize state information from the active to the standby RP to help rebuild the routing table on the NSF-capable device in environments where neighbor devices are not NSF-aware.



Note For NSF operation, routing protocols depend on Cisco Express Forwarding to continue forwarding packets while routing protocols rebuild the routing information.

BGP Operation

When a NSF-capable device begins a BGP session with a BGP peer, it sends an OPEN message to the peer. Included in the message is a declaration that the NSF-capable device has “graceful restart capability.” Graceful restart is the mechanism by which BGP routing peers avoid a routing flap following a switchover. If the BGP peer has this capability, it is aware that the device sending the message is NSF-capable. Both the NSF-capable device and its BGP peer(s) need to exchange the Graceful Restart Capability in their OPEN messages, at the time of session establishment. If both peers do not exchange the Graceful Restart Capability, the session is not graceful restart capable.

If the BGP session is lost during the RP switchover, the NSF-aware BGP peer marks all routes associated with the NSF-capable device as stale; however, it continues to use these routes to make forwarding decisions for a set period of time. This functionality means that no packets are lost while the newly active RP is waiting for convergence of the routing information with the BGP peers.

After an RP switchover occurs, the NSF-capable device reestablishes the session with the BGP peer. In establishing the new session, it sends a new graceful restart message that identifies the NSF-capable device as having restarted.

At this point, the routing information is exchanged between two BGP peers. Once this exchange is complete, the NSF-capable device uses the routing information to update the RIB and the FIB with the new forwarding information. The NSF-aware device uses the network information to remove stale routes from its BGP table. Following that, the BGP protocol is fully converged.

If a BGP peer does not support the graceful restart capability, it will ignore the graceful-restart capability in an OPEN message; but will establish a BGP session with the NSF-capable device. This function allows interoperability with non-NSF-aware BGP peers (and without NSF functionality), but the BGP session with non-NSF-aware BGP peers will not be graceful restart capable.



Note BGP support in NSF requires that neighbor networking devices be NSF-aware; that is, devices must have the Graceful Restart Capability and advertise that capability in their OPEN message during session establishment. If an NSF-capable device discovers that a particular BGP neighbor does not have Graceful Restart Capability, it will not establish an NSF-capable session with that neighbor. All other neighbors that have Graceful Restart Capability will continue to have NSF-capable sessions with this NSF-capable networking device.

EIGRP Operation

Enhanced Interior Gateway Routing Protocol (EIGRP) NSF capabilities are exchanged by EIGRP peers in hello packets. The NSF-capable device notifies its neighbors that an NSF restart operation has started by setting the restart (RS) bit in a hello packet. When an NSF-aware device receives notification from an NSF-capable neighbor that an NSF-restart operation is in progress, the NSF-capable and NSF-aware devices immediately exchange their topology tables. The NSF-aware device sends an end-of-table update packet when the transmission of its topology table is complete. The NSF-aware device then performs the following actions to assist the NSF-capable device:

- The EIGRP hello hold timer is expired to reduce the time interval set for hello packet generation and transmission. This allows the NSF-aware device to reply to the NSF-capable device more quickly reducing the amount of time required for the NSF-capable device to rediscover neighbors and rebuild the topology table.

- The route-hold timer is started. This timer is used to set the period of time that the NSF-aware device will hold known routes for the NSF-capable neighbor. This timer is configured with the **timers graceful-restart purge-time** command. The default time period is 240 seconds.
- In the peer list, the NSF-aware device notes that the NSF-capable neighbor is restarting, maintains adjacency, and holds known routes for the NSF-capable neighbor until the neighbor signals that it is ready for the NSF-aware device to send its topology table, or the route-hold timer expires. If the route-hold timer expires on the NSF-aware device, the NSF-aware device discards held routes and treats the NSF-capable device as a new device joining the network and reestablishes adjacency accordingly.
- The NSF-aware device continues to send queries to the NSF-capable device which is still in the process of converging after a switchover, effectively extending the time before a stuck-in-active condition can occur.

When the switchover operation is complete, the NSF-capable device notifies its neighbors that it has reconverged and has received all of their topology tables by sending an end-of-table update packet to assisting devices. The NSF-capable device then returns to normal operation. The NSF-aware device will look for alternate paths (go active) for any routes that are not refreshed by the NSF-capable (restarting device). The NSF-aware device will then return to normal operation. If all paths are refreshed by the NSF-capable device, the NSF-aware device will immediately return to normal operation.



Note NSF-aware devices are completely compatible with non-NSF aware or -capable neighbors in an EIGRP network. A non-NSF aware neighbor will ignore NSF capabilities and reset adjacencies and otherwise maintain the peering sessions normally.

OSPF Operation

When an OSPF NSF-capable device performs a supervisor engine switchover, it must perform the following tasks in order to resynchronize its link state database with its OSPF neighbors:

- Relearn the available OSPF neighbors on the network without causing a reset of the neighbor relationship.
- Reacquire the contents of the link state database for the network.

As quickly as possible after a supervisor engine switchover, the NSF-capable device sends an OSPF NSF signal to neighboring NSF-aware devices. Neighbor networking devices recognize this signal as an indicator that the neighbor relationship with this device should not be reset. As the NSF-capable device receives signals from other devices on the network, it can begin to rebuild its neighbor list.

After neighbor relationships are reestablished, the NSF-capable device begins to resynchronize its database with all of its NSF-aware neighbors. At this point, the routing information is exchanged between the OSPF neighbors. Once this exchange is complete, the NSF-capable device uses the routing information to remove stale routes, update the RIB, and update the FIB with the new forwarding information. The OSPF protocols are then fully converged.



Note OSPF support in NSF requires that all neighbor networking devices be NSF-aware. If an NSF-capable device discovers that it has non-NSF -aware neighbors on a particular network segment, it disables NSF capabilities for that segment. Other network segments composed entirely of NSF-capable or NSF-aware devices continue to provide NSF capabilities.

How to Configure Cisco Nonstop Forwarding with Stateful Switchover

Configuring Stateful Switchover

You must configure SSO in order to use NSF with any supported protocol.

Procedure

	Command or Action	Purpose
Step 1	enable Example: Device> enable	Enables privileged EXEC mode. <ul style="list-style-type: none">• Enter your password if prompted.
Step 2	show redundancy states Example: Device# show redundancy states	Displays the operating redundancy mode.
Step 3	redundancy Example: Device(config)# redundancy	Enters redundancy configuration mode.
Step 4	mode sso Example: Device(config-red)# mode sso	Configures stateful switchover. <ul style="list-style-type: none">• When this command is entered, the standby supervisor module is reloaded and begins to work in SSO mode.
Step 5	end Example: Device(config-red)# end	Exits redundancy configuration mode and returns to privileged EXEC mode.
Step 6	show redundancy states Example: Device# show redundancy states	Displays the operating redundancy mode.
Step 7	debug redundancy status Example: Device# debug redundancy status	Enables the debugging of redundancy status events.

Verifying Cisco Express Forwarding with Cisco Nonstop Forwarding

Procedure

show cef state

Displays the state of Cisco Express Forwarding on a networking device.

Example:

```
Device# show cef state
```

```
CEF Status:
RP instance
common CEF enabled
IPv4 CEF Status:
CEF enabled/running
dCEF enabled/running
CEF switching enabled/running
universal per-destination load sharing algorithm, id DEA83012
IPv6 CEF Status:
CEF disabled/not running
dCEF disabled/not running
universal per-destination load sharing algorithm, id DEA83012
RRP state:
I am standby RRP: no
RF Peer Presence: yes
RF PeerComm reached: yes
RF Progression blocked: never
Redundancy mode: rpr(1)
CEF NSF sync: disabled/not running
CEF ISSU Status:
FIBHWIDB broker
No slots are ISSU capable.
FIBIDB broker
No slots are ISSU capable.
FIBHWIDB Subblock broker
No slots are ISSU capable.
FIBIDB Subblock broker
No slots are ISSU capable.
Adjacency update
No slots are ISSU capable.
IPv4 table broker
No slots are ISSU capable.
CEF push
No slots are ISSU capable.
```

Configuration Examples for Cisco Nonstop Forwarding with Stateful Switchover

Example: Configuring Stateful Switchover

This example shows how to configure the system for SSO and displays the redundancy state:

```
Device(config)# redundancy
Device(config-red)# mode sso
Device(config-red)# end
Device#
```

The following is sample output from the **show redundancy states** command:

```
show redundancy states
my state = 13 -ACTIVE
peer state = 8 -STANDBY HOT
Mode = Duplex
Unit = Primary
Unit ID = 5
Redundancy Mode (Operational) = sso
Redundancy Mode (Configured) = sso
Split Mode = Disabled
Manual Swact = Enabled
Communications = Up
client count = 29
client_notification_TMR = 30000 milliseconds
keep_alive TMR = 9000 milliseconds
keep_alive count = 1
keep_alive threshold = 18
RF debug mask = 0x0
```

Additional References for Cisco Nonstop Forwarding with Stateful Switchover

Related Documents

Related Topic	Document Title
For complete syntax and usage information for the commands used in this chapter.	See the <i>High Availability</i> section of the <i>Command Reference (Catalyst 9600 Series Switches)</i>

Feature History for Cisco Nonstop Forwarding with Stateful Switchover

This table provides release and related information for features explained in this module.

These features are available on all releases subsequent to the one they were introduced in, unless noted otherwise.

Release	Feature	Feature Information
Cisco IOS XE Gibraltar 16.11.1	Cisco Nonstop Forwarding with Stateful Switchover	Cisco NSF works with the SSO feature. NSF works with SSO to minimize the amount of time a network is unavailable to users following a switchover. The main objective of NSF SSO is to continue forwarding IP packets following a Route Processor (RP) switchover.
Cisco IOS XE Cupertino 17.7.1	Cisco Nonstop Forwarding with Stateful Switchover	This feature was implemented on Cisco Catalyst 9600 Series Supervisor 2 Module (C9600X-SUP-2), which was introduced in this release.

Use Cisco Feature Navigator to find information about platform and software image support. To access Cisco Feature Navigator, go to <https://cfnng.cisco.com>.



CHAPTER 2

Configuring Cisco StackWise Virtual

- [Prerequisites for Cisco StackWise Virtual, on page 11](#)
- [Restrictions for Cisco StackWise Virtual, on page 11](#)
- [Information About Cisco StackWise Virtual, on page 14](#)
- [How to Configure Cisco StackWise Virtual, on page 25](#)
- [Configuration Examples for StackWise Virtual, on page 39](#)
- [Verifying Cisco StackWise Virtual Configuration, on page 44](#)
- [Additional References for StackWise Virtual, on page 44](#)
- [Feature History for Cisco StackWise Virtual, on page 44](#)

Prerequisites for Cisco StackWise Virtual

- Both switches in the Cisco StackWise Virtual pair must be directly connected to each other.
- Both switches in the Cisco StackWise Virtual pair must be of the same switch model.
- Both supervisors in the Cisco StackWise Virtual pair must be of the same supervisor model.
- Both switches in the Cisco StackWise Virtual pair must be running the same license level.
- Both switches in the Cisco StackWise Virtual pair must be running the same software version.
- Both switches in the Cisco StackWise Virtual pair must be running the same SDM template.
- All the ports used for configuring a StackWise Virtual Link (SVL) must share the same speed. For example, you cannot configure a 10G or a 40G port to form an SVL, simultaneously. Furthermore, all ports used for configuring SVL must be either from the same line card or across line cards within the same chassis.

Restrictions for Cisco StackWise Virtual



Note Unless stated otherwise, the restrictions are applicable to all models of the Catalyst 9600 Switches.

- If a dual-rate optic is used as SVL and/or DAD link, it automatically links up to the highest speed supported by the dual-rate optic (that is, 10/25G optic will link up at 25G), and lower speeds cannot be configured on the SVL and/or DAD links.
- Cisco StackWise Virtual can be configured only on the same supervisor module slot on both the chassis as asymmetric supervisor module slots between the chassis is not supported. For example, if you have inserted the supervisor module in slot 3 in chassis 1, then chassis 2 should also have the supervisor module in slot 3.
- Cisco StackWise Virtual configuration commands will be recognised only on a switch running Network Advantage license.
- Only Cisco Transceiver Modules are supported.
- When deploying Cisco StackWise Virtual, ensure that VLAN ID 4094 is not used anywhere on the network. All inter-chassis system control communication between stack members is carried over the reserved VLAN ID 4094 from the global range.



Note This does not apply to the Cisco Catalyst 9600 Series Supervisor 2 Module (C9600X-SUP-2).

- Dual-Active Detection (DAD) and SVL configuration must be performed manually and the devices should be rebooted for the configuration changes to take effect.



Note This does not apply to the Cisco Catalyst 9600 Series Supervisor 2 Module (C9600X-SUP-2).

- In a Cisco StackWise Virtual solution, QSA along with 10G interfaces can be used as data ports or SVL or DAD links.
- In a Cisco StackWise Virtual solution, QSA along with 1G interfaces can be used as data ports or DAD links. SVL links are not supported on 1G interfaces.
- The following are the restrictions for C9600-LC-48TX, C9600-LC-48YL, and C9600-LC-24C line cards:
 - DAD links are supported only in 1G interfaces, and SVL links are supported on the C9600-LC-48TX line card only with interfaces that are operating at 10G speed.
 - DAD links configured between C9600-LC-48TX line card and C9600-LC-48YL line card or C9600-LC-24C line card is supported only in 1G interfaces.
 - DAD links configured between two C9600-LC-48YL line cards or between two C9600-LC-24C line cards are supported in both 10G and 1G interfaces.

DAD links configured between C9600-LC-48YL line card and C9600-LC-24C line card are also supported in both 10G and 1G interfaces.
- The following are the restrictions for Cisco Catalyst 9600 Series Supervisor 2 Module (C9600X-SUP-2):
 - SVL and DAD links are not supported on breakout interfaces when operating in SVL mode. Breakout interfaces are only supported for regular data and control traffic carrying ports (not SVL and DAD links) when operating in SVL mode.

- Cisco Catalyst 9600 Series Supervisor 2 Module (C9600X-SUP-2) operating in SVL models is FIPS 140-2 compliant. FIPS keys must be configured on both the switch members individually to enable SVL with FIPS mode.
- 1-G interfaces are not supported.
- C9600X-SUP-2 on a C9606R chassis does not support Quad-Supervisor with RPR.
- When SVL and/or DAD links are configured on line cards C9600-LC-48YL and/or C9600-LC-40YL4CD, the other port in the port-group must also be set at the same speed. For example, If Fif1/1/0/45 is 25G optic, and is configured as SVL link, interface Fif1/1/0/46 (second port in port-group) must also be set to 25G.
- If a dual-rate optic is used as SVL and/or DAD link, it automatically links up to the highest speed supported by the dual-rate optic (that is, 10/25G optic will link up at 25G), and lower speeds cannot be configured on the links. For example, Fif1/1/0/45 is 10/25G optic, and configured as SVL link, Fif1/1/0/45 will automatically link up to 25G. Fif1/1/0/46 needs to be either same 10/25G optic and set to 25G, or an optic that only supports 25G.
- The interface VLAN MAC address that is assigned by default, can be overridden using the **mac-address** command. If this command is configured on a single SVI or router port that requires Layer 3 injected packets, all other SVIs or routed ports on the device also must be configured with the same first four most significant bytes (4MSB) of the MAC address. For example, if you set the MAC address of any SVI to xxxx.yyyy.zzzz, set the MAC address of all other SVIs to start with xxxx.yyyy. If Layer 3 injected packets are not used, this restriction does not apply.



Note This applies to all Layer 3 ports, SVIs, and routed ports. This does not apply to GigabitEthernet0/0 port.

- Secure StackWise Virtual is supported only on two node front-side stacking.
- Do not configure Secure Stackwise Virtual and Federal Information Processing Standards (FIPS) at the same time as they are mutually exclusive features that cannot co-exist.

Configuring both at the same time is redundant as Secure StackWise Virtual is FIPS 140-2 compliant. Secure StackWise Virtual will encrypt control packets as well. Therefore, enabling FIPS is not required.



Note This does not apply to the Cisco Catalyst 9600 Series Supervisor 2 Module (C9600X-SUP-2).

- Only 128-bit authorization key is supported.
- Secure StackWise Virtual is not supported on DAD Links.
- Broadcast, Unknown Unicast and Multicast (BUM) Traffic Optimization is not applicable to VLANs with standalone or physical ports.

Information About Cisco StackWise Virtual

Overview of Cisco StackWise Virtual

Cisco StackWise Virtual is a network system virtualization technology that pairs two directly connected switches into one virtual switch. The switches in a Cisco StackWise Virtual solution increase operational efficiency by using single control and management plane, scale system bandwidth with distributed forwarding plane, and help in building resilient networks using the recommended network design. Cisco StackWise Virtual allows two directly connected physical switches to operate as a single logical virtual switch using an Ethernet connection.

Cisco StackWise Virtual Topology

A typical network design consists of core, distribution, and access layers. The default mode of a switch is standalone. When two redundant switches are deployed in the distribution layer, the following network challenges arise:

- If VLAN IDs are reused between access layers then, it will introduce a spanning tree loop that will impact the overall performance of the network.
- Spanning tree protocols and configuration are required to protect Layer 2 network against spanning tree protocol loop, and root and bridge protocol data unit management.
- Additional protocols such as first hop redundancy protocol are required to virtualize the IP gateway function. This should align with STP root priorities for each VLAN.
- The Protocol independent multicast designated router (PIM DR) configuration should be fine-tuned to selectively build a multicast forwarding topology on a VLAN.
- The standalone distribution layer system provides protocol-driven remote failure and detection, which results in slower convergence time. Fine-tune First Hop Redundancy Protocol (FHRP) and PIM timers for rapid fault detection and recovery process.

We recommend Cisco StackWise Virtual model for aggregation layers and collapsed aggregation and core layers. On Cisco Catalyst 9600 Series Supervisor 1 Module, the stack can be formed over a 40G or 100G link to ensure that the distribution or the aggregation switches can be deployed over a large distance. Additionally, on the Cisco Catalyst 9600 Series Supervisor 2 Module (C9600X-SUP-2), the stack can be formed over a 400-G link.



Note Ensure that the cables or transceivers or both on all the SVL and DAD links are not disturbed when SVL is brought up.

Note that STP keeps one of the ports connected to the distribution switches blocked on the access switches. As a result of this, an active link failure causes STP convergence and the network suffers from traffic loss, flooding, and a possible transient loop in the network. On the other hand, if the switches are logically merged into one switch, all the access switches might form an EtherChannel bundle with distribution switches, and a link failure within an EtherChannel would not have any impact as long as at least one member within the EtherChannel is active.

Figure 1: Typical Network Design using Cisco StackWise Virtual

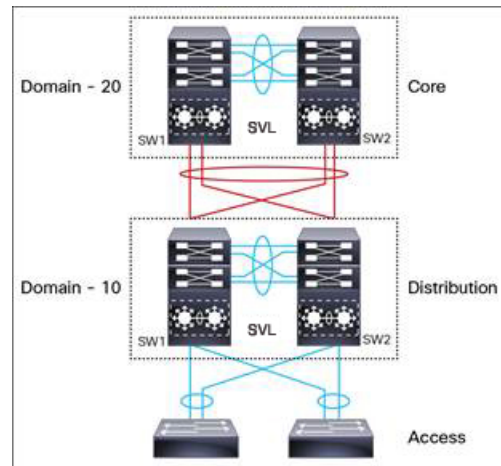

Etherchannel in StackWise Virtual is capable of implementing Multi-chassis EtherChannel (MEC) across the stack members. When access layer and aggregation layer are collapsed into a single StackWise Virtual system, MEC across the different access layer domain members and across distribution and access layer switches will not be supported. MEC is designed to forward the traffic over the local link irrespective of the hash result.

Since the control plane, management plane, and data plane are integrated, the system behaves as a single switch.

The virtualization of multiple physical switches into a single logical switch is from a control and management plane perspective only. Because of the control plane being common, it may look like a single logical entity to peer switches. The data plane of the switches is distributed. Each switch is capable of forwarding over its local interfaces without involving other members. However, when a packet coming into a switch has to be forwarded over a different member's port, the forwarding context of the packet is carried over to the destination switch after ingress processing is performed in the ingress switch. Egress processing is done only in the egress switch. This provides a uniform data plane behavior to the entire switch irrespective whether of the destination port is in a local switch or in a remote switch. However, the common control plane ensures that all the switches have equivalent data plane entry for each forwarding entity.

An election mechanism elects one of the switches to be Cisco StackWise Virtual active and the other switch to be Cisco StackWise Virtual standby in terms of Control Plane functions. The active switch is responsible for all the management, bridging and routing protocols, and software data path. The standby switch is in hot standby state ready to take over the role of active, if the active switch fails over.

The following are the components of the Cisco StackWise Virtual solution:

- Stack members
- SVL: 10G, 25G, 40G, 50G, 100G, or 400G Ethernet connections. SVL is established using the 10G, 25G, 40G, 50G, 100G, or 400G interfaces depending on the switch models. However, a combination of two different speeds is not supported.

SVL is the link that connects the switches over Ethernet. Typically, Cisco StackWise Virtual consists of multiple 400G, 100G, 50G, 25G, 40G or 10G physical links. It carries all the control and data traffic between the switching units. You can configure SVL on a supported port. When a switch is powered up and the hardware is initialized, it looks for a configured SVL before the initialization of the control plane.

The Link Management Protocol (LMP) is activated on each link of the SVL as soon as the links are established. LMP ensure the integrity of the links and monitors and maintains the health of the links. The redundancy role

of each switch is resolved by the StackWise Discovery Protocol (SDP). It ensures that the hardware and software versions are compatible to form the SVL and determines which switch becomes active or standby from a control plane perspective.



Note On the Cisco Catalyst 9600 Series Supervisor 2 Module (C9600X-SUP-2), Link Aggregation Control Protocol (LACP) replaces LMP, and Intermediate System to Intermediate System (ISIS) replaces SDP.

Cisco StackWise Virtual Header (SVH) is 64-byte frame header that is prepended over all control, data, and management plane traffic that traverse over each SVL between the two stack members of the Cisco StackWise Virtual domain. The SVH-encapsulated traffic operates at OSI Layer 2 and can be recognized and processed only by Cisco StackWise Virtual-enabled switches. SVL interfaces are non-bridgeable and non-routeable, and allows non-routeable traffic over L2 or L3 network.

Cisco StackWise Virtual Redundancy

Cisco StackWise Virtual operates stateful switchover (SSO) between the active and standby switches. The following are the ways in which Cisco StackWise Virtual's redundancy model differs from that of the standalone mode:

- The Cisco StackWise Virtual active and standby switches are hosted in separate switches and use a StackWise Virtual link to exchange information.
- The active switch controls both the switches of Cisco StackWise Virtual. The active switch runs the Layer 2 and Layer 3 control protocols and manages the switching modules of both the switches.
- The Cisco StackWise Virtual active and standby switches perform data traffic forwarding.



Note If the Cisco StackWise Virtual active switch fails, the standby switch initiates a switchover and assumes the Cisco StackWise Virtual active switch role.

SSO Redundancy

A StackWise Virtual system operates with SSO redundancy if it meets the following requirements:

- Both the switches must be running the same software version, unless they are in the process of software upgrade.
- SVL-related configuration in the two switches must match.
- License type must be same on both the switch models.
- Both the switch models must be in the same StackWise Virtual domain.

With SSO redundancy, the StackWise Virtual standby switch is always ready to assume control if a fault occurs on the StackWise Virtual active switch. Configuration, forwarding, and state information are synchronized from the StackWise Virtual active switch to the redundant switch at startup, and whenever changes to the StackWise Virtual active switch configuration occur. If a switchover occurs, traffic disruption is minimized.

If StackWise Virtual does not meet the requirements for SSO redundancy, it will be incapable of establishing a relationship with the peer switch. StackWise Virtual runs stateful switchover (SSO) between the StackWise Virtual active and standby switches. The StackWise Virtual determines the role of each switch during initialization.

The CPU in the StackWise Virtual standby switch runs in hot standby state. StackWise Virtual uses SVL to synchronize configuration data from the StackWise Virtual active switch to the StackWise Virtual standby switch. Also, protocols and features that support high availability synchronize their events and state information to the StackWise Virtual standby switch.

Nonstop Forwarding

While implementing Nonstop Forwarding (NSF) technology in systems using SSO redundancy mode, network disruptions are minimized for campus users and applications. High availability is provided even when the control-plane processing stack-member switch is reset. During a failure of the underlying Layer 3, NSF-capable protocols perform graceful network topology resynchronization. The preset forwarding information on the redundant stack-member switch remains intact; this switch continues to forward the data in the network. This service availability significantly lowers the mean time to repair (MTTR) and increases the mean time between failure (MTBF) to achieve a high level of network availability.

Multichassis EtherChannels

Multichassis EtherChannel (MEC) is an EtherChannel bundled with physical ports having common characteristics such as speed and duplex, that are distributed across each Cisco StackWise Virtual system. A Cisco StackWise Virtual MEC can connect to any network element that supports EtherChannel (such as a host, server, router, or switch).

On the Cisco Catalyst 9600 Series Supervisor 1 Module, Cisco StackWise Virtual supports up to 192 MECs deployed in Layer 2 or Layer 3 modes. Cisco Catalyst 9600 Series Supervisor 2 Module (C9600X-SUP-2), Cisco StackWise Virtual support up to 240 MECs deployed in Layer 2 or Layer 3 modes, and EtherChannel 241 is reserved for internal SVL link EtherChannel bundling.

In a Cisco StackWise Virtual system, an MEC is an EtherChannel with additional capability. A multichassis EtherChannel link reduces the amount of traffic that requires transmission across the SVL by populating the index port only with the ports local to the physical switch. This allows the switch to give precedence to the local ports of the multichassis EtherChannel link over those on the remote switch.

Each MEC can optionally be configured to support either Cisco PAgP, IEEE LACP, or Static ON mode. We recommend that you implement EtherChannel using Cisco PAgP or LACP with a compatible neighbor. If a remotely connected neighbor such as Cisco Wireless LAN Controller (WLC) does not support this link-bundling protocol, then a Static ON mode can be deployed. These protocols run only on the Cisco StackWise Virtual active switch.

An MEC can support up to eight physical links that can be distributed in any proportion between the Cisco StackWise Virtual active switch and the Cisco StackWise Virtual standby switch. We recommend that you distribute the MEC ports across both switches evenly.

MEC Minimum Latency Load Balancing

The StackWise Virtual environment is designed such that data forwarding always remains within the switch. The Virtual Stack always tries to forward traffic on the locally available links. This is true for both Layer 2 and Layer3 links. The primary motivation for local forwarding is to avoid unnecessarily sending data traffic over the SVL and thus reduce the latency (extra hop over the SVL) and congestion. The bidirectional traffic is load-shared between the two StackWise Virtual members. However, for each StackWise Virtual member,

ingress and egress traffic forwarding is based on locally-attached links that are part of MEC. This local forwarding is a key concept in understanding convergence and fault conditions in a StackWise Virtual enabled campus network.

The active and standby switches support local forwarding that will individually perform the desired lookups and forward the traffic on local links to uplink neighbors. If the destination is a remote switch in the StackWise Virtual domain, ingress processing is performed on the ingress switch and then traffic is forwarded over the SVL to the egress switch where only egress processing is performed.

MEC Failure Scenarios

The following sections describe issues that may arise and the resulting impact:

Single MEC Link Failure

If a link within a MEC fails (and other links in the MEC are still operational), the MEC redistributes the load among the operational links, as in a regular port.

All MEC Links to the Cisco StackWise Virtual Active Switch Fail

If all the links to the Cisco StackWise Virtual active switch fail, a MEC becomes a regular EtherChannel with operational links to the Cisco StackWise Virtual standby switch.

Data traffic that terminates on the Cisco StackWise Virtual active switch reaches the MEC by crossing the SVL to the Cisco StackWise Virtual standby switch. Control protocols continue to run in the Cisco StackWise Virtual active switch. Protocol messages reach the MEC by crossing the SVL.

All MEC Links Fail

If all the links in an MEC fail, the logical interface for the EtherChannel is set to Unavailable. Layer 2 control protocols perform the same corrective action as for a link-down event on a regular EtherChannel.

On adjacent switches, routing protocols and the Spanning Tree Protocol (STP) perform the same corrective action as for a regular EtherChannel.

Cisco StackWise Virtual Standby Switch Failure

If the Cisco StackWise Virtual standby switch fails, a MEC becomes a regular EtherChannel with operational links on the Cisco StackWise Virtual active switch. Connected peer switches detect the link failures, and adjust their load-balancing algorithms to use only the links to the StackWise Virtual active switch.

Cisco StackWise Virtual Active Switch Failure

Cisco StackWise Virtual active switch failure results in a stateful switchover (SSO). After the switchover, a MEC is operational on the new Cisco StackWise Virtual active switch. Connected peer switches detect the link failures (to the failed switch), and adjust their load-balancing algorithms to use only the links to the new Cisco StackWise Virtual active switch.

Cisco StackWise Virtual Packet Handling

In Cisco StackWise Virtual, the Cisco StackWise Virtual active switch runs the Layer 2 and Layer 3 protocols and features and manages the ports on both the switches. Cisco StackWise Virtual uses SVL to communicate system and protocol information between the peer switches and to carry data traffic between the two switches.

The following sections describe packet handling in Cisco StackWise Virtual.

Traffic on StackWise Virtual Link

SVL carries data traffic and in-band control traffic between two switches. All the frames that are forwarded over the SVL are encapsulated with a special StackWise Virtual Header (SVH). The SVH adds an overhead of 64 bytes for control and data traffic, which provides information for Cisco StackWise Virtual to forward the packet on the peer switch.

An SVL transports control messages between two switches. Messages include protocol messages that are processed by the Cisco StackWise Virtual active switch, but received or transmitted by interfaces on the Cisco StackWise Virtual standby switch. Control traffic also includes module programming between the Cisco StackWise Virtual active switch and the switching modules on the Cisco StackWise Virtual standby switch.

Cisco StackWise Virtual transmits data traffic over an SVL under the following circumstances:

- Layer 2 traffic flooded over a VLAN (even for dual-homed links).
- Packets processed by software on the Cisco StackWise Virtual active switch where the ingress interface is on the Cisco StackWise Virtual standby switch.
- The packet destination is on the peer switch, as described in the following examples:
 - Traffic within a VLAN where the known destination interface is on the peer switch.
 - Traffic that is replicated for a multicast group and the multicast receivers are on the peer switch.
 - The known unicast destination MAC address is on the peer switch.
 - The packet is a MAC notification frame destined for a port on the peer switch.

An SVL also transports system data, such as NetFlow export data and SNMP data, from the Cisco StackWise Virtual standby switch to the Cisco StackWise Virtual active switch.

Traffic on the SVL is load balanced with the same global hashing algorithms available for EtherChannels (the default algorithm is source-destination IP and Port).

Interface numbering on the Cisco Catalyst 9600 Series Supervisor 1 Module and Cisco Catalyst 9600 Series Supervisor 2 Module (C9600X-SUP-2) operating in SVL mode is 4 tuple for SVL links, DAD links, and regular data traffic front-panel ports. For breakout interfaces, interface numbering is 5 tuple.

Layer 2 Protocols

The Cisco StackWise Virtual active switch runs the Layer 2 protocols (such as STP and VTP) for the switching modules on both the switches. Protocol messages that are received on the standby switch ports must traverse SVLs to reach the active switch where they are processed. Similarly, protocol messages that are transmitted from the standby switch ports originate on the active switch, and traverse the SVLs to reach the standby ports.

All the Layer 2 protocols in Cisco StackWise Virtual work similarly in standalone mode. The following sections describe the difference in behavior for some protocols in Cisco StackWise Virtual.

Spanning Tree Protocol

The Cisco StackWise Virtual active switch runs the STP. The Cisco StackWise Virtual standby switch redirects the STP BPDUs across an SVL to the StackWise Virtual active switch.

The STP bridge ID is commonly derived from the switch MAC address. To ensure that the bridge ID does not change after a switchover, Cisco StackWise Virtual continues to use the original switch MAC address for the STP Bridge ID.

EtherChannel Control Protocols

Link Aggregation Control Protocol (LACP) and Port Aggregation Protocol (PAgP) packets contain a device identifier. Cisco StackWise Virtual defines a common device identifier for both the switches. Use either PAgP or LACP on Multi EtherChannels instead of mode ON, even if all the three modes are supported.



Note A new PAgP enhancement has been defined for assisting with dual-active scenario detection.

Switched Port Analyzer

Switched Port Analyzer (SPAN) on SVL and fast hello DAD link ports is not supported. These ports can be neither a SPAN source, nor a SPAN destination. Cisco StackWise Virtual supports all the SPAN features for non-SVL interfaces. The number of SPAN sessions that are available on Cisco StackWise Virtual matches that on a single switch running in standalone mode.

Private VLANs

Private VLANs on StackWise Virtual work the same way as in standalone mode. The only exception is that the native VLAN on isolated trunk ports must be configured explicitly.

Apart from STP, EtherChannel Control Protocols, SPAN, and private VLANs, the Dynamic Trunking Protocol (DTP), Cisco Discovery Protocol (CDP), VLAN Trunk Protocol (VTP), and Unidirectional Link Detection Protocol (UDLD) are the additional Layer 2 control-plane protocols that run over the SVL connections.

Broadcast, Unknown Unicast and Multicast

Cisco StackWise Virtual supports local switching for Broadcast, Unknown unicast and Multicast (BUM) traffic. In uncommon deployment scenarios, BUM traffic traverses through the StackWise Virtual Links. This section explains how BUM traffic is handled in a Cisco StackWise Virtual setup and in local switching.

When a VLAN is created, StackWise Virtual ports are added to the VLAN flood list. The ingress BUM traffic on active or standby switch traverses through the StackWise Virtual link to the other switch instead of a port in the VLAN. This traffic floods the StackWise Virtual links which impacts the system and network performance.

To address this, StackWise Virtual BUM optimization feature is introduced.

A general deployment guideline for Cisco StackWise Virtual is to distribute MEC ports evenly at the uplink and downlink as shown in the figure. In this topology, BUM traffic prefers the local link on MEC to send the traffic out instead of the StackWise Virtual link. In a scenario where there is a standalone port on a switch or members of EtherChannel on active or standby switch are down, BUM traffic traverses the StackWise Virtual link. When StackWise Virtual BUM optimization is enabled on VLAN, StackWise Virtual port is not added to the VLAN flood list. This design ensures BUM traffic does not traverse StackWise Virtual link only when MEC port channels are part of the VLAN. No optimization is done for VLANs with standalone or physical ports.

Figure 2: Recommended Topology for Cisco StackWise Virtual

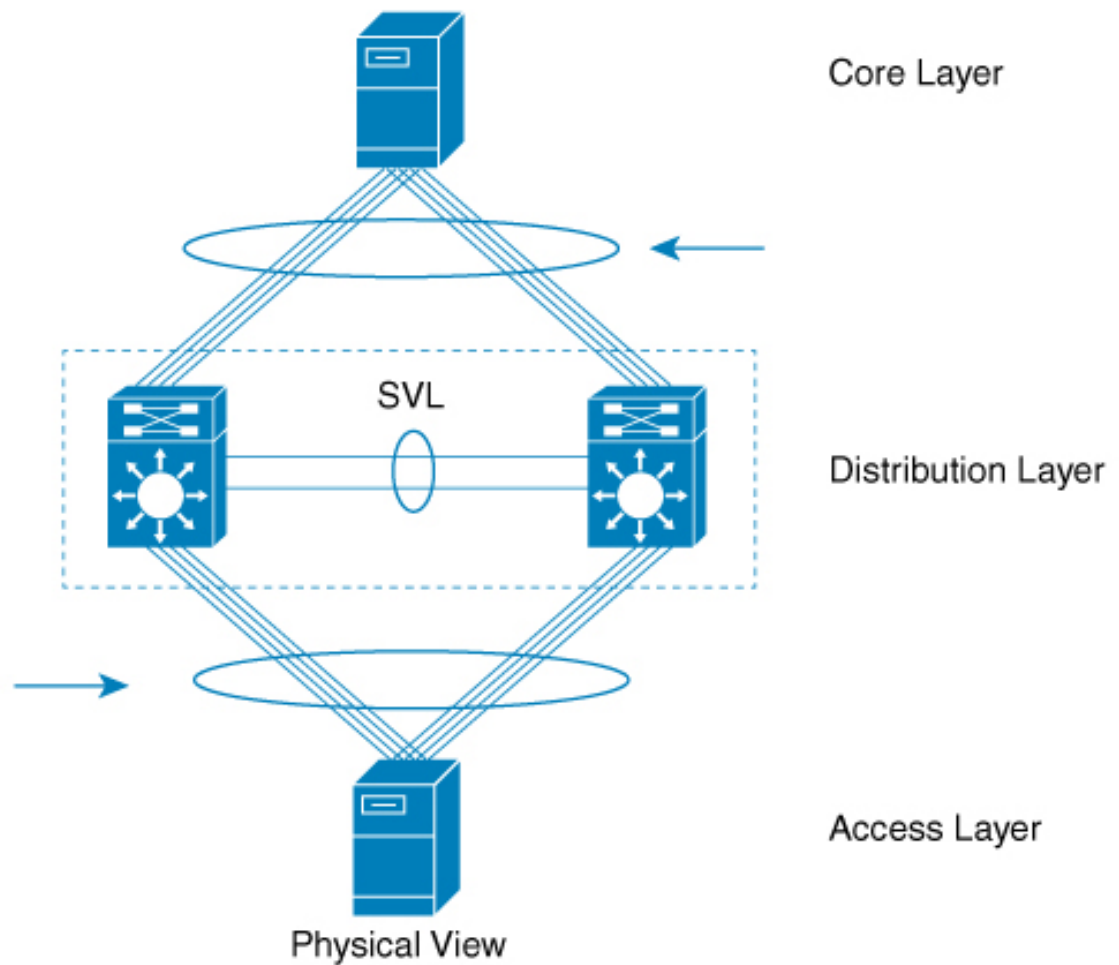

356591

Layer 3 Protocols

The Cisco StackWise Virtual active switch runs the Layer 3 protocols and features for the StackWise Virtual. All the Layer 3 protocol packets are sent to and processed by the Cisco StackWise Virtual active switch. Both the member switches perform hardware forwarding for ingress traffic on their interfaces. When software forwarding is required, packets are sent to the Cisco StackWise Virtual active switch for processing.

The same router MAC address assigned by the Cisco StackWise Virtual active switch is used for all the Layer 3 interfaces on both the Cisco StackWise Virtual member switches. After a switchover, the original router MAC address is still used. The router MAC address is chosen based on chassis-mac and is preserved after switchover by default.

The following sections describe the Layer 3 protocols for Cisco StackWise Virtual.

IPv4 Unicast

The CPU on the Cisco StackWise Virtual active switch runs the IPv4 routing protocols and performs any required software forwarding. All the routing protocol packets received on the Cisco StackWise Virtual standby

switch are redirected to the Cisco StackWise Virtual active switch across the SVL. The Cisco StackWise Virtual active switch generates all the routing protocol packets to be sent out over ports on either of the Cisco StackWise Virtual member switches.

Hardware forwarding is distributed across both members on Cisco StackWise Virtual. The CPU on the Cisco StackWise Virtual active switch sends Forwarding Information Base (FIB) updates to the Cisco StackWise Virtual standby switch, which in turn installs all the routes and adjacencies into hardware.

Packets intended for a local adjacency (reachable by local ports) are forwarded locally on the ingress switch. Packets intended for a remote adjacency (reachable by remote ports) must traverse the SVL.

The CPU on the Cisco StackWise Virtual active switch performs all software forwarding and feature processing (such as fragmentation and Time to Live exceed functions). If a switchover occurs, software forwarding is disrupted until the new Cisco StackWise Virtual active switch obtains the latest Cisco Express Forwarding and other forwarding information.

In virtual switch mode, the requirements to support non-stop forwarding (NSF) match those in the standalone redundant mode of operation.

From a routing peer perspective, Multi-Chassis EtherChannels (MEC) remain operational during a switchover, that is, only the links to the failed switch are down, but the routing adjacencies remain valid.

Cisco StackWise Virtual achieves Layer 3 load balancing over all the paths in the Forwarding Information Base entries, be it local or remote.

IPv6

Cisco StackWise Virtual supports IPv6 unicast and multicast because it is present in the standalone system.

IPv4 Multicast

The IPv4 multicast protocols run on the Cisco StackWise Virtual active switch. Internet Group Management Protocol (IGMP) and Protocol Independent Multicast (PIM) protocol packets received on the Cisco StackWise Virtual standby switch are transmitted across an SVL to the StackWise Virtual active switch. The latter generates IGMP and PIM protocol packets to be sent over ports on either of the Cisco StackWise Virtual members.

The Cisco StackWise Virtual active switch synchronizes the Multicast Forwarding Information Base (MFIB) state to the Cisco StackWise Virtual standby switch. On both the member switches, all the multicast routes are loaded in the hardware, with replica expansion table (RET) entries programmed for only local, outgoing interfaces. Both the member switches are capable of performing hardware forwarding.



Note To avoid multicast route changes as a result of a switchover, we recommend that all the links carrying multicast traffic be configured as MEC rather than Equal Cost Multipath (ECMP).

For packets traversing an SVL, all Layer 3 multicast replications occur on the egress switch. If there are multiple receivers on the egress switch, only one packet is replicated and forwarded over the SVL, and then replicated to all the local egress ports.

Software Features

Software features run only on the Cisco StackWise Virtual active switch. Incoming packets to the Cisco StackWise Virtual standby switch that require software processing are sent across an SVL to the Cisco StackWise Virtual active switch.

Dual-Active Detection

If the standby switch detects a complete loss of the SVL, it assumes the active switch has failed and will take over as the active switch. However, if the original Cisco StackWise Virtual active switch is still operational, both the switches will now be Cisco StackWise Virtual active switches. This situation is called a dual-active scenario. This scenario can have adverse effects on network stability because both the switches use the same IP addresses, SSH keys, and STP bridge IDs. Cisco StackWise Virtual detects a dual-active scenario and takes recovery action. DAD link is the dedicated link used to mitigate this.

If the last available SVL fails, the Cisco StackWise Virtual standby switch cannot determine the state of the Cisco StackWise Virtual active switch. To ensure network uptime without delay, the Cisco StackWise Virtual standby switch then assumes the Cisco StackWise Virtual active role. The original Cisco StackWise Virtual active switch enters recovery mode and brings down all its interfaces, except the SVL and the management interfaces.



Note On the Cisco Catalyst 9600 Series Supervisor 2 Module (C9600X-SUP-2):

- Dynamic addition and removal of SVL and DAD links are supported. If the switch is already operating in SVL mode, a device restart is not required for the SVL and DAD link addition or removal configuration to take effect.
- If a user tries to remove the last active SVL link, the user is notified of a stack split through a syslog message.

Dual-Active-Detection Link with Fast Hello

To use the dual-active fast hello packet detection method, you must provision a direct ethernet connection between the two Cisco StackWise Virtual switches. You can dedicate up to four links for this purpose.

The two switches start with exchanging dual-active hello messages containing information about the initial switch states. If all SVLs fail and a dual-active scenario occurs, each switch will trigger an exchange of the dual-active hello messages which allows it to recognize that there is a dual-active scenario from the peer's messages.

This initiates recovery actions as described in the [Recovery Actions, on page 24](#) section. If a switch does not receive an expected dual-active fast hello message from the peer before the timer expires, the switch assumes that the link is no longer capable of dual-active detection.



Note Do not use the same port for StackWise Virtual Link and dual-active detection link.

Dual-Active Detection with enhanced PAgP

Port aggregation protocol (PAgP) is a Cisco proprietary protocol used for managing EtherChannels. If a StackWise Virtual MEC terminates on a Cisco switch, you can run PAgP protocol on the MEC. If PAgP is running on the MECs between the StackWise Virtual switch and an upstream or downstream switch, the StackWise Virtual can use PAgP to detect a dual-active scenario. The MEC must have at least one port on each switch of the StackWise Virtual setup.

Enhanced PAGP is an extension of the PAGP protocol. In virtual switch mode, ePAGP messages include a new type length value (TLV) which contains the ID of the StackWise Virtual active switch. Only switches in virtual switch mode send the new TLV.

When the StackWise Virtual standby switch detects SVL failure, it initiates SSO and becomes StackWise Virtual active. Subsequent ePAGP messages sent to the connected switch from the newly StackWise Virtual active switch contain the new StackWise Virtual active ID. The connected switch sends ePAGP messages with the new StackWise Virtual active ID to both StackWise Virtual switches.

If the formerly StackWise Virtual active switch is still operational, it detects the dual-active scenario because the StackWise Virtual active ID in the ePAGP messages changes.

Figure 3: Dual-active-detection with ePAGP

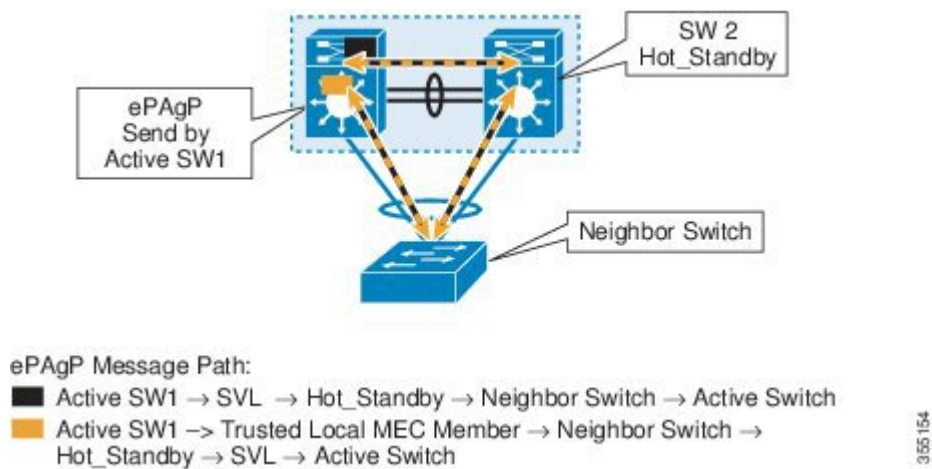

Note To avoid PAGP flaps and to ensure that dual-active detection functions as expected, the stack MAC persistent wait timer must be configured as indefinite using the command **stack-mac persistent timer 0**.

Recovery Actions

A Cisco StackWise Virtual active switch that detects a dual-active condition shuts down all of its non-SVL or non-DAD interfaces to remove itself from the network. The switch then waits in recovery mode until the SVLs recover. You should physically repair the SVL failure and the switch automatically reloads and restores itself as the standby switch. To enable the switch to remain in recovery mode after restoring the SVL links, see [Disabling Recovery Reload, on page 36](#) section.

Implementing Cisco StackWise Virtual

The two-node solution of Cisco StackWise Virtual is normally deployed at the aggregation layer. Two switches are connected over an SVL.

Cisco StackWise Virtual combines the two switches into a single logical switch with a large number of ports, offering a single point of management. One of the member switches is the active and works as the control and management plane, while the other one is the standby. The virtualization of multiple physical switches into a single logical switch is only from a control and management perspective. Because of the control plane being common, it may look like a single logical entity to peer switches. The data plane of the switches are

converged, that is, the forwarding context of a switch might be passed to the other member switch for further processing when traffic is forwarded across the switches. However, the common control plane ensures that all the switches have equivalent data plane entry for each forwarding entity.

Figure 4: Two-Node Solution

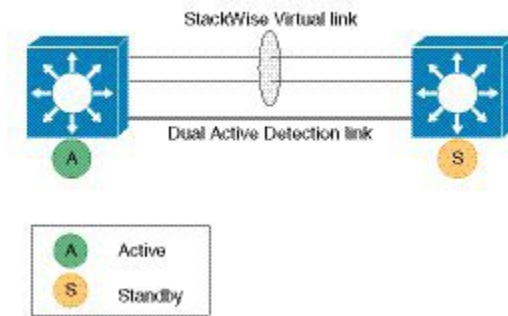

An election mechanism that determines which switch is Cisco StackWise Virtual active and which one is a control plane standby, is available. The active switch is responsible for management, bridging and routing protocols, and software data path. These are centralized on the active switch supervisor of the Cisco StackWise Virtual active switch.

How to Configure Cisco StackWise Virtual

Configuring Cisco StackWise Virtual Settings

To enable StackWise Virtual, perform the following procedure on both the switches:

Procedure

	Command or Action	Purpose
Step 1	enable Example: Device> enable	Enables privileged EXEC mode. Enter your password, if prompted.
Step 2	switch <i>switch-number</i> renumber <i>new switch-number</i> Example: Device# switch 1 renumber 2	(Optional) Reassigns the switch number. The default switch number will be 1. The valid values for the new switch number are 1 and 2.
Step 3	switch <i>switch-number</i> priority <i>priority-number</i> Example: Device# switch 1 priority 5	(Optional) Assigns the priority number. The default priority number is 1. The highest priority number is 15.
Step 4	configure terminal Example:	Enters global configuration mode.

	Command or Action	Purpose
	Device# <code>configure terminal</code>	
Step 5	stackwise-virtual Example: Device (config)# <code>stackwise-virtual</code>	Enables Cisco StackWise Virtual and enters stackwise-virtual submode.
Step 6	domain id Example: Device (config-stackwise-virtual)# <code>domain 2</code>	(Optional) Specifies the Cisco StackWise Virtual domain ID. The domain ID range is from 1 to 255. The default value is one.
Step 7	end Example: Device (config-stackwise-virtual)# <code>end</code>	Returns to privileged EXEC mode.
Step 8	show stackwise-virtual Example: Device# <code>show stackwise-virtual</code>	
Step 9	write memory Example: Device# <code>write memory</code>	Saves the running-configuration which resides in the system RAM and updates the ROMmon variables. If you do not save the changes, the changes will no longer be part of the startup configuration when the switch reloads. Note that the configurations for stackwise-virtual and domain are saved to the running-configuration and the startup-configuration after the reload. Note On the Cisco Catalyst 9600 Series Supervisor 2 Module (C9600X-SUP-2), the system database is updated instead of ROMMON variables.
Step 10	reload Example: Device# <code>reload</code>	Restarts the switch and forms the stack.

Configuring Cisco StackWise Virtual Link



- Note**
- Depending on the switch model, SVL is supported on all 400G, 100G, 50G, 40G, 25G and 10G interfaces of the Cisco Catalyst 9600 Series switches. However, a combination of different interface speeds is not supported.
 - Dynamic addition and removal of SVL links are supported on the Cisco Catalyst 9600 Series Supervisor 2 Module (C9600X-SUP-2), and therefore, a reload is not required for adding or removing the SVL links when the device is already operating in SVL mode.
 - If a user tries to remove the last active SVL link, they will be notified of a stack split through a syslog message.

To configure a switch port as an SVL port, perform the following procedure on both the switches:

Procedure

	Command or Action	Purpose
Step 1	enable Example: Device> enable	Enables privileged EXEC mode. Enter your password, if prompted.
Step 2	configure terminal Example: Device# configure terminal	Enters global configuration mode.
Step 3	interface { HundredGigabitEthernet FortyGigabitEthernet TenGigabitEthernet TwentyFiveGigabitEthernet } <interface> Example: Device(config)# interface FortyGigabitEthernet1/0/5	Enters ethernet interface configuration mode.
Step 4	stackwise-virtual link <i>link value</i> Example: Device(config-if)# stackwise-virtual link 1	Associates the interface with configured SVL.
Step 5	end Example: Device(config-if)# end	Returns to privileged EXEC mode.
Step 6	write memory Example: Device# write memory	Saves the running-configuration which resides in the system RAM and updates the ROMMON variables. If you do not save the changes, the

	Command or Action	Purpose
		<p>changes will no longer be part of the startup configuration when the switch reloads. Note that the configuration for stackwise-virtual link link value is saved only in the running-configuration and not the startup-configuration.</p> <p>Note On the Cisco Catalyst 9600 Series Supervisor 2 Module (C9600X-SUP-2), the system database is updated instead of ROMMON variables.</p>
<p>Step 7</p>	<p>reload</p> <p>Example:</p> <pre>Device# reload</pre>	<p>Restarts the switch.</p> <p>Note: When converting a Cisco Catalyst 9600 Series switch from standalone mode to SVL mode for the first time, one of the switches boots up or resets, for resolving the switch number conflict and sets the SWITCH_NUMBER environment variable to 2. The following message appears on the console prompt indicating this:</p> <pre>Waiting for remote chassis to join ##### Chassis number is 2 All chassis in the stack have been discovered. Accelerating discovery Chassis is reloading, reason: Configured Switch num conflicts with peer, Changing local switch number to 2 and reloading to take effect On the Cisco Catalyst 9600 Series Supervisor 2 Module (C9600X-SUP-2), the following message is displayed on the console prompt: %CLUSTERMGR-1-RELOAD: B0/0: clustermgr: Reloading due to reason Chassis is reloading; switch num conflicts with peer, changing local switch number to 2 and reloading to take effect %PMAN-5-EXITACTION: B0/0: pvp: Process manager is exiting: process exit with reload fru code %PMAN-5-EXITACTION: R0/0: pvp: Process manager is exiting: reload fru action requested</pre>

While restarting the Cisco Catalyst 9600 Series Supervisor 2 Module (C9600X-SUP-2) to enable the SVL, an initial prompt corresponding to the IOSd-BP is seen:

** Note ** Please note the MAC address in this prompt corresponds to the BIA on the GigabitEthernet 0/0 which is the Management interface on the switch

This prompt is a transitional prompt during the bringup phase before the IOS-XE prompt appears on the console, please do not issue any show commands on this prompt. None of the standard show commands are supported on IOSd-BP prompt.

Once the LACP and ISIS protocol negotiations are completed for the SVL and DAD links, IOSd-RP prompt will be launched which is the regular IOS-XE CLI prompt

Initializing Hardware.....

System Bootstrap, Version 17.11.1[Int-Alpha], RELEASE SOFTWARE (P)
Compiled Fri Aug 26 10:18:40 2022 by rel

Current ROMMON image : Primary Rommon Image

Last reset cause:CPU Reset
C9600X-SUP-2 platform with 33554432 Kbytes of main memory

Preparing to autoboot. [Press Ctrl-C to interrupt] 0
boot: attempting to boot from [bootflash:packages.conf]
boot: reading file packages.conf

<output truncated>

The following is a sample output from the C9600-X-SUP2 module bootup in SVL mode:

<<Beginning of the IOSd-BP prompt >>>>>

```
*Sep 24 04:09:28.926: %LINK-3-UPDOWN: Interface CEOBC, changed state to up
sw.3C57310481C0-bp>enable
sw.3C57310481C0-bp#
sw.3C57310481C0-bp#
*Sep 24 04:09:29.926: %LINEPROTO-5-UPDOWN: Line protocol on Interface CEOBC, changed state
to up
sw.3C57310481C0-bp#
sw.3C57310481C0-bp#
*Sep 24 04:09:38.960: %PKI-2-NON_AUTHORITATIVE_CLOCK: PKI functions can not be initialized
until an authoritative time source, like NTP, can be obtained.
sw.3C57310481C0-bp#
sw.3C57310481C0-bp#
*Sep 24 04:09:51.642: %SPA_OIR-6-ONLINECARD: SPA (C9600-LC-48YL) online in subslot 2/0
*Sep 24 04:09:52.068: %SPA_OIR-6-ONLINECARD: SPA (C9600-LC-24C) online in subslot 5/0
sw.3C57310481C0-bp#
sw.3C57310481C0-bp#
*Sep 24 04:10:12.810: %SPA_OIR-6-ONLINECARD: SPA (C9600-LC-48TX) online in subslot 6/0
sw.3C57310481C0-bp#
*Sep 24 04:10:18.494: %LINK-3-UPDOWN: Interface HundredGigE5/0/17, changed state to up
*Sep 24 04:10:20.512: %LINK-3-UPDOWN: Interface Port-channel241, changed state to up
*Sep 24 04:10:21.512: %LINEPROTO-5-UPDOWN: Line protocol on Interface HundredGigE5/0/17,
changed state to up
*Sep 24 04:10:21.512: %LINEPROTO-5-UPDOWN: Line protocol on Interface Port-channel241,
changed state to up
sw.3C57310481C0-bp#
*Sep 24 04:10:23.515: %CLNS-5-ADJCHANGE: ISIS: Adjacency to 0490.0415.8000 (Port-channel241)
Up, new adjacency
*Sep 24 04:10:30.611: %CLNS-5-ADJCHANGE: ISIS: Adjacency to sw.3C5731049E00 (Port-channel241)
Up, new adjacency
Restricted Rights Legend
```

Use, duplication, or disclosure by the Government is subject to restrictions as set forth in subparagraph (c) of the Commercial Computer Software - Restricted Rights clause at FAR sec. 52.227-19 and subparagraph (c) (1) (ii) of the Rights in Technical Data and Computer

Software clause at DFARS sec. 252.227-7013.

Cisco Systems, Inc.
170 West Tasman Drive
San Jose, California 95134-1706

Cisco IOS Software [Dublin], Catalyst L3 Switch Software (CAT9K_IOSXE), Experimental Version
17.10.20220921:075136 [BLD_V1710_THROTTLE_LATEST_20220921_071938:/nobackup/mcpres/s2c-build-ws
101]

Copyright (c) 1986-2022 by Cisco Systems, Inc.
Compiled Wed 21-Sep-22 00:52 by mcpre

This software version supports only Smart Licensing as the software licensing mechanism.

PLEASE READ THE FOLLOWING TERMS CAREFULLY. INSTALLING THE LICENSE OR
LICENSE KEY PROVIDED FOR ANY CISCO SOFTWARE PRODUCT, PRODUCT FEATURE,
AND/OR SUBSEQUENTLY PROVIDED SOFTWARE FEATURES (COLLECTIVELY, THE
"SOFTWARE"), AND/OR USING SUCH SOFTWARE CONSTITUTES YOUR FULL
ACCEPTANCE OF THE FOLLOWING TERMS. YOU MUST NOT PROCEED FURTHER IF YOU
ARE NOT WILLING TO BE BOUND BY ALL THE TERMS SET FORTH HEREIN.

Your use of the Software is subject to the Cisco End User License Agreement
(EULA) and any relevant supplemental terms (SEULA) found at
<http://www.cisco.com/c/en/us/about/legal/cloud-and-software/software-terms.html>.

You hereby acknowledge and agree that certain Software and/or features are
licensed for a particular term, that the license to such Software and/or
features is valid only for the applicable term and that such Software and/or
features may be shut down or otherwise terminated by Cisco after expiration
of the applicable license term (e.g., 90-day trial period). Cisco reserves
the right to terminate any such Software feature electronically or by any
other means available. While Cisco may provide alerts, it is your sole
responsibility to monitor your usage of any such term Software feature to
ensure that your systems and networks are prepared for a shutdown of the
Software feature.

*Sep 24 04:10:35.378: %IOSXE_OIR-6-ONLINECARD: Card (fp) online in slot F0
*Sep 24 04:10:35.468: %SYS-5-CONFIG_P: Configured programmatically by process IOSD ipc task
from console as vty2

FIPS: Crimson DB Key Check : Key Not Found, FIPS Mode Not Enabled
cisco C9606R (X86) processor (revision V01) with 6029940K/6147K bytes of memory.

Processor board ID FXS2418Q1V9
0 Virtual Ethernet interface
78 Forty/Hundred Gigabit Ethernet interfaces
136 Ten/TwentyFive/Fifty Gigabit Ethernet interfaces
2 Forty/Hundred/TwoHundred Gigabit Ethernet interfaces
4 Forty/Hundred/FourHundred Gigabit Ethernet interfaces
96 Ten Gigabit Ethernet interfaces
32768K bytes of non-volatile configuration memory.
33554432K bytes of physical memory.
11161600K bytes of Bootflash at bootflash:.
1638400K bytes of Crash Files at crashinfo:.
234430023K bytes of SATA hard disk at disk0:.
11161600K bytes of Bootflash at bootflash-2-0:.
1638400K bytes of Crash Files at crashinfo-2-0:.
234430023K bytes of SATA hard disk at disk0-2-0:.

Base Ethernet MAC Address : 3c:57:31:04:81:c0

```
Motherboard Assembly Number : 4DB9
Motherboard Serial Number : FXS241400M8
Model Revision Number : V02
Motherboard Revision Number : 6
Model Number : C9606R
System Serial Number : FXS2418Q1V9
```

<<followed by the regular IOS-XE CLI prompt>>

Enabling 400G SVL on the C9600X-LC-32CD Line Card

SVL and DAD link configurations on the QSFP-DD interfaces (400G Ethernet ports 27 and 31) of the C9600X-LC-32CD line card are not supported when the ports are operating in non-SVL mode. To enable the SVL links on ports 27 and 31, you must first enable StackWise Virtual on both the switches without configuring any links as SVL or DAD.

After both the switches are up in StackWise Virtual mode after reload, execute the **hw-module switch {1 | 2} slot number port-group range mode 400G** command to enable the 400G interface. After the **hw-module** configuration is complete, you can configure the linked 400G interfaces (FourHundredGigabitEthernet 27 and FourHundredGigabitEthernet 31) as SVL links and run the **write memory** command to save the configuration.

The switches then auto-detect the SVL links, and one of the switches restarts because of stack merge. In the next restart cycle, the same switch restarts again to set switch number 2. In subsequent restart cycles, the device joins the SVL stack as standby, and the entire SVL system reaches SSO state. You can use the **show stackwise-virtual link** and **show switch** commands to verify whether the switch is operating in SVL mode in SSO state.

Configuring Secure StackWise Virtual

Before you begin



Note

- Ensure that the devices are in a standalone mode.
- Disable FIPS mode using the **no fips authorization-key** command before configuring the Secure StackWise Virtual authorization key.

Procedure

	Command or Action	Purpose
Step 1	enable Example: Device> enable	Enables privileged EXEC mode. Enter your password, if prompted.
Step 2	configure terminal Example: Device# configure terminal	Enters global configuration mode.

	Command or Action	Purpose
Step 3	secure-stackwise-virtual authorization-key <128-bits> Example: Device(config)# secure-stackwise-virtual authorization-key <128-bits>	Configures the Secure StackWise Virtual authorization key.
Step 4	exit Example: Device(config)# exit	Returns to privileged EXEC mode.
Step 5	reload Example: Device# reload	Restarts the switch and the configuration of Secure StackWise Virtual takes effect.

Configuring BUM Traffic Optimization

To configure BUM traffic optimization globally, perform the following procedure:

Procedure

	Command or Action	Purpose
Step 1	enable Example: Device> enable	Enables privileged EXEC mode. Enter your password, if prompted.
Step 2	configure terminal Example: Device# configure terminal	Enters global configuration mode.
Step 3	svl l2bum optimization Example: Device(config)# svl l2bum optimization	Enables the BUM traffic optimization within StackWise Virtual setup globally. This feature is enabled by default. Use the no form of this command to disable this feature.
Step 4	end Example: Device(config-if)# end	Returns to privileged EXEC mode.
Step 5	show platform pm l2bum-status vlan <i>vlan-id</i> Example: Device# show platform pm l2bum-status vlan 1	Displays the number of forwarding ports in VLAN. number of physical ports count in forwarding state

	Command or Action	Purpose
Step 6	show platform software fed switch ac fss bum-opt summary Example: Device# <code>show platform software fed switch ac fss bum-opt summary</code>	Displays the final state of optimization.

Configuring StackWise Virtual Fast Hello Dual-Active-Detection Link

To configure StackWise Virtual Fast Hello DAD link, perform the following procedure. This procedure is optional.



Note Dynamic addition and removal of DAD links are supported on Cisco Catalyst 9600 Series Supervisor 2 Module (C9600X-SUP-2), and therefore, a reload is not required for adding or removing the DAD links when the device is already operating in SVL mode.

Procedure

	Command or Action	Purpose
Step 1	enable Example: Device> <code>enable</code>	Enables privileged EXEC mode. <ul style="list-style-type: none"> • Enter your password, if prompted.
Step 2	configure terminal Example: Device# <code>configure terminal</code>	Enters global configuration mode.
Step 3	interface { HundredGigabitEthernet FortyGigabitEthernet TenGigabitEthernet TwentyFiveGigabitEthernet } <interface> Example: Device(config)# <code>interface FortyGigabitEthernet1/0/20</code>	Enters ethernet interface configuration mode.
Step 4	stackwise-virtual dual-active-detection Example: Device(config-if)# <code>stackwise-virtual dual-active-detection</code>	Associates the interface with StackWise Virtual dual-active-detection. Note This command will not be visible on the device after the configuration, but will continue to function.
Step 5	end Example: Device(config-if)# <code>end</code>	Returns to privileged EXEC mode.

	Command or Action	Purpose
Step 6	write memory Example: Device# <code>write memory</code>	Saves the running-configuration which resides in the system RAM and updates the ROMMON variables. If you do not save the changes, the changes will no longer be part of the startup configuration when the switch reloads. Note that the configuration for stackwise-virtual dual-active-detection is saved only in the running-configuration and not the startup-configuration. Note On the Cisco Catalyst 9600 Series Supervisor 2 Module (C9600X-SUP-2), the system database is updated instead of ROMMON variables.
Step 7	reload Example: Device# <code>reload</code>	Restarts the switch and configuration takes effect.

Enabling ePAgP Dual-Active-Detection

To enable ePAgP dual-active-detection on a switch port, perform the following procedure on both the switches. This procedure is optional.

Procedure

	Command or Action	Purpose
Step 1	enable Example: Device> <code>enable</code>	Enables privileged EXEC mode. <ul style="list-style-type: none"> • Enter your password if prompted.
Step 2	configure terminal Example: Device# <code>configure terminal</code>	Enters global configuration mode.
Step 3	interface { HundredGigabitEthernet FortyGigabitEthernet TenGigabitEthernet TwentyFiveGigabitEthernet } <i>interface</i> Example: Device(config)# <code>interface</code> FortyGigabitEthernet 1/0/5	Enters the interface configuration mode.

	Command or Action	Purpose
Step 4	channel-group <i>group_ID</i> mode desirable Example: Device(config-if) # channel-group 1 mode desirable	Enables PAgP MEC with channel-group id in the range of 1 to for 10 GigabitEthernet interfaces.
Step 5	exit Example: Device(config-if) # exit	Exits interface configuration.
Step 6	interface port-channel <i>channel-group-id</i> Example: Device(config) # interface port-channel 1	Selects a port channel interface to configure.
Step 7	shutdown Example: Device(config-if) # shutdown	Shuts down an interface.
Step 8	exit Example: Device(config-if) # exit	Exits interface configuration.
Step 9	stackwise-virtual Example: Device(config) # stackwise-virtual	Enters the StackWise Virtual configuration mode.
Step 10	dual-active detection pagp Example: Device(config-stackwise-virtual) # dual-active detection pagp	Enables pagp dual-active detection. This is enabled by default.
Step 11	dual-active detection pagp trust channel-group <i>channel-group id</i> Example: Device(config-stackwise-virtual) # dual-active detection pagp trust channel-group 1	Enables dual-active detection trust mode on channel-group with the configured ID.
Step 12	exit Example: Device(config-stackwise-virtual) # exit	Exits the StackWise-Virtual configuration mode.
Step 13	interface port-channel <i>portchannel</i> Example: Device(config) # interface port-channel 1	Configured port-channel on the switch.

	Command or Action	Purpose
Step 14	no shutdown Example: Device(config-if)# no shutdown	Enables the configured port-channel on the switch.
Step 15	end Example: Device(config-if)# end	Exits interface configuration.
Step 16	write memory Example: Device# write memory	Saves the running-configuration which resides in the system RAM and updates the ROMMON variables. If you do not save the changes, the changes will no longer be part of the startup configuration when the switch reloads. Note that the configuration for dual-active detection pagp trust channel-group <i>channel-group id</i> is saved to the running-configuration and the startup-configuration after the reload. Note On the Cisco Catalyst 9600 Series Supervisor 2 Module (C9600X-SUP-2), the system database is updated instead of ROMMON variables.
Step 17	reload Example: Device# reload	Restarts the switch and configuration takes effect.

Disabling Recovery Reload

After recovering from StackWise Virtual link failure, the switch in recovery mode performs a recovery action by automatically reloading the switch. This is the default behaviour in the event of a link failure. In order to retain a switch in recovery mode and prevent the switch from reloading automatically, you must perform the following steps.

Procedure

	Command or Action	Purpose
Step 1	enable Example: Device> enable	Enables privileged EXEC mode. Enter your password, if prompted.
Step 2	configure terminal Example:	Enters global configuration mode.

	Command or Action	Purpose
	Device# <code>configure terminal</code>	
Step 3	stackwise-virtual Example: Device(config)# <code>stackwise-virtual</code>	Enables Cisco StackWise Virtual and enters stackwise-virtual mode.
Step 4	dual-active recovery-reload-disable Example: Device(config-stackwise-virtual)# <code>dual-active recovery-reload-disable</code>	Disables automatic recovery reload of the switch. Disables automatic reload of the switch in recovery mode. Note that the configuration for dual-active recovery-reload-disable is saved only in the running-configuration and not the startup-configuration.
Step 5	end Example: Device(config-stackwise-virtual)# <code>end</code>	Returns to privileged EXEC mode.

Disabling Cisco StackWise Virtual

To disable Cisco StackWise Virtual on a switch, perform the following procedure:

Procedure

	Command or Action	Purpose
Step 1	enable Example: Device> <code>enable</code>	Enables privileged EXEC mode. Enter your password, if prompted.
Step 2	configure terminal Example: Device# <code>configure terminal</code>	Enters global configuration mode.
Step 3	interface {HundredGigabitEthernet FortyGigabitEthernet TenGigabitEthernet TwentyFiveGigabitEthernet} <interface> Example: Device(config)# <code>interface FortyGigabitEthernet 1/0/10</code>	Enters ethernet interface configuration mode.
Step 4	no stackwise-virtual dual-active-detection Example:	Dissociates the interface from StackWise Virtual DAD.

	Command or Action	Purpose
	<code>Device(config-if)# no stackwise-virtual dual-active-detection</code>	
Step 5	Repeat step 3 Example: <code>Device(config)# interface FortyGigabitEthernet 1/0/5</code>	Enters the interface configuration mode.
Step 6	<code>no stackwise-virtual link link</code> Example: <code>Device(config-if)# no stackwise-virtual link 1</code>	Dissociates the interface from SVL.
Step 7	<code>exit</code> Example: <code>Device(config-if)# exit</code>	Exits interface configuration.
Step 8	<code>no stackwise-virtual</code> Example: <code>Device(config)# no stackwise-virtual</code>	Disables StackWise Virtual configuration.
Step 9	<code>exit</code> Example: <code>Device(config)# exit</code>	Exits the global configuration mode.
Step 10	<code>write memory</code> Example: <code>Device# write memory</code>	Saves the running configuration.
Step 11	<code>reload</code> Example: <code>Device# reload</code>	Restarts the switch and the configuration takes effect.

Disabling Secure StackWise Virtual

To disable Secure StackWise Virtual, perform the following procedure:

Procedure

	Command or Action	Purpose
Step 1	<code>enable</code> Example: <code>Device> enable</code>	Enables privileged EXEC mode. Enter your password if prompted.

	Command or Action	Purpose
Step 2	configure terminal Example: Device# <code>configure terminal</code>	Enters global configuration mode.
Step 3	secure-stackwise-virtual zeroize sha1-key Example: Device(config)# <code>secure-stackwise-virtual zeroize sha1-key</code>	Zeroization of the Secure StackWise Virtual SHA-1 key from the device by deleting the IOS image and configuration files.
Step 4	reload Example: Device# <code>reload</code>	Restarts the device and disables Secure StackWise Virtual. Note You must reboot the device.
Step 5	configure terminal Example: Device# <code>configure terminal</code>	Enters global configuration mode.
Step 6	no secure-stackwise-virtual authorization-key Example: Device(config)# <code>no secure-stackwise-virtual authorization-key</code>	Removes the authorization key without zeroizing it. Note You must reload the device for the authorization key to be removed.

Configuration Examples for StackWise Virtual

This section provides the following configuration examples:

- [Example: Configuring StackWise Virtual Link, on page 39](#)
- [Example: Displaying StackWise Virtual Link Information, on page 42](#)

Example: Configuring StackWise Virtual Link

The following is a sample configuration for configuring SVL on a switch.

```
On Switch 1:
Device>enable
Device#configure terminal
Device(config)#interface FortyGigabitEthernet1/0/5
Device(config-if)#stackwise-virtual link 1
WARNING: All the extraneous configurations will be removed for FortyGigabitEthernet1/1/1
on reboot
INFO: Upon reboot, the config will be part of running config but not part of start up config.
Device(config-if)#end
Device#write memory
Device#reload
```

```

On Switch 2:
Device>enable
Device#configure terminal
Device(config)#interface FortyGigabitEthernet1/0/5
Device(config-if)#stackwise-virtual link 1
WARNING: All the extraneous configurations will be removed for FortyGigabitEthernet1/1/1
on reboot
INFO: Upon reboot, the config will be part of running config but not part of start up config.
Device(config-if)#end
Device#write memory
Device#reload

```

The following example show how to configure SVL on the Cisco Catalyst 9600 Series Supervisor 2 Module (C9600X-SUP-2):

```

Device> enable
Device# configure terminal
Device(config)# interface FiftyGigabitEthernet1/0/5
Device(config-if)# stackwise-virtual link 1
WARNING: AUTO-LC-SHUTDOWN is disabled for chassis 1. Suggested to be enabled and configured
with highest priority for line cards with stackwise virtual links
WARNING: All the extraneous configurations will be removed for FiftyGigE1/0/5
*Sep 29 09:33:25.572: %SYS-5-CONFIG_P: Configured programmatically by process Exec from
console as console

```

Example: Configuring Secure StackWise Virtual

The following is a sample configuration for configuring Secure StackWise Virtual.

```
Device (config)# secure-stackwise-virtual authorization-key <128-bits>
```

Example: Displaying Secure StackWise Virtual Authorization Key and Status

The following is an example displaying the Secure StackWise Virtual authorization key.

```
Device# show secure-stackwise-virtual authorization-key

Secure-stackwise-virtual: Stored key (16) : 12345678901234567890123456789012
```

The following is an example displaying the Secure StackWise Virtual authorization key status.

```
Device# show secure-stackwise-virtual status

Switch is running in SECURE-SVL mode
```

Example: Disabling Secure StackWise Virtual

The following is an example of Secure StackWise Virtual authorization key zeroization.

```
Device(config)# secure-stackwise-virtual zeroize sha1-key

**Critical Warning** - This command is irreversible
and will zeroize the Secure-SVL-VPK by Deleting
the IOS image and config files, please use extreme
caution and confirm with Yes on each of three
iterations to complete. The system will reboot
after the command executes successfully
Do you want to proceed ?? (yes/[no]):
```

Example: Configuring StackWise Virtual Fast Hello Dual-Active-Detection Link

The following example shows how to configure a StackWise Virtual Fast Hello dual-active detection link on a Switch 1 and Switch 2. You cannot configure StackWise Virtual Fast Hello dual-active-detection links on ports that are already configured as StackWise Virtual link ports:

```
On Switch 1:
Device>enable
Device#configure terminal
Device(config)#interface FortyGigabitEthernet1/0/3
Device(config-if)#stackwise-virtual dual-active-detection
Please reload the switch for Stackwise Virtual configuration to take effect
Upon reboot, the config will be part of running config but not part of start up config.
Device(config-if)#exit
On Switch 2:
Device(config)#interface FortyGigabitEthernet1/0/3
Device(config-if)#stackwise-virtual dual-active-detection
Please reload the switch for Stackwise Virtual configuration to take effect
Upon reboot, the config will be part of running config but not part of start up config.
Device(config-if)#end
On both the switches:
Device#write memory
Device#reload
```

The following is a sample configuration for configuring a StackWise Virtual Fast Hello dual-active-detection link on the Cisco Catalyst 9600 Series Supervisor 2 Module (C9600X-SUP-2).

```
Device> enable
Device# configure terminal
Device(config)# interface FiftyGigabitEthernet2/5/0/41
Device(config-if)# stackwise-virtual dual-active-detection
WARNING: All the extraneous configurations will be removed for FiftyGigE2/5/0/41.
*Sep 29 09:38:01.035: %SYS-5-CONFIG_P: Configured programmatically by process Exec from
console as console
*Sep 29 09:38:01.063: %LINEPROTO-5-UPDOWN: Line protocol on Interface FiftyGigE2/5/0/41,
changed state to down
Device(config-if)#
*Sep 29 09:38:02.067: %LINEPROTO-5-UPDOWN: Line protocol on Interface FiftyGigE1/6/0/41,
changed state to down
Device(config-if)#
Device(config-if)#
*Sep 29 09:38:03.067: %LINK-3-UPDOWN: Interface FiftyGigE1/6/0/41, changed state to down
*Sep 29 09:38:03.080: %LINK-3-UPDOWN: Interface FiftyGigE2/5/0/41, changed state to down
Device(config-if)#
*Sep 29 09:38:07.544: %CLUSTERMG-6-DUAL_ACTIVE_CFG_MSG: Chassis 2 B0/0: clustermgr: Dual
Active Detection link is available now1/6/0
*Sep 29 09:38:09.525: %LINK-3-UPDOWN: Interface FiftyGigE1/6/0/41, changed state to up
*Sep 29 09:38:09.544: %LINK-3-UPDOWN: Interface FiftyGigE2/5/0/41, changed state to up
*Sep 29 09:38:10.525: %LINEPROTO-5-UPDOWN: Line protocol on Interface FiftyGigE1/6/0/41,
changed state to up/41
Device(config-if)#
Device(config-if)#
Device(config-if)#
*Sep 29 09:38:10.544: %LINEPROTO-5-UPDOWN: Line protocol on Interface FiftyGigE2/5/0/41,
changed state to upstackwise-virtual dual-active-detection
Device(config-if)#stackwise-virtual dual-active-detection
WARNING: All the extraneous configurations will be removed for FiftyGigE1/6/0/41.
*Sep 29 09:38:14.108: %SYS-5-CONFIG_P: Configured programmatically by process Exec from
console as console
*Sep 29 09:38:14.141: %LINEPROTO-5-UPDOWN: Line protocol on Interface FiftyGigE1/6/0/41,
changed state to down
```

Example: Displaying StackWise Virtual Link Information

```

Device(config-if)#
*Sep 29 09:38:14.144: %CLUSTERMGR-6-DUAL_ACTIVE_CFG_MSG: Chassis 2 B0/0: clustermgr: Dual
Active Detection links are not available anymore
Device#
*Sep 29 09:38:16.213: %LINK-3-UPDOWN: Interface FiftyGigE1/6/0/41, changed state to down
*Sep 29 09:38:16.216: %LINK-3-UPDOWN: Interface FiftyGigE2/5/0/41, changed state to down
*Sep 29 09:38:17.206: %SYS-5-CONFIG_I: Configured from console by console
*Sep 29 09:38:17.217: %LINEPROTO-5-UPDOWN: Line protocol on Interface FiftyGigE2/5/0/41,
changed state to down
*Sep 29 09:38:17.254: %CLUSTERMGR-6-DUAL_ACTIVE_CFG_MSG: Chassis 2 B0/0: clustermgr: Dual
Active Detection link is available now
*Sep 29 09:38:17.255: %CLUSTERMGR-6-DUAL_ACTIVE_CFG_MSG: Chassis 1 B0/0: clustermgr: Dual
Active Detection link is available now
Device#
*Sep 29 09:38:19.252: %LINK-3-UPDOWN: Interface FiftyGigE2/5/0/41, changed state to up
*Sep 29 09:38:19.256: %LINK-3-UPDOWN: Interface FiftyGigE1/6/0/41, changed state to up
*Sep 29 09:38:20.252: %LINEPROTO-5-UPDOWN: Line protocol on Interface FiftyGigE2/5/0/41,
changed state to up
Device#
Device#
*Sep 29 09:38:20.256: %LINEPROTO-5-UPDOWN: Line protocol on Interface FiftyGigE1/6/0/41,
changed state to up
Device#

```

Example: Displaying StackWise Virtual Link Information

Sample output of show stackwise-virtual link command

In this example, the output is displayed from a switch where SVL is configured.

```

Device# show stackwise-virtual link

Stackwise Virtual Link(SVL) Information:
-----
Flags:
-----
Link Status
-----
U-Up D-Down
Protocol Status
-----
S-Suspended P-Pending E-Error T-Timeout R-Ready
-----
Switch          SVL          Ports                               Link-Status    Protocol-Status
-----
1                1            FortyGigabitEthernet1/1/0/5        U              R
2                1            FortyGigabitEthernet2/1/0/5        U              R

```

The following is a sample output from the Cisco Catalyst 9600 Series Supervisor 2 Module (C9600X-SUP-2):

```

Device# show stackwise-virtual link

Stackwise Virtual Link(SVL) Information:
-----
Flags:
-----
Link Status
-----
U-Up D-Down
Protocol Status
-----

```



```
s-Suspended P-Bundled E-Error D-Down R-RLayer3 I-Indiv
-----
Switch  SVL      Ports                Link-Status  Protocol-Status
-----  -
1        1      HundredGigE1/0/7    U             P
2        1      HundredGigE2/0/7    U             P
```

By default in standalone mode, the switches are identified as Switch 1 unless explicitly changed to some other switch number. During the conversion to StackWise Virtual, the switch numbers are changed automatically to reflect two switches in a StackWise Virtual domain.

In Cisco Catalyst 9600 Series Switches, the interface numbering will be in 4 tuple format after reload and the switch conversion to Cisco StackWise Virtual

Example: Displaying StackWise Virtual Dual-Active-Detection Link Information

Sample output of show stackwise-virtual dual-active-detection command

StackWise Virtual DAD links configuration:

```
Device# show stackwise-virtual dual-active-detection

Recovery Reload for switch 1: Enabled
Recovery Reload for switch 2: Enabled

Dual-Active-Detection Configuration:
-----
Switch  Dad port                Status
-----  -
1        FortyGigabitEthernet1/1/0/3    up
2        FortyGigabitEthernet2/1/0/3    up
```

StackWise Virtual DAD links configuration after configuring the **dual-active recovery-reload-disable** command:

```
Device# show stackwise-virtual dual-active-detection

Recovery Reload for switch 1: Disabled
Recovery Reload for switch 2: Disabled
Dual-Active-Detection Configuration:
-----
Switch  Dad port  Status
-----  -
1  FortyGigabitEthernet1/1/0/3  up
2  FortyGigabitEthernet2/1/0/3  up
```

Sample output of show stackwise-virtual dual-active-detection epagp command

StackWise Virtual DAD ePAgP information:

```
Device# show stackwise-virtual dual-active-detection pagp

Pagp dual-active detection enabled: Yes
In dual-active recovery mode: No
Recovery Reload for switch 1: Enabled
Recovery Reload for switch 2: Enabled

Channel group 11
Port                Dual-Active      Partner          Partner          Partner
                   Detect Capable   Name             Port             Version
```

```

Fo1/1/0/17      Yes      SwitchA      Hu2/0/1      1.1
Fo2/1/0/21      Yes      SwitchA      Hu1/0/4      1.1

```

Partner Name and **Partner Port** fields in the output represent the name and the ports of the peer switch to which the PagP port-channel is connected through MEC.

Verifying Cisco StackWise Virtual Configuration

To verify your StackWise Virtual configuration, use the following **show** commands:

Table 1: show Commands to Verify Cisco StackWise Virtual Configuration

show stackwise-virtual switch <i>number</i> <1-2>	Displays information of a particular switch in the stack.
show stackwise-virtual link	Displays StackWise Virtual link information.
show secure-stackwise-virtual authorization-key	Displays the installed Secure StackWise Virtual authorization key.
show secure-stackwise-virtual status	Displays the Secure StackWise Virtual status.
show secure-stackwise-virtual interface	Displays the Secure StackWise Virtual interface statistics.
show stackwise-virtual bandwidth	Displays the bandwidth available for the Cisco StackWise Virtual.
show stackwise-virtual neighbors	Displays the Cisco StackWise Virtual neighbors.
show stackwise-virtual dual-active-detection	Displays StackWise Virtual dual-active-detection information.
show stackwise-virtual dual-active-detection pagp	Displays ePAgP dual-active-detection information.
Switch $\frac{1}{2}$ renumber $\frac{1}{2}$	(Optional)Assigns a new switch number. The default number is 1.

Additional References for StackWise Virtual

Table 2: Related Documents

Related Topic	Document Title
For complete syntax and usage information for the commands used in this chapter.	High Availability Command Reference for Catalyst 9600 Switches

Feature History for Cisco StackWise Virtual

This table provides release and related information for features explained in this module.

These features are available on all releases subsequent to the one they were introduced in, unless noted otherwise.

Release	Feature	Feature Information
Cisco IOS XE Gibraltar 16.12.1	Cisco StackWise Virtual	<p>Cisco StackWise Virtual is a network system virtualization technology that pairs two switches into one virtual switch to simplify operational efficiency with a single control and management plane</p> <p>Also supported in the introductory release, are the following features:</p> <ul style="list-style-type: none"> • BGP EVPN VXLAN on switches with Cisco StackWise Virtual: Support for the <i>BGP EVPN VXLAN</i> feature on switches with Cisco StackWise Virtual configured. • Secure StackWise Virtual: Secure StackWise Virtual support was introduced for two node front-side stacking. Secure StackWise Virtual is FIPS 140-2 compliant and encrypts control packets as well. • Recovery Reload: Support for disabling DAD recovery reload. Enter the dual-active recovery-reload-disable command in stackwise virtual mode (config-stackwise-virtual).
Cisco IOS XE Amsterdam 17.2.1	BUM Traffic Optimization on switches with Cisco StackWise Virtual	Support for the <i>BUM Traffic Optimization</i> feature was introduced on switches with Cisco StackWise Virtual configured.
	Cisco StackWise Virtual: Interface and line card configurations	<p>DAD links are now supported for the following interface and line card configurations:</p> <ul style="list-style-type: none"> • 1G interface on a C9600-LC-48TX line card. • 1G interface if configured between a C9600-LC-48TX line card and either a C9600-LC-48YL line card or a C9600-LC-24C line card. • 1G interface and 10G interface if configured between two C9600-LC-48YL line cards or between two C9600-LC-24C line cards. • 1G interface and 10G interface if configured between a C9600-LC-48YL line card and a C9600-LC-24C line card.
Cisco IOS XE Dublin 17.10.1	Cisco StackWise Virtual	Support for this feature was introduced on the Cisco Catalyst 9600 Series Supervisor 2 Module (C9600X-SUP-2).

Use the Cisco Feature Navigator to find information about platform and software image support. To access Cisco Feature Navigator, go to [Cisco Feature Navigator](#).



CHAPTER 3

Quad-Supervisor with Route Processor Redundancy

- [Prerequisites for Quad-Supervisor with RPR, on page 47](#)
- [Restrictions for Quad-Supervisor with RPR, on page 48](#)
- [Information About Quad-Supervisor with RPR, on page 48](#)
- [How to Implement Quad-Supervisor with RPR, on page 51](#)
- [Monitoring Quad-Supervisor with RPR, on page 56](#)
- [Implementation Examples for Quad-Supervisor with RPR, on page 58](#)
- [Additional References for Quad-Supervisor with RPR, on page 61](#)
- [Feature History for Quad-Supervisor with RPR, on page 62](#)

Prerequisites for Quad-Supervisor with RPR

- The minimum required software version for all the supervisors in the Quad-Supervisor setup is Cisco IOS XE Amsterdam 17.2.1 .

If the system detects that either of the redundant supervisor modules is running a software version that is not compatible with this feature, it displays a syslog to upgrade the supervisor module. After 5 warnings to upgrade, the system forces the supervisor module running the incompatible software version into reset mode.

- All supervisors in the chassis must be running the same software version.



Note If you are replacing any supervisor in the Quad-Supervisor setup, you must ensure that the new supervisor is running the same software version as the other supervisors in the setup *before* installing it.

- You must be familiar with the Cisco StackWise Virtual feature and related terminologies. For more information, see the *Configuring Cisco StackWise Virtual* chapter in this guide.
- You must have installed at least one redundant supervisor. This serves as the in-chassis standby supervisor (ICS) (terms are explained below).

Restrictions for Quad-Supervisor with RPR

- When using a Quad-Supervisor with Route Processor Redundancy (RPR), a console is not available for the ICS supervisors.
- Cisco In-Service Software Upgrade (ISSU) or image upgrade in a Quad-Supervisor setup is not supported if one of the chassis is not available at the time of the upgrade.

Information About Quad-Supervisor with RPR

Understanding Quad-Supervisor with RPR

The Quad-Supervisor with Route Processor Redundancy (RPR) feature provides intra-chassis redundancy where Cisco StackWise Virtual is configured between two chassis. This intra-chassis redundancy is provided by the redundant supervisor installed in the chassis. The added redundancy reduces the time taken to reach the ready state with full bandwidth in the event of a supervisor failure or a forced switchover.

The following supervisors make up a Quad-Supervisor with RPR:

- A Cisco StackWise Virtual active supervisor
- A Cisco StackWise Virtual standby supervisor
- In-Chassis Standby supervisors (ICS) – These are the redundant supervisors which are partially booted. In Quad-Supervisor with RPR, there can be an ICS present in one of the chassis or an ICS in both the chassis.

In Quad-Supervisor with RPR, when the Cisco StackWise Virtual active supervisor goes down or is rebooted, the Cisco StackWise Virtual standby supervisor becomes the new active supervisor, and the in-chassis standby supervisor takes over as the new Cisco StackWise Virtual standby supervisor. Since the ICS is partially booted, the time taken for it to come up to ready state is reduced.

Switchovers are automatically triggered by supervisor failures. You can also manually initiate a switchover.

SSO and RPR Operations in a Quad-Supervisor Setup

With Stateful Switchover (SSO), both start-up and running configurations are synced. Applications also sync all their state data. On switchover, line cards are not reset and state reconciliation is not required since all data have been synced by the applications.

With RPR, only start-up configuration is synced between the supervisors. Applications do not sync any state data. When a switchover occurs, all line cards are reset and the system state is reconciled.

When a failure occurs in a Quad-Supervisor setup and a switchover takes place:

1. SSO operates between two chassis (where the Cisco StackWise Virtual standby becomes the new Cisco StackWise Virtual active and continues to forward traffic).
2. RPR operates within a chassis (the line cards in the old active chassis are reset).

Switchovers in Quad-Supervisor with RPR

The switch supports Quad-Supervisor with RPR where there may be one ICS or two ICSs. The following subsections explain and illustrate how the feature works in both setups.

Quad-Supervisor with RPR with One ICS

In a Quad-Supervisor with RPR with one in-chassis standby supervisor, the ICS can be present in the chassis with the Cisco StackWise Virtual active supervisor or in the chassis with the Cisco StackWise Virtual standby supervisor.

If the ICS is present in the chassis with the Cisco StackWise Virtual active supervisor, and the Cisco StackWise Virtual active supervisor fails, the following changes occur:

- The Cisco StackWise Virtual active supervisor which failed becomes the new ICS in the set up.
- The Cisco StackWise Virtual standby supervisor takes over as the new Cisco StackWise Virtual active supervisor.
- The ICS completes booting and becomes the new Cisco StackWise Virtual standby supervisor.

Each of the following boxes represents a possible existing setup; the adjacent box represents the outcome of a switchover scenario:

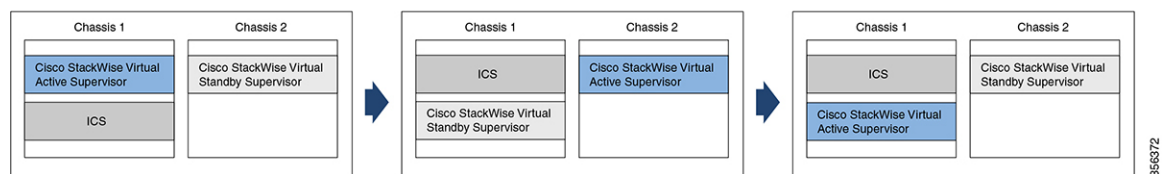

If the ICS is present in the chassis with the Cisco StackWise Virtual standby supervisor, and the Cisco StackWise Virtual active supervisor fails, the following changes occur:

- The Cisco StackWise Virtual standby supervisor takes over as the new Cisco StackWise Virtual active supervisor.
- The Cisco StackWise Virtual active supervisor which failed becomes the new Cisco StackWise Virtual standby supervisor in the set up.
- The ICS remains unchanged.

Each of the following boxes represents a possible existing setup; the adjacent box represents the outcome of a switchover scenario:

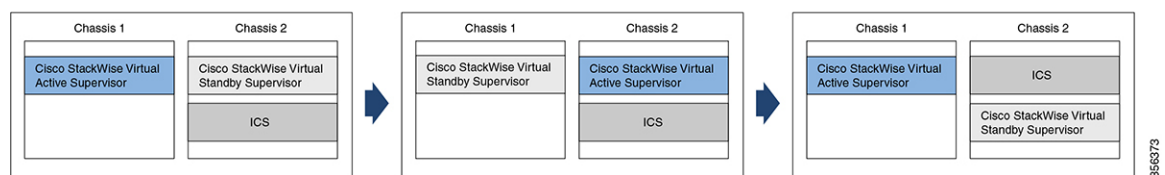

Quad-Supervisor with RPR with Two ICS

In a Quad-Supervisor with RPR with two in-chassis standby supervisors, if the Cisco StackWise Virtual active supervisor fails, the following changes occur:

- The Cisco StackWise Virtual active supervisor which failed becomes the new ICS in Chassis 1.
- The Cisco StackWise Virtual standby supervisor takes over as the new Cisco StackWise Virtual active supervisor in Chassis 2.
- The ICS in Chassis 1 completes booting and becomes the new Cisco StackWise Virtual standby supervisor.
- The ICS in Chassis 2 remains unchanged.

Each of the following boxes represents a possible existing set-up; the adjacent box represents the outcome of a switchover scenario:

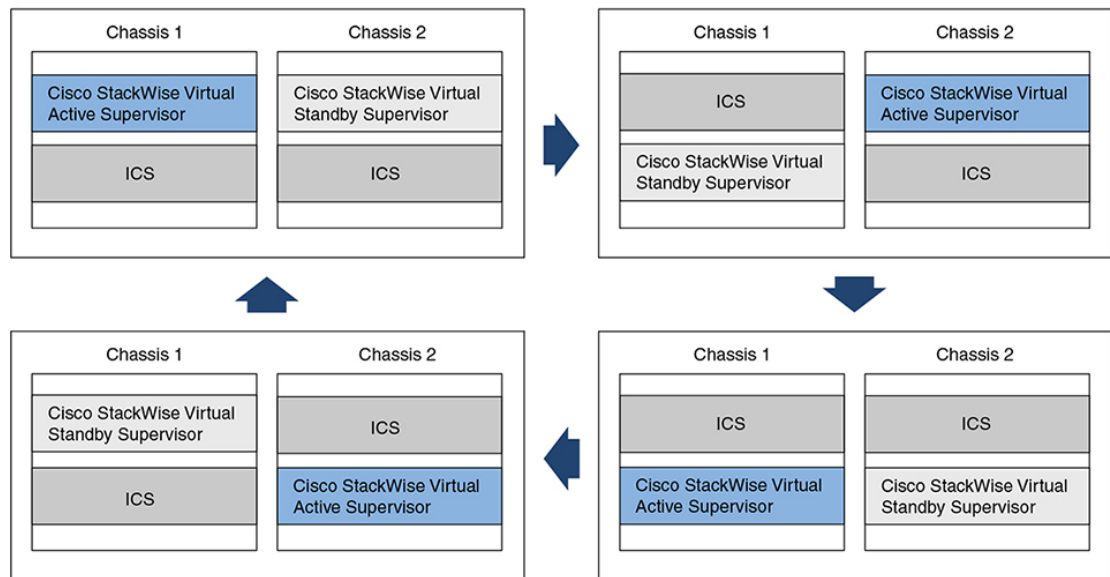

356374

Interaction with Other Features

The following sections describe the interaction of Quad-Supervisor RPR with different features.

Performing ISSU in a Quad-Supervisor with RPR

You can perform ISSU in a Quad-Supervisor with RPR. This section describes the sequence of events that occur during ISSU in a Quad-Supervisor with RPR.

When you enter the **install activate issu** command in privileged EXEC mode to install the new software version on all the supervisors:

1. The new version is downloaded on all the supervisors in the setup.
2. The new version is activated on the ICSs on both the chassis and the ICSs are then reloaded.
3. Then the new version is activated onto the Cisco StackWise Virtual standby supervisor and it is reloaded.
4. The new version is activated onto the Cisco StackWise Virtual active supervisor. This triggers the switchover process in the Quad-Supervisor setup.



Note During ISSU, if any of the supervisors fail, the system cancels the ISSU process and all the supervisors revert to the original version and you have to start the ISSU process again.

For more information about performing ISSU, refer to the *Configuring ISSU* chapter in this guide.

Upgrading in Install Mode in Quad-Supervisor with RPR

You can upgrade a Quad-Supervisor setup with RPR in install mode. This section describes the sequence of events that occur when upgrading a Quad-Supervisor setup with RPR in install mode.

When you enter the **install add file *file-name* activate commit** command in privileged EXEC mode, the new software version is activated onto all the supervisors at the same time and after reload, the Quad-Supervisor comes up with the same setup as before.

For more information about upgrading in install mode, refer to the release notes for the software release.

How to Implement Quad-Supervisor with RPR

Depending on your current setup, there are two methods to implement a Quad-Supervisor setup with RPR:

- Implementing a Quad-Supervisor with RPR on two chassis.
- Implementing a Quad-Supervisor with RPR on an existing Cisco StackWise Virtual setup.

The following sections provide information on both methods.

Implementing Quad-Supervisor with RPR on Two Chassis

If you have one supervisor module installed in each chassis, follow the procedure below to implement Quad-Supervisor with RPR:

Procedure

Step 1 Configure **software auto-upgrade enable**.

Note The redundant supervisor module should be running the same software version as the rest of the setup.

To upgrade the software version of the supervisor modules, enter the **software auto-upgrade enable** command in global configuration mode on the active supervisor modules in the two chassis.

Step 2 Insert the ICS.

Insert the redundant supervisor module in the chassis.

Note To know more about the procedure to upgrade the software version of a supervisor module, refer to the [Upgrading the Software Version, on page 52](#) section in this chapter.

Step 3 Configure Cisco StackWise Virtual.

Configure a StackWise Virtual link between the two chassis. The setup will now come up in Quad-Supervisor with RPR.

Step 4 Verify the setup.

Run the **show module** command in privileged EXEC mode to verify that the setup is in Quad-Supervisor with RPR.

Implementing Quad-Supervisor with RPR on an Existing Cisco StackWise Virtual Setup

If you have a Cisco StackWise Virtual link configured between two chassis, follow the procedure below to implement Quad-Supervisor with RPR:



Note The Cisco StackWise Virtual setup must be running the minimum required software version or higher.

Procedure

Step 1 Configure **software auto-upgrade enable**.

Enter the **software auto-upgrade enable** command in global configuration mode on the Cisco StackWise Virtual active supervisor module.

Step 2 Insert the ICS running the same software version as the rest of the setup.

Insert the redundant supervisor module in the chassis. The setup will now come up in Quad-Supervisor with RPR.

Note To know more about the procedure to upgrade the software version of a supervisor module, refer to the *Upgrading the Software Version* section in this chapter.

Step 3 Verify the setup.

Run the **show module** command in privileged EXEC mode to verify that the setup is in Quad-Supervisor with RPR.

Upgrading the Software Version

You must upgrade the software version of a supervisor in any of the following scenarios:

- When you are implementing Quad-Supervisor.

In this scenario, all the supervisor modules may not be running a software version that supports the feature.

- When you are installing a new supervisor in a Quad-Supervisor setup.

In this scenario, the new or replacement supervisor module may not be running the same software version as the others in the setup, or it may be shipped with a version where the feature is not available.

- When you perform a Return Material Authorization (RMA) for a supervisor module.

There are three methods you can use to upgrade the software version.

- Upgrade using a spare chassis - in this method, you use a third chassis that is not part of your setup to upgrade the software version of the supervisor.
- Upgrade without using a spare chassis - in this method, if you do not have a spare chassis, you use one of the existing chassis to upgrade the software version of the supervisor. This method involves some downtime.
- Upgrade using a USB flash - if you do not have a spare chassis, you use this method to upgrade the software version of the supervisor without any downtime by using a USB flash.

The following sections describe all the methods.

Upgrading the Software Version Using a Spare Chassis

Perform this task to upgrade the software version of the new or replacement supervisor module.

Procedure

- Step 1** Install the supervisor module in a spare chassis.
Install the new supervisor module in a third chassis.
- Step 2** Upgrade the software version of the supervisor module.
Upgrade the software version in install mode.
For more information about upgrading in install mode, refer to the release notes for the software release.
- Note** Ensure that the software version you are upgrading to is the same version running on the other supervisor modules in the setup.
- Step 3** Verify the software version.
Run the **show version** command in privileged EXEC mode and verify that the supervisor module is running the new software version.
- Step 4** Remove the supervisor module from the chassis.
Once the supervisor module is running the new software version, remove it from the chassis.
-

Upgrading the Software Version Without Using a Spare Chassis

Perform this task to upgrade the software version of the new or replacement supervisor module if you do not have a spare chassis. This method will involve some downtime.

Procedure

- Step 1** Power down the Cisco StackWise Virtual standby chassis.
Power down the Cisco StackWise Virtual standby chassis (henceforth referred to as Chassis 2) from the Cisco StackWise Virtual setup. Traffic will continue to go to the Cisco StackWise Virtual active chassis.
- Step 2** Remove the supervisor module that was in Cisco StackWise Virtual mode.
Remove the supervisor module that was in Cisco StackWise Virtual mode from Chassis 2 and store it safely.
- Step 3** Pull out the linecards from the chassis.
Pull out the linecards from Chassis 2, but let them remain in the chassis. This will ensure that there is no impact on downstream devices.
- Caution** As the system is not running when all the linecards are pulled out, the device can be impacted due to insufficient cooling. Therefore, ensure that you perform Step 4 to Step 6 immediately after Step 3.
- Step 4** Insert the two new supervisor modules in the chassis.
Insert the two new supervisor modules (that will act as the ICS in the Quad-Supervisor setup) in Chassis 2.
- Step 5** Upgrade the software version of the supervisor modules.
Power on Chassis 2 and upgrade the software version of the two supervisor modules in install mode.
- Step 6** Remove both the supervisor modules from the chassis.
Remove both the supervisor modules from Chassis 2.
- Step 7** Reinsert the original supervisor module and the linecards into the chassis.
Reinsert the supervisor module that was in Cisco StackWise Virtual mode and all the linecards into Chassis 2.
- Step 8** The chassis reloads.
The supervisor module comes up as the Cisco StackWise Virtual standby supervisor module. All line cards also come up and traffic re-converges between the two chassis.
-

Upgrading the Software Version Using a USB Flash

Perform this task to upgrade the software version of the new or replacement supervisor module if you do not have a spare chassis.

Procedure

- Step 1** Configure **software auto-upgrade enable**.
Enter the **software auto-upgrade enable** command in global configuration mode on the Cisco StackWise Virtual active supervisor module.

- Step 2** Copy the software image to USB flash.
Copy the new software image (<imagefile>.bin) to the USB flash.
- Step 3** Insert the supervisor module.
Insert the ICS supervisor module into required slot in the chassis.
- Step 4** Insert the USB flash into the supervisor module.
Insert the USB flash with the new software image into the ICS supervisor module.
- Step 5** Connect the console port of the supervisor module to a terminal server.
Connect the console port of the ICS supervisor module to a terminal server, to access it in ROMMON mode.
- Step 6** Switch into ROM monitor (ROMMON) mode.
Press Control + C to break into ROMMON mode.
- Step 7** **Note** Perform the following substeps only if the ICS supervisor module was previously used in a Cisco StackWise Virtual setup.

Remove the Cisco StackWise Virtual settings if applicable.

- a) Unset the ROMMON variables related to Cisco StackWise Virtual

Look for any of the following Cisco StackWise Virtual ROMMON variables and unset them:

- D_STACK_DISTR_STACK_LINK2=""
- D_STACK_DAD=""
- D_STACK_MODE=""
- D_STACK_DOMAIN_NUM=""
- D_STACK_DISTR_STACK_LINK1=""

```
rommon 1 > unset D_STACK_DISTR_STACK_LINK2
rommon 1 > unset D_STACK_DAD
rommon 1 > unset D_STACK_MODE
rommon 1 > unset D_STACK_DOMAIN_NUM
rommon 1 > unset D_STACK_DISTR_STACK_LINK1
```

- b) Set the switch-number ROMMON variable to 1.

If the switch number ROMMON variable is set to 2, change it to *SWITCH_NUMBER=1*.

```
rommon 1 > SWITCH_NUMBER=1
```

- Step 8** Set to manual-boot the supervisor module.
Set *MANUAL_BOOT* to yes.
rommon 1 > MANUAL_BOOT=yes
- Step 9** Manually boot the new software image on the ICS from ROMMON.
Manually boot the new software image on the ICS in bundle mode from the USB flash.
- Note** Do not change the boot variable in ROMMON.

The supervisor module goes for a reset as it gets converted from Standalone mode to Cisco StackWise Virtual mode. It will then fall back into ROMMON.

Step 10 Unset manual-boot.

Unset `MANUAL_BOOT` to enable auto-boot.

```
rommon 1 > unset MANUAL_BOOT
```

Step 11 Manually boot the new software image on the ICS from ROMMON.

Manually boot the new software image on the ICS in bundle mode from the USB flash.

Note Do not change the boot variable in ROMMON.

The ICS in the Cisco StackWise Virtual Active chassis will now come up with the new software version.

Step 12 Upgrade the ICS in the Cisco StackWise Virtual Standby chassis.

To upgrade the ICS in the Cisco StackWise Virtual Standby chassis, enter the **install auto-upgrade** command on the Cisco StackWise Virtual Active supervisor module.

Manually Initiating a Switchover

You can also manually initiate a switchover by entering the **redundancy force switch-over** command on the Cisco StackWise Virtual active supervisor in privileged EXEC mode.

To reload a single supervisor in the Quad-Supervisor setup enter the **hw-module switch *switch-number* subslot *subslot-number* oir power-cycle** command in privileged EXEC mode. This power cycles only the supervisor you specify. Note the following about this command:

- When you run this command on a Cisco StackWise Virtual active supervisor a switchover is triggered.
- When you run this command for a Cisco StackWise Virtual standby supervisor, it reloads and becomes the new ICS. The current ICS in the chassis takes over as the new Cisco StackWise Virtual standby supervisor and
- When you run this command on either ICS, the redundant supervisor reloads and comes up in a partially booted state.

Monitoring Quad-Supervisor with RPR

On the physical chassis, the Cisco StackWise Virtual active supervisor is denoted by a green LED. The Cisco StackWise Virtual standby supervisor and the ICS are denoted by an amber LED.

The **show module** command displays the redundancy mode that the supervisor is operating on.

The following is a sample output for the **show module** command run on the Quad-Supervisor with RPR where SUP1 is the Cisco StackWise Virtual active supervisor, SUP3 is the Cisco StackWise Virtual standby supervisor, and SUP2 and SUP4 are ICS:

```
Switch# show module
Chassis Type: C9606R
```

Switch Number 1

Mod	Ports	Card Type	Model	Serial No.
2	24	24-Port 40GE/12-Port 100GE	C9600-LC-24C	CAT2235L0DK
3	0	Supervisor 1 Module	C9600-SUP-1	EZY59054555
4	0	Supervisor 1 Module	C9600-SUP-1	CAT2139L0WE

Mod	MAC addresses	Hw	Fw	Sw	Status
2	F4DB.E673.2880 to F4DB.E673.28FF	0.6	16.12.1[FC2]	BLD_V171	ok
3	0011.2234.0000 to 0011.2234.002F	0.1	16.12.1[FC2]	BLD_V171	ok
4	--	--	--	--	Provisioned

Mod	Redundancy Role	Operating Redundancy Mode	Configured Redundancy Mode
3	Active	sso	sso
4	InChassis-Standby	rpr	rpr

Switch Number 2

Mod	Ports	Card Type	Model	Serial No.
2	24	24-Port 40GE/12-Port 100GE	C9600-LC-24C	CAT2235L0DB
3	0	Supervisor 1 Module	C9600-SUP-1	CAT2139L0VU
4	0	Supervisor 1 Module	C9600-SUP-1	BLF30443724

Mod	MAC addresses	Hw	Fw	Sw	Status
2	F4DB.E673.2200 to F4DB.E673.227F	0.6	16.12.1[FC2]	BLD_V171	ok
3	00A7.42DA.3140 to 00A7.42DA.316F	0.1	16.12.1[FC2]	BLD_V171	ok
4	--	--	--	--	Provisioned

Mod	Redundancy Role	Operating Redundancy Mode	Configured Redundancy Mode
3	Standby	sso	sso
4	InChassis-Standby	rpr	rpr

Chassis 1 MAC address range: 64 addresses from 6cb2.ae49.5540 to 6cb2.ae49.557f

Chassis 2 MAC address range: 64 addresses from 6cb2.ae49.5040 to 6cb2.ae49.507f

For information about the in-chassis standby supervisors, enter the **show redundancy rpr** command in privileged EXEC mode on the Cisco StackWise Virtual active supervisor.

The following is a sample output of the **show redundancy rpr** command run on the Cisco StackWise Virtual active supervisor:

```
Switch# show redundancy rpr
My Switch Id = 1
Peer Switch Id = 2
Last switchover reason = none
Configured Redundancy Mode = sso
Operating Redundancy Mode = sso
Switch 1 Slot 3 Processor Information:
-----
Current Software State = ACTIVE
Uptime in current state = 21 hours, 51 minutes
Image Version = Cisco IOS Software [Amsterdam], Catalyst L3 Switch Software (CAT9K_IOSXE),
  Expe
  rimental Version 17.1.1
Copyright (c) 1986-2019 by Cisco Systems, Inc.
Compiled Fri 13-Sep-19 07:27 by mcpre
```

```

BOOT = bootflash:packages.conf

Switch 1 Slot 4 Processor Information:
-----
Current Software State = InChassis-Standby (Ready)
Uptime in current state = 21 hours, 51 minutes
Image Version =
BOOT =

Switch 2 Slot 3 Processor Information:
-----
Current Software State = STANDBY HOT
Uptime in current state = 21 hours, 51 minutes
Image Version = Cisco IOS Software [Amsterdam], Catalyst L3 Switch Software (CAT9K_IOSXE),
  Expe
  rimental Version 17.1.1
Copyright (c) 1986-2019 by Cisco Systems, Inc.
Compiled Fri 13-Sep-19 07:27 by mcpre
BOOT = bootflash:packages.conf

Switch 2 Slot 4 Processor Information:
-----
Current Software State = InChassis-Standby (Ready)
Uptime in current state = 21 hours, 51 minutes
Image Version =
BOOT =

```

Implementation Examples for Quad-Supervisor with RPR

Example: Quad-Supervisor with RPR with One ICS

The following example describes and illustrates a switchover scenario with one ICS.

Consider a setup where SUP1 is the Cisco StackWise Virtual active supervisor in Chassis 1, SUP2 is the ICS in Chassis 1, and SUP3 is the Cisco StackWise Virtual standby supervisor in Chassis 2. If SUP1 fails, the following changes occur:

- SUP1 which failed becomes the new ICS in the set up.
- SUP3 takes over as the new Cisco StackWise Virtual active supervisor.
- SUP2 completes booting and becomes the new Cisco StackWise Virtual standby supervisor.

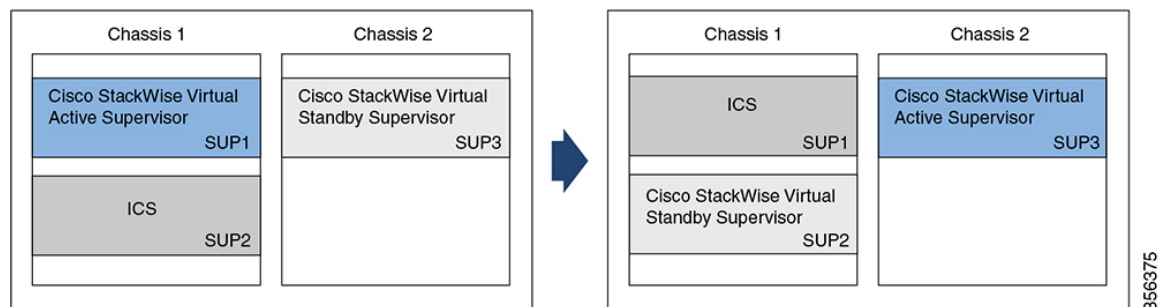

Example: Quad-Supervisor with RPR with Two ICS

The following example describes and illustrates a switchover scenario with two ICS.

Consider a setup where SUP1 is the Cisco StackWise Virtual active supervisor in Chassis 1, SUP2 is the ICS in Chassis 1, SUP3 is the Cisco StackWise Virtual standby supervisor in Chassis 2, and SUP4 is the ICS in Chassis 2. If SUP1 fails, the following changes occur:

- SUP1 which failed becomes the new ICS in Chassis 1.
- SUP3 takes over as the new Cisco StackWise Virtual active supervisor in Chassis 2.
- SUP2 completes booting and becomes the new Cisco StackWise Virtual standby supervisor in Chassis 1.
- SUP4 in Chassis 2 remains unchanged.

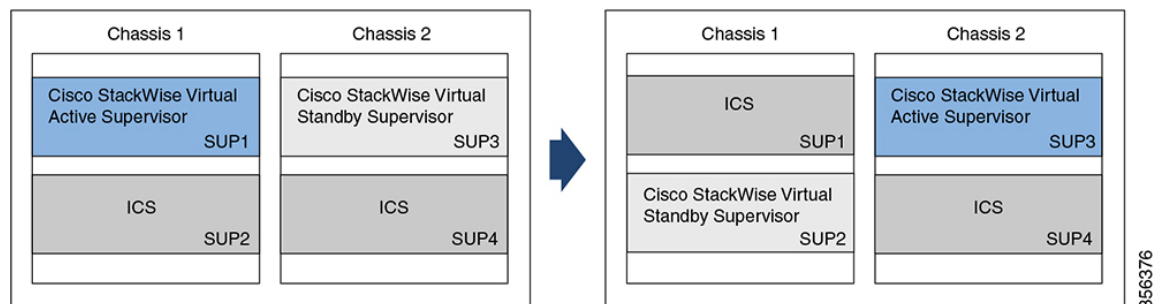

356376

Example: Performing ISSU in a Quad-Supervisor with RPR

The following is an example of a 3-step ISSU in a Quad-Supervisor with RPR:

```
Device# install add file bootflash:<image.bin>
Device# install activate issu
Device# install commit
```

The following is an example of a 1-step ISSU in a Quad-Supervisor with RPR:

```
Device# install add file bootflash:<image.bin> activate issu commit
```

The figure below shows the Quad-Supervisor with RPR with 2 ICS before and after ISSU:

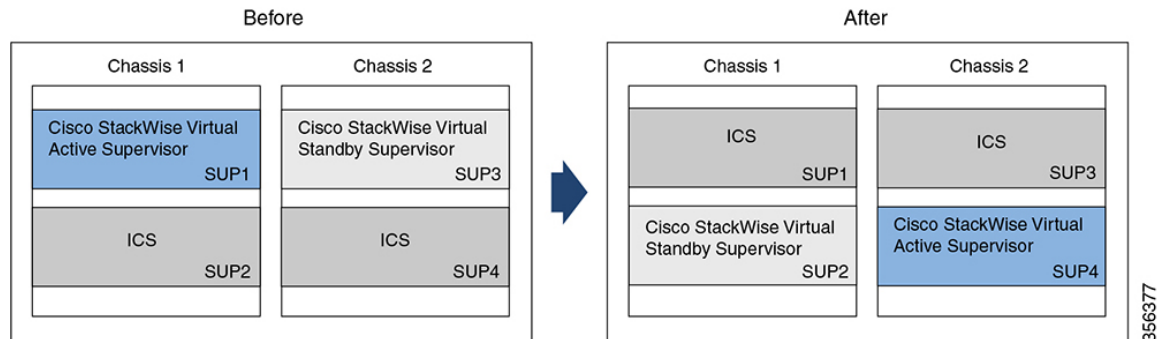

356377

The figure below shows the Quad-Supervisor with RPR with 1 ICS installed in the chassis with the Cisco StackWise Virtual active supervisor before and after ISSU:

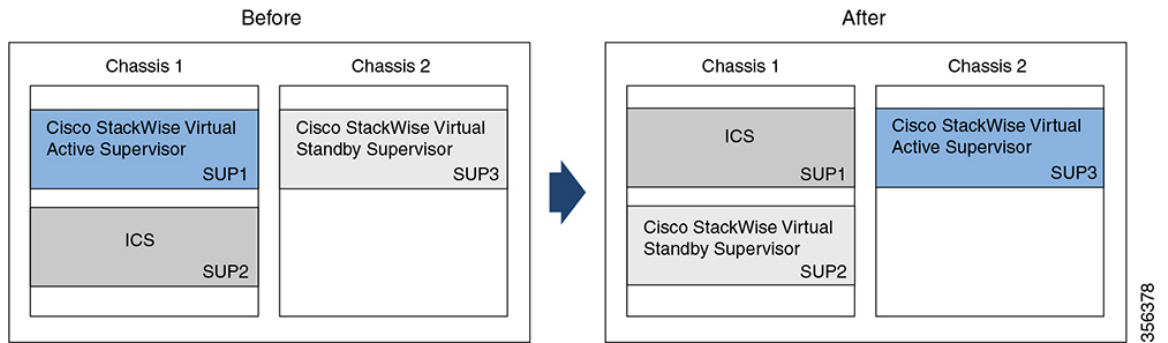

The figure below shows the Quad-Supervisor with RPR with 1 ICS installed in the chassis with the Cisco StackWise Virtual standby supervisor before and after ISSU:

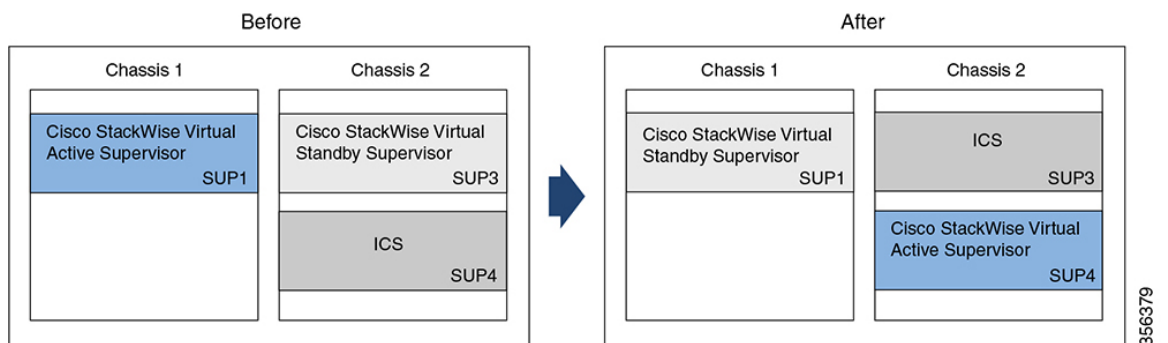

Command Outputs with Information About Quad-Supervisor with RPR

When Quad-Supervisor with RPR is implemented, the outputs for some commands display information that denote the role of each supervisor in the chassis.

This section shows you how to identify which supervisor the output is referring to based on the naming convention.

The following table lists some filesystems and their naming convention for each supervisor in a Quad-Supervisor setup:

Filesystems	Cisco StackWise Virtual active supervisor in Chassis 1	Cisco StackWise Virtual standby supervisor in Chassis 2	ICS in Chassis 1	ICS in Chassis 2
bootflash	bootflash:	bootflash-2-0 or stby-bootflash:	bootflash-1-1	bootflash-2-1
crashinfo	crashinfo:	crashinfo-2-0 or stby-crashinfo:	crashinfo-1-1	crashinfo-2-1
disk0	disk0:	disk0-2-0 or stby-disk0	disk0-1-1	disk0-2-1
usbflash0	usbflash0:	usbflash0-2-0 or stby-usbflash0	usbflash0-1-1	usbflash0-2-1

Other filesystems also follow the above naming convention for the different supervisors in a Quad-Supervisor setup.

The following is a sample output from the **show file systems** command run in privileged EXEC mode:

```
Device# show file systems
File Systems:

      Size (b)      Free (b)      Type  Flags  Prefixes
      -          -          -      -      -
      -          -          opaque rw      system:
      -          -          opaque rw      tmpsys:
* 11250098176      7044366336    disk  rw      bootflash: flash:
  11250171904      2430599168    disk  rw      bootflash-2-0:
  1651314688        0             disk  rw      crashinfo:
  1651507200        0             disk  rw      crashinfo-2-0:
  236154740736      224072753152  disk  rw      disk0:
  236155043840      223982125056  disk  rw      disk0-2-0:
  16497074176      16379744256   disk  ro      webui:
      -          -          opaque rw      null:
      -          -          opaque ro      tar:
      -          -          network rw      tftp:
      33554432      33476510      nvram rw      nvram:
      -          -          opaque wo      syslog:
      -          -          network rw      rcp:
      -          -          network rw      http:
      -          -          network rw      ftp:
      -          -          network rw      scp:
      -          -          network rw      sftp:
      -          -          network rw      https:
      -          -          opaque ro      cns:
  11250171904      2516582400    disk  rw      bootflash-1-1:
  1651507200        0             disk  rw      crashinfo-1-1:
  236155043840      224073351168  disk  rw      disk0-1-1:
      33554432      33480606      nvram rw      stby-nvram:
      -          -          nvram  rw      stby-rcsf:
  11250098176      2429427712    disk  rw      stby-bootflash:
  1651314688        0             disk  rw      stby-crashinfo:
  236154740736      223982034944  disk  rw      stby-disk0:
  11250171904      5734662144    disk  rw      bootflash-2-1:
  1651507200        0             disk  rw      crashinfo-2-1:
  236155043840      224073351168  disk  rw      disk0-2-1:
      -          -          opaque rw      revrcsf:
```

Additional References for Quad-Supervisor with RPR

Related Documents

Related Topic	Document Title
For information about how to install supervisor modules into the chassis.	See the <i>Cisco Catalyst 9600 Series Supervisor Module Installation Note</i>
For information about configuring Cisco StackWise Virtual between two chassis.	See the <i>Configuring Cisco StackWise Virtual</i> chapter in the <i>High Availability Configuration Guide</i> of the required release.
For information about performing ISSU.	See the <i>Configuring ISSU</i> chapter in the <i>High Availability Configuration Guide</i> of the required release.

Feature History for Quad-Supervisor with RPR

This table provides release and related information for features explained in this module.

These features are available on all releases subsequent to the one they were introduced in, unless noted otherwise.

Release	Feature	Feature Information
Cisco IOS XE Amsterdam 17.2.1	Quad-Supervisor with Route Processor Redundancy (RPR)	A Quad-Supervisor RPR setup provides <i>intra-chassis</i> redundancy where Cisco StackWise Virtual is configured between two chassis. The added redundancy reduces the time taken to reach the ready state with full bandwidth in the event of a failure or a forced switchover.

Use Cisco Feature Navigator to find information about platform and software image support. To access Cisco Feature Navigator, go to <https://cfmg.cisco.com>.



CHAPTER 4

Configuring Graceful Insertion and Removal

Graceful Insertion and Removal (GIR) provides an alternative method to minimize network service impact caused by device maintenance. GIR leverages redundant paths in the network to smoothly remove a device under maintenance, out of service, and insert it back to service when the maintenance is complete. This module describes the how to configure GIR.

- [Restrictions for Graceful Insertion and Removal, on page 63](#)
- [Information About Graceful Insertion and Removal, on page 63](#)
- [How to Configure Graceful Insertion and Removal, on page 66](#)
- [Monitoring Graceful Insertion and Removal, on page 68](#)
- [Configuration Examples for Graceful Removal and Insertion, on page 68](#)
- [Additional References for Graceful Insertion and Removal , on page 70](#)
- [Feature History for Graceful Insertion and Removal, on page 70](#)

Restrictions for Graceful Insertion and Removal

- The BGP instance in the maintenance template should match the BGP instance on the device. Also, do not configure more than one BGP instances under the maintenance template.
- GIR is supported for layer two interface shutdown, ISIS routing protocol, HSRP, VRRPv3 and BGP. This is configured either by creating customized templates or without a template.

Information About Graceful Insertion and Removal

Overview

Graceful Insertion and Removal (GIR) isolates a switch from the network in order to perform debugging or an upgrade. The switch can be put into maintenance mode using the **start maintenance** command. When switch maintenance is complete, the switch will return to normal mode on either reaching the configured maintenance timeout, or by enabling the **stop maintenance** command.

Creating a maintenance mode template before you put the switch in maintenance mode is optional. The objective of maintenance mode for a device is to minimize traffic disruption at the time of removal from the network, as well as during the time of insertion. There are mainly three stages:

- Graceful removal of the node from network.
- Performing maintenance on the device.
- Graceful insertion into the network.

A switch can be put into maintenance mode using default template or a custom template. The default template contains all the ISIS instances, along with **shut down I2**. In the custom template, you can configure the required ISIS instances and **shutdown I2** option. On entering maintenance mode, all participating protocols are isolated, and L2 ports are shut down. When normal mode is restored, all the protocols and L2 ports are brought back up.

Snapshots are taken automatically while entering and exiting the maintenance mode. You can use the **snapshot create** *snapshot-name snapshot-description* command to capture and store snapshots for pre-selected features. Snapshots are useful to compare the state of a switch before it went into maintenance mode and after it came back to normal mode. The snapshot process consists of three parts:

- Creating a snapshot of the states of a few preselected features on the switch and storing them on the persistent storage media.
- Listing the snapshots taken at various time intervals and managing them.
- Comparing snapshots and showing the summary and details of each feature.

The maximum number of snapshots that may be stored on the switch is 10. You can use the **snapshot delete** *snapshot-name* command, to delete a specific snapshot from the device.

You can create multiple templates for the maintenance template or the snapshot template. But only one maintenance template and one snapshot template can be applied to the device at one time.

Snapshot templates can be created to generate specific snapshots. A new snapshot template can be created using the **snapshot-template** *template-name* command. The command **snapshot-template** *default-snapshot-template* can be used to specify the default snapshot template in the maintenance mode. The **snapshot create** [**template** *template-name*] *snapshot-name snapshot-description* command can be used to apply a specific template to the snapshot create feature.

Layer 2 Interface Shutdown

Layer 2 interfaces, such as ports on a switch, are shut down when the system is transitioning into maintenance mode. Layer 2 interfaces are shut down by using the **shutdown I2** (maintenance template configuration mode) command in the custom template.

Custom Template

As a network administrator, you can create a template that is applied when the system goes into maintenance mode. This allows you to isolate specific protocols. All instances that need to be isolated must be explicitly specified.

You can create multiple templates with different configurations. However, only a single template is applied to the maintenance mode CLI. Once applied, the template cannot be updated. If the template has to be updated, then you must remove it, make the changes, and then re-apply.

Within a template, protocols belonging to one class are serviced in parallel. The order of priority of the protocols is the same as that of the default template.

To configure this feature, enter the maintenance mode using the **system mode maintenance** command and enable the feature using the **template template-name class** command.

For example if the custom template has the following protocols:

```
Maintenance-template foo
router isis 100
  hsrp Et0/1 1
  hsrp Et0/1 2
router isis 200

Maintenance-template foo class
router isis 100
  hsrp Et0/1 1
  hsrp Et0/1 2
router isis 200
```

In the above example, since isis belongs to CLASS_IGP, router isis 100 & router isis 200 will be serviced in parallel. Once acknowledgements are received for both these protocols belonging to IGP class, FHRP_CLASS clients, hsrp Et0/1 and hsrp Et0/1 2 will be serviced in parallel.

When the template-class feature is configured, the protocols follow an order based on the class they belong to when entering maintenance mode. The protocols follow the opposite order when returning to normal mode.

System Mode Maintenance Counters

GIR has counters to track the following events:

- Number of times the switch went into maintenance.
- Ack statistics per client.
- Nack statistics per client
- Number of times a particular client did not acknowledge.
- Number of times switch over happened during GIR. GIR infra will rsync this counter to track multiple switchovers.
- Number of times the failsafe timer expired.
- Number of times system got out of maintenance on a timeout expiry.

Enter the **show system mode maintenance counters** command in privileged EXEC mode, to display the counters that are being tracked by the feature.

Enter the **clear system mode maintenance counters** command in privileged EXEC mode, to clear the counters supported by the feature.

The client-ack timeout value can be configured using the **failsafe failsafe-timeout-value** command. Failsafe time is the time that the GIR engine allows a client to transition. Each client sends a notification to the GIR engine about its transition. If it takes more than the failsafe time to transition, it is assumed to have transitioned. The failsafe timer can be configured between 5 - 180 minutes, with a default of 30 minutes.

How to Configure Graceful Insertion and Removal

Creating a Maintenance Template

Procedure

	Command or Action	Purpose
Step 1	enable Example: Device> enable	Enables privileged EXEC mode. Enter your password if prompted.
Step 2	configure terminal Example: Device# configure terminal	Enters the global configuration mode.
Step 3	maintenance-template <i>template_name</i> Example: Device(config)# maintenance-template girl	Creates a template with the specified name. For example, see Examples: Creating customer profile.
Step 4	router <i>routing_protocol instance_id</i> shutdown I2 Example: Device(config-maintenance-templ)# router isis 1 Device(config-maintenance-templ)# shutdown I2 Device(config-maintenance-templ)# router bgp AS-number	Creates instances that should be isolated under this template. <ul style="list-style-type: none"> • router: Configures routing protocols and associated instance id. • shutdown I2: Shuts down layer 2 interfaces.

Configuring System Mode Maintenance

Procedure

	Command or Action	Purpose
Step 1	enable Example: Device> enable	Enables privileged EXEC mode. Enter your password if prompted.
Step 2	configure terminal Example: Device# configure terminal	Enters the global configuration mode.

	Command or Action	Purpose
Step 3	system mode maintenance Example: Device(config)# system mode maintenance	Enters system mode maintenance configuration mode. Different sub commands to create maintenance mode parameters are configured in this mode.
Step 4	timeout <i>timeout-value</i> template <i>template-name</i> failsafe <i>failsafe-timeout-value</i> on-reload reset-reason maintenance	Configures maintenance mode parameters. <ul style="list-style-type: none"> • timeout: Configures maintenance mode timeout period in minutes, after which the system automatically returns to normal mode. The default timeout value is never. • template: Configures maintenance mode using the specified template. • failsafe: Configures client-ack timeout value. If the system is going into maintenance mode, it will continue to reach maintenance. If the system is exiting from maintenance mode, then it will reach normal mode. <ul style="list-style-type: none"> • on-reload reset-reason maintenance: Configures the system such that when the system is reloaded it enters the maintenance mode. If it is not configured the system enters the normal mode when it is reloaded.

Starting and Stopping Maintenance Mode

Procedure

	Command or Action	Purpose
Step 1	enable Example: Device> enable	Enables privileged EXEC mode. Enter your password if prompted.
Step 2	start maintenance Example: Device# start maintenance	Puts the system into maintenance mode.
Step 3	stop maintenance Example: Device# stop maintenance	Puts the system back into normal mode.

Monitoring Graceful Insertion and Removal

Use the following commands to check the status of or display statistics generated by the GIR feature:

Table 3: Privileged EXEC Commands

Command	Purpose
<code>show system mode [maintenance [clients template template-name]]</code>	Displays information about system mode.
<code>show system snapshots [dump <snapshot-file-name>]</code>	Displays all the snapshots present on the device.
<code>show system snapshots [dump <snapshot-file-name>]xml</code>	Displays all the snapshots present on the device in XML format.
<code>show system snapshots compare snapshot-name1 snapshot-name2</code>	Displays differences between snapshots taken before entering maintenance mode and after exiting from the maintenance mode.

Table 4: Global Configuration Commands for Troubleshooting

Command	Purpose
<code>debug system mode maintenance</code>	Displays information to help troubleshoot the GIR feature.

Configuration Examples for Graceful Removal and Insertion

The following examples show the sequence followed to enable GIR during a maintenance window.

Example: Configuring Maintenance Templates

Any protocol that is supported by GIR can be configured in the maintenance template. This example shows how to configure a maintenance template t1 with an ISIS routing protocol instance.

```
Device# configure terminal
Device(config)# maintenance-template t1
Device(config-maintenance-templ)# router isis 1
```

This example shows how to configure a maintenance template t1 with shutdown l2.

```
Device# configure terminal
Device(config)# maintenance-template t1
Device(config-maintenance-templ)# shutdown l2
```

This example shows how to configure a maintenance template t1 with a BGP routing protocol instance.

```
Device# configure terminal
Device(config)# maintenance-template t1
Device(config-maintenance-templ)# router BGP 1
```

Example: Configuring System Mode Maintenance

This example shows how to create a maintenance template and configure the maintenance mode parameters.

```
Device# configure terminal
Device(config)# system mode maintenance
Device(config-maintenance)# timeout 20
Device(config-maintenance)# failsafe 30
Device(config-maintenance)# on-reload reset-reason maintenance
Device(config-maintenance)# template t1
Device(config-maintenance)# exit
```

Example: Starting and Stopping the Maintenance Mode

This example shows how to put the system into maintenance mode.

```
Device# start maintenance
```

After the activity is completed, the system can be put out of maintenance mode.

This example shows how to put the system out of maintenance mode.

```
Device# stop maintenance
```

Example: Displaying System Mode Settings

This example shows how to display system mode settings using different options.

```
Device# show system mode
System Mode: Normal

Device# show system mode maintenance
System Mode: Normal
Current Maintenance Parameters:
Maintenance Duration: 15(mins)
Failsafe Timeout: 30(mins)
Maintenance Template: t1
Reload in Maintenance: False

Device# show system mode maintenance clients
System Mode: Normal
Maintenance Clients:
CLASS-EGP
CLASS-IGP
router isis 1: Transition None
CLASS-MCAST
CLASS-L2

Device# show system mode maintenance template default
System Mode: Normal
default maintenance-template details:
```

```
router isis 1
router isis 2
```

```
Device# show system mode maintenance template t1
System Mode: Normal
Maintenance Template t1 details:
router isis 1
```

Additional References for Graceful Insertion and Removal

Related Documents

Related Topic	Document Title
For complete syntax and usage information for the commands used in this chapter.	See the <i>High Availability</i> section of the <i>Command Reference (Catalyst 9600 Series Switches)</i>

Feature History for Graceful Insertion and Removal

This table provides release and related information for features explained in this module.

These features are available on all releases subsequent to the one they were introduced in, unless noted otherwise.

Release	Feature	Feature Information
Cisco IOS XE Gibraltar 16.11.1	Graceful Insertion and Removal	Provides an alternative method to minimize network service impact caused by device maintenance. GIR leverages redundant paths in the network to smoothly remove a device under maintenance, out of service, and insert it back to service when the maintenance is complete.
Cisco IOS XE Cupertino 17.7.1	Graceful Insertion and Removal	This feature was implemented on Cisco Catalyst 9600 Series Supervisor 2 Module (C9600X-SUP-2), which was introduced in this release.

Use Cisco Feature Navigator to find information about platform and software image support. To access Cisco Feature Navigator, go to <https://cfng.cisco.com>.



CHAPTER 5

Troubleshooting High Availability

- [Overview](#), on page 71
- [Support Articles](#), on page 71
- [Feedback Request](#), on page 72
- [Disclaimer and Caution](#), on page 72

Overview

This chapter provides links to documents authored by Cisco subject matter experts (SMEs). They aim to help you resolve technical issues without requiring a support ticket. If these documents are unable to resolve your issue, we recommend visiting the applicable [Cisco Community](#). There is a wealth of information and advice available from fellow Cisco customers who may have experienced this issue already and provided a solution. If you are not able to find a resolution on the Community, it may be best that you raise a support ticket at [Cisco Support](#). In cases where a support ticket has to be raised, these documents provide guidance about the data that should be collected and added to the support ticket. Specify the support document you referred, and TAC can create an improvement request with the document owner.

Support Articles

The documents in this section were created using specific software and hardware listed in the Components Used section of each article. However, this does not mean that they are limited to what is listed in Components Used, and generally remain relevant for later versions of software and hardware. Note that there could be some changes in the software or hardware that can cause commands to stop working, the syntax to change, or GUIs and CLIs to look different from one release to another.

The following are the support articles associated with this technology:

Document	Description
Catalyst 9600 - Migration to Quad-Supervisor Stackwise Virtual setup	This document describes how to configure two Catalyst 9600 switches running IOS-XE versions 16.11.X or 16.12.X to Quad-supervisor Stackwise Virtual setup on IOS-XE version 17.X.

Document	Description
Replace a Supervisor Module or Stack Member of Catalyst 9000 in HA	This document describes how to replace a supervisor module or a stack member of Catalyst 9K switches in HA (High Availability) setup.
Troubleshoot SVL on Catalyst 9000 Switches	This document describes how to identify, collect useful logs, and solve problems that can occur with StackWise-virtual (SVL) on Catalyst 9000 switches.

Feedback Request

Your input helps. A key aspect to improving these support documents is customer feedback. Note that these documents are owned and maintained by multiple teams within Cisco. If you find an issue specific to the document (unclear, confusing, information missing, etc):

- Provide feedback using the **Feedback** button located at the right panel of the corresponding article. The document owner will be notified, and will either update the article, or flag it for removal.
- Include information regarding the section, area, or issue you had with the document and what could be improved. Provide as much detail as possible.

Disclaimer and Caution

The information in this document was created from the devices in a specific lab environment. All of the devices used in this document started with a cleared (default) configuration. If your network is live, ensure that you understand the potential impact of any command.