



Cisco ACI Virtualization Guide, Release 5.1(x)

First Published: 2020-11-29

Americas Headquarters

Cisco Systems, Inc.
170 West Tasman Drive
San Jose, CA 95134-1706
USA
<http://www.cisco.com>
Tel: 408 526-4000
800 553-NETS (6387)
Fax: 408 527-0883

THE SPECIFICATIONS AND INFORMATION REGARDING THE PRODUCTS IN THIS MANUAL ARE SUBJECT TO CHANGE WITHOUT NOTICE. ALL STATEMENTS, INFORMATION, AND RECOMMENDATIONS IN THIS MANUAL ARE BELIEVED TO BE ACCURATE BUT ARE PRESENTED WITHOUT WARRANTY OF ANY KIND, EXPRESS OR IMPLIED. USERS MUST TAKE FULL RESPONSIBILITY FOR THEIR APPLICATION OF ANY PRODUCTS.

THE SOFTWARE LICENSE AND LIMITED WARRANTY FOR THE ACCOMPANYING PRODUCT ARE SET FORTH IN THE INFORMATION PACKET THAT SHIPPED WITH THE PRODUCT AND ARE INCORPORATED HEREIN BY THIS REFERENCE. IF YOU ARE UNABLE TO LOCATE THE SOFTWARE LICENSE OR LIMITED WARRANTY, CONTACT YOUR CISCO REPRESENTATIVE FOR A COPY.

The Cisco implementation of TCP header compression is an adaptation of a program developed by the University of California, Berkeley (UCB) as part of UCB's public domain version of the UNIX operating system. All rights reserved. Copyright © 1981, Regents of the University of California.

NOTWITHSTANDING ANY OTHER WARRANTY HEREIN, ALL DOCUMENT FILES AND SOFTWARE OF THESE SUPPLIERS ARE PROVIDED "AS IS" WITH ALL FAULTS. CISCO AND THE ABOVE-NAMED SUPPLIERS DISCLAIM ALL WARRANTIES, EXPRESSED OR IMPLIED, INCLUDING, WITHOUT LIMITATION, THOSE OF MERCHANTABILITY, FITNESS FOR A PARTICULAR PURPOSE AND NON-INFRINGEMENT OR ARISING FROM A COURSE OF DEALING, USAGE, OR TRADE PRACTICE.

IN NO EVENT SHALL CISCO OR ITS SUPPLIERS BE LIABLE FOR ANY INDIRECT, SPECIAL, CONSEQUENTIAL, OR INCIDENTAL DAMAGES, INCLUDING, WITHOUT LIMITATION, LOST PROFITS OR LOSS OR DAMAGE TO DATA ARISING OUT OF THE USE OR INABILITY TO USE THIS MANUAL, EVEN IF CISCO OR ITS SUPPLIERS HAVE BEEN ADVISED OF THE POSSIBILITY OF SUCH DAMAGES.

Any Internet Protocol (IP) addresses and phone numbers used in this document are not intended to be actual addresses and phone numbers. Any examples, command display output, network topology diagrams, and other figures included in the document are shown for illustrative purposes only. Any use of actual IP addresses or phone numbers in illustrative content is unintentional and coincidental.

All printed copies and duplicate soft copies of this document are considered uncontrolled. See the current online version for the latest version.

Cisco has more than 200 offices worldwide. Addresses and phone numbers are listed on the Cisco website at www.cisco.com/go/offices.

Cisco and the Cisco logo are trademarks or registered trademarks of Cisco and/or its affiliates in the U.S. and other countries. To view a list of Cisco trademarks, go to this URL: <https://www.cisco.com/c/en/us/about/legal/trademarks.html>. Third-party trademarks mentioned are the property of their respective owners. The use of the word partner does not imply a partnership relationship between Cisco and any other company. (1721R)

© 2020 Cisco Systems, Inc. All rights reserved.



CONTENTS

CHAPTER 1

New and Changed Information 1

New and Changed Information 1

CHAPTER 2

Cisco ACI Virtual Machine Networking 3

Cisco ACI VM Networking Support for Virtual Machine Managers 3

Mapping Cisco ACI and VMware Constructs 5

Virtual Machine Manager Domain Main Components 5

Virtual Machine Manager Domains 6

VMM Domain VLAN Pool Association 6

VMM Domain EPG Association 7

About Trunk Port Group 10

Attachable Entity Profile 10

EPG Policy Resolution and Deployment Immediacy 11

Guidelines for Deleting VMM Domains 13

NetFlow with Virtual Machine Networking 14

 About NetFlow with Virtual Machine Networking 14

 About NetFlow Exporter Policies with Virtual Machine Networking 14

 NetFlow Support with VMware vSphere Distributed Switch 14

 Configuring a NetFlow Exporter Policy for VM Networking Using the GUI 15

 Consuming a NetFlow Exporter Policy Under a VMM Domain Using the GUI 15

 Enabling NetFlow on an Endpoint Group to VMM Domain Association Using the GUI 16

Troubleshooting VMM Connectivity 16

CHAPTER 3

Cisco ACI with VMware VDS Integration 19

Configuring Virtual Machine Networking Policies 19

 Cisco APIC Supported VMware VDS Versions 20

Guidelines for Upgrading VMware DVS from 5.x to 6.x and VMM Integration	20
Guidelines for VMware VDS Integration	21
Mapping Cisco ACI and VMware Constructs	22
VMware VDS Parameters Managed By APIC	23
VDS Parameters Managed by APIC	23
VDS Port Group Parameters Managed by APIC	23
Creating a VMM Domain Profile	24
Prerequisites for Creating a VMM Domain Profile	24
vCenter Domain Operational Workflow	25
Creating a vCenter Domain Profile Using the GUI	26
Creating a Read-Only VMM Domain	28
Creating a Read-Only VMM Domain Using the Cisco APIC GUI	28
Promoting a Read-Only VMM Domain to Read-Write	29
Promoting a Read-Only VMM Domain Caveats	29
Promoting a Read-Only VMM Domain Using the Cisco APIC GUI	30
Enhanced LACP Policy Support	31
Enhanced LACP Limitations	32
Create LAGs for DVS Uplink Port Groups Using the Cisco APIC GUI	32
Associate Application EPGs to VMware vCenter Domains with Enhanced LACP Policies Using the Cisco APIC GUI	33
Remove the Enhanced LACP Configuration Before a Downgrade	34
Port Binding	34
Types of Binding	35
Configure Port Binding Using the GUI	35
Configure Port Binding Using the REST API	36
Endpoint Retention Configuration	37
Configuring Endpoint Retention Using the GUI	37
Creating VDS Uplink Port Groups	37
Creating a Trunk Port Group	38
Trunk Port Group	38
Creating a Trunk Port Group Using the GUI	38
Using VMware vSphere vMotion	39
Working with Blade Servers	40
Guidelines for Cisco UCS B-Series Servers	40

Setting up an Access Policy for a Blade Server Using the GUI	41
Troubleshooting the Cisco ACI and VMware VMM System Integration	42
Additional Reference Sections	42
Custom User Account with Minimum VMware vCenter Privileges	42
Quarantine Port Groups	44
On-Demand VMM Inventory Refresh	44
Physically Migrating the ESXi Host	45
Guidelines for Migrating a vCenter Hypervisor VMK0 to an ACI Inband VLAN	45
Create the Necessary Management EPG Policies in APIC	45
Migrate the VMK0 to the Inband ACI VLAN	45

CHAPTER 4**Managing Uplinks for VMM Domains 47**

Managing Uplinks for VMM Domains	47
Prerequisites for Managing Uplinks for VMM Domains	48
Workflow for Managing Uplinks for VMM Domains	48
Specifying Uplinks for the VMM Domain	48
Create a VMM Domain for a VMware VDS and Specify the Number of Uplinks	49
Create a VMM Domain for Cisco ACI Virtual Edge and Specify the Number of Uplinks	51
Edit the VMM Domain and Modify the Uplinks	53
Define Uplink Roles to Configure Failover	55
Associate an EPG with a VMM Domain and Define Uplink Roles	55
Edit the EPG-Domain Association and Define Uplink Roles	56

CHAPTER 5**Custom EPG Name Configuration and Cisco ACI 59**

Configuring Custom EPG Names for VMM Domains	59
Guidelines for Using Custom Names for EPGs	59
Prerequisites for Configuring a Custom EPG Name	60
Configuring Custom EPG Names	61
Configure a Custom EPG Name Using the GUI	61
Change or Delete the Custom EPG Name Using the GUI	61
Verifying EPG Names	62
Verify the Port Group Name in VMware vCenter	62
Verify a VM Network Name Change in Microsoft SCVMM	62

CHAPTER 6**Microsegmentation with Cisco ACI 65**

Microsegmentation with Cisco ACI 65

Benefits of Microsegmentation with Cisco ACI 66

How Microsegmentation Using Cisco ACI Works 66

Attributes for Microsegmentation with Cisco ACI 68

Methods of Filtering VMs for uSeg EPGs 70

VM Filtering when Matching Any Attribute 71

VM Filtering when Matching All Attributes 73

VM Filtering when Using Simple or Block Statements 73

VM Filtering when Using EPG Match Precedence 74

Precedence of Operators 74

Scenarios for Using Microsegmentation with Cisco ACI 75

Using Microsegmentation with Cisco ACI with VMs Within a Single Application EPG 75

Using Microsegmentation with Cisco ACI with VMs in Different Application EPGs 77

Using Microsegmentation with Network-based Attributes 78

Configuring Microsegmentation with Cisco ACI 78

Prerequisites for Configuring Microsegmentation with Cisco ACI 78

Workflow for Configuring Microsegmentation with Cisco ACI 79

Configuring Microsegmentation with Cisco ACI Using the GUI 80

CHAPTER 7**Intra-EPG Isolation Enforcement and Cisco ACI 85**

Intra-EPG Isolation for VMware VDS or Microsoft Hyper-V Virtual Switch 85

Configuring Intra-EPG Isolation for VMware VDS or Microsoft Hyper-V Virtual Switch using the GUI 89

CHAPTER 8**Cisco ACI with Cisco UCSM Integration 91**

Automating Networking Policies for Cisco UCS Devices with Cisco ACI 91

Cisco UCSM Integration Prerequisites 92

Integrating Cisco UCSM into the Cisco ACI Fabric Using the Cisco APIC GUI 93

Creating an Integration Group Using the Cisco APIC GUI 93

Creating an Integration for the Integration Group Using the Cisco APIC GUI 94

Managing Uplink Port Channels Using the Cisco APIC GUI 96

Associating a Switch Manager with the Virtual Controller Using the Cisco APIC GUI 97

Downgrading Cisco APIC with Cisco UCSM Integration 97

CHAPTER 9

Cisco ACI with VMware NSX-T Data Center 99

Cisco ACI with VMware NSX-T Data Center 99

CHAPTER 10

Cisco ACI with Cisco ACI vPod 101

Cisco ACI with Cisco ACI vPod 101

CHAPTER 11

Cisco ACI with Cisco ACI Virtual Edge 103

Cisco ACI with Cisco ACI Virtual Edge 103

CHAPTER 12

Cisco ACI with VMware vRealize 105

About Cisco ACI with VMware vRealize 105

Cisco ACI with VMware vRealize Solution Overview 106

Physical and Logical Topology 106

About the Mapping of ACI Constructs in VMware vRealize 108

Event Broker VM Customization 109

Getting Started with Cisco ACI with VMware vRealize 110

Prerequisites for Getting Started with Cisco ACI with VMware vRealize 110

Setting Up an IaaS Handle in vRealize Orchestrator 111

Cisco ACI with VMware vRealize Installation Workflow 112

Installing the APIC Plug-in on the vRealize Orchestrator 112

Setting Up the VMware vRealize Automation Appliance for ACI 113

Day-0 Operations of ACI 115

Associating AEP with VMware VMM Domain 116

Cisco ACI with VMware vRealize Upgrade Workflow 116

Upgrading the APIC Plug-in on the vRealize Orchestrator 117

Verifying the Connection Between APIC and vRealize 117

Cisco ACI with VMware vRealize Downgrade Workflow 118

Deleting Package and Workflows 118

Use Case Scenarios for the Administrator and Tenant Experience 119

Overview of Tier Application Deployment 119

Deploying a Single-Tier Application Using Property Groups 119

Deploying a 3-Tier Application Using a Multi-Machine Blueprint 121

About Plan Types	125
About vRealize Service Categories and Catalog Items	126
Mapping of the ACI Plan Types to vRealize Service Categories	126
ACI Administrator Services in vRealize	128
List of Admin Services Catalog Items for ACI Administrator Services	128
ACI Tenant Services in vRealize	131
List of Network Security Catalog Items for ACI Tenant Services	131
List of Tenant Network Services Catalog Items for ACI Tenant Services	132
List of Tenant Shared Plan Catalog Items for ACI Tenant Services	133
List of Tenant VPC Plan Catalog Items for ACI Tenant Services	134
List of VM Services Catalog Items for ACI Tenant Services	135
Entitlements for ACI catalog-items in vRealize	136
List of Entitlements for ACI Catalog Items	136
ACI Plug-in in vRealize Orchestrator	136
APIC Workflows	136
APIC Inventory View	137
About Load Balancing and Firewall Services	138
Prerequisites for Enabling Services	138
Configuring the Services on APIC Using XML POST	139
Deleting the Services Configuration	142
About L3 External Connectivity	142
Prerequisites for Configuring L3 External Connectivity for vRealize	142
Administrator Experiences	143
Cisco ACI with Cisco AVS or Cisco ACI Virtual Edge	143
Cisco AVS or Cisco ACI Virtual Edge VMM Domain Creation	143
Update of Cisco AVS or Cisco ACI Virtual Edge VMM Domain Encapsulation Pools	146
Deletion of Cisco AVS or Cisco ACI Virtual Edge and the VMM Domain	148
Cisco AVS or Cisco ACI Virtual Edge VMM Domain Security Domain Mapping	151
Distributed Firewall Policy	152
Tenant Experiences in a Shared or Virtual Private Cloud Plan	157
Creating Networks in a Shared Plan	157
Verifying the Newly Created Network on VMware vRealize and APIC	158
Creating a Bridge Domain in a VPC Plan	158
Creating a Network and Associating to a Bridge Domain in a VPC Plan	159

Creating a Security Policy Within the Tenant	160
Consuming a Shared Service in the Common Tenant	162
Updating Security Policies (Access Control Lists)	164
Deleting Security Policies (Access Control Lists)	165
Creating the Network in the VPC Plan	166
Updating a Tenant Network Association with the VMM Domain	168
Microsegmentation	169
Creating the VMs and Attaching to Networks Without Using the Machine Blueprints	179
About Adding the Load Balancer to the Tenant Network	179
Configuring the Firewall	183
Configuring the Firewall and Load Balancer	185
Configuring the Inter-EPG Firewall	187
Attaching an External L3 Network Internet Access	189
Application Deployment Scenarios	191
About Property Groups	192
About Service Blueprints	192
Integration with vRealize Network Profiles (IPAM)	193
Documentation of APIC Workflows in vRealize Orchestrator	193
List of Methods in ApicConfigHelper Class	194
Writing Custom Workflows Using the APIC Plug-in Method	200
Multi-Tenancy and Role based Access Control Using Security Domains	201
Adding the Tenant	201
Deleting the Tenant	201
APIC Credentials for Workflows	202
Adding APIC with Admin Credentials	202
Adding APIC with Tenant Credentials	202
Troubleshooting	202
Collecting the Logs to Report	203
Installing the ACI Helper Scripts	203
Removing the APIC Plug-in	204
Plug-in Overview	204
Configuring a vRA Host for the Tenant in the vRealize Orchestrator	205
Configuring an IaaS Host in the vRealize Orchestrator	206

CHAPTER 13**Cisco ACI vCenter Plug-in 207**

- About Cisco ACI with VMware vSphere Web Client 207
 - Cisco ACI vCenter Plug-in Overview 207
- Getting Started with Cisco ACI vCenter Plug-in 208
 - Cisco ACI vCenter Plug-in Software Requirements 208
 - Required APIC Configuration 209
 - Installing the Cisco ACI vCenter Plug-in 209
 - Connecting the Cisco ACI vCenter Plug-in to your Cisco ACI Fabric 210
 - Connecting vCenter Plug-in to the Cisco ACI Fabric Using Credentials 211
 - Connecting vCenter Plug-in to your ACI Fabric Using an Existing Certificate 211
 - Connecting vCenter Plug-in to your ACI Fabric by Creating a New Certificate 212
- Cisco ACI vCenter Plug-in Features and Limitations 213
 - Role-based Access Control for Cisco ACI vCenter Plug-in 218
 - Recommended RBAC Configuration for Cisco ACI vCenter Plug-in 220
- Upgrading VMware vCenter when Using the Cisco ACI vCenter Plug-in 220
- Cisco ACI vCenter Plug-in GUI 221
 - Cisco ACI vCenter Plug-in GUI Architecture Overview 221
 - Cisco ACI vCenter Plug-in Overview 222
 - GUI Tips 227
- Performing ACI Object Configurations 228
 - Creating a New Tenant 228
 - Creating a New Application Profile 228
 - Creating an EPG Using the Drag and Drop Method 229
 - Creating a New uSeg EPG Using the Drag and Drop Method 230
 - Creating a Contract Between Two EPGs Using the Drag and Drop Method 231
 - Adding an EPG to an Existing Contract Using Drag and Drop Method 232
 - Adding an EPG to an Existing Contract using the Security Tab 233
 - Setting up L3 External Network 233
 - Setting up L2 External Network 234
 - Creating a VRF Using the Drag and Drop Method 235
 - Creating a Bridge Domain 236
 - Start a New Troubleshooting Session Between Endpoints 236
 - Start an Existing Troubleshooting Session Between Endpoints 237

Uninstalling the Cisco ACI vCenter Plug-in	237
Upgrading the Cisco ACI vCenter Plug-in	238
Troubleshooting the Cisco ACI vCenter Plug-in Installation	238
Reference Information	239
Alternative Installation of the Cisco ACI vCenter Plug-in	239

CHAPTER 14
Cisco ACI with Microsoft SCVMM 243

About Cisco ACI with Microsoft SCVMM	243
Cisco ACI with Microsoft SCVMM Solution Overview	244
Physical and Logical Topology of SCVMM	244
About the Mapping of ACI Constructs in SCVMM	244
SCVMM Fabric Cloud and Tenant Clouds	245
Getting Started with Cisco ACI with Microsoft SCVMM	246
Prerequisites for Getting Started with Cisco ACI with Microsoft SCVMM	246
Installing, Setting Up, and Verifying the Cisco ACI with Microsoft SCVMM Components	247
Installing the APIC SCVMM Agent on SCVMM	249
Installing the APIC SCVMM Agent on a Highly Available SCVMM	250
Generating APIC OpFlex Certificate	250
Adding the OpFlex Certificate Policy to APIC	252
Installing the OpflexAgent Certificate	253
Configuring APIC IP Settings with OpflexAgent Certificate on the SCVMM Agent	255
Configuring APIC IP Settings with OpflexAgent Certificate on the SCVMM Agent on a Highly Available SCVMM	256
Installing the APIC Hyper-V Agent on the Hyper-V Server	257
Verifying the Installation of Cisco ACI with Microsoft SCVMM	260
Setting Up ACI Policies	262
Upgrading the Cisco ACI with Microsoft SCVMM Components	267
Upgrading the ACI Microsoft SCVMM Components Workflow	267
Upgrading the APIC SCVMM Agent on SCVMM	268
Upgrading the APIC SCVMM Agent on a High Available SCVMM	269
Upgrading the APIC Hyper-V Agent	269
Deploying Tenant Policies	270
Deployment Tenant Policies Prerequisites	270
Creating a Tenant	271

Creating an EPG	271
Associating the Microsoft VMM Domain with an EPG	271
Verifying the EPG is Associated with the VMM Domain on APIC	272
Verifying the EPG is Associated with the VMM Domain on SCVMM	272
Creating a Static IP Address Pool	273
Connecting and Powering on the Virtual Machine	274
Verifying the Association on APIC	274
Viewing EPGs on APIC	275
Troubleshooting the Cisco ACI with Microsoft SCVMM	275
Troubleshooting APIC to SCVMM Connectivity	275
Troubleshooting Leaf to Hyper-V Host Connectivity	275
Troubleshooting the EPG Configuration Issue	276
Reference Information	276
Installing the APIC Agent on SCVMM Using the Windows Command Prompt	276
Installing the APIC Hyper-V Agent on the Hyper-V Server Using the Windows Command Prompt	277
Programmability References	278
ACI SCVMM PowerShell Cmdlets	278
Configuration References	279
MAC Address Configuration Recommendations	279
Uninstalling the Cisco ACI with Microsoft SCVMM Components	280
Uninstalling the APIC SCVMM Agent	281
Uninstalling the APIC SCVMM Agent on a Highly Available SCVMM	281
Downgrading the Cisco APIC Controller and the Switch Software with Cisco ACI and Microsoft SCVMM Components	282
Exporting APIC OpFlex Certificate	283

CHAPTER 15

Cisco ACI with Microsoft Windows Azure Pack	285
About Cisco ACI with Microsoft Windows Azure Pack	285
Cisco ACI with Microsoft Windows Azure Pack Solution Overview	286
Physical and Logical Topology	287
About the Mapping of ACI Constructs in Microsoft Windows Azure Pack	288
Getting Started with Cisco ACI with Microsoft Windows Azure Pack	289
Prerequisites for Getting Started with Cisco ACI with Microsoft Windows Azure Pack	289

Installing, Setting Up, and Verifying the Cisco ACI with Microsoft Windows Azure Pack Components	290
Installing ACI Azure Pack Resource Provider	291
Installing the OpflexAgent Certificate	291
Configuring ACI Azure Pack Resource Provider Site	293
Installing ACI Azure Pack Admin Site Extension	294
Installing ACI Azure Pack Tenant Site Extension	294
Setting Up ACI	294
Verifying the Windows Azure Pack Resource Provider	295
Upgrading the Cisco ACI with Microsoft Windows Azure Pack Components	295
Upgrading the ACI Windows Azure Pack Workflow	296
Upgrading the ACI Windows Azure Pack Resource Provider	297
Upgrading the ACI Azure Pack Admin Site Extension	297
Upgrading the ACI Azure Pack Tenant Site Extension	298
Use Case Scenarios for the Administrator and Tenant Experience	298
Admin Tasks	301
About Plan Types	301
About Plan Options	302
Creating a Plan	303
Creating a Tenant	304
Allowing Tenants to Provide Shared Services	304
Allowing Tenants to Consume Shared Service	305
Allowing Tenants to Consume NAT Firewall and ADC Load Balancer Services	305
Viewing the Shared Service Providers and Consumers	306
Managing Shared Services	306
About Load Balancing	307
About L3 External Connectivity	315
Tenant Tasks	317
Shared or Virtual Private Cloud Plan Experience	317
Troubleshooting Cisco ACI with Microsoft Windows Azure Pack	330
Troubleshooting as an Admin	330
Troubleshooting as a Tenant	330
Troubleshooting the EPG Configuration Issue	330
Programmability References	330

ACI Windows Azure Pack PowerShell Cmdlets	330
Uninstalling the Cisco ACI with Microsoft Windows Azure Pack Components	332
Uninstalling the APIC Windows Azure Pack Resource Provider	332
Uninstalling the ACI Azure Pack Resource Provider	333
Uninstalling the ACI Azure Pack Admin Site Extension	333
Uninstalling the ACI Azure Pack Tenant Site Extension	333
Uninstalling the APIC Hyper-V Agent	334
Downgrading Cisco APIC and the Switch Software with Cisco ACI and Microsoft Windows Azure Pack Components	334

APPENDIX A
Performing NX-OS CLI Tasks 337

Cisco ACI Virtual Machine Networking	337
Configuring a NetFlow Exporter Policy for Virtual Machine Networking Using the NX-OS-Style CLI	337
Consuming a NetFlow Exporter Policy Under a VMM Domain Using the NX-OS-Style CLI for VMware VDS	338
Enabling or Disabling NetFlow on an Endpoint Group Using the NX-OS-Style CLI for VMware VDS	338
Cisco ACI with VMware VDS Integration	339
Creating a VMware VDS Domain Profile	339
Creating a vCenter Domain Profile Using the NX-OS Style CLI	339
Creating a Read-Only VMM Domain Using the NX-OS Style CLI	341
Promoting a Read-Only VMM Domain Using the NX-OS Style CLI	342
Enhanced LACP Policy Support	343
Create LAGs for DVS Uplink Port Groups Using the NX-OS Style CLI	343
Associate Application EPGs to VMware vCenter Domains with Enhanced LACP Policies Using the NX-OS Style CLI	343
Endpoint Retention Configuration	344
Configure Endpoint Retention Using the NX-OS Style CLI	344
Creating a Trunk Port Group	344
Creating a Trunk Port Group Using the NX-OS Style CLI	344
Custom EPG Names and Cisco ACI	347
Configure or Change a Custom EPG Name Using the NX-OS Style CLI	347
Delete a Custom EPG Name Using the NX-OS Style CLI	348
Microsegmentation with Cisco ACI	349

Configuring Microsegmentation with Cisco ACI Using the NX-OS-Style CLI	349
Intra-EPG Isolation Enforcement and Cisco ACI	351
Configuring Intra-EPG Isolation for VMware VDS or Microsoft Hyper-V Virtual Switch using the NX-OS Style CLI	351
Cisco ACI with Cisco UCSM Integration	353
Integrating Cisco UCSM Using the NX-OS Style CLI	353
Cisco ACI with Microsoft SCVMM	354
Creating a Static IP Address Pool Using the NX-OS Style CLI	354
Creating a SCVMM Domain Profile Using the NX-OS Style CLI	355

APPENDIX B**Performing REST API Tasks 357**

Cisco ACI Virtual Machine Networking	357
Configuring a NetFlow Exporter Policy for VM Networking Using the REST API	357
Consuming a NetFlow Exporter Policy Under a VMM Domain Using the REST API for VMware VDS	357
Enabling NetFlow on an Endpoint Group for VMM Domain Association for VMware VDS	358
Cisco ACI with VMware VDS Integration	358
Creating a VMware VDS Domain Profile	358
Creating a vCenter Domain Profile Using the REST API	358
Creating a Read-Only VMM Domain Using the REST API	361
Promoting a Read-Only VMM Domain Using the REST API	363
Enhanced LACP Policy Support	364
Create LAGs for DVS Uplink Port Groups Using REST API	364
Associate Application EPGs to VMware vCenter Domains with Enhanced LACP Policies Using REST API	365
Endpoint Retention Configuration	366
Configuring Endpoint Retention Using the REST API	366
Creating a Trunk Port Group	366
Creating a Trunk Port Group Using the REST API	366
Working with Blade Servers	367
Setting Up an Access Policy for a Blade Server Using the REST API	367
Custom EPG Names and Cisco ACI	368
Configure or Change a Custom EPG Name Using REST API	368
Delete a Custom EPG Name Using REST API	369
Microsegmentation with Cisco ACI	370

Configuring Microsegmentation with Cisco ACI Using the REST API	370
Intra-EPG Isolation Enforcement with Cisco ACI	371
Configuring Intra-EPG Isolation for VMware VDS or Microsoft Hyper-V Virtual Switch using the REST API	371
Cisco ACI with Cisco UCSM Integration	372
Integrating Cisco UCSM Using REST API	372
Cisco ACI with Microsoft SCVMM	373
Creating a SCVMM Domain Profile Using the REST API	373
Displaying the Certificate Information to be Used on APIC Using the REST API	376



CHAPTER 1

New and Changed Information

This chapter contains the following sections:

- [New and Changed Information, on page 1](#)

New and Changed Information

The following table provides an overview of the significant changes to this guide for the Cisco Application Policy Infrastructure Controller APIC 5.1(x) family of releases. The tables do not provide an exhaustive list of all changes to the guide or of the new features.

Table 1: New Features and Changed Behavior in the Cisco ACI Virtualization Guide, Cisco APIC Release 5.1(x)

Cisco APIC Release Version	Feature	Description	Where Documented
5.1(1)	Support for VMware NSX-T Data Center integration	You can integrate VMware NSX-T Data Center with Cisco Application Centric Infrastructure (ACI). Integration enables you to use Cisco Application Policy Infrastructure Controller (APIC) to create and work with VMware NSX-T Data Center network constructs.	<ul style="list-style-type: none">• Cisco ACI with VMware NSX-T Data Center, on page 99 in this guide.• Cisco ACI and VMware NSX-T Data Center Integration on Cisco.com.



CHAPTER 2

Cisco ACI Virtual Machine Networking

This chapter contains the following sections:

- [Cisco ACI VM Networking Support for Virtual Machine Managers, on page 3](#)
- [Mapping Cisco ACI and VMware Constructs, on page 5](#)
- [Virtual Machine Manager Domain Main Components , on page 5](#)
- [Virtual Machine Manager Domains, on page 6](#)
- [VMM Domain VLAN Pool Association, on page 6](#)
- [VMM Domain EPG Association, on page 7](#)
- [About Trunk Port Group, on page 10](#)
- [Attachable Entity Profile, on page 10](#)
- [EPG Policy Resolution and Deployment Immediacy, on page 11](#)
- [Guidelines for Deleting VMM Domains, on page 13](#)
- [NetFlow with Virtual Machine Networking, on page 14](#)
- [Troubleshooting VMM Connectivity, on page 16](#)

Cisco ACI VM Networking Support for Virtual Machine Managers

Benefits of ACI VM Networking

Cisco Application Centric Infrastructure (ACI) virtual machine (VM) networking supports hypervisors from multiple vendors. It provides the hypervisors programmable and automated access to high-performance scalable virtualized data center infrastructure.

Programmability and automation are critical features of scalable data center virtualization infrastructure. The Cisco ACI open REST API enables virtual machine integration with and orchestration of the policy model-based Cisco ACI fabric. Cisco ACI VM networking enables consistent enforcement of policies across both virtual and physical workloads that are managed by hypervisors from multiple vendors.

Attachable entity profiles easily enable VM mobility and placement of workloads anywhere in the Cisco ACI fabric. The Cisco Application Policy Infrastructure Controller (APIC) provides centralized troubleshooting, application health score, and virtualization monitoring. Cisco ACI multi-hypervisor VM automation reduces or eliminates manual configuration and manual errors. This enables virtualized data centers to support large numbers of VMs reliably and cost effectively.

Supported Products and Vendors

Cisco ACI supports virtual machine managers (VMMs) from the following products and vendors:

- **Cisco Unified Computing System Manager (UCSM)**

Integration of Cisco UCSM is supported beginning in Cisco APIC Release 4.1(1). For information, see the chapter "Cisco ACI with Cisco UCSM Integration" in the *Cisco ACI Virtualization Guide, Release 4.1(1)*.

- **Cisco Application Centric Infrastructure (ACI) Virtual Pod (vPod)**

Cisco ACI vPod is in general availability beginning in Cisco APIC Release 4.0(2). For information, see the [Cisco ACI vPod documentation](#) on Cisco.com.

- **Cisco ACI Virtual Edge**

For information, see the [Cisco ACI Virtual Edge documentation](#) on Cisco.com.

- **Cloud Foundry**

Cloud Foundry integration with Cisco ACI is supported beginning with Cisco APIC Release 3.1(2). For information, see the knowledge base article, [Cisco ACI and Cloud Found Integration](#) on Cisco.com.

- **Kubernetes**

For information, see the knowledge base article, [Cisco ACI and Kubernetes Integration](#) on Cisco.com.

- **Microsoft System Center Virtual Machine Manager (SCVMM)**

For information, see the chapters "Cisco ACI with Microsoft SCVMM" and "Cisco ACI with Microsoft Windows Azure Pack" in the *Cisco ACI Virtualization Guide* on Cisco.com

- **OpenShift**

For information, see the [OpenShift documentation](#) on Cisco.com.

- **OpenStack**

For information, see the [OpenStack documentation](#) on Cisco.com.

- **Red Hat Virtualization (RHV)**

For information, see the knowledge base article, [Cisco ACI and Red Hat Integration](#) on Cisco.com.

- **VMware Virtual Distributed Switch (VDS)**

For information, see the chapter "Cisco ACI with VMware VDS Integration" in the *Cisco ACI Virtualization Guide*.

See the [Cisco ACI Virtualization Compatibility Matrix](#) for the most current list of verified interoperable products.



Note Beginning with Cisco APIC Release 5.0(1), Cisco Application Virtual Switch (AVS) is no longer supported. If you use Cisco AVS and upgrade to Cisco APIC Release 5.0(1), in case of issues, the fabric will not be supported. Also, a fault will be raised for the Cisco AVS domain.

If you use Cisco AVS, we recommend that you migrate to Cisco Application Centric Infrastructure (ACI) Virtual Edge. See the *Cisco ACI Virtual Edge Installation Guide, Release 3.0(x)* on Cisco.com.

Mapping Cisco ACI and VMware Constructs

Cisco Application Centric Infrastructure (ACI) and VMware use different terms to describe the same constructs. This section provides a table for mapping Cisco ACI and VMware terminology; the information is relevant to VMware vSphere Distributed Switch (VDS) and Cisco ACI Virtual Edge.

Cisco ACI Terms	VMware Terms
Endpoint group (EPG)	Port group, portgroup
LACP Active	<ul style="list-style-type: none"> • Route based on IP hash (downlink port group) • LACP Enabled/Active (uplink port group)
LACP Passive	<ul style="list-style-type: none"> • Route based on IP hash (downlink port group) • LACP Enabled/Active (uplink port group)
MAC Pinning	<ul style="list-style-type: none"> • Route based on originating virtual port • LACP Disabled
MAC Pinning-Physical-NIC-Load	<ul style="list-style-type: none"> • Route based on physical NIC load • LACP Disabled
Static Channel - Mode ON	<ul style="list-style-type: none"> • Route based on IP Hash (downlink port group) • LACP Disabled
Virtual Machine Manager (VMM) domain	VDS
VM controller	vCenter (Datacenter)

Virtual Machine Manager Domain Main Components

ACI fabric virtual machine manager (VMM) domains enable an administrator to configure connectivity policies for virtual machine controllers. The essential components of an ACI VMM domain policy include the following:

- **Virtual Machine Manager Domain Profile**—Groups VM controllers with similar networking policy requirements. For example, VM controllers can share VLAN pools and application endpoint groups (EPGs). The APIC communicates with the controller to publish network configurations such as port groups that are then applied to the virtual workloads. The VMM domain profile includes the following essential components:
 - **Credential**—Associates a valid VM controller user credential with an APIC VMM domain.

- **Controller**—Specifies how to connect to a VM controller that is part of a policy enforcement domain. For example, the controller specifies the connection to a VMware vCenter that is part a VMM domain.



Note A single VMM domain can contain multiple instances of VM controllers, but they must be from the same vendor (for example, from VMware or from Microsoft).

- **EPG Association**—Endpoint groups regulate connectivity and visibility among the endpoints within the scope of the VMM domain policy. VMM domain EPGs behave as follows:
 - The APIC pushes these EPGs as port groups into the VM controller.
 - An EPG can span multiple VMM domains, and a VMM domain can contain multiple EPGs.
- **Attachable Entity Profile Association**—Associates a VMM domain with the physical network infrastructure. An attachable entity profile (AEP) is a network interface template that enables deploying VM controller policies on a large set of leaf switch ports. An AEP specifies which switches and ports are available, and how they are configured.
- **VLAN Pool Association**—A VLAN pool specifies the VLAN IDs or ranges used for VLAN encapsulation that the VMM domain consumes.

Virtual Machine Manager Domains

An APIC VMM domain profile is a policy that defines a VMM domain. The VMM domain policy is created in APIC and pushed into the leaf switches.

VMM domains provide the following:

- A common layer in the ACI fabric that enables scalable fault-tolerant support for multiple VM controller platforms.
- VMM support for multiple tenants within the ACI fabric.

VMM domains contain VM controllers such as VMware vCenter or Microsoft SCVMM Manager and the credential(s) required for the ACI API to interact with the VM controller. A VMM domain enables VM mobility within the domain but not across domains. A single VMM domain can contain multiple instances of VM controllers but they must be the same kind. For example, a VMM domain can contain many VMware vCenters managing multiple controllers each running multiple VMs but it may not also contain SCVMM Managers. A VMM domain inventories controller elements (such as pNICs, vNICs, VM names, and so forth) and pushes policies into the controller(s), creating port groups, and other necessary elements. The ACI VMM domain listens for controller events such as VM mobility and responds accordingly.

VMM Domain VLAN Pool Association

VLAN pools represent blocks of traffic VLAN identifiers. A VLAN pool is a shared resource and can be consumed by multiple domains such as VMM domains and Layer 4 to Layer 7 services.

Each pool has an allocation type (static or dynamic), defined at the time of its creation. The allocation type determines whether the identifiers contained in it will be used for automatic assignment by the Cisco APIC (dynamic) or set explicitly by the administrator (static). By default, all blocks contained within a VLAN pool have the same allocation type as the pool but users can change the allocation type for encapsulation blocks contained in dynamic pools to static. Doing so excludes them from dynamic allocation.

A VMM domain can associate with only one dynamic VLAN pool. By default, the assignment of VLAN identifiers to EPGs that are associated with VMM domains is done dynamically by the Cisco APIC. While dynamic allocation is the default and preferred configuration, an administrator can statically assign a VLAN identifier to an endpoint group (EPG) instead. In that case, the identifiers used must be selected from encapsulation blocks in the VLAN pool associated with the VMM domain, and their allocation type must be changed to static.

The Cisco APIC provisions VMM domain VLAN on leaf ports based on EPG events, either statically binding on leaf ports or based on VM events from controllers such as VMware vCenter or Microsoft SCVMM.



Note In dynamic VLAN pools, if a VLAN is disassociated from an EPG, it is automatically reassociated with the EPG in five minutes.



Note Dynamic VLAN association is not a part of configuration rollback, that is, in case an EPG or tenant was initially removed and then restored from the backup, a new VLAN is automatically allocated from the dynamic VLAN pools.

VMM Domain EPG Association

The Cisco Application Centric Infrastructure (ACI) fabric associates tenant application profile endpoint groups (EPGs) to virtual machine manager (VMM) domains, The Cisco ACI does so either automatically by an orchestration component such as Microsoft Azure, or by a Cisco Application Policy Infrastructure Controller (APIC) administrator creating such configurations. An EPG can span multiple VMM domains, and a VMM domain can contain multiple EPGs.

Figure 1: VMM Domain EPG Association

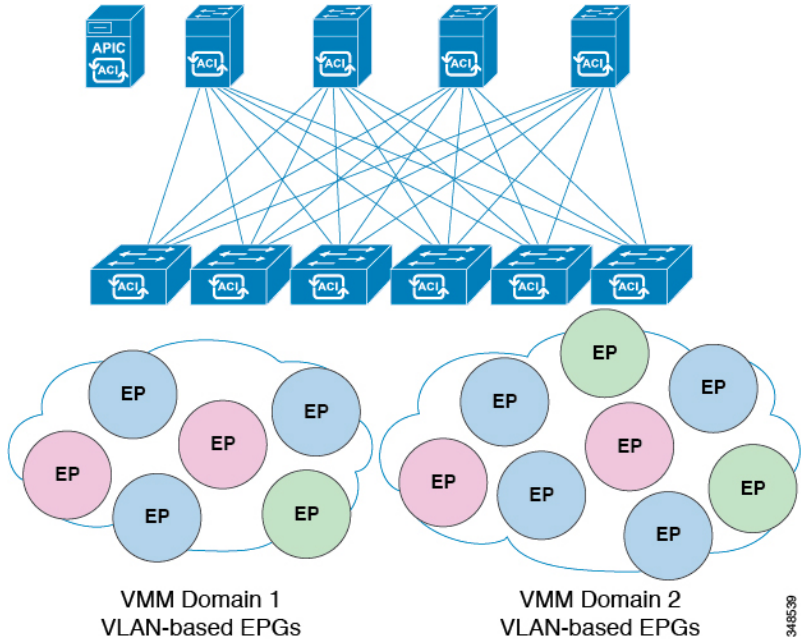

In the preceding illustration, end points (EPs) of the same color are part of the same EPG. For example, all the green EPs are in the same EPG although they are in two different VMM domains.

See the latest *Verified Scalability Guide for Cisco ACI* for virtual network and VMM domain EPG capacity information.

Figure 2: VMM Domain EPG VLAN Consumption

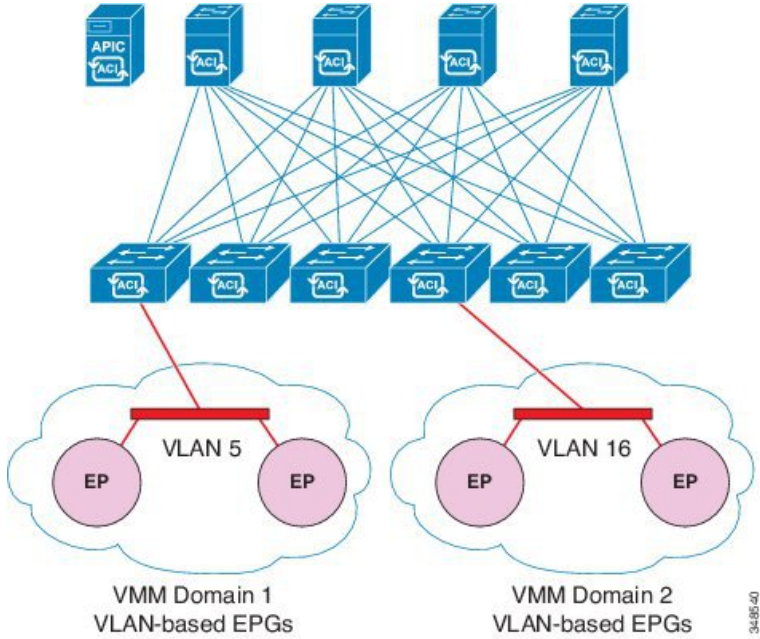



Note When multiple VMM domains with an overlapping VLAN ID range are connected to the same leaf switch, those domains should use the same VLAN pool. With the same VLAN pool, Cisco APIC can make sure to pick a different VLAN ID for each domain-to-EPG association. Otherwise, Cisco APIC might pick a VLAN ID that is already used on the switch for another domain-to-EPG association, which causes the VLAN deployment fail.

When multiple VMM domains with an overlapping VLAN ID range are connected to the same leaf switch and those domains use the same VLAN pool, you can have multiple VMM domains associated with the same EPG. However, each domain-to-EPG association deploys a different VLAN ID, respectively, even though the VLANs are for the same EPG and potentially are on the same port. If using VLAN IDs in this manner is suboptimal to your requirements, you can use the same VMM domain with multiple VMM controllers instead of having multiple VMM domains.

EPGs can use multiple VMM domains in the following ways:

- An EPG within a VMM domain is identified by using an encapsulation identifier. Cisco APIC can manage the identifier automatically, or the administrator can statically select it. An example is a VLAN, a Virtual Network ID (VNID).
- An EPG can be mapped to multiple physical (for baremetal servers) or virtual domains. It can use different VLAN or VNID encapsulations in each domain.



Note By default, the Cisco APIC dynamically manages the allocation of a VLAN for an EPG. VMware DVS administrators have the option to configure a specific VLAN for an EPG. In that case, the VLAN is chosen from a static allocation block within the pool that is associated with the VMM domain.

Applications can be deployed across VMM domains.

Figure 3: Multiple VMM Domains and Scaling of EPGs in the Fabric

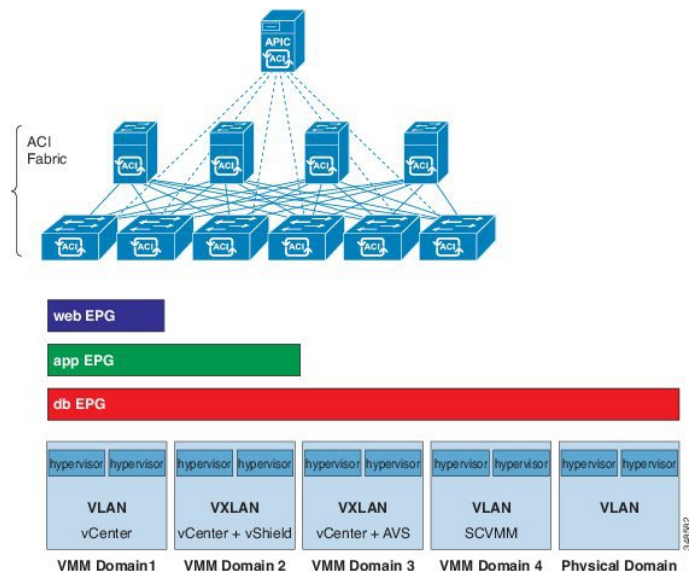

While live migration of VMs within a VMM domain is supported, live migration of VMs across VMM domains is not supported.



Note When you change the VRF on a bridge domain that is linked to an EPG with an associated VMM domain, the port-group is deleted and then added back on vCenter. This results in the EPG being undeployed from the VMM domain. This is expected behavior.

About Trunk Port Group

You use a trunk port group to aggregate the traffic of endpoint groups (EPGs) for VMware virtual machine manager (VMM) domains. Unlike regular port groups, which are configured under the Tenants tab in the Cisco Application Policy Infrastructure Controller (APIC) GUI, trunk port groups are configured under the VM Networking tab. Regular port groups follow the *T/A/E* format of EPG names.

The aggregation of EPGs under the same domain is based on a VLAN range, which is specified as encapsulation blocks contained in the trunk port group. Whenever the encapsulation of an EPG is changed or the encapsulation block of a trunk port group is changed, the aggregation is re-evaluated to determine if the EGP should be aggregated.

A trunk port group controls the leaf deployment of network resources, such as VLANs, that allocated to the EPGs being aggregated. The EPGs include both base EPG and microsegmented (uSeg) EPGs. In the case of a uSeg EPG, the VLAN ranges of the trunk port group are needed to include both the primary and secondary VLANs.

For more information, see the following procedures:

- [Creating a Trunk Port Group Using the GUI, on page 38](#)
- [Creating a Trunk Port Group Using the NX-OS Style CLI, on page 344](#)
- [Creating a Trunk Port Group Using the REST API, on page 366](#)

Attachable Entity Profile

The ACI fabric provides multiple attachment points that connect through leaf ports to various external entities such as bare metal servers, virtual machine hypervisors, Layer 2 switches (for example, the Cisco UCS fabric interconnect), or Layer 3 routers (for example Cisco Nexus 7000 Series switches). These attachment points can be physical ports, FEX ports, port channels, or a virtual port channel (vPC) on leaf switches.



Note When creating a VPC domain between two leaf switches, both switches must be in the same switch generation, one of the following:

- Generation 1 - Cisco Nexus N9K switches without “EX” or “FX” on the end of the switch name; for example, N9K-9312TX
- Generation 2 – Cisco Nexus N9K switches with “EX” or “FX” on the end of the switch model name; for example, N9K-93108TC-EX

Switches such as these two are not compatible VPC peers. Instead, use switches of the same generation.

An Attachable Entity Profile (AEP) represents a group of external entities with similar infrastructure policy requirements. The infrastructure policies consist of physical interface policies that configure various protocol options, such as Cisco Discovery Protocol (CDP), Link Layer Discovery Protocol (LLDP), or Link Aggregation Control Protocol (LACP).

An AEP is required to deploy VLAN pools on leaf switches. Encapsulation blocks (and associated VLANs) are reusable across leaf switches. An AEP implicitly provides the scope of the VLAN pool to the physical infrastructure.

The following AEP requirements and dependencies must be accounted for in various configuration scenarios, including network connectivity, VMM domains, and multipod configuration:

- The AEP defines the range of allowed VLANs but it does not provision them. No traffic flows unless an EPG is deployed on the port. Without defining a VLAN pool in an AEP, a VLAN is not enabled on the leaf port even if an EPG is provisioned.
- A particular VLAN is provisioned or enabled on the leaf port that is based on EPG events either statically binding on a leaf port or based on VM events from external controllers such as VMware vCenter or Microsoft Azure Service Center Virtual Machine Manager (SCVMM).
- Attached entity profiles can be associated directly with application EPGs, which deploy the associated application EPGs to all those ports associated with the attached entity profile. The AEP has a configurable generic function (infraGeneric), which contains a relation to an EPG (infraRsFuncToEpg) that is deployed on all interfaces that are part of the selectors that are associated with the attachable entity profile.

A virtual machine manager (VMM) domain automatically derives physical interface policies from the interface policy groups of an AEP.

An override policy at the AEP can be used to specify a different physical interface policy for a VMM domain. This policy is useful in scenarios where a VM controller is connected to the leaf switch through an intermediate Layer 2 node, and a different policy is desired at the leaf switch and VM controller physical ports. For example, you can configure LACP between a leaf switch and a Layer 2 node. At the same time, you can disable LACP between the VM controller and the Layer 2 switch by disabling LACP under the AEP override policy.

EPG Policy Resolution and Deployment Immediacy

Whenever an endpoint group (EPG) associates to a virtual machine manager (VMM) domain, the administrator can choose the resolution and deployment preferences to specify when a policy should be pushed into leaf switches.

Resolution Immediacy

- **Pre-provision:** Specifies that a policy (for example, VLAN, VXLAN binding, contracts, or filters) is downloaded to a leaf switch even before a VM controller is attached to the virtual switch (for example, VMware vSphere Distributed Switch (VDS)). This pre-provisions the configuration on the switch.

This helps the situation where management traffic for hypervisors/VM controllers is also using the virtual switch associated to the Cisco Application Policy Infrastructure Controller (APIC) VMM domain (VMM switch).

Deploying a VMM policy such as VLAN on a Cisco Application Centric Infrastructure (ACI) leaf switch requires Cisco APIC to collect CDP/LLDP information from both hypervisors through the VM controller and Cisco ACI leaf switch. However, if the VM controller is supposed to use the same VMM policy (VMM switch) to communicate with its hypervisors or even Cisco APIC, the CDP/LLDP information for hypervisors can never be collected because the policy that is required for VM controller/hypervisor management traffic is not deployed yet.

When using pre-provision immediacy, policy is downloaded to Cisco ACI leaf switch regardless of CDP/LLDP neighborhood. Even without a hypervisor host that is connected to the VMM switch.

- **Immediate:** Specifies that EPG policies (including contracts and filters) are downloaded to the associated leaf switch software upon ESXi host attachment to a DVS. LLDP or OpFlex permissions are used to resolve the VM controller to leaf node attachments.

The policy will be downloaded to leaf when you add host to the VMM switch. CDP/LLDP neighborhood from host to leaf is required.

- **On Demand:** Specifies that a policy (for example, VLAN, VXLAN bindings, contracts, or filters) is pushed to the leaf node only when an ESXi host is attached to a DVS and a VM is placed in the port group (EPG).

The policy will be downloaded to the leaf when host is added to the VMM switch. The VM needs to be placed into a port group (EPG). CDP/LLDP neighborhood from host to leaf is required.

With both immediate and on demand, if host and leaf lose LLDP/CDP neighborhood the policies are removed.



Note In OpFlex-based VMM domains, an OpFlex agent on the hypervisor reports a VM/EP virtual network interface card (vNIC) attachment to an EPG to the leaf OpFlex process. When using On Demand Resolution Immediacy, the EPG VLAN/VXLAN is programmed on **all** leaf port channel ports, virtual port channel ports, or both when the following are true:

- Hypervisors are connected to leafs on port channel or virtual port channel attached directly or through blade switches.
- A VM or instance vNIC is attached to an EPG.
- Hypervisors are attached as part of the EPG or VMM domain.

Opflex-based VMM domains are Microsoft Security Center Virtual Machine Manager (SCVMM) and HyperV, Cisco ACI Virtual Edge, and Cisco Application Virtual Switch (AVS).

Deployment Immediacy

Once the policies are downloaded to the leaf software, deployment immediacy can specify when the policy is pushed into the hardware policy content-addressable memory (CAM).

- Immediate: Specifies that the policy is programmed in the hardware policy CAM as soon as the policy is downloaded in the leaf software.
- On demand: Specifies that the policy is programmed in the hardware policy CAM only when the first packet is received through the data path. This process helps to optimize the hardware space.



Note When you use on demand deployment immediacy with MAC-pinned VPCs, the EPG contracts are not pushed to the leaf ternary content-addressable memory (TCAM) until the first endpoint is learned in the EPG on each leaf. This can cause uneven TCAM utilization across VPC peers. (Normally, the contract would be pushed to both peers.)

Guidelines for Deleting VMM Domains

Follow the sequence below to assure that the Cisco Application Policy Infrastructure Controller (APIC) request to delete a VMM domain automatically triggers the associated VM controller (for example VMware vCenter or Microsoft SCVMM) to complete the process normally, and that no orphan EPGs are stranded in the Cisco Application Centric Infrastructure (ACI) fabric.

1. The VM administrator must detach all the VMs from the port groups (in the case of VMware vCenter) or VM networks (in the case of SCVMM), created by the Cisco APIC.
2. The Cisco ACI administrator deletes the VMM domain in the Cisco APIC. The Cisco APIC triggers deletion of VMware VDS or SCVMM logical switch and associated objects.



Note The VM administrator should not delete the virtual switch or associated objects (such as port groups or VM networks); allow the Cisco APIC to trigger the virtual switch deletion upon completion of step 2 above. EPGs could be orphaned in the Cisco APIC if the VM administrator deletes the virtual switch from the VM controller before the VMM domain is deleted in the Cisco APIC.

If this sequence is not followed, the VM controller does delete the virtual switch associated with the Cisco APIC VMM domain. In this scenario, the VM administrator must manually remove the VM and vtep associations from the VM controller, then delete the virtual switch(es) previously associated with the Cisco APIC VMM domain.

NetFlow with Virtual Machine Networking

About NetFlow with Virtual Machine Networking

The NetFlow technology provides the metering base for a key set of applications, including network traffic accounting, usage-based network billing, network planning, as well as denial of services monitoring, network monitoring, outbound marketing, and data mining for both service providers and enterprise customers. Cisco provides a set of NetFlow applications to collect NetFlow export data, perform data volume reduction, perform post-processing, and provide end-user applications with easy access to NetFlow data. If you have enabled NetFlow monitoring of the traffic flowing through your datacenters, this feature enables you to perform the same level of monitoring of the traffic flowing through the Cisco Application Centric Infrastructure (Cisco ACI) fabric.

Instead of hardware directly exporting the records to a collector, the records are processed in the supervisor engine and are exported to standard NetFlow collectors in the required format.

For more information about NetFlow, see the *Cisco APIC and NetFlow* knowledge base article.

About NetFlow Exporter Policies with Virtual Machine Networking

A virtual machine manager exporter policy (`netflowVmmExporterPol`) describes information about the data collected for a flow that is sent to the reporting server or NetFlow collector. A NetFlow collector is an external entity that supports the standard NetFlow protocol and accepts packets marked with valid NetFlow headers.

An exporter policy has the following properties:

- `VmmExporterPol.dstAddr`—This mandatory property specifies the IPv4 or IPv6 address of the NetFlow collector that accepts the NetFlow flow packets. This must be in the host format (that is, "/32" or "/128"). An IPv6 address is supported in vSphere Distributed Switch (vDS) version 6.0 and later.
- `VmmExporterPol.dstPort`—This mandatory property specifies the port on which the NetFlow collector application is listening on, which enables the collector to accept incoming connections.
- `VmmExporterPol.srcAddr`—This optional property specifies the IPv4 address that is used as the source address in the exported NetFlow flow packets.

NetFlow Support with VMware vSphere Distributed Switch

The VMware vSphere Distributed Switch (VDS) supports NetFlow with the following caveats:

- The external collector must be reachable through the ESX. ESX does not support virtual routing and forwardings (VRFs).
- A port group can enable or disable NetFlow.
- VDS does not support flow-level filtering.

Configure the following VDS parameters in VMware vCenter:

- Collector IP address and port. IPv6 is supported on VDS version 6.0 or later. These are mandatory.
- Source IP address. This is optional.

- Active flow timeout, idle flow timeout, and sampling rate. These are optional.

Configuring a NetFlow Exporter Policy for VM Networking Using the GUI

The following procedure configures a NetFlow exporter policy for VM networking.

Procedure

- Step 1** On the menu bar, choose **Fabric > Access Policies**.
- Step 2** In the navigation pane, expand **Policies > Interface > NetFlow**.
- Step 3** Right-click **NetFlow Exporters for VM Networking** and choose **Create NetFlow Exporter for VM Networking**.
- Step 4** In the **Create NetFlow Exporter for VM Networking** dialog box, fill in the fields as required.
- Step 5** Click **Submit**.
-

Consuming a NetFlow Exporter Policy Under a VMM Domain Using the GUI

The following procedure consumes a NetFlow exporter policy under a VMM domain using the GUI.

Procedure

- Step 1** On the menu bar, choose **Virtual Networking > Inventory**.
- Step 2** In the **Navigation** pane, expand the **VMM Domains** folder, right-click **VMware**, and choose **Create vCenter Domain**.
- Step 3** In the **Create vCenter Domain** dialog box, fill in the fields as required, except as specified:
- In the **NetFlow Exporter Policy** drop-down list, choose the desired exporter policy or create a new one.
 - In the **Active Flow Timeout** field, enter the desired active flow timeout, in seconds.

The **Active Flow Timeout** parameter specifies the delay that NetFlow waits after the active flow is initiated, after which NetFlow sends the collected data. The range is from 60 to 3600. The default value is 60.
 - In the **Idle Flow Timeout** field, enter the desired idle flow timeout, in seconds.

The **Idle Flow Timeout** parameter specifies the delay that NetFlow waits after the idle flow is initiated, after which NetFlow sends the collected data. The range is from 10 to 300. The default value is 15.
 - (VDS only) In the **Sampling Rate** field, enter the desired sampling rate.

The **Sampling Rate** parameter specifies how many packets that NetFlow will drop after every collected packet. If you specify a value of 0, then NetFlow does not drop any packets. The range is from 0 to 1000. The default value is 0.
- Step 4** Click **Submit**.
-

Enabling NetFlow on an Endpoint Group to VMM Domain Association Using the GUI

The following procedure enables NetFlow on an endpoint group to VMM domain association.

Before you begin

You must have configured the following:

- An application profile
- An application endpoint group

Procedure

-
- Step 1** On the menu bar, choose **Tenants > All Tenants**.
- Step 2** In the **Work** pane, double-click the tenant's name.
- Step 3** In the left navigation pane, expand *tenant_name* > **Application Profiles** > *application_profile_name* > **Application EPGs** > *application_EPG_name*
- Step 4** Right-click **Domains (VMs and Bare-Metals)** and choose **Add VMM Domain Association**.
- Step 5** In the **Add VMM Domain Association** dialog box, fill in the fields as required; however, in the **NetFlow** area, choose **Enable**.
- Step 6** Click **Submit**.
-

Troubleshooting VMM Connectivity

The following procedure resolves VMM connectivity issues:

Procedure

-
- Step 1** Trigger inventory resync on the Application Policy Infrastructure Controller (APIC).
For more information about how to trigger an inventory resync on APIC, see the following knowledge base article:
http://www.cisco.com/c/en/us/td/docs/switches/datacenter/aci/apic/sw/kb/b_KB_VMM_OnDemand_Inventory_in_APIC.html
- Step 2** If step 1 does not fix the issue, for the impacted EPGs, set the resolution immediacy to use preprovisioning in the VMM domain.
"Pre-Provision" removes the need for neighbor adjacencies or OpFlex permissions and subsequently the dynamic nature of VMM Domain VLAN Programming. For more information about Resolution Immediacy types, see the following EPG Policy Resolution and Deployment Immediacy section:

http://www.cisco.com/c/en/us/td/docs/switches/datacenter/aci/apic/sw/1-x/aci-fundamentals/b_ACI-Fundamentals/b_ACI-Fundamentals_chapter_01011.html#concept_EF87ADDAD4EF47BDA741EC6EFDAECBBD

Step 3 If steps 1 and 2 do not fix the issue and you see the issue on all of the VMs, then delete the VM controller policy and readd the policy.

Note Deleting the controller policy impacts traffic for all VMs that are on that controller.



CHAPTER 3

Cisco ACI with VMware VDS Integration

This chapter contains the following sections:

- [Configuring Virtual Machine Networking Policies, on page 19](#)
- [Creating a VMM Domain Profile, on page 24](#)
- [Creating VDS Uplink Port Groups, on page 37](#)
- [Creating a Trunk Port Group, on page 38](#)
- [Creating a Trunk Port Group Using the GUI, on page 38](#)
- [Using VMware vSphere vMotion, on page 39](#)
- [Working with Blade Servers, on page 40](#)
- [Troubleshooting the Cisco ACI and VMware VMM System Integration, on page 42](#)
- [Additional Reference Sections, on page 42](#)

Configuring Virtual Machine Networking Policies

Cisco Application Policy Infrastructure Controller (APIC) integrates with third-party VM managers (VMMs)—such as VMware vCenter—to extend the benefits of Cisco Application Centric Infrastructure (ACI) to the virtualized infrastructure. Cisco APIC enables the administrator to use Cisco ACI policies inside the VMM system.

The following modes of Cisco ACI and VMware VMM integration are supported:

- **VMware VDS:** When integrated with Cisco ACI, the VMware vSphere Distributed Switch (VDS) enables you to configure VM networking in the Cisco ACI fabric.
- **Cisco ACI Virtual Edge:** For information about how to install and configure Cisco ACI Virtual Edge, see the *Cisco ACI Virtual Edge Installation Guide* and the *Cisco ACI Virtual Edge Configuration Guide* on Cisco.com.



Note Beginning with Cisco APIC Release 5.0(1), Cisco Application Virtual Switch (AVS) is no longer supported. If you use Cisco AVS and upgrade to Cisco APIC Release 5.0(1), in case of issues, the fabric will not be supported. Also, a fault will be raised for the Cisco AVS domain.

If you use Cisco AVS, we recommend that you migrate to Cisco ACI Virtual Edge. See the *Cisco ACI Virtual Edge Installation Guide, Release 3.0(x)* on Cisco.com.



Note When a Cisco APIC is connected to a VMware vCenter with many folders, you may see a delay when pushing new port groups from the Cisco APIC to the VMware vCenter.

Cisco APIC Supported VMware VDS Versions

Different versions of VMware vSphere Distributed Switch (DVS) support different versions of Cisco Application Policy Infrastructure Controller (APIC). See the [Cisco ACI Virtualization Compatibility Matrix](#) for information about the compatibility of VMware components with Cisco APIC.

VMware vSphere

See the [ACI Virtualization Compatibility Matrix](#) for the supported release versions.

Adding ESXi Host Considerations

When adding additional VMware ESXi hosts to the virtual machine manager (VMM) domain with VMware vSphere Distributed Switch (VDS), ensure that the version of ESXi host is compatible with the Distributed Virtual Switch (DVS) version already deployed in the vCenter. For more information about VMware VDS compatibility requirements for ESXi hosts, see the VMware documentation.

If the ESXi host version is not compatible with the existing DVS version, vCenter will not be able to add the ESXi host to the DVS, and an incompatibility error will occur. Modification of the existing DVS version setting from the Cisco APIC is not possible. To lower the DVS version in the vCenter, you need to remove and reapply the VMM domain configuration with a lower setting.

ESXi 6.5 Hosts with VIC Cards and UCS Servers



Important If you have ESXi 6.5 hosts running UCS B-Series or C-Series server with VIC cards, some of the vmnics may go down on a port state event, such as a link flap or a TOR reload. To prevent this problem, do not use the default eNIC driver but install it from the VMware website: <https://my.vmware.com/web/vmware/details?downloadGroup=DT-ESXI65-CISCO-NENIC-1020&productId=614>.

VMware vCenter High Availability

VMware vCenter High Availability (VCHA), introduced in VMware vSphere 6.5, eliminates the single point of failure of VMware vCenter.

With VCHA, if the VMware vCenter active node fails, the passive node takes over. The passive node has the same IP address, credentials, and other information as the active node. No new VMM configuration is needed to take advantage of VCHA. Once the passive node takes over, and is reachable, Cisco APIC automatically reconnects.

Guidelines for Upgrading VMware DVS from 5.x to 6.x and VMM Integration

This section describes the guidelines for upgrading VMware Distributed Virtual Switch (DVS) from 5.x to 6.x and VMM integration.

- DVS versioning is only applicable to the VMware DVS and not the Cisco Application Virtual Switch (AVS). DVS upgrades are initiated from VMware vCenter, or the relevant orchestration tool and not ACI. The **Upgrade Version** option appears grayed out for AVS switches within vCenter.
- If you are upgrading the DVS from 5.x to 6.x, you must upgrade the vCenter Server to version 6.0 and all hosts connected to the distributed switch to ESXi 6.0. For full details on upgrading your vCenter and Hypervisor hosts, see VMware's upgrade documentation. To upgrade the DVS go to the Web Client: **Home > Networking > DatacenterX > DVS-X > Actions Menu > Upgrade Distributed Switch**.
- There is no functional impact on the DVS features, capability, performance and scale if the DVS version shown in vCenter does not match the VMM domain DVS version configured on the APIC. The APIC and VMM Domain DVS Version is only used for initial deployment.
- VMM integration for DVS mode allows you to configure port-channels between leaf switch ports and ESXi hypervisor ports from APIC. LACP is either supported in enhanced or basic mode for port channels. Here is the matrix of support on ACI and VMware side:

Table 2: LACP Support

	ACI release prior to 3.2.7	ACI release after 3.2.7	VMware DVS release prior to 6.6	VMware DVS release after 6.6
Basic LACP	Yes	Yes	Yes	No
Enhanced LACP	No	Yes	Yes	Yes

When VMware side DVS is upgraded to version 6.6 or higher, LACP has to be reconfigured from Basic mode to Enhanced mode. If you have already configured enhanced LACP (eLACP) with prior versions of DVS (prior to 6.6), you need not reconfigure eLACP when upgrading to DVS 6.6.



Note Beginning with DVS version 6.6, basic LACP is not supported.

Migrating LACP from basic to enhanced, can result in traffic loss; perform the migration during a maintenance window.

For more details about eLACP, and to add eLACP to a VMM domain, see the *Enhanced LACP Policy Support* section, later in this chapter.

Guidelines for VMware VDS Integration

Follow the guidelines in this section when integrating VMware vSphere Distributed Switch (VDS) into Cisco Application Centric Infrastructure (ACI).

- Do not change the following settings on a VMware VDS configured for VMM integration:
 - VMware vCenter hostname (if you are using DNS).
 - VMware vCenter IP address (if you are using IP).
 - VMware vCenter credentials used by Cisco APIC.
 - Data center name

- Folder, VDS, or portgroup name.
 - Folder structure containing the VMware VDS.
For example, do not put the folder in another folder.
 - Uplink port-channel configuration, including LACP/port channel, LLDP, and CDP configuration
 - VLAN on a portgroup
 - Active uplinks for portgroups pushed by Cisco APIC.
 - Security parameters (promiscuous mode, MAC address changes, forged transmits) for portgroups pushed by Cisco APIC.
- Use supported versions of VMware vCenter/vSphere with the version of Cisco ACI that you are running.
 - If you are adding or removing any portgroups, use Cisco APIC or the Cisco ACI vCenter plug-in in VMware vCenter.
 - Know that Cisco APIC may overwrite some changes that are made in VMware vCenter.
For example, when Cisco APIC updates a portgroup, port binding, promiscuous mode, and load-balancing can be overwritten

Mapping Cisco ACI and VMware Constructs

Table 3: Mapping of Cisco Application Centric Infrastructure (ACI) and VMware Constructs

Cisco ACI Terms	VMware Terms
Endpoint group (EPG)	Port group
LACP Active	<ul style="list-style-type: none"> • Route based on IP hash (downlink port group) • LACP Enabled/Active (uplink port group)
LACP Passive	<ul style="list-style-type: none"> • Route based on IP hash (downlink port group) • LACP Enabled/Active (uplink port group)
MAC Pinning	<ul style="list-style-type: none"> • Route based on originating virtual port • LACP Disabled
MAC Pinning-Physical-NIC-Load	<ul style="list-style-type: none"> • Route based on physical NIC load • LACP Disabled
Static Channel - Mode ON	<ul style="list-style-type: none"> • Route Based on IP Hash (downlink port group) • LACP Disabled
Virtual Machine Manager (VMM) Domain	vSphere Distributed Switch (VDS)

Cisco ACI Terms	VMware Terms
VM controller	vCenter (Datacenter)

VMware VDS Parameters Managed By APIC

VDS Parameters Managed by APIC

See the section [Mapping Cisco ACI and VMware Constructs, on page 5](#) in this guide for a table of corresponding Cisco Application Centric Infrastructure (ACI) and VMware terminology.

VMware VDS	Default Value	Configurable Using Cisco APIC Policy?
Name	VMM domain name	Yes (Derived from Domain)
Description	APIC Virtual Switch	No
Folder Name	VMM domain name	Yes (Derived from Domain)
Version	Highest supported by vCenter	Yes
Discovery Protocol	LLDP	Yes
Uplink Ports and Uplink Names	8	Yes (From Cisco APIC Release 4.2(1))
Uplink Name Prefix	uplink	Yes (From Cisco APIC Release 4.2(1))
Maximum MTU	9000	Yes
LACP policy	disabled	Yes
Alarms	2 alarms added at the folder level	No



Note Cisco APIC does not manage port mirroring. You can configure port mirroring directly from VMware vCenter. Cisco APIC does not override the configuration. If Cisco APIC manages the configuration, Cisco APIC raises a fault. If Cisco APIC does not manage the configuration, Cisco APIC does not raise a fault.

VDS Port Group Parameters Managed by APIC

VMware VDS Port Group	Default Value	Configurable using APIC Policy
Name	Tenant Name Application Profile Name EPG Name	Yes (Derived from EPG)
Port binding	Static binding	Yes
VLAN	Picked from VLAN pool	Yes

VMware VDS Port Group	Default Value	Configurable using APIC Policy
Load balancing algorithm	Derived based on port-channel policy on APIC	Yes
Promiscuous mode	Disabled	Yes
Forged transmit	Disabled	Yes
Mac change	Disabled	Yes
Block all ports	False	No

Creating a VMM Domain Profile

VMM domain profiles specify connectivity policies that enable virtual machine controllers to connect to the Cisco Application Centric Infrastructure (ACI) fabric. They group VM controllers with similar networking policy requirements. For example, VM controllers can share VLAN pools and application endpoint groups (EPGs). The Cisco Application Policy Infrastructure Controller (APIC) communicates with the controller to publish network configurations such as port groups that are then applied to the virtual workloads. For details, see the [Cisco Application Centric Infrastructure Fundamentals](#) on Cisco.com.



Note In this section, examples of a VMM domain are a vCenter domain.

Pushing the VMM Domain After Deleting It

You may accidentally delete the VMware Distributed Virtual Switch (DVS) that you created in Cisco APIC from the VMware vCenter. If that occurs, the Cisco APIC policy is not pushed again to VMware vCenter.

To push the VMM domain again to the VMware vCenter, disconnect the Cisco APIC VMware vCenter connectivity. Doing so ensures that after reconnection, Cisco APIC again pushes the VMM domain to the VMware vCenter and the DVS is recreated in VMware vCenter.

Read-Only VMM Domains

Beginning with Cisco APIC Release 3.1(1), you also can create a read-only VMM domain. A read-only VMM domain enables you to view inventory information for a VDS in the VMware vCenter that Cisco APIC does not manage. Procedures to configure a read-only VMM domain differ slightly from procedures to create other VMM domains. However, the same workflow and prerequisites apply.

Prerequisites for Creating a VMM Domain Profile

To configure a VMM domain profile, you must meet the following prerequisites:

- All fabric nodes are discovered and configured.
- Inband (inb) or out-of-band (oob) management has been configured on the APIC.

- A Virtual Machine Manager (VMM) is installed, configured, and reachable through the inb/oob management network (for example, a vCenter).

vCenter Domain Operational Workflow

Figure 4: A Sequential Illustration of the vCenter Domain Operational Workflow

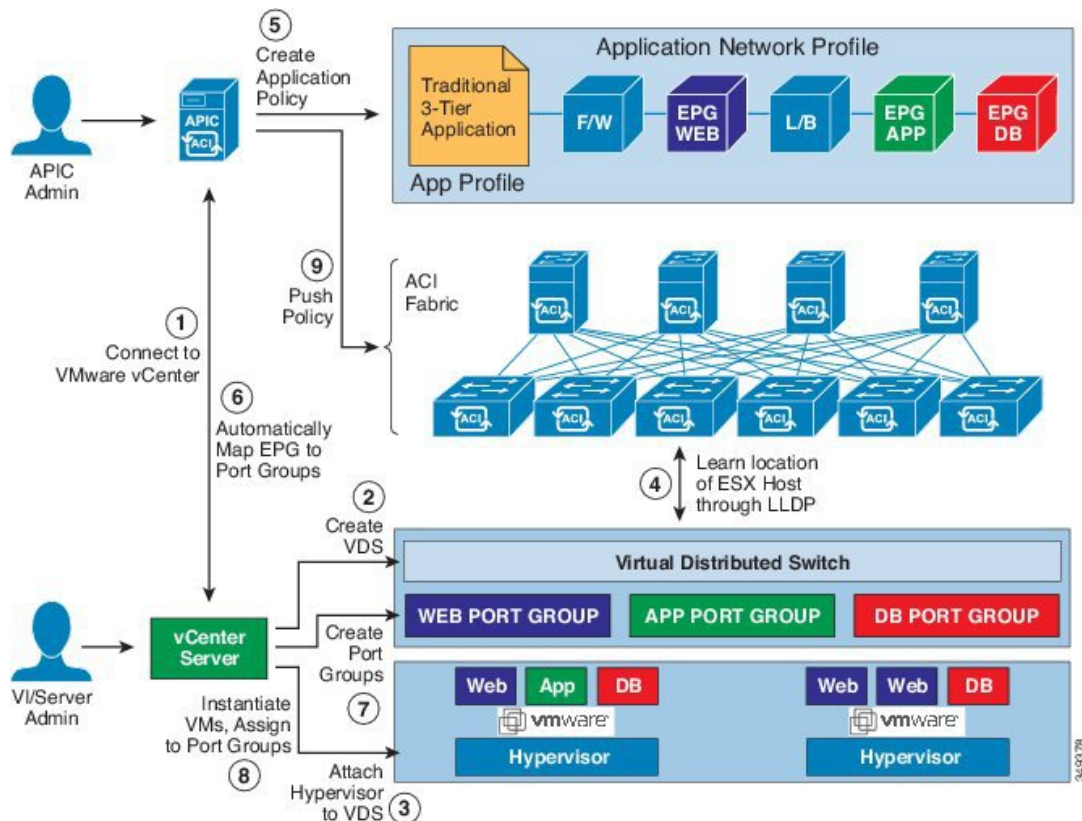

The APIC administrator configures the vCenter domain policies in the APIC. The APIC administrator provides the following vCenter connectivity information:

- The vCenter IP address, vCenter credentials, VMM domain policies, and VMM domain SPAN
- Policies (VLAN pools, domain type such as VMware VDS, Cisco Nexus 1000V switch)
- Connectivity to physical leaf interfaces (using attach entity profiles)

1. The APIC automatically connects to the vCenter.
2. The APIC creates the VDS—or uses an existing VDS if there is one already created—matching the name of the VMM domain.



Note If you use an existing VDS, the VDS must be inside a folder with the same name.



Note If you want to see an existing VDS from the vCenter, you can do so by specifying the **Read Only Mode** in the **Access Mode** area when you create a VMM domain with the same name as the VDS in vCenter using the Cisco APIC. This VMM in **Read Only Mode** is not managed by APIC. You may not be able to modify any properties of this VMM domain except vCenter user credentials and vCenter IP address.

3. The vCenter administrator or the compute management tool adds the ESX host or hypervisor to the APIC VDS and assigns the ESX host hypervisor ports as uplinks on the APIC VDS. These uplinks must connect to the ACI leaf switches.
4. The APIC learns the location of the hypervisor host to the leaf connectivity using LLDP or CDP information of the hypervisors.
5. The APIC administrator creates and associates application EPG policies.
6. The APIC administrator associates EPG policies to VMM domains.
7. The APIC automatically creates port groups in the VMware vCenter under the VDS. This process provisions the network policy in the VMware vCenter.



Note

- The port group name is a concatenation of the tenant name, the application profile name, and the EPG name.
- The port group is created under the VDS, and it was created earlier by the APIC.

8. The vCenter administrator or the compute management tool instantiates and assigns VMs to the port groups.
9. The APIC learns about the VM placements based on the vCenter events. The APIC automatically pushes the application EPG and its associated policy (for example, contracts and filters) to the ACI fabric.

Creating a vCenter Domain Profile Using the GUI

An overview of the tasks that you perform to create a vCenter Domain are as follows (details are in the steps that follow):

- Create or select a switch profile.
- Create or select an interface profile.
- Create or select an interface policy group.
- Create or select VLAN pool.
- Create vCenter domain.
- Create vCenter credentials.

Procedure

- Step 1** On the menu bar, click **Fabric > Access Policies**.
- Step 2** In the navigation pane, click **Quick Start**, and then in the central pane click **Configure an interface, PC, and VPC**.
- Step 3** In the **Configure an interface, PC, and VPC** dialog box, perform the following actions:

- a) Expand **Configured Switch Interfaces**.
- b) Click the + icon.
- c) Make sure that the **Quick** radio button is chosen.
- d) From the **Switches** drop-down list, choose the appropriate leaf ID.

In the **Switch Profile Name** field, the switch profile name automatically populates.

- e) Click the + icon to configure the switch interfaces.
- f) In the **Interface Type** area, check the appropriate radio button.
- g) In the **Interfaces** field, enter the desired interface range.
- h) In the **Interface Selector Name** field, the selector name automatically populates.
- i) In the **Interface Policy Group** area, choose the **Create One** radio button.
- j) From the **Link Level Policy** drop-down list, choose the desired link level policy.
- k) From the **CDP Policy** drop-down list, choose the desired CDP policy.

Note Similarly choose the desired interface policies from the available policy areas.

- l) In the **Attached Device Type** area, choose **ESX Hosts**.
- m) In the **Domain** area, make sure that the **Create One** radio button is chosen.
- n) In the **Domain Name** field, enter the domain name.
- o) In the **VLAN** area, make sure that the **Create One** radio button is chosen.
- p) In the **VLAN Range** field, enter the VLAN range as appropriate.

Note We recommend a range of at least 200 VLAN numbers. Do not define a range that includes your manually assigned infra VLAN. If you do so, it can trigger a fault, depending on your version of Cisco Application Policy Infrastructure Controller (APIC). There are specific use cases and options to be set if your infra VLAN needs to be extended as part of an OpFlex integration.

- q) In the **vCenter Login Name** field, enter the login name.
- r) (Optional) From the **Security Domains** drop-down list, choose the appropriate security domain.
- s) In the **Password** field, enter a password.
- t) In the **Confirm Password** field, reenter the password.
- u) Expand **vCenter**.

- Step 4** In the **Create vCenter Controller** dialog box, enter the appropriate information, and click **OK**.

- Step 5** In the **Configure Interface, PC, And VPC** dialog box, complete the following actions:

If you do not specify policies in the **Port Channel Mode** and the **vSwitch Policy** areas, the same policies that you configured earlier in this procedure will take effect for the vSwitch.

- a) From the **Port Channel Mode** drop-down list, choose a mode.
- b) In the **vSwitch Policy** area, click the desired radio button to enable CDP or LLDP.
- c) From the **NetFlow Exporter Policy** drop-down list, choose a policy or create one.

A NetFlow exporter policy configures the external collector reachability.

- d) Choose values from the **Active Flow Timeout**, **Idle Flow Timeout**, and **Sampling Rate** drop-down lists.
- e) Click **SAVE** twice and then click **SUBMIT**.

Step 6 Verify the new domain and profiles, by performing the following actions:

- a) On the menu bar, choose **Virtual Networking > Inventory**.
- b) In the **Navigation** pane, expand **VMM Domains > VMware > Domain_name > vCenter_name**.

In the work pane, under **Properties**, view the VMM domain name to verify that the controller is online. In the **Work** pane, the vCenter properties are displayed including the operational status. The displayed information confirms that connection from the APIC controller to the vCenter Server is established, and the inventory is available.

Creating a Read-Only VMM Domain

Beginning in Cisco APIC Release 3.1(1), you can create a read-only VMM domain. Doing so enables you to view inventory information for a VDS in the VMware vCenter that Cisco APIC does not manage.

After you create the read-only VMM domain, you can view hypervisors, VMs, NIC status, and other inventory information, as with regular VMM domains. You can associate an EPG to the VMM domain and configure policies for it. However, policies are not pushed from the read-only VMM domain to the VDS. Also, no faults are raised for a read-only VMM domain.

You can create a read-only VMM domain using the Cisco APIC GUI, the NX-OS style CLI, or REST API. See the following sections in this guide for instructions:

- [Creating a Read-Only VMM Domain Using the Cisco APIC GUI, on page 28](#)
- [Creating a Read-Only VMM Domain Using the REST API, on page 361](#)
- [Creating a Read-Only VMM Domain Using the NX-OS Style CLI, on page 341](#)

Creating a Read-Only VMM Domain Using the Cisco APIC GUI

In order to create a read-only VMM domain, you create the domain in the **Create vCenter Domain** dialog box under the **Virtual Networking** tab. Do not follow the procedure in the section [Creating a vCenter Domain Profile Using the GUI, on page 26](#) to create the domain. That procedure does not enable you to set an access mode for the VMM domain.

Before you begin

- Fulfill the prerequisites in the section [Prerequisites for Creating a VMM Domain Profile, on page 24](#).
- In the VMware vCenter, ensure that under the **Networking** tab, the VDS is contained by a folder.

Also ensure that the folder and the VDS have the exact same name of the read-only VMM domain that you plan to create.

Procedure

Step 1 Log in to Cisco APIC.

Step 2 Choose **Virtual Networking > Inventory** and then expand the **VMM Domains** folder.

Step 3 Right-click the **VMM Domains** folder and choose **Create vCenter Domain**.

Step 4 In the **Create vCenter Domain** dialog box, complete the following steps:

a) In the **Virtual Switch Name** field, enter a name for the domain.

Note The name of the read-only domain must be the same as the name of the VDS and the folder that contains in the VMware vCenter.

b) In the **Virtual Switch** area, choose **VMware vSphere Distributed Switch**.

c) In the **Access Mode** area, choose **Read Only Mode**.

d) In the **vCenter Credentials** area, click the + (plus) icon, and then create the VMware vCenter credentials for the domain.

e) In the **vCenter** area, click the + (plus) icon, and then add a vCenter controller for the domain.

f) Click **Submit**.

What to do next

You can attach an EPG to the read-only VMM domain and configure policies for it. However, those policies are not pushed to the VDS in the VMware vCenter.

Promoting a Read-Only VMM Domain to Read-Write

Beginning in Cisco APIC Release 4.0(1), you can promote an existing read-only VMM domain to a fully managed read-write VMM domain. Doing so enables you to not only view the inventory information for a VDS in the VMware vCenter, but also have Cisco APIC manage it.

Creating read-only VMM domains is described in [Creating a Read-Only VMM Domain, on page 28](#).

Before you promote an existing read-only VMM domain, carefully consider the guidelines and limitations described in [Promoting a Read-Only VMM Domain Caveats, on page 29](#).

Promoting a VMM domain from Read-Only to Read-Write will allow the APIC to monitor and manage the VMM domain as well as allow you to associate EPGs to it as Port Groups. You can promote a read-only VMM domain using the Cisco APIC GUI, the NX-OS style CLI, or REST API. See this section for the Cisco APIC GUI procedure. See the appendices for the procedures [Promoting a Read-Only VMM Domain Using the NX-OS Style CLI, on page 342](#) and [Promoting a Read-Only VMM Domain Using the REST API, on page 363](#).

Promoting a Read-Only VMM Domain Caveats

When promoting a read-only VMM domain to read-write, keep in mind the following caveats:

- Promoting a read-only domain requires a specific network folder structure for the domain's VDS on the vCenter server. If your existing VDS is not contained in a network folder but is located directly under the datacenter, you will need to create a network folder with the same name as the VDS and move the VDS into that network folder before promoting the domain to read-write in order for APIC to properly manage it. Promoting a domain whose VDS is configured directly under the datacenter will cause APIC to create a new VDS inside a new network folder instead.
- When creating port-groups in vCenter for the read-only VMM domains you plan to promote to fully managed, it is recommended that you name them in the `<tenant-name>|<application-name>|<EPG-name>` format.

When you promote a VMM domain to fully managed and associate an EPG with the domain, any port-groups that are named in this standard format will be automatically added to the EPG.

If you chose a different format for the port-group names, you will need to manually re-assign all the VMs from the existing port-group to the new one created by the APIC for the EPG after you promote the domain:

- Create an EPG and associate it with the VMM domain.
A fault will be raised on the VMM domain as it cannot find an EPG policy for the port-group
- Remove the virtual machines (VMs) from the existing port-group and attach them to the EPG.



Note This may cause traffic loss during the process.

- Once the VMs have been detached from port-group, delete the old port-group from the vCenter.
All VMs must be detached from the port-group before you can delete it.
- When migrating a domain from read-only to read-write, it is recommended that you use a VLAN range that is unique and separate from the physical domain range in order to avoid potentially running out of available VLANs during migration process.
- If you want to use the same EPG on multiple VMMs and VMware vCenters, configure a link aggregation group (LAG) policy with the same name as the domain. An EPG can be connected to only one LAG policy. If you want to use different LAG policies, you must associate each one with a different EPG.
See the section [Enhanced LACP Policy Support, on page 31](#) in this guide for more information.

Promoting a Read-Only VMM Domain Using the Cisco APIC GUI

You can use the Cisco APIC GUI to promote a read-only VMM domain.

Before you begin

Instructions for promoting a read-only VMM domain to a managed domain assume you have completed the following prerequisites:

- Fulfill the prerequisites in the section [Prerequisites for Creating a VMM Domain Profile, on page 24](#).
- Configure a read-only domain as described in [Creating a Read-Only VMM Domain, on page 28](#).
- In the VMware vCenter, under the **Networking** tab, ensure that the VDS is contained by a network folder of the exact same name of the read-only VMM domain that you plan to promote.

Procedure

- Step 1** Log in to Cisco APIC.
- Step 2** Associate an Access Entity Profile (AEP) with the read-only VMM domain.
- Navigate to **Fabric > Access Policies > Policies > Global > Attachable Access Entity Profiles**.
 - Select an AEP and associate it with the read-only VMM domain you plan to promote to fully managed.

- Step 3** Promote the VMM domain.
- Navigate to **Virtual Networking > Inventory**.
 - Expand the **VMM Domains > VMware** folder.
 - Select the read-only VMM Domain you want to promote.
 - Change the **Access Mode** setting to *Read Write Mode*.
 - Select a **VLAN Pool** from the drop down menu to associate a VLAN pool with the domain.
 - Click **Submit** to save changes.

- Step 4** Create a new Link Aggregation Group (LAG) policy.

If you are using vCenter version 5.5 or later, you must create a LAG policy for the domain to use Enhanced LACP feature, as described in [Create LAGs for DVS Uplink Port Groups Using the Cisco APIC GUI, on page 32](#).

Otherwise, you can skip this step.

- Step 5** Associate the LAG policy with appropriate EPGs.

If you are using vCenter version 5.5 or later, you must associate the LAG policy with the EPGs to use Enhanced LACP feature, as described in [Associate Application EPGs to VMware vCenter Domains with Enhanced LACP Policies Using the Cisco APIC GUI, on page 33](#).

Otherwise, you can skip this step.

What to do next

Any EPGs you attach to the VMM domain and any policies you configure will now be pushed to the VDS in the VMware vCenter.

Enhanced LACP Policy Support

In Cisco Application Policy Infrastructure Controller (APIC) Release 3.2(7), you can improve uplink load balancing by applying different Link Aggregation Control Protocol (LACP) policies to different distributed virtual switch (DVS) uplink port groups.

Cisco APIC now supports VMware's Enhanced LACP feature, which is available for DVS 5.5 and later. Previously, the same LACP policy applied to all DVS uplink port groups. Before Cisco APIC Release 3.2(7), it was not possible to manage VMware link aggregation groups (LAGs) with Cisco APIC.

When you enable Enhanced LACP policy on the ACI side, it will push the configuration to DVS. Later, even if you remove the policy on the ACI side, enhanced LACP is still available on the DVS side, because after an enhanced LACP policy is enabled, it can not be reverted.



Note Enhanced LACP policy can be enabled either on the ACI or DVS side.

You can choose from up to 20 different load-balancing algorithms when you create a VMware vCenter virtual machine manager (VMM) domain for Cisco Application Centric Infrastructure (ACI) Virtual Edge or VMware VDS. You apply different policies to different uplink portgroups.

You have eight DVS uplink portgroups, and you must configure at least two uplinks in the same policy. So you can have up to four different LACP policies for each DVS. Enhanced LACP supports only active and passive LACP modes.



Note For Cisco ACI Virtual Edge VXLAN mode, it is mandatory to use a load-balancing algorithm having a UDP port. We recommend the algorithm **Source and Destination TCP/UDP Port**. In VLXAN mode, traffic is always sent between VTEP to the FTEP IP. So communication is always between one pair of IP address. So for VXLAN traffic, the only way to distinguish traffic is using the UDP port number.

The following sections provide instructions for configuring multiple LACP policies for DVS uplinks using the Cisco APIC GUI, NX-OS style CLI, or REST API.

Enhanced LACP Limitations

Be aware of the following limitations when using enhanced Link Aggregation Control Protocol (LACP) policies.

- You cannot fall back to the previous version of LACP after upgrading to enhanced LACP.
- You cannot downgrade to a version of Cisco Application Policy Infrastructure Controller (APIC) earlier than 3.2(7) without removing the enhanced LACP configuration. See the procedure [Remove the Enhanced LACP Configuration Before a Downgrade, on page 34](#) in this guide.
- For Cisco Application Centric Infrastructure (ACI) Virtual Edge, VXLAN mode traffic always uses the source IP address as the TEP IP address. To ensure proper load balancing, we recommend the algorithm **Source and Destination TCP/UDP Port**.
- If traffic is present for a Cisco ACI Virtual Edge domain over enhanced LACP, and you increase or reduce the number of uplinks, a traffic loss of 5 or 10 seconds occurs.
- Traffic is disrupted when an enhanced LACP LAG policy name conflicts with the name of a previous enhanced LACP link aggregation group (LAG) policy uplink. If you have an enhanced LACP LAG policy that is named ELACP-DVS for a DVS domain, its uplink is automatically named ELACP-DVS-1, ELACP-DVS-2, ELACP-DVS-3, and so on, depending on the number uplinks configured in the policy.

Traffic loss occurs if you then try to configure or add another enhanced LAG policy with a name that conflicts with a previous policy uplink name. To remedy the issue, delete the LAG policy and re-create it with a different name.

Create LAGs for DVS Uplink Port Groups Using the Cisco APIC GUI

Improve distributed virtual switch (DVS) uplink port group load balancing by putting the port groups into link aggregation groups (LAGs) and associating them with specific load-balancing algorithms. You can perform this task using the Cisco Application Policy Infrastructure Controller (APIC) GUI.

Before you begin

- You must have created a VMware vCenter virtual machine manager (VMM) domain for VMware VDS or Cisco Application Centric Infrastructure (ACI) Virtual Edge.
- If a vSwitch policy container does not exist, create one.



Note You must configure a port channel policy before you create an enhanced LAG policy. You can create a port channel policy when you create a vCenter domain profile.

Procedure

- Step 1** Log into the Cisco APIC.
- Step 2** Go to **Virtual Networking > Inventory > VMM Domains > VMware > domain**.
- Step 3** In the work pane, choose **Policy > VSwitch Policy**.
- Step 4** If you have not already done so, in the **Properties** area, choose a policy.
- Step 5** In the **Enhanced LAG Policy** area, click the + (plus) icon and then complete the following steps:
- In the **Name** field, enter the name of the LAG.
 - From the **Mode** drop-down list, choose **LACP Active** or **LACP Passive**.
 - From the **Load Balancing Mode** drop-down list, choose a load-balancing method.
 - In the **Number of Links** selector, choose how many DVS uplink port groups to include in the LAG.
You can put two to eight uplink port groups into a LAG.
 - Click **Update** and then click **Submit**.
- Step 6** Repeat Step 5 to create other LAGs for the DVS.
-

What to do next

If you are using VMware VDS, associate endpoint groups (EPGs) to the domain with the enhanced LACP policy. If you are using Cisco Application Centric Infrastructure (ACI) Virtual Edge, associate internally created inside and outside port groups with the enhanced LACP policy, then associate EPGs to the domain with the policy.

Associate Application EPGs to VMware vCenter Domains with Enhanced LACP Policies Using the Cisco APIC GUI

Associate application endpoint groups (EPGs) with the VMware vCenter domain with LAGs and a load-balancing algorithm. You can perform this task using the Cisco Application Policy Infrastructure Controller (APIC) GUI.

Before you begin

You must have created link aggregation groups (LAGs) for distributed virtual switch (DVS) uplink port groups and associated a load-balancing algorithm to the LAGs.



Note This procedure assumes that you have not yet associated an application EPG with a VMware vCenter domain. If you have already done so, you edit the domain association.

Procedure

- Step 1** Log into Cisco APIC.
- Step 2** Go to **Tenants > tenant > Application Profiles > application_profile > Application EPGs > EPG > Domains (VMs and Bare-Metals)**.
- Step 3** Right-click **Domains (VMs and Bare-Metals)** and choose **Add VMM Domain Association**.
- Step 4** In the **Add VMM Domain Association** dialog box, complete the following steps:
- From the **VMM Domain Profile** drop-down list, choose the domain that you want to associate the EPG to.
 - From the **Enhanced Lag Policy**, choose the policy configured for the domain that you want to apply to the EPG.
 - (Optional) In the **Delimiter** field, enter one of the following: |, ~, !, @, ^, +, or =.
If you do not enter a symbol, the system default | delimiter will appear in the policy.
 - Add remaining values as desired for the domain association, and then click **Submit**.
- Step 5** Repeat Step 2 through Step 4 for other application EPGs in the tenant as desired.
-

Remove the Enhanced LACP Configuration Before a Downgrade

Before you downgrade Cisco Application Policy Infrastructure Controller (APIC) to a release earlier than 3.2(7), you must remove the enhanced LACP configuration. Complete the steps in this procedure to remove the configuration.

Procedure

- Step 1** Reassign uplinks on all ESXi hosts from link aggregation groups (LAGs) to normal uplinks.
- Step 2** Remove LAG associations from all EPGs associated with the distributed virtual switch (DVS).
You can expect traffic loss while performing this step.
- Step 3** Change port channel settings to static channel or MAC pinning, which will cause traffic to recover once the port channel is up.
- Step 4** Remove all LAG-related configuration from the virtual machine manager (VMM).
- Step 5** Verify that all LAG-related policies are deleted from VMware vCenter.
-

What to do next

Downgrade to a Cisco APIC release earlier than 3.2(7).

Port Binding

Port Binding is a parameter which determines the connection between the virtual machines and virtual network adapters to a vDS and how to use those virtual machines.

You can configure the binding type for an EPG. Depending on the binding type, you can also configure the number of ports and port allocation. Port binding is not configurable for non user-configured EPGs such as EPGs created by system and service EPGs.

Types of Binding

These three different types of port binding determine when ports in a port group are assigned to virtual machines:

- **Static Binding**— When you connect a virtual machine to a port group configured with static binding, a port is immediately assigned and reserved for it, guaranteeing connectivity at all times. The port is disconnected only when the virtual machine is removed from the port group. You can connect a virtual machine to a static-binding port group only through the vCenter server. In static binding type, there are two types of port allocation: Fixed and Elastic. If port allocation is fixed, only a limited number of VMs can be attached, based on the number of ports. If you try adding more number of VMs than the number of ports, the following error is displayed— *No free port available*. But in case of elastic port allocation, when an attempt is made to attach more VMs than the number of ports specified, the number of ports is automatically increased by 8. The default values for binding type is static and number of ports is 0. If the binding type is static, then, typically, the port allocation is elastic. The port allocation can be changed/updated by the user on fvRsDomAtt (EPG to VMM Domain association). If the binding type is static and port allocation is fixed, you can change the number of ports. But if the binding type is static and port allocation is elastic, you can configure only once and the number of ports cannot be updated. This is because, in elastic mode, vCenter takes care of dynamically increasing the ports and there is no need to modify it from the APIC.
- **Dynamic Binding**— In a port group configured with dynamic binding, a port is assigned to a virtual machine only when the virtual machine is powered on and its NIC is in a connected state. The port is disconnected when the virtual machine is powered off or the NIC of the virtual machine is disconnected. Virtual machines connected to a port group configured with dynamic binding must be powered on and off through vCenter. Dynamic binding can be used in environments where you have more virtual machines than available ports, but do not plan to have a greater number of virtual machines active than the available ports. For example, if you have 300 virtual machines and 100 available ports, but will not have more than 90 virtual machines active at one time, dynamic binding is appropriate for your port group. Dynamic binding type does not support port allocation. So, only the type and number of ports can be modified using the VMM domain association configuration (fvRsDomAtt) on APIC.



Note The Dynamic Binding option (lateBinding in vSphere) has been deprecated as of vSphere 5.0, and is not available on the VMware vSphere GUI.

- **Ephemeral Binding**— In a port group configured with ephemeral binding, a port is created and assigned to a virtual machine by the host when the virtual machine is powered on and its NIC is in a connected state. When the virtual machine powers off or the NIC of the virtual machine is disconnected, the port is deleted. In ephemeral, the number of ports option disappears on vCenter and that is because if the binding type is ephemeral, then all the ports on the switch can be used.

Configure Port Binding Using the GUI

Use this procedure to configure port binding for a VMM domain.

Procedure

- Step 1** Login to Cisco APIC.
- Step 2** Go to **Tenants > tenant > Application Profile > application profile > Application EPGs > application EPG**.
- Step 3** Right-click the application EPG that you want to associate with a VMM domain, and then choose **Add VMM Domain Association**.
- Step 4** In the **Add VMM Domain Association** dialog box, select the required port binding. The available options are:
- **Dynamic Binding**— a port is assigned to a virtual machine only when the virtual machine is powered on and its NIC is in a connected state. The port is disconnected when the virtual machine is powered off or the NIC of the virtual machine is disconnected.
 - **Ephemeral**— a port is created and assigned to a virtual machine by the host when the virtual machine is powered on and its NIC is in a connected state. When the virtual machine powers off or the NIC of the virtual machine is disconnected, the port is deleted.
 - **Default**—behavior is similar to the behavior when you choose static binding.
 - **Static Binding**— a port is immediately assigned and reserved for it, guaranteeing connectivity at all times. The port is disconnected only when the virtual machine is removed from the port group.
 - **Port Allocation**— this field is displayed only when Static Binding is selected. The options are, Fixed and Elastic.
 - a. **Elastic**—the default number of ports is set to eight. When all ports are assigned, a new set of eight ports is created.
 - b. **Fixed**—the default number of ports is set to eight. No additional ports are created when all ports are assigned.
 - **Number of Ports**— this field is displayed when Dynamic Binding or Static Binding is selected. The default value is 0; recommended value is 8.
- For more details about the types of port binding, see [Types of Binding, on page 35](#).
- Step 5** Click **Submit**.
-

Configure Port Binding Using the REST API

Use the following to configure port binding using REST API. The example below displays the port binding as *staticBinding*.

```
<fvAp name="ap">
  <fvAEPg name="Epg1">
    <fvRsBd tnFvBDName="BD1" />
    <fvRsDomAtt resImedcy="immediate" switchingMode="native"
bindingType="staticBinding" numPorts="12" portAllocation="fixed"
  tDn="uni/vmmp-VMware/dom-mininetlacc2">
    </fvRsDomAtt>
  </fvAEPg>
</fvAp>
```

Endpoint Retention Configuration

After you create a vCenter domain, you can configure endpoint retention. This feature enables you to delay the deletion of an endpoint, reducing the chances of dropped traffic.

You configure endpoint retention in the APIC GUI or with the NX-OS style CLI or the REST API. For information, see the following sections in this guide:

- [Configuring Endpoint Retention Using the GUI, on page 37](#)
- [Configure Endpoint Retention Using the NX-OS Style CLI, on page 344](#)
- [Configuring Endpoint Retention Using the REST API, on page 366](#)

Configuring Endpoint Retention Using the GUI

Before you begin

You must have created a vCenter domain.

Procedure

-
- Step 1** Log in to Cisco APIC.
 - Step 2** Choose **VM Networking > Inventory**.
 - Step 3** In the left navigation pane, expand the **VMware** folder and then click the vCenter domain that you created earlier.
 - Step 4** In the central **Domain** work pane, make sure that the **Policy** and **General** tabs are selected.
 - Step 5** In the **End Point Retention Time (seconds)** counter, choose the number of seconds to retain endpoints before they are detached.

You can choose between 0 and 600 seconds. The default is 0.
 - Step 6** Click **Submit**.
-

Creating VDS Uplink Port Groups

Each VMM domain appears in the vCenter as a vSphere Distributed Switch (VDS). The virtualization administrator associates hosts to the VDS created by the APIC and selects which vmnics to use for the specific VDS. The configuration of the VDS uplinks are performed from the APIC controller by changing the vSwitch configuration from the Attach Entity Profile (AEP) that is associated with the VMM domain. You can find the AEP in the APIC GUI in the Fabric Access Policies configuration area.



Note When working with ACI and vSphere VMM integration, Link Aggregation Groups (LAGs) are not a supported method of creating interface teams on distributed switches created by the APIC. The APIC pushes the necessary interface teaming configuration based on the settings in the Interface Policy Group and/or AEP vSwitch policy. It is not supported or required to manually create interface teams in vCenter.

Creating a Trunk Port Group

Trunk Port Group

You use a trunk port group to aggregate the traffic of endpoint groups (EPGs) for VMware virtual machine manager (VMM) domains.

For details about trunk port groups, see the section [About Trunk Port Group, on page 10](#).

For procedures to create trunk port groups, see the following sections:

- [Creating a Trunk Port Group Using the GUI, on page 38](#)
- [Creating a Trunk Port Group Using the NX-OS Style CLI, on page 344](#)
- [Creating a Trunk Port Group Using the REST API, on page 366](#)

Creating a Trunk Port Group Using the GUI

This section describes how to create a trunk port group using the GUI.

Before you begin

Ensure that the trunk port group is tenant independent.

Procedure

-
- Step 1** Log in to the APIC GUI.
- Step 2** On the menu bar, choose **Virtual Networking**.
- Step 3** In the navigation pane, choose **VMM Domains > VMware > domain > Trunk Port Groups** and right-click **Create Trunk Port Group**.
- Step 4** In the **Create Trunk Port Group** dialog box, perform the following actions:
- a) In the **Name** field, enter the EPG name.
 - b) For the **Promiscuous Mode** buttons, click either **Disabled** or **Enabled**.

The virtual machines attached to the trunk port group receives unicast traffic not destined to their MAC addresses. The options are:

 - **Enabled**
 - **Disabled** (default)
 - c) For the **Trunk Portgroup Immediacy** buttons, click either **Immediate** or **On Demand**.

The field specifies whether policies are resolved immediately or when needed on the leaf switches. The options are:

 - **Immediate**

- **On Demand** (default)

- d) For the **MAC changes** buttons, click either **Disabled** or **Enabled**. The default is **Enabled**.

The field allows definition of new MAC addresses for the network adapter within the VM. The options are:

- **Enabled** (default)
- **Disabled**

- e) For the **Forged transmits** buttons, click either **Disabled** or **Enabled**. The default is **Enabled**.

The field specifies whether to allow forged transmits. A forged transmit occurs when a network adapter starts sending out traffic that identifies itself as something else. This security policy compares the effective address of the virtual network adapter and the source address inside of an 802.3 Ethernet frame generated by the virtual machine to ensure that they match. The options are:

- **Enabled** (default)
- **Disabled**

- f) From the **Enhanced Lag Policy** drop-down list, choose the uplink with the Link Aggregation Control Protocol (LACP) policy that you want to apply.

The policy consists of distributed virtual switch (DVS) uplink port groups configured in link aggregation groups (LAGs) and associated with a load-balancing algorithm. You must have previously applied at least one uplink with an LACP policy to a DVS uplink port group. Doing so enables you to improve uplink load balancing.

For information about enhanced LACP, see the section [Enhanced LACP Policy Support, on page 31](#) in this guide.

- g) In the **VLAN Ranges** field, choose the + icon and enter the VLAN range (vlan-100 vlan-200).

Note If you do not specify a VLAN Range, the VLAN list will be taken from the domain's VLAN namespace.

- h) Click **Update**.

Step 5 Click **Submit**.

Using VMware vSphere vMotion

VMware vSphere vMotion enables you to move a virtual machine (VM) between different physical hosts without interruption in service.

See the VMware website for information about VMware vSphere vMotion, including documentation.

When you use VMware vMotion to move a VM behind a VMware distributed virtual switch (DVS), traffic is interrupted from several seconds to several minutes. The interruption can last up to 15 minutes—the default local endpoint retention interval. The interruption occurs when both of the following two cases are true:

- When virtual switches use only Reverse Address Resolution Protocol (RARP) to indicate VM moves

- When a bridge domain is associated with a First Hop Security (FHS) policy that has the IP Inspection enabled

To work around the issue, disassociate the FHS policy from the bridge domain or change the policy to one in which IP inspection is disabled.

Working with Blade Servers

Guidelines for Cisco UCS B-Series Servers

When integrating blade server systems into Cisco ACI Cisco Application Centric Infrastructure for purposes of VMM integration (for example, integrating Cisco Unified Computing System (UCS) blade servers or other non-Cisco blade servers) you must consider the following guidelines:



Note This example shows how to configure a port channel access policy for integrating Cisco UCS blade servers. You can use similar steps to set up a virtual port channel or individual link access policies depending upon how your Cisco UCS blade server uplinks are connected to the fabric. If no port channel is explicitly configured on the Cisco Application Policy Infrastructure Controller (APIC) for the UCS blade server uplinks, the default behavior will be mac-pinning.

- The VM endpoint learning relies on either the Cisco Discovery Protocol (CDP) or Link Layer Discovery Protocol (LLDP). If supported, CDP must be enabled all the way from the leaf switch port through any blade switches and to the blade adapters.
- Ensure the management address type, length, and value (TLV) is enabled on the blade switch (CDP or LLDP protocol) and advertised towards servers and fabric switches. Configuration of management TLV address must be consistent across CDP and LLDP protocols on the blade switch.
- The Cisco APIC does not manage fabric interconnects and the blade server, so any UCS specific policies such as CDP or port channel policies must be configured from the UCS Manager.
- VLANs defined in the VLAN pool used by the attachable access entity profile on the Cisco APIC, must also be manually created on the UCS and allowed on the appropriate uplinks connecting to the fabric. This must include the infrastructure VLAN if applicable. For details, see the *Cisco UCS Manager GUI Configuration Guide*.
- When you are working with the Cisco UCS B-series server, both CDP and LLDP are supported, beginning from UCSM 2.2.4b. If UCS B-series server is using earlier firmware, LLDP is not supported.
- CDP is disabled by default in Cisco UCS Manager. In Cisco UCS Manager, you must enable CDP by creating a Network Control Policy.
- Do not enable fabric failover on the adapters in the UCS server service profiles. Cisco recommends that you allow the hypervisor to handle failover at the virtual switch layer so that load balancing of traffic is appropriately performed.



Note Symptom: The change of management IP of the unmanaged node such as blade switch or fabric interconnect gets updated in the VMware vCenter, but the VMware vCenter does not send any events to Cisco APIC.

Condition: This causes the Cisco APIC to be out of sync with VMware vCenter.

Workaround: You need to trigger an inventory pull for the VMware vCenter controller that manages ESX servers behind the unmanaged node.

Setting up an Access Policy for a Blade Server Using the GUI

Before you begin

To operate with the Cisco APIC, the Cisco UCS Fabric Interconnect must be at least a version 2.2(1c). All components, such as the BIOS, CIMC, and the adapter must be a version 2.2(1c) or later. For further details, see the *Cisco UCS Manager CLI Configuration Guide*.

Procedure

-
- Step 1** On the menu bar, choose **Fabric > Access Policies**.
 - Step 2** In the navigation pane, click **Quick Start**.
 - Step 3** In the central pane, click **Configure an interface, PC, and VPC**.
 - Step 4** In the **Configure Interface, PC, and VPC** dialog box, click the + icon to select switches.
 - Step 5** In the **Switches** field, from the drop-down list, choose the desired switch IDs.
 - Step 6** Click the + icon to configure the switch interfaces.
 - Step 7** In the **Interface Type** field, click the **VPC** radio button.
 - Step 8** In the **Interfaces** field, enter the appropriate interface or interface range that is connected to the blade server.
 - Step 9** In the **Interface Selector Name** field, enter a name.
 - Step 10** From the **CDP Policy** drop-down list, choose default
The default CDP policy is set to disabled. (Between the leaf switch and the blade server, CDP must be disabled.)
 - Step 11** From the **LLDP Policy** drop-down list, choose default.
The default LLDP policy is set to enabled for the receive and transmit states. (Between the leaf switch and the blade server, LLDP must be enabled.)
 - Step 12** From the **LACP Policy** drop-down list, choose **Create LACP Policy**.
Between the leaf switch and the blade server, the LACP policy must be set to active.
 - Step 13** In the **Create LACP Policy** dialog box, perform the following actions:
 - a) In the **Name** field, enter a name for the policy.
 - b) In the **Mode** field, the **Active** radio button is checked.
 - c) Keep the remaining default values and click **Submit**.
 - Step 14** From the **Attached Device Type** field drop-down list, choose **ESX Hosts**.
 - Step 15** In the **Domain Name** field, enter a name as appropriate.

- Step 16** In the **VLAN Range** field, enter the range.
- Step 17** In the **vCenter Login Name** field, enter the login name.
- Step 18** In the **Password** field, and the **Confirm Password** field, enter the password.
- Step 19** Expand the **vCenter** field, and in the **Create vCenter Controller** dialog box, enter the desired content and click **OK**.
- Step 20** In the **vSwitch Policy** field, perform the following actions:
- Between the blade server and the ESX hypervisor, CDP must be enabled, LLDP must be disabled, and LACP must be disabled so Mac Pinning must be set.
- Check the **MAC Pinning** check box.
 - Check the **CDP** check box.
 - Leave the **LLDP** check box unchecked because LLDP must remain disabled.
- Step 21** Click **Save**, and click **Save** again. Click **Submit**.
The access policy is set.
-

Troubleshooting the Cisco ACI and VMware VMM System Integration

For troubleshooting information, see the following links:

- [Cisco APIC Troubleshooting Guide](#)
- [ACI Troubleshooting Book](#)

Additional Reference Sections

Custom User Account with Minimum VMware vCenter Privileges

Setting VMware vCenter privileges allows the Cisco Application Policy Infrastructure Controller (APIC) to send VMware API commands to VMware vCenter for the creation of the DVS. Setting privileges also allows Cisco APIC to publish port groups and relay all necessary alerts.

To configure the VMware vCenter from Cisco APIC, your credentials must allow the following minimum set of privileges within the VMware vCenter:

- **Alarms** (read/write/modify)

Cisco APIC creates two alarms in the folder, one for DVS and another for port-group. The alarm is raised when the EPG or Domain policy is deleted on Cisco APIC. However, the alarms cannot be deleted for DVS or port-group because of the virtual machines (VMs) that are attached.

- **Distributed Switch** (read/write/modify)
- **dvPort Group** (read/write/modify)
- **Folder** (read/write/modify)

- **Network** (read/write/modify)

Cisco APIC manages the network settings such as add or delete port-groups, setting host/DVS MTU, LLDP/CDP, LACP.

- **Host** (read/write/modify)

- **Host.Configuration.Advanced settings**
- **Host.Local operations.Reconfigure virtual machine**
- **Host.Configuration.Network configuration**

- **Virtual machine** (read/write/modify)

If you use Service Graph in addition to the already listed privileges, you need the **Virtual machine** privilege for the virtual appliances that are used for Service Graph.

- **Virtual machine.Configuration.Modify device settings**
- **Virtual machine.Configuration.Settings**

If you want to deploy service VMs using the service VM orchestration feature, enable the following privileges in addition to the preceding privileges.

For information about the feature, see the "Service VM Orchestration" chapter of the [Cisco APIC Layer 4 to Layer 7 Services Deployment Guide](#).

- **Datastore** (read/write/modify)

- **Allocate space**
- **Browse datastore**
- **Low level file operations**
- **Remove file**

- **Host** (read/write/modify)

- **Local operations.Delete virtual machine**
- **Local operations.Reconfigure virtual machine**

- **Resource** (read/write/modify)

- **Assign virtual machine to resource pool**

- **Virtual machine** (read/write/modify)

- **Inventory.Create new**
- **Inventory.Create from existing**
- **Inventory.Remove**
- **Configuration.Add new disk**
- **Provisioning.Deploy template**

- **Provisioning.Clone template**
- **Provisioning.Clone virtual machine**
- **Provisioning.Customize**
- **Interaction (all)**
- **Global (read/write/modify)**
 - **Manage Custom Attributes**
 - **Set Custom Attribute**

Quarantine Port Groups

The quarantine port group feature provides a method to clear port group assignments under certain circumstances. In the VMware vCenter, when a VMware vSphere Distributed Switch (VDS) is created, a quarantine port group is created in the VDS by default. The quarantine port group default policy is to block all ports.

As part of integration with Layer 4 to Layer 7 virtual service appliances, such as a load balancer or firewall, the Application Policy Infrastructure Controller (APIC) creates service port groups in vCenter for service stitching and orchestrates placement of virtual appliances, such as service virtual machines (VMs), in these service port groups as part of the service graph rendering mechanism. When the service graph is deleted, the service VMs are automatically moved to the quarantine port group. This auto-move to a quarantine port group on delete is only done for service VMs, which are orchestrated by the APIC.

You can take further action with the port in quarantine port group as desired. For example, you can migrate all of the ports from the quarantine port group to another port group, such as a VM network.

The quarantine port group mechanism is not applicable to regular tenant endpoint groups (EPGs) and their associated port groups and tenant VMs. Therefore, if the tenant EPG is deleted, any tenant VMs present in the associated port group remains intact and they will not be moved to the quarantine port group. The placement of tenant VMs into the tenant port group is outside the realm of the APIC.

On-Demand VMM Inventory Refresh

Triggered Inventory provides a manual trigger option to pull and refresh Cisco Application Policy Infrastructure Controller (APIC) inventory from the virtual machine manager (VMM) controller. It is not required in normal scenarios. Use it with discretion only when errors occur.

When there is a process restart, leadership change, or background periodic 24-hour inventory audit, Cisco APIC pulls inventory to keep VMM inventory aligned with the VMM controller inventory. At certain times, VMware vCenter APIs can error out, and Cisco APIC may not have fully downloaded the inventory from the VMware vCenter despite retries. Cisco APIC indicates this condition with a user-visible fault. In this case, triggered inventory allows you to start an inventory pull from the Cisco APIC VMM to the VMware vCenter.

Cisco APIC does not maintain any synchronization between the VMM configuration and the VMware vCenter VDS configuration. If you directly change VDS settings from the VMware vCenter, Cisco APIC does not try to overwrite the user settings (except for PVLAN configuration).

Physically Migrating the ESXi Host

Complete the tasks in this procedure to physically migrate ESXi hosts.

Procedure

-
- | | |
|---------------|---|
| Step 1 | Put the host into maintenance mode or evacuate the virtual machine (VM) workload by another method. |
| Step 2 | Remove the ESXi host from the VMware VDS, Cisco Application Centric Infrastructure (ACI) Virtual Edge, or Cisco Application Virtual Switch. |
| Step 3 | Physically recable the ESXi host to the new leaf switch or pair of leaf switches |
| Step 4 | Add the ESXi host back to the VMware VDS, Cisco Application Centric Infrastructure (ACI) Virtual Edge, or Cisco Application Virtual Switch. |
-

Guidelines for Migrating a vCenter Hypervisor VMK0 to an ACI Inband VLAN

Follow the guidelines below to migrate the default vCenter hypervisor VMK0 out of bound connectivity to ACI inband ports. An ACI fabric infrastructure administrator configures the APIC with the necessary policies, then the vCenter administrator migrates the VMK0 to the appropriate ACI port group.

Create the Necessary Management EPG Policies in APIC

As an ACI fabric infrastructure administrator, use the following guidelines when creating the management tenant and VMM domain policies:

- Choose a VLAN to use for ESX management.
- Add the VLAN chosen for ESX management to a range (or Encap Block) in the VLAN pool associated with the target VMM domain. The range where this VLAN is added must have allocation mode set to static allocation.
- Create a management EPG in the ACI management tenant (mgmt).
- Verify that the bridge domain associated with the management EPG is also associated with the private network (inb).
- Associate the management EPG with the target VMM domain as follows:
 - Use resolution immediacy as pre-provision.
 - Specify the management VLAN in the Port Encap field of the VM domain profile association.

As a result, APIC creates the port group under vCenter with VLAN specified by the user. APIC also automatically pushes the policies on the leaf switches associated with the VMM domain and Attach Entity Profile (AEP).

Migrate the VMK0 to the Inband ACI VLAN

By default vCenter configures the default VMK0 on the hypervisor management interface. The ACI policies created above enable the vCenter administrator to migrate the default VMK0 to the port group that is created by APIC. Doing so frees up the hypervisor management port.



CHAPTER 4

Managing Uplinks for VMM Domains

- [Managing Uplinks for VMM Domains, on page 47](#)
- [Prerequisites for Managing Uplinks for VMM Domains, on page 48](#)
- [Workflow for Managing Uplinks for VMM Domains, on page 48](#)
- [Specifying Uplinks for the VMM Domain, on page 48](#)
- [Define Uplink Roles to Configure Failover , on page 55](#)

Managing Uplinks for VMM Domains

Beginning with Cisco Application Policy Infrastructure Controller (APIC) Release 4.2(1), you can specify the number of uplinks for endpoint groups (EPGs) that you associate with virtual domains. You can also rename, add, or delete uplinks. You can also configure failover by defining some uplinks as active and some as standby.

Cisco APIC supports specifying and modifying uplinks for VMware vSphere Distributed Switch (VDS) and Cisco Application Centric Infrastructure (ACI) Virtual Edge Virtual Machine Manager (VMM) domains. Cisco APIC supports failover for EPG uplinks for VDS and Cisco Application Centric Infrastructure (ACI) Virtual Edge when it is in native switching mode.

You can specify from one to 32 uplinks for a VMware VDS or Cisco ACI Virtual Edge. However, you are not required to do so; if you do not, Cisco APIC by default specifies eight uplinks, all active. Specifying more uplinks makes it easier to configure failover. You do not need to rename uplinks, but doing so makes it easier to manage them.

Defining some uplinks as active and others as standby is optional; however, doing so enables failover, ensuring that EPG traffic continues to flow even if some uplinks fail.



Note You can also manage uplinks by applying different enhanced Link Aggregation Control Protocol (LACP) policies to different distributed virtual switch (DVS) uplink port groups. Enhanced LACP is supported for VMware VDS and for Cisco ACI Virtual Edge. For VMware VDS, see the [Enhanced LACP Policy Support, on page 31](#) section in this guide; for Cisco ACI Virtual Edge, see the section "Enhanced LACP Policy Support" in the [Cisco ACI Virtual Edge Configuration Guide](#) .

Prerequisites for Managing Uplinks for VMM Domains

Perform the following tasks before you manage uplinks for endpoint groups (EPGs) for VMware vSphere Distributed Switch (VDS) or Cisco Application Centric Infrastructure (ACI) Virtual Edge Virtual Machine Manager (VMM) domains.

- Install Cisco Application Policy Infrastructure Controller (APIC) Release 4.2(1) in your fabric.
- Make the basic configurations that are required for VMware vSphere Distributed Switch (VDS) VMM domain or Cisco ACI Virtual Edge VMM domain.

This includes creating a tenant, bridge domain, attachable access entity profile (AEP), and at least one endpoint group (EPG). It also includes associating the VMM domain to an EPG,

Workflow for Managing Uplinks for VMM Domains

This section lists the tasks that you must perform to manage uplinks for endpoint groups (EPGs) that you associate with a VMware vSphere Distributed Switch (VDS) or Cisco Application Centric Infrastructure (ACI) Virtual Edge Virtual Machine Manager (VMM) domain.

1. Fulfill all the prerequisites.
2. Create a VMM domain for the VMware VDS or Cisco ACI Virtual Edge and specify the number of uplinks as part of the domain creation.

See [Create a VMM Domain for a VMware VDS and Specify the Number of Uplinks, on page 49](#) or [Create a VMM Domain for Cisco ACI Virtual Edge and Specify the Number of Uplinks, on page 51](#).

3. Modify the uplinks: You can rename or delete the uplinks that you specified in the previous task, or you can specify more uplinks.

You do this by editing the VMM domain. You can also specify the number uplinks at this point if you did not do so when you created a VMM domain.

See the procedure [Edit the VMM Domain and Modify the Uplinks, on page 53](#).

4. Associate an endpoint group (EPG) with the VMM domain and optionally configure active and standby uplinks as part of the association.

Configuring active and standby uplinks enables failover for uplinks within an EPG associated with the VMM domain.

See the section [Define Uplink Roles to Configure Failover, on page 55](#).

Specifying Uplinks for the VMM Domain

You can specify the number of uplinks for a specific Virtual Machine Manager (VMM) domain when you create the Virtual Machine Manager (VMM) domain. You can do so only if you create the domain under the **Virtual Networking** tab in the Cisco Application Policy Infrastructure Controller (APIC) GUI. You cannot specify uplinks if you use create the domain with the configuration wizard under the **Fabric** tab.

The procedures for creating a VMM domain under the **Virtual Networking** differ slightly for VMware vSphere Distributed Switch (VDS) and Cisco Application Centric Infrastructure (ACI) Virtual Edge.

If you have already created a VMM domain, you can still specify the uplinks by editing the VMM domain. The procedure is the same for VMware vSphere Distributed Switch or Cisco ACI Virtual Edge.

Create a VMM Domain for a VMware VDS and Specify the Number of Uplinks

When you create a Virtual Machine Manager (VMM) domain for a VMware vSphere Distributed Switch (VDS), you can specify the number of uplinks that will be configured on the VMware VDS. When you specify uplinks, you determine the ports on the virtual switch that connect to the physical leaf switch.

You specify uplinks in step 4 h of this procedure. If you do not specify uplinks, by default, Cisco APIC specifies eight uplinks, all active.



Note You cannot configure the uplinks when you create the VMM domain using the configuration wizard under the **Fabric** tab. However, if you have already created the domain, you can still add uplinks. Skip this procedure and complete the procedure [Edit the VMM Domain and Modify the Uplinks, on page 53](#).

Before you begin

Fulfill the following prerequisites before you configure a Virtual Machine Manager (VMM) domain for the VMware vSphere Distributed Switch (VDS).

- All fabric nodes are discovered and configured.
- In-band (inb) or out-of-band (oob) management has been configured on the Cisco APIC.
- A VMM is installed, configured, and reachable through the `inb` or `oob` management network (for example, VMware vCenter).
- Ensure that you have enough VLAN IDs in the VLAN pool. If you do not, ports on EPGs might report that no encapsulation is available.
- Ensure that you have the administrator/root credentials to the VMware vCenter.
- Create interface and switch profiles.
- Create an attachable entity profile (AEP).

During the procedure to create a vCenter domain profile, you are asked to choose or create an AEP. If you want to create an AEP ahead of time, follow the procedure "Create a Global Attachable Access Entity Profile" in the [Cisco APIC Basic Configuration Guide](#).

Procedure

- Step 1** Log in to Cisco Application Policy Infrastructure Controller (APIC).
- Step 2** Go to **Virtual Networking** > **Inventory**.
- Step 3** In the Inventory navigation pane, expand **VMM Domains**, right-click **VMware**, and then choose **Create vCenter Domain**.

Step 4 In the **Create vCenter Domain** dialog box, complete the following steps:

- a) In the **Virtual Switch Name** field, enter a name.
- b) In the **Virtual Switch Area**, choose **VMware vSphere Distributed Switch**.
Choosing **VMware vSphere Distributed Switch** creates the VMM domain for the VMware VDS.
- c) From the **Associated Attachable Entity Profile** drop-down list, create or choose a profile that you created earlier.
See "Create a Global Attachable Access Entity Profile" in the [Cisco APIC Basic Configuration Guide](#) for instructions.
- d) From the VLAN Pool drop-down list, choose **Create VLAN Pool** and configure the pool using the **Create VLAN Pool** and **Create Ranges** dialog boxes.

Note If you plan to configure a floating Layer 3 outside network connection (L3Out), the VLAN pool must have a static VLAN range. Also, the VLAN pool must be the same as the VLAN pool of the L3Out domain. For example, both the range for the L3Out domain and the VMM domain must be 200-209.

- e) In the **vCenter Credentials** area, click the + (plus) icon, and in the **Create vCenter Credential** dialog box, do the following: Enter the VMware vCenter account profile name in the **Name** field, the VMware vCenter username in the **Username** field, enter and confirm the VMware vCenter password, and then click **OK**.
- f) In the **vCenter** area, click the + (plus) icon, and in the **Add vCenter Controller** dialog box, do the following: Enter the VMware vCenter controller name, the VMware vCenter host name or IP address, the DVS version, data center name (which must match the data center name configured in VMware vCenter), select the credentials created in the previous step, and then click **OK**.
- g) In the **Create vCenter Domain** dialog box, click **OK**.

In the VMware work pane, you should see the newly created VMM domain, which will be pushed to VMware vCenter.

Note Perform the following step if you plan to specify the number of uplinks. This step is optional.

- h) From the **Number of Uplinks** drop-down list, choose the number of uplinks for the virtual switch uplink port group.

You can associate from one to 32 uplinks to the virtual switch uplink port group. This step is optional; if you do not choose a value, eight uplinks are associated with the port group by default.

You can name the uplinks after you finish creating the VMM domain. You can also configure failover for the uplinks when you create or edit the VMM domain association for an EPG.

What to do next

You can do the following:

- Rename, add, or delete uplinks; see [Edit the VMM Domain and Modify the Uplinks](#), on page 53.
- Configure failover for the uplinks; see [Define Uplink Roles to Configure Failover](#), on page 55.

Create a VMM Domain for Cisco ACI Virtual Edge and Specify the Number of Uplinks

When you create a Virtual Machine Manager (VMM) domain for a Cisco Application Centric Infrastructure (ACI) Virtual Edge, you can specify the number of uplinks for endpoint groups (EPGs) that you associate with the domain. When you specify uplinks, you determine the ports on the virtual switch that connect to the physical leaf switch with the EPGs.

You specify the uplinks in step 4 h of this procedure. If you do not specify uplinks, by default, Cisco APIC specifies eight uplinks, all active, to an EPG.



Note You cannot configure the uplinks when you create the Cisco ACI Virtual Edge VMM domain using the configuration wizard under the **Fabric** tab. However, if you have already created the Cisco ACI Virtual Edge, you can still add uplinks. See the procedure [Edit the VMM Domain and Modify the Uplinks, on page 53](#).

Before you begin

- Ensure that the multicast IP address pool has enough multicast IP addresses to accommodate the number of EPGs that will be pushed to the VMware vCenter domain. You can add more IP addresses to a multicast address pool that is already associated with a VMware vCenter domain at any time.
- Ensure that you have enough VLAN IDs in the VLAN pool. If you do not, ports on EPGs might report that no encapsulation is available.
- Ensure that VMware vCenter is installed, configured, and reachable through the in-band/out-of-band management network.
- Ensure that you have the administrator/root credentials to the VMware vCenter.
- Create interface and switch profiles. See the section "Create Port Channel Switch and Interface Profiles" in Appendix B of the [Cisco ACI Virtual Edge Installation Guide](#) for instructions.
- Create an attachable entity profile (AEP).

During the procedure to create a vCenter domain profile, you are asked to choose or create an AEP. If you want to create an AEP ahead of time, follow the procedure "Configuring an Attachable Entity Profile Using the GUI" in the [Cisco ACI Virtual Edge Configuration Guide](#).



Note Enable the infrastructure VLAN within the AEP assigned to the Cisco ACI Virtual Edge VMM domain. Do this regardless of whether you create the AEP before or during VMware vCenter domain profile creation. In the **Create Attachable Access Entity Profile** dialog box, check the **Enable Infrastructure VLAN** check box.

Procedure

Step 1 Log in to Cisco APIC.

Step 2 Go to **Virtual Networking > Inventory**.

Step 3 In the Inventory navigation pane, expand **VMM Domains**, right-click **VMware**, and then choose **Create vCenter Domain**.

Step 4 In the **Create vCenter Domain** dialog box, complete the following steps:

- a) In the **Virtual Switch Name** field, enter a name.
- b) In the **Virtual Switch Area**, choose **Cisco AVE**.

Choosing **Cisco AVE** creates the VMM domain for Cisco ACI Virtual Edge.

Note Perform the following two substeps if you want to use VMware vSphere Proactive HA. Cisco APIC tells VMware vCenter to quarantine a host with a non-working Cisco ACI Virtual Edge and move the VMs to a host with a working Cisco ACI Virtual Edge. The feature is not available for Cisco ACI Virtual Edge when it is part of Cisco ACI vPod.

Enable Proactive HA in VMware vCenter. See the appendix "Improving Cisco ACI Virtual Edge Availability with VMware vSphere Proactive HA" in the [Cisco ACI Virtual Edge Installation Guide](#).

- c) With the **AVE Time Out Time (seconds)** selector, choose the time period to trigger VMware vCenter to quarantine a host with a nonworking Cisco ACI Virtual Edge and move VMs from the host.

You can choose any value between 10 and 300 seconds, inclusive. The default is 30 seconds.

- d) Check the **Host Availability Assurance** check box.

Checking the check box creates a VMware Proactive HA object in VMware vCenter. The object enables VMware vCenter to quarantine a host with a nonworking Cisco ACI Virtual Edge and move VMs from the host.

Note Activation of VMware Proactive HA in vCenter is required before a host with non-working Cisco ACI Virtual Edge can be quarantined.

- e) In the **Switching Preference** area, choose **No Local Switching** or **Local Switching**.

For information about switching preferences, see the section "What Cisco ACI Virtual Edge Is" in the *Overview* chapter of the [Cisco ACI Virtual Edge Installation Guide](#).

Note If you choose **No Local Switching**, you can use only VXLAN encapsulation.

- f) If you chose **Local Switching** in Step 4f, in the **Default Encap Mode** area, choose a mode.

You can choose **VLAN mode** or **VXLAN mode**. You can use both encapsulation methods within the same VMM domain. See the section "Mixed-Mode Encapsulation Configuration" in the [Cisco ACI Virtual Edge Configuration Guide](#).

- g) From the **Associated Attachable Entity Profile** drop-down list, create or choose a profile that you created earlier.

See "Configuring an Attachable Entity Profile Using the GUI" in the [Cisco ACI Virtual Edge Configuration Guide](#) for instructions.

- h) From the VLAN Pool drop-down list, choose or create a VLAN pool.

If Cisco ACI Virtual Edge will be deployed in mixed-mode or VLAN mode, create two VLAN pools: one for primary encapsulation and one for private VLAN implementation. The role for the private VLAN pool must be internal. If Cisco ACI Virtual Edge will be deployed in VXLAN mode, only a private VLAN pool is necessary.

- i) In the **AVE Fabric-Wide Multicast Address** field, enter an address.

- j) From the **Pool of Multicast Addresses (one per-EPG)** drop-down list, choose or create a pool.
- k) In the **vCenter Credentials** area, click the + (plus) icon, and in the **Create vCenter credential** dialog box, do the following: Enter the VMware vCenter account profile name in the **Name** field, the VMware vCenter username in the **Username** field, enter and confirm the VMware vCenter password, and then click **OK**.
- l) In the **vCenter** area, click the + (plus) icon, and in the **Create vCenter Controller** dialog box, do the following: Enter the VMware vCenter controller name, the VMware vCenter host name or IP address, the DVS version, data center name (which must match the data center name configured in VMware vCenter), select the credentials created in the previous step, and then click **OK**.

You can choose a DVS version 5.5 or later.

- m) In the **Create vCenter Domain** dialog box, click **Submit**.

In the VMware work pane, you should see the newly created VMM domain, which will be pushed to VMware vCenter.

Disregard the options for choosing a port channel mode, vSwitch policy, interface controls, and firewall mode. You can configure Distributed Firewall later; see the instructions in the [Cisco ACI Virtual Edge Configuration Guide](#).

- n) From the **Number of Uplinks** drop-down list, choose the number of uplinks for the virtual switch uplink port group.

You can associate from one to 32 uplinks to the virtual switch uplink port group. This step is optional; if you do not choose a value, eight uplinks are associated with the port group by default.

You can name the uplinks after you finish creating the VMM domain. You can also configure failover for the uplinks when you create or edit the VMM domain association for an EPG.

What to do next

- Add one or more ESXi hosts and their PNICs to the newly created Cisco ACI Virtual Edge DVS using the vSphere Web Client on the VMware vCenter.
- Enable vSphere Proactive HA in VMware vCenter if you have not done so already.
- Rename the uplinks or configure failover for them. See the sections [Edit the VMM Domain and Modify the Uplinks, on page 53](#) and [Define Uplink Roles to Configure Failover, on page 55](#).
- Configure failover for the uplinks; see [Define Uplink Roles to Configure Failover, on page 55](#).

Edit the VMM Domain and Modify the Uplinks

You can modify the uplinks that you previously specified for the virtual switch uplink port group by editing the Virtual Machine Manager (VMM) domain. Renaming, adding, or deleting uplinks is supported for VMware vSphere Distributed Switch (VDS) or Cisco Application Centric Infrastructure Virtual Edge.

You do not need to rename uplinks; if you do not, they use the default names assigned by Cisco Application Policy Infrastructure Controller (APIC). The default names are `uplink1`, `uplink2`, and so on. Renaming uplinks does not change the unique IDs of the uplinks but can help you organize them by function.



Note You can also use this procedure to specify uplinks if you did not do so when you created the VMM domain.

Before you begin

You must have created a VMM domain for a VMware VDS or Cisco ACI Virtual Edge.

Procedure

- Step 1** Log in to Cisco APIC.
- Step 2** Go to **Virtual Networking > Inventory**.
- Step 3** In the **Inventory** navigation pane, expand the **VMM Domains** and **VMware** folders, and then choose the VMM domain.
- Step 4** In the central **Domain** work pane, do the following:

Option	Description
If you want to...	Then...
Specify uplinks	<ol style="list-style-type: none"> Make sure that the Create Uplinks check box is checked. From the Number of Uplinks drop-down list, choose the number of uplinks to specify. You can specify up to 32 uplinks. If you do not specify uplinks, Cisco APIC specifies eight by default, all active.
Rename specified uplinks	<ol style="list-style-type: none"> In the Name of Uplinks area, click the + (plus) icon. From the Uplink ID field, choose an uplink to name. In the Uplink Name field, enter a name for the uplink. Repeat the process to name other uplinks. Click Update.
Add uplinks	<p>From the Number of Uplinks drop-down list, choose the number of uplinks to specify</p> <p>You can create from one to 32 uplinks.</p>
Delete uplinks	<ol style="list-style-type: none"> In the Name of Uplinks area, click the + (plus) icon. In the uplink table, choose an uplink, and then click the trash can icon. Repeat the process to name other uplinks that you want to delete. <p>Note You cannot delete uplinks after you have defined some as active and some as standby for an EPG associated with a VMM domain. Defining uplinks as active or standby enables failover for the uplinks in the EPG.</p>

Step 5 Click **Submit**.

Define Uplink Roles to Configure Failover

You can define some uplinks in an endpoint group (EPG) as active and some links as standby. Doing so enables failover for the uplinks within the EPG, which you associate with a Virtual Machine Manager (VMM) domain.

If an active link fails, another active link takes over. If there are no active links available, standby links take over.

You define links as active or standby when you create a VMM domain association for the EPG. If you have already associated the EPG with the VMM domain, you can configure failover for the EPG uplinks by editing the VMM domain association. These procedures are the same for VMware vSphere Distributed Switch and Cisco Application Centric Infrastructure (ACI) Virtual Edge.



Note In addition to defining uplink roles, you can choose a load-balancing mode when you configure a port channel policy. Beginning in Cisco Application Policy Infrastructure Controller (APIC) Release 4.2(1), you can choose explicit failover as a mode. Choosing explicit failover, a non-load balancing mode, ensures that uplinks fail over in the order that you define when you create the EPG-VMM domain association.

Associate an EPG with a VMM Domain and Define Uplink Roles

You can enable failover for the uplinks in the endpoint group (EPG) that you associate with a Virtual Machine Manager (VMM) domain. You do so while associating the EPG with the domain by specifying which of the uplinks are active uplinks and which are standby uplinks.

Before you begin

You must have completed the following tasks:

- Created a VMM domain for a VMware vSphere Distributed Switch (VDS) or a Cisco Application Centric Infrastructure (ACI) Virtual Edge
- Created a tenant, application profile, and at least one EPG.

Procedure

- Step 1** Log in to Cisco Application Policy Infrastructure Controller (APIC).
- Step 2** Go to **Tenants** > *tenant* .
- Step 3** In the *tenant* navigation pane, expand the following: *tenant* > **Application Profiles** > *application_profile* .
- Step 4** Right-click the **Domains (VMs and Bare-Metals)** folder and choose **Add VMM Domain Association (VMs and Bare-Metals)**.
- Step 5** In the **Add VMM Domain Association** dialog box, perform the following steps:

- a) From the **VMM Domain Profile** drop-down list, choose the domain.
- b) Configure the association as is appropriate for your setup.
- c) In the **Active Uplinks Order** field, enter the IDs of the uplinks that you want to be active, using commas but no spaces to separate the uplinks.

The order decides the order in which active uplinks take over for a failed uplink.

Note If you configure uplink failover, you cannot rename, add, or delete the uplinks. However, you can edit the failover. For example, you can change the uplinks that are active or standby.

- d) In the **Standby Uplinks** field, enter the IDs of the uplinks that you want to be standby, using commas but no spaces separate the uplinks.

Note Uplinks that you specify but do not define as active or standby are classed as unused. To make an active or standby link unused, remove it from the active or standby list. However, you cannot make all uplinks unused. If you do not specify any uplinks, all available uplinks are classed as active.

- e) Click **Submit**.

Edit the EPG-Domain Association and Define Uplink Roles

If the endpoint group (EPG) is already associated with a Virtual Machine Manager (VMM) domain, you can still define some uplinks as active and some as standby by editing the VMM domain association. Defining uplink roles enables failover for the uplinks in the EPG.

Before you begin

You must have associated an EPG to a VMware vSphere Distributed Switch (VDS) or a Cisco Application Centric Infrastructure (ACI) VMM domain.

Procedure

- Step 1** Log in to Cisco Application Policy Infrastructure Controller (APIC).
- Step 2** Go to **Tenants > tenant**.
- Step 3** In the *tenant* navigation pane, expand the following: *tenant > Application Profiles > application_profile*.
- Step 4** Choose the **Domains (VMs and Bare-Metals)** folder.
- Step 5** In the **Domains (VMs and Bare-Metals)** central work pane, right-click the domain and then choose **Edit VMM Domain Association**.
- Step 6** In the **Edit VMM Domain Association** dialog box, complete the following steps:
 - a) In the **Active Uplinks Order** field, enter the IDs of the uplinks that you want to be active, using commas but no spaces to separate the uplinks.

The order decides the order in which active uplinks take over for a failed uplink.

Note If you configure uplink failover, you cannot rename, add, or delete the uplinks. However, you can edit the failover. For example, you can change the uplinks that are active or on standby.

- b) In the **Standby Uplinks** field, enter the IDs of the uplinks that you want to be standby, using commas but no spaces to separate the uplinks.

Note Uplinks that you specify but do not define as active or standby are classed as unused. To make an active or standby link unused, remove it from the active or standby list. However, you cannot make all uplinks unused.

- c) Make any other changes as required for your setup.
 - d) Click **OK**.
-



CHAPTER 5

Custom EPG Name Configuration and Cisco ACI

- [Configuring Custom EPG Names for VMM Domains, on page 59](#)
- [Guidelines for Using Custom Names for EPGs, on page 59](#)
- [Prerequisites for Configuring a Custom EPG Name, on page 60](#)
- [Configuring Custom EPG Names, on page 61](#)
- [Verifying EPG Names, on page 62](#)

Configuring Custom EPG Names for VMM Domains

When you associate an endpoint group (EPG) to a Virtual Machine Manager (VMM) domain, Cisco Application Centric Infrastructure (ACI) automatically creates a VMware vCenter port group or a Microsoft VM network. Beginning in Cisco Application Policy Infrastructure Controller (APIC) Release 4.2(3), it is easier to manage the port groups or VM networks because you now have the option of giving the EPG a custom name.

In earlier Cisco APIC releases, Cisco ACI creates port group or VM network names using a specific format: `tenant|application|epg` for VMware vCenter-based domains and `tenant|application|epg|domain` for Microsoft System Center Virtual Machine Manager (SCVMM). The format can result in long, similar names that are difficult to distinguish from each other.

However, beginning in Cisco APIC Release 4.2(3), you can optionally give the EPG a custom name when you create the VMM domain association. The name is then carried over to the port group in VMware vCenter or the Microsoft VM network. Using a custom name enables you to associate a simple or meaningful EPG name in Cisco APIC with a VMware vCenter port group or a Microsoft VM network. It also enables consistent naming between port groups and VM networks. Also, for Microsoft SCVMM, using a custom EPG name provides the ability to create a VM network in situations where the VM network creation would fail due to the 64-character limit when concatenating `tenant|application|epg|domain`.

For VMware vSphere Distributed Switch (VDS) domains, you can configure, edit, and delete the custom EPG names through Cisco APIC GUI, REST API, or NX-OS Style CLI. For Microsoft SCVMM, you can configure, edit, and delete the custom EPG names through Cisco APIC GUI or REST API.

Guidelines for Using Custom Names for EPGs

The following are guidelines that you should follow when you configure or use custom endpoint group (EPG) names:

- The custom name limit is 80 characters for VMware vCenter port groups, and 61 characters for Microsoft System Center Virtual Machine Manager (SCVMM) VM networks.

The Cisco Application Centric Infrastructure (ACI) SCVMM Agent adds extra characters to the object name depending on the object type. This is why the character limit for SCVMM is 61 characters instead of 80.

Special character rule - each special character (not alphabets, digits) are considered three times the normal character length (A-Z, a-z, 0-9). This provides a consistent logic for special characters as VMM treats some special characters differently. Example: if an alphabet length is considered as one, special character length is considered as three.

- We require that all custom EPG names be removed before you downgrade Cisco Application Policy Infrastructure Controller (APIC) from Release 4.2(3) or earlier; custom names for EPGs were not supported in previous versions.

Downgrading without removing custom EPG names does not directly cause a loss of traffic; however, later configuration of EPG policies does.

- When you use static IP address pools, we recommend that you use short custom names.

The name of the `fvCepNetCfg` managed object is added to the SCVMM static IP address pool name, and a long name could prevent the SCVMM VM network from being deployed.

- The custom name should not overlap with another EPG name, custom or not.

Prerequisites for Configuring a Custom EPG Name

You must complete the following tasks before you can configure a custom endpoint group (EPG) name:

- Create a Virtual Machine Manager (VMM) domain for VMware vSphere Distributed Switch (VDS) or Microsoft System Center Virtual Machine Manager (SCVMM).

For instructions, see the chapter "Cisco ACI with VMware VDS Integration" or "Cisco ACI with Microsoft SCVMM" in the *Cisco ACI Virtualization Guide*.

- Create a tenant, bridge domain, application profile, and at least one EPG.

For instructions, see the *Cisco APIC Basic Configuration Guide*, the chapter "Cisco ACI with VMware VDS Integration" or "Cisco ACI with Microsoft SCVMM" in the *Cisco ACI Virtualization Guide*.

- Upgrade Cisco Application Policy Infrastructure Controller (APIC) and the Cisco ACI fabric to Cisco APIC Release 4.2(3).

For information and instructions, see the *Cisco ACI Upgrade Checklist*, the *Cisco APIC Upgrade/Downgrade Support Matrix*, and the *Cisco APIC Installation, Upgrade, and Downgrade Guide*.

- (For SCVMM), upgrade the SCVMM and Hyper-V Cisco ACI agents to Cisco APIC Release 4.2(3).

For instructions, see "Cisco ACI with Microsoft SCVMM" in the *Cisco ACI Virtualization Guide*.

Configuring Custom EPG Names

Configure a Custom EPG Name Using the GUI

Complete the following procedure to configure a custom endpoint group (EPG) name when you associate the EPG with a Virtual Machine Manager (VMM) domain. The procedure is the same for VMware vSphere Distributed Switch and Microsoft System Center Virtual Machine Manager (SCVMM).

Before you begin

You must have performed the tasks in the section [Prerequisites for Configuring a Custom EPG Name](#), on page 60 in this chapter.

Procedure

- Step 1** Log in to Cisco Application Policy Infrastructure Controller (APIC).
- Step 2** Go to **Tenants > tenant > Application Profile > application profile > Application EPGs > application EPG**.
- Step 3** Right-click the application EPG that you want to associate with a VMM domain, and then choose **Add VMM Domain Association**.
- Step 4** In the **Add VMM Domain Association** dialog box, complete the following steps:
- From the **VMM Domain Profile** drop-down list, choose the VMM domain that you created earlier.
 - Configure the association as your setup requires.
 - In the **Custom EPG Name** field enter a name for the EPG, which will become the name of the VMware vCenter port group or the Microsoft VM network.

A custom name for a VMware vCenter port group is 80 characters; a custom name for a Microsoft VM network is 61 characters.
 - Click **Submit**.
-

What to do next

Verify the name, using one of the following procedures in this chapter:

- [Verify the Port Group Name in VMware vCenter](#), on page 62
- [Verify a VM Network Name Change in Microsoft SCVMM](#), on page 62

Change or Delete the Custom EPG Name Using the GUI

You can change or delete a custom endpoint group (EPG) name using the Cisco Application Policy Infrastructure Controller (APIC) GUI.

Procedure

- Step 1** Log in to Cisco APIC.
 - Step 2** Go to **Tenants > tenant > Application Profile > application profile > Application EPGs > application EPG**.
 - Step 3** Expand the folder for the application EPG associated with the Virtual Machine Manager (VMM) domain and then click **Domains (VMs and Bare-Metals)**.
 - Step 4** In the central work pane, right-click the domain that the EPG is associated with and choose **Edit VMM Domain Association**.
 - Step 5** In the **Edit VMM Domain Association** dialog box, change the custom name by typing a new one in the **Custom EPG Name** field or delete the name by emptying the field.
 - Step 6** Click **Update**.
-

What to do next

Verify the change, using one of the following procedures in this chapter:

- [Verify the Port Group Name in VMware vCenter, on page 62](#)
- [Verify a VM Network Name Change in Microsoft SCVMM, on page 62](#)

Verifying EPG Names

Verify the Port Group Name in VMware vCenter

You can verify the custom or default endpoint group (EPG) name for the port group in VMware vCenter.

Procedure

- Step 1** Launch the VMware vSphere vCenter client.
 - Step 2** Navigate to the Distributed Virtual Switch and the port group.
If there is no custom EPG name applied to the port group, the port group has the default name `tenant|application|epg`. If the custom EPG name is applied the port group will have that name—for example, `WebEPG`.
-

Verify a VM Network Name Change in Microsoft SCVMM

You can verify if the endpoint (EPG) name has changed in the Microsoft System Center Virtual Machine Manager (SCVMM) Agent.

Procedure

Step 1 Log in to the SCVMM server, and go to **SCVMM > Jobs > History**.

Step 2 Click **Refresh** to see the most recent jobs.

The recent jobs window shows the following as **Completed**:

- **Change properties of static IP address pool**

Note The static IP address pool is present only when the policy is present on Cisco Application Policy Infrastructure Controller (APIC).

- **Change properties of logical network definition**

- **Change properties of VM Network**

- **Change properties of VM subnet**



CHAPTER 6

Microsegmentation with Cisco ACI

This chapter contains the following sections:

- [Microsegmentation with Cisco ACI, on page 65](#)

Microsegmentation with Cisco ACI

Microsegmentation with the Cisco Application Centric Infrastructure (ACI) enables you to automatically assign endpoints to logical security zones called endpoint groups (EPGs). These EPGs are based on various network-based or virtual machine (VM)-based attributes.

This chapter contains conceptual information about Microsegmentation with Cisco ACI and instructions for configuring microsegmented (uSeg) EPGs. We assume that you are familiar with EPGs, tenants, contracts, and other key concepts relating to Cisco ACI policies. For more information, see *Cisco Application Centric Infrastructure Fundamentals*.

Supported Endpoints

The Cisco Application Policy Infrastructure Controller (APIC) manages microsegmentation policies, and the Cisco ACI fabric enforces the policies. Microsegmentation with Cisco ACI supports virtual endpoints that are attached to the following:

- Cisco ACI Virtual Edge
- Microsoft Hyper-V Virtual Switch
- VMware vSphere Distributed Switch (VDS)

Microsegmentation with network-based attributes also supports bare-metal environments. See the section "Using Microsegmentation with Network-based Attributes on Bare Metal" in the [Cisco APIC Basic Configuration Guide, Release 3.x](#).

Microsegmentation with Cisco ACI also supports physical endpoints using EPGs with IP-based attributes.



Note You can configure Microsegmentation with Cisco ACI for physical and virtual endpoints, and you can share the same EPGs for both physical and virtual endpoints.

Layer 4 to Layer 7 service graphs are supported for contracts between microsegmented EPGs and between microsegmented EPGs and regular EPGs. See the *Cisco APIC Layer 4 to Layer 7 Services Deployment Guide* on [Cisco.com](https://www.cisco.com) for detailed information and configuration procedures.

Limitations

- If you use Cisco ACI Virtual Edge or Microsoft Hyper-V Virtual Switch, note the following: If you want to use a MAC-based EPG and any attribute other than IP for virtual endpoints, do not configure any overlapping IP attribute filters for physical endpoints or virtual endpoints on a VDS VMM domain. If you do so, the Cisco ACI Virtual Edge or Microsoft Hyper-V Virtual Switch, microsegmentation EPG classification is overwritten.
- Configuring a Layer 4 to Layer 7 virtual IP (VIP) address under microsegmented EPGs or their corresponding base EPGs is not supported.
- A VMware distributed virtual switch (VDS) domain with EDM UCSM integration may fail. The domain fails if you configure microsegmentation on the endpoint group (EPG) attached to the domain and you use UCSM Mini 6324, which does not support private VLANs.

Benefits of Microsegmentation with Cisco ACI

Endpoint groups (EPGs) are used to group virtual machines (VMs) within a tenant and apply filtering and forwarding policies to them. Microsegmentation with Cisco ACI adds the ability to group endpoints in existing application EPGs into new microsegment (uSeg) EPGs and configure network or VM-based attributes for those uSeg EPGs. This enables you to filter with those attributes and apply more dynamic policies. Microsegmentation with Cisco ACI also allows you to apply policies to any endpoints within the tenant.

Example: Microsegmentation with Cisco ACI Within a Single EPG or Multiple EPGs in the Same Tenant

You might assign web servers to an EPG so that you can apply the similar policies. By default, all endpoints within an EPG can freely communicate with each other. However, if this web EPG contains a mix of production and development web servers, you might not want to allow communication between these different types of web servers. Microsegmentation with Cisco ACI allows you to create a new EPG and autoassign endpoints based on their VM name attribute, such as "Prod-xxxx" or "Dev-xxx".

Example: Microsegmentation for Endpoint Quarantine

You might have separate EPGs for web servers and database servers, and each one contains both Windows and Linux VMs. If a virus affecting only Windows threatens your network, you can isolate Windows VMs across all EPGs by creating a new EPG called, for example, "Windows-Quarantine" and applying the VM-based operating systems attribute to filter out all Windows-based endpoints. This quarantined EPG could have more restrictive communication policies, such as limiting allowed protocols or preventing communication to any other EPGs by not having any contract. A microsegment EPG can have a contract or not have a contract.

How Microsegmentation Using Cisco ACI Works

Microsegmentation using Cisco Application Centric Infrastructure (ACI) involves the Cisco Application Policy Infrastructure Controller (APIC), vCenter or Microsoft System Center Virtual Machine Manager (SCVMM), and leaf switches. This section describes the workflow for microsegmentation using Cisco ACI Virtual Edge, VMware VDS, or Microsoft Hyper-V Virtual Switch.

Cisco APIC

1. The user configures a VMM domain for Cisco ACI Virtual Edge, VMware VDS, or Microsoft Hyper-V Virtual Switch in the Cisco APIC.
2. The Cisco APIC connects to vCenter or SCVMM and does the following:
 - a. Creates an instance of Cisco ACI Virtual Edge, VMware VDS, or Microsoft Hyper-V Virtual Switch.
 - b. Pulls VM and hypervisor inventory information from the associated VMware vCenter or Microsoft SCVMM.
3. The user creates an application EPG and associates it with a vCenter/SCVMM domain. In each vCenter/SCVMM domain, a new encapsulation is allocated for this application EPG. The application EPG does not have any attributes.

The vCenter/SCVMM administrator assigns virtual endpoints to this application EPG—not to any microsegment (uSeg) EPGs. It is the application EPG that appears in vCenter/SCVMM as a port group.

4. The user creates an uSeg EPG and associates it with the VMM domain.

The uSeg EPG does not appear in vCenter/SCVMM as a port group; it has a special function: The uSeg EPG has VM-based attributes to match filter criteria. If a match occurs between the uSeg EPG VM attributes and VMs, the Cisco APIC dynamically assigns the VMs to the uSeg EPG.

The endpoints are transferred from the application EPG to the uSeg EPG. If the uSeg EPG is deleted, the endpoints are assigned back to the application EPG.

The uSeg EPG must be assigned to a VMM domain in order for it to take effect. When you associate an uSeg EPG to a VMM domain, its criteria is applied for that VMM domain only. If you have VMware VDS, you must also assign the uSeg EPG to the same bridge domain as the application EPG.

In the case of VMware VDS, its criteria is applied for that VMM domain and bridge domain.

Leaf Switch

1. The physical leaf switch pulls the attribute policies from the Cisco APIC.
2. The Cisco ACI Virtual Edge or Microsoft Hyper-V Virtual Switch sends a VM attach message to the physical leaf switch using the OpFlex protocol when a VM attaches to Cisco ACI Virtual Edge or Microsoft Hyper-V Virtual Switch.

VMware vSphere Distributed Switch (VDS) does not send a VM attach message using the OpFlex protocol.

In case of Microsoft Hyper-V Virtual Switch, endpoint information synchronization happens every 5 minutes. So it takes up to 5 minutes to get endpoints to move to the microsegmented EPG or move back from the microsegmented EPG.

3. The physical leaf switch matches the VM against the configured attribute policies for the tenant.
4. If the VM matches the configured VM attributes, the physical leaf switch pushes the uSeg EPG—along with the corresponding encapsulation—to the Cisco ACI Virtual Edge, or Microsoft Hyper-V Virtual Switch.

Note that this action does not change the original port-group assignment for the VM in vCenter/SCVMM.

For VMware VDS, the physical leaf switch does not push the microsegmented EPG. The leaf switch performs the attribute-based microsegmentation.

Packet Forwarding for Cisco ACI Virtual Edge or Microsoft Hyper-V Virtual Switch

1. When the VM sends the data packets, Cisco ACI Virtual Edge or Microsoft Hyper-V Virtual Switch tags the packets using encapsulation corresponding to the uSeg EPG, not the application EPG.
2. The physical leaf hardware sees an attribute-based encapsulated VM packet and matches it with the configured policy.

The VM is dynamically assigned to an uSeg EPG, and the packet is forwarded based on the policy defined for that particular uSeg EPG.

Packet Forwarding for VMware VDS

When you enable Microsegmentation with Cisco ACI, Cisco APIC allocates a pair of VLANs (PVLANS) and configures a PVLAN portgroup on VMware vCenter. Doing so forces traffic to go to the leaf switch even if two VMs in the same portgroup try to talk to each other.

You must configure a PVLAN on blade switches of ESXi servers are not directly connected to leaf switches.



Note If you configure Microsegmentation with Cisco ACI for EPGs associated with VMware VDS VMM domains, you may experience brief traffic disruption.

Attributes for Microsegmentation with Cisco ACI

Applying attributes to uSeg EPGs enables you to apply forwarding and security policies with greater granularity than you can apply policies to EPGs without attributes. Attributes are unique within the tenant.

There are two types of attributes that you can apply to uSeg EPGs: network-based attributes and VM-based attributes.

Network-Based Attributes

The network-based attributes are IP (IP address filter) and MAC (MAC Address Filter). You can apply one or more MAC or IP addresses to a uSeg EPG. Both IPv4 and IPv6 addresses are supported.

For IP addresses, you simply specify the address or the subnet; for MAC addresses, you simply specify the address.



Note If you want to use a network-based attribute and classify IP addresses in the same subnet, you must use the MAC-based network attribute. IP-based microsegmented EPGs do not support classification for IP addresses in the same subnet. IP-based microsegmented EPGs are supported only when traffic requires Layer 3 routing. If the traffic is bridged, the microsegmentation policy cannot be enforced.

VM-Based Attributes

You can apply multiple VM-based attributes to VMware VDS, or Cisco ACI Virtual Edge uSeg EPGs. The VM-based attributes are VMM Domain, Operating System, Hypervisor Identifier, Datacenter, VM Identifier, VM Name, VNic Dn (vNIC domain name), Custom Attribute, and Tag.



Note The attribute Datacenter corresponds to Cloud for Microsoft Hyper-V Virtual Switch.



Note The attribute VM Folder also appears in the GUI. This feature is for beta testing only, and should not be deployed in production environments.

When you create any VM-based attribute, in addition to naming the attribute, you must do the following:

1. Specify the attribute type, such as **VM Name** or **Hypervisor Identifier**.
2. Specify the operator, such as **Equals**, or **Starts With**.
3. Specify the value, such as a particular vNIC or name of the operating system.

Custom Attribute and Tag Attribute

The Custom Attribute and the Tag attribute allow you to define attributes based on criteria that are not used in other attributes. For example, you might want to define a Custom Attribute called "Security Zone" in VMware vCenter and then associate this attribute to one or more VMs with such values as "DMZ" or "Edge." The APIC administrator can then create an uSeg EPG based on that VM Custom Attribute.

The Custom Attribute and the Tag attribute appear in the APIC GUI as VM attributes:

- Custom Attribute
 - Available for Cisco ACI Virtual Edge and VMware VDS as a VM attribute configured in VMware vCenter
 - Available for Microsoft Hyper-V Virtual Switch as a Custom Property configured in Microsoft SCVMM
- Tag Attribute: Available for Cisco ACI Virtual Edge and VMware VDS only

If you want to use a Custom Attribute or a Tag attribute for Cisco ACI Virtual Edge or VMware VDS, must also add it in VMware vSphere Web Client. If you want to use a Custom Attribute for Microsoft Hyper-V Virtual Switch, you must also add it as a Custom Property in Microsoft SCVMM. We recommend doing so before configuring the uSeg EPG. That allows you to choose the Custom Attribute or Tag attribute in the drop-down list while configuring microsegmentation policy in Cisco APIC.

You can add the Custom Attribute or Tag attribute in vSphere Web Client or SCVMM after you configure the uSeg EPG in Cisco APIC. However, if you do so, you do not see the Custom Attribute or Tag attribute in the drop-down list in Cisco APIC, although you can type the name of the Custom Attribute or Tag attribute in the text box.

See VMware vSphere ESXi and VMware vCenter Server documentation for instructions for adding a Custom Attribute or Tag attribute in vSphere Web Client. See Microsoft documentation for instructions for adding a Custom Attribute in SCVMM.

Although similar to the Custom Attribute, the Tag attribute differs from in it several ways:

- The Tag attribute can be applied to any object in VMware vCenter, such as a host or data center; the Custom Attribute can be applied only to VMs and ESXi hosts. However, only the Tag attribute for VMs is relevant to microsegmentation.
- The Tag attribute does not have a name and value like the Custom Attribute. Tags are simply labels that get applied or not to objects.
- To configure a Custom Attribute, you provide details about the controller and VM as well as an operator and a value. To configure the Tag attribute, you provide the attribute type, category, operator, and tag name.

**Note**

- The Tag attribute can be defined for a microsegmented EPG only when the VMware vCenter is running vSphere 6.0 or later.
- To enable Microsegmentation with Cisco ACI using the Tag attribute, enable the VMware vCenter tag collection on Cisco APIC. You do this with a REST API call for each VMM domain, as shown in the following example:

```
https://APIC-IPA/api/node/mo.xml
Body:
<polUni>
<vmmProvP vendor="VMware">
  <vmmDomP name="Domain-Name" enableTag="yes">
  </vmmDomP>
</vmmProvP>
</polUni>
```

Ensure that the domain name is correct.

Uniqueness of Attributes Within a Tenant

Attributes must be unique within a tenant. Uniqueness depends on the value of the attribute.

For example, for a network-based attribute, you can use the attribute IP Address Filter multiple times within a tenant. You can do so provided that the attribute has a different value for the IP address each time it is used. So you cannot use the IP Address Filter attribute with the address 192.168.33.77 more than once; however, you can use the IP Address Filter attribute a second time, provided that the IP address is different, for example 192.168.33.78.

Methods of Filtering VMs for uSeg EPGs

You can configure uSeg EPGs with multiple attributes. However, VMs can become part of only one uSeg EPG. When a VM has attributes matching more than one uSeg EPG in the tenant, Cisco APIC puts the VM into a uSeg EPG based on filtering rules.

Depending on how you define the attributes, you can use different filtering rules:

- **Matching any attribute**—You can match any attribute, and Cisco APIC follows a the default precedence among attributes in deciding which uSeg EPG that a VM will join.

For more information, see the section [VM Filtering when Matching Any Attribute, on page 71](#) in this guide.

- **Matching all attributes**—You can match all of the VM-based attributes defined for the uSeg EPG. You cannot match all for multiple network-based attributes.

For more information, see the section [VM Filtering when Matching All Attributes, on page 73](#) in this guide.

- **Using simple or block statements**—You can create multiple statements to filter for multiple attributes, or you can create block, or nested, statements to create precise filtering rules.

For more information, see the section [VM Filtering when Using Simple or Block Statements, on page 73](#) in this guide.

- **Overriding existing rules**—When you create a uSeg EPG, you can set its precedence, overriding other rules. You can set the precedence when you match any attribute or match all attributes. You need to set match precedence to break ties across EPGs in the tenant. You can match all attributes and not set match precedence; however, in such cases, if you have multiple uSeg EPGs with similar attributes, the VM can get matched to any of the uSeg EPGs arbitrarily.

For more information, see the section [VM Filtering when Using EPG Match Precedence, on page 74](#) in this guide.

VM Filtering when Matching Any Attribute

Matching any attribute defined for a uSeg EPG is the default.

If you have multiple attributes and match any, Cisco APIC filters for VMs matching any of the attributes and—if VMs match other EPGs in the tenant—puts them into uSeg EPG based on the precedence of attributes.

How Rules for Attribute Precedence are Applied

The following table lists the attributes that can be specified for an uSeg EPG:

Attribute	Type	Precedence Order	Example
MAC	Network	1- Cisco ACI Virtual Edge/Microsoft Hyper-V Virtual Switch 2- VMware VDS	5c:01:23:ab:cd:ef
IP	Network	1- VMware VDS 2- Cisco ACI Virtual Edge/Microsoft Hyper-V Virtual Switch	192.168.33.77 10.1.0.0/16
VNic Dn (vNIC domain name)	VM	3	a1:23:45:67:89:0b
VM Identifier	VM	4	VM-598
VM Name	VM	5	HR_VDI_VM1
Hypervisor Identifier	VM	6	host-25
VMM Domain	VM	7	AVE-SJC-DC1

Attribute	Type	Precedence Order	Example
Datacenter	VM	8	SJC-DC1
Custom Attribute	VM	9	SG_DMZ
Operating System	VM	10	Windows 2008
Tag (Cisco ACI Virtual Edge and VMware VDS only)	VM	11	Linux
VM Folder (Cisco ACI Virtual Edge and VMware VDS only) Note The VM Folder attribute is for beta testing only, and should not be deployed in production environments. Contact Cisco for information about this feature.	VM	12	VM_Folder_1



Note Precedence of MAC-based and IP-based attributes differ for VMware VDS and Cisco ACI Virtual Edge and Microsoft Hyper-V Virtual Switch.

Examples of how Rules for Precedence are Applied

You might have four uSeg EPGs containing attributes that match the same VM, and each uSeg EPG has a different network or VM attribute: Operating System, Hypervisor Identifier, IP; and another has MAC.

Rules for Microsoft Hyper-V Virtual Switch are applied in this order: MAC, IP, Hypervisor Identifier, and Operating System. The rule is applied to MAC, and the subsequent rules are skipped. However, if the uSeg EPG with the MAC attribute is deleted, the rule is applied to IP Address Filter, and the subsequent rules are skipped—and so on with the other attributes.

Rules for VMware VDS are applied in this order: IP Address Filter, MAC Address Filter, Hypervisor Identifier, and Operating System. The rule is applied to IP, and the subsequent rules are skipped. However, if the uSeg EPG with the IP attribute is deleted, the rule is applied to MAC and the subsequent rules are skipped—and so on with the other attributes.

In another case, you might have uSeg EPGs containing the same VM, and each uSeg EPG has a different VM attribute: VMM Domain, Datacenter, Custom Attribute, and VNic Dn. The rule is applied to VNic Dn, and the subsequent rules as skipped. However, if the uSeg EPG with the VNic Dn attribute is deleted, the rule is applied to VMM Domain, and the subsequent rules are skipped—and so on with the other attributes.

VM Filtering when Matching All Attributes

You can filter by matching all VM-based attributes defined for a uSeg EPG. You do so by choosing **Match All** from a drop-down list in the APIC GUI or specify matching in the NX-OS CLI or REST API.

If you match all attributes, Cisco APIC does not put any VM into the uSeg EPG unless it matches all the attributes defined for the uSeg EPG.

For example, you have a uSeg EPG with the following attributes: Hypervisor Identifier where the hypervisor is host-25, VM Name that contains "vm," and Operating System of Linux. Cisco APIC puts into the uSeg EPG only those VMs that have the hypervisor host-25, a VM Name containing "vm," and have the operating system Linux. It would not put into the uSeg EPG a VM that matches the first two attributes but has the operating system Microsoft.



Note Matching all attributes is supported for VM-based attributes only. You cannot choose Match All for network-based attributes.

If you want to match all VM-based attributes, you might want to set the EPG match precedence when you create the uSeg EPG. Doing so allows you to decide which uSeg EPG should override other uSeg EPGs. However, you can set EPG match precedence whether you match any attribute or all attributes. For more information, see the section [VM Filtering when Using EPG Match Precedence](#), on page 74 in this guide.



Note If you use Microsoft Hyper-V Virtual Switch and want to downgrade to APIC Release 2.3(1) from a later release, you first need to delete any uSegs configured with the Match All filter. The Match All filter is supported for Microsoft beginning with APIC Release 3.0(1).

VM Filtering when Using Simple or Block Statements

When you define attributes for a uSeg EPG, you can define multiple attributes in simple statements or in block statements. You can combine simple and block statements to create complex filters for attributes.

Simple statements contain a single attribute. You can have as many simple statements as you want for each uSeg EPG. You can match any of the attributes or all of the attributes.

Block statements contain multiple attributes at different levels in a hierarchy. You can have only two sublevels within a block statement. You can match any of the attributes or all of the attributes for each level of the block statement.



Note You cannot put network-based attributes into sublevels of block statements. However, you can create sublevels for network-based attributes if the network-based attribute is at the top level of a block statement.

When you have block statements, Cisco APIC first filters for attributes defined on the top level. It then filters on the next-highest level, and then the next-highest level.

You can create simple and block statements in the APIC GUI, the NX-OS CLI, and the REST API.

Example of Using Block Statements

You want to put some VMs into a uSeg EPG so you can update Linux on them. The VMs are within a single data center, but you want to limit the update to VMs within two VMM domains. You can use block statements to set up filtering for those VMs.

Because you are filtering for VMs that run Linux and are in a single data center, you create two simple statements: one for the Operating System attribute with the value Linux and one for the attribute Datacenter with the value of datacenter3. For these statements you choose Match All because you want to capture all VMs in the tenant that run Linux and belong to datacenter 3.

However, among VMs that run Linux and belong to datacenter3, you now want to capture VMs that belong only to the VMM domains mininet2 or mininet4. You create a block statement as a sublevel of the two simple statements. The blocks statement contains two attributes: one for the attribute VMM domain with the value of mininet 2 and one for the attribute VMM domain with the value of mininet 4. You choose match any for the block statement because you want to capture VMs that are in either VMM domain.

Once you define the attributes, Cisco APIC first filters for VMs that run Linux and also are in datacenter3. It then searches among those VMs for the ones that belong to either mininet2 or mininet4.

VM Filtering when Using EPG Match Precedence

EPG Match Precedence enables you to override default precedence rules for uSeg EPGs when filtering for VM-based attributes. You configure it when you create the uSeg EPG in the GUI, NX-OS CLI, or REST API.

EPG Match Precedence is optional when matching any attribute or matching all attributes. However, when you match all attributes—filtering on multiple attributes—setting precedence enables Cisco APIC to break ties between uSeg EPGs.



Note You cannot use EPG Match Precedence when filtering network-based attributes. If you try to do so, you see an error message.

When you configure EPG Match Precedence, you give the uSeg EPG an integer value; the higher the number the higher the precedence. You can have nearly 4.3 billion (2^{32}) levels of precedence. The default is 0, which does not set any precedence.

For example, you might have two uSeg EPGs, each with only one attribute. One has the attribute VM Name, and the other has Operating System. A VM might match both uSeg EPGs. By default, Cisco APIC would assign the VM to the uSeg EPG with the VM Name attribute because that attribute has higher precedence than the attribute Operating System.

However, if you give the uSeg EPG with the attribute Operating System a precedence of 10 and give the uSeg EPG with the attribute VM Name a precedence of 7, Cisco APIC will give the VM matching both uSeg EPGs to the uSeg EPG with the Operating System attribute.

Precedence of Operators

In addition to applying filtering rules based on attributes of uSeg EPGs within a tenant, Cisco APIC applies filtering rules within VM-based attributes based on the operator type.

When you configure a microsegment with a VM-based attribute, you select one of four operators: Contains, Ends With, Equals, or Starts With. Each operators specifies the string or value match for the specific attribute.

For example, you might want to create a microsegment with the VM Name attribute and want to filter for VMs with names that start with "HR_VM" or VMs that contain "HR" anywhere in their name. Or you might want to configure a microsegment for a specific VM and filter for the name "HR_VM_01."

How Rules for Operator Precedence are Applied

The operators for a specific VM attribute within a tenant determine the order in which the VM-based attributes for microsegments are applied. They also determine which operator will have precedence among a group of microsegments that share the same attribute and overlapping values. The table below shows the default operator precedence for Cisco ACI Virtual Edge and Microsoft Hyper-V Virtual Switch:

Operator Type	Precedence Order
Equals	1
Contains	2
Starts With	3
Ends With	4

Examples of how Rules for Precedence are Applied

You have three Human Resources VM machines in a datacenter cluster under the same tenant: VM_01_HR_DEV, VM_01_HR_TEST, and VM_01_HR_PROD. You have created two microsegmented EPGs based on the VM Name attribute:

Criterion	Microsegment CONTAIN-HR	Microsegment HR-VM-01-PROD
Attribute type	VM Name	VM Name
Operator type	Contains	Equals
Value	VM_01_HR	VM_01_HR_PROD

Because the operator type Equals has precedence over the operator type Contains, the value VM_01_HR_PROD is matched before the value VM_01_HR. So the VM named VM_01_HR_PROD will be put into microsegment HR-VM-01-PROD because it is an exact criterion match and because the operator Equals has precedence over the operator Contains, even though the VM name matches both microsegments. The other two VMs will be put in the Microsegment CONTAIN-HR.

Scenarios for Using Microsegmentation with Cisco ACI

This section contains examples of circumstances in which you might find Microsegmentation useful in your network.

Using Microsegmentation with Cisco ACI with VMs Within a Single Application EPG

You can use Microsegmentation with Cisco ACI to create new, uSeg EPGs to contain VMs from a single application EPG. By default, VMs within an application EPG can communicate with each other; however, you might want to prevent communication between groups of VMs, if VRF is in enforced mode and there is no contract between uSeg EPGs.

For more information about Intra-EPG Isolation knob, that controls communication between VMs within the EPG, see [Intra-EPG Isolation for VMware VDS or Microsoft Hyper-V Virtual Switch, on page 85](#).

Example: Putting VMs from the Same Application EPG into a Microsegmented EPG

Your company deploys a virtual desktop infrastructure (VDI) for its Human Resources, Finance, and Operations departments. The VDI virtual desktop VMs are part of a single application EPG called EPG_VDI with identical access requirements to the rest of the application EPGs.

Service contracts are built in such a way such that the EPG-VDI has access to Internet resources and internal resources. But at the same time, the company must ensure that each of the VM groups—Human Resources, Finance, and Operations—cannot access the others even though they belong to the same application EPG, EPG_VDI.

To meet this requirement, you can create filters in the Cisco APIC that would check the names of the VMs in the application EPG, EPG_VDI. If you create a filter with the value "HR_VM," Cisco APIC creates a uSeg EPG—a microsegment—for all Human Resource VMs. Cisco APIC looks for matching values in all the EPGs in a tenant even though you want to group the matching VMs within one EPG. So when you create VMs, we recommend that you choose names unique within the tenant.

Similarly, you can create filters with the keyword "FIN_VMs" for Finance virtual desktops and "OPS_VMs" for Operations virtual desktops. These uSeg EPGs are represented as new EPGs within the Cisco APIC policy model. You can then apply contracts and filters to control access between the VM groups even though they belong to the same application EPG.

Figure 5: Microsegmentation with Cisco ACI with VMs from a Single Application EPG

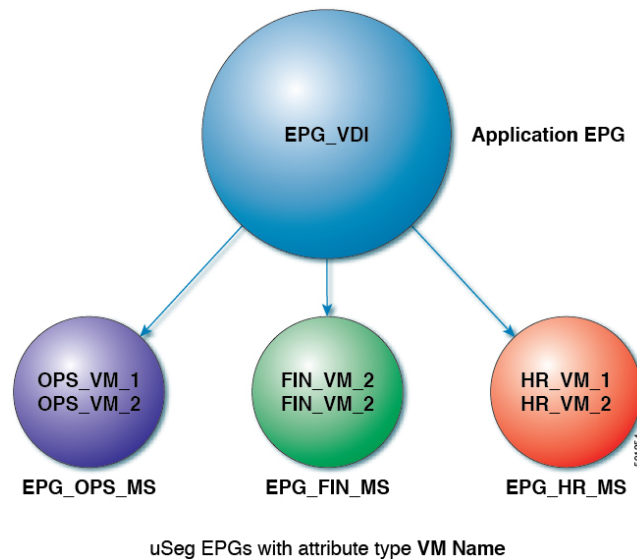

In the illustration above, all the virtual desktop VMs from the Human Resources, Finance, and Operations groups have been moved from the application EPG, EPG_VDI, to new, uSeg EPGs: EPG_OPS_MS, EP_FIN_MS, and EPG_HR_MS. Each uSeg EPG has the attribute type VM Name with a value to match key parts of the VM's name. EPG_OPS_MS has the value OPS_VM, so all VMs in the tenant containing OPS_VM in their names become part of EPG_OPS_MS. The other uSeg EPGs have corresponding values, resulting in the movement of VMs in the tenant with matching names to the uSeg EPGs.

Using Microsegmentation with Cisco ACI with VMs in Different Application EPGs

You can configure Microsegmentation with Cisco ACI to put VMs that belong to different application EPGs into a new uSeg EPG. You might want to do this to apply policy to VMs that share a certain characteristic although they belong to different application EPGs.

Example: Putting VMs in Different Application EPGs into a New uSeg EPG

Your company deploys a three-tier web application. The application is built on VMs that run different operating systems and different versions of the same operating system. For example, the VMs might run Linux, Windows 2008, and Windows 2008 R2. The application is distributed; the company has divided the VMs into three different EPGs: EPG_Web, EPG_App, and EPG_DB.

Because of a recent vulnerability in the Windows 2008 operating system, your company's security team decided to quarantine VMs running Windows 2008 in case those VMs are compromised. The security team also decided to upgrade all Windows 2008 VMs to Windows 2012. It also wants to microsegment all production VMs across all EPGs and restrict external connectivity to those VMs.

To meet this requirement, you can configure a uSeg EPG in the Cisco APIC. The attribute would be Operating System, and the value of the attribute would be Windows 2008.

You can now quarantine the VMs running Windows 2008 and upgrade them to Windows 2012. Once the upgrade is complete, the VMs will no longer be part of the uSeg EPG you created for VMs running Windows 2008. This change will be reflected dynamically to Cisco APIC, and those virtual machines revert to their original EPGs.

Figure 6: Microsegmentation with Cisco ACI in Different Application EPGs

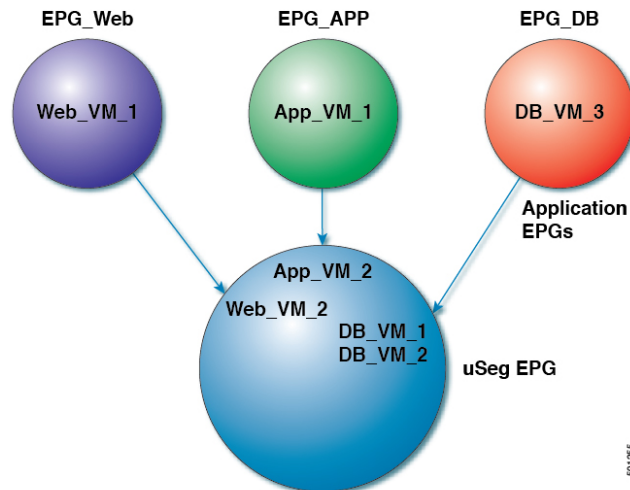

EPG Windows with attribute type Operating System and value Windows

In the illustration above, the new uSeg EPG EPG_Windows has the attribute type Operating System and the value Windows. The VMs App_VM_2, DB_VM_1, DB_VM_2, and Web_VM_2, run Windows as their operating system—and so have been moved to the new uSeg EPG EPG_Windows. However, the VMs App_VM_1, DB_VM_3, and Web_VM_1 run Linux and so remain in their application EPGs.

Using Microsegmentation with Network-based Attributes

You can use Cisco APIC to configure Microsegmentation with Cisco ACI to create a new, uSeg EPG using a network-based attribute, a MAC address or one or more IP addresses. You can configure Microsegmentation with Cisco ACI using network-based attributes to isolate VMs within a single application EPG or VMs in different EPGs.

Using an IP-based Attribute

You can use an IP-based filter to isolate a single IP address, a subnet, or multiple of noncontiguous IP addresses. Isolating multiple IP addresses in a single microsegment can be more convenient than specifying VMs by name. You might want to isolate VMs based on IP addresses as a quick and simple way to create a security zone, similar to using a firewall.

Using a MAC-based Attribute

You can use a MAC-based filter to isolate a single MAC address or multiple MAC addresses. You might want to do this if you have a server sending bad traffic in the network; by creating a microsegment with a MAC-based filter, you can isolate the server.

Configuring Microsegmentation with Cisco ACI

The following sections contain instructions for configuring Microsegmentation with Cisco ACI Virtual Edge, VMware VDS, or Microsoft Hyper-V Virtual Switch using the Cisco APIC GUI and NX-OS style CLI. You can adapt the procedures for your network's specific needs.



Note If VXLAN load balancing is enabled in the VMware vCenter domain profile, Microsegmentation with Cisco ACI is not supported on the domain.

Prerequisites for Configuring Microsegmentation with Cisco ACI

Before you can configure Microsegmentation with Cisco ACI for Cisco ACI Virtual Edge, VMware VDS or Microsoft Hyper-V Virtual Switch, you need to fulfill the following prerequisites:

- Ensure you meet the microsegmentation hardware requirements. Cisco Nexus 9000 series switches are supported; however, Nexus 9000 series switches without a product ID suffix or with a suffix earlier than -EX are not supported.
- You must already have VMs with names that can be used with the filters that you will use when creating the uSeg EPGs.

If you do not have VMs with names that can be used, you can go ahead and create the uSeg EPGs and then change the VM names that can be used with the filters. Cisco APIC will automatically make the VMs part of the new uSeg EPGs.

- You must already have an application EPG.
- The corresponding bridge domain must have an IP subnet defined. Otherwise, the VMs will not be able to communicate.
- You must have chosen your own attributes, names, and values.

Attributes, names, and values used in the preceding scenarios were provided as examples.

- You must create a contract before creating a microsegment with one or more attributes if you want to associate the EPG with a contract.
- If you have Cisco ACI Virtual Edge or VMware VDS and want to use a VM Custom Attribute, you also need to add it in VMware vSphere Web Client. If you have Microsoft Hyper-V Virtual Switch and want to use a VM Custom Attribute, you also need to add it in Microsoft SCVMM.

We recommend adding the Custom Attribute in VMware vSphere Web Client or in Microsoft SCVMM before configuring Microsegmentation in Cisco APIC. This enables you to choose the Custom Attribute in the drop-down list while configuring the microsegment in the Cisco APIC GUI.

See VMware vSphere ESXi and vCenter Server documentation for instructions for adding a Custom Attribute in vSphere Web Client. See Microsoft documentation for instructions for adding a Custom Attribute in SCVMM.

- For Microsoft Hyper-V Virtual Switch based microsegmentation, one of the following is required:
 - SCVMM 2012 R2 Build 3.2.8145.0 or newer
 - SCVMM 2016 Build 4.0.1662.0 or newer

These builds include a feature called "Enable Dynamic VLAN on the vNIC of a virtual machine," which will be automatically enabled by the Cisco SCVMM Agent to allow live migration of virtual machines that use Microsegmentation with ACI. For more information, see Microsoft's documentation: <https://support.microsoft.com>.

- If you have VMware VDS or a bare-metal server, make sure to set the VRF policy-enforcement direction to "ingress." Otherwise, there will be a fault.
- If you have VMware VDS, make sure the PVLANS are set up on the blade switch. Also make sure that static VLANs are deployed so that VLAN usage is consistent.

Workflow for Configuring Microsegmentation with Cisco ACI

This section provides a high-level description of the tasks that you need to perform in order to configure Microsegmentation with Cisco ACI.

1	Create the uSeg EPG: Specify a name and bridge domain for the new uSeg EPG and choose a network-based or VM-based attribute for the EPG. Note For VMware VDS, you need to choose the same bridge domain for the new uSeg EPG that is used by the application EPG. Otherwise, the VDS uSeg will not match VM attributes or place the VM into the uSeg EPG.
2	Associate the new uSeg EPG with a VMM domain profile; you need to associate it with the same VMM domain profile used by the application EPG.
3	Configure attributes for the uSeg EPG.
4	Verify that the end points have moved from the application EPG to the uSeg EPG.

Follow the instructions for these steps in the [Configuring Microsegmentation with Cisco ACI, on page 78](#) section in this guide.

Configuring Microsegmentation with Cisco ACI Using the GUI

You can use Cisco APIC to configure Microsegmentation with Cisco ACI to put VMs that belong to different application EPGs or the same EPG into a new uSeg EPG. The task is essentially the same for Cisco ACI Virtual Edge, VMware VDS, and Microsoft Hyper-V Virtual Switch; the slight differences are noted in the procedure.

Procedure

-
- Step 1** Log into the Cisco APIC.
- Step 2** Choose **Tenants** and then choose the tenant where you want to create a microsegment.
- Step 3** In the tenant navigation pane, expand the tenant folder, the **Application Profiles** folder, and the *profile* folder.
- Step 4** Complete one of the following actions:
- If you are using Cisco ACI Virtual Edge or Microsoft Hyper-V Virtual Switch, skip the following substeps and continue with Step 5.
 - If you are using VMware VDS, complete the following substeps.
 - a) Expand the **Application EPGs** folder and the folder for the application EPG.
 - b) Right-click on the folder **Domains (VMs and Bare-Metals)**.
 - c) In the **Add VMM Domain Association** dialog box, after you choose the VMM domain, check the **Allow Micro-Segmentation** check box.

If you are using VMware VDS, you also must configure all the required parameters.
 - d) Click **Submit**.
- Step 5** In the tenant navigation pane, right-click the **uSeg EPGs** folder, and then choose **Create Useg EPG**.
- Step 6** In the **Create USeg EPG Step 1 > Identity** dialog box, complete the following steps to begin creation of an uSeg EPG for a group of VMs:
- a) In the **Name** field, enter a name.

We recommend that you choose a name that indicates that the new uSeg EPG is a microsegment.
 - b) In the intra-EPG isolation field, select **enforced** or **unenforced**.

If you select **enforced**, Cisco ACI prevents all communication between the endpoint devices within this uSeg EPG.
 - c) In the **Bridge Domain** area, choose a bridge domain from the drop-down list.

Note For VMware VDS, you must choose the same bridge domain that is used for the application EPG. Otherwise, the VDS uSeg will not match VM attributes and will not place the VM into a uSeg EPG.
 - d) (Optional) In the **Epg Match Precedence** field, choose an integer to set the precedence for the uSeg EPG among other VM-based attribute uSeg EPGs, overriding default rules.

The larger the integer, the higher the precedence.
 - e) Click **Next**.
- Step 7** In the **Create USeg EPG Step 2 > Domains**, complete the following steps to associate the uSeg EPG with a VMM domain.

- a) Click the + (plus) icon at the right of the dialog box.
- b) From the **Domain Profile** drop-down list, choose a profile.
If you have a Cisco ACI Virtual Edge or a VMware VDS, choose a VMware domain; if you have a Microsoft Hyper-V Virtual Switch, choose a Microsoft domain.
Note You must choose the same domain that is used by the application EPG.
- c) From the **Deploy Immediacy** drop-down list, accept the default **On Demand** if you have Cisco ACI Virtual Edge or Microsoft Hyper-V Virtual Switch; choose **Immediate** if you have VMware VDS.
- d) From the **Resolution Immediacy** drop-down list, accept the default **Immediate**.
- e) In the **Encap Mode** drop-down list, accept the default **Auto**.
- f) In the **Port Encap (or Secondary VLAN for Micro-Seg)** field, accept the default value if you are using VMware VDS; accept the default value if you are using Cisco ACI Virtual Edge or Microsoft Hyper-V Virtual Switch.
- g) If you have Cisco ACI Virtual Edge, from the **Switching Mode** drop-down list, choose a mode.
Choose **AVE** to switch the uSeg EPG through Cisco ACI Virtual Edge; choose **native** to switch the uSeg EPG through the VMware VDS.
- h) Click **Update** and then click **Finish**.

Step 8 In the navigation page for the tenant, open the folder for the uSeg EPG that you just created.

Step 9 Click the **uSeg Attributes** folder.

The uSeg Attributes work pane appears, where you configure attributes to filter for VMs that you want to put into the uSeg EPG.

Step 10 (Optional) If you will filter using VM-based attributes, in the **uSeg Attributes** work pane, from the match drop-down list, choose **Match Any** or **Match All**.

The match feature enables you to use multiple attributes to filter VMs for the uSeg EPG. The default is **Match Any**. The match all feature is supported for VM-based attributes only. See the sections "VM Filtering when Matching Any Attribute" and "VM Filtering when Matching All Attributes" in the microsegmentation chapter of the *Cisco ACI Virtualization Guide*.

Step 11 Click the + or the +(icon to add a filtering statement.

The + icon allows you to create a simple statement, one that creates a filter for a single attribute. You can add multiple simple statements to filter for multiple attributes. The +(icon allows you to create a block, or nested, statement, which allows you to set attributes in a hierarchy, which filters for the highest-level attribute first and then filters for lower-level attributes. See the section [VM Filtering when Using Simple or Block Statements](#), on page 73 in this guide for more information.

Step 12 Complete one of the following series of steps to configure the filter.

If you want to use...	Then...
An IP-based attribute	<ol style="list-style-type: none"> a. From the Select a type... drop-down list, choose IP. b. From the Use EPG Subnet? drop-down list, choose Yes or No. If you choose Yes, you will use a previously defined subnet as the IP attribute filter. If you choose No, enter the VM IP address or a subnet with the appropriate subnet mask in the field to the right of the Use EPG Subnet? drop-down list.

If you want to use...	Then...
	<p>c. (Optional) Create a second IP Address filter by repeating substeps a through c. You might want to create a second IP Address filter to include discontinuous IP addresses in the microsegment.</p> <p>d. Click Submit.</p>
A MAC-based attribute	<p>a. From the Select a type... drop-down list, choose MAC.</p> <p>b. In the right field, enter the MAC address of the VM.</p> <p>c. Click Submit.</p>
A VM-based Custom Attribute	<p>a. From the Select a type... drop-down list, choose VM - Custom Attribute.</p> <p>b. Click the search icon next to the field to the right of the Select a type... drop-down list.</p> <p>c. In the Select Custom Attribute dialog box, choose a controller from the Controller drop-down list.</p> <p>d. From the VM drop-down list, choose a VM.</p> <p>e. From the Attribute Name drop-down list, choose the name, and then click Select.</p> <p>f. From the operator drop-down list, choose an operator, and then enter a value in the field to the right of the drop-down list.</p> <p>g. Click Submit.</p>
A VM-based Tag attribute (Cisco ACI Virtual Edge and VMware VDS only)	<p>a. From the Select a type... drop-down list, choose VM - Tag.</p> <p>b. Click the magnifying glass icon next to the Category field, and in the Select VM Category dialog box, choose the category from the Category Name drop-down list, and then click Select.</p> <p>The category that you enter must be identical to the one assigned earlier for the tag in VMware vCenter.</p> <p>c. From the operator drop-down list, choose the appropriate operator.</p> <p>d. Click the magnifying glass icon next to the field on the right, and in the Select VM Tag dialog box, select a tag from the Tag Name drop-down list and then click Select.</p> <p>e. Click Submit.</p>
Any other VM-based Attribute	<p>a. From the Select a type... drop-down list, choose a VM attribute.</p> <p>b. From the operator drop-down list, choose the appropriate operator.</p> <p>c. Complete one of the following steps:</p> <ul style="list-style-type: none"> • If you chose the Datacenter VM-based attribute, enter the name of the data center in the field to the right of the operator drop-down list.

If you want to use...	Then...
	<ul style="list-style-type: none"> • If you chose any other VM-based attribute, click the search icon next to the field to the right of the operator drop-down list, choose appropriate values for the attribute in the Select VM Identifier dialog box, and then click Select. <p>d. Click Submit.</p>

Step 13 Click the + or the +(icon to add additional attributes for the uSeg EPG.

Step 14 Repeat Step 2 through Step 13 to create additional uSeg EPGs.

What to do next

Verify that the uSeg EPG was created correctly.

If you configured a VM-based attribute, complete the following steps:

1. In the Cisco APIC navigation pane, click the new microsegment.
2. In the work pane, click the **Operational** tab and then ensure that the **Client End-Points** tab is active.
3. In the work pane, verify that the VMs that you wanted to move from the application EPG appear as endpoints for the new uSeg EPG.

If you configured an IP- or MAC-based attribute, make sure that traffic is running on the VMs that you put into the new microsegments.



CHAPTER 7

Intra-EPG Isolation Enforcement and Cisco ACI

This chapter contains the following sections:

- [Intra-EPG Isolation for VMware VDS or Microsoft Hyper-V Virtual Switch, on page 85](#)

Intra-EPG Isolation for VMware VDS or Microsoft Hyper-V Virtual Switch

Intra-EPG Isolation is an option to prevent physical or virtual endpoint devices that are in the same base EPG or microsegmented (uSeg) EPG from communicating with each other. By default, endpoint devices included in the same EPG are allowed to communicate with one another. However, conditions exist in which total isolation of the endpoint devices from one another within an EPG is desirable. For example, you may want to enforce intra-EPG isolation if the endpoint VMs in the same EPG belong to multiple tenants, or to prevent the possible spread of a virus.

A Cisco Application Centric Infrastructure (ACI) virtual machine manager (VMM) domain creates an isolated PVLAN port group at the VMware VDS or Microsoft Hyper-V Virtual Switch for each EPG that has intra-EPG isolation enabled. A fabric administrator specifies primary encapsulation or the fabric dynamically specifies primary encapsulation at the time of EPG-to-VMM domain association. When the fabric administrator selects the VLAN-pri and VLAN-sec values statically, the VMM domain validates that the VLAN-pri and VLAN-sec are part of a static block in the domain pool.

Primary encapsulation is defined per EPG VLAN. In order to use primary encapsulation for Intra-EPG isolation, you must deploy it in one of the following ways:

- Segregate primary and secondary VLAN defined ports on different switches. EPG VLAN is created per switch. If you have port encapsulation, and only static ports on a switch for an EPG, primary encapsulation is not associated.
- Use a different encapsulation for static ports that use only port encapsulation. This creates a second EPG VLAN that does not have primary encapsulation associated with it.

In the example below, consider egress traffic on two interfaces (Eth1/1, Eth1/3) with primary VLAN-1103. Eth1/1 port encap was changed to VLAN-1132 (from VLAN-1130), so that it does not share the secondary VLAN with Eth1/3.

```
Port encap with VLAN-1130 on Eth1/1
Eth1/1: Port Encap only VLAN-1130
Eth1/6: Primary VLAN-1103 and Secondary VLAN-1130
```

```
fab2-leaf3# show vlan id 53 ext
```

VLAN Name	Encap	Ports
53 JT:jt-ap:EPG1-1	vlan-1130	Eth1/1, Eth1/3

```
module-1# show sys int eltmc info vlan access_encap_vlan 1130
  vlan_id:          53  :::      isEpg:             1
  bd_vlan_id:       52  :::      hwEpgId:          11278
  srcpolicyincom:   0   :::      data_mode:        0
  accencaptype:     0   :::      fabencaptype:     2
  accencapval:      1130 :::      fabencapval:      12192
  sclass:           49154 :::      sglabel:          12
  sclassprio:       1   :::      floodmetptr:      13
  maclearnen:       1   :::      iplernen:         1
  sclasslrnen:      1   :::      bypselfwdchk:     0
  qosusetc:         0   :::      qosuseexp:        0
  isolated:         1   :::      primary_encap:  1103
  proxy_arp:        0   :::      qinq_core:        0
  ivxlan_dl:        0   :::      dtag_mode:        0
  is_service_epg:   0
```

Port encap changed to VLAN-1132 on Eth1/1

```
fab2-leaf3# show vlan id 62 ext
```

VLAN Name	Encap	Ports
62 JT:jt-ap:EPG1-1	vlan-1132	Eth1/1

```
module-1# show sys int eltmc info vlan access_encap_vlan 1132
[SDK Info]:
  vlan_id:          62  :::      isEpg:             1
  bd_vlan_id:       52  :::      hwEpgId:          11289
  srcpolicyincom:   0   :::      data_mode:        0
  accencaptype:     0   :::      fabencaptype:     2
  accencapval:      1132 :::      fabencapval:      11224
  sclass:           49154 :::      sglabel:          12
  sclassprio:       1   :::      floodmetptr:      13
  maclearnen:       1   :::      iplernen:         1
  sclasslrnen:      1   :::      bypselfwdchk:     0
  qosusetc:         0   :::      qosuseexp:        0
  isolated:         1   :::      primary_encap:  0
  proxy_arp:        0   :::      qinq_core:        0
  ivxlan_dl:        0   :::      dtag_mode:        0
  is_service_epg:   0
```

```
fab2-leaf3# show vlan id 53 ext
```

VLAN Name	Encap	Ports
53 JT:jt-ap:EPG1-1	vlan-1130	Eth1/3

```
module-1# show sys int eltmc info vlan access_encap_vlan 1130
[SDK Info]:
  vlan_id:          53  :::      isEpg:             1
  bd_vlan_id:       52  :::      hwEpgId:          11278
  srcpolicyincom:   0   :::      data_mode:        0
  accencaptype:     0   :::      fabencaptype:     2
  accencapval:      1130 :::      fabencapval:      12192
  sclass:           49154 :::      sglabel:          12
  sclassprio:       1   :::      floodmetptr:      13
  maclearnen:       1   :::      iplernen:         1
```

```

sclasslrnen:          1   :::   bypselffwdchk:          0
qosusetc:             0   :::   qosuseexp:             0
isolated:             1   :::   primary_encap:       1103
proxy_arp:            0   :::   qinq_core:             0
ivxlan_dl:            0   :::   dtag_mode:             0

```

**Note**

- When intra-EPG isolation is not enforced, the VLAN-pri value is ignored even if it is specified in the configuration.
- A VMware distributed virtual switch (DVS) domain with EDM UCSM integration may fail. The domain fails if you configure intra-EPG isolation on the endpoint group (EPG) attached to the domain and you use UCSM Mini 6324, which does not support private VLANs.

BPDUs are not forwarded through EPGs with intra-EPG isolation enabled. Therefore, when you connect an external Layer 2 network that runs spanning tree in a VLAN that maps to an isolated EPG on Cisco ACI, Cisco ACI might prevent spanning tree in the external network from detecting a Layer 2 loop. You can avoid this issue by ensuring that there is only a single logical link between Cisco ACI and the external network in these VLANs.

VLAN-pri/VLAN-sec pairs for the VMware VDS or Microsoft Hyper-V Virtual Switch are selected per VMM domain during the EPG-to-domain association. The port group created for the intra-EPG isolation EPGs uses the VLAN-sec tagged with type set to `PVLAN`. The VMware VDS or the Microsoft Hyper-V Virtual Switch and fabric swap the VLAN-pri/VLAN-sec encapsulation:

- Communication from the Cisco ACI fabric to the VMware VDS or Microsoft Hyper-V Virtual Switch uses VLAN-pri.
- Communication from the VMware VDS or Microsoft Hyper-V Virtual Switch to the Cisco ACI fabric uses VLAN-sec.

Figure 7: Intra-EPG Isolation for VMware VDS or Microsoft Hyper-V Virtual Switch

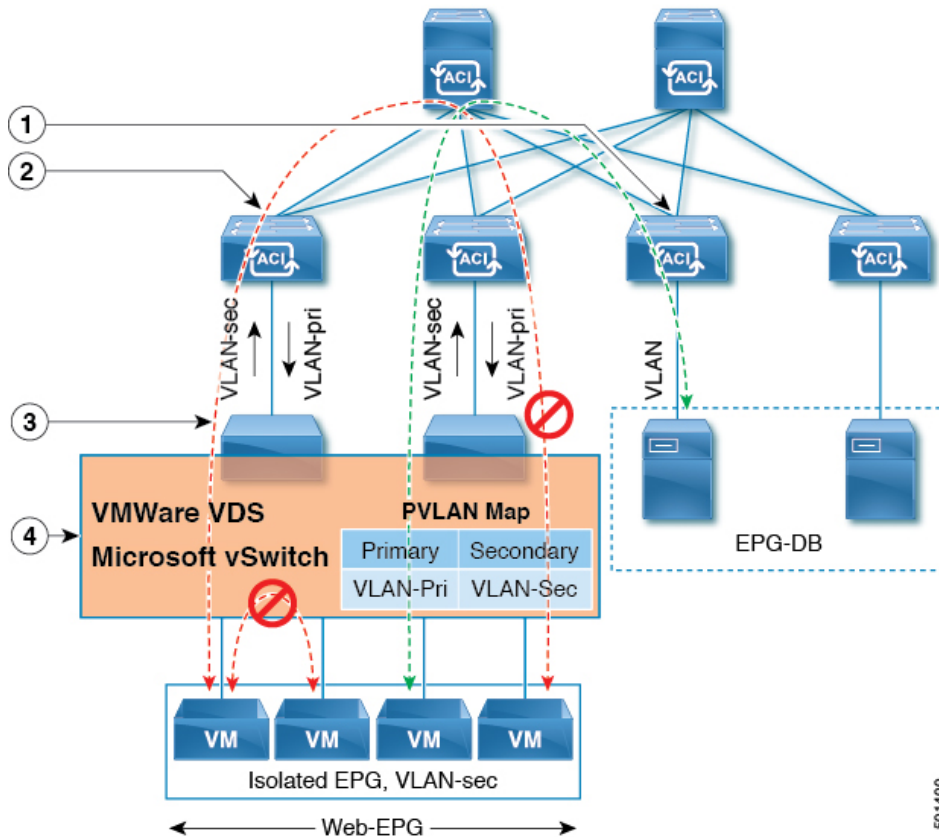

501400

Note these details regarding this illustration:

1. EPG-DB sends VLAN traffic to the Cisco ACI leaf switch. The Cisco ACI egress leaf switch encapsulates traffic with a primary VLAN (PVLAN) tag and forwards it to the Web-EPG endpoint.
2. The VMware VDS or Microsoft Hyper-V Virtual Switch sends traffic to the Cisco ACI leaf switch using VLAN-sec. The Cisco ACI leaf switch drops all intra-EPG traffic because isolation is enforced for all intra VLAN-sec traffic within the Web-EPG.
3. The VMware VDS or Microsoft Hyper-V Virtual Switch VLAN-sec uplink to the Cisco ACI leaf switch is in isolated trunk mode. The Cisco ACI leaf switch uses VLAN-pri for downlink traffic to the VMware VDS or Microsoft Hyper-V Virtual Switch.
4. The PVLAN map is configured in the VMware VDS or Microsoft Hyper-V Virtual Switch and Cisco ACI leaf switches. VM traffic from WEB-EPG is encapsulated in VLAN-sec. The VMware VDS or Microsoft Hyper-V Virtual Switch denies local intra-WEB EPG VM traffic according to the PVLAN tag. All intra-ESXi host or Microsoft Hyper-V host VM traffic is sent to the Cisco ACI leaf switch using VLAN-Sec.

Related Content

For information on configuring intra-EPG isolation in a Cisco ACI Virtual Edge environment, see the chapter "Intra-EPG Isolation Enforcement for Cisco ACI Virtual Edge" in the [Cisco ACI Virtual Edge Configuration Guide](#).

Configuring Intra-EPG Isolation for VMware VDS or Microsoft Hyper-V Virtual Switch using the GUI

Procedure

- Step 1** Log into Cisco APIC.
- Step 2** Choose **Tenants** > *tenant*.
- Step 3** In the left navigation pane expand the **Application Profiles** folder and appropriate application profile.
- Step 4** Right-click the **Application EPGs** folder and then choose **Create Application EPG**.
- Step 5** In the **Create Application EPG** dialog box, complete the following steps:
- In the **Name** field, add the EPG name.
 - In the **Intra EPG Isolation** area, click **Enforced**.
 - In the **Bridge Domain** field, choose the bridge domain from the drop-down list.
 - Associate the EPG with a bare metal/physical domain interface or with a VM Domain.
 - For the VM Domain case, check the **Associate to VM Domain Profiles** check box.
 - For the bare metal case, check the **Statically Link with Leaves/Paths** check box.
 - Click **Next**.
 - In the **Associated VM Domain Profiles** area, click the + icon.
 - From the **Domain Profile** drop-down list, choose the desired VMM domain.
- For the static case, in the **Port Encap (or Secondary VLAN for Micro-Seg)** field, specify the secondary VLAN, and in the **Primary VLAN for Micro-Seg** field, specify the primary VLAN. If the Encap fields are left blank, values will be allocated dynamically.
- Note** For the static case, a static VLAN must be available in the VLAN pool.
- Step 6** Click **Update** and click **Finish**.
-



CHAPTER 8

Cisco ACI with Cisco UCSM Integration

- [Automating Networking Policies for Cisco UCS Devices with Cisco ACI](#), on page 91
- [Cisco UCSM Integration Prerequisites](#), on page 92
- [Integrating Cisco UCSM into the Cisco ACI Fabric Using the Cisco APIC GUI](#), on page 93
- [Downgrading Cisco APIC with Cisco UCSM Integration](#), on page 97

Automating Networking Policies for Cisco UCS Devices with Cisco ACI

Beginning with Cisco Application Policy Infrastructure Controller (APIC) Release 4.1(1), you can automate networking policies on Cisco Unified Computing System (UCS) devices. To do so, you integrate Cisco UCS Manager (UCSM) into the Cisco Application Centric Infrastructure (ACI) fabric.

Cisco APIC takes hypervisor NIC information from the Cisco UCSM and a virtual machine manager (VMM) to automate VLAN programming. The automation applies to all the devices that the Cisco UCSM manages: Cisco UCS Fabric Interconnects and Cisco UCS B-Series Blade Chassis with UCS Blade Switches and Virtual Interface Card (VIC) Interfaces.

After you fulfill the prerequisites, you must perform two tasks in Cisco Application Policy Infrastructure Controller (APIC) to integrate Cisco UCSM into Cisco ACI:

- Create an integration group, which is the basis for your security domain.

Integration groups allow you to tie various types of integrations into the Cisco ACI fabric. Integration groups also allow a specific set of users to access the integrations with that group.

For example, you may have multiple pods in your fabric and have administrators who are assigned to different pods. You can create an integrations group for each pod and add the integrations that reside within specific pods. You can then assign the security domain to the group for the administrators who oversee the pod.

- Create an integration of the type **UCSM**, which allows the Cisco APIC to manage the networking portion of the Cisco UCSM.

You can perform these tasks in the Cisco APIC GUI under the **Integrations** tab, by using REST API, or the NX-OS style CLI.

You may also need to associate a switch manager with the virtual machine manager:

- If you use Cisco AVS or Microsoft SCVMM, you must associate a switch manager with the virtual machine manager.
- If you use Cisco ACI Virtual Edge or VMware vSphere Distributed Switch (VDS), you must associate a switch manager with the virtual machine if one of the following is true:
 - LLDP or CDP is not enabled in the VMM domain vSwitch policy.
 - The ESXi management port (vmknic) is bound to a portgroup managed by Cisco ACI.

Cisco APIC is used only to manage the networking component of Cisco UCS devices. The Cisco UCS data management engine (DME) performs its usual functions. These include managing the databases of all physical elements, the logical configuration data for profile, policies, pools, vNIC and vHBA templates, and networking-related configuration details. DME also monitors the health and state of components.



Note A VMware distributed virtual switch (DVS) domain with EDM UCSM integration may fail. The domain fails if you configure microsegmentation or enable intra-EPG isolation on the endpoint group (EPG) attached to the domain and you use UCSM Mini 6324, which does not support private VLANs.

The section assumes that you are familiar with Cisco UCS and Cisco UCSM. For more information, see the [Cisco UCS documentation](#) and [Cisco UCSM documentation](#) on Cisco.com.

Cisco UCSM Integration Prerequisites

Integrating Cisco Unified Computing System Manager (UCSM) with Cisco Application Centric Infrastructure (ACI) fabric has the following prerequisites:

- Cisco Application Policy Infrastructure Controller (APIC) Release 4.1(1) or later.
- Cisco UCS and Cisco UCSM properly installed and configured in your data center.
- Cisco UCSM 3.2 or later.
- UCSM vNIC templates that are configured as Updating Template type.
- Creation of a VMware VMM domain or a Microsoft System Center Virtual Machine Manager (SCVMM) domain.
- Installation of the Cisco External Switch app, which can be found in the [Cisco ACI App Center](#) on Cisco.com.

For information about these tasks, see the [Cisco APIC documentation](#) and the [Cisco UCSM documentation](#) on Cisco.com.

Integrating Cisco UCSM into the Cisco ACI Fabric Using the Cisco APIC GUI

This section contains instructions for integrating Cisco Unified Computing System Manager (UCSM) into the Cisco Application Centric Infrastructure (ACI) fabric using the Cisco Application Policy Infrastructure Controller (APIC) GUI.

Creating an Integration Group Using the Cisco APIC GUI

Integrating the Cisco Unified Computing System Manager (UCSM) into the Cisco Application Policy Infrastructure Controller (ACI) fabric requires an integration group. The integration group provides a consistent security domain for various integrations in the fabric.

When you create the integration group, you can optionally create a security domain or choose an existing one. A security domain enables you to restrict access to Cisco UCSM devices associated with the group.

You can create the group and configure a security domain in the Cisco APIC GUI.

Before you begin

You must have fulfilled the prerequisites that are listed in the section [Cisco UCSM Integration Prerequisites, on page 92](#) in this guide.

Procedure

-
- Step 1** Log in to Cisco APIC.
- Step 2** Go to **Integrations > Create Group**.
- Step 3** In the **Create Integration Group** dialog box, complete the following steps:
- In the **Name** field, enter the name of the integration group.
Note Step 3b through Step 3d are optional.
 - In the **Security Domains** area, click the + (plus) icon.
 - In the **Create Security Domain** dialog box, in the **Name** field.
Alternatively, you can choose an existing security domain. In that case, skip step 3d.
 - In the **Create Security Domain** dialog box, in the **Description** field, type a description of the security domain.
 - Click **Update** and then click **Submit**.
The group that you created appears in the **Integrations** central pane.
-

What to do next

Create an integration for the integration group. See the section [Creating an Integration for the Integration Group Using the Cisco APIC GUI, on page 94](#) in this guide.

Also, if you created a security domain, assign users and access rights. See the [Cisco APIC Security Configuration Guide](#) on Cisco.com.

Creating an Integration for the Integration Group Using the Cisco APIC GUI

After you create an integration group, you must create an integration for it. An integration takes information from the Cisco UCSM and the target virtual machine manager (VMM) domain to program the VLANs on all the Cisco UCSM interfaces. The integration correlates the VMM physical NIC MAC address against the Cisco UCSM MAC address. The integration then programs UCSM NICs configured through UCSM vNIC templates.

Create an integration for each Cisco UCSM fabric. If you have multiple Cisco UCSM fabrics, create one integration for each additional fabric.

Before you begin

You must have completed the following tasks:

- Fulfilled the prerequisites in the section [Cisco UCSM Integration Prerequisites](#), on page 92.
- Created an integration group, following the steps in the section [Creating an Integration Group Using the Cisco APIC GUI](#), on page 93.

Procedure

-
- Step 1** Log in to the Cisco Application Policy Infrastructure Controller (APIC):
- Step 2** Go to **Integrations > integration group**.
- Step 3** Double-click the integration group.
- Step 4** In the left navigation pane, expand the integration group folder.
- Step 5** Right-click the **UCSM** folder and then choose **Create Integration Manager**.
- Step 6** In the **Create Integration** dialog box, complete the following steps:

- In the **Name** field, enter a name for the integration.
- In the **Device IP/FQDN** field, enter the Cisco UCSM virtual IP address or fully qualified domain name (FQDN).

Cisco APIC supports the addition of port number to the IP address if you must specify a port number for a firewall or other authentication device. If you do not specify a port, Cisco APIC configures an HTTP connection.

The following are examples of device IP addresses or FQDNs:

- `UCSM1.datacenter.intranet`

Note: When configured with an FQDN, the app that was installed as a prerequisite must have picked up the DNS changes. If you have added or removed DNS servers from the Cisco APIC configuration, disable and then re-enable the external SwitchApp so the changes can take effect on the app.

- `UCSM1.datacenter.intranet:8080`
- `172.16.10.2`
- `172.16.10.2:8080`

If you have multiple Cisco UCSM fabrics, each fabric requires its own integration.

- c) In the **Username** field, type the username that has Network Administrator read and write privileges and Server Profile Administrator read privileges on the Cisco UCSM.
- d) In the **Password** field, type the user password that has read, write, and computer permissions on the Cisco UCSM.
- e) In the **Confirm Password** field, retype the password.
- f) In the **Deployment policy** field, choose **Leaf Enforced** or accept the default **Pre-Provision**.

If you choose the default **Pre-Provision** policy, Cisco APIC detects which VMM domain that you use. Cisco APIC then pushes all VLANs associated with that domain to the target Cisco UCSM.

If you choose the **Leaf Enforced** policy, Cisco APIC detects only the VLANs that are deployed to the top-of-rack leaf nodes. Cisco APIC then filters out any undeployed VLANs, resulting in fewer VLANs pushed to the Cisco UCSM.

If you choose to deploy a Cisco Application Centric Infrastructure (ACI)-managed EPG to an ESXi management NIC (vmknic), you must do one of the following:

- Configure the EPG-VMM domain association with a Resolution Immediacy as Pre-Provision.
- Configure the UCSM Integration Manager Deployment Policy as Pre-Provision.

- g) In the **Preserve NIC Profile Config** field, choose Overwrite, or accept the default **Preserve**.

If you choose the default **Preserve** option, Cisco APIC does not remove manually configured VLANs present on the virtual NIC (vNIC) templates. If you choose the **Overwrite** option, manually configured VLANs are removed. You can remove previously configured VLANs later if you wish.

If you choose **Preserve**, you can switch to **Overwrite** once you have completed integration to guarantee consistent configuration between Cisco APIC and Cisco UCSM.

- h) Click **Submit**.

Cisco APIC creates the integration, which you can view in the central work pane under the **UCSM** folder. The **System Info** section shows the name of the Cisco UCSM target, its capabilities, and firmware version—Information that Cisco APIC took from the Cisco UCSM. The **System Info** also shows the IDs and management IP addresses of the Cisco Fabric Interconnects.

You can also see the topology (Fabric Interconnects to top-of-rack switches) under the **Topology** tab in the work pane for the integration. In the **System Info** section of the work pane, you can see the path information.

What to do next

Perform the following tasks:

- (Optional) To change the connection policy, click the **Policy** tab, change the content of the fields as required, and then click **Submit**.
- You may need to specify configuration of specific uplink port channels. If so, follow instructions in the section [Managing Uplink Port Channels Using the Cisco APIC GUI, on page 96](#).

This task is not necessary if traffic from the Cisco UCSM fabric only flows up to the Cisco ACI leafs.

- If you use SCVMM, you must associate a switch manager to the virtual controller, following the instructions in the section [Associating a Switch Manager with the Virtual Controller Using the Cisco APIC GUI, on page 97](#).
- If you use Cisco ACI Virtual Edge or VMware vSphere Distributed Switch (VDS), you must associate a switch manager with the virtual machine manager if LLDP or CDP is *not* enabled in the VMM domain vSwitch policy.

Managing Uplink Port Channels Using the Cisco APIC GUI

By default, any global VLAN created on a Cisco Unified Computing System Manager (UCSM) exists on both fabric interconnects in the Cisco UCSM Fabric. When Cisco Application Policy Infrastructure Controller (APIC) creates a VLAN, that VLAN is available across all uplinks.

However, your deployment may require that you specify a specific uplink port channel. For example, Layer 2 disjoint networks require that you make that specification.

To specify the uplink port channel for Cisco UCSM and the UCSM Fabric Interconnects, complete the steps in this procedure.

Before you begin

You must have created an integration group for Cisco UCSM and an integration for the integration group. If you have not already done so, follow the instructions in the sections [Creating an Integration Group Using the Cisco APIC GUI, on page 93](#) and [Creating an Integration for the Integration Group Using the Cisco APIC GUI, on page 94](#) in this guide.

Procedure

-
- Step 1** Log in to Cisco APIC.
- Step 2** Go to **Integrations > integration group > UCSM > integration**.
- Step 3** In the **Integration** work pane, click the **Uplink Profiles** tab.
- The work pane displays the uplink profiles, which are the port channel interfaces named on the Cisco UCSM.
- Step 4** Click the desired uplink profile, and under the **Managed** column, click **True**.
- Step 5** Click the desired uplink profile, check the check box under the **Managed** column, and then click **Update**.
-

What to do next

Note the following:

- If you use Microsoft SCVMM, you must associate a switch manager with the virtual machine manager.
- If you use Cisco ACI Virtual Edge or VMware vSphere Distributed Switch (VDS), you must associate a switch manager with the virtual machine if LLDP or CDP is *not* enabled in the VMM domain vSwitch policy.

If necessary, follow the instructions in the section [Associating a Switch Manager with the Virtual Controller Using the Cisco APIC GUI, on page 97](#).

Associating a Switch Manager with the Virtual Controller Using the Cisco APIC GUI

If you use Cisco Application Centric Infrastructure (ACI) Virtual Edge with a VMware domain, you can choose a switch manager to associate with the virtual controller. You can also choose a switch manager if you use a Microsoft System Center Virtual Machine Manager (SCVMM) domain.

Associating a Switch Manager to a virtual machine manager (VMM) controller allows the Cisco Unified Computing System Manager (UCSM) Integration to determine the NIC profiles for mapping VMM domains that do not rely on Link Layer Discover Protocol (LLDP) or Cisco Discovery Protocol (CDP) for their endpoint group (EPG) deployments.

For Microsoft System Center Virtual Machine Manager (SCVMM), creating this association is mandatory. In the case of Cisco ACI Virtual Edge and VMware DVS, create the association if LLDP/CDP is not used in your VMM Domain

Before you begin

You must have completed the following tasks:

- Fulfilled all the tasks in the section [Cisco UCSM Integration Prerequisites, on page 92](#).
- Created an integration group, following the instructions in the section [Creating an Integration Group Using the Cisco APIC GUI, on page 93](#).
- Created an integration, following the instructions in the section [Creating an Integration for the Integration Group Using the Cisco APIC GUI, on page 94](#).

Procedure

-
- | | |
|---------------|--|
| Step 1 | Log in to Cisco APIC. |
| Step 2 | Complete one of the following sets of steps, depending on what kind of virtual domain you use: Go to Virtual Networking > Inventory . <ul style="list-style-type: none">• If you use Microsoft SCVMM, go to Virtual Networking > Inventory > VMM Domains > Microsoft > domain > Controllers > Controller.• If you use Cisco ACI Virtual Edge, go to Virtual Networking > Inventory > > VMM Domains > VMware > domain > Controllers > controller. |
| Step 3 | In the Controller Instance central work pane, choose the Policy and General tabs. |
| Step 4 | In the Properties area, click the Associated Switch Managers + (plus) icon. |
| Step 5 | Choose an option from the Switch Manager drop-down list, click Update , and then click Submit . |
-

Downgrading Cisco APIC with Cisco UCSM Integration

If you want to downgrade Cisco Application Policy Infrastructure Controller (APIC) from Release 4.1(1) to an earlier release, you must take extra steps if you have integrated Cisco UCS Manager (UCSM) into the

Cisco Application Centric Infrastructure (ACI) fabric. If you do not, global VLANs may be deleted from Cisco UCSM resulting in traffic loss.

Procedure

- Step 1** Back up the Cisco UCSM configuration.
See the chapter "Backing Up and Restoring the Configuration" in the [Cisco UCS Manager GUI Configuration Guide](#) on Cisco.com.
- Step 2** Remove the Cisco External Switch app from the Cisco APIC **Apps** tab.
Downgrading the Cisco APIC or removing the integration before removing the External Switch app triggers a cleanup of the Cisco UCSM.
- Step 3** After Cisco External Switch app has been removed from Cisco APIC, you can proceed the downgrade.
The configuration that was published from Cisco APIC continues to remain on your UCSM.
-



CHAPTER 9

Cisco ACI with VMware NSX-T Data Center

- [Cisco ACI with VMware NSX-T Data Center, on page 99](#)

Cisco ACI with VMware NSX-T Data Center

Beginning with Cisco Application Policy Infrastructure Controller (APIC) Release 5.1(1), you can integrate VMware NSX-T Data Center with Cisco Application Centric Infrastructure (ACI).

VMware NSX-T Data Center allows administrators to provision network services for ESXi environments. VMware NSX-T Data Center uses an NSX manager; however, integration is similar to that of other virtual machine managers (VMMs).

Integrating VMware NSX-T Data Center enables administrators to use Cisco APIC to apply Cisco ACI policy inside the VMM system.

You can find information—prerequisites and procedures—in the [Cisco ACI and VMware NSX-T Integration](#) document on Cisco.com.



CHAPTER 10

Cisco ACI with Cisco ACI vPod

- [Cisco ACI with Cisco ACI vPod, on page 101](#)

Cisco ACI with Cisco ACI vPod

Cisco Application Centric Infrastructure (ACI) Virtual Pod (vPod) is a software-only solution that enables you to virtually extend the Cisco ACI fabric into bare-metal cloud environments and other remote locations. It is in general availability beginning in Cisco APIC Release 4.0(2).



Note Cisco ACI vPod is in limited availability in Cisco APIC Release 4.0(1). Contact your Cisco account team before using Cisco ACI vPod or Cisco ACI Virtual Edge as part of Cisco ACI vPod if you use Cisco APIC Release 4.0(1).

You can deploy Cisco ACI vPod wherever you have at least two servers on which you can run the ESXi hypervisor. It allows you to use Cisco ACI Virtual Edge where you do not have a physical leaf.

Cisco ACI vPod and its components—a pair of virtual spines (vSpines), a pair of virtual leafs (vLeafs), and Cisco ACI Virtual Edge—run on the ESXi hypervisor. The vSpines and vLeafs handle control plane management, and the Cisco ACI Virtual Edge handles packet forwarding, policy enforcement, and all data plane management.

Cisco ACI vPod manages a data center defined by the VMware vCenter Server. You can have up to eight instances of Cisco ACI Virtual Edge in each Cisco ACI vPod in the remote location. You use Cisco APIC to manage Cisco ACI vPod nodes and enforce Cisco ACI policy in the virtual data center.

Cisco ACI vPod communicates with a physical, on-premises pod or multipod over an interpod network. You configure the physical pod or multipod, the interpod connection, and Cisco ACI vPod in Cisco APIC. You then use the Cisco ACI vCenter plug-in, a Python script, or PowerCLI to deploy Cisco ACI vPod component virtual machines (VMs).

Cisco ACI vPod is compatible with any server hardware listed in the *VMware Hardware Compatibility Guide*.

You can find information about Cisco ACI vPod in the following documents on [Cisco.com](#):

- [Cisco ACI Virtual Pod Release Notes](#)
- [Cisco ACI Virtual Pod Installation Guide](#)
- [Cisco ACI Virtual Pod Getting Started Guide](#)



CHAPTER 11

Cisco ACI with Cisco ACI Virtual Edge

- [Cisco ACI with Cisco ACI Virtual Edge, on page 103](#)

Cisco ACI with Cisco ACI Virtual Edge

Beginning with the Cisco APIC Release 3.1(1), the Cisco Application Centric Infrastructure (ACI) supports Cisco ACI Virtual Edge. Cisco ACI Virtual Edge is a hypervisor-independent distributed service VM that leverages the native distributed virtual switch that belongs to the hypervisor. Cisco ACI Virtual Edge runs in the user space, operates as a virtual leaf, and is managed by the Cisco Application Policy Infrastructure Controller (APIC).

You can find information about Cisco ACI Virtual Edge in the following documents on [Cisco.com](#):

- Cisco ACI Virtual Edge Release Notes
- Cisco ACI Virtual Edge Installation Guide
- Cisco ACI Virtual Edge Configuration Guide



CHAPTER 12

Cisco ACI with VMware vRealize

This chapter contains the following sections:

- [About Cisco ACI with VMware vRealize, on page 105](#)
- [Getting Started with Cisco ACI with VMware vRealize, on page 110](#)
- [Cisco ACI with VMware vRealize Upgrade Workflow, on page 116](#)
- [Cisco ACI with VMware vRealize Downgrade Workflow, on page 118](#)
- [Use Case Scenarios for the Administrator and Tenant Experience, on page 119](#)
- [Troubleshooting, on page 202](#)
- [Removing the APIC Plug-in, on page 204](#)
- [Plug-in Overview, on page 204](#)
- [Configuring a vRA Host for the Tenant in the vRealize Orchestrator, on page 205](#)
- [Configuring an IaaS Host in the vRealize Orchestrator, on page 206](#)

About Cisco ACI with VMware vRealize

Cisco Application Centric Infrastructure (ACI), in addition to integrating with VMware vCenter, integrates with VMware's products vRealize Automation (vRA) and vRealize Orchestrator (vRO). vRA and vRO are parts of the VMware vRealize Suite for building and managing multivendor hybrid cloud environments.

Beginning with Cisco APIC Release 3.1(1), vRA and vRO support Cisco Application Centric Infrastructure (ACI) Virtual Edge (Cisco ACI Virtual Edge) in addition to VMware DVS.

This chapter discusses about vRealize Automation, Release 7.x. For details about Cisco ACI and VMware vRealize Automation, Release 8.x integration, see the [Cisco ACI vRealize 8 Plug-in Guide](#).



Note Beginning with Cisco Application Policy Infrastructure Controller (APIC) Release 5.0(1), Cisco Application Virtual Switch (AVS) is no longer supported. If you use Cisco AVS and upgrade to Cisco APIC Release 5.0(1), in case of issues, the fabric will not be supported. Also, a fault will be raised for the Cisco AVS domain.

If you use Cisco AVS, we recommend that you migrate to Cisco ACI Virtual Edge. See the *Cisco ACI Virtual Edge Installation Guide* on Cisco.com.



Note In the Cisco APIC GUI, Cisco ACI Virtual Edge is indicated with the term **AVE**.

Cisco ACI with VMware vRealize Solution Overview

vRA integration is delivered through a set of service blueprints imported into vRA. The service blueprints leverage the vRO Application Policy Infrastructure Controller (APIC) workflows, providing a set of catalog items in a self-service portal that allows Tenants to build, manage, and remove networking components.

Multi-machine with ACI workflows achieve following functionalities:

- Auto-create Tenant Endpoint Groups (EPGs)
- Required policies in APIC
- Create VMs and portgroups in vCenter
- Auto-place the VMs in respective port groups
- Created by APIC
- Create security policy with access lists
- Configure L4-L7 services, and provide external connectivity

This consumption model allows users to deploy single and multi-tier application workloads in single click with pre-defined as well as customizable compute and network policies. Catalog items are published by infrastructure administrators, whereby granular entitlements can be added or removed on a per-tenant basis.

The integration offers two modes of networking:

Mode	Description
Shared	Shared mode is for Tenants who do not have a preference for what IP address space they use and a shared address space with shared context (VRF) is used across tenants. Isolation is provided using ACI Endpoint Groups (EPGs) and connectivity among EPGs are enabled using a white listing method.
Virtual Private Cloud (VPC)	VPC mode is a bring your own address space architecture, where network connectivity is isolated via a unique context (VRF) per tenant and external connectivity is provided via a common shared L3 out.

Physical and Logical Topology

This section shows the logical model of the vRealize ACI Integration and comparison between a Shared Services Plan and Virtual Private Cloud Plan.

Figure 8: This figure shows a logical model of the vRealize ACI Integration.

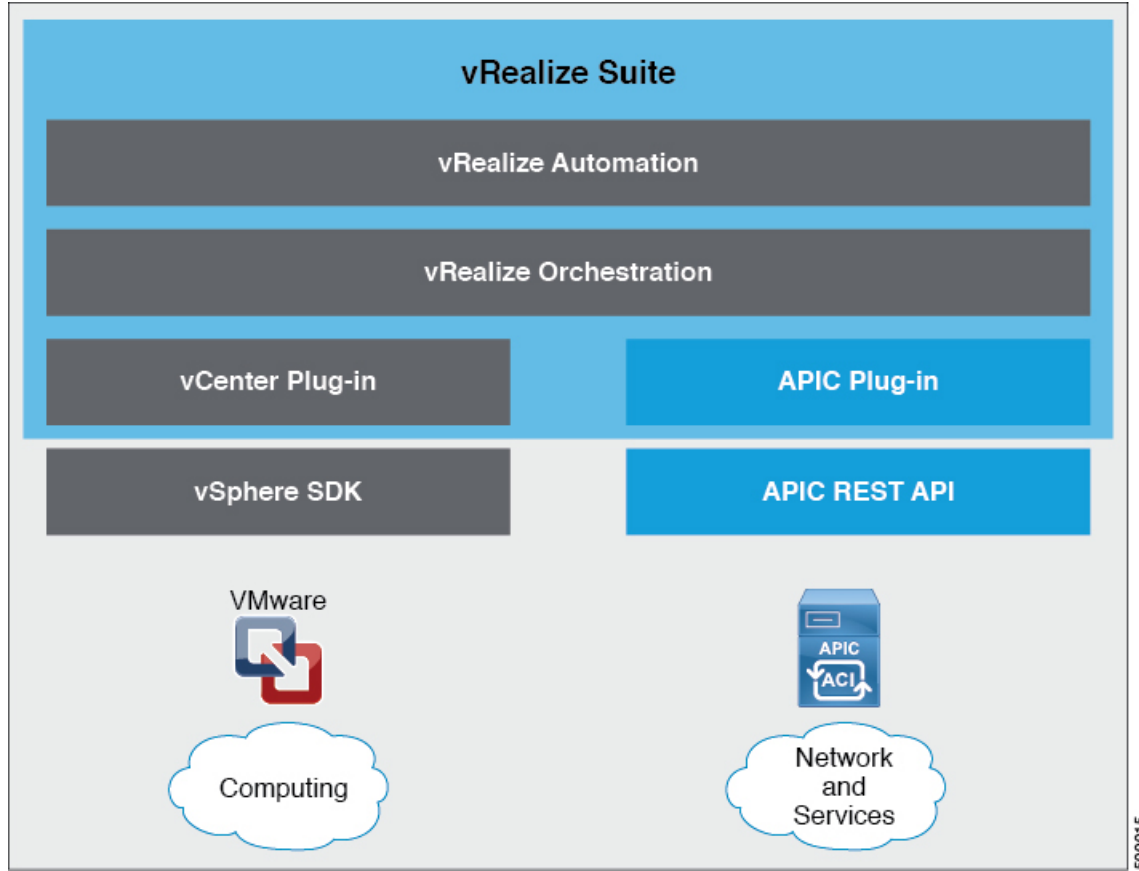
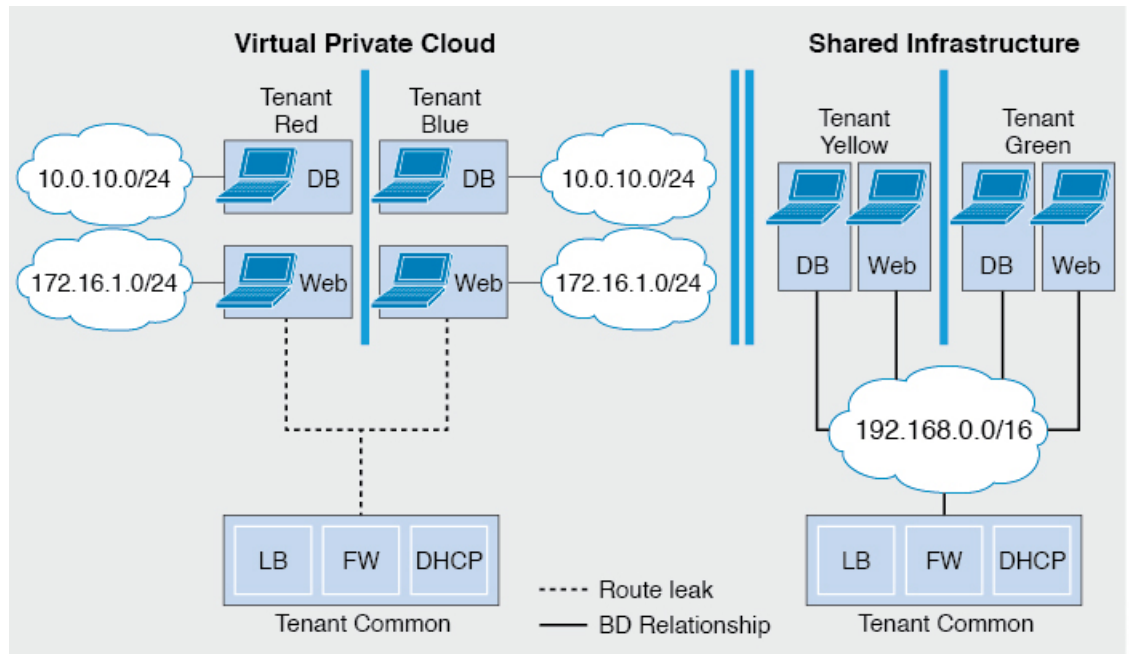

Figure 9: This figure shows the comparison between a Shared Services Plan and Virtual Private Cloud Plan.



For details, see the *Cisco APIC Basic Configuration Guide*.

About the Mapping of ACI Constructs in VMware vRealize

This table shows the mapping between the features of Cisco ACI policy and vRealize policy

Cisco ACI	VMware vRealize
Tenant	Tenant
EPGs	Networks
Layer 3 external connectivity	External routed network
Contract	Security policy
Filter	Rule entry list
L4-L7 service device	Shared load balancer or firewall

This list provides details regarding the features:

- **Tenant**—Tenants can be employees within an organization, business units, application owners, or applications. Or if you are a service provider, they can be hosting customers (individuals or organizations that pay you to provide IT services).
- **Networks**—In Cisco ACI, the term “network” refers to EPGs, which are used to provide a new model for mapping applications to the network. Rather than using forwarding constructs, such as addresses or VLANs, to apply connectivity and policy, EPGs use a grouping of application endpoints. EPGs are mapped to networks in the vRealize portal. The isolated networks act as containers for collections of

applications, or of application components and tiers, that can be used to apply forwarding and policy logic. They allow the separation of network policy, security, and forwarding from addressing and instead apply these to logical application boundaries. When a network is created in vRealize, in the back end it is created as a port group in vCenter. A vRealize tenant can use vCenter to manage the computing resources and can attach the virtual machine to the appropriate network.

- Layer 3 external connectivity—The Cisco ACI fabric connects to the outside through Layer 3 external networks. These constructs are also available for vRealize tenants to access other services within the data center, across the data center, or on the internet.
- Security policy—Cisco ACI is built on a highly secure model, in which traffic between EPGs (isolated networks) is denied, unless explicitly allowed by policy contracts. A Cisco ACI contract is mapped to a security policy in the vRealize portal. The security policy describes which networks (EPGs) will provide and consume a service. The security policy contains one or more rule entry lists (filters), stateless firewall rules that describe a set of Layer 4 TCP or User Datagram Protocol (UDP) port numbers that define the communication between the various applications.
- Shared load balancer and firewall—Cisco ACI treats services as an integral part of an application. Any services that are required are managed as a service graph that is instantiated on the Application Policy Infrastructure Controller (APIC). Users define the service for the application, and service graphs identify the set of network and service functions that are needed by the application. Cisco ACI has an open ecosystem of L4-7 service vendors whose services integrate natively with Cisco ACI. This integration is achieved through device packages written and owned by the vendors. The APIC manages the network services and inserts the services according to the Cisco ACI policy model. For vRealize, Cisco ACI offers F5 and Citrix load balancers and Cisco ASA firewalls, both in virtual and physical form factors, which are connected to the Cisco ACI fabric and shared across the various vRealize tenants. After the device has been integrated into Cisco ACI, the vRealize administrator can choose to add the device as a premium service and upsell the plan. The vRealize administrator manages the virtual IP address range for the shared device, to simplify the vRealize tenant's workflow.
- VPC plan—In a VPC plan, vRealize tenants can define their own address spaces, bring a DHCP server, and map their address spaces to networks. A VPC tenant can also be offered services, such as load balancing, from the shared service plan. In this scenario, a device would have multiple virtual NICs (vNICs). One vNIC would connect to the private address space, and another would connect to the shared service infrastructure. The vNIC that connects to the shared service infrastructure would have an address assigned by the infrastructure and would also consume a shared load balancer owned by the infrastructure.

Event Broker VM Customization

vRealize Automation Event Broker is a workflow subscription service for vRealize Automation to call workflows from the vRealize Orchestrator under predefined conditions the user sets. It is supported beginning with Cisco APIC 3.0(1).

A deployment of a single or multitier application is automatically subscribed to the Event Broker. Machine operations such as creation or deletion on any machine, configured by the vRA, trigger the Event Broker. This invokes the preconfigured operations to the Cisco APIC defined by the Property Groups associated to a single or multitier application.

To add the Cisco APIC workflow subscription, follow the instructions at [Setting Up the VMware vRealize Automation Appliance for ACI, on page 113](#). The workflow subscription then will be added automatically.

Getting Started with Cisco ACI with VMware vRealize

This section describes how to get started with Cisco ACI with VMware vRealize.

You must download and unzip the Cisco ACI and VMware vRealize file for the 2.2(1) release before installing Cisco ACI with VMware vRealize.

Procedure

- Step 1** Go to Cisco's Application Policy Infrastructure Controller (APIC) Website:
<http://www.cisco.com/c/en/us/support/cloud-systems-management/application-policy-infrastructure-controller-apic/tsd-products-support-series-home.html>
- Step 2** Choose **All Downloads for this Product**.
- Step 3** Choose the release version and the **apic-vrealize-2.2.1x.tgz** file.
- Step 4** Click **Download**.
- Step 5** Unzip the **apic-vrealize-2.2.1x.tgz** file.

Note Cisco ACI with VMware vRealize only supports ASCII characters. Non-ASCII characters are not supported.

Prerequisites for Getting Started with Cisco ACI with VMware vRealize

Before you get started, ensure that you have verified that your vRealize computing environment meets the following prerequisites:

- vRealize Automation(vRA) Release 7.0-7.4 must be installed.
See VMware's vRealize documentation.
It is highly recommended to use vRA 8.x. For details about vRA 8.x integration with Cisco ACI, see the [Cisco ACI vRealize 8 Plug-in Guide](#).
- The vRealize ACI plug-in version and the Cisco APIC version must match.
- A tenant is configured in vRealize automation and associated with identity store. The tenant must have one or more users configured with "Infra Admin", "Tenant Admin", and "Tenant user" roles.
See VMware's vRealize documentation.
- The tenant must have one more "Business group" configured.
See VMware's vRealize documentation.
- Configure vRealize Orchestrator as an end-point.
See VMware's vRealize documentation.
- Configure vCenter as an endpoint.
See VMware's vRealize documentation.

- Configure "Reservations" using the vCenter compute resources.
See VMware's vRealize documentation.
- Set up the vRealize Appliance.
See VMware's vRealize documentation.
- If Layer 3 (L3) Out policies are to be consumed by a tenant, you must configure a BGP route reflector.
See the *Cisco APIC Basic Configuration Guide* about Configuring an MP-BGP Route Reflector Using the Basic GUI or Configuring an MP-BGP Route Reflector.
- Setup a vRA handle in vRO.
This is used for Installing the ACI service catalog workflow.
- Setup a IAAS handle in vRO.
This is used for Installing the ACI service catalog workflow.
See [Setting Up an IaaS Handle in vRealize Orchestrator, on page 111](#).
- Install the vCAC/vRA Custom Property Toolkit for vCO/vRO. You can download the package from the following URL:
<https://communities.vmware.com/docs/DOC-26693>
- The embedded vRO in vRA has the vCAC vRO plug-in that is installed by default. If you are using a standalone vRO, the vCAC vRO plug-in must be installed. You can download the plug-in from the following URL:
<https://solutionexchange.vmware.com/store/products/vmware-vrealize-orchestrator-plug-in-for-vra-6-2-0>

Setting Up an IaaS Handle in vRealize Orchestrator

This section describes how to set up an Infrastructure as a Service (IaaS) handle in the vRealize Orchestrator (vRO).

Procedure

-
- Step 1** Log in to the VMware vRealize Orchestrator as administrator.
 - Step 2** Once the VMware vRealize Orchestrator GUI appears, from the drop-down list, choose **Run** from the menu bar.
 - Step 3** In the **navigation** pane, choose the **Workflows** icon.
 - Step 4** Choose **Administrator@vra_name > Library > vRealize Automation > Configuration > Add the IaaS host of a vRA host**.
 - Step 5** Right-click **Add the IaaS host of a vRA host** and choose **Start Workflow**.
 - Step 6** In the **Start Workflow: Add the IaaS host of a vRA host** dialog box, perform the following actions:
 - a) In the **vRA host** field, enter your vRealize Handle.
 - b) Click **Next**.
 - Step 7** In the next screen, perform the following actions:
 - a) In the **Host Name** field, enter a name.

- b) In the **Host URL** field, enter the URL of your IaaS host.
- c) Use the default values for the remaining fields.
- d) Click **Next**.

Step 8 In the next screen, perform the following actions:

- a) In the **Session mode** drop-down list, choose **Shared Session**.
- b) In the **Authentication user name** field, enter the authentication user name.
- c) In the **Authentication password** field, enter the password.
- d) Click **Next**.

Step 9 In the next screen, perform the following actions:

- a) In the **Workstation for NTLM authentication** field, enter the name of the workstation that you will use for NTLM authentication.
- b) In the **Domain for NTLM authentication** field, enter the domain that is used in the IaaS host URL.
- c) Click **Submit**.

Cisco ACI with VMware vRealize Installation Workflow

This section describes the Cisco ACI with VMware vRealize installation workflow.

Procedure

Step 1 Install the APIC plug-in on the vRealize Orchestrator (vRO).

For more information, see [Installing the APIC Plug-in on the vRealize Orchestrator, on page 112](#).

Step 2 Set up the VMware vRealize Automation Appliance for ACI.

For more information, see [Setting Up the VMware vRealize Automation Appliance for ACI, on page 113](#).

Installing the APIC Plug-in on the vRealize Orchestrator

This section describes how to install APIC plug-in on the vRealize Orchestrator.

Procedure

Step 1 Once you have unzipped the package, save the **aci-vra-plugin-3.0.1000.N.dar** file in a known directory.

Step 2 Log in to the vRA appliance as root using SSH, enter:

```
$ ssh root@<vra_ip>
```

Step 3 Start the configurator to enable the configurator services web interface, enter the following commands:

```
# service vco-configurator start
.
.
.
```



```
Tomcat started.
Status:           Running as PID=15178
```

Ensure the status is running.

Step 4 Log in to the VMware appliance using the Firefox browser, enter:

https://appliance_address:8283/vco-controlcenter

Note Cisco recommends using the Firefox browser.

Do not use the Internet Explorer or the Chrome browser for the first time. There is a known issue when you use the default username and password. It does not login properly.

For more information, see <https://communities.vmware.com/thread/491785>.

a) In the VMware vRealize Orchestrator Configuration GUI, enter the default username and password which is **vmware/vmware**. You will then be required to change the password.

Step 5 Under the **Plug-Ins** section, click **Manage Plug-Ins**.

Step 6 Under Install plug-in, click the Browse... button and perform the following steps:

a) Locate where you saved the **aci-vra-plugin-3.0.1000.N.dar** file and choose the **aci-vra-plugin-3.0.1000.N.dar** file.

b) Click **Install** on the right, and when the Cisco APIC Plug-in displays, click **Install** again.

- A message highlighted in green displays, saying that the plug-in is installed.

- A message highlighted in yellow displays, saying "The Orchestrator server must be restarted for the changes to take effect. The restart can be performed from the Startup Options page."

Step 7 Click **Startup Options**.

You will be directed to the **Startup Options** page.

Step 8 Click **Restart** to restart the server. Wait until the Current Status displays **RUNNING**.

Step 9 Navigate back to the **Manage Plug-Ins** page by clicking **Home** on the top left and then clicking **Manage Plug-Ins** under the **Plug-Ins** section.

Step 10 Verify the Cisco APIC plug-in has been installed by looking for it under **Plug-Ins**.

The plug-in will be displayed first with the Cisco icon.

Setting Up the VMware vRealize Automation Appliance for ACI

This section describes how to set up the VMware vRealize Automation Appliance for Cisco ACI.

Procedure

Step 1 Log in to the VMware vRealize Automation Appliance as the administrator through your tenant portal using the browser:

https://appliance_address/vcac/org/tenant_id

Example:

https://192.168.0.10/vcac/org/tenant1

Enter the admin username and password.

Step 2

In the VMware vRealize Automation Appliance GUI, perform the following actions:

- a) Choose **Administration > Users & Groups > Custom Groups**
- b) In the **Custom Group** pane, click **Add** to add a custom group.
- c) Enter the name of the custom group. (Service Architect)
- d) In the **Roles to this group** field, select the custom group you created in the previous step. (Service Architect)
- e) Choose the **Member** pane, enter and select the user name(s).
- f) Click **Add**.
This creates a custom group with members.
- g) In the **Custom Group** pane, choose the custom group you created. (Service Architect)
- h) In the **Edit Group** pane, you can verify the members in the **Members** pane.

Step 3

In the browser, enter the vRealize Automation Appliance.

https://appliance_address

For example:

https://vra3-app.ascisco.net

- a) Choose the **vRealize Orchestrator Client** to download the client.jnlp file.
- b) The **Downloads** dialog box will appear, launch the **client.jnlp** file.

Step 4

Log in to the VMware vRealize Orchestrator as administrator.

Step 5

Once the VMware vRealize Orchestrator GUI appears, from the drop-down list, choose **Run** from the menu bar.

Step 6

In the **Navigation** pane, choose the **Workflows** icon.

Step 7

Choose **Administrator@vra3-app.ascisco.net > Cisco APIC Workflows > Utils > Install ACI Service Catalog**.

Step 8

Right-click **Install ACI Service Catalog** and choose **Start Workflow**.

Step 9

In the **Start Workflow - Install ACI Service Catalog** dialog box, perform the following actions:

- a) In the **APIC Hostname/IP Address** field, enter the APIC hostname or IP address.
- b) In the **APIC Admin Password** field, enter the APIC admin password.
- c) In the **vRealize Automation IP Address** field, provide the IP address for the vRA.
- d) In the **vRealize Automation handle** field, click **Not set**, navigate and choose the vRealize automation handle for this appliance.
- e) In the **Business group** field, click **Not set** to choose business group.

Note If running vRealize 7.0, you need to select the **Business Group** from **Business Group (Deprecated)**.

Note Usernames need to include the domain name. For example: admin1@vsphere.local

- f) In the **Admin User** field, enter the tenant admin user.
- g) In the **vRealize Automation Admin Password** field, enter the admin password for the vRA.
- h) In the **End users** field, click **Not set** and enter the user names to enable privilege for.

Note Do not copy and paste the end user names, you should type the user names.

- i) In the **JSON File containing vRealize Properties** field, click **Not set**, navigate and choose the JSON file containing the vRealize properties. (aci-vra-properties-3.0.1000.x.json)

Note Usernames need to include the domain name. For example: admin1@vsphere.local

- j) In the **Zip file containing the service blueprints** field, click **Not set**, navigate and choose the zip file containing the service blueprints. (aci-vra-asd-3.0.1000.x.zip)
- k) Click **Submit**.

Step 10 In the **Navigation** pane, you will see a green check mark next to the **Install ACI Service Catalog**, if the installation was successful.

Step 11 In the **Navigation** pane, choose the **Workflows** icon.

Step 12 Right-click **Install ACI Property Definitions** and choose **Start Workflow**.

Step 13 In the **Start Workflow - Install ACI Property Definitions** dialog box, click **Net set**, navigate and choose the IaaS host.

- a) Click **Submit**.

In the **Navigation** pane, you will see a green checkmark next to the **Install ACI Property Definitions**, if the installation was successful.

Step 14 To verify as a tenant, log in to the vRealize Automation Appliance as tenant, choose **Catalog** and you will see the services.

Step 15 To verify as an administrator, log in to the vRealize Automation Appliance as administrator, choose **Catalog** and you will see the services.

- a) Choose **Infrastructure > Blueprints > Property Definitions** and you will see the properties.

Day-0 Operations of ACI

This section describes day-0 operations of ACI.

Before you begin

- Fabric bring-up

Bring up the fabric and all topologies are supported.

- Access policies

- Attach Entity Policy (AEP)

- Configure access policies between the leaf switches and ESXi hosts to ensure CDP and LLDP is enabled between the leaf and host.

- Layer 3 (L3) Out configuration

- Create any L3 Out configurations in the common tenant that you wish to be consumed user tenants.

- You can choose any name for the L3 policy.

- External EPG must be named "[L3OutName|InstP]".

- Create two policies.

For shared plan, specify "default" and for VPC plan, specify "vpcDefault".

For more information, see [About L3 External Connectivity, on page 142](#).

- Service graph templates and devices

Create any service graph devices in the common tenant.

For more information, see [Configuring the Services on APIC Using XML POST, on page 139](#).

- Security domains and tenant user

- vRealize plug-in requires two user accounts.

The first account needs administrator privileges. This account allows you to create, read, update, and destroy objects in the tenant common, access policies, and VMM domains.

The second account needs restricted tenant privileges. This account allows you to only read common tenant and VMM domains, but you can create, read, update, and destroy objects in their own tenant.

- Role-based access control (RBAC) rules are enforced through the APIC not the plug-in.

Procedure

See the *Cisco APIC Basic Configuration Guide* for more information.

Associating AEP with VMware VMM Domain

This section describes how to associate an attachable entity profile (AEP) with VMware VMM domain.



Note You do not need to perform this procedure if the domain type is Cisco AVS.

Procedure

-
- Step 1** Log in to the APIC GUI, and then choose **Fabric > Access Policies**.
- Step 2** In the navigation pane, expand **Policies > Global > Attachable Access Entity Profiles** and then click the *profile*.
- Step 3** In the work pane, perform the following actions:
- In the **Domains (VMM, Physical or External) Associated to Interfaces** field, click the + to expand.
 - In the **unformed** field, choose a VMM domain and click **Update**.
-

Cisco ACI with VMware vRealize Upgrade Workflow

This section describes the Cisco ACI with VMware vRealize upgrade workflow.

Procedure

- Step 1** Upgrade the APIC image.
- Step 2** Upgrade the APIC plug-in on the vRealize Orchestrator (vRO).
For more information, see [Upgrading the APIC Plug-in on the vRealize Orchestrator, on page 117](#).
- Step 3** Set Up the VMware vRealize Automation Appliance for ACI.
For more information, see [Setting Up the VMware vRealize Automation Appliance for ACI, on page 113](#).
- Step 4** Verify the connection between APIC and vRealize.
For more information, see [Verifying the Connection Between APIC and vRealize, on page 117](#).
-

Upgrading the APIC Plug-in on the vRealize Orchestrator

This section describes how to upgrade the APIC plug-in certificate on the vRealize Orchestrator.

Procedure

- Step 1** To upgrade, first follow the directions in [Installing the APIC Plug-in on the vRealize Orchestrator, on page 112](#).
- Step 2** Upgrade your service blueprints, service categories, and entitlements, see [Setting Up the VMware vRealize Automation Appliance for ACI, on page 113](#).
-

Verifying the Connection Between APIC and vRealize

After you have upgraded the Application Policy Infrastructure Controller (APIC) controller and the switch software, you must verify the connection from the vRealize Orchestrator to APIC.

Before you begin

- Ensure the APIC controller and the switch software is upgraded.
For more information, see the *Cisco ACI Firmware Management Guide*.

Procedure

- Step 1** Log in to the vRealize Orchestrator as administrator.
- Step 2** In the **navigation** pane, choose the Inventory icon.
- Step 3** Expand the **Cisco APIC Plugin**, choose the APIC and check the following:
- a) In the **General** pane, check if the controllers are showing in the **Name** field.

- b) Check if you can maneuver through the nested hierarchy below the APIC. This ensures you are communicating with APIC.

If the connection from vRO to APIC is not established, then next to the APIC name the string **down** will be present, indicating that the connection is down.

Cisco ACI with VMware vRealize Downgrade Workflow

This section describes the Cisco ACI with VMware vRealize downgrade workflow.

Procedure

- Step 1** Downgrade the APIC image.
 - Step 2** Delete the APIC plug-in package and all the APIC workflows.
For more information, see [Deleting Package and Workflows](#) , on page 118.
 - Step 3** Install the APIC plug-in on the vRealize Orchestrator (vRO).
For more information, see [Upgrading the APIC Plug-in on the vRealize Orchestrator](#), on page 117.
 - Step 4** Set up the VMware vRealize Automation Appliance for ACI.
For more information, see [Setting Up the VMware vRealize Automation Appliance for ACI](#), on page 113.
 - Step 5** Verify the connection between APIC and vRealize.
For more information, see [Verifying the Connection Between APIC and vRealize](#), on page 117.
-

Deleting Package and Workflows

This section describes how to delete the package and workflows.

Procedure

- Step 1** Log in to the vRO client as administrator.
- Step 2** Choose the **Design** role.
- Step 3** Choose the **Packages** tab.
- Step 4** Right-click on the **com.cisco.apic.package** and choose **Delete element with content**.
- Step 5** Choose **Keep Shared** in the pop-up window.
- Step 6** Choose the **Workflows** tab.
- Step 7** Ensure that all workflows in the "Cisco APIC workflows" folder and subfolders are deleted.

To delete the workflow: Select the workflow, right-click and choose **Delete**.

Use Case Scenarios for the Administrator and Tenant Experience

This section describes use case scenarios for the administrator and tenant experience.

Overview of Tier Application Deployment

This section describes the overview of 3-tier application deployment.

Deployment of a single-tier application using property groups	See Deploying a Single-Tier Application Using Property Groups , on page 119.
Deployment of a 3-tier application using a multi-machine blueprint	See Deploying a 3-Tier Application Using a Multi-Machine Blueprint , on page 121.

Deploying a Single-Tier Application Using Property Groups

This section describes how to deploy a single-tier application using property groups.

Procedure

- Step 1** Connect to the vRealize Automation appliance by pointing your browser to the following URL:
`https://appliance_address/vcac/org/tenant_id`
- Step 2** Enter the tenant administrator username and password.
- Step 3** Choose **Catalog**.
- Step 4** Click **Configure Property Groups**.
 You will configure the database tier.
- Step 5** Click **Request**.
- Step 6** In the **Request Information** tab, enter a description of the request.
- Step 7** Click **Next**.
- Step 8** In the **Common** tab, perform the following actions:
- In the **IaaS Host for vRealize** field, click **Add**.
 - Put a check in the box next to the desired IaaS host.
 - Click **Submit**.
 - In the **APIC Tenant** field, click **Add**.
 - Expand *apic_name* > **Tenants**.
 - Put a check in the box next to the desired tenant's name.

Example:

green

- g) Click **Submit**.
- h) In the **Property Group Name** field, enter a name for the property group.

Example:

green-app-bp

- i) In the **Plan Type (Shared or VPC)** field, click **Shared**.
- j) In the **VMM Domain/DVS** field, click **Add**.
- k) Expand *apic_name* > **Vcenters** > *vcenter_name*
- l) Put a check in the box next to the desired vCenter's name.

Example:

green

- m) Click **Submit**.

Step 9 Click **Next**.

Step 10 In the **VM Networking** tab, leave all of the fields at their default values.

Step 11 Click **Next**.

Step 12 In the **Security** tab, perform the following actions:

- a) In the **Configure Security Policy** drop-down list, choose **No**.

Step 13 In the **Load Balancer** tab, from the drop-down list, choose **No**.

Step 14 In the **Firewall** tab, from the drop-down list, choose **No**.

Step 15 Click **Submit**.

Step 16 Click **OK**.

Step 17 To verify your request, choose the **Requests** tab.

- a) Choose the request you submitted and click **view details**. Ensure the status is **Successful**.

Step 18 (Optional) To edit a blueprint in the property group, choose **Infrastructure** > **Blueprints** > **Property Groups**.

- a) In the **Property Group** pane, choose the property group you created (green-app-bp) and click **edit**.
- b) In the **Edit Property Group** pane, choose the property group you want to edit and click on the pencil icon to edit a certain blueprint.
- c) Once you have completed your edits, click **OK**.

Step 19 Attach the property group to the VMs, choose **Infrastructure** > **Blueprints**.

Step 20 In the **Blueprints** pane, click **New Blueprint**, from the drop-down list, choose **Virtual** > **vSphere (vCenter)**.

Step 21 In the **New Blueprint vSphere (vCenter)**pane, perform the following actions:

- a) In the **Blueprint Information** tab, enter the information to create your blueprint and click **OK**. See VMware's documentation for details on how to create your machine blueprint.
- b) In the **Build Information** tab, enter the information to create your property group and click **OK**. See VMware's documentation for details on how to create your machine blueprint.

Step 22 In the **Properties** tab, perform the following actions:

- a) In the **Property Groups** field, choose your property group that you created (green-app-bp) and click **OK**.
- b) Click on the magnifying glass icon for the newly created property group (green-app-bp).
- c) In the **Property Group Custom Properties** dialog box, ensure that the properties match your property group and this makes a connection with the VM and the ACI networking.
- d) In the **New Blueprint vSphere (vCenter)**pane, click **OK**.

- Step 23** In the **Blueprints** pane, perform the following actions:
- Choose your property group that you created (green-app-bp), hover and choose **Publish**.
 - Click **OK**.
 - Choose **Administration > Catalog Management > Catalog Items**.
- Step 24** In the **Catalog Items** pane, perform the following actions.
- Find and choose the blueprint that you created (Green App Tier).
- Step 25** In the **Configure Catalog Item** pane, perform the following actions.
- In the **Details** tab, in the **Service** field, choose **VM Services**.
 - Check the check box for **New and noteworthy**.
 - Click **Update**.
- You now have deployed a single-tier application using property groups.
- Step 26** To verify the deployment of the single-tier application, log out of the administrator session and log back in as the tenant.
- Click the **Catalog** tab.
 - In the **navigation** pane, choose **VM Services**.
 - In the **Work** pane, choose the blueprint you created.
 - In the **Catalog Item Details** pane, verify the properties of the blueprint and click **Request**.
 - In the **New Request** pane, click **Submit** and then **OK**.
- This provisions a new virtual machine, ACI networking, and connects the two together.

Deploying a 3-Tier Application Using a Multi-Machine Blueprint

VMware vRealize multi-machine blueprints are groupings of one or more machine blueprints to be deployed simultaneously. A common use case is a three-tier web application, where the web, app, and database tiers are deployed together. From a networking perspective, you must push the application policy into Cisco Application Centric Infrastructure (ACI) to enable secure communication between tiers that need to communicate. This is achieved by creating a security policy and associating the relevant machines dynamically at deployment time.

When configuring a blueprint that will be used in a multi-machine blueprint, a security policy must be created. During the creation process, the consumer and provider must be provided. The provider is always the machine that you are building, and the consumer can be any other machine or network.

As an example, say that you have a MySQL database machine blueprint that provides a service on port 3306. The application tier machines need to access this database, but the web tier machines do not. Under the **Security Policy** section of the **Configure Property Group** workflow, you create a policy with the "app" tier as the consumer, listing port 3306 as permissible (everything else is denied by default) and the blueprint will automatically place the "db" tier as the provider.

The "app" tier also must provide a service; in this example a server is listening on port 8000. The web tier will then consume this service. The security policy must be specified in the "app" tier property group.



Note Machine prefixes generate a unique name for each virtual machine that is deployed. An example prefix for a tenant named "Green" could be "green-web-", plus three unique digits for each machine. The sequence would be: "green-web-001", "green-web-002", "green-web-003", and so on. It is important that you follow a similar scheme with your machine prefixes so that the Application Policy Infrastructure Controller (APIC) plug-in can accurately predict the name of the consumer endpoint group. Additionally, every machine must be on the same prefix number. For example, the names for a 3-tier app must be: green-db-001, green-app-001, and green-web-001. If any tier were not aligned, the security policy would fail to form a correct relationship. This is a requirement because vRealize does not provide the name of the sibling tiers, so the plug-in must infer the siblings' names based on its own name.

When configuring a security policy under a property group, the consumer name should be the second word of the machine prefix. For the example prefix "green-web-", the consumer name would be "web".

This section describes how to deploy a 3-tier application using a multi-machine blueprint.

Procedure

Step 1 Connect to the vRealize Automation appliance by pointing your browser to the following URL:

```
https://appliance_address/vcac/org/tenant_id
```

Step 2 Enter the tenant administrator username and password.

Step 3 Choose **Catalog**.

Step 4 Click **Configure Property Group**.

You will configure the database tier.

Step 5 Click **Request**.

Step 6 In the **Request Information** tab, enter a description of the request.

Step 7 Click **Next**.

Step 8 In the **Common** tab, perform the following actions:

- a) In the **IaaS Host for vRealize** field, click **Add**.
- b) Put a check in the box next to the desired IaaS host.
- c) Click **Submit**.
- d) In the **APIC Tenant** field, click **Add**.
- e) Expand *apic_name* > **Tenants**.
- f) Put a check in the box next to the desired tenant's name.

Example:

```
green
```

g) Click **Submit**.

h) In the **Property Group Name** field, enter a name for the property group.

Example:

```
green-db-mm
```

i) In the **VMM Domain/DVS** field, click **Add**.

j) Expand *apic_name* > **Vcenters** > *vcenter_name*

- k) Put a check in the box next to the desired vCenter's name.

Example:

green

- l) Click **Submit**.

Step 9 Click **Next**.

Step 10 In the **VM Networking** tab, leave all of the fields at their default values.

Step 11 Click **Next**.

Step 12 In the **Security** tab, perform the following actions:

- a) In the **Configure Security Policy** drop-down list, choose **Yes**.
- b) In the **Consumer Network/EPG Name of Security Policy** field, enter the name of the consumer network, without the full machine prefix.

Example:

app

The database tier must have the application tier as the consumer.

- c) In the **Starting Port Number in Security Policy** field, enter the starting port number.

Example:

3306

- d) In the **Ending Port Number in Security Policy** field, enter the ending port number.

Example:

3306

- e) For the other fields, leave their values at the defaults.

Step 13 Click **Next**.

Step 14 In the **Load Balancer** tab, leave the field at its default value.

Step 15 Click **Next**.

Step 16 In the **Firewall** tab, leave the field at its default value.

Step 17 Click **Submit**.

Step 18 Click **OK**.

Step 19 Click **Configure Property Group**.

This time, you will configure the application tier.

Step 20 Click **Request**.

Step 21 In the **Request Information** tab, enter a description of the request.

Step 22 Click **Next**.

Step 23 In the **Common** tab, perform the following actions:

- a) In the **IaaS Host for vRealize** field, click **Add**.
- b) Put a check in the box next to the desired IaaS host.
- c) Click **Submit**.
- d) In the **APIC Tenant** field, click **Add**.
- e) Expand *apic_name* > **Tenants**.

- f) Put a check in the box next to the desired tenant's name.

Example:

green

- g) Click **Submit**.
h) In the **Property Group Name** field, enter a name for the property group.

Example:

green-app-mm

- i) In the **VMM Domain/DVS** field, click **Add**.
j) Expand *apic_name* > **Vcenters** > *vcenter_name*
k) Put a check in the box next to the desired vCenter's name.

Example:

green

- l) Click **Submit**.

Step 24 Click **Next**.

Step 25 In the **VM Networking** tab, leave all of the fields at their default values.

Step 26 Click **Next**.

Step 27 In the **Security** tab, perform the following actions:

- a) In the **Configure Security Policy** drop-down list, choose **Yes**.
b) In the **Consumer Network/EPG Name of Security Policy** field, enter the name of the consumer network, without the full machine prefix.

Example:

web

The application tier must have the web tier as the consumer.

- c) In the **Starting Port Number in Security Policy** field, enter the starting port number.

Example:

8000

- d) In the **Ending Port Number in Security Policy** field, enter the ending port number.

Example:

8000

- e) For the other fields, leave their values at the defaults.

Step 28 Click **Next**.

Step 29 In the **Load Balancer** tab, leave the field at its default value.

Step 30 Click **Next**.

Step 31 In the **Firewall** tab, leave the field at its default value.

Step 32 Click **Submit**.

Step 33 Click **OK**.

Step 34 Click **Configure Property Group**.

You will configure the web tier.

- Step 35** Click **Request**.
- Step 36** In the **Request Information** tab, enter a description of the request.
- Step 37** Click **Next**.
- Step 38** In the **Common** tab, perform the following actions:
- In the **IaaS Host for vRealize** field, click **Add**.
 - Put a check in the box next to the desired IaaS host.
 - Click **Submit**.
 - In the **APIC Tenant** field, click **Add**.
 - Expand *apic_name* > **Tenants**.
 - Put a check in the box next to the desired tenant's name.
- Example:
- ```
green
```
- Click **Submit**.
  - In the **Property Group Name** field, enter a name for the property group.
- Example:
- ```
green-web-mm
```
- In the **VMM Domain/DVS** field, click **Add**.
 - Expand *apic_name* > **Vcenters** > *vcenter_name*
 - Put a check in the box next to the desired vCenter's name.
- Example:
- ```
green
```
- Click **Submit**.
- Step 39** Click **Next**.
- Step 40** In the **VM Networking** tab, leave all of the fields at their default values.
- Step 41** Click **Next**.
- Step 42** In the **Security** tab, leave the field at its default value.
- Because this is a consumer policy, you do not need to configure the security policy.
- Step 43** Click **Next**.
- Step 44** In the **Load Balancer** tab, leave the field at its default value.
- Step 45** Click **Next**.
- Step 46** In the **Firewall** tab, leave the field at its default value.
- Step 47** Click **Submit**.
- Step 48** Click **OK**.
- 

## About Plan Types

The administrator creates the plan with their own values. The plan types are as follows:

|                                                                      | Shared Infrastructure | Virtual Private Cloud (VPC) |
|----------------------------------------------------------------------|-----------------------|-----------------------------|
| Isolated Networks                                                    | Yes                   | Yes                         |
| Firewall                                                             | Yes                   | Yes                         |
| Provider DHCP                                                        | Yes                   | Yes                         |
| Shared Load Balancer                                                 | Yes                   | Yes                         |
| Public Internet Access                                               | Yes                   | Yes                         |
| Shared Services between Tenants                                      | Yes                   | Yes                         |
| Bring your own address space (Private Address Space) and DHCP Server | No                    | Yes                         |

## About vRealize Service Categories and Catalog Items

This section describes the vRealize services categories and catalog items. The list of all catalog items they are grouped into services and each of these services are assigned an entitlement. ACI entitlement is assigned to certain users.

For more information, see [ACI Administrator Services in vRealize, on page 128](#).

For more information, see [ACI Tenant Services in vRealize, on page 131](#).

For more information, see [Entitlements for ACI catalog-items in vRealize, on page 136](#).

## Mapping of the ACI Plan Types to vRealize Service Categories

This section shows the mapping of the Cisco ACI plan types to vRealize service categories.

Figure 10: vRA - User, Entitlements, Services and Blueprints

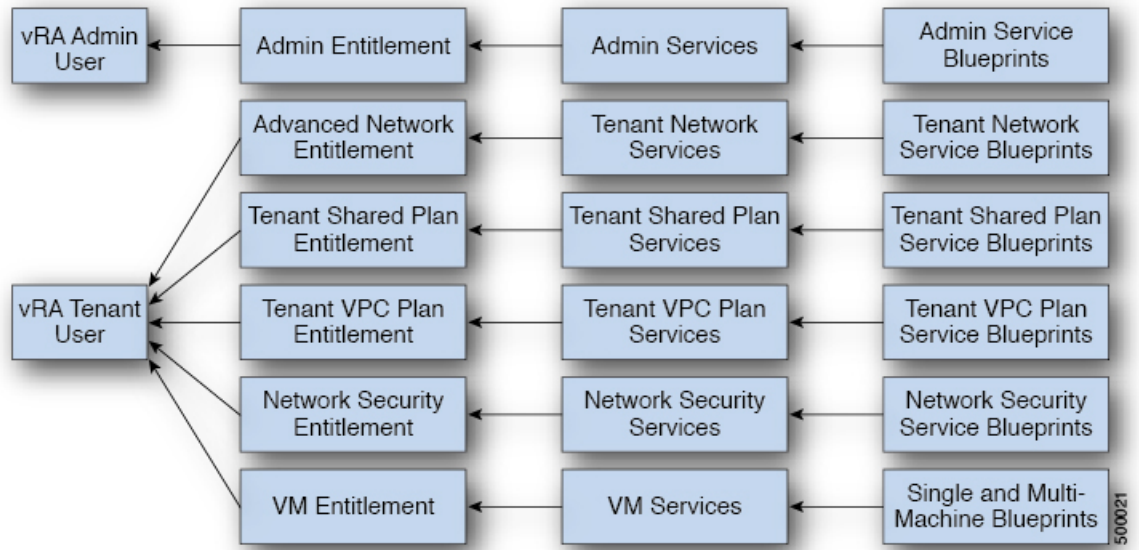

| vRA Catalog Category     | List of Blueprints                                                                                                                                                                                                                                                                                                                                                                                                                                                                                                                                                                                                                                                                                                                                                                                                                                                                                                                                                                                                                                                                                                                                                                                                                                                                                                                                                                                                          |
|--------------------------|-----------------------------------------------------------------------------------------------------------------------------------------------------------------------------------------------------------------------------------------------------------------------------------------------------------------------------------------------------------------------------------------------------------------------------------------------------------------------------------------------------------------------------------------------------------------------------------------------------------------------------------------------------------------------------------------------------------------------------------------------------------------------------------------------------------------------------------------------------------------------------------------------------------------------------------------------------------------------------------------------------------------------------------------------------------------------------------------------------------------------------------------------------------------------------------------------------------------------------------------------------------------------------------------------------------------------------------------------------------------------------------------------------------------------------|
| Admin service blueprints | Add APIC with Admin credentials<br>Add APIC with Tenant credentials<br>Add Provider for Shared Service (Contract)<br>Add or Update Tenant<br>Add VIP Pool<br>Add VMM Domain, AVS Local Switching with Vlan Encap<br>Add VMM Domain, AVS Local Switching with Vxlan Encap<br>Add VMM Domain, AVS No Local Switching<br>Add VMM Domain, AVE Local Switching with Vlan Encap<br>Add VMM Domain, AVE Local Switching with Vxlan Encap<br>Add VMM Domain, AVE No Local Switching<br>Add VMM Domain, DVS and Vlan Pool<br>Add or Delete Bridge Domain in Tenant-common<br>Add or Delete Consumer for Shared Service (Contract)<br>Add or Delete L3 context (VRF) in Tenant-common<br>Add or Delete Router Id<br>Add or Delete Subnets in Bridge Domain for Tenant-Common<br>Update FW Policy (DFW) association to AVS or AVE VMM Domain<br>Configure Property Group<br>Create FW Policy (DFW) and Associate to AVS or AVE VMM Domain<br>Delete APIC<br>Delete FW Policy (DFW)<br>Delete Provider Shared Service (Contract)<br>Delete Tenant<br>Delete VIP Pool<br>Delete VMM Domain, AVS or AVE, and VLAN, Multicast Pool<br>Delete VMM Domain, DVS and Vlan Pool<br>Generate and Add Certificate to APIC<br>Rest API<br>Update FW Policy (DFW) AVS or AVE<br>Update Vlan Pool, AVS or AVE<br>Update Multicast Pool, AVS<br>Update VMM Domain DVS security domain mapping<br>Update AVS or AVE VMM Domain Security Domain Mapping |

| vRA Catalog Category                  | List of Blueprints                                                                                                                                                                                                                                                                                                                                                                                                                                              |
|---------------------------------------|-----------------------------------------------------------------------------------------------------------------------------------------------------------------------------------------------------------------------------------------------------------------------------------------------------------------------------------------------------------------------------------------------------------------------------------------------------------------|
| Tenant Shared Plan service blueprints | Add a Useg Network - Shared Plan<br>Add FW and LB to Tenant Network - Shared Plan<br>Add FW to Tenant Network - Shared Plan<br>Add Loadbalancer to Tenant Network - Shared plan<br>Add Tenant Network - Shared plan<br>Delete a Useg Network - Shared Plan<br>Delete FW and LB from Tenant Network - Shared Plan<br>Delete FW from Tenant Network - Shared Plan<br>Delete Loadbalancer from Tenant Network - Shared Plan<br>Delete Tenant Network - Shared plan |
| Tenant VPC Plan service blueprints    | Add a Useg Network - VPC Plan<br>Add FW and LB to Tenant Network - VPC Plan<br>Add FW to Tenant Network - VPC Plan<br>Add Loadbalancer to Tenant Network - VPC plan<br>Add Tenant Network - VPC plan<br>Delete a Useg Network - VPC Plan<br>Delete FW and LB from Tenant Network - VPC Plan<br>Delete Loadbalancer from Tenant Network - VPC Plan<br>Delete Tenant Network - VPC plan                                                                           |
| Network Security service blueprints   | Add Security Policy (Contracts)<br>Delete Security Policy (Contracts)<br>Update Access List Security Rules                                                                                                                                                                                                                                                                                                                                                      |
| Tenant Network Service blueprints     | Add or Delete Bridge domain in Tenant<br>Add or Delete L3 Context (VRF) in Tenant<br>Add or Delete Subnets in Bridge domain<br>Add or Delete Useg Attribute<br>Attach or Detach L3 external connectivity to Network<br>Update Tenant Network                                                                                                                                                                                                                    |

## ACI Administrator Services in vRealize

This section describes the ACI Administrator Services in vRealize.

### List of Admin Services Catalog Items for ACI Administrator Services

This section provides a list of the admin services catalog items for ACI administrator services.

| Catalog Item                                         | Description                                                                                          |
|------------------------------------------------------|------------------------------------------------------------------------------------------------------|
| Add APIC with Tenant Credentials                     | This creates the Application Policy Infrastructure Controller (APIC) handle with tenant credentials. |
| Add APIC with Admin Credentials                      | This creates the APIC handle with Admin credentials.                                                 |
| Add or Delete Bridge Domain in Tenant-common         | This adds or deletes the bridge domain in tenant-common.                                             |
| Add or Delete Consumer for Shared Service (Contract) | This adds or deletes consumer for shared service (Contract).                                         |
| Add or Delete L3 context (VRF) in Tenant-common      | This adds or deletes Layer 3 context (VRF) in tenant-common.                                         |



| Catalog Item                                             | Description                                                                                                                                                                                                                                                                                 |
|----------------------------------------------------------|---------------------------------------------------------------------------------------------------------------------------------------------------------------------------------------------------------------------------------------------------------------------------------------------|
| Add or Delete Subnets in Bridge Domain for Tenant-Common | This adds or deletes subnets in the bridge domain for tenant-common.                                                                                                                                                                                                                        |
| Add Provider for Shared Service (Contract)               | This adds provider for shared service (Contract).                                                                                                                                                                                                                                           |
| Add or Delete Router Id                                  | This adds or deletes the router Id.                                                                                                                                                                                                                                                         |
| Add or Update Tenant                                     | This adds or updates a tenant.<br><br>If the tenant wants to use the Firewall between EPGs, set "Enable inter-EPG Firewall" to <b>Yes</b> . Also the number application tiers should be set. To use typical 3-tier web, app, db application the number of tiers should be set to <b>3</b> . |
| Add VIP Pool                                             | This adds the Virtual IP Pool.                                                                                                                                                                                                                                                              |
| Configure Property Group                                 | This configures the property group.                                                                                                                                                                                                                                                         |
| Delete APIC                                              | This deletes the APIC.                                                                                                                                                                                                                                                                      |
| Delete Provider Shared Service (Contract)                | This deletes the provider shared service (Contract).                                                                                                                                                                                                                                        |
| Delete Tenant                                            | This deletes a tenant.                                                                                                                                                                                                                                                                      |
| Delete VIP Pool                                          | This deletes the Virtual IP Pool.                                                                                                                                                                                                                                                           |
| Generate and Add Certificate to APIC                     | This blueprints can be used to generate a certificate for a given user. This certificate then be used in the certificate based access to APIC.                                                                                                                                              |
| REST API                                                 | This is the REST API.                                                                                                                                                                                                                                                                       |

This section provides a list of the admin services catalog items for ACI administrator services for the VMM domain type DVS.

| Catalog Item                                  | Description                                                                                                                                                                                                                                                         |
|-----------------------------------------------|---------------------------------------------------------------------------------------------------------------------------------------------------------------------------------------------------------------------------------------------------------------------|
| Add VMM Domain, DVS and VLAN Pool             | This adds VMM Domain, DVS, and VLAN Pool.<br><br>Ensure all hosts of the data-center that has the APIC created DVS in vCenter, must have at least one physical NIC attached. This ensures that the port-groups of the DVS are available for virtual NIC placements. |
| Delete VMM Domain, DVS, and VLAN Pool         | This deletes the VMM Domain, DVS and VLAN Pool.                                                                                                                                                                                                                     |
| Update Vlan Pool (encap blocks)               | This updates the Vlan Pool (encap blocks).                                                                                                                                                                                                                          |
| Update VMM Domain DVS security domain mapping | This updates the VMM Domain DVS security domain mapping.                                                                                                                                                                                                            |

This section provides a list of the admin services catalog items for ACI administrator services for the VMM domain type Cisco AVS or Cisco ACI Virtual Edge (AVE).



**Note** Beginning with Cisco APIC Release 5.0(1), Cisco Application Virtual Switch (AVS) is no longer supported. If you use Cisco AVS and upgrade to Cisco APIC Release 5.0(1), in case of issues, the fabric will not be supported. Also, a fault will be raised for the Cisco AVS domain.

If you use Cisco AVS, we recommend that you migrate to Cisco ACI Virtual Edge. See the *Cisco ACI Virtual Edge Installation Guide* on Cisco.com.

| Catalog Item                                                  | Description                                                                                                                                                                                                                                                                         |
|---------------------------------------------------------------|-------------------------------------------------------------------------------------------------------------------------------------------------------------------------------------------------------------------------------------------------------------------------------------|
| Add VMM Domain, AVS or AVE Local Switching with Vlan Encap    | This creates a VMM domain in Cisco APIC with VLAN as the default encapsulation mode. It also creates a VLAN pool and multicast address pool (in the case of mixed mode). This item also creates an associated Cisco AVS or Cisco ACI Virtual Edge with local switching in vCenter.  |
| Add VMM Domain, AVS or AVE Local Switching with Vxlan Encap   | This creates a VMM domain in Cisco APIC with VXLAN as the default encapsulation mode. It also creates a multicast address pool and VLAN pool (in the case of mixed mode). This item also creates an associated Cisco AVS or Cisco ACI Virtual Edge with local switching in vCenter. |
| Add VMM Domain, AVS or AVE No Local Switching                 | This adds VMM domain, multicast address pool in Cisco APIC and creates an associated Cisco AVS or Cisco ACI Virtual Edge with no local switching in vCenter.                                                                                                                        |
| Update Multicast Pool, AVS or AVE                             | This updates the multicast pool for Cisco AVS or Cisco ACI Virtual Edge VMM domain.                                                                                                                                                                                                 |
| Update VLAN Pool, AVS or AVE                                  | This updates the VLAN pool for the Cisco AVS or Cisco ACI Virtual Edge VMM domain.                                                                                                                                                                                                  |
| Update AVS or AVE VMM Domain Security Domain Mapping          | This updates the security domain mapping of the Cisco AVS or Cisco ACI Virtual Edge VMM domain.                                                                                                                                                                                     |
| Delete VMM Domain AVS or AVE, Vlan, Multicast Pool            | This deletes the Cisco AVS or Cisco ACI Virtual Edge VMM Domain and VLAN Pools and Multicast Pool in Cisco APIC and deletes the associated Cisco AVS or Cisco ACI Virtual Edge in vCenter.                                                                                          |
| Create FW Policy (DFW) and Associate to AVS or AVE VMM Domain | This creates a Distributed Firewall policy and associates it to the Cisco AVS or Cisco ACI Virtual Edge VMM domain.                                                                                                                                                                 |
| Update FW Policy (DFW) association to AVS or AVE VMM Domain   | This associates/dissociates an existing Distributed Firewall policy to the Cisco AVS or Cisco ACI Virtual Edge VMM domain.                                                                                                                                                          |

| Catalog Item           | Description                                            |
|------------------------|--------------------------------------------------------|
| Update FW Policy (DFW) | This updates the existing Distributed Firewall Policy. |
| Delete FW Policy (DFW) | This deletes the existing Distributed Firewall Policy. |

To submit a request:

1. Log in to the vRealize Automation as admin, choose **Catalog > Admin Services**.
2. Choose a request, enter the information in the fields and click **Submit**.

To view your request:

1. In the vRealize Automation GUI, choose **Requests**.
2. Choose the request you submitted and click **view details**.

## ACI Tenant Services in vRealize

This section describes the ACI tenant services in the vRealize.

### List of Network Security Catalog Items for ACI Tenant Services

This section provides a list of the Network Security catalog items for ACI tenant services.

| Catalog Item                       | Description                                                                                                                                                                                                                                                                                                                                                                                                                                                                                                                                                                                                                                                                                   |
|------------------------------------|-----------------------------------------------------------------------------------------------------------------------------------------------------------------------------------------------------------------------------------------------------------------------------------------------------------------------------------------------------------------------------------------------------------------------------------------------------------------------------------------------------------------------------------------------------------------------------------------------------------------------------------------------------------------------------------------------|
| Add Security Policy (Contracts)    | This creates the security policy between tenant networks. For example: APIC contracts between consumer EPG and provider EPG.                                                                                                                                                                                                                                                                                                                                                                                                                                                                                                                                                                  |
| Delete Security Policy (Contracts) | This deletes the security policy between tenant networks. For example: APIC contracts between consumer EPG and provider EPG.                                                                                                                                                                                                                                                                                                                                                                                                                                                                                                                                                                  |
| Update Access List Security Rules  | <p>This adds or removes access list rules associated with a Security Policy Filter created in APIC (using Add Security Policy (Contracts)). The access list rules are of the format &lt;source-port, destination-port, protocol, ethertype&gt;.</p> <p><b>Note</b> The Source and Dest Ports are not allowed for arp, icmp, icmpv6 rules. Ports are valid only for tcp and udp protocols. The access list rules are deployed and enforced in ACI fabric and they are stateless in nature.</p> <p>In addition this blueprint also has an option to update the stateful firewall rules on a Firewall appliance such as Cisco-ASA for a specific service graph that is provided as an input.</p> |

To submit a request:

1. Log in to the vRealize Automation as admin, choose **Catalog > Network Security**.
2. Choose a request, enter the information in the fields and click **Submit**.

To view your request:

1. In the vRealize Automation GUI, choose **Requests**.
2. Choose the request you submitted and click **view details**.

## List of Tenant Network Services Catalog Items for ACI Tenant Services

The following table lists the Tenant Network Services catalog items for ACI tenant services. You must log in to the tenant portal with tenant administrator privileges to execute the Tenant Network Services catalog items.

| Catalog Item                                         | Description                                                             |
|------------------------------------------------------|-------------------------------------------------------------------------|
| Add or Delete Bridge Domain in Tenant                | This adds or deletes the bridge domain in tenant.                       |
| Add or Delete L3 Context (VRF) in Tenant             | This adds or deletes Layer 3 context (VRF) in tenant.                   |
| Add or Delete Subnets in Bridge domain               | This adds or deletes subnets in the bridge domain.                      |
| Attach or Detach L3 external connectivity to Network | This attaches or detaches Layer 3 external connectivity to the network. |
| Update Tenant Network                                | This updates the tenant network.                                        |

The following table lists the Tenant Network Services catalog items for VMM domain of type Cisco AVS and Cisco ACI Virtual Edge only. You must log in to the tenant portal with tenant administrator privileges to execute the Tenant Network Services catalog items.



**Note** Beginning with Cisco APIC Release 5.0(1), Cisco Application Virtual Switch (AVS) is no longer supported. If you use Cisco AVS and upgrade to Cisco APIC Release 5.0(1), in case of issues, the fabric will not be supported. Also, a fault will be raised for the Cisco AVS domain.

If you use Cisco AVS, we recommend that you migrate to Cisco ACI Virtual Edge. See the *Cisco ACI Virtual Edge Installation Guide* on Cisco.com.

| Catalog Item                 | Description                                               |
|------------------------------|-----------------------------------------------------------|
| Add or Delete Useg Attribute | This adds or deletes an attribute for a microsegment EPG. |

To submit a request:

1. Log in to the vRealize Automation as tenant admin, choose **Catalog > Tenant Network Services**.
2. Choose a request, enter the information in the fields and click **Submit**.

To view your request:

1. In the vRealize Automation GUI, choose **Requests**.
2. Choose the request you submitted and click **view details**.

## List of Tenant Shared Plan Catalog Items for ACI Tenant Services

The following table lists the Tenant Shared Plan catalog items for ACI tenant services. You must log in to the tenant portal with tenant administrator privileges to execute the Tenant Shared Plan catalog items.

| Catalog Items                                          | Description                                                                           |
|--------------------------------------------------------|---------------------------------------------------------------------------------------|
| Add Tenant Network                                     | This adds the tenant network in a shared plan.                                        |
| Add FW and LB to Tenant Network - Shared Plan          | This adds a firewall and load balancer to the tenant network in a shared plan.        |
| Add FW to Tenant Network - Shared Plan                 | This adds a firewall to the tenant network in a shared plan.                          |
| Add Load Balancer to Tenant Network - Shared Plan      | This adds load balancer to the tenant network in a shared plan.                       |
| Delete FW and LB from Tenant Network - Shared Plan     | This deletes the firewall and load balancer from the tenant network in a shared plan. |
| Delete FW from Tenant Network - Shared Plan            | This deletes the firewall from the tenant network in a shared plan.                   |
| Delete Load Balancer from Tenant Network - Shared Plan | This deletes load balancer from the tenant network in a shared plan.                  |
| Delete Tenant Network - Shared Plan                    | This deletes the tenant network in a shared plan.                                     |

The following table lists the Tenant Shared Plan catalog items for VMM domain of type Cisco AVS only. You must log in to the tenant portal with tenant administrator privileges to execute the Tenant Shared Plan catalog items.



**Note** Beginning with Cisco APIC Release 5.0(1), Cisco Application Virtual Switch (AVS) is no longer supported. If you use Cisco AVS and upgrade to Cisco APIC Release 5.0(1), in case of issues, the fabric will not be supported. Also, a fault will be raised for the Cisco AVS domain.

If you use Cisco AVS, we recommend that you migrate to Cisco ACI Virtual Edge. See the *Cisco ACI Virtual Edge Installation Guide* on Cisco.com.

| Catalog Item                        | Description                                       |
|-------------------------------------|---------------------------------------------------|
| Add a Useg Network - Shared Plan    | This adds a microsegment EPG in a shared plan.    |
| Delete a Useg network - Shared Plan | This deletes a microsegment EPG in a shared plan. |

To submit a request:

1. Log in to the vRealize Automation as admin, choose **Catalog > Tenant Shared Plan**.
2. Choose a request, enter the information in the fields and click **Submit**.

To view your request:

1. In the vRealize Automation GUI, choose **Requests**.
2. Choose the request you submitted and click **view details**.



**Note** Symptom: You might see errors in the VMware vCenter during the deletion of the service graph through the vRealize Automation (vRA) workflow.

Condition: During the deletion of the service graph, if a port group is deleted before service devices such as VPX or F5 are configured, then these errors are seen. This sequence cannot be controlled through vRA.

Workaround: There is no workaround. These errors are transitory and will stop once the reconfiguration of the service devices is done.

## List of Tenant VPC Plan Catalog Items for ACI Tenant Services

The following table lists the Tenant Virtual Private Cloud (VPC) Plan catalog items for ACI tenant services. You must log in to the tenant portal with tenant administrator privileges to execute the Tenant VPC Plan catalog items

| Catalog Item                                        | Description                                                                    |
|-----------------------------------------------------|--------------------------------------------------------------------------------|
| Add Tenant Network - VPC Plan                       | This adds the tenant network in a VPC plan.                                    |
| Add FW and LB to Tenant Network - VPC Plan          | This adds the firewall and load balancer to the tenant network in a VPC plan.  |
| Add FW to Tenant Network - VPC Plan                 | This adds the firewall to the tenant network in a VPC plan.                    |
| Add Load-balancer to Tenant Network - VPC Plan      | This adds the load balancer to tenant network in a VPC plan.                   |
| Delete FW and LB from Tenant Network - VPC Plan     | This deletes the firewall and load balancer from tenant network in a VPC plan. |
| Delete Load-balancer from Tenant Network - VPC Plan | This deletes load balancer from tenant network in a VPC plan.                  |
| Delete Tenant Network - VPC Plan                    | This deletes the tenant network in a VPC plan.                                 |

The following table lists the Tenant VPC Plan catalog items for VMM domain of type Cisco AVS or Cisco ACI Virtual Edge only. You must log in to the tenant portal with tenant administrator privileges to execute the Tenant VPC Plan catalog items.



**Note** Beginning with Cisco APIC Release 5.0(1), Cisco Application Virtual Switch (AVS) is no longer supported. If you use Cisco AVS and upgrade to Cisco APIC Release 5.0(1), in case of issues, the fabric will not be supported. Also, a fault will be raised for the Cisco AVS domain.

If you use Cisco AVS, we recommend that you migrate to Cisco ACI Virtual Edge. See the *Cisco ACI Virtual Edge Installation Guide* on Cisco.com.

| Catalog Item                     | Description                                    |
|----------------------------------|------------------------------------------------|
| Add a Useg Network - VPC plan    | This adds a microsegment EPG in a VPC plan.    |
| Delete a Useg Network - VPC plan | This deletes a microsegment EPG in a VPC plan. |

To submit a request:

1. Log in to the vRealize Automation as admin, choose **Catalog > Tenant VPC Plan**.
2. Choose a request, enter the information in the fields and click **Submit**.

To view your request:

1. In the vRealize Automation GUI, choose **Requests**.
2. Choose the request you submitted and click **view details**.

## List of VM Services Catalog Items for ACI Tenant Services

This section provides a list of the VM services catalog items for ACI tenant services.

This service category has the tenant catalog items based on single machine and multi-machine blueprints. For example, for typical three tier application, it contains 3 catalog items "Web", "App", "Db" using single-machine blueprints and 1 catalog item "Web-App-Db" using multi-machine blueprint.

| Catalog Item | Description                                                                                                                              |
|--------------|------------------------------------------------------------------------------------------------------------------------------------------|
| App          | This is the application VM.                                                                                                              |
| Db           | This is the database VM.                                                                                                                 |
| Test         | This is the single-machine VM blueprint for testing property groups.                                                                     |
| Web          | This is the web VM.                                                                                                                      |
| Web-Db-App   | This multi-machine blueprint creates a 3-tier application, load balancer attached to the Web tier and the security policy configuration. |

To submit a request:

1. Log in to the vRealize Automation as admin, choose **Catalog > VM Services**.
2. Choose a request, enter the information in the fields and click **Submit**.

To view your request:

1. In the vRealize Automation GUI, choose **Requests**.
2. Choose the request you submitted and click **view details**.

## Entitlements for ACI catalog-items in vRealize

This section describes the entitlements for ACI catalog-items in vRealize. Each service category must have an entitlement. Entitlement enables the catalog items to be available for the users.

You can create and manage entitlements to control the access to the catalog items, actions, and specify the approval policies to apply the catalog requests. You can update the priority of the entitlement to determine which approval policy applies to a particular request.

### List of Entitlements for ACI Catalog Items

This section provides a list of the entitlements for ACI catalog items.

| Name                                 |
|--------------------------------------|
| VMs Entitlements                     |
| Admin Entitlements                   |
| Tenant Shared Plan Entitlements      |
| Tenant VPC Plan Entitlements         |
| Common Network Services Entitlements |
| Tenant Network Services Entitlements |
| Tenant-common Network Services       |
| Network Security Entitlements        |

To edit an entitlement:

1. Log in to the vRealize Automation as admin, choose **Administration > Catalog Management > Entitlements**.
2. Choose an entitlement to edit, enter the information in the fields and click **Update**.

## ACI Plug-in in vRealize Orchestrator

The service category and the catalog item maps to a workflow.

### APIC Workflows

These are the service categories and the catalog items and each catalog items is implemented as a workflow in the vRealize Orchestrator and the catalog items parameter are exactly same as the workflow parameters.



| Service Categories      | Description                                                                                                    |
|-------------------------|----------------------------------------------------------------------------------------------------------------|
| Admin Services          | Admin catalog-items to be executed by the global administrator                                                 |
| Network Security        | Catalog-items for configuring security policies                                                                |
| Tenant Network Services | For configuring network services (bridge-domain, subnets)                                                      |
| Tenant Shared Plan      | For configuring EPG/networks, microsegment EPGs, consuming load balancer, and firewall services in shared mode |
| Tenant VPC Plan         | For configuring EPG/networks, microsegment EPGs, consuming load balancer, and firewall services in VPC mode    |
| VM Services             | Single-machine and multi-machine blueprints configured with ACI property groups                                |

## APIC Inventory View

In the Inventory view of the vRealize Orchestrator GUI, the Cisco APIC Plugin is a read only view. The Cisco APIC Plugin for vRealize Orchestrator maps to the APIC. For example, if you look at an object in the vRealize Orchestrator GUI it provides the MultiApicDn in the Cisco APIC GUI.

The screenshot shows the VMware vRealize Orchestrator GUI. The left pane displays a tree structure of objects, including 'dev5-admin1 (dev5-admin1)' and 'dev5-coke (dev5-coke)'. The right pane shows the 'General' tab for the selected object, displaying properties: MultiApicDn (dev5-admin1:uni/tn-common), Name (common), Description, Health (100), and Faults.

## About Load Balancing and Firewall Services

VLAN, virtual routing and forwarding (VRF) stitching is supported by traditional service insertion models, the Application Policy Infrastructure Controller (APIC) can automate service insertion while acting as a central point of policy control. The APIC policies manage both the network fabric and services appliances. The APIC can configure the network automatically so that traffic flows through the services. The APIC can also automatically configure the service according to the application's requirements, which allows organizations to automate service insertion and eliminate the challenge of managing the complex techniques of traditional service insertion.

Perimeter Firewall is typically used to provide state-full firewall services for all incoming external traffic to the application. Once the traffic passes the firewall, another typical service that is inserted is the load balancing. The external traffic is sent towards, a virtual IP. The load balancer terminates this traffic and load balances the incoming traffic among the available servers (such as web servers) behind the load balancers.

See the *Cisco APIC Layer 4 to Layer 7 Services Deployment Guide* for more information.

APIC vRealize plug-in can be used to create new multi-tier applications while inserting the load balancer and/or firewall services for the traffic between them or it can be used to insert the firewall and load-balancer services for traffic between existing application end-point groups. For creating a multi-tier application with L4-7 services, a property group has to be created using "Configure Property Group" catalog-item in the "Admin Services". In addition of L4-7 services between existing application end-point groups can be done by choosing the appropriate catalog-item from the "Tenant Shared Services" items.



---

**Note** In this release, only support for Shared-Plan is supported for Load balancer and Firewall services.

---

## Prerequisites for Enabling Services

This section describes the prerequisites for enabling services.

You must perform the following tasks to deploy Layer 4 to Layer 7 services using the APIC vRealize plug-in:

- Device package for load balancer needs to be uploaded by APIC admin.

Use the link to download the required Citrix, F5, and Cisco ASA device packages:

<http://www.cisco.com/c/en/us/solutions/collateral/data-center-virtualization/application-centric-infrastructure/solution-overview-c22-734587.html>

Ensure the device package version is certified for the APIC release that you are using.

- Device cluster for load balancer, firewall needs to be created in tenant "common" by APIC-admin. Citrix and F5 are the supported vendors for load balancers. Cisco ASA is the supported vendor for firewall.
- For stand-alone firewall or load balancer service, a service graph template with single node must be configured. For the firewall and load balancer service, a service graph template with two nodes must be configured.
- For the abstract service graph, the firewall node (vnsAbsNode) must be named **FW**, and the load balancer node must be named **SLB**.
- For the load balancer only abstract service graph name (vnsAbsGraph) should be same as the load balancer device cluster (vnsLdevVip).

- For the load balancer only service, the consumer L3 connectivity policy must be configured in the "default" VRF of the tenant common.
- For the firewall, the consumer L3 connectivity policy must be configured in the separate VRF ("outside") of the tenant common.
- The firewall device needs to be deployed in the routed mode. For firewall device connectivity, two additional L3 connectivity policy must be configured. One must be configured in the "outside" VRF, and is used as the external connection to the firewall device. The other must be configured in the "default" VRF and is used as the internal connection to the firewall device. These two L3 connectivity policies, attached to the firewall enables the firewall to do the VRF stitching and re-direct the traffic appropriately between the VRFs. The administrator has to ensure that appropriate prefixes with the correct import and export flags are configured under the L3 external connectivity policies.
- The following convention should be used when configuring the L3 connectivity policies. For the L3 connectivity policy should be named as **L3ExtName**, the child L3 instance should be named as **L3ExtNameInst**.
- The interface IP addresses that are used on the firewall and load balancer devices need to be configured in the abstract graph.
- For the 2-node abstract graph, an access list to permit all traffic needs to be configured for the firewall node.

## Configuring the Services on APIC Using XML POST

Only the administrator can configure and post the XML POST. The template POSTs are located in the `apic-vrealize` package under the `services` directory.

### Before you begin

- The device package file should be uploaded on the Application Policy Infrastructure Controller (APIC). See the *Cisco APIC Layer 4 to Layer 7 Device Package Development Guide* for more information.
- The tenant common should have the two bridge domains named "default" and "vpcDefault". Ensure that the subnets being used by the tenant who is consuming the load balancer are added to these bridge domains. Typically you would have created these bridge domains and subnets while setting up the DHCP infrastructure for vRealize tenants.
- For a non-Virtual Private Cloud (VPC) plan, the backend interface of the load balancer should be placed in the default EPG under the tenant common that was created above. For a VPC plan, the EPG should be "vpcDefault".
- Ensure that the VIP subnet is linked with L3. One VIP per EPG will be allocated from the VIP pool associated with the tenant.
- Prerequisites for the service scripts:
  - Python 2.7
  - Python libraries:
    - jinja2
    - yaml

- glob
- json
- requests
- xml
- re

## Procedure

**Step 1** Use the following link to download the required device packages Citrix, F5, and ASA. Ensure that the device package version is certified for the APIC release that you are using. Store the device package zip files in this directory:

<http://www.cisco.com/c/en/us/solutions/collateral/data-center-virtualization/application-centric-infrastructure/solution-overview-c22-734587.html>

**Step 2** Replace the `VENDOR-DEVICE-PACKAGE.zip` entries in the `shared.cfg` or `vpc.cfg` file with the correct device package files.

**Step 3** Edit the `setup.yaml` file and change the variables to according to your setup.

The template variables in the `setup.yaml` file are:

```
TEMPLATE_VARS:
 VCENTER: "vcenter1"
 ASA_IP: "1.1.1.1"
 ASA_CLUSTER: "AsaCluster1"
 ASA_VM: "asav-service5"
 OUTSIDE_CTX: "outside"
 INSIDE_CTX: "default"
 FW_GRAPH: "FWOnlyGraph"
 FW_SLB_GRAPH: "FWAndSLBGraph"
 BD_WEB: "default"
 CITRIX_MGMT_IP: "1.1.1.1"
 FW_NODE: "FW"
 SLB_NODE: "SLB"
 CITRIX_GRAPH: "CitrixCluster1_L3"
 CITRIX_CLUSTER: "CitrixCluster1_L3"
 CITRIX_GRAPH: "CitrixCluster1_L3"
 CITRIX_VM: "NS-service4"
 F5_BD: "F5Cluster1_L3"
 F5_EPG: "F5Cluster1_L3"
 F5_CLUSTER: "F5Cluster1_L3"
 F5_MGMT_IP: "1.1.1.1"
 F5_GRAPH: "F5Cluster1_L3"
 F5_ABS_NODE: "SLB"
 # Use deleted to generate the "deleted" version of the posts
 # STATUS: "deleted"
 STATUS: ""
```

**Step 4** Enter the following commands:

For Shared Plan:

**Example:**

```
../jinja.py setup.yaml tn-common-template.xml > tn-common.xml
../jinja.py setup.yaml Shared-Plan-Citrix-graph-template.xml > Shared-Plan-Citrix-graph.xml
../jinja.py setup.yaml Shared-Plan-F5-graph-template.xml > Shared-Plan-F5-graph.xml
```

For VPC Plan:

**Example:**

```
../jinja.py setup.yaml VPC-tn-common-template.xml > VPC-tn-common.xml
../jinja.py setup.yaml VPC-Plan-Citrix-LB-graph-template.xml > VPC-Plan-Citrix-LB-graph.xml
../jinja.py setup.yaml VPC-Plan-F5-LB-graph-template.xml > VPC-Plan-F5-LB-graph.xml
```

If you see python errors, ensure that the prerequisite python libraries are installed in the system.

**Step 5** Edit the `shared.cfg` or `vpc.cfg` file and set the values for `hosts`: `<YOUR_APIC_IP>` and `passwd`: `<YOUR_APIC_ADMIN_PASSWD>`.

Sample of the `shared.cfg` file:

**Example:**

```
host: <YOUR_APIC_IP>:443
name: admin
passwd: <YOUR_APIC_ADMIN_PASSWD>
tests:
 - type: file
 path: /ppi/node/mo/.xml
 file: asa-device-pkg-1.2.2.1.zip
 # Replace actual ASA Device package file in the line below
 file: ASA-DEVICE-PACKAGE.zip
 wait: 2
 - type: file
 path: /ppi/node/mo/.xml
 # file: CitrixNetscalerPackage.zip
 # Replace actual Citrix Device package file in the line below
 file: CITRIX-DEVICE-PACKAGE.zip
 wait: 2
 - type: file
 path: /ppi/node/mo/.xml
 # file: CitrixNetscalerPackage.zip
 # Replace actual F5 Device package file in the line below
 file: F5-DEVICE-PACKAGE.zip
 wait: 2
 - type: xml
 path: /api/node/mo/.xml
 file: tn-common.xml
 wait: 0
 - type: xml
 path: /api/node/mo/.xml
 file: Shared-Plan-Citrix-graph.xml
 wait: 0
 - type: xml
 path: /api/node/mo/.xml
 file: Shared-Plan-F5-graph.xml
 wait: 0
```

**Step 6** Post the templates.

For Shared Plan, enter the following command:

**Example:**

```
../request.py shared.cfg
```

For VPC Plan, enter the following command:

**Example:**

```
../request.py vpc.cfg
```

## Deleting the Services Configuration

This section describes how to delete the services configuration. Only the administrator can configure and post the XML POST. The template POSTs are located in the `apic-vrealize` package under the `services` directory.

### Procedure

- 
- Step 1** Edit the `shared.cfg` file and set the values for `hosts`: `<YOUR_APIC_IP>` and `passwd`: `<YOUR_APIC_ADMIN_PASSWD>`.
- Step 2** Edit the `setup.yaml` file and set the `STATUS` variable to `deleted` to generate the deleted version of the posts.
- Step 3** Run the following commands:
- ```
./jinja.py setup.yaml tn-common-template.xml > tn-common-del.xml
./jinja.py setup.yaml Shared-Plan-Citrix-graph-template.xml > Shared-Plan-Citrix-graph-del.xml
./jinja.py setup.yaml Shared-Plan-F5-graph-template.xml > Shared-Plan-F5-graph-del.xml
```
- Step 4** Post the templates:
- ```
../request.py shared_del.cfg
```
- 

## About L3 External Connectivity

Layer 3 (L3) external connectivity is an Cisco Application Centric Infrastructure (ACI) feature to connect ACI fabric to an external network by L3 routing protocols, including static routing, OSPF, EIGRP, and BGP. By setting up L3 external connectivity for vRealize, it allows a tenant network to initiate outgoing traffic destined outside the fabric and to attract traffic from outside. The assumption of this feature is the tenant virtual machine IP addresses are visible outside the fabric without NAT, ACI L3 external connectivity does not include NAT.

### Prerequisites for Configuring L3 External Connectivity for vRealize

To configure Layer 3 (L3) external connectivity for vRealize, you must meet the following prerequisites:

- Ensure you have logged in to the Application Policy Infrastructure Controller (APIC) GUI, on the menu bar, choose **Tenant > common**.
  - Create a l3ExtOut called “**default**”, refer to BD “**default**”.

- Create l3extInstP name="**defaultInstP**" under the l3ExtOut. This is to be used by shared service tenants.

See for L3 external connectivity configuration.

- Ensure you have logged in to the APIC GUI, on the menu bar, choose **Tenant** > **common**.
  - Create a l3ExtOut called "**vpcDefault**", refer to BD "**vpcDefault**".
  - Create l3extInstP name="**vpcDefaultInstP**" under this l3ExtOut.  
This is to be used by VPC tenants.

See *Cisco APIC Basic Configuration Guide* for configuring external connectivity for tenants.

vRealize leverages the common l3ExtOut configuration with no special requirement other than the naming convention highlighted above

## Administrator Experiences



---

**Note** Beginning with Cisco Application Policy Infrastructure Controller (APIC) Release 5.0(1), Cisco Application Virtual Switch (AVS) is no longer supported. If you use Cisco AVS and upgrade to Cisco APIC Release 5.0(1), in case of issues, the fabric will not be supported. Also, a fault will be raised for the Cisco AVS domain.

If you use Cisco AVS, we recommend that you migrate to Cisco Application Centric Infrastructure (ACI) Virtual Edge Virtual Edge. See the *Cisco ACI Virtual Edge Installation Guide, Release 3.0(x)* on Cisco.com.

---

### Cisco ACI with Cisco AVS or Cisco ACI Virtual Edge

See the following documentation for general information about Cisco Application Virtual Switch (AVS) or Cisco ACI Virtual Edge:

- Cisco AVS: See the [Cisco AVS guides](#) on Cisco.com



---

**Note** Beginning with Cisco APIC Release 5.0(1), Cisco Application Virtual Switch (AVS) is no longer supported. If you use Cisco AVS and upgrade to Cisco APIC Release 5.0(1), in case of issues, the fabric will not be supported. Also, a fault will be raised for the Cisco AVS domain.

If you use Cisco AVS, we recommend that you migrate to Cisco ACI Virtual Edge. See the *Cisco ACI Virtual Edge Installation Guide* on Cisco.com.

---

- Cisco ACI Virtual Edge: See the [Cisco ACI Virtual Edge documentation](#) on Cisco.com.

### Cisco AVS or Cisco ACI Virtual Edge VMM Domain Creation

You can create VMM domains for Cisco AVS or Cisco ACI Virtual Edge using VLAN or VXLAN encapsulation or with no local switching.



**Note** Beginning with Cisco APIC Release 5.0(1), Cisco Application Virtual Switch (AVS) is no longer supported. If you use Cisco AVS and upgrade to Cisco APIC Release 5.0(1), in case of issues, the fabric will not be supported. Also, a fault will be raised for the Cisco AVS domain.

If you use Cisco AVS, we recommend that you migrate to Cisco ACI Virtual Edge. See the *Cisco ACI Virtual Edge Installation Guide* on Cisco.com.

Beginning with Cisco APIC Release 2.1(1), you can mix encapsulation modes. That is, you can configure a VMM domain to use VLAN or VXLAN and later add EPGs that override the domain's default encapsulation. For details, see the section "Mixed-Mode Encapsulation Configuration" in the [Cisco Application Virtual Switch Configuration Guide](#) or the chapter "Mixed-Mode Encapsulation" in the [Cisco ACI Virtual Edge Configuration Guide](#).

You also can create a Cisco AVS or Cisco ACI Virtual Edge VMM domain with no local switching. In local switching mode, the leaf forwards all traffic, and VXLAN is the only allowed encapsulation type. See the [Cisco Application Virtual Switch Installation Guide](#) or the [Cisco ACI Virtual Edge Installation Guide](#).

After you create a Cisco AVS or Cisco ACI Virtual Edge VMM domain, you can update the domain's encapsulation pools and delete the Cisco AVS or Cisco ACI Virtual Edge and the VMM domain.

## Creating a Cisco AVS or Cisco ACI Virtual Edge VMM Domain

This section shows how to create a Cisco AVS or a Cisco ACI Virtual Edge VMM Domain supporting no encapsulation, VLAN, or VXLAN encapsulation. When you choose the virtual switch (**Cisco AVS** or **Cisco AVE**) and the switching preference (**Local Switching** or **No Local Switching**), the vRealize GUI shows or hides mandatory or optional field inputs.



**Note** Beginning with Cisco APIC Release 5.0(1), Cisco Application Virtual Switch (AVS) is no longer supported. If you use Cisco AVS and upgrade to Cisco APIC Release 5.0(1), in case of issues, the fabric will not be supported. Also, a fault will be raised for the Cisco AVS domain.

If you use Cisco AVS, we recommend that you migrate to Cisco ACI Virtual Edge. See the *Cisco ACI Virtual Edge Installation Guide* on Cisco.com.

### Before you begin

We recommend that you created an attachable access entity profile (AAEP) as part of day-0 operation of Cisco ACI.

### Procedure

- 
- Step 1** Log in to vRealize Automation as the administrator and then choose **Catalog**.
- Step 2** Choose **Add VMM Domain** and **AVS** or **AVE**.
- Step 3** In the **New Request** dialog box, complete the following steps:
- View the Service Blueprint Information for the input fields and then click **Request**.
  - In the **Request Information** pane, add a description and then click **Next**.
  - In the **Domain name** field, enter the VMM domain name.



- d) For the **Virtual Switch** selector, choose **Cisco AVS** or **Cisco AVE**.
  - e) For the **Switching Preference** selector, choose **Lo Local Switching** or **Local Switching**.
  - f) If you chose **Local Switching**, for the **Encap mode** selector choose **VLAN** or **VXLAN**.  
**Encap mode** is applicable only for **Local Switching**.
  - g) In the **AAEP Name** field, enter an attachable access entity profile (AAEP) name to associate it to the VMM domain.  
If the AAEP that you enter doesn't exist, it is created.
  - h) For the **VLAN Ranges** to be allocated, click **Not set** and then add values to create VLANs.  
For **Encap\_Block\_Role**, specify **external** or **internal**.
  - i) (Optional) In the **AVS Fabric-wide Multicast Address** or **AVE Fabric-wide Multicast Address** field, enter a valid multicast address between 224.0.0.0 and 239.255.255.255, inclusive, for the multicast address block range.
  - j) (Optional) In the **Multicast Address Start** field, enter the starting multicast address between 224.0.0.0 and 239.255.255.255, inclusive, for the multicast address block range.
  - k) (Optional) In the **Multicast Address End** field, between 224.0.0.0 and 239.255.255.255, inclusive, for the multicast address block range.
  - l) In the **AAA Domain** area, click the green cross, choose a security domain, and then click **Next**.
  - m) In the **vcenter IP (or Hostname)** field, enter the host name or IP address.  
If you use the host name, you already must have configured a DNS policy on Cisco APIC. If you do not have a DNS policy configured, enter the IP address of the vCenter server.
  - n) From the **DVS Version** drop-down list, choose the DVS version.
  - o) In the **Username** field, enter the user name for logging in to the vCenter.
  - p) In the **Password** field, enter the password for logging into the vCenter.
  - q) In the **vCenter Datacenter** field, enter the data center name.
- Note** The name that you enter for the data center must match exactly the name in vCenter. The name is case-sensitive.

---

## Verifying Cisco AVS or Cisco ACI Virtual Edge Creation in vCenter



- Note** Beginning with Cisco APIC Release 5.0(1), Cisco Application Virtual Switch (AVS) is no longer supported. If you use Cisco AVS and upgrade to Cisco APIC Release 5.0(1), in case of issues, the fabric will not be supported. Also, a fault will be raised for the Cisco AVS domain.
- If you use Cisco AVS, we recommend that you migrate to Cisco ACI Virtual Edge. See the *Cisco ACI Virtual Edge Installation Guide* on Cisco.com.

---

### Procedure

- Step 1** Open a vSphere Client connection to a vCenter server.
- Step 2** In vCenter, choose **Home > Inventory > Networking** view.

- Step 3** Choose the data center.
- Step 4** Under the data center, ensure that the Cisco AVS or the Cisco ACI Virtual Edge and its folder are created.

### Verifying Creation of the Cisco AVS or Cisco ACI Virtual Edge VMM Domain on Cisco APIC



**Note** Beginning with Cisco APIC Release 5.0(1), Cisco Application Virtual Switch (AVS) is no longer supported. If you use Cisco AVS and upgrade to Cisco APIC Release 5.0(1), in case of issues, the fabric will not be supported. Also, a fault will be raised for the Cisco AVS domain.

If you use Cisco AVS, we recommend that you migrate to Cisco ACI Virtual Edge. See the *Cisco ACI Virtual Edge Installation Guide* on Cisco.com.

#### Procedure

- Step 1** Log in to Cisco APIC as the administrator.
- Step 2** Choose **Virtual Networking > Inventory**.
- Step 3** In the **Inventory** navigation pane, choose **VMM Domains > VMware**.
- Step 4** In the work pane, under **Properties**, in the **vCenter Domains** field, ensure that the newly created VMM domain is listed.

### Update of Cisco AVS or Cisco ACI Virtual Edge VMM Domain Encapsulation Pools

After you create a Cisco AVS VMM or Cisco ACI Virtual Edge domain, you can update VLAN or multicast address pools. You should then verify the update.



**Note** Beginning with Cisco APIC Release 5.0(1), Cisco Application Virtual Switch (AVS) is no longer supported. If you use Cisco AVS and upgrade to Cisco APIC Release 5.0(1), in case of issues, the fabric will not be supported. Also, a fault will be raised for the Cisco AVS domain.

If you use Cisco AVS, we recommend that you migrate to Cisco ACI Virtual Edge. See the *Cisco ACI Virtual Edge Installation Guide* on Cisco.com.

### Updating the VLAN Pool of a Cisco AVS or Cisco ACI Virtual Edge VMM Domain



**Note** Beginning with Cisco APIC Release 5.0(1), Cisco Application Virtual Switch (AVS) is no longer supported. If you use Cisco AVS and upgrade to Cisco APIC Release 5.0(1), in case of issues, the fabric will not be supported. Also, a fault will be raised for the Cisco AVS domain.

If you use Cisco AVS, we recommend that you migrate to Cisco ACI Virtual Edge. See the *Cisco ACI Virtual Edge Installation Guide* on Cisco.com.

## Procedure

---

**Step 1** Log in to the vRealize Automation as the administrator and then choose **Catalog**.

**Step 2** Choose **Update Vlan Pool, AVS** or **Update Vlan Pool, AVE**.

**Note** This update operation is only supported for dynamic VLAN pools. Static VLAN pools are not supported.

**Step 3** View the Service Blueprint Information for the input fields and then click **Request**.

**Step 4** In the **New Request** dialog box, complete the following steps:

- a) Add the description and then click **Next**.
  - b) In the **Vlan Pool Name** field, enter the name of the existing VLAN pool.
  - c) In the **List of encap blocks** area, click the green cross next to **New**.
  - d) For each Encap block, in the **VlanStart** column, enter the starting VLAN.
  - e) In the **VlanEnd** column, enter the ending VLAN.
  - f) For **encapRole**, specify **external** or **internal**.
  - g) Tick the check box in **IsAddoperation** to add encap blocks to the VLAN pool.  
Leave the check box unchecked to remove an entered encap block from a VLAN pool.
  - h) Click **Submit**.
- 

## What to do next

Complete the procedure [Verifying the Update of the VLAN Pool of a Cisco AVS or Cisco ACI Virtual Edge VMM Domain in Cisco APIC](#), on page 147.

## Verifying the Update of the VLAN Pool of a Cisco AVS or Cisco ACI Virtual Edge VMM Domain in Cisco APIC



**Note** Beginning with Cisco APIC Release 5.0(1), Cisco Application Virtual Switch (AVS) is no longer supported. If you use Cisco AVS and upgrade to Cisco APIC Release 5.0(1), in case of issues, the fabric will not be supported. Also, a fault will be raised for the Cisco AVS domain.

If you use Cisco AVS, we recommend that you migrate to Cisco ACI Virtual Edge. See the *Cisco ACI Virtual Edge Installation Guide* on Cisco.com.

---

## Procedure

---

**Step 1** Log in to Cisco APIC as the administrator.

**Step 2** Choose **Fabric > Access Policies**.

**Step 3** In the **Policies** navigation pane, expand the **Pools** folder.

**Step 4** Expand the **VLAN** folder.

**Step 5** Choose the VLAN pool.

**Step 6** In the work pane, ensure that the VLAN pool is updated.

---

## Updating the Multicast Address Pool of a Cisco AVS or Cisco ACI Virtual Edge VMM Domain

### Procedure

---

- Step 1** Log in to vRealize Automation as the administrator and then choose **Catalog**.
- Step 2** Choose **Update Multicast Pool, AVS or AVE**.
- Step 3** View the Service Blueprint Information for the input fields and then click **Request**.
- Step 4** In the **New Request** dialog box, complete the following steps:
- In the **Multicast Pool Name** field, enter the name of the existing multicast address pool.
  - In the **List of Multicast Address Range** area, click the green cross next to **New**.
  - For each multicast address block, enter the starting multicast address between 224.0.0.0 and 239.255.255.255, inclusive, in the **MulticastAddressStart** column.
  - In the **MulticastAddressEnd** column, enter the ending multicast address between 224.0.0.0 and 239.255.255.255, inclusive.
  - Check the check box in the column **IsAddOperation** to add multicast address blocks to the multicast address pool.  
  
Leave the check box unchecked to remove an entered multicast address block from the multicast address pool.
  - Click **Submit**.
- 

### What to do next

Complete the procedure [Verifying the Update of a Multicast Address Pool on Cisco APIC](#) , on page 148.

## Verifying the Update of a Multicast Address Pool on Cisco APIC

### Procedure

---

- Step 1** Log in to Cisco APIC as the administrator.
- Step 2** Choose **Fabric > Access Policies**.
- Step 3** in the **Policies** navigation pane, expand the **Pools** folder.
- Step 4** Expand the **Multicast Address** folder.
- Step 5** Choose the multicast address pool.
- Step 6** In the work pane, ensure that the multicast address pool is updated.
- 

## Deletion of Cisco AVS or Cisco ACI Virtual Edge and the VMM Domain

You can delete the Cisco AVS or Cisco ACI Virtual Edge and the VMM domain. After you do so, you should verify the deletion.



---

**Note** Beginning with Cisco APIC Release 5.0(1), Cisco Application Virtual Switch (AVS) is no longer supported. If you use Cisco AVS and upgrade to Cisco APIC Release 5.0(1), in case of issues, the fabric will not be supported. Also, a fault will be raised for the Cisco AVS domain.

If you use Cisco AVS, we recommend that you migrate to Cisco ACI Virtual Edge. See the *Cisco ACI Virtual Edge Installation Guide* on Cisco.com.

---

## Deleting the Cisco AVS or Cisco ACI Virtual Edge and the VMM Domain



---

**Note** Beginning with Cisco APIC Release 5.0(1), Cisco Application Virtual Switch (AVS) is no longer supported. If you use Cisco AVS and upgrade to Cisco APIC Release 5.0(1), in case of issues, the fabric will not be supported. Also, a fault will be raised for the Cisco AVS domain.

If you use Cisco AVS, we recommend that you migrate to Cisco ACI Virtual Edge. See the *Cisco ACI Virtual Edge Installation Guide* on Cisco.com.

---

### Procedure

- 
- Step 1** Log in to vRealize Automation as the administrator and then choose **Catalog**.
- Step 2** Choose **Delete VMM Domain, AVS or AVE**.
- Step 3** View the Service Blueprint Information for the input fields and then click **Request**.
- Step 4** In the **New Request** dialog box, complete the following steps:

- Add a description and then click **Next**.
- In the **Domain name** field, enter the name of the VMM domain that you want to delete.

**Note** If the VMM domain has an associated multicast address pool (*Domain/AVS or AVE name\_mcastpool*) or a VLAN pool (*Domain/AVS or AVE name\_vlanpool*), it also will be deleted.

- Click **Submit**.
- 

### What to do next

Complete the following procedures:

- [Verifying Cisco AVS or Cisco ACI Virtual Edge Deletion in vCenter, on page 150](#)
- [Verifying VMM Domain Deletion on Cisco APIC, on page 150](#)
- [Verifying VLAN Pool Deletion on Cisco APIC, on page 150](#)
- [Verifying Multicast Address Pool Deletion on Cisco APIC, on page 151](#)

## Verifying Cisco AVS or Cisco ACI Virtual Edge Deletion in vCenter



---

**Note** Beginning with Cisco APIC Release 5.0(1), Cisco Application Virtual Switch (AVS) is no longer supported. If you use Cisco AVS and upgrade to Cisco APIC Release 5.0(1), in case of issues, the fabric will not be supported. Also, a fault will be raised for the Cisco AVS domain.

If you use Cisco AVS, we recommend that you migrate to Cisco ACI Virtual Edge. See the *Cisco ACI Virtual Edge Installation Guide* on Cisco.com.

---

### Procedure

---

- Step 1** Open a vSphere Client connection to a vCenter server.
  - Step 2** In vCenter, choose **Home > Inventory > Networking** view.
  - Step 3** Choose the data center.
  - Step 4** Under the data center, ensure that the Cisco AVS or Cisco ACI Virtual Edge and its folder are deleted.
- 

## Verifying VMM Domain Deletion on Cisco APIC

### Procedure

---

- Step 1** Log in to Cisco APIC as the administrator.
  - Step 2** Choose **Virtual Networking > Inventory**.
  - Step 3** In the **Inventory** navigation pane, expand the **VMM Domains** folder and the **VMware** folder.
  - Step 4** Under **VMware**, ensure that the deleted VMM domain is not present.
- 

## Verifying VLAN Pool Deletion on Cisco APIC

### Procedure

---

- Step 1** Log in to Cisco APIC as the administrator.
  - Step 2** Choose **Fabric > Access Policies**
  - Step 3** In the **Policies** navigation pane, expand the **Pools** folder.
  - Step 4** Choose the **VLAN** folder.
  - Step 5** In the work pane, under **Pools - VLAN**, ensure that the VLAN pool (*Domain/AVS name\_vlanpool*) is deleted.
-

## Verifying Multicast Address Pool Deletion on Cisco APIC

### Procedure

- 
- Step 1** Log in to Cisco APIC as the administrator.
  - Step 2** Choose **Fabric > Access Policies**.
  - Step 3** In the **Policies** navigation pane, expand the **Pools** folder.
  - Step 4** Choose the **Multicast Address** folder.
  - Step 5** In the work pane, under **Pools - Multicast Address**, ensure that the multicast address pool (*Domain/AVS or AVE name\_mcastpool*) is deleted.
- 

## Cisco AVS or Cisco ACI Virtual Edge VMM Domain Security Domain Mapping

You can update the security domain mapping for the Cisco AVS or Cisco ACI Virtual Edge VMM domain.



---

**Note** Beginning with Cisco APIC Release 5.0(1), Cisco Application Virtual Switch (AVS) is no longer supported. If you use Cisco AVS and upgrade to Cisco APIC Release 5.0(1), in case of issues, the fabric will not be supported. Also, a fault will be raised for the Cisco AVS domain.

If you use Cisco AVS, we recommend that you migrate to Cisco ACI Virtual Edge. See the *Cisco ACI Virtual Edge Installation Guide* on Cisco.com.

---

## Updating the Security Domain Mapping of the Cisco AVS or Cisco ACI Virtual Edge VMM Domain



---

**Note** Beginning with Cisco APIC Release 5.0(1), Cisco Application Virtual Switch (AVS) is no longer supported. If you use Cisco AVS and upgrade to Cisco APIC Release 5.0(1), in case of issues, the fabric will not be supported. Also, a fault will be raised for the Cisco AVS domain.

If you use Cisco AVS, we recommend that you migrate to Cisco ACI Virtual Edge. See the *Cisco ACI Virtual Edge Installation Guide* on Cisco.com.

---

### Procedure

- 
- Step 1** Log in to vRealize Automation as the administrator and then choose **Catalog**.
  - Step 2** Choose **Update AVS or AVE VMM Domain Security Domain Mapping** and complete the following steps:
    - a) View the Service Blueprint Information for the input fields and then click **Request**.
    - b) In the **Request Information** pane, add a description and then click **Next**.
    - c) In the **AVS/VMM-domain name** field, enter the VMM domain name.
    - d) In the **AAA Domain list** table, click **New** and enter the AAA domain name.

For each entry, specify the existing security domain in the **aaaDomainName** column. Check the check box in the **IsAddOperation** column to add the AVS or AVE VMM domain to the AAA domain. If unchecked, the AVS or AVE VMM domain is removed from the AAA domain.

e) Click **Submit**.

---

### What to do next

Complete the procedure [Verifying the Security Domain Mapping of the Cisco AVS or Cisco ACI Virtual Edge VMM Domain, on page 152](#).

### Verifying the Security Domain Mapping of the Cisco AVS or Cisco ACI Virtual Edge VMM Domain



---

**Note** Beginning with Cisco APIC Release 5.0(1), Cisco Application Virtual Switch (AVS) is no longer supported. If you use Cisco AVS and upgrade to Cisco APIC Release 5.0(1), in case of issues, the fabric will not be supported. Also, a fault will be raised for the Cisco AVS domain.

If you use Cisco AVS, we recommend that you migrate to Cisco ACI Virtual Edge. See the *Cisco ACI Virtual Edge Installation Guide* on Cisco.com.

---

### Procedure

- 
- Step 1** Log in to Cisco APIC as the administrator.
  - Step 2** Choose **Virtual Networking > Inventory > VMM Domains > VMware**.
  - Step 3** Choose the VMM domain.
  - Step 4** In the work pane, under **Properties**, ensure that the **Security Domains** field has been updated.
- 

## Distributed Firewall Policy

You can create, update, and delete a Distributed Firewall (DFW) policy and update the DFW policy association with the Cisco AVS or Cisco ACI Virtual Edge VMM domain.

For detailed information about Distributed Firewall, see the one of the following:

- The section "Distributed Firewall in the [Cisco ACI AVS Configuration Guide](#)
- The chapter "Distributed Firewall" in the [Cisco ACI Virtual Edge Configuration Guide](#)



---

**Note** Beginning with Cisco APIC Release 5.0(1), Cisco Application Virtual Switch (AVS) is no longer supported. If you use Cisco AVS and upgrade to Cisco APIC Release 5.0(1), in case of issues, the fabric will not be supported. Also, a fault will be raised for the Cisco AVS domain.

If you use Cisco AVS, we recommend that you migrate to Cisco ACI Virtual Edge. See the *Cisco ACI Virtual Edge Installation Guide* on Cisco.com.

---



## Creating a Distributed Firewall Policy

This section describes how to create a DFW policy and associate it with a Cisco AVS or Cisco ACI Virtual Edge VMM domain.

### Procedure

- 
- Step 1** Log in to vRealize Automation as the administrator and then choose **Catalog**.
- Step 2** Choose **Create FW Policy (DFW) and Associate to AVS or AVE VMM Domain** and complete the following steps:
- View the Service Blueprint Information for the input fields and then click **Request**.
  - In the **Request Information** pane, add the description and click **Next**.
  - In the **FW Policy Name** field, enter a name for the policy.
  - From the **Mode** drop-down list, choose **Learning**, **Enabled**, or **Disabled**.
    - Learning**—Cisco AVS or Cisco ACI Virtual Edge monitors all TCP communication and creates flows in a flow table but does not enforce the firewall. Learning mode lets you enable the firewall without losing traffic.
    - Enabled**—Enforces the Distributed Firewall. If you upgrade from an earlier version of Cisco AVS—one that does not support Distributed Firewall—and are upgrading Cisco AVS only, you must first upgrade all the Cisco AVS hosts in that VMM domain and then enable Distributed Firewall.
    - Disabled**—Does not enforce the Distributed Firewall and removes all flow information from the Cisco AVS or Cisco ACI Virtual Edge. Choose this mode only if you do not want to use the Distributed Firewall.
  - In the **VMM Name** field, enter the name of the existing Cisco AVS or Cisco ACI Virtual Edge VMM domain to which you want to associate the DFW policy and then click **Next**.
  - In the **Syslog Form** page, choose **Disabled** or **Enabled** from the **Administrative State** drop-down list.
  - Cisco AVS or Cisco ACI Virtual Edge reports the flows that are permitted or denied by the Distributed Firewall to the system log (syslog) server. Do the following:
    - From the **Permitted flows** drop-down list, choose **yes** if you want Cisco AVS or Cisco ACI Virtual Edge to report permitted flows to the syslog server. Choose **no** if you do not want Cisco AVS or Cisco ACI Virtual Edge to report permitted flows to the syslog server.
    - From the **Denied flows** drop-down list, choose **yes** if you want Cisco AVS or Cisco ACI Virtual Edge to report denied flows to the syslog server. Choose **no** if you do not want Cisco AVS or Cisco ACI Virtual Edge to report denied flows to the syslog server.
  - In the **Polling Interval (seconds)** area, enter an interval from 60 to 86,400 seconds.
  - From the **Log Level** drop-down list, choose a logging severity level that is greater than or equal to the severity level defined for the syslog server.
  - In the **Dest Group** area, enter an existing syslog monitoring destination group.
  - Click **Submit**.
-

**What to do next**

Complete the procedure [Verifying Distributed Firewall Policy Creation on Cisco APIC, on page 154](#).

*Verifying Distributed Firewall Policy Creation on Cisco APIC*

This section describes how to verify the creation of a distributed firewall policy on Cisco APIC.

**Procedure**

- 
- Step 1** Log in to Cisco APIC as the administrator.
  - Step 2** Choose **Fabric > Access Policies**.
  - Step 3** In the **Policies** navigation pane, choose **Policies > Interface > Firewall**.
  - Step 4** In the work pane, under **Interface - Firewall**, confirm that the corresponding firewall policy is created.
  - Step 5** To view the distributed firewall policy association with a VMM domain, do the following:
    - a) Choose **Virtual Networking > Inventory > VMM Domains > VMware**.
    - b) Click the corresponding VMM domain.
    - c) In the work pane, click **VSwitch Policy**, and then confirm that the created distributed firewall policy is present in the **Firewall Policy** field.
- 

**Updating a Distributed Firewall Policy**

This section describes how to update an existing DFW policy.

**Procedure**

- 
- Step 1** Log in to vRealize Automation as the administrator and then choose **Catalog**.
  - Step 2** Choose **Update FW Policy (DFW)** and complete the following steps:
 

In the service blueprint, some drop-down lists have a **<NO CHANGE>** option that you can choose if you do not want to change the configured value.

    - a) View the Service Blueprint Information for the input fields and then click **Request**.
    - b) In the **Request Information** pane, add the description and click **Next**.
    - c) In the **FW Policy Name** field, enter an updated name for the policy.
    - d) From the **Mode** drop-down list, choose **Learning, Enabled, Disabled**, or **<NO CHANGE>**. Click **Next**.
    - e) In the **Syslog Form** page, choose **Disabled, Enabled**, or **<NO CHANGE>** from the **Administrative State** drop-down list.
    - f) From the **Permitted flows** drop-down list, choose **yes, no**, or **<NO CHANGE>**.
    - g) From the **Denied flows** drop-down list, choose **yes, no**, or **<NO CHANGE>**.
    - h) In the **Polling Interval (seconds)** area, update the interval to a value from 60 to 86,400 seconds.

**Note** If you do not specify an interval, no update occurs.

    - i) From the **Log Level** drop-down list, choose a logging severity level that is greater than or equal to the severity level defined for the syslog server. Choose **<NO CHANGE>** if you do not want to change the log level.
    - j) In the **Dest Group** area, enter a new or existing syslog monitoring destination group.

**Note** If you do not enter a new or existing syslog monitoring destination group, no update occurs.

k) Click **Submit**.

---

### *Verifying a Distributed Firewall Policy Update on Cisco APIC*

This section describes how to verify an update to a distributed firewall policy on Cisco APIC.

#### **Procedure**

---

- Step 1** Log in to Cisco APIC as the administrator.
  - Step 2** Choose **Fabric > Access Policies**.
  - Step 3** In the **Policies** navigation pane, choose **Policies > Interface > Firewall**.
  - Step 4** In the work pane, under **Interface - Firewall**, double-click the required firewall policy and confirm that it is updated.
- 

### **Deleting a Distributed Firewall Policy**

This section describes how to delete a DFW policy.

#### **Procedure**

---

- Step 1** Log in to vRealize Automation as the administrator and then choose **Catalog**.
  - Step 2** Choose **Delete FW Policy (DFW)** and complete the following steps:
    - a) View the Service Blueprint Information for the input fields and then click **Request**.
    - b) In the **Request Information** pane, add the description and click **Next**.
    - c) In the **FW Policy Name** field, enter the name of the DFW policy that you want to delete.
    - d) Click **Submit**.
- 

### *Verifying a Distributed Firewall Policy Deletion on Cisco APIC*

This section describes how to verify the deletion of a distributed firewall policy on Application Policy Infrastructure Controller.

#### **Procedure**

---

- Step 1** Log in to Cisco APIC.
  - Step 2** Choose **Fabric > Access Policies**.
  - Step 3** In the **Policies** navigation pane, choose **Policies > Interface > Firewall**.
  - Step 4** In the work pane, under **Interface - Firewall**, confirm that the deleted firewall policy is not present.
-

## Updating a Distributed Firewall Policy Association with the Cisco AVS or Cisco ACI Virtual Edge VMM Domain

This section describes how to update a DFW policy that is associated with a Cisco AVS or Cisco ACI Virtual Edge VMM domain.



**Note** Beginning with Cisco APIC Release 5.0(1), Cisco Application Virtual Switch (AVS) is no longer supported. If you use Cisco AVS and upgrade to Cisco APIC Release 5.0(1), in case of issues, the fabric will not be supported. Also, a fault will be raised for the Cisco AVS domain.

If you use Cisco AVS, we recommend that you migrate to Cisco ACI Virtual Edge. See the *Cisco ACI Virtual Edge Installation Guide* on Cisco.com.

### Procedure

- 
- Step 1** Log in to vRealize Automation as the administrator and then choose **Catalog**.
- Step 2** Choose **Update FW Policy (DFW) association to AVS or AVE VMM Domain** and complete the following steps:
- a) View the Service Blueprint Information for the input fields and then click **Request**.
  - b) In the **Request Information** pane, add the description and click **Next**.
  - c) In the **FW Policy Name** field, enter a name for the policy.
  - d) In the **VMM Domain name** field, enter an existing Cisco AVS or Cisco ACI Virtual Edge VMM domain name.
  - e) From the **Operation** drop-down list, choose one of the following options:
    - **add**—Associates the DFW policy with the Cisco AVS or Cisco ACI Virtual Edge VMM domain.
    - **del**—Disassociates the DFW policy from the Cisco AVS or Cisco ACI Virtual Edge VMM domain.
  - f) Click **Submit**.
- 

### What to do next

Complete the procedure [Verifying Microsegment Association Updates with Cisco AVS or Cisco ACI Virtual Edge VMM Domains on APIC, on page 179](#)

### Verifying a Distributed Firewall Policy Association with the Cisco AVS or Cisco ACI Virtual Edge VMM Domain on APIC

This section describes how to verify the association of a distributed firewall policy with Cisco AVS or Cisco ACI Virtual Edge on Cisco APIC.



**Note** Beginning with Cisco APIC Release 5.0(1), Cisco Application Virtual Switch (AVS) is no longer supported. If you use Cisco AVS and upgrade to Cisco APIC Release 5.0(1), in case of issues, the fabric will not be supported. Also, a fault will be raised for the Cisco AVS domain.

If you use Cisco AVS, we recommend that you migrate to Cisco ACI Virtual Edge. See the *Cisco ACI Virtual Edge Installation Guide* on Cisco.com.

### Procedure

---

- Step 1** Log in to Cisco APIC as the administrator.
  - Step 2** Choose **Virtual Networking > Inventory > VMM Domains > VMware**.
  - Step 3** Click the required VMM domain.
  - Step 4** In the **Work** pane, under **Properties**, confirm that the distributed firewall policy is associated with the VMM domain in the **Firewall Policy** field for vSwitch Policies.
- 

## Tenant Experiences in a Shared or Virtual Private Cloud Plan

### Creating Networks in a Shared Plan

This section describes how to create a network in a shared plan.

### Procedure

---

- Step 1** Log in to the vRealize Automation as the tenant administrator, choose **Catalog**.
- Step 2** In the **navigation** pane, choose **Tenant Shared Plan**.
- Step 3** In the **Tenant Shared Plan** pane, choose **Add Tenant Network - Shared Plan** and perform the following actions:
  - a) View the Service Blueprint Information for the input fields and click **Request**.
  - b) In the **Request Information** pane, add the description and click **Next**.
  - c) In the **Step** pane, perform the following actions:
  - d) In the **NetworkEPG name** field, enter the name of the new shared network (new-shared-network).
  - e) In the **Domain/DVS** field, click **Add**, expand *your\_apic* > **vCenters** > *your\_vcenter*, and then select the DVS.
  - f) From the **encapMode** drop-down list, choose either **Auto**, **VLAN**, or **VXLAN** for the encapsulation mode.
    - Note** The **encapMode** field is applicable only if the VMM domain type is Cisco AVS or Cisco ACI Virtual Edge (Local Switching). Selecting VLAN or VXLAN for VDS VMM Domain, may lead into unpredictable results.
  - g) In the **Application Tier Number** field, enter a numeric value from 1 to 10.
  - h) In the **Intra EPG Deny** field, select a value either **Yes** or **No**.
  - i) In the **Allow Microsegmentation** field, select a value, either **Yes** or **No**.
    - Note** The **Allow Microsegmentation** field is applicable only if the VMM domain type is VDS VMM Domain.
  - j) In the **Use Default BD?** field, select a value either **Yes** or **No**.
    - If you selected **No**, choose a custom bridge domain by clicking on **Add**.
      - Expand *your\_apic\_user* > **Tenants** > *your\_tenant* > **Networking** > **BridgeDomains** > *your\_bridgedomain* and select this bridge domain.

- k) In the **Switching Mode** selector, choose **native** or **AVE**.  
The **native** option is default switching; **AVE** is for Cisco ACI Virtual Edge switching.
- l) Click **Submit**.

---

## Verifying the Newly Created Network on VMware vRealize and APIC

This section describes how to verify the newly created network on VMware vRealize and Application Policy Infrastructure Controller (APIC) .

### Procedure

- Step 1** Log in to the vRealize Automation as the tenant administrator, choose **Request** and ensure your request status is successful.
- Step 2** Log into the APIC GUI as the Tenant, choose **Tenants**.
- Step 3** In the **navigation** pane, expand the **Tenant name > Application Profiles > default > Application EPGs > EPG new-shared-network**.
- Step 4** In the **Properties** pane, ensure the **Received Bridge Domain** field is common/default.
- Step 5** In the **navigation** pane, choose **Domains (VMs and Bare-Metals)**, ensure it is bound to **VMware/your\_vmm\_domain**.

---

## Creating a Bridge Domain in a VPC Plan

This section describes how to create a bridge domain in a VPC plan.

### Procedure

- Step 1** Log in to the vRealize Automation as the tenant administrator, choose **Catalog**.
- Step 2** In the **navigation** pane, choose **Tenant Network Services**.
- Step 3** In the **Tenant Network Services** pane, choose **Add or Delete Bridge domain in Tenant** and perform the following actions:
  - a) View the Service Blueprint Information for the input fields and click **Request**.
  - b) In the **Request Information** pane, add the description and click **Next**.
  - c) In the **Step** pane, perform the following actions:
  - d) In the **Add a bridge domain** field, choose **Yes**.
  - e) In the **Bridge Domain name** field, enter the bridge domain name (new-bd).
  - f) In the **Enable ARP Flooding** field, choose **No**.
  - g) In the **Enable flooding for L2 Unknown Unicast** field, choose **hardware-proxy**.
  - h) In the **Enable flooding for L3 Unknown Multicast** field, choose **flood**.
  - i) In the **L3 context (VRF)** field, click **Add**, expand **your\_apic > Tenants > your\_tenant > Networking > VRFs** and select the VRF (ctx1).
  - j) Click **Submit**.
  - k) In the **Operation** field, choose **Add**.

- l) Click **Submit**.

---

## Verifying the Newly Created Bridge Domain on APIC

This section describes how to verify the newly created bridge domain on Application Policy Infrastructure Controller (APIC).

### Procedure

- 
- Step 1** Log into the APIC GUI as the tenant, choose **Tenants**.
  - Step 2** In the **navigation** pane, expand the **Tenant name > Networking > Bridge Domain > your\_newly\_created\_bd**.
  - Step 3** In the **Properties** pane, ensure the fields are the same as in the VMware vRealize GUI.
- 

## Creating a Network and Associating to a Bridge Domain in a VPC Plan

This section describes how to create a network and associating to a bridge domain in a VPC Plan.

### Procedure

- 
- Step 1** Log in to the vRealize Automation as the tenant administrator, choose **Catalog**.
  - Step 2** In the **navigation** pane, choose **Tenant VPC Plan**.
  - Step 3** In the **Tenant VPC Plan** pane, choose **Add Tenant Network - VPC Plan** and perform the following actions:
    - a) View the Service Blueprint Information for the input fields and click **Request**.
    - b) In the **Request Information** pane, add the description and click **Next**.
    - c) In the **Step** pane, perform the following actions:
    - d) In the **NetworkEPG name** field, enter the name of the new shared network (new-vpc-network).
    - e) In the **Domain/DVS** field, click **Add**, expand **your\_apic > vCenters > your\_vcenter** and select the DVS.
    - f) From the **encapMode** drop-down list, choose either **Auto**, **VLAN**, or **VXLAN** for the encapsulation mode.
 

**Note** The **encapMode** field is applicable only if the VMMdomain type is Cisco AVS or Cisco ACI Virtual Edge (Local Switching). Selecting VLAN or VXLAN for VDS VMM Domain, may lead into unpredictable results.
    - g) In the **Application Tier Number** field, enter a numeric value from 1-10.
    - h) In the **Intra EPG Deny** field, select a value either **Yes** or **No**.
    - i) In the **Allow Microsegmentation** field, select a value either **Yes** or **No**.
 

**Note** The **Allow Microsegmentation** field is applicable only if the VMMdomain type is VDS VMM Domain.
    - j) In the **Use Default BD?** field, select a value either **Yes** or **No**.

If you selected **No**, choose a custom bridge domain by clicking on **Add**.

- Expand **your\_apic\_user > Tenants > your\_tenant > Networking > BridgeDomains > your\_bridgedomain** and select this bridge domain.

- k) In the **Subnet Prefix** field, enter the gateway IP address and the subnet mask (10.1.1.1/24).
- l) Click **Submit**.

## Verifying the Network and Association to the Bridge Domain in a VPC Plan on APIC

This section describes how to verify the newly created bridge domain on APIC.

### Procedure

- Step 1** Log into the APIC GUI as the Tenant, choose **Tenants**.
- Step 2** In the **navigation** pane, expand the **Tenant name > Application Profiles > default > Application EPGs > EPG new-vpc-network**.
- Step 3** In the **Properties** pane, ensure the Bridge Domain is *your\_tenant/bd1*.
- Step 4** In the **navigation** pane, choose **Domains (VMs and Bare-Metals)**, ensure it is bound to *VMware/your\_vmm\_domain*.
- Step 5** In the **navigation** pane, expand the **Tenant name > Networking > Bridge Domain > bd1 > Subnets**.
- Step 6** In the Subnets pane, ensure the gateway IP address and subnet mask that you enter when creating a network and associating to a bridge domain in a VPC plan (10.1.1.1/24) and the scope is Private to VRF.
- Step 7** On the menu bar, choose **Virtual Networking**.
- Step 8** In the navigation pane, expand the **VMM Domains > VMware > your\_vmm\_domain > Controllers > vcenter1 > DVS - your\_vmm\_domain > Portgroups** and ensure you see the port group with the tenant application profile EPG name.

## Creating a Security Policy Within the Tenant

This section describes how to create a security policy within the tenant.

This figure shows that Web and App are in the same bridge domain, but there is no communication. Web and App are isolated, but they can communicate to their gateway. You need to create a security policy for Web and App to communicate.

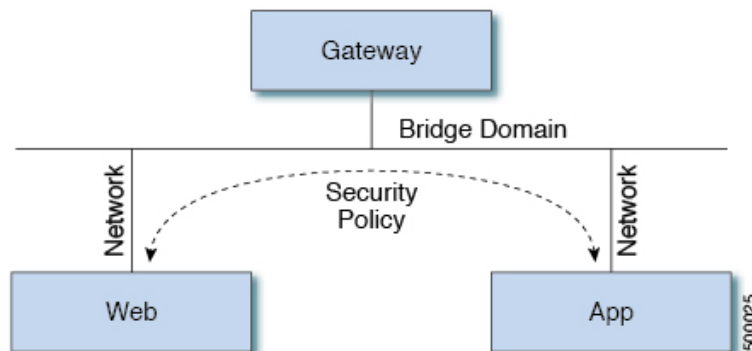

### Before you begin

Ensure you have set up two shared networks with two virtual machines (VMs).



## Procedure

- Step 1** Log in to the vRealize Automation as admin, choose **Catalog > Network Security**.
- Step 2** Choose **Add Security Policy (Contracts)**
- Step 3** Choose **Request**.
- Step 4** In the **Request Information** tab, enter a description of the request.
- Step 5** Choose **Next**.
- Step 6** In the **Step** tab, perform the following actions:
- a) In the **Rule Entry List** field, enter the values and click **Save**.

This table shows the values for each Rule Entry:

| Rule Entry List | Values                                                                                                                    |
|-----------------|---------------------------------------------------------------------------------------------------------------------------|
| dstFormPort     | <ul style="list-style-type: none"> <li>• Blank</li> <li>• Unspecified</li> <li>• 1-65535</li> </ul>                       |
| dstToPort       | <ul style="list-style-type: none"> <li>• Blank</li> <li>• Unspecified</li> <li>• 1-65535</li> </ul>                       |
| protocol        | <ul style="list-style-type: none"> <li>• icmp</li> <li>• icmpv6</li> <li>• tcp</li> <li>• udp</li> <li>• Blank</li> </ul> |
| etherType       | <ul style="list-style-type: none"> <li>• IP</li> <li>• ARP</li> </ul>                                                     |

- b) In the **Consumer Network/EPG name** field, click **Add** to locate and choose the consumer network/EPG. (web-host)
- c) Click **Submit**.
- d) In the **Provider Network/EPG name** field, click **Add** to locate and choose the provider network/EPG. (app-host)
- e) Click **Submit**.

**Step 7** Click **Submit**.

**Step 8** Click **OK**.

## Verifying the Security Policy Within the Tenant on APIC

This section describes how to verify the security policy within the tenant on APIC.

### Procedure

---

- Step 1** Log in to Cisco APIC and then choose **TENANTS**.
  - Step 2** In the **navigation** pane, expand **Tenant *your\_tenant*** > **Networking** > **Security Policies** > **Contracts**.
    - a) Ensure the name nested under **Contracts** is the provider and consumer name. (app-host\_ctrct\_web-hosts)
  - Step 3** In the **navigation** pane, expand **Tenant *your\_tenant*** > **Networking** > **Security Policies** > **Filters**.
    - a) Ensure the name nested under **Filters** is the provider and consumer name. (app-hostflt\_web-hosts)
  - Step 4** In the **navigation** pane, expand **Tenant *your\_tenant*** > **Networking** > **Application Profiles** > **default** > **Application EPGs** > **EPG web-hosts** > **Contracts**.
    - a) In the **work** pane, ensure the consumer is **Consumed**.
  - Step 5** In the **navigation** pane, expand **Tenant *your\_tenant*** > **Networking** > **Application Profiles** > **default** > **Application EPGs** > **EPG app-hosts** > **Contracts**.
    - a) In the **work** pane, ensure the provider is **Provided**.
- 

## Verifying the Connectivity of the Security Policy within the Tenant

This section describes how to verify the connectivity of the security policy within the tenant.

### Procedure

---

- Step 1** Log in to the virtual machine (web-host), from the command line, ping the other VM (app-host).
  - Step 2** Log in to the virtual machine (app-host), from the command line, ping the other VM (web-host).
- This ensure the VMs are communicating with each other.
- 

## Consuming a Shared Service in the Common Tenant

This section describes consuming a shared service in the common tenant.

### Before you begin

You must have an EPG in the common tenant that has a bridge domain relationship to "common/default".

### Procedure

---

- Step 1** Log in to the vRealize Automation as tenant, choose **Catalog** > **Network Security**.
- Step 2** Choose **Add Security Policy (Contracts)**
- Step 3** Choose **Request**.

**Step 4** In the **Request Information** tab, enter a description of the request.

**Step 5** Choose **Next**.

**Step 6** In the **Step** tab, perform the following actions:

- a) In the **Rule Entry List** field, enter the values and click **Save**.

This table shows the values for each Rule Entry:

| Rule Entry List | Values                                                                                                                    |
|-----------------|---------------------------------------------------------------------------------------------------------------------------|
| dstFormPort     | <ul style="list-style-type: none"> <li>• Blank</li> <li>• Unspecified</li> <li>• 1-65535</li> </ul>                       |
| dstToPort       | <ul style="list-style-type: none"> <li>• Blank</li> <li>• Unspecified</li> <li>• 1-65535</li> </ul>                       |
| protocol        | <ul style="list-style-type: none"> <li>• icmp</li> <li>• icmpv6</li> <li>• tcp</li> <li>• udp</li> <li>• Blank</li> </ul> |
| etherType       | <ul style="list-style-type: none"> <li>• IP</li> <li>• ARP</li> </ul>                                                     |

- b) In the **Consumer Network/EPG name** field, click **Add** to locate and choose the consumer network/EPG. (web-host)
- c) Click **Submit**.
- d) In the **Provider Network/EPG name** field, click **Add** to locate and choose the provider network/EPG. (SYSLOG-EPG)
- e) Click **Submit**.

**Step 7** Click **Submit**.

**Step 8** Click **OK**.

## Verifying the Security Policy in the Tenant Common on APIC

This section describes how to verify the security policy in the tenant common on APIC.

### Procedure

---

- Step 1** Log in to Cisco APIC as the tenant, and then choose **TENANTS**.
- Step 2** In the **navigation** pane, expand **Tenant *your\_tenant*** > **Networking** > **Security Policies** > **Contracts**.
- a) Ensure the name nested under **Contracts** is the provider and consumer name. (SYSLOG-EPG\_ctrct\_web-hosts)
- Step 3** In the **navigation** pane, expand **Tenant *your\_tenant*** > **Networking** > **Security Policies** > **Filters**.
- a) Ensure the name nested under **Filters** is the provider and consumer name. (SYSLOG-EPGflt\_web-hosts)
- Step 4** In the **navigation** pane, expand **Tenant *your\_tenant*** > **Networking** > **Application Profiles** > **default** > **Application EPGs** > **EPG web-hosts** > **Contracts**.
- a) In the **work** pane, ensure the consumer is **Consumed**.
- Step 5** In the **navigation** pane, expand **Tenant *your\_tenant*** > **Networking** > **Application Profiles** > **default** > **Application EPGs** > **EPG SYSLOG-EPG-hosts** > **Contracts**.
- a) In the **work** pane, ensure the provider is **Provided**.
- 

### Verifying the Connectivity of the Security Policy in the Tenant Common

This section describes how to verify the connectivity of the security policy in the tenant common.

#### Procedure

---

- Step 1** Log in to the virtual machine (web-host), from the command line, ping the other VM (SYSLOG-EPG).
- Step 2** Log in to the virtual machine (SYSLOG-EPG), from the command line, ping the other VM (web-host).
- This ensure the VMs are communicating with each other.
- 

### Updating Security Policies (Access Control Lists)

This section describes how to update security policies (access control lists).

#### Procedure

---

- Step 1** Log in to the vRealize Automation as tenant, choose **Catalog** > **Network Security**.
- Step 2** Choose **Update Security policies (Access Control Lists)**
- Step 3** Choose **Request**.
- Step 4** In the **Request Information** tab, enter a description of the request.
- Step 5** Choose **Next**.
- Step 6** In the **Step** tab, perform the following actions:
- a) In the **apic security filter name** field, click **Add** to locate and choose a filter that been pushed by vRealize.
- b) In the **Rule Entry List** field, enter the values and click **Save**. You must recreate the rule entry list.

**Note** This updating security policies access control lists will push new rules in including over writing existing rule of the same name.

This table shows the values for each Rule Entry:

| Rule Entry List | Values                                                                                                                    |
|-----------------|---------------------------------------------------------------------------------------------------------------------------|
| dstFormPort     | <ul style="list-style-type: none"> <li>• Blank</li> <li>• Unspecified</li> <li>• 1-65535</li> </ul>                       |
| dstToPort       | <ul style="list-style-type: none"> <li>• Blank</li> <li>• Unspecified</li> <li>• 1-65535</li> </ul>                       |
| protocol        | <ul style="list-style-type: none"> <li>• icmp</li> <li>• icmpv6</li> <li>• tcp</li> <li>• udp</li> <li>• Blank</li> </ul> |
| etherType       | <ul style="list-style-type: none"> <li>• IP</li> <li>• ARP</li> </ul>                                                     |

- c) In the **Update firewall access-list** field, if the access-list being use by a firewall, click **Yes** otherwise click **No**.
  - d) Click **Submit**.
- Step 7** Click **OK**.
- Step 8** To verify your request, choose the **Requests** tab.
- a) Choose the request you submitted and click **view details**. Ensure the status is **Successful**.

## Deleting Security Policies (Access Control Lists)

This section describes how to delete security policies (access control lists).

### Procedure

- Step 1** Log in to the vRealize Automation as tenant, choose **Catalog > Network Security**.
- Step 2** Choose **Delete Security policies (Access Control Lists)**
- Step 3** Choose **Request**.

- Step 4** In the **Request Information** tab, enter a description of the request.
- Step 5** Choose **Next**.
- Step 6** In the **Step** tab, perform the following actions:
- In the **Consume Network/EPG name** field, click **Add** to locate and choose the provider network/EPG. (web-host)
  - In the **Provider Network/EPG name** field, click **Add** to locate and choose the provider network/EPG. (app-host)
  - Click **Submit**.
- Step 7** Click **OK**.
- Step 8** To verify your request, choose the **Requests** tab.
- Choose the request you submitted and click **view details**. Ensure the status is **Successful**.

## Creating the Network in the VPC Plan

This section describes how to create the network in the VPC plan.

### Procedure

- Step 1** Log in to the vRealize Automation Appliance as the tenant, choose **Catalog > Tenant VPC Plan > Add Tenant Network - VPC plan** and click **Request**.
- Step 2** In the **Request Information** pane, perform the following actions:
- In the **Description** field, enter the description.
  - Click **Next**.
- Step 3** In the **Step** pane, perform the following actions:
- In the **Network/EPG name** field, enter the Network/EPG name. (web-hosts-vpc)
  - In the **Domain Type** field, from the drop-down list, choose either **VmmDomain (Dynamic Binding)** for connecting to virtual machines or **PhysDomain (Static Binding)** for connecting to physical infrastructure. Cisco recommends choosing **VmmDomain (Dynamic Binding)** to use the full features of the vRealize plug-in.
  - In the **Domain/DVS** field, click **Add**, expand *your\_apic* > **vCenters** > *your\_vcenter*, and then select the DVS.
  - From the **encapMode** drop-down list, choose either **Auto**, **VLAN**, or **VXLAN** for the encapsulation mode.
- Note** The **encapMode** field is applicable only if the VMM domain type is Cisco AVS or Cisco ACI Virtual Edge (Local Switching). Selecting VLAN or VXLAN for VDS VMM Domain, may lead into unpredictable results.
- In the **Application Tier Number** field, enter a numeric value from 1 to 10.
  - In the **Intra EPG Deny** field, select a value either **Yes** or **No**.
  - In the **Allow Microsegmentation** field, select a value either **Yes** or **No**.
- Note** The **Allow Microsegmentation** field is applicable only if the VMM domain type is VDS VMM Domain.
- In the **Use Default BD?** field, select a value either **Yes** or **No**.

If you selected **No**, choose a custom bridge domain by clicking on **Add**.

- Expand *your\_apic\_user* > **Tenants** > *your\_tenant* > **Networking** > **BridgeDomains** > *your\_bridgedomain* and select this bridge domain.

- In the **Subnet prefix** field, enter the gateway IP address and the subnet mask. (192.168.1.1/24)  
The subnet prefix is the subnet that this VPC will have available to any hosts.
- Click **Submit**.
- Click **OK**.

- Step 4** Choose **Requests**.
- Step 5** Choose the request you submitted and click **view details**.
- Step 6** Ensure that your request status is **Successful**.

### Verifying the Network in the VPC Plan on APIC

This section describes how to verify the network in the VPC plan on APIC.

#### Procedure

- Step 1** Log in to Cisco APIC as the tenant, and then choose **Tenants** > *your\_tenant*.
- Step 2** In the navigation pane, choose **Tenant** *your\_tenant* > **Application Profiles** > **default** > **Application EPGs** > **EPG web-hosts-vpc**
- Step 3** In the properties pane, in the Bridge Domain field, verify your tenant name and bd1 is present. (green/bd1)
- Step 4** In the navigation pane, choose **Tenant** *your\_tenant* > **Application Profiles** > **default** > **Application EPGs** > **EPG web-hosts-vpc** > **Domains (VMs and Bare-Metals)**.
- Step 5** Ensure the state is formed and the domain profile is VMware/*vmmdomain\_you\_specified*.
- Step 6** In the navigation pane, choose **Tenant** *your\_tenant* > **Networking** > **Bridge Domains** > **bd1** > **Subnets**.
- Step 7** Under **Subnets**, ensure the subnet prefix that you specified is present.

### Verifying the Network in the VPC Plan on vCenter

This section describes how to verify the network in the VPC plan on vCenter.

#### Procedure

- Step 1** Log in to vSphere Web Client GUI, choose the Networking icon.
- Step 2** In the navigation pane, choose *vCenter\_IP/Host* > **Datacenter** > *green* > *distributed\_virtual\_switch* > *port\_group* and ensure it is present.  
The *port\_group* name is in the following format: Tenant Name|Application Profile Name|Application EPG Name.

## Updating a Tenant Network Association with the VMM Domain

This section describes how to update a tenant network association with the VMM domain.

### Procedure

---

- Step 1** Log in to vRealize Automation as the tenant administrator and choose **Catalog**.
- Step 2** In the **navigation** pane, choose **Tenant Network services**.
- Step 3** Choose **Update Tenant Network** and perform the following actions:
- View the Service Blueprint Information for the input fields and click **Request**.
  - In the **Request Information** pane, add the description and click **Next**.
  - In the **Tenant name** field, input the name of corresponding tenant.
  - In the **Network/EPG** field, click **Add**, expand *your\_apic* > **Tenants** > *your\_tenant* > **End-Point-Groups**, and then select the EPG.
  - From the **Domain Type** drop-down list, choose the domain type. The domain type is **VmmDomain (Dynamic Binding)** for VMware VDS or Cisco AVS or Cisco ACI Virtual Edge.
  - In the **Domain/DVS field**, click **Add**, expand *your\_apic* > **vCenters** > *your\_vcenter*, and then select the DVS to associate the tenant network (EPG) to the VMM domain.
  - From the **encapMode** drop-down list, choose **Auto**, **VLAN**, or **VXLAN** for the encapsulation mode.
 

**Note** The **encapMode** field is applicable only when associating an EPG to a VMM domain of the Cisco AVS or Cisco ACI Virtual Edge (Local Switching) type. That association is performed in the following step.
  - From the **Operation** drop-down list, choose **add** to associate the tenant network with the VMM domain or choose **delete** to disassociate the tenant network from the VMM domain.
  - In the **Switching Mode** selector, choose **native** or **AVE**.
 

The **native** option is default switching, and **AVE** is for Cisco ACI Virtual Edge.
  - Click **Submit**.
- 

### Verifying Tenant Network Association with VMM Domains on APIC

This section describes how to verify a tenant Network association with VMM domains on APIC.

### Procedure

---

- Step 1** Log in to Cisco APIC as the tenant, and then choose **Tenants** > *your\_tenant*.
- Step 2** In the **navigation** pane, choose **Tenant *your\_tenant* > Application Profiles > default > Application EPGs > your\_tenant\_network > Domains (VMs and Bare-Metals)**.
- Step 3** Confirm that any associations with VMM domains are correct.
-



## Microsegmentation

This section describes microsegmentation in shared and VPC plans and explains the usage-related service blueprints.



---

**Note** Starting with the Cisco APIC vRealize Plug-In 2.0(1) release, the service blueprints related to microsegmentation are supported only for Cisco AVS VMM domains.

---

### Microsegmentation with Cisco ACI

Microsegmentation with the Cisco ACI provides the ability to automatically assign endpoints to logical security zones called endpoint groups (EPGs) based on various attributes.

For detailed information about Microsegmentation, see the chapter "Microsegmentation with Cisco ACI" in the *Cisco ACI Virtualization Guide*.

### Microsegmentation in a Shared Plan

You can create, update, and delete a microsegment in a shared plan.

#### Creating a Microsegment in a Shared Plan

This section describes how to create a microsegment in a shared plan.



---

**Note** Beginning with Cisco APIC Release 5.0(1), Cisco Application Virtual Switch (AVS) is no longer supported. If you use Cisco AVS and upgrade to Cisco APIC Release 5.0(1), in case of issues, the fabric will not be supported. Also, a fault will be raised for the Cisco AVS domain.

If you use Cisco AVS, we recommend that you migrate to Cisco ACI Virtual Edge. See the *Cisco ACI Virtual Edge Installation Guide* on Cisco.com.

---

### Procedure

- 
- Step 1** Log in to vRealize Automation as the tenant administrator and then choose **Catalog**.
  - Step 2** In the **navigation** pane, choose **Tenant Shared Plan**.
  - Step 3** Choose **Add a Useg Network - Shared Plan** and complete the following steps:
    - a) View the Service Blueprint Information for the input fields and then click **Request**.
    - b) In the **Request Information** pane, add a description and then click **Next**.
    - c) In the **Tenant name** field, enter the name of the corresponding tenant.
    - d) In the **Network/EPG name** field, enter the name of the microsegment (uSeg) that you want to create.
    - e) From the **Domain Type** drop-down list, choose the domain type. For the Cisco AVS or Cisco ACI Virtual Edge VMM domain, the domain type is **VmmDomain (Dynamic Binding)**.
    - f) In the **Domain/DVS** field, click **Add**, expand *your\_apic* > **vCenters** > *your\_vcenter*, and then select the DVS (Cisco AVS or Cisco ACI Virtual Edge VMM domain) to associate the uSeg to the VMM domain.
    - g) From the **encapMode** drop-down list, choose **Auto**, **VLAN**, or **VXLAN** for the encapsulation mode.

**Note** The **encapMode** field is applicable only if the **VMMdomain** type is Cisco AVS or Cisco ACI Virtual Edge (Local Switching).

- h) In the **Application Tier Number** field, enter the number of the tier to which the uSeg belongs. The default tier number is 1. The tier number that you enter must be less than or equal to the number of application tiers that were created as part of the tenant creation via the service blueprint **Add or Update Tenant** option.

For example, if you enter tier number 2, the uSeg will be placed in BD (common/cmnb2), which is part of VRF (common/default). See the following table for reference.

| Tier Number | BD             | VRF            |
|-------------|----------------|----------------|
| 1           | common/default | common/default |
| 2           | common/cmnb2   | common/default |
| 3           | common/cmnb3   | common/default |

- i) From the **Intra EPG Deny** drop-down list, choose **Yes** to enforce intra-EPG isolation. Choose **No** if you do not want to enforce intra-EPG isolation.

Intra-EPG isolation is not supported in AVS or Cisco ACI Virtual Edge VLAN mode, DVS-VXLAN mode, or for Microsoft VMM domains. If you enforce intra-EPG isolation for those modes or domains, ports might go into blocked state.

- j) In the **Ip Criteria** table, click **New** and enter the IP criteria (or IP attribute). The following columns apply to each entry:

- **Name**—Name of the IP criteria (or IP attribute).
- **Description**—Description of the IP criteria.
- **IP**—For IP addresses, specify the address or the subnet (for example, 1.1.1.1 or 1.1.1.0/30).

- k) In the **Mac Criteria** table, click **New** and enter the MAC criteria (or MAC attribute). The following columns apply to each entry:

- **Name**—Name of the MAC criteria (or MAC attribute).
- **Description**—Description of the MAC criteria.
- **MAC**—For MAC addresses, specify the address (for example, 00:50:56:44:44:5D).

- l) In the **VM Criteria** table, click **New** and enter the VM criteria (or VM attribute). The following columns apply to each entry:

- **Name**—Name of the VM criteria (or VM attribute).
- **Type**—The following table lists the supported attribute types, their mapping in APIC, and examples. (The MAC attribute and IP attribute have precedence 1 and 2, respectively.)

| Type in vRealize | Type in APIC (Mapping) | Precedence | Examples          |
|------------------|------------------------|------------|-------------------|
| vnic             | VNic Dn                | 3          | 00:50:56:44:44:5D |
| vm               | VM Identifier          | 4          | vm-821            |

| Type in vRealize | Type in APIC (Mapping) | Precedence | Examples     |
|------------------|------------------------|------------|--------------|
| vmName           | VM Name                | 5          | HR_VDI_VM1   |
| hv               | Hypervisor Identifier  | 6          | host-43      |
| domain           | VMM Domain             | 7          | AVS-SJC-DC1  |
| datacenter       | Datacenter             | 8          | DCI          |
| customLabel      | Custom Attribute       | 9          | SG_DMZ       |
| guestOS          | Operating System       | 10         | Windows 2008 |

- **Operator**—The following table lists the supported operators and their mapping in APIC.

| Operator in vRealize | Operator in APIC (Mapping) |
|----------------------|----------------------------|
| equals               | Equals                     |
| contains             | Contains                   |
| startsWith           | Starts With                |
| endsWith             | Ends With                  |

- **AttributeName**—Enter an attribute name. In the VM Criteria table, the **AttributeName** applies only to the **customLabel** attribute type.
- **VmmDomain\_vC\_VmName**—In the VM Criteria table, it is applicable only for the type **vnic**, operator **equals**. The format to input is <VmmDomain>/<vC>/<VmName>, where <VmmDomain> (AVS VMM domain) and <vC> (vCenter) belong to a controller instance. For example: vmmdomain1/vcenter1/VM1.
- **Value**—Enter the attribute type value. Examples of each attribute type are listed in the preceding Type table.

m) Click **Submit**.

### What to do next

Complete the procedure [Verifying Microsegmentation Creation in a Shared Plan on APIC](#), on page 171.

### Verifying Microsegmentation Creation in a Shared Plan on APIC

This section describes how to verify that microsegmentation creation in a shared plan has been successful on Application Policy Infrastructure Controller.

### Procedure

- Step 1** Log in to Cisco APIC as the tenant, and then choose **Tenants** > *your\_tenant*.

- Step 2** In the navigation pane, choose **Tenant *your\_tenant* > Application Profiles > default > uSeg EPGs**.
  - Step 3** In the **uSeg EPGs** pane, double-click the required uSeg to view its properties.
  - Step 4** In the **Properties** pane, confirm that the configuration is correct.
  - Step 5** In the navigation pane, choose **Tenant *your\_tenant* > Application Profiles > default > uSeg EPGs > *your\_useg* > Domains (VMs and Bare-Metals)**.
  - Step 6** Confirm that the state is formed and that the domain profile is **VMware/vmmdomain\_*you\_specified***.
- 

### Deleting a Microsegment in a Shared Plan

This section describes how to delete a microsegment.

#### Procedure

---

- Step 1** Log in to vRealize Automation as the tenant administrator and then choose **Catalog**.
  - Step 2** In the **navigation** pane, choose **Tenant Shared Plan**.
  - Step 3** Choose **Delete a Useg Network - Shared Plan** and then complete the following steps:
    - a) View the Service Blueprint Information for the input fields and then click **Request**.
    - b) In the **Request Information** pane, add a description and then click **Next**.
    - c) In the **Tenant name** field, confirm that the tenant name is hard coded to the corresponding tenant.
    - d) In the **Network/EPG** field, click **Add**, expand ***priapic* > Tenants > *appurtenant* > Useg-End-Point-Groups**, and then select the microsegment EPG.
    - e) Click **Submit**.
- 

#### What to do next

Complete the procedure [Verifying Microsegmentation Deletion on APIC, on page 172](#).

### Verifying Microsegmentation Deletion on APIC

This section describes how to verify microsegmentation deletion on Application Policy Infrastructure Controller.

#### Procedure

---

- Step 1** Log in to Cisco APIC as the tenant, and then choose **Tenants > *your\_tenant***.
  - Step 2** In the navigation pane, choose **Tenant *your\_tenant* > Application Profiles > default > uSeg EPGs**.
  - Step 3** In the **uSeg EPGs** pane, confirm that the deleted uSeg is not present.
- 

### Microsegmentation in a VPC Plan

You can create, update, and delete a microsegment in a VPC plan.

## Creating a Microsegment in a VPC Plan

This section describes how to create a microsegment in a VPC plan.

### Procedure

- Step 1** Log in to vRealize Automation as the tenant administrator and then choose **Catalog**.
- Step 2** In the **navigation** pane, choose **Tenant VPC Plan**.
- Step 3** Choose **Add a Useg Network - VPC Plan** and complete the following steps:
- View the Service Blueprint Information for the input fields and then click **Request**.
  - In the **Request Information** pane, add a description and then click **Next**.
  - In the **Tenant name** field, enter the name of the corresponding tenant.
  - In the **Network/EPG name** field, enter the name of the microsegment (uSeg) that you want to create.
  - From the **Domain Type** drop-down list, choose the domain type.
  - In the **Domain/DVS** field, click **Add**, expand *your\_apic* > **vCenters** > *your\_vcenter*, and then select the DVS (Cisco AVS or Cisco ACI Virtual Edge VMM domain) to associate the uSeg to the VMM domain.
  - From the **encapMode** drop-down list, choose **Auto**, **VLAN**, or **VXLAN** for the encapsulation mode.
- Note** The **encapMode** field is applicable only if the VMM domain type is Cisco AVS or Cisco ACI Virtual Edge (Local Switching).
- In the **Subnet** field, enter the gateway IP address and the subnet mask (1.1.1.1/24).
  - In the **Application Tier Number** field, enter the number of the tier to which the uSeg belongs. The default tier number is 1. The tier number that you enter must be less than or equal to the number of application tiers that were created as part of the tenant creation through the service blueprint **Add or Update Tenant** option.

For example, for a tenant named *coke*, if you enter tier number 2, the uSeg is placed in BD (*coke/bd2*), which is part of VRF (*coke/ctx1*). See the following table for reference.

| Tier Number | BD       | VRF       |
|-------------|----------|-----------|
| 1           | coke/bd1 | coke/ctx1 |
| 2           | coke/bd2 | coke/ctx1 |
| 3           | coke/bd3 | coke/ctx1 |

- From the **Intra EPG Deny** drop-down list, choose **Yes** to enforce intra-EPG isolation. Choose **No** if you do not want to enforce intra-EPG isolation.

Intra-EPG isolation is not supported in Cisco AVS or Cisco ACI Virtual Edge VLAN mode, DVS-VXLAN mode, or for Microsoft VMM domains. If you enforce intra-EPG isolation for those modes or domains, ports may go into blocked state.

- In the **Ip Criteria** table, click **New** and enter the IP criteria (or IP attribute). The following columns apply to each entry:
  - Name**—Name of the IP criteria (or IP attribute).
  - Description**—Description of the IP criteria.
  - IP**—For IP addresses, specify the address or the subnet (for example, 1.1.1.1 or 1.1.1.0/30).

- l) In the **Mac Criteria** table, click **New** and enter the MAC criteria (or MAC attribute). The following columns apply to each entry:
- **Name**—Name of the MAC criteria (or MAC attribute).
  - **Description**—Description of the MAC criteria.
  - **MAC**—For MAC addresses, specify the address (for example, 00:50:56:44:44:5D).
- m) In the **VM Criteria** table, click **New** and enter the VM criteria (or VM attribute). The following columns apply to each entry:
- **Name**—Name of the VM criteria (or VM attribute).
  - **Description**—Description of the VM criteria.
  - **Type**—The following table lists the supported attribute types, their mapping in APIC, and examples. (The MAC attribute and IP attribute have precedence 1 and 2, respectively.)

| Type in vRealize | Type in APIC (Mapping) | Precedence | Examples          |
|------------------|------------------------|------------|-------------------|
| vnic             | VNic Dn                | 3          | 00:50:56:44:44:5D |
| vm               | VM Identifier          | 4          | vm-821            |
| vmName           | VM Name                | 5          | HR_VDI_VM1        |
| hv               | Hypervisor Identifier  | 6          | host-43           |
| domain           | VMM Domain             | 7          | AVS-SJC-DC1       |
| datacenter       | Datacenter             | 8          | DCI               |
| customLabel      | Custom Attribute       | 9          | SG_DMZ            |
| guestOS          | Operating System       | 10         | Windows 2008      |

- **Operator**—The following table lists the supported operators and their mapping in APIC.

| Operator in vRealize | Operator in APIC (Mapping) |
|----------------------|----------------------------|
| equals               | Equals                     |
| contains             | Contains                   |
| startsWith           | Starts With                |
| endsWith             | Ends With                  |

- **AttributeName**—Enter an attribute name. In the VM Criteria table, the **AttributeName** applies only to the **customLabel** attribute type.
- **VmmDomain\_vC\_VmName**—In the VM Criteria table, it is applicable only for the type **vnic**, operator **equals**. The format to input is <VmmDomain>/<vC>/<VmName> where <VmmDomain> (AVS VMM domain) and <vC> (vCenter) belong to a controller instance. For example: vmmdomain1/vcenter1/VM1.

- **Value**—Enter the attribute type value. Examples of each attribute type are listed in the preceding Type table.

n) Click **Submit**.

---

### What to do next

Complete the procedure [Verifying Microsegmentation Creation in a VPC Plan on APIC](#), on page 175.

### Verifying Microsegmentation Creation in a VPC Plan on APIC

This section describes how to verify microsegmentation creation in a VPC plan on Application Policy Infrastructure Controller.

#### Procedure

- 
- Step 1** Log in to Cisco APIC as the tenant, and then choose **Tenants > your\_tenant**.
  - Step 2** In the navigation pane, choose **Tenant your\_tenant > Application Profiles > default > uSeg EPGs**.
  - Step 3** In the **uSeg EPGs** pane, double-click the required uSeg to view its properties.
  - Step 4** In the **Properties** pane, confirm that the configuration is correct.
  - Step 5** In the navigation pane, choose **Tenant your\_tenant > Application Profiles > default > uSeg EPGs > your\_useg > Domains (VMs and Bare-Metals)**.
  - Step 6** Confirm that the state is formed and that the domain profile is **VMware/vmmdomain\_you\_specified**.
  - Step 7** In the navigation pane, choose **Tenant your\_tenant > Networking > Bridge Domains > corresponding\_bd > Subnets**.
  - Step 8** Under **Subnets**, confirm that the subnet prefix that you specified is present.
- 

### Deleting a Microsegment in a VPC Plan

This section describes how to delete a microsegment.

#### Procedure

- 
- Step 1** Log in to vRealize Automation as the tenant administrator and then choose **Catalog**.
  - Step 2** In the **navigation** pane, choose **Tenant VPC Plan**.
  - Step 3** Choose **Delete a Useg Network - VPC Plan** and then complete the following steps:
    - a) View the Service Blueprint Information for the input fields and then click **Request**.
    - b) In the **Request Information** pane, add a description and then click **Next**.
    - c) In the **Tenant name** field, confirm that the tenant name is hard coded to the corresponding tenant.
    - d) In the **Network/EPG** field, click **Add**, expand **your\_apic > Tenants > your\_tenant > Useg-End-Point-Groups** and select the uSeg EPG.
    - e) Click **Submit**.
-

**What to do next**

Complete the procedure [Verifying Microsegmentation Deletion on APIC](#), on page 172.

**Updating Microsegment Attributes**

This section describes how to update an existing microsegment.

**Procedure**

- 
- Step 1** Log in to vRealize Automation as the tenant administrator and then choose **Catalog**.
- Step 2** In the **navigation** pane, choose **Tenant Network services**.
- Step 3** Choose **Add or Delete Useg Attribute** and complete the following steps:
- View the Service Blueprint Information for the input fields and then click **Request**.
  - In the **Request Information** pane, add a description and then click **Next**.
  - In the **Network/EPG** field, click **Add**, expand *your\_apic* > **Tenants** > *your\_tenant* > **Useg-End-Point-Groups** and select the uSeg EPG.
  - In the **Tenant name** field, enter the name of the corresponding tenant.
  - If you want to add IP criteria, in the **Add Ip Criteria** table, click **New** and enter the IP criteria (or IP attribute). The following columns apply to each entry:
    - Name**—Name of the IP criteria (or IP attribute).
    - Description**—Description of the IP criteria.
    - IP**—For IP addresses, specify the address or the subnet (for example, 1.1.1.1 or 1.1.1.0/30).
  - If you want to add Mac criteria, in the **Add Mac Criteria** table, click **New** and enter the MAC criteria (or MAC attribute). The following columns apply to each entry:
    - Name**—Name of the MAC criteria (or MAC attribute).
    - Description**—Description of the MAC criteria.
    - MAC**—For MAC addresses, specify the address (for example, 00:50:56:44:44:5D).
  - If you want to add VM criteria, in the **Add Vm Criteria** table, click **New** and enter the VM criteria (or VM attribute). The following columns apply to each entry:
    - Name**—Name of the VM criteria (or VM attribute).
    - Type**—The following table lists the supported attribute types, their mapping in APIC, and examples. (The MAC attribute and IP attribute have precedence 1 and 2, respectively.)

| Type in vRealize | Type in APIC (Mapping) | Precedence | Examples          |
|------------------|------------------------|------------|-------------------|
| vnic             | VNic Dn                | 3          | 00:50:56:44:44:5D |
| vm               | VM Identifier          | 4          | vm-821            |
| vmName           | VM Name                | 5          | HR_VDI_VM1        |
| hv               | Hypervisor Identifier  | 6          | host-43           |



| Type in vRealize | Type in APIC (Mapping) | Precedence | Examples     |
|------------------|------------------------|------------|--------------|
| domain           | VMM Domain             | 7          | AVS-SJC-DC1  |
| datacenter       | Datacenter             | 8          | DCI          |
| customLabel      | Custom Attribute       | 9          | SG_DMZ       |
| guestOS          | Operating System       | 10         | Windows 2008 |

- **Operator**—The following table lists the supported operators and their mapping in APIC.

| Operator in vRealize | Operator in APIC (Mapping) |
|----------------------|----------------------------|
| equals               | Equals                     |
| contains             | Contains                   |
| startsWith           | Starts With                |
| endsWith             | Ends With                  |

- **AttributeName**—Enter an attribute name. In the VM Criteria table, the **AttributeName** applies only to the **customLabel** attribute type.
- **Value**—Enter the attribute type value. Examples of each attribute type are listed in the preceding Type table.
- **VmmDomain\_vC\_VmName**—In the VM Criteria table, it is applicable only for the type **vnic**, operator **equals**. The format to input is <VmmDomain>/<vC>/<VmName>, where <VmmDomain> (AVS VMM domain) and <vC> (vCenter) belong to a controller instance. For example: vmmdomain1/vcenter1/VM1.

- If you want to delete existing IP criteria, in the **Delete IP Criteria** table, click **New** and enter the name of the IP criteria (or IP attribute) to delete.
- If you want to delete existing Mac criteria, in the **Delete Mac Criteria** table, click **New** and enter the name of the MAC criteria (or MAC attribute) to delete.
- If you want to delete existing VM criteria, in the **Delete Vm Criteria** table, click **New** and enter the name of the VM criteria (or VM attribute) to delete.
- Click **Submit**.

### What to do next

Complete the procedure [Verifying a Microsegmentation Attributes Update on APIC](#), on page 177.

## Verifying a Microsegmentation Attributes Update on APIC

This section describes how to verify that microsegmentation attributes have been updated on Application Policy Infrastructure Controller.

## Procedure

---

- Step 1** Log in to Cisco APIC as the tenant, and then choose **Tenants** > *your\_tenant*.
- Step 2** In the navigation pane, choose **Tenant** *your\_tenant* > **Application Profiles** > **default** > **uSeg EPGs**.
- Step 3** In the **uSeg EPGs** pane, double-click the required uSeg to view its properties.
- Step 4** In the **Properties** pane, confirm that the attributes in the **uSeg Attributes** field have been updated.
- 

## Updating a Microsegment Association with the Cisco AVS or Cisco ACI Virtual Edge VMM Domain

This section describes how to update a microsegment that is associated with a Cisco AVS or Cisco ACI Virtual Edge VMM domain.

## Procedure

---

- Step 1** Log in to vRealize Automation as the tenant administrator and then choose **Catalog**.
- Step 2** In the **navigation** pane, choose **Tenant Network services**.
- Step 3** Choose **Update Tenant Network** and complete the following steps:
- View the Service Blueprint Information for the input fields and then click **Request**.
  - In the **Request Information** pane, add the description and click **Next**.
  - In the **Tenant name** field, enter the name of the corresponding tenant.
  - In the **Network/EPG** field, click **Add**, expand *your\_apic* > **Tenants** > *your\_tenant* > **Useg-End-Point-Groups** and select the uSeg EPG.
  - From the **Domain Type** drop-down list, choose the domain type. For the Cisco AVS or Cisco ACI Virtual Edge VMM domain, the domain type is **VmmDomain (Dynamic Binding)**.
  - In the **Domain/DVS** field, click **Add**, expand *your\_apic* > **vCenters** > *your\_vcenter* and then select the DVS (Cisco AVS or Cisco ACI Virtual Edge VMM domain) to associate the uSeg to the VMM domain.
  - From the **encapMode** drop-down list, choose **Auto**, **VLAN**, or **VXLAN** for the encapsulation mode.
 

**Note** The **encapMode** field is applicable only when associating an EPG to a VMM domain of the Cisco AVS or Cisco ACI Virtual Edge (Local Switching) type. That association is performed in the following step.
  - From the **Operation** drop-down list, choose **add** to associate the microsegment with the Cisco AVS or Cisco ACI Virtual Edge domain. Choose **delete** to disassociate the microsegment from the Cisco AVS or Cisco ACI Virtual Edge VMM domain.
  - Click **Submit**.
- 

## What to do next

Complete the procedure [Verifying Microsegment Association Updates with Cisco AVS or Cisco ACI Virtual Edge VMM Domains on APIC](#), on page 179.

## Verifying Microsegment Association Updates with Cisco AVS or Cisco ACI Virtual Edge VMM Domains on APIC

This section describes how to verify updates to microsegment associations with Cisco AVS or Cisco ACI Virtual Edge VMM domains on Cisco APIC.



**Note** Beginning with Cisco APIC Release 5.0(1), Cisco Application Virtual Switch (AVS) is no longer supported. If you use Cisco AVS and upgrade to Cisco APIC Release 5.0(1), in case of issues, the fabric will not be supported. Also, a fault will be raised for the Cisco AVS domain.

If you use Cisco AVS, we recommend that you migrate to Cisco ACI Virtual Edge. See the *Cisco ACI Virtual Edge Installation Guide* on Cisco.com.

### Procedure

- Step 1** Log in to Cisco APIC as the tenant, and then choose **Tenants > your\_tenant**.
- Step 2** In the navigation pane, choose **Tenant your\_tenant > Application Profiles > default > uSeg EPGs > your\_useg > Domains (VMs and Bare-Metals)**.
- Step 3** Confirm that any associations with VMM domains are correct.

## Creating the VMs and Attaching to Networks Without Using the Machine Blueprints

This section describes how to verify the creating machines (VMs) and attaching to networks without using the machine blueprints.

### Procedure

- Step 1** Log in to vSphere Web Client GUI, choose the **Networking** icon.
- Step 2** In the pane, choose **vCenter\_IP/Host > Datacenter > Unmanaged** and choose the virtual machine you want to attach ACI network to.
- Step 3** In the **Summary** pane, in the **VM Hardware** section, click **Edit Settings**.
- Step 4** In the **Edit Settings** dialog box, choose the network adapter that you want to connect to the ACI network and from the drop-down list, choose the port group you created. (green|default|web-hosts-vpc (green))
- Step 5** Click **OK**.  
Now this VM can take advantage of the ACI networking.

## About Adding the Load Balancer to the Tenant Network

This section covers the configuration steps to add a load balancer service to a tenant network (APIC's EPG). This release only supports shared plan for load balancer. In subsequent releases we will have support for VPC plan.

In this plan, the load balancer is deployed in tn-common thereby offering consumption model for vRA and APIC tenant using shared infrastructure.

Figure 11: Shared Plan - Load Balancer Overview

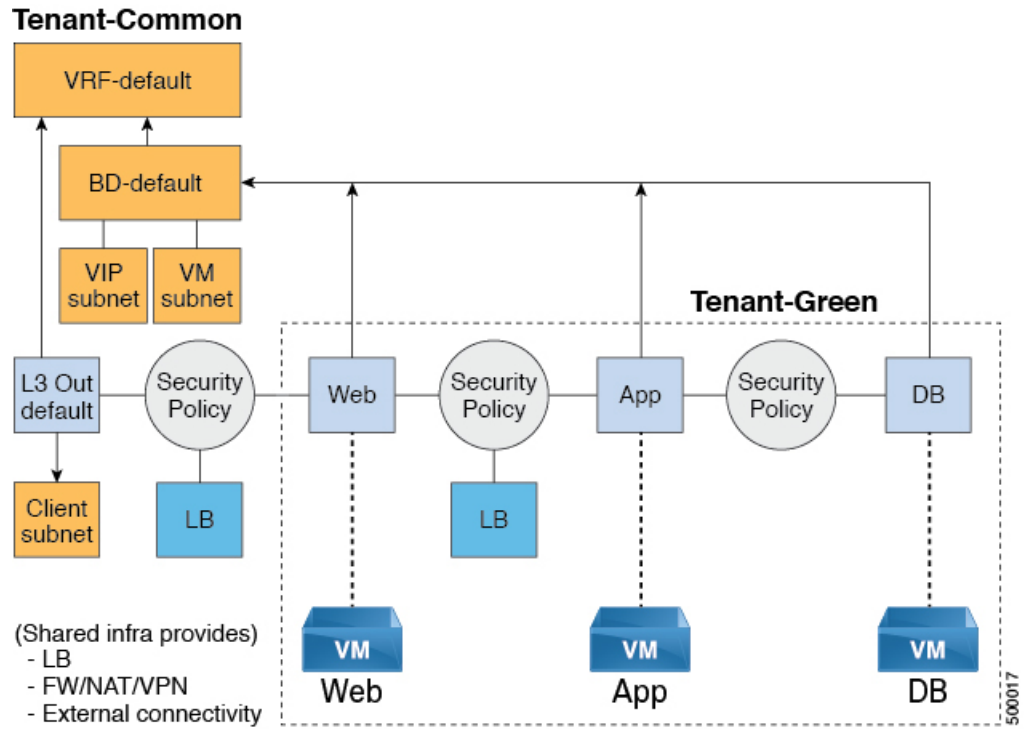
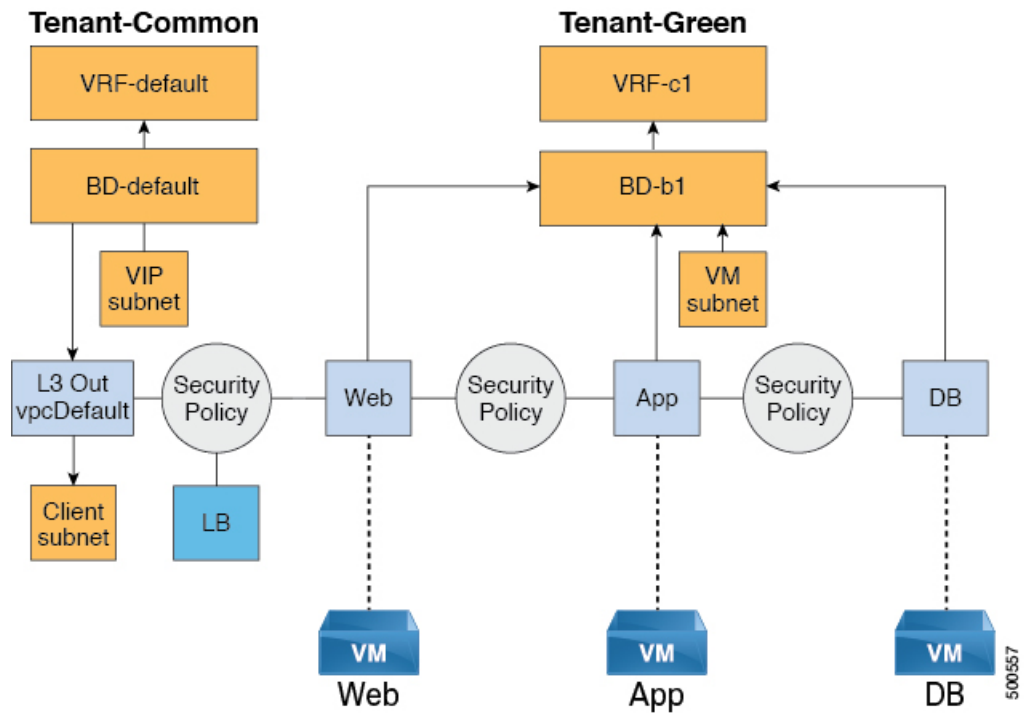

Figure 12: VPC Plan - Load Balancer Only



## Configuration Prerequisites on APIC

This section describes the configuration prerequisites on APIC.

- Device package for load balancer needs to be uploaded by APIC admin.
- Device cluster for load balancer needs to be created in tn-common or tenant "common" by APIC-admin. Citrix and F5 are the supported vendors for load balancers.
- Shared Plan load balancer service graph templates for Citrix and F5 needs to be created in tn-common by APIC-admin.

## Adding the VIP Pool

This section describes how to add the VIP Pool.

### Before you begin

Before vRA-Tenant can consumer Load balancer services, vRA admin needs to create a Virtual-IP pool per vRA tenant, using the "Add VIP pool" service blueprint in Admin catalog.

For example for Tenant-Red, VIP pool is 6.1.1.1 to 6.1.1.30 and for Tenant-Green, VIP pool is 6.1.2.1 to 6.1.2.30.



---

**Note** The VIP pool should be in one of the subnets defined under BD "default" in the tenant "common"

---

### Procedure

---

- Step 1** Log in to the vRealize Automation as admin, choose **Catalog > Admin Services**.
- Step 2** Choose **Add VIP Pool** and perform the following actions:
- a) In the **Tenant** field, enter the Tenant name.
  - b) In the **VIP address start** field, enter the VIP address start.
  - c) In the **VIP Address End** field, enter the VIP address end.
  - d) In the **Internal VIP for Inter-EPG in VPC plan** field, select Yes or No.
  - e) Click **Submit**.
- 

## Deleting the VIP Pool

This section describes how to delete the VIP Pool.

This blueprint is to do necessary cleanup of VIP pool, once all the load balancer services consumed in the tenant are deleted.

### Procedure

---

- Step 1** Log in to the vRealize Automation as admin, choose **Catalog > Admin Services**.
- Step 2** Choose **Delete VIP Pool**, perform the following action items.

- a) In the **Tenant** field, click **Add**, expand *your\_apic* > **Tenants** and select the tenant.
  - b) In the **VIP address start** field, enter the VIP address start.
  - c) In the **VIP Address End** field, enter the VIP address end.
  - d) In the **Internal VIP for Inter-EPG in VPC plan** field, select Yes or No.
  - e) Click **Submit**.
- 

### Adding the Load Balancer to the Tenant-Network in a Shared Plan

vRA-Tenant can add a load balancer (LB) to Tenant-Network. The required parameters are Network-Name, LB device cluster, LB-endpoint (protocol, port), Vendor Type, and Consumer EPG or L3out. As part of this workflow, all the required service graph instance and contract (security policy) with chosen Tenant-Network as Provider-EPG is created. The consumer of this load balanced endpoint could be L3out in tenant common, or it could be another Tenant-Network belonging to the tenant.

#### Procedure

---

- Step 1** Log in to the vRealize Automation as admin, choose **Catalog > Tenant Shared Plan**.
  - Step 2** Choose **Add Load Balancer to Tenant Network - Shared Plan**, click **Request**.
  - Step 3** Enter the requested information in the fields.
  - Step 4** Click **Submit**.
- 

### Adding the Load Balancer to the Tenant-Network in a VPC Plan

This section describes how to add the load balancer to the tenant-network in a VPC Plan.



**Note** In a VPC plan, the Inter-EPG load balancer is not supported. Only the load balancer between L3out and First-Tier (Web) is supported in release 1.2(2x).

---

#### Procedure

---

- Step 1** Log in to the vRealize Automation as admin, choose **Catalog > Tenant VPC Plan**.
  - Step 2** Choose **Add Load Balancer to Tenant Network - VPC Plan**, click **Request**.
  - Step 3** Enter the requested information in the fields.
  - Step 4** Click **Submit**.
- 

### Deleting the Load Balancer from the Tenant-Network in a Shared Plan

You can delete the load balancer service (lb-port, lb-protocol) from an existing tenant network or endpoint group.

### Procedure

---

- Step 1** Log in to the vRealize Automation as admin, choose **Catalog > Tenant Shared Plan**.
  - Step 2** Choose **Delete Load Balancer to Tenant Network - Shared Plan** and click **Request**.
  - Step 3** Enter the requested information in the fields.
  - Step 4** Click **Submit**.
- 

### Deleting the Load Balancer from the Tenant-Network in a VPC Plan

You can delete the load balancer service (lb-port, lb-protocol) from an existing tenant network or endpoint group.

### Procedure

---

- Step 1** Log in to the vRealize Automation as admin, choose **Catalog > Tenant VPC Plan**.
  - Step 2** Choose **Delete Load Balancer to Tenant Network - VPC Plan** and click **Request**.
  - Step 3** Enter the requested information in the fields.
  - Step 4** Click **Submit**.
- 

## Configuring the Firewall

This section discusses the configuration steps to add a firewall service to a tenant network (the Application Policy Infrastructure Controller's endpoint group).

Figure 13: Shared Plan - Perimeter Firewall Only Overview

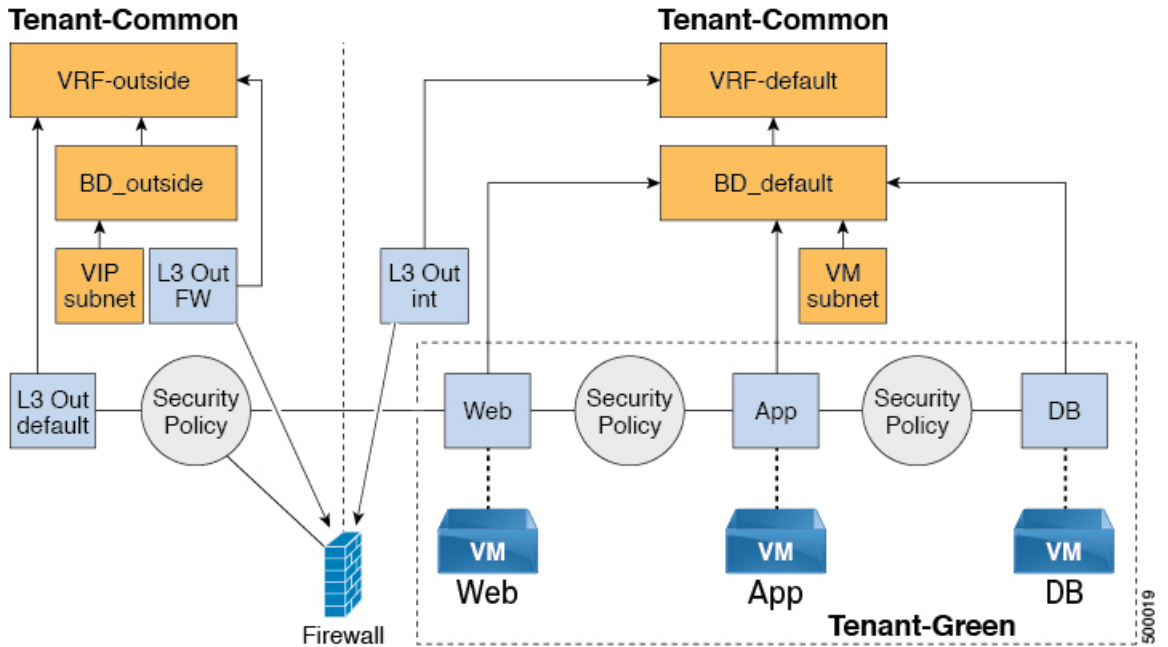

**Note** The perimeter firewall only service is not supported in VPC Plan. In VPC plan, the firewall service can be configured between EPGs.

### Adding the Firewall to the Tenant-Network in a Shared Plan

You can add the firewall to an existing tenant network or endpoint group. The consumer of the firewall must have a Layer 3 out connectivity policy configured in another VRF for example, "outside" VRF.

#### Procedure

- Step 1** Log in to the vRealize Automation as admin, choose **Catalog > Tenant Shared Plan**.
- Step 2** Choose **Add FW to Tenant Network - Shared Plan** and click **Request**.
- Step 3** Enter the requested information in the fields.
- Step 4** Click **Submit**.

### Deleting the Firewall from the Tenant-Network in a Shared Plan

You can delete the firewall from an existing tenant network or endpoint group.

#### Procedure

- Step 1** Log in to the vRealize Automation as admin, choose **Catalog > Tenant Shared Plan**.



- Step 2** Choose **Delete FW from Tenant Network - Shared Plan** and click **Request**.
- Step 3** Enter the requested information in the fields.
- Step 4** Click **Submit**.

## Configuring the Firewall and Load Balancer

This section covers the configuration steps to add a firewall and load balancer service to a tenant network (the Application Policy Infrastructure Controller's endpoint group).

In this plan, the firewall and load balancer devices are deployed in the "common" tenant, there by offering consumption model for vRealize Automation (vRA) and the APIC tenant using the shared infrastructure.

*Figure 14: Shared Plan - Firewall and Load Balancer Overview*

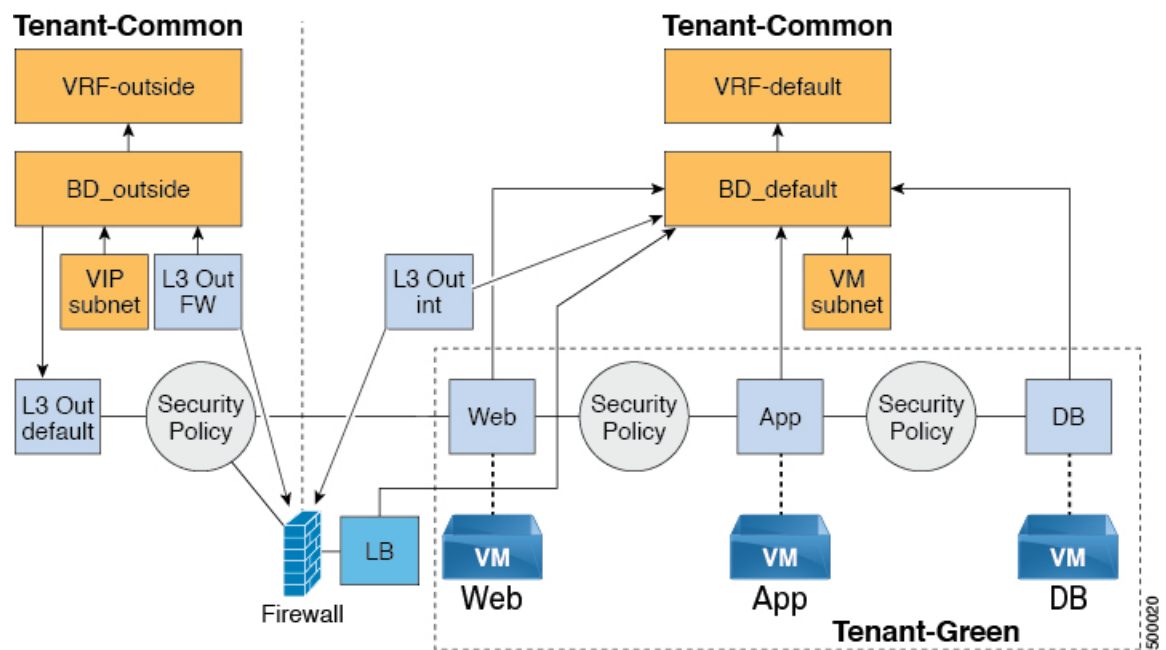
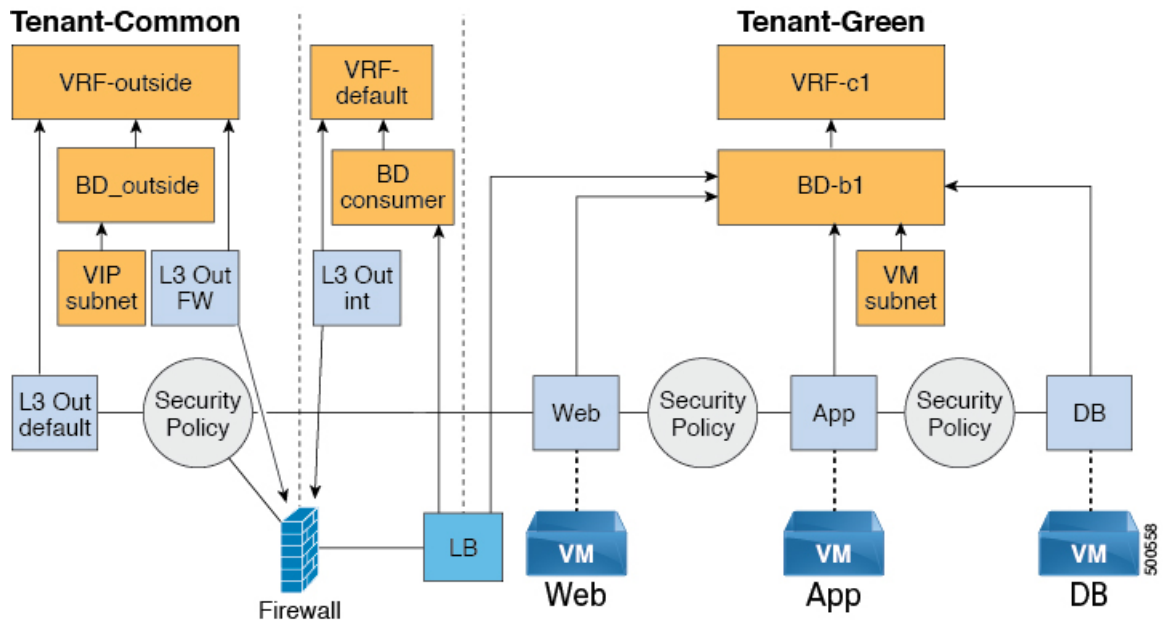

Figure 15: VPC Plan - Perimeter Firewall and Load Balancer



### Adding the Firewall and Load Balancer to the Tenant-Network in a Shared Plan

The virtual IP address pool must be added to the tenant before using the firewall and load balancer service.

See [Adding the VIP Pool, on page 181](#).

The firewall and load balancer can be added to an existing tenant network or endpoint group. The consumer of the firewall must have a Layer 3 out connectivity policy configured in the "outside" VRF.

#### Before you begin

For both Firewall and Load-Balancer only services have to be met before a firewall and load balancer service can be deployed.

#### Procedure

- 
- Step 1** Log in to the vRealize Automation as admin, choose **Catalog > Tenant Shared Plan**.
  - Step 2** Choose **Add FW and LB to Tenant Network - Shared Plan** and click **Request**.
  - Step 3** Enter the requested information in the fields.
  - Step 4** Click **Submit**.
- 

### Adding the Firewall and Load Balancer to the Tenant-Network in a VPC Plan

This section describes how to add the firewall and load balancer to the Tenant-Network in a VPC Plan.



---

**Note** Whenever a firewall and load balancer (LB) workflow is executed then external leg of LB is pointing to "default" Bridge Domain (BD). Customers should always deploy internal leg of firewall in "default" BD under tn-common. This ensures that both the firewall and load balancer point to same BD and traffic flows in an uninterrupted way.

---

#### Procedure

---

- Step 1** Log in to the vRealize Automation as admin, choose **Catalog > Tenant VPC Plan**.
  - Step 2** Choose **Add FW and LB to Tenant Network - VPC Plan** and click **Request**.
  - Step 3** Enter the requested information in the fields.
  - Step 4** Click **Submit**.
- 

### Deleting the Firewall and Load Balancer from the Tenant-Network in a Shared Plan

#### Procedure

---

- Step 1** Log in to the vRealize Automation as admin, choose **Catalog > Tenant Shared Plan**.
  - Step 2** Choose **Delete FW and LB from Tenant Network - Shared Plan** and click **Request**.
  - Step 3** Enter the requested information in the fields.
  - Step 4** Click **Submit**.
- 

### Deleting the Firewall and Load Balancer from the Tenant-Network in a VPC Plan

#### Procedure

---

- Step 1** Log in to the vRealize Automation as admin, choose **Catalog > Tenant VPC Plan**.
  - Step 2** Choose **Delete FW and LB from Tenant Network - VPC Plan** and click **Request**.
  - Step 3** Enter the requested information in the fields.
  - Step 4** Click **Submit**.
- 

## Configuring the Inter-EPG Firewall

This section describes how to configure the inter-EPG firewall service to a tenant network (the Application Policy Infrastructure Controller's endpoint group).

Figure 16: VPC Plan - Inter EPG FW

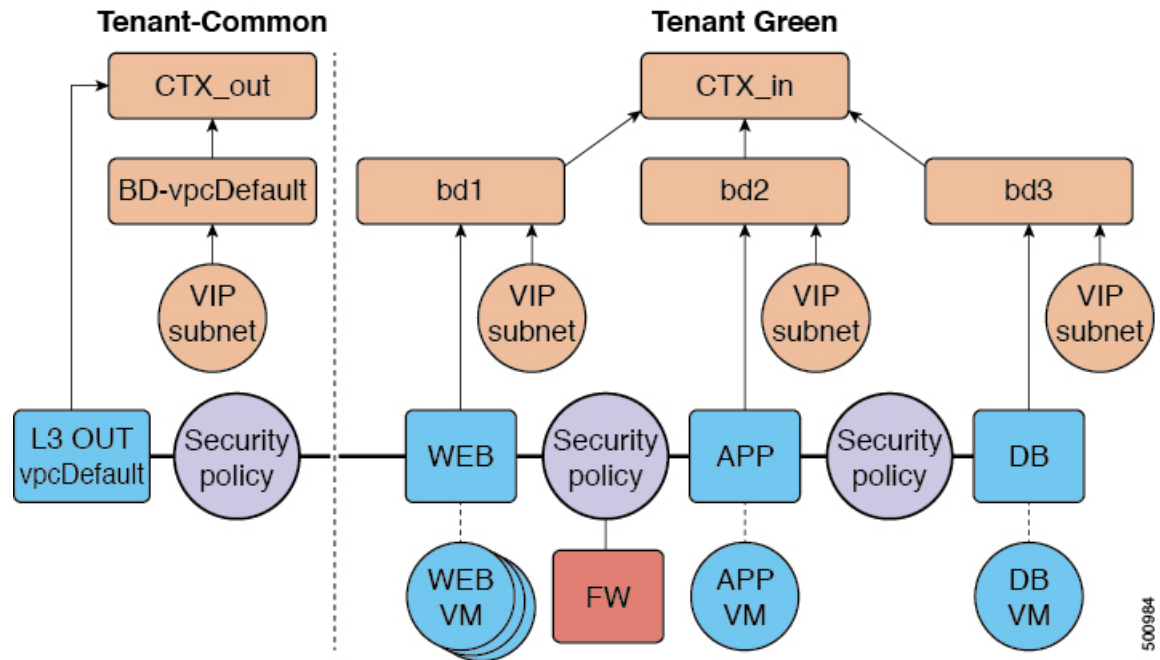

### Adding the Firewall to the Tenant-Network in a VPC Plan

This section describes how to add the firewall to an existing tenant network or endpoint group (EPG). When adding the tenant, "Enable Inter-EPG Firewall" should be set to "yes" and the number of tiers used in the application should be configured. When configuring the network (EPG) tier number should be set. In this scenario, the firewall is configured between a provider EPG and consumer EPG.

#### Procedure

- 
- Step 1** Log into the vRealize Automation as admin, choose **Catalog > Tenant VPC Plan**.
  - Step 2** Choose **Add FW to Tenant Network - VPC Plan** and click **Request**.
  - Step 3** Enter the requested information in the fields.
  - Step 4** Click **Submit**.
- 

### Deleting the Firewall from the Tenant-Network in a VPC Plan

This section describes how to delete the firewall from an existing tenant network or endpoint group (EPG).

#### Procedure

- 
- Step 1** Log into the vRealize Automation as admin, choose **Catalog > Tenant VPC Plan**.
  - Step 2** Choose **Delete FW from Tenant Network - VPC Plan** and click **Request**.
  - Step 3** Enter the requested information in the fields.

**Step 4** Click **Submit**.

## Attaching an External L3 Network Internet Access

This section describes how to attach an external Layer 3 (L3) Network Internet Access.

### Before you begin

- You can choose any name for the L3 policy.
- External L3 policy instance must be named [L3OutName|InstP].

### Procedure

- Step 1** Log in to the vRealize Automation as tenant, choose **Catalog > Tenant Network service**.
- Step 2** Choose **Attach or Detach L3 external connectivity to Network**
- Step 3** Choose **Request**.
- Step 4** In the **Request Information** tab, enter a description of the request.
- Step 5** Choose **Next**.
- Step 6** In the **Step** tab, perform the following actions:
- a) In the **Rule Entry List** field, enter the values and click **Save**.

This table shows the values for each Rule Entry:

| Rule Entry List | Values                                                                                                                    |
|-----------------|---------------------------------------------------------------------------------------------------------------------------|
| dstFormPort     | <ul style="list-style-type: none"> <li>• Blank</li> <li>• Unspecified</li> <li>• 1-65535</li> </ul>                       |
| dstToPort       | <ul style="list-style-type: none"> <li>• Blank</li> <li>• Unspecified</li> <li>• 1-65535</li> </ul>                       |
| protocol        | <ul style="list-style-type: none"> <li>• icmp</li> <li>• icmpv6</li> <li>• tcp</li> <li>• udp</li> <li>• Blank</li> </ul> |
| etherType       | <ul style="list-style-type: none"> <li>• IP</li> <li>• ARP</li> </ul>                                                     |

- b) In the **L3out Policy** field, click **Add** to locate and choose the L3 connectivity policy in the common tenant. (default)
- c) In the **Network/EPG name** field, click **Add** to locate and choose the network/EPG in the common tenant. (web-host)
- d) In the **EPG/Network plan type** field, click **Add** to locate and choose the network/EPG in the common tenant. (web-host)
- e) In the **Operation** field, click **Add** to add a Layer3 Out.

**Step 7** To verify your request, choose the **Requests** tab.

- a) Choose the request you submitted and click **view details**. Ensure the status is **Successful**.

## Verify the Security and L3 Policy on the APIC

This section describes how to verifying the security and Layer 3 (L3) policy on APIC.

### Procedure

**Step 1** Log in to Cisco APIC as the tenant, and then choose **TENANTS > common**.

**Step 2** In the **navigation** pane, expand **Tenant Common > Networking > Security Policies > Contracts**.

- a) Nested under **Contracts** there should be a new contract with the *end\_user\_tenant name-L3ext\_ctrct\_network\_name* that you connected to. (green-L3ext\_ctrct\_web-hosts)
- b) Expand the *end\_user\_tenant name-L3ext\_ctrct\_network\_name*. (green-L3ext\_ctrct\_web-hosts)
- c) Choose the *end\_user\_tenant name-L3ext\_ctrct\_network\_name*. (green-L3ext\_ctrct\_web-hosts)
- d) In the **Property** pane, in the **Filter** field, click the filter. (green-L3ext\_filt\_web-hosts)
- e) In the **Properties** pane, you can see the filter is mapped to vRealize.

**Step 3** In the **navigation** pane, expand **Tenant Common > Networking > External Routed Networks > default > Networks > defaultInstP**.

- a) In the **Properties** pane, in the **Provided Contracts** field, you should see the *end\_user\_tenant name-L3ext\_ctrct\_network\_name*. (green-L3ext\_filt\_web-hosts)
- b) In the **Consumed Contracts** field, you should see the *end\_user\_tenant name-L3ext\_ctrct\_network/EPG\_name*. (green-L3ext\_filt\_web-hosts)

**Step 4** On the menu bar choose **TENANTS > your\_tenant**.

**Step 5** In the **navigation** pane, expand **Tenant your\_tenant > Application Profile > default > Application EPGs > EPG web-hosts > Contracts**.

- a) In the **Contracts** pane, you can verify the contract and consumes a contract is present.

## Verifying the Network Connectivity

This section describes how to verify the network connectivity.

## Procedure

Log in to the virtual machine (web-host), from the command line, ping the other VM.

## Application Deployment Scenarios

The following table shows the supported deployment scenarios:

| Deployment Scenario                                   | Description                                                                                                     |
|-------------------------------------------------------|-----------------------------------------------------------------------------------------------------------------|
| <b>Web &gt; L3out</b>                                 | Web Tier to L3 external connectivity policy connected using security policy (L3out configured in "default" VRF) |
| <b>Web &gt; Firewall &gt; L3out</b>                   | Web Tier with Firewall and L3out (L3out configured in "outside" VRF)                                            |
| <b>Web &gt; Load Balancer &gt; L3out</b>              | Web Tier with Load balancer connected to L3out (L3out configured in "default")                                  |
| <b>Web &gt; Load Balancer and Firewall &gt; L3out</b> | Web Tier with Load balancer and Firewall service connected to L3out (L3out configured in "outside")             |
| <b>Application &gt; Web</b>                           | App tier to Web tier, connected using security policy                                                           |
| <b>Database &gt; Application</b>                      | Db tier to App tier, connected using security policy                                                            |
| <b>Application &gt; Load Balancer &gt; Web</b>        | App tier to Web tier using Load balancer. Traffic from Web tier towards App tier is load balanced.              |
| <b>Application &gt; Firewall &gt; Web</b>             | App tier to Web tier using firewall.                                                                            |

In a multi-tenant deployment, there are some restrictions in the service deployment configuration. The administrator must decide whether the applications in this deployment will use firewall services or a load balancer-only service at the first (web) tier.

The following table shows the supported combinations of services in the shared plan:

| Deployment Type                             | FW + LB > L3out | LB only > L3out | FW > L3out | LB between EPGs | FW between EPGs |
|---------------------------------------------|-----------------|-----------------|------------|-----------------|-----------------|
| Firewall only or Firewall and Load balancer | Yes             |                 | Yes        | Yes             | Yes             |
| Load Balancer only                          |                 | Yes             |            | Yes             |                 |

In case of multi-tenancy, you should use a dedicated service device for each tenant.

## About Property Groups

Property groups are a vRealize Automation (vRA) construct that provide virtual machine customization. Using property groups, vRA can invoke workflows in vRealize Orchestration (vRO) at given stage of virtual machine's life cycle. This virtual machine extension capability is used by Application Policy Infrastructure Controller (APIC) vRealize to invoke APIC vRA workflows and configure APIC policies.

APIC vRealize supports a number of application deployment scenarios. In a multi-tier application, the APIC security policy or the load balancing or firewall services can be inserted between tiers. This is achieved by the following steps:

1. Execute the **Configure Property Group** catalog-item in the **Admin Services** catalog to create a property group.
2. Use the **Security Policy**, **Load Balancer**, and **Firewall** tabs to customize the property group.
3. Enable the property group in the single-machine blueprint at the **Infrastructure > Blueprints > Single Machine Blueprint** level in vRealize.

## About Service Blueprints

This section describes the service blueprints.

In vRealize there are two sets of blueprints one is a machine blueprints that is for compute for installing, setting up VMs, and spinning VMs. There is a single- and a multi-machine blueprint for launching single-tier application workload or multi-tier application workload that is called machine blueprint for networking workflows.

Admin workflow:

- Create APIC handles
- Create VMM domains
- Create Tenants
- Create subnets in common
- Create Layer 4-7 devices

Tenant workflow:

- Create EPGs
- Create contracts
- Provide contracts
- Consume contracts
- Consume L3Outs
- Consume Layer 4-7 devices



## Integration with vRealize Network Profiles (IPAM)

vRealize IP address management (IPAM) uses the network profiles concept to assign a pool of addresses to one or more networks. You can assign network profiles to ACI backed networks in the same fashion as a regular vRealize network.

To integrate with the vRealize IPAM:

### Procedure

---

- Step 1** Ensure the subnet exists to the bridge domain.  
See **Add or Delete Subnets in Bridge Domain for Tenant-Common**.
- Step 2** Create a network profile.  
See VMware's documentation for creating a network profile.
- Step 3** This depends on if your blueprint generates a new network or not:  
If you use the same network for each machine blueprint:  
Under your vCenter reservation find the EPG (Network Path) and assign the network profile to it.
- In the vCenter, navigate to **Infrastructure > Reservations**.
  - Find "Your Reservation", hover and click **Edit**.
  - Navigate to **Network > Find desired Network Path (EPG)**, from the drop-down list, choose the Network Profile and click **Ok**.
- If you generate a network per VM:  
Add a property to your property group with the network profile as the value.
- In the vCenter, navigate to **Infrastructure > Blueprints > Property Groups**.
  - Find "Your Blueprint", hover and click **Edit**.
  - Click + **New Property**.
  - Set the Name to "*VirtualMachine.NetworkX.NetworkProfileName*".  
where *X* is the VM NIC number (in the range [0-9]).
  - Set the Value to the name of the Network Profile you created.
  - Click the green tick icon to confirm and click **Ok**.
- New applications will be assigned an address from this pool.
- Step 4** Use guest customizations to assign the IP address to the server.  
See VMware's documentation for guest customizations.
- 

## Documentation of APIC Workflows in vRealize Orchestrator

To get documentation on the APIC methods and types, the vRO API search can be used.

- Log in to the vRO GUI, choose **Tools > API Search**

## 2. Enter **APIC**.

This shows the list of all APIC methods and types.

## List of Methods in ApicConfigHelper Class

This section provides a list of methods in `ApicConfigHelper` class.

- This adds an APIC host to the repository and does a login to the APIC:

```
ApicHandle addHost(String hostName,
 String hostIp0,
 String hostIp1,
 String hostIp2,
 String userName,
 String pwd,
 int port,
 boolean noSsl,
 String role,
 String tenantName)
```

- This gets the APIC handle give the APIC name:

```
ApicHandle getApicHandle(String hostName)
```

- This gets the list of APIC handles for a given <role, username>:

```
List<ApicHandle> getApicHandleByRole(String role, String userName)
```

- This removes an APIC host from the repository:

```
boolean removeHost(String inApicName)
```

- This creates Tenant endpoint group and association to vmmDomain in APIC:

```
ApiResponse addNetwork(ApicHandle handle,
 String tenantName,
 String apName,
 String epgroupName,
 String bdName,
 String ctxName,
 String subnet,
 String domName,
 boolean vmm,
 boolean vpc,
 boolean intraEpgDeny,
 boolean allowUseg,
 String encapMode)
```

- This updates the domain of the endpoint group by adding or deleting:

```
ApiResponse updateNetwork(ApicHandle handle,
 String tenantName,
 String apName,
 String epgroupName,
 String domName,
 boolean vmm,
 boolean add,
 String encapMode)
```

- This adds or deletes subnets to the bridge domain in the virtual private cloud (VPC) tenant:

```
ApiResponse updateSubnets(ApicHandle handle,
 String tenantName,
 String bdName,
```

```
fvSubnet subnetList[],
boolean add)
```

- This adds or deletes the bridge domain to or from the tenant:

```
ApiResponse updateBD(ApicHandle handle,
String tenantName,
String bdName,
String ctxName,
boolean arpFlooding,
String l2UnknownUnicast,
String l3UnknownMulticast,
boolean add)
```

- This adds or deletes the context (Ctx) to or from the tenant:

```
ApiResponse updateCtx(ApicHandle handle,
String tenantName,
String ctxName,
boolean add)
```

- This adds or deletes the following based on add or delete:

```
ApiResponse addOrDeleteLBToNetwork(ApicHandle handle,
String tenantName,
String apName,
String epgName,
String bdName,
String ctxName,
boolean vpc,
String planName,
String lbVendor,
String ldevName,
String graphName,
boolean sharedLb,
String protocol,
String port,
String consumerDn,
String snipIntAddress,
String snipIntNetMask,
String snipExtAddress,
String snipExtNetMask,
String snipNextHopGW,
boolean addOperation)
```

- This opens a connection to the URL, sends the postBody string to the URL location, and returns result:

```
ApiResponse addOrDelFWReq(ApicHandle handle,
String tenantName,
String apName,
String epgName,
String ctrctName,
String graphName,
vzEntry entryList[],
String consumerDn,
boolean addOp,
boolean updateOp)
```

- This adds the firewall service to an endpoint group in the shared and VPC plan:

```
ApiResponse addFWToNetwork(ApicHandle handle,
String tenantName,
String apName,
String epgName,
boolean vpc,
String fwVendor,
```

```
String ldevName,
String graphName,
vzEntry entryList[],
String fwL3extExternal,
String fwL3extInternal,
boolean skipFWReq,
String consumerDn)
```

- This deletes the firewall from the endpoint group in the shared and VPC Plan:

```
ApicResponse deleteFWFromNetwork(ApicHandle handle,
String tenantName,
String apName,
String epgroupName,
boolean vpc,
String graphName,
String ctrctName,
String protocol,
String startPort,
boolean skipFWReq,
String consumerDn)
```

- This implements the REST API to APIC:

```
String apicRestApi(ApicHandle handle,
String apiUrl,
String method,
String postBody)
```

- This adds or deletes the router ID in a tenant:

```
ApicResponse addOrDelRouterId(ApicHandle handle,
String rtrId,
boolean addOp)
```

- This deletes the tenant endpoint group and the association:

```
ApicResponse deleteNetwork(ApicHandle handle,
String tenantName,
String apName,
String epgroupName)
```

- This creates the tenant, bridge domain and the context (Ctx) in APIC:

```
ApicResponse addTenant(ApicHandle handle,
String tenantName,
String bdName,
String ctxName,
String aaaDomain)
```

- This deletes the tenant in APIC:

```
ApicResponse deleteTenant(ApicHandle handle,
String tenantName)
```

- This adds VlanS, vmmDomP, vmmCtrlP, vmmUsrAccp and required relation objects to the APIC:

```
ApicResponse addVmmDomain(ApicHandle handle,
String dvsName,
String vcenterIP,
String userName,
String passwd,
String datacenter,
String vlanPoolName,
int vlanStart,
```

```
int vlanEnd,
String aaaDomain)
```

- This deletes VlanNS and vmmDomP objects from the APIC:

```
ApiResponse deleteVmmDomain(ApicHandle handle,
String domName,
String vlanPoolName)
```

- This adds or deletes encap blocks in the VLAN pool:

```
ApiResponse updateVlanPool(ApicHandle handle,
String vlanPoolName,
fvnsEncapBlk encapList[])
```

- This adds the security policy (contract entry):

```
ApiResponse addSecurityPolicySet(ApicHandle handle,
String tenant,
String ap,
String srcEpg,
String dstEpg,
vzEntry entryList[],
boolean createFlg
)
```

- This updates the security policy (contract entry):

```
ApiResponse updateSecurityFilters(ApicHandle handle,
String tenant,
String filterName,
vzEntry entryList[]
)
```

- This adds or removes the consumer contract interface:

```
ApiResponse updateSharedSvcConsumer(ApicHandle handle,
String tenant,
String ap,
String consumerEpg,
vzBrCP contract,
boolean add
)
```

- This updates the security policy (contract entry):

```
ApiResponse updateL3outPolicy(ApicHandle handle,
String tenant,
String ap,
String dstEpg,
vzEntry entryList[],
l3extOut l3out,
boolean vpc,
boolean add
)
```

- This deletes all the security policy (contracts):

```
ApiResponse deleteSecurityPolicy(ApicHandle handle,
String tenant,
String ap,
String srcEpg,
String dstEpg
)
```

- This creates VIP address block in the tn-common:

```
ApicResponse addVipPool(ApicHandle handle,
 String planName,
 String addrStart,
 String addrEnd)
```

- This deletes VIP address block in the tn-common:

```
ApicResponse deleteVipPool(ApicHandle handle,
 String planName,
 String addrStart,
 String addrEnd)
```

- This adds or deletes the security domain associations:

```
ApicResponse updateVmmDomain(ApicHandle handle,
 String domName,
 aaaDomainRef aaaList[])
```

- This deletes a shared service provider (endpoint group) from a contract:

```
ApicResponse deleteSharedServiceProvider(ApicHandle handle,
 String tenant,
 String ap,
 String srcEpg,
 String dstEpg,
 vzBrCP contract)
```

- This creates a Cisco AVS VMM domain and adds related objects to the APIC:

```
ApicResponse addAvsVmmDomain(ApicHandle handle,
 String dvsName,
 String aepName,
 String vcenterIP,
 String userName,
 String passwd,
 String dvsVersion,
 String datacenter,
 String mcastIP,
 String poolName,
 String rangeStart,
 String rangeEnd,
 String aaaDomain,
 int domType,
 String secondRangeStart,
 String secondRangeEnd,
 String secondPoolName)
```



---

**Note** Beginning with Cisco APIC Release 5.0(1), Cisco Application Virtual Switch (AVS) is no longer supported. If you use Cisco AVS and upgrade to Cisco APIC Release 5.0(1), in case of issues, the fabric will not be supported. Also, a fault will be raised for the Cisco AVS domain.

If you use Cisco AVS, we recommend that you migrate to Cisco ACI Virtual Edge. See the *Cisco ACI Virtual Edge Installation Guide* on Cisco.com.

---

- This updates the pools (VLAN, Multicast Address) relevant to a Cisco AVS VMM domain:

```
ApicResponse updateAvsVlanMcastPool(ApicHandle handle,
 String poolName,
 fvnsEncapBlk encapList[],
 int poolType)
```

- This deletes a Cisco AVS VMM domain:

```
ApicResponse deleteAvsVmmDomain(ApicHandle handle,
 String domName,
 String poolName,
 int poolType)
```

- This deletes a Cisco AVS VMM domain which is in mixed mode:

```
ApicResponse deleteAvsVmmDomainMixedmode(ApicHandle handle,
 String domName)
```

- This creates Distributed Firewall for a Cisco AVS VMM domain:

```
ApicResponse createFWPol(ApicHandle handle,
 String polName,
 String vmmName,
 String polMode,
 String pInterval,
 String logLevel,
 String adminState,
 String destGrpName,
 String inclAction,
 int caseVal)
```

- This updates Distributed Firewall association with a Cisco AVS VMM domain:

```
ApicResponse updateFWPolMapping(ApicHandle handle,
 String polName,
 String vmmName,
 Boolean opValue)
```

- This deletes Distributed Firewall:

```
ApicResponse deleteFWPol(ApicHandle handle,
 String polName)
```

- This adds or deletes attribute(s) for a Microsegment EPG:

```
ApicResponse addOrDelUsegAttr(ApicHandle handle,
 String tenantName,
 String apName,
 String epgName,
 String criteriaName,
 fvVmAttrV addFvVmAttrList[],
 fvMacAttr addFvMacAttrList[],
 fvIpAttr addFvIpAttrList[],
 fvVmAttr delFvVmAttrList[],
 fvMacAttr delFvMacAttrList[],
 fvIpAttr delFvIpAttrList[])
```

- This adds a microsegment EPG:

```
ApicResponse addUsegEpg(ApicHandle handle,
 String tenantName,
 String apName,
 String epgName,
 String bdName,
 String ctxName,
 String subnet,
 String domName,
 String criteriaName,
 boolean vmm,
 boolean vpc,
 boolean intraEpgDeny,
 fvVmAttrV fvVmAttrList[],
```

```
fvMacAttr fvMacAttrList[],
fvIpAttr fvIpAttrList[],
String encapMode)
```

## Writing Custom Workflows Using the APIC Plug-in Method

This section describes how to write custom workflows using the Application Policy Infrastructure Controller (APIC) plug-in method. Tenants might have unique requirements for their logical network topology that are not covered by the out-of-box designs. Existing Cisco APIC workflows can be combined together into a custom workflow that enables limitless network designs.

All workflows expect a set of input parameters, and workflows that create new objects will export a set of output parameters. Output parameters can be chained into the input parameter of the next workflow.

The following example procedure creates a custom workflow that builds a new network, and then directly passes the newly created network into the input of the attach Layer 3 workflow.

### Procedure

- 
- Step 1** Log in to the vRealize Orchestrator.
  - Step 2** Switch to the **Design** mode.
  - Step 3** In the Navigation pane, create a folder named "Custom Workflows".
  - Step 4** Choose the **Custom Workflows** folder.
  - Step 5** In the Work pane, click the **New workflow** button.
  - Step 6** In the **Workflow name** dialog box, enter a name for the workflow.  
Example:  
`Create_Network_Attach_L3`
  - Step 7** Click **OK**.
  - Step 8** Choose the **Schema** tab.
  - Step 9** In the Navigation pane, expand **All Workflows > Administrator > Cisco APIC workflows > Tenant Shared Plan**
  - Step 10** Drag and drop **Add Tenant Network - Shared Plan** onto the blue arrow in the Work pane.
  - Step 11** In the **Do you want to add the activity's parameters as input/output to the current workflow?** dialog box, click **Setup...**
  - Step 12** In the **Promote Workflow Input/Output Parameters** dialog box, click **Promote**.  
Leave all of the values at their defaults.
  - Step 13** In the Navigation pane, expand **All Workflows > Administrator > Cisco APIC workflows > Advanced Network Services**.
  - Step 14** Drag and drop **Attach or Detach L3 external connectivity to Network** onto the blue arrow that is to the right of the **Add Tenant Network** object in the Work pane.
  - Step 15** In the **Do you want to add the activity's parameters as input/output to the current workflow?** dialog box, click **Setup...**
  - Step 16** In the **Promote Workflow Input/Output Parameters** dialog box, click **Promote**.  
Leave all of the values at their defaults.



- Step 17** Choose the **Inputs** tab.
- The screen displays the inputs for the workflow. You can verify that the inputs are all exposed and that the created endpoint group is an output parameter.
- Step 18** Choose the **Schema** tab.
- Step 19** In the Work pane, click **Validate** to verify that the custom workflow is valid.
- Step 20** Click **Close**.
- Step 21** Click **Run** to test the workflow.
- Step 22** In the **Start Workflow** dialog box, click **Submit** to start the workflow.
- 

## Multi-Tenancy and Role based Access Control Using Security Domains

APIC and vRA both supports multi-tenancy natively. vRA tenant user is mapped one-to-one with a APIC tenant user and thus Tenant names need to match exactly on both systems.

For every vRA tenant, APIC admin needs to ensure that an user account and required security domains and roles are created in APIC as part of Day-0 operation.

As a next step, vRA-Admin would execute Add Tenant service blueprint (part of Admin catalog), to create/update Tenant in APIC and associate it with the right security Domain. For eg: Tenant-Green on vRA is mapped to Tenant-Green in APIC with association to Security Domain "Domain-Green" enabled for "User-Green".

By associating tenant to right security domains, Role based access control is enforced and it allows for granular as well stricter Tenant policy enforcement.

### Adding the Tenant

This section describes how to add the tenant.

In this blueprint, a tenant identified by input parameter "Tenant" is created in APIC with association the security domain that is provided as second input.

#### Procedure

---

- Step 1** Log in to the vRealize Automation as admin, choose **Catalog > Admin Services**.
- Step 2** Choose **Add Tenant**, enter the information in the fields and click **Submit**.
- 

### Deleting the Tenant

This section describes how to delete the tenant from APIC.

#### Procedure

---

- Step 1** Log in to the vRealize Automation as admin, choose **Catalog > Admin Services**.

**Step 2** Choose **Delete Tenant**, enter the information in the fields and click **Submit**.

---

## APIC Credentials for Workflows

As part of ACI-integration with vRA, this release supports pairing up vRA with a ACI fabric managed by a APIC-cluster.

The network service blueprints are categorized into Admin and Tenant workflows and accordingly vRA admin has to setup APIC connection handles for APIC-Admin credential as well as APIC-Tenant credential for every vRA-Tenant.

As part of plug-in, the right handles (Admin vs Tenant) are auto-selected implicitly based on the workflow context and the privileges needs to create and managed objects in APIC. This provides stronger access control and isolation among tenants.

### Adding APIC with Admin Credentials

This section describes how to add APIC with admin credentials.

All the blueprints and workflows that are part of catalog items in Admin portal are performed using the Admin-credential.

#### Procedure

---

- Step 1** Log in to the vRealize Automation as admin, choose **Catalog > Network Security**.
  - Step 2** Choose **Add APIC with Admin Credentials**, enter the information in the fields and click **Submit**.
  - Step 3** To access APIC using certificates, set the "Use certificate authentication" to **yes** and enter the **Certificate Name** and **Private Key** parameters.
- 

### Adding APIC with Tenant Credentials

This section describes how to using tenant admin credentials (security domain).

#### Procedure

---

- Step 1** Log in to the vRealize Automation as admin, choose **Catalog > Admin Services**.
  - Step 2** Choose **Add APIC with Tenant credentials**, enter the information in the fields and click **Submit**.
  - Step 3** To access APIC using certificates, set the "Use certificate authentication" to **yes** and enter the **Certificate Name** and **Private Key** parameters.
- 

## Troubleshooting

This section describes the troubleshooting techniques.

## Collecting the Logs to Report

This section describes how to collect the log files from the vRealize Appliance to report.

### Procedure

To collect the log files, enter the following commands:

```
tar xvfz apic-vrealize-1.2.1x.tgz
cd apic-vrealize-1.2.1x
cd scripts/
./get_logs.sh
Usage: get_logs.sh [-u] [-p <password>] [-s <vra_setup>]
 -p password (can be skipped for default passwd)
 -s vra_setup
 -u un-compress (ie., don't create .tar.gz file)
```

```
Example:
./get_logs.sh -p ***** -s vra-app
...
VMware vRealize Automation Appliance
Compressing Logs
logs/
logs/app-server/
logs/app-server/catalina.out
logs/app-server/server.log
logs/configuration/
logs/configuration/catalina.out
Logs saved in vra_logs_201511251716.tar.gz
```

## Installing the ACI Helper Scripts

This section describes how to install the helper scripts. The ACI helper scripts provide the following:

- Restarts the vco-server and vco-configurator
- Uninstalls the APIC plug-in

### Procedure

To install the helper scripts, enter the following commands:

```
cd scripts
./install_apic_scripts.sh
Usage: install_apic_scripts.sh [-p <password>] [-s <vra_setup>]
 -p password
 -s vra_setup
```

```
Example:
./install_apic_scripts.sh -p ***** -s vra-app
Copying APIC scripts 'rmapic', 'restart' to vra: vra-app
```

# Removing the APIC Plug-in

This section describes how to remove the APIC plug-in.

## Procedure

- 
- Step 1** Log into the VMware vRealize Orchestrator as administrator.
- Step 2** Run the Delete APIC workflow for all APIC handles.
- Step 3** Install the ACI helper scripts, which can be found in [Installing the ACI Helper Scripts](#) , on page 203.
- Step 4** Log in to the VRA appliance as root, using SSH: `$ssh root@vra_ip`.
- Step 5** Change the permissions to the `rmapic` bash script to be executable:
- ```
$ chmod a+x rmapic
```
- Step 6** Execute the `rmapic` bash script to remove the APIC plug-in:
- ```
$ ~/rmapic
```
- Step 7** To verify that the plug-in has been uninstalled, log in to the VMware appliance using the Firefox browser: `https://appliance_address:8283/vco-controlcenter`
- Step 8** Under the **Plug-Ins** section, click **Manage Plug-Ins**.
- Step 9** Verify that the Cisco APIC Plug-in is no longer listed under **Plug-In**.
- 

## Plug-in Overview

| vRA Blueprints input parameters | vRO Javascript Object Name | APIC Managed Object Name    |
|---------------------------------|----------------------------|-----------------------------|
| Tenant                          | ApicTenant                 | com.cisco.apic.mo.fvTenant  |
| Bridge Domain                   | ApicBridgeDomain           | com.cisco.apic.mo.fvBD      |
| VRF                             | ApicL3Context              | com.cisco.apic.mo.fvCtx     |
| Tenant Network (EPG)            | ApicEPG                    | com.cisco.apic.mo.fvAEPg    |
| Security Policy (Contracts)     | ApicSecurityPolicy         | com.cisco.apic.mo.vzBrCP    |
| Security Filters                | ApicSecurityFilter         | com.cisco.apic.mo.vzFilter  |
| Security Rules                  | ApicSecurityRule           | com.cisco.apic.mo.vzEntry   |
| AAA Domain                      | ApicAAADomain              | com.cisco.apic.mo.aaaDomain |
| VMM Domain                      | ApicVmmDomain              | com.cisco.apic.mo.vmmDomP   |

| vRA Blueprints input parameters | vRO Javascript Object Name | APIC Managed Object Name     |
|---------------------------------|----------------------------|------------------------------|
| VMM Controller                  | ApicVmmController          | com.cisco.apic.mo.vmmCtrlrP  |
| Physical Domain                 | ApicPhysicalDomain         | com.cisco.apic.mo.physDomP   |
| L4-L7 Device Cluster            | ApicLogicalLBDevice        | com.cisco.apic.mo.vnsLDevVip |
| L3 external connectivity        | ApicL3Connectivity         | com.cisco.apic.mo.l3extOut   |

## Configuring a vRA Host for the Tenant in the vRealize Orchestrator

This section describes how to configure a vRA host for the tenant in the vRealize Orchestrator (vRO).



**Note** There will be one vRA host handle already created by default. This is for the global tenant and is used for administration purposes and to create the IaaS host handle.

### Procedure

- Step 1** Log in to the VMware vRealize Orchestrator as administrator.
- Step 2** Once the VMware vRealize Orchestrator GUI appears, from the drop-down list, choose **Run** from the menu bar.
- Step 3** In the **Navigation** pane, choose the **Workflows** icon.
- Step 4** Choose **Administrator@vra\_name > Library > vRealize Automation > Configuration > Add a vRA host**.
- Step 5** Right-click **Add a vRA host** and choose **Start Workflow**.
- Step 6** In the **Start Workflow: Add a vRA host** dialog box, perform the following actions:
  - a) In the **Host Name** field, enter the host's name.
  - b) In the **Host URL** field, enter the host's URL.
  - c) For **Automatically install SSL certificates**, choose **Yes**.
  - d) In the **Connection timeout** field, enter "30".
  - e) In the **Operation timeout** field, enter "60".
  - f) For **Session Mode**, choose **Shared session**.
  - g) In the **Tenant** field, enter the tenant's name.
  - h) In the **Authentication username** field, enter your tenant administrator username.
  - i) In the **Authentication pwd** field, enter your tenant administrator password.
  - j) Click **Submit**.

# Configuring an IaaS Host in the vRealize Orchestrator

This section describes how to configure an IaaS host in the vRealize Orchestrator (vRO).

## Procedure

---

- Step 1** Log in to the VMware vRealize Orchestrator as administrator.
- Step 2** Once the VMware vRealize Orchestrator GUI appears, from the drop-down list, choose **Run** from the menu bar.
- Step 3** In the **Navigation** pane, choose the **Workflows** icon.
- Step 4** Choose **Administrator@vra\_name > Library > vRealize Automation > Configuration > Add the IaaS host of a vRA host**.
- Step 5** Right-click **Add the IaaS host of a vRA host** and choose **Start Workflow**.
- Step 6** In the **Start Workflow: Add the IaaS host of a vRA host** dialog box, perform the following actions:
- In the **vRA Host** drop-down list, choose the default vRA host that was created by the system. Do not choose the tenant handle.
  - In the **Host Name** field, leave the auto-filled name as is.
  - In the **Host URL** field, enter the vRA host's URL.
  - In the **Connection timeout** field, enter "30".
  - In the **Operation timeout** field, enter "60".
  - For **Session Mode**, choose **Shared session**.
  - In the **Authentication username** field, enter your IaaS administrator username.
  - In the **Authentication pwd** field, enter your IaaS administrator password.
  - In the **Workstation for NTLM authentication** field, enter your IaaS host name.
  - In the **Domain for NTLM authentication** field, enter your IaaS domain name.
  - Click **Submit**.
-



# CHAPTER 13

## Cisco ACI vCenter Plug-in

---

This chapter contains the following sections:

- [About Cisco ACI with VMware vSphere Web Client, on page 207](#)
- [Getting Started with Cisco ACI vCenter Plug-in, on page 208](#)
- [Cisco ACI vCenter Plug-in Features and Limitations, on page 213](#)
- [Upgrading VMware vCenter when Using the Cisco ACI vCenter Plug-in, on page 220](#)
- [Cisco ACI vCenter Plug-in GUI, on page 221](#)
- [Performing ACI Object Configurations, on page 228](#)
- [Uninstalling the Cisco ACI vCenter Plug-in, on page 237](#)
- [Upgrading the Cisco ACI vCenter Plug-in, on page 238](#)
- [Troubleshooting the Cisco ACI vCenter Plug-in Installation, on page 238](#)
- [Reference Information, on page 239](#)

### About Cisco ACI with VMware vSphere Web Client

The Cisco ACI vCenter plug-in is a user interface that allows you to manage the ACI fabric from within the vSphere Web client.

This allows the VMware vSphere Web Client to become a single pane of glass to configure both VMware vCenter and the ACI fabric.

The Cisco ACI vCenter plug-in empowers virtualization administrators to define network connectivity independently of the networking team while sharing the same infrastructure.

No configuration of in-depth networking is done through the Cisco ACI vCenter plug-in. Only the elements that are relevant to virtualization administrators are exposed.

### Cisco ACI vCenter Plug-in Overview

The Cisco Application Centric Infrastructure (ACI) vCenter plug-in for the VMware vSphere Web Client, adds a new view to the GUI called Cisco ACI Fabric.

The Cisco Application Centric Infrastructure (ACI) vCenter plug-in does not change existing integration of ACI with vCenter, it allows you to configure an EPG, uSeg EPG, contract, tenant, VRF, and bridge domain from the VMware vSphere Web Client.

Cisco Application Centric Infrastructure (ACI) vCenter plug-in is stateless, fetches everything from Application Policy Infrastructure Controller (APIC) and does not store any information.

The following is a brief overview of the features provided by Cisco ACI vCenter plug-in:

For more detailed information, see [Cisco ACI vCenter Plug-in Features and Limitations, on page 213](#).

The Cisco ACI vCenter plug-in provides the possibility to create, read, update and delete (CRUD) the following object on the ACI Fabric:

- Tenant
- Application Profile
- EPG / uSeg EPG
- Contract
- VRF
- Bridge Domain

The Cisco ACI vCenter plug-in also provides a more limited operation regarding the usage of L2 and L3 Out, where all of the advanced configuration needs to be done in APIC beforehand.

- Preconfigured L2 and L3 Out can be used as providers or consumers of a contract.
- Cannot be created, edited or deleted.

The Cisco ACI vCenter plug-in also allows to consume preconfigured L4-L7 Services, by applying existing graph template to a Contract.

- Can use existing graph templates, not create them.
- Only empty mandatory parameter of the function profile will be displayed and configurable.

The Cisco ACI vCenter plug-in also has troubleshooting capabilities:

- Endpoint to endpoint sessions (Faults, Audits, Events, Stats, Contract, Traceroute )

## Getting Started with Cisco ACI vCenter Plug-in

### Cisco ACI vCenter Plug-in Software Requirements

The Cisco ACI vCenter plug-in Software Requirements:

| Platform Series                                     | Recommended Release                                                                                                               |
|-----------------------------------------------------|-----------------------------------------------------------------------------------------------------------------------------------|
| vCenter                                             | Cisco APIC supports any version of Linux Appliance and Windows Server that VMware supports. See VMware documentation for details. |
| Application Policy Infrastructure Controller (APIC) | Release 3.2(2) and later                                                                                                          |



## Required APIC Configuration

This sections describes the required APIC configuration.

At least one VMM domain should already exists between the APIC and the vCenter where the plug-in is being installed.

For more information, see the *Cisco Application Centric Infrastructure Fundamentals Guide*.

## Installing the Cisco ACI vCenter Plug-in

This section describes how to install the Cisco Application Centric Infrastructure (ACI) vCenter plug-in. You must have working HTTPS traffic between your VMware vCenter and Cisco Application Policy Infrastructure Controller (APIC). That is because VMware vCenter downloads the plug-in directly from the Cisco APIC.

If you cannot enable HTTPS traffic between your VMware vCenter and Cisco APIC, and you wish to use your own web server to host the Cisco ACI vCenter plug-in zip file, see the [Alternative Installation of the Cisco ACI vCenter Plug-in, on page 239](#).

If you are using VMware vCenter 5.5 (Update 3e or later) or vCenter 6.0 (Update 2 or later), follow the procedure in this section. If you are using an earlier release of vCenter 5.5 or 6.0, see the [Alternative Installation of the Cisco ACI vCenter Plug-in, on page 239](#).

To install a plug-in, the vCenter must download the plug-in from a Web server. In the following procedure, the Cisco APIC is used as the Web server, and the VMware vCenter downloads the plug-in directly from the Cisco APIC.

Before vCenter 5.5 Update 3e or vCenter 6.0 Update 2, vCenter uses TLSv1 for the HTTPS communication, which is now obsolete. For security reasons Cisco APIC only supports TLSv1.1 and TLSv1.2, therefore the vCenter will not be able to download the plug-in from the Cisco APIC. The plug-in must be put on a separate Web server, that allows TLSv1 or that does not use HTTPS.



---

**Note** If you log out of VMware vCenter 6 .7 and then log back in, you may not see the vCenter plug-in icon. If that occurs, clear the cookies and history or log in using another browser.

---

### Before you begin

- Make sure all of the prerequisites are met.

For more information, see the [Cisco ACI vCenter Plug-in Software Requirements, on page 208](#) and [Required APIC Configuration, on page 209](#) sections.

- Ensure HTTPS traffic is allowed between your vCenter server and APIC.
- If you are installing the Cisco ACI vCenter plug-in for VMware vCenter 6.7, you need PowerCLI version 11.2.0 or later.



**Note** During installation, you may see the following error on the console:

```
Error: Invalid server certificate. Use
Set-PowerCLIConfiguration to set the value for the
InvalidCertificationAction option to Prompt if you'd
like to connect once or to add a permanent exception
for this server.
```

To avoid seeing this error, enter the following command before installation:  
**Set-PowerCLIConfiguration -InvalidCertificateAction Ignore -Confirm:\$false**

### Procedure

**Step 1** Go to the following URL:

**Example:**

```
https://<APIC>/vcplugin
```

**Step 2** Follow the instructions on that web page.

## Connecting the Cisco ACI vCenter Plug-in to your Cisco ACI Fabric

This section describes how to connect the Cisco Application Centric Infrastructure (ACI) vCenter plug-in to your Cisco ACI fabric.



- Note**
- The registration is VMware vCenter-wide and it does not take into account the user that performs it. It is a configuration for the whole VMware vCenter, not just for the logged-in user that performs it.
  - Role Based Access Control (RBAC) is based on the credentials used upon registration. Permission of the Cisco Application Policy Infrastructure Controller (APIC) account used for the registration defines configuration restriction on the Cisco ACI vCenter plug-in.

You can connect the plug-in to your Cisco ACI fabric, using one of the following ways:

|                                                                                               |                                                                                                                                      |
|-----------------------------------------------------------------------------------------------|--------------------------------------------------------------------------------------------------------------------------------------|
| Connect the Cisco ACI vCenter plug-in to your Cisco ACI fabric using credentials.             | For more information, see <a href="#">Connecting vCenter Plug-in to the Cisco ACI Fabric Using Credentials</a> , on page 211.        |
| Connect the Cisco ACI vCenter plug-in to your Cisco ACI fabric using an existing certificate. | For more information, see <a href="#">Connecting vCenter Plug-in to your ACI Fabric Using an Existing Certificate</a> , on page 211. |

|                                                                                               |                                                                                                                                      |
|-----------------------------------------------------------------------------------------------|--------------------------------------------------------------------------------------------------------------------------------------|
| Connect the Cisco ACI vCenter plug-in to your Cisco ACI fabric by creating a new certificate. | For more information, see <a href="#">Connecting vCenter Plug-in to your ACI Fabric by Creating a New Certificate</a> , on page 212. |
|-----------------------------------------------------------------------------------------------|--------------------------------------------------------------------------------------------------------------------------------------|

## Connecting vCenter Plug-in to the Cisco ACI Fabric Using Credentials

This section describes how to connect the Cisco Application Centric Infrastructure (ACI) vCenter plug-in to your Cisco ACI fabric using credentials.

### Before you begin

Ensure the Cisco ACI vCenter plug-in is installed. For more information, see [Installing the Cisco ACI vCenter Plug-in](#), on page 209.

### Procedure

- 
- Step 1** Log into the VMware vSphere Web Client.
- Step 2** In the **Navigator** pane, choose **Cisco ACI Fabric**.
- Step 3** In the **Getting Started** pane, choose **Connect vSphere to your ACI Fabric**.
- Step 4** In the **Register a new ACI Fabric** dialog box, click **Yes** to register a new ACI fabric.
- Step 5** In the **Register a new APIC Node** dialog box, perform the following actions:
- In the **IP/FQDN** field, enter the IP address or the fully qualified domain name (FQDN).
  - In the **Use Certificate** field, do not put a check in the Use Certificate check box to use Cisco Application Policy Infrastructure Controller (APIC) authentication.
  - In the **Username** field, enter the user name (admin).
  - In the **Password** field, enter the password.
  - Click **OK**.
- Step 6** In the **Information** dialog box, click **OK**.
- The Cisco APIC node was successfully added to the Cisco ACI fabric.
- Step 7** In the **ACI Fabric** pane, you will see the new registered Cisco APIC discover the other Cisco APICs.
- The Cisco ACI vCenter plug-in always uses a single Cisco APIC for its requests. However, it switches the Cisco APIC if the Cisco APIC currently used is no longer available.

**Note** Registering the Cisco ACI fabric with the Cisco ACI vCenter plug-in is not supported for remote users.

---

## Connecting vCenter Plug-in to your ACI Fabric Using an Existing Certificate

This section describes how to connect the vCenter plug-in to your ACI fabric using an existing certificate.

### Before you begin

- A certificate is already setup on the APIC for the admin user.
- You have the name and private key of the certificate.

## Procedure

---

- Step 1** Log in to the VMware vSphere Web Client.
- Step 2** In the **Navigator** pane, choose **Cisco ACI Fabric**.
- Step 3** In the **Getting Started** pane, choose **Connect vSphere to your ACI Fabric**.
- Step 4** In the **Register a new ACI Fabric** dialog box, click **Yes** to register a new ACI fabric.
- Step 5** In the **Register a new APIC Node** dialog box, perform the following actions:
- In the **IP/FQDN** field, enter the IP address or the fully qualified domain name (FQDN).
  - In the **Use Certificate** field, check the **Use Certificate** check box.
- Step 6** In the **Action** section, choose **Use an existing certificate**.
- Step 7** In the **Name** field, enter the certificate name.
- Step 8** In the **Private Key** section, paste the private key of the certificate.
- Step 9** Click **Check Certificate**.
- The status switches to Connection Success.
- Note** If connection failure is displayed, check that the certificate name and private key are correct, and try again.
- Step 10** Click **OK**.
- Step 11** In the **Information** dialog box, click **OK**.  
The APIC node was successfully added to the ACI fabric.
- Step 12** In the **ACI Fabric** pane the newly registered APIC discovers the other APICs.
- The Cisco ACI vCenter plug-in always uses a single APIC for its requests. If the currently used APIC is no longer available, the Cisco ACI vCenter plug-in switches APICs.
- 

## Connecting vCenter Plug-in to your ACI Fabric by Creating a New Certificate

This section describes how to connect the vCenter plug-in to your ACI fabric by creating a new certificate.

### Before you begin

- Ensure the plug-in is installed.
- You have access to the APIC admin credentials.

## Procedure

---

- Step 1** Log into the VMware vSphere Web Client.
- Step 2** In the **Navigator** pane, choose **Cisco ACI Fabric**.
- Step 3** In the **Getting Started** pane, choose **Connect vSphere to your ACI Fabric**.
- Step 4** In the **Register a new ACI Fabric** dialog box, click **Yes** to register a new ACI fabric.
- Step 5** In the **Register a new APIC Node** dialog box, perform the following actions:

- a) In the **IP/FQDN** field, enter the IP address or the fully qualified domain name (FQDN).
- b) In the **Use Certificate** field, check the **Use Certificate** check box.

**Step 6** In the **Action** field, choose **Generate a new certificate**.

**Step 7** In the **Name** field, enter the new certificate name.

**Step 8** Click the **Generate certificate** button.

**Step 9** Copy the displayed certificate.

From -----BEGIN CERTIFICATE----- included, to -----END CERTIFICATE----- included.

**Step 10** Add this certificate to the admin user in APIC. Make sure to use the same certificate name.

- a) Log into the APIC GUI as admin.
- b) On the menu bar, choose **Admin**.
- c) In the **Navigation** pane, expand **Security Management > Local Users > admin**.
- d) In the **Work** pane, in the **User Certificate** section, click the plus icon to add the certificate.
- e) In the **Name** field, enter the certificate name.
- f) In the **Data** field, paste the certificate content that you copied in step 8.
- g) Click **Submit**.

**Step 11** In the vCenter plug-in, click **Check Certificate**.

The status changes to Connection Success.

**Note** If a Connection Failure message displays, check that the certificate is correctly added on the APIC and that the certificate names are the same.

**Step 12** Click **OK**.

**Step 13** In the **Information dialog** box, click **OK**.  
The APIC node is successfully added to the ACI fabric.

**Step 14** In the **ACI Fabric** pane, the newly registered APIC discovers the other APICs.

The Cisco ACI vCenter plug-in always uses a single APIC for its requests. If the currently used APIC is no longer available, the Cisco ACI vCenter plug-in switches APICs.

---

## Cisco ACI vCenter Plug-in Features and Limitations

This section describes the possible operations provided by the Cisco ACI vCenter plug-in, for all object types it manages. It also goes over intentional configuration limitations.

For more information about the objects, see the *Cisco Application Centric Infrastructure Fundamentals Guide*.

### Tenants

The Cisco ACI vCenter plug-in allows CRUD operations on the Tenant object. The following attributes are exposed in the plug-in:

- Name: The name of the tenant.
- Description (Optional): The description of the tenant.

When a tenant is created by the plug-in, a VRF `<tenant_name>_default` and a Bridge Domain `<tenant_name>_default` connected to that VRF are automatically created inside. An Application Profile `<tenant_name>_default` is also created inside it.

The infrastructure Tenant (infra) and the management Tenant (mgmt) are not exposed in the plug-in.



---

**Note** The tenants visible in the plug-in will also depends on the permissions associated with the account used while registering the ACI fabric into the plug-in.

---

### Application Profiles

The Cisco ACI vCenter plug-in allows CRUD operations on the Application Profile objects. The following attributes are exposed in the plug-in:

- Name: The name of the Application Profile.
- Description (Optional): The description of the Application Profile.

### Endpoint Groups

The Cisco ACI vCenter plug-in allows CRUD operations on the Endpoint Group objects. The following attributes are exposed in the plug-in:

- Name: The name of the Endpoint Group.
- Description (Optional): The description of the Endpoint Group
- Bridge Domain: The Bridge Domain associated with this Endpoint Group.
- Intra-EPG Isolation: This allows to deny all traffic between the virtual machines that are connected to an EPG. By default, all virtual machines in the same EPG can talk to each other.
- Distributed Switch: The DVS where the EPG is deployed. This correspond to the association with a VMM domain in ACI

By default, all EPGs created with the plug-in are associated with the VMM Domain pointing to the vCenter where the plug-in is used. If there are multiple VMM Domains pointing to the same vCenter, you must choose at least one, in the form of selected on which DVS to deploy the EPG.

Allow microsegmentation (only for DVS): This allows you to create a “Base EPG”. All the virtual machines connected to this EPG are candidates to apply microsegmentation rules of a uSeg EPG. Microsegmented EPG rules only applies to virtual machine that are connected to a “Base EPG”.

An EPG linked to a VMM domain pointing to the vCenter where the plug-in is being used is displayed as "Virtual." Other EPGs are displayed as "Physical."

Update and Delete actions are only authorized for EPGs linked to a VMM domain that is pointing to the vCenter (Virtual). Others EPGs (Physical) are read-only. Updates are still authorized to make EPGs consume or provide contracts, regardless of their VMM domain.

### uSeg EPGs

The Cisco ACI vCenter plug-in allows CRUD operations on the mircosegemented EPG objects. The following attributes are exposed in the plug-in:

- Name: The name of the microsegmented EPG.
- Description (Optional): The description of the microsegmented EPG.
- Bridge Domain: The Bridge Domain associated with this microsegmented EPG.
- Intra-EPG Isolation: This allows to deny all traffic between the virtual machines that are connected to an EPG. By default, all virtual machines in the same EPG can talk to each other.
- Distributed Switch: The DVS where the EPG is deployed. This correspond to the association with a VMM domain in ACI

By default, all EPGs created with the plug-in are associated with the VMM Domain pointing to the vCenter where the plug-in is used. If there are multiple VMM Domains pointing to the same vCenter, you must choose at least one, in the form of selected on which DVS to deploy the EPG.

- Miro-segmentation attributes: List of rules that decide which VM belongs to this microsegmented EPG. Rules options include: IP, MAC, VM name, OS, Host, VM id, VNic, Domain, Data Center, Custom Attribute.



**Note** Domain attributes (VMM Domain) only allow you to select VMM domains to the local vCenter. You choose a domain by selecting the corresponding DVS.

Custom attributes can only be chosen. They cannot be set by the plug-in. They must be set by the VMware vSphere Client. To create custom labels, see the documentation on the VMware website.

### L2 and L3 External Networks

Layer 2 and Layer 3 External Networks must be created and configured on the APIC by the network administrator. They are read-only on the vCenter plug-in.

The only plug-in operations permitted on these objects are to make them consume or provide contracts.

The visible information for an L3 External Network is:

- Name: The name of the L3 External Network
- Subnets: External subnets represented by this L3 external network
- VRF: The VRF this L3 External Network belongs to
- Connected Bridge Domains: The Bridge Domains connected to this L3 External Network

The visible information for an L2 External Network is:

- Name: The name of the L2 External Network
- Bridge Domain: The bridge domain associated with this Bridge Domain
- VLAN ID: The VLAN ID associated with this L2 External Network

### VRF

The Cisco ACI vCenter plug-in allows CRUD operations on the VRF objects. The following attributes are exposed in the plug-in:

- Name: The name of the VRF
- Description (Optional): The description of the VRF
- Enforce policies: Determine if the contracts need to be enforced for the EPG in this VRF.

### Bridge Domains

The Cisco ACI vCenter plug-in allows CRUD operations on the Bridge Domain objects. The following attributes are exposed in the plug-in:

- Name: The name of the Bridge Domain
- Description (Optional): The description of the Bridge Domain
- Private Subnets: List of gateways for this Bridge Domain.



#### Note

- Shared and advertised subnets are read only. They cannot be configured by the plug-in. Only the private subnets can be added or deleted.
- If the Bridge Domain has been connected to an L3/L2 Out by the APIC, it cannot be deleted.

### Contracts

The Cisco ACI vCenter plug-in allows CRUD operations on the Contract objects. The following attributes are exposed in the plug-in:

- Name: The name of the contract
- Description (Optional): The description of the contract.
- Consumers: The consumers for the contract (EPG, uSeg EPGs, L2/L3 External Networks)
- Providers: The providers for the contract (EPG, uSeg EPGs, L2/L3 External Networks)
- Filters: List of filters associated with the contract
- Apply both direction: Indicate if the specified Filters are applying only from consumers to providers or also from providers to consumers.
- L4-L7 Graph Template: It is possible to associate existing graph template to a Contract. See L4-L7 Service section below.



#### Note

- Subject is not exposed. The plug-in only manages contracts with a single subject. Contracts with multiple subjects are seen, but not editable.
- If the consumer and the contract are not in the same tenant, a contract interface is automatically created (named to `_Tenant-name_contract-name`).



## Filters

The Cisco ACI vCenter plug-in allows CRUD operations on the Filter objects. All parameters from the APIC are exposed.

## L4-L7 Services

- L4-L7 services can only be added on contracts that have a single provider.
- The graph template cannot be created by the plug-in (only consume existing graph templates)
  - The graph template must be configured so that it contains:
    - Association with devices
    - Association with a function profile
  - Only support graph templates with a maximum of two nodes
- The Function Profile folders naming and hierarchy must be valid as the plug-in does not allow folder manipulation.
  - Only empty mandatory parameters of the function profile are editable by the plug-in.
- Graph connectors can be configured.
  - All parameters from the APIC are exposed
  - You can only consume redirect policies, if needed, not create them

## Troubleshooting

- Only endpoint to endpoint troubleshooting sessions are supported.
  - You can choose an existing session or create a new one
  - The physical topology (spine / leaf) is not displayed.
  - The topology display is VM-centric, focusing on Host, VM, vNIC, and the EPG the vNICs connect to
- Available information in a session:
  - Faults
  - Contracts: A table listing all the Contract/Filters/Entries between the two EPGs (hit counts are not displayed)
  - Drop/Stats
  - Audits/Events
  - Traceroute
- Atomic Counter and SPAN are not available

- A more basic troubleshooting tool is available between objects that are not endpoints (VM, EPG, L3 Out), that only display configured contracts between two selected objects.
- A view of VMs and their connection to EPGs is available.
  - For a given VM, it is possible to view the EPGs to which its VNICs are connected.
- If a L4-L7 connector is used as source or destination of a troubleshooting session, then it is expected to get the following error on the Contract section of the troubleshooting wizard:  
The feature required the source and destination endpoint to both be part on an EPG.  
You can safely ignore the error message.

## Role-based Access Control for Cisco ACI vCenter Plug-in

Starting with Cisco APIC Release 3.1(1), the Cisco ACI vCenter plug-in supports enhanced role-based access control (RBAC) based on Cisco APIC user roles and security domains.

The UI of the Cisco ACI vCenter plug-in reflects the read and write privileges of Cisco APIC users. For example, if the user tries to access contract features but does not have read privilege for contracts, a gray screen displays with message saying the user does not have permission. A user who does not have write privileges sees a disabled link or action.

### Setting Read and Write Roles

The following table describes how each privilege should be set for read and write roles in order to enable or disable the different features of Cisco ACI vCenter plug-in RBAC.



**Note** You must create Cisco APIC roles and associate them when assigning a security domain to a user or users. You also must add security domains to any tenant the user will have access to.

**Table 4: Cisco ACI vCenter Plug-in RBAC Privileges**

| Roles                            | Workflow      | Limited Read Role                                              | Write Role             |
|----------------------------------|---------------|----------------------------------------------------------------|------------------------|
| Mandatory settings for all roles |               | vmm-connectivity and vmm-ep                                    |                        |
| Application Profile              | List          | tenant-network-profile or tenant-epg                           |                        |
|                                  | Create/Delete |                                                                | tenant-network-profile |
| EPG                              | List          | tenant-epg, tenant-connectivity-l2, and tenant-connectivity-l3 |                        |
|                                  | Create/Delete | tenant-connectivity-l2 and tenant-connectivity-l3              | tenant-epg             |

| Roles           | Workflow                | Limited Read Role                                 | Write Role                                        |
|-----------------|-------------------------|---------------------------------------------------|---------------------------------------------------|
| VRF             | List                    | tenant-connectivity-l2 and tenant-connectivity-l3 |                                                   |
|                 | Create/Delete           |                                                   | tenant-connectivity-l2 and tenant-connectivity-l3 |
| Bridge Domain   | List BD                 | tenant-connectivity-l2 and tenant-connectivity-l3 |                                                   |
|                 | Create/Delete BD        |                                                   | tenant-connectivity-l2 and tenant-connectivity-l3 |
|                 | List BD Subnet          | tenant-connectivity-l2 and tenant-connectivity-l3 |                                                   |
|                 | Create/Delete BD Subnet |                                                   | tenant-connectivity-l2 and tenant-connectivity-l3 |
| Contract        | List Contract           | tenant-security and tenant-epg                    |                                                   |
|                 | Create/Delete Contract  |                                                   | tenant-security and tenant-epg                    |
|                 | List Filter             | tenant-security and tenant-epg                    |                                                   |
|                 | Create/Delete Filter    | tenant-epg                                        | tenant-security                                   |
| L4L7            | List                    | tenant-security, tenant-epg, and nw-svc-policy    |                                                   |
|                 | Create/Delete           | tenant-epg                                        | tenant-security and nw-svc-policy                 |
| Troubleshooting | List Session            | admin*                                            |                                                   |
|                 | Create/Delete Session   |                                                   | admin*                                            |
| L2 Out          | List L2Outs             | tenant-ext-connectivity-l2                        |                                                   |
|                 | Contract creation       | tenant-ext-connectivity-l2                        | tenant-security                                   |
| L3 Out          | List L3Outs             | tenant-ext-connectivity-l3                        |                                                   |
|                 | Contract creation       | tenant-ext-connectivity-l3                        | tenant-security                                   |



**Note** In the preceding table, you must add roles marked with an asterisk (\*) with the security domain "all."

For more information about Cisco APIC user roles and security domains, see the section "User Access: Roles, Privileges, and Security Domains" in [Cisco ACI Fundamentals](#).

## Recommended RBAC Configuration for Cisco ACI vCenter Plug-in

We recommend that you define two user roles with privileges to be created on APIC for aaaUser:

- `vcplugin_read`—defines the read permissions of aaaUser.
- `vcplugin_write`—defines the write permissions of aaaUser.

You can register the Cisco ACI fabric only as a local user on Cisco APIC. If the default log-in domain is local, you can log in as admin or any local username and password.

However, if the default login domain is not local, you can still register the fabric by specifying the local domain in the username:

```
apic#local domain\username
```

The local domain name must exist on Cisco APIC before you enter the local domain and username.



---

**Note** Any RBAC configuration requires that you assign the security domain or domains of aaaUser to the VMM domain between Cisco APIC and VMware vCenter.

---



---

**Note** The Cisco ACI vCenter plug-in adapts to any combination of user roles that follow the permissions described in the RBAC privileges table in [Role-based Access Control for Cisco ACI vCenter Plug-in, on page 218](#) in this guide.

---

## Upgrading VMware vCenter when Using the Cisco ACI vCenter Plug-in

If you are upgrading VMware vCenter from version 6.0 to version 6.5, and you are using the Cisco ACI vCenter plug-in, you need to take an additional step before you proceed with the upgrade.



---

**Note** It is a best practice to uninstall the vCenter plug-in before you upgrade the VMware vCenter and then reinstall it after the upgrade.

---

### Procedure

---

Delete the folder `C:\ProgramData\cisco_aci_plugin\` on the vCenter.

If you do not delete the folder, and you try to register a fabric again after the upgrade, you see the following error message: "Error while saving setting in `C:\ProgramData\cisco_aci_plugin\user_domain.properties`"

where the user is the user currently logged in to the vSphere Web Client, and the domain is the domain to which it belongs.

Although you can still register a fabric, you do not have rights to override settings that were created in the old VMware vCenter. You need to enter any changes in Cisco APIC configuration again after restarting VMware vCenter.

## Cisco ACI vCenter Plug-in GUI

### Cisco ACI vCenter Plug-in GUI Architecture Overview

This section describes the Cisco ACI vCenter plug-in GUI architecture Overview.

#### Main Menu

Figure 17: Main Menu

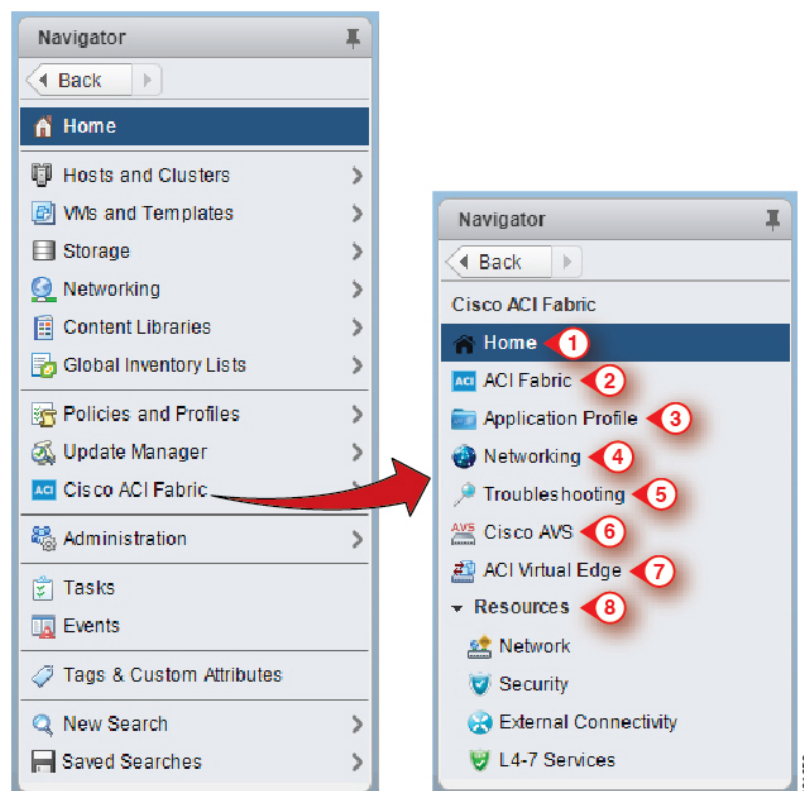



**Note** Beginning with Cisco APIC Release 5.0(1), Cisco Application Virtual Switch (AVS) is no longer supported. If you use Cisco AVS and upgrade to Cisco APIC Release 5.0(1), in case of issues, the fabric will not be supported. Also, a fault will be raised for the Cisco AVS domain.

If you use Cisco AVS, we recommend that you migrate to Cisco ACI Virtual Edge. See the *Cisco ACI Virtual Edge Installation Guide* on Cisco.com.

|   |                                                                                                                                                                                                                                                                                                                                                                                                                                                                                                                                     |
|---|-------------------------------------------------------------------------------------------------------------------------------------------------------------------------------------------------------------------------------------------------------------------------------------------------------------------------------------------------------------------------------------------------------------------------------------------------------------------------------------------------------------------------------------|
| 1 | <p><b>Home</b>—Displays the Cisco ACI vCenter plug-in home page and has a <b>Getting Started</b> and an <b>About</b> tab.</p> <p>The <b>Getting Started</b> tab that allows you to perform basic tasks such as <b>Create a new Tenant</b>, <b>Create a new Application Profile</b>, <b>Create a new Endpoint Group</b> and click the <a href="#">Cisco Application Centric Infrastructure (ACI)</a> link to explore the ACI website.</p> <p>The <b>About</b> tab displays the current version of the Cisco ACI vCenter plug-in.</p> |
| 2 | <p><b>ACI Fabric</b>—Used to register an ACI Fabric in the plug-in and manage the tenants of the fabrics.</p>                                                                                                                                                                                                                                                                                                                                                                                                                       |
| 3 | <p><b>Application Profile</b>—Used to manage application profiles by a drag and drop interface of EPG, uSeg EPG, L2/L3Out and Contract. Provides visibility on an application health, Stats and Faults.</p>                                                                                                                                                                                                                                                                                                                         |
| 4 | <p><b>Networking</b>—Drag and Drop interface to manage VRFs and Bridge Domains.</p>                                                                                                                                                                                                                                                                                                                                                                                                                                                 |
| 5 | <p><b>Troubleshooting</b>—View contracts defined between to entity, Start endpoint to endpoint troubleshooting sessions, browse the virtual machines (VMs) and view their connections to the endpoint groups (EPGs).</p>                                                                                                                                                                                                                                                                                                            |
| 6 | <p><b>Cisco AVS</b>—Install, upgrade, or uninstall Cisco AVS.</p> <p>See the <a href="#">Cisco Application Virtual Switch Installation Guide</a> for information.</p>                                                                                                                                                                                                                                                                                                                                                               |
| 7 | <p><b>Cisco ACI Virtual Edge</b>—Install or uninstall Cisco ACI Virtual Edge, or migrate from Cisco AVS or VMware VDS to ACI Virtual Edge.</p> <p>See the <a href="#">Cisco ACI Virtual Edge Installation Guide</a> for information.</p>                                                                                                                                                                                                                                                                                            |
| 8 | <p><b>Resources</b>—Allows you to browse in a hierarchical view of all objects managed by the plug-in.</p>                                                                                                                                                                                                                                                                                                                                                                                                                          |



**Note** While navigating through **Application Profile**, **Networking** and **Resources** sections, a selection bar at the top of each screen allows you to select an active tenant. Content displayed for each section is specific to the tenant selected in that bar.

## Cisco ACI vCenter Plug-in Overview

This section describes the Cisco ACI vCenter plug-in GUI overview.



---

**Note** All of the times for faults, stats, event and audits are shown in the local timezone of the browser. If the Cisco APIC time zone does not match the time zone of your system, the time stamp can have a different time zone.

---

### Home

In the VMware vSphere Web Client, in the **Navigator** pane, choose **Home**. In the **Work** pane displays the following tabs:

- **Getting Started** tab

The bottom of the **Getting Started** pane enables you to do the following things:

- Click **Create a new Tenant** to create a new tenant.
- Click **Create a new Application Profile** to create a new application profile.
- Click **Create a new Endpoint Group** to create a new endpoint group.
- Click the [Cisco Application Centric Infrastructure \(ACI\)](#) link to explore the ACI website.

- **About** tab

The **About** pane displays the Cisco ACI vCenter plug-in version.

### ACI Fabric

In the VMware vSphere Web Client, in the **Navigator** pane, choose **Cisco ACI Fabric**. In the **Work** pane displays the following tabs:

- **ACI Fabric** tab

The **ACI Fabric** pane enables you to do the following things:

- Click **Register a new ACI Fabric / ACI Node** to register a new ACI fabric or ACI node.
- View information about the current Cisco APIC states of the fabric.



---

**Note** When the plug-in detects the Cisco APIC as unavailable, it stops trying to connect to it and will not update its status anymore. To avoid having to wait for the timeout that comes with trying to connect to an unresponsive Cisco APIC. Click **Reload** to refresh the Cisco APIC state. This forces it to try to reconnect to each Cisco APIC, even to the unavailable ones. This updates their status, if they are available again.

---

- **Tenants** tab

The **Tenants** pane enables you to do the following things:

- Manage the different tenants present in the registered ACI Fabrics.
- Click **Create a new Tenant** to create a new tenant.
- View the different tenants.

If you select a tenant in the table, you can delete a tenant if you click **Delete Tenant** *<tenant\_name>*.

If you select a tenant in the table, you can edit the tenant description if you right-click the *<tenant\_name>* and choose **Edit settings**.

Figure 18: ACI Fabric - Home

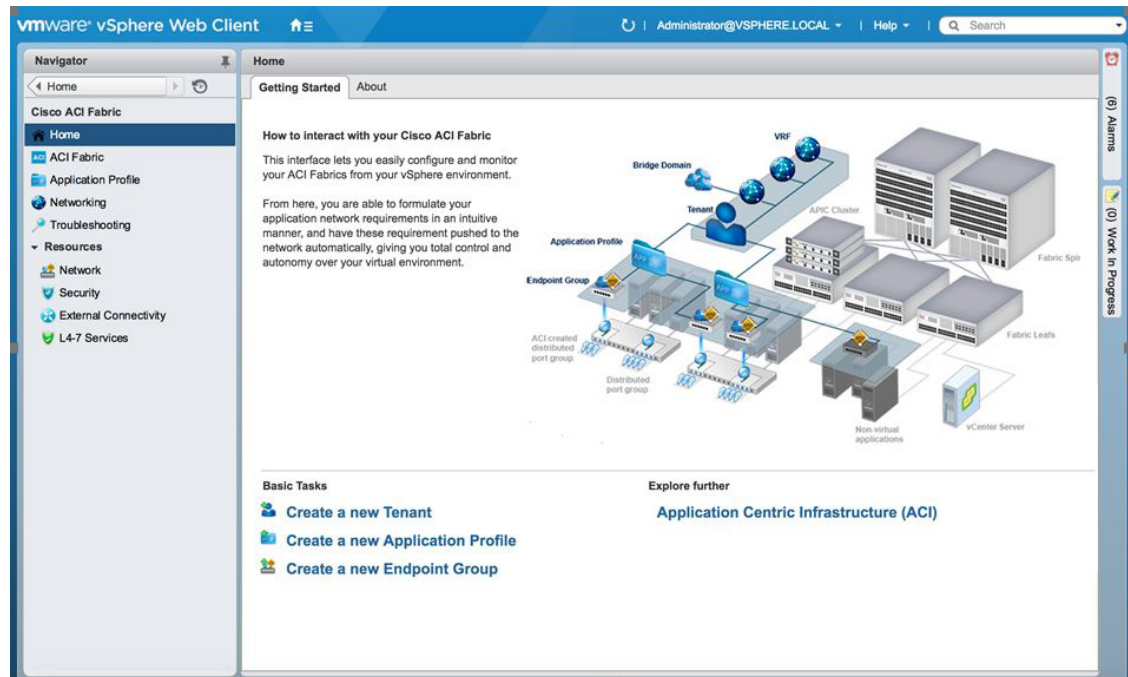

## Application Profile

In the VMware vSphere Web Client, in the **Navigator** pane, choose **Cisco ACI Fabric > Application Profile**. In the **Work** pane enables you to do the following things:

- Choose an active tenant and the application profile.
- Click **Create a new Application Profile** to create a new application profile.
- Use the **Drag and drop to configure** section to drag and drop the different elements to configure your Application Profiles fully. The elements are:
  - Endpoint Group
  - uSeg
  - L3 External Network
  - L2 External Network
  - Contract
- View the Policy, Traffic Stats, Health, Faults, Audit Logs, and Events by using the tabs. In the **Policy** tab, you can switch back to Consumer and Provider view or traffic view.



## Networking

In the VMware vSphere Web Client, in the **Navigator** pane, choose **Cisco ACI Fabric > Networking**. In the **Work** pane enables you to do the following things:

- Set up your own addressing for all endpoint groups by creating isolated VRFs that are populated with bridge domains. An endpoint group will be associated with one bridge domain.
- Choose an active tenant.
- Use the **Drag and drop to configure** section to drag and drop the following elements:
  - VRF
  - Bridge Domain



---

**Note** The available Layer 3 and Layer 2 endpoint groups are displayed here, but are not configurable.

---

## Troubleshooting

In the VMware vSphere Web Client, in the **Navigator** pane, choose **Cisco ACI Fabric > Troubleshooting**. In the **Work** pane displays the following tabs:

- **Policy Checker** tab

The **Policy Checker** tab enables you to select two entities (Virtual Machine, endpoint group, Layer 3 external network or endpoint), and view all of the contracts and Layer 4 to Layer 7 services that are enforced between those 2 entities.

You can also start a troubleshooting session between two endpoints:

- Choose the time frame of the session in the **From, To** and fixed time check box.
  - You can configure the time frame by putting a check in the **Fix Time** check box.
  - In the **Source Destination** section, you can choose the source and destination endpoints. Click on **Start Troubleshooting session** to start a new troubleshooting session.
  - In the **Troubleshooting Session**, you can inspect faults, configured contracts, event, audits, and traffic stats.
  - You can start a trace route between the two endpoints if you click **Traceroute**.
  - You can click the icon next to an elements to get details that correspond to the category that you chose in the left pane.
  - You can get a topology that represents, for each endpoint, the corresponding vNIC, VM, and host, and the EPG to which the vNIC is connected.
- **Virtual Machines** tab
- This view is to visualize if the network interface cards of your virtual machine are connected to any endpoint groups.
- You can restrict the list by using the search field.

- You view each of the VMs if the vNICs are connected to an EPG.
- You can quickly view if the associated EPG has good health or any faults, and view the tenant and application profile to which it belongs.

## Resources

### • Network

In the VMware vSphere Web Client, in the **Navigator** pane, choose **Cisco ACI Fabric > Resources > Network**. In the **Work** pane displays the following tabs:

#### • Endpoint Groups tab

Configure the network infrastructure by creating endpoint groups. Each endpoint group has a corresponding VMware Distributed Port Group where you can connect your virtual machines. You can organize your different endpoint groups into application profiles.

- Choose an active tenant.
- Click **Create a new Application Profile** to create a new application profile.
- Choose an application in the table and click **Create a new Endpoint Group** to create a new endpoint group.
- View the table to see the application profiles and endpoint groups of an active tenant.
- Choose an endpoint group to view all of the VMs that are connected to it.

#### • VRFs tab

For all endpoint groups, you can setup your own addressing by creating isolated VRFs that are populated with bridge domains. An endpoint group will be associated with one bridge domain.

- Choose an active tenant.
- Click **Create a new VRF** to create a new VRF.
- Click **Create a new Bridge Domain** to create a new bridge domain.
- View the table to see the VRFs.

### • Security

In the VMware vSphere Web Client, in the **Navigator** pane, choose **Cisco ACI Fabric > Resources > Security**. In the **Work** pane displays the following tabs:

#### • Contracts tab

Contracts allows you to define security policies between different endpoint groups and security policies between endpoint groups and Layer 3 and Layer 2 external networks.

- Choose an active tenant.
- Click **Create a new Contract** to create a new contract.
- View the table to see the contracts.

- **Filters tab**

Filters are entities that matches a given type of traffic (based on protocol, port, etc.). They are used by contracts to define the authorized services between endpoint groups and Layer 3 external networks.

- Choose an active tenant.
- Click **Create a new Filter** to create a new filter.
- View the table to see the filters.

- **External Connectivity**

In the VMware vSphere Web Client, in the **Navigator** pane, choose **Cisco ACI Fabric > Resources > External Connectivity**. In the **Work** pane displays the following tabs:

- **L3 External Networks tab**

Layer 3 external networks are defined by the Cisco APIC administrator. You have the possibility to consume the defined networks in your contracts and Layer 4 to Layer 7 services, in order to bring external connectivity to your infrastructure.

- Choose an active tenant.
- View the table to see the Layer 3 external networks.

- **L2 External Networks tab**

Layer 2 external networks are defined by the Cisco APIC administrator. You have the possibility to consume the defined networks in your Contracts and Layer 4 to Layer 7 services, in order to bring external connectivity to your infrastructure.

- Choose an active tenant.
- View the table to see the Layer 2 external networks.

- **L4-7 Services**

In the VMware vSphere Web Client, in the **Navigator** pane, choose **Cisco ACI Fabric > Resources > External Connectivity**. In the **Work** pane displays the following:

- Layer 4 to Layer 7 services enables you to add pre-provisioned firewalls and load balancers between your endpoint groups and Layer 3 external networks.
- Choose an active tenant.
- View the table to see the Layer 4 to Layer 7 graph instances currently deployed inside the tenant.

## GUI Tips

This section provides GUI tips.

- You can right-click on ACI object displayed in tables or in graph, to get associated actions.
- When a Virtual Machine object is displayed inside a table in the vCenter plug-in, you can double-click on it to navigate to that Virtual Machine in the vSphere Web Client.

# Performing ACI Object Configurations

## Creating a New Tenant

This section describes how to create a new tenant.

### Before you begin

Ensure that an ACI fabric is registered. For more information, see [Connecting vCenter Plug-in to the Cisco ACI Fabric Using Credentials, on page 211](#).

### Procedure

---

- Step 1** Log into the VMware vSphere Web Client.
  - Step 2** In the **Work** pane, choose **Cisco ACI Fabric**.
  - Step 3** In the **Navigator** pane, choose **ACI Fabric**.
  - Step 4** In the **ACI Fabric** pane, choose the **Tenants** tab.
  - Step 5** In the **Tenants** pane, click **Create a new Tenant**.
  - Step 6** In the **New Tenant** dialog box, perform the following actions:
    - a) In the **Enter a name for the Tenant** field, enter the tenant name.
    - b) (Optional) In the **Enter a description for the Tenant** field, enter the description for the tenant.
    - c) Click **OK**.
- 

## Creating a New Application Profile

This section describes how to create a new application profile.

### Before you begin

- Ensure that a tenant has been created.

For more information, see [Creating a New Tenant, on page 228](#).

### Procedure

---

- Step 1** Log into the VMware vSphere Web Client.
- Step 2** In the **Work** pane, choose **Cisco ACI Fabric**.
- Step 3** In the **Navigator** pane, choose **Resources > Network**.
- Step 4** In the **Network** pane, under the **Endpoint Groups** tab, perform the following actions:
  - a) From the **Tenant** drop-down list, choose the tenant name.
  - b) Click **Create a new Application Profile**.

- Step 5** In the **New Application Profile** dialog box, perform the following actions:
- In the **Name** field, the application profile name.
  - (Optional) In the **Description** field, enter the description of the application profile name.
  - Click **OK**.

---

## Creating an EPG Using the Drag and Drop Method

This section describes how to create an endpoint group (EPG) using the drag and drop method.



**Note** Beginning with Cisco APIC Release 5.0(1), Cisco Application Virtual Switch (AVS) is no longer supported. If you use Cisco AVS and upgrade to Cisco APIC Release 5.0(1), in case of issues, the fabric will not be supported. Also, a fault will be raised for the Cisco AVS domain.

If you use Cisco AVS, we recommend that you migrate to Cisco ACI Virtual Edge. See the *Cisco ACI Virtual Edge Installation Guide* on Cisco.com.

### Before you begin

- Ensure that a tenant has been created.  
For more information, see [Creating a New Tenant, on page 228](#).
- Ensure that an application profile has been created.  
For more information, see [Creating a New Application Profile, on page 228](#).

### Procedure

- 
- Step 1** Log into the VMware vSphere Web Client.
- Step 2** In the **Navigator** pane, choose **Application Profile**.
- Step 3** In the **Application Profile** pane, perform the following actions:
- In the **Tenant** field, from the drop-down list, choose a tenant.
  - In the **Application Profile** field, from the drop-down list, choose an application profile.
  - In the **Drag and drop to configure** element area, drag and drop **Endpoint Group**.
- Step 4** In the **New Endpoint Group** dialog box, perform the following actions:
- In the **Name** field, enter the name of the endpoint group.
  - (Optional) In the **Description** field, enter the description of the EPG.
  - In the **Bridge Domain** field, choose any bridge domain from common or from the tenant where the EPG is created. The default bridge domain is common/default. Click the pen icon to choose another bridge domain.
- Step 5** In the **Distributed Switch** field, perform the following actions:
- Put a check in at least one distributed switch check box to connect the EPG to the chosen distributed switches.
  - Put a check in the **Allow micro-segmentation** check box to allow micro-segmentation.

The **Allow micro-segmentation** check box only shows if the distributed switch is DVS. If the distributed switch is AVS, then the GUI does not show the **Allow micro-segmentation** check box. All EPGs are considered to be base EPGs if the distributed switch is AVS.

This allows you to create a base EPG. All of the virtual machines that are connected to this EPG are candidates to apply the micro-segmentation rules of a uSeg EPG. Micro-segmented EPG rules only apply to virtual machines that are connected to a base EPG.

- c) Put a check in the **Intra EPG isolation** check box to isolate the EPG.

This allows you to deny all traffic between the virtual machines that are connected to this EPG. This rule also applies to machines that are seen under a microsegmented EPG. By default, all virtual machines in the same EPG can talk to each other.

**Step 6** Click **OK** to push the new EPG on APIC.

You will see the new EPG that you created in the topology.

## Creating a New uSeg EPG Using the Drag and Drop Method

This section describes how to create a new uSeg EPG using the drag and drop method.

### Before you begin

- Ensure that a tenant has been created  
For more information, see [Create a New Tenant](#).
- Ensure that an application profile has been created.  
For more information, see [Creating a New Application Profile, on page 228](#).
- (DVS only) Ensure you have created a base EPG, and connected all the VMs that needs to participate in micro-segmentation to that base EPG. For more information, see [Creating a new Endpoint Group](#).

### Procedure

- Step 1** Log in to the VMware vSphere Web Client.
- Step 2** In the **Navigator** pane, choose **Application Profile**.
- Step 3** In the **Application Profile** pane, perform the following actions:
- a) From the **Tenant** drop-down list, choose a tenant.
  - b) From the **Application Profile** drop-down list, choose an application profile.
  - c) In the **Drag and drop to configure** element area, drag and drop the uSeg into the topology.
- Step 4** In the **New Endpoint Group** dialog box, perform the following actions:
- a) In the **Name** field, enter the name of the EPG.
  - b) In the **Description** field, enter the description of the EPG.
- Step 5** In the **Distributed Switch** field, choose which distributed switch needs to be associated with that uSeg EPG.
- Note** If there is only one DVS, no check box is displayed as it is chosen by default.

- Step 6** In the **Bridge Domain** field, choose any bridge domain from common or from the tenant where the uSeg EPG is created. The default bridge domain is common/default. Click the **pen** icon to select another bridge domain.
- Step 7** Put a check in the **Intra EPG isolation** check box to isolate the EPG.
- Step 8** In the **Microsegmentation** section, click the + icon.
- Step 9** In the **New micro-segmentation Attribute** dialog box, perform the following actions:
- In the **Name** field, enter the name of the new attribute.
  - (Optional) In the **Description** field, enter the description of the new attribute.
  - In the **Type** section, choose the type on which to filter.
  - In the **Operator** section, choose **Contains the operator you wish to use**.
  - If available, click the **Browse** button to choose a specific object, instead of manually entering a value.
  - Click **OK** to add the new attribute to the uSeg EPG.
- Step 10** Repeat Step 7 and Step 8 to add other attributes to the uSeg EPG.
- Step 11** Click **OK**.
- 

## Creating a Contract Between Two EPGs Using the Drag and Drop Method

This section describes how to create a contract between two endpoint groups (EPGs) using the drag and drop method.

### Before you begin

- Ensure that two EPGs have been created.

For more information, see [Creating an EPG Using the Drag and Drop Method, on page 229](#).

### Procedure

---

- Step 1** Log into the VMware vSphere Web Client.
- Step 2** In the **Work** pane, choose **Cisco ACI Fabric**.
- Step 3** In the **Navigator** pane, choose **Application Profile**.
- Step 4** In the **Application Profile** pane, perform the following actions:
- From the **Tenant** drop-down list, choose a tenant.
  - From the **Application Profile** drop-down list, choose an application profile.
- Step 5** In the **Drag and drop to configure** element area, drag and drop the contract on the source EPG.
- Step 6** Click on the destination EPG. An arrow will display, going from the source EPG to the destination EPG.
- Step 7** In the **New Contract** dialog box, perform the following actions:
- In the **Consumers** field, verify that it displays the correct EPG.
  - In the **Providers** field, verify that it displays the correct EPG.
  - In the **Name** field, enter the name of the contract.
  - (Optional) In the **Description** field, enter the description of the contract.
  - In the **Filters** field, click the + icon to add filters to the contract.
  - In the **new** dialog box, drag and drop all the filters you wish to add to the Contract from the list on the left to the list on the right and click **OK**.

- g) (Optional) Check the **Configure L4-7 service** check box to configure Layer 4 to Layer 7 services.
- h) Click **OK** to create the contract.

## Adding an EPG to an Existing Contract Using Drag and Drop Method

This section describes how to add an EPG to an existing contract using the drag and drop method.



**Note** Beginning with Cisco APIC Release 5.0(1), Cisco Application Virtual Switch (AVS) is no longer supported. If you use Cisco AVS and upgrade to Cisco APIC Release 5.0(1), in case of issues, the fabric will not be supported. Also, a fault will be raised for the Cisco AVS domain.

If you use Cisco AVS, we recommend that you migrate to Cisco ACI Virtual Edge. See the *Cisco ACI Virtual Edge Installation Guide* on Cisco.com.

### Before you begin

- Ensure that a contract has been created.
  - Ensure that an EPG has been created.
- For more information, see [Creating an EPG Using the Drag and Drop Method, on page 229](#).
- Ensure that the contract is visible on the **Application Profile** pane. For example, if another EPG of the Application Profile is already using the contract. If this is not the case, follow the steps of [Adding an EPG to an Existing Contract using the Security Tab](#).

### Procedure

- Step 1** Log into the VMware vSphere Web Client. In the **Navigator** pane, choose **Application Profile** .
- Step 2** In the **Navigator** pane, choose **Application Profile** .
- Step 3** In the **Application Profile** pane, perform the following actions:
  - a) From the **Tenant** drop-down list, choose a tenant.
  - b) From the **Application Profile** drop-down list, choose an application profile.
- Step 4** In the **Drag and drop to configure** element area, drag and drop the contract, and do one of the following:
  - To have the EPG consume the contract:
    - a. Drag and drop the **Contract** on the EPG that needs to consume the contract.
    - b. Choose the relevant contract (an arrow is displayed going from the EPG to the contract), and click the contract to make the EPG consume the contract.
  - To have the EPG provide the contract:
    - a. Drag and drop the **Contract** on the contract that the EPG needs to provide.



- b. Choose the relevant contract (an arrow is displayed going from the contract to the EPG), and click the **Contract** to make the EPG provide that contract.

---

## Adding an EPG to an Existing Contract using the Security Tab

### Before you begin

- Ensure that a contract has been created.
- Ensure that an EPG has been created.

For more information, see [Creating an EPG Using the Drag and Drop Method, on page 229](#).

### Procedure

---

- Step 1** Log into the VMware vSphere Web Client.
- Step 2** In the **Navigator** pane, choose **Resources > Security**.
- Step 3** From the **Tenant** drop-down list, choose a tenant.
- Step 4** Click on the contract where the EPG needs to be added in the list of contract.
- Step 5** Click on the + icon of either the **Consumers** or **Providers** columns (to respectively have the EPG consume or provide the contract).
- Step 6** From the menu that opens, choose **Add Endpoint Groups**.
- Step 7** In the dialog box, perform the following actions:
  - a) Expand the tenant where the EPG is located.
  - b) Expand the **Application Profile** where the EPG is located.
  - c) Drag and drop the EPG from the list on the left to the list on the right.
  - d) Click **OK**.

---

## Setting up L3 External Network

This section describes how to connect an a Layer 3 external network.



---

**Note** You cannot do any configuration with a Layer 3 external network. You can only set up a Layer 3 external network that exists in Cisco Application Policy Infrastructure Controller (APIC).

---

### Before you begin

- Ensure that a Layer 3 (L3) external network on APIC is configured. For more information, see the *Cisco APIC Basic Configuration Guide*.

- Ensure that an EPG has been created. For more information, see [Creating an EPG Using the Drag and Drop Method, on page 229](#).

### Procedure

---

- Step 1** Log in to the VMware vSphere Web Client.
- Step 2** In the **Navigator** pane, choose **Application Profile**.
- Step 3** In the **Application Profile** pane, perform the following actions:
- From the **Tenant** drop-down list, choose a tenant.
  - From the **Application Profile** drop-down list, choose an application profile (app).
  - In the **Drag and drop to configure** element area, drag and drop the **L3 External Network** into the topology.
- Step 4** In the **Select an object** dialog box, expand Tenant <tenant\_name> (tenant1), choose the Layer 3 external network and click **OK**.
- Step 5** In the **Drag and drop to configure** element area, drag and drop the **Contract** on top of the Layer 3 external network and drag to connect the EPG (WEB).
- Step 6** In the **New Contract** dialog box, perform the following actions:
- In the **Consumers** field, verify that it displays the correct Layer 3 external network (L3ext).
  - In the **Providers** field, verify that it displays the correct EPG (WEB).
  - In the **Name** field, enter the name of the contract (L3ext-to-WEB).
  - (Optional) In the **Description** field, enter the description of the contract.
  - In the **Filters** field, you can add traffic filters by clicking the + icon.
  - In the **new** dialog box, drag and drop all the filters you wish to add to the contract from the list on the left to the list on the right and click **OK**.
  - (Optional) Check the **Configure L4-7 service** check box to configure Layer 4 to Layer 7 services.
  - Click **OK** to create the contract.
- 

The contract is connected to the Layer 3 external network in the topology.

## Setting up L2 External Network

This section describes how to connect Layer 2 (L2) External Network.



---

**Note** You cannot do any configuration with an L2 External Network. You can only set up an L2 External Network that exists in the Cisco Application Policy Infrastructure Controller (APIC).

---

### Before you begin

- Ensure that a L2 external network on APIC is configured. For more information, see the *Cisco APIC Basic Configuration Guide*.
- Ensure that a EPG exists.

## Procedure

---

- Step 1** Log in to the VMware vSphere Web Client.
- Step 2** In the **Navigator** pane, choose **Application Profile**.
- Step 3** In the **Application Profile** pane, perform the following actions:
- From the **Tenant** drop-down list, choose a tenant (tenant1).
  - From the **Application Profile** drop-down list, choose Expenses.
  - In the **Drag and drop to configure** element area, drag and drop the **L2 External Network** into the topology.
  - In the **Drag and drop to configure** element area, drag and drop the **Contract** on top of the L2 external network, and then drag to connect the EPG (WEB).
- Step 4** In the **New Contract** dialog box, perform the following actions:
- In the **Consumers** field, verify that it displays the correct L2 External Network (L2ext).
  - In the **Providers** field, verify that it displays the correct EPG (WEB).
  - In the **Name** field, enter the name of the contract (L2ext-to-WEB).
  - In the **Description** field, enter the description of the contract.
  - In the **Filters** field, you can add traffic filters by clicking the + icon.
  - In the **new** dialog box, drag and drop all the filters you wish to add to the contract from the list on the left to the list on the right and click **OK**.
  - (Optional) Check the **Configure L4-7 service** check box to configure Layer 4 to Layer 7 services.
  - Click **OK**.

---

The contract is connected to the L2 external network in the topology.

## Creating a VRF Using the Drag and Drop Method

This sections describes how to create a VRF using the drag and drop method.

### Procedure

---

- Step 1** Log into the VMware vSphere Web Client.
- Step 2** In the **Work** pane, choose **Networking**.
- Step 3** In the **Networking** pane, perform the following actions:
- From the **Tenant** drop-down list, choose a tenant
  - In the **Drag and drop to configure** element area, drag and drop the VRF into the pane.
- Step 4** In the **New VRF** dialog box, perform the following actions:
- In the **Name** field, enter the name of the VRF.
  - (Optional) In the **Description** field, enter the description of the VRF.
  - In the **Security** section, check the **Enforce Policies** check box. Enforce Policies determines if the security rules (Contracts) should be enforced or not for that VRF.
  - Click **OK**.
-

## Creating a Bridge Domain

This section describes how to create a bridge domain.

### Before you begin

- Ensure that a VRF (Private Network) exists.

### Procedure

---

- Step 1** Log in to the VMware vSphere Web Client.
- Step 2** In the **Navigator** pane, choose **Networking**.
- Step 3** In the **Networking** pane, perform the following actions:
- a) From the **Tenant** drop-down list, choose a tenant (tenant1).
  - b) In the **Drag and drop to configure** element area, drag and drop the Bridge Domain on top of the VRF in the topology.
- Step 4** In the **New Bridge Domain** dialog box, perform the following actions:
- a) In the **Name** field, enter the name of the bridge domain (BD2).
  - b) (Optional) In the **Description** field, enter the description of the bridge domain.
  - c) In the **Private Subnets** section, enter the private subnets (2.2.2.2/24) and click the + icon to add the subnet to the bridge domain.
  - d) (Optional) Repeat substeps c and d to add the desired number of subnets to the bridge domain.
  - e) Click **OK**.
- 

The bridge domain connects to the VRF in the topology.

## Start a New Troubleshooting Session Between Endpoints

This section describes how to start a new troubleshooting session between endpoints.

### Procedure

---

- Step 1** Log into the VMware vSphere Web Client.
- Step 2** In the **Work** pane, choose **Cisco ACI Fabric**.
- Step 3** In the **Navigator** pane, choose **Troubleshooting**.
- Step 4** In the **Policy Checker** tab, in the **Session name** section, enter the new session name.
- Step 5** In the **Source and Destination** section, click **Select source**.
- Step 6** From the Menu that opens, click on **Select Endpoint**.
- Step 7** In the new dialog box that opens, select the endpoint to use as source and click **OK**.
- Step 8** In the **Source and Destination** section, click **Select destination**.
- Step 9** From the Menu that opens, click on **Select Endpoint**.
- Step 10** In the new dialog box that opens, select the endpoint to use as destination and click **OK**.

- Step 11** Click **Start Troubleshooting Session**.
- Step 12** In the **Troubleshooting** pane, you can inspect the faults, configured contracts, event, audits and traffic stats. A topology displays your configuration for each endpoint, the corresponding vNIC, VM, host, and the EPG to which the vNIC is connected. You can click the icon next to an elements to get details, corresponding to the category selected in the left pane.
- Step 13** In the **Navigation** pane, click **Traceroute** to start a traceroute between the two endpoints.
- 

## Start an Existing Troubleshooting Session Between Endpoints

This section describes how to start an existing troubleshooting session between endpoints.

### Before you begin

#### Procedure

---

- Step 1** Log into the VMware vSphere Web Client, in the **Work** pane, choose **Cisco ACI Fabric**.
- Step 2** In the **Navigator** pane, choose **Troubleshooting**.
- Step 3** In the **Policy Checker** tab, in the **Session name** section, click **Select an existing session**.
- In the **Select a section** dialog box, choose a troubleshooting session.
  - Click **OK**.
- You can only do endpoint to endpoint troubleshooting.
- Step 4** Click **Start Troubleshooting Session**.
- Step 5** In the **Troubleshooting** pane, you can inspect the faults, configured contracts, event, audits and traffic stats. A topology displays your configuration for each endpoint, the corresponding vNIC, VM, host, and the EPG to which the vNIC is connected. You can click the icon next to an elements to get details, corresponding to the category selected in the left pane.
- Step 6** In the **Navigation** pane, click **Traceroute** to start a traceroute between the two endpoints.
- 

## Uninstalling the Cisco ACI vCenter Plug-in

This section describes how to uninstall the VMware vCenter Plug-in.

### Before you begin

- You must have a PowerCLI console available.
- You must have the `ACIPlugin-Uninstall.ps1` script available.

You can find the script inside the plug-in archive, or you can download it from:  
[https://APIC\\_IP/vcplugin/ACIPlugin-Uninstall.ps1](https://APIC_IP/vcplugin/ACIPlugin-Uninstall.ps1).

## Procedure

---

- Step 1** Open a PowerCLI console.
- Step 2** Run the `ACIPlugin-Uninstall.ps1` script.
- Step 3** When prompted, in the **vCenter IP / FQDN** field, enter the vCenter where the plug-in needs to be uninstalled.
- Step 4** In the dialog box that appears, enter the root privilege credentials of the vCenter. you should see the following message in the console if the uninstallation was successful:

```
[x] Uninstalled ACI vCenter Plugin
```

---

# Upgrading the Cisco ACI vCenter Plug-in

This section describes how to upgrade the Cisco ACI vCenter Plug-in.

## Procedure

---

To upgrade the Cisco ACI vCenter Plug-in, you must follow the installation procedure.

For more information, see [Installing the Cisco ACI vCenter Plug-in, on page 209](#).

---

# Troubleshooting the Cisco ACI vCenter Plug-in Installation

This section describes how to troubleshoot the Cisco ACI vCenter plug-in installation.

If the Cisco ACI vCenter plug-in is not seen the VMware vSphere Web Client GUI, perform the following actions:

- Make sure the .zip file can be downloaded from the vCenter by ensuring that HTTPS/HTTP traffic is working between the vCenter and web server where the .zip is hosted.
- Ensure that you have enabled HTTP download if your using a HTTP web server.
- Ensure that the thumbprint used is correct if you are using HTTPS.
- Check if the registration has happened by going to the following URL:

```
https://<VCENTER_IP>/mob/?moid=ExtensionManager&doPath=extensionList%5b"com%2ecisco%2eaciPlugin"%5d
```

You should see the Cisco ACI vCenter plug-in details.

If you do not and the page is blank, this indicates that the registration did not succeed. This means an error occurred while executing the registration script. To resolve this, you must perform the installation procedure again and note if an error is displayed by the registration scripts.

- Check the vSphere Web Client logs.

- **Linux Appliance:**  
/var/log/vmware/vsphere-client/logs/vsphere\_client\_virgo.log
- **5.5 Windows 2008:** C:\ProgramData\VMware\vsphere Web Client\serviceability\logs\vsphere\_client\_virgo.log
- **6.0 Windows 2008:**  
%ALLUSERSPROFILE%\VMware\CenterServer\logs\vsphere-client\logs\vsphere\_client\_virgo.log
- Searching for 'vcenter-plugin' or 'com.cisco.aciPlugin' in the log displays relevant information about the install/upgrade.

#### An Example of a successful upgrade:

```
[2016-05-31T19:32:56.780Z] [INFO] -extensionmanager-pool-11139 70002693 100019
200004 com.vmware.vise.vim.extension.VcExtensionManager
Downloading plugin package from https://172.23.137.72/vcenter-plugin-2.0.343.6.zip
(no proxy defined)
[2016-05-31T19:32:56.872Z] [INFO] m-catalog-manager-pool-11128 70002693 100019 200004

com.vmware.vise.vim.cm.CmCatalogManager
Detected service providers (ms):206
[2016-05-31T19:32:56.872Z] [INFO] m-catalog-manager-pool-11128 70002693 100019 200004

com.vmware.vise.vim.cm.CmCatalogManager
No new locales or service infos to download.
[2016-05-31T19:32:57.678Z] [INFO] -extensionmanager-pool-11139 70002693 100019 200004

com.vmware.vise.vim.extension.VcExtensionManager
Done downloading plugin package from https://172.23.137.72/vcenter-plugin-2.0.343.6.zip

[2016-05-31T19:32:58.438Z] [INFO] -extensionmanager-pool-11139 70002693 100019 200004

com.vmware.vise.vim.extension.VcExtensionManager
Done expanding plugin package to /etc/vmware/vsphere-client/vc-packages/vsphere-client-
serenity/com.cisco.aciPlugin-2.0.343.6
[2016-05-31T19:32:58.440Z] [INFO] -extensionmanager-pool-11139 70002693 100019 200004

com.vmware.vise.extensionfw.ExtensionManager
Undeploying plugin package 'com.cisco.aciPlugin:2.0.343.5'.
```

## Reference Information

### Alternative Installation of the Cisco ACI vCenter Plug-in

This section describes how to install the Cisco ACI vCenter plug-in. If you cannot enable HTTPS traffic between your vCenter and APIC and you wish to use your own web server to host the Cisco ACI vCenter plug-in zip file, follow this procedure.

#### Before you begin

- Make sure that all the prerequisites are met.

For more information, see [Cisco ACI vCenter Plug-in Software Requirements, on page 208](#).

For more information, see [Required APIC Configuration, on page 209](#).

- Have a PowerCLI console available.

For more information, see VMware documentation.

## Procedure

### Step 1

Make the .zip file available on a Web server.

- If the Web server is not HTTPS: By default, vCenter will only allow a download from HTTPS sources. To allow from HTTP, open and edit the following configuration file for your vCenter version:
  - vCenter 5.5 Linux Appliance: **/var/lib/vmware/vsphere-client/webclient.properties**
  - vCenter 6.0 Linux Appliance: **/etc/vmware/vsphere-client/webclient.properties**
  - vCenter 5.5 Windows 2008: **%ALLUSERSPROFILE%\VMware\VSphere Web Client\webclient.properties**
  - vCenter 6.0 Windows 2008: **C:\ProgramData\VMware\vCenterServer\cfg\vsphere-client\webclient.properties**
- Add **allowHttp=true** at the end of the file.
- If the Web server is not HTTPS, restart the vSphere Web Client service using the **'/etc/init.d/vsphere-client restart'** command.

### Step 2

Run the script using the PowerCLI console or Python:

| Option                      | Description                                                                                                                                                                                                                                                                                                                                                                                                                                                                                                                                                                                                                                                                                                                                                                                                                                                                                                                                                             |
|-----------------------------|-------------------------------------------------------------------------------------------------------------------------------------------------------------------------------------------------------------------------------------------------------------------------------------------------------------------------------------------------------------------------------------------------------------------------------------------------------------------------------------------------------------------------------------------------------------------------------------------------------------------------------------------------------------------------------------------------------------------------------------------------------------------------------------------------------------------------------------------------------------------------------------------------------------------------------------------------------------------------|
| To use the PowerCLI console | <ol style="list-style-type: none"> <li>Open a PowerCLI console.</li> <li>Run the <b>ACIPlugin-Install.ps1</b> script.</li> </ol> <p>When prompted, enter the following information:</p> <ul style="list-style-type: none"> <li>• In the <b>vCenter IP / FQDN</b> field, enter the vCenter where the plug-in needs to be installed.</li> <li>• In the <b>Plugin .zip file URL</b> field, enter the URL where the vCenter will be able to download the plug-in.</li> </ul> <p><b>Note</b> Ensure you have not renamed the .zip file.</p> <ul style="list-style-type: none"> <li>• If you are using HTTP, leave the SHA1 thumbprint field empty. If you are using HTTPS, enter the SHA1 thumbprint of the Web server used, using one of the following formats:           <ul style="list-style-type: none"> <li>• Separated by colons:<br/>xx:xx:xx:xx:xx:xx:xx:xx:xx:xx:xx:xx</li> <li>• Separated by spaces:<br/>xx xx xx xx xx xx xx xx xx xx xx</li> </ul> </li> </ul> |



| Option        | Description                                                                                                                                                                                                                                                                                                                                                                                                                                                                                                                                                                                                                                                                                                                                                                                                                                                                                                                                                                                                                                                                                                                                                                                                                                                                  |
|---------------|------------------------------------------------------------------------------------------------------------------------------------------------------------------------------------------------------------------------------------------------------------------------------------------------------------------------------------------------------------------------------------------------------------------------------------------------------------------------------------------------------------------------------------------------------------------------------------------------------------------------------------------------------------------------------------------------------------------------------------------------------------------------------------------------------------------------------------------------------------------------------------------------------------------------------------------------------------------------------------------------------------------------------------------------------------------------------------------------------------------------------------------------------------------------------------------------------------------------------------------------------------------------------|
|               | <p><b>Note</b> Some browsers on Windows might display the certificate thumbprint as a single non-delimited string (for example, xxxxxxxxxxxxxxxxxxxx), which the installation script does not process correctly. Make sure that the SHA1 thumbprint of the Web server uses one of the correct formats. Otherwise, the Cisco ACI vCenter plug-in appears to fail.</p> <p>c. In the dialog box, enter the root privilege credentials of the vCenter.</p>                                                                                                                                                                                                                                                                                                                                                                                                                                                                                                                                                                                                                                                                                                                                                                                                                       |
| To use Python | <p><b>Note</b> You must use Python 2.7.9 or higher and have the pyvmomi package installed in the Python environment.</p> <p>Run the Python script: <code>python deployPlugin.py</code></p> <p>When prompted, enter the following information:</p> <ul style="list-style-type: none"> <li>• In the <b>vCenter IP</b> field, enter the vCenter where the plug-in needs to be installed.</li> <li>• In the <b>vCenter Username &amp; Password</b> field, enter the root privilege credentials of the vCenter.</li> <li>• In the <b>Plugin .zip file URL</b> field, enter the URL where the vCenter will be able to download the plug-in.</li> </ul> <p>Ensure you have not renamed the .zip file.</p> <ul style="list-style-type: none"> <li>• In the <b>Https server thumbprint</b> field, Leave this empty, if you are using HTTP. Otherwise, enter the SHA1 thumbprint of the Web server used. The fields are separated with colons. For example:</li> </ul> <pre>D7:9F:07:61:10:B3:92:93:E3:49:AC:89:84:5B:03:80:C1:9E:2F:8B</pre> <p><b>Note</b> There is also a <code>deploy.cfg</code> file available, where you can pre-enter your information. You can then run the script with the file as argument. For example:</p> <pre>\$ python deployPlugin.py deploy.cfg</pre> |

**Step 3** Log into the vSphere Web Client once the registration is completed.

**Note** First login may take longer, as the vCenter will be downloading and deploying the plug-in from the Web server.

Once the VMware vSphere Web Client loads, you will see the **Cisco ACI Fabric** in the **Navigator** pane. This allows you to manage your ACI fabric.

**Note** After you register the plug-in, when you launch the web client for the first time, an error message might display asking to reload the web client. Click **Reload** to refresh the page and the error message will not appear again.





# CHAPTER 14

## Cisco ACI with Microsoft SCVMM

---

This chapter contains the following sections:

- [About Cisco ACI with Microsoft SCVMM, on page 243](#)
- [Getting Started with Cisco ACI with Microsoft SCVMM, on page 246](#)
- [Upgrading the Cisco ACI with Microsoft SCVMM Components, on page 267](#)
- [Deploying Tenant Policies, on page 270](#)
- [Troubleshooting the Cisco ACI with Microsoft SCVMM, on page 275](#)
- [Reference Information, on page 276](#)
- [Programmability References, on page 278](#)
- [Configuration References, on page 279](#)
- [Uninstalling the Cisco ACI with Microsoft SCVMM Components, on page 280](#)
- [Downgrading the Cisco APIC Controller and the Switch Software with Cisco ACI and Microsoft SCVMM Components, on page 282](#)
- [Exporting APIC OpFlex Certificate, on page 283](#)

### About Cisco ACI with Microsoft SCVMM

The Application Policy Infrastructure Controller (APIC) integrates with Microsoft VM management systems and enhances the network management capabilities of the platform. The Cisco Application Centric Infrastructure (ACI) integrates at the following levels of the Microsoft VM Management systems:

- Cisco ACI with Microsoft System Center Virtual Machine Manager (SCVMM)—When integrated with Cisco ACI, SCVMM enables communication between ACI and SCVMM for network management.



---

**Note** Migrating from SCVMM to SCVMM HA is not supported by Microsoft.

---

- Cisco ACI and Microsoft Windows Azure Pack—For information about how to set up Cisco ACI and Microsoft Windows Azure Pack, see [Cisco ACI with Microsoft Windows Azure Pack Solution Overview, on page 286](#).

## Cisco ACI with Microsoft SCVMM Solution Overview

At this integration point the Application Policy Infrastructure Controller (APIC) and Microsoft System Center Virtual Machine Manager (SCVMM) communicate with each other for network management. Endpoint groups (EPGs) are created in APIC and are created as VM networks in SCVMM. Compute is provisioned in SCVMM and can consume these networks.

### Physical and Logical Topology of SCVMM

This figure shows a representative topology of a typical System Center Virtual Machine Manager (SCVMM) deployment with Cisco Application Centric Infrastructure (ACI) fabric. The Microsoft SCVMM service can be deployed as a Standalone Service or as a Highly Available Service on physical hosts or virtual machines, but will logically be viewed as a single SCVMM instance which communicates to the APIC.

Connectivity between an SCVMM Service and the Application Policy Infrastructure Controller (APIC) is over the management network.

**Figure 19: Topology with ACI Fabric and SCVMM**

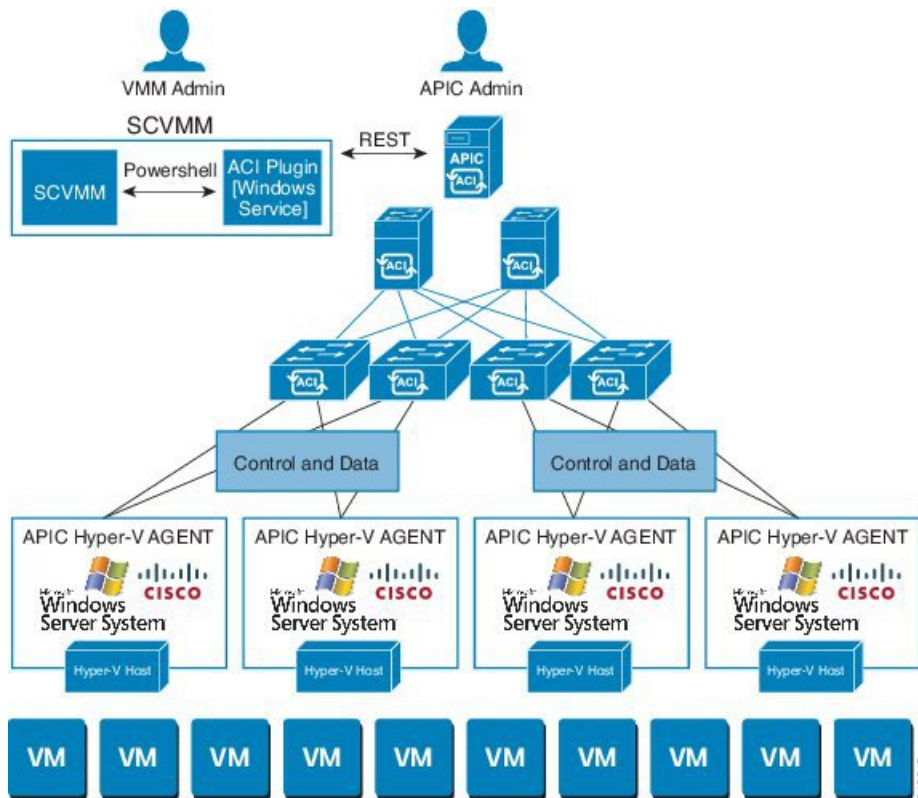

### About the Mapping of ACI Constructs in SCVMM

This section shows a table and figure of the mapping of Application Policy Infrastructure Controller (APIC) constructs in Microsoft System Center Virtual Machine Manager (SCVMM).

Table 5: Mapping of APIC and SCVMM constructs

| APIC                | System Center                                         |
|---------------------|-------------------------------------------------------|
| VMM Domain          | Logical Switch and Logical Network                    |
| VMM Controller      | SCVMM                                                 |
| SCVMM Cloud Name    | Cloud (Fabric)                                        |
| EPG                 | VM Network                                            |
| Infrastructure VLAN | One infrastructure VM network for each logical switch |

Figure 20: Mapping of ACI and SCVMM constructs

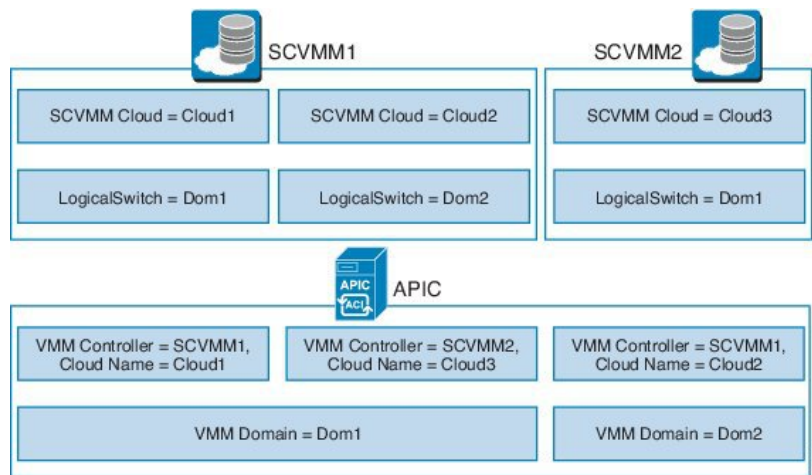

The mapping is bound by the following rule:

- One VMM domain cannot map to the same SCVMM more than once.

## SCVMM Fabric Cloud and Tenant Clouds

Microsoft System Center Virtual Machine Manager (SCVMM) provides an object called "Cloud", which acts as a container of logical and physical fabric resources. ACI Integration with SCVMM automatically creates the various logical networking pieces and enables the logical networks at your designated cloud. When configuring ACI Integration with SCVMM, the fabric cloud is the cloud that is specified as the root container on the Application Policy Infrastructure Controller (APIC), while the tenant cloud is an SCVMM cloud that contains a subset of the host groups specified in the fabric cloud. SCVMM contains all the host groups that will be used to deploy the logical switch. Once the fabric cloud is set up and the logical switch has been deployed to the hosts in the host groups, an SCVMM Admin can then create tenant clouds and enable the apicLogicalNetwork on that tenant cloud, enabling Windows Azure Pack tenants to create and deploy tenant networks on the fabric.

Example:

```
SCVMM Cloud Name: Fabric_Cloud
Host Groups: All Hosts
Host Group HumanResources:
```

```

HyperV Node: Node-2-24
Host Group Engineering:
HyperV Node: Node-2-25

SCVMM Cloud Name: HR_Cloud
Host Groups: HumanResources

SCVMM Cloud Name: Engineering_Cloud
Host Groups: Engineering

```

## Getting Started with Cisco ACI with Microsoft SCVMM

This section describes how to get started with Cisco Application Centric Infrastructure (ACI) with Microsoft System Center Virtual Machine Manager (SCVMM).

You must download and unzip the Cisco ACI and Microsoft Integration file for the 2.2(1) release before installing Cisco ACI with Microsoft Windows Azure Pack.

1. Go to Cisco's Application Policy Infrastructure Controller (APIC) Website:

<http://www.cisco.com/c/en/us/support/cloud-systems-management/application-policy-infrastructure-controller-apic/tsd-products-support-series-home.html>

2. Choose **All Downloads for this Product**.
3. Choose the release version and the **aci-msft-pkg-2.2.1x.zip** file.
4. Click **Download**.
5. Unzip the **aci-msft-pkg-2.2.1x.zip** file.



---

**Note** Cisco ACI with Microsoft System Center Virtual Machine Manager (SCVMM) only supports ASCII characters. Non-ASCII characters are not supported.

Ensure that **English** is set in the System Locale settings for Windows, otherwise ACI with SCVMM will not install. In addition, if the System Locale is later modified to a non-English Locale after the installation, the integration components may fail when communicating with the APIC and the ACI fabric.

---

## Prerequisites for Getting Started with Cisco ACI with Microsoft SCVMM

Before you get started, ensure that you have verified that your computing environment meets the following prerequisites:

- Ensure that one of the following Microsoft System Center Virtual Machine Manager (SCVMM) versions with the Administrator Console Builds are met:
  - SCVMM 2019 RTM (Build 10.19.1013.0) or newer
  - SCVMM 2016 RTM (Build 4.0.1662.0) or newer
  - SCVMM 2012 R2 with Update Rollup 9 (Build 3.2.8145.0) or newer

- Ensure that Windows Server 2019, or 2016, or 2012 R2 is installed on the Hyper-V server with the Hyper-V role enabled.  
See Microsoft's documentation.
- Ensure the cloud is configured in SCVMM and appropriate hosts added to that cloud.  
See Microsoft's documentation.
- If there are switches between the Cisco Application Centric Infrastructure (ACI) leaf switch and the Hyper-V host (such as a Fabric Interconnect), you must allow the infrastructure VLAN on these intermediary devices.
- Ensure "default" AEP exists with infrastructure VLAN enabled.
- Ensure you have the Cisco MSI files for APIC SCVMM and the Host Agent.  
See [Getting Started with Cisco ACI with Microsoft SCVMM](#), on page 246.
- Ensure that you scheduled a maintenance window for the SCVMM Installation. The Cisco ACI SCVMM Installation process will automatically restart the current running SCVMM service instance.



---

**Note** If the VMs in SCVMM are configured with Dynamic MAC, then it takes time for the APIC to update the VM Inventory as the SCVMM takes time to learn or discover these MAC addresses.

---

- Ensure the Hyper-V Management Tools is installed on the Hyper-V hosts as well as the SCVMM server.  
To install the Hyper-V Management Tools feature:
  1. In the **Remote Server Administration Tools, Add Roles and Features > Feature > Remote Server Administration Tools > Role Administration Tools > Hyper-V Management Tools** and finish the wizard to install the feature.
  2. Repeat for each Hyper-V and the SCVMM server.

This installs the Hyper-V PowerShell cmdlets needed for the APIC SCVMM and host agent.

## Installing, Setting Up, and Verifying the Cisco ACI with Microsoft SCVMM Components

This section describes how to install, set up, and verify the Cisco Application Centric Infrastructure (ACI) with Microsoft System Center Virtual Machine Manager (SCVMM) components.

| Component                                                                                                             | Task                                                                                                                                                                                                                                                                                                                               |
|-----------------------------------------------------------------------------------------------------------------------|------------------------------------------------------------------------------------------------------------------------------------------------------------------------------------------------------------------------------------------------------------------------------------------------------------------------------------|
| Install the APIC SCVMM Agent on SCVMM or on a Highly Available SCVMM                                                  | See <a href="#">Installing the APIC SCVMM Agent on SCVMM, on page 249.</a><br><br>See <a href="#">Installing the APIC SCVMM Agent on a Highly Available SCVMM, on page 250</a><br><br>For the Windows Command Prompt method, see <a href="#">Installing the APIC Agent on SCVMM Using the Windows Command Prompt, on page 276.</a> |
| Generate the OpflexAgent certificate                                                                                  | See <a href="#">Generating APIC OpFlex Certificate, on page 250.</a>                                                                                                                                                                                                                                                               |
| Add the OpFlex certificate policy to APIC                                                                             | See <a href="#">Adding the OpFlex Certificate Policy to APIC, on page 252.</a>                                                                                                                                                                                                                                                     |
| Install the OpflexAgent certificate                                                                                   | See <a href="#">Installing the OpflexAgent Certificate, on page 253.</a>                                                                                                                                                                                                                                                           |
| Configure APIC IP Settings with APIC credentials on the SCVMM Agent or on the SCVMM Agent on a Highly Available SCVMM | See <a href="#">Configuring APIC IP Settings with OpflexAgent Certificate on the SCVMM Agent, on page 255.</a><br><br>or<br><br>See <a href="#">Configuring APIC IP Settings with OpflexAgent Certificate on the SCVMM Agent on a Highly Available SCVMM, on page 256.</a>                                                         |
| Install the APIC Hyper-V Agent on the Hyper-V server                                                                  | See <a href="#">Installing the APIC Hyper-V Agent on the Hyper-V Server, on page 257.</a><br><br>For the Windows Command Prompt method, see <a href="#">Installing the APIC Hyper-V Agent on the Hyper-V Server Using the Windows Command Prompt , on page 277.</a>                                                                |
| Verify the APIC SCVMM Agent installation on SCVMM or on a Highly Available SCVMM                                      | See <a href="#">Verifying the APIC SCVMM Agent Installation on SCVMM, on page 260.</a><br><br>or<br><br>See <a href="#">Verifying the APIC SCVMM Agent Installation on a Highly Available SCVMM, on page 260.</a>                                                                                                                  |
| Verify the APIC Hyper-V Agent installation on the Hyper-V server                                                      | See <a href="#">Verifying the APIC Hyper-V Agent Installation on the Hyper-V Server, on page 261.</a>                                                                                                                                                                                                                              |



| Component                                      | Task                                                                                                                                                                                                                                                                                                                                                                                                       |
|------------------------------------------------|------------------------------------------------------------------------------------------------------------------------------------------------------------------------------------------------------------------------------------------------------------------------------------------------------------------------------------------------------------------------------------------------------------|
| Create SCVMM Domain Profiles                   | See <a href="#">Creating SCVMM Domain Profiles, on page 262</a> and <a href="#">Creating a SCVMM Domain Profile Using the GUI, on page 262</a> .<br><br>For the NX-OS Style CLI method, see <a href="#">Creating a SCVMM Domain Profile Using the NX-OS Style CLI, on page 355</a> .<br><br>For the REST API method, see <a href="#">Creating a SCVMM Domain Profile Using the REST API, on page 373</a> . |
| Verify the SCVMM VMM Domain and SCVMM VMM      | See <a href="#">Verifying the SCVMM VMM Domain and SCVMM VMM, on page 265</a> .                                                                                                                                                                                                                                                                                                                            |
| Deploy the logical switch to the host on SCVMM | See <a href="#">Deploying the Logical Switch to the Host on SCVMM, on page 265</a> .                                                                                                                                                                                                                                                                                                                       |
| Enable the Logical Network on Tenant Clouds    | See <a href="#">Enabling the Logical Network on Tenant Clouds, on page 266</a> .                                                                                                                                                                                                                                                                                                                           |

## Installing the APIC SCVMM Agent on SCVMM

This section describes how to install the Application Policy Infrastructure Controller (APIC) SCVMM agent on System Center Virtual Machine Manager (SCVMM).

### Procedure

- 
- Step 1** Log in to the SCVMM server with SCVMM administrator credentials.
- Step 2** On the SCVMM server in Explorer, locate the **APIC SCVMM Agent.msi** file.
- Step 3** Right-click **APIC SCVMM Agent.msi** file and select **Install**.
- Step 4** In the **Cisco APIC SCVMM Agent Setup** dialog box, perform the following actions:
- Click **Next**.
  - Check the **I accept the terms in the License Agreement** check box and click **Next**.
  - Enter your account name and password credentials.

Provide the same credentials that you used for the SCVMM console. The Cisco APIC SCVMM agent requires these credentials for the SCVMM operations to be able to function.

The installation process verifies the entered account name and password credentials. If the installation fails, the SCVMM shows an error message and you must re-enter valid credentials.

- After successful validation of the account name and password credentials, click **Install**.
- Click **Finish**.

**Note** You can configure only one APIC cluster per SCVMM, as one SCVMM can interact with only one APIC cluster.

## Installing the APIC SCVMM Agent on a Highly Available SCVMM

This section describes how to install the Application Policy Infrastructure Controller (APIC) SCVMM agent on a Highly Available System Center Virtual Machine Manager (SCVMM).

### Procedure

- 
- Step 1** Log in to the Current Owner Node of the Highly Available SCVMM installation.
- Step 2** On the SCVMM server in File Explorer, locate the **APIC SCVMM Agent.msi** file.
- Step 3** Right-click **APIC SCVMM Agent.msi** file and select **Install**.
- Step 4** In the **Cisco APIC SCVMM Agent Setup** dialog box, perform the following actions:
- Click **Next**.
  - Check the **I accept the terms in the License Agreement** check box and click **Next**.
  - Enter your account name and password credentials.

Provide the same credentials that you used for the SCVMM console. The Cisco APIC SCVMM agent requires these credentials for the SCVMM operations to be able to function.

The installation process verifies the entered account name and password credentials. If the installation fails, the SCVMM shows an error message and you must re-enter valid credentials.

- After successful validation of the account name and password credentials, click **Install**.
  - Click **Finish**.
- Step 5** Repeat steps 1-4 for each Standby Node in the Windows Failover Cluster.
- 

## Generating APIC OpFlex Certificate

This section describes how to generate APIC OpFlex certificate to secure communication between the Application Policy Infrastructure Controller (APIC) and SCVMM agents.



**Note** This should only be done once per installation.

---

### Procedure

- 
- Step 1** Log in to the SCVMM server, choose **Start > Run > Windows Powershell**, and then, in the app bar, click **Run as administrator**.
- Step 2** Load **ACISCVMMPSCmdlets** and create a new OpflexAgent.pfx certificate file, by entering the following commands:

```
Windows PowerShell
Copyright (C) 2013 Microsoft Corporation. All rights reserved.

PS C:\Users\Administrator\INSCISCO> cd \
PS C:\> cd '.\Program Files (x86)\ApicVMMService'
PS C:\Program Files (x86)\ApicVMMService> Import-Module .\ACIScvmPsCmdlets.dll
PS C:\Program Files (x86)\ApicVMMService> Get-Command -Module ACIScvmPsCmdlets
```

| CommandType | Name                  | ModuleName       |
|-------------|-----------------------|------------------|
| -----       | ----                  | -----            |
| Cmdlet      | Get-ACIScvmOpflexInfo | ACIScvmPsCmdlets |
| Cmdlet      | Get-ApicConnInfo      | ACIScvmPsCmdlets |
| Cmdlet      | Get-ApicCredentials   | ACIScvmPsCmdlets |
| Cmdlet      | New-ApicOpflexCert    | ACIScvmPsCmdlets |
| Cmdlet      | Read-ApicOpflexCert   | ACIScvmPsCmdlets |
| Cmdlet      | Set-ApicConnInfo      | ACIScvmPsCmdlets |
| Cmdlet      | Set-ApicCredentials   | ACIScvmPsCmdlets |

**Step 3** Generate a new OpFlex Certificate, by entering the following commands. The "New-ApicOpflexCert" PowerShell command will both generate the PFX certificate package file for use on other machines and install the certificate to the local machine's Certificate Store.

```
PS C:\Program Files (x86)\ApicVMMService> $pfxpassword = ConvertTo-SecureString "MyPassword"
-AsPlainText -Force
PS C:\Program Files (x86)\ApicVMMService> New-ApicOpflexCert -ValidNotBefore 1/1/2015
-ValidNotAfter 1/1/2020
-Email t0@domain.com -Country USA -State CA -Locality "San Jose" -Organization MyOrg
-PfxPassword $pfxpassword
Successfully created:
C:\Program Files (x86)\ApicVMMService\OpflexAgent.pfx

PS C:\Program Files (x86)\ApicVMMService>
```

**Step 4** Display the certificate information to be used on APIC using the REST API.

See [Displaying the Certificate Information to be Used on APIC Using the REST API](#), on page 251.

## Displaying the Certificate Information to be Used on APIC Using the REST API

This section describes how to display the certificate information to be used on APIC using the REST API.

### Procedure

To display the certificate information to be used on the APIC.

```
PS C:\Program Files (x86)\ApicVMMService> $pfxpassword = ConvertTo-SecureString "MyPassword"
-AsPlainText -Force
PS C:\Program Files (x86)\ApicVMMService> Read-ApicOpflexCert -PfxFile
"C:\Program Files (x86)\ApicVMMService\OpflexAgent.pfx" -PfxPassword $pfxpassword
-----BEGIN CERTIFICATE-----
MIIDojCCAoqgAwIBAgIQHz+F21luOpFKK0p3jxWRfjANBgkqhkiG9w0BAQ0FADBFMRwwGgYJKoZI
hvcNAQkBFgl0MEBkb21haW4uY29tMQ4wDAYDVQQKDAVNeU9yZzELMAkGA1UECAwCQ0ExDDAKBgNV
BAYTA1VTQTEUMBIGA1UEAwwLT3BmbGV4QWdlbnQwHhcNMjUwMTAxMDAwMDAwHhcnMTAwMDAw
MDAwWjBFMRwwGgYJKoZIhvcNAQkBFgl0MEBkb21haW4uY29tMQ4wDAYDVQQKDAVNeU9yZzELMAkG
A1UECAwCQ0ExDDAKBgNVBAYTA1VTQTEUMBIGA1UEAwwLT3BmbGV4QWdlbnQwggEiMA0GCSqGSIb3
DQEBQUAA4IBDwAwggEKAoIBAQCzQS3rvrIdxiHfeAUqtX68CdjILl+nDtqBH8LzDk0RBVb0KU6V
9cYjCAMwW24FJo0Pmt4XblvFJDbZUfjWgEY1JmDxqHIAhKIujGsyDoSzdXaKUUV3ig0bzcswEGvx
khGpAJB8BCnOdhD3B7Tj00D8G18asdlu24xOy/8MtMDuan/2b32QRmnluiZhSX3cwjnPfI2JQVif
n68L12yMcp1kJvi6H7RxVOiES33uz00qjxcPbFhsuoFFleMT1Ng41stZMTM+xcE6z72zgAYN6wFq
TlpTCLCC+0u/q1yghYu0LBnARCYwDbe2xoa8C1VcL3XYQlEFfp1+Hfffd//p1ro+bAgMBAAGjWjBY
MBIGA1UdEwEB/wQIMAYBAf8CAQAwEwYDVR0lBAwwCgYIKwYBBQUHAwEwHQYDVR0OBBYEFGuZLCG5
4DEcP+bPiFbiDjMDQ3tMMA4GA1UdDwEB/wQEAwIBBjANBgkqhkiG9w0BAQ0FAAOCQAQEAnc5kKvN4
Q62tIYa1S2HSyiwjaMq7bXoqIH/ICPRqEXu1XE6+VnLnYqpo3TitLmU4G99uz+as8dySNwAEYghk
8jgLpu39HH6yWxdPiZlccQ17J5B5vRu3Xjnc/2/ZPq1QDEElobrAodTko4uAHG41FBHLwAZA/f72
5fcicyb/pjNPhPgpCP0r7svElQ/bjAP1wK8PhCfd7k2rJx5jHr+YX8SCoM2jKyzaQx1BAdufspx3U
```

```
7AWH0aF7ExdWy/hW6CduO9NjF+98XNqe0cNH/2oSKYCl9qEK6FesdOBFvCj1RYR9ENqiY4q7xpyB
tqDkM80V0JslU2xXn+G0yCWGO3VRQ==
-----END CERTIFICATE-----
PS C:\Program Files (x86)\ApicVMMService>
```

## Adding the OpFlex Certificate Policy to APIC

This section describes how to add the OpFlex certificate policy to the Application Policy Infrastructure Controller (APIC).

### Procedure

Add the AAA policy to allow authenticate this certificate on the APIC server. The Hyper-V agent certificate policy can be added in APIC through the GUI or REST Post:

- GUI method:
  - a. Log in to the APIC GUI, on the menu bar, choose **ADMIN > AAA**.
  - b. In the **Navigation** pane, choose **Security Management > Local Users** and click on **admin**.
  - c. In the **PROPERTIES** pane, choose **Actions > Create X509 Certificate**, in the drop-down list, enter the name and data.
  - d. In the **Create X509 Certificate** dialog box, in the **Name** field, you must enter "**OpflexAgent**".
  - e. On the SCVMM server, enter the output of the PowerShell Read-ApicOpflexCert cmdlet.
  - f. When you run the Read-ApicOpflexCert cmdlet, provide the full link when prompted for the name of the pfx file: **C:\Program Files (x86)\ApicVMMService\OpflexAgent.pfx**, then enter the password.
  - g. Copy from the beginning of "-----BEGIN CERTIFICATE-----" to the end of "-----END CERTIFICATE-----" and paste it in the **DATA** field.
  - h. Click **SUBMIT**.
  - i. In the **PROPERTIES** pane, under the **User Certificates** field, you will see the user certificate displayed.

- REST Post method:

```
POST
http://<apic-ip>/api/policymgr/mo/uni/userext/user-admin.json?rsp-subtree=full
{"aaaUserCert":{"attributes":
{"name":"OpflexAgent", "data":
-----BEGIN CERTIFICATE-----
MIIDojCCAoqgAwIBAgIQHz+F21luuOpFKK0p3jxWrfjANBgkqhkiG9w0BAQ0FADBFMRwwGgYJKoZI
hvcNAQkBFgl0MEBkb21haW4uY29tMQ4wDAYDVQQKDAVNeU9yZzELMAkGA1UECAwCQ0ExDDAKBgNV
BAYTA1VTQTEUMBIGAlUEAwLT3BmbGV4QWdlbnQwHhcNMTUwMTAxMDAwMDAwWhcNMjAwMTAxMDAw
MDAwWjBFMRwwGgYJKoZIhvcNAQkBFgl0MEBkb21haW4uY29tMQ4wDAYDVQQKDAVNeU9yZzELMAkG
AlUECAwCQ0ExDDAKBgNVBAYTA1VTQTEUMBIGAlUEAwLT3BmbGV4QWdlbnQwggEiMA0GCSqGSIb3
DQEBAQUAA4IBDwAwggEKAoIBAQCzQS3rvrIdxihfeAUqtX68CdjIL1+nDtqBH8LzDkORBVB0KU6V
9cYjCAMwW24FJo0PMt4Xb1vFJDbZUfjWgEY1JmDxqHIAhKIujGsyDoSzdXaKUUv3ig0bzcswEGvx
khGpAJB8BCnOdhd3B7Tj0OD8G18asd1u24xOy/8MtMDuan/2b32QRmnluiZhsX3cwjnP12JQVif
n68L12yMcp1kJvi6H7RxVOiES33uz00qjxcPbFhsuoFF1eMT1Ng41sTzMTM+xcE6z72zgAYN6wFq
T1pTCLCC+0u/qlyghYu0LbnARCYwDbe2xoa8C1VcL3XYQ1EF1p1+HFfd//p1ro+bAgMBAAGjWjBY
MBIGAlUdEwEB/wQIMAYBAF8CAQAwEwYDVR01BAAwCgYIKWYBBQUHAWEwEwYDVR0OBBYEFguzLCG5
```

```

4DEcP+bPiFbiDjMDQ3tMMA4GA1UdDwEB/wQEAWIBBjANBgkqhkiG9w0BAQ0FAAOCAQEANc5kKvN4
Q62tIYa1S2HSyiwjaMq7bXoqIH/ICPRqEXu1XE6+VnLnYqpo3TittLmU4G99uz+aS8dySNWaEYghk
8jgIpu39HH6yWxdPiZlcCQ17J5B5vRu3Xjnc/2/ZPq1QDEElobrAODtko4uAHG41FBHLwAZA/f72
5fcIyb/pjNPhPgpCP0r7svElQ/bjAP1wK8PhCfd7k2rJx5jHr+YX8SCom2jKyzaQx1BAdufspX3U
7AWH0aF7ExdWy/hW6Cdu09NJf+98XNQe0cNH/2oSKYCl9qEK6FesdOBFvCj1RYR9ENqiY4q7xpyB
tqDkBm80V0JslU2xXn+G0yCWGO3VRQ==
-----END CERTIFICATE-----

```

## Installing the OpflexAgent Certificate

This section describes how to install the OpflexAgent Certificate.

### Procedure

**Step 1** Log in to the SCVMM server with administrator credentials.

**Step 2** Use one of the following methods:

- For large-scale deployments, see Microsoft's documentation for Deploy Certificates by Using Group Policy:

[https://technet.microsoft.com/en-us/library/cc770315\(v=ws.10\).aspx](https://technet.microsoft.com/en-us/library/cc770315(v=ws.10).aspx).

- For small-scale deployments follow these steps:

You must add OpFlex security certificate to the local machine. The Microsoft SCVMM agent has a security certificate file named **OpflexAgent.pfx** located in the **C:\Program Files (x86)\ApicVMMService** folder on the SCVMM server. If the following steps are not performed on your SCVMM servers, the APIC SCVMM Agent cannot communicate with the Application Policy Infrastructure Controller (APIC).

Install the OpFlex security certificate on the SCVMM Windows Server 2012 local machine's certificate repository. On each SCVMM server, install this certificate by performing the following steps:

- Choose **Start > Run**.
- Enter **mmc** and click **OK**.
- In the **Console Root** window, on the menu bar, choose **Add/Remove Snap-in**.
- In the **Available Snap-ins** field, choose **Certificates** and click **Add**.
- In the **Certificates snap-in** dialog box, choose the **Computer Account** radio button, and click **Next**.
- In the **Select Computer** dialog box, choose the **Local Computer** radio button, and click **Finish**.
- Click **OK** to go back to the main **MMC Console** window.
- In the **MMC Console** window, double-click **Certificates (local computer)** to expand its view.
- Right-click **Certificates** under **Personal** and choose **All Tasks > Import**.
- In the **Certificates Import Wizard** dialog box, perform the following actions:
  - Click **Next**.
  - Browse to the **Opflex Agent** file and click **Next**.

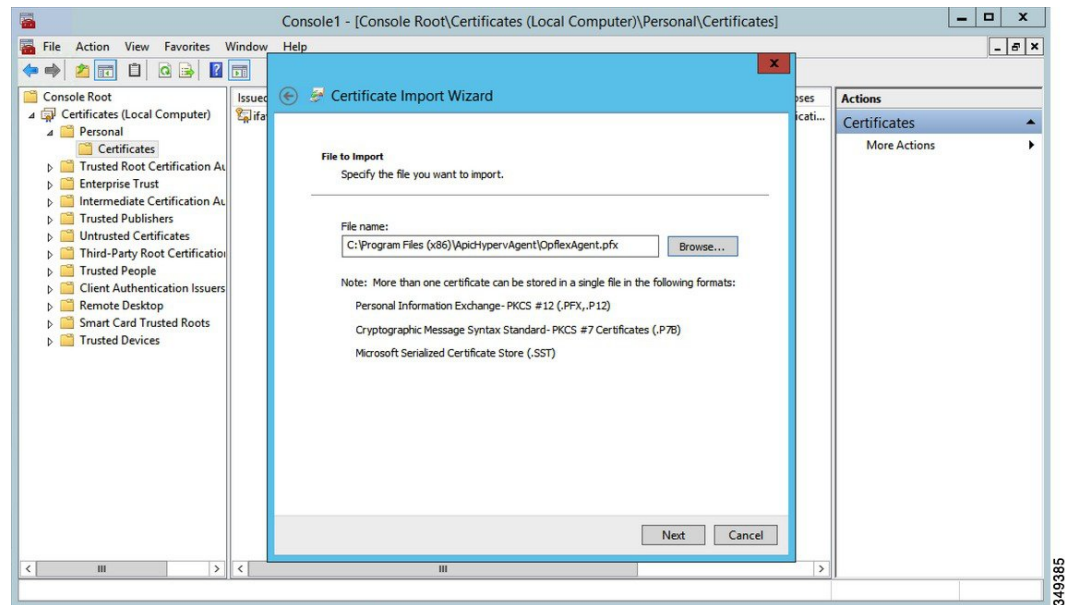

- k. Enter the password for the certificate that was provided when you installed MSI.
- l. You must choose the **Mark this key as exportable. This will allow you to back up or transport your keys at a later time** radio button.
- m. Choose the **Include all extended properties** radio button.
- n. Choose the **Place all certificates in the following store** radio button, browse to locate **Personal**, and click **Next**.
- o. Click **Finish**.
- p. Click **OK**.

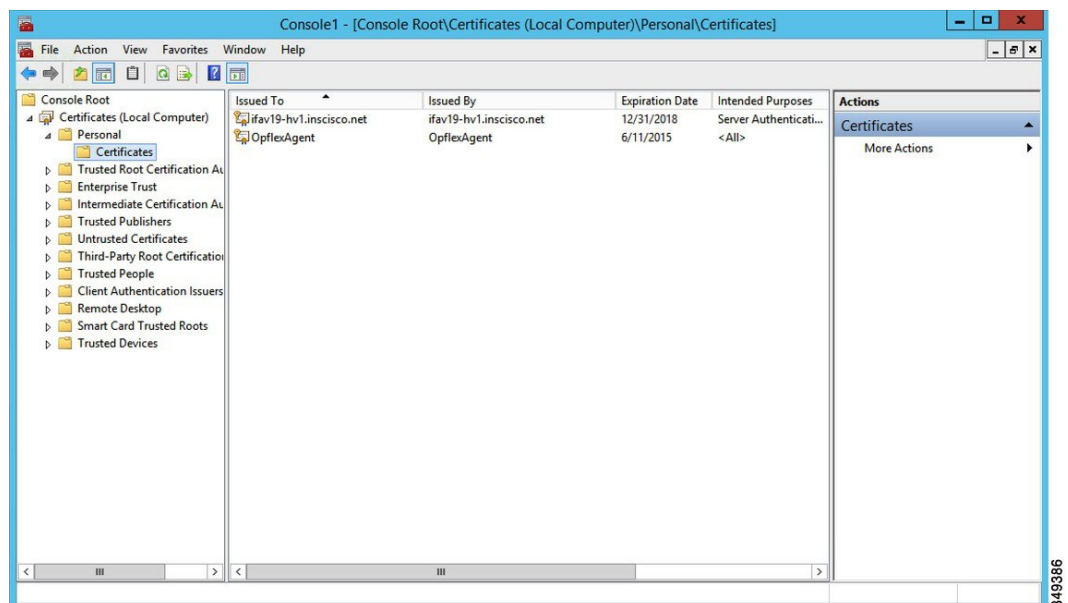

**Step 3** Repeat steps 1 through 5 for each SCVMM server.

## Configuring APIC IP Settings with OpflexAgent Certificate on the SCVMM Agent

This section describes how to configure the Cisco Application Policy Infrastructure Controller (APIC) IP settings with OpflexAgent Certificate on the System Center Virtual Machine Manager (SCVMM) agent.

### Procedure

**Step 1** Log in to the SCVMM server and choose **Start > Run > Windows PowerShell**.

**Step 2** Load **ACISCVMMPSCmdlets** by entering the following commands:

#### Example:

**Note** **Get-APICredentials** and **Set-APICredentials** are now deprecated, use **Get-APICConnInfo** and **Set-APICConnInfo**.

```
Windows PowerShell
Copyright (C) 2013 Microsoft Corporation. All rights reserved.
```

```
PS C:\Users\Administrator.INSCISCO> cd \
PS C:\> cd '.\Program Files (x86)\ApicVMMService'
PS C:\Program Files (x86)\ApicVMMService> Import-Module .\ACIScvmmpscmdlets.dll
PS C:\Program Files (x86)\ApicVMMService> Get-Command -Module ACIScvmmpscmdlets
```

| CommandType | Name                    | ModuleName        |
|-------------|-------------------------|-------------------|
| Cmdlet      | Get-ACIScvmmpOpflexInfo | ACIScvmmpscmdlets |
| Cmdlet      | Get-APICConnInfo        | ACIScvmmpscmdlets |
| Cmdlet      | Get-APICredentials      | ACIScvmmpscmdlets |
| Cmdlet      | New-APICOpflexCert      | ACIScvmmpscmdlets |
| Cmdlet      | Read-APICOpflexCert     | ACIScvmmpscmdlets |
| Cmdlet      | Set-APICConnInfo        | ACIScvmmpscmdlets |
| Cmdlet      | Set-APICredentials      | ACIScvmmpscmdlets |

```
PS C:\Program Files (x86)\ApicVMMService>
```

**Step 3** Set up Cisco APIC connection parameters for the SCVMM agent by entering the following commands, adding at least one Cisco APIC:

```
PS C:\Users\administrator.APIC> Set-APICConnInfo -ApicNameOrIPAddress APIC_1_IP
-CertificateSubjectName OpflexAgent
```

Apic Credential is successfully set to APIC SCVMM service agent.

If you enter more than one **-ApicNameOrIPAddress**, use the following format:

```
"APIC_1_IP;APIC_2_IP;APIC_3_IP;APIC_N_IP"
```

If you enter the wrong information in **Set-APICredentials**, the information fails to apply and validate on the Cisco APIC. This information is not preserved.

```
PS C:\Program Files (x86)\ApicVMMService> Set-APICConnInfo -ApicNameOrIPAddress APIC_1_IP
-CertificateSubjectName O
pflexAgentWrong
Failed cmdlet with Error: Invalid APIC Connection Settings.
Set-APICConnInfo : The remote server returned an error: (400) Bad Request.
```

```

At line:1 char:1
+ Set-APicConnInfo -ApicNameOrIPAddress APIC_1_IP -CertificateSubjectName Opf ...
+ ~~~~~
+ CategoryInfo : InvalidArgument: (:) [Set-APicConnInfo], WebException
+ FullyQualifiedErrorId : Failed cmdlet with Error: Invalid APIC Connection
Settings.,Cisco.ACI.SCVMM.
PowerShell.SetAPicConnInfo

```

- Step 4** Verify that the Cisco APIC connection parameters are set properly on Cisco APIC SCVMM Agent by entering the following command:

```
PS C:\Program Files (x86)\ApicVMMService> Get-APicConnInfo
```

```

EndpointAddress :
Username :
Password :
ApicAddresses : 172.23.139.224
ConnectionStatus : Connected
adminSettingsFlags : 0
certificateSubjectName : OpflexAgent
ExtensionData :

```

```
PS C:\Program Files (x86)\ApicVMMService>
```

## Configuring APIC IP Settings with OpflexAgent Certificate on the SCVMM Agent on a Highly Available SCVMM

This section describes how to configure the Application Policy Infrastructure Controller (APIC) IP settings with OpflexAgent Certificate on the System Center Virtual Machine Manager (SCVMM) agent.

### Procedure

- Step 1** Log in to the Owner Node SCVMM server and choose **Start > Run > Windows PowerShell**.
- Step 2** Load **ACISCVMMPSCmdlets** by entering the following commands:

#### Example:

**Note** Get-APICredentials and Set-APICredentials are now deprecated, use Get-APICConnInfo and Set-APICConnInfo.

```

Windows PowerShell
Copyright (C) 2013 Microsoft Corporation. All rights reserved.

```

```

PS C:\Users\Administrator.INSCISCO> cd \
PS C:\> cd '.\Program Files (x86)\ApicVMMService'
PS C:\Program Files (x86)\ApicVMMService> Import-Module .\ACIScvmPsCmdlets.dll
PS C:\Program Files (x86)\ApicVMMService> Get-Command -Module ACIScvmPsCmdlets

```

| CommandType | Name                  | ModuleName       |
|-------------|-----------------------|------------------|
| -----       | ----                  | -----            |
| Cmdlet      | Get-ACIScvmOpflexInfo | ACIScvmPsCmdlets |
| Cmdlet      | Get-APICConnInfo      | ACIScvmPsCmdlets |
| Cmdlet      | Get-APICredentials    | ACIScvmPsCmdlets |
| Cmdlet      | New-APICOpflexCert    | ACIScvmPsCmdlets |



```

Cmdlet Read-ApicOpflexCert ACIScvmPsCmdlets
Cmdlet Set-ApicConnInfo ACIScvmPsCmdlets
Cmdlet Set-ApicCredentials ACIScvmPsCmdlets

```

```
PS C:\Program Files (x86)\ApicVMMService>
```

**Step 3** Set up Cisco APIC connection parameters for the SCVMM agent by entering the following commands, adding one or more Cisco APIC:

```
PS C:\Users\administrator.APIC> Set-ApicConnInfo -ApicNameOrIPAddress APIC_1_IP
-CertificateSubjectName OpflexAgent
```

```
Apic Credential is successfully set to APIC SCVMM service agent. 10:25 AM
```

If you enter more than one `-ApicNameOrIPAddress`, use the following format:

```
"APIC_1_IP;APIC_2_IP;APIC_3_IP;APIC_N_IP"
```

If you enter the wrong information in `Set-ApicCredentials`, the information fails to apply and validate on the Cisco APIC. This information is not preserved.

```

PS C:\Program Files (x86)\ApicVMMService> Set-ApicConnInfo -ApicNameOrIPAddress APIC_1_IP
-CertificateSubjectName O
pflexAgentWrong
Failed cmdlet with Error: Invalid APIC Connection Settings.
Set-ApicConnInfo : The remote server returned an error: (400) Bad Request.
At line:1 char:1
+ Set-ApicConnInfo -ApicNameOrIPAddress APIC_1_IP -CertificateSubjectName Opf ...
+ ~~~~~
+ CategoryInfo : InvalidArgument: (:) [Set-ApicConnInfo], WebException
+ FullyQualifiedErrorId : Failed cmdlet with Error: Invalid APIC Connection
Settings.,Cisco.ACI.SCVMM.
PowerShell.SetApicConnInfo

```

**Step 4** Verify that the Cisco APIC connection parameters are set properly on the Cisco APIC SCVMM Agent by entering the following command:

```
PS C:\Program Files (x86)\ApicVMMService> Get-ApicConnInfo
```

```

EndpointAddress :
Username :
Password :
ApicAddresses : 172.23.139.224
ConnectionStatus : Connected
adminSettingsFlags : 0
certificateSubjectName : OpflexAgent
ExtensionData

```

## Installing the APIC Hyper-V Agent on the Hyper-V Server

This section describes how to install the APIC Hyper-V agent on the Hyper-V server.

### Before you begin

Scheduled downtime for the Hyper-V node. For more information regarding Hyper-V Maintenance Mode behavior, see: <https://technet.microsoft.com/en-us/library/hh882398.aspx>

## Procedure

---

- Step 1** Log on to the SCVMM server and bring the Hyper-V node into Maintenance Mode.
- Step 2** Log in to the Hyper-V server with administrator credentials.
- Step 3** On the Hyper-V server in File Explorer, locate the **APIC Hyper-V Agent.msi** file.
- Step 4** Right-click the **APIC Hyper-V Agent.msi** file and choose **Install**.
- Step 5** In the **ApicHypervAgent Setup** dialog box, perform the following actions:
- Check the **I accept the terms in the License Agreement** check box.
  - Click **Install**.
  - Click **Finish**.
- Step 6** Follow the steps in Microsoft's documentation to view and bring the apicVSwitch Logical Switch into compliance. Also referred to in this guide as Host Remediate or Logical Switch Instance Remediation: <https://technet.microsoft.com/en-us/library/dn249415.aspx>
- Step 7** Use one of the following methods:
- For large-scale deployments, see Microsoft's documentation for Deploy Certificates by Using Group Policy: [https://technet.microsoft.com/en-us/library/cc770315\(v=ws.10\).aspx](https://technet.microsoft.com/en-us/library/cc770315(v=ws.10).aspx)
  - For small-scale deployments follow these steps:
 

You must add OpFlex security certificate in the local system. The Microsoft Hyper-V agent has a security certificate file named **OpflexAgent.pfx** located in the **C:\Program Files (x86)\ApicVMMService** folder on the SCVMM server. If the following steps are not performed on your Hyper-V servers, the APIC Hyper-V Agent cannot communicate with the Cisco Application Centric Infrastructure (ACI) fabric leaf switches.

Install the OpFlex security certificate on the Hyper-V Windows Server 2012 local machine's certificate repository. On each Hyper-V server, install this certificate by performing the following steps:

    - Choose **Start > Run**.
    - Enter **mmc** and click **OK**.
    - In the **Console Root** window, on the menu bar, choose **Add/Remove Snap-in**.
    - In the **Available Snap-ins** field, choose **Certificates** and click **Add**.
    - In the **Certificates snap-in** dialog box, choose the **Computer Account** radio button, and click **Next**.
    - In the **Select Computer** dialog box, choose the **Local Computer** radio button, and click **Finish**.
    - Click **OK** to go back to the main **MMC Console** window.
    - In the **MMC Console** window, double-click **Certificates (local computer)** to expand its view.
    - Right-click **Certificates** under **Personal** and choose **All Tasks > Import**.
    - In the **Certificates Import Wizard** dialog box, perform the following actions:
      - Click **Next**.
      - Browse to the **Opflex Agent** file and click **Next**.

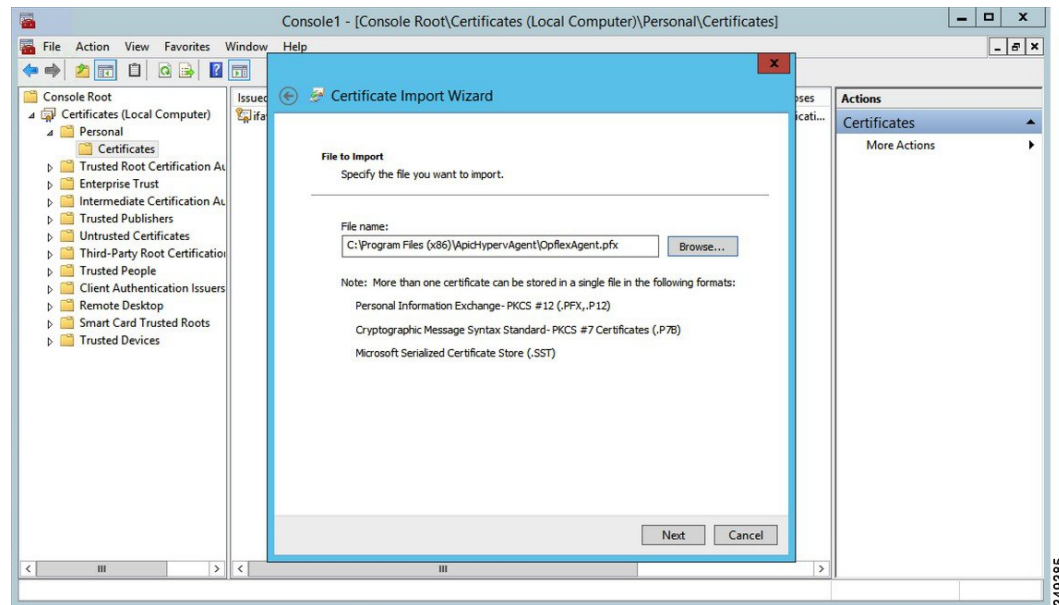

- k. Enter the password for the certificate that was provided when you installed MSI.
- l. You must choose the **Mark this key as exportable. This will allow you to back up or transport your keys at a later time** radio button.
- m. Choose the **Include all extended properties** radio button.
- n. Choose the **Place all certificates in the following store** radio button, browse to locate **Personal**, and click **Next**.
- o. Click **Finish**.
- p. Click **OK**.

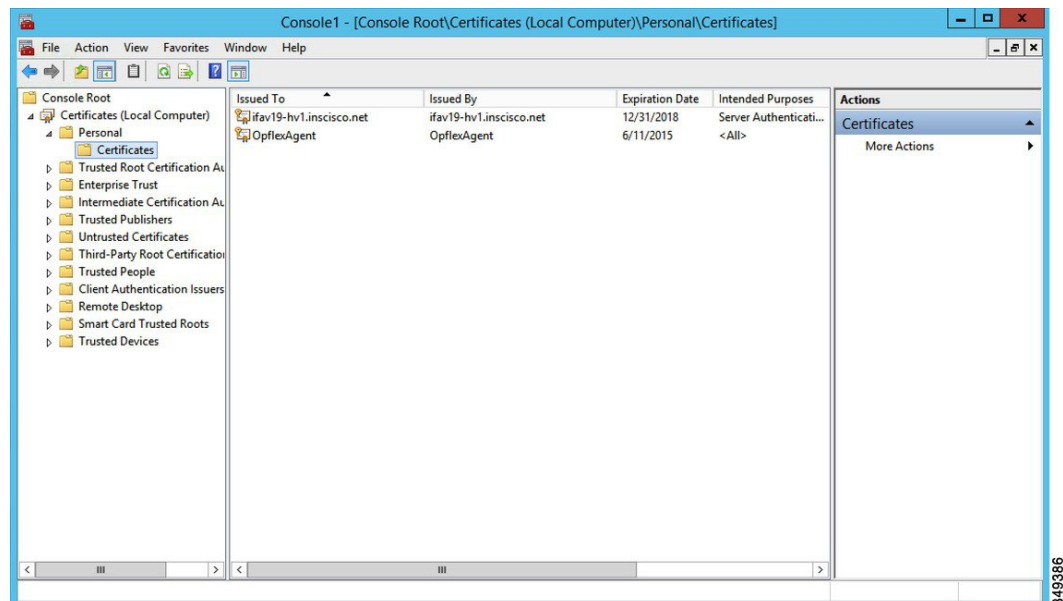

- Step 8** Log on to the SCVMM Sserver and bring the Hyper-V node out of Maintenance Mode.
- Step 9** Repeat steps 1 through 8 for each Hyper-V server.

## Verifying the Installation of Cisco ACI with Microsoft SCVMM

### Verifying the APIC SCVMM Agent Installation on SCVMM

This section describes how to verify the APIC SCVMM agent installation on System Center Virtual Machine Manager (SCVMM).

#### Procedure

- Step 1** Choose **Start > Control Panel**.
- Step 2** In the **Control Panel** window, enter **Control Panel\Programs\Programs and Features** in the address bar.
- Step 3** Locate **Cisco APIC SCVMM Agent**. If **Cisco APIC SCVMM Agent** is present, then the product is installed. If **Cisco APIC SCVMM Agent** is not present, then the product is not installed. See the [Installing the APIC SCVMM Agent on SCVMM, on page 249](#) or [Installing the APIC Agent on SCVMM Using the Windows Command Prompt, on page 276](#) section.
- Step 4** Verify the **ApicVMMService** is in RUNNING state through the GUI or CLI:
- GUI method: Choose **Start > Run** and enter **services.msc**. In the **Service** pane, locate the **ApicVMMService** and verify the state is RUNNING.
  - CLI method: From the command prompt, enter the **sc.exe query ApicHypervAgent** command and verify the state is RUNNING:

```
sc.exe query ApicVMMService

SERVICE_NAME: ApicVMMService
TYPE : 10 WIN32_OWN_PROCESS
STATE : 4 RUNNING
(STOPPABLE, NOT_PAUSABLE, ACCEPTS_SHUTDOWN)
WIN32_EXIT_CODE : 0 (0x0)
SERVICE_EXIT_CODE : 0 (0x0)
CHECKPOINT : 0x0
WAIT_HINT : 0x0
```

### Verifying the APIC SCVMM Agent Installation on a Highly Available SCVMM

This section describes how to verify the APIC SCVMM agent installation on a Highly Available System Center Virtual Machine Manager (SCVMM).

#### Procedure

- Step 1** Choose **Start > Control Panel**.
- Step 2** In the **Control Panel** window, enter **Control Panel\Programs\Programs and Features** in the address bar.

**Step 3** Locate **Cisco APIC SCVMM Agent**. If **Cisco APIC SCVMM Agent** is present, then the product is installed. If **Cisco APIC SCVMM Agent** is not present, then the product is not installed. See the [Installing the APIC SCVMM Agent on SCVMM, on page 249](#) or [Installing the APIC Agent on SCVMM Using the Windows Command Prompt, on page 276](#) section.

**Step 4** Verify the **ApicVMMService** is in RUNNING state through the GUI or CLI:

- GUI method: Choose **Start > Run** and enter **services.msc**. In the **Service** pane, locate the **ApicVMMService** and verify the state is RUNNING.
- CLI method: From the command prompt, enter the **sc.exe query ApicHypervAgent** command and verify the state is RUNNING:

```
sc.exe query ApicVMMService

SERVICE_NAME: ApicVMMService
TYPE : 10 WIN32_OWN_PROCESS
STATE : 4 RUNNING
(STOPPABLE, NOT_PAUSABLE, ACCEPTS_SHUTDOWN)
WIN32_EXIT_CODE : 0 (0x0)
SERVICE_EXIT_CODE : 0 (0x0)
CHECKPOINT : 0x0
WAIT_HINT : 0x0
```

**Step 5** Choose **Start > PowerShell** and enter the following commands:

```
PS C:\Users\administrator.APIC\Downloads> Get-ClusterResource -Name ApicVMMService
```

| Name           | State  | OwnerGroup      | ResourceType    |
|----------------|--------|-----------------|-----------------|
| ApicVMMService | Online | clustervmm07-ha | Generic Service |

```
PS C:\Users\administrator.APIC\Downloads> Get-ClusterCheckpoint -ResourceName ApicVMMService
```

| Resource       | Name                            |
|----------------|---------------------------------|
| ApicVMMService | SOFTWARE\Wow6432Node\Cisco\Apic |

```
PS C:\Users\administrator.APIC\Downloads> Get-ClusterResourceDependency -Resource ApicVMMService
```

| Resource       | DependencyExpression            |
|----------------|---------------------------------|
| ApicVMMService | ([VMM Service clustervmm07-ha]) |

## Verifying the APIC Hyper-V Agent Installation on the Hyper-V Server

This section describes how to verify the APIC Hyper-V agent installation on the Hyper-V server.

### Procedure

**Step 1** Choose **Start > Control Panel**.

**Step 2** In the **Control Panel** window, enter **Control Panel\Programs\Programs and Features** in the address bar.

**Step 3** Locate **Cisco APIC Hyperv Agent**. If **Cisco APIC Hyperv Agent** is present, then the product is installed.

If **Cisco APIC Hyperv Agent** is not present, then the product is not installed. See the [Installing the APIC Hyper-V Agent on the Hyper-V Server, on page 257](#) or [Installing the APIC Hyper-V Agent on the Hyper-V Server Using the Windows Command Prompt , on page 277](#) section.

**Step 4** Verify the **ApicHypervAgent** is in RUNNING state through the GUI or CLI:

- GUI method: Choose **Start > Run** and enter **services.msc**. In the **Service** pane, locate the **ApicHypervAgent** and verify the state is RUNNING.
- CLI method: From the command prompt, enter the **sc.exe query ApicHypervAgent** command and verify the state is RUNNING:

```
sc.exe query ApicHypervAgent

SERVICE_NAME: ApicHypervAgent
TYPE : 10 WIN32_OWN_PROCESS
STATE : 4 RUNNING
 (STOPPABLE, NOT_PAUSABLE, ACCEPTS_SHUTDOWN)
WIN32_EXIT_CODE : 0 (0x0)
SERVICE_EXIT_CODE : 0 (0x0)
CHECKPOINT : 0x0
WAIT_HINT : 0x0
```

## Setting Up ACI Policies

### Creating SCVMM Domain Profiles

In this section, the examples of a VMM domain are System Center Virtual Machine Manager (SCVMM) domains. The example tasks are as follows:

- Configuring the VMM domain name and SCVMM controller.
- Creating an attach entity profile and associating it to the VMM domain.
- Configuring a pool.
- Verifying all configured controllers and their operational states.

#### *Creating a SCVMM Domain Profile Using the GUI*

##### **Before you begin**

Before you create a VMM domain profile, you must establish connectivity to an external network using in-band or out-of-band management network on the Application Policy Infrastructure Controller (APIC).

##### **Procedure**

- 
- Step 1** Log in to the APIC GUI, and then choose **Virtual Networking > Inventory**.
  - Step 2** In the **Navigation** pane, expand **VMM Domains**, right-click the VM Provider **Microsoft** and choose **Create SCVMM Domain**.
  - Step 3** In the **Create SCVMM domain** dialog box, in the **Name** field, enter the domain's name (productionDC).

- Step 4** Optional: In the **Delimiter** field, enter one of the following: |, ~, !, @, ^, +, or =. If you do not enter a symbol, the system default | delimiter will appear in the policy.
- Step 5** In the **Associated Attachable Entity Profile** field, from the drop-down list, choose **Create Attachable Entity Profile**, and perform the following actions to configure the list of switch interfaces across the span of the VMM domain:
- In the **Create Attachable Access Entity Profile** dialog box, in the **Profile** area, in the **Name** field, enter the name (profile1), and click **Next**.
  - In the **Association to Interfaces** area, expand **Interface Policy Group**.
  - In the **Configured Interface, PC, and VPC** dialog box, in the **Configured Interfaces, PC, and VPC** area, expand **Switch Profile**.
  - In the **Switches** field, from the drop-down list, check the check boxes next to the desired switch IDs (101 and 102).
  - In the **Switch Profile Name** field, enter the name (swprofile1).
  - Expand the + icon to configure interfaces.
  - Choose the appropriate interface ports individually in the switch image (interfaces 1/1, 1/2, and 1/3). The **Interfaces** field gets populated with the corresponding interfaces.
  - In the **Interface Selector Name** field, enter the name (selector1).
  - In the **Interface Policy Group** field, from the drop-down list, choose **Create Interface Policy Group**.
  - In the **Create Access Port Policy Group** dialog box, in the **Name** field, enter the name (group1).
  - Click **Submit**.
  - Click **Save**, and click **Save** again.
  - Click **Submit**.
  - In the **Select the interfaces** area, under **Select Interfaces**, click the **All** radio button.
  - Verify that in the **vSwitch Policies** field, the **Inherit** radio button is selected.
  - Click **Finish**.
- The **Attach Entity Profile** is selected and is displayed in the **Associated Attachable Entity Profile** field.
- Step 6** In the **VLAN Pool** field, from the drop-down list, choose **Create VLAN Pool**. In the **Create VLAN Pool** dialog box, perform the following actions:
- In the **Name** field, enter the VLAN pool name (VlanRange).
  - In the **Allocation Mode** field, verify that the **Dynamic Allocation** radio button is selected.
  - Expand **Encap Blocks** to add a VLAN block. In the **Create Ranges** dialog box, enter a VLAN range.  
**Note** We recommend a range of at least 200 VLAN numbers. Do not define a range that includes the reserved VLAN ID for infrastructure network because that VLAN is for internal use.
  - Click **OK**, and click **Submit**.  
In the **VLAN Pool** field, "VlanRange-dynamic" is displayed.
- Step 7** Expand **SCVMM**. In the **Create SCVMM Controller** dialog box, verify that the **Type** is **SCVMM**, and then perform the following actions:
- In the **Name** field, enter the name (SCVMM1).
  - To connect to a SCVMM HA Cluster, specify the SCVMM HA Cluster IP address or the SCVMM Cluster Resource DNS name, which was specified during the SCVMM HA installation. See How to Connect to a Highly Available VMM Management Server by Using the VMM Console: <https://technet.microsoft.com/en-us/library/gg610673.aspx>
  - In the **Host Name (or IP Address)** field, enter the Fully Qualified Domain Name (FQDN) or IP address of your SCVMM.
  - In the **SCVMM Cloud Name** field, enter the SCVMM cloud name (ACI-Cloud).

- e) Click **OK**.
- f) In the **Create SCVMM Domain** dialog box, click **Submit**.

- Step 8** Verify the new domain and profiles, by performing the following actions:
- a) On the menu bar, choose **Virtual Networking > Inventory**.
  - b) In the navigation pane, choose **VMM Domains > Microsoft > productionDC > SCVMM1**.
  - c) In the **Work** pane, view the VMM domain name to verify that the controller is online.
  - d) In the **Work** pane, the SCVMM1 properties are displayed including the operational status. The displayed information confirms that connection from the APIC controller to the SCVMM server is established, and the inventory is available.
- 

### Configuring the Port Channel Policy

This section describes how to configure the port channel policy.

#### Modifying the Interface Port Channel Policy

The Cisco ACI SCVMM Agent synchronizes the SCVMM uplink port profile with the aggregated interface port channel policies and performs an automated update when there are changes to the policy.

To update the policy for Hyper-V servers, perform the following steps.

#### Procedure

---

- Step 1** Log in to the Cisco APIC GUI, and on the menu bar, choose **Fabric > Access Policies**.
  - Step 2** In the navigation pane, expand **Interfaces > Leaf Interfaces > Policy Groups**.
  - Step 3** Choose the policy group and check the name of the policy group.
  - Step 4** Navigate to the policy group and update it based on your requirements (for example, LACP or MAC pinning).
- 

#### Overriding the VMM Domain VSwitch Policies for Blade Servers

When Blade servers are connected to ACI fabric interface port channel policy will be used between interface and fabric interconnect. When fabric interconnect is configured for LACP you will need to configure the Hyper-V server for MAC pinning mode.

To configure the Hyper-V server for MAC pinning mode perform the following steps.

#### Procedure

---

- Step 1** Log in to the APIC GUI, on the menu bar, choose **Virtual Networking**.
- Step 2** In the navigation pane, expand **VMM Domains > Microsoft > Domain\_Name**.
- Step 3** In the **Work** pane, click **ACTIONS** and choose **Create VSwitch Policies**.
- Step 4** On the port channel policy, select the existing policy for mac pinning or create a new policy.



**Note** If the hosts are already connected to logical switch, then the SCVMM admin should perform host remediate for all the hosts for uplink policy to take effect.

---

## Verifying the SCVMM VMM Domain and SCVMM VMM

### Procedure

---

In the System Center Virtual Machine Manager Console GUI, the following object has been created by the SCVMM agent for the newly created SCVMM VMM domain and VMM Controller's rootContName (SCVMM Cloud Name):

a) Click **Fabric** at the bottom left side pane and under fabric verify the following objects:

**Note** Do not manually change this setting through the SCVMM GUI. It is managed via the ACI Agent installed on the SCVMM Server. The SCVMM Port Profile configuration is set based on APIC configuration, see [Configuring the Port Channel Policy](#) section.

#### Example:

1. Choose **Networking > Logical Switches** and in the right side pane, the logical switch name is **apicVSwitch\_VMMdomainName > Properties**.

ACI/SCVMM Integration only supports **Logical Switch > Uplink Mode as Team**.

2. Choose **Networking > Logical Networks** and in the right side pane, the logical network name is **apicLogicalNetwork\_VMMdomainName**.

3. Choose **Networking > Port Profiles** and in the right side pane, the port profile name is **apicUplinkPortProfile\_VMMdomainName > Properties**.

LACP uplink configuration: Load Balancing Algorithm: Address Hash, Teaming Mode: LACP.

All other uplink configurations (ex: mac-pinning): Load Balancing Algorithm: Hyper-V Port, Teaming Mode: Switch Independent.

b) Click **VMs and Services** in the bottom left side pane.

#### Example:

1. Choose **VM Networks**.

2. In the right side pane, the VM network name is **apicInfra|10.0.0.30|SCVMM Controller HostNameORIPAddress filed value|VMMdomainName**.

You must use infra VM Network to create VTEP on the Hyper-V server.

---

## Deploying the Logical Switch to the Host on SCVMM

This section describes how to deploy the logical switch to the host on System Center Virtual Machine Manager (SCVMM).



---

**Note** If SCVMM upgrade is performed and hosts are already connected to logical switch then SCVMM admin should perform host remediation for all the hosts for hosts to establish connection to leaf.

---

### Procedure

---

- Step 1** Log in to the SCVMM server, in the **Navigation** pane, choose **Fabric** on the bottom left.
- Step 2** In the **Navigation** pane, expand **Networking > Logical Switches** to ensure the logical switch is created (apicVswitch\_cloud1).
- Step 3** In the **Navigation** pane, choose **VMs and Services** on the bottom left.
- Step 4** In the **Navigation** pane, expand **All Hosts**.
- Step 5** Choose the Hyper-V host folder (Dev8).
- Step 6** Right-click the Hyper-V host (Dev8-HV1) and choose **Properties**.
- Step 7** In the **Dev8-HV1.inscisco.net Properties** dialog box, choose **Virtual Switches** and perform the following actions:
- Choose + **New Virtual Switch**.
  - Choose **New Logical Switch**.
  - In the **Logical switch** field, from the drop-down list, choose a logical switch (apicVswitch\_cloud1).
  - In the **Adapter** field, from the drop-down list, choose an adapter (Leaf1-1-1 - Intel(R) Ethernet Server Adapter X520-2 #2).
  - In the **Uplink Port Profile** field, from the drop-down list, choose an Uplink Port Profile (apicUplinkPortProfile\_Cloud01).
  - Click **New Virtual Network Adapter**, choose the unnamed virtual network adapter, and enter the name (dev8-hv1-infra-vtep).
  - Click **Browse**.
  - In the **Dev8-HV1.inscisco.net Properties** dialog box, choose the VM network (apicInfra|10.0.0.30|dev8-scvmm.apic.net|Cloud01) and click **OK**.
  - In the **Virtual Machine Manager** dialog box, click **OK**.
- Step 8** Click **Jobs** on the bottom left.
- Step 9** In the **History** pane, you can check the status of the **Change properties of virtual machine host** job to ensure that the job has completed.
- Step 10** You must refresh the host under SCVMM for the Hyper-V server to reflect proper Hyper-V Host IP address in SCVMM. Once it has been refreshed, the APIC GUI reflects the updated Hyper-V Host IP information.
- 

### Enabling the Logical Network on Tenant Clouds

This section describes how to enable the Cisco ACI Integration with SCVMM Tenant Clouds. For more information, see the [SCVMM Fabric Cloud and Tenant Clouds, on page 245](#).

## Procedure

---

- Step 1** Log in to the SCVMM server with SCVMM administrator credentials, and open up the SCVMM Admin Console.
- Step 2** On the SCVMM Admin Console, navigate to VMs and Services.
- Step 3** In the **Navigation** pane, expand **Clouds**, right-click on your target Tenant Cloud (HR\_Cloud) and choose **Properties**.
- Step 4** In the Pop-Up Window, in the **Navigation** pane, choose **Logical Networks**
- Locate the logical network which was automatically created as part of associating the VMM Domain to this SCVMM.
  - Click the logical network check box (apicLogicalNetwork\_MyVmmDomain).
  - Click **OK**.
- The tenant cloud is now ready to be used within ACI Integration at the Windows Azure Pack Plan configuration page.
- 

# Upgrading the Cisco ACI with Microsoft SCVMM Components

If you are trying to upgrade to SCVMM 2016, you must follow the Microsoft procedure and then install the Cisco ACI with Microsoft SCVMM components as a fresh install.

## Prerequisites:

If upgrading to SCVMM 2012 R2, Microsoft servers that you integrate into ACI must be updated with the KB2919355 and KB3000850 update rollups prior to upgrading ACI to the 2.2(1) release. The KB2919355 update rollup includes the 2929781 patch, which adds new TLS cipher suites and changes the cipher suite priorities in Windows 8.1 and Windows Server 2012 R2.

You must patch the following Microsoft servers:

- Microsoft Windows Azure Pack Resource Provider Servers
- Microsoft Windows Azure Pack Tenant Site Servers
- Microsoft Windows Azure Pack Admin Site Servers
- Microsoft System Center Service Provider Foundation/Orchestration Servers
- Microsoft System Center 2012 R2 Servers
- Microsoft HyperV 2012 R2 Servers

## Upgrading the ACI Microsoft SCVMM Components Workflow

This sections describes upgrading the ACI Microsoft SCVMM components workflow.

## Procedure

---

- Step 1** Upgrade the APIC Controller and the Switch Software.  
For more information, see the *Cisco APIC Firmware Management Guide*.
- Step 2** Upgrade the APIC SCVMM Agent on SCVMM or Upgrade the APIC SCVMM Agent on a Highly Available SCVMM.  
For more information, see [Upgrading the APIC SCVMM Agent on SCVMM, on page 268](#).  
For more information, see [Upgrading the APIC SCVMM Agent on a High Available SCVMM, on page 269](#).
- Step 3** Upgrade the APIC Hyper-V Agent.  
For more information, see [Upgrading the APIC Hyper-V Agent, on page 269](#).
- 

## Upgrading the APIC SCVMM Agent on SCVMM

This section describes how to upgrade the APIC SCVMM agent on System Center Virtual Machine Manager (SCVMM).

### Before you begin

Scheduled downtime for the Microsoft SCVMM Server. The upgrade process will automatically restart the Microsoft System Center Virtual Machine Manager Service, resulting in the SCVMM Service to be temporarily unable to handle any change or query requests.

### Procedure

---

Upgrade the APIC SCVMM agent on SCVMM.

If upgrading from release 1.1(2x) or later:

- a) Follow the steps outlined in the [Installing the APIC SCVMM Agent on SCVMM, on page 249](#).

The MSI packages handles uninstalling the previous version and installing the new version as part of the upgrade.

If upgrading from a prior release of 1.1(2x):

- a) Follow the steps outlined in the [Installing the APIC SCVMM Agent on SCVMM, on page 249](#).

The MSI packages handles uninstalling the previous version and installing the new version as part of the upgrade.

- b) Follow the steps outline in the [Exporting APIC OpFlex Certificate, on page 283](#).
- c) Follow the steps outline in the [Installing the OpflexAgent Certificate, on page 253](#).

- d) Follow the steps outline in the [Configuring APIC IP Settings with OpflexAgent Certificate on the SCVMM Agent, on page 255](#) or [Configuring APIC IP Settings with OpflexAgent Certificate on the SCVMM Agent on a Highly Available SCVMM, on page 256](#).

---

## Upgrading the APIC SCVMM Agent on a High Available SCVMM

This section describes how to upgrade the APIC SCVMM agent on a high available System Center Virtual Machine Manager (SCVMM).

### Procedure

---

- Step 1** Log in to a Standby node of the Highly Available SCVMM installation.
  - Step 2** On the SCVMM server in File Explorer, locate the **APIC SCVMM Agent.msi** file.
  - Step 3** Right-click **APIC SCVMM Agent.msi** file and select **Install**.  
  
The MSI packages handles uninstalling the previous version and installing the new version as part of the upgrade.
  - Step 4** In the **Cisco APIC SCVMM Agent Setup** dialog box, perform the following actions:
    - a) Click **Next**.
    - b) Check the **I accept the terms in the License Agreement** check box and click **Next**.
    - c) Enter your account name and password credentials.  
  
Provide the same credentials as used for the SCVMM console. The Cisco APIC SCVMM agent requires these credentials for the SCVMM operations to be able to function.  
  
The installation process verifies the entered account name and password credentials. If the installation fails, the SCVMM shows an error message and you must re-enter valid credentials.
    - d) After successful validation of the account name and password credentials, click **Install**.
    - e) Click **Finish**.
  - Step 5** Repeat steps 1-4 for each Standby Node in the Windows Failover Cluster.
  - Step 6** Failover from the Current Owner Node of the Highly Available SCVMM installation to one of the newly upgrade Standby Nodes.
  - Step 7** Follow steps 2-4 on the final Standby Node of the Windows Failover Cluster.
- 

## Upgrading the APIC Hyper-V Agent

This section describes how to upgrade the APIC Hyper-V agent.

### Before you begin

Scheduled downtime for the Hyper-V node. For more information regarding Hyper-V Maintenance Mode behavior, see: <https://technet.microsoft.com/en-us/library/hh882398.aspx>

## Procedure

---

Upgrade the APIC Hyper-V agent.

If upgrading from release 1.1(2x) or later:

- a) Follow steps 1-8 in the [Installing the APIC Hyper-V Agent on the Hyper-V Server, on page 257](#). Skip step 7. Step 7 is not required for upgrades as the OpflexAgent certificate is already installed on the Hyper-V node.

The MSI packages handles uninstalling the previous version and installing the new version as part of the upgrade.

If upgrading from a prior release of 1.1(2x):

- a) Follow the steps outlined in the [Uninstalling the APIC Hyper-V Agent, on page 334](#).
- b) Follow steps 1-8 in the [Installing the APIC Hyper-V Agent on the Hyper-V Server, on page 257](#). Skip step 7. Step 7 is not required for upgrades as the OpflexAgent certificate is already installed on the Hyper-V node.

The MSI packages handles uninstalling the previous version and installing the new version as part of the upgrade.

---

# Deploying Tenant Policies

## Deployment Tenant Policies Prerequisites

Ensure that your computing environment meets the following prerequisites:

- Ensure you have installed the APIC SCVMM Agent.  
For details, see [Installing the APIC SCVMM Agent on SCVMM, on page 249](#).
- Ensure you have installed the APIC Hyper-V Agent.  
For details, see [Installing the APIC Hyper-V Agent on the Hyper-V Server, on page 257](#).
- Ensure you have created a logical switch.  
See Microsoft's documentation.
- Ensure you have created a virtual switch.  
See Microsoft's documentation.

## Creating a Tenant

### Procedure

---

- Step 1** On the menu bar, choose **TENANTS**, and perform the following actions:
- Click **Add Tenant**.  
The **Create Tenant** dialog box opens.
  - In the **Name** field, add the tenant name (ExampleCorp).
- Step 2** Click **Finish**.  
See the *Cisco APIC Basic Configuration Guide* for more information.
- 

## Creating an EPG

This section describes how to create an endpoint group (EPG).

### Procedure

---

- Step 1** Log in to the APIC GUI, on the menu bar, choose **TENANTS > Tenant Name**.
- Step 2** In the **Navigation** pane, expand **Tenant Name > Application Profiles > Application Profile Name**, right-click **Application EPGs**, and choose **Create Application EPG**.
- Step 3** In the **Create Application EPG** dialog box, perform the following actions:
- In the **Name** field, enter the name (EPG1).
  - In the **Bridge Domain** field, from the drop-down list, choose one to associate with the bridge domain.
  - In the **Associate to VM Domain Profiles** field, click the appropriate radio button and click **Next**.
  - In the **Associated VM Domain Profiles** field, click the + icon, and choose a cloud to add (Cloud10).  
You have now created an EPG.
- 

## Associating the Microsoft VMM Domain with an EPG

This section describes how to create a VM Network by associating the Microsoft VMM domain with an endpoint group (EPG).



---

**Note** Content in the **Hypervisors**, **Virtual Machines**, and **Virtualization Ratio** areas of the Cisco APIC capacity dashboard appears as 0 when SCVMM endpoints are learned in Pre-Provision mode.

---

### Before you begin

Ensure you have created an EPG.

### Procedure

---

- Step 1** Log in to the Cisco APIC GUI and on the menu bar, choose **Tenants > Tenant Name**.
- Step 2** In the **Navigation** pane, expand **Tenant Name > Application Profiles > Application Profile Name > Application EPGs** and select an existing EPG.
- Step 3** In the **Navigation** pane, choose **Domains (VMs and Bare-Metals)**.
- Step 4** In the **Domains (VM and Bare-Metals)** pane, click on the **ACTIONS** and choose **Add VMM Domain Association**.
- Step 5** In the **Add VMM Domain Association** dialog box, click the **Deploy Immediacy** field radio button for either **Immediate** or **On Demand**.  
See [EPG Policy Resolution and Deployment Immediacy, on page 11](#) for more information.
- Step 6** In the **Add VMM Domain Association** dialog box, click the **Resolution Immediacy** field radio button for either **Immediate**, **On Demand**, or **Pre-Provision**.  
See [EPG Policy Resolution and Deployment Immediacy, on page 11](#) for more information.  
You have now created a VM Network.
- Step 7** Optional: In the **Delimiter** field, use a single character as the VM Network Name delimiter, enter one of the following: |, ~, !, @, ^, +, or = . If you do not enter a symbol, the system default of | will be used.
- 

## Verifying the EPG is Associated with the VMM Domain on APIC

This section describes how to verify the endpoint group association with the VMM domain on Application Policy Infrastructure Controller (APIC).

### Procedure

---

- Step 1** Log in to the APIC GUI, on the menu bar, choose **Virtual Networking > Inventory**.
- Step 2** In the navigation pane, expand **VMM Domains > Microsoft > Cloud10 > Controller > Controller1 > Distributed Virtual Switch > SCVMM|Tenant|SCVMM|EPG1|Cloud1**.  
The name of the new VM Network is in the following format: *Tenant Name|Application Profile Name|Application EPG Name|Microsoft VMM Domain*.
- Step 3** In the **PROPERTIES** pane, verify the EPG associated with the VMM domain, the VM Network, and the details such as NIC NAME, VM NAME, IP, MAC, and STATE.
- 

## Verifying the EPG is Associated with the VMM Domain on SCVMM

This section describes how to verify the endpoint group (EPG) associated with the VMM domain on System Center Virtual Machine Manager (SCVMM).



## Procedure

---

- Step 1** Open the **Virtual Machine Manager Console** icon on your desktop.
- Step 2** In the bottom left pane, click on **VMs and Services** or press **Ctrl+M**.
- Step 3** In the **VMs and Services** pane, click on **VM Networks** and verify the EPG associated with the VMM domain.
- The EPG associated with the VMM domain is in the following format: *Tenant Name|Application Profile Name|Application EPG Name|Microsoft VMM Domain*.
- 

## Creating a Static IP Address Pool

Static IP Address Pools enable an Microsoft SCVMM Server to statically assign IP Address to virtual machines during the VM Template Deployment phase. This feature removes the need to request a DHCP address from a DHCP Server. This feature is most often used to deploy server VMs which require statically assigned IP Addresses in the network such as: Windows Active Directory Domain Controllers, DNS Servers, DHCP Servers, Network Gateways, etc.

For more information regarding Static IP address pools, see the Microsoft Documentation: [https://technet.microsoft.com/en-us/library/jj721568.aspx#BKMK\\_StaticIPAddressPools](https://technet.microsoft.com/en-us/library/jj721568.aspx#BKMK_StaticIPAddressPools)

With Cisco ACI SCVMM Integration - the Cisco APIC can automate the deployment of a Static IP Address Pool to a VM Network, bypassing the need to perform these operations on the Microsoft SCVMM Server itself.

### Before you begin

Ensure an EPG is associated to a Microsoft SCVMM VMM Domain.

## Procedure

---

- Step 1** Log in to the APIC GUI, on the menu bar, choose **TENANTS > Tenant Name**.
- Step 2** In the **Navigation** pane, expand **Tenant Name > Application Profiles > Application Profile Name > Application EPGs > Your Target EPG**, right-click **Subnets**, and choose **Create EPG Subnet**.
- Step 3** In the **Create EPG Subnet** dialog box, perform the following actions:
- Enter a default Gateway IP in address/mask format.
  - Click **Submit**.
- Step 4** Right-click on the newly created subnet and choose **Create Static IP Pool Policy**.
- Step 5** In the **Create Static IP Pool Policy** dialog box, perform the following actions:
- Enter a Name (IP).
  - Enter a Start IP and End IP.
  - Enter optional Static IP Pool policies.

The DNS Servers, DNS Search Suffix, Wins Servers fields Allow a list of entries, simply use semicolon to separate the entries. For example within the DNS Servers Field:

**192.168.1.1;192.168.1.2**

**Note** When configuring the Start IP and End IP, ensure they are within the same Subnet as the Gateway defined in Step 3. If not deployment of the Static IP Address Pool to SCVMM fails.

Only 1 Static IP Address Pool will be used for a given EPG. Do not create multiple Static IP Pool Policies under a Subnet as the others will not take effect.

The Static IP Address Pool Policy follows the VMM Domain association. If this EPG is deployed to multiple SCVMM Controllers in the same VMM Domain, then the same Static IP Addresses will be deployed, causing duplicate IP Addresses. For this scenario, deploy an addition EPG with a non-overlapping Address pool and create the necessary policies and contracts for the endpoints to communicate.

---

## Connecting and Powering on the Virtual Machine

This section describes how to connect and power on the virtual machine.

### Procedure

- 
- Step 1** Log in to the SCVMM server, choose **VMs and Services > All Hosts**, and choose one of the hosts.
  - Step 2** In the **VMs** pane, right-click on the VM host that you want to associate to the VM Network and choose **Properties**.
  - Step 3** In the **Properties** dialog box, choose **Hardware Configuration**, and choose a network adapter (Network Adapter 1).
  - Step 4** In the **Network Adapter 1** pane, perform the following actions to connect to a VM network:
    - a) Click the **Connect to a VM network** radio button.
    - b) Click the **Browse** button.
    - c) Verify the list of VM networks, which lists all of the VM networks to which the hypervisor is associated.
  - Step 5** Power on the virtual machine.
- 

## Verifying the Association on APIC

This section describes how to verify the association on Application Policy Infrastructure Controller (APIC).

### Procedure

- 
- Step 1** Log in to the APIC GUI, on the menu bar, choose **Virtual Networking > Inventory**.
  - Step 2** In the navigation pane, expand **VMM Domains > Microsoft > Cloud10 > Controller > Controller1 > Hypervisors > Hypervisor1 > Virtual Machines** to verify the association.
-

## Viewing EPGs on APIC

This section describes how to view endpoint groups (EPGs) on the Application Policy Infrastructure Controller (APIC).

### Procedure

---

- Step 1** Log in to the APIC GUI, on the menu bar, choose **TENANTS > Tenant Name**.
  - Step 2** In the **Navigation** pane, expand **Tenant Name > Application Profiles > VMM > Application EPGs > EPG1**.
  - Step 3** In the **Application EPG - EPG1** pane, click the **OPERATIONAL** button, and verify if the endpoint group is present.
- 

## Troubleshooting the Cisco ACI with Microsoft SCVMM

### Troubleshooting APIC to SCVMM Connectivity

Use the ApicVMMSvc logs to debug the System Center Virtual Machine Manager (SCVMM) server.

### Procedure

---

- Step 1** Log in to the SCVMM server, go to the **ApicVMMSvc** logs. Located at **C:\Program Files (X86)\ApicVMMSvc\Logs**.
  - Step 2** Check the **ApicVMMSvc** logs to debug.  
If you are unable to debug, on the SCVMM server copy all the **ApicVMMSvc** logs from **C:\Program Files (X86)\ApicVMMSvc\Logs** and send them to Cisco Tech Support.
- 

### Troubleshooting Leaf to Hyper-V Host Connectivity

Use the ApicHypervAgent logs to debug the Hyper-V servers.

### Procedure

---

- Step 1** Log in to the Hyper-V servers, go to the **ApicHypervAgent** logs. Located at **C:\Program Files (x86)\ApicHypervAgent\Logs**.
- Step 2** Check the **ApicHypervAgent** logs to debug.

If you are unable to debug, on the Hyper-V servers copy all the **ApicHypervAgent** logs from **C:\Program Files (x86)\ApicHypervAgent\Logs** and send them to Cisco Tech Support.

## Troubleshooting the EPG Configuration Issue

If during the lifetime of the endpoint group (EPG), the VLAN ID of the EPG changes on the APIC, then SCVMM needs to update the VLAN configuration on all virtual machines for the new setting to take effect.

### Procedure

To perform this operation run the following PowerShell commands on the SCVMM server:

#### Example:

```
$VMs = Get-SCVirtualMachine
$VMs | Read-SCVirtualMachine
$NonCompliantAdapters=Get-SCVirtualNetworkAdapter -All | Where-Object
{$_ .VirtualNetworkAdapterComplianceStatus -eq "NonCompliant"}
$NonCompliantAdapters | Repair-SCVirtualNetworkAdapter
```

## Reference Information

### Installing the APIC Agent on SCVMM Using the Windows Command Prompt

This section describes how to install the APIC Agent on System Center Virtual Machine Manager (SCVMM) using the Windows Command Prompt.

### Procedure

- Step 1** Log in to the SCVMM server with SCVMM administrator credential.
- Step 2** Launch the command prompt, change to the folder where you copied the **APIC SCVMM Agent.msi** file, and execute following commands:

#### Example:

```
C:\>cd MSIPackage

C:\MSIPackage>dir
Volume in drive C has no label.
Volume Serial Number is 726F-5AE6

Directory of C:\MSIPackage

02/24/2015 01:11 PM <DIR> .
02/24/2015 01:11 PM <DIR> ..
02/24/2015 05:47 AM 3,428,352 APIC SCVMM Agent.msi
 1 File(s) 3,428,352 bytes
```

```

2 Dir(s) 37,857,198,080 bytes free

C:\MSIPackage>msiexec.exe /I "APIC SCVMM Agent.msi" /Qn ACCOUNT="inscisco\Administrator"
PASSWORD="MyPassword" /log "C:\InstallLog.txt"
C:\MSIPackage>sc.exe query ApicVMMService

SERVICE_NAME: ApicVMMService
 TYPE : 10 WIN32_OWN_PROCESS
 STATE : 4 RUNNING
 (STOPPABLE, NOT_PAUSABLE, ACCEPTS_SHUTDOWN)
 WIN32_EXIT_CODE : 0 (0x0)
 SERVICE_EXIT_CODE : 0 (0x0)
 CHECKPOINT : 0x0
 WAIT_HINT : 0x0

```

- Step 3** If the `msiexec.exe` installer package succeeds, it finishes without any warning or error messages. If it fails, it displays the appropriate warning or error message.

## Installing the APIC Hyper-V Agent on the Hyper-V Server Using the Windows Command Prompt

This section describes how to install the APIC Hyper-V Agent on the Hyper-V server using the windows Command Prompt.

### Procedure

- Step 1** Log in to the Hyper-V server with administrator credentials.
- Step 2** Launch the command prompt, change to the folder where you copied the **APIC Hyper-V Agent.msi** file, and execute the following commands:

#### Example:

```

C:\>cd MSIPackage

C:\MSIPackage>dir
Volume in drive C has no label.
Volume Serial Number is C065-FB79

Directory of C:\MSIPackage

02/24/2015 01:11 PM <DIR> .
02/24/2015 01:11 PM <DIR> ..
02/24/2015 05:44 AM 958,464 APIC Hyper-V Agent.msi
 1 File(s) 958,464 bytes
 2 Dir(s) 749,486,202,880 bytes free

C:\MSIPackage>msiexec.exe /I "APIC Hyper-V Agent.msi" /log "C:\InstallLog.txt"

C:\MSIPackage>msiexec.exe /I "APIC Hyper-V Agent.msi" /Qn /log "C:\InstallLog.txt"

C:\MSIPackage>sc.exe query ApicHyperVAgent

SERVICE_NAME: ApicHyperVAgent
 TYPE : 10 WIN32_OWN_PROCESS
 STATE : 4 RUNNING
 (STOPPABLE, NOT_PAUSABLE, ACCEPTS_SHUTDOWN)

```

```

WIN32_EXIT_CODE : 0 (0x0)
SERVICE_EXIT_CODE : 0 (0x0)
CHECKPOINT : 0x0
WAIT_HINT : 0x0

```

**Step 3** Repeat steps 1 through 2 for each Hyper-V server.

If the **msiexec.exe** installer package succeeds, it finishes without any warning or error messages. If it fails, it displays the appropriate warning or error message.

## Programmability References

### ACI SCVMM PowerShell Cmdlets

This section describes how to list the Cisco Application Centric Infrastructure (ACI) System Center Virtual Machine Manager (SCVMM) PowerShell cmdlets, help, and examples.

#### Procedure

**Step 1** Log in to the SCVMM server, choose **Start > Run > Windows PowerShell**.

**Step 2** Enter the following commands:

#### Example:

```

Windows PowerShell
Copyright (C) 2013 Microsoft Corporation. All rights reserved.

```

```

PS C:\Program Files (x86)\ApicVMMService> cd C:\Program Files (x86)\ApicVMMService>
PS C:\Program Files (x86)\ApicVMMService> Import-Module .\ACIScvmPsCmdlets.dll
PS C:\Program Files (x86)\ApicVMMService> Add-Type -Path .\Newtonsoft.Json.dll
PS C:\Program Files (x86)\ApicVMMService> Get-Command -Module ACIScvmPsCmdlets

```

| CommandType | Name                  | ModuleName       |
|-------------|-----------------------|------------------|
| -----       | ----                  | -----            |
| Cmdlet      | Get-ACIScvmOpflexInfo | ACIScvmPsCmdlets |
| Cmdlet      | Get-ApicConnInfo      | ACIScvmPsCmdlets |
| Cmdlet      | Get-ApicCredentials   | ACIScvmPsCmdlets |
| Cmdlet      | New-ApicOpflexCert    | ACIScvmPsCmdlets |
| Cmdlet      | Read-ApicOpflexCert   | ACIScvmPsCmdlets |
| Cmdlet      | Set-ApicConnInfo      | ACIScvmPsCmdlets |
| Cmdlet      | Set-ApicCredentials   | ACIScvmPsCmdlets |

**Step 3** Generating help:

#### Example:

```
commandname -?
```

**Step 4** Generating examples:

#### Example:

```
get-help commandname -examples
```

---

## Configuration References

### MAC Address Configuration Recommendations

This section describes the MAC address configuration recommendations.

- Both Dynamic and Static MAC are supported.
- **Static** MAC for the VM Network adapter is recommended if you want the VM inventory to show up quickly on APIC.
- If you choose **Dynamic** MAC there is a delay for the VM inventory to show up on APIC. The delay is because Dynamic MACs are not learned by SCVMM right away.



---

**Note** The Data plane works fine even though the VM inventory does not show up.

---

Figure 21: Shows the MAC address section in the Properties pane.

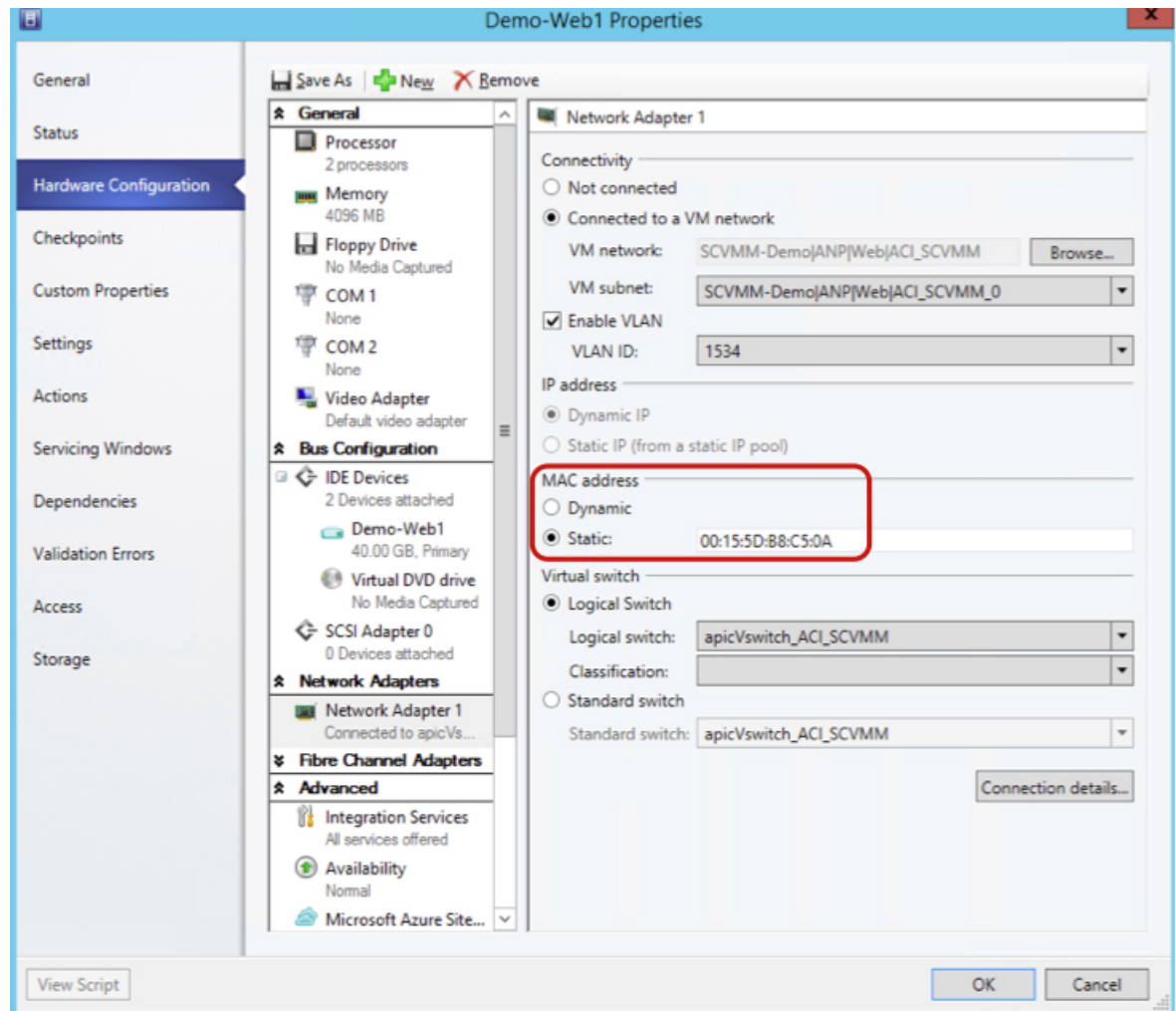

## Uninstalling the Cisco ACI with Microsoft SCVMM Components

This section describes how to uninstall the Cisco Application Centric Infrastructure (ACI) with Microsoft System Center Virtual Machine Manager (SCVMM) components.

### Procedure

- 
- Step 1** Detach all virtual machines from the VM networks.  
See Microsoft's documentation.
- Step 2** Delete the Infra VLAN tunnel endpoint (VTEP) and APIC logical switches on all Hyper-Vs.  
See Microsoft's documentation.



- Step 3** Verify the APIC GUI to make sure all the VMs and hosts are disconnected.
- Step 4** Delete the VMM Domain from the Application Policy Infrastructure Controller (APIC).  
See [Guidelines for Deleting VMM Domains, on page 13](#).
- Step 5** Verify the logical switch and logical networks are removed from SCVMM.
- Step 6** Uninstall the APIC SCVMM Agent on SCVMM or on a Highly Available SCVMM.  
See [Uninstalling the APIC SCVMM Agent, on page 281](#).  
See [Uninstalling the APIC SCVMM Agent on a Highly Available SCVMM, on page 281](#)
- 

## Uninstalling the APIC SCVMM Agent

This section describes how to uninstall the APIC SCVMM Agent.

### Procedure

---

- Step 1** Log in to the SCVMM server.
- Step 2** Choose **Start > Control Panel > Uninstall a Program**.
- Step 3** In the **Programs and Features** window, right-click **ApicVMMService** and choose **Uninstall**.  
This uninstalls the APIC SCVMM Agent.
- Step 4** To verify if the APIC SCVMM Agent is uninstalled, in the **Programs and Features** window, verify that **ApicVMMService** is not present.
- 

## Uninstalling the APIC SCVMM Agent on a Highly Available SCVMM

This section describes how to install the Application Policy Infrastructure Controller (APIC) SCVMM agent on a Highly Available System Center Virtual Machine Manager (SCVMM).

### Procedure

---

- Step 1** Log in to any node within the Highly Available SCVMM Failover Cluster.
- Step 2** Open the **Failover Cluster Manager Application**.
- Step 3** In the **Windows Failover Cluster Manager** window, select **ApicVMMService** in the Highly Available SCVMM Roles/Resources tab.
- Step 4** Right-click on the **ApicVMMService Role** and choose **Take Offline**.
- Step 5** Once the Role is offline, right-click on the **ApicVMMService Role** and choose **Remove**.
- Step 6** On each node within the Highly Available SCVMM Failover Cluster, perform the following actions to uninstall the APIC SCVMM Agent:
- Log in to the SCVMM server.
  - Choose **Start > Control Panel > Uninstall a Program**.
  - In the **Programs and Features** window, right-click **ApicVMMService** and choose **Uninstall**.

This uninstalls the APIC SCVMM Agent.

- d) To verify if the APIC SCVMM Agent is uninstalled, in the **Programs and Features** window, verify that **ApicVMMService** is not present.
- 

## Downgrading the Cisco APIC Controller and the Switch Software with Cisco ACI and Microsoft SCVMM Components

This section describes how to downgrade the Cisco APIC and the switch software with Cisco ACI and Microsoft System Center Virtual Machine Manager (SCVMM) components.

### Procedure

---

- Step 1** Uninstall the Cisco APIC SCVMM Agent on SCVMM or on a highly available SCVMM.  
See [Uninstalling the APIC SCVMM Agent, on page 281](#).  
See [Uninstalling the APIC SCVMM Agent on a Highly Available SCVMM, on page 281](#).
  - Step 2** Downgrade the Cisco APIC Hyper-V Agent by Completing the following steps:
    - a) Log in to the SCVMM server and bring the Hyper-V node into maintenance mode.
    - b) Log in to the Hyper-V server with administrator credentials.
    - c) Uninstall the Cisco APIC Hyper-V agent.
    - d) Install Cisco APIC Hyper-V agent to the version that the Cisco ACI fabric is being downgraded to.
  - Step 3** Downgrade the switch software.
  - Step 4** Downgrade the Cisco APIC.  
See the *Cisco APIC Firmware Management Guide* for details.
  - Step 5** On the SCVMM server, install the SCVMM agent for the version that the Cisco ACI fabric is being downgraded to.  
See [Installing the APIC SCVMM Agent on SCVMM, on page 249](#)  
See [Installing the APIC SCVMM Agent on a Highly Available SCVMM, on page 250](#)
  - Step 6** Follow the steps in Microsoft's documentation to view and bring the Cisco APIC vSwitch logical switch into compliance.  
See [How to View Host Network Adapter Settings and Increase Compliance with Logical Switch Settings in VMM](#).
-

# Exporting APIC OpFlex Certificate

This section describes how to back up APIC OpFlex certificate to a file which can be used to deploy new Hyper-V nodes, System Center Virtual Machine Manager (SCVMM) and Windows Azure Pack Resource Provider servers to the ACI Fabric when the original OpFlex certificate cannot be located.

## Procedure

- 
- Step 1** Log in to a Hyper-V node which is currently a member of the ACI Fabric.
- Step 2** Export the certificate from the Hyper-V node by performing the following actions:
- Choose **Start > Run** and type **certlm.msc** to launch the Certificate Manager.
  - In the **navigation** pane, right-click on **Certificates - Local Computer** and choose **Find Certificates**.
  - In the **Find Certificate** dialog box, perform the following actions:
    - In the **Find in** field, from the drop-down list, choose **All certificate stores**.
    - In the **Contains** field, enter **OpflexAgent**.
    - In the **Look in Field** field, from the drop-down list, choose **Issued By**.
    - Click **Find Now**.Your result list should have a single Certificate in the list.
  - Right-click on the newly found **OpflexAgent** certificate and choose **Export**.  
The Certificate Export Wizard will appear.
- Step 3** In the **Certificate Export Wizard** dialog box, perform the following actions:
- In the **Welcome to the Certificate Export Wizard** dialog box, click **Next**
  - In the **Export Private Key** dialog box, choose the **Yes, export the private key** radio button, and click **Next**.
  - In the **Export File Format** dialog box, choose the **Personal Information Exchange - PKCS #12 (.PFX)** radio button, check the **Include all certificates in the certificate path if possible** and **Export all extended properties** check box. Click **Next**.
  - In the **Security** dialog box, check the **Password** check box, enter your PFX password and enter your PFX password again to confirm. Click **Next**.  
Your PFX password will be used later to import the PFX file on the target machine.
  - In the **File to Export** dialog box, enter the filename you wish to save the exported file (C:\OpflexAgent.pfx) and click **Next**.
  - In the **Completing the Certificate Export Wizard** dialog box, review all your specified settings are correct and click **Finish**.
  - The **Certificate Export Wizard** dialog box will appear with **The export was successful**. and click **Ok**.
- Step 4** Copy the PFX file to a known location.

You can deploy the certificate through an Active Directory Group Policy or copy the file to your various Microsoft Servers which host your SCVMM, Windows Azure Pack Resource Provider, and Hyper-V services for integration into the ACI Fabric.

---



## CHAPTER 15

# Cisco ACI with Microsoft Windows Azure Pack

This chapter contains the following sections:

- [About Cisco ACI with Microsoft Windows Azure Pack, on page 285](#)
- [Getting Started with Cisco ACI with Microsoft Windows Azure Pack, on page 289](#)
- [Upgrading the Cisco ACI with Microsoft Windows Azure Pack Components, on page 295](#)
- [Use Case Scenarios for the Administrator and Tenant Experience, on page 298](#)
- [Troubleshooting Cisco ACI with Microsoft Windows Azure Pack, on page 330](#)
- [Programmability References, on page 330](#)
- [Uninstalling the Cisco ACI with Microsoft Windows Azure Pack Components, on page 332](#)
- [Downgrading Cisco APIC and the Switch Software with Cisco ACI and Microsoft Windows Azure Pack Components, on page 334](#)

## About Cisco ACI with Microsoft Windows Azure Pack

Cisco Application Centric Infrastructure (ACI) integrates in Microsoft Windows Azure Pack to provide a self-service experience for the tenant.

ACI enhances the network management capabilities of the platform. Microsoft Windows Azure Pack is built on top of an existing Microsoft System Center Virtual Machine Manager (SCVMM) installation. Cisco ACI has integration points at each of these layers, enabling you to leverage the work performed in a SCVMM environment and use it in a Microsoft Windows Azure Pack installation.

- Cisco ACI with Microsoft Windows Azure Pack—Microsoft Windows Azure Pack for Windows Server is a collection of Microsoft Azure technologies that include the following capabilities:
  - Management portal for tenants
  - Management portal for administrators
  - Service management API
- Cisco ACI with Microsoft System Center Virtual Machine Manager —For information about how to set up Cisco ACI with Microsoft System Center Virtual Machine Manager (SCVMM), see details in [Cisco ACI with Microsoft SCVMM Solution Overview, on page 244](#).



---

**Note** You cannot configure direct server return (DSR) through Windows Azure Pack. If you want to configure DSR, you must do so in Cisco APIC. See the chapter "Configuring Direct Server Return" in the *Cisco APIC Layer 4 to Layer 7 Services Deployment Guide* for information.

---

## Cisco ACI with Microsoft Windows Azure Pack Solution Overview

Cisco Application Centric Infrastructure (ACI) integrates in Microsoft Windows Azure Pack to provide a self-service experience for tenants. ACI resource provider in Windows Azure Pack drives the Application Policy Infrastructure Controller (APIC) for network management. Networks are created in System Center Virtual Machine Manager (SCVMM) and are available in Windows Azure Pack for respective tenants. ACI Layer 4 to Layer 7 capabilities for F5 and Citrix load balancers and stateless firewall are provided for tenants. For details, see the [About Load Balancing, on page 307](#).

Windows Azure Pack for Windows Server is a collection of Microsoft Azure technologies, available to Microsoft customers at no additional cost for installation into your data center. It runs on top of Windows Server 2012 R2 and System Center 2012 R2 and, through the use of the Windows Azure technologies, enables you to offer a rich, self-service, multi-tenant cloud, consistent with the public Windows Azure experience.

Windows Azure Pack includes the following capabilities:

- Management portal for tenants—a customizable self-service portal for provisioning, monitoring, and managing services such as networks, bridge domains, VMs, firewalls, load balancers, external connectivity, and shared services. See the User Portal GUI.
- Management portal for administrators—a portal for administrators to configure and manage resource clouds, user accounts, and tenant offers, quotas, pricing, Web Site Clouds, Virtual Machine Clouds, and Service Bus Clouds.
- Service management API—a REST API that helps enable a range of integration scenarios including custom portal and billing systems.

See [Use Case Scenarios for the Administrator and Tenant Experience, on page 298](#) for details.

## Physical and Logical Topology

Figure 22: Topology of a typical Windows Azure Pack deployment with ACI Fabric

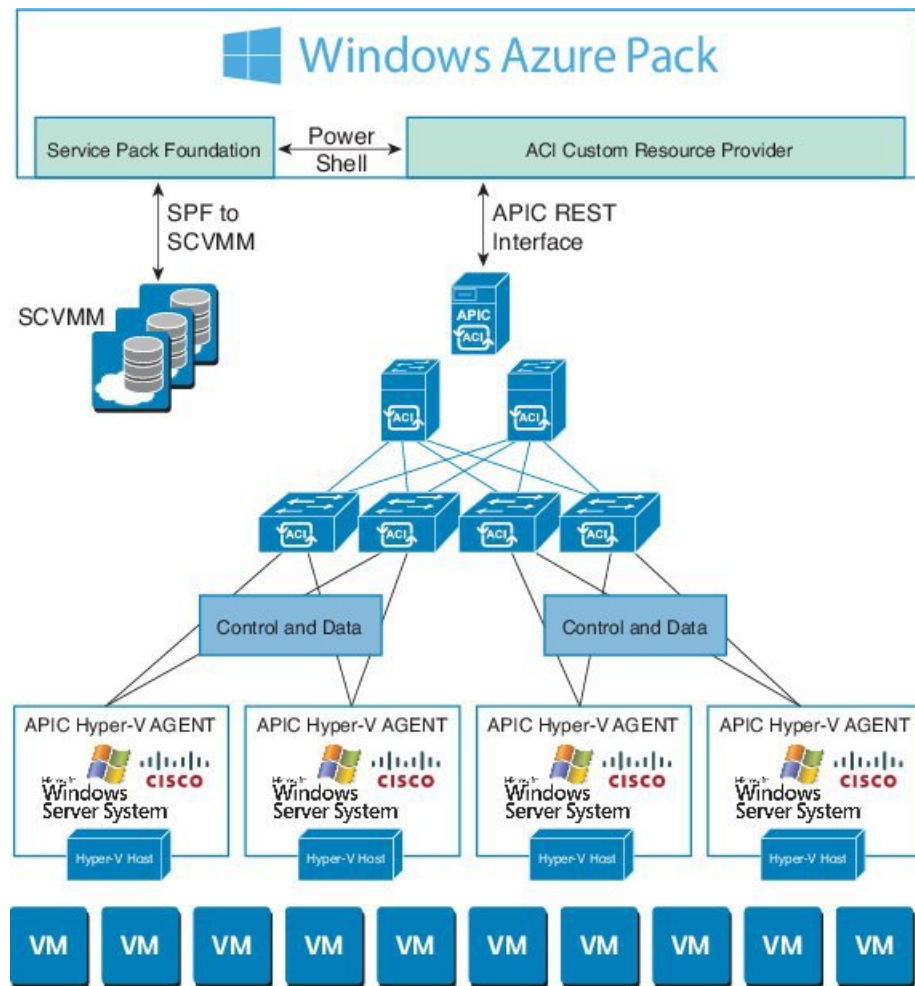

The above figure shows a representative topology of a typical Windows Azure Pack deployment with Cisco Application Centric Infrastructure (ACI) fabric. Connectivity between Windows Azure Pack and Application Policy Infrastructure Controller (APIC) is over the management network. Tenants interface is only with Windows Azure Pack either through the GUI or REST API. Tenants do not have direct access to APIC.

Figure 23: ACI in Resource Provider Framework

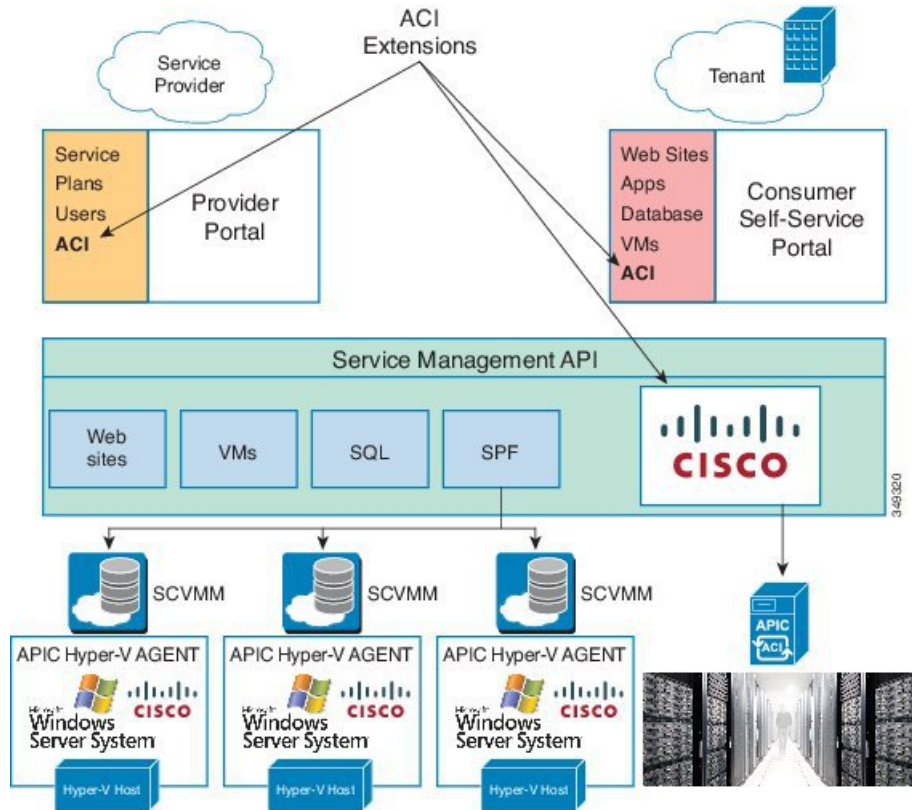

## About the Mapping of ACI Constructs in Microsoft Windows Azure Pack

This section shows a table of the mapping of Cisco Application Centric Infrastructure (ACI) constructs in Microsoft Windows Azure Pack.

**Table 6: Mapping of ACI and Windows Azure Pack constructs**

| Windows Azure Pack | ACI                   |
|--------------------|-----------------------|
| Subscription       | Tenant                |
| Network            | EPG                   |
| Firewall Rule      | Intra-tenant contract |
| Shared Service     | Inter-tenant contract |
| SCVMM Cloud        | VM Domain             |



# Getting Started with Cisco ACI with Microsoft Windows Azure Pack

This section describes how to get started with Cisco ACI with Microsoft Windows Azure Pack.

Before you install Cisco ACI with Microsoft Windows Azure Pack, download and unzip the folder containing the Cisco ACI and matching Microsoft integration files for the Cisco APIC release.

1. Go to [Cisco's Application Policy Infrastructure Controller \(APIC\) website](#).
2. Choose **All Downloads for this Product > APIC Software**.
3. Choose the release version and the matching zipped folder.
4. Click **Download**.
5. Unzip the zipped folder.



---

**Note**

Cisco ACI with Microsoft Windows Azure Pack only supports ASCII characters. Non-ASCII characters are not supported.

Ensure that **English** is set in the System Locale settings for Windows, otherwise Cisco ACI with Windows Azure Pack will not install. Also, if the System Locale is modified to a non-English Locale after installation, the integration components may fail when communicating with Cisco APIC and the Cisco ACI fabric.

---

## Prerequisites for Getting Started with Cisco ACI with Microsoft Windows Azure Pack

Before you get started, ensure that you have verified that your computing environment meets the following prerequisites:

- Ensure Cisco Application Centric Infrastructure (ACI) with Microsoft System Center Virtual Machine Manager (SCVMM) has been set up.  
For more information, see [Getting Started with Cisco ACI with Microsoft SCVMM, on page 246](#).
- Ensure that Microsoft Windows Azure Pack Update Rollup 5, 6, 7, 9, 10, or 11 is installed.  
See Microsoft's documentation.
- Ensure that Windows Server 2016 is installed.  
See Microsoft's documentation.
- Ensure that Hyper-V Host is installed.  
See Microsoft's documentation.
- Ensure a cloud is configured on SCVMM.  
See Microsoft's documentation.

- Ensure a VM cloud is configured on Windows Azure Pack.  
See Microsoft's documentation.
- Ensure "default" AEP exists with infrastructure VLAN enabled.
- Ensure "default" and "vpcDefault" bridge domains and corresponding "default" and "vpcDefault" EPGs exist in tenant common.
- Ensure you have the Cisco MSI files for APIC Windows Azure Pack Resource and the Host Agent.  
For more information, see [Getting Started with Cisco ACI with Microsoft SCVMM, on page 246](#).



---

**Note** Symptom: When you either create or update a plan it may fail with an error message.

Condition: If you have configured Microsoft's Windows Azure Pack without the FQDN, you will encounter the following error message:

```
Cannot validate the new quota settings because one of the underlying services failed to respond. Details: An error has occurred.
```

Workaround: When you configure the VM Clouds, follow Microsoft's Windows Azure Pack UI instructions which informs you to use the FQDN for your SCVMM server.

---

## Installing, Setting Up, and Verifying the Cisco ACI with Microsoft Windows Azure Pack Components

This section describes how to install, set up, and verify the Cisco ACI with Microsoft Windows Azure Pack components.

| Component                                       | Task                                                                                  |
|-------------------------------------------------|---------------------------------------------------------------------------------------|
| Install ACI Azure Pack Resource Provider        | See <a href="#">Installing ACI Azure Pack Resource Provider, on page 291</a> .        |
| Install the OpflexAgent certificate             | See <a href="#">Installing the OpflexAgent Certificate, on page 291</a> .             |
| Configure ACI Azure Pack Resource Provider Site | See <a href="#">Configuring ACI Azure Pack Resource Provider Site, on page 293</a> .  |
| Install ACI Azure Pack Admin site extension     | See <a href="#">Installing ACI Azure Pack Admin Site Extension, on page 294</a> .     |
| Install ACI Azure Pack tenant site extension    | See <a href="#">Installing ACI Azure Pack Tenant Site Extension, on page 294</a> .    |
| Set up the ACI                                  | See <a href="#">Setting Up ACI, on page 294</a> .                                     |
| Verify the Windows Azure Pack Resource Provider | See <a href="#">Verifying the Windows Azure Pack Resource Provider, on page 295</a> . |

## Installing ACI Azure Pack Resource Provider

This section describes how to install ACI Azure Pack Resource Provider on the Windows Azure Pack server.

### Procedure

---

- Step 1** Log in to the Microsoft Service Provider Foundation Server which provides VM Clouds in the Windows Azure Pack environment. Locate and copy over **ACI Azure Pack - Resource Provider Site.msi** file.
- Step 2** Double-click the **ACI Azure Pack - Resource Provider Site.msi** file.
- Step 3** In the **Setup** dialog box, perform the following actions to install ACI Azure Pack - Resource Provider:
- Check the **I accept the terms in the License Agreement** check box.
  - Click **Install**.
  - Click **Install**.
  - Click **Finish**.
- 

## Installing the OpflexAgent Certificate

This section describes how to install the OpflexAgent Certificate.

### Procedure

---

- Step 1** Log in to the Windows Azure Pack server with administrator credentials.
- Step 2** Use one of the following methods:
- For large-scale deployments, see Microsoft's documentation for Deploy Certificates by Using Group Policy:  
[https://technet.microsoft.com/en-us/library/cc770315\(v=ws.10\).aspx](https://technet.microsoft.com/en-us/library/cc770315(v=ws.10).aspx).
  - For small-scale deployments follow these steps:  
You must add OpFlex security certificate to the local system. The ACI Windows Azure Pack resource provider uses the same security certificate file from the Cisco ACI SCVMM installation process located on your SCVMM Server at: **C:\Program Files (x86)\ApicVMMService\OpflexAgent.pfx**. Copy this file to the Windows Azure Pack Resource Provider Server. If the following steps are not performed on your ACI Windows Azure Pack resource provider servers, the APIC ACI Windows Azure Pack resource provider cannot communicate with the Application Policy Infrastructure Controller (APIC) .  
Install the OpFlex security certificate on the ACI Windows Azure Pack resource provider Windows Server 2012 local machine's certificate repository. On each ACI Windows Azure Pack resource provider server, install this certificate by performing the following steps:
    - Choose **Start > Run**.
    - Enter **mmc** and click **OK**.
    - In the **Console Root** window, on the menu bar, choose **Add/Remove Snap-in**.
    - In the **Available Snap-ins** field, choose **Certificates** and click **Add**.

- e. In the **Certificates snap-in** dialog box, choose the **Computer Account** radio button, and click **Next**.
- f. In the **Select Computer** dialog box, choose the **Local Computer** radio button, and click **Finish**.
- g. Click **OK** to go back to the main **MMC Console** window.
- h. In the **MMC Console** window, double-click **Certificates (local computer)** to expand its view.
- i. Right-click **Certificates** under **Personal** and choose **All Tasks > Import**.
- j. In the **Certificates Import Wizard** dialog box, perform the following actions:
  1. Click **Next**.
  2. Browse to the **Opflex Agent** file and click **Next**.

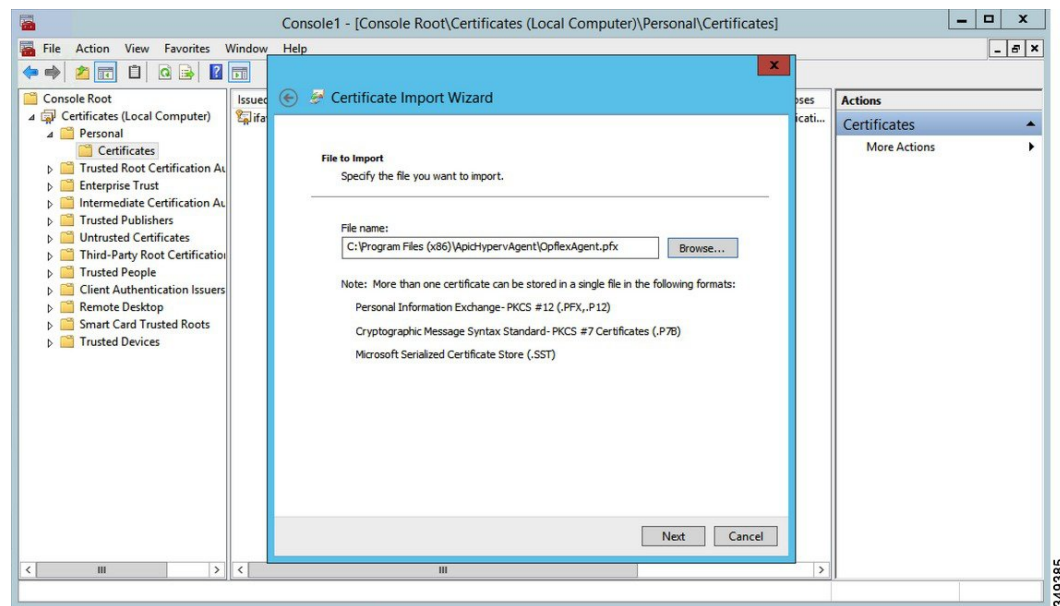

- k. Enter the password for the certificate that was provided when you installed MSI.
- l. You must choose the **Mark this key as exportable. This will allow you to back up or transport your keys at a later time** radio button.
- m. Choose the **Include all extended properties** radio button.
- n. Choose the **Place all certificates in the following store** radio button, browse to locate **Personal**, and click **Next**.
- o. Click **Finish**.
- p. Click **OK**.

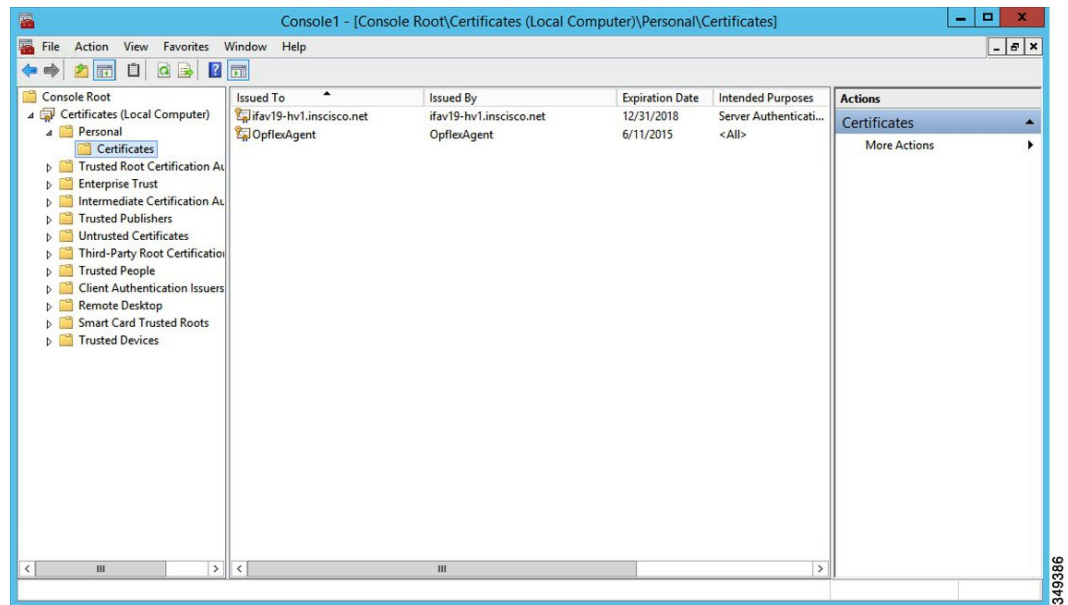

349386

## Configuring ACI Azure Pack Resource Provider Site

This section describes how to configure ACI Azure Pack Resource Provider IIS Site on the Windows Azure Pack server.

### Procedure

- Step 1** Log in to the Windows Azure Pack server and open the **Internet Information Services Manager Application**.
- Step 2** Navigate to **Application Pools > Cisco-ACI**.
- Step 3** Click the **Advanced Settings** in the Actions tab.
- Locate the Identity field and click on the ellipses to the left of the scroll bar.
  - Select Custom Account and input your account name and password credentials for Service Provider Foundation Administrator. The Service Provider Foundation Administrator user account should have the following group memberships: Administrators, SPF\_Admin. This user account is required as the Resource Provider queries the attached SCVMM servers. In addition, the User Credentials must have permission to write to the Local Machine Registry and have Read/Write access to the following directory for Resource Provider Logging:  
**C:\Windows\System32\config\systemprofile\AppData\Local**
  - Click **OK** to exit Application Pool Identity.
- Step 4** Click **OK** to exit Advanced Settings

## Installing ACI Azure Pack Admin Site Extension

This section describes how to install ACI Azure Pack Admin Site Extension on the Windows Azure Pack server.

### Procedure

---

- Step 1** Log in to the Windows Azure Pack server and locate the **ACI Azure Pack - Admin Site Extension.msi** file.
  - Step 2** Double-click the **ACI Azure Pack - Admin Site Extension.msi** file.
  - Step 3** In the **Setup** dialog box, perform the following actions to install ACI Azure Pack - Admin Site Extension:
    - a) Check the **I accept the terms in the License Agreement** check box.
    - b) Click **Install**.
    - c) Click **Finish**.
- 

## Installing ACI Azure Pack Tenant Site Extension

This section describes how to install ACI Azure Pack Tenant Site Extension on the Windows Azure Pack server.

### Procedure

---

- Step 1** Log in to the Windows Azure Pack server and locate the **ACI Azure Pack - Tenant Site Extension.msi** file.
  - Step 2** Double-click the **ACI Azure Pack - Tenant Site Extension.msi** file.
  - Step 3** In the **Setup** dialog box, perform the following actions to install ACI Azure Pack - Tenant Site Extension:
    - a) Check the **I accept the terms in the License Agreement** check box.
    - b) Click **Install**.
    - c) Click **Finish**.
- 

## Setting Up ACI

This section describes how to setup ACI.

### Procedure

---

- Step 1** Log in to the Service Management Portal.
- Step 2** In the **navigation** pane, choose **ACI**.  
If you do not see **ACI**, click **Refresh**.
- Step 3** Click the QuickStart icon.
- Step 4** In the **QuickStart** pane, perform the following actions in order:
  - a) Click on **Register your ACI REST endpoint**.

- b) In the **ENDPOINT URL** field, enter the resource provider address: Cisco-ACI port (`http://resource_provider_address:50030`).
- c) In the **USERSNAME** field, enter the user name (domain administrator).
- d) In the **PASSWORD** field, enter the password (domain administrator password).

- Step 5** Choose the **ACI > Setup** tab, and perform the following actions:
- a) In the **APIC ADDRESS** field, enter the APIC IP Address(es).
  - b) In the **CERTIFICATE NAME** field, enter OpflexAgent.

---

## Verifying the Windows Azure Pack Resource Provider

This section describes how to verify the Windows Azure Pack Resource Provider.

### Procedure

---

- Step 1** Log in to the Service Management Portal (Admin Portal).
  - Step 2** In the navigation pane, choose **ACI**.
  - Step 3** In the **aci** pane, choose the QuickStart Cloud icon.  
Ensure the **Register your ACI REST Endpoint** link is greyed out.
  - Step 4** In the **aci** pane, choose **SETUP**.  
Ensure that you see the APIC Address has valid apic addresses and the Certificate name is OpflexAgent.
- 

# Upgrading the Cisco ACI with Microsoft Windows Azure Pack Components

### Prerequisites:

Microsoft servers that you integrate into ACI must be updated with the KB2919355 and KB3000850 update rollups prior to upgrading ACI to the 2.0(1) release. The KB2919355 update rollup includes the 2929781 patch, which adds new TLS cipher suites and changes the cipher suite priorities in Windows 8.1 and Windows Server 2012 R2.

You must patch the following Microsoft servers:

- Microsoft Windows Azure Pack Resource Provider Servers
- Microsoft Windows Azure Pack Tenant Site Servers
- Microsoft Windows Azure Pack Admin Site Servers
- Microsoft System Center Service Provider Foundation/Orchestration Servers
- Microsoft System Center 2012 R2 Servers
- Microsoft HyperV 2012 R2 Servers

To upgrade the .msi files for each Cisco ACI with Windows Azure Pack Integration follow the Microsoft general guidelines for upgrading Windows Azure Pack Components listed per Update Rollup. The general guidelines are:

- If the system is currently operational (handling customer traffic), schedule downtime for the Azure servers. The Windows Azure Pack does currently not support rolling upgrades.
- Stop or redirect customer traffic to sites that you consider satisfactory.
- Create backups of the computers.



---

**Note** If you are using virtual machines (VMs), take snapshots of their current state.

If you are not using VMs, take a backup of each MgmtSvc-\* folder in the inetpub directory on each machine that has a Windows Azure Pack component installed.

Collect information and files that are related to your certificates, host headers, or any port changes.

Once the upgrade is complete and has been verified, follow Hyper-V best practices regarding managing VM snapshots: [https://technet.microsoft.com/en-us/library/dd560637\(v=ws.10\).aspx](https://technet.microsoft.com/en-us/library/dd560637(v=ws.10).aspx)

---

## Upgrading the ACI Windows Azure Pack Workflow

This section describes upgrading the ACI Windows Azure Pack Workflow.

### Procedure

---

- Step 1** Upgrade the APIC Controller and the Switch Software.  
See the *Cisco APIC Firmware Management Guide*.
- Step 2** Upgrade the ACI Windows Azure Pack.  
If upgrading from a prior release of 1.1(2x):
- You must uninstall the APIC Windows Azure Pack Resource Provider, see [Uninstalling the APIC Windows Azure Pack Resource Provider, on page 332](#).
  - Follow the steps that are outlined in the [Installing, Setting Up, and Verifying the Cisco ACI with Microsoft Windows Azure Pack Components, on page 290](#).
  - Skip to step 6, Upgrade the APIC SCVMM Agent on SCVMM or Upgrade the APIC SCVMM Agent on a Highly Available SCVMM.
- If upgrading from release 1.1(2x) or later:
- Proceed to step 3.
- Step 3** Upgrade the ACI Windows Azure Pack Resource Provider.  
For more information, see [Upgrading the ACI Windows Azure Pack Resource Provider, on page 297](#).
- Step 4** Upgrade the ACI Azure Pack Admin Site Extension.  
For more information, see [Upgrading the ACI Azure Pack Admin Site Extension, on page 297](#).



- Step 5** Upgrade the ACI Azure Pack Tenant Site Extension.  
For more information, see [Upgrading the ACI Azure Pack Tenant Site Extension, on page 298](#).
- Step 6** Upgrade the APIC SCVMM Agent on SCVMM or Upgrade the APIC SCVMM Agent on a Highly Available SCVMM.  
For more information, see [Upgrading the APIC SCVMM Agent on SCVMM, on page 268](#).  
For more information, see [Upgrading the APIC SCVMM Agent on a High Available SCVMM, on page 269](#).
- Step 7** Upgrade the APIC Hyper-V Agent.  
For more information, see [Upgrading the APIC Hyper-V Agent, on page 269](#).
- 

## Upgrading the ACI Windows Azure Pack Resource Provider

This section describes how to upgrade the ACI Windows Azure Pack resource provider.

### Procedure

---

Upgrade the ACI Windows Azure Pack resource provider.

If upgrading from release 1.1(2x) or later:

- a) Follow the steps outlined in the [Installing ACI Azure Pack Resource Provider, on page 291](#).  
The MSI packages handles uninstalling the previous version and installing the new version as part of the upgrade.
- b) Follow the steps outline in the [Configuring ACI Azure Pack Resource Provider Site, on page 293](#).

If upgrading from a prior release of 1.1(2x):

- a) Follow the steps outlined in the [Uninstalling the APIC Windows Azure Pack Resource Provider, on page 332](#).
  - b) Follow the steps outlined in the [Installing ACI Azure Pack Resource Provider, on page 291](#).  
The MSI packages handles uninstalling the previous version and installing the new version as part of the upgrade.
  - c) Follow the steps outline in the [Configuring ACI Azure Pack Resource Provider Site, on page 293](#).
- 

## Upgrading the ACI Azure Pack Admin Site Extension

This section describes how to upgrade the ACI Azure Pack Admin site extension.

### Procedure

---

Upgrade the ACI Azure Pack Admin site extension.

- a) Follow the steps outlined in the [Installing ACI Azure Pack Admin Site Extension, on page 294](#).

The MSI packages handles uninstalling the previous version and installing the new version as part of the upgrade.

## Upgrading the ACI Azure Pack Tenant Site Extension

This section describes how to upgrade the ACI Azure Pack Tenant site extension.

### Procedure

Upgrade the ACI Azure Pack Tenant site extension.

- a) Follow the steps outlined in the [Installing ACI Azure Pack Tenant Site Extension, on page 294](#).

The MSI packages handles uninstalling the previous version and installing the new version as part of the upgrade.

## Use Case Scenarios for the Administrator and Tenant Experience

This section describes the use case scenarios for the administrator and tenant experience.



**Note** If the shared service consumer is in a different VRF than the provider, route leaking between the VRFs will automatically occur in order to enable the communication.

| Use case                                                                                                                   | Shared Plan | VPC Plan | User   | Task                                                                                                            |
|----------------------------------------------------------------------------------------------------------------------------|-------------|----------|--------|-----------------------------------------------------------------------------------------------------------------|
| Creating a plan<br>This allows the administrator to create plans with their own moderation values.                         | Yes         | Yes      | Admin  | 1. See <a href="#">About Plan Types, on page 301</a> .                                                          |
|                                                                                                                            |             |          | Admin  | 2. See <a href="#">Creating a Plan, on page 303</a> .                                                           |
| Creating a tenant<br>This allows the administrator to create a tenant.                                                     | Yes         | Yes      | Admin  | See <a href="#">Creating a Tenant, on page 304</a> .                                                            |
| Creating and verifying networks in a shared plan<br>This allows the tenant to create and verify networks in a shared plan. | Yes         | No       | Tenant | 1. See <a href="#">Creating Networks in a Shared Plan, on page 317</a> .                                        |
|                                                                                                                            |             |          | Tenant | 2. See <a href="#">Verifying the Network you Created on Microsoft Windows Azure Pack on APIC, on page 317</a> . |

| Use case                                                                                                                                                                                                                                                                                        | Shared Plan | VPC Plan | User   | Task                                                                                                                            |
|-------------------------------------------------------------------------------------------------------------------------------------------------------------------------------------------------------------------------------------------------------------------------------------------------|-------------|----------|--------|---------------------------------------------------------------------------------------------------------------------------------|
| <p>Creating the network in VPC plan</p> <p>This allows the tenant to create networks in a VPC plan.</p>                                                                                                                                                                                         | No          | Yes      | Tenant | See <a href="#">Creating the Network in VPC Plan, on page 319</a> .                                                             |
| <p>Creating a bridge domain in a VPC plan and creating a network and associating to the bridge domain</p> <p>This applies only in a virtual private cloud (VPC) plan. This allows a tenant to bring its own IP address space for the networks.</p>                                              | No          | Yes      | Tenant | 1. See <a href="#">Creating a Bridge Domain in a VPC Plan, on page 318</a> .                                                    |
|                                                                                                                                                                                                                                                                                                 |             |          | Tenant | 2. See <a href="#">Creating a Network and Associating to a Bridge Domain in a VPC Plan, on page 318</a> .                       |
| <p>Creating a firewall within the same subscription.</p> <p>This allows the tenant to create a firewall within the same subscription.</p>                                                                                                                                                       | Yes         | Yes      | Tenant | See <a href="#">Creating a Firewall Within the Same Subscription, on page 319</a> .                                             |
| <p>Allowing tenants to provide shared services</p> <p>This allows tenants to create networks, attach compute services (servers) to those networks, and offer the connectivity to these services to other tenants. The administrator needs to explicitly enable this capability in the plan.</p> | Yes         | Yes      | Admin  | 1. See <a href="#">Allowing Tenants to Provide Shared Services, on page 304</a> .                                               |
|                                                                                                                                                                                                                                                                                                 |             |          | Tenant | 2. See <a href="#">Providing a Shared Service, on page 320</a> .                                                                |
|                                                                                                                                                                                                                                                                                                 |             |          | Tenant | 3. See <a href="#">Adding Access Control Lists, on page 322</a> or <a href="#">Deleting Access Control Lists, on page 323</a> . |
|                                                                                                                                                                                                                                                                                                 |             |          | Admin  | 4. See <a href="#">Allowing Tenants to Consume Shared Service, on page 305</a> .                                                |
|                                                                                                                                                                                                                                                                                                 |             |          | Tenant | 5. See <a href="#">Setting up the Shared Service to be Consumed, on page 321</a> .                                              |
|                                                                                                                                                                                                                                                                                                 |             |          | Admin  | 6. See <a href="#">Viewing the Shared Service Providers and Consumers, on page 306</a> .                                        |

| Use case                                                                                                                                                   | Shared Plan | VPC Plan | User   | Task                                                                                                                                                               |
|------------------------------------------------------------------------------------------------------------------------------------------------------------|-------------|----------|--------|--------------------------------------------------------------------------------------------------------------------------------------------------------------------|
| Allowing tenants to consume NAT firewall and ADC load balancer services                                                                                    | No          | Yes      | Admin  | 1. See <a href="#">Allowing Tenants to Consume NAT Firewall and ADC Load Balancer Services</a> , on page 305.                                                      |
|                                                                                                                                                            |             |          | Tenant | 2. See <a href="#">Adding NAT Firewall Layer 4 to Layer 7 Services to a VM Network</a> , on page 326.                                                              |
|                                                                                                                                                            |             |          | Tenant | 3. See <a href="#">Adding NAT Firewall Port-Forwarding Rules for a VM Network</a> , on page 327.                                                                   |
|                                                                                                                                                            |             |          | Tenant | 4. See <a href="#">Adding NAT Firewall With a Private ADC Load Balancer Layer 4 to Layer 7 Services to a VM Network</a> , on page 327.                             |
|                                                                                                                                                            |             |          | Tenant | 5. See <a href="#">Adding a Public ADC Load Balancer Layer 4 to Layer 7 Services to a VM Network</a> , on page 328.                                                |
|                                                                                                                                                            |             |          | Tenant | 6. See <a href="#">Adding ADC Load Balancer Configuration for a VM Network</a> , on page 329.                                                                      |
| Managing shared services<br>This allows the administrator to deprecate a shared service from new tenants and revoke a tenant access from a shared service. | Yes         | Yes      | Admin  | See <a href="#">Deprecating a Shared Service from New Tenants</a> , on page 306.<br><br>See <a href="#">Revoking a Tenant from a Shared Service</a> , on page 307. |
| Creating VMs and attaching to networks                                                                                                                     | Yes         | Yes      | Tenant | See <a href="#">Creating VMs and Attaching to Networks</a> , on page 320.                                                                                          |
| Creating the load balancer                                                                                                                                 | Yes         | Yes      | Admin  | 1. See <a href="#">About Load Balancing</a> , on page 307.                                                                                                         |
|                                                                                                                                                            |             |          | Admin  | 2. See <a href="#">Importing the Device Package on APIC</a> , on page 308.                                                                                         |
|                                                                                                                                                            |             |          | Admin  | 3. See <a href="#">Configuring the Load Balancer Device on APIC using XML POST</a> , on page 308.                                                                  |
|                                                                                                                                                            |             |          | Admin  | 4. See <a href="#">Creating a Load Balancer to a Plan</a> , on page 314.                                                                                           |
|                                                                                                                                                            |             |          | Tenant | 5. See <a href="#">Configuring the Load Balancer</a> , on page 322.                                                                                                |

| Use case                                                                                                                                                     | Shared Plan | VPC Plan | User       | Task                                                                                                                |
|--------------------------------------------------------------------------------------------------------------------------------------------------------------|-------------|----------|------------|---------------------------------------------------------------------------------------------------------------------|
| Creating external connectivity<br>This allows a tenant network to initiate outgoing traffic destined outside the fabric and to attract traffic from outside. | Yes         | Yes      | APIC Admin | 1. See <a href="#">About L3 External Connectivity</a> , on page 315.                                                |
|                                                                                                                                                              |             |          | APIC Admin | 2. See <a href="#">Prerequisites for Configuring L3 External Connectivity for Windows Azure Pack</a> , on page 315. |
|                                                                                                                                                              |             |          | APIC Admin | 3. See <a href="#">Creating a Contract to be Provided by the l3extinstP "default"</a> , on page 316.                |
|                                                                                                                                                              |             |          | APIC Admin | 4. See <a href="#">Creating a Contract to be Provided by the l3extinstP "vpcDefault"</a> , on page 316.             |
|                                                                                                                                                              |             |          | Tenant     | 5. See <a href="#">Creating a Network for External Connectivity</a> , on page 324.                                  |
|                                                                                                                                                              |             |          | Tenant     | 6. See <a href="#">Creating a Firewall for External Connectivity</a> , on page 325.                                 |
|                                                                                                                                                              |             |          | APIC Admin | 7. See <a href="#">Verifying Tenant L3 External Connectivity on APIC</a> , on page 325.                             |

## Admin Tasks

### About Plan Types

The administrator creates the plan with their own values. The plan types are as follows:

|                                                                      | Shared Infrastructure | Virtual Private Cloud |
|----------------------------------------------------------------------|-----------------------|-----------------------|
| Isolated Networks                                                    | Yes                   | Yes                   |
| Firewall                                                             | Yes                   | Yes                   |
| Provider DHCP                                                        | Yes                   | Yes *                 |
| Shared Load Balancer                                                 | Yes                   | Yes *                 |
| Public Internet Access                                               | Yes                   | Yes                   |
| Shared Services between Tenants                                      | Yes                   | Yes                   |
| Bring your own address space (Private Address Space) and DHCP Server | No                    | Yes                   |

\* In a Virtual Private Cloud (VPC) plan, a load balancer and DHCP is not supported for private address space. Both features are still offered to a tenant, but owned by the shared infrastructure.

## About Plan Options

This section describes about the plan options.

- APIC Tenant: Disable Auto Creation of an APIC Tenant
  - Default: Unselected.
 

Unselected: Cisco ACI Azure Pack Resource Provider will automatically create/delete an APIC tenant. The APIC tenant name will be the Subscription ID (GUID) of the Windows Azure Pack tenant. No manual intervention by the APIC admin is required as the Resource Provider will handle all the necessary mapping.

Selected: Cisco ACI Azure Pack Resource Provider will NOT automatically create/delete an APIC tenant. The APIC tenant must be explicitly mapped to a Windows Azure Pack Subscription ID. Once this mapping is established on the APIC, the Azure Pack Tenant will be able to perform his normal operations of working with networks, firewalls, load balancers, etc.
- Features enabled by Disabling Auto Creation of an APIC Tenant
  - SCVMM and Windows Azure Pack VM Network names take on the APIC Tenant Name rather than a GUID. This increases readability for an SCVMM Admin and Azure Pack Tenant as VM Networks will have a friendly name rather than a GUID.
- Plan Quotas: Azure Pack Plan Admins can now create Plans which limit the number of EPGs, BDs, and VRFs an Azure Pack Tenant can create.
  - The EPG, BD, and VRF created by the APIC admin under an APIC Tenant count against their quota for Azure Pack Plan.
    - Example 1: Plan Admin creates an Azure Pack plan with a limit of 5 EPGs. Azure Pack Tenant creates 4 EPGs and the APIC Admin creates an EPG for the Azure Pack Tenant. The Azure Pack Tenant has now reached his plan quota and cannot create EPGs until he is below plan quota.
    - Example 2: Plan Admin creates an Azure Pack plan with a limit of 5 EPGs. Azure Pack Tenant creates 5 EPGs. An APIC Admin creates an EPG for the Azure Pack Tenant. The Azure Pack Tenant has now reached his plan quota and cannot create EPGs until he is below plan quota.
    - These quotas are enforced for the Azure Pack Tenant, but do not apply to the APIC Admin. An APIC admin can continue to create EPGs, BDs, and VRFs for an Azure Pack Tenant even when the Tenant has gone beyond his quota.
- All Plan Types - Publishing EPGs
  - Ability for an APIC admin to push EPGs to Windows Azure Pack tenants.
  - An APIC admin can now create EPGs for their Azure Pack Tenants by creating the EPG on the APIC and associating it to the VMM Domain (SCVMM Cloud) associated with the Tenant's Plan.
  - The "default" Application Profile under the tenant is considered Azure Pack Tenant owned space. This means that the Azure Pack Tenant is allowed to create contracts with it and delete it.
  - All other Application Profiles will be considered APIC Admin owned space. These EPGs will be available to the Azure Pack Tenant for consumption, but the Azure Pack tenant will not be allowed

to modify, delete, or work with the EPG outside of associating with a Virtual Machine Network Adapter.

## Creating a Plan

This allows the administrator to create plans with their own values.

### Procedure

- 
- Step 1** Log in to the Service Management Portal (Admin Portal).
- Step 2** In the **navigation** pane, choose **PLANS**.
- Step 3** Choose **NEW**.
- Step 4** In the **NEW** pane, choose **CREATE PLAN**.
- Step 5** In the **Let's Create a Hosting Plan** dialog box, enter the name for your plan (Bronze) and click the arrow for next.
- Step 6** In the **Select services for a Hosting Plan** dialog box, choose your features. Check the check box for **VIRTUAL MACHINE CLOUDS, NETWORKING (ACI)**, and click the arrow for next.
- Step 7** In the **Select add-ons for the plan** dialog box, click the checkmark for next.
- Step 8** In the **plans** pane, wait for the plan (Bronze) to be created and choose the (Bronze) plan arrow to configure it.
- Step 9** In the **Bronze** pane under plan services, choose **Virtual Machine Clouds** arrow.
- Step 10** In the **virtual machine clouds** pane, perform the following actions:
- In the **VMM MANAGEMENT SERVER** field, choose the VMM management server (172.23.142.63).
  - In the **VIRTUAL MACHINE CLOUD** field, choose the cloud name (Cloud01).
  - Scroll down and choose **Add templates**.
  - In the **Select templates to add to this plan** dialog box, check the check box for your template(s) and click the checkmark for next.
  - Scroll down to **Custom Settings**, check the **Disable built-in network extensions for tenants** check box for SCVMM.
  - Click **SAVE** at the bottom.
  - Once completed, click **OK**.
- Step 11** In the Service Management Portal, click the back arrow which takes you back to the **Bronze** pane.
- Step 12** In the **Bronze** pane under plan services, click **Networking (ACI)** and perform the following actions:
- In the **PLAN TYPE** field, from the drop-down list, choose the plan type.
  - For Virtual Private Cloud plan type, enter a valid value between 1 to 4000 number for the “Maximum EPG allowed per tenant”, “Maximum BD allowed per tenant” and “Maximum CTX allowed per tenant”.  
  
For Shared Infrastructure Plan type, enter a valid value between 1 to 4000 number for the “Maximum EPG allowed per tenant”.
  - Click **SAVE**.
- Step 13** Click **OK**.  
You have now created a plan.
-

## Creating a Tenant

This allows the administrator to create a tenant.

### Procedure

---

- Step 1** Log in to the Service Management Portal (Admin Portal).
- Step 2** In the **navigation** pane, choose **USER ACCOUNTS**.
- Step 3** Choose **NEW**.
- Step 4** In the **NEW** pane, scroll down and choose **USER ACCOUNTS**.
- Step 5** In the **NEW** pane, choose **QUICK CREATE** and perform the following actions:
- In the **ENTER EMAIL ADDRESS** field, enter the email address (tenant@domain.com).
  - In the **ENTER PASSWORD** field, enter the password.
  - In the **CONFIRM PASSWORD** field, enter the password again.
  - In the **CHOOSE PLAN** field, choose a plan (BRONZE).
  - Click **CREATE**.
  - Click **OK**.
- You have now created a tenant.
- Step 6** For Windows Azure Pack Tenants associated with Plans that “Disable Auto Creation of an APIC Tenant”, Take note of the Azure Pack Tenant Login and Subscription ID.
- Log in to the APIC GUI, on the menu bar, choose **TENANTS > Tenant Name**. The Tenant is the intended APIC Tenant targeted for Azure Pack Subscription mapping.
  - Select the **Policy** Tab.
  - In the GUID section, click the + icon to add a new Azure Pack subscription mapping.
  - Populate the GUID with the Azure Pack Tenant Subscription ID and the Account Name with the Azure Pack Login Account.
  - Click **Submit** to save the changes.
- Note** An APIC Tenant can only map to a single Azure Pack Tenant Subscription ID.
- 

## Allowing Tenants to Provide Shared Services

This option allows tenants to create networks, attach compute services (servers) to those networks, and offer the connectivity to these services to other tenants. The administrator needs to explicitly enable this capability in the plan.

### Procedure

---

- Step 1** Log in to the Service Management Portal (Admin Portal).
- Step 2** In the **navigation** pane, choose **PLANS**.
- Choose a plan.
  - Click **Networking (ACI)** under plan services.



- Step 3** In the **networking (aci)** pane, check the **allow tenants to provide shared services** check box and click **SAVE**.
- 

## Allowing Tenants to Consume Shared Service

Even though tenants are allowed to create a shared service to be used by other tenants, the administrator needs to select the services which can be shared across tenants. This procedure shows how Windows Azure Pack admin can choose the shared services for the plan:

### Before you begin

- Ensure the administrator has allowed tenants to provide shared services.
- Ensure the tenant has provided a shared service.

### Procedure

---

- Step 1** Log in to the Service Management Portal (Admin Portal).
- Step 2** In the **navigation** pane, choose **PLANS**.
- Step 3** In the **plans** pane, choose **PLANS**.
- a) Click on the plan (Gold).
- Step 4** In the **Gold** pane, choose **Networking (ACI)**.
- Step 5** In the **networking (aci)** pane, check the shared service check box you want to give access to (DBSrv).
- Step 6** Click **SAVE**.
- 

## Allowing Tenants to Consume NAT Firewall and ADC Load Balancer Services

Cisco Application Centric Infrastructure (ACI) has the concept of service graphs, which allows a tenant to insert service nodes performing various Layer 4 to Layer 7 functions between two endpoint groups (EPGs) within the fabric.

Windows Azure Pack with ACI integration now includes the ability to easily and seamlessly provision and deploy services graphs in a Virtual Private Cloud (VPC) setting where the external NAT firewall IP and external ADC load balancer sit within a shared space. The most common use-case for this is the service provider model where a limited number externally accessible IP addresses are available for use, in which case various port-forwarding techniques or load balancing of an entire EPG is done against the one external IP.

Tenants within Azure Pack can utilize a strict VPC model where all their networking is contained within the tenant virtual routing and forwarding (VRF) or a split VRF model where an APIC admin can configure a set of L3Out which is accessible by all tenants utilizing the ACI fabric. The following are instructions on providing a split VRF workflow allowing Azure Pack tenants to consume the Layer 4 to Layer 7 service devices as well as being allocated public addresses for the services provided from within the tenant VRF:

### Before you begin

- Ensure the Application Policy Infrastructure Controller (APIC) administrator has configured at least 1 Layer 4 to Layer 7 resource pool in tenant common. For information, see the chapter "Configuring Layer 4 to Layer 7 Resource Pools" in the [Cisco APIC Layer 4 to Layer 7 Services Deployment Guide](#).

### Procedure

---

- Step 1** Log in to the Service Management Portal (Admin Portal).
- Step 2** In the **navigation** pane, choose **PLANS**.
- Step 3** In the **plans** pane, choose **PLANS**.
- a) Click on the plan (Gold).
- Step 4** In the **Gold** pane, choose **Networking (ACI)**.
- Step 5** In the **networking (aci)** pane, choose the Layer 4 to Layer 7 services pool provisioned by the APIC admin for Azure Pack consumption.
- Step 6** Click **SAVE**.
- 

## Viewing the Shared Service Providers and Consumers

This allows the administrator to view the shared service providers and consumers.

### Before you begin

- Ensure the administrator has allowed tenants to provide shared services.
- Ensure the tenant has provided a shared service.
- Ensure the administrator has enabled the shared service on a plan.
- Ensure the tenant has set up the shared service to be consumed.

### Procedure

---

- Step 1** Log in to the Service Management Portal (Admin Portal).
- Step 2** In the **navigation** pane, choose **ACI**.
- Step 3** In the **ACI** pane, choose **SHARED SERVICES** to view the shared service providers.
- Step 4** Click on the provider.
- Step 5** Click **INFO** to display all the users that are consuming this shared service.
- 

## Managing Shared Services

### Deprecating a Shared Service from New Tenants

This allows the administrator to deprecate a shared service from new tenants.

### Procedure

---

- Step 1** Log in to the Service Management Portal (Admin Portal).
- Step 2** In the **navigation** pane, choose **PLANS**.

- Step 3** In the **plans** pane, choose the plan (Gold).
- Step 4** In the **gold** pane, choose **Networking (ACI)**.
- Step 5** In the **networking (aci)** pane, uncheck the service from the plan and click **SAVE**.  
You have deprecated the shared service from tenants.

## Revoking a Tenant from a Shared Service

This allows the administrator to revoke a tenant from a shared service.

### Procedure

- Step 1** Log in to the Service Management Portal (Admin Portal).
- Step 2** In the **navigation** pane, choose **ACI**.
- Step 3** In the **aci** pane, choose the shared service (DBSrv).
- Step 4** Click **INFO** to ensure that the user you want to revoke is present in that shared service.
- Step 5** In the **navigation** pane, choose **PLANS**.
- Step 6** In the **plans** pane, choose the plan (Gold).
- Step 7** In the **gold** pane, choose **Networking (ACI)**.
- Step 8** In the **networking (aci)** pane, uncheck the service from the plan and click **SAVE**.
- Step 9** In the **navigation** pane, choose **ACI**.
- Step 10** In the **aci** pane, choose **SHARED SERVICES**.
- Step 11** In the **aci** pane, choose the shared service (DBSrv) and click **INFO**.
- Step 12** In the **Revoke Consumers of DBSrv** dialog box, check the check box of the user you want to revoke.
- Step 13** Click the checkmark.

## About Load Balancing

VLAN, virtual routing and forwarding (VRF) stitching is supported by traditional service insertion models, the Application Policy Infrastructure Controller (APIC) can automate service insertion while acting as a central point of policy control. The APIC policies manage both the network fabric and services appliances. The APIC can configure the network automatically so that traffic flows through the services. The APIC can also automatically configure the service according to the application's requirements, which allows organizations to automate service insertion and eliminate the challenge of managing the complex techniques of traditional service insertion.

See the *Cisco APIC Layer 4 to Layer 7 Services Deployment Guide* for more information.

You must perform the following tasks to deploy Layer 4 to Layer 7 services using the APIC GUI:

|                                                                                     |                                                                         |
|-------------------------------------------------------------------------------------|-------------------------------------------------------------------------|
| Import the device package.<br>Only the administrator can import the device package. | See <a href="#">Importing the Device Package on APIC</a> , on page 308. |
|-------------------------------------------------------------------------------------|-------------------------------------------------------------------------|

|                                                                                                                                                                                                                                                            |                                                                                                      |
|------------------------------------------------------------------------------------------------------------------------------------------------------------------------------------------------------------------------------------------------------------|------------------------------------------------------------------------------------------------------|
| <p>Configure and post the XML POST to Application Policy Infrastructure Controller (APIC)</p> <p>Refer to Microsoft's Windows Azure Pack Services section about the device package.</p> <p>Only the administrator can configure and post the XML POST.</p> | <p>See <a href="#">Configuring the Load Balancer Device on APIC using XML POST</a>, on page 308.</p> |
| <p>Creating a load balancer to a plan</p> <p>The VIP range to Windows Azure Pack is set.</p> <p>Only the administrator can create a load balancer to a plan.</p>                                                                                           | <p>See <a href="#">Creating a Load Balancer to a Plan</a>, on page 314.</p>                          |
| <p>Configure the load balancer</p> <p>Only the tenant can configure the load balancer.</p>                                                                                                                                                                 | <p>See <a href="#">Configuring the Load Balancer</a>, on page 322.</p>                               |

### Importing the Device Package on APIC

Only the administrator can import the device package. The administrator can import a device package into the Application Policy Infrastructure Controller (APIC) so that the APIC knows what devices you have and what the devices can do.

#### Before you begin

Ensure you have downloaded the device package.

#### Procedure

- 
- Step 1** Log in to the APIC GUI, on the menu bar, choose **L4-L7 SERVICES > PACKAGES**.
- Step 2** In the **navigation** pane, choose **Quick Start**.
- Step 3** In the **Quick Start** pane, choose **Import a Device Package**.
- Step 4** In the **Import Device Package** dialog box, perform the following action:
- Click **BROWSE** and locate your device package such as F5 or Citrix device package.
  - Click **SUBMIT**.
- 

### Configuring the Load Balancer Device on APIC using XML POST

Only the administrator can configure and post the XML POST.

#### Before you begin

- The device package file should be uploaded on the Application Policy Infrastructure Controller (APIC). See *Cisco APIC Layer 4 to Layer 7 Device Package Development Guide* for more information.
- The tenant common should have the two bridge domains named "default" and "vpcDefault". Ensure that the subnets being used by the tenant who is consuming the load balancer is added to these bridge domains.

Typically you would have created these bridge domains and subnets while setting up the DHCP infrastructure for Windows Azure Pack tenants.

- For a non-VPC plan, the backend interface of the load balancer should be placed in the default EPG under the tenant common that was created above. For a VPC plan, the EPG should be "vpcDefault".
- The VIP interface of the load balancer should be placed in an EPG of your choice which should be linked to external world.

See *Cisco APIC Layer 4 to Layer 7 Device Package Development Guide* for L3 extOut external connectivity outside the Fabric.

- (Optional) If desired, ensure the VIP subnet is linked with L3 or L2 extOut. One VIP per EPG will be allocated.

## Procedure

**Step 1** These are example XML POSTs for Citrix and F5:

a) Citrix example XML POST:

### Example:

```
<polUni dn="uni">
 <fvTenant dn="uni/tn-common" name="common">

 <vnsLDevVip name="MyLB" devtype="VIRTUAL">

 <!-- Device Package -->
 <vnsRsMDevAtt tDn="uni/infra/mDev-Citrix-NetScaler-1.0"/>

 <!-- VmmDomain -->
 <vnsRsALDevToDomP tDn="uni/vmmp-VMware/dom-mininet"/>

 <vnsCMgmt name="devMgmt" host="172.31.208.179" port="80"/>
 <vnsCCred name="username" value="nsroot"/>
 <vnsCCredSecret name="password" value="nsroot"/>

 <vnsDevFolder key="enableFeature" name="EnableFeature">
 <vnsDevParam key="LB" name="lb_1" value="ENABLE"/>
 <vnsDevParam key="CS" name="cs_1" value="ENABLE"/>
 <vnsDevParam key="SSL" name="ssl_1" value="ENABLE"/>
 </vnsDevFolder>
 <vnsDevFolder key="enableMode" name="EnableMode_1">
 <vnsDevParam key="USIP" name="usip_1" value="DISABLE"/>
 <vnsDevParam key="USNIP" name="usnip_1" value="ENABLE"/>
 </vnsDevFolder>

 <vnsCDev name="ADC1" devCtxLbl="C1">
 <vnsCIf name="l_1"/>
 <vnsCIf name="mgmt"/>

 <vnsCMgmt name="devMgmt" host="172.31.208.179" port="80"/>
 <vnsCCred name="username" value="nsroot"/>
 <vnsCCredSecret name="password" value="nsroot"/>
 </vnsCDev>

 <vnsLIf name="C5">
 <vnsRsMetaIf tDn="uni/infra/mDev-Citrix-NetScaler-1.0/mIfLbl-outside"/>

 <vnsRsCIfAtt tDn="uni/tn-common/lDevVip-MyLB/cDev-ADC1/cIf-[1_1]"/>
 </vnsLDevVip>
 </fvTenant>
</polUni>
```

```

 </vnsLif>
 <vnsLif name="C4">
 <vnsRsMetaIf tDn="uni/infra/mDev-Citrix-NetScaler-1.0/mIfLbl-inside"/>
 <vnsRsCIfAtt tDn="uni/tn-common/lDevVip-MyLB/cDev-ADC1/cIf-[1_1]"/>
 </vnsLif>

 </vnsLDevVip>

 <vnsAbsGraph name = "MyLB">

 <!-- Node2 Provides SLB functionality -->
 <vnsAbsNode name = "Node2" funcType="GoTo" >

 <vnsRsDefaultScopeToTerm
tDn="uni/tn-common/AbsGraph-MyLB/AbsTermNodeProv-Output1/outtmn1"/>

 <vnsAbsFuncConn name = "C4">
 <vnsRsMConnAtt
tDn="uni/infra/mDev-Citrix-NetScaler-1.0/mFunc-LoadBalancing/mConn-external" />
 </vnsAbsFuncConn>

 <vnsAbsFuncConn name = "C5" attNotify="true">
 <vnsRsMConnAtt
tDn="uni/infra/mDev-Citrix-NetScaler-1.0/mFunc-LoadBalancing/mConn-internal" />
 </vnsAbsFuncConn>

 <vnsAbsDevCfg>
 <vnsAbsFolder key="Network"
 name="network"
 scopedBy="epg">
 <vnsAbsFolder key="nsip" name="snip1">
 <vnsAbsParam key="ipaddress" name="ip1" value="5.5.5.251"/>

 <vnsAbsParam key="netmask" name="netmask1"
value="255.255.255.0"/>
 <vnsAbsParam key="hostroute" name="hostroute"
value="DISABLED"/>
 <vnsAbsParam key="dynamicrouting" name="dynamicrouting"
value="ENABLED"/>
 <vnsAbsParam key="type" name="type" value="SNIP"/>
 </vnsAbsFolder>
 </vnsAbsFolder>
 </vnsAbsDevCfg>

 <vnsAbsFuncCfg>
 <vnsAbsFolder key="internal_network"
 name="internal_network"
 scopedBy="epg">
 <vnsAbsCfgRel name="internal_network_key"
 key="internal_network_key"
 targetName="network/snip1"/>
 </vnsAbsFolder>
 </vnsAbsFuncCfg>

 <vnsRsNodeToMFunc
tDn="uni/infra/mDev-Citrix-NetScaler-1.0/mFunc-LoadBalancing"/>
 </vnsAbsNode>

 <vnsAbsTermNodeCon name = "Input1">
 <vnsAbsTermConn name = "C1"/>
 </vnsAbsTermNodeCon>

 <vnsAbsTermNodeProv name = "Output1">

```

```

 <vnsAbsTermConn name = "C6"/>
 </vnsAbsTermNodeProv>

 <vnsAbsConnection name = "CON1" adjType="L2">
 <vnsRsAbsConnectionConns
tDn="uni/tn-common/AbsGraph-MyLB/AbsTermNodeCon-Input1/AbsTConn" />
 <vnsRsAbsConnectionConns
tDn="uni/tn-common/AbsGraph-MyLB/AbsNode-Node2/AbsFConn-C4" />
 </vnsAbsConnection>

 <vnsAbsConnection name = "CON3" adjType="L2">
 <vnsRsAbsConnectionConns
tDn="uni/tn-common/AbsGraph-MyLB/AbsNode-Node2/AbsFConn-C5" />
 <vnsRsAbsConnectionConns
tDn="uni/tn-common/AbsGraph-MyLB/AbsTermNodeProv-Output1/AbsTConn" />
 </vnsAbsConnection>

</vnsAbsGraph>

</fvTenant>
</polUni>

```

## b) F5 example XML POST:

### Example:

```

<polUni dn="uni">
 <fvTenant name="common">

 <fvBD name="MyLB">
 <fvSubnet ip="6.6.6.254/24" />
 <fvRsCtx tnFvCtxName="default"/>
 </fvBD>

 <vnsLDevVip name="MyLB" devtype="VIRTUAL">
 <vnsRsMDevAtt tDn="uni/infra/mDev-F5-BIGIP-1.1.1"/>
 <vnsRsALDevToDomP tDn="uni/vmmp-VMware/dom-mininet"/>
 <vnsCMgmt name="devMgmt" host="172.31.210.88" port="443"/>
 <vnsCCred name="username" value="admin"/>
 <vnsCCredSecret name="password" value="admin"/>

 <vnsLIf name="internal">
 <vnsRsMetaIf tDn="uni/infra/mDev-F5-BIGIP-1.1.1/mIfLbl-internal"/>
 <vnsRsCIfAtt tDn="uni/tn-common/lDevVip-MyLB/cDev-BIGIP-1/cIf-[1_1]"/>
 </vnsLIf>

 <vnsLIf name="external">
 <vnsRsMetaIf tDn="uni/infra/mDev-F5-BIGIP-1.1.1/mIfLbl-external"/>
 <vnsRsCIfAtt tDn="uni/tn-common/lDevVip-MyLB/cDev-BIGIP-1/cIf-[1_2]"/>
 </vnsLIf>

 <vnsCDev name="BIGIP-1">
 <vnsCIf name="1_1"/>
 <vnsCIf name="1_2"/>

 <vnsCMgmt name="devMgmt" host="172.31.210.88" port="443"/>
 <vnsCCred name="username" value="admin"/>
 <vnsCCredSecret name="password" value="admin"/>

 <vnsDevFolder key="HostConfig" name="HostConfig">
 <vnsDevParam key="HostName" name="HostName"
value="example22-bigip1.ins.local"/>
 <vnsDevParam key="NTPServer" name="NTPServer" value="172.23.48.1"/>
 </vnsDevFolder>
 </fvTenant>
</polUni>

```

```

 </vnsCDev>

</vnsLDevVip>
<vnsAbsGraph name = "MyLB">
<vnsAbsTermNodeCon name = "Consumer">
 <vnsAbsTermConn name = "Consumer">
 </vnsAbsTermConn>
</vnsAbsTermNodeCon>
<!-- Node1 Provides Virtual-Server functionality -->
<vnsAbsNode name = "Virtual-Server" funcType="GoTo">

 <vnsAbsFuncConn name = "internal" attNotify="yes">
 <vnsRsMConnAtt
 tDn="uni/infra/mDev-F5-BIGIP-1.1.1/mFunc-Virtual-Server/mConn-internal"
 />

 </vnsAbsFuncConn>
<vnsAbsFuncConn name = "external">
 <vnsRsMConnAtt
 tDn="uni/infra/mDev-F5-BIGIP-1.1.1/mFunc-Virtual-Server/mConn-external"
 />

 </vnsAbsFuncConn>
<vnsRsNodeToMFunc
 tDn="uni/infra/mDev-F5-BIGIP-1.1.1/mFunc-Virtual-Server"/>
<vnsAbsDevCfg>
 <vnsAbsFolder key="Network" name="webNetwork">

 <!-- Active Bigip SelfIP -->
<vnsAbsFolder key="ExternalSelfIP" name="External1" devCtxLbl="ADC1">
 <vnsAbsParam key="SelfIPAddress" name="seflfipaddress"
 value="6.6.6.251"/>
 <vnsAbsParam key="SelfIPNetmask" name="selfipnetmask"
 value="255.255.255.0"/>
 <vnsAbsParam key="Floating" name="floating"
 value="NO"/>
 </vnsAbsFolder>
<vnsAbsFolder key="InternalSelfIP" name="Internal1" devCtxLbl="ADC1">
 <vnsAbsParam key="SelfIPAddress" name="seflfipaddress"
 value="12.0.251.251"/>
 <vnsAbsParam key="SelfIPNetmask" name="selfipnetmask"
 value="255.255.0.0"/>
 <vnsAbsParam key="Floating" name="floating"
 value="NO"/>
 </vnsAbsFolder>
<vnsAbsFolder key="Route" name="Route">
 <vnsAbsParam key="DestinationIPAddress" name="DestinationIPAddress"
 value="0.0.0.0" />
 <vnsAbsParam key="DestinationNetmask" name="DestinationNetmask"
 value="0.0.0.0"/>
 <vnsAbsParam key="NextHopIPAddress" name="NextHopIP"
 value="6.6.6.254"/>
 </vnsAbsFolder>
 </vnsAbsFolder>
</vnsAbsDevCfg>
<vnsAbsFuncCfg>
 <vnsAbsFolder key="NetworkRelation" name="webNetwork">
 <vnsAbsCfgRel key="NetworkRel" name="webNetworkRel"
 targetName="webNetwork"/>
 </vnsAbsFolder>
</vnsAbsFuncCfg>
</vnsAbsNode>
<vnsAbsTermNodeProv name = "Provider">
 <vnsAbsTermConn name = "Provider" >
 </vnsAbsTermConn>
</vnsAbsTermNodeProv>

```



```

 <vnsAbsConnection name = "CON3" adjType="L3">
 <vnsRsAbsConnectionConns
tDn="uni/tn-common/AbsGraph-MyLB/AbsTermNodeCon-Consumer/AbsTConn" />
 <vnsRsAbsConnectionConns
tDn="uni/tn-common/AbsGraph-MyLB/AbsNode-Virtual-Server/AbsFConn-external" />
 </vnsAbsConnection>
 <vnsAbsConnection name = "CON1" adjType="L2">
 <vnsRsAbsConnectionConns
tDn="uni/tn-common/AbsGraph-MyLB/AbsNode-Virtual-Server/AbsFConn-internal" />
 <vnsRsAbsConnectionConns
tDn="uni/tn-common/AbsGraph-MyLB/AbsTermNodeProv-Provider/AbsTConn" />
 </vnsAbsConnection>
 </vnsAbsGraph>
</fvTenant>

</polUni>

```

**Step 2** These are the configurable parameters for Citrix and F5:

a) Configurable parameters for Citrix:

Parameter	Sample Value	Description
vnsLDevVip name	"MyLB"	This value is an identifier for your load balancer and is shown in the Windows Azure Pack admin portal in the plan section for the load balancer selection. You can modify this globally throughout the XML POST with the same alternate value.
vnsRsALDevToDomP tDn	"uni/vmmp-Vmware/dom-mininet"	This is the VMM Domaiin where your load balancer VM sits. For example, if you have a virtual load balancer you can associate it with a vCenter VMM domain, a SCVMM, or a physical domain.  <b>Note</b> Whichever domain you give it should have an associated VLAN range with it.
vnsCMgmt name="devMgmt" host	"172.31.208.179"	This is the IP address of the load balancer that communicates to Cisco Application Centric Infrastructure (ACI) fabric.
vnsCCred name	"username"	This is the username.
vnsCCredSecret name	"password"	This is the password.
vnsAbsParam key	"ipaddress"	This is the IP address which the fabric identifies for this device.

Parameter	Sample Value	Description
vnsAbsParam key="ipaddress" name="ipl" value	"5.5.5.251"	This IP address should be one of your bridge domains.

b) Configurable parameters for F5:

Parameter	Sample Value	Description
fvBD name	"MyLB"	This value is an identifier for your load balancer and is shown in the Windows Azure Pack admin portal in the plan section for the load balancer selection. You can modify this globally throughout the XML POST with the same alternate value.
vnsRsALDevToDomP tDn	"uni/vmmp-Vmware/dom-mininet"	This can be any VMM domain with a valid VLAN ENCAP Block.  <b>Note</b> In this Windows Azure Pack load balancer configuration, this VMM domain has no other relevance for the LB configuration. This is used for backward compatibility.
vnsCMgmt name="devMgmt" host	"172.31.210.88"	This is the IP address of the load balancer that communicates to ACI fabric.
vnsCCred name	"username"	This is the username.
vnsCCredSecret name	"password"	This is the password.

**Step 3** POST one of the device packages for either F5 or Citrix.

## Creating a Load Balancer to a Plan

Only the administrator can import the device package.

### Before you begin

- Import the device package.
- Configure and post the XML POST to Application Policy Infrastructure Controller (APIC) .

## Procedure

---

- Step 1** Log in to the Service Management Portal (Admin Portal).
- Step 2** In the **Navigation** pane, choose **PLANS**.
- Step 3** In the **plans** pane, choose the plan that you want to add a load balancer (shareplan).
- Step 4** In the **shareplan** pane, choose **Networking (ACI)**.
- Step 5** In the **networking (aci)** pane, perform the following actions to add a shared load balancer:
- Check the **shared load balancer** check box
  - In the **LB DEVICE ID IN APIC** field, from the drop-down list, choose the load balancer (MyLB).
  - In the **VIP RANGE** field, provide the VIP range (5.5.5.1 - 5.5.5.100).
  - Click **SAVE**.

**Note** You can have a single load balancer that is shared across different plans as long as the VIP ranges do not overlap.

---

## About L3 External Connectivity

Layer 3 (L3) external connectivity is an Cisco Application Centric Infrastructure (ACI) feature to connect ACI fabric to an external network by L3 routing protocols, including static routing, OSPF, EIGRP, and BGP. By setting up L3 external connectivity for Microsoft Windows Azure Pack, it allows a tenant network to initiate outgoing traffic destined outside the fabric and to attract traffic from outside. The assumption of this feature is the tenant virtual machine IP addresses are visible outside the fabric without NAT, ACI L3 external connectivity does not include NAT.

### Prerequisites for Configuring L3 External Connectivity for Windows Azure Pack

To configure Layer 3 (L3) external connectivity for Windows Azure Pack, you must meet the following prerequisites:

- Ensure you have logged in to the Application Policy Infrastructure Controller (APIC) GUI, on the menu bar, choose **TENANT > common**.
  - Create a l3ExtOut called "**default**", refer to BD "**default**".
  - Create l3extInstP name="**defaultInstP**" under the l3ExtOut. This is to be used by shared service tenants.

See the *Cisco APIC Basic Configuration Guide* for L3 external connectivity configuration.

- Ensure you have logged in to the APIC GUI, on the menu bar, choose **TENANT > common**.
  - Create a l3ExtOut called "**vpcDefault**", refer to BD "**vpcDefault**".
  - Create l3extInstP name="**vpcDefaultInstP**" under this l3ExtOut.

This is to be used by VPC tenants.

See the *Cisco APIC Basic Configuration Guide* for configuring external connectivity for tenants.

Windows Azure Pack leverages the common l3ExtOut configuration with no special requirement other than the naming convention highlighted above

## Creating a Contract to be Provided by the l3extinstP "default"

This section describes how to creating a contract to be provided by the l3extinstP "default".

See [Prerequisites for Configuring L3 External Connectivity for Windows Azure Pack, on page 315](#).

Make sure the scope is "Global". This contract allows all traffic from consumer to provider, and only allow TCP established from provider to consumer.

### Procedure

- 
- Step 1** Log in to the APIC GUI, on the menu bar, choose **TENANTS > common**.
- Step 2** In the **Navigation** pane, expand **Tenant Name > Security Policies > Contracts**.
- Step 3** Click **ACTION**, from the drop-down list, choose **Create Contract**.
- Step 4** In the **Create Contract** dialog box, perform the following actions:
- In the **Name** field, enter the name (L3\_DefaultOut).
  - In the **Scope** field, from the drop-down list, choose **Global**.
  - In the **Subjects** field, click the + icon.
  - In the **Create Contract Subject** dialog box, perform the following actions:
  - In the **Name** field, enter the name of your choice.
  - Uncheck **Apply Both direction**.
  - In the **Filter Chain For Consumer to Provider** field, click the + icon, from the drop-down list, choose **default/common**, and click **Update**.
  - In the **Filter Chain For Provider to Consumer** field, click the + icon, from the drop-down list, choose **est/common**, and click **Update**.
  - Click **OK** to close the **Create Contract Subject** dialog box.
  - Click **OK** to close the **Create Contract** dialog box.
- You have now creating a contract to be provided by the l3extinstP "default".
- 

## Creating a Contract to be Provided by the l3extinstP "vpcDefault"

This section describes how to creating a contract to be provided by the l3extinstP "vpcDefault".

See [Prerequisites for Configuring L3 External Connectivity for Windows Azure Pack, on page 315](#).

Make sure the scope is "Global". This contract allows all traffic from consumer to provider, and only allow TCP established from provider to consumer.

### Procedure

- 
- Step 1** Log in to the APIC GUI, on the menu bar, choose **TENANTS > common**.
- Step 2** In the **Navigation** pane, expand **Tenant Name > Security Policies > Contracts**.
- Step 3** Click **ACTION**, from the drop-down list, choose **Create Contract**.
- Step 4** In the **Create Contract** dialog box, perform the following actions:
- In the **Name** field, enter the name (L3\_VpcDefaultOut).
  - In the **Scope** field, from the drop-down list, choose **Global**.
  - In the **Subjects** field, click the + icon.

- d) In the **Create Contract Subject** dialog box, perform the following actions:
- e) In the **Name** field, enter the name of your choice.
- f) Uncheck **Apply Both direction**.
- g) In the **Filter Chain For Consumer to Provider** field, click the + icon, from the drop-down list, choose **default/common**, and click **Update**.
- h) In the **Filter Chain For Provider to Consumer** field, click the + icon, from the drop-down list, choose **est/common**, and click **Update**.
- i) Click **OK** to close the **Create Contract Subject** dialog box.
- j) Click **OK** to close the **Create Contract** dialog box.

You have now creating a contract to be provided by the l3extinstP "vpcDefault".

## Tenant Tasks

This section describes the tenant tasks.



**Note** If the shared service consumer is in a different VRF than the provider, route leaking between the VRFs will automatically occur in order to enable the communication.

## Shared or Virtual Private Cloud Plan Experience

This is an experience of a tenant in a shared or virtual private cloud (VPC) plan.

### Creating Networks in a Shared Plan

This allows the administrator to create networks in a shared plan.

#### Procedure

- Step 1** Log in to the Service Management Portal (Tenant Portal).
- Step 2** In the **navigation** pane, choose **ACI**.
- Step 3** In the **ACI** pane, choose **NETWORKS**.
- Step 4** Click **NEW**.
- Step 5** In the **NEW** pane, choose **NETWORKS** and perform the following actions:
  - a) In the **NETWORK NAME** field, enter the name of the network (S01).
  - b) Click **CREATE**.
  - c) Click **REFRESH**.

### Verifying the Network you Created on Microsoft Windows Azure Pack on APIC

This section describes how to verify the network you created on Microsoft Windows Azure Pack on APIC.

### Procedure

---

- Step 1** Log in to the APIC GUI, on the menu bar, choose **TENANTS**.
- Step 2** In the **Navigation** pane, expand **Tenant 018b2f7d-9e80-43f0-abff-7559c026bad5 > Application Profiles > default > Application EPGs > EPG Network01** to verify that the network you created on Microsoft Windows Azure Pack was created on APIC.
- 

### Creating a Bridge Domain in a VPC Plan

This applies only in a virtual private cloud (VPC) plan. This allows a tenant to bring its own IP address space for the networks.

### Procedure

---

- Step 1** Log in to the Service Management Portal (Tenant Portal).
- Step 2** In the **navigation** pane, choose **ACI**.
- Step 3** Click **NEW**.
- Step 4** In the **NEW** pane, choose **BRIDGE DOMAIN**.
- Step 5** In the **BRIDGE DOMAIN** field, enter the bridge domain name (BD01).
- Step 6** If the current tenant is subscribed to multiple Azure Pack Plans, select the Subscription to create the Bridge Domain against.
- Step 7** Optional: In the **SUBNET'S GATEWAY** field, enter the subnet's gateway (192.168.1.1/24).
- Step 8** In the **CONTEXT** field, select a Context that is already part of the subscription or choose **Create One** to create a new Context for the Bridge Domain.
- Step 9** Click **CREATE**.
- 

### Creating a Network and Associating to a Bridge Domain in a VPC Plan

This allows the tenant to create a network and associate to a bridge domain in a VPC plan.

### Procedure

---

- Step 1** Log in to the Service Management Portal (Tenant Portal).
- Step 2** In the **navigation** pane, choose **ACI**.
- Step 3** Click **NEW**.
- Step 4** In the **NEW** pane, choose **NETWORK**.
- Step 5** In the **NETWORK NAME** field, enter the network name (S01).
- Step 6** In the **BRIDGE NAME** field, enter the bridge name (BD01).
- Step 7** Click **CREATE**.
- Step 8** In the **aci** pane, choose **NETWORKS**.

You will see the network is now associated to the bridge domain.

---

## Creating a Firewall Within the Same Subscription

This allows the tenant to create a firewall within the same subscription.

### Before you begin

Ensure two networks have been created.

### Procedure

---

- Step 1** Log in to the Service Management Portal (Tenant Portal).
  - Step 2** In the **navigation** pane, choose **ACI**.
  - Step 3** Click **NEW**.
  - Step 4** In the **NEW** pane, choose **FIREWALL**.
  - Step 5** In the **FROM NETWORK** field, in the drop-down list, choose the network name (WEB01).
  - Step 6** In the **TO NETWORK** field, in the drop-down list, choose another network name (WEB02).
  - Step 7** In the **PROTOCOL** field, enter the protocol (tcp).
  - Step 8** In the **PORT RANGE BEGIN** field, enter the beginning port range (50).
  - Step 9** In the **PORT RANGE END** field, enter the end of the port range (150).
  - Step 10** Click **CREATE**.  
You have added a firewall within the same subscription.
- 

## Creating the Network in VPC Plan

This allows the tenant to create networks in a VPC plan.

### Procedure

---

- Step 1** Log in to the Service Management Portal (Tenant Portal).
- Step 2** In the **Navigation** pane, choose **ACI**.
- Step 3** Click **NEW**.
- Step 4** In the **NEW** pane, choose **ACI > NETWORK** and perform the following actions:
  - a) In the **NETWORK NAME** field, enter the network name (Network01).
  - b) Option 1: Creating a network in a shared Bridge Domain.
    - In the **BRIDGE DOMAIN** field, from the drop-down, choose the bridge domain. (default).
    - Click **CREATE**.  
This could take a few minutes for this process to complete.
  - c) Option 2: Creating a network in a Tenant Bridge Domain.

- In the **BRIDGE DOMAIN** field, from the drop-down, choose the bridge domain (myBridgeDomain).
- d) Optional: To deploy the Network with a Static IP Address Pool, perform the following actions:
- Enter a Gateway in Address/Mask format (192.168.1.1/24). The resultant Static IP Address Pool will use the full range of the Gateway Subnet.
  - Enter DNS Servers. If more than one is required, separate out the list with semicolons (192.168.1.2;192.168.1.3)
- Note** The Subnet will be validated against all other subnets in the Context. The Network create will return an error if an overlap is detected.
- Click **CREATE**.
- This could take a few minutes for this process to complete.
- 

## Creating VMs and Attaching to Networks

This allows the tenant to create VMs and attach to networks.

### Procedure

---

- Step 1** Log in to the Service Management Portal (Tenant Portal).
- Step 2** In the **navigation** pane, choose **ACI**.
- Step 3** Click **NEW**.
- Step 4** In the **NEW** pane, choose **STANDALONE VIRTUAL MACHINE > FROM GALLERY**.
- Step 5** In the **Virtual Machine Configuration** dialog box, choose your configuration (LinuxCentOS).
- Step 6** Click the arrow for next.
- Step 7** In the **Portal Virtual Machine Settings** dialog box, perform the following actions:
- a) In the **NAME** field, enter the VM name (SVM01).
  - b) In the **ADMINISTRATOR ACCOUNT** field, root displays.
  - c) In the **NEW PASSWORD** field, enter a new password.
  - d) In the **CONFIRM** field, re-enter the password to confirm.
  - e) Click the arrow for next.
- Step 8** In the **Provide Virtual Machine Hardware Information** dialog box, perform the following actions:
- a) In the **NETWORK ADAPTER 1** field, from the drop-down list, choose the network adapter to associate and compute (6C6DB302-aObb-4d49-a22c-151f2fbad0e9|default|S01).
  - b) Click the checkmark.
- Step 9** In the **navigation** pane, choose **Virtual Machines** to check the status of the VM (SVM01).
- 

## Providing a Shared Service

This allows the tenant to provide a shared service.



### Before you begin

Ensure the administrator has allowed tenants to provide shared services.

### Procedure

---

- Step 1** Log in to the Service Management Portal (Tenant Portal).
- Step 2** In the **navigation** pane, choose **ACI**.
- Step 3** In the **ACI** pane, choose **SHARED SERVICE**.
- Step 4** In the **SHARED SERVICES** dialog box, perform the following actions:
- In the **ACTION** field, from the drop-down list, choose **PROVIDE A SHARED SERVICE CONTRACT**.
  - In the **NETWORK** field, from the drop-down list, choose the network (WEB01).
  - In the **SERVICE NAME** field, enter the service name (DBSrv).
  - In the **DESCRIPTION** field, enter the description.
  - In the **PROTOCOL** field, enter the protocol (tcp).
  - In the **PORT RANGE BEGIN** field, enter the beginning port range (139).
  - In the **PORT RANGE END** field, enter the end port range (139).
  - Click the checkmark.
- 

## Setting up the Shared Service to be Consumed

This allows the tenant to setup the shared service to be consumed.

### Before you begin

- Ensure the administrator has allowed tenants to provide shared services.
- Ensure the tenant has provided a shared service.
- Ensure the administrator has enabled the shared service on a plan.
- If the shared service consumer is in a different VRF than the provider, route leaking between the VRFs will automatically occur in order to enable the communication.

### Procedure

---

- Step 1** Log in to the Service Management Portal (Tenant Portal).
- Step 2** In the **navigation** pane, choose **ACI > SHARED SERVICE**.
- Step 3** In the **SHARED SERVICE** dialog box, perform the following actions:
- In the **Network** field, choose the network (V1).
  - In the **Consumed Services** field, check the service check box (DBSrv).
  - Check the checkmark.
- Step 4** In the **aci** pane, choose **SHARED SERVICES** to check the consumer of the plan.
-

## Configuring the Load Balancer

This allows the tenant to configure the load balancer.

### Before you begin

- Ensure the administrator imported the device package.
- Ensure the administrator configured and posted the XML POST to Application Policy Infrastructure Controller (APIC).
- Ensure the administrator added the load balancer to a plan.

### Procedure

---

- Step 1** Log in to the Service Management Portal (Tenant Portal).
- Step 2** In the **navigation** pane, choose **ACI**.
- Step 3** Click **NEW**.
- Step 4** In the **NEW** pane, choose **LOAD BALANCER**.
- Step 5** In the **NETWORK NAME** field, enter the network name (WEB01).
- Step 6** In the **PORT** field, enter the port (80).
- Step 7** In the **PROTOCOL** field, enter the protocol (tcp).
- Step 8** Click **CREATE**.
- Step 9** In the **ACI** pane, choose **LOAD BALANCER** to check the network, virtual server, application server, port, and protocol of the load balancer.

The bridge domain should have the following subnets:

- SNIP subnet
- Host subnet
- VIP subnet

If you want the VIP subnet, it should be linked with L3 or L2 extOut.

---

## Adding Access Control Lists

This allows the tenant to add access control lists (ACLs) to the shared service.

### Procedure

---

- Step 1** Log in to the Service Management Portal (Tenant Portal).
- Step 2** In the **navigation** pane, choose **ACI**.
- Step 3** In the **aci** pane, choose **SHARED SERVICES**.
- Step 4** In the **aci** pane, choose a shared service to which you want to add more ACLs (DBSrv).
- Step 5** Click **+ACL** to add ACLs.

- Step 6** In the **Add ACL for DBSrv** dialog box, perform the following actions:
- In the **PROTOCOL** field, enter the protocol (tcp).
  - In the **PORT NUMBER BEGIN** field, enter the beginning port number (301).
  - In the **PORT NUMBER END** field, enter the end port number (400).
  - Click the checkmark.
- 

## Deleting Access Control Lists

This allows the tenant to delete access control lists (ACLs) from the shared service.

### Procedure

---

- Step 1** Log in to the Service Management Portal (Tenant Portal).
- Step 2** In the **navigation** pane, choose **ACI**.
- Step 3** In the **aci** pane, perform the following actions:
- Choose **SHARED SERVICES**.
  - Choose a shared service from which you want to delete ACLs (DBSrv).
  - Click **Trash ACL** to delete ACLs.
- Step 4** In the **Delete ACL from DBSrv** dialog box, check the ACLs check box that you want to delete and click the checkmark.
- 

## Preparing a Tenant L3 External Out on APIC for Use at Windows Azure Pack

This section describes how to prepare a tenant L3 External Out on APIC for use at Windows Azure Pack.

### Procedure

---

- Step 1** Log in to the APIC GUI, on the menu bar, choose **TENANTS > Tenant Name**.
- Step 2** In the **Navigation** pane, expand **Tenant Name > Networking > External Routed Networks**, right-click **External Routed Networks**, and choose **Create Routed Outside**.
- Step 3** In the **Create Route Outside** dialog box, perform the following actions:
- Enter a Name (myRouteOut).
  - Select a VRF (3b4efb29-f66e-4c93-aed4-dc88ed4be8f2/CTX\_01).
  - Configure the current dialog box according to your network config requirements. The following website provides more information about ACI Fabric Layer 3 Outside Connectivity: [http://www.cisco.com/c/en/us/td/docs/switches/datacenter/aci/apic/sw/1-x/basic-config/b\\_ACI\\_Config\\_Guide/b\\_ACI\\_Config\\_Guide\\_chapter\\_0110.html](http://www.cisco.com/c/en/us/td/docs/switches/datacenter/aci/apic/sw/1-x/basic-config/b_ACI_Config_Guide/b_ACI_Config_Guide_chapter_0110.html)
  - Click **Next**.
  - Click **Finish**.
- Step 4** In the **Navigation** pane, expand **Tenant Name > Networking > External Routed Networks > Route Outside Name**, right-click **Logical Node Profiles**, and choose **Create Node Profile**.

- Step 5** Follow the L3ExtOut Guide to complete your Node Profile Creation. The following website provides more information about ACI Fabric Layer 3 Outside Connectivity: [http://www.cisco.com/c/en/us/td/docs/switches/datacenter/aci/apic/sw/1-x/basic-config/b\\_ACI\\_Config\\_Guide/b\\_ACI\\_Config\\_Guide\\_chapter\\_0110.html](http://www.cisco.com/c/en/us/td/docs/switches/datacenter/aci/apic/sw/1-x/basic-config/b_ACI_Config_Guide/b_ACI_Config_Guide_chapter_0110.html)
- Step 6** In the Navigation pane, expand **Tenant Name** > **Networking** > **External Routed Networks** > **Route Outside Name**, right-click **Networks**, and choose **Create External Network**.
- Step 7** In the **Create External Network** dialog box, perform the following actions:
- Enter the Name in the following format: <**RouteOutsideName**>**InstP**. For example: Route Outside Name is **myRoutOut**, my External Network Name is **myRoutOutInstP**.
  - In the **Subnet** section, click the + icon .
  - Enter your External Subnet details in the **Create Subnet** dialog box per your network design.
  - In the **Create Subnet** dialog box, click **OK** to complete.
  - In the **Create External Network** dialog box, click **Submit**.
- Step 8** In the **Navigation** pane, expand **Tenant Name** > **Networking** > **Bridge Domains** > **Bridge Domain Name**, select the **L3 Configurations** tab and perform the following actions:
- Click the + icon to the right of **Associated L3 Outs**.
  - In the drop-down list, select the L3 Out (3b4efb29-f66e-4c93-aed4-dc88ed4be8f2/myRouteOut).
  - Click **UPDATE**.
  - Click **Submit** on the Bridge Domain - <Name> Page.
- Step 9** Optional: For Tenant Networks which do not use the ACI Integrated Windows Azure Pack Integrated Static IP Address Pool feature.
- In the **Navigation** pane, expand **Tenant Name** > **Networking** > **Bridge Domains** > **Bridge Domain Name**, select the **L3 Configurations** tab and perform the following actions:
- Click the + icon to the right of **Subnets**.
  - In the **Create Subnet** dialog box, perform the following actions:
    - Enter a Gateway IP in Address/Mask format.
    - Check the **Advertised Externally** check box .
    - Click **Submit**.

---

## Creating a Network for External Connectivity

This allows the tenant to create a network for external connectivity.

External Connectivity can be established either through the ACI Common L3ExtOut or through a user defined L3ExtOut.

### Procedure

---

- Step 1** Log in to the Service Management Portal (Tenant Portal).
- Step 2** In the **navigation** pane, choose **ACI**.
- Step 3** Click **NEW**.
- Step 4** In the **NEW** pane, choose **NETWORK**.

- Step 5** In the **NETWORK NAME** field, enter the network name (wapL3test).
- Step 6** Option 1: Uses the Bridge Domain's Subnet for Route Advertisement.  
Click **CREATE**.
- Step 7** Option 2: Uses the EPG's Subnet for Route Advertisement.  
Enter a Gateway in Address/Mask format (192.168.1.1/24).  
a) Click **CREATE**.
- 

### Creating a Firewall for External Connectivity

This allows the tenant to create a firewall for external connectivity.

External Connectivity can be established either through the ACI Common L3ExtOut or through a user defined L3ExtOut.

#### Procedure

---

- Step 1** Log in to the Service Management Portal (Tenant Portal).
- Step 2** In the **navigation** pane, choose **ACI**.
- Step 3** Click **NEW**.
- Step 4** In the **NEW** pane, choose **FIREWALL**.
- Step 5** Option 1: For Shared Windows Azure Pack Plans or VPC Windows Azure Pack Plans using the ACI Common L3ExtOut \*External:default.  
a) In the **FROM NETWORK** field, in the drop-down list, choose the network name (\*External:default).  
Option 2: For VPC Windows Azure Pack Plans using a user defined External Network.  
a) In the **FROM NETWORK** field, in the drop-down list, choose the network name (External:myRouteOut).
- Step 6** In the **TO NETWORK** field, in the drop-down list, choose another network name (wapL3test).
- Step 7** In the **PROTOCOL** field, enter the protocol (tcp).
- Step 8** In the **PORT RANGE BEGIN** field, enter the beginning port range (12345).
- Step 9** In the **PORT RANGE END** field, enter the end of the port range (45678).
- Step 10** Click **CREATE**.  
You have added a firewall for external connectivity.
- 

### Verifying Tenant L3 External Connectivity on APIC

This section describes how to verify the Tenant L3 External Connectivity on APIC.

#### Procedure

---

- Step 1** Log in to the APIC GUI, on the menu bar, choose **TENANTS**.

- Step 2** In the **Navigation** pane, expand **Tenant b81b7a5b-7ab8-4d75-a217-fee3bb23f427 > Application Profiles > Application EPG**, ensure the network you created in [Creating a Network for External Connectivity, on page 324](#) exists (wapL3test).
- Step 3** In the **Navigation** pane, expand **EPG wapL3test > Contracts**, ensure the contract name exists in the format of L3+EPG name+protocols+port range (L3wapL3testtcp1234545678), the contract is **Provided** by the EPG, and the STATE is **formed**.
- Step 4** Option 1: For Shared L3 Out deployments, where the contract was created with \*External:default, on the menu bar, choose **TENANTS > common**.  
Option 2: For Tenant owned L3 Out deployments, on the menu bar, choose **TENANTS > <your tenant-id>**.
- Step 5** In the **Navigation** pane, expand **Security Policies > Imported Contracts**, ensure the contract that you verified in step 3 is imported as an contract interface.
- Step 6** Option 1: For Shared L3 Out deployments, where the contract was created with \*External:default, on the menu bar, choose **TENANTS > common**.  
Option 2: For Tenant owned L3 Out deployments, choose **TENANTS > <your tenant-id>**.
- Step 7** In the **External Network Instance Profile -defaultInstP** pane, in the **Consumed Contracts** field, search for the contract interface that you verified in step 5 and ensure it exists and the STATE is **formed**.
- Step 8** On the menu bar, choose **TENANTS**.
- Step 9** In the **Navigation** pane, expand **Tenant b81b7a5b-7ab8-4d75-a217-fee3bb23f427 > Application Profiles > Application EPG > EPG wapL3test > Contracts**.
- Step 10** In the **Contracts** pane, in the **Consumed Contracts** field, ensure the default contract that you defined in [Prerequisites for Configuring L3 External Connectivity for Windows Azure Pack, on page 315](#) for either shared service tenant or for VPC tenant is consumed by this EPG and the STATE is **formed**.
- Step 11** Option 2: For VPC Windows Azure Pack Plans using a user defined External Network with a Tenant Network with a Gateway specified.  
In the **Navigation** pane, select **Tenant Name > Application Profiles > Application EPG > EPG wapL3test > Subnets > Subnet Address**, verify that the Scope is marked as **Advertised Externally**.

## Adding NAT Firewall Layer 4 to Layer 7 Services to a VM Network

This provisions an Adaptive Security Appliance (ASA) firewall or firewall context, dynamically allocate a network address translation (NAT) IP from the external IP address pool, configure dynamic PAT on the ASA to allow outbound traffic, and provision the rest of the service graph for an easy deployment.

### Before you begin

- Ensure the Azure Pack plan is configured to access an Layer 4 to Layer 7 service pool.
- Ensure the ACI VM network has been created with a gateway or subnet.
- If the private subnet of the Layer 4 to Layer 7 resource pool was not provided by the APIC admin, attempting to add Layer 4 to Layer 7 services with an overlapping subnet results in an error and no configuration will be pushed. In this case, delete and recreate the VM network with an alternate subnet.

### Procedure

---

- Step 1** Log in to the Service Management Portal (Tenant Portal).
  - Step 2** In the **navigation** pane, choose **ACI**.
  - Step 3** In the **aci** pane, choose **NETWORKS**, click on the arrow to enter further network configuration.
  - Step 4** Click the **Enable direct internet access using NAT** check box.
  - Step 5** Click **SAVE**.
- 

### Adding NAT Firewall Port-Forwarding Rules for a VM Network

This configures the network address translation (NAT) firewall to forward traffic from the NAT IP to the internal IP within the VM network.

#### Before you begin

- Ensure the Cisco Application Centric Infrastructure (ACI) VM network has been configured to enable NAT.

### Procedure

---

- Step 1** Log in to the Service Management Portal (Tenant Portal).
  - Step 2** In the **navigation** pane, choose **ACI**.
  - Step 3** In the **aci** pane, choose **NETWORKS**, click on the arrow to enter further network configuration.
  - Step 4** In the **NETWORKS** pane, choose **RULES**.
  - Step 5** Click **ADD** at the bottom panel.
  - Step 6** Input the required information for the Port-Forwarding Rule.  
**Note** The destination IP address should be an IP address within the bounds of the VM network subnet.
  - Step 7** Click the **SAVE** checkmark.
- 

### Adding NAT Firewall With a Private ADC Load Balancer Layer 4 to Layer 7 Services to a VM Network

In addition to deploying a NAT firewall, this configuration will also deploy an internal load balancer. In this scenario, the load balancer VIPs are dynamically allocated from the Layer 4 to Layer 7 private IP address subnet (per tenant VRF). In this 2-Node service graph deployment, it is assumed that the tenant creates a Port-Forwarding Rule to forward traffic to the internal load balancer for traffic load balancing.

#### Before you begin

- Ensure the Azure Pack Plan is configured to access an Layer 4 to Layer 7 service pool.
- Ensure the ACI VM network has been created with a gateway or subnet.

- If the private subnet of the Layer 4 to Layer 7 resource pool was not provided by the APIC admin, attempting to add Layer 4 to Layer 7 services with an overlapping subnet results in an error and no configuration will be pushed. In this case, delete and recreate the VM network with an alternate subnet.

### Procedure

---

- Step 1** Log in to the Service Management Portal (Tenant Portal).
  - Step 2** In the **navigation** pane, choose **ACI**.
  - Step 3** In the **aci** pane, choose **NETWORKS**, click on the arrow to enter further network configuration.
  - Step 4** Click the **Enable direct internet access using NAT** check box.
  - Step 5** Click the **Enable internal load balancer (internal)** check box.
  - Step 6** Click **SAVE**.
- 

### Requesting Additional NAT Firewall Public IP Addresses for a VRF

Use this procedure to allocate additional public IP addresses for use with NAT rules. You can request this public IP address from any EPG where NAT is enabled. It is therefore available for all EPGs in the VRF.

NAT rules are saved for each EPG. So we recommend that the destination IP of the NAT rule points only to an endpoint within the EPG and not somewhere else in the VRF.

#### Before you begin

Ensure the Cisco ACI VM network has been configured for the NAT firewall.

### Procedure

---

- Step 1** Log in to the Service Management Portal (Tenant Portal).
- Step 2** In the **navigation** pane, choose **ACI**.
- Step 3** In the **aci** pane, choose **NETWORKS**, and then click the arrow to enter further network configuration.
- Step 4** In the **NETWORKS** pane, choose **IP ADDRESS**.
- Step 5** At the bottom panel, click **REQUEST IP ADDRESS**.
- Step 6** Click **OK**.

If there is an available public IP address in the L4-L7 resource pool, an IP address is allocated and be present in this table. This IP address also is present in the **RULES** tab, for configuring inbound NAT rules.

---

### Adding a Public ADC Load Balancer Layer 4 to Layer 7 Services to a VM Network

This provisions a load balancer, dynamically allocate a VIP from the external IP address pool, add the necessary routes and provision the rest of the service graph for an easy deployment.

#### Before you begin

- Ensure the Azure Pack Plan is configured to access an Layer 4 to Layer 7 service pool.



- Ensure the ACI VM network has been created with a gateway or subnet.
- If the private subnet of the Layer 4 to Layer 7 resource pool was not provided by the APIC admin, attempting to add Layer 4 to Layer 7 services with an overlapping subnet results in an error and no configuration will be pushed. In this case, delete and recreate the VM network with an alternate subnet.

### Procedure

---

- Step 1** Log in to the Service Management Portal (Tenant Portal).
- Step 2** In the **navigation** pane, choose **ACI**.
- Step 3** In the **aci** pane, choose **NETWORKS**, click on the arrow to enter further network configuration.
- Step 4** Click the **Enable load balancer (public)** check box.
- Step 5** (Optional) Click the **Allow Outbound Connections** check box.
- Note** This option is only available if NAT has NOT been configured for this VM network.
- Step 6** Click **SAVE**.
- 

### Adding ADC Load Balancer Configuration for a VM Network

This configures either the public, private ADC load balancer, listening on the VIP allocated to the VM network and forwarding load balancing traffic to the real servers based on the one with the least number of connections. The entire VM network will be load balanced. As VMs or VNICs come online, they will be added to the load balancer automatically. Since the entire VM Network is load balanced, it is assumed that all endpoints in the VM network are the same and can service the load balancer configuration defined.

#### Before you begin

- Ensure the ACI VM network has been configured for either public or private load balancing.

### Procedure

---

- Step 1** Log in to the Service Management Portal (Tenant Portal).
- Step 2** In the **navigation** pane, choose **ACI**.
- Step 3** In the **aci** pane, choose **NETWORKS**, click on the arrow to enter further network configuration.
- Step 4** In the **NETWORKS** pane, choose **LOAD BALANCERS**.
- Step 5** Click **ADD** at the bottom panel.
- Step 6** Input the required information for the load balancer (Name: HTTP, Protocol: TCP, Port: 80).
- Step 7** Click the **SAVE** checkmark.
-

# Troubleshooting Cisco ACI with Microsoft Windows Azure Pack

## Troubleshooting as an Admin

### Procedure

---

Windows Azure Pack Administrator can look at all networks deployed by tenants in the admin portal. In case there is an issue, use the APIC GUI to look for any faults on the following objects:

- a) VMM domain
  - b) Tenant and EPG corresponding to the Windows Azure Pack tenant networks.
- 

## Troubleshooting as a Tenant

If there is an error message, provide the error message along with the description of the workflow and action to your Administrator.

## Troubleshooting the EPG Configuration Issue

If during the lifetime of the endpoint group (EPG), the VLAN ID of the EPG changes on the APIC then SCVMM needs to update the VLAN configuration on all virtual machines for the new setting to take effect.

### Procedure

---

To perform this operation, run the following PowerShell commands on the SCVMM server:

#### Example:

```
$VMs = Get-SCVirtualMachine
$VMs | Read-SCVirtualMachine
$NonCompliantAdapters=Get-SCVirtualNetworkAdapter -All | Where-Object
{$_VirtualNetworkAdapterComplianceStatus -eq "NonCompliant"}
$NonCompliantAdapters | Repair-SCVirtualNetworkAdapter
```

---

## Programmability References

### ACI Windows Azure Pack PowerShell Cmdlets

This section describes how to list the Cisco Application Centric Infrastructure (ACI) Windows Azure Pack PowerShell cmdlets, help, and examples.

## Procedure

**Step 1** Log in to the Windows Azure Pack server, choose **Start > Run > Windows PowerShell**.

**Step 2** Enter the followings commands:

### Example:

```
Windows PowerShell
Copyright (C) 2013 Microsoft Corporation. All rights reserved.
```

```
PS C:\Users\administrator> cd C:\inetpub\Cisco-ACI\bin
PS C:\inetpub\Cisco-ACI\bin> Import-Module .\ACIWapPsCmdlets.dll
PS C:\inetpub\Cisco-ACI\bin> Add-Type -Path .\Newtonsoft.Json.dll
PS C:\inetpub\Cisco-ACI\bin> Get-Command -Module ACIWapPsCmdlets
```

CommandType	Name	ModuleName
-----	----	-----
Cmdlet	Add-ACIWAPEndpointGroup	ACIWapPsCmdlets
Cmdlet	Get-ACIWAPAdminObjects	ACIWapPsCmdlets
Cmdlet	Get-ACIWAPAllEndpointGroups	ACIWapPsCmdlets
Cmdlet	Get-ACIWAPBDSubnets	ACIWapPsCmdlets
Cmdlet	Get-ACIWAPConsumersForSharedService	ACIWapPsCmdlets
Cmdlet	Get-ACIWAPEndpointGroups	ACIWapPsCmdlets
Cmdlet	Get-ACIWAPEndpoints	ACIWapPsCmdlets
Cmdlet	Get-ACIWAPLBConfiguration	ACIWapPsCmdlets
Cmdlet	Get-ACIWAPOpflexInfo	ACIWapPsCmdlets
Cmdlet	Get-ACIWAPPlans	ACIWapPsCmdlets
Cmdlet	Get-ACIWAPStatelessFirewall	ACIWapPsCmdlets
Cmdlet	Get-ACIWAPSubscriptions	ACIWapPsCmdlets
Cmdlet	Get-ACIWAPTenantCtx	ACIWapPsCmdlets
Cmdlet	Get-ACIWAPTenantPlan	ACIWapPsCmdlets
Cmdlet	Get-ACIWAPTenantSharedService	ACIWapPsCmdlets
Cmdlet	Get-ACIWAPVlanNamespace	ACIWapPsCmdlets
Cmdlet	New-ApicOpflexCert	ACIWapPsCmdlets
Cmdlet	Read-ApicOpflexCert	ACIWapPsCmdlets
Cmdlet	Remove-ACIWAPEndpointGroup	ACIWapPsCmdlets
Cmdlet	Remove-ACIWAPPlan	ACIWapPsCmdlets
Cmdlet	Remove-ACIWAPTenantCtx	ACIWapPsCmdlets
Cmdlet	Set-ACIWAPAdminLogin	ACIWapPsCmdlets
Cmdlet	Set-ACIWAPBDSubnets	ACIWapPsCmdlets
Cmdlet	Set-ACIWAPLBConfiguration	ACIWapPsCmdlets
Cmdlet	Set-ACIWAPLogin	ACIWapPsCmdlets
Cmdlet	Set-ACIWAPOpflexOperation	ACIWapPsCmdlets
Cmdlet	Set-ACIWAPPlan	ACIWapPsCmdlets
Cmdlet	Set-ACIWAPStatelessFirewall	ACIWapPsCmdlets
Cmdlet	Set-ACIWAPTenantSharedService	ACIWapPsCmdlets
Cmdlet	Set-ACIWAPUpdateShareServiceConsumption	ACIWapPsCmdlets
Cmdlet	Set-ACIWAPVlanNamespace	ACIWapPsCmdlets

**Step 3** Generating help:

### Example:

```
commandname -?
```

**Step 4** Generating examples:

### Example:

```
get-help commandname -examples
```

# Uninstalling the Cisco ACI with Microsoft Windows Azure Pack Components

This section describes how to uninstall the Cisco Application Centric Infrastructure (ACI) with Microsoft Windows Azure Pack components.



**Note** Uninstall involves removing artifacts such as VM and logical networks. Uninstalling succeeds only when no other resource, such as a VM or a host, is consuming them.

Component	Task
Detach all virtual machines from the VM networks	See Microsoft's documentation.
Delete VXLAN tunnel endpoint (VTEP) logical switch on all hyper-Vs	See Microsoft's documentation.
Delete cloud on System Center Virtual Machine Manager (SCVMM)	See Microsoft's documentation.
To uninstall the ACI with Microsoft Windows Azure Pack 1.1(1j) release, uninstall the APIC Windows Azure Pack Resource Provider	See <a href="#">Uninstalling the APIC Windows Azure Pack Resource Provider</a> , on page 332.
To uninstall this release of ACI with Microsoft Windows Azure Pack, uninstall the following: <ul style="list-style-type: none"> <li>• ACI Azure Pack Resource Provider</li> <li>• ACI Azure Pack Admin Site Extension</li> <li>• ACI Azure Pack Tenant Site Extension</li> </ul>	See <a href="#">Uninstalling the ACI Azure Pack Resource Provider</a> , on page 333. See <a href="#">Uninstalling the ACI Azure Pack Admin Site Extension</a> , on page 333. See <a href="#">Uninstalling the ACI Azure Pack Tenant Site Extension</a> , on page 333.
Uninstall the APIC Hyper-V Agent	See <a href="#">Uninstalling the APIC Hyper-V Agent</a> , on page 334.

## Uninstalling the APIC Windows Azure Pack Resource Provider

This section describes how to uninstall the APIC Windows Azure Pack Resource Provider.

### Procedure

- Step 1** Log in to the Windows Azure Pack server.
- Step 2** Choose **Start > Control Panel > Uninstall a Program**.
- Step 3** In the **Programs and Features** window, right-click **APIC Windows Azure Pack Resource Provider** and choose **Uninstall**.  
This uninstalls the APIC Windows Azure Pack Resource Provider from the Windows Azure Pack server.

- Step 4** To verify if the APIC Windows Azure Pack Resource Provider is uninstalled, perform the following actions:
- Choose **Start > Control Panel > Uninstall a Program**.
  - In the **Programs and Features** window, verify that **APIC Windows Azure Pack Resource Provider** is not present.
- 

## Uninstalling the ACI Azure Pack Resource Provider

This section describes how to uninstall the ACI Azure Pack Resource Provider.

### Procedure

---

- Step 1** Log in to the Windows Azure Pack server.
- Step 2** Choose **Start > Control Panel > Uninstall a Program**.
- Step 3** In the **Programs and Features** window, right-click **ACI Azure Pack Resource Provider** and choose **Uninstall**.  
This uninstalls the ACI Azure Pack Resource Provider from the Windows Azure Pack server.
- Step 4** To verify if the ACI Azure Pack Resource Provider is uninstalled, perform the following actions:
- Choose **Start > Control Panel > Uninstall a Program**.
  - In the **Programs and Features** window, verify that **ACI Azure Pack Resource Provider** is not present.
- 

## Uninstalling the ACI Azure Pack Admin Site Extension

This section describes how to uninstall the ACI Azure Pack Admin Site Extension.

### Procedure

---

- Step 1** Log in to the Windows Azure Pack server.
- Step 2** Choose **Start > Control Panel > Uninstall a Program**.
- Step 3** In the **Programs and Features** window, right-click **ACI Azure Pack Admin Site Extension** and choose **Uninstall**.  
This uninstalls the ACI Azure Pack Admin Site Extension from the Windows Azure Pack server.
- Step 4** To verify if the ACI Azure Pack Admin Site Extension is uninstalled, perform the following actions:
- Choose **Start > Control Panel > Uninstall a Program**.
  - In the **Programs and Features** window, verify that **ACI Azure Pack Admin Site Extension** is not present.
- 

## Uninstalling the ACI Azure Pack Tenant Site Extension

This section describes how to uninstall the ACI Azure Pack Tenant Site Extension.

### Procedure

---

- Step 1** Log in to the Windows Azure Pack server.
- Step 2** Choose **Start > Control Panel > Uninstall a Program**.
- Step 3** In the **Programs and Features** window, right-click **ACI Azure Pack Tenant Site Extension** and choose **Uninstall**.  
This uninstalls the ACI Azure Pack Tenant Site Extension from the Windows Azure Pack server.
- Step 4** To verify if the ACI Azure Pack Tenant Site Extension is uninstalled, perform the following actions:
- Choose **Start > Control Panel > Uninstall a Program**.
  - In the **Programs and Features** window, verify that **ACI Azure Pack Tenant Site Extension** is not present.
- 

## Uninstalling the APIC Hyper-V Agent

This section describes how to uninstall the APIC Hyper-V Agent.

### Procedure

---

- Step 1** Log in to the Hyper-V server.
- Step 2** Choose **Start > Control Panel > Uninstall a Program**.
- Step 3** In the **Programs and Features** window, right-click **Cisco APIC HyperV Agent** and choose **Uninstall**.  
This uninstalls the APIC Hyper-V Agent from the Hyper-V server.
- Step 4** To verify if the APIC Hyper-V Agent is uninstalled, perform the following actions:
- Choose **Start > Control Panel > Uninstall a Program**.
  - In the **Programs and Features** window, verify that **Cisco APIC HyperV Agent** is not present.
- Step 5** Repeat steps 1-4 for each Hyper-V server.
- 

## Downgrading Cisco APIC and the Switch Software with Cisco ACI and Microsoft Windows Azure Pack Components

This section describes how to downgrade the Cisco APIC and the switch software with Cisco ACI with Microsoft Windows Azure Pack components.



- Note** Layer 4 to Layer 7 resource pool configurations created and used in Cisco APIC 3.1(1) and later are not compatible with older Cisco APIC/Windows Azure Pack builds. Steps 1 to 3 apply when downgrading from Cisco APIC 3.1(1) or later to earlier versions.
-

## Procedure

---

- Step 1** Review the list of Layer 4 to Layer 7 resource pools on the Cisco APIC.
- Note the list of resource pools that were created in Cisco APIC 3.1(1) or later. These resource pools have the Function Profiles tab in the GUI and have *version normalized* in the NX-OS Style CLI configuration.
- Step 2** Windows Azure Pack Tenants Portal: Perform the following steps for each Cisco ACI VM network that has a Virtual Private Cloud using Layer 4 to Layer 7 Cloud orchestrator mode resource pools (resource pools created in Cisco APIC 3.1(1) or later):
- Log in to the Service Management Portal (Tenant Portal).
  - In the navigation pane, choose **ACI**.
  - In the **aci** pane, choose **NETWORKS**, click the arrow to enter further network configuration.
  - Uncheck the box **Enable direct internet access using NAT** if it is checked.
  - Uncheck the box **Enable internal load balancer** (internal) if it is checked.
  - Uncheck the box **Enable load balancer** (public) if it is checked.
  - Click **SAVE**.
- Step 3** Windows Azure Pack Admin: Perform the following steps for each Windows Azure Pack plan where ACI Networking has been added as a Plan Service and the Plan is using Layer 4 to Layer 7 cloud orchestrator mode resource pools.
- Log in to the Service Management Portal (Admin Portal).
  - In the navigation pane, choose **PLANS**.
  - In the plans pane, choose **PLANS**, and then click the plan (Gold).
  - In the **Gold** pane, choose **Networking** (ACI).
  - In the **networking** (aci) pane, perform one of the following steps:
    - Choose the Layer 4 to Layer 7 resource pools provisioned by the Cisco APIC admin in Cisco APIC 3.0(x) or earlier for Azure Pack consumption.
    - Choose **Choose one...** to disable Virtual Private Cloud NAT Firewall and ADC Load Balancer services for Azure Pack Tenants.
  - Click **SAVE**.
- Step 4** Uninstall Cisco ACI with Microsoft Windows Azure Pack components.
- See [Uninstalling the Cisco ACI with Microsoft Windows Azure Pack Components, on page 332](#).
- Step 5** Downgrade the APIC controller and the switch software.
- See the [Cisco APIC Firmware Management, Installation, Upgrade, and Downgrade Guide](#).
- Step 6** Install the downgrade version of Cisco ACI with Microsoft Windows Azure Pack components.
- See the [Installing, Setting Up, and Verifying the Cisco ACI with Microsoft Windows Azure Pack Components, on page 290](#).
-







## APPENDIX **A**

# Performing NX-OS CLI Tasks

---

- [Cisco ACI Virtual Machine Networking, on page 337](#)
- [Cisco ACI with VMware VDS Integration, on page 339](#)
- [Custom EPG Names and Cisco ACI, on page 347](#)
- [Microsegmentation with Cisco ACI, on page 349](#)
- [Intra-EPG Isolation Enforcement and Cisco ACI, on page 351](#)
- [Cisco ACI with Cisco UCSM Integration, on page 353](#)
- [Cisco ACI with Microsoft SCVMM, on page 354](#)

## Cisco ACI Virtual Machine Networking

### Configuring a NetFlow Exporter Policy for Virtual Machine Networking Using the NX-OS-Style CLI

The following example procedure uses the NX-OS-style CLI to configure a NetFlow exporter policy for virtual machine networking.

#### Procedure

---

**Step 1** Enter the configuration mode.

**Example:**

```
apic1# config
```

**Step 2** Configure the exporter policy.

**Example:**

```
apic1(config)# flow vm-exporter vmExporter1 destination address 2.2.2.2 transport udp 1234
apic1(config-flow-vm-exporter)# source address 4.4.4.4
apic1(config-flow-vm-exporter)# exit
apic1(config)# exit
```

---

## Consuming a NetFlow Exporter Policy Under a VMM Domain Using the NX-OS-Style CLI for VMware VDS

The following procedure uses the NX-OS-style CLI to consume a NetFlow exporter policy under a VMM domain.

### Procedure

---

**Step 1** Enter the configuration mode.

**Example:**

```
apicl# config
```

**Step 2** Consume the NetFlow exporter policy.

**Example:**

```
apicl(config)# vmware-domain mininet
apicl(config-vmware)# configure-dvs
apicl(config-vmware-dvs)# flow exporter vmExporter1
apicl(config-vmware-dvs-flow-exporter)# active-flow-timeout 62
apicl(config-vmware-dvs-flow-exporter)# idle-flow-timeout 16
apicl(config-vmware-dvs-flow-exporter)# sampling-rate 1
apicl(config-vmware-dvs-flow-exporter)# exit
apicl(config-vmware-dvs)# exit
apicl(config-vmware)# exit
apicl(config)# exit
```

---

## Enabling or Disabling NetFlow on an Endpoint Group Using the NX-OS-Style CLI for VMware VDS

The following procedure enables or disables NetFlow on an endpoint group using the NX-OS-style CLI.

### Procedure

---

**Step 1** Enable NetFlow:

**Example:**

```
apicl# config
apicl(config)# tenant tn1
apicl(config-tenant)# application appl
apicl(config-tenant-app)# epg epg1
apicl(config-tenant-app-epg)# vmware-domain member mininet
apicl(config-tenant-app-epg-domain)# flow monitor enable
apicl(config-tenant-app-epg-domain)# exit
apicl(config-tenant-app-epg)# exit
apicl(config-tenant-app)# exit
apicl(config-tenant)# exit
apicl(config)# exit
```

**Step 2** (Optional) If you no longer want to use NetFlow, disable the feature:

**Example:**

```
apic1(config-tenant-app-epg-domain) # no flow monitor enable
```

---

## Cisco ACI with VMware VDS Integration

### Creating a VMware VDS Domain Profile

### Creating a vCenter Domain Profile Using the NX-OS Style CLI

**Before you begin**

This section describes how to create a vCenter domain profile using the NX-OS style CLI:

**Procedure**

---

**Step 1** In the CLI, enter configuration mode:

**Example:**

```
apic1# configure
apic1(config)#
```

**Step 2** Configure a VLAN domain:

**Example:**

```
apic1(config)# vlan-domain dom1 dynamic
apic1(config-vlan)# vlan 150-200 dynamic
apic1(config-vlan)# exit
apic1(config)#
```

**Step 3** Add interfaces to this VLAN domain. These are the interfaces to be connected to VMware hypervisor uplink ports:

**Example:**

```
apic1(config)# leaf 101-102
apic1(config-leaf)# interface ethernet 1/2-3
apic1(config-leaf-if)# vlan-domain member dom1
apic1(config-leaf-if)# exit
apic1(config-leaf)# exit
```

**Step 4** Create a VMware domain and add VLAN domain membership:

**Example:**

```
apic1(config)# vmware-domain vmmdom1
apic1(config-vmware)# vlan-domain member dom1
```

```
apicl(config-vmware)#
```

Create the domain with a specific delimiter:

**Example:**

```
apicl(config)# vmware-domain vmmdom1 delimiter @
```

**Step 5** Configure the domain type to DVS:

**Example:**

```
apicl(config-vmware)# configure-dvs
apicl(config-vmware-dvs)# exit
apicl(config-vmware)#
```

**Step 6** (Optional) Configure a retention time for detached endpoints:

You can choose a delay of between 0 and 600 seconds. The default is 0.

**Example:**

```
apicl(config)# vmware-domain <domainName>
apicl(config-vmware)# ep-retention-time <value>
```

**Step 7** Configure a controller in the domain:

**Example:**

```
apicl(config-vmware)# vcenter 192.168.66.2 datacenter prodDC
apicl(config-vmware-vc)# username administrator
Password:
Retype password:
apicl(config-vmware-vc)# exit
apicl(config-vmware)# exit
apicl(config)# exit
```

**Note** When configuring the password, you must precede special characters such as '\$' or '!' with a backslash (\\$) to avoid misinterpretation by the Bash shell. The escape backslash is necessary only when configuring the password; the backslash does not appear in the actual password.

**Step 8** Verify configuration:

**Example:**

```
apicl# show running-config vmware-domain vmmdom1
Command: show running-config vmware-domain vmmdom1
Time: Wed Sep 2 22:14:33 2015
vmware-domain vmmdom1
 vlan-domain member dom1
 vcenter 192.168.66.2 datacenter prodDC
 username administrator password *****
 configure-dvs
 exit
exit
```

## Creating a Read-Only VMM Domain Using the NX-OS Style CLI

You can use the NX-OS style CLI to create a read-only VMM domain.

### Before you begin

- Fulfill the prerequisites in the section [Prerequisites for Creating a VMM Domain Profile, on page 24](#).
- In the VMware vCenter, ensure that under the **Networking** tab, the VDS is contained by a folder.

Also ensure that the folder and the VDS have the exact same name of the read-only VMM domain that you plan to create.

### Procedure

**Step 1** In the CLI, enter configuration mode:

#### Example:

```
apic1# configure
apic1(config)#
```

**Step 2** Configure a controller in the domain:

#### Example:

**Note** The name of the read-only domain (labVDS) must be the same as the name of the VDS and the folder that contains in the VMware vCenter.

```
apic1(config)# vmware-domain labVDS access-mode readonly
apic1(config-vmware)# vcenter 10.1.1.1 datacenter prodDC
apic1(config-vmware-vc)# username administrator@vpsphere.local
Password:
Retype password:
apic1(config-vmware-vc)# exit
apic1(config-vmware)# configure-dvs
apic1(config-vmware-dvs)# exit
apic1(config-vmware)# end
```

**Note** When configuring the password, you must precede special characters such as '\$' or '!' with a backslash ('\') to avoid misinterpretation by the Bash shell. The escape backslash is necessary only when configuring the password; the backslash does not appear in the actual password.

**Step 3** Verify the configuration:

#### Example:

```
apic1# show running-config vmware-domain prodVDS
Command: show running-config vmware-domain prodVDS
Time: Wed Sep 2 22:14:33 2015
vmware-domain prodVDS access-mode readonly
 vcenter 10.1.1.1 datacenter prodDC
 username administrator@vpsphere.local password *****
configure-dvs
 exit
exit
```

**What to do next**

You can attach an EPG to the read-only VMM domain and configure policies for it. However, those policies are not pushed to the VDS in the VMware vCenter.

## Promoting a Read-Only VMM Domain Using the NX-OS Style CLI

You can use the NX-OS style CLI to promote a read-only VMM domain.

**Before you begin**

Instructions for promoting a read-only VMM domain to a managed domain assume you have completed the following prerequisites:

- Fulfill the prerequisites in the section [Prerequisites for Creating a VMM Domain Profile, on page 24](#).
- Configure a read-only domain as described in [Creating a Read-Only VMM Domain, on page 28](#).
- In the VMware vCenter, under the **Networking** tab, ensure that the VDS is contained by a network folder of the exact same name of the read-only VMM domain that you plan to promote.

**Procedure**

**Step 1** In the CLI, enter configuration mode.

**Example:**

```
apicl# configure
apicl(config)#
```

**Step 2** Change the VMM domain's access mode to managed.

In the following example, replace *vmmDom1* with the VMM domain you have previously configured as read-only.

**Example:**

```
apicl(config)# vmware-domain vmmDom1 access-mode readwrite
apicl(config-vmware)# exit
apicl(config)# exit
```

**Step 3** Create a new Link Aggregation Group (LAG) policy.

If you are using vCenter version 5.5 or later, you must create a LAG policy for the domain to use Enhanced LACP feature, as described in [Create LAGs for DVS Uplink Port Groups Using the NX-OS Style CLI, on page 343](#).

Otherwise, you can skip this step.

**Step 4** Associate the LAG policy with appropriate EPGs.

If you are using vCenter version 5.5 or later, you must associate the LAG policy with the EPGs to use Enhanced LACP feature, as described in [Associate Application EPGs to VMware vCenter Domains with Enhanced LACP Policies Using the NX-OS Style CLI, on page 343](#).

Otherwise, you can skip this step.

---

### What to do next

Any EPGs you attach to the VMM domain and any policies you configure will now be pushed to the VDS in the VMware vCenter.

## Enhanced LACP Policy Support

### Create LAGs for DVS Uplink Port Groups Using the NX-OS Style CLI

Improve distributed virtual switch (DVS) uplink port group load balancing by putting the port groups into link aggregation groups (LAGs) and associating them with specific load-balancing algorithms. You can perform this task using the NX-OS style CLI.

#### Before you begin

You must have created a VMware vCenter virtual machine manager (VMM) domain for VMware VDS or Cisco Application Centric Infrastructure (ACI) Virtual Edge.

#### Procedure

---

Create or delete an enhanced LACP policy.

#### Example:

```
apic1(config-vmware)# enhancedlacp LAG name
apic1(config-vmware-enhancedlacp)# lbmode loadbalancing mode
apic1(config-vmware-enhancedlacp)# mode mode
apic1(config-vmware-enhancedlacp)# numlinks max number of uplinks
apic1(config-vmware)# no enhancedlacp LAG name to delete
```

---

#### What to do next

If you are using VMware VDS, associate endpoint groups (EPGs) to the domain with the enhanced LACP policy. If you are using Cisco Application Centric Infrastructure (ACI) Virtual Edge, associate internally created inside and outside port groups with the enhanced LACP policy, then associate EPGs to the domain with the policy.

### Associate Application EPGs to VMware vCenter Domains with Enhanced LACP Policies Using the NX-OS Style CLI

Associate application endpoint groups (EPGs) with the VMware vCenter domain with LAGs and a load-balancing algorithm. You can perform this task using NX-OS style CLI. You can also deassociate application EPGs from the domain.

**Before you begin**

You must have created link aggregation groups (LAGs) for distributed virtual switch (DVS) uplink port groups and associated a load-balancing algorithm to the LAGs.

**Procedure**

---

**Step 1** Associate an application EPG with the domain or deassociate it from the domain.

**Example:**

```
apic1(config-tenant-app-epg-domain)# lag-policy name of the LAG policy to associate
apic1(config-tenant-app-epg-domain)# no lag-policy name of the LAG policy to deassociate
```

**Step 2** Repeat Step 1 for other application EPGs in the tenant as desired.

---

## Endpoint Retention Configuration

### Configure Endpoint Retention Using the NX-OS Style CLI

**Before you begin**

You must have created a vCenter domain.

**Procedure**

---

**Step 1** In the CLI, enter configuration mode:

**Example:**

```
apic1# configure
apic1(config)#
```

**Step 2** Configure a retention time for detached endpoints:

You can choose a delay of between 0 and 600 seconds. The default is 0.

**Example:**

```
apic1(config)# vmware-domain <domainName>
apic1(config-vmware)# ep-retention-time <value>
```

---

## Creating a Trunk Port Group

### Creating a Trunk Port Group Using the NX-OS Style CLI

This section describes how to create a trunk port group using the NX-OS Style CLI.



**Before you begin**

- Trunk port groups must be tenant independent.

**Procedure**

**Step 1** Go to the vmware-domain context, enter the following command:

**Example:**

```
apic1(config-vmware)# vmware-domain ifav2-vcenter1
```

**Step 2** Create a trunk port group, enter the following command:

**Example:**

```
apic1(config-vmware)# trunk-portgroup trunkpg1
```

**Step 3** Enter the VLAN range:

**Example:**

```
apic1(config-vmware-trunk)# vlan-range 2800-2820, 2830-2850
```

**Note** If you do not specify a VLAN range, the VLAN list will be taken from the domain's VLAN namespace.

**Step 4** The mac changes is accept by default. If you choose to not to accept the mac changes, enter the following command:

**Example:**

```
apic1(config-vmware-trunk)# no mac-changes accept
```

**Step 5** The forged transmit is accept by default. If you choose to not to accept the forged transmit, enter the following command:

**Example:**

```
apic1(config-vmware-trunk)# no forged-transmit accept
```

**Step 6** The promiscuous mode is disable by default. If you choose to enable promiscuous mode on the trunk port group:

**Example:**

```
apic1(config-vmware-trunk)# allow-promiscuous enable
```

**Step 7** The trunk port group immediacy is set to on-demand by default. If you want to enable immediate immediacy, enter the following command:

**Example:**

```
apic1(config-vmware-trunk)# immediacy-immediate enable
```

**Step 8** Show the VMware domain:

**Example:**

```
apic1(config-vmware)# show vmware domain name mininet
Domain Name : mininet
Virtual Switch Mode : VMware Distributed Switch
Switching Encap Mode : vlan
Vlan Domain : mininet (2800-2850, 2860-2900)
Physical Interfaces :
```

```

Number of EPGs : 2
Faults by Severity : 0, 2, 4, 0
LLDP override : no
CDP override : no
Channel Mode override : no

```

vCenters:

Faults: Grouped by severity (Critical, Major, Minor, Warning)

vCenter	Type	Datacenter	Status	ESXs	VMs	Faults
172.22.136.195	vCenter	mininet	online	2	57	0,0,4,0

Trunk Portgroups:

Name	VLANs
epgtr1	280-285
epgtr2	280-285
epgtr3	2800-2850

apic1(config-vmware)# **show vmware domain name mininet trunk-portgroup**

Name	Aggregated EPG
epgtr1	test wwwtestcom3 test830
epgtr2	test wwwtestcom3 test830
epgtr3	test wwwtestcom3 test833

apic1(config-vmware)# **show vmware domain name ifav2-vcenter1 trunk-portgroup name trunkpg1**

Name	Aggregated EPG	Encap
trunkpg1	LoadBalance ap1 epg1	vlan-318
	LoadBalance ap1 epg2	vlan-317
	LoadBalance ap1 failover-epg	vlan-362
	SH:13I:common:ASAv-HA:test-rhi rhiExt rhiExtInstP	vlan-711
	SH:13I:common:ASAv-HA:test-rhi rhiInt rhiIntInstP	vlan-712
	test-dyn-ep ASA_FWctxctx1bd-inside int	vlan-366
	test-dyn-ep ASA_FWctxctx1bd-inside1 int	vlan-888
	test-dyn-ep ASA_FWctxctx1bd-outside ext	vlan-365
	test-dyn-ep ASA_FWctxctx1bd-outside1 ext	vlan-887
	test-inb FW-Inbctxtrans-vrfinside-bd int	vlan-886
	test-inb FW-Inbctxtrans-vrfoutside-bd ext	vlan-882
	test-inb inb-ap inb-epg	vlan-883
	test-pbr pbr-ap pbr-cons-epg	vlan-451
	test-pbr pbr-ap pbr-prov-epg	vlan-452
	test1 ap1 epg1	vlan-453
	test1 ap1 epg2	vlan-485

```

test1|ap1|epg3 vlan-454
test2-scale|ASA- vlan-496
Trunkctxctx1bd-inside1|int
test2-scale|ASA- vlan-811
Trunkctxctx1bd-inside10|int

```

```

apic1(config-vmware)# show running-config vmware-domain mininet
Command: show running-config vmware-domain mininet
Time: Wed May 25 21:09:13 2016
vmware-domain mininet
 vlan-domain member mininet type vmware
 vcenter 172.22.136.195 datacenter mininet
 exit
 configure-dvs
 exit
 trunk-portgroup epgr1 vlan 280-285
 trunk-portgroup epgr2 vlan 280-285
 trunk-portgroup epgr3 vlan 2800-2850
 exit

```

## Custom EPG Names and Cisco ACI

### Configure or Change a Custom EPG Name Using the NX-OS Style CLI

You can use the NX-OS Style CLI to configure or change a custom endpoint group (EPG) name. Execute the following command in configuration mode for the application EPG domain.



**Note** You can use the NX-OS Style CLI to configure or change a custom EPG name only for VMware vCenter-based domains. If you use Microsoft System Center Virtual Machine Manager, you can use the Cisco Application Policy Infrastructure Controller (APIC) GUI or the REST API to configure or change a custom EPG name.



**Note** Make sure to attach the EPG to the Virtual Machine Manager (VMM) using a single CLI under the following circumstances:

- You attach the EPG and specify a custom EPG name.
- You intend that the attachment takes over an existing EPG in VMware vCenter with the same name as the custom EPG name.

If you fail to attach the EPG and specify a custom EPG name in a single CLI line, you may create duplicate EPGs.

**Before you begin**

You must have performed the tasks in the section [Prerequisites for Configuring a Custom EPG Name](#), on page 60 in this chapter.

**Procedure**

---

Add or modify the custom EPG name for port-groups in VMM domain;

**Example:**

```
apic1(config-tenant-app-epg-domain)# custom-epg-name My\|Port-group_Name\!XYZ
apic1(config-tenant-app-epg-domain)# show running-config
Command: show running-config tenant Tenant1 application Appl epg Epg1 vmware-domain member
dvs1
Time: Tue Nov 12 07:33:00 2019
tenant Tenant1
 application Appl
 epg Epg1
 vmware-domain member dvs1
 custom-epg-name My|Port-group_Name!XYZ
 exit
 exit
exit
```

---

**What to do next**

Verify the port group name, using [Verify the Port Group Name in VMware vCenter](#), on page 62 in this chapter.

## Delete a Custom EPG Name Using the NX-OS Style CLI

You can delete a custom endpoint group (EPG) name using the NX-OS Style CLI. Doing so renames the port group in the Virtual Machine Manager domain to the default format: *tenant|application|epg*.



---

**Note** You can use the NX-OS Style CLI to delete a custom EPG name only for VMware vCenter-based domains. If you use Microsoft System Center Virtual Machine Manager, you can use the Cisco Application Policy Infrastructure Controller (APIC) GUI or the REST API to delete a custom EPG name.

---

**Procedure**

---

Remove the custom EPG name, applying the default name format to the port group in the VMM domain.

**Example:**

```
apic1(config-tenant-app-epg-domain)# no custom-epg-name
apic1(config-tenant-app-epg-domain)# show running-config
Command: show running-config tenant Tenant1 application Appl epg Epg1 vmware-domain member
dvs1
Time: Tue Nov 12 07:51:38 2019
tenant Tenant1
```

```

application App1
 epg Epg1
 vmware-domain member dvs1
 exit
exit
exit
exit

```

### What to do next

Verify the change, using [Verify the Port Group Name in VMware vCenter, on page 62](#) in this chapter.

## Microsegmentation with Cisco ACI

### Configuring Microsegmentation with Cisco ACI Using the NX-OS-Style CLI

This section describes how to configure Microsegmentation with Cisco ACI for Cisco ACI Virtual Edge, VMware VDS, or Microsoft Hyper-V Virtual Switch using VM-based attributes within an application EPG.

#### Procedure

**Step 1** In the CLI, enter configuration mode:

**Example:**

```

apic1# configure
apic1(config)#

```

**Step 2** Create the uSeg EPG:

**Example:**

This example is for an application EPG.

**Note** The command to allow microsegmentation in the following example is required for VMware VDS only.

```

apic1(config)# tenant cli-ten1
apic1(config-tenant)# application cli-a1
apic1(config-tenant-app)# epg cli-baseEPG1
apic1(config-tenant-app-epg)# bridge-domain member cli-bd1
apic1(config-tenant-app-epg)# vmware-domain member cli-vmml allow-micro-segmentation

```

**Example:**

(Optional) This example sets match EPG precedence for the uSeg EPG:

```

apic1(config)# tenant Coke
apic1(config-tenant)# application cli-a1
apic1(config-tenant-app)# epg cli-uepg1 type micro-segmented
apic1(config-tenant-app-uepg)# bridge-domain member cli-bd1
apic1(config-tenant-app-uepg)# match-precedence 10

```

**Example:**

This example uses a filter based on the attribute VM Name.

```

apicl(config)# tenant cli-ten1
apicl(config-tenant)# application cli-a1
apicl(config-tenant-app)# epg cli-uepg1 type micro-segmented
apicl(config-tenant-app-uepg)# bridge-domain member cli-bd1
apicl(config-tenant-app-uepg)# attribute-logical-expression 'vm-name contains <cos1>'

```

**Example:**

This example uses a filter based on an IP address.

```

apicl(config)# tenant cli-ten1
apicl(config-tenant)# application cli-a1
apicl(config-tenant-app)# epg cli-uepg1 type micro-segmented
apicl(config-tenant-app-uepg)# bridge-domain member cli-bd1
apicl(config-tenant-app-uepg)# attribute-logical-expression 'ip equals <FF:FF:FF:FF:FF:FF>'

```

**Example:**

This example uses a filter based on a MAC address.

```

apicl(config)# tenant cli-ten1
apicl(config-tenant)# application cli-a1
apicl(config-tenant-app)# epg cli-uepg1 type micro-segmented
apicl(config-tenant-app-uepg)# bridge-domain member cli-bd1
apicl(config-tenant-app-uepg)# attribute-logical-expression 'mac equals <FF-FF-FF-FF-FF-FF>'

```

**Example:**

This example uses the operator AND to match all attributes and the operator OR to match any attribute.

```

apicl(config)# tenant cli-ten1
apicl(config-tenant)# application cli-a1
apicl(config-tenant-app)# epg cli-uepg1 type micro-segmented
apicl(config-tenant-app-uepg)# attribute-logical-expression 'hv equals host-123 OR (guest-os
 equals "Ubuntu Linux (64-bit)" AND domain contains fex) '

```

**Example:**

This example uses a filter based on the attribute VM-Custom Attribute.

```

apicl(config)# tenant cli-ten1
apicl(config-tenant)# application cli-a1
apicl(config-tenant-app)# epg cli-uepg1 type micro-segmented
apicl(config-tenant-app-uepg)# bridge-domain member cli-bd1
apicl(config-tenant-app-uepg)# attribute-logical-expression 'custom <Custom Attribute Name>
 equals <Custom Attribute value>'

```

**Step 3** (Cisco ACI Virtual Edge only): Attach the uSeg EPG to a Cisco ACI Virtual Edge VMM domain, specifying the switching and encapsulation modes:

**Example:**

```

vmware-domain member AVE-CISCO
 switching-mode AVE
 encap-mode vxlan
 exit

```

**Step 4** Verify the uSeg EPG creation:

**Example:**

The following example is for a uSeg EPG with a VM name attribute filter

```

apicl(config-tenant-app-uepg)# show running-config
Command: show running-config tenant cli-ten1 application cli-a1 epg cli-uepg1 type
micro-segmented # Time: Thu Oct 8 11:54:32 2015
 tenant cli-ten1
 application cli-a1
 epg cli-uepg1 type micro-segmented

```

```

 bridge-domain cli-bd1
 attribute-logical-expression 'vm-name contains cos1 force'
 {vmware-domain | microsoft-domain} member cli-vmml
 exit
 exit
exit

```

## Intra-EPG Isolation Enforcement and Cisco ACI

### Configuring Intra-EPG Isolation for VMware VDS or Microsoft Hyper-V Virtual Switch using the NX-OS Style CLI

#### Procedure

**Step 1** In the CLI, create an intra-EPG isolation EPG:

#### Example:

The following example is for VMware VDS:

```

apic1(config)# tenant Test_Isolation
apic1(config-tenant)# application PVLAN
apic1(config-tenant-app)# epg EPG1
apic1(config-tenant-app-epg)# show running-config
Command: show running-config tenant Tenant_VMM application Web epg intraEPGDeny
tenant Tenant_VMM
 application Web
 epg intraEPGDeny
 bridge-domain member VMM_BD
 vmware-domain member PVLAN encap vlan-2001 primary-encap vlan-2002 push on-demand
 vmware-domain member mininet
 exit
 isolation enforce
 exit
exit
exit
apic1(config-tenant-app-epg)#

```

#### Example:

The following example is for Microsoft Hyper-V Virtual Switch:

```

apic1(config)# tenant Test_Isolation
apic1(config-tenant)# application PVLAN
apic1(config-tenant-app)# epg EPG1
apic1(config-tenant-app-epg)# show running-config
Command: show running-config tenant Tenant_VMM application Web epg intraEPGDeny
tenant Tenant_VMM
 application Web
 epg intraEPGDeny
 bridge-domain member VMM_BD
 microsoft-domain member domain1 encap vlan-2003 primary-encap vlan-2004
 microsoft-domain member domain2
 exit
 isolation enforce

```

```

 exit
 exit
 exit
apic1(config-tenant-app-epg)#

```

## Step 2 Verify the configuration:

### Example:

```

show epg StaticEPG detail
Application EPg Data:
Tenant : Test_Isolation
Application : PVLAN
AEPg : StaticEPG
BD : VMM_BD
uSeg EPG : no
Intra EPG Isolation : enforced
Vlan Domains : VMM
Consumed Contracts : VMware_vDS-Ext
Provided Contracts : default,Isolate_EPG
Denied Contracts :
Qos Class : unspecified
Tag List :
VMM Domains:
Domain Type Deployment Immediacy Resolution Immediacy State
Encap Primary

DVS1 VMware On Demand immediate formed
 auto auto
Static Leaves:
Node Encap Deployment Immediacy Mode Modification Time

Static Paths:
Node Interface Encap Modification Time

1018 eth101/1/1 vlan-100 2016-02-11T18:39:02.337-08:00
1019 eth1/16 vlan-101 2016-02-11T18:39:02.337-08:00
Static Endpoints:
Node Interface Encap End Point MAC End Point IP Address
Modification Time

Dynamic Endpoints:
Encap: (P):Primary VLAN, (S):Secondary VLAN
Node Interface Encap End Point MAC End Point IP Address
Modification Time

1017 eth1/3 vlan-943 (P) 00:50:56:B3:64:C4 ---
 2016-02-17T18:35:32.224-08:00
 vlan-944 (S)

```



---

# Cisco ACI with Cisco UCSM Integration

## Integrating Cisco UCSM Using the NX-OS Style CLI

You can use the NX-OS style CLI to integrate Cisco UCS Manager (UCSM) into the Cisco Application Centric Infrastructure (ACI) fabric.

### Before you begin

You must have fulfilled the prerequisites in the section [Cisco UCSM Integration Prerequisites](#), on page 92 in this guide.

### Procedure

---

Create the integration group, the integration for the integration group, and choose the Leaf Enforced or the Preprovision policy.

If you choose the default **Pre-provision** policy, Cisco Application Policy Infrastructure Controller (APIC) detects which virtual machine manager (VMM) domain that you use. Cisco APIC then pushes all VLANs associated with that domain to the target Cisco UCSM.

If you choose the **Leaf Enforced** policy, Cisco APIC detects only the VLANs that are deployed to the top-of-rack leaf nodes. Cisco APIC then filters out any undeployed VLANs, resulting in fewer VLANs pushed to the Cisco UCSM.

**Note** The following example includes an example of specifying the uplink port channel, which your deployment might require. For example, Layer 2 disjoint networks require that you make that specification.

### Example:

```
APIC-1# config terminal
APIC-1(config)# integrations-group GROUP-123
APIC-1(config-integrations-group)# integrations-mgr UCSM_001 Cisco/UCSM
APIC-1(config-integrations-mgr)#
APIC-1(config-integrations-mgr)# device-address 1.1.1.2
APIC-1(config-integrations-mgr)# user admin
Password:
Retype password:
APIC-1(config-integrations-mgr)#
APIC-1(config-integrations-mgr)# encap-sync preprovision
APIC-1(config-integrations-mgr)# nicprof-vlan-preserve ?
overwrite overwrite
preserve preserve
APIC-1(config-integrations-mgr)# nicprof-vlan-preserve preserve
APIC-1(config-integrations-mgr)#
exit
```

---

# Cisco ACI with Microsoft SCVMM

## Creating a Static IP Address Pool Using the NX-OS Style CLI

### Procedure

---

**Step 1** In the CLI, enter configuration mode:

**Example:**

```
apicl# config
```

**Step 2** Create the Static IP Address Pool:

**Example:**

```
apicl(config)# tenant t0
apicl(config-tenant)# application a0
apicl(config-tenant-app)# epg e0
apicl(config-tenant-app-epg)# mic
microsoft microsoft-domain
apicl(config-tenant-app-epg)# microsoft static-ip-pool test_pool gateway 1.2.3.4/5
apicl(config-tenant-app-epg-ms-ip-pool)# iprange 1.2.3.4 2.3.4.5
apicl(config-tenant-app-epg-ms-ip-pool)# dns
dnssearchsuffix dnsservers dnssuffix
apicl(config-tenant-app-epg-ms-ip-pool)# dnssuffix testsuffix
apicl(config-tenant-app-epg-ms-ip-pool)# exit
apicl(config-tenant-app-epg)# no mi
microsoft microsoft-domain
apicl(config-tenant-app-epg)# no microsoft static-ip-pool ?
test_pool
apicl(config-tenant-app-epg)# no microsoft static-ip-pool test_pool gateway ?
gwAddress gwAddress
apicl(config-tenant-app-epg)# no microsoft static-ip-pool test_pool gateway 1.2.3.4/5
apicl(config-tenant-app-epg)#
```

**Step 3** Verify the Static IP Address Pool:

**Example:**

```
apicl(config-tenant-app-epg-ms-ip-pool)# show running-config
Command: show running-config tenant t0 application a0 epg e0 microsoft static-ip-pool
test_pool gateway 1.2.3.4/5
Time: Thu Feb 11 23:08:04 2016
tenant t0
 application a0
 epg e0
 microsoft static-ip-pool test_pool gateway 1.2.3.4/5
 iprange 1.2.3.4 2.3.4.5
 dnsservers
 dnssuffix testsuffix
 dnssearchsuffix
 winservers
 exit
 exit
 exit
```

---

## Creating a SCVMM Domain Profile Using the NX-OS Style CLI

This section describes how to create a SCVMM domain profile using the command-line interface (CLI).

### Procedure

---

**Step 1** In the NX-OS Style CLI, configure a vlan-domain and add the VLAN ranges:

**Example:**

```
apic1# configure
apic1(config)# vlan-domain vmm_test_1 dynamic
apic1(config-vlan)# vlan 150-200 dynamic
apic1(config-vlan)# exit
```

**Step 2** Add interfaces to the vlan-domain:

**Example:**

```
apic1(config)# leaf 101
apic1(config-leaf)# interface ethernet 1/2
apic1(config-leaf-if)# vlan-domain member vmm_test_1
apic1(config-leaf-if)# exit
apic1(config-leaf)# exit
```

**Step 3** Create the Microsoft SCVMM domain and associate it with the previously created vlan-domain. Create the SCVMM controller under this domain:

**Example:**

```
apic1(config)# microsoft-domain mstest
apic1(config-microsoft)# vlan-domain member vmm_test_1
apic1(config-microsoft)# scvmm 134.5.6.7 cloud test
apic1#
```

---





## APPENDIX **B**

# Performing REST API Tasks

---

- [Cisco ACI Virtual Machine Networking, on page 357](#)
- [Cisco ACI with VMware VDS Integration, on page 358](#)
- [Custom EPG Names and Cisco ACI, on page 368](#)
- [Microsegmentation with Cisco ACI, on page 370](#)
- [Intra-EPG Isolation Enforcement with Cisco ACI, on page 371](#)
- [Cisco ACI with Cisco UCSM Integration, on page 372](#)
- [Cisco ACI with Microsoft SCVMM, on page 373](#)

## Cisco ACI Virtual Machine Networking

### Configuring a NetFlow Exporter Policy for VM Networking Using the REST API

The following example XML shows how to configure a NetFlow exporter policy for VM networking using the REST API:

```
<polUni>
 <infraInfra>
 <netflowVmmExporterPol name="vmExporter1" dstAddr="2.2.2.2" dstPort="1234"
srcAddr="4.4.4.4"/>
 </infraInfra>
</polUni>
```

### Consuming a NetFlow Exporter Policy Under a VMM Domain Using the REST API for VMware VDS

The following example XML shows how to consume a NetFlow exporter policy under a VMM domain using the REST API:

```
<polUni>
 <vmmProvP vendor="VMware">
 <vmmDomP name="mininet">
 <vmmVSwitchPolicyCont>
 <vmmRsVswitchExporterPol tDn="uni/infra/vmmexporterpol-vmExporter1"
activeFlowTimeOut="62" idleFlowTimeOut="16" samplingRate="1"/>
 </vmmVSwitchPolicyCont>
 </vmmDomP>
 </vmmProvP>
</polUni>
```

```

 </vmmDomP>
 </vmmProvP>
</polUni>

```

## Enabling NetFlow on an Endpoint Group for VMM Domain Association for VMware VDS

The following example XML shows how to enable NetFlow on an endpoint group for VMM domain association using the REST APIs:

```

<polUni>
 <fvTenant name="t1">
 <fvAp name="a1">
 <fvAEPg name="EPG1">
 <fvRsDomAtt tDn="uni/vmmp-VMware/dom-mininet" netflowPref="enabled" />
 </fvAEPg>
 </fvAp>
 </fvTenant>
</polUni>

```

## Cisco ACI with VMware VDS Integration

### Creating a VMware VDS Domain Profile

### Creating a vCenter Domain Profile Using the REST API

#### Procedure

**Step 1** Configure a VMM domain name, a controller, and user credentials.

#### Example:

POST URL: `https://<api-ip>/api/node/mo/.xml`

```

<polUni>
<vmmProvP vendor="VMware">
<!-- VMM Domain -->
<vmmDomP name="productionDC">
<!-- Association to VLAN Namespace -->
<infraRsVlanNs tDn="uni/infra/vlanns-VlanRange-dynamic"/>
<!-- Credentials for vCenter -->
<vmmUsrAccP name="admin" usr="administrator" pwd="admin" />
<!-- vCenter IP address -->
<vmmCtrlrP name="vcenter1" hostOrIp="<vcenter ip address>" rootContName="<Datacenter Name in vCenter>">
<vmmRsAcc tDn="uni/vmmp-VMware/dom-productionDC/usracc-admin"/>
</vmmCtrlrP>
</vmmDomP>
</vmmProvP>

```

#### Example:

```

<polUni>
<vmmProvP vendor="VMware">
 <vmmDomP name="mininet" delimiter="@" >
 </vmmDomP>
 </vmmProvP>
</polUni>

```

**Step 2** Create an attachable entity profile for VLAN namespace deployment.

**Example:**

```

POST URL: https://<apic-ip>/api/policymgr/mo/uni.xml
<infraInfra>
<infraAttEntityP name="profile1">
<infraRsDomP tDn="uni/vmmp-VMware/dom-productionDC"/>
</infraAttEntityP>
</infraInfra>

```

**Step 3** Create an interface policy group and selector.

**Example:**

```

POST URL: https://<apic-ip>/api/policymgr/mo/uni.xml

<infraInfra>
 <infraAccPortP name="swprofilelifselector">
 <infraHPortS name="selector1" type="range">
 <infraPortBlk name="blk"
 fromCard="1" toCard="1" fromPort="1" toPort="3">
 </infraPortBlk>
 <infraRsAccBaseGrp tDn="uni/infra/funcprof/accportgrp-group1" />
 </infraHPortS>
 </infraAccPortP>

 <infraFuncP>
 <infraAccPortGrp name="group1">
 <infraRsAttEntP tDn="uni/infra/attentp-profile1" />
 </infraAccPortGrp>
 </infraFuncP>
</infraInfra>

```

**Step 4** Create a switch profile.

**Example:**

```

POST URL: https://<apic-ip>/api/policymgr/mo/uni.xml

<infraInfra>
 <infraNodeP name="swprofile1">
 <infraLeafS name="selectorswprofile11718" type="range">
 <infraNodeBlk name="single0" from_="101" to_="101"/>
 <infraNodeBlk name="single1" from_="102" to_="102"/>
 </infraLeafS>
 <infraRsAccPortP tDn="uni/infra/accportprof-swprofilelifselector"/>
 </infraNodeP>
</infraInfra>

```

**Step 5** Configure the VLAN pool.

**Example:**

POST URL: `https://<apic-ip>/api/node/mo/.xml`

```
<polUni>
<infraInfra>
<fvnsVlanInstP name="VlanRange" allocMode="dynamic">
 <fvnsEncapBlk name="encap" from="vlan-100" to="vlan-400"/>
</fvnsVlanInstP>
</infraInfra>
</polUni>
```

**Step 6** Locate all the configured controllers and their operational state.

**Example:**

```
GET:
https://<apic-ip>/api/node/class/compCtrlr.xml?
<imdata>
<compCtrlr apiVer="5.1" ctrlrPKey="uni/vmmp-VMware/dom-productionDC/ctrlr-vcenter1"
deployIssues="" descr="" dn="comp/prov-VMware/ctrlr-productionDC-vcenter1" domName="
productionDC"
hostOrIp="esx1" mode="default" model="VMware vCenter Server 5.1.0 build-756313"
name="vcenter1" operSt="online" port="0" pwd="" remoteOperIssues="" scope="vm"
usr="administrator" vendor="VMware, Inc." ... />
</imdata>
```

**Step 7** Locate the hypervisor and VMs for a vCenter with the name 'vcenter1' under a VMM domain called 'ProductionDC'.

**Example:**

```
GET:
https://<apic-ip>/api/node/mo/comp/prov-VMware/ctrlr-productionDC-vcenter1.xml?query-target=children
<imdata>
<compHv descr="" dn="comp/prov-VMware/ctrlr-productionDC-vcenter1/hv-host-4832" name="esx1"
state="poweredOn" type="hv" ... />
<compVm descr="" dn="comp/prov-VMware/ctrlr-productionDC-vcenter1/vm-vm-5531" name="AppVM1"
state="poweredOff" type="virt" .../>
<hvsLNode dn="comp/prov-VMware/ctrlr-productionDC-vcenter1/sw-dvs-5646" lacpEnable="yes"
lacpMode="passive" ldpConfigOperation="both" ldpConfigProtocol="lldp" maxMtu="1500"
mode="default" name="apicVswitch" .../>
</imdata>
```

**Step 8** (Optional) Configure a retention time for detached endpoints:

You can choose a delay of between 0 and 600 seconds. The default is 0 seconds.

**Example:**

```
POST URL: https://<apic-ip>/api/policymgr/mo/uni.xml
<vmmProvP vendor="VMware" >
<vmmDomP name="mininetavs" mode="nlkv" enfPref="sw" epRetTime="60">
<infraRsVlanNs tDn="uni/infra/vlanns-inst-dynamic"/>
<vmmUsrAccP
name="defaultAccP"
usr="administrator"
pwd="admin"
/>
</vmmDomP>
</vmmProvP>
```



## Creating a Read-Only VMM Domain Using the REST API

You can use REST API to create a read-only VMM domain.

### Before you begin

- Fulfill the prerequisites in the section [Prerequisites for Creating a VMM Domain Profile, on page 24](#).
- In the VMware vCenter, ensure that under the **Networking** tab, the VDS is contained by a folder.

Also ensure that the folder and the VDS have the exact same name of the read-only VMM domain that you plan to create.

### Procedure

**Step 1** Configure a VMM domain name, a controller, and user credentials.

#### Example:

```
POST URL: https://<api-ip>/api/node/mo/.xml
<polUni>
 <vmmProvP vendor="VMware">
 <!-- VMM Domain -->
 <vmmDomP name="productionDC" accessMode="read-only">
 <!-- Association to VLAN Namespace -->
 <infraRsVlanNs tDn="uni/infra/vlanns-VlanRange-dynamic"/>
 <!-- Credentials for vCenter -->
 <vmmUsrAccP name="admin" usr="administrator" pwd="admin" />
 <!-- vCenter IP address -->
 <vmmCtrlrP name="vcenter1" hostOrIp="<vcenter ip address>" rootContName="<Datacenter Name in vCenter>">
 <vmmRsAcc tDn="uni/vmmp-VMware/dom-productionDC/usracc-admin"/>
 </vmmCtrlrP>
 </vmmDomP>
 </vmmProvP>
```

#### Example:

```
<polUni>
 <vmmProvP vendor="VMware">
 <vmmDomP name="mininet" delimiter="@ " >
 </vmmDomP>
</vmmProvP>
</polUni>
```

**Step 2** Create an attachable entity profile for VLAN namespace deployment.

#### Example:

```
POST URL: https://<apic-ip>/api/policymgr/mo/uni.xml
<infraInfra>
 <infraAttEntityP name="profile1">
 <infraRsDomP tDn="uni/vmmp-VMware/dom-productionDC"/>
 </infraAttEntityP>
</infraInfra>
```

**Step 3** Create an interface policy group and selector.

#### Example:

```

POST URL: https://<apic-ip>/api/policymgr/mo/uni.xml

<infraInfra>
 <infraAccPortP name="swprofilelifselector">
 <infraHPortS name="selector1" type="range">
 <infraPortBlk name="blk"
 fromCard="1" toCard="1" fromPort="1" toPort="3">
 </infraPortBlk>
 <infraRsAccBaseGrp tDn="uni/infra/funcprof/accportgrp-group1" />
 </infraHPortS>
 </infraAccPortP>

 <infraFuncP>
 <infraAccPortGrp name="group1">
 <infraRsAttEntP tDn="uni/infra/attentp-profile1" />
 </infraAccPortGrp>
 </infraFuncP>
</infraInfra>

```

#### Step 4 Create a switch profile.

##### Example:

```

POST URL: https://<apic-ip>/api/policymgr/mo/uni.xml

<infraInfra>
 <infraNodeP name="swprofile1">
 <infraLeafS name="selectorswprofile11718" type="range">
 <infraNodeBlk name="single0" from_"101" to_"101"/>
 <infraNodeBlk name="single1" from_"102" to_"102"/>
 </infraLeafS>
 <infraRsAccPortP tDn="uni/infra/accportprof-swprofilelifselector"/>
 </infraNodeP>
</infraInfra>

```

#### Step 5 Configure the VLAN pool.

##### Example:

```

POST URL: https://<apic-ip>/api/node/mo/.xml

<polUni>
<infraInfra>
<fvnsVlanInstP name="VlanRange" allocMode="dynamic">
 <fvnsEncapBlk name="encap" from="vlan-100" to="vlan-400"/>
</fvnsVlanInstP>
</infraInfra>
</polUni>

```

#### Step 6 Locate all the configured controllers and their operational state.

##### Example:

```

GET:
https://<apic-ip>/api/node/class/compCtrlr.xml?
<imdata>
<compCtrlr apiVer="5.1" ctrlrPKey="uni/vmmp-VMware/dom-productionDC/ctrlr-vcenter1"
deployIssues="" descr="" dn="comp/prov-VMware/ctrlr-productionDC-vcenter1" domName="
productionDC"
hostOrIp="esx1" mode="default" model="VMware vCenter Server 5.1.0 build-756313"
name="vcenter1" operSt="online" port="0" pwd="" remoteOperIssues="" scope="vm"
usr="administrator" vendor="VMware, Inc." ... />

```

```
</imdata>
```

**Step 7** Locate the hypervisor and VMs for a vCenter with the name 'vcenter1' under a VMM domain called 'ProductionDC'.

**Example:**

GET:  
 https://<apic-ip>/api/node/mo/comp/prov-VMware/ctrlr-productionDC-vcenter1.xml?query-target=children

```
<imdata>
<compHv descr="" dn="comp/prov-VMware/ctrlr-productionDC-vcenter1/hv-host-4832" name="esx1"
state="poweredOn" type="hv" ... />
<compVm descr="" dn="comp/prov-VMware/ctrlr-productionDC-vcenter1/vm-vm-5531" name="AppVM1"
state="poweredOff" type="virt" .../>
<hvsLNode dn="comp/prov-VMware/ctrlr-productionDC-vcenter1/sw-dvs-5646" lACPEnable="yes"
lACPMode="passive" ldpConfigOperation="both" ldpConfigProtocol="lldp" maxMtu="1500"
mode="default" name="apicVswitch" .../>
</imdata>
```

**Step 8** (Optional) Configure a retention time for detached endpoints:

You can choose a delay of between 0 and 600 seconds. The default is 0 seconds.

**Example:**

```
POST URL: https://<apic-ip>/api/policymgr/mo/uni.xml
<vmmProvP vendor="VMware" >
<vmmDomP name="mininetavs" mode="nlkv" enfPref="sw" epRetTime="60">
<infraRsVlanNs tDn="uni/infra/vlanns-inst-dynamic"/>
<vmmUsrAccP
name="defaultAccP"
usr="administrator"
pwd="admin"
/>
</vmmDomP>
</vmmProvP>
```

**What to do next**

You can attach an EPG to the read-only VMM domain and configure policies for it. However, those policies are not pushed to the VDS in the VMware vCenter.

## Promoting a Read-Only VMM Domain Using the REST API

You can use REST API to promote a read-only VMM domain.

**Before you begin**

Instructions for promoting a read-only VMM domain to a managed domain assume you have completed the following prerequisites:

- Fulfill the prerequisites in the section [Prerequisites for Creating a VMM Domain Profile, on page 24](#).
- Configure a read-only domain as described in [Creating a Read-Only VMM Domain, on page 28](#).

- In the VMware vCenter, under the **Networking** tab, ensure that the VDS is contained by a network folder of the exact same name of the read-only VMM domain that you plan to promote.

## Procedure

---

**Step 1** Configure a VMM domain name, a controller, and user credentials.

In the following example, replace *vmmDom1* with the VMM domain you have previously configured as read-only.

**Example:**

```
POST URL: https://<apic-ip>/api/policymgr/mo/.xml

<vmmDomP dn="uni/vmmp-VMware/dom-vmmDom1" accessMode="read-write" prefEncapMode="unspecified"
 enfPref="hw">
</vmmDomP>
```

**Step 2** Create a new Link Aggregation Group (LAG) policy.

If you are using vCenter version 5.5 or later, you must create a LAG policy for the domain to use Enhanced LACP feature, as described in [Create LAGs for DVS Uplink Port Groups Using REST API, on page 364](#).

Otherwise, you can skip this step.

**Step 3** Associate the LAG policy with appropriate EPGs.

If you are using vCenter version 5.5 or later, you must associate the LAG policy with the EPGs to use Enhanced LACP feature, as described in [Associate Application EPGs to VMware vCenter Domains with Enhanced LACP Policies Using REST API, on page 365](#).

Otherwise, you can skip this step.

---

### What to do next

Any EPGs you attach to the VMM domain and any policies you configure will now be pushed to the VDS in the VMware vCenter.

## Enhanced LACP Policy Support

### Create LAGs for DVS Uplink Port Groups Using REST API

Improve distributed virtual switch (DVS) uplink port group load balancing by putting the port groups into link aggregation groups (LAGs) and associating them with specific load-balancing algorithms. You can perform this task using REST API.

#### Before you begin

You must have created a VMware vCenter virtual machine manager (VMM) domain for VMware VDS or Cisco Application Centric Infrastructure (ACI) Virtual Edge.

## Procedure

---

**Step 1** Create the the LAG and associate it with a load-balancing algorithm.

### Example:

```
<polUni>
<vmmProvP vendor="VMware">
 <vmmDomP name="mininetlacpavs">
 <vmmVSwitchPolicyCont>
 <lacpEnhancedLagPol name="lag2" mode="passive" lbmode="vlan" numLinks="4">
 </lacpEnhancedLagPol>
 </vmmVSwitchPolicyCont>
 </vmmDomP>
</vmmProvP>
</polUni>
```

**Step 2** Repeat the step to create other LAGs for the DVS.

---

### What to do next

If you are using VMware VDS, associate endpoint groups (EPGs) to the domain with the enhanced LACP policy. If you are using Cisco Application Centric Infrastructure (ACI) Virtual Edge, associate internally created inside and outside port groups with the enhanced LACP policy, then associate EPGs to the domain with the policy.

## Associate Application EPGs to VMware vCenter Domains with Enhanced LACP Policies Using REST API

Associate application endpoint groups (EPGs) with the VMware vCenter domain with LAGs and a load-balancing algorithm. You can perform this task using REST API. You can also deassociate application EPGs from the domain.

### Before you begin

You must have created link aggregation groups (LAGs) for distributed virtual switch (DVS) uplink port groups and associated a load-balancing algorithm to the LAGs.

## Procedure

---

**Step 1** Associate an EPG to a VMware vCenter domain with LAGs associated to a load-balancing algorithm.

### Example:

```
<polUni>
 <fvTenant
 dn="uni/tn-coke"
 name="coke">
 <fvCtx name="cokectx"/>
 <fvAp
 dn="uni/tn-coke/ap-sap"
 name="sap">
 <fvAEPg
 dn="uni/tn-coke/ap-sap/epg-web3"
 name="web3" >
```

```

 <fvRsBd tnFvBDName="cokeBD2" />
 <fvRsDomAtt resImedcy="immediate" switchingMode="native"
 tDn="uni/vmmp-VMware/dom-mininetlacpavs">
 <fvAEPgLagPolAtt >
 <fvRsVmmVSwitchEnhancedLagPol
 tDn="uni/vmmp-VMware/dom-mininetlacpavs/vswitchpolcont/enlacplagp-lag2"/>
 </fvAEPgLagPolAtt>
 </fvRsDomAtt>
 </fvAEPg>
 </fvAp>
 </fvTenant>
 </polUni>

```

**Step 2** Repeat Step 1 for other application EPGs in the tenant, as desired.

## Endpoint Retention Configuration

### Configuring Endpoint Retention Using the REST API

#### Before you begin

You must have configured a vCenter domain.

#### Procedure

Configure a retention time for detached endpoints:

You can choose a delay of between 0 and 600 seconds. The default is 0 seconds.

```

POST URL: https://<apic-ip>/api/policymgr/mo/uni.xml
<vmmProvP vendor="VMware" >

 <vmmDomP name="mininetavs" epRetTime="60">
 </vmmDomP>
</vmmProvP>

```

## Creating a Trunk Port Group

### Creating a Trunk Port Group Using the REST API

This section describes how to create a trunk port group using the REST API.

#### Before you begin

- Trunk port groups must be tenant independent.

## Procedure

Create a trunk port group:

### Example:

```
<vmmProvP vendor="VMware">
 <vmmDomP name="DVS1">
 <vmmUsrAggr name="EPGAggr_1">
 <fvnsEncapBlk name="blk0" from="vlan-100" to="vlan-200"/>
 </vmmUsrAggr>
 </vmmDomP>
</vmmProvP>
```

# Working with Blade Servers

## Setting Up an Access Policy for a Blade Server Using the REST API

### Procedure

Set up an access policy for a blade server.

### Example:

POST: <https://<ip or hostname APIC>/api/node/mo/uni.xml>

```
<polUni>
 <infraInfra>
 <!-- Define LLDP CDP and LACP policies -->
 <lldpIfPol name="enable_lldp" adminRxSt="enabled" adminTxSt="enabled"/>
 <lldpIfPol name="disable_lldp" adminRxSt="disabled" adminTxSt="disabled"/>
 <cdpIfPol name="enable_cdp" adminSt="enabled"/>
 <cdpIfPol name="disable_cdp" adminSt="disabled"/>
 <lacpLagPol name='enable_lacp' ctrl='15' descr='LACP' maxLinks='16' minLinks='1'
mode='active'/>
 <lacpLagPol name='disable_lacp' mode='mac-pin'/>

 <!-- List of nodes. Contains leaf selectors. Each leaf selector contains list of
node blocks -->
 <infraNodeP name="leaf1">
 <infraLeafS name="leaf1" type="range">
 <infraNodeBlk name="leaf1" from_="1017" to_="1017"/>
 </infraLeafS>
 <infraRsAccPortP tDn="uni/infra/accportprof-portselector"/>
 </infraNodeP>

 <!-- PortP contains port selectors. Each port selector contains list of ports. It
also has association to port group policies -->
 <infraAccPortP name="portselector">
 <infraHPortS name="pselc" type="range">
 <infraPortBlk name="blk" fromCard="1" toCard="1" fromPort="39" toPort="40">

 </infraPortBlk>
 <infraRsAccBaseGrp tDn="uni/infra/funcprof/accbundle-leaf1_PC"/>
 </infraAccPortP>
 </infraInfra>
 </polUni>
```

```

 </infraHPortS>
 </infraAccPortP>

 <!-- FuncP contains access bundle group policies -->
 <infraFuncP>
 <!-- Access bundle group has relation to PC, LDP policies and to attach
entity profile -->
 <infraAccBndlGrp name="leaf1_PC" lagT='link'>
 <infraRsLldpIfPol tnLldpIfPolName="enable_lldp"/>
 <infraRsLacpPol tnLacpLagPolName='enable_lacp'/>
 <infraRsAttEntP tDn="uni/infra/attentp-vmm-FI2"/>
 </infraAccBndlGrp>
 </infraFuncP>

 <!-- AttEntityP has relation to VMM domain -->
 <infraAttEntityP name="vmm-FI2">
 <infraRsDomP tDn="uni/vmmp-VMware/dom-productionDC"/>
 <!-- Functions -->
 <infraProvAcc name="provfunc"/>
 <!-- Policy overrides for VMM -->
 <infraAttPolicyGroup name="attpolicy">
 <!-- RELATION TO POLICIES GO HERE -->
 <infraRsOverrideCdpIfPol tnCdpIfPolName="enable_cdp"/>
 <infraRsOverrideLldpIfPol tnLldpIfPolName="disable_lldp"/>
 <infraRsOverrideLacpPol tnLacpLagPolName="disable_lacp"/>
 </infraAttPolicyGroup/>
 </infraAttEntityP>

 </infraInfra>
</polUni>

OUTPUT:
<?xml version="1.0" encoding="UTF-8"?>
<imdata></imdata>

```

## Custom EPG Names and Cisco ACI

### Configure or Change a Custom EPG Name Using REST API

You can configure or change a custom endpoint group (EPG) name using REST API. You can configure the name as part of `fvRsDomAtt` in a REST post.

#### Before you begin

You must have performed the tasks in the section [Prerequisites for Configuring a Custom EPG Name](#), on [page 60](#) in this chapter.

#### Procedure

Configure the custom EPG name.

#### Example:



```

<fvTenant name="Tenant1">
 <fvAp name="App1">
 <fvAEPg name="Epg1">
 <fvRsDomAtt tDn="uni/vmmp-VMware/dom-dvs1"
 customEpgName='My|Port-group_Name!XYZ'
 />
 </fvAEPg>
 </fvAp>
</fvTenant>

```

---

### What to do next

Verify the name, using one of the following procedures in this chapter:

- [Verify the Port Group Name in VMware vCenter, on page 62](#)
- [Verify a VM Network Name Change in Microsoft SCVMM, on page 62](#)

## Delete a Custom EPG Name Using REST API

You can delete a custom endpoint group (EPG) name using REST API. Doing so renames the port group in the Virtual Machine Manager (VMM) domain to the default format *tenant|application|epg* or the Microsoft VM network to the default format *tenant|application|epg|domain*.

### Procedure

---

Delete the custom EPG name by setting the `customEpgName` to empty.

#### Example:

```

<fvTenant name="Tenant1">
 <fvAp name="App1">
 <fvAEPg name="Epg1">
 <fvRsDomAtt tDn="uni/vmmp-VMware/dom-dvs1"
 customEpgName='My|Port-group_Name!XYZ'
 />
 </fvAEPg>
 </fvAp>
</fvTenant>

```

---

### What to do next

Verify the name, using one of the following procedures in this chapter:

- [Verify the Port Group Name in VMware vCenter, on page 62](#)
- [Verify a VM Network Name Change in Microsoft SCVMM, on page 62](#)

# Microsegmentation with Cisco ACI

## Configuring Microsegmentation with Cisco ACI Using the REST API

This section describes how to configure Microsegmentation with Cisco ACI for Cisco ACI Virtual Edge, VMware VDS, or Microsoft Hyper-V Virtual Switch using the REST API.

### Procedure

- Step 1** Log in to the Cisco APIC.
- Step 2** Post the policy to `https://apic-ip-address/api/node/mo/.xml`.

#### Example:

This example configures a uSeg EPG with the attributes VM Name containing "vm" and Operating System attributes containing values of "CentOS" and "Linux," with matching for all attributes and with an EPG Match Precedence of 1.

```
<fvAEPg name="Security" isAttrBasedEPg="yes" pcEnfPref="unenforced" status="">
 <fvRsBd tnFvBDName="BD1" />
 <fvRsDomAtt tDn="uni/vmmp-VMware/dom-mininet"/>
 <fvCrtrn name="default" match="all" prec="1">
 <fvVmAttr name="foo" type="vm-name" operator="contains" value="vm"/>
 <fvSCrtrn name="sub-def" match="any">
 <fvVmAttr name="foo1" type="guest-os" operator="contains"
value="CentOS"/>
 <fvVmAttr name="foo2" type="guest-os" operator="contains"
value="Linux"/>
 </fvSCrtrn>
 </fvCrtrn>
</fvAEPg>
```

#### Example:

This example is for an application EPG with microsegmentation enabled.

```
<polUni>
 <fvTenant dn="uni/tn-User-T1" name="User-T1">
 <fvAp dn="uni/tn-User-T1/ap-Application-EPG" name="Application-EPG">
 <fvAEPg dn="uni/tn-User-T1/ap-Application-EPG/applicationEPG" name="applicationEPG"
pcEnfPref="enforced" >
 <fvRsBd tnFvBDName="BD1" />
 <fvRsDomAtt tDn="uni/vmmp-VMware/dom-cli-vmm1" classPref="useg"/>
 </fvAEPg>
 </fvAp>
 </fvTenant>
</polUni>
```

In the example above, the string `<fvRsDomAtt tDn="uni/vmmp-VMware/dom-cli-vmm1" classPref="useg"/>` is relevant only for VMware VDS and not for Cisco ACI Virtual Edge, or Microsoft Hyper-V Virtual Switch.

#### Example:

This example attaches a uSeg EPG to a Cisco ACI Virtual Edge VMM domain to add the switching mode.

```
<fvRsDomAtt resImedcy="immediate" instrImedcy="immediate" switchingMode="AVE" encapMode="auto"
tDn="uni/vmmp-VMware/dom-AVE-CISCO" primaryEncapInner="" secondaryEncapInner=""/>
```

## Intra-EPG Isolation Enforcement with Cisco ACI

### Configuring Intra-EPG Isolation for VMware VDS or Microsoft Hyper-V Virtual Switch using the REST API

#### Procedure

**Step 1** Send this HTTP POST message to deploy the application using the XML API.

#### Example:

```
POST https://apic-ip-address/api/mo/uni/tn-ExampleCorp.xml
```

**Step 2** For a VMware VDS or Microsoft Hyper-V Virtual Switch deployment, include one of the following XML structures in the body of the POST message.

#### Example:

The following example is for VMware VDS:

```
<fvTenant name="Tenant_VMM" >
 <fvAp name="Web">
 <fvAEPg name="IntraEPGDeny" pcEnfPref="enforced">
 <!-- pcEnfPref="enforced" ENABLES ISOLATION-->
 <fvRsBd tnFvBDName="bd" />
 <!-- STATIC ENCAP ASSOCIATION TO VMM DOMAIN-->
 <fvRsDomAtt encap="vlan-2001" instrImedcy="lazy" primaryEncap="vlan-2002"
resImedcy="immediate" tDn="uni/vmmp-VMware/dom-DVS1">
 </fvAEPg>
 </fvAp>
</fvTenant>
```

#### Example:

The following example is for Microsoft Hyper-V Virtual Switch:

```
<fvTenant name="Tenant_VMM" >
 <fvAp name="Web">
 <fvAEPg name="IntraEPGDeny" pcEnfPref="enforced">
 <!-- pcEnfPref="enforced" ENABLES ISOLATION-->
 <fvRsBd tnFvBDName="bd" />
 <!-- STATIC ENCAP ASSOCIATION TO VMM DOMAIN-->
 <fvRsDomAtt tDn="uni/vmmp-Microsoft/dom-domain1">
 <fvRsDomAtt encap="vlan-2004" instrImedcy="lazy" primaryEncap="vlan-2003"
resImedcy="immediate" tDn="uni/vmmp-Microsoft/dom-domain2">
 </fvAEPg>
 </fvAp>
</fvTenant>
```

# Cisco ACI with Cisco UCSM Integration

## Integrating Cisco UCSM Using REST API

You can use REST API to integrate Cisco UCS Manager (UCSM) into the Cisco Application Centric Infrastructure (ACI) fabric.

### Before you begin

You must have fulfilled the prerequisites that are listed in the section [Cisco UCSM Integration Prerequisites](#), on page 92 in this guide.

### Procedure

Create the integration group and the integration for the integration group, and choose the Leaf Enforced or the Preprovision policy:

If you choose the default **Pre-provision** policy, Cisco Application Policy Infrastructure Controller (APIC) detects which virtual machine manager (VMM) domain that you use. Cisco APIC then pushes all VLANs associated with that domain to the target Cisco UCSM.

If you choose the **Leaf Enforced** policy, Cisco APIC detects only the VLANs that are deployed to the top-of-rack leaf nodes. Cisco APIC then filters out any undeployed VLANs, resulting in fewer VLANs pushed to the Cisco UCSM.

**Note** The following example includes an example of specifying the uplink port channel, which your deployment might require. For example, Layer 2 disjoint networks require that you make that specification.

### Example:

```
<extdevGroupP name="GROUP">
 <extdevMgrP deviceAddress="172.23.138.144:11000" inventoryTrigSt="untriggered"
 isAppManaged="yes" name="UCSM_00" srcDevType="uni/infra/devCont/devt-Cisco-UCSM"
 usr="username" pwd="password">
 <extdevUplinkProf apicControlled="yes" externalId="fabric/lan/B/pc-1"
 name="FI-B"/>
 <extdevUplinkProf apicControlled="yes" externalId="fabric/lan/A/pc-1"
 name="FI-A"/>
 <extdevSwMgrPolCont>
 <extdevSwMgrFlags encapDeployMode="preprovision"
 nicProfCfgPreserveMode="preserve"/>
 </extdevSwMgrPolCont>
 <extdevAssociatedAppsCont>
 <extdevRsFromDevMgrToApp isDefaultConn="yes"
 tDn="pluginContr/plugin-Cisco_ExternalSwitch"/>
 </extdevAssociatedAppsCont>
 </extdevMgrP>
 <aaaDomainRef name="MySecDomain"/>
 </extdevGroupP>
```

# Cisco ACI with Microsoft SCVMM

## Creating a SCVMM Domain Profile Using the REST API

This section describes how to create a SCVMM domain profile using the REST API.

### Procedure

**Step 1** Configure a VMM domain name and System Center Virtual Machine Manager (SCVMM) Controller.

#### Example:

```
https://<apic-ip>/api/node/mo/.xml

<polUni>
<vmmProvP vendor="Microsoft">
<!-- VMM Domain -->
<vmmDomP name="productionDC">
<!-- Association to VLAN Namespace -->
<infraRsVlanNs tDn="uni/infra/vlanns-VlanRange-dynamic"/>
<!-- SCVMM IP address information
<vmmCtrlrP name="SCVMM1" hostOrIp="172.21.120.21" rootContName="rootCont01"> -->
</vmmCtrlrP>
</vmmDomP>
</vmmProvP>
```

**Step 2** Create an attachable entity profile for VLAN namespace deployment.

#### Example:

```
https://<apic-ip>/api/policymgr/mo/uni.xml
<infraInfra>
<infraAttEntityP name="profile1">
<infraRsDomP tDn="uni/vmmp-Microsoft/dom-productionDC"/>
</infraAttEntityP>
</infraInfra>
```

**Step 3** Create an interface policy group and selector.

#### Example:

```
https://<apic-ip>/api/policymgr/mo/uni.xml

<infraInfra>
 <infraAccPortP name="swprofilelifselector">
 <infraHPortS name="selector1" type="range">
 <infraPortBlk name="blk"
 fromCard="1" toCard="1" fromPort="1" toPort="3">
 </infraPortBlk>
 </infraHPortS>
 </infraAccPortP>

 <infraFuncP>
 <infraAccPortGrp name="group1">
 <infraRsAttEntP tDn="uni/infra/attentp-profile1" />
 </infraAccPortGrp>
 </infraFuncP>
</infraInfra>
```

**Step 4** Create a switch profile.**Example:**

```
https://<apic-ip>/api/policymgr/mo/uni.xml <infraInfra>
 <infraNodeP name="swprofile1"> <infraLeafs
 name="selectorswprofile11718" type="range"> <infraNodeBlk name="single0"
 from_"101" to_"101"/> <infraNodeBlk name="single1" from_"102"
 to_"102"/> </infraLeafs> <infraRsAccPortP
 tDn="uni/infra/accportprof-swprofilelifselector"/> </infraNodeP>
 </infraInfra>
```

**Step 5** Configure the VLAN pool.**Example:**

```
https://<apic-ip>/api/node/mo/.xml

<polUni>
<infraInfra>
<fvnsVlanInstP name="VlanRange" allocMode="dynamic">
 <fvnsEncapBlk name="encap" from="vlan-100" to="vlan-400"/>
</fvnsVlanInstP>
</infraInfra>
</polUni>
```

**Step 6** Locate all the configured controllers and their operational state.**Example:**

```
GET:
https://<apic-ip>/api/node/class/vmmAgtStatus.xml

<imdata totalCount="11">
<vmmAgtStatus HbCount="9285" childAction="" dn="uni/vmmp-Microsoft/dom-productionDC
/ctrlr-SCVMM1/AgtStatus-172.21.120.21" lastHandshakeTime="2015-02-24T23:02:51.800+00:00"
lcOwn="local"
modTs="2015-02-24T23:02:53.695+00:00" monPolDn="uni/infra/moninfra-default"
name="172.21.120.21"
operSt="online" remoteErrMsg="" remoteOperIssues="" status="" uid="15374"/>
</imdata>
```

**Step 7** Get the Hyper-Vs under one controller.**Example:**

```
https://<apic-ip>/api/node/class/opflexODev.json?query-target-filter=and(eq(opflexODev.
ctrlrName,'Scale-Scvmm1.incisisco.net'),eq(opflexODev.domName,'Domain1'),ne(opflexODev.isSecondary,'true'))

{"totalCount": "8", "subscriptionId": "72057718609018900", "imdata": [{"opflexODev": {"attributes": {"childAction":
":", "ctrlrName": "Scale-Scvmm1.incisisco.net", "devId": "167807069", "devOperIssues": "", "devType": "hyperv", "dn":
"topology/pod-1/node-191/sys/br-[eth1/43]/odev-167807069", "domName": "Domain1", "encap": "unknown", "features": "0
", "hbStatus": "valid-dvs", "hostName": "Scale-Hv2.incisisco.net", "id": "0", "ip": "0.0.0.0", "ipAddr": "10.0.136.93",
"isSecondary": "false", "lNodeDn": "", "lastHandshakeTime": "2015-04-15T17:10:25.684-07:00", "lastNumHB": "19772",
"lcOwn": "local", "mac": "00:00:00:00:00:00", "maxMissHb": "0", "modTs": "2015-04-15T17:12:09.485-07:00", "monPolDn":
"uni/fabric/monfab-default", "name": "", "numHB": "19772", "operSt": "identified", "pcIfId": "1", "portId": "0", "state
": "connected", "status": "", "transitionStatus": "attached", "uid": "15374", "updateTs": "0", "uuid": "", "version": ""}
}}, {"opflexODev": {"attributes": {"childAction": "", "ctrlrName": "Scale-Scvmm1.incisisco.net", "devId": "167831641"
, "devOperIssues": "", "devType": "hyperv", "dn": "topology/pod-1/node-191/sys/br-[eth1/43]/odev-167831641", "domName":
"Domain1", "encap": "unknown", "features": "0", "hbStatus": "valid-dvs", "hostName": "Scale-Hv6.incisisco.net", "id":
"0", "ip": "0.0.0.0", "ipAddr": "10.0.232.89", "isSecondary": "false", "lNodeDn": "", "lastHandshakeTime": "2015-04-
15T17:10:26.492-07:00", "lastNumHB": "15544", "lcOwn": "local", "mac": "00:00:00:00:00:00", "maxMissHb": "0", "modTs":
"2015-04-15T17:12:10.292-07:00", "monPolDn": "uni/fabric/monfab-default", "name": "", "numHB": "15544", "operSt":
"identified", "pcIfId": "1", "portId": "0", "state": "connected", "status": "", "transitionStatus": "attached", "uid": ""
```

```

15374", "updateTs": "0", "uuid": "", "version": ""}}, {"opflexODev": {"attributes": {"childAction": "", "ctrlrName": "Scale-Scvmm1.incisisco.net", "devId": "167831643", "devOperIssues": "", "devType": "hyperv", "dn": "topology/pod-1/node-191/sys/br-[eth1/43]/odev-167831643", "domName": "Domain1", "encap": "unknown", "features": "0", "hbStatus": "valid-dvs", "hostName": "Scale-Hv3.incisisco.net", "id": "0", "ip": "0.0.0.0", "ipAddr": "10.0.232.91", "isSecondary": "false", "lNodeDn": "", "lastHandshakeTime": "2015-04-15T17:10:23.268-07:00", "lastNumHB": "15982", "lOwn": "local", "mac": "00:00:00:00:00:00", "maxMissHb": "0", "modTs": "2015-04-15T17:12:07.068-07:00", "monPolDn": "uni/fabric/monfab-default", "name": "", "numHB": "15982", "operSt": "identified", "pcIfId": "1", "portId": "0", "state": "connected", "status": "", "transitionStatus": "attached", "uid": "15374", "updateTs": "0", "uuid": "", "version": ""}}, {"opflexODev": {"attributes": {"childAction": "", "ctrlrName": "Scale-Scvmm1.incisisco.net", "devId": "167807070", "devOperIssues": "", "devType": "hyperv", "dn": "topology/pod-1/node-191/sys/br-[eth1/43]/odev-167807070", "domName": "Domain1", "encap": "unknown", "features": "0", "hbStatus": "valid-dvs", "hostName": "Scale-Hv8.incisisco.net", "id": "0", "ip": "0.0.0.0", "ipAddr": "10.0.136.94", "isSecondary": "false", "lNodeDn": "", "lastHandshakeTime": "2015-04-15T17:10:26.563-07:00", "lastNumHB": "14219", "lOwn": "local", "mac": "00:00:00:00:00:00", "maxMissHb": "0", "modTs": "2015-04-15T17:12:10.364-07:00", "monPolDn": "uni/fabric/monfab-default", "name": "", "numHB": "14219", "operSt": "identified", "pcIfId": "1", "portId": "0", "state": "connected", "status": "", "transitionStatus": "attached", "uid": "15374", "updateTs": "0", "uuid": "", "version": ""}}, {"opflexODev": {"attributes": {"childAction": "", "ctrlrName": "Scale-Scvmm1.incisisco.net", "devId": "167831642", "devOperIssues": "", "devType": "hyperv", "dn": "topology/pod-1/node-191/sys/br-[eth1/43]/odev-167831642", "domName": "Domain1", "encap": "unknown", "features": "0", "hbStatus": "valid-dvs", "hostName": "Scale-Hv4.incisisco.net", "id": "0", "ip": "0.0.0.0", "ipAddr": "10.0.232.90", "isSecondary": "false", "lNodeDn": "", "lastHandshakeTime": "2015-04-15T17:10:24.978-07:00", "lastNumHB": "13947", "lOwn": "local", "mac": "00:00:00:00:00:00", "maxMissHb": "0", "modTs": "2015-04-15T17:12:08.778-07:00", "monPolDn": "uni/fabric/monfab-default", "name": "", "numHB": "13947", "operSt": "identified", "pcIfId": "1", "portId": "0", "state": "connected", "status": "", "transitionStatus": "attached", "uid": "15374", "updateTs": "0", "uuid": "", "version": ""}}, {"opflexODev": {"attributes": {"childAction": "", "ctrlrName": "Scale-Scvmm1.incisisco.net", "devId": "167807071", "devOperIssues": "", "devType": "hyperv", "dn": "topology/pod-1/node-190/sys/br-[eth1/43]/odev-167807071", "domName": "Domain1", "encap": "unknown", "features": "0", "hbStatus": "valid-dvs", "hostName": "Scale-Hv7.incisisco.net", "id": "0", "ip": "0.0.0.0", "ipAddr": "10.0.136.95", "isSecondary": "false", "lNodeDn": "", "lastHandshakeTime": "2015-04-15T17:12:10.057-07:00", "lastNumHB": "5708", "lOwn": "local", "mac": "00:00:00:00:00:00", "maxMissHb": "0", "modTs": "2015-04-15T17:12:09.659-07:00", "monPolDn": "uni/fabric/monfab-default", "name": "", "numHB": "5708", "operSt": "identified", "pcIfId": "1", "portId": "0", "state": "connected", "status": "", "transitionStatus": "attached", "uid": "15374", "updateTs": "0", "uuid": "", "version": ""}}, {"opflexODev": {"attributes": {"childAction": "", "ctrlrName": "Scale-Scvmm1.incisisco.net", "devId": "167807067", "devOperIssues": "", "devType": "hyperv", "dn": "topology/pod-1/node-190/sys/br-[eth1/43]/odev-167807067", "domName": "Domain1", "encap": "unknown", "features": "0", "hbStatus": "valid-dvs", "hostName": "Scale-Hv1.incisisco.net", "id": "0", "ip": "0.0.0.0", "ipAddr": "10.0.136.91", "isSecondary": "false", "lNodeDn": "", "lastHandshakeTime": "2015-04-15T17:12:08.637-07:00", "lastNumHB": "17659", "lOwn": "local", "mac": "00:00:00:00:00:00", "maxMissHb": "0", "modTs": "2015-04-15T17:12:08.240-07:00", "monPolDn": "uni/fabric/monfab-default", "name": "", "numHB": "17659", "operSt": "identified", "pcIfId": "1", "portId": "0", "state": "connected", "status": "", "transitionStatus": "attached", "uid": "15374", "updateTs": "0", "uuid": "", "version": ""}}, {"opflexODev": {"attributes": {"childAction": "", "ctrlrName": "Scale-Scvmm1.incisisco.net", "devId": "167831644", "devOperIssues": "", "devType": "hyperv", "dn": "topology/pod-1/node-190/sys/br-[eth1/43]/odev-167831644", "domName": "Domain1", "encap": "unknown", "features": "0", "hbStatus": "valid-dvs", "hostName": "Scale-Hv5.incisisco.net", "id": "0", "ip": "0.0.0.0", "ipAddr": "10.0.232.92", "isSecondary": "false", "lNodeDn": "", "lastHandshakeTime": "2015-04-15T17:12:09.093-07:00", "lastNumHB": "15433", "lOwn": "local", "mac": "00:00:00:00:00:00", "maxMissHb": "0", "modTs": "2015-04-15T17:12:08.695-07:00", "monPolDn": "uni/fabric/monfab-default", "name": "", "numHB": "15433", "operSt": "identified", "pcIfId": "1", "portId": "0", "state": "connected", "status": "", "transitionStatus": "attached", "uid": "15374", "updateTs": "0", "uuid": "", "version": ""}}}}

```

## Step 8 Get the VMs under one Hyper-V.

### Example:

```

https://<apic-ip>/api/node/mo/topology/pod-1/node-190/sys/br-[eth1/43]/odev-167807067.
json?query-target=children&target-subtree-class=opflexOVm&subscription=yes

```

```

{"totalCount": "1", "subscriptionId": "72057718609018947", "imdata": [{"opflexOVm": {"attributes": {"childAction": "", "ctrlrName": "Scale-Scvmm1.incisisco.net", "dn": "topology/pod-1/node-190/sys/br-[eth1/43]/odev-167807067/ovm-ExtConn_1002_EPG17_003", "domName": "Domain1", "id": "0", "lOwn": "local", "modTs": "2015-04-14T17:36:51.512-07:00", "name": "ExtConn_1002_EPG17_003", "state": "Powered On", "status": "", "uid": "15374"}}}}

```

## Step 9 Get VNICs under one VM.

### Example:

```
https://<apic-ip>/api/node/class/opflexIDep.json?query-target-filter=eq(opflexIDep.
containerName,'ExtConn_1002_EPG17_003')
```

```
{
 "totalCount": "4",
 "subscriptionId": "72057718609018983",
 "imdata": [
 {
 "opflexIDep": {
 "attributes": {
 "brIfId": "eth1/43",
 "childAction": "",
 "compHvDn": "",
 "compVmDn": "",
 "containerName": "ExtConn_1002_EPG17_003",
 "ctrlrName": "Scale-Scvmm1.incsisco.net",
 "dn": "topology/pod-1/node-190/sys/br-[eth1/43]/idep-00:15:5D:D2:14:84-encap-[vlan-1398]",
 "domName": "Domain1",
 "domPDn": "",
 "dpAttr": "0",
 "encap": "vlan-1398",
 "epHostAddr": "http://10.0.136.91:17000/Vleaf/policies/setpolicies",
 "epPolDownloadHint": "all",
 "epgID": "",
 "epgID": "",
 "epppDownloadHint": "always",
 "epppdn": "uni/eppp/fv-[uni/tn-ExtConn_1002/ap-SCVMM/epg-EPG17]",
 "gtag": "0",
 "handle": "0",
 "hypervisorName": "Scale-Hv1.incsisco.net",
 "id": "0",
 "instType": "unknown",
 "ip": "0.0.0.0",
 "lcC": "",
 "lcOwn": "local",
 "mac": "00:15:5D:D2:14:84",
 "mcastAddr": "0.0.0.0",
 "modTs": "2015-04-14T17:36:50.838-07:00",
 "monPolDn": "uni/fabric/monfab-default",
 "name": "00155DD21484",
 "pcIfId": "1",
 "portId": "0",
 "scopeId": "0",
 "state": "up",
 "status": "",
 "transitionStatus": "attached",
 "uuid": "",
 "vendorId": "Microsoft",
 "vmAttr": "vm-name",
 "vmAttrDn": "",
 "vmAttrOp": "equals",
 "vmAttrOverride": "0",
 "vmmSrc": "msft"
 }
 },
 "opflexIDep": {
 "attributes": {
 "brIfId": "eth1/43",
 "childAction": "",
 "compHvDn": "",
 "compVmDn": "",
 "containerName": "ExtConn_1002_EPG17_003",
 "ctrlrName": "Scale-Scvmm1.incsisco.net",
 "dn": "topology/pod-1/node-190/sys/br-[eth1/43]/idep-00:15:5D:D2:14:85-encap-[vlan-1438]",
 "domName": "Domain1",
 "domPDn": "",
 "dpAttr": "0",
 "encap": "vlan-1438",
 "epHostAddr": "http://10.0.136.91:17000/Vleaf/policies/setpolicies",
 "epPolDownloadHint": "all",
 "epgID": "",
 "epppDownloadHint": "always",
 "epppdn": "uni/eppp/fv-[uni/tn-ExtConn_1002/ap-SCVMM-Domain1/epg-EPG17]",
 "gtag": "0",
 "handle": "0",
 "hypervisorName": "Scale-Hv1.incsisco.net",
 "id": "0",
 "instType": "unknown",
 "ip": "0.0.0.0",
 "lcC": "",
 "lcOwn": "local",
 "mac": "00:15:5D:D2:14:85",
 "mcastAddr": "0.0.0.0",
 "modTs": "2015-04-14T17:36:51.025-07:00",
 "monPolDn": "uni/fabric/monfab-default",
 "name": "00155DD21485",
 "pcIfId": "1",
 "portId": "0",
 "scopeId": "0",
 "state": "up",
 "status": "",
 "transitionStatus": "attached",
 "uuid": "",
 "vendorId": "Microsoft",
 "vmAttr": "vm-name",
 "vmAttrDn": "",
 "vmAttrOp": "equals",
 "vmAttrOverride": "0",
 "vmmSrc": "msft"
 }
 },
 "opflexIDep": {
 "attributes": {
 "brIfId": "eth1/43",
 "childAction": "",
 "compHvDn": "",
 "compVmDn": "",
 "containerName": "ExtConn_1002_EPG17_003",
 "ctrlrName": "Scale-Scvmm1.incsisco.net",
 "dn": "topology/pod-1/node-191/sys/br-[eth1/43]/idep-00:15:5D:D2:14:84-encap-[vlan-1398]",
 "domName": "Domain1",
 "domPDn": "",
 "dpAttr": "0",
 "encap": "vlan-1398",
 "epHostAddr": "http://10.0.136.91:17000/Vleaf/policies/setpolicies",
 "epPolDownloadHint": "all",
 "epgID": "",
 "epppDownloadHint": "always",
 "epppdn": "uni/eppp/fv-[uni/tn-ExtConn_1002/ap-SCVMM/epg-EPG17]",
 "gtag": "0",
 "handle": "0",
 "hypervisorName": "Scale-Hv1.incsisco.net",
 "id": "0",
 "instType": "unknown",
 "ip": "0.0.0.0",
 "lcC": "",
 "lcOwn": "local",
 "mac": "00:15:5D:D2:14:84",
 "mcastAddr": "0.0.0.0",
 "modTs": "2015-04-14T17:36:50.731-07:00",
 "monPolDn": "uni/fabric/monfab-default",
 "name": "00155DD21484",
 "pcIfId": "1",
 "portId": "0",
 "scopeId": "0",
 "state": "up",
 "status": "",
 "transitionStatus": "attached",
 "uuid": "",
 "vendorId": "Microsoft",
 "vmAttr": "vm-name",
 "vmAttrDn": "",
 "vmAttrOp": "equals",
 "vmAttrOverride": "0",
 "vmmSrc": "msft"
 }
 },
 "opflexIDep": {
 "attributes": {
 "brIfId": "eth1/43",
 "childAction": "",
 "compHvDn": "",
 "compVmDn": "",
 "containerName": "ExtConn_1002_EPG17_003",
 "ctrlrName": "Scale-Scvmm1.incsisco.net",
 "dn": "topology/pod-1/node-191/sys/br-[eth1/43]/idep-00:15:5D:D2:14:85-encap-[vlan-1438]",
 "domName": "Domain1",
 "domPDn": "",
 "dpAttr": "0",
 "encap": "vlan-1438",
 "epHostAddr": "http://10.0.136.91:17000/Vleaf/policies/setpolicies",
 "epPolDownloadHint": "all",
 "epgID": "",
 "epppDownloadHint": "always",
 "epppdn": "uni/eppp/fv-[uni/tn-ExtConn_1002/ap-SCVMM-Domain1/epg-EPG17]",
 "gtag": "0",
 "handle": "0",
 "hypervisorName": "Scale-Hv1.incsisco.net",
 "id": "0",
 "instType": "unknown",
 "ip": "0.0.0.0",
 "lcC": "",
 "lcOwn": "local",
 "mac": "00:15:5D:D2:14:85",
 "mcastAddr": "0.0.0.0",
 "modTs": "2015-04-14T17:36:50.932-07:00",
 "monPolDn": "uni/fabric/monfab-default",
 "name": "00155DD21485",
 "pcIfId": "1",
 "portId": "0",
 "scopeId": "0",
 "state": "up",
 "status": "",
 "transitionStatus": "attached",
 "uuid": "",
 "vendorId": "Microsoft",
 "vmAttr": "vm-name",
 "vmAttrDn": "",
 "vmAttrOp": "equals",
 "vmAttrOverride": "0",
 "vmmSrc": "msft"
 }
 }
]
 }
}
```

## Displaying the Certificate Information to be Used on APIC Using the REST API

This section describes how to display the certificate information to be used on APIC using the REST API.

### Procedure

To display the certificate information to be used on the APIC.

```
PS C:\Program Files (x86)\ApicVMMService> $pfxpassword = ConvertTo-SecureString "MyPassword"
-AsPlainText -Force
PS C:\Program Files (x86)\ApicVMMService> Read-ApicOpflexCert -PfxFile
"C:\Program Files (x86)\ApicVMMService\OpflexAgent.pfx" -PfxPassword $pfxpassword
-----BEGIN CERTIFICATE-----
MIIDoJCCAoqgAwIBAgIQHz+F21uuOpFKK0p3jxWRFjANBgkqhkiG9w0BAQ0FADBfMRwwGgYJKoZI
```



```
hvcNAQkBFg10MEBkb21haW4uY29tMQ4wDAYDVQKDAVNeU9yZzELMAkGA1UECAwCQ0ExDDAKBgNV
BAYTA1VTQTEUMBIGA1UEAwLT3BmbGV4QWdlbnQwHhcNMTUwMTAxMDAwMDAwWhcNMjAwMTAxMDAw
MDAwWjBfMRwwGgYJKoZIhvcNAQkBFg10MEBkb21haW4uY29tMQ4wDAYDVQKDAVNeU9yZzELMAkG
A1UECAwCQ0ExDDAKBgNVBAYTA1VTQTEUMBIGA1UEAwLT3BmbGV4QWdlbnQwggEiMA0GCSqGSIb3
DQEBAQUAA4IBDwAwggEKAoIBAQCzQS3rvrIdxiHfeAUqtX68CdjILl+nDtqBH8LzDk0REVB0KU6V
9cYjCAMwW24FJo0PMt4XblvFJDbZUfjWgEY1JmDxqHIAhKIuJGsyDoSZdXaKUUv3ig0bzcswEGvx
khGpAJB8BCnODhD3B7Tj0OD8G18asd1u24xOy/8MtMDuan/2b32QRmn1uiZhSX3cwjnPI2JQVIif
n68L12yMcp1kJvi6H7RxVOiES33uz00qjxcPbFhsuFF1eMT1Ng41stZMTM+xcE6z72zgAYN6wFq
T1pTCLCC+0u/q1yghYu0LBnARCYwDbe2xoa8C1VcL3XYQ1EFlp1+HFFd//p1ro+bAgMBAAGjWjBY
MBIGA1UdEwEB/wQIMAYBAf8CAQAwEwYDVR0lBAwwCgYIKWYBBQUHAWEwHQYDVR0OBBYEFGuzLCG5
4DEcP+bPiFbiDjMDQ3tMMA4GA1UdDwEB/wQEAwIBBjANBgkqhkiG9w0BAQ0FAAOCAQEANc5kKvN4
Q62tIYa1S2HSyiwjaMq7bXoqIH/ICPRqEXu1XE6+VnLnYqpo3TitLmU4G99uz+as8dySNWaEYghk
8jgLpu39HH6yWxdPiZlCCQ17J5B5vRu3Xjnc/2/ZPq1QDEElobrAOdTko4uAHG41FBHLwAZA/f72
5fcIyb/pjNPhPgpCP0r7svElQ/bjAP1wK8PhCfd7k2rJx5jHr+YX8SCoM2jKyzaQx1BAdufspX3U
7AWH0aF7ExdWy/hW6CduO9NJf+98XNqe0cNH/2oSKYCl9qEK6FesdOBFvCj1RyR9ENqiY4q7xpyB
tqDk8m80V0JslU2xXn+G0yCWGO3VRQ==
-----END CERTIFICATE-----
PS C:\Program Files (x86)\ApicVMMService>
```

