



## **Cisco Nexus 3548 Switch NX-OS Layer 2 Switching Configuration Guide, Release 10.2(x)**

**First Published:** 2021-08-24

**Last Modified:** 2023-09-01

### **Americas Headquarters**

Cisco Systems, Inc.  
170 West Tasman Drive  
San Jose, CA 95134-1706  
USA  
<http://www.cisco.com>  
Tel: 408 526-4000  
800 553-NETS (6387)  
Fax: 408 527-0883





# CHAPTER 1

## New and Changed Information

---

- [New and Changed Information](#), on page 1

## New and Changed Information

*Table 1: New and Changed Features for Cisco NX-OS Release 10.2(x)*

Feature	Description	Changed in Release	Where Documented
IGMP Snooping on Private VLANs	Section added for IGMP Snooping on Private VLANs	10.2(2)F	<a href="#">Enabling IGMP Snooping on Private VLANs</a> , on page 26





## CHAPTER 2

# Overview

---

- [Licensing Requirements](#), on page 3
- [Supported Platforms](#), on page 3
- [Layer 2 Ethernet Switching Overview](#), on page 3
- [VLANs](#), on page 4
- [Spanning Tree](#), on page 4

## Licensing Requirements

For a complete explanation of Cisco NX-OS licensing recommendations and how to obtain and apply licenses, see the [Cisco NX-OS Licensing Guide](#) and the [Cisco NX-OS Licensing Options Guide](#).

## Supported Platforms

Starting with Cisco NX-OS release 7.0(3)I7(1), use the [Nexus Switch Platform Support Matrix](#) to know from which Cisco NX-OS releases various Cisco Nexus 9000 and 3000 switches support a selected feature.

## Layer 2 Ethernet Switching Overview

The device supports simultaneous, parallel connections between Layer 2 Ethernet segments. Switched connections between Ethernet segments last only for the duration of the packet. New connections can be made between different segments for the next packet.

The device assigns a domain (for example, a server) to each device to solve traffic congestion caused by high-bandwidth devices and large number of users.

Because collisions cause significant congestion in Ethernet networks, an effective solution is full-duplex communication. Typically, 10/100-Mbps Ethernet operates in half-duplex mode, which means that stations can either receive or transmit. In full-duplex mode, which is configurable on these interfaces, two stations can transmit and receive at the same time. When packets can flow in both directions simultaneously, the effective Ethernet bandwidth doubles. 1/10-Gigabit Ethernet operates in full-duplex only.

# VLANs

A VLAN is a switched network that is logically segmented by function, project team, or application, without regard to the physical locations of the users. VLANs have the same attributes as physical LANs, but you can group end stations even if they are not physically located on the same LAN segment.

Any switch port can belong to a VLAN, and unicast, broadcast, and multicast packets are forwarded and flooded only to end stations in that VLAN. Each VLAN is considered as a logical network, and packets destined for stations that do not belong to the VLAN must be forwarded through a bridge or a router.

All ports are assigned to the default VLAN (VLAN1) when the device comes up.

The devices support 4094 VLANs in accordance with the IEEE 802.1Q standard. These VLANs are organized into several ranges, and you use each range slightly differently. Some of these VLANs are reserved for internal use by the device and are not available for configuration.



---

**Note** Inter-Switch Link (ISL) trunking is not supported.

---

## Spanning Tree

This section discusses the implementation of the Spanning Tree Protocol (STP). Spanning tree is used to refer to IEEE 802.1w and IEEE 802.1s. When the IEEE 802.1D Spanning Tree Protocol is referred to in the publication, 802.1D is stated specifically.

## STP Overview

STP provides a loop-free network at the Layer 2 level. Layer 2 LAN ports send and receive STP frames, which are called Bridge Protocol Data Units (BPDUs), at regular intervals. Network devices do not forward these frames but use the frames to construct a loop-free path.

802.1D is the original standard for STP, and many improvements have enhanced the basic loop-free STP. You can create a separate loop-free path for each VLAN, which is named Per VLAN Spanning Tree (PVST+). Additionally, the entire standard was reworked to make the loop-free convergence process faster to keep up with the faster equipment. This STP standard with faster convergence is the 802.1w standard, which is known as Rapid Spanning Tree (RSTP).

Finally, the 802.1s standard, Multiple Spanning Trees (MST), allows you to map multiple VLANs into a single spanning tree instance. Each instance runs an independent spanning tree topology.

Although the software can interoperate with legacy 802.1D systems, the device runs Rapid PVST+ and MST. You can use either Rapid PVST+ or MST in a given VDC; you cannot mix both in one VDC. Rapid PVST+ is the default STP protocol.



---

**Note** Cisco NX-OS uses the extended system ID and MAC address reduction; you cannot disable these features.

---

In addition, Cisco has created some proprietary features to enhance the spanning tree activities.

## Rapid PVST+

Rapid PVST+ is the default spanning tree mode for the software and is enabled by default on the default VLAN and all newly created VLANs.

A single instance, or topology, of RSTP runs on each configured VLAN, and each Rapid PVST+ instance on a VLAN has a single root device. You can enable and disable STP on a per-VLAN basis when you are running Rapid PVST+.

## MST

The software also supports MST. The multiple independent spanning tree topologies enabled by MST provide multiple forwarding paths for data traffic, enable load balancing, and reduce the number of STP instances required to support a large number of VLANs.

MST incorporates RSTP, so it also allows rapid convergence. MST improves the fault tolerance of the network because a failure in one instance (forwarding path) does not affect other instances (forwarding paths).



---

**Note** Changing the spanning tree mode disrupts the traffic because all spanning tree instances are stopped for the previous mode and started for the new mode.

---

You can force specified interfaces to send prestandard, rather than standard, MST messages using the command-line interface.

## STP Extensions

The software supports the following Cisco proprietary features:

- Spanning tree port types—The default spanning tree port type is normal. You can configure interfaces connected to Layer 2 hosts as edge ports and interfaces connected to Layer 2 switches or bridges as network ports.
- Bridge Assurance—Once you configure a port as a network port, Bridge Assurance sends BPDUs on all ports and moves a port into the blocking state if it no longer receives BPDUs. This enhancement is available only when you are running Rapid PVST+ or MST.
- BPDU Guard—BPDU Guard shuts down the port if that port receives a BPDU.
- BPDU Filter—BPDU Filter suppresses sending and receiving BPDUs on the port.
- Loop Guard—Loop guard prevents the occurrence of loop bridging because of unidirectional link failure in a point-to-point link.
- Root Guard—Root guard prevents a port from becoming a root port or a blocked port. If you configure a port with root guard then the port receives a superior BPDU and it immediately goes to root-inconsistent (blocked) state.







## CHAPTER 3

# Configuring VLANs

---

- [Information About VLANs, on page 7](#)
- [Configuring a VLAN, on page 11](#)

## Information About VLANs

### Understanding VLANs

A VLAN is a group of end stations in a switched network that is logically segmented by function or application, without regard to the physical locations of the users. VLANs have the same attributes as physical LANs, but you can group end stations even if they are not physically located on the same LAN segment.

Any switch port can belong to a VLAN, and unicast, broadcast, and multicast packets are forwarded and flooded only to end stations in that VLAN. Each VLAN is considered as a logical network, and packets destined for stations that do not belong to the VLAN must be forwarded through a router. The following figure shows VLANs as logical networks. The stations in the engineering department are assigned to one VLAN, the stations in the marketing department are assigned to another VLAN, and the stations in the accounting department are assigned to another VLAN.

Figure 1: VLANs as Logically Defined Networks

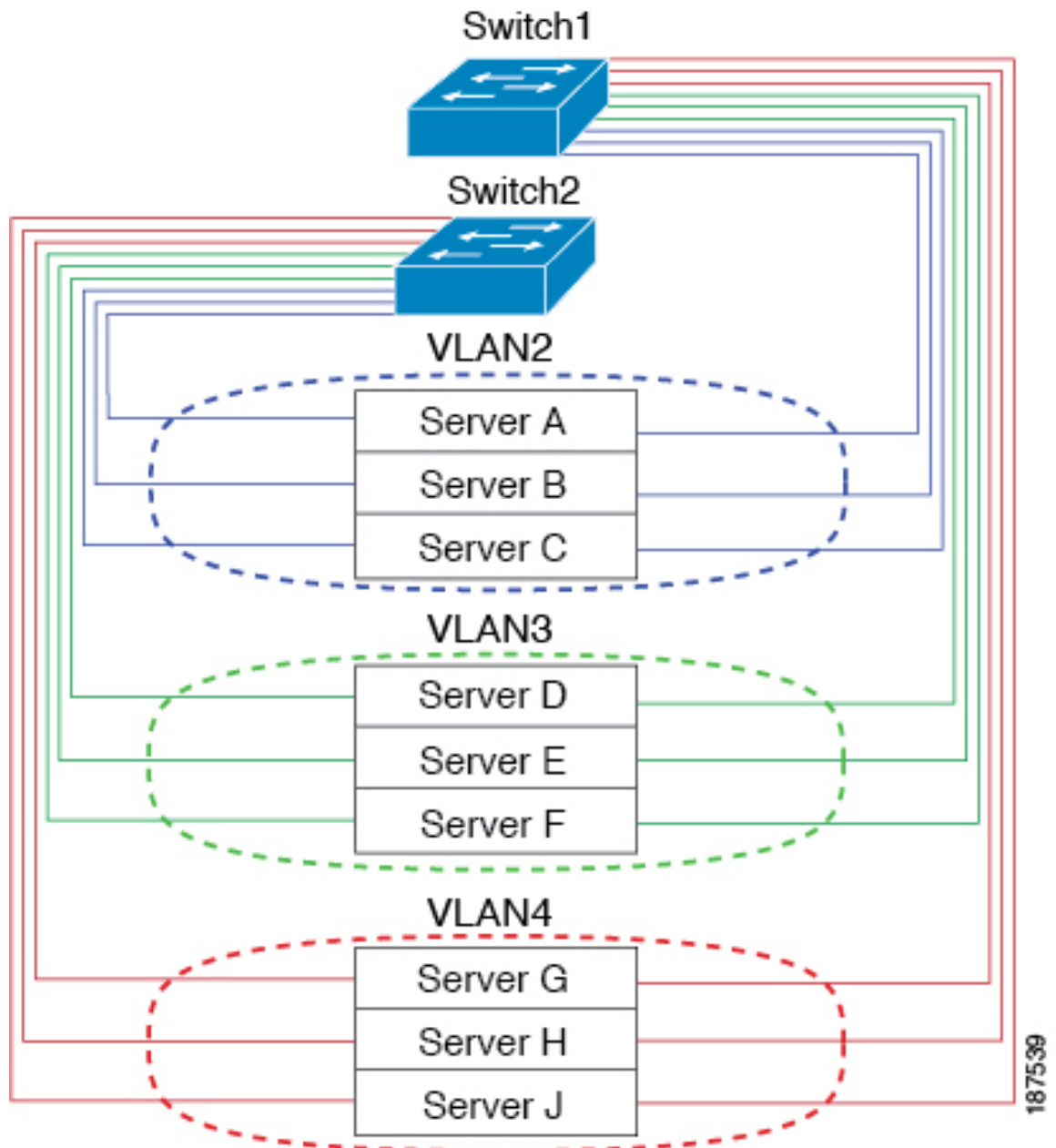

VLANs are usually associated with IP subnetworks. For example, all the end stations in a particular IP subnet belong to the same VLAN. To communicate between VLANs, you must route the traffic.

By default, a newly created VLAN is operational; that is, the newly created VLAN is in the no shutdown condition. Additionally, you can configure VLANs to be in the active state, which is passing traffic, or the suspended state, in which the VLANs are not passing packets. By default, the VLANs are in the active state and pass traffic.

## VLAN Ranges



**Note** The extended system ID is always automatically enabled in Cisco NX-OS devices.

The device supports up to 4094 VLANs in accordance with the IEEE 802.1Q standard. The software organizes these VLANs into ranges, and you use each range slightly differently.

For information about configuration limits, see the configuration limits documentation for your switch.

This table describes the VLAN ranges.

**Table 2: VLAN Ranges**

VLANs Numbers	Range	Usage
1	Normal	Cisco default. You can use this VLAN, but you cannot modify or delete it.
2 to 1005	Normal	You can create, use, modify, and delete these VLANs.
1006 to 3967 and 4048 to 4093	Extended	You can create, name, and use these VLANs. You cannot change the following parameters: <ul style="list-style-type: none"> <li>• The state is always active.</li> <li>• The VLAN is always enabled. You cannot shut down these VLANs.</li> </ul>
3968 to 4047 and 4094	Internally allocated	These 80 VLANs and VLAN 4094 are allocated for internal device use. You cannot create, delete, or modify any VLANs within the block reserved for internal use.

The software allocates a group of VLAN numbers for features such as multicast and diagnostics that need to use internal VLANs for their operation. You cannot use, modify, or delete any of the VLANs in the reserved group. You can display the VLANs that are allocated internally and their associated use.

## Creating, Deleting, and Modifying VLANs

VLANs are numbered from 1 to 4094. All configured ports belong to the default VLAN when you first bring up the switch. The default VLAN (VLAN1) uses only default values. You cannot create, delete, or suspend activity in the default VLAN.

You create a VLAN by assigning a number to it. You can delete VLANs as well as move them from the active operational state to the suspended operational state. If you attempt to create a VLAN with an existing VLAN ID, the switch goes into the VLAN submode but does not create the same VLAN again.

Newly created VLANs remain unused until ports are assigned to the specific VLAN. All the ports are assigned to VLAN1 by default.

Depending on the range of the VLAN, you can configure the following parameters for VLANs (except the default VLAN):

- VLAN name

- Shutdown or not shutdown

When you delete a specified VLAN, the ports associated to that VLAN are shut down and no traffic flows. However, the system retains all the VLAN-to-port mapping for that VLAN, and when you reenables, or recreates, the specified VLAN, the system automatically reinstates all the original ports to that VLAN.



---

**Note** Commands entered in the VLAN configuration submode are immediately executed.

VLANs 3968 to 4049 and 4094 are reserved for internal use; these VLANs cannot be changed or used.

---

## About the VLAN Trunking Protocol

VLAN Trunking Protocol (VTP) is a distributed VLAN database management protocol that synchronizes the VTP VLAN database across domains. A VTP domain includes one or more network switches that share the same VTP domain name and are connected with trunk interfaces.

### Guidelines and Limitations for VTP

VTP has the following configuration guidelines and limitations:

- VLAN 1 is required on all trunk ports used for switch interconnects if VTP is supported in the network. Disabling VLAN 1 from any of these ports prevents VTP from functioning properly.
- If you enable VTP, you must configure either version 1 or version 2.
- If **system vlan long-name** knob is enabled, then VTP configurations will come up in OFF mode and users can change the mode to Transparent. However, changing the mode to Server or Client is not allowed.
- The **show running-configuration** command does not show VLAN or VTP configuration information for VLANs 1 to 1000.
- If you are using VTP in a Token Ring environment, you must use version 2.
- VTPv3 pruning is supported on Cisco Nexus 9000 switches.
- You must enter the **copy running-config startup-config** command followed by a reload after changing a reserved VLAN range. For example:

```
switch(config)# system vlan 2000 reserve
This will delete all configs on vlans 2000-2081. Continue anyway? (y/n) [no] y
```

After the switch reload, VLANs 2000 to 2081 are reserved for internal use, which requires that you enter the **copy running-config startup-config** command before the switch reload. Creating VLANs within this range is not allowed.

- SNMP can perform GET and SET operations on the CISCO-VTP-MIB objects.
- VTP server mode and VTP client mode are not supported. The only supported mode is transparent mode, which is the default mode.
- In SNMP, the `vlanTrunkPortVtpEnabled` object indicates whether the VTP feature is enabled or not.

# Configuring a VLAN

## Creating and Deleting a VLAN

You can create or delete all VLANs except the default VLAN and those VLANs that are internally allocated for use by the switch. Once a VLAN is created, it is automatically in the active state.



**Note** When you delete a VLAN, ports associated to that VLAN shut down. The traffic does not flow and the packets are dropped.



**Note** To configure more than 507 VLANs, you need to configure the Spanning Tree MST mode. See the *Cisco Nexus 3548 Switch NX-OS Verified Scalability Guide, Release 6.x* for information on the scalability numbers.

### SUMMARY STEPS

1. switch# **configure terminal**
2. switch(config)# **vlan** {vlan-id | vlan-range}
3. switch(config-vlan)# **no vlan** {vlan-id | vlan-range}

### DETAILED STEPS

	Command or Action	Purpose
<b>Step 1</b>	switch# <b>configure terminal</b>	Enters global configuration mode.
<b>Step 2</b>	switch(config)# <b>vlan</b> {vlan-id   vlan-range}	Creates a VLAN or a range of VLANs.  If you enter a number that is already assigned to a VLAN, the switch moves into the VLAN configuration submode for that VLAN. If you enter a number that is assigned to an internally allocated VLAN, the system returns an error message. However, if you enter a range of VLANs and one or more of the specified VLANs is outside the range of internally allocated VLANs, the command takes effect on <i>only</i> those VLANs outside the range. The range is from 2 to 4094; VLAN1 is the default VLAN and cannot be created or deleted. You cannot create or delete those VLANs that are reserved for internal use.
<b>Step 3</b>	switch(config-vlan)# <b>no vlan</b> {vlan-id   vlan-range}	Deletes the specified VLAN or range of VLANs and removes you from the VLAN configuration submode. You cannot delete VLAN1 or the internally allocated VLANs.

**Example**

This example shows how to create a range of VLANs from 15 to 20:

```
switch# configure terminal
switch(config)# vlan 15-20
```



---

**Note** You can create and delete VLANs in the VLAN configuration submode.

---

## Configuring a VLAN

To configure or modify the VLAN for the following parameters, you must be in the VLAN configuration submode:

- Name



---

**Note** VLAN name can be either a short name (up to 32 characters) or long name (up to 128 characters). To configure VLAN long-name of up to 128 characters, you must enable **system vlan long-name** command.

---

- Shut down



---

**Note** You cannot create, delete, or modify the default VLAN or the internally allocated VLANs. Additionally, some of these parameters cannot be modified on some VLANs.

---

### SUMMARY STEPS

1. switch# **configure terminal**
2. switch(config)# **vlan** {*vlan-id* | *vlan-range*}
3. switch(config-vlan)# **name** *vlan-name*
4. switch(config-vlan)# **state** {**active** | **suspend**}
5. (Optional) switch(config-vlan)# **no shutdown**

### DETAILED STEPS

	Command or Action	Purpose
<b>Step 1</b>	switch# <b>configure terminal</b>	Enters global configuration mode.
<b>Step 2</b>	switch(config)# <b>vlan</b> { <i>vlan-id</i>   <i>vlan-range</i> }	Enters VLAN configuration submode. If the VLAN does not exist, the system first creates the specified VLAN.
<b>Step 3</b>	switch(config-vlan)# <b>name</b> <i>vlan-name</i>	Names the VLAN. You can enter up to 32 alphanumeric characters to name the VLAN. You cannot change the name

	Command or Action	Purpose
		of VLAN1 or the internally allocated VLANs. The default value is VLANxxxx where xxxx represents four numeric digits (including leading zeroes) equal to the VLAN ID number.
<b>Step 4</b>	switch(config-vlan)# <b>state</b> { <b>active</b>   <b>suspend</b> }	Sets the state of the VLAN to active or suspend. While the VLAN state is suspended, the ports associated with this VLAN are shut down, and that VLAN does not pass any traffic. The default state is active. You cannot suspend the state for the default VLAN or VLANs 1006 to 4094.
<b>Step 5</b>	(Optional) switch(config-vlan)# <b>no shutdown</b>	Enables the VLAN. The default value is <b>no shutdown</b> (or enabled). You cannot shut down the default VLAN, VLAN1, or VLANs 1006 to 4094.

### Example

This example shows how to configure optional parameters for VLAN 5:

```
switch# configure terminal
switch(config)# vlan 5
switch(config-vlan)# name accounting
switch(config-vlan)# state active
switch(config-vlan)# no shutdown
```

## Adding Ports to a VLAN

After you have completed the configuration of a VLAN, assign ports to it.

### SUMMARY STEPS

1. switch# **configure terminal**
2. switch(config)# **interface** {**ethernet slot/port** | **port-channel number**}
3. switch(config-if)# **switchport access vlan** *vlan-id*

### DETAILED STEPS

	Command or Action	Purpose
<b>Step 1</b>	switch# <b>configure terminal</b>	Enters global configuration mode.
<b>Step 2</b>	switch(config)# <b>interface</b> { <b>ethernet slot/port</b>   <b>port-channel number</b> }	Specifies the interface to configure, and enters the interface configuration mode. The interface can be a physical Ethernet port or an EtherChannel.
<b>Step 3</b>	switch(config-if)# <b>switchport access vlan</b> <i>vlan-id</i>	Sets the access mode of the interface to the specified VLAN.

**Example**

This example shows how to configure an Ethernet interface to join VLAN 5:

```
switch# configure terminal
switch(config)# interface ethernet 1/13
switch(config-if)# switchport access vlan 5
```

## Configuring a VLAN as a Routed SVI

You can configure a VLAN to be a routed switch virtual interface (SVI).

**Before you begin**

- Install the Layer 3 license.
- Make sure you understand the guidelines and limitations of this feature.

**SUMMARY STEPS**

1. switch# **configure terminal**
2. switch(config)# **feature interface-vlan**
3. switch(config)# **interface-vlan** *vlan-id*
4. switch(config-if)# **copy running-config startup-config**

**DETAILED STEPS**

	Command or Action	Purpose
<b>Step 1</b>	switch# <b>configure terminal</b>	Enters global configuration mode.
<b>Step 2</b>	switch(config)# <b>feature interface-vlan</b>	Enables the creation of SVIs.
<b>Step 3</b>	switch(config)# <b>interface-vlan</b> <i>vlan-id</i>	Creates a VLAN interface (SVI) and enters interface configuration mode.
<b>Step 4</b>	switch(config-if)# <b>copy running-config startup-config</b>	Copies the running configuration to the startup configuration.

**Example**

This example shows how to configure a VLAN as a routed SVI:

```
switch# configure terminal
switch(config)# feature interface-vlan
switch(config)# interface vlan 5
switch(config-if)# copy running-config startup-config
switch(config-if)#
```

This example shows how to remove the routed SVI function from a VLAN:



```
switch# configure terminal
switch(config)# no interface vlan 5
switch(config-if)# copy running-config startup-config
switch(config-if)#
```

### What to do next

You can configure routing protocols on this interface.

## Configuring a VLAN as a Management SVI

You can configure a VLAN to be a management switch virtual interface (SVI).

### SUMMARY STEPS

1. switch# **configure terminal**
2. switch(config)# **feature interface-vlan**
3. switch(config)# **interface-vlan *vlan-id* management**
4. switch(config-if)# **copy running-config startup-config**

### DETAILED STEPS

	Command or Action	Purpose
<b>Step 1</b>	switch# <b>configure terminal</b>	Enters global configuration mode.
<b>Step 2</b>	switch(config)# <b>feature interface-vlan</b>	Enables the creation of SVIs.
<b>Step 3</b>	switch(config)# <b>interface-vlan <i>vlan-id</i> management</b>	Creates a VLAN interface (SVI) and configures the SVI to be used for in-band management.
<b>Step 4</b>	switch(config-if)# <b>copy running-config startup-config</b>	Copies the running configuration to the startup configuration.

### Example

This example shows how to configure a VLAN as a management SVI:

```
switch# configure terminal
switch(config)# feature interface-vlan
switch(config)# interface vlan 5
switch(config-if)# management
switch(config-if)# copy running-config startup-config
switch(config-if)#
```

This example shows how to remove the management function from an SVI:

```
switch# configure terminal
switch(config)# interface vlan 5
switch(config-if)# no management
switch(config-if)# copy running-config startup-config
switch(config-if)#
```

## Configuring VTP

You can enable and configure VTP. If you enable VTP, you must configure either version 1 or version 2. If you are using VTP in a Token Ring environment, you must use version 2.

### SUMMARY STEPS

1. switch# **configure terminal**
2. switch(config)# **feature vtp**
3. switch(config)# **vtp domain** *domain-name*
4. switch(config)# **vtp version** {1 | 2}
5. switch(config)# **vtp file** *file-name*
6. switch(config)# **vtp password** *password-value*
7. switch(config)# **exit**
8. (Optional) switch# **show vtp status**
9. (Optional) switch# **show vtp counters**
10. (Optional) switch# **show vtp interface**
11. (Optional) switch# **show vtp password**
12. (Optional) switch# **copy running-config startup-config**

### DETAILED STEPS

	Command or Action	Purpose
<b>Step 1</b>	switch# <b>configure terminal</b>	Enters global configuration mode.
<b>Step 2</b>	switch(config)# <b>feature vtp</b>	Enables VTP on the device. The default is disabled.
<b>Step 3</b>	switch(config)# <b>vtp domain</b> <i>domain-name</i>	Specifies the name of the VTP domain that you want this device to join. The default is blank.
<b>Step 4</b>	switch(config)# <b>vtp version</b> {1   2}	Sets the VTP version that you want to use. The default is version 1.
<b>Step 5</b>	switch(config)# <b>vtp file</b> <i>file-name</i>	Specifies the ASCII filename of the IFS file system file where the VTP configuration is stored.
<b>Step 6</b>	switch(config)# <b>vtp password</b> <i>password-value</i>	Specifies the password for the VTP administrative domain.
<b>Step 7</b>	switch(config)# <b>exit</b>	Exits the configuration submenu.
<b>Step 8</b>	(Optional) switch# <b>show vtp status</b>	Displays information about the VTP configuration on the device, such as the version, mode, and revision number.
<b>Step 9</b>	(Optional) switch# <b>show vtp counters</b>	Displays information about VTP advertisement statistics on the device.
<b>Step 10</b>	(Optional) switch# <b>show vtp interface</b>	Displays the list of VTP-enabled interfaces.
<b>Step 11</b>	(Optional) switch# <b>show vtp password</b>	Displays the password for the management VTP domain.

	Command or Action	Purpose
Step 12	(Optional) switch# <b>copy running-config startup-config</b>	Copies the running configuration to the startup configuration.

**Example**

This example shows how to configure VTP for the device:

```
switch# configure terminal
switch(config)# feature vtp
switch(config)# vtp domain accounting
switch(config)# vtp version 2
switch(config)# exit
switch#
```

This example shows the VTP status and that the switch is capable of supporting Version 2 and that the switch is running Version 1:

```
switch(config)# show vtp status
VTP Status Information
-----
VTP Version : 2 (capable)
Configuration Revision : 0
Maximum VLANs supported locally : 1005
Number of existing VLANs : 502
VTP Operating Mode : Transparent
VTP Domain Name :
VTP Pruning Mode : Disabled (Operationally Disabled)
VTP V2 Mode : Disabled
VTP Traps Generation : Disabled
MD5 Digest : 0xF5 0xF1 0xEC 0xE7 0x29 0x0C 0x2D 0x01
Configuration last modified by 60.10.10.1 at 0-0-00 00:00:00
VTP version running : 1
```

## Verifying the VLAN Configuration

Use one of the following commands to verify the configuration:

Command	Purpose
switch# <b>show running-config vlan</b> [vlan_id   vlan_range]	Displays VLAN information.
switch# <b>show vlan</b> [brief   id [vlan_id   vlan_range]   name name   summary ]	Displays selected configuration information for the defined VLAN(s).

## Feature History for VLANs

Feature Name	Release	Feature Information
CISCO-VTP-MIB	5.0(3)U4(1)	Support for this MIB object was added.





## CHAPTER 4

# Configuring Private VLANs

---

- [Information About Private VLANs, on page 19](#)
- [Guidelines and Limitations for Private VLANs, on page 24](#)
- [Configuring a Private VLAN, on page 25](#)
- [Verifying the Private VLAN Configuration, on page 38](#)

## Information About Private VLANs

A private VLAN (PVLAN) partitions the Ethernet broadcast domain of a VLAN into subdomains, allowing you to isolate the ports on the switch from each other. A subdomain consists of a primary VLAN and one or more secondary VLANs (see the following figure). All VLANs in a PVLAN domain share the same primary VLAN. The secondary VLAN ID differentiates one subdomain from another. The secondary VLANs can either be isolated VLANs or community VLANs. A host on an isolated VLAN can communicate only with the associated promiscuous port in its primary VLAN. Hosts on community VLANs can communicate among themselves and with their associated promiscuous port but not with ports in other community VLANs.

Figure 2: Private VLAN Domain

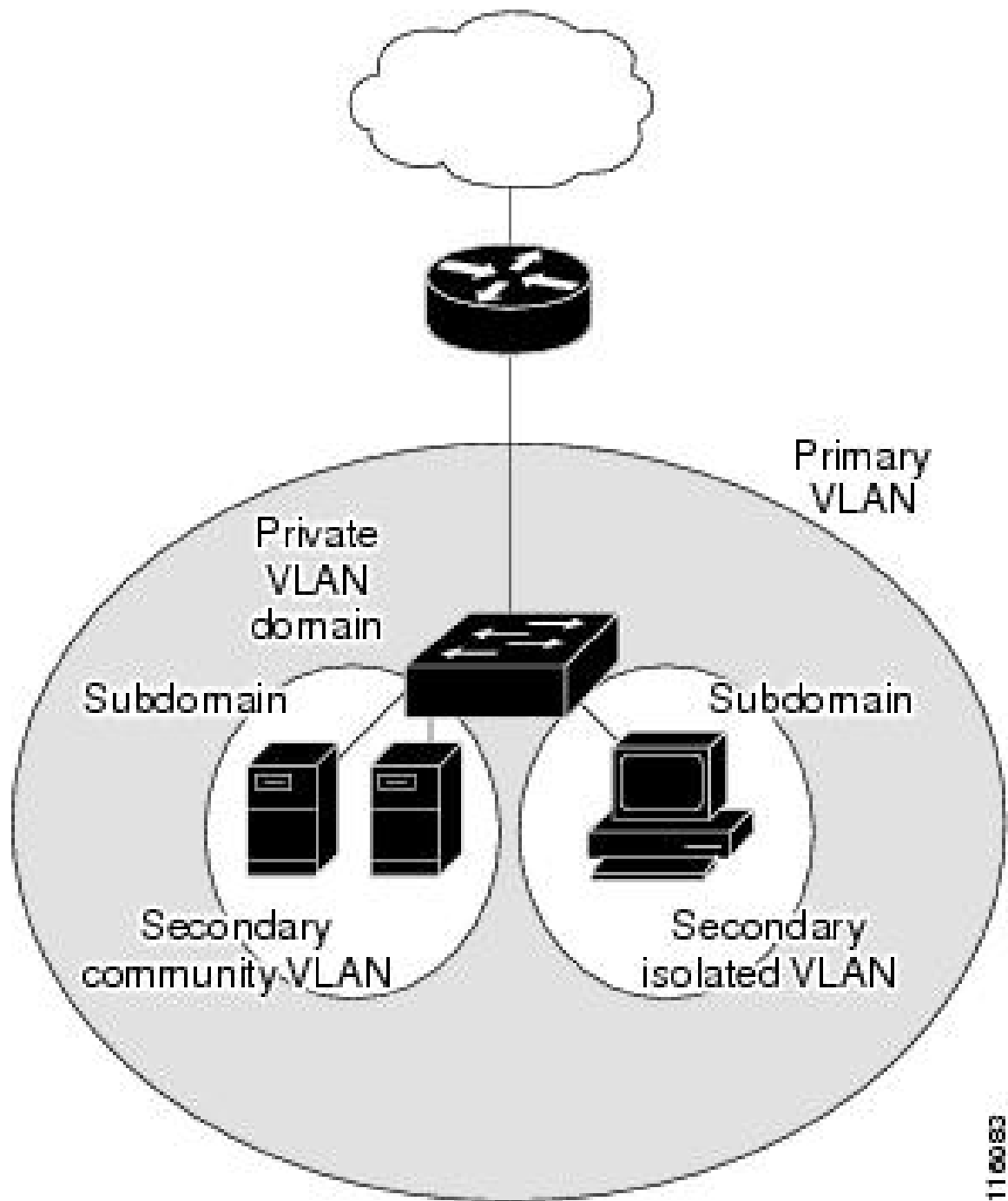

**Note** You must first create the VLAN before you can convert it to a PVLAN, either primary or secondary.

## Primary and Secondary VLANs in Private VLANs

A private VLAN domain has only one primary VLAN. Each port in a private VLAN domain is a member of the primary VLAN; the primary VLAN is the entire private VLAN domain.

Secondary VLANs provide isolation between ports within the same private VLAN domain. The following two types are secondary VLANs within a primary VLAN:

- Isolated VLANs—Ports within an isolated VLAN cannot communicate directly with each other at the Layer 2 level.
- Community VLANs—Ports within a community VLAN can communicate with each other but cannot communicate with ports in other community VLANs or in any isolated VLANs at the Layer 2 level.

## Private VLAN Ports

The three types of PVLAN ports are as follows:

- Promiscuous port—A promiscuous port belongs to the primary VLAN. The promiscuous port can communicate with all interfaces, including the community and isolated host ports, that belong to those secondary VLANs associated to the promiscuous port and associated with the primary VLAN. You can have several promiscuous ports in a primary VLAN. Each promiscuous port can have several secondary VLANs or no secondary VLANs that are associated to that port. You can associate a secondary VLAN to more than one promiscuous port, as long as the promiscuous port and secondary VLANs are within the same primary VLAN. You may want to do this for load-balancing or redundancy purposes. You can also have secondary VLANs that are not associated to any promiscuous port.

A promiscuous port can be configured as an access port.

- Isolated port—An isolated port is a host port that belongs to an isolated secondary VLAN. This port has complete isolation from other ports within the same PVLAN domain, except that it can communicate with associated promiscuous ports. PVLANS block all traffic to isolated ports except traffic from promiscuous ports. Traffic received from an isolated port is forwarded only to promiscuous ports. You can have more than one isolated port in a specified isolated VLAN. Each port is completely isolated from all other ports in the isolated VLAN.

An isolated port can be configured an access port.

- Community port—A community port is a host port that belongs to a community secondary VLAN. Community ports communicate with other ports in the same community VLAN and with associated promiscuous ports. These interfaces are isolated from all other interfaces in other communities and from all isolated ports within the PVLAN domain.

A community port must be configured as an access port.

## Primary, Isolated, and Community Private VLANs

Primary VLANs and the two types of secondary VLANs (isolated and community) have these characteristics:

- Primary VLAN— The primary VLAN carries traffic from the promiscuous ports to the host ports, both isolated and community, and to other promiscuous ports.
- Isolated VLAN —An isolated VLAN is a secondary VLAN that carries unidirectional traffic upstream from the hosts toward the promiscuous ports. You can configure only one isolated VLAN in a PVLAN

domain. An isolated VLAN can have several isolated ports. The traffic from each isolated port also remains completely separate.

- **Community VLAN**—A community VLAN is a secondary VLAN that carries upstream traffic from the community ports to the promiscuous port and to other host ports in the same community. You can configure multiple community VLANs in a PVLAN domain. The ports within one community can communicate, but these ports cannot communicate with ports in any other community or isolated VLAN in the private VLAN.

The following figure shows the traffic flows within a PVLAN, along with the types of VLANs and types of ports.

**Figure 3: Private VLAN Traffic Flows**

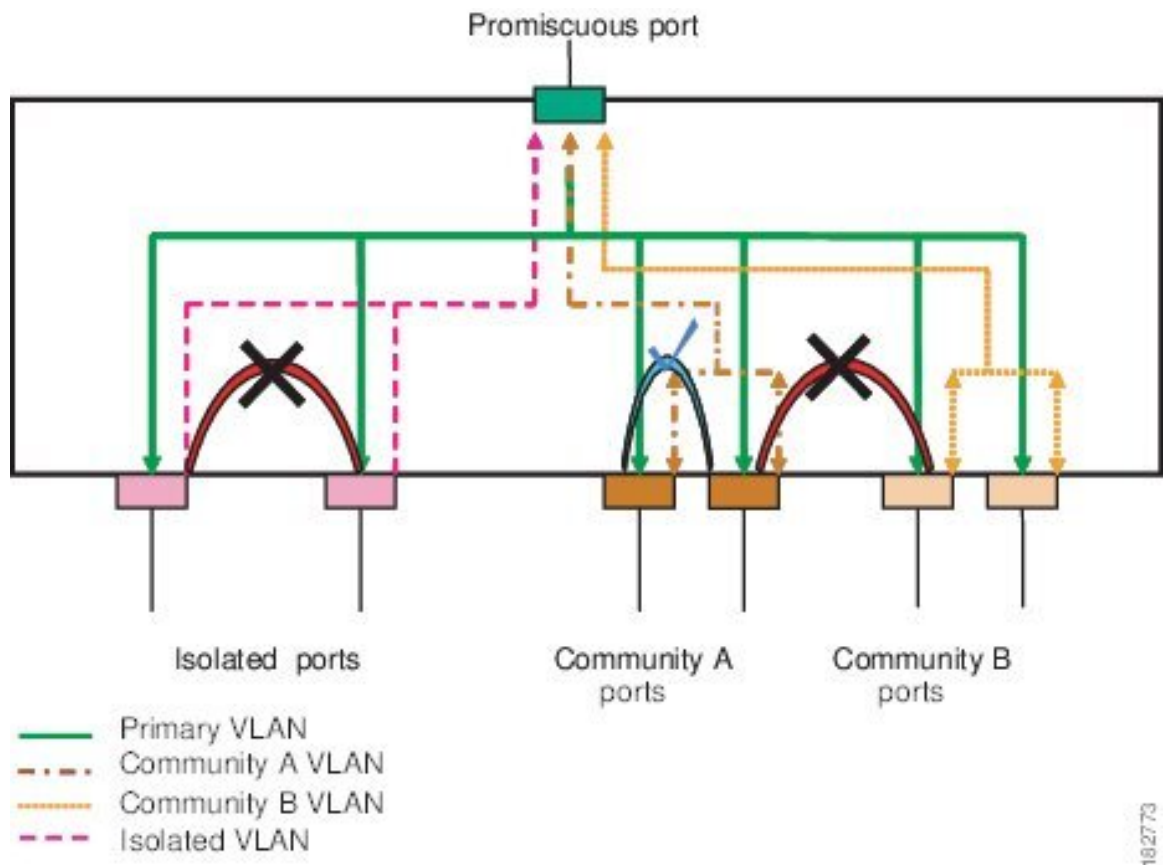

**Note** The PVLAN traffic flows are unidirectional from the host ports to the promiscuous ports. Traffic received on primary VLAN enforces no separation and forwarding is done as in a normal VLAN.

A promiscuous access port can serve only one primary VLAN and multiple secondary VLANs (community and isolated VLANs). With a promiscuous port, you can connect a wide range of devices as access points to a PVLAN. For example, you can use a promiscuous port to monitor or back up all the PVLAN servers from an administration workstation.



In a switched environment, you can assign an individual PVLAN and associated IP subnet to each individual or common group of end stations. The end stations need to communicate only with a default gateway to communicate outside the private VLAN.

## Associating Secondary VLANs with a Primary Private VLAN

When you associate secondary VLANs with a primary VLAN, follow these guidelines:

- The *secondary-vlan-list* parameter cannot contain spaces. It can contain multiple comma-separated items. Each item can be a single secondary VLAN ID or a hyphenated range of secondary VLAN IDs.
- The *secondary-vlan-list* parameter can contain multiple community VLAN IDs and one isolated VLAN ID.
- Enter a *secondary-vlan-list* or use the **add** keyword with a *secondary-vlan-list* to associate secondary VLANs with a primary VLAN.
- Use the **remove** keyword with a *secondary-vlan-list* to clear the association between secondary VLANs and a primary VLAN.
- You change the association between a secondary and primary VLAN by removing the existing association and then adding the desired association.

If you delete either the primary or secondary VLAN, the VLAN becomes inactive on the port where the association is configured. When you enter the **no private-vlan** command, the VLAN returns to the normal VLAN mode. All primary and secondary associations on that VLAN are suspended, but the interfaces remain in PVLAN mode. If you again convert the specified VLAN to PVLAN mode, the original associations are reinstated.

If you enter the **no vlan** command for the primary VLAN, all PVLAN associations with that VLAN are lost. However, if you enter the **no vlan** command for a secondary VLAN, the PVLAN associations with that VLAN are suspended and are reinstated when you recreate the specified VLAN and configure it as the previous secondary VLAN.

### Before you begin

Ensure that the PVLAN feature is enabled.

### SUMMARY STEPS

1. switch# **configure terminal**
2. switch(config)# **vlan primary-vlan-id**
3. switch(config-vlan)# **private-vlan association** {[**add**] *secondary-vlan-list* | **remove secondary-vlan-list**}
4. (Optional) switch(config-vlan)# **no private-vlan association**

### DETAILED STEPS

	Command or Action	Purpose
Step 1	switch# <b>configure terminal</b>	Enters global configuration mode.
Step 2	switch(config)# <b>vlan primary-vlan-id</b>	Enters the number of the primary VLAN that you are working in for the PVLAN configuration.

	Command or Action	Purpose
<b>Step 3</b>	switch(config-vlan)# <b>private-vlan association</b> {[add] <i>secondary-vlan-list</i>   <b>remove</b> <i>secondary-vlan-list</i> }	Associates the secondary VLANs with the primary VLAN. Use the <b>remove</b> keyword with a <i>secondary-vlan-list</i> to clear the association between secondary VLANs and a primary VLAN.
<b>Step 4</b>	(Optional) switch(config-vlan)# <b>no private-vlan association</b>	Removes all associations from the primary VLAN and returns it to normal VLAN mode.

### Example

This example shows how to associate community VLANs 100 through 110 and isolated VLAN 200 with primary VLAN 5:

```
switch# configure terminal
switch(config)# vlan 5
switch(config-vlan)# private-vlan association 100-110, 200
```

## Broadcast Traffic in Private VLANs

Broadcast traffic from ports in a private VLAN flows in the following ways:

- The broadcast traffic flows from a promiscuous port to all ports in the primary VLAN (which includes all the ports in the community and isolated VLANs). This broadcast traffic is distributed to all ports within the primary VLAN, including those ports that are not configured with private VLAN parameters.
- The broadcast traffic from an isolated port is distributed only to those promiscuous ports in the primary VLAN that are associated to that isolated port.
- The broadcast traffic from community ports is distributed to all ports within the port's community and to all promiscuous ports that are associated to the community port. The broadcast packets are not distributed to any other communities within the primary VLAN or to any isolated ports.

## Private VLAN Port Isolation

You can use PVLANS to control access to end stations as follows:

- Configure selected interfaces connected to end stations as isolated ports to prevent any communication. For example, if the end stations are servers, this configuration prevents communication between the servers.
- Configure interfaces connected to default gateways and selected end stations (for example, backup servers) as promiscuous ports to allow all end stations access to a default gateway.

## Guidelines and Limitations for Private VLANs

When configuring PVLANS, follow these guidelines:

- You must have already created the VLAN before you can assign the specified VLAN as a private VLAN.
- You must enable PVLANS before the switch can apply the PVLAN functionality.
- IGMP runs only on the primary VLAN and uses the configuration of the primary VLAN for all secondary VLANs.
- Any IGMP join request in the secondary VLAN is treated as if it is received in the primary VLAN.
- You cannot disable PVLANS if the switch has any operational ports in a PVLAN mode.
- Enter the **private-vlan synchronize** command from within the Multiple Spanning Tree (MST) region definition to map the secondary VLANs to the same MST instance as the primary VLAN.
- You cannot connect a second switch to a promiscuous or isolated PVLAN trunk. The promiscuous or isolated PVLAN trunk is supported only on host-switch.

## Configuring a Private VLAN

### Enabling Private VLANs

You must enable PVLANS on the switch to use the PVLAN functionality.



---

**Note** The PVLAN commands do not appear until you enable the PVLAN feature.

---

#### SUMMARY STEPS

1. switch# **configure terminal**
2. switch(config)# **feature private-vlan**
3. (Optional) switch(config)# **no feature private-vlan**

#### DETAILED STEPS

	Command or Action	Purpose
<b>Step 1</b>	switch# <b>configure terminal</b>	Enters global configuration mode.
<b>Step 2</b>	switch(config)# <b>feature private-vlan</b>	Enables the PVLAN feature on the switch.
<b>Step 3</b>	(Optional) switch(config)# <b>no feature private-vlan</b>	Disables the PVLAN feature on the switch.  <b>Note</b> You cannot disable PVLANS if there are operational ports on the switch that are in PVLAN mode.

#### Example

This example shows how to enable the PVLAN feature on the switch:

```
switch# configure terminal
switch(config)# feature private-vlan
```

## Enabling IGMP Snooping on Private VLANs

Beginning with Cisco NX-OS Release 10.2(2), you can enable IGMP Snooping on Private VLANs.

### Procedure

	Command or Action	Purpose
<b>Step 1</b>	switch(config)# <b>feature private-vlan</b>	Enables the PVLAN feature on the switch.
<b>Step 2</b>	(Optional) switch(config)# <b>no system multicast pvlan route-replication</b>	Enables the IGMP Snooping feature on PVLAN. The no option disables the IGMP Snooping feature.

### Example

This example shows how to enable the IGMP Snooping feature on PVLAN:

```
switch# configure terminal
switch(config)# feature private-vlan
switch(config)# system multicast pvlan route-replication
```

## Configuring a VLAN as a Private VLAN

To create a PVLAN, you first create a VLAN, and then configure that VLAN to be a PVLAN.

### Before you begin

Ensure that the PVLAN feature is enabled.

### SUMMARY STEPS

1. switch# **configure terminal**
2. switch(config)# **vlan** {vlan-id | vlan-range}
3. switch(config-vlan)# **private-vlan** {community | isolated | primary}
4. (Optional) switch(config-vlan)# **no private-vlan** {community | isolated | primary}

### DETAILED STEPS

	Command or Action	Purpose
<b>Step 1</b>	switch# <b>configure terminal</b>	Enters global configuration mode.
<b>Step 2</b>	switch(config)# <b>vlan</b> {vlan-id   vlan-range}	Places you into the VLAN configuration submenu.
<b>Step 3</b>	switch(config-vlan)# <b>private-vlan</b> {community   isolated   primary}	Configures the VLAN as either a community, isolated, or primary PVLAN. In a PVLAN, you must have one primary

	Command or Action	Purpose
		VLAN. You can have multiple community and isolated VLANs.
<b>Step 4</b>	(Optional) switch(config-vlan)# <b>no private-vlan {community   isolated   primary}</b>	Removes the PVLAN configuration from the specified VLAN(s) and returns it to normal VLAN mode. If you delete either the primary or secondary VLAN, the ports that are associated with the VLAN become inactive.

### Example

This example shows how to assign VLAN 5 to a PVLAN as the primary VLAN:

```
switch# configure terminal
switch(config)# vlan 5
switch(config-vlan)# private-vlan primary
```

This example shows how to assign VLAN 100 to a PVLAN as a community VLAN:

```
switch# configure terminal
switch(config)# vlan 100
switch(config-vlan)# private-vlan community
```

This example shows how to assign VLAN 200 to a PVLAN as an isolated VLAN:

```
switch# configure terminal
switch(config)# vlan 200
switch(config-vlan)# private-vlan isolated
```

## Associating Secondary VLANs with a Primary Private VLAN

When you associate secondary VLANs with a primary VLAN, follow these guidelines:

- The *secondary-vlan-list* parameter cannot contain spaces. It can contain multiple comma-separated items. Each item can be a single secondary VLAN ID or a hyphenated range of secondary VLAN IDs.
- The *secondary-vlan-list* parameter can contain multiple community VLAN IDs and one isolated VLAN ID.
- Enter a *secondary-vlan-list* or use the **add** keyword with a *secondary-vlan-list* to associate secondary VLANs with a primary VLAN.
- Use the **remove** keyword with a *secondary-vlan-list* to clear the association between secondary VLANs and a primary VLAN.
- You change the association between a secondary and primary VLAN by removing the existing association and then adding the desired association.

If you delete either the primary or secondary VLAN, the VLAN becomes inactive on the port where the association is configured. When you enter the **no private-vlan** command, the VLAN returns to the normal VLAN mode. All primary and secondary associations on that VLAN are suspended, but the interfaces remain in PVLAN mode. If you again convert the specified VLAN to PVLAN mode, the original associations are reinstated.

If you enter the **no vlan** command for the primary VLAN, all PVLAN associations with that VLAN are lost. However, if you enter the **no vlan** command for a secondary VLAN, the PVLAN associations with that VLAN are suspended and are reinstated when you recreate the specified VLAN and configure it as the previous secondary VLAN.

### Before you begin

Ensure that the PVLAN feature is enabled.

### SUMMARY STEPS

1. switch# **configure terminal**
2. switch(config)# **vlan primary-vlan-id**
3. switch(config-vlan)# **private-vlan association** {[add] secondary-vlan-list | **remove secondary-vlan-list**}
4. (Optional) switch(config-vlan)# **no private-vlan association**

### DETAILED STEPS

	Command or Action	Purpose
<b>Step 1</b>	switch# <b>configure terminal</b>	Enters global configuration mode.
<b>Step 2</b>	switch(config)# <b>vlan primary-vlan-id</b>	Enters the number of the primary VLAN that you are working in for the PVLAN configuration.
<b>Step 3</b>	switch(config-vlan)# <b>private-vlan association</b> {[add] secondary-vlan-list   <b>remove secondary-vlan-list</b> }	Associates the secondary VLANs with the primary VLAN. Use the <b>remove</b> keyword with a <i>secondary-vlan-list</i> to clear the association between secondary VLANs and a primary VLAN.
<b>Step 4</b>	(Optional) switch(config-vlan)# <b>no private-vlan association</b>	Removes all associations from the primary VLAN and returns it to normal VLAN mode.

### Example

This example shows how to associate community VLANs 100 through 110 and isolated VLAN 200 with primary VLAN 5:

```
switch# configure terminal
switch(config)# vlan 5
switch(config-vlan)# private-vlan association 100-110, 200
```

## Configuring an Interface as a Private VLAN Host Port

In PVLANs, host ports are part of the secondary VLANs, which are either community VLANs or isolated VLANs. Configuring a PVLAN host port involves two steps. First, you define the port as a PVLAN host port and then you configure a host association between the primary and secondary VLANs.



**Note** We recommend that you enable BPDU Guard on all interfaces configured as a host ports.

### Before you begin

Ensure that the PVLAN feature is enabled.

### SUMMARY STEPS

1. switch# **configure terminal**
2. switch(config)# **interface** *type* [*chassis*/]*slot*/*port*
3. switch(config-if)# **switchport mode private-vlan host**
4. switch(config-if)# **switchport private-vlan host-association** {*primary-vlan-id*} {*secondary-vlan-id*}
5. (Optional) switch(config-if)# **no switchport private-vlan host-association**

### DETAILED STEPS

	Command or Action	Purpose
<b>Step 1</b>	switch# <b>configure terminal</b>	Enters global configuration mode.
<b>Step 2</b>	switch(config)# <b>interface</b> <i>type</i> [ <i>chassis</i> /] <i>slot</i> / <i>port</i>	Selects the port to configure as a PVLAN host port. This port can be on a FEX (identified by the chassis option).
<b>Step 3</b>	switch(config-if)# <b>switchport mode private-vlan host</b>	Configures the port as a host port for a PVLAN.
<b>Step 4</b>	switch(config-if)# <b>switchport private-vlan host-association</b> { <i>primary-vlan-id</i> } { <i>secondary-vlan-id</i> }	Associates the port with the primary and secondary VLANs of a PVLAN. The secondary VLAN can be either an isolated or community VLAN.
<b>Step 5</b>	(Optional) switch(config-if)# <b>no switchport private-vlan host-association</b>	Removes the PVLAN association from the port.

### Example

This example shows how to configure Ethernet port 1/12 as a host port for a PVLAN and associate it to primary VLAN 5 and secondary VLAN 101:

```
switch# configure terminal
switch(config)# interface ethernet 1/12
switch(config-if)# switchport mode private-vlan host
switch(config-if)# switchport private-vlan host-association 5 101
```

## Configuring an Interface as a Private VLAN Promiscuous Port

In a PVLAN domain, promiscuous ports are part of the primary VLAN. Configuring a promiscuous port involves two steps. First, you define the port as a promiscuous port and then you configure the mapping between a secondary VLAN and the primary VLAN.

### Before you begin

Ensure that the PVLAN feature is enabled.

### SUMMARY STEPS

1. switch# **configure terminal**
2. switch(config)# **interface** *type slot/port*
3. switch(config-if)# **switchport mode private-vlan promiscuous**
4. switch(config-if)# **switchport private-vlan mapping** {*primary-vlan-id*} {*secondary-vlan-list* | **add secondary-vlan-list** | **remove secondary-vlan-list**}
5. (Optional) switch(config-if)# **no switchport private-vlan mapping**

### DETAILED STEPS

	Command or Action	Purpose
<b>Step 1</b>	switch# <b>configure terminal</b>	Enters global configuration mode.
<b>Step 2</b>	switch(config)# <b>interface</b> <i>type slot/port</i>	Selects the port to configure as a PVLAN promiscuous port. A physical interface is required. This port cannot be on a FEX.
<b>Step 3</b>	switch(config-if)# <b>switchport mode private-vlan promiscuous</b>	Configures the port as a promiscuous port for a PVLAN. You can only enable a physical Ethernet port as the promiscuous port.
<b>Step 4</b>	switch(config-if)# <b>switchport private-vlan mapping</b> { <i>primary-vlan-id</i> } { <i>secondary-vlan-list</i>   <b>add secondary-vlan-list</b>   <b>remove secondary-vlan-list</b> }	Configures the port as a promiscuous port and associates the specified port with a primary VLAN and a selected list of secondary VLANs. The secondary VLAN can be either an isolated or community VLAN.
<b>Step 5</b>	(Optional) switch(config-if)# <b>no switchport private-vlan mapping</b>	Clears the mapping from the PVLAN.

### Example

This example shows how to configure Ethernet interface 1/4 as a promiscuous port associated with primary VLAN 5 and secondary isolated VLAN 200:

```
switch# configure terminal
switch(config)# interface ethernet 1/4
switch(config-if)# switchport mode private-vlan promiscuous
switch(config-if)# switchport private-vlan mapping 5 200
```



## Configuring a Layer 2 Interface as a Private VLAN Isolated Trunk Port

You can configure a Layer 2 interface as a private VLAN isolated trunk port. These isolated trunk ports carry traffic for multiple secondary VLANs as well as normal VLANs.



**Note** You must associate the primary and secondary VLANs before they become operational on the private VLAN isolated trunk port.

### Before you begin

Ensure that the private VLAN feature is enabled.

### SUMMARY STEPS

1. **config t**
2. **interface** *{type slot/port}*
3. **switchport**
4. **switchport mode private-vlan trunk secondary**
5. (Optional) **switchport private-vlan trunk native vlan** *vlan-id*
6. **switchport private-vlan trunk allowed vlan** *{add vlan-list | all | except vlan-list | none | remove vlan-list}*
7. [**no**] **switchport private-vlan association trunk** *{primary-vlan-id [secondary-vlan-id]}*
8. **exit**
9. (Optional) **show interface switchport**
10. (Optional) **copy running-config startup-config**

### DETAILED STEPS

	Command or Action	Purpose
Step 1	<b>config t</b>  <b>Example:</b> switch# config t switch(config)#	Enters configuration mode.
Step 2	<b>interface</b> <i>{type slot/port}</i>  <b>Example:</b> switch(config)# interface ethernet 2/11 switch(config-if)#	Selects the Layer 2 port to configure as a private VLAN isolated trunk port.
Step 3	<b>switchport</b>  <b>Example:</b> switch(config-if)# switchport switch(config-if)#	Configures the Layer 2 port as a switch port.
Step 4	<b>switchport mode private-vlan trunk secondary</b>  <b>Example:</b>	Configures the Layer 2 port as an isolated trunk port to carry traffic for multiple isolated VLANs.

	Command or Action	Purpose
	<pre>switch(config-if)# switchport mode private-vlan trunk secondary switch(config-if)#</pre>	<p><b>Note</b> You cannot put community VLANs into the isolated trunk port.</p>
<b>Step 5</b>	<p>(Optional) <b>switchport private-vlan trunk native vlan <i>vlan-id</i></b></p> <p><b>Example:</b></p> <pre>switch(config-if)# switchport private-vlan trunk native vlan 5</pre>	<p>Sets the native VLAN for the 802.1Q trunk. Valid values are from 1 to 3968 and 4048 to 4093. The default value is 1.</p> <p><b>Note</b> If you are using a private VLAN as the native VLAN for the isolated trunk port, you must enter a value for a secondary VLAN or a normal VLAN; you cannot configure a primary VLAN as the native VLAN.</p>
<b>Step 6</b>	<p><b>switchport private-vlan trunk allowed vlan {add <i>vlan-list</i>   all   except <i>vlan-list</i>   none   remove <i>vlan-list</i>}</b></p> <p><b>Example:</b></p> <pre>switch(config-if)# switchport private-vlan trunk allowed vlan add 1 switch(config-if)#</pre>	<p>Sets the allowed VLANs for the private VLAN isolated trunk interface. Valid values are from 1 to 3968 and 4048 to 4093.</p> <p>When you map the private primary and secondary VLANs to the isolated trunk port, the system automatically puts all the primary VLANs into the allowed VLAN list for this port.</p> <p><b>Note</b> Ensure that the native VLAN is part of the allowed VLAN list. The default for this command is to allow no VLANs on this interface, so you must configure the native VLAN as an allowed VLAN, unless it is already added as an associated VLAN, to pass native VLAN traffic.</p>
<b>Step 7</b>	<p><b>[no] switchport private-vlan association trunk {<i>primary-vlan-id</i> [<i>secondary-vlan-id</i>]}</b></p> <p><b>Example:</b></p> <pre>switch(config-if)# switchport private-vlan association trunk 10 101 switch(config-if)#</pre>	<p>Associate the Layer 2 isolated trunk port with the primary and secondary VLANs of private VLANs. The secondary VLAN must be an isolated VLAN. You can associate a maximum of 16 private VLAN primary and secondary pairs on each isolated trunk port. You must reenter the command for each pair of primary and secondary VLANs that you are working with.</p> <p><b>Note</b> Each secondary VLAN on an isolated trunk port must be associated with a different primary VLAN. You cannot put two isolated VLANs that are associated with the same primary VLAN into a private VLAN isolated trunk port. If you do, the last entry overwrites the previous entry.</p> <p>or</p> <p>Remove the private VLAN association from the private VLAN isolated trunk port.</p>

	Command or Action	Purpose
Step 8	<b>exit</b> <b>Example:</b> <pre>switch(config-if)# exit switch(config)#</pre>	Exits the interface configuration mode.
Step 9	(Optional) <b>show interface switchport</b> <b>Example:</b> <pre>switch# show interface switchport</pre>	Displays information on all interfaces configured as switch ports.
Step 10	(Optional) <b>copy running-config startup-config</b> <b>Example:</b> <pre>switch(config)# copy running-config startup-config</pre>	Copies the running configuration to the startup configuration.

### Example

This example shows how to configure the Layer 2 port 2/1 as a private VLAN isolated trunk port associated with three different primary VLANs and an associated secondary VLAN:

```
switch# config t
switch(config)# interface ethernet 2/1
switch(config-if)# switchport mode private-vlan trunk secondary
switch(config-if)# switchport private-vlan trunk allowed vlan add 1
switch(config-if)# switchport private-vlan association trunk 10 101
switch(config-if)# switchport private-vlan association trunk 20 201
switch(config-if)# switchport private-vlan association trunk 30 102
switch(config-if)# exit
switch(config)#
```

## Configuring a Layer 2 Interface as a Private VLAN Promiscuous Trunk Port

You can configure a Layer 2 interface as a private VLAN promiscuous trunk port and then associate that promiscuous trunk port with multiple primary VLANs. These promiscuous trunk ports carry traffic for multiple primary VLANs as well as normal VLANs.



**Note** You must associate the primary and secondary VLANs before they become operational on the private VLAN promiscuous trunk port.

### Before you begin

Ensure that the private VLAN feature is enabled.

### SUMMARY STEPS

1. **config t**
2. **interface** *{type slot/port}*
3. **switchport**

4. **switchport mode private-vlan trunk promiscuous**
5. (Optional) **switchport private-vlan trunk native vlan** *vlan-id*
6. **switchport mode private-vlan trunk allowed vlan** {**add** *vlan-list* | **all** | **except** *vlan-list* | **none** | **remove** *vlan-list*}
7. [**no**]**switchport private-vlan mapping trunk** *primary-vlan-id* [*secondary-vlan-id*] {**add** *secondary-vlan-list* | **remove** *secondary-vlan-id*}
8. **exit**
9. (Optional) **show interface switchport**
10. (Optional) **copy running-config startup-config**

## DETAILED STEPS

	Command or Action	Purpose
<b>Step 1</b>	<b>config t</b> <b>Example:</b> switch# config t switch(config)#	Enters configuration mode.
<b>Step 2</b>	<b>interface</b> { <i>type slot/port</i> } <b>Example:</b> switch(config)# interface ethernet 2/1 switch(config-if)#	Selects the Layer 2 port to configure as a private VLAN promiscuous trunk port.
<b>Step 3</b>	<b>switchport</b> <b>Example:</b> switch(config-if)# switchport switch(config-if)#	Configures the Layer 2 port as a switch port.
<b>Step 4</b>	<b>switchport mode private-vlan trunk promiscuous</b> <b>Example:</b> switch(config-if)# switchport mode private-vlan trunk promiscuous switch(config-if)#	Configures the Layer 2 port as a promiscuous trunk port to carry traffic for multiple private VLANs as well as normal VLANs.
<b>Step 5</b>	(Optional) <b>switchport private-vlan trunk native vlan</b> <i>vlan-id</i> <b>Example:</b> switch(config-if)# switchport private-vlan trunk native vlan 5	Sets the native VLAN for the 802.1Q trunk. Valid values are from 1 to 3968 and 4048 to 4093. The default value is 1. <b>Note</b> If you are using a private VLAN as the native VLAN for the promiscuous trunk port, you must enter a value for a primary VLAN or a normal VLAN; you cannot configure a secondary VLAN as the native VLAN.
<b>Step 6</b>	<b>switchport mode private-vlan trunk allowed vlan</b> { <b>add</b> <i>vlan-list</i>   <b>all</b>   <b>except</b> <i>vlan-list</i>   <b>none</b>   <b>remove</b> <i>vlan-list</i> } <b>Example:</b>	Sets the allowed VLANs for the private VLAN promiscuous trunk interface. Valid values are from 1 to 3968 and 4048 to 4093.  When you map the private primary and secondary VLANs to the promiscuous trunk port, the system automatically

	Command or Action	Purpose
	<pre>switch(config-if)# switchport private-vlan trunk allowed vlan add 1 switch(config-if)#</pre>	<p>puts all the primary VLANs into the allowed VLAN list for this port.</p> <p><b>Note</b> Ensure that the native VLAN is part of the allowed VLAN list. The default for this command is to allow no VLANs on this interface, so you must configure the native VLAN as an allowed VLAN, unless it is already added as an associated VLAN, to pass native VLAN traffic.</p>
<b>Step 7</b>	<p><b>[no]switchport private-vlan mapping trunk primary-vlan-id [secondary-vlan-id] {add secondary-vlan-list   remove secondary-vlan-id}</b></p> <p><b>Example:</b></p> <pre>switch(config-if)# switchport private-vlan mapping trunk 4 add 5 switch(config-if)#</pre>	<p>Map or remove the mapping for the promiscuous trunk port with the primary VLAN and a selected list of associated secondary VLANs. The secondary VLAN can be either an isolated or community VLAN. The private VLAN association between primary and secondary VLANs must be operational to pass traffic. You can map a maximum of 16 private VLAN primary and secondary pairs on each promiscuous trunk port. You must reenter the command for each primary VLAN that you are working with.</p> <p>or</p> <p>Remove the private VLAN promiscuous trunk mappings from the interface.</p>
<b>Step 8</b>	<p><b>exit</b></p> <p><b>Example:</b></p> <pre>switch(config-if)# exit switch(config)#</pre>	Exits the interface configuration mode.
<b>Step 9</b>	<p>(Optional) <b>show interface switchport</b></p> <p><b>Example:</b></p> <pre>switch# show interface switchport</pre>	Displays information on all interfaces configured as switch ports.
<b>Step 10</b>	<p>(Optional) <b>copy running-config startup-config</b></p> <p><b>Example:</b></p> <pre>switch(config)# copy running-config startup-config</pre>	Copies the running configuration to the startup configuration.

### Example

This example shows how to configure the Layer 2 port 2/1 as a promiscuous trunk port associated with two primary VLANs and their associated secondary VLANs:

```
switch# config t
switch(config)# interface ethernet 2/1
switch(config-if)# switchport
switch(config-if)# switchport mode private-vlan trunk promiscuous
switch(config-if)# switchport private-vlan trunk allowed vlan add 1
```

```
switch(config-if) # switchport private-vlan mapping trunk 2 add 3
switch(config-if) # switchport private-vlan mapping trunk 4 add 5
switch(config-if) # switchport private-vlan mapping trunk 1 add 20
switch(config-if) # exit
switch(config) #
```

## Mapping Secondary VLANs to the VLAN Interface of a Primary VLAN



**Note** See the *Cisco Nexus 7000 Series NX-OS Interfaces Configuration Guide* for information on assigning IP addresses to VLAN interfaces on primary VLANs of private VLANs.

You map secondary VLANs to the VLAN interface of a primary VLAN. Isolated and community VLANs are both called secondary VLANs. To allow Layer 3 processing of private VLAN ingress traffic, you map secondary VLANs to the VLAN network interface of a primary VLAN.



**Note** You must enable VLAN network interfaces before you configure the VLAN network interface. VLAN network interfaces on community or isolated VLANs that are associated with a primary VLAN will be out of service. Only the VLAN network interface on the primary VLAN is in service.

### Before you begin

- Enable the private VLAN feature.
- Enable the VLAN interface feature.
- Ensure that you are in the correct VDC (or enter the **switchto vdc** command). You can repeat VLAN names and IDs in different VDCs, so you must confirm that you are working in the correct VDC.
- Ensure that you are working on the correct primary VLAN Layer 3 interface to map the secondary VLANs.

### SUMMARY STEPS

1. **config t**
2. **interface vlan primary-vlan-ID**
3. Enter one of the following commands:
4. **exit**
5. (Optional) **show interface vlan primary-vlan-id private-vlan mapping**
6. (Optional) **copy running-config startup-config**

### DETAILED STEPS

	Command or Action	Purpose
Step 1	<b>config t</b> Example:	Enters global configuration mode.

	Command or Action	Purpose						
	<pre>switch# config t switch(config)#</pre>							
<b>Step 2</b>	<p><b>interface</b> <code>vlan</code> <i>primary-vlan-ID</i></p> <p><b>Example:</b></p> <pre>switch(config)# interface vlan 5 switch(config-if)#</pre>	Enters the number of the primary VLAN that you are working in for the private VLAN configuration and places you into the interface configuration mode for the primary VLAN.						
<b>Step 3</b>	<p>Enter one of the following commands:</p> <table border="1"> <thead> <tr> <th>Option</th> <th>Description</th> </tr> </thead> <tbody> <tr> <td><b>private-vlan mapping</b> {[add] <i>secondary-vlan-list</i>   remove <i>secondary-vlan-list</i>}</td> <td>Maps the secondary VLANs to the SVI or Layer 3 interface of the primary VLAN. This action allows the Layer 3 switching of private VLAN ingress traffic.</td> </tr> <tr> <td><b>no private-vlan mapping</b></td> <td>Clears the mapping to the Layer 3 interface between the secondary VLANs and the primary VLANs.</td> </tr> </tbody> </table> <p><b>Example:</b></p> <pre>switch(config-if)# private-vlan mapping 100-105, 109</pre>	Option	Description	<b>private-vlan mapping</b> {[add] <i>secondary-vlan-list</i>   remove <i>secondary-vlan-list</i> }	Maps the secondary VLANs to the SVI or Layer 3 interface of the primary VLAN. This action allows the Layer 3 switching of private VLAN ingress traffic.	<b>no private-vlan mapping</b>	Clears the mapping to the Layer 3 interface between the secondary VLANs and the primary VLANs.	
Option	Description							
<b>private-vlan mapping</b> {[add] <i>secondary-vlan-list</i>   remove <i>secondary-vlan-list</i> }	Maps the secondary VLANs to the SVI or Layer 3 interface of the primary VLAN. This action allows the Layer 3 switching of private VLAN ingress traffic.							
<b>no private-vlan mapping</b>	Clears the mapping to the Layer 3 interface between the secondary VLANs and the primary VLANs.							
<b>Step 4</b>	<p><b>exit</b></p> <p><b>Example:</b></p> <pre>switch(config-if)# exit switch(config)#</pre>	Exits interface configuration mode.						
<b>Step 5</b>	<p>(Optional) <b>show interface</b> <code>vlan</code> <i>primary-vlan-id</i> <b>private-vlan mapping</b></p> <p><b>Example:</b></p> <pre>switch(config)# show interface vlan 101 private-vlan mapping</pre>	Displays the interface private VLAN information.						
<b>Step 6</b>	<p>(Optional) <b>copy running-config startup-config</b></p> <p><b>Example:</b></p> <pre>switch(config)# copy running-config startup-config</pre>	Copies the running configuration to the startup configuration.						

**Example**

This example shows how to map the secondary VLANs 100 through 105 and 109 on the Layer 3 interface of the primary VLAN 5:

```
switch # config t
switch(config)# interface vlan 5
switch(config-if)# private-vlan mapping 100-105, 109
```

```
switch(config-if)# exit
switch(config)#
```

## Verifying the Private VLAN Configuration

Use the following commands to display PVLAN configuration information.

Command	Purpose
switch# <b>show feature</b>	Displays the features enabled on the switch.
switch# <b>show interface switchport</b>	Displays information on all interfaces configured as switch ports.
switch# <b>show vlan private-vlan [type]</b>	Displays the status of the PVLAN.

This example shows how to display the PVLAN configuration:

```
switch# show vlan private-vlan
Primary  Secondary  Type          Ports
-----  -
5        100        community
5        101        community     Eth1/12, Eth100/1/1
5        102        community
5        110        community
5        200        isolated      Eth1/2

switch# show vlan private-vlan type
Vlan Type
-----
5    primary
100  community
101  community
102  community
110  community
200  isolated
```

This example shows how to display enabled features (some of the output has been removed for brevity):

```
switch# show feature
Feature Name          Instance  State
-----
fcsp                  1        enabled
...
interface-vlan       1        enabled
private-vlan         1        enabled
udld                  1        disabled
```



...





## CHAPTER 5

# Configuring Access and Trunk Interfaces

---

- [Information About Access and Trunk Interfaces, on page 41](#)
- [Configuring Access and Trunk Interfaces, on page 45](#)
- [Verifying the Interface Configuration, on page 50](#)

## Information About Access and Trunk Interfaces

### Understanding Access and Trunk Interfaces

Ethernet interfaces can be configured either as access ports or a trunk ports, as follows:

- An access port can have only one VLAN configured on the interface; it can carry traffic for only one VLAN.
- A trunk port can have two or more VLANs configured on the interface; it can carry traffic for several VLANs simultaneously.



---

**Note** Cisco NX-OS supports only IEEE 802.1Q-type VLAN trunk encapsulation.

---

The following figure shows how you can use trunk ports in the network. The trunk port carries traffic for two or more VLANs.

Figure 4: Devices in a Trunking Environment

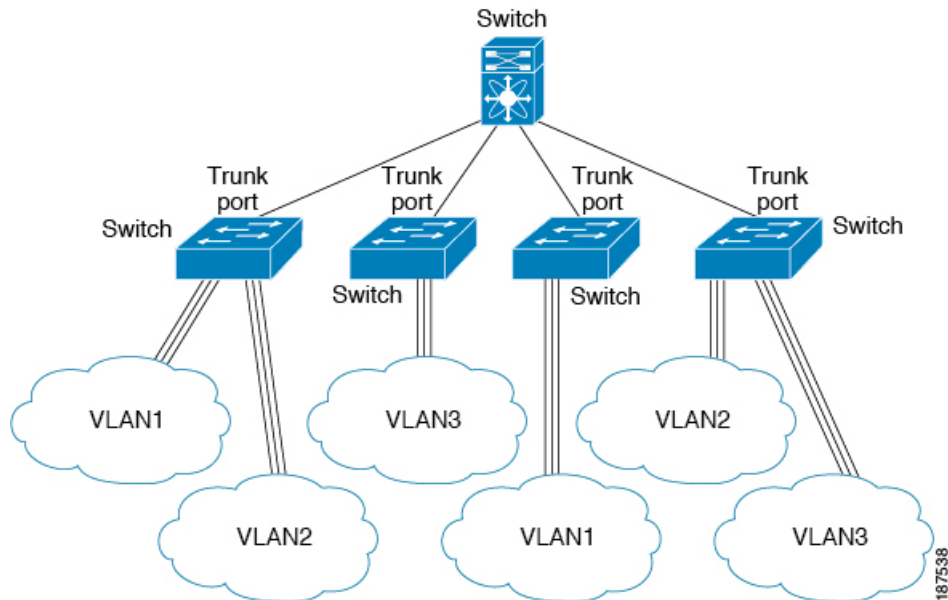

In order to correctly deliver the traffic on a trunk port with several VLANs, the device uses the IEEE 802.1Q encapsulation or tagging method.

To optimize the performance on access ports, you can configure the port as a host port. Once the port is configured as a host port, it is automatically set as an access port, and channel grouping is disabled. Use the host designation to decrease the time it takes the designated port to begin to forward packets.



**Note** Only an end station can be set as a host port; you will receive an error message if you attempt to configure other ports as hosts.

If an access port receives a packet with an 802.1Q tag in the header other than the access VLAN value, that port drops the packet without learning its MAC source address.



**Note** An Ethernet interface can function as either an access port or a trunk port; it cannot function as both port types simultaneously.

## Understanding IEEE 802.1Q Encapsulation

A trunk is a point-to-point link between the device and another networking device. Trunks carry the traffic of multiple VLANs over a single link and allow you to extend VLANs across an entire network.

To correctly deliver the traffic on a trunk port with several VLANs, the device uses the IEEE 802.1Q encapsulation (tagging) method. This tag carries information about the specific VLAN to which the frame and packet belong. This method allows packets that are encapsulated for several different VLANs to traverse the same port and maintain traffic separation between the VLANs. The encapsulated VLAN tag also allows the trunk to move traffic end-to-end through the network on the same VLAN.

Figure 5: Header Without and With 802.1Q Tag Included

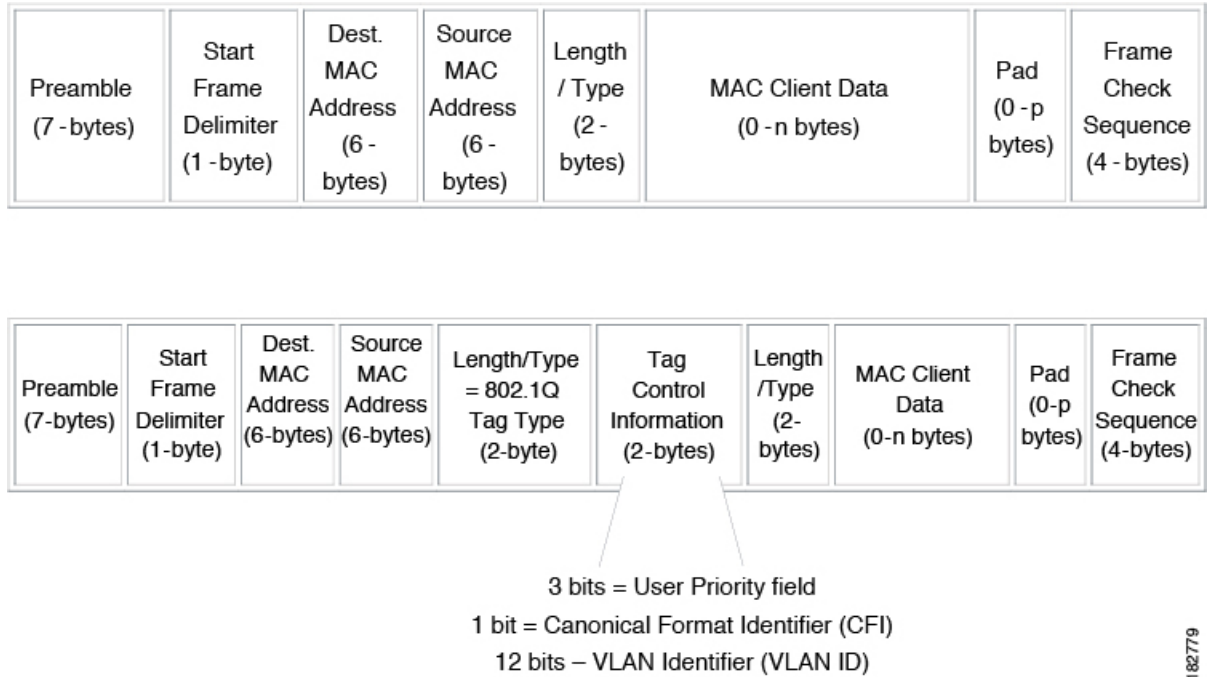

182779

## Understanding Access VLANs

When you configure a port in access mode, you can specify which VLAN will carry the traffic for that interface. If you do not configure the VLAN for a port in access mode, or an access port, the interface carries traffic for the default VLAN (VLAN1).

You can change the access port membership in a VLAN by specifying the new VLAN. You must create the VLAN before you can assign it as an access VLAN for an access port. If you change the access VLAN on an access port to a VLAN that is not yet created, the system will shut that access port down.



**Note** If you change the VLAN on an access port or a trunk port it will flap the interface. However, if the port is part of a vPC, then first change the native VLAN on the secondary vPC, and then to primary vPC.

If an access port receives a packet with an 802.1Q tag in the header other than the access VLAN value, that port drops the packet without learning its MAC source address.

## Understanding the Native VLAN ID for Trunk Ports

A trunk port can carry untagged packets simultaneously with the 802.1Q tagged packets. When you assign a default port VLAN ID to the trunk port, all untagged traffic travels on the default port VLAN ID for the trunk port, and all untagged traffic is assumed to belong to this VLAN. This VLAN is referred to as the native VLAN ID for a trunk port. The native VLAN ID is the VLAN that carries untagged traffic on trunk ports.

The trunk port sends an egressing packet with a VLAN that is equal to the default port VLAN ID as untagged; all the other egressing packets are tagged by the trunk port. If you do not configure a native VLAN ID, the trunk port uses the default VLAN.



---

**Note** Native VLAN ID numbers *must* match on both ends of the trunk.

---

## Understanding Allowed VLANs

By default, a trunk port sends traffic to and receives traffic from all VLANs. All VLAN IDs are allowed on each trunk. However, you can remove VLANs from this inclusive list to prevent traffic from the specified VLANs from passing over the trunk. You can add any specific VLANs later that you may want the trunk to carry traffic for back to the list.

To partition the Spanning Tree Protocol (STP) topology for the default VLAN, you can remove VLAN1 from the list of allowed VLANs. Otherwise, VLAN1, which is enabled on all ports by default, will have a very big STP topology, which can result in problems during STP convergence. When you remove VLAN1, all data traffic for VLAN1 on this port is blocked, but the control traffic continues to move on the port.

## Understanding Native 802.1Q VLANs

To provide additional security for traffic passing through an 802.1Q trunk port, the **vlan dot1q tag native** command was introduced. This feature provides a means to ensure that all packets going out of a 802.1Q trunk port are tagged and to prevent reception of untagged packets on the 802.1Q trunk port.

Without this feature, all tagged ingress frames received on a 802.1Q trunk port are accepted as long as they fall inside the allowed VLAN list and their tags are preserved. Untagged frames are tagged with the native VLAN ID of the trunk port before further processing. Only those egress frames whose VLAN tags are inside the allowed range for that 802.1Q trunk port are received. If the VLAN tag on a frame happens to match that of the native VLAN on the trunk port, the tag is stripped off and the frame is sent untagged.

This behavior could potentially be exploited to introduce "VLAN hopping" in which a hacker could try and have a frame jump to a different VLAN. It is also possible for traffic to become part of the native VLAN by sending untagged packets into an 802.1Q trunk port.

To address the above issues, the **vlan dot1q tag native** command performs the following functions:

- On the ingress side, all untagged data traffic is dropped.
- On the egress side, all traffic is tagged. If traffic belongs to native VLAN it is tagged with the native VLAN ID.

This feature is supported on all the directly connected Ethernet and Port Channel interfaces.



---

**Note** You can enable the **vlan dot1q tag native** command by entering the command in the global configuration mode.

---

# Configuring Access and Trunk Interfaces

## Configuring a LAN Interface as an Ethernet Access Port

You can configure an Ethernet interface as an access port. An access port transmits packets on only one, untagged VLAN. You specify which VLAN traffic that the interface carries. If you do not specify a VLAN for an access port, the interface carries traffic only on the default VLAN. The default VLAN is VLAN1.

The VLAN must exist before you can specify that VLAN as an access VLAN. The system shuts down an access port that is assigned to an access VLAN that does not exist.

### SUMMARY STEPS

1. switch# **configure terminal**
2. switch(config)# **interface** *{{type slot/port}}* | **{port-channel number}}**
3. switch(config-if)# **switchport mode** *{access | trunk}*
4. switch(config-if)# **switchport access vlan** *vlan-id*

### DETAILED STEPS

	Command or Action	Purpose
<b>Step 1</b>	switch# <b>configure terminal</b>	Enters global configuration mode.
<b>Step 2</b>	switch(config)# <b>interface</b> <i>{{type slot/port}}</i>   <b>{port-channel number}}</b>	Specifies an interface to configure, and enters interface configuration mode.
<b>Step 3</b>	switch(config-if)# <b>switchport mode</b> <i>{access   trunk}</i>	Sets the interface as a nontrunking nontagged single-VLAN Ethernet interface. An access port can carry traffic in one VLAN only. By default, an access port carries traffic for VLAN1; to set the access port to carry traffic for a different VLAN, use the <b>switchport access vlan</b> command.
<b>Step 4</b>	switch(config-if)# <b>switchport access vlan</b> <i>vlan-id</i>	Specifies the VLAN for which this access port will carry traffic. If you do not enter this command, the access port carries traffic on VLAN1 only; use this command to change the VLAN for which the access port carries traffic.

### Example

This example shows how to set an interface as an Ethernet access port that carries traffic for a specific VLAN only:

```
switch# configure terminal
switch(config)# interface ethernet 1/10
switch(config-if)# switchport mode access
switch(config-if)# switchport access vlan 5
```

## Configuring Access Host Ports

By using a switchport host, you can make an access port a spanning-tree edge port, and enable BPDU Filtering and BPDU Guard at the same time.

### Before you begin

Ensure that you are configuring the correct interface; it must be an interface that is connected to an end station.

### SUMMARY STEPS

1. switch# **configure terminal**
2. switch(config)# **interface** *type slot/port*
3. switch(config-if)# **switchport host**

### DETAILED STEPS

	Command or Action	Purpose
<b>Step 1</b>	switch# <b>configure terminal</b>	Enters global configuration mode.
<b>Step 2</b>	switch(config)# <b>interface</b> <i>type slot/port</i>	Specifies an interface to configure, and enters interface configuration mode.
<b>Step 3</b>	switch(config-if)# <b>switchport host</b>	Sets the interface to spanning-tree port type edge, turns on BPDU Filtering and BPDU Guard.  <b>Note</b> Apply this command only to switchports that connect to hosts.

### Example

This example shows how to set an interface as an Ethernet access host port with EtherChannel disabled:

```
switch# configure terminal
switch(config)# interface ethernet 1/10
switch(config-if)# switchport host
```

## Configuring Trunk Ports

You can configure an Ethernet port as a trunk port; a trunk port transmits untagged packets for the native VLAN plus encapsulated, tagged, packets for multiple VLANs.



**Note** Cisco NX-OS supports only 802.1Q encapsulation.



**SUMMARY STEPS**

1. switch# **configure terminal**
2. switch(config)# **interface** {*type slot/port* | **port-channel number**}
3. switch(config-if)# **switchport mode** {**access** | **trunk**}

**DETAILED STEPS**

	<b>Command or Action</b>	<b>Purpose</b>
<b>Step 1</b>	switch# <b>configure terminal</b>	Enters global configuration mode.
<b>Step 2</b>	switch(config)# <b>interface</b> { <i>type slot/port</i>   <b>port-channel number</b> }	Specifies an interface to configure, and enters interface configuration mode.
<b>Step 3</b>	switch(config-if)# <b>switchport mode</b> { <b>access</b>   <b>trunk</b> }	Sets the interface as an Ethernet trunk port. A trunk port can carry traffic in one or more VLANs on the same physical link (VLANs are based on the trunk-allowed VLANs list). By default, a trunk interface can carry traffic for all VLANs. To specify that only certain VLANs are allowed on the specified trunk, use the <b>switchport trunk allowed vlan</b> command.

**Example**

This example shows how to set an interface as an Ethernet trunk port:

```
switch# configure terminal
switch(config)# interface ethernet 1/3
switch(config-if)# switchport mode trunk
```

**Configuring the Native VLAN for 802.1Q Trunking Ports**

If you do not configure this parameter, the trunk port uses the default VLAN as the native VLAN ID.

**SUMMARY STEPS**

1. switch# **configure terminal**
2. switch(config)# **interface** {*type slot/port* | **port-channel number**}
3. switch(config-if)# **switchport trunk native vlan** *vlan-id*

**DETAILED STEPS**

	<b>Command or Action</b>	<b>Purpose</b>
<b>Step 1</b>	switch# <b>configure terminal</b>	Enters global configuration mode.
<b>Step 2</b>	switch(config)# <b>interface</b> { <i>type slot/port</i>   <b>port-channel number</b> }	Specifies an interface to configure, and enters interface configuration mode.

	Command or Action	Purpose
<b>Step 3</b>	switch(config-if)# <b>switchport trunk native vlan</b> <i>vlan-id</i>	Sets the native VLAN for the 802.1Q trunk. Valid values are from 1 to 4094, except those VLANs reserved for internal use. The default value is VLAN1.

### Example

This example shows how to set the native VLAN for an Ethernet trunk port:

```
switch# configure terminal
switch(config)# interface ethernet 1/3
switch(config-if)# switchport trunk native vlan 5
```

## Configuring the Allowed VLANs for Trunking Ports

You can specify the IDs for the VLANs that are allowed on the specific trunk port.

Before you configure the allowed VLANs for the specified trunk ports, ensure that you are configuring the correct interfaces and that the interfaces are trunks.

### SUMMARY STEPS

1. switch# **configure terminal**
2. switch(config)# **interface** *{type slot/port | port-channel number}*
3. switch(config-if)# **switchport trunk allowed vlan** *{vlan-list all | none [add |except | none | remove {vlan-list}]}*

### DETAILED STEPS

	Command or Action	Purpose
<b>Step 1</b>	switch# <b>configure terminal</b>	Enters global configuration mode.
<b>Step 2</b>	switch(config)# <b>interface</b> <i>{type slot/port   port-channel number}</i>	Specifies an interface to configure, and enters interface configuration mode.
<b>Step 3</b>	switch(config-if)# <b>switchport trunk allowed vlan</b> <i>{vlan-list all   none [add  except   none   remove {vlan-list}]}</i>	<p>Sets allowed VLANs for the trunk interface. The default is to allow all VLANs on the trunk interface: 1 to 3967 and 4048 to 4094. VLANs 3968 to 4047 are the default VLANs reserved for internal use by default; this group of VLANs is configurable. By default, all VLANs are allowed on all trunk interfaces.</p> <p><b>Note</b> You cannot add internally allocated VLANs as allowed VLANs on trunk ports. The system returns a message if you attempt to list an internally allocated VLAN as an allowed VLAN.</p>

**Example**

This example shows how to add VLANs to the list of allowed VLANs on an Ethernet trunk port:

```
switch# configure terminal
switch(config)# interface ethernet 1/3
switch(config-if)# switchport trunk allow vlan 15-20
```

## Configuring Native 802.1Q VLANs

Typically, you configure 802.1Q trunks with a native VLAN ID, which strips tagging from all packets on that VLAN. This configuration allows all untagged traffic and control traffic to transit the Cisco Nexus device. Packets that enter the switch with 802.1Q tags that match the native VLAN ID value are similarly stripped of tagging.

To maintain the tagging on the native VLAN and drop untagged traffic, enter the **vlan dot1q tag native** command. The switch will tag the traffic received on the native VLAN and admit only 802.1Q-tagged frames, dropping any untagged traffic, including untagged traffic in the native VLAN.

Control traffic continues to be accepted untagged on the native VLAN on a trunked port, even when the **vlan dot1q tag native** command is enabled.



---

**Note** The **vlan dot1q tag native** command is enabled on global basis.

---

### SUMMARY STEPS

1. switch# **configure terminal**
2. switch(config)# **vlan dot1q tag native [tx-only]**
3. (Optional) switch(config)# **no vlan dot1q tag native [tx-only]**
4. (Optional) switch# **show vlan dot1q tag native**

### DETAILED STEPS

	Command or Action	Purpose
<b>Step 1</b>	switch# <b>configure terminal</b>	Enters global configuration mode.
<b>Step 2</b>	switch(config)# <b>vlan dot1q tag native [tx-only]</b>	Enables dot1q (IEEE 802.1Q) tagging for all native VLANs on all trunked ports on the Cisco Nexus device. By default, this feature is disabled.
<b>Step 3</b>	(Optional) switch(config)# <b>no vlan dot1q tag native [tx-only]</b>	Disables dot1q (IEEE 802.1Q) tagging for all native VLANs on all trunked ports on the switch.
<b>Step 4</b>	(Optional) switch# <b>show vlan dot1q tag native</b>	Displays the status of tagging on the native VLANs.

### Example

This example shows how to enable 802.1Q tagging on the switch:

```
switch# configure terminal
switch(config)# vlan dot1q tag native
switch(config)# exit
switch# show vlan dot1q tag native
vlan dot1q native tag is enabled
```

## Verifying the Interface Configuration

Use the following commands to display access and trunk interface configuration information.

Command	Purpose
switch# <b>show interface</b>	Displays the interface configuration
switch# <b>show interface switchport</b>	Displays information for all Ethernet interfaces, including access and trunk interfaces.
switch# <b>show interface brief</b>	Displays interface configuration information.



## CHAPTER 6

# Configuring Rapid PVST+

- [Information About Rapid PVST+, on page 51](#)
- [Configuring Rapid PVST+, on page 67](#)
- [Verifying the Rapid PVST+ Configuration, on page 77](#)

## Information About Rapid PVST+

The Rapid PVST+ protocol is the IEEE 802.1w standard, Rapid Spanning Tree Protocol (RSTP), implemented on a per VLAN basis. Rapid PVST+ interoperates with the IEEE 802.1D standard, which mandates a single STP instance for all VLANs, rather than per VLAN.

Rapid PVST+ is enabled by default on the default VLAN (VLAN1) and on all newly created VLANs in the software. Rapid PVST+ interoperates with switches that run legacy IEEE 802.1D STP.

RSTP is an improvement on the original STP standard, 802.1D, which allows faster convergence.



---

**Note** Spanning tree is used to refer to IEEE 802.1w and IEEE 802.1s. If the text is discussing the IEEE 802.1D Spanning Tree Protocol, 802.1D is stated specifically.

---

## Understanding STP

### STP Overview

For an Ethernet network to function properly, only one active path can exist between any two stations.

When you create fault-tolerant internetworks, you must have a loop-free path between all nodes in a network. The STP algorithm calculates the best loop-free path throughout a switched network. LAN ports send and receive STP frames, which are called Bridge Protocol Data Units (BPDUs), at regular intervals. Switches do not forward these frames but use the frames to construct a loop-free path.

Multiple active paths between end stations cause loops in the network. If a loop exists in the network, end stations might receive duplicate messages and switches might learn end station MAC addresses on multiple LAN ports. These conditions result in a broadcast storm, which creates an unstable network.

STP defines a tree with a root bridge and a loop-free path from the root to all switches in the network. STP forces redundant data paths into a blocked state. If a network segment in the spanning tree fails and a redundant path exists, the STP algorithm recalculates the spanning tree topology and activates the blocked path.

When two LAN ports on a switch are part of a loop, the STP port priority and port path cost setting determine which port on the switch is put in the forwarding state and which port is put in the blocking state.

## Understanding How a Topology is Created

All switches in an extended LAN that participate in a spanning tree gather information about other switches in the network by exchanging of BPDUs. This exchange of BPDUs results in the following actions:

- The system elects a unique root switch for the spanning tree network topology.
- The system elects a designated switch for each LAN segment.
- The system eliminates any loops in the switched network by placing redundant interfaces in a backup state; all paths that are not needed to reach the root switch from anywhere in the switched network are placed in an STP-blocked state.

The topology on an active switched network is determined by the following:

- The unique switch identifier Media Access Control (MAC) address of the switch that is associated with each switch
- The path cost to the root that is associated with each interface
- The port identifier that is associated with each interface

In a switched network, the root switch is the logical center of the spanning tree topology. STP uses BPDUs to elect the root switch and root port for the switched network, as well as the root port and designated port for each switched segment.

## Understanding the Bridge ID

Each VLAN on each switch has a unique 64-bit bridge ID that consists of a bridge priority value, an extended system ID (IEEE 802.1t), and an STP MAC address allocation.

### Bridge Priority Value

The bridge priority is a 4-bit value when the extended system ID is enabled.



---

**Note** In Cisco NX-OS, the extended system ID is always enabled; you cannot disable the extended system ID.

---

### Extended System ID

A 12-bit extended system ID field is part of the bridge ID.

Figure 6: Bridge ID with Extended System ID



The switches always use the 12-bit extended system ID.

Combined with the bridge ID, the system ID extension functions as the unique identifier for a VLAN.

Table 3: Bridge Priority Value and Extended System ID with the Extended System ID Enabled

Bridge Priority Value				Extended System ID (Set Equal to the VLAN ID)											
Bit 16	Bit 15	Bit 14	Bit 13	Bit 12	Bit 11	Bit 10	Bit 9	Bit 8	Bit 7	Bit 6	Bit 5	Bit 4	Bit 3	Bit 2	Bit 1
32768	16384	8192	4096	2048	1024	512	256	128	64	32	16	8	4	2	1

STP MAC Address Allocation



**Note** Extended system ID and MAC address reduction is always enabled on the software.

With MAC address reduction enabled on any switch, you should also enable MAC address reduction on all other connected switches to avoid undesirable root bridge election and spanning tree topology issues.

When MAC address reduction is enabled, the root bridge priority becomes a multiple of 4096 plus the VLAN ID. You can only specify a switch bridge ID (used by the spanning tree algorithm to determine the identity of the root bridge, the lowest being preferred) as a multiple of 4096. Only the following values are possible:

- 0
- 4096
- 8192
- 12288
- 16384
- 20480
- 24576
- 28672
- 32768
- 36864
- 40960
- 45056

- 49152
- 53248
- 57344
- 61440

STP uses the extended system ID plus a MAC address to make the bridge ID unique for each VLAN.



---

**Note** If another bridge in the same spanning tree domain does not run the MAC address reduction feature, it could achieve root bridge ownership because its bridge ID may fall between the values specified by the MAC address reduction feature.

---

## Understanding BPDUs

Switches transmit bridge protocol data units (BPDUs) throughout the STP instance. Each switch sends configuration BPDUs to communicate and compute the spanning tree topology. Each configuration BPDU contains the following minimal information:

- The unique bridge ID of the switch that the transmitting switch determines is the root bridge
- The STP path cost to the root
- The bridge ID of the transmitting bridge
- Message age
- The identifier of the transmitting port
- Values for the hello, forward delay, and max-age protocol timer
- Additional information for STP extension protocols

When a switch transmits a Rapid PVST+ BPDU frame, all switches connected to the VLAN on which the frame is transmitted receive the BPDU. When a switch receives a BPDU, it does not forward the frame but instead uses the information in the frame to calculate a BPDU, and, if the topology changes, initiate a BPDU transmission.

A BPDU exchange results in the following:

- One switch is elected as the root bridge.
- The shortest distance to the root bridge is calculated for each switch based on the path cost.
- A designated bridge for each LAN segment is selected. This is the switch closest to the root bridge through which frames are forwarded to the root.
- A root port is selected. This is the port providing the best path from the bridge to the root bridge.
- Ports included in the spanning tree are selected.



## Election of the Root Bridge

For each VLAN, the switch with the lowest numerical value of the bridge ID is elected as the root bridge. If all switches are configured with the default priority (32768), the switch with the lowest MAC address in the VLAN becomes the root bridge. The bridge priority value occupies the most significant bits of the bridge ID.

When you change the bridge priority value, you change the probability that the switch will be elected as the root bridge. Configuring a lower value increases the probability; a higher value decreases the probability.

The STP root bridge is the logical center of each spanning tree topology in a network. All paths that are not needed to reach the root bridge from anywhere in the network are placed in STP blocking mode.

BPDUs contain information about the transmitting bridge and its ports, including bridge and MAC addresses, bridge priority, port priority, and path cost. STP uses this information to elect the root bridge for the STP instance, to elect the root port leading to the root bridge, and to determine the designated port for each segment.

## Creating the Spanning Tree Topology

In the following figure, Switch A is elected as the root bridge because the bridge priority of all the switches is set to the default (32768) and Switch A has the lowest MAC address. However, due to traffic patterns, or link types, Switch A might not be the ideal root bridge. By increasing the priority (lowering the numerical value) of the ideal switch so that it becomes the root bridge, you force an STP recalculation to form a new spanning tree topology with the ideal switch as the root.

Figure 7: Spanning Tree Topology

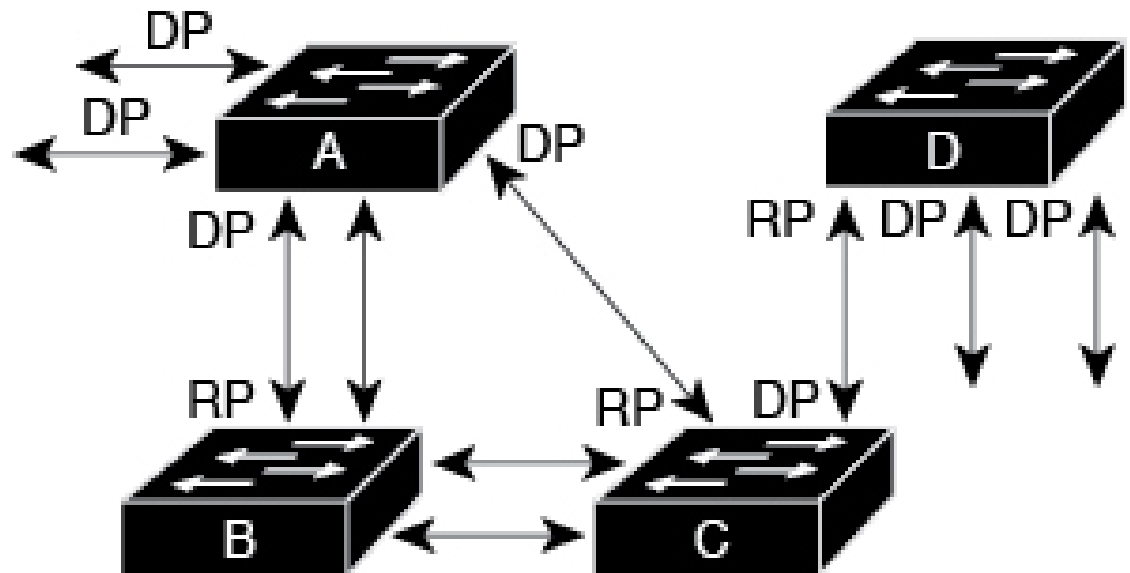

RP = Root Port  
 DP = Designated Port

187026

When the spanning tree topology is calculated based on default parameters, the path between source and destination end stations in a switched network might not be ideal. For instance, connecting higher-speed links

to a port that has a higher number than the current root port can cause a root-port change. The goal is to make the fastest link the root port.

For example, assume that one port on Switch B is a fiber-optic link, and another port on Switch B (an unshielded twisted-pair [UTP] link) is the root port. Network traffic might be more efficient over the high-speed fiber-optic link. By changing the STP port priority on the fiber-optic port to a higher priority (lower numerical value) than the root port, the fiber-optic port becomes the new root port.

## Understanding Rapid PVST+

### Rapid PVST+ Overview

Rapid PVST+ is the IEEE 802.1w (RSTP) standard implemented per VLAN. A single instance of STP runs on each configured VLAN (if you do not manually disable STP). Each Rapid PVST+ instance on a VLAN has a single root switch. You can enable and disable STP on a per-VLAN basis when you are running Rapid PVST+.



---

**Note** Rapid PVST+ is the default STP mode for the switch.

---

Rapid PVST+ uses point-to-point wiring to provide rapid convergence of the spanning tree. The spanning tree reconfiguration can occur in less than 1 second with Rapid PVST+ (in contrast to 50 seconds with the default settings in the 802.1D STP).



---

**Note** Rapid PVST+ supports one STP instance for each VLAN.

---

Using Rapid PVST+, STP convergence occurs rapidly. Each designated or root port in the STP sends out a BPDU every 2 seconds by default. On a designated or root port in the topology, if hello messages are missed three consecutive times, or if the maximum age expires, the port immediately flushes all protocol information in the table. A port considers that it loses connectivity to its direct neighbor root or designated port if it misses three BPDUs or if the maximum age expires. This rapid aging of the protocol information allows quick failure detection. The switch automatically checks the PVID.

Rapid PVST+ provides for rapid recovery of connectivity following the failure of a network device, a switch port, or a LAN. It provides rapid convergence for edge ports, new root ports, and ports connected through point-to-point links as follows:

- Edge ports—When you configure a port as an edge port on an RSTP switch, the edge port immediately transitions to the forwarding state. (This immediate transition was previously a Cisco-proprietary feature named PortFast.) You should only configure on ports that connect to a single end station as edge ports. Edge ports do not generate topology changes when the link changes.

Enter the **spanning-tree port type** interface configuration command to configure a port as an STP edge port.



---

**Note** We recommend that you configure all ports connected to a host as edge ports.

---

- Root ports—If Rapid PVST+ selects a new root port, it blocks the old root port and immediately transitions the new root port to the forwarding state.
- Point-to-point links—If you connect a port to another port through a point-to-point link and the local port becomes a designated port, it negotiates a rapid transition with the other port by using the proposal-agreement handshake to ensure a loop-free topology.

Rapid PVST+ achieves rapid transition to the forwarding state only on edge ports and point-to-point links. Although the link type is configurable, the system automatically derives the link type information from the duplex setting of the port. Full-duplex ports are assumed to be point-to-point ports, while half-duplex ports are assumed to be shared ports.

Edge ports do not generate topology changes, but all other designated and root ports generate a topology change (TC) BPDU when they either fail to receive three consecutive BPDUs from the directly connected neighbor or the maximum age times out. At this point, the designated or root port sends out a BPDU with the TC flag set. The BPDUs continue to set the TC flag as long as the TC While timer runs on that port. The value of the TC While timer is the value set for the hello time plus 1 second. The initial detector of the topology change immediately floods this information throughout the entire topology.

When Rapid PVST+ detects a topology change, the protocol does the following:

- Starts the TC While timer with a value equal to twice the hello time for all the non-edge root and designated ports, if necessary.
- Flushes the MAC addresses associated with all these ports.

The topology change notification floods quickly across the entire topology. The system flushes dynamic entries immediately on a per-port basis when it receives a topology change.



---

**Note** The TCA flag is used only when the switch is interacting with switches that are running legacy 802.1D STP.

---

The proposal and agreement sequence then quickly propagates toward the edge of the network and quickly restores connectivity after a topology change.

## Rapid PVST+ BPDUs

Rapid PVST+ and 802.1w use all six bits of the flag byte to add the role and state of the port that originates the BPDU and the proposal and agreement handshake. The following figure shows the use of the BPDU flags in Rapid PVST+.

Figure 8: Rapid PVST+ Flag Byte in BPDU

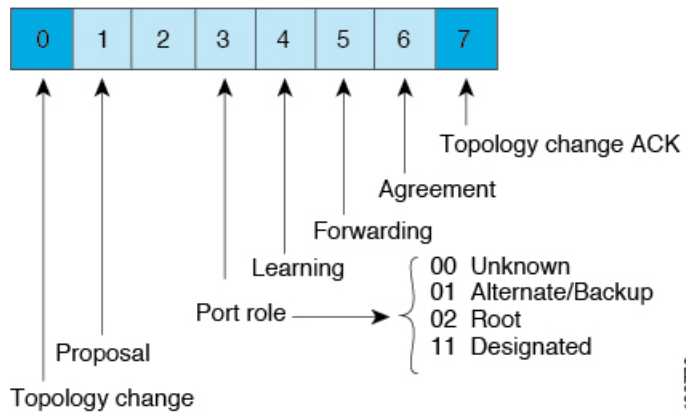

Another important change is that the Rapid PVST+ BPDU is type 2, version 2, which makes it possible for the switch to detect connected legacy (802.1D) bridges. The BPDU for 802.1D is version 0.

## Proposal and Agreement Handshake

As shown in the following figure, Switch A is connected to Switch B through a point-to-point link, and all of the ports are in the blocking state. Assume that the priority of Switch A is a smaller numerical value than the priority of Switch B.

Figure 9: Proposal and Agreement Handshaking for Rapid Convergence

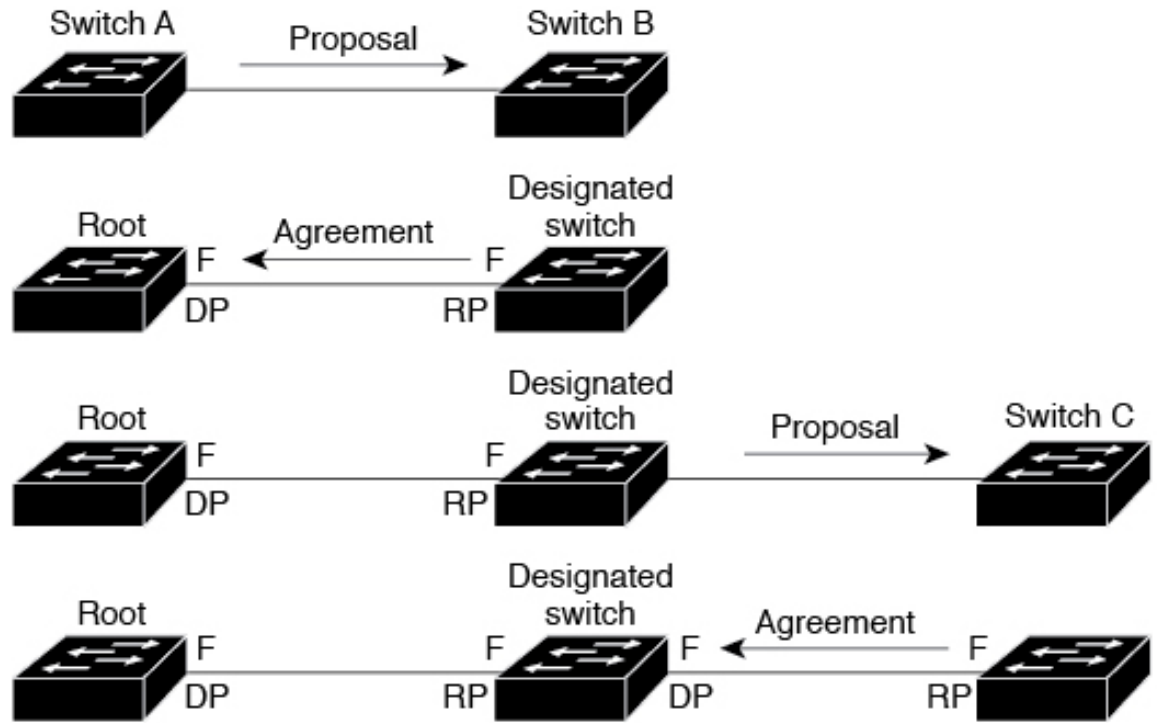

DP = designated port  
 RP = root port  
 F = forwarding

184443

Switch A sends a proposal message (a configuration BPDU with the proposal flag set) to Switch B, proposing itself as the designated switch.

After receiving the proposal message, Switch B selects as its new root port the port from which the proposal message was received, forces all non-edge ports to the blocking state, and sends an agreement message (a BPDU with the agreement flag set) through its new root port.

After receiving the agreement message from Switch B, Switch A also immediately transitions its designated port to the forwarding state. No loops in the network can form because Switch B blocked all of its non-edge ports and because there is a point-to-point link between Switches A and B.

When Switch C connects to Switch B, a similar set of handshaking messages are exchanged. Switch C selects the port connected to Switch B as its root port, and both ends of the link immediately transition to the forwarding state. With each iteration of this handshaking process, one more network device joins the active topology. As the network converges, this proposal-agreement handshaking progresses from the root toward the leaves of the spanning tree.

The switch learns the link type from the port duplex mode: a full-duplex port is considered to have a point-to-point connection and a half-duplex port is considered to have a shared connection. You can override the default setting that is controlled by the duplex setting by entering the **spanning-tree link-type** interface configuration command.

This proposal/agreement handshake is initiated only when a non-edge port moves from the blocking to the forwarding state. The handshaking process then proliferates step-by-step throughout the topology.

## Protocol Timers

The following table describes the protocol timers that affect the Rapid PVST+ performance.

**Table 4: Rapid PVST+ Protocol Timers**

Variable	Description
Hello timer	Determines how often each switch broadcasts BPDUs to other switches. The default is 2 seconds, and the range is from 1 to 10.
Forward delay timer	Determines how long each of the listening and learning states last before the port begins forwarding. This timer is generally not used by the protocol but is used as a backup. The default is 15 seconds, and the range is from 4 to 30 seconds.
Maximum age timer	Determines the amount of time protocol information received on an port is stored by the switch. This timer is generally not used by the protocol, but it is used when interoperating with 802.1D spanning tree. The default is 20 seconds; the range is from 6 to 40 seconds.

## Port Roles

Rapid PVST+ provides rapid convergence of the spanning tree by assigning port roles and learning the active topology. Rapid PVST+ builds upon the 802.1D STP to select the switch with the highest priority (lowest numerical priority value) as the root bridge. Rapid PVST+ then assigns one of these port roles to individual ports:

- Root port—Provides the best path (lowest cost) when the switch forwards packets to the root bridge.
- Designated port—Connects to the designated switch, which incurs the lowest path cost when forwarding packets from that LAN to the root bridge. The port through which the designated switch is attached to the LAN is called the designated port.
- Alternate port—Offers an alternate path toward the root bridge to the path provided by the current root port. An alternate port provides a path to another switch in the topology.
- Backup port—Acts as a backup for the path provided by a designated port toward the leaves of the spanning tree. A backup port can exist only when two ports are connected in a loopback by a point-to-point link or when a switch has two or more connections to a shared LAN segment. A backup port provides another path in the topology to the switch.
- Disabled port—Has no role within the operation of the spanning tree.

In a stable topology with consistent port roles throughout the network, Rapid PVST+ ensures that every root port and designated port immediately transition to the forwarding state while all alternate and backup ports are always in the blocking state. Designated ports start in the blocking state. The port state controls the operation of the forwarding and learning processes.

A port with the root or a designated port role is included in the active topology. A port with the alternate or backup port role is excluded from the active topology (see the following figure).

Figure 10: Sample Topology Demonstrating Port Roles

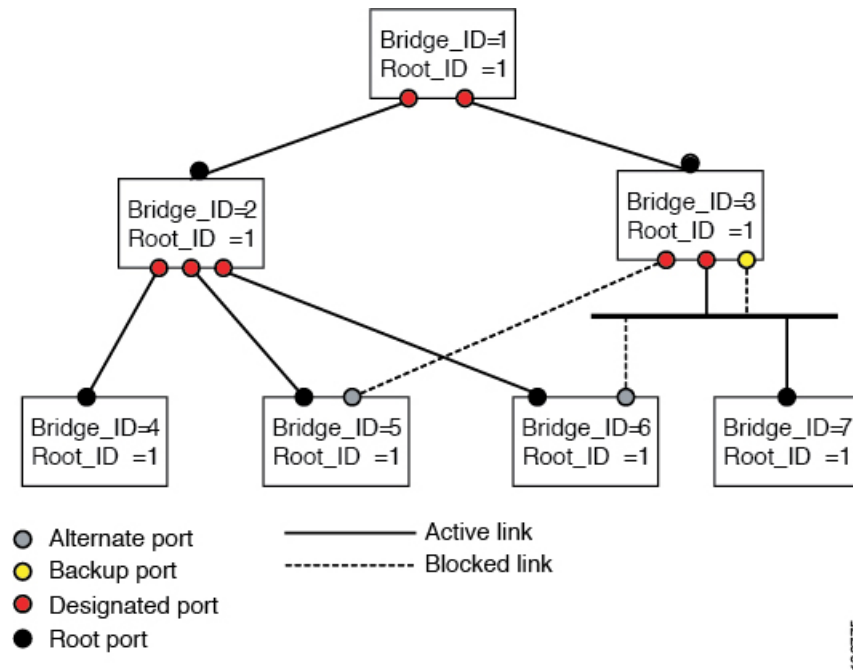

## Port States

### Rapid PVST+ Port State Overview

Propagation delays can occur when protocol information passes through a switched LAN. As a result, topology changes can take place at different times and at different places in a switched network. When a LAN port transitions directly from nonparticipation in the spanning tree topology to the forwarding state, it can create temporary data loops. Ports must wait for new topology information to propagate through the switched LAN before starting to forward frames.

Each LAN port on a software using Rapid PVST+ or MST exists in one of the following four states:

- Blocking—The LAN port does not participate in frame forwarding.
- Learning—The LAN port prepares to participate in frame forwarding.
- Forwarding—The LAN port forwards frames.
- Disabled—The LAN port does not participate in STP and is not forwarding frames.

When you enable Rapid PVST+, every port in the software, VLAN, and network goes through the blocking state and the transitory states of learning at power up. If properly configured, each LAN port stabilizes to the forwarding or blocking state.

When the STP algorithm places a LAN port in the forwarding state, the following process occurs:

- The LAN port is put into the blocking state while it waits for protocol information that suggests it should go to the learning state.
- The LAN port waits for the forward delay timer to expire, moves the LAN port to the learning state, and restarts the forward delay timer.

- In the learning state, the LAN port continues to block frame forwarding as it learns the end station location information for the forwarding database.
- The LAN port waits for the forward delay timer to expire and then moves the LAN port to the forwarding state, where both learning and frame forwarding are enabled.

## Blocking State

A LAN port in the blocking state does not participate in frame forwarding.

A LAN port in the blocking state performs as follows:

- Discards frames received from the attached segment.
- Discards frames switched from another port for forwarding.
- Does not incorporate the end station location into its address database. (There is no learning on a blocking LAN port, so there is no address database update.)
- Receives BPDUs and directs them to the system module.
- Receives, processes, and transmits BPDUs received from the system module.
- Receives and responds to network management messages.

## Learning State

A LAN port in the learning state prepares to participate in frame forwarding by learning the MAC addresses for the frames. The LAN port enters the learning state from the blocking state.

A LAN port in the learning state performs as follows:

- Discards frames received from the attached segment.
- Discards frames switched from another port for forwarding.
- Incorporates the end station location into its address database.
- Receives BPDUs and directs them to the system module.
- Receives, processes, and transmits BPDUs received from the system module.
- Receives and responds to network management messages.

## Forwarding State

A LAN port in the forwarding state forwards frames. The LAN port enters the forwarding state from the learning state.

A LAN port in the forwarding state performs as follows:

- Forwards frames received from the attached segment.
- Forwards frames switched from another port for forwarding.
- Incorporates the end station location information into its address database.
- Receives BPDUs and directs them to the system module.
- Processes BPDUs received from the system module.



- Receives and responds to network management messages.

## Disabled State

A LAN port in the disabled state does not participate in frame forwarding or STP. A LAN port in the disabled state is virtually nonoperational.

A disabled LAN port performs as follows:

- Discards frames received from the attached segment.
- Discards frames switched from another port for forwarding.
- Does not incorporate the end station location into its address database. (There is no learning, so there is no address database update.)
- Does not receive BPDUs from neighbors.
- Does not receive BPDUs for transmission from the system module.

## Summary of Port States

The following table lists the possible operational and Rapid PVST+ states for ports and the corresponding inclusion in the active topology.

**Table 5: Port State Active Topology**

Operational Status	Port State	Is Port Included in the Active Topology?
Enabled	Blocking	No
Enabled	Learning	Yes
Enabled	Forwarding	Yes
Disabled	Disabled	No

## Synchronization of Port Roles

When the switch receives a proposal message on one of its ports and that port is selected as the new root port, Rapid PVST+ forces all other ports to synchronize with the new root information.

The switch is synchronized with superior root information received on the root port if all other ports are synchronized. An individual port on the switch is synchronized if either of the following applies:

- That port is in the blocking state.
- It is an edge port (a port configured to be at the edge of the network).

If a designated port is in the forwarding state and is not configured as an edge port, it transitions to the blocking state when the Rapid PVST+ forces it to synchronize with new root information. In general, when the Rapid PVST+ forces a port to synchronize with root information and the port does not satisfy any of the above conditions, its port state is set to blocking.

After ensuring that all of the ports are synchronized, the switch sends an agreement message to the designated switch that corresponds to its root port. When the switches connected by a point-to-point link are in agreement about their port roles, Rapid PVST+ immediately transitions the port states to the forwarding state. The sequence of events is shown in the following figure.

**Figure 11: Sequence of Events During Rapid Convergence**

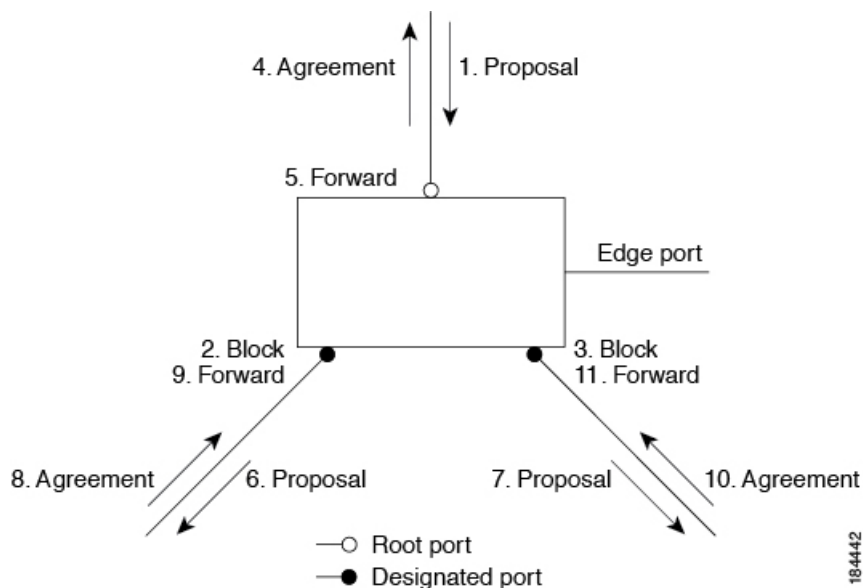

## Processing Superior BPDUs

A superior BPDUs is a BPDUs with root information (such as a lower switch ID or lower path cost) that is superior to what is currently stored for the port.

If a port receives a superior BPDUs, Rapid PVST+ triggers a reconfiguration. If the port is proposed and is selected as the new root port, Rapid PVST+ forces all the other ports to synchronize.

If the received BPDUs is a Rapid PVST+ BPDUs with the proposal flag set, the switch sends an agreement message after all of the other ports are synchronized. The new root port transitions to the forwarding state as soon as the previous port reaches the blocking state.

If the superior information received on the port causes the port to become a backup port or an alternate port, Rapid PVST+ sets the port to the blocking state and sends an agreement message. The designated port continues sending BPDUs with the proposal flag set until the forward-delay timer expires. At that time, the port transitions to the forwarding state.

## Processing Inferior BPDUs

An inferior BPDUs is a BPDUs with root information (such as a higher switch ID or higher path cost) that is inferior to what is currently stored for the port.

If a designated port receives an inferior BPDUs, it immediately replies with its own information.

## Spanning-Tree Dispute Mechanism

The software checks the consistency of the port role and state in the received BPDUs to detect unidirectional link failures that could cause bridging loops.

When a designated port detects a conflict, it keeps its role, but reverts to a discarding state because disrupting connectivity in case of inconsistency is preferable to opening a bridging loop.

The following figure illustrates a unidirectional link failure that typically creates a bridging loop. Switch A is the root bridge, and its BPDUs are lost on the link leading to Switch B. The 802.1w-standard BPDUs include the role and state of the sending port. With this information, Switch A can detect that Switch B does not react to the superior BPDUs it sends and that Switch B is the designated, not root port. As a result, Switch A blocks (or keeps blocking) its port, which prevents the bridging loop. The block is shown as an STP dispute.

**Figure 12: Detecting Unidirectional Link Failure**



## Port Cost



**Note** Rapid PVST+ uses the short (16-bit) path-cost method to calculate the cost by default. With the short path-cost method, you can assign any value in the range of 1 to 65535. However, you can configure the switch to use the long (32-bit) path-cost method, which allows you to assign any value in the range of 1 to 200,000,000. You configure the path-cost calculation method globally.

The STP port path-cost default value is determined from the media speed and path-cost calculation method of a LAN interface. If a loop occurs, STP considers the port cost when selecting a LAN interface to put into the forwarding state.

**Table 6: Default Port Cost**

Bandwidth	Short Path-Cost Method of Port Cost	Long Path-Cost Method of Port Cost
10 Mbps	100	2,000,000
100 Mbps	19	200,000
1 Gigabit Ethernet	4	20,000
10 Gigabit Ethernet	2	2,000

You can assign lower cost values to LAN interfaces that you want STP to select first and higher cost values to LAN interfaces that you want STP to select last. If all LAN interfaces have the same cost value, STP puts the LAN interface with the lowest LAN interface number in the forwarding state and blocks other LAN interfaces.

On access ports, you assign the port cost by the port. On trunk ports, you assign the port cost by the VLAN; you can configure the same port cost to all the VLANs on a trunk port.

## Port Priority

If a loop occurs and multiple ports have the same path cost, Rapid PVST+ considers the port priority when selecting which LAN port to put into the forwarding state. You can assign lower priority values to LAN ports that you want Rapid PVST+ to select first and higher priority values to LAN ports that you want Rapid PVST+ to select last.

If all LAN ports have the same priority value, Rapid PVST+ puts the LAN port with the lowest LAN port number in the forwarding state and blocks other LAN ports. The possible priority range is from 0 through 224 (the default is 128), configurable in increments of 32. The software uses the port priority value when the LAN port is configured as an access port and uses the VLAN port priority values when the LAN port is configured as a trunk port.

## Rapid PVST+ and IEEE 802.1Q Trunks

In a network of Cisco switches connected through 802.1Q trunks, the switches maintain one instance of STP for each VLAN allowed on the trunks. However, non-Cisco 802.1Q switches maintain only one instance of STP for all VLANs allowed on the trunks.

When you connect a Cisco switch to a non-Cisco switch through an 802.1Q trunk, the Cisco switch combines the STP instance of the 802.1Q VLAN of the trunk with the STP instance of the non-Cisco 802.1Q switch. However, all per-VLAN STP information that is maintained by Cisco switches is separated by a cloud of non-Cisco 802.1Q switches. The non-Cisco 802.1Q cloud that separates the Cisco switches is treated as a single trunk link between the switches.

## Rapid PVST+ Interoperation with Legacy 802.1D STP

Rapid PVST+ can interoperate with switches that are running the legacy 802.1D protocol. The switch knows that it is interoperating with equipment running 802.1D when it receives a BPDU version 0. The BPDUs for Rapid PVST+ are version 2. If the BPDU received is an 802.1w BPDU version 2 with the proposal flag set, the switch sends an agreement message after all of the other ports are synchronized. If the BPDU is an 802.1D BPDU version 0, the switch does not set the proposal flag and starts the forward-delay timer for the port. The new root port requires twice the forward-delay time to transition to the forwarding state.

The switch interoperates with legacy 802.1D switches as follows:

- **Notification**—Unlike 802.1D BPDUs, 802.1w does not use TCN BPDUs. However, for interoperability with 802.1D switches, Cisco NX-OS processes and generates TCN BPDUs.
- **Acknowledgement**—When an 802.1w switch receives a TCN message on a designated port from an 802.1D switch, it replies with an 802.1D configuration BPDU with the TCA bit set. However, if the TC-while timer (the same as the TC timer in 802.1D) is active on a root port connected to an 802.1D switch and a configuration BPDU with the TCA set is received, the TC-while timer is reset.

This method of operation is required only for 802.1D switches. The 802.1w BPDUs do not have the TCA bit set.

- **Protocol migration**—For backward compatibility with 802.1D switches, 802.1w selectively sends 802.1D configuration BPDUs and TCN BPDUs on a per-port basis.

When a port is initialized, the migrate-delay timer is started (specifies the minimum time during which 802.1w BPDUs are sent), and 802.1w BPDUs are sent. While this timer is active, the switch processes all BPDUs received on that port and ignores the protocol type.

If the switch receives an 802.1D BPDU after the port migration-delay timer has expired, it assumes that it is connected to an 802.1D switch and starts using only 802.1D BPDUs. However, if the 802.1w switch is using 802.1D BPDUs on a port and receives an 802.1w BPDU after the timer has expired, it restarts the timer and starts using 802.1w BPDUs on that port.



**Note** If you want all switches to renegotiate the protocol, you must restart Rapid PVST+.

## Rapid PVST+ Interoperation with 802.1s MST

Rapid PVST+ interoperates seamlessly with the IEEE 802.1s Multiple Spanning Tree (MST) standard. No user configuration is needed.

## Configuring Rapid PVST+

Rapid PVST+, which has the 802.1w standard applied to the Rapid PVST+ protocol, is the default STP setting in the software.

You enable Rapid PVST+ on a per-VLAN basis. The software maintains a separate instance of STP for each VLAN (except on those VLANs on which you disable STP). By default, Rapid PVST+ is enabled on the default VLAN and on each VLAN that you create.

## Enabling Rapid PVST+

Once you enable Rapid PVST+ on the switch, you must enable Rapid PVST+ on the specified VLANs.

Rapid PVST+ is the default STP mode. You cannot simultaneously run MST and Rapid PVST+.



**Note** Changing the spanning tree mode disrupts traffic because all spanning tree instances are stopped for the previous mode and started for the new mode.

### SUMMARY STEPS

1. switch# **configure terminal**
2. switch(config)# **spanning-tree mode rapid-pvst**

### DETAILED STEPS

	Command or Action	Purpose
<b>Step 1</b>	switch# <b>configure terminal</b>	Enters global configuration mode.
<b>Step 2</b>	switch(config)# <b>spanning-tree mode rapid-pvst</b>	Enables Rapid PVST+ on the switch. Rapid PVST+ is the default spanning tree mode.

	Command or Action	Purpose
		<b>Note</b> Changing the spanning tree mode disrupts traffic because all spanning tree instances are stopped for the previous mode and started for the new mode.

**Example**

This example shows how to enable Rapid PVST+ on the switch:

```
switch# configure terminal
switch(config)# spanning-tree mode rapid-pvst
```



**Note** Because STP is enabled by default, entering the **show running-config** command to view the resulting configuration does not display the command that you entered to enable Rapid PVST+.

## Enabling Rapid PVST+ per VLAN

You can enable or disable Rapid PVST+ on each VLAN.



**Note** Rapid PVST+ is enabled by default on the default VLAN and on all VLANs that you create.

### SUMMARY STEPS

1. switch# **configure terminal**
2. switch(config)# **spanning-tree** *vlan-range*
3. (Optional) switch(config)# **no spanning-tree** *vlan-range*

### DETAILED STEPS

	Command or Action	Purpose
<b>Step 1</b>	switch# <b>configure terminal</b>	Enters global configuration mode.
<b>Step 2</b>	switch(config)# <b>spanning-tree</b> <i>vlan-range</i>	Enables Rapid PVST+ (default STP) on a per VLAN basis. The <i>vlan-range</i> value can be 2 through 4094 (except reserved VLAN values).
<b>Step 3</b>	(Optional) switch(config)# <b>no spanning-tree</b> <i>vlan-range</i>	Disables Rapid PVST+ on the specified VLAN.

	Command or Action	Purpose
		<p><b>Caution</b> Do not disable spanning tree on a VLAN unless all switches and bridges in the VLAN have spanning tree disabled. You cannot disable spanning tree on some of the switches and bridges in a VLAN and leave it enabled on other switches and bridges. This action can have unexpected results because switches and bridges with spanning tree enabled will have incomplete information regarding the physical topology of the network.</p> <p>Do not disable spanning tree in a VLAN without ensuring that there are no physical loops present in the VLAN. Spanning tree serves as a safeguard against misconfigurations and cabling errors.</p>

### Example

This example shows how to enable STP on a VLAN:

```
switch# configure terminal
switch(config)# spanning-tree vlan 5
```

## Configuring the Root Bridge ID

The software maintains a separate instance of STP for each active VLAN in Rapid PVST+. For each VLAN, the switch with the lowest bridge ID becomes the root bridge for that VLAN.

To configure a VLAN instance to become the root bridge, modify the bridge priority from the default value (32768) to a significantly lower value.

When you enter the **spanning-tree vlan *vlan\_ID* root** command, the switch checks the bridge priority of the current root bridges for each VLAN. The switch sets the bridge priority for the specified VLANs to 24576 if this value will cause the switch to become the root for the specified VLANs. If any root bridge for the specified VLANs has a bridge priority lower than 24576, the switch sets the bridge priority for the specified VLANs to 4096 less than the lowest bridge priority.



**Note** The **spanning-tree vlan *vlan\_ID* root** command fails if the value required to be the root bridge is less than 1.



**Caution** The root bridge for each instance of STP should be a backbone or distribution switch. Do not configure an access switch as the STP primary root.

Enter the **diameter** keyword to specify the network diameter (that is, the maximum number of bridge hops between any two end stations in the network). When you specify the network diameter, the software automatically selects an optimal hello time, forward delay time, and maximum age time for a network of that diameter, which can significantly reduce the STP convergence time. You can enter the **hello-time** keyword to override the automatically calculated hello time.



**Note** With the switch configured as the root bridge, do not manually configure the hello time, forward-delay time, and maximum-age time using the **spanning-tree mst hello-time**, **spanning-tree mst forward-time**, and **spanning-tree mst max-age** configuration commands.

## SUMMARY STEPS

1. switch# **configure terminal**
2. switch(config)# **spanning-tree vlan** *vlan-range* **root primary** [**diameter** *dia* [**hello-time** *hello-time*]]

## DETAILED STEPS

	Command or Action	Purpose
<b>Step 1</b>	switch# <b>configure terminal</b>	Enters global configuration mode.
<b>Step 2</b>	switch(config)# <b>spanning-tree vlan</b> <i>vlan-range</i> <b>root primary</b> [ <b>diameter</b> <i>dia</i> [ <b>hello-time</b> <i>hello-time</i> ]]	Configures a software switch as the primary root bridge. The <i>vlan-range</i> value can be 2 through 4094 (except reserved VLAN values.) The <i>dia</i> default is 7. The <i>hello-time</i> can be from 1 to 10 seconds, and the default value is 2 seconds.

### Example

This example shows how to configure the switch as the root bridge for a VLAN:

```
switch# configure terminal
switch(config)# spanning-tree vlan 5 root primary diameter 4
```

## Configuring a Secondary Root Bridge

When you configure a software switch as the secondary root, the STP bridge priority is modified from the default value (32768) so that the switch is likely to become the root bridge for the specified VLANs if the primary root bridge fails (assuming the other switches in the network use the default bridge priority of 32768). STP sets the bridge priority to 28672.

Enter the **diameter** keyword to specify the network diameter (that is, the maximum number of bridge hops between any two end stations in the network). When you specify the network diameter, the software automatically selects an optimal hello time, forward delay time, and maximum age time for a network of that diameter, which can significantly reduce the STP convergence time. You can enter the **hello-time** keyword to override the automatically calculated hello time.



You configure more than one switch in this manner to have multiple backup root bridges. Enter the same network diameter and hello time values that you used when configuring the primary root bridge.



**Note** With the switch configured as the root bridge, do not manually configure the hello time, forward-delay time, and maximum-age time using the **spanning-tree mst hello-time**, **spanning-tree mst forward-time**, and **spanning-tree mst max-age** global configuration commands.

## SUMMARY STEPS

1. switch# **configure terminal**
2. switch(config)# **spanning-tree vlan *vlan-range* root secondary [diameter *dia* [hello-time *hello-time*]]**

## DETAILED STEPS

	Command or Action	Purpose
Step 1	switch# <b>configure terminal</b>	Enters global configuration mode.
Step 2	switch(config)# <b>spanning-tree vlan <i>vlan-range</i> root secondary [diameter <i>dia</i> [hello-time <i>hello-time</i>]]</b>	Configures a software switch as the secondary root bridge. The <i>vlan-range</i> value can be 2 through 4094 (except reserved VLAN values). The <i>dia</i> default is 7. The <i>hello-time</i> can be from 1 to 10 seconds, and the default value is 2 seconds.

### Example

This example shows how to configure the switch as the secondary root bridge for a VLAN:

```
switch# configure terminal
switch(config)# spanning-tree vlan 5 root secondary diameter 4
```

## Configuring the Rapid PVST+ Port Priority

You can assign lower priority values to LAN ports that you want Rapid PVST+ to select first and higher priority values to LAN ports that you want Rapid PVST+ to select last. If all LAN ports have the same priority value, Rapid PVST+ puts the LAN port with the lowest LAN port number in the forwarding state and blocks other LAN ports.

The software uses the port priority value when the LAN port is configured as an access port and uses VLAN port priority values when the LAN port is configured as a trunk port.

## SUMMARY STEPS

1. switch# **configure terminal**
2. switch(config)# **interface *type slot/port***
3. switch(config-if)# **spanning-tree [vlan *vlan-list*] port-priority *priority***

## DETAILED STEPS

	Command or Action	Purpose
<b>Step 1</b>	switch# <b>configure terminal</b>	Enters global configuration mode.
<b>Step 2</b>	switch(config)# <b>interface</b> <i>type slot/port</i>	Specifies the interface to configure, and enters interface configuration mode.
<b>Step 3</b>	switch(config-if)# <b>spanning-tree</b> [ <b>vlan</b> <i>vlan-list</i> ] <b>port-priority</b> <i>priority</i>	Configures the port priority for the LAN interface. The <i>priority</i> value can be from 0 to 224. The lower the value indicates the higher the priority. The priority values are 0, 32, 64, 96, 128, 160, 192, and 224. All other values are rejected. The default value is 128.

**Example**

This example shows how to configure the access port priority of an Ethernet interface:

```
switch# configure terminal
switch(config)# interface ethernet 1/4
switch(config-if)# spanning-tree port-priority 160
```

You can only apply this command to a physical Ethernet interface.

## Configuring the Rapid PVST+ Path-Cost Method and Port Cost

On access ports, you assign port cost by the port. On trunk ports, you assign the port cost by VLAN; you can configure the same port cost on all the VLANs on a trunk.



**Note** In Rapid PVST+ mode, you can use either the short or long path-cost method, and you can configure the method in either the interface or configuration submenu. The default path-cost method is short.

## SUMMARY STEPS

1. switch# **configure terminal**
2. switch(config)# **spanning-tree pathcost method** {long | short}
3. switch(config)# **interface** *type slot/port*
4. switch(config-if)# **spanning-tree** [**vlan** *vlan-id*] **cost** [*value* | auto]

## DETAILED STEPS

	Command or Action	Purpose
<b>Step 1</b>	switch# <b>configure terminal</b>	Enters global configuration mode.
<b>Step 2</b>	switch(config)# <b>spanning-tree pathcost method</b> {long   short}	Selects the method used for Rapid PVST+ path-cost calculations. The default method is the short method.

	Command or Action	Purpose
Step 3	switch(config)# <b>interface</b> <i>type slot/port</i>	Specifies the interface to configure, and enters interface configuration mode.
Step 4	switch(config-if)# <b>spanning-tree</b> [ <b>vlan</b> <i>vlan-id</i> ] <b>cost</b> [ <i>value</i>   <b>auto</b> ]	<p>Configures the port cost for the LAN interface. The cost value, depending on the path-cost calculation method, can be as follows:</p> <ul style="list-style-type: none"> <li>• short—1 to 65535</li> <li>• long—1 to 200000000</li> </ul> <p><b>Note</b> You configure this parameter per interface on access ports and per VLAN on trunk ports.</p> <p>The default is <b>auto</b>, which sets the port cost on both the path-cost calculation method and the media speed.</p>

### Example

This example shows how to configure the access port cost of an Ethernet interface:

```
switch# configure terminal
switch (config)# spanning-tree pathcost method long
switch (config)# interface ethernet 1/4
switch(config-if)# spanning-tree cost 1000
```

You can only apply this command to a physical Ethernet interface.

## Configuring the Rapid PVST+ Bridge Priority of a VLAN

You can configure the Rapid PVST+ bridge priority of a VLAN.



**Note** Be careful when using this configuration. For most situations, we recommend that you configure the primary root and secondary root to modify the bridge priority.

### SUMMARY STEPS

1. switch# **configure terminal**
2. switch(config)# **spanning-tree vlan** *vlan-range* **priority** *value*

### DETAILED STEPS

	Command or Action	Purpose
Step 1	switch# <b>configure terminal</b>	Enters global configuration mode.

	Command or Action	Purpose
<b>Step 2</b>	switch(config)# <b>spanning-tree vlan</b> <i>vlan-range</i> <b>priority</b> <i>value</i>	Configures the bridge priority of a VLAN. Valid values are 0, 4096, 8192, 12288, 16384, 20480, 24576, 28672, 32768, 36864, 40960, 45056, 49152, 53248, 57344, and 61440. All other values are rejected. The default value is 32768.

### Example

This example shows how to configure the bridge priority of a VLAN:

```
switch# configure terminal
switch(config)# spanning-tree vlan 5 priority 8192
```

## Configuring the Rapid PVST+ Hello Time for a VLAN

You can configure the Rapid PVST+ hello time for a VLAN.



**Note** Be careful when using this configuration. For most situations, we recommend that you configure the primary root and secondary root to modify the hello time.

### SUMMARY STEPS

1. switch# **configure terminal**
2. switch(config)# **spanning-tree vlan** *vlan-range* **hello-time** *hello-time*

### DETAILED STEPS

	Command or Action	Purpose
<b>Step 1</b>	switch# <b>configure terminal</b>	Enters global configuration mode.
<b>Step 2</b>	switch(config)# <b>spanning-tree vlan</b> <i>vlan-range</i> <b>hello-time</b> <i>hello-time</i>	Configures the hello time of a VLAN. The hello time value can be from 1 to 10 seconds. The default is 2 seconds.

### Example

This example shows how to configure the hello time for a VLAN:

```
switch# configure terminal
switch(config)# spanning-tree vlan 5 hello-time 7
```

## Configuring the Rapid PVST+ Forward Delay Time for a VLAN

You can configure the forward delay time per VLAN when using Rapid PVST+.

**SUMMARY STEPS**

1. switch# **configure terminal**
2. switch(config)# **spanning-tree vlan *vlan-range* forward-time *forward-time***

**DETAILED STEPS**

	Command or Action	Purpose
<b>Step 1</b>	switch# <b>configure terminal</b>	Enters global configuration mode.
<b>Step 2</b>	switch(config)# <b>spanning-tree vlan <i>vlan-range</i> forward-time <i>forward-time</i></b>	Configures the forward delay time of a VLAN. The forward delay time value can be from 4 to 30 seconds, and the default is 15 seconds.

**Example**

This example shows how to configure the forward delay time for a VLAN:

```
switch# configure terminal
switch(config)# spanning-tree vlan 5 forward-time 21
```

## Configuring the Rapid PVST+ Maximum Age Time for a VLAN

You can configure the maximum age time per VLAN when using Rapid PVST+.

**SUMMARY STEPS**

1. switch# **configure terminal**
2. switch(config)# **spanning-tree vlan *vlan-range* max-age *max-age***

**DETAILED STEPS**

	Command or Action	Purpose
<b>Step 1</b>	switch# <b>configure terminal</b>	Enters configuration mode.
<b>Step 2</b>	switch(config)# <b>spanning-tree vlan <i>vlan-range</i> max-age <i>max-age</i></b>	Configures the maximum aging time of a VLAN. The maximum aging time value can be from 6 to 40 seconds, and the default is 20 seconds.

**Example**

This example shows how to configure the maximum aging time for a VLAN:

```
switch# configure terminal
switch(config)# spanning-tree vlan 5 max-age 36
```

## Specifying the Link Type

Rapid connectivity (802.1w standard) is established only on point-to-point links. By default, the link type is controlled from the duplex mode of the interface. A full-duplex port is considered to have a point-to-point connection; a half-duplex port is considered to have a shared connection.

If you have a half-duplex link physically connected point-to-point to a single port on a remote switch, you can override the default setting on the link type and enable rapid transitions.

If you set the link to shared, STP moves back to 802.1D.

### SUMMARY STEPS

1. switch# **configure terminal**
2. switch(config)# **interface** *type slot/port*
3. switch(config-if)# **spanning-tree link-type** {**auto** | **point-to-point** | **shared**}

### DETAILED STEPS

	Command or Action	Purpose
<b>Step 1</b>	switch# <b>configure terminal</b>	Enters global configuration mode.
<b>Step 2</b>	switch(config)# <b>interface</b> <i>type slot/port</i>	Specifies the interface to configure, and enters the interface configuration mode.
<b>Step 3</b>	switch(config-if)# <b>spanning-tree link-type</b> { <b>auto</b>   <b>point-to-point</b>   <b>shared</b> }	Configures the link type to be either a point-to-point link or shared link. The system reads the default value from the switch connection, as follows: half duplex links are shared and full-duplex links are point-to-point. If the link type is shared, the STP reverts to 802.1D. The default is auto, which sets the link type based on the duplex setting of the interface.

### Example

This example shows how to configure the link type as a point-to-point link:

```
switch# configure terminal
switch (config)# interface ethernet 1/4
switch(config-if)# spanning-tree link-type point-to-point
```

You can only apply this command to a physical Ethernet interface.

## Restarting the Protocol

A bridge running Rapid PVST+ can send 802.1D BPDUs on one of its ports when it is connected to a legacy bridge. However, the STP protocol migration cannot determine whether the legacy switch has been removed from the link unless the legacy switch is the designated switch. You can restart the protocol negotiation (force the renegotiation with neighboring switches) on the entire switch or on specified interfaces.

Command	Purpose
switch# <b>clear spanning-tree detected-protocol</b> [ <b>interface interface</b> [ <i>interface-num</i>   <i>port-channel</i> ]]	Restarts Rapid PVST+ on all interfaces on the switch or specified interfaces.

This example shows how to restart Rapid PVST+ on an Ethernet interface:

```
switch# clear spanning-tree detected-protocol interface ethernet 1/8
```

## Verifying the Rapid PVST+ Configuration

Use the following commands to display Rapid PVST+ configuration information.

Command	Purpose
<b>show running-config spanning-tree</b> [all]	Displays the current spanning tree configuration.
<b>show spanning-tree</b> [options]	Displays selected detailed information for the current spanning tree configuration.

This example shows how to display spanning tree status:

```
switch# show spanning-tree brief
```

```
VLAN0001
  Spanning tree enabled protocol rstp
  Root ID    Priority    32768
             Address    001c.b05a.5447
             Cost        2
             Port        131 (Ethernet1/3)
             Hello Time  2 sec  Max Age 20 sec  Forward Delay 15 sec
  Bridge ID  Priority    32769 (priority 32768 sys-id-ext 1)
             Address    000d.ec6d.7841
             Hello Time  2 sec  Max Age 20 sec  Forward Delay 15 sec
Interface   Role Sts Cost      Prio.Nbr Type
-----
Eth1/3      Root FWD 2         128.131 P2p Peer (STP)
```







## CHAPTER 7

# Configuring Multiple Spanning Tree

- [Information About MST, on page 79](#)
- [Configuring MST, on page 88](#)
- [Verifying the MST Configuration, on page 105](#)

## Information About MST

### MST Overview



---

**Note** Spanning tree is used to refer to IEEE 802.1w and IEEE 802.1s. If the text is discussing the IEEE 802.1D Spanning Tree Protocol, 802.1D is stated specifically.

---

MST maps multiple VLANs into a spanning tree instance with each instance having a spanning tree topology independent of other spanning tree instances. This architecture provides multiple forwarding paths for data traffic, enables load balancing, and reduces the number of STP instances required to support a large number of VLANs.

MST provides rapid convergence through explicit handshaking as each MST instance uses the IEEE 802.1w standard, which eliminates the 802.1D forwarding delay and quickly transitions root bridge ports and designated ports to the forwarding state.

MAC address reduction is always enabled while you are using MST. You cannot disable this feature.

MST improves spanning tree operation and maintains backward compatibility with these STP versions:

- Original 802.1D spanning tree
- Rapid per-VLAN spanning tree (Rapid PVST+)  
IEEE 802.1w defined the Rapid Spanning Tree Protocol (RSTP) and was incorporated into IEEE 802.1D.
- IEEE 802.1s defined MST and was incorporated into IEEE 802.1Q.



---

**Note** You must enable MST; Rapid PVST+ is the default spanning tree mode.

---

## MST Regions

To allow switches to participate in MST instances, you must consistently configure the switches with the same MST configuration information.

A collection of interconnected switches that have the same MST configuration is an MST region. An MST region is a linked group of MST bridges with the same MST configuration.

The MST configuration controls the MST region to which each switch belongs. The configuration includes the name of the region, the revision number, and the MST VLAN-to-instance assignment map.

A region can have one or multiple members with the same MST configuration. Each member must be capable of processing 802.1w bridge protocol data units (BPDUs). There is no limit to the number of MST regions in a network.

Each region can support up to 65 MST instances (MSTIs). Instances are identified by any number in the range from 1 to 4094. The system reserves Instance 0 for a special instance, which is the IST. You can assign a VLAN to only one MST instance at a time.

The MST region appears as a single bridge to adjacent MST regions and to other Rapid PVST+ regions and 802.1D spanning tree protocols.



---

**Note** We recommend that you do not partition the network into a large number of regions.

---

## MST BPDUs

Each region has only one MST BPDU, and that BPDU carries an M-record for each MSTI within the region (see the following figure). Only the IST sends BPDUs for the MST region; all M-records are encapsulated in that one BPDU that the IST sends. Because the MST BPDU carries information for all instances, the number of BPDUs that need to be processed to support MSTIs is significantly reduced.

Figure 13: MST BPDUs with M-Records for MSTIs

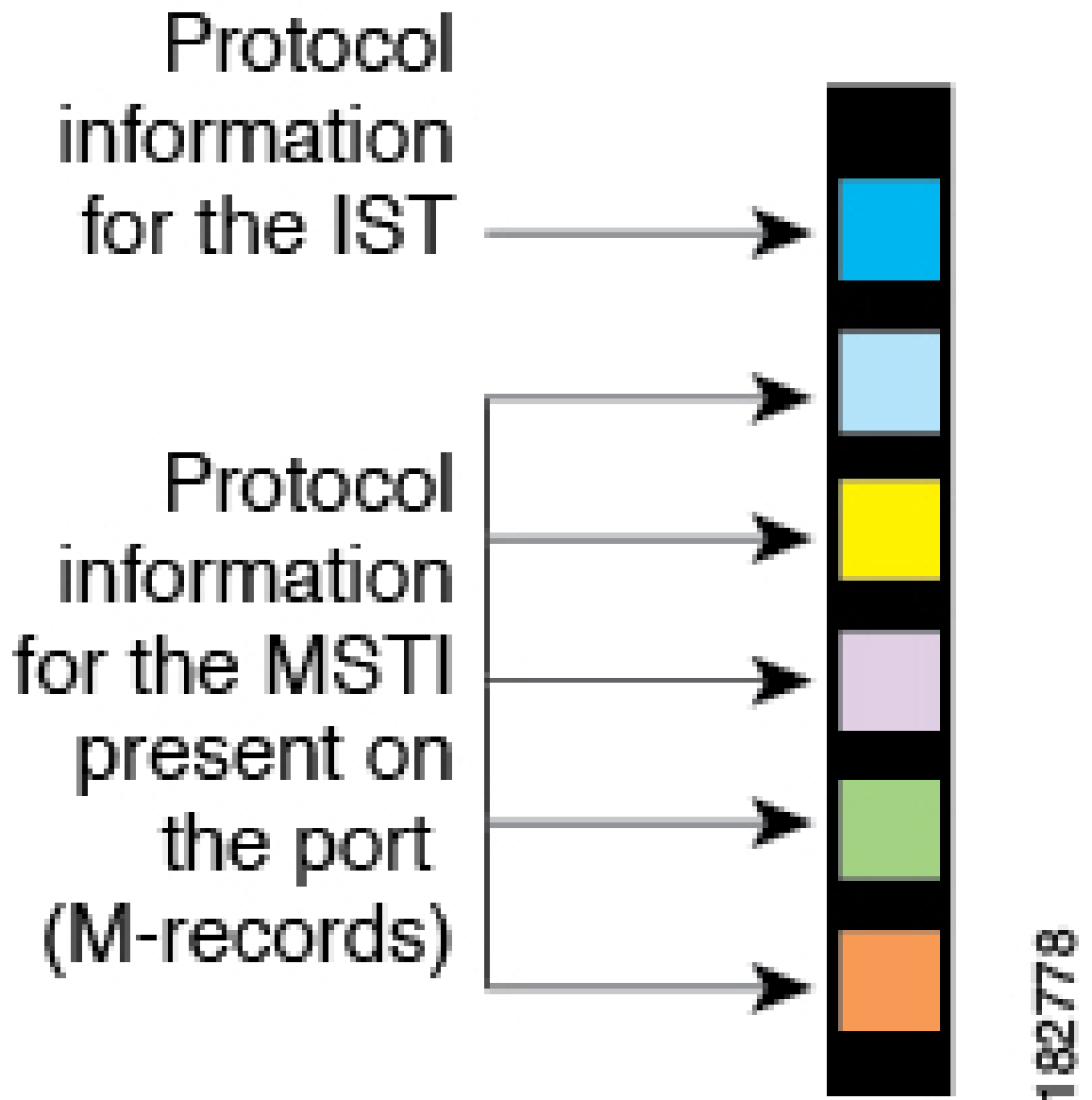

## MST Configuration Information

The MST configuration that must be identical on all switches within a single MST region is configured by the user.

You can configure the following three parameters of the MST configuration:

- Name—32-character string, null padded and null terminated, identifying the MST region
- Revision number—Unsigned 16-bit number that identifies the revision of the current MST configuration



**Note** You must set the revision number when required as part of the MST configuration. The revision number is *not* incremented automatically each time that the MST configuration is committed.

- MST configuration table—4096-element table that associates each of the potential 4094 VLANs supported to a given instance with the first (0) and last element (4095) set to 0. The value of element number *X* represents the instance to which VLAN *X* is mapped.



**Caution** When you change the VLAN-to-MSTI mapping, the system restarts MST.

MST BPDUs contain these three configuration parameters. An MST bridge accepts an MST BPDU into its own region only if these three configuration parameters match exactly. If one configuration attribute differs, the MST bridge considers the BPDU to be from another MST region.

## IST, CIST, and CST

### IST, CIST, and CST Overview

Unlike Rapid PVST+, in which all the STP instances are independent, MST establishes and maintains IST, CIST, and CST spanning trees, as follows:

- An IST is the spanning tree that runs in an MST region.

MST establishes and maintains additional spanning trees within each MST region; these spanning trees are called multiple spanning tree instances (MSTIs).

Instance 0 is a special instance for a region, known as the IST. The IST always exists on all ports; you cannot delete the IST, or instance 0. By default, all VLANs are assigned to the IST. All other MST instances are numbered from 1 to 4094.

The IST is the only STP instance that sends and receives BPDUs. All of the other MSTI information is contained in MST records (M-records), which are encapsulated within MST BPDUs.

All MSTIs within the same region share the same protocol timers, but each MSTI has its own topology parameters, such as the root bridge ID, the root path cost, and so forth.

An MSTI is local to the region; for example, MSTI 9 in region A is independent of MSTI 9 in region B, even if regions A and B are interconnected.

- The CST interconnects the MST regions and any instance of 802.1D and 802.1w STP that may be running on the network. The CST is the one STP instance for the entire bridged network and encompasses all MST regions and 802.1w and 802.1D instances.
- A CIST is a collection of the ISTs in each MST region. The CIST is the same as an IST inside an MST region, and the same as a CST outside an MST region.

The spanning tree computed in an MST region appears as a subtree in the CST that encompasses the entire switched domain. The CIST is formed by the spanning tree algorithm running among switches that support the 802.1w, 802.1s, and 802.1D standards. The CIST inside an MST region is the same as the CST outside a region.

## Spanning Tree Operation Within an MST Region

The IST connects all the MST switches in a region. When the IST converges, the root of the IST becomes the CIST regional root. The CIST regional root is also the CIST root if there is only one region in the network. If the CIST root is outside the region, the protocol selects one of the MST switches at the boundary of the region as the CIST regional root.

When an MST switch initializes, it sends BPDUs that identify itself as the root of the CIST and the CIST regional root, with both the path costs to the CIST root and to the CIST regional root set to zero. The switch also initializes all of its MSTIs and claims to be the root for all of them. If the switch receives superior MST root information (lower switch ID, lower path cost, and so forth) than the information that is currently stored for the port, it relinquishes its claim as the CIST regional root.

During initialization, an MST region might have many subregions, each with its own CIST regional root. As switches receive superior IST information from a neighbor in the same region, they leave their old subregions and join the new subregion that contains the true CIST regional root. This action causes all subregions to shrink except for the subregion that contains the true CIST regional root.

All switches in the MST region must agree on the same CIST regional root. Any two switches in the region will only synchronize their port roles for an MSTI if they converge to a common CIST regional root.

## Spanning Tree Operations Between MST Regions

If you have multiple regions or 802.1w or 802.1D STP instances within a network, MST establishes and maintains the CST, which includes all MST regions and all 802.1w and 802.1D STP switches in the network. The MSTIs combine with the IST at the boundary of the region to become the CST.

The IST connects all the MST switches in the region and appears as a subtree in the CIST that encompasses the entire switched domain. The root of the subtree is the CIST regional root. The MST region appears as a virtual switch to adjacent STP switches and MST regions.

The following figure shows a network with three MST regions and an 802.1D switch (D). The CIST regional root for region 1 (A) is also the CIST root. The CIST regional root for region 2 (B) and the CIST regional root for region 3 (C) are the roots for their respective subtrees within the CIST.

Figure 14: MST Regions, CIST Regional Roots, and CST Root

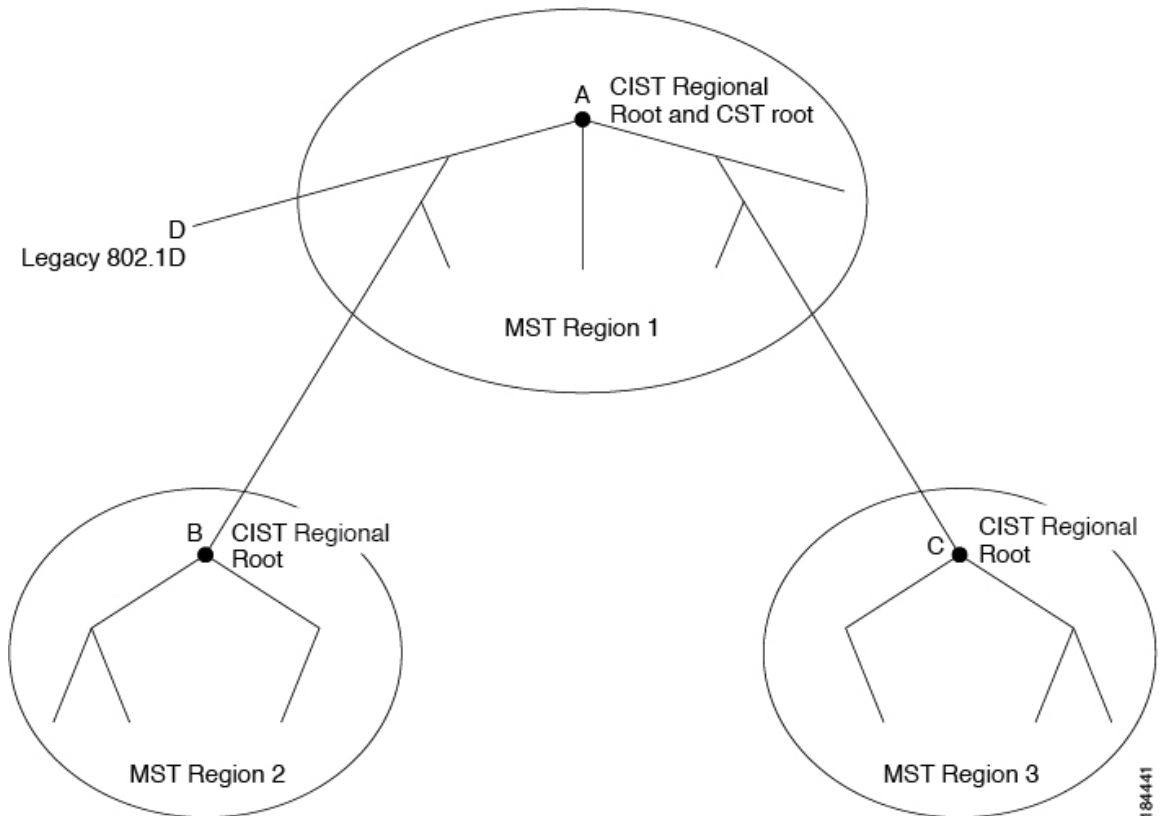

Only the CST instance sends and receives BPDUs. MSTIs add their spanning tree information into the BPDUs (as M-records) to interact with neighboring switches and compute the final spanning tree topology. Because of this process, the spanning tree parameters related to the BPDU transmission (for example, hello time, forward time, max-age, and max-hops) are configured only on the CST instance but affect all MSTIs. You can configure the parameters related to the spanning tree topology (for example, the switch priority, the port VLAN cost, and the port VLAN priority) on both the CST instance and the MSTI.

MST switches use Version 3 BPDUs or 802.1D STP BPDUs to communicate with 802.1D-only switches. MST switches use MST BPDUs to communicate with MST switches.

## MST Terminology

MST naming conventions include identification of some internal or regional parameters. These parameters are used only within an MST region, compared to external parameters that are used throughout the whole network. Because the CIST is the only spanning tree instance that spans the whole network, only the CIST parameters require the external qualifiers and not the internal or regional qualifiers. The MST terminology is as follows:

- The CIST root is the root bridge for the CIST, which is the unique instance that spans the whole network.
- The CIST external root path cost is the cost to the CIST root. This cost is left unchanged within an MST region. An MST region looks like a single switch to the CIST. The CIST external root path cost is the root path cost calculated between these virtual switches and switches that do not belong to any region.

- If the CIST root is in the region, the CIST regional root is the CIST root. Otherwise, the CIST regional root is the closest switch to the CIST root in the region. The CIST regional root acts as a root bridge for the IST.
- The CIST internal root path cost is the cost to the CIST regional root in a region. This cost is only relevant to the IST, instance 0.

## Hop Count

MST does not use the message-age and maximum-age information in the configuration BPDU to compute the STP topology inside the MST region. Instead, the protocol uses the path cost to the root and a hop-count mechanism similar to the IP time-to-live (TTL) mechanism.

By using the **spanning-tree mst max-hops** global configuration command, you can configure the maximum hops inside the region and apply it to the IST and all MST instances in that region.

The hop count achieves the same result as the message-age information (triggers a reconfiguration). The root bridge of the instance always sends a BPDU (or M-record) with a cost of 0 and the hop count set to the maximum value. When a switch receives this BPDU, it decrements the received remaining hop count by one and propagates this value as the remaining hop count in the BPDUs that it generates. When the count reaches zero, the switch discards the BPDU and ages the information held for the port.

The message-age and maximum-age information in the 802.1w portion of the BPDU remain the same throughout the region (only on the IST), and the same values are propagated by the region-designated ports at the boundary.

You configure a maximum aging time as the number of seconds that a switch waits without receiving spanning tree configuration messages before attempting a reconfiguration.

## Boundary Ports

A boundary port is a port that connects one region to another. A designated port knows that it is on the boundary if it detects an STP bridge or receives an agreement proposal from an MST bridge with a different configuration or a Rapid PVST+ bridge. This definition allows two ports that are internal to a region to share a segment with a port that belongs to a different region, creating the possibility of receiving both internal and external messages on a port (see the following figure).

**Figure 15: MST Boundary Ports**

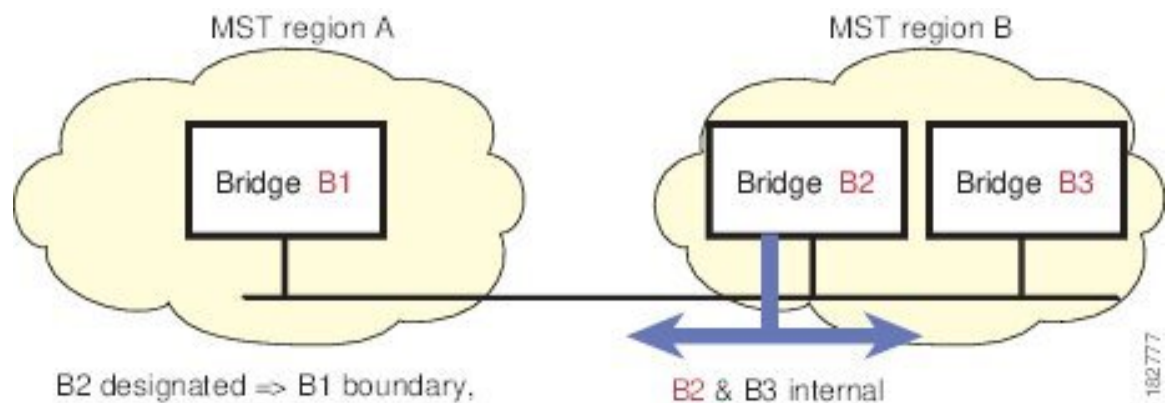

At the boundary, the roles of MST ports do not matter; the system forces their state to be the same as the IST port state. If the boundary flag is set for the port, the MST port-role selection process assigns a port role to the boundary and assigns the same state as the state of the IST port. The IST port at the boundary can take up any port role except a backup port role.

## Spanning-Tree Dispute Mechanism

Currently, this feature is not present in the IEEE MST standard, but it is included in the standard-compliant implementation. The software checks the consistency of the port role and state in the received BPDUs to detect unidirectional link failures that could cause bridging loops.

When a designated port detects a conflict, it keeps its role but reverts to a discarding state because disrupting connectivity in case of inconsistency is preferable to opening a bridging loop.

The following figure shows a unidirectional link failure that typically creates a bridging loop. Switch A is the root bridge, and its BPDUs are lost on the link leading to Switch B. Rapid PVST+ (802.1w) and MST BPDUs include the role and state of the sending port. With this information, Switch A can detect that Switch B does not react to the superior BPDUs that it sends and that Switch B is the designated, not root port. As a result, Switch A blocks (or keeps blocking) its port, which prevents the bridging loop. The block is shown as an STP dispute.

*Figure 16: Detecting a Unidirectional Link Failure*

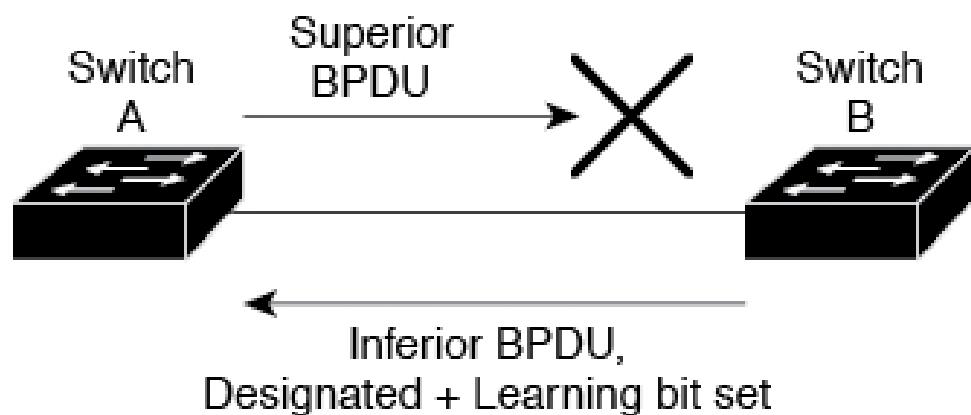

184440

## Port Cost and Port Priority

Spanning tree uses port costs to break a tie for the designated port. Lower values indicate lower port costs, and spanning tree chooses the least costly path. Default port costs are taken from the bandwidth of the interface, as follows:

- 10 Mbps—2,000,000
- 100 Mbps—200,000
- 1 Gigabit Ethernet—20,000
- 10 Gigabit Ethernet—2,000

You can configure the port costs in order to influence which port is chosen.





---

**Note** MST always uses the long path-cost calculation method, so the range of valid values is between 1 and 200,000,000.

---

The system uses port priorities to break ties among ports with the same cost. A lower number indicates a higher priority. The default port priority is 128. You can configure the priority to values between 0 and 224, in increments of 32.

## Interoperability with IEEE 802.1D

A switch that runs MST supports a built-in protocol migration feature that enables it to interoperate with 802.1D STP switches. If this switch receives an 802.1D configuration BPDU (a BPDU with the protocol version set to 0), it sends only 802.1D BPDUs on that port. In addition, an MST switch can detect that a port is at the boundary of a region when it receives an 802.1D BPDU, an MST BPDU (Version 3) associated with a different region, or an 802.1w BPDU (Version 2).

However, the switch does not automatically revert to the MST mode if it no longer receives 802.1D BPDUs because it cannot detect whether the 802.1D switch has been removed from the link unless the 802.1D switch is the designated switch. A switch might also continue to assign a boundary role to a port when the switch to which this switch is connected has joined the region.

To restart the protocol migration process (force the renegotiation with neighboring switches), enter the **clear spanning-tree detected-protocols** command.

All Rapid PVST+ switches (and all 802.1D STP switches) on the link can process MST BPDUs as if they are 802.1w BPDUs. MST switches can send either Version 0 configuration and topology change notification (TCN) BPDUs or Version 3 MST BPDUs on a boundary port. A boundary port connects to a LAN, the designated switch of which is either a single spanning tree switch or a switch with a different MST configuration.



---

**Note** MST interoperates with the Cisco prestandard Multiple Spanning Tree Protocol (MSTP) whenever it receives prestandard MSTP on an MST port; no explicit configuration is necessary.

---

## Interoperability with Rapid PVST+: Understanding PVST Simulation

MST interoperates with Rapid PVST+ with no need for user configuration. The PVST simulation feature enables this seamless interoperability.



---

**Note** PVST simulation is enabled by default. That is, by default, all interfaces on the switch interoperate between MST and Rapid PVST+.

---

However, you may want to control the connection between MST and Rapid PVST+ to protect against accidentally connecting an MST-enabled port to a Rapid PVST+-enabled port. Because Rapid PVST+ is the default STP mode, you may encounter many Rapid PVST+-enabled connections.

Disabling Rapid PVST+ simulation, which can be done per port or globally for the entire switch, moves the MST-enabled port to the blocking state once it detects it is connected to a Rapid PVST+-enabled port. This port remains in the inconsistent state until the port stops receiving Rapid PVST+/SSTP BPDUs, and then the port resumes the normal STP transition process.

## Configuring MST

### MST Configuration Guidelines

When configuring MST, follow these guidelines:

- When you are in the MST configuration mode, the following guidelines apply:
  - Each command reference line creates its pending regional configuration.
  - The pending region configuration starts with the current region configuration.
  - To leave the MST configuration mode without committing any changes, enter the **abort** command.
  - To leave the MST configuration mode and commit all the changes that you made before you left the mode, enter the **exit** command.

### Enabling MST

You must enable MST; Rapid PVST+ is the default.



---

**Caution** Changing the spanning tree mode disrupts traffic because all spanning tree instances are stopped for the previous mode and started for the new mode.

---

#### SUMMARY STEPS

1. switch# **configure terminal**
2. switch# **configure terminal**
3. switch(config)# **spanning-tree mode mst**
4. (Optional) switch(config)# **no spanning-tree mode mst**

#### DETAILED STEPS

	Command or Action	Purpose
<b>Step 1</b>	switch# <b>configure terminal</b>	Enters global configuration mode.
<b>Step 2</b>	switch# <b>configure terminal</b>	Enters configuration mode.
<b>Step 3</b>	switch(config)# <b>spanning-tree mode mst</b>	Enables MST on the switch.
<b>Step 4</b>	(Optional) switch(config)# <b>no spanning-tree mode mst</b>	Disables MST on the switch and returns you to Rapid PVST+.

**Example**

This example shows how to enable MST on the switch:

```
switch# configure terminal
switch(config)# spanning-tree mode mst
```



**Note** Because STP is enabled by default, entering a **show running-config** command to view the resulting configuration does not display the command that you entered to enable STP.

## Entering MST Configuration Mode

You enter MST configuration mode to configure the MST name, VLAN-to-instance mapping, and MST revision number on the switch.

For two or more switches to be in the same MST region, they must have the identical MST name, VLAN-to-instance mapping, and MST revision number.



**Note** Each command reference line creates its pending regional configuration in MST configuration mode. In addition, the pending region configuration starts with the current region configuration.

When you are working in MST configuration mode, note the difference between the **exit** and **abort** commands.

### SUMMARY STEPS

1. switch# **configure terminal**
2. switch(config)# **spanning-tree mst configuration**
3. switch(config-mst)# **exit** or switch(config-mst)# **abort**
4. (Optional) switch(config)# **no spanning-tree mst configuration**

### DETAILED STEPS

	Command or Action	Purpose
Step 1	switch# <b>configure terminal</b>	Enters global configuration mode.
Step 2	switch(config)# <b>spanning-tree mst configuration</b>	Enters MST configuration mode on the system. You must be in the MST configuration mode to assign the MST configuration parameters, as follows: <ul style="list-style-type: none"> <li>• MST name</li> <li>• Instance-to-VLAN mapping</li> <li>• MST revision number</li> </ul>

	Command or Action	Purpose
<b>Step 3</b>	switch(config-mst)# <b>exit</b> or switch(config-mst)# <b>abort</b>	Exits or aborts. <ul style="list-style-type: none"> <li>The <b>exit</b> command commits all the changes and exits MST configuration mode.</li> <li>The <b>abort</b> command exits the MST configuration mode without committing any of the changes.</li> </ul>
<b>Step 4</b>	(Optional) switch(config)# <b>no spanning-tree mst configuration</b>	Returns the MST region configuration to the following default values: <ul style="list-style-type: none"> <li>The region name is an empty string.</li> <li>No VLANs are mapped to any MST instance (all VLANs are mapped to the CIST instance).</li> <li>The revision number is 0.</li> </ul>

## Specifying the MST Name

You configure a region name on the bridge. For two or more bridges to be in the same MST region, they must have the identical MST name, VLAN-to-instance mapping, and MST revision number.

### SUMMARY STEPS

1. switch# **configure terminal**
2. switch(config)# **spanning-tree mst configuration**
3. switch(config-mst)# **name name**

### DETAILED STEPS

	Command or Action	Purpose
<b>Step 1</b>	switch# <b>configure terminal</b>	Enters global configuration mode.
<b>Step 2</b>	switch(config)# <b>spanning-tree mst configuration</b>	Enters MST configuration submode.
<b>Step 3</b>	switch(config-mst)# <b>name name</b>	Specifies the name for MST region. The <i>name</i> string has a maximum length of 32 case-sensitive characters. The default is an empty string.

### Example

This example shows how to set the name of the MST region:

```
switch# configure terminal
switch(config)# spanning-tree mst configuration
switch(config-mst)# name accounting
```

## Specifying the MST Configuration Revision Number

You configure the revision number on the bridge. For two or more bridges to be in the same MST region, they must have the identical MST name, VLAN-to-instance mapping, and MST revision number.

### SUMMARY STEPS

1. `switch# configure terminal`
2. `switch(config)# spanning-tree mst configuration`
3. `switch(config-mst)# revision version`

### DETAILED STEPS

	Command or Action	Purpose
Step 1	<code>switch# configure terminal</code>	Enters global configuration mode.
Step 2	<code>switch(config)# spanning-tree mst configuration</code>	Enters MST configuration submode.
Step 3	<code>switch(config-mst)# revision version</code>	Specifies the revision number for the MST region. The range is from 0 to 65535, and the default value is 0.

### Example

This example shows how to configure the revision number of the MSTI region for 5:

```
switch# configure terminal
switch(config)# spanning-tree mst configuration
switch(config-mst)# revision 5
```

## Specifying the Configuration on an MST Region

For two or more switches to be in the same MST region, they must have the same VLAN-to-instance mapping, the same configuration revision number, and the same MST name.

A region can have one member or multiple members with the same MST configuration; each member must be capable of processing IEEE 802.1w RSTP BPDUs. There is no limit to the number of MST regions in a network, but each region can support only up to 65 MST instances. You can assign a VLAN to only one MST instance at a time.

### SUMMARY STEPS

1. `switch# configure terminal`
2. `switch(config)# spanning-tree mst configuration`
3. `switch(config-mst)# instance instance-id vlan vlan-range`
4. `switch(config-mst)# name name`
5. `switch(config-mst)# revision version`

## DETAILED STEPS

	Command or Action	Purpose
<b>Step 1</b>	switch# <b>configure terminal</b>	Enters global configuration mode.
<b>Step 2</b>	switch(config)# <b>spanning-tree mst configuration</b>	Enters MST configuration submode.
<b>Step 3</b>	switch(config-mst)# <b>instance</b> <i>instance-id</i> <b>vlan</b> <i>vlan-range</i>	<p>Maps VLANs to an MST instance as follows:</p> <ul style="list-style-type: none"> <li>• For <i>instance-id</i> , the range is from 1 to 4094.</li> <li>• For <b>vlan</b> <i>vlan-range</i> , the range is from 1 to 4094.</li> </ul> <p>When you map VLANs to an MST instance, the mapping is incremental, and the VLANs specified in the command are added to or removed from the VLANs that were previously mapped.</p> <p>To specify a VLAN range, enter a hyphen; for example, enter the <b>instance 1 vlan 1-63</b> command to map VLANs 1 through 63 to MST instance 1.</p> <p>To specify a VLAN series, enter a comma; for example, enter the <b>instance 1 vlan 10, 20, 30</b> command to map VLANs 10, 20, and 30 to MST instance 1.</p>
<b>Step 4</b>	switch(config-mst)# <b>name</b> <i>name</i>	Specifies the instance name. The <i>name</i> string has a maximum length of 32 case-sensitive characters.
<b>Step 5</b>	switch(config-mst)# <b>revision</b> <i>version</i>	Specifies the configuration revision number. The range is from 0 to 65535.

**Example**

To return to defaults, do the following:

- To return to the default MST region configuration settings, enter the **no spanning-tree mst configuration** configuration command.
- To return to the default VLAN-to-instance map, enter the **no instance** *instance-id* **vlan** *vlan-range* MST configuration command.
- To return to the default name, enter the **no name** MST configuration command.
- To return to the default revision number, enter the **no revision** MST configuration command.
- To reenabling Rapid PVST+, enter the **no spanning-tree mode** or the **spanning-tree mode rapid-pvst** global configuration command.

This example shows how to enter MST configuration mode, map VLANs 10 to 20 to MST instance 1, name the region region1, set the configuration revision to 1, display the pending configuration, apply the changes, and return to global configuration mode:

```
switch(config)# spanning-tree mst configuration
switch(config-mst)# instance 1 vlan 10-20
```

```

switch(config-mst)# name region1
switch(config-mst)# revision 1
switch(config-mst)# show pending
Pending MST configuration
Name      [region1]
Revision  1
Instances configured 2
Instance  Vlans Mapped
-----  -----
0         1-9,21-4094
1         10-20
-----  -----

```

## Mapping and Unmapping VLANs to MST Instances



**Caution** When you change the VLAN-to-MSTI mapping, the system restarts MST.



**Note** You cannot disable an MSTI.

For two or more bridges to be in the same MST region, they must have the identical MST name, VLAN-to-instance mapping, and MST revision number.

### SUMMARY STEPS

1. switch# **configure terminal**
2. switch(config)# **spanning-tree mst configuration**
3. switch(config-mst)# **instance** *instance-id* **vlan** *vlan-range*
4. switch(config-mst)# **no instance** *instance-id* **vlan** *vlan-range*

### DETAILED STEPS

	Command or Action	Purpose
<b>Step 1</b>	switch# <b>configure terminal</b>	Enters global configuration mode.
<b>Step 2</b>	switch(config)# <b>spanning-tree mst configuration</b>	Enters MST configuration submenu.
<b>Step 3</b>	switch(config-mst)# <b>instance</b> <i>instance-id</i> <b>vlan</b> <i>vlan-range</i>	Maps VLANs to an MST instance, as follows: <ul style="list-style-type: none"> <li>• For <i>instance-id</i> the range is from 1 to 4094. Instance 0 is reserved for the IST for each MST region.</li> <li>• For <i>vlan-range</i> the range is from 1 to 4094.</li> </ul>

	Command or Action	Purpose
		When you map VLANs to an MSTI, the mapping is incremental, and the VLANs specified in the command are added to or removed from the VLANs that were previously mapped.
<b>Step 4</b>	switch(config-mst)# <b>no instance</b> <i>instance-id</i> <b>vlan</b> <i>vlan-range</i>	Deletes the specified instance and returns the VLANs to the default MSTI, which is the CIST.

### Example

This example shows how to map VLAN 200 to MSTI 3:

```
switch# configure terminal
switch(config)# spanning-tree mst configuration
switch(config-mst)# instance 3 vlan 200
```

## Configuring the Root Bridge

You can configure the switch to become the root bridge.



**Note** The root bridge for each MSTI should be a backbone or distribution switch. Do not configure an access switch as the spanning tree primary root bridge.

Enter the **diameter** keyword, which is available only for MSTI 0 (or the IST), to specify the network diameter (that is, the maximum number of hops between any two end stations in the network). When you specify the network diameter, the switch automatically sets an optimal hello time, forward-delay time, and maximum-age time for a network of that diameter, which can significantly reduce the convergence time. You can enter the **hello** keyword to override the automatically calculated hello time.



**Note** With the switch configured as the root bridge, do not manually configure the hello time, forward-delay time, and maximum-age time using the **spanning-tree mst hello-time**, **spanning-tree mst forward-time**, and **spanning-tree mst max-age** global configuration commands.

### SUMMARY STEPS

1. switch# **configure terminal**
2. switch(config)# **spanning-tree mst** *instance-id* **root** {**primary** | **secondary**} [**diameter** *dia* [**hello-time** *hello-time*]]
3. (Optional) switch(config)# **no spanning-tree mst** *instance-id* **root**



## DETAILED STEPS

	Command or Action	Purpose
Step 1	switch# <b>configure terminal</b>	Enters global configuration mode.
Step 2	switch(config)# <b>spanning-tree mst <i>instance-id</i> root {primary   secondary} [diameter <i>dia</i> [hello-time <i>hello-time</i>]]</b>	Configures a switch as the root bridge as follows: <ul style="list-style-type: none"> <li>• For <i>instance-id</i>, you can specify a single instance, a range of instances separated by a hyphen, or a series of instances separated by a comma. The range is from 1 to 4094.</li> <li>• For diameter <i>net-diameter</i>, specify the maximum number of hops between any two end stations. The default is 7. This keyword is available only for MST instance 0.</li> <li>• For hello-time <i>seconds</i>, specify the interval in seconds between the generation of configuration messages by the root bridge. The range is from 1 to 10 seconds; the default is 2 seconds.</li> </ul>
Step 3	(Optional) switch(config)# <b>no spanning-tree mst <i>instance-id</i> root</b>	Returns the switch priority, diameter, and hello time to default values.

## Example

This example shows how to configure the switch as the root switch for MSTI 5:

```
switch# configure terminal
switch(config)# spanning-tree mst 5 root primary
```

## Configuring a Secondary Root Bridge

You can execute this command on more than one switch to configure multiple backup root bridges. Enter the same network diameter and hello-time values that you used when you configured the primary root bridge with the **spanning-tree mst root primary** configuration command.

## SUMMARY STEPS

1. switch# **configure terminal**
2. switch(config)# **spanning-tree mst *instance-id* root {primary | secondary} [diameter *dia* [hello-time *hello-time*]]**
3. (Optional) switch(config)# **no spanning-tree mst *instance-id* root**

## DETAILED STEPS

	Command or Action	Purpose
Step 1	switch# <b>configure terminal</b>	Enters global configuration mode.

	Command or Action	Purpose
<b>Step 2</b>	switch(config)# <b>spanning-tree mst</b> <i>instance-id</i> <b>root</b> { <b>primary</b>   <b>secondary</b> } [ <b>diameter</b> <i>dia</i> [ <b>hello-time</b> <i>hello-time</i> ]]	Configures a switch as the secondary root bridge as follows: <ul style="list-style-type: none"> <li>• For <i>instance-id</i>, you can specify a single instance, a range of instances separated by a hyphen, or a series of instances separated by a comma. The range is from 1 to 4094.</li> <li>• For diameter <i>net-diameter</i>, specify the maximum number of hops between any two end stations. The default is 7. This keyword is available only for MST instance 0.</li> <li>• For hello-time <i>seconds</i>, specify the interval in seconds between the generation of configuration messages by the root bridge. The range is from 1 to 10 seconds; the default is 2 seconds.</li> </ul>
<b>Step 3</b>	(Optional) switch(config)# <b>no spanning-tree mst</b> <i>instance-id</i> <b>root</b>	Returns the switch priority, diameter, and hello-time to default values.

### Example

This example shows how to configure the switch as the secondary root switch for MSTI 5:

```
switch# configure terminal
switch(config)# spanning-tree mst 5 root secondary
```

## Configuring the Port Priority

If a loop occurs, MST uses the port priority when selecting an interface to put into the forwarding state. You can assign lower priority values to interfaces that you want selected first and higher priority values to the interface that you want selected last. If all interfaces have the same priority value, MST puts the interface with the lowest interface number in the forwarding state and blocks the other interfaces.

### SUMMARY STEPS

1. switch# **configure terminal**
2. switch(config)# **interface** {{*type slot/port*} | {**port-channel** *number*}}
3. switch(config-if)# **spanning-tree mst** *instance-id* **port-priority** *priority*

### DETAILED STEPS

	Command or Action	Purpose
<b>Step 1</b>	switch# <b>configure terminal</b>	Enters global configuration mode.
<b>Step 2</b>	switch(config)# <b>interface</b> {{ <i>type slot/port</i> }   { <b>port-channel</b> <i>number</i> }}	Specifies an interface to configure, and enters interface configuration mode.

	Command or Action	Purpose
Step 3	switch(config-if)# <b>spanning-tree mst</b> <i>instance-id</i> <b>port-priority</b> <i>priority</i>	<p>Configures the port priority as follows:</p> <ul style="list-style-type: none"> <li>For <i>instance-id</i>, you can specify a single MSTI, a range of MSTIs separated by a hyphen, or a series of MSTIs separated by a comma. The range is from 1 to 4094.</li> <li>For <i>priority</i>, the range is 0 to 224 in increments of 32. The default is 128. A lower number indicates a higher priority.</li> </ul> <p>The priority values are 0, 32, 64, 96, 128, 160, 192, and 224. The system rejects all other values.</p>

### Example

This example shows how to set the MST interface port priority for MSTI 3 on Ethernet port 3/1 to 64:

```
switch# configure terminal
switch(config)# interface ethernet 3/1
switch(config-if)# spanning-tree mst 3 port-priority 64
```

You can only apply this command to a physical Ethernet interface.

## Configuring the Port Cost

The MST path-cost default value is derived from the media speed of an interface. If a loop occurs, MST uses the cost when selecting an interface to put in the forwarding state. You can assign lower cost values to interfaces that you want selected first and higher cost to interfaces values that you want selected last. If all interfaces have the same cost value, MST puts the interface with the lowest interface number in the forwarding state and blocks the other interfaces.



**Note** MST uses the long path-cost calculation method.

### SUMMARY STEPS

1. switch# **configure terminal**
2. switch(config)# **interface** *{{type slot/port}}* | **port-channel** *number}}*
3. switch(config-if)# **spanning-tree mst** *instance-id* **cost** [*cost* | **auto**]

### DETAILED STEPS

	Command or Action	Purpose
Step 1	switch# <b>configure terminal</b>	Enters global configuration mode.

	Command or Action	Purpose
<b>Step 2</b>	switch(config)# <b>interface</b> <i>{{type slot/port}}</i>   <b>port-channel</b> <i>number</i> }}	Specifies an interface to configure, and enters interface configuration mode.
<b>Step 3</b>	switch(config-if)# <b>spanning-tree mst</b> <i>instance-id</i> <b>cost</b> [ <i>cost</i>   <b>auto</b> ]	Configures the cost.  If a loop occurs, MST uses the path cost when selecting an interface to place into the forwarding state. A lower path cost represents higher-speed transmission as follows: <ul style="list-style-type: none"> <li>• For <i>instance-id</i>, you can specify a single instance, a range of instances separated by a hyphen, or a series of instances separated by a comma. The range is from 1 to 4094.</li> <li>• For <i>cost</i>, the range is from 1 to 200000000. The default value is auto, which is derived from the media speed of the interface.</li> </ul>

### Example

This example shows how to set the MST interface port cost on Ethernet 3/1 for MSTI 4:

```
switch# configure terminal
switch(config)# interface ethernet 3/1
switch(config-if)# spanning-tree mst 4 cost 17031970
```

## Configuring the Switch Priority

You can configure the switch priority for an MST instance so that it is more likely that the specified switch is chosen as the root bridge.



**Note** Exercise care when using this command. For most situations, we recommend that you enter the **spanning-tree mst root primary** and the **spanning-tree mst root secondary** global configuration commands to modify the switch priority.

### SUMMARY STEPS

1. switch# **configure terminal**
2. switch(config)# **spanning-tree mst** *instance-id* **priority** *priority-value*

### DETAILED STEPS

	Command or Action	Purpose
<b>Step 1</b>	switch# <b>configure terminal</b>	Enters global configuration mode.

	Command or Action	Purpose
Step 2	switch(config)# <b>spanning-tree mst</b> <i>instance-id</i> <b>priority</b> <i>priority-value</i>	<p>Configures a switch priority as follows:</p> <ul style="list-style-type: none"> <li>For <i>instance-id</i>, you can specify a single instance, a range of instances separated by a hyphen, or a series of instances separated by a comma. The range is from 1 to 4094.</li> <li>For <i>priority</i>, the range is from 0 to 61440 in increments of 4096; the default is 32768. A lower number indicates that the switch will most likely be chosen as the root bridge.</li> </ul> <p>Priority values are 0, 4096, 8192, 12288, 16384, 20480, 24576, 28672, 32768, 36864, 40960, 45056, 49152, 53248, 57344, and 61440. The system rejects all other values.</p>

### Example

This example shows how to configure the priority of the bridge to 4096 for MSTI 5:

```
switch# configure terminal
switch(config)# spanning-tree mst 5 priority 4096
```

## Configuring the Hello Time

You can configure the interval between the generation of configuration messages by the root bridge for all instances on the switch by changing the hello time.



**Note** Exercise care when using this command. For most situations, we recommend that you enter the **spanning-tree mst** *instance-id* **root primary** and the **spanning-tree mst** *instance-id* **root secondary** configuration commands to modify the hello time.

### SUMMARY STEPS

1. switch# **configure terminal**
2. switch(config)# **spanning-tree mst hello-time** *seconds*

### DETAILED STEPS

	Command or Action	Purpose
Step 1	switch# <b>configure terminal</b>	Enters global configuration mode.
Step 2	switch(config)# <b>spanning-tree mst hello-time</b> <i>seconds</i>	Configures the hello time for all MST instances. The hello time is the interval between the generation of configuration messages by the root bridge. These messages mean that the

	Command or Action	Purpose
		switch is alive. For <i>seconds</i> , the range is from 1 to 10, and the default is 2 seconds.

### Example

This example shows how to configure the hello time of the switch to 1 second:

```
switch# configure terminal
switch(config)# spanning-tree mst hello-time 1
```

## Configuring the Forwarding-Delay Time

You can set the forward delay timer for all MST instances on the switch with one command.

### SUMMARY STEPS

1. switch# **configure terminal**
2. switch(config)# **spanning-tree mst forward-time seconds**

### DETAILED STEPS

	Command or Action	Purpose
<b>Step 1</b>	switch# <b>configure terminal</b>	Enters global configuration mode.
<b>Step 2</b>	switch(config)# <b>spanning-tree mst forward-time seconds</b>	Configures the forward time for all MST instances. The forward delay is the number of seconds that a port waits before changing from its spanning tree blocking and learning states to the forwarding state. For <i>seconds</i> , the range is from 4 to 30, and the default is 15 seconds.

### Example

This example shows how to configure the forward-delay time of the switch to 10 seconds:

```
switch# configure terminal
switch(config)# spanning-tree mst forward-time 10
```

## Configuring the Maximum-Aging Time

The maximum-aging timer is the number of seconds that a switch waits without receiving spanning tree configuration messages before attempting a reconfiguration.

You set the maximum-aging timer for all MST instances on the switch with one command (the maximum age time only applies to the IST).

**SUMMARY STEPS**

1. switch# **configure terminal**
2. switch(config)# **spanning-tree mst max-age** *seconds*

**DETAILED STEPS**

	Command or Action	Purpose
<b>Step 1</b>	switch# <b>configure terminal</b>	Enters global configuration mode.
<b>Step 2</b>	switch(config)# <b>spanning-tree mst max-age</b> <i>seconds</i>	Configures the maximum-aging time for all MST instances. The maximum-aging time is the number of seconds that a switch waits without receiving spanning tree configuration messages before attempting a reconfiguration. For <i>seconds</i> , the range is from 6 to 40, and the default is 20 seconds.

**Example**

This example shows how to configure the maximum-aging timer of the switch to 40 seconds:

```
switch# configure terminal
switch(config)# spanning-tree mst max-age 40
```

## Configuring the Maximum-Hop Count

MST uses the path cost to the IST regional root and a hop-count mechanism similar to the IP time-to-live (TTL) mechanism. You configure the maximum hops inside the region and apply it to the IST and all MST instances in that region. The hop count achieves the same result as the message-age information (triggers a reconfiguration).

**SUMMARY STEPS**

1. switch# **configure terminal**
2. switch(config)# **spanning-tree mst max-hops** *hop-count*

**DETAILED STEPS**

	Command or Action	Purpose
<b>Step 1</b>	switch# <b>configure terminal</b>	Enters global configuration mode.
<b>Step 2</b>	switch(config)# <b>spanning-tree mst max-hops</b> <i>hop-count</i>	Specifies the number of hops in a region before the BPDU is discarded, and the information held for a port is aged. For <i>hop-count</i> , the range is from 1 to 255, and the default value is 20 hops.

**Example**

This example shows how to set the maximum hops to 40:

```
switch# configure terminal
switch(config)# spanning-tree mst max-hops 40
```

## Configuring PVST Simulation Globally

You can block this automatic feature either globally or per port. You can enter the global command and change the PVST simulation setting for the entire switch while you are in interface command mode.

**SUMMARY STEPS**

1. switch# **configure terminal**
2. switch(config)# **no spanning-tree mst simulate pvst global**

**DETAILED STEPS**

	Command or Action	Purpose
<b>Step 1</b>	switch# <b>configure terminal</b>	Enters global configuration mode.
<b>Step 2</b>	switch(config)# <b>no spanning-tree mst simulate pvst global</b>	Disables all interfaces on the switch from automatically interoperating with connected switch that is running in Rapid PVST+ mode. By default, all interfaces on the switch operate seamlessly between Rapid PVST+ and MST.

**Example**

This example shows how to prevent the switch from automatically interoperating with a connecting switch that is running Rapid PVST+:

```
switch# configure terminal
switch(config)# no spanning-tree mst simulate pvst global
```

## Configuring PVST Simulation Per Port

MST interoperates seamlessly with Rapid PVST+. However, to prevent an accidental connection to a switch that does not run MST as the default STP mode, you may want to disable this automatic feature. If you disable PVST simulation, the MST-enabled port moves to the blocking state once it detects it is connected to a Rapid PVST+-enabled port. This port remains in the inconsistent state until the port stops receiving BPDUs, and then the port resumes the normal STP transition process.

You can block this automatic feature either globally or per port.



## SUMMARY STEPS

1. switch# **configure terminal**
2. switch(config)# **interface** *{{type slot/port}}* | **{port-channel number}}**
3. switch(config-if)# **spanning-tree mst simulate pvst disable**
4. switch(config-if)# **spanning-tree mst simulate pvst**
5. switch(config-if)# **no spanning-tree mst simulate pvst**

## DETAILED STEPS

	Command or Action	Purpose
<b>Step 1</b>	switch# <b>configure terminal</b>	Enters global configuration mode.
<b>Step 2</b>	switch(config)# <b>interface</b> <i>{{type slot/port}}</i>   <b>{port-channel number}}</b>	Specifies an interface to configure, and enters interface configuration mode.
<b>Step 3</b>	switch(config-if)# <b>spanning-tree mst simulate pvst disable</b>	Disables specified interfaces from automatically interoperating with a connected switch that is running in Rapid PVST+ mode.  By default, all interfaces on the switch operate seamlessly between Rapid PVST+ and MST.
<b>Step 4</b>	switch(config-if)# <b>spanning-tree mst simulate pvst</b>	Reenables the seamless operation between MST and Rapid PVST+ on specified interfaces.
<b>Step 5</b>	switch(config-if)# <b>no spanning-tree mst simulate pvst</b>	Sets the interface to the switch-wide MST and Rapid PVST+ interoperation that you configured using the <b>spanning-tree mst simulate pvst global</b> command.

## Example

This example shows how to prevent the specified interfaces from automatically interoperating with a connecting switch that is not running MST:

```
switch# configure terminal
switch(config)# interface ethernet 1/4
switch(config-if)# spanning-tree mst simulate pvst disable
```

## Specifying the Link Type

Rapid connectivity (802.1w standard) is established only on point-to-point links. By default, the link type is controlled from the duplex mode of the interface. A full-duplex port is considered to have a point-to-point connection; a half-duplex port is considered to have a shared connection.

If you have a half-duplex link physically connected point-to-point to a single port on a remote switch, you can override the default setting on the link type and enable rapid transitions.

If you set the link to shared, STP reverts to 802.1D.

## SUMMARY STEPS

1. switch# **configure terminal**
2. switch(config)# **interface** *type slot/port*
3. switch(config-if)# **spanning-tree link-type** {**auto** | **point-to-point** | **shared**}

## DETAILED STEPS

	Command or Action	Purpose
<b>Step 1</b>	switch# <b>configure terminal</b>	Enters configuration mode.
<b>Step 2</b>	switch(config)# <b>interface</b> <i>type slot/port</i>	Specifies the interface to configure, and enters interface configuration mode.
<b>Step 3</b>	switch(config-if)# <b>spanning-tree link-type</b> { <b>auto</b>   <b>point-to-point</b>   <b>shared</b> }	Configures the link type to be either point to point or shared. The system reads the default value from the switch connection. Half-duplex links are shared and full-duplex links are point to point. If the link type is shared, the STP reverts to 802.1D. The default is auto, which sets the link type based on the duplex setting of the interface.

## Example

This example shows how to configure the link type as point to point:

```
switch# configure terminal
switch (config)# interface ethernet 1/4
switch(config-if)# spanning-tree link-type point-to-point
```

## Restarting the Protocol

An MST bridge can detect that a port is at the boundary of a region when it receives a legacy BPDU or an MST BPDU that is associated with a different region. However, the STP protocol migration cannot determine whether the legacy switch, which is a switch that runs only IEEE 802.1D, has been removed from the link unless the legacy switch is the designated switch. Enter this command to restart the protocol negotiation (force the renegotiation with neighboring switches) on the entire switch or on specified interfaces.

## SUMMARY STEPS

1. switch# **clear spanning-tree detected-protocol** [**interface** *interface* [*interface-num* | *port-channel*]]

## DETAILED STEPS

	Command or Action	Purpose
<b>Step 1</b>	switch# <b>clear spanning-tree detected-protocol</b> [ <b>interface</b> <i>interface</i> [ <i>interface-num</i>   <i>port-channel</i> ]]	Restarts MST on the entire switch or specified interfaces.

**Example**

This example shows how to restart MST on the Ethernet interface on slot 2, port 8:

```
switch# clear spanning-tree detected-protocol interface ethernet 2/8
```

## Verifying the MST Configuration

Use the following commands to display MST configuration information.

Command	Purpose
<code>show running-config spanning-tree [all]</code>	Displays the current spanning tree configuration.
<code>show spanning-tree mst [options]</code>	Displays detailed information for the current MST configuration.

This example shows how to display the current MST configuration:

```
switch# show spanning-tree mst configuration
```

```
% Switch is not in mst mode
```

```
Name      [mist-attempt]
```

```
Revision 1      Instances configured 2
```

```
Instance  Vlans mapped
```

```
-----
0          1-12,14-41,43-4094
1          13,42
```





## CHAPTER 8

# Configuring STP Extensions

- [Overview, on page 107](#)

## Overview

Cisco has added extensions to Spanning Tree Protocol (STP) that make convergence more efficient. In some cases, even though similar functionality may be incorporated into the IEEE 802.1w Rapid Spanning Tree Protocol (RSTP) standard, we recommend using these extensions. All of these extensions can be used with both RPVST+ and Multiple Spanning Tree Protocol (MST).

The available extensions are spanning tree port types, Bridge Assurance, BPDU Guard, BPDU Filtering, Loop Guard, and Root Guard. Many of these features can be applied either globally or on specified interfaces.



---

**Note** Spanning tree is used to refer to IEEE 802.1w and IEEE 802.1s. If the text is discussing the IEEE 802.1D Spanning Tree Protocol, 802.1D is stated specifically.

---

## Information About STP Extensions

### Understanding STP Port Types

You can configure a spanning tree port as an edge port, a network port, or a normal port. A port can be in only one of these states at a given time. The default spanning tree port type is normal. Depending on the type of device to which the interface is connected, you can configure a spanning tree port as one of these port types.

#### Spanning Tree Edge Ports

Edge ports, which are connected to hosts, can be either an access port or a trunk port. The edge port interface immediately transitions to the forwarding state, without moving through the blocking or learning states. (This immediate transition was previously configured as the Cisco-proprietary feature PortFast.)

Interfaces that are connected to hosts should not receive STP bridge protocol data units (BPDUs).



---

**Note** If you configure a port connected to another switch as an edge port, you might create a bridging loop.

---

## Spanning Tree Network Ports

Network ports are connected only to switches or bridges. Configuring a port as a network port while Bridge Assurance is enabled globally, enables Bridge Assurance on that port.



---

**Note** If you mistakenly configure ports that are connected to hosts or other edge devices as spanning tree network ports, those ports automatically move into the blocking state.

---

## Spanning Tree Normal Ports

Normal ports can be connected to either hosts, switches, or bridges. These ports function as normal spanning tree ports.

The default spanning tree interface is a normal port.

## Understanding Bridge Assurance

You can use Bridge Assurance to protect against certain problems that can cause bridging loops in the network. Specifically, you use Bridge Assurance to protect against a unidirectional link failure and a device that continues to forward data traffic when it is no longer running the spanning tree algorithm.



---

**Note** Bridge Assurance is supported only by Rapid PVST+ and MST. Legacy 802.1D spanning tree does not support Bridge Assurance.

---

Bridge Assurance is enabled by default and can only be disabled globally. Also, Bridge Assurance can be enabled only on spanning tree network ports that are point-to-point links. Finally, both ends of the link must have Bridge Assurance enabled.

With Bridge Assurance enabled, BPDUs are sent out on all operational network ports, including alternate and backup ports, for each hello time period. If the port does not receive a BPDU for a specified period, the port moves into the blocking state and is not used in the root port calculation. Once that port receives a BPDU, it resumes the normal spanning tree transitions.

## Understanding BPDU Guard

Enabling BPDU Guard shuts down that interface if a BPDU is received.

You can configure BPDU Guard at the interface level. When configured at the interface level, BPDU Guard shuts the port down as soon as the port receives a BPDU, regardless of the port type configuration.

When you configure BPDU Guard globally, it is effective only on operational spanning tree edge ports. In a valid configuration, LAN edge interfaces do not receive BPDUs. A BPDU that is received by an edge LAN interface signals an invalid configuration, such as the connection of an unauthorized host or switch. BPDU Guard, when enabled globally, shuts down all spanning tree edge ports when they receive a BPDU.

BPDU Guard provides a secure response to invalid configurations, because you must manually put the LAN interface back in service after an invalid configuration.



---

**Note** When enabled globally, BPDU Guard applies to all operational spanning tree edge interfaces.

---

## Understanding BPDU Filtering

You can use BPDU Filtering to prevent the switch from sending or even receiving BPDUs on specified ports.

When configured globally, BPDU Filtering applies to all operational spanning tree edge ports. You should connect edge ports only to hosts, which typically drop BPDUs. If an operational spanning tree edge port receives a BPDU, it immediately returns to a normal spanning tree port type and moves through the regular transitions. In that case, BPDU Filtering is disabled on this port, and spanning tree resumes sending BPDUs on this port.

In addition, you can configure BPDU Filtering by the individual interface. When you explicitly configure BPDU Filtering on a port, that port does not send any BPDUs and drops all BPDUs that it receives. You can effectively override the global BPDU Filtering setting on individual ports by configuring the specific interface. This BPDU Filtering command on the interface applies to the entire interface, whether the interface is trunking or not.



**Caution** Use care when configuring BPDU Filtering per interface. If you explicitly configuring BPDU Filtering on a port that is not connected to a host, it can result in bridging loops because the port ignores any BPDU that it receives and goes to forwarding.

If the port configuration is not set to default BPDU Filtering, the edge configuration does not affect BPDU Filtering. The following table lists all the BPDU Filtering combinations.

**Table 7: BPDU Filtering Configurations**

BPDU Filtering Per Port Configuration	BPDU Filtering Global Configuration	STP Edge Port Configuration	BPDU Filtering State
Default	Enabled	Enabled	Enabled. The port transmits at least 10 BPDUs. If this port receives any BPDUs, the port returns to the spanning tree normal port state and BPDU Filtering is disabled.
Default	Enabled	Disabled	Disabled
Default	Disabled	Enabled/Disabled	Disabled
Disable	Enabled/Disabled	Enabled/Disabled	Disabled
Enabled	Enabled/Disabled	Enabled/Disabled	<p><b>Caution</b> BPDUs are never sent and if received, they do not trigger the regular STP behavior - use with caution.</p>

## Understanding Loop Guard

Loop Guard protects networks from loops that are caused by the following:

- Network interfaces that malfunction
- Busy CPUs
- Anything that prevents the normal forwarding of BPDUs

An STP loop occurs when a blocking port in a redundant topology erroneously transitions to the forwarding state. This transition usually happens because one of the ports in a physically redundant topology (not necessarily the blocking port) stops receiving BPDUs.

Loop Guard is useful only in switched networks where devices are connected by point-to-point links. On a point-to-point link, a designated bridge cannot disappear unless it sends an inferior BPDU or brings the link down.



---

**Note** Loop Guard can be enabled only on network and normal spanning tree port types.

---

You can use Loop Guard to determine if a root port or an alternate/backup root port receives BPDUs. If the port does not receive BPDUs, Loop Guard puts the port into an inconsistent state (blocking) until the port starts to receive BPDUs again. A port in the inconsistent state does not transmit BPDUs. If the port receives BPDUs again, the protocol removes its loop-inconsistent condition, and the STP determines the port state because such recovery is automatic.

Loop Guard isolates the failure and allows STP to converge to a stable topology without the failed link or bridge. Disabling Loop Guard moves all loop-inconsistent ports to the listening state.

You can enable Loop Guard on a per-port basis. When you enable Loop Guard on a port, it is automatically applied to all of the active instances or VLANs to which that port belongs. When you disable Loop Guard, it is disabled for the specified ports.

## Understanding Root Guard

When you enable Root Guard on a port, Root Guard does not allow that port to become a root port. If a received BPDU triggers an STP convergence that makes that designated port become a root port, that port is put into a root-inconsistent (blocked) state. After the port stops sending superior BPDUs, the port is unblocked again. Through STP, the port moves to the forwarding state. Recovery is automatic.

Root Guard enabled on an interface applies this functionality to all VLANs to which that interface belongs.

You can use Root Guard to enforce the root bridge placement in the network. Root Guard ensures that the port on which Root Guard is enabled is the designated port. Normally, root bridge ports are all designated ports, unless two or more of the ports of the root bridge are connected. If the bridge receives superior BPDUs on a Root Guard-enabled port, the bridge moves this port to a root-inconsistent STP state. In this way, Root Guard enforces the position of the root bridge.

You cannot configure Root Guard globally.



---

**Note** You can enable Root Guard on all spanning tree port types: normal, edge, and network ports.

---



# Configuring STP Extensions

## STP Extensions Configuration Guidelines

When configuring STP extensions, follow these guidelines:

- Configure all access and trunk ports connected to hosts as edge ports.
- Bridge Assurance runs only on point-to-point spanning tree network ports. You must configure each side of the link for this feature.
- Loop Guard does not run on spanning tree edge ports.
- Enabling Loop Guard on ports that are not connected to a point-to-point link will not work.
- You cannot enable Loop Guard if Root Guard is enabled.

## Configuring Spanning Tree Port Types Globally

The spanning tree port type designation depends on the type of device the port is connected to, as follows:

- Edge—Edge ports are connected to hosts and can be either an access port or a trunk port.
- Network—Network ports are connected only to switches or bridges.
- Normal—Normal ports are neither edge ports nor network ports; they are normal spanning tree ports. These ports can be connected to any type of device.

You can configure the port type either globally or per interface. By default, the spanning tree port type is normal.

### Before you begin

Ensure that STP is configured.

Ensure that you are configuring the ports correctly for the type of device to which the interface is connected.

### SUMMARY STEPS

1. switch# **configure terminal**
2. switch(config)# **spanning-tree port type edge default**
3. switch(config)# **spanning-tree port type network default**

### DETAILED STEPS

	Command or Action	Purpose
Step 1	switch# <b>configure terminal</b>	Enters global configuration mode.
Step 2	switch(config)# <b>spanning-tree port type edge default</b>	Configures all interfaces as edge ports. Using this command assumes all ports are connected to hosts/servers. Edge ports immediately transition to the forwarding state without passing through the blocking or learning state at linkup. By default, spanning tree ports are normal port types.

	Command or Action	Purpose
Step 3	switch(config)# <b>spanning-tree port type network default</b>	<p>Configures all interfaces as spanning tree network ports. Using this command assumes all ports are connected to switches and bridges. If you enable Bridge Assurance, it automatically runs on network ports. By default, spanning tree ports are normal port types.</p> <p><b>Note</b> If you configure interfaces connected to hosts as network ports, those ports automatically move into the blocking state.</p>

### Example

This example shows how to configure all access and trunk ports connected to hosts as spanning tree edge ports:

```
switch# configure terminal
switch(config)# spanning-tree port type edge default
```

This example shows how to configure all ports connected to switches or bridges as spanning tree network ports:

```
switch# configure terminal
switch(config)# spanning-tree port type network default
```

## Configuring Spanning Tree Edge Ports on Specified Interfaces

You can configure spanning tree edge ports on specified interfaces. Interfaces configured as spanning tree edge ports immediately transition to the forwarding state without passing through the blocking or learning states on linkup.

This command has four states:

- **spanning-tree port type edge**—This command explicitly enables edge behavior on the access port.
- **spanning-tree port type edge trunk**—This command explicitly enables edge behavior on the trunk port.



**Note** If you enter the **spanning-tree port type edge trunk** command, the port is configured as an edge port even in the access mode.

- **spanning-tree port type normal**—This command explicitly configures the port as a normal spanning tree port and the immediate transition to the forwarding state is not enabled.
- **no spanning-tree port type**—This command implicitly enables edge behavior if you define the **spanning-tree port type edge default** command in global configuration mode. If you do not configure the edge ports globally, the **no spanning-tree port type** command is equivalent to the **spanning-tree port type disable** command.

**Before you begin**

Ensure that STP is configured.

Ensure that the interface is connected to hosts.

**SUMMARY STEPS**

1. switch# **configure terminal**
2. switch(config)# **interface** *type slot/port*
3. switch(config-if)# **spanning-tree port type edge**

**DETAILED STEPS**

	<b>Command or Action</b>	<b>Purpose</b>
<b>Step 1</b>	switch# <b>configure terminal</b>	Enters global configuration mode.
<b>Step 2</b>	switch(config)# <b>interface</b> <i>type slot/port</i>	Specifies the interface to configure, and enters the interface configuration mode.
<b>Step 3</b>	switch(config-if)# <b>spanning-tree port type edge</b>	Configures the specified access interfaces to be spanning edge ports. Edge ports immediately transition to the forwarding state without passing through the blocking or learning state at linkup. By default, spanning tree ports are normal port types.

**Example**

This example shows how to configure the Ethernet access interface 1/4 to be a spanning tree edge port:

```
switch# configure terminal
switch(config)# interface ethernet 1/4
switch(config-if)# spanning-tree port type edge
```

**Configuring Spanning Tree Network Ports on Specified Interfaces**

You can configure spanning tree network ports on specified interfaces.

Bridge Assurance runs only on spanning tree network ports.

This command has three states:

- **spanning-tree port type network**—This command explicitly configures the port as a network port. If you enable Bridge Assurance globally, it automatically runs on a spanning tree network port.
- **spanning-tree port type normal**—This command explicitly configures the port as a normal spanning tree port and Bridge Assurance cannot run on this interface.
- **no spanning-tree port type**—This command implicitly enables the port as a spanning tree network port if you define the **spanning-tree port type network default** command in global configuration mode. If you enable Bridge Assurance globally, it automatically runs on this port.



---

**Note** A port connected to a host that is configured as a network port automatically moves into the blocking state.

---

**Before you begin**

Ensure that STP is configured.

Ensure that the interface is connected to switches or routers.

**SUMMARY STEPS**

1. switch# **configure terminal**
2. switch(config)# **interface** type slot/port
3. switch(config-if)# **spanning-tree port type network**

**DETAILED STEPS**

	Command or Action	Purpose
<b>Step 1</b>	switch# <b>configure terminal</b>	Enters global configuration mode.
<b>Step 2</b>	switch(config)# <b>interface</b> type slot/port	Specifies the interface to configure, and enters the interface configuration mode. The interface can be a physical Ethernet port.
<b>Step 3</b>	switch(config-if)# <b>spanning-tree port type network</b>	Configures the specified interfaces to be spanning network ports. If you enable Bridge Assurance, it automatically runs on network ports. By default, spanning tree ports are normal port types.

**Example**

This example shows how to configure the Ethernet interface 1/4 to be a spanning tree network port:

```
switch# configure terminal
switch(config)# interface ethernet 1/4
switch(config-if)# spanning-tree port type network
```

**Enabling BPDU Guard Globally**

You can enable BPDU Guard globally by default. In this condition, the system shuts down an edge port that receives a BPDU.



---

**Note** We recommend that you enable BPDU Guard on all edge ports.

---

**Before you begin**

Ensure that STP is configured.

Ensure that you have configured some spanning tree edge ports.

**SUMMARY STEPS**

1. switch# **configure terminal**
2. switch(config)# **spanning-tree port type edge bpduguard default**

**DETAILED STEPS**

	Command or Action	Purpose
<b>Step 1</b>	switch# <b>configure terminal</b>	Enters global configuration mode.
<b>Step 2</b>	switch(config)# <b>spanning-tree port type edge bpduguard default</b>	Enables BPDU Guard by default on all spanning tree edge ports. By default, global BPDU Guard is disabled.

**Example**

This example shows how to enable BPDU Guard on all spanning tree edge ports:

```
switch# configure terminal
switch(config)# spanning-tree port type edge bpduguard default
```

**Enabling BPDU Guard on Specified Interfaces**

You can enable BPDU Guard on specified interfaces. Enabling BPDU Guard shuts down the port if it receives a BPDU.

You can configure BPDU Guard on specified interfaces as follows:

- **spanning-tree bpduguard enable**—Unconditionally enables BPDU Guard on the interface.
- **spanning-tree bpduguard disable**—Unconditionally disables BPDU Guard on the interface.
- **no spanning-tree bpduguard**—Enables BPDU Guard on the interface if it is an operational edge port and if the **spanning-tree port type edge bpduguard default** command is configured.

**Before you begin**

Ensure that STP is configured.

**SUMMARY STEPS**

1. switch# **configure terminal**
2. switch(config)# **interface** *type slot/port*
3. switch(config-if)# **spanning-tree bpduguard {enable | disable}**
4. (Optional) switch(config-if)# **no spanning-tree bpduguard**

## DETAILED STEPS

	Command or Action	Purpose
<b>Step 1</b>	switch# <b>configure terminal</b>	Enters global configuration mode.
<b>Step 2</b>	switch(config)# <b>interface</b> <i>type slot/port</i>	Specifies the interface to configure, and enters the interface configuration mode.
<b>Step 3</b>	switch(config-if)# <b>spanning-tree bpduguard {enable   disable}</b>	Enables or disables BPDU Guard for the specified spanning tree edge interface. By default, BPDU Guard is disabled on physical Ethernet interfaces.
<b>Step 4</b>	(Optional) switch(config-if)# <b>no spanning-tree bpduguard</b>	Disables BPDU Guard on the interface.  <b>Note</b> Enables BPDU Guard on the interface if it is an operational edge port and if you enter the <b>spanning-tree port type edge bpduguard default</b> command.

**Example**

This example shows how to explicitly enable BPDU Guard on the Ethernet edge port 1/4:

```
switch# configure terminal
switch (config)# interface ethernet 1/4
switch(config-if)# spanning-tree bpduguard enable
switch(config-if)# no spanning-tree bpduguard
```

**Enabling BPDU Filtering Globally**

You can enable BPDU Filtering globally by default on spanning tree edge ports.

If an edge port with BPDU Filtering enabled receives a BPDU, it loses its operation status and as edge port and resumes the regular STP transitions. However, this port maintains its configuration as an edge port.



**Caution** Be careful when using this command: using it incorrectly can cause bridging loops.



**Note** When enabled globally, BPDU Filtering is applied *only* on ports that are operational edge ports. Ports send a few BPDUs at linkup before they effectively filter outbound BPDUs. If a BPDU is received on an edge port, it immediately loses its operational edge port status and BPDU Filtering is disabled.

**Before you begin**

Ensure that STP is configured.

Ensure that you have configured some spanning tree edge ports.

**SUMMARY STEPS**

1. switch# **configure terminal**
2. switch(config)# **spanning-tree port type edge bpdudfilter default**

**DETAILED STEPS**

	Command or Action	Purpose
<b>Step 1</b>	switch# <b>configure terminal</b>	Enters global configuration mode.
<b>Step 2</b>	switch(config)# <b>spanning-tree port type edge bpdudfilter default</b>	Enables BPDU Filtering by default on all operational spanning tree edge ports. Global BPDU Filtering is disabled by default.

**Example**

This example shows how to enable BPDU Filtering on all operational spanning tree edge ports:

```
switch# configure terminal
switch(config)# spanning-tree port type edge bpdudfilter default
```

**Enabling BPDU Filtering on Specified Interfaces**

You can apply BPDU Filtering to specified interfaces. When enabled on an interface, that interface does not send any BPDUs and drops all BPDUs that it receives. This BPDU Filtering functionality applies to the entire interface, whether trunking or not.



**Caution** Be careful when you enter the **spanning-tree bpdudfilter enable** command on specified interfaces. Explicitly configuring BPDU Filtering on a port that is not connected to a host can result in bridging loops because the port ignores any BPDU it receives and goes to forwarding.

You can enter this command to override the port configuration on specified interfaces.

This command has three states:

- **spanning-tree bpdudfilter enable**—Unconditionally enables BPDU Filtering on the interface.
- **spanning-tree bpdudfilter disable**—Unconditionally disables BPDU Filtering on the interface.
- **no spanning-tree bpdudfilter**—Enables BPDU Filtering on the interface if the interface is an operational edge port and if you configure the **spanning-tree port type edge bpdudfilter default** command.



**Note** When you enable BPDU Filtering locally on a port, this feature prevents the device from receiving or sending BPDUs on this port.

**Before you begin**

Ensure that STP is configured.

**SUMMARY STEPS**

1. switch# **configure terminal**
2. switch(config)# **interface** *type slot/port*
3. switch(config-if)# **spanning-tree bpdudfilter** {enable | disable}
4. (Optional) switch(config-if)# **no spanning-tree bpdudfilter**

**DETAILED STEPS**

	Command or Action	Purpose
<b>Step 1</b>	switch# <b>configure terminal</b>	Enters global configuration mode.
<b>Step 2</b>	switch(config)# <b>interface</b> <i>type slot/port</i>	Specifies the interface to configure, and enters the interface configuration mode.
<b>Step 3</b>	switch(config-if)# <b>spanning-tree bpdudfilter</b> {enable   disable}	Enables or disables BPDU Filtering for the specified spanning tree edge interface. By default, BPDU Filtering is disabled.
<b>Step 4</b>	(Optional) switch(config-if)# <b>no spanning-tree bpdudfilter</b>	Disables BPDU Filtering on the interface.  <b>Note</b> Enables BPDU Filtering on the interface if the interface is an operational spanning tree edge port and if you enter the <b>spanning-tree port type edge bpdudfilter default</b> command.

**Example**

This example shows how to explicitly enable BPDU Filtering on the Ethernet spanning tree edge port 1/4:

```
switch# configure terminal
switch (config)# interface ethernet 1/4
switch(config-if)# spanning-tree bpdudfilter enable
```

**Enabling Loop Guard Globally**

You can enable Loop Guard globally by default on all point-to-point spanning tree normal and network ports. Loop Guard does not run on edge ports.

Loop Guard provides additional security in the bridge network. Loop Guard prevents alternate or root ports from becoming the designated port because of a failure that could lead to a unidirectional link.



**Note** Entering the Loop Guard command for the specified interface overrides the global Loop Guard command.



**Before you begin**

Ensure that STP is configured.

Ensure that you have spanning tree normal ports or have configured some network ports.

**SUMMARY STEPS**

1. switch# **configure terminal**
2. switch(config)# **spanning-tree loopguard default**

**DETAILED STEPS**

	Command or Action	Purpose
<b>Step 1</b>	switch# <b>configure terminal</b>	Enters global configuration mode.
<b>Step 2</b>	switch(config)# <b>spanning-tree loopguard default</b>	Enables Loop Guard by default on all spanning tree normal and network ports. By default, global Loop Guard is disabled.

**Example**

This example shows how to enable Loop Guard on all spanning tree normal or network ports:

```
switch# configure terminal
switch(config)# spanning-tree loopguard default
```

**Enabling Loop Guard or Root Guard on Specified Interfaces**

You can enable either Loop Guard or Root Guard on specified interfaces.

Enabling Root Guard on a port means that port cannot become a root port, and LoopGuard prevents alternate or root ports from becoming the designated port because of a failure that could lead to a unidirectional link.

Both Loop Guard and Root Guard enabled on an interface apply to all VLANs to which that interface belongs.



---

**Note** Entering the Loop Guard command for the specified interface overrides the global Loop Guard command.

---

**Before you begin**

Ensure that STP is configured.

Ensure that you are configuring Loop Guard on spanning tree normal or network ports.

**SUMMARY STEPS**

1. switch# **configure terminal**
2. switch(config)# **interface** *type slot/port*
3. switch(config-if)# **spanning-tree guard** {loop | root | none}

## DETAILED STEPS

	Command or Action	Purpose
<b>Step 1</b>	switch# <b>configure terminal</b>	Enters global configuration mode.
<b>Step 2</b>	switch(config)# <b>interface</b> <i>type slot/port</i>	Specifies the interface to configure, and enters the interface configuration mode.
<b>Step 3</b>	switch(config-if)# <b>spanning-tree guard</b> { <b>loop</b>   <b>root</b>   <b>none</b> }	Enables or disables either Loop Guard or Root Guard for the specified interface. By default, Root Guard is disabled by default, and Loop Guard on specified ports is also disabled.  <b>Note</b> Loop Guard runs only on spanning tree normal and network interfaces.

**Example**

This example shows how to enable Root Guard on Ethernet port 1/4:

```
switch# configure terminal
switch (config)# interface ethernet 1/4
switch(config-if)# spanning-tree guard root
```

**Verifying the STP Extension Configuration**

Use the following commands to display the configuration information for the STP extensions.

Command	Purpose
<b>show running-config spanning-tree</b> [ <b>all</b> ]	Displays the current status of spanning tree on the switch.
<b>show spanning-tree</b> [ <i>options</i> ]	Displays selected detailed information for the current spanning tree configuration.



## CHAPTER 9

# Configuring Flex Links

---

- [Information about Flex Links, on page 121](#)
- [Guidelines and Limitations for Flex Link, on page 123](#)
- [Default Settings for Flex Link, on page 124](#)
- [Configuring Flex Links, on page 124](#)
- [Configuring Flex Link Preemption, on page 126](#)
- [Verifying Flex Link Configuration, on page 127](#)

## Information about Flex Links

Flex Links are a pair of a Layer 2 interfaces (switch ports or port channels) where one interface is configured to act as a backup to the other. The feature provides an alternative solution to the Spanning Tree Protocol (STP). You can disable STP and still retain basic link redundancy. Flex Links are typically configured in service provider or enterprise networks where customers do not want to run STP on the switch. If the switch is running STP, Flex Links are not necessary because STP already provides link-level redundancy or backup.

You can configure Flex Links on one Layer 2 interface (the active link) by assigning another Layer 2 interface as the Flex Links or backup link. The Flex Links interface can be on the same switch. When one of the links is up and forwarding traffic, the other link is in standby mode, ready to begin forwarding traffic if the other link shuts down. At any given time only one of the interfaces is in the linkup state and forwarding traffic. If the primary link shuts down, the standby link starts forwarding traffic. When the active link comes back up, it goes into standby mode and does not forward traffic. Flex Links are not configured by default and there are no backup interfaces defined. STP is disabled on Flex Link interfaces.

Figure 17: Flex Links Configuration Example

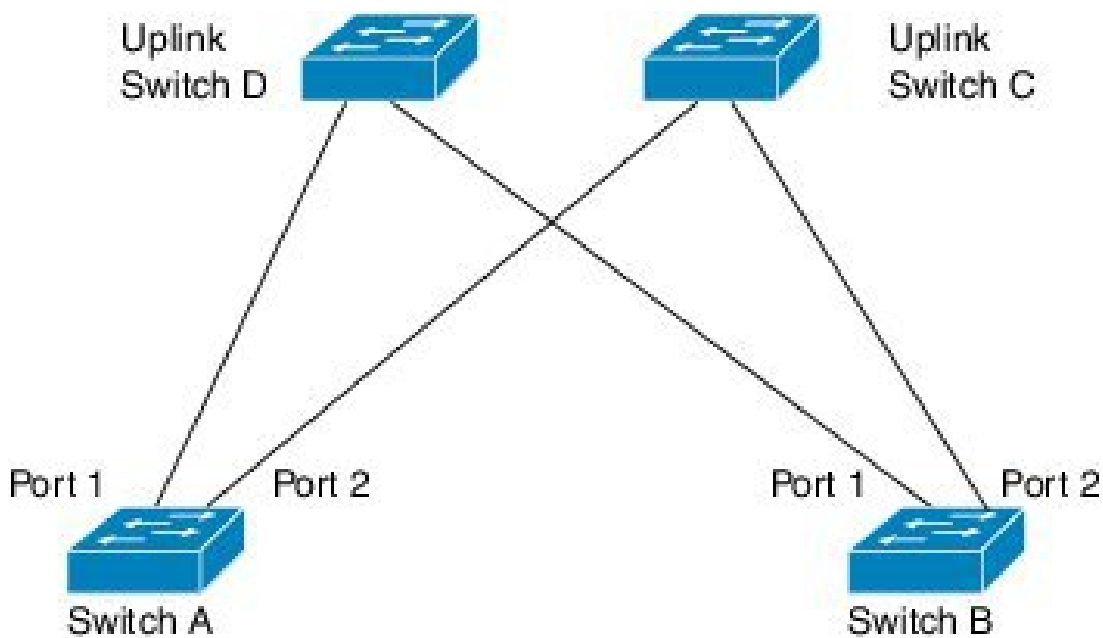

In the Flex Links Configuration Example, Switches A and B are downlink switches. Ports 1 and 2 on switches A and B are connected to uplink switches C and D. Because they are configured as Flex Links, only one of the interfaces is forwarding traffic; the other is in standby mode. The interface that is forwarding traffic is the active interface. If port 1 on switch A is the active interface, it begins forwarding traffic between port 1 and switch D; the link between port 2 (the backup interface) and switch C is not forwarding traffic. If port 1 goes down, port 2 comes up and starts forwarding traffic to switch C. When port 1 comes back up, it goes into standby mode and does not forward traffic; port 2 continues forwarding traffic.

Flex Links are supported only on Layer 2 ports and port channels, not on VLANs or on Layer 3 ports. It provides link redundancy for switch topologies where other types of redundancies such as STP, VPC and Layer 2 Multi-Path are not required or desired.

## Preemption

You can optionally configure a preemption mechanism to specify the active interface. For example, you can configure a Flex Link pair with preemption mode so that when a port comes back up, if it has greater bandwidth than the peer port, it will begin forwarding after 60 seconds and the peer port will be on standby. This is done by entering the preemption mode bandwidth and delay commands.

If a primary (forwarding) link goes down, the network management stations are notified. If the standby link goes down, you are notified.

You can configure preemption in the following three modes:

- **Forced**-The active interface always preempts the backup interface.
- **Bandwidth**-The interface with the higher bandwidth always acts as the active interface.
- **Off**-There is no preemption; the first interface that is working is put in forwarding mode.

You can also configure the preemption delay as a specified amount of time (in seconds) before preempting a working interface for another. This ensures that the counterpart in the upstream switch has transitioned to an STP forwarding state before the switch over.

## Multicast

When a Flex Link interface is learned as an mrouter port, the standby (non-forwarding) interface is also co-learned as an mrouter port if the link is up. This co-learning is for internal software state maintenance and has no relevance with respect to IGMP operations or hardware forwarding unless multicast fast-convergence is enabled. With multicast fast-convergence configured, the co-learned mrouter port is immediately added to the hardware. Flex Link supports multicast fast convergence for IPv4 IGMP.

## Guidelines and Limitations for Flex Link

Consider the following guidelines and limitations when configuring Flex Links:

- Because the Spanning Tree Protocol is implicitly disabled on Flex Link interfaces, ensure that you do not configure any other redundant paths in the same topology to prevent loops. In addition, configure the corresponding links to upstream switches by using the spanning-tree port type normal command so they do not get blocked by Bridge Assurance.
- Flex Links are designed for uplink interfaces, which are typically configured as trunk ports. As a link backup mechanism, a Flex Link pair must have the same configuration characteristics, including the same switchport mode and list of allowed VLANs. Port-profile makes a convenient tool for syncing up such configurations for the Flex Link pair. Flex Link does not require that the two interfaces have the same configurations. However, long term mismatches in configurations may result in forwarding problems, particularly during failover.
- Flex Links cannot be configured on the following interface types:
  - Layer 3 interfaces
  - SPAN destinations
  - Port channel members
  - Interfaces configured with Private VLANs
  - Interfaces in end node mode
  - Layer 2 multi-path
- You can configure only one Flex Link backup link for any active link and it must be a different interface from the active interface.
- An interface can belong to only one Flex Link pair; it can be a backup link for only one active link.
- Neither of the links can be a port that belongs to an EtherChannel. However, you can configure two port channels (EtherChannel logical interfaces) as Flex Links, and you can configure a port channel and a physical interface as Flex Links, with either the port channel or the physical interface as the active link.
- STP is disabled on Flex Link ports. A Flex Link port does not participate in STP, even if the VLANs present on the port are configured for STP. When STP is not enabled, be sure that there are no loops in the configured topology.

- Do not configure any STP features (for example, PortFast, and BPDU Guard) on Flex Links ports.
- vPC is not supported. Flex Link is used in place of vPC where configuration simplicity is desired and there is no need for active-active redundancy.



**Note** Flex Link is only supported on Nexus 3500 Series switches. You cannot configure Flex Link on Nexus 3000 or Nexus 3100 Series switches.

## Default Settings for Flex Link

*Table 8: Flex Link Default Parameter Settings*

Parameter	Definition
Multicast Fast-Convergence	Disabled
Preemption mode	Off
Preemption delay	35 seconds

## Configuring Flex Links

You can configure a pair of layer 2 interfaces (switch ports or port channels) as Flex Link interfaces, where one interface is configured to act as a backup to the other.

### SUMMARY STEPS

1. switch# **configure terminal**
2. switch(config) # **feature flexlink**
3. switch(config) # **interface** {**ethernet** *slot/port* | **port-channel** *channel-no* }
4. switch(config-if) # **switchport backup interface** {**ethernet** *slot/port* | **port-channel** *channel-no*} [**multicast fast-convergence**]
5. (Optional) switch(config-if) # **end**
6. (Optional) switch# **show interface switchport backup**
7. (Optional) switch# **copy running-config startup-config**

### DETAILED STEPS

	Command or Action	Purpose
<b>Step 1</b>	switch# <b>configure terminal</b>	Enters global configuration mode.
<b>Step 2</b>	switch(config) # <b>feature flexlink</b>	Enables Flex Link.
<b>Step 3</b>	switch(config) # <b>interface</b> { <b>ethernet</b> <i>slot/port</i>   <b>port-channel</b> <i>channel-no</i> }	Specifies the Ethernet or port channel interface and enters interface configuration mode.

	Command or Action	Purpose
		The port channel range is 1 to 48.
<b>Step 4</b>	switch(config-if) # <b>switchport backup interface</b> { <b>ethernet</b> <i>slot/port</i>   <b>port-channel</b> <i>channel-no</i> } [ <b>multicast fast-convergence</b> ]	Specifies a physical layer 2 interface (Ethernet or port channel) as the backup interface in a Flex Link pair. When one link is forwarding traffic the other interface is in standby mode. <ul style="list-style-type: none"> <li>• <b>ethernet</b> <i>slot/port</i>—Specifies the backup Ethernet interface. The slot number is 1 and the port number is from 1 to 48.</li> <li>• <b>port-channel</b> <i>port-channel-no</i>—Specifies the backup port channel interface. The port-channel-no number is from 1 to 4096.</li> <li>• <b>multicast</b>—Specifies the multicast parameters.</li> <li>• <b>fast-convergence</b>—Configures fast convergence on the backup interface.</li> </ul>
<b>Step 5</b>	(Optional) switch(config-if) # <b>end</b>	Return to privileged EXEC mode.
<b>Step 6</b>	(Optional) switch# <b>show interface switchport backup</b>	Verifies the configuration.
<b>Step 7</b>	(Optional) switch# <b>copy running-config startup-config</b>	Saves the change persistently through reboots and restarts by copying the running configuration to the startup configuration.

### Example

This example shows how to configure an Ethernet switchport backup pair: Ethernet 1/1 is active interface, Ethernet 1/2 is the backup interface:

```
switch(config)# feature flexlink
switch(config)# interface ethernet 1/1
switch(config-if)# switchport backup interface ethernet 1/2
switch(config-if)# exit
switch(config)# interface port-channel300
switch(config-if)# switchport backup interface port-channel301
switch(config-if)# show ip igmp snooping mrouter
Type: S - Static, D - Dynamic, V - vPC Peer Link,
      I - Internal, C - Co-learned, U - User Configured
Vlan  Router-port  Type      Uptime      Expires
200   Po300          D         13:13:47    00:03:15
200   Po301          DC        13:13:47    00:03:15
```

This example shows how to configure the port channel switchport backup pair with multicast fast convergence:

```
switch(config)# interface port-channel10
switch(config-if)# switchport backup interface port-channel20 multicast fast-convergence
```

This example shows an example of multicast convergence with a pair of Flex Link interfaces: po305 and po306. A general query received on po305 makes it an mrouter port and po306 as co-learned.

```

switch(config)# interface po305
Switch(config-if)# switchport backup interface po306
switch# show ip igmp snooping mrouter
Type: S - Static, D - Dynamic, V - vPC Peer Link, I - Internal, C - Co-learned
Vlan Router-port Type Uptime Expires
4 Po300 D 00:00:12 00:04:50
4 Po301 DC 00:00:12 00:04:50

```

## Configuring Flex Link Preemption

You can configure a preemption scheme for a pair of Flex Links.

### Before you begin

Enable the Flex Link feature.

### SUMMARY STEPS

1. switch# **configure terminal**
2. switch(config)# **interface ethernet slot/port**
3. switch(config-if)# **switchport backup interface ethernet slot/port**
4. switch(config-if)# **switchport backup interface ethernet slot/port preemption mode [bandwidth | forced | off ]**
5. switch(config-if)# **switchport backup interface ethernet slot/port preemption delay delay-time**
6. (Optional) switch(config-if)# **end**
7. (Optional) switch# **show interface switchport backup**
8. (Optional) switch# **copy running-config startup-config**

### DETAILED STEPS

	Command or Action	Purpose
<b>Step 1</b>	switch# <b>configure terminal</b>	Enters global configuration mode.
<b>Step 2</b>	switch(config)# <b>interface ethernet slot/port</b>	Specifies the Ethernet interface and enters interface configuration mode.  The interface is a physical Layer 2 interface or a port channel (logical interface).  The slot/port range is from 1 to 48.
<b>Step 3</b>	switch(config-if)# <b>switchport backup interface ethernet slot/port</b>	Configures a physical Layer 2 interface (or port channel) as part of a Flex Link pair with the interface. When one link is forwarding traffic, the other interface is in standby mode.
<b>Step 4</b>	switch(config-if)# <b>switchport backup interface ethernet slot/port preemption mode [bandwidth   forced   off ]</b>	Configures a physical Layer 2 interface (Ethernet or port channel) as part of a flex link pair. When one link is forwarding traffic the other interface is in standby mode. <ul style="list-style-type: none"> <li>• preemption—Configures a preemption scheme for a backup interface pair.</li> <li>• mode—Specifies the preemption mode.</li> </ul>



	Command or Action	Purpose
		Configure a preemption mechanism for a Flex Link interface pair. You can configure the preemption as: <ul style="list-style-type: none"> <li>bandwidth—Interface with higher bandwidth always acts as the active interface</li> <li>forced—Active interface always preempts the backup</li> <li>off—No preemption happens from active to backup</li> </ul>
<b>Step 5</b>	switch(config-if)# <b>switchport backup interface ethernet slot/port preemption delay delay-time</b>	Configure the delay time until a port preempts another port. The delay-time range is from 1 to 300 seconds. The default preemption delay is 35 seconds.  <b>Note</b> Setting a delay time only works with forced and bandwidth modes.
<b>Step 6</b>	(Optional) switch(config-if)# <b>end</b>	Return to privileged EXEC mode.
<b>Step 7</b>	(Optional) switch# <b>show interface switchport backup</b>	Verifies the configuration.
<b>Step 8</b>	(Optional) switch# <b>copy running-config startup-config</b>	Saves the change persistently through reboots and restarts by copying the running configuration to the startup configuration.

### Example

This example shows how to sets the preemption mode to forced, sets the delay time to 50, and verifies the configuration:

```
switch(config)# configure terminal
switch(config)# interface ethernet 1/48
switch(config-if)# switchport backup interface ethernet 1/4 preemption mode forced
switch(config-if)# switchport backup interface ethernet 1/4 preemption delay 50
switch(config-if)# end
switch# show interface switchport backup detail
```

Switch Backup Interface Pairs:

```
Active Interface      Backup Interface      State
-----
Ethernet1/48         Ethernet1/4           Active Down/Backup Down
Preemption Mode      : forced
Preemption Delay     : 50 seconds
Multicast Fast Convergence : Off
Bandwidth           : 10000000 Kbit (Ethernet1/48), 10000000 Kbit (Ethernet1/4)
```

## Verifying Flex Link Configuration

Use the following commands to display flex link configuration information:

Command	Purpose
<b>show interface switchport backup</b>	Displays information about all switchport Flex Link interfaces.
<b>show interface switchport backup detail</b>	Displays detailed information about all switchport Flex Link interfaces.
<b>show running-config backup</b> <b>show startup-config backup</b>	Displays the running or startup configuration for backup interfaces.
<b>show running-config flexlink</b> <b>show startup-config flexlink</b>	Displays the running or startup configuration for flex link interfaces.

### Example

This example shows information about all switchport Flex Link interfaces:

```
switch# show interface switchport backup
```

Switch Backup Interface Pairs:

Active Interface	Backup Interface	State
Ethernet1/1	Ethernet1/2	Active Down/Backup Down
Ethernet1/8	Ethernet1/45	Active Down/Backup Down
Ethernet1/48	Ethernet1/4	Active Down/Backup Down
port-channel10	port-channel20	Active Down/Backup Up
port-channel300	port-channel301	Active Down/Backup Down

This example shows details about all switchport Flex Link interfaces:

```
switch# show interface switchport backup detail
```

Switch Backup Interface Pairs:

Active Interface	Backup Interface	State
Ethernet1/1	Ethernet1/2	Active Down/Backup Down
Preemption Mode : off Multicast Fast Convergence : Off Bandwidth : 10000000 Kbit (Ethernet1/1), 10000000 Kbit (Ethernet1/2)		
Ethernet1/8	Ethernet1/45	Active Down/Backup Down
Preemption Mode : forced Preemption Delay : 10 seconds Multicast Fast Convergence : Off Bandwidth : 10000000 Kbit (Ethernet1/8), 10000000 Kbit (Ethernet1/45)		
Ethernet1/48	Ethernet1/4	Active Down/Backup Down
Preemption Mode : forced Preemption Delay : 50 seconds Multicast Fast Convergence : Off Bandwidth : 10000000 Kbit (Ethernet1/48), 10000000 Kbit (Ethernet1/4)		

```

port-channel10      port-channel20      Active Down/Backup Up
  Preemption Mode   : forced
  Preemption Delay  : 10 seconds
  Multicast Fast Convergence : Off
  Bandwidth : 100000 Kbit (port-channel10), 10000000 Kbit (port-channel20)

port-channel300     port-channel301     Active Down/Backup Down
  Preemption Mode   : off
  Multicast Fast Convergence : Off
  Bandwidth : 100000 Kbit (port-channel300), 100000 Kbit (port-channel301)

```

This example shows the running configuration for backup interfaces

```

switch# show running-config backup

!Command: show running-config backup
!Time: Sun Mar  2 03:05:17 2014

version 6.0(2)A3(1)
feature flexlink

interface port-channel10
  switchport backup interface port-channel20 preemption mode forced
  switchport backup interface port-channel20 preemption delay 10

interface port-channel300
  switchport backup interface port-channel301

interface Ethernet1/1
  switchport backup interface Ethernet1/2

interface Ethernet1/8
  switchport backup interface Ethernet1/45 preemption mode forced
  switchport backup interface Ethernet1/45 preemption delay 10

interface Ethernet1/48
  switchport backup interface Ethernet1/4 preemption mode forced
  switchport backup interface Ethernet1/4 preemption delay 50

```

This example shows the startup configuration for backup interfaces

```

switch# show startup-config backup

!Command: show startup-config backup
!Time: Sun Mar  2 03:05:35 2014
!Startup config saved at: Sun Mar  2 02:54:58 2014

version 6.0(2)A3(1)
feature flexlink

interface port-channel10
  switchport backup interface port-channel20 preemption mode forced
  switchport backup interface port-channel20 preemption delay 10

interface Ethernet1/8
  switchport backup interface Ethernet1/45 preemption mode forced

```

```
switchport backup interface Ethernet1/45 preempton delay 10
```

This example shows the running configuration of Flex Link:

```
switch# show running-config flexlink

!Command: show running-config flexlink
!Time: Sun Mar  2 03:11:49 2014

version 6.0(2)A3(1)
feature flexlink

interface port-channel10
  switchport backup interface port-channel20 preempton mode forced

interface port-channel300
  switchport backup interface port-channel301

interface port-channel305
  switchport backup interface port-channel306

interface Ethernet1/1
  switchport backup interface Ethernet1/2

interface Ethernet1/8
  switchport backup interface Ethernet1/45 preempton mode forced
  switchport backup interface Ethernet1/45 preempton delay 10

interface Ethernet1/48
  switchport backup interface Ethernet1/4 preempton mode forced
  switchport backup interface Ethernet1/4 preempton delay 50
```

This example shows the startup configuration of Flex Link:

```
switch# show startup-config flexlink

!Command: show startup-config flexlink
!Time: Sun Mar  2 03:06:00 2014
!Startup config saved at: Sun Mar  2 02:54:58 2014

version 6.0(2)A3(1)
feature flexlink

interface port-channel10
  switchport backup interface port-channel20 preempton mode forced
  switchport backup interface port-channel20 preempton delay 10

interface Ethernet1/8
  switchport backup interface Ethernet1/45 preempton mode forced
  switchport backup interface Ethernet1/45 preempton delay 10
```



# CHAPTER 10

## Configuring LLDP

- [Configuring LLDP, on page 131](#)
- [Configuring Interface LLDP, on page 133](#)
- [MIBs for LLDP, on page 135](#)

## Configuring LLDP

### Before you begin

Ensure that the Link Layer Discovery Protocol (LLDP) feature is enabled on the switch.

### SUMMARY STEPS

1. switch# **configure terminal**
2. switch# **feature lldp**
3. switch(config)# **lldp** {**holdtime** *seconds* | **reinit** *seconds* | **timer** *seconds* | **tlv-select** {**dcbxp** | **management-address** | **power management** | **port-description** | **port-vlan** | **system-capabilities** | **system-description** | **system-name**}}
4. switch(config)# **no lldp** {**holdtime** | **reinit** | **timer**}
5. (Optional)switch# **show lldp**

### DETAILED STEPS

	Command or Action	Purpose
Step 1	switch# <b>configure terminal</b>	Enters global configuration mode.
Step 2	switch# <b>feature lldp</b>	Enable LLDP.
Step 3	switch(config)# <b>lldp</b> { <b>holdtime</b> <i>seconds</i>   <b>reinit</b> <i>seconds</i>   <b>timer</b> <i>seconds</i>   <b>tlv-select</b> { <b>dcbxp</b>   <b>management-address</b>   <b>power management</b>   <b>port-description</b>   <b>port-vlan</b>   <b>system-capabilities</b>   <b>system-description</b>   <b>system-name</b> }}	Configures LLDP options. Use the <b>holdtime</b> option to set the length of time (10 to 255 seconds) that a device should save LLDP information received before discarding it. The default value is 120 seconds.

	Command or Action	Purpose
		<p>Use the <b>reinit</b> option to set the length of time (1 to 10 seconds) to wait before performing LLDP initialization on any interface. The default value is 2 seconds.</p> <p>Use the <b>timer</b> option to set the rate (5 to 254 seconds) at which LLDP packets are sent. The default value is 30 seconds.</p> <p>Use the <b>tlv-select</b> option to specify the type length value (TLV). The default is enabled to send and receive all TLVs.</p> <p>Use the <b>dcbxp</b> option to specify the Data Center Ethernet Parameter Exchange (DCBXP) TLV messages.</p> <p>Use the <b>management-address</b> option to specify the management address TLV messages.</p> <p>Use the <b>power management</b> option to specify the power management TLV for LLDP.</p> <p>Use the <b>port-description</b> option to specify the port description TLV messages.</p> <p>Use the <b>port-vlan</b> option to specify the port VLAN ID TLV messages.</p> <p>Use the <b>system-capabilities</b> option to specify the system capabilities TLV messages.</p> <p>Use the <b>system-description</b> option to specify the system description TLV messages.</p> <p>Use the <b>system-name</b> option to specify the system name TLV messages.</p>
<b>Step 4</b>	switch(config)# <b>no lldp {holdtime   reinit   timer}</b>	Resets the LLDP values to their defaults.
<b>Step 5</b>	(Optional)switch# <b>show lldp</b>	Displays LLDP configurations.

### Example

This example shows how to configure the global LLDP hold time to 200 seconds:

```
switch# configure terminal
switch(config)# lldp holdtime 200
switch(config)#
```

This example shows how to enable LLDP to send or receive the management address TLVs:

```
switch# configure terminal
switch(config)# lldp tlv-select management-address
switch(config)#
```

# Configuring Interface LLDP

## SUMMARY STEPS

1. switch# **configure terminal**
2. switch(config)# **interface** *type slot/port*
3. switch(config-if)# **[no] lldp {receive | transmit}**
4. (Optional) switch# **show lldp {interface | neighbors [detail | interface | system-detail] | timers | traffic}**

## DETAILED STEPS

	Command or Action	Purpose
<b>Step 1</b>	switch# <b>configure terminal</b>	Enters global configuration mode.
<b>Step 2</b>	switch(config)# <b>interface</b> <i>type slot/port</i>	Selects the interface to change.
<b>Step 3</b>	switch(config-if)# <b>[no] lldp {receive   transmit}</b>	Sets the selected interface to either receive or transmit. The <b>no</b> form of the command disables the LLDP transmit or receive.
<b>Step 4</b>	(Optional) switch# <b>show lldp {interface   neighbors [detail   interface   system-detail]   timers   traffic}</b>	Displays LLDP configurations.

### Example

This example shows how to set an interface to transmit LLDP packets:

```
switch# configure terminal
switch(config)# interface ethernet 1/2
switch(config-if)# lldp transmit
```

This example shows how to configure an interface to disable LLDP:

```
switch# configure terminal
switch(config)# interface ethernet 1/2
switch(config-if)# no lldp transmit
switch(config-if)# no lldp receive
```

This example shows how to display LLDP interface information:

```
switch# show lldp interface ethernet 1/2
tx_enabled: TRUE
rx_enabled: TRUE
dcbx_enabled: TRUE
Port MAC address:    00:0d:ec:a3:5f:48
Remote Peers Information
```

No remote peers exist

This example shows how to display LLDP neighbor information:

```
switch# show lldp neighbors
Capability codes:
  (R) Router, (B) Bridge, (T) Telephone, (C) DOCSIS Cable Device
  (W) WLAN Access Point, (P) Repeater, (S) Station, (O) Other
Device ID           Local Intf      Hold-time  Capability  Port ID
SW-INSBU-JWALA-PP52.cisco.com
  mgmt0             120            B          Ethernet1/37
MTC-2               Eth1/41        120        BR          Ethernet1/43
MTC-CR2             Eth1/42        120        BR          Ethernet1/43
MTC-CR2             Eth1/43        120        BR          Ethernet1/42
MTC-2               Eth1/44        120        BR          Ethernet1/41
MTC-CR2             Eth1/45        120        BR          Ethernet1/41
MTC-2               Eth1/46        120        BR          Ethernet1/44
MTC-2               Eth1/47        120        BR          Ethernet1/42
MTC-CR2             Eth1/48        120        BR          Ethernet1/44
Total entries displayed: 9
```

This example shows how to display the system details about LLDP neighbors:

```
switch# sh lldp neighbors system-detail
Capability codes:
  (R) Router, (B) Bridge, (T) Telephone, (C) DOCSIS Cable Device
  (W) WLAN Access Point, (P) Repeater, (S) Station, (O) Other
Device ID Local Intf Chassis ID PortID Hold-time Capability
switch-2 Eth1/7 0005.73b7.37ce Eth1/7 120 B
switch-3 Eth/9 0005.73b7.37d0 Eth1/9 120 B
switch-4 Eth1/10 0005.73b7.37d1 Eth1/10 120 B
Total entries displayed: 3
```

This example shows how to display LLDP timer information:

```
switch# show lldp timers
LLDP Timers
holdtime 120 seconds
reinit 2 seconds
msg_tx_interval 30 seconds
```

This example shows how to display information about LLDP counters:

```
switch# show lldp traffic
LLDP traffic statistics:
Total frames out: 8464
Total Entries aged: 6
Total frames in: 6342
Total frames received in error: 2
Total frames discarded: 2
Total TLVs unrecognized: 0
```



## MIBs for LLDP

MIB	Link
LLDP-MIB	<a href="ftp://ftp.cisco.com/pub/mibs/supportlists/nexus3000/Nexus3000MIBSupportList.html">ftp://ftp.cisco.com/pub/mibs/supportlists/nexus3000/Nexus3000MIBSupportList.html</a>





# CHAPTER 11

## Configuring MAC Address Tables

- [Information About MAC Addresses, on page 137](#)
- [Configuring MAC Addresses, on page 137](#)
- [Configuring MAC Move Loop Detection, on page 140](#)
- [Verifying the MAC Address Configuration, on page 141](#)
- [MAC Move Loop Detection, on page 142](#)
- [Generating Syslog Error Messages, on page 143](#)

### Information About MAC Addresses

To switch frames between LAN ports, the switch maintains an address table. When the switch receives a frame, it associates the media access control (MAC) address of the sending network device with the LAN port on which it was received.

The switch dynamically builds the address table by using the MAC source address of the frames received. When the switch receives a frame for a MAC destination address not listed in its address table, it floods the frame to all LAN ports of the same VLAN except the port that received the frame. When the destination station replies, the switch adds its relevant MAC source address and port ID to the address table. The switch then forwards subsequent frames to a single LAN port without flooding all LAN ports.

You can also enter a MAC address, which is termed a static MAC address, into the table. These static MAC entries are retained across a reboot of the switch.

You cannot enter a multicast address as a statically configured MAC address, both for IP multicast and non-IP multicast MAC addresses. This is not supported by the N3548 platform.

The address table can store a number of unicast address entries without flooding any frames. The switch uses an aging mechanism, defined by a configurable aging timer, so if an address remains inactive for a specified number of seconds, it is removed from the address table.

### Configuring MAC Addresses

#### Configuring Static MAC Addresses

You can configure static MAC addresses for the switch. These addresses can be configured in interface configuration mode or in VLAN configuration mode.

## SUMMARY STEPS

1. switch# **configure terminal**
2. switch(config) # **mac address-table static** *mac\_address* **vlan** *vlan-id* {**drop** | **interface** {*type slot/port*} | **port-channel** *number*}
3. (Optional) switch(config)# **no mac address-table static** *mac\_address* **vlan** *vlan-id*

## DETAILED STEPS

	Command or Action	Purpose
<b>Step 1</b>	switch# <b>configure terminal</b>	Enters global configuration mode.
<b>Step 2</b>	switch(config) # <b>mac address-table static</b> <i>mac_address</i> <b>vlan</b> <i>vlan-id</i> { <b>drop</b>   <b>interface</b> { <i>type slot/port</i> }   <b>port-channel</b> <i>number</i> }	Specifies a static address to add to the MAC address table.
<b>Step 3</b>	(Optional) switch(config)# <b>no mac address-table static</b> <i>mac_address</i> <b>vlan</b> <i>vlan-id</i>	Deletes the static entry from the MAC address table.  Use the <b>mac address-table static</b> command to assign a static MAC address to a virtual interface.

## Example

This example shows how to put a static entry in the MAC address table:

```
switch# configure terminal
switch(config) # mac address-table static 12ab.47dd.ff89 vlan 3 interface ethernet 1/4
switch(config) #
```

## Disabling MAC Address Learning on Layer 2 Interfaces

You can now disable and re-enable MAC address learning on Layer 2 interfaces.

## SUMMARY STEPS

1. switch# **configure terminal**
2. switch(config)# **interface** *type slot/port*
3. switch(config-if)# [**no**] **switchport mac-learn disable**
4. switch(config-if)# **clear mac address-table dynamic interface** *type slot/port*

## DETAILED STEPS

	Command or Action	Purpose
<b>Step 1</b>	switch# <b>configure terminal</b>	Enters global configuration mode.
<b>Step 2</b>	switch(config)# <b>interface</b> <i>type slot/port</i>	Enters the interface configuration mode for the specified interface.
<b>Step 3</b>	switch(config-if)# [ <b>no</b> ] <b>switchport mac-learn disable</b>	Disables MAC address learning on Layer 2 interfaces.

	Command or Action	Purpose
		<p>The <b>no</b> form of this command re-enables MAC address learning on Layer 2 interfaces.</p> <p><b>Note</b> In Warp mode, the Cisco Nexus 3500 switch does not flood Layer 3 traffic to the VLAN in which the port configured using <b>switchport mac-learn disable</b> is present, and the traffic is dropped. In Normal mode, the switch should flood the Layer 3 traffic to this VLAN.</p>
<b>Step 4</b>	<pre>switch(config-if)# clear mac address-table dynamic interface type slot/port</pre>	<p>Clears the MAC address table for the specified interface.</p> <p><b>Important</b> After disabling MAC address learning on an interface, ensure that you clear the MAC address table.</p>

### Example

This example shows how to disable MAC address learning on Layer 2 interfaces:

```
switch# configure terminal
switch(config)# interface ethernet 1/4
switch(config-if)# switchport mac-learn disable
switch(config-if)# clear mac address-table dynamic interface ethernet 1/4
```

This example shows how to re-enable MAC address learning on Layer 2 interfaces:

```
switch# configure terminal
switch(config)# interface ethernet 1/4
switch(config-if)# no switchport mac-learn disable
```

## Configuring the Aging Time for the MAC Table

You can configure the amount of time that an entry (the packet source MAC address and port that packet ingresses) remain in the MAC table. MAC aging time can be configured in either interface configuration mode or in VLAN configuration mode.



**Note** The Cisco Nexus device does not support per-VLAN CAM aging timers.

### SUMMARY STEPS

1. switch# **configure terminal**
2. switch(config)# **mac-address-table aging-time seconds**

### DETAILED STEPS

	Command or Action	Purpose
<b>Step 1</b>	switch# <b>configure terminal</b>	Enters global configuration mode.

	Command or Action	Purpose
Step 2	switch(config)# <b>mac-address-table aging-time</b> <i>seconds</i>	Specifies the time before an entry ages out and is discarded from the MAC address table.  The <i>seconds</i> range is from 0 to 1000000. The default is 1800 seconds. Entering the value 0 disables the MAC aging.

### Example

This example shows how to set the aging time for entries in the MAC address table to 1800 seconds (30 minutes):

```
switch# configure terminal
switch(config) # mac-address-table aging-time 1800
switch(config) #
```

## Clearing Dynamic Addresses from the MAC Table

You can clear all dynamic entries in the MAC address table.

Command	Purpose
switch(config)# <b>clear mac-address-table dynamic</b> { <i>address mac-addr</i> } { <i>interface [type slot/port   port-channel number]</i> } { <i>vlan vlan-id</i> }	Clears the dynamic address entries from the MAC address table.

This example shows how to clear the dynamic entries in the MAC address table:

```
switch# clear mac-address-table dynamic
```

## Configuring MAC Move Loop Detection

When the number of MAC address moves between two ports exceeds a threshold, it forms a loop. You can configure the action of bringing down the port with the lower interface index when such a loop is detected by using the **mac address-table loop-detect port-down** command. To revert to the default action of disabling MAC learning, use the **no** form of this command.

### SUMMARY STEPS

1. switch# **configure terminal**
2. switch(config)# [**no**] **mac address-table loop-detect port-down**
3. switch(config)# **mac address-table loop-detect port-down edge-port**

### DETAILED STEPS

	Command or Action	Purpose
Step 1	switch# <b>configure terminal</b>	Enters global configuration mode.

	Command or Action	Purpose
Step 2	switch(config)# [no] mac address-table loop-detect port-down	Specifies the port-down action for MAC move loop detection. The <b>no</b> form of this command reverts to the default action of disabling MAC learning for 180 seconds.
Step 3	switch(config)# mac address-table loop-detect port-down edge-port	Enables the err-disabled detection for the edge-port on the MAC move loop detection.

### Example

This example shows how to configure port-down as the action for MAC move loop detection.

```
switch# configure terminal
switch(config)# mac address-table loop-detect port-down
```

This example shows how to enable the err-disabled detection for the edge-port on the MAC move loop detection.

```
switch# configure terminal
switch(config)# mac address-table loop-detect port-down edge-port
```

## Verifying the MAC Address Configuration



**Note** On Cisco Nexus 3000 and Cisco Nexus 3548 Series platforms, the self router MAC or HSRP VMAC are dynamically learned by the switch under the following conditions:

- When there is a transient loop in the network due to which the switch receives its own packets.
- When there are spoofed packets where the source MAC is same as the Router MAC or HSRP MAC.

This behavior is different from other Cisco Nexus platforms. However, there is no operational impact due to these self MAC entries that are present in the MAC table. Any packet that is destined to the router MAC or HSRP MAC is routed. There is no Layer 2 lookup on these packets.

Use one of the following commands to verify the configuration:

**Table 9: MAC Address Configuration Verification Commands**

Command	Purpose
<b>show mac address-table aging-time</b>	Displays the MAC address aging time for all VLANs defined in the switch.
<b>show mac address-table</b>	Displays the contents of the MAC address table. <b>Note</b> IGMP snooping learned MAC addresses are not displayed.
<b>show mac address-table loop-detect</b>	Displays the currently configured action.

This example shows how to display the MAC address table:

```
switch# show mac address-table
VLAN      MAC Address      Type    Age      Port
-----+-----+-----+-----+-----
1         0018.b967.3cd0   dynamic 10       Eth1/3
1         001c.b05a.5380   dynamic 200      Eth1/3
Total MAC Addresses: 2
```

This example shows how to display the current aging time:

```
switch# show mac address-table aging-time
Vlan      Aging Time
-----+-----
1         300
13        300
42        300
```

This example shows how to display the currently configured action:

```
switch# configure terminal
switch(config)# show mac address-table loop-detect
Port Down Action Mac Loop Detect : enabled
```

```
switch# configure terminal
switch(config)# no mac address-table loop-detect port-down
switch(config)# show mac address-table loop-detect
Port Down Action Mac Loop Detect : disabled
```

## MAC Move Loop Detection

Cisco Nexus 3548 Series switches leverage L2FM for software MAC learning (and, subsequently, loop detection). If a host (MAC address) moves between two interfaces within the same VLAN, it would trigger a MAC move. If there are a large number of such MAC moves in a short duration of time, the control plane of the switch and the CPU performance could get impacted. L2FM protects the switch from such scenarios by disabling MAC learning on the specific VLAN once the number of MAC moves for the corresponding MAC address exceeds a threshold.

For Cisco Nexus 3548 switches, the MAC move learn disable threshold criteria is when a single MAC addresses moves 10 or more times in a duration of one second within the same VLAN. Once threshold limit is hit, all new MAC learning on the corresponding VLAN is disabled for a period between 120 seconds to 240 seconds within the same VLAN. After that, new MAC learning is re-enabled on that VLAN. There is no impact of this on rest of the VLANs on the switch.



---

**Note** If Cisco Nexus 3548 Series switches is operated in N9K mode, the generated syslog messages will be similar to Cisco Nexus 9000 Series switches.

---



# Generating Syslog Error Messages

To see MAC move notifications in syslogs, follow the below steps:

## SUMMARY STEPS

1. `config t`
2. `logging level l2fm 5`
3. (Optional) `mac address-table notification mac-move`

## DETAILED STEPS

	Command or Action	Purpose
Step 1	<b>config t</b> <b>Example:</b> <pre>switch# config t switch(config)#</pre>	Enters configuration mode.
Step 2	<b>logging level l2fm 5</b> <b>Example:</b> <pre>switch(config)# logging level l2fm 5</pre>	Enables logging of all L2FM events from level 5 up to the highest severity events.
Step 3	(Optional) <b>mac address-table notification mac-move</b> <b>Example:</b> <pre>switch(config)# mac address-table notification mac-move</pre>	Enables MAC move notification on the switch. <b>Note</b> <ul style="list-style-type: none"> <li>• MAC move notification is enabled by default.</li> <li>• This command ensures that the syslog for L2FM detect displays when there is a MAC address move.</li> </ul>

Following are the sample generated syslog messages:

- When MAC move is detected:

```
2018 Nov 14 16:04:23.881 N9K %L2FM-4-L2FM_MAC_MOVE2: Mac XXXX.XXXX.XXXX
in vlan 741 has moved between Po6 to Eth1/3
```

- When MAC learning on VLAN is disabled:

```
2016 Apr 11 18:00:18 %L2FM-2-L2FM_MAC_FLAP_DISABLE_LEARN_N3K: Loops detected in the
network for mac XXXX.XXXX.XXXX among ports Eth1/48 and Eth1/50/3 on vlan 4 - Disabling
dynamic learning notifications for a period between 120 and 240 second
```

- When MAC learning on VLAN is re-enabled:

```
2023 Nov 29 21:23:19 N-3164Q-40G %L2FM-2-L2FM_MAC_FLAP_RE_ENABLE_LEARN:
Re-enabling learning in vlan 500
```

### Example

In order to check if the MAC addresses move, enter the command:

```
switch# show mac address-table notification mac-move
MAC Move Notify Triggers: 1206
Number of MAC Addresses added: 944088
Number of MAC Addresses moved: 265
Number of MAC Addresses removed: 943920
```



---

**Note** The following are the possible causes for MAC moves:

- MAC addresses move because of server NIC teaming and moving between Active-Active, Active-Standby states, etc.
  - MAC addresses move because the source of the data is physically moved across all switches while STP states are converged and in correct states.
  - Due to loops in the network.
-



## CHAPTER 12

# Configuring IGMP Snooping

- [Information About IGMP Snooping, on page 145](#)
- [Configuring IGMP Snooping Parameters, on page 148](#)
- [Verifying the IGMP Snooping Configuration, on page 150](#)

## Information About IGMP Snooping

The IGMP snooping software examines IGMP protocol messages within a VLAN to discover which interfaces are connected to hosts or other devices interested in receiving this traffic. Using the interface information, IGMP snooping can reduce bandwidth consumption in a multiaccess LAN environment to avoid flooding the entire VLAN. The IGMP snooping feature tracks which ports are attached to multicast-capable routers to help it manage the forwarding of IGMP membership reports. The IGMP snooping software responds to topology change notifications.



---

**Note** IGMP snooping is supported on all Ethernet interfaces. However, it is not supported on PVLAN. The term *snooping* is used because Layer 3 control plane packets are intercepted and influence Layer 2 forwarding decisions.

---

Cisco NX-OS supports IGMPv2 and IGMPv3. IGMPv2 supports IGMPv1, and IGMPv3 supports IGMPv2. Although not all features of an earlier version of IGMP are supported, the features related to membership query and membership report messages are supported for all IGMP versions.

The following figure shows an IGMP snooping switch that is located between the host and the IGMP router. The IGMP snooping switch snoops the IGMP membership reports and leave messages and forwards them only when necessary to the connected IGMP routers.

Figure 18: IGMP Snooping Switch

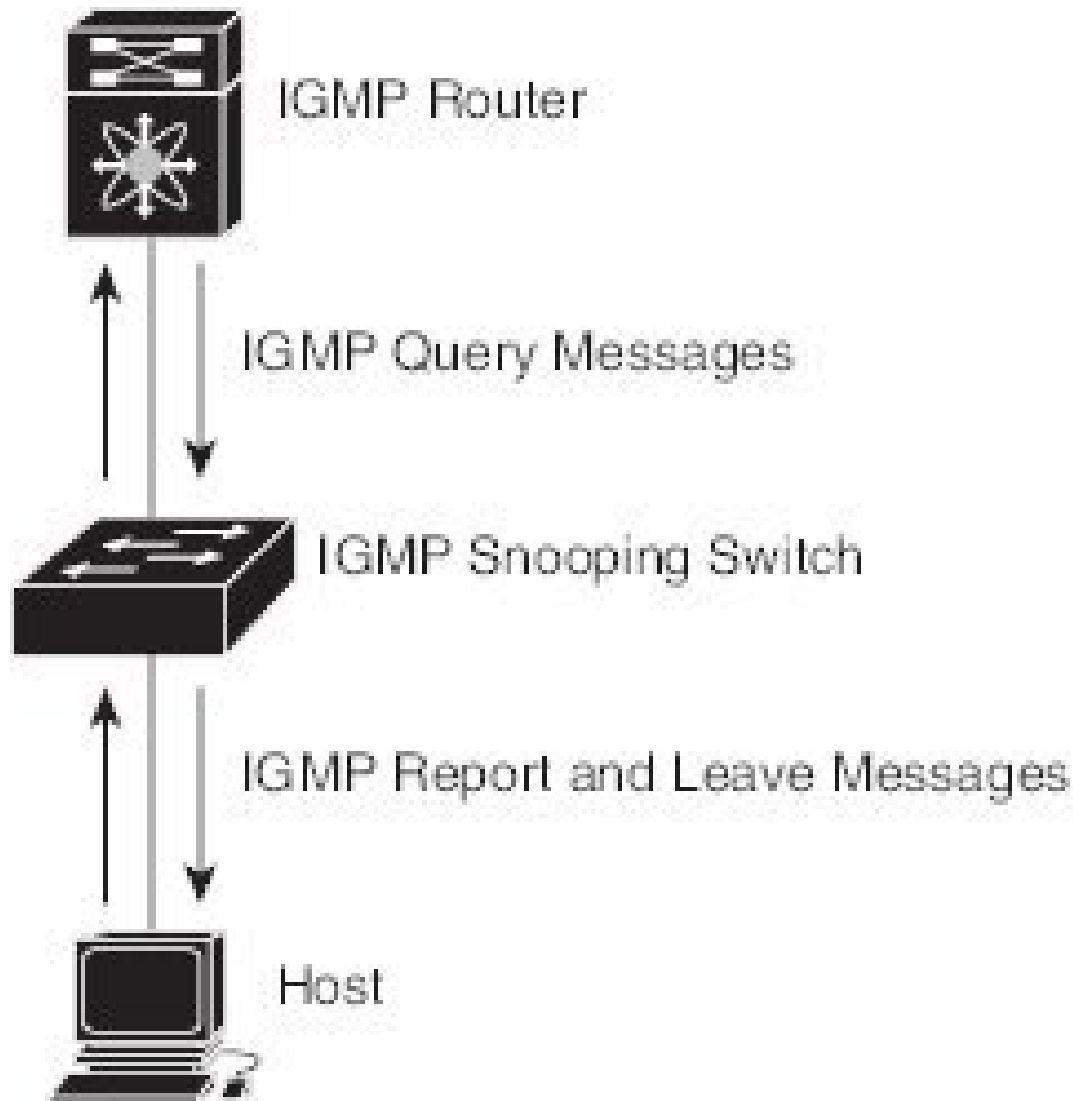

2-40804

The Cisco NX-OS IGMP snooping software supports optimized multicast flooding (OMF) that forwards unknown traffic to routers only and performs no data driven state creation. For more information about IGMP snooping, see <http://tools.ietf.org/wg/magma/draft-ietf-magma-snoop/rfc4541.txt>.

## IGMPv1 and IGMPv2

Both IGMPv1 and IGMPv2 support membership report suppression, which means that if two hosts on the same subnet want to receive multicast data for the same group, the host that receives a member report from the other host suppresses sending its report. Membership report suppression occurs for hosts that share a port.

If no more than one host is attached to each VLAN switch port, you can configure the fast leave feature in IGMPv2. The fast leave feature does not send last member query messages to hosts. As soon as the software receives an IGMP leave message, the software stops forwarding multicast data to that port.

IGMPv1 does not provide an explicit IGMP leave message, so the software must rely on the membership message timeout to indicate that no hosts remain that want to receive multicast data for a particular group.



---

**Note** Cisco NX-OS ignores the configuration of the last member query interval when you enable the fast leave feature because it does not check for remaining hosts.

---

## IGMPv3

The IGMPv3 snooping implementation on the switch forwards IGMPv3 reports to allow the upstream multicast router to do source-based filtering.

By default, the software tracks hosts on each VLAN port. The explicit tracking feature provides a fast leave mechanism.

Even though the IGMPv3 membership reports provide a full accounting of group members on a LAN segment, when the last host leaves, the software sends a membership query. You can configure the parameter last member query interval. If no host responds before the timeout, the software removes the group state.

## IGMP Snooping Querier

When there is no multicast router in the VLAN to originate the queries, you must configure an IGMP snooping querier to send membership queries.

When an IGMP snooping querier is enabled, it sends out periodic IGMP queries that trigger IGMP report messages from hosts that want to receive IP multicast traffic. IGMP snooping listens to these IGMP reports to establish appropriate forwarding.

Currently, you can configure the same SVI IP address for the switch querier and the IGMP snooping querier. Both queriers will then be active at the same time, and both queriers will send general queries to the VLAN periodically. To prevent this from happening, ensure that you use different IP addresses for the IGMP snooping querier and the switch querier.

## IGMP Forwarding

The control plane of the Cisco Nexus device is able to detect IP addresses but forwarding occurs using the IP multicast group only.

When a host connected to the switch wants to join an IP multicast group, it sends an unsolicited IGMP join message, specifying the IP multicast group to join. Alternatively, when the switch receives a general query from a connected router, it forwards the query to all interfaces, physical and virtual, in the VLAN. Hosts wanting to join the multicast group respond by sending a join message to the switch. The switch CPU creates a multicast forwarding table entry for the group if it is not already present. The CPU also adds the interface where the join message was received to the forwarding table entry. The host associated with that interface receives multicast traffic for that multicast group.

The router sends periodic multicast general queries and the switch forwards these queries through all ports in the VLAN. Interested hosts respond to the queries. If at least one host in the VLAN wants to receive multicast traffic, the router continues forwarding the multicast traffic to the VLAN. The switch forwards multicast group traffic to only those hosts listed in the forwarding table for that multicast group.

When hosts want to leave a multicast group, they can either silently leave, or they can send a leave message. When the switch receives a leave message from a host, it sends a group-specific query to determine if any other devices connected to that interface are interested in traffic for the specific multicast group. The switch then updates the forwarding table for that IP multicast group so that only those hosts interested in receiving multicast traffic for the group are listed in the forwarding table. If the router receives no reports from a VLAN, it removes the group for the VLAN from its IGMP cache.

## Configuring IGMP Snooping Parameters

To manage the operation of the IGMP snooping process, you can configure the optional IGMP snooping parameters described in the following table.

**Table 10: IGMP Snooping Parameters**

Parameter	Description
IGMP snooping	Enables IGMP snooping on a per-VLAN basis. The default is enabled.  <b>Note</b> If the global setting is disabled, all VLANs are treated as disabled, whether they are enabled or not.
Explicit tracking	Tracks IGMPv2 and IPMPv3 membership reports from individual hosts for each port on a per-VLAN basis. The default is enabled.
Fast leave	Enables the software to remove the group state when it receives an IGMP Leave report without sending an IGMP query message. This parameter is used for IGMPv2 hosts when no more than one host is present on each VLAN port. The default is disabled.
Last member query interval	Sets the interval that the software waits after sending an IGMP query to verify that no hosts that want to receive a particular multicast group remain on a network segment. If no hosts respond before the last member query interval expires, the software removes the group from the associated VLAN port. Values range from 1 to 25 seconds. The default is 1 second.
Snooping querier	Configures a snooping querier on an interface when there is no multicast router in the VLAN to generate queries. The default is disabled.
Report suppression	Limits the membership report traffic sent to multicast-capable routers. When you disable report suppression, all IGMP reports are sent as is to multicast-capable routers. The default is enabled.
Multicast router	Configures a static connection to a multicast router. The interface to the router must be in the selected VLAN.
Static group	Configures an interface that belongs to a VLAN as a static member of a multicast group.

You can disable IGMP snooping either globally or for a specific VLAN.

## SUMMARY STEPS

1. switch# **configure terminal**
2. switch(config)# **ip igmp snooping**
3. switch(config)# **vlan configuration** *vlan-id*
4. switch(config-vlan)# **ip igmp snooping**
5. switch(config-vlan)# **ip igmp snooping explicit-tracking**
6. switch(config-vlan)# **ip igmp snooping fast-leave**
7. switch(config-vlan)# **ip igmp snooping last-member-query-interval** *seconds*
8. switch(config-vlan)# **ip igmp snooping querier** *IP-address*
9. switch(config-vlan)# **ip igmp snooping report-suppression**
10. switch(config-vlan)# **ip igmp snooping mrouter interface** *interface*
11. switch(config-vlan)# **ip igmp snooping static-group** *group-ip-addr* [**source** *source-ip-addr*] **interface** *interface*

## DETAILED STEPS

	Command or Action	Purpose
<b>Step 1</b>	switch# <b>configure terminal</b>	Enters global configuration mode.
<b>Step 2</b>	switch(config)# <b>ip igmp snooping</b>	Globally enables IGMP snooping. The default is enabled.  <b>Note</b> If the global setting is disabled, all VLANs are treated as disabled, whether they are enabled or not.
<b>Step 3</b>	switch(config)# <b>vlan configuration</b> <i>vlan-id</i>	Enters VLAN configuration mode.
<b>Step 4</b>	switch(config-vlan)# <b>ip igmp snooping</b>	Enables IGMP snooping for the current VLAN. The default is enabled.  <b>Note</b> If IGMP snooping is enabled globally, this command is not required.
<b>Step 5</b>	switch(config-vlan)# <b>ip igmp snooping explicit-tracking</b>	Tracks IGMPv2 and IGMPv3 membership reports from individual hosts for each port on a per-VLAN basis. The default is enabled on all VLANs.
<b>Step 6</b>	switch(config-vlan)# <b>ip igmp snooping fast-leave</b>	Supports IGMPv2 hosts that cannot be explicitly tracked because of the host report suppression mechanism of the IGMPv2 protocol. When you enable fast leave, the IGMP software assumes that no more than one host is present on each VLAN port. The default is disabled for all VLANs.
<b>Step 7</b>	switch(config-vlan)# <b>ip igmp snooping last-member-query-interval</b> <i>seconds</i>	Removes the group from the associated VLAN port if no hosts respond to an IGMP query message before the last member query interval expires. Values range from 1 to 25 seconds. The default is 1 second.
<b>Step 8</b>	switch(config-vlan)# <b>ip igmp snooping querier</b> <i>IP-address</i>	Configures a snooping querier when you do not enable PIM because multicast traffic does not need to be routed.

	Command or Action	Purpose
		The IP address is used as the source in messages. The default is disabled.
<b>Step 9</b>	switch(config-vlan)# <b>ip igmp snooping report-suppression</b>	Limits the membership report traffic sent to multicast-capable routers. When you disable report suppression, all IGMP reports are sent as is to multicast-capable routers. The default is enabled.
<b>Step 10</b>	switch(config-vlan)# <b>ip igmp snooping mrouter interface interface</b>	Configures a static connection to a multicast router. The interface to the router must be in the selected VLAN. You can specify the interface by type and number.
<b>Step 11</b>	switch(config-vlan)# <b>ip igmp snooping static-group group-ip-addr [source source-ip-addr] interface interface</b>	Configures an interface belonging to a VLAN as a static member of a multicast group. You can specify the interface by type and number.

### Example

This example shows how to configure IGMP snooping parameters for a VLAN:

```
switch# configure terminal
switch(config)# vlan configuration 5
switch(config-vlan)# ip igmp snooping last-member-query-interval 3
switch(config-vlan)# ip igmp snooping querier 172.20.52.106
switch(config-vlan)# ip igmp snooping explicit-tracking
switch(config-vlan)# ip igmp snooping fast-leave
switch(config-vlan)# ip igmp snooping report-suppression
switch(config-vlan)# ip igmp snooping mrouter interface ethernet 1/10
switch(config-vlan)# ip igmp snooping static-group 230.0.0.1 interface ethernet 1/10
switch(config-vlan)# end
```

## Verifying the IGMP Snooping Configuration

Use the following commands to verify the IGMP snooping configuration.

Command	Description
<b>show ip igmp snooping</b> [[vlan] <i>vlan-id</i> ]	Displays IGMP snooping configuration by VLAN.
<b>show ip igmp snooping groups</b> [[vlan] <i>vlan-id</i> ] <b>[detail]</b>	Displays IGMP snooping information about groups by VLAN.
<b>show ip igmp snooping querier</b> [[vlan] <i>vlan-id</i> ]	Displays IGMP snooping queriers by VLAN.
<b>show ip igmp snooping mrouter</b> [[vlan] <i>vlan-id</i> ]	Displays multicast router ports by VLAN.
<b>show ip igmp snooping explicit-tracking vlan</b> <i>vlan-id</i>	Displays IGMP snooping explicit tracking information by VLAN.





**Note VPC behavior for v2 EHT:** In a VPC scenario, the explicit host tracking is not synced to the VPC peer. However in a VPC peer, the EHT is also learned by cfs sync and is displayed by using the detail option.

This example shows how to verify the IGMP snooping parameters:

```
switch# show ip igmp snooping
Global IGMP Snooping Information:
  IGMP Snooping enabled
IGMP Snooping information for vlan 1
  IGMP snooping enabled
  IGMP querier none
  Switch-querier disabled
  Explicit tracking enabled
  Fast leave disabled
  Report suppression enabled
  Router port detection using PIM Hellos, IGMP Queries
  Number of router-ports: 0
  Number of groups: 0
IGMP Snooping information for vlan 5
IGMP snooping enabled
  IGMP querier present, address: 192.0.2.1, version: 3
  Querier interval: 125 secs
  Querier last member query interval: 10 secs
  Querier robustness: 2
  Switch-querier enabled, address 192.0.2.1, currently running
  Explicit tracking enabled
  Fast leave enabled
  Report suppression enabled
  Router port detection using PIM Hellos, IGMP Queries
  Number of router-ports: 1
  Number of groups: 1
```

This example shows how to display the IGMP snooping configuration for explicit tracking on an IGMPv2 host:

```
switch# show ip igmp snooping explicit tracking
IGMP Snooping Explicit-tracking information
Vlan Source/Group
  Intf      Reporter      Uptime      Last-Join Expires  Ver  Reports
100 */225.1.1.69
  Eth1/43   10.1.1.2     00:00:02   00:00:02  00:04:17 v2   1
100 */225.1.1.70
  Eth1/43   10.1.1.2     00:00:02   00:00:02  00:04:17 v2   1
100 */225.1.1.71
  Eth1/43   10.1.1.2     00:00:02   00:00:02  00:04:17 v2   1
100 */225.1.1.72
  Eth1/43   10.1.1.2     00:00:02   00:00:02  00:04:17 v2   1
100 */225.1.1.73
  Eth1/43   10.1.1.2     00:00:02   00:00:02  00:04:17 v2   1
100 */225.1.1.74
  Eth1/43   10.1.1.2     00:00:02   00:00:02  00:04:17 v2   1
100 */225.1.1.75
  Eth1/43   10.1.1.2     00:00:02   00:00:02  00:04:17 v2   1
100 */225.1.1.76
  Eth1/43   10.1.1.2     00:00:02   00:00:02  00:04:17 v2   1
100 */225.1.1.77
  Eth1/43   10.1.1.2     00:00:02   00:00:02  00:04:17 v2   1
100 */225.1.1.78
  Eth1/43   10.1.1.2     00:00:02   00:00:02  00:04:17 v2   1
switch#:
```





## CHAPTER 13

# Configuring Traffic Storm Control

---

- [Information About Traffic Storm Control, on page 153](#)
- [Guidelines and Limitations for Traffic Storm Control, on page 155](#)
- [Configuring Traffic Storm Control, on page 156](#)
- [Traffic Storm Control Example Configuration, on page 157](#)
- [Default Settings for Traffic Storm Control, on page 157](#)

## Information About Traffic Storm Control

A traffic storm occurs when packets flood the LAN, creating excessive traffic and degrading network performance. You can use the traffic storm control feature to prevent disruptions on Ethernet interfaces by a broadcast or multicast traffic storm.

Traffic storm control (also called traffic suppression) allows you to monitor the levels of the incoming broadcast or multicast traffic over a 10-microsecond interval. During this interval, the traffic level, which is a percentage of the total available bandwidth of the port, is compared with the traffic storm control level that you configured. When the ingress traffic reaches the traffic storm control level that is configured on the port, traffic storm control drops the traffic until the interval ends.

The following figure shows the broadcast traffic patterns on an Ethernet interface during a specified time interval. In this example, traffic storm control occurs between times T1 and T2 and between T4 and T5. During those intervals, the amount of broadcast traffic exceeded the configured threshold.

Figure 19: Broadcast Suppression

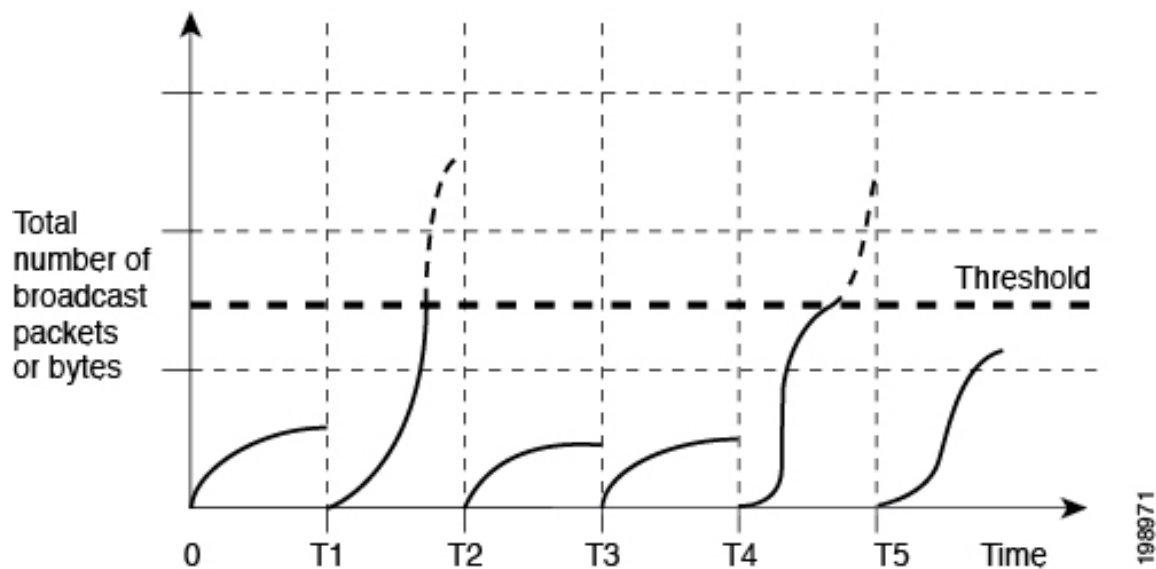

The traffic storm control threshold numbers and the time interval allow the traffic storm control algorithm to work with different levels of packet granularity. For example, a higher threshold allows more packets to pass through.

Traffic storm control is implemented in the hardware. The traffic storm control circuitry monitors packets that pass from an Ethernet interface to the switching bus. Using the Individual/Group bit in the packet destination address, the circuitry determines if the packet is broadcast, tracks the current count of packets within the 10-microsecond interval, and filters out subsequent packets when a threshold is reached.

Cisco Nexus N3548 Series switches support aggregation mode on traffic storm control. In Cisco NX-OS, the traffic types are configured in line rate by default. When the broadcast and multicast storm control is enabled, the traffic is filtered according to the rate configured for each levels. However, in aggregation mode, all traffic types including unicast, multicast, and broadcast are filtered according to the rate configured at the port level.

Traffic storm control uses a bandwidth-based method to measure traffic. You set the percentage of total available bandwidth that the controlled traffic can use. Because packets do not arrive at uniform intervals, the 10-microsecond interval can affect the operation of traffic storm control.

The following are examples of how traffic storm control operation is affected:

- If you enable broadcast traffic storm control, and broadcast traffic exceeds the level within the 10-microsecond interval, traffic storm control drops all exceeding broadcast traffic until the end of the interval.
- If you enable multicast traffic storm control, and the multicast traffic exceeds the level within the 10-microsecond interval, traffic storm control drops all exceeding multicast traffic until the end of the interval.
- If you enable broadcast and multicast traffic storm control, and broadcast traffic exceeds the level within the 10-microsecond interval, traffic storm control drops all exceeding broadcast traffic until the end of the interval.

- If you enable broadcast and multicast traffic storm control, and multicast traffic exceeds the level within the 10-microsecond interval, traffic storm control drops all exceeding multicast traffic until the end of the interval.

By default, Cisco NX-OS takes no corrective action when traffic exceeds the configured level.

## Guidelines and Limitations for Traffic Storm Control

When configuring the traffic storm control level, follow these guidelines and limitations:

- Egress multicast storm control is not supported.
- You can configure traffic storm control on a port-channel interface.
- Specify the level as a percentage of the total interface bandwidth:
  - The level can be from 0 to 100.
  - The optional fraction of a level can be from 0 to 99.
  - 100 percent means no traffic storm control.
  - 0.0 percent suppresses all traffic.
- There are local link and hardware limitations that prevent storm-control drops from being counted separately. Instead, storm-control drops are counted with other drops in the indiscards counter.
- Because of hardware limitations and the method by which packets of different sizes are counted, the level percentage is an approximation. Depending on the sizes of the frames that make up the incoming traffic, the actual enforced level might differ from the configured level by several percentage points.
- Unicast and broadcast storm control is currently available for both Cisco Nexus N3548 Series switches and Cisco Nexus N3548-X Series switches.
- Enabling port level storm control forces aggregation mode that filters unicast, broadcast, and multicast traffic.
- Enabling port level storm control, filters all types of traffic such as multicast, broadcast, unicast. Unicast traffic both known and unknown is filtered only when there is MC / BC traffic along with UC traffic, and the rate of MC/BC traffic exceeds configured port storm control level, until the overall traffic rate falls below the storm-control level. In other words, port level storm-control will not filter unicast traffic when there is just unicast traffic on the link or MC/BC traffic on the link is within the configured storm-control level.
- Configuring storm control values at the port level overrides multicast and broadcast rate limit values limiting all the traffic to a single traffic threshold.
  - Port level storm control uses multicast rate limit values.
  - A traffic threshold fraction value that is less than 10 is rounded off to 0 and that information is displayed as a warning message. The round off value is based on port speed of 0.9 for 10G port, 89 for 1G port and 3 for 40G ports.
- If multicast is enabled and you disable the port level storm control, the multicast values continue to function at a value that is configured at the port level.

- If multicast is disabled and you disable the port level storm control, the multicast values and the registries get reset.

## Configuring Traffic Storm Control

You can set the percentage of total available bandwidth that the controlled traffic can use.



**Note** Traffic storm control uses a 10-microsecond interval that can affect the operation of traffic storm control.

### SUMMARY STEPS

1. switch# **configure terminal**
2. switch(config)# **interface** {*ethernet slot/port* | **port-channel** *number*}
3. switch(config-if)# [**no**] **storm-control** [**broadcast** | **multicast**] **level** *percentage* [*fraction*]

### DETAILED STEPS

	Command or Action	Purpose
<b>Step 1</b>	switch# <b>configure terminal</b>	Enters global configuration mode.
<b>Step 2</b>	switch(config)# <b>interface</b> { <i>ethernet slot/port</i>   <b>port-channel</b> <i>number</i> }	Enters interface configuration mode.
<b>Step 3</b>	switch(config-if)# [ <b>no</b> ] <b>storm-control</b> [ <b>broadcast</b>   <b>multicast</b> ] <b>level</b> <i>percentage</i> [ <i>fraction</i> ]	Configures traffic storm control for traffic on the interface. The default state is disabled.

### Example

This example shows how to configure traffic storm control for port channels 122 and 123:

```
switch# configure terminal
switch(config)# interface port-channel 122, port-channel 123
switch(config-if-range)# storm-control multicast level 66.75
switch(config-if-range)# storm-control broadcast level 66.75
switch(config-if-range)#
```

## Verifying the Traffic Storm Control Configuration

Use the following commands to display traffic storm control configuration information:

Command	Purpose
<b>show interface</b> [ <i>ethernet slot/port</i>   <b>port-channel</b> <i>number</i> ] <b>counters storm-control</b>	Displays the traffic storm control configuration for the interfaces.
<b>show running-config interface</b>	Displays the traffic storm control configuration.

# Traffic Storm Control Example Configuration

This example shows how to configure traffic storm control:

```
switch# configure terminal
switch(config)# interface ethernet 1/4
switch(config-if)# storm-control broadcast level 40
switch(config-if)# storm-control multicast level 40
```

## Default Settings for Traffic Storm Control

The following table lists the default settings for traffic storm control parameters.

**Table 11: Default Traffic Storm Control Parameters**

Parameters	Default
Traffic storm control	Disabled
Threshold percentage	100

