



## IPv6 VPN over MPLS

The Border Gateway Protocol over Multiprotocol Label Switching VPN feature is an implementation of the provider edge (PE)-based Virtual Private Network (VPN) model. In principle, there is no difference between IPv4 and IPv6 VPNs. In both IPv4 and IPv6, multiprotocol Border Gateway Protocol (BGP) is the center of the Multiprotocol Label Switching (MPLS) VPN for IPv6 (VPNv6) architecture. It is used to distribute IPv6 routes over the service provider backbone, using the same procedures to work with overlapping addresses, redistribution policies, and scalability issues.

- [Finding Feature Information, on page 1](#)
- [Prerequisites for IPv6 VPN over MPLS, on page 1](#)
- [Restrictions for IPv6 VPN over MPLS, on page 2](#)
- [Information About IPv6 VPN over MPLS, on page 2](#)
- [How to Configure IPv6 VPN over MPLS, on page 8](#)
- [Configuration Examples for IPv6 VPN over MPLS, on page 45](#)
- [Additional References, on page 51](#)
- [Glossary, on page 51](#)

## Finding Feature Information

Your software release may not support all the features documented in this module. For the latest caveats and feature information, see [Bug Search Tool](#) and the release notes for your platform and software release. To find information about the features documented in this module, and to see a list of the releases in which each feature is supported, see the feature information table at the end of this module.

Use Cisco Feature Navigator to find information about platform support and Cisco software image support. To access Cisco Feature Navigator, go to [www.cisco.com/go/cfn](http://www.cisco.com/go/cfn). An account on Cisco.com is not required.

## Prerequisites for IPv6 VPN over MPLS

Your network must be running the following services before you configure IPv6 VPN operation:

- Multiprotocol Label Switching (MPLS) in provider backbone devices
- MPLS with Virtual Private Network (VPN) code in provider devices with VPN provider edge (PE) devices
- Border Gateway Protocol (BGP) in all devices providing a VPN service

- Cisco Express Forwarding switching in every MPLS-enabled device
- Class of Service (CoS) feature

## Restrictions for IPv6 VPN over MPLS

IPv6 VPN over MPLS (6VPE) supports a Multiprotocol Label Switching (MPLS) IPv4-signaled core. An MPLS IPv6-signaled core is not supported.

## Information About IPv6 VPN over MPLS

### IPv6 VPN over MPLS Overview

Multiprotocol Border Gateway Protocol (BGP) is the center of the Multiprotocol Label Switching (MPLS) IPv6 Virtual Private Network (VPN) architecture in both IPv4 and IPv6. It is used to distribute IPv6 routes over the service provider backbone, using the same procedures to work with overlapping addresses, redistribution policies, and scalability issues.

Although IPv6 should not have overlapping address space, IPv6 addresses are prepended with a route distinguisher (RD). A network layer reachability information (NLRI) 3-tuple format (which contains length, IPv6 prefix, and label) is defined to distribute these routes using multiprotocol BGP. The extended community attribute (for example, the route target) is used to control redistribution of routing information by tagging exported routes and filtering imported ones.

For scalability, route reflectors can be used to concentrate routing paths and avoid a full provider edge (PE) mesh. BGP features in IPv6, such as route refresh, automatic route filtering, and outbound route filtering, help reduce the number of routes held in each PE. This document focuses on the following differences between IPv6 and IPv4:

- Creation of a new multiprotocol BGP IPv6 VPN address family and specification of a IPv6 VPN address format
- Specification of a new IPv6 VPN NLRI
- Specification of BGP next-hop encoding when the device has an IPv4-based MPLS core

Some IPv6 VPN features, such as interprovider and Carrier Supporting Carrier (CSC) topologies, are specific to BGP-MPLS IPv6 VPN. Others, such as the link between Autonomous System Boundary Routers (ASBRs), might support IPv4 only, IPv6 only, or both, regardless of the address family being transported.

## Addressing Considerations for IPv6 VPN over MPLS

Regardless of the Virtual Private Network (VPN) model deployed, an addressing plan must be defined for the VPN that allows hosts to communicate with other sites using one site within one VPN, as well as with public resources.

VPN IPv4 sites often use private addressing for their addressing plan. These addresses do not need to be registered, and they are not routable on the public network. Whenever a host within a private site needs to

access a public domain, it goes through a device that finds a public address on its behalf. With IPv4, this can be a network address translator or an application proxy.

Given the larger address space available with IPv6, the easiest approach to IPv6 addressing is to use IPv6 global addresses for the private addressing plan. Another approach is to use unique local addresses (ULAs). ULAs are easy to filter at site boundaries based on their scope. ULAs are also Internet service provider (ISP)-independent and can be used for communications inside a site without any permanent or intermittent Internet connectivity.

In IPv6 VPN over MPLS (6VPE), ULAs are treated as regular global addresses. The device configuration filters ULA prefixes to prevent them from appearing in the public domain. Link-local addresses on the peer will not be announced by Border Gateway Protocol (BGP) (IPv6 or IPv6 VPN) speakers.

A host within a private site that needs to access a public domain can do so through an IPv6 application proxy (such as a web proxy for accessing web pages), which accesses the public resource on the host's behalf with a global routable address, or the host can use a public address of its own. In the latter case, if ULAs have been deployed, the IPv6 host also is configured with a routable global address. A source address selection algorithm is used to select one or the other, based on the destination address.

## Basic IPv6 VPN over MPLS Functionality

IPv6 VPN over MPLS (6VPE) takes advantage of the coexistence between IPv6 and IPv4 by leveraging an existent Multiprotocol Label Switching (MPLS) IPv4 core network:

### IPv6 VPN Architecture Overview

The figure below illustrates the important aspects of the IPv6 Virtual Private Network (VPN) architecture.

*Figure 1: Simple IPv6 VPN Architecture*

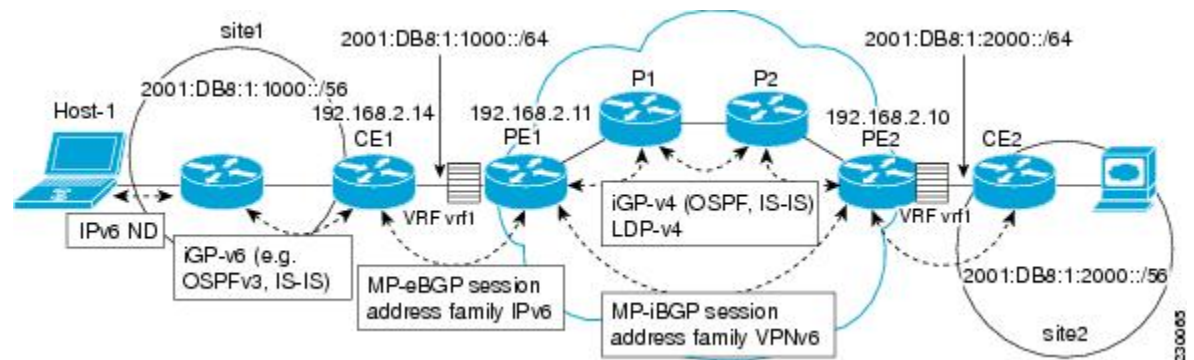

The customer edge (CE) devices are connected to the provider's backbone using provider edge (PE) devices. The PE devices are connected using provider (P1 and P2 in the figure above) devices. The provider (P) devices are unaware of VPN routes, and, in the case of IPv6 over MPLS (6VPE), might support only IPv4. Only PE devices perform VPN-specific tasks. For 6VPE, the PE devices are dual-stack (IPv4 and IPv6) devices.

The routing component of the VPN operation is divided into core routing and edge routing. Core routing, which involves PE devices and P devices, typically is performed by an IPv4 Interior Gateway Protocol (IGP) such as Open Shortest Path First (OSPF) or Intermediate System-to-Intermediate System (IS-IS). In the figure above, the IGP distributes only routes internal to the provider's autonomous system. The core routing enables connectivity among P and PE devices.

Edge routing takes place in two directions: routing between PE pairs and routing between a PE and a CE. Routing between PE pairs is achieved using multiprotocol internal BGP (iBGP) using the IPv6 VPN address family. This method distributes routes learned from CEs through PE-CE routing, using appropriate route export policies at the ingress PE device and appropriate route import policies at the egress PE device.

Routing between the CE and its PE is achieved using a routing protocol that is VPN routing and forwarding (VRF) aware. Static routes, external BGP (eBGP), and Enhanced Interior Gateway Routing Protocol (EIGRP) are VRF-instance aware. In the figure above, eBGP is used between the CE (CE1) and the PE (PE1). At the same time, the CE runs an IPv6 IGP within the VPN site (site1 in the figure above). The CE redistributes IGP routes into multiprotocol-eBGP address family IPv6. At the PE, these routes are installed in the VRF named vrf1, and forwarded to the remote PEs (PE2 in the figure above), according to export policies defined for this VRF.

## IPv6 VPN Next Hop

When the device announces a prefix using the MP\_REACH\_NLRI attribute, the Multiprotocol Border Gateway Protocol (MP-BGP) running on one provider edge (PE) inserts a BGP next hop in the update message sent to a remote PE. This next hop is either propagated from the received update (for instance, if the PE is a route reflector), or it is the address of the PE sending the update message (the egress PE).

For the IPv6 Virtual Private Network (VPN) address family, the next hop must be an IPv6 VPN address, regardless of the nature of the network between the PE speakers. Because the route distinguisher (RD) has no significance (the address is not part of any VPN), it is set to 0. If the provider network is a native IPv6 network, the remaining part of the next hop is the IPv6 address of the egress PE. Otherwise, it is an IPv4 address used as an IPv6-mapped address (for example, ::FFFF:IPv4-address).

## MPLS Forwarding

When it receives IPv6 traffic from one customer site, the ingress provider edge (PE) device uses Multiprotocol Label Switching (MPLS) to tunnel IPv6 Virtual Private Network (VPN) packets over the backbone toward the egress PE device identified as the Border Gateway Protocol (BGP) next hop. The ingress PE device prepends the IPv6 packets with the outer and inner labels before putting the packet on the egress interface.

Under normal operation, a provider (P) device along the forwarding path does not look inside the frame beyond the first label. The provider (P) device either swaps the incoming label with an outgoing one or removes the incoming label if the next device is a PE device. Removing the incoming label is called penultimate hop popping. The remaining label (BGP label) is used to identify the egress PE interface toward the customer site. The label also hides the protocol version (IPv6) from the last P device, which it would otherwise need to forward an IPv6 packet.

A P device is ignorant of the IPv6 VPN routes. The IPv6 header remains hidden under one or more MPLS labels. When the P device receives an MPLS-encapsulated IPv6 packet that cannot be delivered, it has two options. If the P device is IPv6 aware, it exposes the IPv6 header, builds an Internet Control Message Protocol (ICMP) for IPv6 message, and sends the message, which is MPLS encapsulated, to the source of the original packet. If the P device is not IPv6 aware, it drops the packet.

## VRF Concepts

A virtual routing and forwarding (VRF) entity works with a private customer-specific Routing Information Base (RIB) and Forwarding Information Base (FIB). Although IPv4 and IPv6 routing tables are distinct, it is convenient for the two protocols to share the same VRF for a specific customer.

IPv6 VPN customers are likely to be existing VPNv4 customers that are either deploying dual-stack hosts and devices or shadowing some of their IPv4 infrastructure with IPv6 nodes. Several deployment models are

possible. Some customers use separate logical interfaces for IPv4 and IPv6 and define separate VRFs on each. Although this approach provides flexibility to configure separate policies for IPv4 and IPv6, it prevents sharing the same policy. Another approach, the multiprotocol VRF, keeps a single VRF on the provider edge-customer edge (PE-CE) interface, and enables it for IPv4, IPv6, or both. It is then possible to define common or separate policies for each IP version. With this approach, a VRF is better defined as the set of tables, interfaces, and policies found at the PE, and is used by sites of a particular VPN connected to this PE.

The figure below illustrates the multiprotocol VRF, in which the VRF named `vrf1` is enabled for both IPv4 and IPv6 and is associated with two interfaces (IF1, IF2), two sets of tables (IPv4 RIB and FIB and IPv6 RIB and FIB), and a set of common or distinct policies.

Figure 2: Multiprotocol VRF

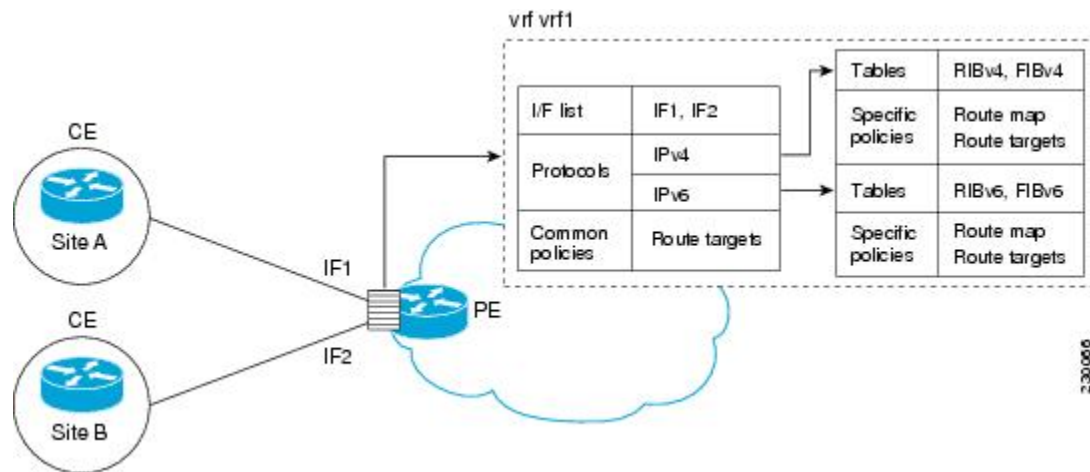

## IPv6 VPN Scalability

Provider edge (PE)-based Virtual Private Networks (VPNs) such as Border Gateway Protocol-Multiprotocol Label Switching (BGP-MPLS) IPv6 VPN scale better than customer edge (CE)-based VPNs. A network designer must consider scaling when designing the network. The following points need to be considered:

- Routing table size, which includes the size of virtual routing and forwarding (VRF) tables and BGP tables
- Number of BGP sessions, which grows as a square number of PEs

Routing table size concerns occur with PEs that handle many customer sites. Not only do these PEs have one Routing Information Base (RIB) and Forwarding Information Base (FIB) per connected customer, but also the PEs' BGP tables, which total all entries from individual VRFs, grow accordingly. Another scalability problem occurs when the number of PEs in the provider network grows beyond a certain level. Assuming that a significant number of sites belonging to the same VPN are spread over many PEs, the number of multiprotocol BGP sessions may rapidly become prohibitive:  $(n - 1) \times n / 2$ , where  $n$  is the number of PEs.

The following features are included in IPv6 VPN over MPLS:

- Route refresh and automatic route filtering—Limits the size of routing tables, because only routes imported into a VRF are kept locally. When the import policy changes, a route refresh can be sent to query a retransmission of routing updates.
- Outbound route filtering (ORF)—Allows the ingress PE to advertise filters to the egress PE so that updates are not sent unnecessarily over the network.

- Route reflectors—Route reflectors (RRs) are internal BGP (iBGP) peers that propagate iBGP routes learned from other iBGP peers. RRs are used to concentrate iBGP sessions.

## Advanced IPv6 MPLS VPN Functionality

Advanced Multiprotocol Label Switching (MPLS) features such as accessing the Internet from a Virtual Private Network (VPN) for IPv4, multi-autonomous-system backbones, and Carrier Supporting Carriers (CSCs) are generally the same for IPv6 as for IPv4. However, there are differences in addressing and in the way IPv6 over MPLS (6VPE) operates over an IPv4 backbone.

The following sections describe concepts for advanced IPv6 MPLS VPN functionality:

### Internet Access

Most Virtual Private Network (VPN) sites require access to the Internet. RFC 4364 describes a set of models for enabling IPv4 and IPv6 VPN access to the Internet. In one model, one interface is used by the customer edge (CE) to connect to the Internet and a different one to connect to the virtual routing and forwarding (VRF) instance. Another model is in which all Internet routes are redistributed into the VRF; however, this approach has the disadvantage of requiring the Internet routes be replicated in each VRF.

In one scenario, a static route is inserted into the VRF table, with a next hop that points to the Internet gateway found in the IPv6 default table. The figure below illustrates this scenario, in which Internet access is provided to the customer in the VRF named `vrf1`.

**Figure 3: Internet Access Topology**

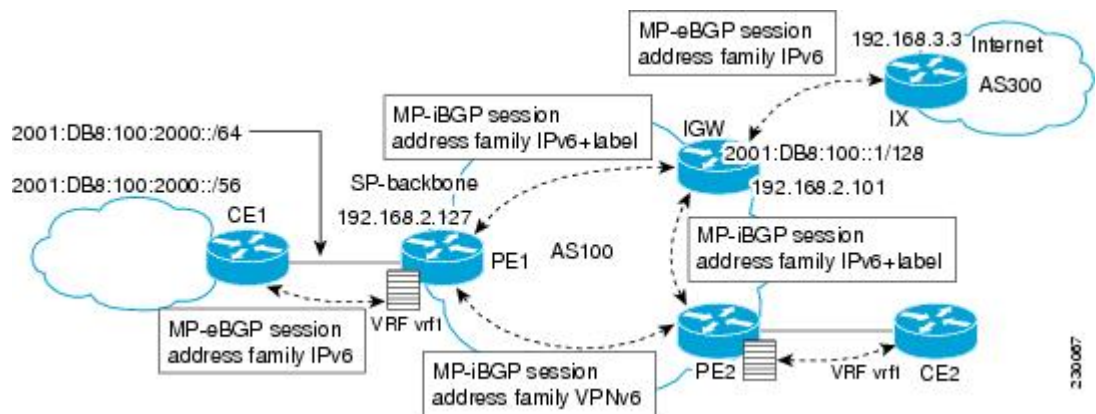

A customer site that has access public resources over the Internet must be known by a public prefix. Unlike IPv4, IPv6 does not offer a Network Address Translation (NAT) mechanism that translates private addresses into public addresses when leaving the site boundaries. This implies that hosts within the site speak with public addresses and appear in the public domain.

For outbound traffic, the default route configured in the VRF table at ingress provider edge (PE1) directs traffic for destinations outside the VPN to the Internet gateway.

For inbound traffic, a route must exist at the Internet gateway to direct the traffic for a customer site via its PE of attachment (PE1 in the figure above). This route can be distributed by the ingress PE (PE1) using multiprotocol internal Border Gateway Protocol (iBGP) (with the IPv6 address family configuration), so no specific configuration is needed on a per-VPN PE basis at the Internet gateway. Nevertheless, for inbound traffic at PE1, a route must exist in the default table for the customer site global prefix pointing to the VRF of the site.

## Multiautonomous-System Backbones

The problem of interprovider Virtual Private Networks (VPNs) is similar for IPv6 and IPv4, assuming that IPv6 was deployed everywhere IPv4 was deployed.

In IPv6 deployments that cross autonomous system boundaries, providers may have to obtain a peering model, or work with the peering model put in place for VPNv4.

The figure below illustrates interprovider scenarios in IPv6 VPN.

**Figure 4: Interprovider Scenarios**

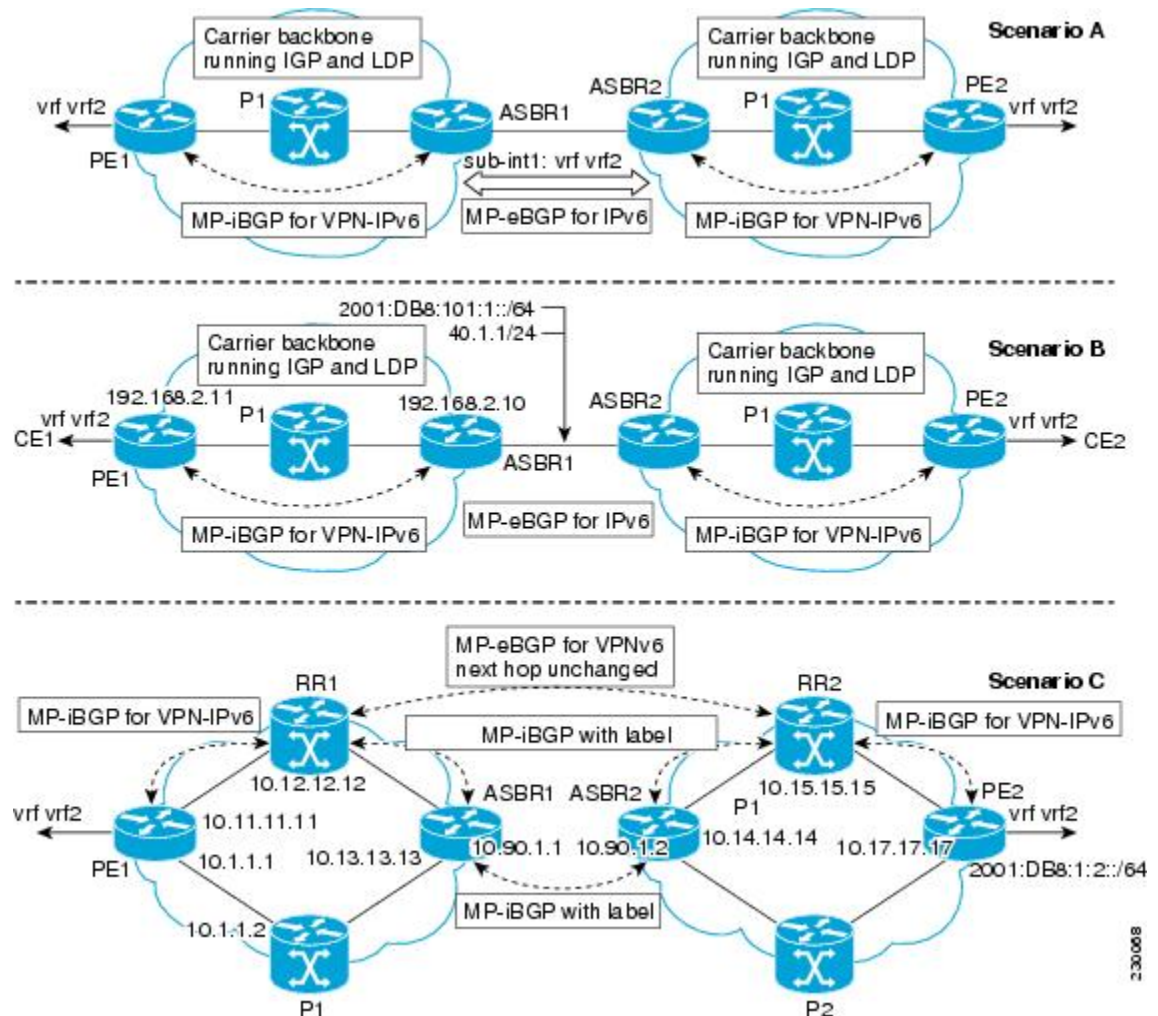

Depending on the network protocol used between Autonomous System Boundary Routers (ASBRs), the three scenarios shown in the figure above can have several implementation options. For instance, scenario B, which suggests a multiprotocol external Border Gateway Protocol (eBGP) IPv6 VPN peering between ASBRs, could use either an IPv6 or an IPv4 link.

In scenario C, multihop multiprotocol eBGP redistributes IPv6 VPN routes across route reflectors in different autonomous systems. Labeled IPv4 routes to the provider edge (PE) devices (in the IPv6 over MPLS case) need to be advertised across ASBRs so that a complete labeled switch path is set up end to end.

## Carrier Supporting Carriers

The Carrier Supporting Carrier (CSC) feature provides Virtual Private Network (VPN) access to a customer service provider, so this service needs to exchange routes and send traffic over the Internet service provider (ISP) Multiprotocol Label Switching (MPLS) backbone. The only difference from a regular provider edge (PE) is that it provides MPLS-to-MPLS forwarding on the CSC-customer edge (CE) to CSC-PE interface, rather than IP-to-MPLS forwarding.

The figure below highlights the two ISPs' interface.

Figure 5: CSC IPv6 over MPLS Configuration Example

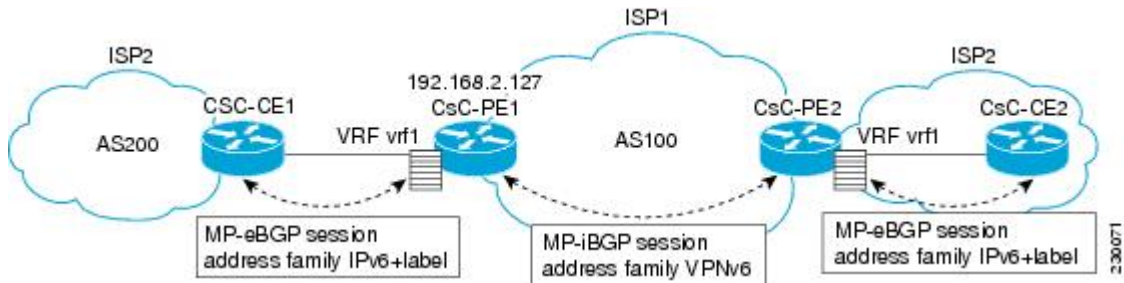

## How to Configure IPv6 VPN over MPLS

### Configuring a Virtual Routing and Forwarding Instance for IPv6

A virtual routing and forwarding (VRF) instance is an address family-independent object that can be enabled and configured for each of the supported address families. Configuring a VRF consists of the following three steps:

- Configuring the address-family-independent part of the VRF
- Enabling and configuring IPv4 for the VRF
- Enabling and configuring IPv6 for the VRF

A VRF is given a name and a route distinguisher (RD). The RD is configured outside the context of the address family, although the RD is used to distinguish overlapping addresses within the context of a particular Border Gateway Protocol (BGP) address family. Having separate RDs for IPv4 VPN addresses and IPv6 VPN addresses does not matter. On Cisco devices, the RDs are the same in order to simplify configuration and VPN management.

Users can configure policies in common between IPv4 and IPv6 when not using an address family context. This feature is shared route targets (import and export), and it is useful in a migration scenario, where IPv4 policies already are configured and IPv6 policies should be the same as the IPv4 policies.

The IPv4 and IPv6 address family can each be enabled and configured separately. Note that the route-target policies entered at this level override global policies that may have been specified during address family-independent configuration.

#### SUMMARY STEPS

1. enable



2. **configure terminal**
3. **vrf definition** *vrf-name*
4. **rd** *route-distinguisher*
5. **route-target** {**import** | **export** | **both**} *route-target-ext-community*
6. **address-family ipv4** [**mdt** | **multicast** | **tunnel** | **unicast** [**vrf** *vrf-name*] | **vrf** *vrf-name*]
7. **route-target** {**import** | **export** | **both**} *route-target-ext-community*
8. **exit**
9. **address-family ipv6** [**vrf** *vrf-name*] [**unicast** | **multicast**]
10. **route-target** {**import** | **export** | **both**} *route-target-ext-community*

## DETAILED STEPS

	Command or Action	Purpose
<b>Step 1</b>	<b>enable</b> <b>Example:</b> Device> enable	Enables privileged EXEC mode. <ul style="list-style-type: none"> <li>• Enter your password if prompted.</li> </ul>
<b>Step 2</b>	<b>configure terminal</b> <b>Example:</b> Device# configure terminal	Enters global configuration mode.
<b>Step 3</b>	<b>vrf definition</b> <i>vrf-name</i> <b>Example:</b> Device(config)# vrf definition vrf1	Configures a VPN VRF routing table and enters VRF configuration mode.
<b>Step 4</b>	<b>rd</b> <i>route-distinguisher</i> <b>Example:</b> Device(config-vrf)# rd 100:1	Specifies the RD for a VRF.
<b>Step 5</b>	<b>route-target</b> { <b>import</b>   <b>export</b>   <b>both</b> } <i>route-target-ext-community</i> <b>Example:</b> Device(config-vrf)# route target import 100:10	Specifies the route target VPN extended communities for both IPv4 and IPv6.
<b>Step 6</b>	<b>address-family ipv4</b> [ <b>mdt</b>   <b>multicast</b>   <b>tunnel</b>   <b>unicast</b> [ <b>vrf</b> <i>vrf-name</i> ]   <b>vrf</b> <i>vrf-name</i> ] <b>Example:</b> Device(config)# address-family ipv4	Enters address family configuration mode to configure a routing session using standard IPv4 address prefixes.
<b>Step 7</b>	<b>route-target</b> { <b>import</b>   <b>export</b>   <b>both</b> } <i>route-target-ext-community</i> <b>Example:</b>	Specifies the route target VPN extended communities specific to IPv4.

	Command or Action	Purpose
	<code>Device(config-vrf-af)# route target import 100:11</code>	
<b>Step 8</b>	<b>exit</b> <b>Example:</b> <code>Device(config-vrf-af)# exit</code>	Exits address family configuration mode on this VRF.
<b>Step 9</b>	<b>address-family ipv6 [vrf vrf-name] [unicast   multicast]</b> <b>Example:</b> <code>Device(config-vrf)# address-family ipv6</code>	Enters address family configuration mode for configuring routing sessions such as BGP that use standard IPv6 address prefixes.
<b>Step 10</b>	<b>route-target {import   export   both}</b> <i>route-target-ext-community</i> <b>Example:</b> <code>Device(config-vrf-af)# route target import 100:12</code>	Specifies the route target VPN extended communities specific to IPv6.

## Binding a VRF to an Interface

In order to specify which interface belongs to which virtual routing and forwarding (VRF) instance, use the **vrf forwarding** command for both IPv4 and IPv6. An interface cannot belong to more than one VRF. When the interface is bound to a VRF, previously configured addresses (IPv4 and IPv6) are removed, and they must be reconfigured.

### SUMMARY STEPS

1. **enable**
2. **configure terminal**
3. **interface** *type number*
4. **vrf forwarding** *vrf-name*
5. **ip address** *ip-address mask [secondary]*
6. **ipv6 address** *{ipv6-address / prefix-length | prefix-name sub-bits/prefix-length}*

### DETAILED STEPS

	Command or Action	Purpose
<b>Step 1</b>	<b>enable</b> <b>Example:</b> <code>Device&gt; enable</code>	Enables privileged EXEC mode. <ul style="list-style-type: none"> <li>• Enter your password if prompted.</li> </ul>
<b>Step 2</b>	<b>configure terminal</b> <b>Example:</b>	Enters global configuration mode.

	Command or Action	Purpose
	Device# configure terminal	
<b>Step 3</b>	<b>interface</b> <i>type number</i> <b>Example:</b>  Device(config)# interface GigabitEthernet 0/0/0	Specifies an interface type and number, and places the device in interface configuration mode.
<b>Step 4</b>	<b>vrf forwarding</b> <i>vrf-name</i> <b>Example:</b>  Device(config-if)# vrf forwarding vrf1	Associates a VPN VRF with an interface or subinterface.  • Note that any address, IPv4 or IPv6, that was configured prior to entering this command will be removed.
<b>Step 5</b>	<b>ip address</b> <i>ip-address mask [secondary]</i> <b>Example:</b>  Device(config-if)# ip address 10.10.10.1 255.255.255.0	Configures an IPv4 address on the interface.
<b>Step 6</b>	<b>ipv6 address</b> { <i>ipv6-address / prefix-length   prefix-name sub-bits/prefix-length</i> } <b>Example:</b>  Device(config-if)# ipv6 address 2001:DB8:100:1::1/64	Configures an IPv6 address on the interface.

## Configuring a Static Route for PE-to-CE Routing

### SUMMARY STEPS

1. **enable**
2. **configure terminal**
3. **ipv6 route** [**vrf** *vrf-name*] *ipv6-prefix / prefix-length* {*ipv6-address | interface-type interface-number [ipv6-address]*} [**next-hop-vrf** [*vrf-name1* | **default**]] [*administrative-distance*] [*administrative-multicast-distance* | **unicast** | **multicast**] [*next-hop-address*] [**tag tag**]

### DETAILED STEPS

	Command or Action	Purpose
<b>Step 1</b>	<b>enable</b> <b>Example:</b>  Device> enable	Enables privileged EXEC mode.  • Enter your password if prompted.
<b>Step 2</b>	<b>configure terminal</b> <b>Example:</b>	Enters global configuration mode.

	Command or Action	Purpose
	Device# configure terminal	
<b>Step 3</b>	<p><b>ipv6 route</b> [vrf vrf-name] ipv6-prefix / prefix-length {ipv6-address   interface-type interface-number [ipv6-address]} [nexthop-vrf [vrf-name1   default]] [administrative-distance] [administrative-multicast-distance]   unicast   multicast [next-hop-address] [tag tag]</p> <p><b>Example:</b></p> <pre>Device(config)# ipv6 route vrf vrf1 ::/0 2001:DB8:200::1 nexthop-vrf default</pre>	Installs the specified IPv6 static route using the specified next hop.

## Configuring eBGP PE-to-CE Routing Sessions

### SUMMARY STEPS

1. enable
2. configure terminal
3. router bgp autonomous-system-number
4. address-family ipv6 [vrf vrf-name] [unicast | multicast]
5. neighbor {ip-address | ipv6-address | peer-group-name} remote-as as-number
6. neighbor {ip-address | ipv6-address | peer-group-name} activate

### DETAILED STEPS

	Command or Action	Purpose
<b>Step 1</b>	<p><b>enable</b></p> <p><b>Example:</b></p> <pre>Device&gt; enable</pre>	<p>Enables privileged EXEC mode.</p> <ul style="list-style-type: none"> <li>• Enter your password if prompted.</li> </ul>
<b>Step 2</b>	<p><b>configure terminal</b></p> <p><b>Example:</b></p> <pre>Device# configure terminal</pre>	Enters global configuration mode.
<b>Step 3</b>	<p><b>router bgp</b> autonomous-system-number</p> <p><b>Example:</b></p> <pre>Device(config)# router bgp 100</pre>	Configures the Border Gateway Protocol (BGP) routing process.
<b>Step 4</b>	<p><b>address-family ipv6</b> [vrf vrf-name] [unicast   multicast]</p> <p><b>Example:</b></p> <pre>Device(config-router)# address-family ipv6 vrf vrf1</pre>	Enters address family configuration mode.

	Command or Action	Purpose
<b>Step 5</b>	<b>neighbor</b> { <i>ip-address</i>   <i>ipv6-address</i>   <i>peer-group-name</i> } <b>remote-as</b> <i>as-number</i>  <b>Example:</b>  Device(config-router-af)# neighbor 2001:DB8:100:1::2 remote-as 200	Adds an entry to the multiprotocol BGP neighbor table.
<b>Step 6</b>	<b>neighbor</b> { <i>ip-address</i>   <i>ipv6-address</i>   <i>peer-group-name</i> } <b>activate</b>  <b>Example:</b>  Device(config-router-af)# neighbor 2001:DB8:100:1::2 activate	Enables the exchange of information for this address family with the specified BGP neighbor.

## Configuring the IPv6 VPN Address Family for iBGP

### SUMMARY STEPS

1. **enable**
2. **configure terminal**
3. **router bgp** *autonomous-system-number*
4. **neighbor** {*ip-address* | *ipv6-address* | *peer-group-name*} **remote-as** *as-number*
5. **neighbor** {*ip-address* | *ipv6-address* | *peer-group-name*} **update-source** *interface-type interface-number*
6. **address-family vpnv6** [*unicast*]
7. **neighbor** {*ip-address* | *ipv6-address* | *peer-group-name*} **activate**
8. **neighbor** {*ip-address* | *ipv6-address* | *peer-group-name*} **send-community** [*both* | *standard* | *extended*]
9. **extended**] **exit**

### DETAILED STEPS

	Command or Action	Purpose
<b>Step 1</b>	<b>enable</b>  <b>Example:</b>  Device> enable	Enables privileged EXEC mode. <ul style="list-style-type: none"> <li>• Enter your password if prompted.</li> </ul>
<b>Step 2</b>	<b>configure terminal</b>  <b>Example:</b>  Device# configure terminal	Enters global configuration mode.
<b>Step 3</b>	<b>router bgp</b> <i>autonomous-system-number</i>  <b>Example:</b>  Device(config)# router bgp 100	Configures the BGP routing process.

	Command or Action	Purpose
<b>Step 4</b>	<b>neighbor</b> { <i>ip-address</i>   <i>ipv6-address</i>   <i>peer-group-name</i> } <b>remote-as</b> <i>as-number</i>  <b>Example:</b>  <pre>Device(config-router)# neighbor 192.168.2.11 remote-as 100</pre>	Adds an entry to the multiprotocol Border Gateway Protocol (BGP) neighbor table. <ul style="list-style-type: none"> <li>• In IPv6 VPN, the peer address typically is an IPv4 address, in order to enable the BGP session to be transported over the IPv4-based core network.</li> </ul>
<b>Step 5</b>	<b>neighbor</b> { <i>ip-address</i>   <i>ipv6-address</i>   <i>peer-group-name</i> } <b>update-source</b> <i>interface-type interface-number</i>  <b>Example:</b>  <pre>Device(config-router)# neighbor 192.168.2.11 update-source Loopback 0</pre>	Enables the BGP session to use a source address on the specified interface.
<b>Step 6</b>	<b>address-family vpv6 [unicast]</b>  <b>Example:</b>  <pre>Device(config-router)# address-family vpv6</pre>	Places the device in address family configuration mode for configuring routing sessions.
<b>Step 7</b>	<b>neighbor</b> { <i>ip-address</i>   <i>ipv6-address</i>   <i>peer-group-name</i> } <b>activate</b>  <b>Example:</b>  <pre>Device(config-router-af)# neighbor 192.168.2.11 activate</pre>	Enables the exchange of information for this address family with the specified BGP neighbor.
<b>Step 8</b>	<b>neighbor</b> { <i>ip-address</i>   <i>ipv6-address</i>   <i>peer-group-name</i> } <b>send-community</b> [ <b>both</b>   <b>standard</b>   <b>extended</b> ]  <b>Example:</b>  <pre>Device(config-router-af)# neighbor 192.168.2.11 send-community extended</pre>	Specifies that a communities attribute should be sent to the BGP neighbor.
<b>Step 9</b>	<b>extended] exit</b>  <b>Example:</b>  <pre>Device(config-router-af)# exit</pre>	Exits address family configuration mode.

## Configuring Route Reflectors for Improved Scalability

In this task, two route reflectors (RRs) are configured for redundancy reasons. Deploying RRs improves scalability by drastically reducing the number of Border Gateway Protocol (BGP) sessions. One RR usually peers with many internal Border Gateway Protocol (iBGP) speakers, preventing a full mesh of BGP sessions.

In a Multiprotocol Label Switching (MPLS)-based core, RRs are not part of the label switch paths and can be located anywhere in the network. For example, in a flat RR design, RRs can be deployed at Level 1 points of presence (POPs) and peer together in a full-mesh topology. In a hierarchical RR design, RRs could be deployed at Level 1 and Level 2 POPs, with Level 1 POPs peering together and with Level 2 RRs.

In a typical case where IPv6 over MPLS (6VPE) is deployed in a preexisting MPLS network (for example, providing VPNv4 services), it is likely that some RR design is already in place, and a similar RR infrastructure for IPv6 Virtual Private Network (VPN) services can be deployed. The figure below illustrates the main peering points between the RR in the ISP POP and the set of its RR clients.

**Figure 6: Route Reflector Peering Design**

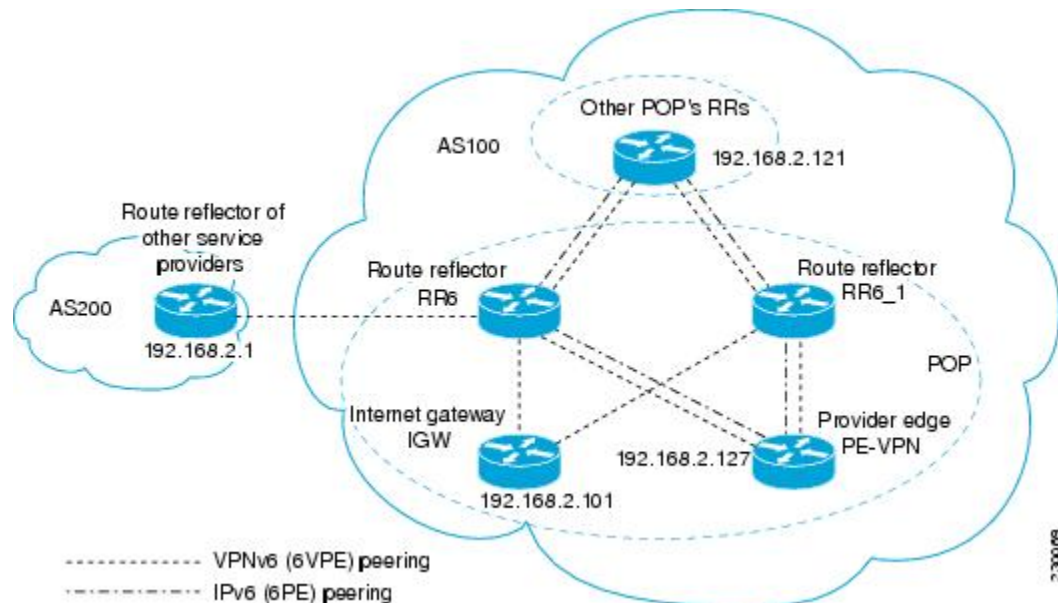

The following list of BGP RR clients must be configured at each IPv6 RR (RR6 and RR6\_1 in the figure above) device, at each POP:

- Provider edge (PE) devices (PE-VPN) of the POP providing IPv6 VPN access to the ISP customers. This includes both IPv6 VPN (6VPE) peering for interconnecting customer sites and IPv6 peering (6PE) for providing Internet access to VPN customers (see the “Configuring Internet Access” section).
- Internet gateway (IGW) located in the POP in order to provide PE customers with access to the IPv6 Internet (see the “Configuring Internet Access” section).
- RRs from other service providers. This feature is used to provide interautonomous-system connectivity, and it includes both IPv6 and IPv6 VPN peering. This service is described in the “Configuring a Multiautonomous-System Backbone for IPv6 VPN” section.
- RRs in other POPs. All RRs peer together, with both IPv6 and IPv6 VPN address families enabled.

## SUMMARY STEPS

1. **enable**
2. **configure terminal**
3. **router bgp** *autonomous-system-number*
4. **neighbor** {*ip-address* | *ipv6-address* | *peer-group-name*} **remote-as** *as-number*
5. **neighbor** {*ip-address* | *ipv6-address* | *peer-group-name*} **update-source** *interface-type interface-number*
6. **neighbor** {*ip-address* | *ipv6-address* | *peer-group-name*} **remote-as** *as-number*
7. **neighbor** {*ip-address* | *ipv6-address* | *peer-group-name*} **update-source** *interface-type interface-number*
8. **neighbor** {*ip-address* | *ipv6-address* | *peer-group-name*} **remote-as** *as-number*

9. **neighbor** {*ip-address* | *ipv6-address* | *peer-group-name*} **update-source** *interface-type interface-number*
10. **neighbor** {*ip-address* | *ipv6-address* | *peer-group-name*} **remote-as** *as-number*
11. **neighbor** {*ip-address* | *ipv6-address* | *peer-group-name*} **update-source** *interface-type interface-number*
12. **neighbor** {*ip-address* | *ipv6-address* | *peer-group-name*} **ebgp-multihop** [*ttl*]
13. **address-family ipv6**
14. **neighbor** {*ip-address* | *peer-group-name* | *ipv6-address*} **activate**
15. **neighbor** { *ip-address* | *ipv6-address* | *peer-group-name*} **send-label**
16. **neighbor** {*ip-address* | *ipv6-address* | *peer-group-name*} **route-reflector-client**
17. **neighbor** {*ip-address* | *peer-group-name* | *ipv6-address*} **activate**
18. **neighbor** { *ip-address* | *ipv6-address* | *peer-group-name*} **send-label**
19. **neighbor** {*ip-address* | *ipv6-address* | *peer-group-name*} **route-reflector-client**
20. **neighbor** {*ip-address* | *peer-group-name* | *ipv6-address*} **activate**
21. **neighbor** { *ip-address* | *ipv6-address* | *peer-group-name*} **send-label**
22. **neighbor** {*ip-address* | *ipv6-address* | *peer-group-name*} **route-reflector-client**
23. **exit**
24. **address-family vpnv6** [**unicast**
25. **neighbor** {*ip-address* | *peer-group-name* | *ipv6-address*} **activate**
26. **neighbor** {*ip-address* | *ipv6-address* | *peer-group-name*} **send-community** [**both** | **standard** | **extended**]
27. **neighbor** {*ip-address* | *ipv6-address* | *peer-group-name*} **route-reflector-client**
28. **neighbor** {*ip-address* | *peer-group-name* | *ipv6-address*} **activate**
29. **neighbor** {*ip-address* | *ipv6-address* | *peer-group-name*} **send-community** [**both** | **standard** | **extended**]
30. **neighbor** {*ip-address* | *ipv6-address* | *peer-group-name*} **route-reflector-client**
31. **neighbor** {*ip-address* | *peer-group-name* | *ipv6-address*} **activate**
32. **neighbor** {*ip-address* | *ipv6-address* | *peer-group-name*} **send-community** [**both** | **standard** | **extended**]
33. **neighbor** {*ip-address* | *ipv6-address* | *peer-group-name*} **route-reflector-client**
34. **neighbor** {*ip-address* | *ipv6-address* | *peer-group-name*} **next-hop-unchanged** [**allpaths**

## DETAILED STEPS

	Command or Action	Purpose
<b>Step 1</b>	<b>enable</b> <b>Example:</b> Device> enable	Enables privileged EXEC mode. <ul style="list-style-type: none"> <li>• Enter your password if prompted.</li> </ul>
<b>Step 2</b>	<b>configure terminal</b> <b>Example:</b> Device# configure terminal	Enters global configuration mode.
<b>Step 3</b>	<b>router bgp</b> <i>autonomous-system-number</i> <b>Example:</b> Device(config)# router bgp 100	Configures the BGP routing process.



	Command or Action	Purpose
<b>Step 4</b>	<b>neighbor</b> { <i>ip-address</i>   <i>ipv6-address</i>   <i>peer-group-name</i> } <b>remote-as</b> <i>as-number</i>  <b>Example:</b>  Device(config-router)# neighbor 192.168.2.101 remote-as 100	Adds an entry to the multiprotocol BGP neighbor table, and provides peering with the Internet gateway in order to provide Internet access.
<b>Step 5</b>	<b>neighbor</b> { <i>ip-address</i>   <i>ipv6-address</i>   <i>peer-group-name</i> } <b>update-source</b> <i>interface-type interface-number</i>  <b>Example:</b>  Device(config-router)# neighbor 192.168.2.101 update-source Loopback 0	Enables the BGP session to use a source address on the specified interface.
<b>Step 6</b>	<b>neighbor</b> { <i>ip-address</i>   <i>ipv6-address</i>   <i>peer-group-name</i> } <b>remote-as</b> <i>as-number</i>  <b>Example:</b>  Device(config-router)# neighbor 192.168.2.121 remote-as 100	Adds an entry to the multiprotocol BGP neighbor table, and provides peering with the other POP's RR.
<b>Step 7</b>	<b>neighbor</b> { <i>ip-address</i>   <i>ipv6-address</i>   <i>peer-group-name</i> } <b>update-source</b> <i>interface-type interface-number</i>  <b>Example:</b>  Device(config-router)# neighbor 192.168.2.121 update-source Loopback 0	Enables the BGP session to use a source address on the specified interface.
<b>Step 8</b>	<b>neighbor</b> { <i>ip-address</i>   <i>ipv6-address</i>   <i>peer-group-name</i> } <b>remote-as</b> <i>as-number</i>  <b>Example:</b>  Device(config-router)# neighbor 192.168.2.127 remote-as 100	Adds an entry to the multiprotocol BGP neighbor table.
<b>Step 9</b>	<b>neighbor</b> { <i>ip-address</i>   <i>ipv6-address</i>   <i>peer-group-name</i> } <b>update-source</b> <i>interface-type interface-number</i>  <b>Example:</b>  Device(config-router)# neighbor 192.168.2.127 update-source Loopback 0	Enables the BGP session to use a source address on the specified interface.
<b>Step 10</b>	<b>neighbor</b> { <i>ip-address</i>   <i>ipv6-address</i>   <i>peer-group-name</i> } <b>remote-as</b> <i>as-number</i>  <b>Example:</b>  Device(config-router)# neighbor 192.168.2.1 remote-as 200	(Optional) Adds an entry to the multiprotocol BGP neighbor table, and provides peering with the RR of the peer ISP in order to provide inter-VPN service.

	Command or Action	Purpose
<b>Step 11</b>	<b>neighbor</b> { <i>ip-address</i>   <i>ipv6-address</i>   <i>peer-group-name</i> } <b>update-source</b> <i>interface-type interface-number</i> <b>Example:</b> <pre>Device(config-router)# neighbor 192.168.2.1 update-source Loopback 0</pre>	(Optional) Enables the BGP session to use a source address on the specified interface.
<b>Step 12</b>	<b>neighbor</b> { <i>ip-address</i>   <i>ipv6-address</i>   <i>peer-group-name</i> } <b>ebgp-multihop</b> [ <i>tth</i> ] <b>Example:</b> <pre>Device(config-router)# neighbor 192.168.2.1 ebgp-multihop</pre>	(Optional) Accepts and attempts BGP connections to external peers residing on networks that are not directly connected.
<b>Step 13</b>	<b>address-family ipv6</b> <b>Example:</b> <pre>Device(config-router)# address-family ipv6</pre>	(Optional) Enters address family configuration mode in order to provide Internet access service.
<b>Step 14</b>	<b>neighbor</b> { <i>ip-address</i>   <i>peer-group-name</i>   <i>ipv6-address</i> } <b>activate</b> <b>Example:</b> <pre>Device(config-router-af)# neighbor 192.168.2.101 activate</pre>	(Optional) Enables the exchange of information for this address family with the specified neighbor.
<b>Step 15</b>	<b>neighbor</b> { <i>ip-address</i>   <i>ipv6-address</i>   <i>peer-group-name</i> } <b>send-label</b> <b>Example:</b> <pre>Device(config-router-af)# neighbor 192.168.2.101 send-label</pre>	(Optional) Enables a BGP device to send MPLS labels with BGP routes to a neighboring BGP device.
<b>Step 16</b>	<b>neighbor</b> { <i>ip-address</i>   <i>ipv6-address</i>   <i>peer-group-name</i> } <b>route-reflector-client</b> <b>Example:</b> <pre>Device(config-router-af)# neighbor 192.168.2.101 route-reflector-client</pre>	(Optional) Configures the device as a BGP route reflector and configures the specified neighbor as its client.
<b>Step 17</b>	<b>neighbor</b> { <i>ip-address</i>   <i>peer-group-name</i>   <i>ipv6-address</i> } <b>activate</b> <b>Example:</b> <pre>Device(config-router-af)# neighbor 192.168.2.121 activate</pre>	(Optional) Enables the exchange of information for this address family with the specified BGP neighbor.

	Command or Action	Purpose
Step 18	<b>neighbor</b> { <i>ip-address</i>   <i>ipv6-address</i>   <i>peer-group-name</i> } <b>send-label</b>  <b>Example:</b>  Device(config-router-af)# neighbor 192.168.2.121 send-label	(Optional) Enables a BGP device to send MPLS labels with BGP routes to a neighboring BGP device.
Step 19	<b>neighbor</b> { <i>ip-address</i>   <i>ipv6-address</i>   <i>peer-group-name</i> } <b>route-reflector-client</b>  <b>Example:</b>  Device(config-router-af)# neighbor 192.168.2.121 route-reflector-client	(Optional) Configures the specified neighbor as a route reflector client.
Step 20	<b>neighbor</b> { <i>ip-address</i>   <i>peer-group-name</i>   <i>ipv6-address</i> } <b>activate</b>  <b>Example:</b>  Device(config-router-af)# neighbor 192.168.2.127 activate	(Optional) Enables the exchange of information for this address family with the specified BGP neighbor.
Step 21	<b>neighbor</b> { <i>ip-address</i>   <i>ipv6-address</i>   <i>peer-group-name</i> } <b>send-label</b>  <b>Example:</b>  Device(config-router-af)# neighbor 192.168.2.127 send-label	(Optional) Enables a BGP device to send MPLS labels with BGP routes to a neighboring BGP device.
Step 22	<b>neighbor</b> { <i>ip-address</i>   <i>ipv6-address</i>   <i>peer-group-name</i> } <b>route-reflector-client</b>  <b>Example:</b>  Device(config-router-af)# neighbor 192.168.2.127 route-reflector-client	(Optional) Configures the specified neighbor as a route reflector client.
Step 23	<b>exit</b>  <b>Example:</b>  Device(config-router-af)# exit	(Optional) Exits address family configuration mode.
Step 24	<b>address-family vpnv6</b> [unicast  <b>Example:</b>  Device(config-router)# address-family vpnv6	Places the device in address family configuration mode for configuring routing sessions.
Step 25	<b>neighbor</b> { <i>ip-address</i>   <i>peer-group-name</i>   <i>ipv6-address</i> } <b>activate</b>  <b>Example:</b>	Enables the exchange of information for this address family with the specified BGP neighbor.

	Command or Action	Purpose
	Device(config-router-af)# neighbor 192.168.2.121 activate	
<b>Step 26</b>	<b>neighbor</b> {ip-address   ipv6-address   peer-group-name} <b>send-community</b> [both   standard   extended] <b>Example:</b> Device(config-router-af)# neighbor 192.168.2.21 send-community extended	Specifies that a communities attribute should be sent to the BGP neighbor.
<b>Step 27</b>	<b>neighbor</b> {ip-address   ipv6-address   peer-group-name} <b>route-reflector-client</b> <b>Example:</b> Device(config-router-af)# neighbor 192.168.2.121 route-reflector-client	Configures the specified neighbor as a route reflector client.
<b>Step 28</b>	<b>neighbor</b> {ip-address   peer-group-name   ipv6-address} <b>activate</b> <b>Example:</b> Device(config-router-af)# neighbor 192.168.2.127 activate	Enables the exchange of information for this address family with the specified BGP neighbor.
<b>Step 29</b>	<b>neighbor</b> {ip-address   ipv6-address   peer-group-name} <b>send-community</b> [both   standard   extended] <b>Example:</b> Device(config-router-af)# neighbor 192.168.2.127 send-community extended	Specifies that a communities attribute should be sent to the BGP neighbor.
<b>Step 30</b>	<b>neighbor</b> {ip-address   ipv6-address   peer-group-name} <b>route-reflector-client</b> <b>Example:</b> Device(config-router-af)# neighbor 192.168.2.127 route-reflector-client	Configures the specified neighbor as a route reflector client.
<b>Step 31</b>	<b>neighbor</b> {ip-address   peer-group-name   ipv6-address} <b>activate</b> <b>Example:</b> Device(config-router-af)# neighbor 192.168.2.1 activate	Enables the exchange of information for this address family with the specified BGP neighbor.
<b>Step 32</b>	<b>neighbor</b> {ip-address   ipv6-address   peer-group-name} <b>send-community</b> [both   standard   extended] <b>Example:</b>	Specifies that a communities attribute should be sent to the BGP neighbor.

	Command or Action	Purpose
	Device(config-router-af)# neighbor 192.168.2.1 send-community extended	
<b>Step 33</b>	<b>neighbor</b> { <i>ip-address</i>   <i>ipv6-address</i>   <i>peer-group-name</i> } <b>route-reflector-client</b>  <b>Example:</b>  Device(config-router-af)# neighbor 192.168.2.1 route-reflector-client	Configures the specified neighbor as a route reflector client.
<b>Step 34</b>	<b>neighbor</b> { <i>ip-address</i>   <i>ipv6-address</i>   <i>peer-group-name</i> } <b>next-hop-unchanged</b> [ <b>allpaths</b> ]  <b>Example:</b>  Device(config-router-af)# neighbor 192.168.2.1 next-hop-unchanged allpaths	Enables an EBGp multihop peer to propagate to the next hop unchanged for paths.

## Configuring Internet Access

Customers with IPv6 Virtual Private Network (VPN) access need to have access to the Internet through IPv6. The design of this service is similar to a global Internet access service. IPv6 VPN over MPLS (6VPE) devices located in a Level 1 point of presence (POP) (colocated with an IGW device) can access the Internet gateway (IGW) natively, whereas 6VPE devices located in Level 2 and Level 3 POPs with no direct access to the IGW can access the IGW in their closest Level 1 POP over 6PE.

Configuring VPN Internet access in such a 6VPE device involves configuring Border Gateway Protocol (BGP) peering with the IGW (in most cases through the IPv6 RR, as described in the “Configuring Route Reflectors for Improved Scalability” section). Then the user must configure cross-table routing to enable communication between the private domain (the VRF) and the public domain (the Internet).

The figure above illustrates the following configuration tasks:

### Configuring the Internet Gateway

#### Configuring iBGP 6PE Peering to the VPN PE

##### SUMMARY STEPS

1. **enable**
2. **configure terminal**
3. **router bgp** *autonomous-system-number*
4. **neighbor** {*ip-address* | *ipv6-address* | *peer-group-name*} **remote-as** *as-number*
5. **neighbor** {*ip-address* | *ipv6-address* | *peer-group-name*} **update-source** *interface-type interface-number*
6. **address-family ipv6**
7. **neighbor** {*ip-address* | *ipv6-address* | *peer-group-name*} **activate**
8. **neighbor** {*ip-address* | *ipv6-address* | *peer-group-name*} **send-label**

## DETAILED STEPS

	Command or Action	Purpose
<b>Step 1</b>	<b>enable</b> <b>Example:</b> Device> enable	Enables privileged EXEC mode. <ul style="list-style-type: none"> <li>• Enter your password if prompted.</li> </ul>
<b>Step 2</b>	<b>configure terminal</b> <b>Example:</b> Device# configure terminal	Enters global configuration mode.
<b>Step 3</b>	<b>router bgp</b> <i>autonomous-system-number</i> <b>Example:</b> Device(config)# router bgp 100	Configures the Border Gateway Protocol (BGP) routing process.
<b>Step 4</b>	<b>neighbor</b> { <i>ip-address</i>   <i>ipv6-address</i>   <i>peer-group-name</i> } <b>remote-as</b> <i>as-number</i> <b>Example:</b> Device(config-router)# neighbor 192.168.2.127 remote-as 100	Adds an entry to the multiprotocol BGP neighbor table to provide peering with the Virtual Private Network (VPN) provider edge (PE).
<b>Step 5</b>	<b>neighbor</b> { <i>ip-address</i>   <i>ipv6-address</i>   <i>peer-group-name</i> } <b>update-source</b> <i>interface-type interface-number</i> <b>Example:</b> Device(config-router)# neighbor 192.168.2.127 update-source Loopback 0	Enables the BGP session to use a source address on the specified interface.
<b>Step 6</b>	<b>address-family ipv6</b> <b>Example:</b> Device(config-router)# address-family ipv6	Enters address family configuration mode in order to exchange global table reachability.
<b>Step 7</b>	<b>neighbor</b> { <i>ip-address</i>   <i>ipv6-address</i>   <i>peer-group-name</i> } <b>activate</b> <b>Example:</b> Device(config-router-af)# neighbor 192.168.2.127 activate	Enables the exchange of information for this address family with the specified BGP neighbor.
<b>Step 8</b>	<b>neighbor</b> { <i>ip-address</i>   <i>ipv6-address</i>   <i>peer-group-name</i> } <b>send-label</b> <b>Example:</b> Device(config-router-af)# neighbor 192.168.2.127 send-label	Enables a BGP device to send Multiprotocol Label Switching (MPLS) labels with BGP routes to a neighboring BGP device, and allows the PE VPN to reach the Internet gateway over MPLS.

## Configuring the Internet Gateway as the Gateway to the Public Domain

Use the 6PE peering configuration established in the “Configuring iBGP 6PE Peering to the VPN PE” section.

### SUMMARY STEPS

1. **enable**
2. **configure terminal**
3. **router bgp** *autonomous-system-number*
4. **address-family ipv6**
5. **network** *ipv6-address/prefix-length*
6. **exit**

### DETAILED STEPS

	Command or Action	Purpose
<b>Step 1</b>	<b>enable</b> <b>Example:</b>  Device> enable	Enables privileged EXEC mode.  • Enter your password if prompted.
<b>Step 2</b>	<b>configure terminal</b> <b>Example:</b>  Device# configure terminal	Enters global configuration mode.
<b>Step 3</b>	<b>router bgp</b> <i>autonomous-system-number</i> <b>Example:</b>  Device(config)# router bgp 100	Configures the Border Gateway Protocol (BGP) routing process.
<b>Step 4</b>	<b>address-family ipv6</b> <b>Example:</b>  Device(config-router)# address-family ipv6	Enters address family configuration mode in order to exchange global table reachability.
<b>Step 5</b>	<b>network</b> <i>ipv6-address/prefix-length</i> <b>Example:</b>  Device(config-router-af)# network 2001:DB8:100::1/128	Configures the network source of the next hop to be used by the provider edge (PE) Virtual Private Network (VPN).
<b>Step 6</b>	<b>exit</b> <b>Example:</b>  Device(config-router-af)# exit	Exits address family configuration mode.

## Configuring eBGP Peering to the Internet

### SUMMARY STEPS

1. **enable**
2. **configure terminal**
3. **router bgp** *autonomous-system-number*
4. **neighbor** {*ip-address* | *ipv6-address* | *peer-group-name*} **remote-as** *as-number*
5. **address-family ipv6**
6. **neighbor** {*ip-address* | *ipv6-address* | *peer-group-name*} **activate**
7. **aggregate-address** *address mask* [**as-set**] [**summary-only**] [**suppress-map** *map-name*] [**advertise-map** *map-name*] [**attribute-map** *map-name*]

### DETAILED STEPS

	Command or Action	Purpose
<b>Step 1</b>	<b>enable</b> <b>Example:</b> Device> enable	Enables privileged EXEC mode. <ul style="list-style-type: none"> <li>• Enter your password if prompted.</li> </ul>
<b>Step 2</b>	<b>configure terminal</b> <b>Example:</b> Device# configure terminal	Enters global configuration mode.
<b>Step 3</b>	<b>router bgp</b> <i>autonomous-system-number</i> <b>Example:</b> Device(config)# router bgp 100	Configures the Border Gateway Protocol (BGP) routing process.
<b>Step 4</b>	<b>neighbor</b> { <i>ip-address</i>   <i>ipv6-address</i>   <i>peer-group-name</i> } <b>remote-as</b> <i>as-number</i> <b>Example:</b> Device(config-router)# neighbor FE80::300::1 GigabitEthernet0/0/0 remote-as 300	Adds an entry to the multiprotocol BGP neighbor table, and provides peering with PE (PE-VPN). <ul style="list-style-type: none"> <li>• Note that the peering is done over link-local addresses.</li> </ul>
<b>Step 5</b>	<b>address-family ipv6</b> <b>Example:</b> Device(config-router)# address-family ipv6	Enters address family configuration mode in order to exchange global table reachability.
<b>Step 6</b>	<b>neighbor</b> { <i>ip-address</i>   <i>ipv6-address</i>   <i>peer-group-name</i> } <b>activate</b> <b>Example:</b> Device(config-router-af)# neighbor FE80::300::1 GigabitEthernet0/0/0 activate	Enables the exchange of information for this address family with the specified BGP neighbor.



	Command or Action	Purpose
<b>Step 7</b>	<b>aggregate-address</b> <i>address mask</i> [ <b>as-set</b> ] [ <b>summary-only</b> ] [ <b>suppress-map</b> <i>map-name</i> ] [ <b>advertise-map</b> <i>map-name</i> ] [ <b>attribute-map</b> <i>map-name</i> ]  <b>Example:</b>  Device(config-router-af)# aggregate-address 2001:DB8::/32 summary-only	Creates an aggregate prefix before advertising it to the Internet.

## Configuring the IPv6 VPN PE

### Configuring a Default Static Route from the VRF to the Internet Gateway

#### SUMMARY STEPS

1. **enable**
2. **configure terminal**
3. **ipv6 route** [**vrf** *vrf-name*] *ipv6-prefix/prefix-length* {*ipv6-address* | *interface-type interface-number* [*ipv6-address*]} [**nexthop-vrf** [*vrf-name1* | **default**]] [*administrative-distance*] [*administrative-multicast-distance* | **unicast** | **multicast**] [*next-hop-address*] [**tag** *tag*]

#### DETAILED STEPS

	Command or Action	Purpose
<b>Step 1</b>	<b>enable</b>  <b>Example:</b>  Device> enable	Enables privileged EXEC mode.  <ul style="list-style-type: none"> <li>• Enter your password if prompted.</li> </ul>
<b>Step 2</b>	<b>configure terminal</b>  <b>Example:</b>  Device# configure terminal	Enters global configuration mode.
<b>Step 3</b>	<b>ipv6 route</b> [ <b>vrf</b> <i>vrf-name</i> ] <i>ipv6-prefix/prefix-length</i> { <i>ipv6-address</i>   <i>interface-type interface-number</i> [ <i>ipv6-address</i> ]} [ <b>nexthop-vrf</b> [ <i>vrf-name1</i>   <b>default</b> ]] [ <i>administrative-distance</i> ] [ <i>administrative-multicast-distance</i>   <b>unicast</b>   <b>multicast</b> ] [ <i>next-hop-address</i> ] [ <b>tag</b> <i>tag</i> ]  <b>Example:</b>  Device(config)# ipv6 route vrf vrf1 ::/0 2001:DB8:100::1 nexthop-vrf default	Configures a default static route from the VRF to the Internet gateway to allow outbound traffic to leave the VRF.

## Configuring a Static Route from the Default Table to the VRF

### SUMMARY STEPS

1. **enable**
2. **configure terminal**
3. **ipv6 route** [vrf vrf-name] ipv6-prefix/prefix-length {ipv6-address | interface-type interface-number [ipv6-address]} [nexthop-vrf [vrf-name1 | default]] [administrative-distance] [administrative-multicast-distance | unicast | multicast] [next-hop-address] [tag tag]

### DETAILED STEPS

	Command or Action	Purpose
Step 1	<b>enable</b> <b>Example:</b> Device> enable	Enables privileged EXEC mode. <ul style="list-style-type: none"> <li>• Enter your password if prompted.</li> </ul>
Step 2	<b>configure terminal</b> <b>Example:</b> Device# configure terminal	Enters global configuration mode.
Step 3	<b>ipv6 route</b> [vrf vrf-name] ipv6-prefix/prefix-length {ipv6-address   interface-type interface-number [ipv6-address]} [nexthop-vrf [vrf-name1   default]] [administrative-distance] [administrative-multicast-distance   unicast   multicast] [next-hop-address] [tag tag] <b>Example:</b> Device(config)# ipv6 route 2001:DB8:100:2000::/64 nexthop-vrf vrf1	Configures a static route from the default table to the VRF to allow inbound traffic to reach the VRF.

## Configuring iBGP 6PE Peering to the Internet Gateway

### SUMMARY STEPS

1. **enable**
2. **configure terminal**
3. **router bgp** autonomous-system-number
4. **neighbor** {ip-address | ipv6-address | peer-group-name} remote-as as-number
5. **neighbor** {ip-address | ipv6-address | peer-group-name} update-source interface-type interface-number
6. **address-family ipv6** [vrf vrf-name] [unicast | multicast]
7. **neighbor** {ip-address | ipv6-address | peer-group-name} activate
8. **neighbor** {ip-address | ipv6-address | peer-group-name} send-label
9. **network** ipv6-address/prefix-length

## DETAILED STEPS

	Command or Action	Purpose
Step 1	<b>enable</b> <b>Example:</b> Device> enable	Enables privileged EXEC mode. <ul style="list-style-type: none"> <li>• Enter your password if prompted.</li> </ul>
Step 2	<b>configure terminal</b> <b>Example:</b> Device# configure terminal	Enters global configuration mode.
Step 3	<b>router bgp</b> <i>autonomous-system-number</i> <b>Example:</b> Device(config)# router bgp 100	Configures the Border Gateway Protocol (BGP) routing process.
Step 4	<b>neighbor</b> { <i>ip-address</i>   <i>ipv6-address</i>   <i>peer-group-name</i> } <b>remote-as</b> <i>as-number</i> <b>Example:</b> Device(config-router)# neighbor 192.168.2.101 remote-as 100	Adds an entry to the multiprotocol BGP neighbor table for peering with the Internet gateway.
Step 5	<b>neighbor</b> { <i>ip-address</i>   <i>ipv6-address</i>   <i>peer-group-name</i> } <b>update-source</b> <i>interface-type interface-number</i> <b>Example:</b> Device(config-router)# neighbor 192.168.2.101 update-source Loopback 0	Enables the BGP session to use a source address on the specified interface.
Step 6	<b>address-family ipv6</b> [ <i>vrf vrf-name</i> ] [ <i>unicast</i>   <i>multicast</i> ] <b>Example:</b> Device(config-router)# address-family ipv6	Enters address family configuration mode to exchange global table reachability.
Step 7	<b>neighbor</b> { <i>ip-address</i>   <i>ipv6-address</i>   <i>peer-group-name</i> } <b>activate</b> <b>Example:</b> Device(config-router-af)# neighbor 192.168.2.101 activate	Enables the exchange of information for this address family with the specified BGP neighbor.
Step 8	<b>neighbor</b> { <i>ip-address</i>   <i>ipv6-address</i>   <i>peer-group-name</i> } <b>send-label</b> <b>Example:</b> Device(config-router-af)# neighbor 192.168.2.101 send-label	Enables label exchange for this address family to this neighbor to enable the Virtual Private Network (VPN) provider edge (PE) to reach the Internet gateway over Multiprotocol Label Switching (MPLS).

	Command or Action	Purpose
<b>Step 9</b>	<b>network</b> <i>ipv6-address/prefix-length</i> <b>Example:</b> <pre>Device(config-router-af)# network 2001:DB8:100:2000::/64</pre>	Provides the virtual routing and forwarding (VRF) prefix to the Internet gateway.

## Configuring a Multiautonomous-System Backbone for IPv6 VPN

Two Virtual Private Network (VPN) sites may be connected to different autonomous systems because the sites are connected to different service providers. The provider edge (PE) devices attached to that VPN is then unable to maintain the internal Border Gateway Protocol (iBGP) connections with each other or with a common route reflector. In this situation, there must be some way to use external BGP (eBGP) to distribute VPN-IPv6 addresses.

The following configuration example illustrates two scenarios, one in which a multiprotocol eBGP-IPv6 VPN peering between autonomous system boundary routers (ASBRs) uses an IPv4 link, and the same scenario using an IPv6 link. If the peering between ASBRs is performed over an IPv4 link, the BGP configuration on ASBR1 is as follows:

```
router bgp 1001
no bgp default ipv4-unicast
no bgp default route-target filter
neighbor 192.1.1.1 remote-as 1002
neighbor 192.168.2.11 remote-as 1001
neighbor 192.168.2.11 update-source Loopback1
!
 address-family vpnv6
!Peering to ASBR2 over an IPv4 link
neighbor 192.1.1.1 activate
neighbor 192.1.1.1 send-community extended
!Peering to PE1 over an IPv4 link
neighbor 192.168.2.11 activate
neighbor 192.168.2.11 next-hop-self
neighbor 192.168.2.11 send-community extended
```

If the peering between ASBRs is performed over an IPv6 link, the BGP configuration on ASBR1 is as follows:

```
router bgp 1001
neighbor 2001:DB8:101::72d remote-as 1002
!
 address-family vpnv6
!Peering to ASBR2 over an IPv6 link
neighbor 2001:DB8:101::72d activate
neighbor 2001:DB8:101::72d send-community extended
```

The next several tasks describe how to configure the PE VPN for a multiautonomous-system backbone using multihop multiprotocol eBGP to redistribute VPN routes across route reflectors (RRs) in different autonomous systems. Labeled IPv4 routes to the PEs are advertised across ASBRs so that a complete label switch path (LSP) is set up end to end.

In this scenario, the ASBRs are not VPN aware; only the RRs are VPN aware. The following configuration should be available and understood:

- The ASBRs are providing the PEs' loopback addresses to service providers they peer with. That includes:

- The VPN PE's IPv4 loopback address (/32) for enabling next-hop resolution at the remote service provider location.
- The VPN RR's IPv4 loopback address (/32) for enabling interprovider (inter-RR) eBGP peering.
- For the VPN PE's IPv4 loopback address, the address providing is performed over multiprotocol BGP, with the label, up to the remote PEs, so that the label establishes an end-to-end LSP. Therefore, the following MP-BGP peering was set up for VPNv4:
  - VPN PEs are iBGP peering with VPN RRs.
  - ASBRs are iBGP peering with VPN RRs.
  - ASBRs are eBGP peering with the remote service provider ASBR.
- The VPN RRs of each service provider are peering together over eBGP and exchanging VPN routes. The next hop is forwarded unchanged, so that the end-to-end LSP is not via RRs.

To enable IPv6 VPN interautonomous-system access in this scenario, the ISP needs to modify the configurations at the PE VPN and at the RR. The same RRs are set up to provide a similar service for VPNv4. In that context, because the peering between the RR and the ASBR and between ASBRs is solely to exchange labels for IPv4 next hops used by both IPv4 VPN and IPv6 VPN, the ASBRs remain completely IPv6 unaware, and no configuration change is required there.

The figure below shows the BGP peering points required to enable IPv6 interprovider connectivity from the PE-VPN device (providing IPv6 VPN access) to the xxCom network.

**Figure 7: BGP Peering Points for Enabling Interautonomous System Scenario C**

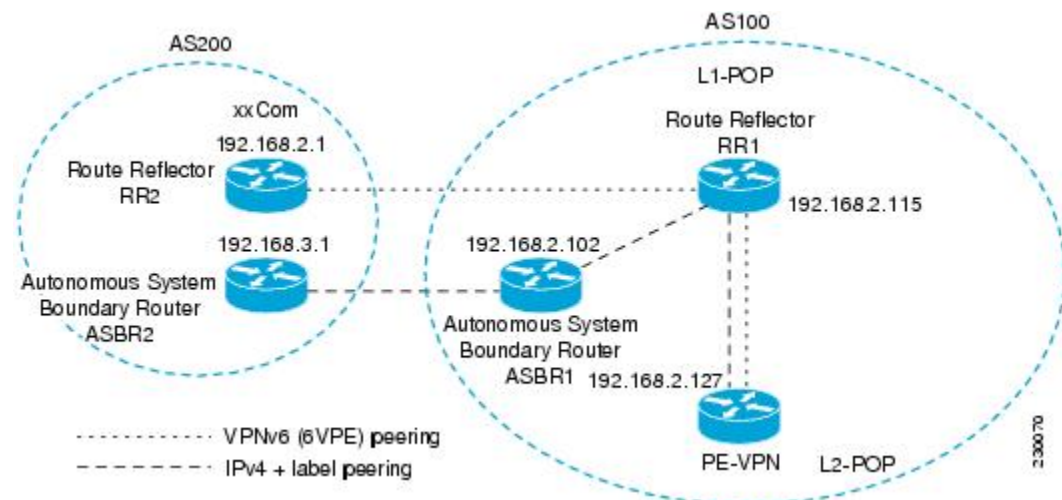

The following additional BGP peerings are necessary to enable interautonomous-system communication from the IPv6 VPN PE located in the Level 2 point of presence (POP):

- IPv4 with label peering from the PE VPN to the route reflector named RR1 (which is already configured if VPNv4 interautonomous system is deployed on the same nodes, using the same LSP).
- IPv4 with label peering from RR1 to ASBR1.
- IPv4 with label peering between ASBR1 and ASBR2.
- IPv6 VPN peering between RR1 and RR2 (which is the route reflector in the other autonomous systems) to exchange IPv6 VPN routes.

- IPv6 VPN peering with RR1. If the same route reflectors used to scale the IPv6 VPN service are used for interautonomous-system capability, then this function might also be already configured (see the “Configuring Route Reflectors for Improved Scalability” section).

Configuring the multiautonomous-system backbone for IPv6 VPN consists of the following tasks:

## Configuring the PE VPN for a Multiautonomous-System Backbone

### Configuring iBGP IPv6 VPN Peering to a Route Reflector

Perform this task to configure internal Border Gateway Protocol (iBGP) IPv6 Virtual Private Network (VPN) peering to a route reflector named RR1.

#### SUMMARY STEPS

1. **enable**
2. **configure terminal**
3. **router bgp** *autonomous-system-number*
4. **neighbor** {*ip-address* | *ipv6-address* | *peer-group-name*} **remote-as** *as-number*
5. **neighbor** {*ip-address* | *ipv6-address* | *peer-group-name*} **update-source** *interface-type interface-number*
6. **address-family vpnv6** [**unicast**]
7. **neighbor** {*ip-address* | *ipv6-address* | *peer-group-name*} **activate**
8. **neighbor** {*ip-address* | *ipv6-address* | *peer-group-name*} **send-community** [**both** | **standard** | **extended**]
9. **exit**

#### DETAILED STEPS

	Command or Action	Purpose
<b>Step 1</b>	<b>enable</b> <b>Example:</b>  Device> enable	Enables privileged EXEC mode.  • Enter your password if prompted.
<b>Step 2</b>	<b>configure terminal</b> <b>Example:</b>  Device# configure terminal	Enters global configuration mode.
<b>Step 3</b>	<b>router bgp</b> <i>autonomous-system-number</i> <b>Example:</b>  Device(config)# router bgp 100	Configures the BGP routing process.
<b>Step 4</b>	<b>neighbor</b> { <i>ip-address</i>   <i>ipv6-address</i>   <i>peer-group-name</i> } <b>remote-as</b> <i>as-number</i> <b>Example:</b>  Device(config-router)# neighbor 192.168.2.115 remote-as 100	Adds an entry to the multiprotocol BGP neighbor table for peering with the route reflector with interautonomous-system functionality.

	Command or Action	Purpose
Step 5	<b>neighbor</b> { <i>ip-address</i>   <i>ipv6-address</i>   <i>peer-group-name</i> } <b>update-source</b> <i>interface-type interface-number</i>  <b>Example:</b>  Device(config-router)# neighbor 192.168.2.115 update-source Loopback 0	Enables the BGP session to use a source address on the specified interface.
Step 6	<b>address-family vpv6 [unicast]</b>  <b>Example:</b>  Device(config-router)# address-family vpv6	(Optional) Places the device in address family configuration mode for configuring routing sessions.
Step 7	<b>neighbor</b> { <i>ip-address</i>   <i>ipv6-address</i>   <i>peer-group-name</i> } <b>activate</b>  <b>Example:</b>  Device(config-router-af)# neighbor 192.168.2.115 activate	Enables the exchange of information for this address family with the specified BGP neighbor.
Step 8	<b>neighbor</b> { <i>ip-address</i>   <i>ipv6-address</i>   <i>peer-group-name</i> } <b>send-community [both   standard   extended]</b>  <b>Example:</b>  Device(config-router-af)# neighbor 192.168.2.115 send-community extended	Specifies that a communities attribute should be sent to the BGP neighbor.
Step 9	<b>exit</b>  <b>Example:</b>  Device(config-router-af)# exit	Exits address family configuration mode.

### Configuring IPv4 and Label iBGP Peering to a Route Reflector

Perform this task to configure IPv4 and label internal Border Gateway Protocol (iBGP) peering to a route reflector named RR1.

#### SUMMARY STEPS

1. **enable**
2. **configure terminal**
3. **router bgp** *autonomous-system-number*
4. **address-family ipv4** [**mdt** | **multicast** | **tunnel** | **unicast** [**vrf** *vrf-name*] | **vrf** *vrf-name*]
5. **neighbor** {*ip-address* | *ipv6-address* | *peer-group-name*} **activate**
6. **neighbor** {*ip-address* | *ipv6-address* | *peer-group-name*} **send-label**

## DETAILED STEPS

	Command or Action	Purpose
<b>Step 1</b>	<b>enable</b> <b>Example:</b>  Device> enable	Enables privileged EXEC mode.  • Enter your password if prompted.
<b>Step 2</b>	<b>configure terminal</b> <b>Example:</b>  Device# configure terminal	Enters global configuration mode.
<b>Step 3</b>	<b>router bgp</b> <i>autonomous-system-number</i> <b>Example:</b>  Device(config)# router bgp 100	Configures the BGP routing process.
<b>Step 4</b>	<b>address-family ipv4</b> [ <b>mdt</b>   <b>multicast</b>   <b>tunnel</b>   <b>unicast</b>   <b>vrf</b> <i>vrf-name</i> ]   <b>vrf</b> <i>vrf-name</i> <b>Example:</b>  Device(config-router)# address-family ipv4	Enters address family configuration mode to configure a routing session using standard IPv4 address prefixes.
<b>Step 5</b>	<b>neighbor</b> { <i>ip-address</i>   <i>ipv6-address</i>   <i>peer-group-name</i> } <b>activate</b> <b>Example:</b>  Device(config-router-af)# neighbor 192.168.2.115 activate	Enables the exchange of information for this address family with the specified BGP neighbor.
<b>Step 6</b>	<b>neighbor</b> { <i>ip-address</i>   <i>ipv6-address</i>   <i>peer-group-name</i> } <b>send-label</b> <b>Example:</b>  Device(config-router-af)# neighbor 192.168.2.115 send-label	Enables label exchange for this address family to this neighbor in order to receive remote provider edge (PE) peer IPv4 loopback with label via RR1 in order to set up an end-to-end label switch path (LSP).

## Configuring the Route Reflector for a Multiautonomous-System Backbone

## Configuring Peering to the PE VPN

## SUMMARY STEPS

- enable**
- configure terminal**
- router bgp** *autonomous-system-number*
- neighbor** {*ip-address* | *ipv6-address* | *peer-group-name*} **remote-as** *as-number*
- neighbor** {*ip-address* | *ipv6-address* | *peer-group-name*} **update-source** *interface-type interface-number*



6. **address-family vpv6 [unicast]**
7. **neighbor {ip-address | ipv6-address | peer-group-name} activate**
8. **neighbor {ip-address | ipv6-address | peer-group-name} send-community [both | standard | extended]**
9. **exit**
10. **address-family ipv4 [mdt | multicast | tunnel | unicast [vrf vrf-name] | vrf vrf-name]**
11. **neighbor {ip-address | ipv6-address | peer-group-name} activate**
12. **neighbor {ip-address | ipv6-address | peer-group-name} send-label**
13. **exit**

## DETAILED STEPS

	Command or Action	Purpose
Step 1	<b>enable</b> <b>Example:</b> Device> enable	Enables privileged EXEC mode. <ul style="list-style-type: none"> <li>• Enter your password if prompted.</li> </ul>
Step 2	<b>configure terminal</b> <b>Example:</b> Device# configure terminal	Enters global configuration mode.
Step 3	<b>router bgp autonomous-system-number</b> <b>Example:</b> Device(config)# router bgp 100	Configures the Border Gateway Protocol (BGP) routing process.
Step 4	<b>neighbor {ip-address   ipv6-address   peer-group-name}</b> <b>remote-as as-number</b> <b>Example:</b> Device(config-router)# neighbor 192.168.2.115 remote-as 100	Adds an entry to the multiprotocol BGP neighbor table for peering with the route reflector for InterAS.
Step 5	<b>neighbor {ip-address   ipv6-address   peer-group-name}</b> <b>update-source interface-type interface-number</b> <b>Example:</b> Device(config-router)# neighbor 192.168.2.115 update-source Loopback 0	Enables the BGP session to use a source address on the specified interface.
Step 6	<b>address-family vpv6 [unicast]</b> <b>Example:</b> Device(config-router)# address-family vpv6	(Optional) Places the device in address family configuration mode.

	Command or Action	Purpose
<b>Step 7</b>	<b>neighbor</b> { <i>ip-address</i>   <i>ipv6-address</i>   <i>peer-group-name</i> } <b>activate</b> <b>Example:</b> <pre>Device(config-router-af)# neighbor 192.168.2.115 activate</pre>	Enables the exchange of information for this address family with the specified BGP neighbor.
<b>Step 8</b>	<b>neighbor</b> { <i>ip-address</i>   <i>ipv6-address</i>   <i>peer-group-name</i> } <b>send-community</b> [ <b>both</b>   <b>standard</b>   <b>extended</b> ] <b>Example:</b> <pre>Device(config-router-af)# neighbor 192.168.2.115 send-community extended</pre>	Specifies that a community attribute should be sent to the BGP neighbor.
<b>Step 9</b>	<b>exit</b> <b>Example:</b> <pre>Device(config-router-af)# exit</pre>	Exits address family configuration mode.
<b>Step 10</b>	<b>address-family ipv4</b> [ <b>mdt</b>   <b>multicast</b>   <b>tunnel</b>   <b>unicast</b> [ <b>vrf</b> <i>vrf-name</i> ]   <b>vrf</b> <i>vrf-name</i> ] <b>Example:</b> <pre>Device(config-router)# address-family ipv4</pre>	Enters address family configuration mode to configure a routing session using standard IPv4 address prefixes.
<b>Step 11</b>	<b>neighbor</b> { <i>ip-address</i>   <i>ipv6-address</i>   <i>peer-group-name</i> } <b>activate</b> <b>Example:</b> <pre>Device(config-router-af)# neighbor 192.168.2.115 activate</pre>	Enables the exchange of information for this address family with the specified BGP neighbor.
<b>Step 12</b>	<b>neighbor</b> { <i>ip-address</i>   <i>ipv6-address</i>   <i>peer-group-name</i> } <b>send-label</b> <b>Example:</b> <pre>Device(config-router-af)# neighbor 192.168.2.115 send-label</pre>	Enables label exchange for this address family to this neighbor in order to send to the local provider edge (PE) the remote PE IPv4 loopback with a label in order to set up an end-to-end label switch path (LSP).
<b>Step 13</b>	<b>exit</b> <b>Example:</b> <pre>Device(config-router-af)# exit</pre>	Exits address family configuration mode.

## Configuring the Route Reflector

### SUMMARY STEPS

1. **enable**
2. **configure terminal**
3. **router bgp** *autonomous-system-number*
4. **neighbor** {*ip-address* | *ipv6-address* | *peer-group-name*} **remote-as** *as-number*
5. **neighbor** {*ip-address* | *ipv6-address* | *peer-group-name*} **update-source** *interface-type interface-number*
6. **address-family vpv6** [**unicast**]
7. **neighbor** {*ip-address* | *ipv6-address* | *peer-group-name*} **activate**
8. **neighbor** {*ip-address* | *ipv6-address* | *peer-group-name*} **send-community** [**both** | **standard** | **extended**]
9. **neighbor** {*ip-address* | *ipv6-address* | *peer-group-name*} **route-reflector-client**
10. **exit**
11. **address-family ipv4** [**mdt** | **multicast** | **tunnel** | **unicast** [**vrf** *vrf-name*] | **vrf** *vrf-name*]
12. **neighbor** {*ip-address* | *ipv6-address* | *peer-group-name*} **activate**
13. **neighbor** {*ip-address* | *ipv6-address* | *peer-group-name*} **send-label**
14. **exit**

### DETAILED STEPS

	Command or Action	Purpose
<b>Step 1</b>	<b>enable</b> <b>Example:</b> Device> enable	Enables privileged EXEC mode. <ul style="list-style-type: none"> <li>• Enter your password if prompted.</li> </ul>
<b>Step 2</b>	<b>configure terminal</b> <b>Example:</b> Device# configure terminal	Enters global configuration mode.
<b>Step 3</b>	<b>router bgp</b> <i>autonomous-system-number</i> <b>Example:</b> Device(config)# router bgp 100	Configures the Border Gateway Protocol (BGP) routing process.
<b>Step 4</b>	<b>neighbor</b> { <i>ip-address</i>   <i>ipv6-address</i>   <i>peer-group-name</i> } <b>remote-as</b> <i>as-number</i> <b>Example:</b> Device(config-router)# neighbor 192.168.2.127 remote-as 100	Adds an entry to the multiprotocol BGP neighbor table for peering with the Virtual Private Network (VPN) provider edge (PE) for Interns.
<b>Step 5</b>	<b>neighbor</b> { <i>ip-address</i>   <i>ipv6-address</i>   <i>peer-group-name</i> } <b>update-source</b> <i>interface-type interface-number</i> <b>Example:</b>	Enables the BGP session to use a source address on the specified interface.

	Command or Action	Purpose
	Device(config-router)# neighbor 192.168.2.127 update-source Loopback 0	
<b>Step 6</b>	<b>address-family vpnv6 [unicast]</b> <b>Example:</b> Device(config-router)# address-family vpnv6	(Optional) Places the device in address family configuration mode.
<b>Step 7</b>	<b>neighbor {ip-address   ipv6-address   peer-group-name}</b> <b>activate</b> <b>Example:</b> Device(config-router-af)# neighbor 192.168.2.127 activate	Enables the exchange of information for this address family with the specified neighbor.
<b>Step 8</b>	<b>neighbor {ip-address   ipv6-address   peer-group-name}</b> <b>send-community [both   standard   extended]</b> <b>Example:</b> Device(config-router-af)# neighbor 192.168.2.127 send-community extended	Specifies that a community attribute should be sent to the BGP neighbor.
<b>Step 9</b>	<b>neighbor {ip-address   ipv6-address   peer-group-name}</b> <b>route-reflector-client</b> <b>Example:</b> Device(config-router-af)# neighbor 192.168.2.127 route-reflector-client	Configures the specified neighbor as a route reflector client.
<b>Step 10</b>	<b>exit</b> <b>Example:</b> Device(config-router-af)# exit	Exits address family configuration mode.
<b>Step 11</b>	<b>address-family ipv4 [mdt   multicast   tunnel   unicast</b> <b>[vrf vrf-name]   vrf vrf-name]</b> <b>Example:</b> Device(config-router)# address-family ipv4	Enters address family configuration mode to configure a routing session using standard IPv4 address prefixes.
<b>Step 12</b>	<b>neighbor {ip-address   ipv6-address   peer-group-name}</b> <b>activate</b> <b>Example:</b> Device(config-router-af)# neighbor 192.168.2.127 activate	Enables the exchange of information for this address family with the specified neighbor.
<b>Step 13</b>	<b>neighbor {ip-address   ipv6-address   peer-group-name}</b> <b>send-label</b>	Enables label exchange for this address family to this neighbor in order to send to the local PE the remote PE

	Command or Action	Purpose
	<b>Example:</b>  Device(config-router-af)# neighbor 192.168.2.127 send-label	IPv4 loopback with a label in order to set up an end-to-end LSP.
<b>Step 14</b>	<b>exit</b>  <b>Example:</b>  Device(config-router-af)# exit	Exits address family configuration mode.

## Configuring Peering to the Autonomous System Boundary Router

### SUMMARY STEPS

1. **enable**
2. **configure terminal**
3. **router bgp** *autonomous-system-number*
4. **neighbor** {*ip-address* | *ipv6-address* | *peer-group-name*} **remote-as** *as-number*
5. **neighbor** {*ip-address* | *ipv6-address* | *peer-group-name*} **update-source** *interface-type interface-number*
6. **address-family ipv4** [**mdt** | **multicast** | **tunnel** | **unicast** [**vrf** *vrf-name*] | **vrf** *vrf-name*]
7. **neighbor** {*ip-address* | *ipv6-address* | *peer-group-name*} **activate**
8. **neighbor** {*ip-address* | *ipv6-address* | *peer-group-name*} **send-label**

### DETAILED STEPS

	Command or Action	Purpose
<b>Step 1</b>	<b>enable</b>  <b>Example:</b>  Device> enable	Enables privileged EXEC mode.  <ul style="list-style-type: none"> <li>• Enter your password if prompted.</li> </ul>
<b>Step 2</b>	<b>configure terminal</b>  <b>Example:</b>  Device# configure terminal	Enters global configuration mode.
<b>Step 3</b>	<b>router bgp</b> <i>autonomous-system-number</i>  <b>Example:</b>  Device(config)# router bgp 100	Configures the Border Gateway Protocol (BGP) routing process.
<b>Step 4</b>	<b>neighbor</b> { <i>ip-address</i>   <i>ipv6-address</i>   <i>peer-group-name</i> } <b>remote-as</b> <i>as-number</i>  <b>Example:</b>  Device(config-router)# neighbor 192.168.2.102 remote-as 100	Adds an entry to the multiprotocol BGP neighbor table for peering with the ASBR1.

	Command or Action	Purpose
<b>Step 5</b>	<b>neighbor</b> { <i>ip-address</i>   <i>ipv6-address</i>   <i>peer-group-name</i> } <b>update-source</b> <i>interface-type interface-number</i>  <b>Example:</b>  Device(config-router)# neighbor 192.168.2.102 update-source Loopback 0	Enables the BGP session to use a source address on the specified interface.
<b>Step 6</b>	<b>address-family ipv4</b> [ <b>mdt</b>   <b>multicast</b>   <b>tunnel</b>   <b>unicast</b> ] [ <b>vrf vrf-name</b> ]   <b>vrf vrf-name</b> ]  <b>Example:</b>  Device(config-router)# address-family ipv4	Enters address family configuration mode to configure a routing session using standard IPv4 address prefixes.
<b>Step 7</b>	<b>neighbor</b> { <i>ip-address</i>   <i>ipv6-address</i>   <i>peer-group-name</i> } <b>activate</b>  <b>Example:</b>  Device(config-router-af)# neighbor 192.168.2.102 activate	Enables the exchange of information for this address family with the specified BGP neighbor.
<b>Step 8</b>	<b>neighbor</b> { <i>ip-address</i>   <i>ipv6-address</i>   <i>peer-group-name</i> } <b>send-label</b>  <b>Example:</b>  Device(config-router-af)# neighbor 192.168.2.102 send-label	Enables label exchange for this address family to this neighbor in order to receive the remote PE IPv4 loopback with the label set to an end-to-end label switch path (LSP).

### Configuring Peering to Another ISP Route Reflector

Perform this task to configure peering to an Internet service provider (ISP) route reflector named RR2.

#### SUMMARY STEPS

1. **enable**
2. **configure terminal**
3. **router bgp** *autonomous-system-number*
4. **neighbor** {*ip-address* | *ipv6-address* | *peer-group-name*} **remote-as** *as-number*
5. **neighbor** {*ip-address* | *ipv6-address* | *peer-group-name*} **update-source** *interface-type interface-number*
6. **neighbor** {*ip-address* | *ipv6-address* | *peer-group-name*} **ebgp-multihop** [*ttl*]
7. **address-family vpnv6** [**unicast**]
8. **neighbor** {*ip-address* | *ipv6-address* | *peer-group-name*} **activate**
9. **neighbor** {*ip-address* | *ipv6-address* | *peer-group-name*} **send-community** [**both** | **standard** | **extended**]
10. **neighbor** {*ip-address* | *ipv6-address* | *peer-group-name*} **next-hop-unchanged** [**allpaths**]

## DETAILED STEPS

	Command or Action	Purpose
Step 1	<b>enable</b> <b>Example:</b> Device> enable	Enables privileged EXEC mode. <ul style="list-style-type: none"> <li>• Enter your password if prompted.</li> </ul>
Step 2	<b>configure terminal</b> <b>Example:</b> Device# configure terminal	Enters global configuration mode.
Step 3	<b>router bgp <i>autonomous-system-number</i></b> <b>Example:</b> Device(config)# router bgp 100	Configures the Border Gateway Protocol (BGP) routing process.
Step 4	<b>neighbor {<i>ip-address</i>   <i>ipv6-address</i>   <i>peer-group-name</i>}</b> <b>remote-as <i>as-number</i></b> <b>Example:</b> Device(config-router)# neighbor 192.168.2.1 remote-as 100	Adds an entry to the multiprotocol BGP neighbor table for external BGP (eBGP) peering with RR2.
Step 5	<b>neighbor {<i>ip-address</i>   <i>ipv6-address</i>   <i>peer-group-name</i>}</b> <b>update-source <i>interface-type interface-number</i></b> <b>Example:</b> Device(config-router)# neighbor 192.168.2.1 update-source Loopback 0	Enables the BGP session to use a source address on the specified interface.
Step 6	<b>neighbor {<i>ip-address</i>   <i>ipv6-address</i>   <i>peer-group-name</i>}</b> <b>ebgp-multihop [<i>ttl</i>]</b> <b>Example:</b> Device(config-router)# neighbor 192.168.2.1 ebgp-multihop	(Optional) Accepts and attempts BGP connections to external peers residing on networks that are not directly connected.
Step 7	<b>address-family vpv66 [unicast]</b> <b>Example:</b> Device(config-router)# address-family vpv66	(Optional) Places the device in address family configuration mode for configuring routing sessions.
Step 8	<b>neighbor {<i>ip-address</i>   <i>ipv6-address</i>   <i>peer-group-name</i>}</b> <b>activate</b> <b>Example:</b> Device(config-router-af)# neighbor 192.168.2.1 activate	Enables the exchange of information for this address family with the specified BGP neighbor.

	Command or Action	Purpose
<b>Step 9</b>	<b>neighbor</b> { <i>ip-address</i>   <i>ipv6-address</i>   <i>peer-group-name</i> } <b>send-community</b> [ <b>both</b>   <b>standard</b>   <b>extended</b> ]  <b>Example:</b>  <pre>Device(config-router-af)# neighbor 192.168.2.1 send-community extended</pre>	Specifies that a communities attribute should be sent to the BGP neighbor.
<b>Step 10</b>	<b>neighbor</b> { <i>ip-address</i>   <i>ipv6-address</i>   <i>peer-group-name</i> } <b>next-hop-unchanged</b> [ <b>allpaths</b> ]  <b>Example:</b>  <pre>Device(config-router-af)# neighbor 192.168.2.1 next-hop-unchanged allpaths</pre>	Enables an eBGP multihop peer to propagate to the next hop unchanged for paths.

## Configuring the ASBR

### Configuring Peering with Router Reflector RR1

#### SUMMARY STEPS

1. **enable**
2. **configure terminal**
3. **router bgp** *autonomous-system-number*
4. **neighbor** {*ip-address* | *ipv6-address* | *peer-group-name*} **remote-as** *as-number*
5. **neighbor** {*ip-address* | *ipv6-address* | *peer-group-name*} **update-source** *interface-type interface-number*
6. **address-family ipv4** [**mdt** | **multicast** | **tunnel** | **unicast** [**vrf** *vrf-name*] | **vrf** *vrf-name*]
7. **neighbor** {*ip-address* | *ipv6-address* | *peer-group-name*} **activate**
8. **neighbor** {*ip-address* | *ipv6-address* | *peer-group-name*} **send-label**
9. **exit**

#### DETAILED STEPS

	Command or Action	Purpose
<b>Step 1</b>	<b>enable</b>  <b>Example:</b>  <pre>Device&gt; enable</pre>	Enables privileged EXEC mode. <ul style="list-style-type: none"> <li>• Enter your password if prompted.</li> </ul>
<b>Step 2</b>	<b>configure terminal</b>  <b>Example:</b>  <pre>Device# configure terminal</pre>	Enters global configuration mode.
<b>Step 3</b>	<b>router bgp</b> <i>autonomous-system-number</i>  <b>Example:</b>	Configures the Border Gateway Protocol (BGP) routing process.



	Command or Action	Purpose
	Device(config)# router bgp 100	
<b>Step 4</b>	<b>neighbor</b> { <i>ip-address</i>   <i>ipv6-address</i>   <i>peer-group-name</i> } <b>remote-as</b> <i>as-number</i>  <b>Example:</b>  Device(config-router)# neighbor 192.168.2.115 remote-as 100	Adds an entry to the multiprotocol BGP neighbor table for peering with RR1.
<b>Step 5</b>	<b>neighbor</b> { <i>ip-address</i>   <i>ipv6-address</i>   <i>peer-group-name</i> } <b>update-source</b> <i>interface-type interface-number</i>  <b>Example:</b>  Device(config-router)# neighbor 192.168.2.115 update-source Loopback 0	Enables the BGP session to use a source address on the specified interface.
<b>Step 6</b>	<b>address-family ipv4</b> [ <b>mdt</b>   <b>multicast</b>   <b>tunnel</b>   <b>unicast</b> [ <b>vrf</b> <i>vrf-name</i> ]   <b>vrf</b> <i>vrf-name</i>  <b>Example:</b>  Device(config-router)# address-family ipv4	Enters address family configuration mode to configure a routing session using standard IPv4 address prefixes.
<b>Step 7</b>	<b>neighbor</b> { <i>ip-address</i>   <i>ipv6-address</i>   <i>peer-group-name</i> } <b>activate</b>  <b>Example:</b>  Device(config-router-af)# neighbor 192.168.2.115 activate	Enables the exchange of information for this address family with the specified BGP neighbor.
<b>Step 8</b>	<b>neighbor</b> { <i>ip-address</i>   <i>ipv6-address</i>   <i>peer-group-name</i> } <b>send-label</b>  <b>Example:</b>  Device(config-router-af)# neighbor 192.168.2.115 send-label	Enables label exchange for this address family to this neighbor in order to send to the local PE the remote PE IPv4 loopback with a label in order to set up an end-to-end label switch path (LSP).
<b>Step 9</b>	<b>exit</b>  <b>Example:</b>  Device(config-router-af)# exit	Exits address family configuration mode.

## Configuring Peering with the Other ISP ASBR2

### SUMMARY STEPS

1. **enable**
2. **configure terminal**
3. **router bgp** *autonomous-system-number*

4. **neighbor** {*ip-address* | *ipv6-address* | *peer-group-name*} **remote-as** *as-number*
5. **neighbor** {*ip-address* | *ipv6-address* | *peer-group-name*} **update-source** *interface-type interface-number*
6. **neighbor** {*ip-address* | *ipv6-address* | *peer-group-name*} **ebgp-multihop** [*ttl*]
7. **address-family ipv4** [**mdt** | **multicast** | **tunnel** | **unicast** [**vrf** *vrf-name*] | **vrf** *vrf-name*]
8. **neighbor** {*ip-address* | *ipv6-address* | *peer-group-name*} **activate**
9. **neighbor** {*ip-address* | *ipv6-address* | *peer-group-name*} **send-label**
10. **network** {*network-number* [**mask** *network-mask*] | *nsap-prefix*} [**route-map** *map-tag*]
11. **network** {*network-number* [**mask** *network-mask*] | *nsap-prefix*} [**route-map** *map-tag*]

## DETAILED STEPS

	Command or Action	Purpose
<b>Step 1</b>	<b>enable</b> <b>Example:</b> Device> enable	Enables privileged EXEC mode. <ul style="list-style-type: none"> <li>• Enter your password if prompted.</li> </ul>
<b>Step 2</b>	<b>configure terminal</b> <b>Example:</b> Device# configure terminal	Enters global configuration mode.
<b>Step 3</b>	<b>router bgp</b> <i>autonomous-system-number</i> <b>Example:</b> Device(config)# router bgp 100	Configures the Border Gateway Protocol (BGP) routing process.
<b>Step 4</b>	<b>neighbor</b> { <i>ip-address</i>   <i>ipv6-address</i>   <i>peer-group-name</i> } <b>remote-as</b> <i>as-number</i> <b>Example:</b> Device(config-router)# neighbor 192.168.3.1 remote-as 100	Adds an entry to the multiprotocol BGP neighbor table for peering with the ASBR2.
<b>Step 5</b>	<b>neighbor</b> { <i>ip-address</i>   <i>ipv6-address</i>   <i>peer-group-name</i> } <b>update-source</b> <i>interface-type interface-number</i> <b>Example:</b> Device(config-router)# neighbor 192.168.3.1 update-source Loopback 0	Enables the BGP session to use a source address on the specified interface.
<b>Step 6</b>	<b>neighbor</b> { <i>ip-address</i>   <i>ipv6-address</i>   <i>peer-group-name</i> } <b>ebgp-multihop</b> [ <i>ttl</i> ] <b>Example:</b> Device(config-router)# neighbor 192.168.3.1 ebgp-multihop	Accepts and attempts BGP connections to external peers residing on networks that are not directly connected.

	Command or Action	Purpose
<b>Step 7</b>	<b>address-family ipv4</b> [ <b>mdt</b>   <b>multicast</b>   <b>tunnel</b>   <b>unicast</b> [ <b>vrf vrf-name</b> ]   <b>vrf vrf-name</b> ] <b>Example:</b> Device(config-router)# address-family ipv4	Enters address family configuration mode to configure a routing session using standard IPv4 address prefixes.
<b>Step 8</b>	<b>neighbor</b> { <i>ip-address</i>   <i>ipv6-address</i>   <i>peer-group-name</i> } <b>activate</b> <b>Example:</b> Device(config-router-af)# neighbor 192.168.3.1 activate	Enables the exchange of information for this address family with the specified BGP neighbor.
<b>Step 9</b>	<b>neighbor</b> { <i>ip-address</i>   <i>ipv6-address</i>   <i>peer-group-name</i> } <b>send-label</b> <b>Example:</b> Device(config-router-af)# neighbor 192.168.3.1 send-label	Enables label exchange for this address family to this neighbor in order to receive the remote provider edge (PE) IPv4 loopback with a label in order to set up an end-to-end label switch path (LSP).
<b>Step 10</b>	<b>network</b> { <i>network-number</i> [ <b>mask network-mask</b> ]   <i>nsap-prefix</i> } [ <b>route-map map-tag</b> ] <b>Example:</b> Device(config-router-af)# network 192.168.2.27 mask 255.255.255.255	Flags a network as local to this autonomous system and enters the network to the BGP table. This configuration is for the PE VPN loopback.
<b>Step 11</b>	<b>network</b> { <i>network-number</i> [ <b>mask network-mask</b> ]   <i>nsap-prefix</i> } [ <b>route-map map-tag</b> ] <b>Example:</b> Device(config-router-af)# network 192.168.2.15 mask 255.255.255.255	Flags a network as local to this autonomous system and enters the network to the BGP table. This configuration is for the RR1 loopback.

## Configuring CSC for IPv6 VPN

Perform this task to configure CsC-PE1 peering configuration with CsC-CE1.

### SUMMARY STEPS

1. **enable**
2. **configure terminal**
3. **hostname** *name*
4. **router bgp** *autonomous-system-number*
5. **address-family ipv6** [**vrf vrf-name**] [**unicast** | **multicast**]
6. **neighbor** {*ip-address* | *ipv6-address* | *peer-group-name*} **remote-as** *as-number*
7. **neighbor** {*ip-address* | *ipv6-address* | *peer-group-name*} **activate**

## 8. neighbor {ip-address | ipv6-address | peer-group-name} send-label

### DETAILED STEPS

	Command or Action	Purpose
<b>Step 1</b>	<b>enable</b> <b>Example:</b> Device> enable	Enables privileged EXEC mode. <ul style="list-style-type: none"> <li>• Enter your password if prompted.</li> </ul>
<b>Step 2</b>	<b>configure terminal</b> <b>Example:</b> Device# configure terminal	Enters global configuration mode.
<b>Step 3</b>	<b>hostname name</b> <b>Example:</b> Device(config)# hostname CSC-PE1	Specifies or modifies the host name for the network server.
<b>Step 4</b>	<b>router bgp autonomous-system-number</b> <b>Example:</b> Device(config)# router bgp 100	Configures the Border Gateway Protocol (BGP) routing process.
<b>Step 5</b>	<b>address-family ipv6 [vrf vrf-name] [unicast   multicast]</b> <b>Example:</b> Device(config-router)# address-family ipv6 vrf ISP2	Enters address family configuration mode.
<b>Step 6</b>	<b>neighbor {ip-address   ipv6-address   peer-group-name}</b> <b>remote-as as-number</b> <b>Example:</b> Device(config-router-af)# neighbor FE80::866C:99 GigabitEthernet0/0/0 remote-as 200	Adds an entry to the multiprotocol BGP neighbor table.
<b>Step 7</b>	<b>neighbor {ip-address   ipv6-address   peer-group-name}</b> <b>activate</b> <b>Example:</b> Device(config-router-af)# neighbor FE80::866C:99 GigabitEthernet0/0/0 activate	Enables the exchange of information for this address family with the specified BGP neighbor.
<b>Step 8</b>	<b>neighbor {ip-address   ipv6-address   peer-group-name}</b> <b>send-label</b> <b>Example:</b>	Enables label exchange for this address family to this neighbor.

	Command or Action	Purpose
	Device(config-router-af)# neighbor FE80::866C:99 GigabitEthernet0/0/0 send-label	

## Configuration Examples for IPv6 VPN over MPLS

### Examples: IPv6 VPN over MPLS Routing

#### Example: BGP IPv6 Activity Summary

```
Device# show bgp ipv6 unicast summary

For address family: IPv6 Unicast
BGP router identifier 192.168.2.126, local AS number 33751
BGP table version is 15, main routing table version 15
12 network entries using 1692 bytes of memory
22 path entries using 1672 bytes of memory
5/4 BGP path/bestpath attribute entries using 580 bytes of memory
14 BGP rrinfo entries using 336 bytes of memory
2 BGP AS-PATH entries using 48 bytes of memory
0 BGP route-map cache entries using 0 bytes of memory
0 BGP filter-list cache entries using 0 bytes of memory
BGP using 4328 total bytes of memory
Dampening enabled. 0 history paths, 0 dampened paths
BGP activity 13/1 prefixes, 23/1 paths, scan interval 60 secs
Neighbor      V   AS MsgRcvd MsgSent  TblVer  InQ  OutQ  Up/Down  State/PfxRcd
192.168.2.146  4 33751   991    983     15   0    0 16:26:21    10
192.168.2.147  4 33751   991    983     15   0    0 16:26:22    10
FE80::4F6B:44 GigabitEthernet1/0/0
                4 20331   982    987     15   0    0 14:55:52     1
```

#### Example: Dumping the BGP IPv6 Tables

Each table (for example, BGP IPv6, BGP IPv6 VPN) can be reviewed individually, as shown in the following example:

```
Device# show bgp ipv6 unicast
BGP table version is 15, local router ID is 192.168.2.126
Status codes: s suppressed, d damped, h history, * valid, > best, i - internal,
               r RIB-failure, S Stale
Origin codes: i - IGP, e - EGP, ? - incomplete
   Network          Next Hop          Metric      LocPrf  Weight Path
* i2001:DB8:100::/48 ::FFFF:192.168.2.101  0        100     0 10000 ?
*>i                 ::FFFF:192.168.2.101  0        100     0 10000 ?
* i2001:DB8::1/128  ::FFFF:192.168.2.101  0        100     0 i
*>i                 ::FFFF:192.168.2.101  0        100     0 i
```

#### Example: Dumping the IPv6 Routing Tables

IPv6 routing tables identify each routing protocol contributor to routable entries, as shown in the following example:

```

Device# show ipv6 route
IPv6 Routing Table - default - 13 entries
Codes: C - Connected, L - Local, S - Static, U - Per-user Static route
       B - BGP, R - RIP, I1 - ISIS L1, I2 - ISIS L2
       IA - ISIS interarea, IS - ISIS summary
       O - OSPF Intra, OI - OSPF Inter, OE1 - OSPF ext 1, OE2 - OSPF ext 2
       ON1 - OSPF NSSA ext 1, ON2 - OSPF NSSA ext 2
B    2001:DB8:100::/48 [200/0]
     via 192.168.2.101 Default-IP-Routing-Table, indirectly connected
B    2001:DB8::1/128 [200/0]
     via 192.168.2.101 Default-IP-Routing-Table, c
LC   2001:DB8::26/128 [0/0]
     via Loopback0, receive

```

From an IPv6 routing perspective, entries reachable over the MPLS backbone are listed as being indirectly connected, because MPLS is providing a Layer 2 tunnel mechanism.

## Examples: IPv6 VPN over MPLS Forwarding

### Example: PE-CE Connectivity

The **ipv6 ping** and **traceroute** commands are useful to check connectivity from a provider edge (PE) to a customer edge (CE), whether locally attached or remote over the Multiprotocol Label Switching (MPLS) backbone.

When a device is locally attached, one can use the **ipv6 ping** command with the CE link-local address (used for external BGP peering), as shown in the following example:

```

Device# ping FE80::4F6B:44%
Loopback0
Type escape sequence to abort.
Sending 5, 100-byte ICMP Echos to FE80::4F6B:44, timeout is 2 seconds:
!!!!
Success rate is 100 percent (5/5), round-trip min/avg/max = 28/33/48 ms

```

The **ipv6 ping** command also can be used to test remote PE or CE reachability, but only IPv6 global addresses can be used (link-local addresses are not advertised beyond the link):

```

Device# ping 2001:DB8:1120:1::44
Type escape sequence to abort.
Sending 5, 100-byte ICMP Echos to 2001:DB8:1120:1:44::1, timeout is 2 seconds:
!!!!
Success rate is 100 percent (5/5), round-trip min/avg/max = 28/33/48 ms

```

Note that the **ping ipv6** and **traceroute** command functions over MPLS require PEs and CEs to announce one IPv6 global prefix. Each 6PE device announces 2001:DB8::PE#/128, filtered at the autonomous system edge. Each IPv6 CE configures 2001:DB8:prefix:CE#/128 and announces it as part of its less-specific prefix (2001:DB8:prefix::/n).

Reachability of remote PEs and CEs can be tested by using the **traceroute** command. If you have configured all PEs with the **no mpls ip propagate-ttl forwarded** command, when the **traceroute** command is executed from a CE, its output will show only the IPv6 nodes:

```

Device# traceroute 2001:DB8::1
Type escape sequence to abort.
Tracing the route to 2001:DB8::1
 1 2001:DB8::26 [AS 33751] 32 msec 32 msec 20 msec

```

```

2 2001:DB8::1 [AS 33751] [MPLS: Label 73 Exp 0] 20 msec 20 msec 20 msec
3 2001:DB8::1 [AS 33751] 28 msec 20 msec 20 msec

```

After the P devices have been upgraded with images that support ICMPv6, the **tracert** command executed on the PE device (Time to Live [TTL] is then propagated) will also show P devices' responses, as shown in the following example:

```

Device# tracert 2001:DB8::1

Type escape sequence to abort.
Tracing the route to 2001:DB8::1
 1 ::FFFF:172.20.25.1 [MPLS: Labels 38/73 Exp 0] 40 msec 32 msec 32 msec
 2 ::FFFF:172.20.10.1 [MPLS: Labels 30/73 Exp 0] 60 msec 32 msec 32 msec
 3 2001:DB8::1 [MPLS: Label 73 Exp 0] 32 msec 32 msec 16 msec

```

When run from a 6VPE device, both the **ping ipv6** and **tracert** commands accept a *vrf* argument, exactly as in the case of VPNv4.

Note that the **tracert** command is useful for evaluating the path across the MPLS backbone, but not for troubleshooting data-plane failures. The P devices are IPv6 unaware (and are also VPNv4 unaware), so the ICMPv6 messages that they generate in response to the **tracert** command are forwarded to the egress PE using the received label stack. The egress PE can route the ICMPv6 message to the source of the traceroute. When the MPLS path is broken, it is also broken from the ICMP message, which cannot reach the egress PE.

## Examples: PE Imposition Path

On Cisco devices, the most useful tool for troubleshooting the imposition path for IPv6 is the **show ipv6 cef** command.

You can use the **show ipv6 cef** command to display the IPv6 forwarding table with label stacks used for each destination prefix, as shown in the following example:

```

Device# show ipv6 cef

2001:DB8:100::/48
  nexthop 172.20.25.1 GigabitEthernet0/0/0 label 38 72
2001:DB8::1/128
  nexthop 172.20.25.1 GigabitEthernet0/0/0 label 38 73
2001:DB8::26/128
  attached to Loopback0, receive

```

You can use the **show ipv6 cef** command to display details for a specific IPv6 entry in the forwarding table and to analyze how the destination was resolved and the label stack computed, as shown in the following example:

```

Device# show ipv6 cef 2001:DB8:100::/48 internal

2001:DB8:100::/48, epoch 0, RIB[B], refcount 4
sources: RIB
..
recursive via 192.168.2.101[IPv4:Default] label 72, fib 0252B1F8, 1 terminal fib
path 024F56A8, path list 024F0BA8, share 0/1, type attached nexthop
ifnums: (none)
path_list contains at least one resolved destination(s). HW IPv4 notified.
nexthop 172.20.25.1 GigabitEthernet0/0/0 label 38, adjacency IP adj out of
GigabitEthernet0/0/0 0289BEF0
output chain: label 72 label 38 TAG adj out of GigabitEthernet0/0/0 0289BD80

```

The detailed output in the previous example shows that each label composing the label stack has a different origin that can be tracked down individually. The Border Gateway Protocol (BGP) table has the bottom label, as shown in the following example:

```
Device# show bgp ipv6 unicast 2001:DB8:100::/48

BGP routing table entry for 2001:DB8:100::/48, version 2
Paths: (2 available, best #2, table default)
  Advertised to update-groups:
    1
  10000
    ::FFFF:192.168.2.101 (metric 30) from 192.168.2.147 (192.168.2.147)
      Origin incomplete, metric 0, localpref 100, valid, internal
      Originator: 192.168.2.101, Cluster list: 192.168.2.147,
      mpls labels in/out nolabel/72
  10000
    ::FFFF:192.168.2.101 (metric 30) from 192.168.2.146 (192.168.2.146)
      Origin incomplete, metric 0, localpref 100, valid, internal, best
      Originator: 192.168.2.101, Cluster list: 192.168.2.146,
      mpls labels in/out nolabel/72
```

Label Distribution Protocol (LDP), as shown in this example, displays the other labels:

```
Device# show mpls ldp bindings 192.168.2.101 32

lib entry: 192.168.2.101/32, rev 56
  local binding: label: 40
  remote binding: lsr: 192.168.2.119:0, label: 38
Device# show mpls ldp bindings 172.20.25.0 24
lib entry: 172.20.25.0/24, rev 2
  local binding: label: imp-null
  remote binding: lsr: 192.168.2.119:0, label: imp-null
```

## Examples: PE Disposition Path

Use the following examples to troubleshoot the disposition path.

The following example shows the Multiprotocol Label Switching (MPLS) forwarding table information for troubleshooting the disposition path.

```
Device# show mpls forwarding-table

Local  Outgoing    Prefix          Bytes Label  Outgoing  Next Hop
Label  Label or VC  or Tunnel Id    Switched     interface
16     Pop Label    192.168.2.114/32  0           GE0/0/0    point2point
17     26          192.168.2.146/32  0           GE0/0/0    point2point
..
72     No Label     2001:DB8:100::/48  63121       GE1/0/0    point2point
73     Aggregate    2001:DB8::1/128   24123
```

The following example shows the label used for switching, which has been announced by iBGP (6PE in this example) and can be checked:

```
Device# show bgp ipv6 2001:DB8:100::/48

BGP routing table entry for 2001:DB8:100::/48, version 2
Paths: (1 available, best #1, table default)
  Advertised to update-groups:
    2
  10000
```



```
FE80::2710:2 (FE80::2710:2) from FE80::2710:2 GigabitEthernet1/0/0 (192.168.2.103)
  Origin incomplete, metric 0, localpref 100, valid, external, best,
```

## Examples: Label Switch Path

Because the 6PE and 6VPE label switch path (LSP) endpoints are IPv4 addresses, the IPv4 tools for troubleshooting LSPs are useful for detecting data-plane failures that would lead to IPv6 traffic null route.

The following example displays the LSP IPv4 end to analyze the LSP:

```
Device# show ipv6 route 2001:DB8::1/128

Routing entry for 2001:DB8::1/128
  Known via "bgp 33751", distance 200, metric 0, type internal
  Route count is 1/1, share count 0
  Routing paths:
    192.168.2.101%Default-IP-Routing-Table indirectly connected
      MPLS Required
      Last updated 02:42:12 ago
```

The following example shows the traceroute LSP:

```
Device# traceroute mpls ipv4 192.168.2.101/32 verbose

Tracing MPLS Label Switched Path to 192.168.2.101/32, timeout is 2 seconds
Codes: '!' - success, 'Q' - request not transmitted,
       '.' - timeout, 'U' - unreachable,
       'R' - downstream router but not target,
       'M' - malformed request
Type escape sequence to abort.
 0 172.20.25.2 0.0.0.0 MRU 1500 [Labels: 38 Exp: 0]
R 1 172.20.25.1 0.0.0.0 MRU 1500 [Labels: 30 Exp: 0] 40 ms, ret code 6
R 2 172.20.10.1 0.0.0.0 MRU 1504 [Labels: implicit-null Exp: 0] 60 ms, ret code 6
! 3 172.20.40.1 48 ms
```

## Examples: IPv6 VPN over MPLS VRF

### Examples: VRF Information

The following entries show VRF information for 6VPE.

The following is sample output from a Cisco Express Forwarding FIB associated with a virtual routing and forwarding (VRF) instance named cisco1:

```
Device# show ipv6 cef vrf cisco1

2001:8::/64
  attached to GigabitEthernet0/0/1
2001:8::3/128
  receive
2002:8::/64
  nexthop 10.1.1.2 GigabitEthernet0/1/0 label 22 19
2010::/64
  nexthop 2001:8::1 GigabitEthernet0/0/1
2012::/64
  attached to Loopback1
2012::1/128
  receive
```

The following is sample output regarding an IPv6 routing table associated with a VRF named cisco1:

```
Device# show ipv6 route vrf cisco1

IPv6 Routing Table cisco1 - 6 entries
Codes: C - Connected, L - Local, S - Static, R - RIP, B - BGP
       U - Per-user Static route
       I1 - ISIS L1, I2 - ISIS L2, IA - ISIS interarea
       O - OSPF intra, OI - OSPF inter, OE1 - OSPF ext 1, OE2 - OSPF ext 2
C    2001:8::/64 [0/0]
     via ::, GigabitEthernet0/0/1
L    2001:8::3/128 [0/0]
     via ::, GigabitEthernet0/0/1
B    2002:8::/64 [200/0]
     via ::FFFF:192.168.1.4,
B    2010::/64 [20/1]
     via 2001:8::1,
C    2012::/64 [0/0]
     via ::, Loopback1
L    2012::1/128 [0/0]
     via ::, Loopback1
```

## Example: IPv6 VPN Configuration Using IPv4 Next Hop

The following example illustrates a 6VPE next hop:

```
interface Loopback0
 ip address 192.168.2.11 255.255.255.255
!
router bgp 100
 neighbor 192.168.2.10 remote-as 100
 neighbor 192.168.2.10 update-source Loopback0
!
 address-family vpnv6
  neighbor 192.168.2.10 activate
  neighbor 192.168.2.10 send-community extended
 exit-address-family
```

By default, the next hop advertised will be the IPv6 Virtual Private Network (VPN) address:

```
[0:0]::FFFF:192.168.2.10
```

Note that it is a 192-bit address in the format of [RD]::FFFF:IPv4-address.

When the Border Gateway Protocol (BGP) IPv6 VPN peers share a common subnet, the MP\_REACH\_NLRI attribute contains a link-local address next hop in addition to the global address next hop. This situation typically occurs in an interautonomous-system topology when autonomous system boundary routers (ASBRs) are facing each other. In that case, the link-local next hop is used locally, and the global next hop is readvertised by BGP.

The BGP next hop is the keystone for building the label stack. The inner label is obtained from the BGP network layer reachability information (NLRI), and the outer label is the Label Distribution Protocol (LDP) label to reach the IPv4 address embedded into the BGP next hop.

## Additional References

### Related Documents

Related Topic	Document Title
Cisco IOS commands	<a href="#">Cisco Master Command List, All Releases</a>
IPv6 addressing and connectivity	<i>IPv6 Configuration Guide Library</i>
IPv6 commands	<a href="#">Cisco IOS IPv6 Command Reference</a>
Cisco IOS IPv6 features	<a href="#">IPv6 Feature Mapping</a>
Configuring MPLS Layer 3 VPNs	"MPLS Virtual Private Networks" module in the <i>MPLS Layer 3 VPNs Configuration Guide</i>

### Standards and RFCs

Standard/RFC	Title
RFCs for IPv6	<a href="#">IPv6 RFCs</a>

### Technical Assistance

Description	Link
The Cisco Support and Documentation website provides online resources to download documentation, software, and tools. Use these resources to install and configure the software and to troubleshoot and resolve technical issues with Cisco products and technologies. Access to most tools on the Cisco Support and Documentation website requires a Cisco.com user ID and password.	<a href="http://www.cisco.com/cisco/web/support/index.html">http://www.cisco.com/cisco/web/support/index.html</a>

## Glossary

- **6VPE device**—Provider edge device providing BGP-MPLS IPv6 VPN service over an IPv4-based MPLS core. It is a IPv6 VPN PE, dual-stack device that implements 6PE concepts on the core-facing interfaces.
- **customer edge (CE) device**—A service provider device that connects to VPN customer sites.

- **Forwarding Information Base (FIB)**—Table containing the information necessary to forward IP datagrams. At a minimum, the FIB contains the interface identifier and next-hop information for each reachable destination network prefix.
- **inbound route filtering (IRF)**—A BGP capability used for filtering incoming BGP updates that are not to be imported by the receiving PE device.
- **IPv6 provider edge device (6PE device)**—Device running a BGP-based mechanism to interconnect IPv6 islands over an MPLS-enabled IPv4 cloud.
- **IPv6 VPN address**—A IPv6 VPN address is a 24-byte identifier, beginning with an 8-byte route distinguisher (RD) and ending with a 16-byte IPv6 address. Sometimes it is called an IPv6 VPN address.
- **IPv6 VPN address family**—The address-family identifier (AFI) identifies a particular network-layer protocol and the subsequent AFI (SAFI) provides additional information. The AFI IPv6 SAFI VPN (AFI=2, SAFI=128) is called the IPv6 VPN address family. Sometimes it is called the IPv6 VPN address family. Similarly AFI IPv4 SAFI VPN is the VPNv4 address family.
- **network layer reachability information (NLRI)**—BGP sends routing update messages containing NLRI to describe a route and how to get there. In this context, an NLRI is a prefix. A BGP update message carries one or more NLRI prefixes and the attributes of a route for the NLRI prefixes; the route attributes include a BGP next hop gateway address and community values.
- **outbound route filtering (ORF)**—A BGP capability used to filtering outgoing BGP routing updates.
- **point of presence (POP)**—Physical location where an interexchange carrier installed equipment to interconnect with a local exchange carrier.
- **provider edge (PE) device**—A service provider device connected to VPN customer sites.
- **route distinguisher (RD)**—A 64-bit value prepended to an IPv6 prefix to create a globally unique IPv6 VPN address.
- **Routing Information Base (RIB)**—Also called the routing table.
- **Virtual routing and forwarding (VRF)**—A VPN routing and forwarding instance in a PE.
- **VRF table**—A routing and a forwarding table associated to a VRF. This is a customer-specific table that enables the PE device to maintain independent routing states for each customer.