



MPLS Traffic Engineering Path Link and Node Protection Configuration Guide, Cisco IOS XE Gibraltar 16.12.x

First Published: 2019-08-15

Americas Headquarters

Cisco Systems, Inc.
170 West Tasman Drive
San Jose, CA 95134-1706
USA
<http://www.cisco.com>
Tel: 408 526-4000
800 553-NETS (6387)
Fax: 408 527-0883

THE SPECIFICATIONS AND INFORMATION REGARDING THE PRODUCTS IN THIS MANUAL ARE SUBJECT TO CHANGE WITHOUT NOTICE. ALL STATEMENTS, INFORMATION, AND RECOMMENDATIONS IN THIS MANUAL ARE BELIEVED TO BE ACCURATE BUT ARE PRESENTED WITHOUT WARRANTY OF ANY KIND, EXPRESS OR IMPLIED. USERS MUST TAKE FULL RESPONSIBILITY FOR THEIR APPLICATION OF ANY PRODUCTS.

THE SOFTWARE LICENSE AND LIMITED WARRANTY FOR THE ACCOMPANYING PRODUCT ARE SET FORTH IN THE INFORMATION PACKET THAT SHIPPED WITH THE PRODUCT AND ARE INCORPORATED HEREIN BY THIS REFERENCE. IF YOU ARE UNABLE TO LOCATE THE SOFTWARE LICENSE OR LIMITED WARRANTY, CONTACT YOUR CISCO REPRESENTATIVE FOR A COPY.

The Cisco implementation of TCP header compression is an adaptation of a program developed by the University of California, Berkeley (UCB) as part of UCB's public domain version of the UNIX operating system. All rights reserved. Copyright © 1981, Regents of the University of California.

NOTWITHSTANDING ANY OTHER WARRANTY HEREIN, ALL DOCUMENT FILES AND SOFTWARE OF THESE SUPPLIERS ARE PROVIDED "AS IS" WITH ALL FAULTS. CISCO AND THE ABOVE-NAMED SUPPLIERS DISCLAIM ALL WARRANTIES, EXPRESSED OR IMPLIED, INCLUDING, WITHOUT LIMITATION, THOSE OF MERCHANTABILITY, FITNESS FOR A PARTICULAR PURPOSE AND NON-INFRINGEMENT OR ARISING FROM A COURSE OF DEALING, USAGE, OR TRADE PRACTICE.

IN NO EVENT SHALL CISCO OR ITS SUPPLIERS BE LIABLE FOR ANY INDIRECT, SPECIAL, CONSEQUENTIAL, OR INCIDENTAL DAMAGES, INCLUDING, WITHOUT LIMITATION, LOST PROFITS OR LOSS OR DAMAGE TO DATA ARISING OUT OF THE USE OR INABILITY TO USE THIS MANUAL, EVEN IF CISCO OR ITS SUPPLIERS HAVE BEEN ADVISED OF THE POSSIBILITY OF SUCH DAMAGES.

Any Internet Protocol (IP) addresses and phone numbers used in this document are not intended to be actual addresses and phone numbers. Any examples, command display output, network topology diagrams, and other figures included in the document are shown for illustrative purposes only. Any use of actual IP addresses or phone numbers in illustrative content is unintentional and coincidental.

All printed copies and duplicate soft copies of this document are considered uncontrolled. See the current online version for the latest version.

Cisco has more than 200 offices worldwide. Addresses and phone numbers are listed on the Cisco website at www.cisco.com/go/offices.

Cisco and the Cisco logo are trademarks or registered trademarks of Cisco and/or its affiliates in the U.S. and other countries. To view a list of Cisco trademarks, go to this URL: <https://www.cisco.com/c/en/us/about/legal/trademarks.html>. Third-party trademarks mentioned are the property of their respective owners. The use of the word partner does not imply a partnership relationship between Cisco and any other company. (1721R)

© 2019 Cisco Systems, Inc. All rights reserved.



CONTENTS

CHAPTER 1

[Read Me First](#) 1

CHAPTER 2

[MPLS Traffic Engineering—Fast Reroute Link and Node Protection](#) 3

[Finding Feature Information](#) 3

[Prerequisites for MPLS Traffic Engineering—Fast Reroute Link and Node Protection](#) 3

[Restrictions for MPLS Traffic Engineering—Fast Reroute Link and Node Protection](#) 4

[Information About MPLS Traffic Engineering—Fast Reroute Link and Node Protection](#) 5

[Fast Reroute](#) 5

[Link Protection](#) 5

[Node Protection](#) 5

[Bandwidth Protection](#) 6

[RSVP Hello Operation](#) 6

[RSVP Hello Instance](#) 7

[Backup Tunnel Support](#) 7

[Backup Bandwidth Protection](#) 8

[RSVP Hello](#) 9

[Fast Reroute Operation](#) 9

[How to Configure MPLS Traffic Engineering—Fast Reroute Link and Node Protection](#) 17

[Enabling Fast Reroute on LSPs](#) 18

[Creating a Backup Tunnel to the Next Hop or to the Next-Next Hop](#) 18

[Assigning Backup Tunnels to a Protected Interface](#) 20

[Associating Backup Bandwidth and Pool Type with a Backup Tunnel](#) 21

[Configuring Backup Bandwidth Protection](#) 22

[Configuring an Interface for Fast Link and Node Failure Detection](#) 23

[Verifying That Fast Reroute Is Operational](#) 24

[Troubleshooting Tips](#) 28

Configuration Examples for MPLS Traffic Engineering—Fast Reroute Link and Node Protection	30
Enabling Fast Reroute for all Tunnels Example	31
Creating an NHOP Backup Tunnel Example	31
Creating an NNHOP Backup Tunnel Example	32
Assigning Backup Tunnels to a Protected Interface	32
Associating Backup Bandwidth and Pool Type with a Backup Tunnel	33
Configuring Backup Bandwidth Protection Example	34
Configuring an Interface for Fast Link and Node Failure Detection Example	34
Configuring RSVP Hello and POS Signals Example	34
Additional References	35
Feature Information for MPLS Traffic Engineering—Fast Reroute Link and Node Protection	36
Glossary	37

CHAPTER 3**MPLS TE Link and Node Protection with RSVP Hellos Support 41**

Finding Feature Information	41
Prerequisites for MPLS TE Link and Node Protection with RSVP Hellos Support	42
Restrictions for MPLS TE Link and Node Protection with RSVP Hellos Support	42
Information About MPLS TE Link and Node Protection with RSVP Hellos Support	42
Fast Reroute	42
Link Protection	42
Node Protection	43
Bandwidth Protection	44
Fast Tunnel Interface Down Detection	44
RSVP Hello	44
RSVP Hello Operation	44
Hello Instance	45
Hello Commands	45
Features of MPLS TE Link and Node Protection with RSVP Hellos Support	46
Backup Tunnel Support	46
Backup Bandwidth Protection	46
RSVP Hello	47
Fast Reroute Operation	47
Fast Reroute Activation	47
Backup Tunnels Terminating at Different Destinations	48

Backup Tunnels Terminating at the Same Destination	49
Backup Tunnel Selection Procedure	49
Bandwidth Protection	50
Load Balancing on Limited-bandwidth Backup Tunnels	50
Load Balancing on Unlimited-bandwidth Backup Tunnels	51
Pool Type and Backup Tunnels	51
Tunnel Selection Priorities	51
Bandwidth Protection Considerations	54
How to Configure MPLS TE Link and Node Protection with RSVP Hellos Support	56
Enabling Fast Reroute on LSPs	57
Creating a Backup Tunnel to the Next Hop or to the Next-Next Hop	58
Assigning Backup Tunnels to a Protected Interface	60
Associating Backup Bandwidth and Pool Type with a Backup Tunnel	61
Configuring Backup Bandwidth Protection	62
Configuring an Interface for Fast Link and Node Failure Detection	63
Configuring an Interface for Fast Tunnel Interface Down	64
Verifying That Fast Reroute Is Operational	65
Troubleshooting Tips	70
Configuration Examples for Link and Node Protection with RSVP Hellos Support	72
Enabling Fast Reroute for All Tunnels Example	73
Creating an NHOP Backup Tunnel Example	73
Creating an NNHOP Backup Tunnel Example	74
Assigning Backup Tunnels to a Protected Interface Example	74
Associating Backup Bandwidth and Pool Type with Backup Tunnels Example	74
Configuring Backup Bandwidth Protection Example	75
Configuring an Interface for Fast Link and Node Failure Detection Example	75
Configuring an Interface for Fast Tunnel Interface Down Example	75
Configuring RSVP Hello and POS Signals Example	75
Additional References	76
Feature Information for Link and Node Protection with RSVP Hellos Support	77
Glossary	78

Prerequisites for MPLS Traffic Engineering-Autotunnel Primary and Backup 81

Restrictions for MPLS Traffic Engineering-Autotunnel Primary and Backup 82

Information About MPLS Traffic Engineering-Autotunnel Primary and Backup 82

 Overview of MPLS Traffic Engineering-Autotunnel Primary and Backup 82

 Benefits of MPLS Traffic Engineering-Autotunnel Primary and Backup Feature 82

MPLS Traffic Engineering 82

MPLS Traffic Engineering Backup Autotunnels 83

 Link Protection 83

 Node Protection 84

 Explicit Paths 84

 Range for Backup Autotunnels 85

MPLS Traffic Engineering Primary Autotunnels 85

 Explicit Paths 85

 Range for Autotunnels 85

MPLS Traffic Engineering Label-Based Forwarding 85

Benefits of MPLS Traffic Engineering Protection 86

 Delivery of Packets During a Failure 86

 Multiple Backup Tunnels Protecting the Same Interface 86

 Scalability 86

 RSVP Hello 86

SSO Redundancy Overview 86

Affinity and Link Attributes with Autotunnel Backup 87

How to Configure MPLS Traffic Engineering Autotunnel Primary and Backup 88

 Establishing MPLS Backup Autotunnels to Protect Fast Reroutable TE LSPs 88

 Establishing MPLS One-Hop Tunnels to All Neighbors 90

Configuration Examples for MPLS Traffic Engineering-Autotunnel Primary and Backup 91

 Establishing MPLS Backup Autotunnels to Protect Fast Reroutable TE LSPs Example 91

 Establishing MPLS One-Hop Tunnels to Neighbors Example 94

Additional References 96

Feature Information for MPLS Traffic Engineering-Autotunnel Primary and Backup 97

Glossary 98

Prerequisites for MPLS Traffic Engineering (TE) Path Protection	101
Restrictions for MPLS Traffic Engineering (TE) Path Protection	102
Information About MPLS Traffic Engineering (TE) Path Protection	102
Traffic Engineering Tunnels	102
Path Protection	102
Enhanced Path Protection	103
ISSU	103
NSF/SSO	103
How to Configure MPLS Traffic Engineering (TE) Path Protection	104
Regular Path Protection Configuration Tasks	104
Configuring Explicit Paths for Secondary Paths	104
Assigning a Secondary Path Option to Protect a Primary Path Option	105
Verifying the Configuration of MPLS Traffic Engineering Path Protection	106
Enhanced Path Protection Configuration Tasks	110
Creating a Path Option List	110
Assigning a Path Option List to Protect a Primary Path Option	111
Verifying the Configuration of MPLS Traffic Engineering Path Protection	112
Configuration Examples for MPLS Traffic Engineering (TE): Regular Path Protection	116
Example Configuring Explicit Paths for Secondary Paths	116
Example Assigning a Secondary Path Option to Protect a Primary Path Option	117
Example Configuring Tunnels Before and After Path Protection	117
Configuration Examples for MPLS Traffic Engineering (TE): Enhanced Path Protection	121
Creating a Path Option List: Example	121
Assigning a Path Option List to Protect a Primary Path Option: Example	123
Example Configuring Tunnels Before and After Path Protection	123
Additional References	127
Feature Information for MPLS Traffic Engineering Path Protection	128
Glossary	129

CHAPTER 6**MPLS Traffic Engineering BFD-triggered Fast Reroute 133**

Finding Feature Information	133
Prerequisites for MPLS Traffic Engineering BFD-triggered Fast Reroute	134
Restrictions for MPLS Traffic Engineering BFD-triggered Fast Reroute	134
Information About MPLS Traffic Engineering BFD-triggered Fast Reroute	134

Bidirectional Forwarding Detection	134
Fast Reroute	134
Link Protection	135
Node Protection	135
Bandwidth Protection	135
How to Configure MPLS Traffic Engineering BFD-triggered Fast Reroute	135
Enabling BFD Support on the Router	136
Enabling Fast Reroute on LSPs	136
Creating a Backup Tunnel to the Next Hop or to the Next-Next Hop	137
Assigning Backup Tunnels to a Protected Interface	140
Enabling BFD on the Protected Interface	142
Associating Backup Bandwidth and Pool Type with a Backup Tunnel	144
Configuring Backup Bandwidth Protection	145
Verifying That Fast Reroute Is Operational	146
Configuration Examples for MPLS Traffic Engineering BFD-triggered Fast Reroute	153
Example Enabling BFD Support on the Router	154
Example Enabling Fast Reroute on LSPs	154
Example Creating a Backup Tunnel to the Next Hop	154
Example Creating an NNHOP Backup Tunnel	155
Example Assigning Backup Tunnels to a Protected Interface	155
Example Enabling BFD on the Protected Interface	155
Example Associating Backup Bandwidth and Pool Type with Backup Tunnels	156
Example Configuring Backup Bandwidth Protection	156
Additional References	156
Feature Information for MPLS Traffic Engineering BFD-triggered Fast Reroute	157
Glossary	158

CHAPTER 7**MPLS Traffic Engineering (TE)--IP Explicit Address Exclusion 161**

Finding Feature Information	161
Prerequisites for MPLS Traffic Engineering (TE)--IP Explicit Address Exclusion	162
Restrictions for MPLS Traffic Engineering (TE)--IP Explicit Address Exclusion	162
Information About MPLS Traffic Engineering (TE)--IP Explicit Address Exclusion	162
MPLS Traffic Engineering	162
Cisco Express Forwarding	162

How to Configure MPLS Traffic Engineering (TE)--IP Explicit Address Exclusion	163
Configuring IP Explicit Address Exclusion	163
Configuring an MPLS Traffic Engineering Tunnel	164
Configuration Examples for MPLS Traffic Engineering (TE)--IP Explicit Address Exclusion	166
Example Configuring IP Explicit Address Exclusion	166
Example Configuring an MPLS Traffic Engineering Tunnel	166
Additional References	167
Feature Information for MPLS Traffic Engineering (TE)--IP Explicit Address Exclusion	168
Glossary	168
<hr/>	
CHAPTER 8	MPLS Traffic Engineering Shared Risk Link Groups 171
Finding Feature Information	171
Prerequisites for MPLS Traffic Engineering Shared Risk Link Groups	171
Restrictions for MPLS Traffic Engineering Shared Risk Link Groups	172
Information About MPLS Traffic Engineering Shared Risk Link Groups	172
MPLS Traffic Engineering Brief Overview	172
MPLS Traffic Engineering Shared Risk Link Groups	172
Fast Reroute Protection for MPLS TE SRLGs	174
Autotunnel Backup for MPLS TE SRLGs	175
How to Configure MPLS Traffic Engineering Shared Risk Link Groups	176
Configuring MPLS TE SRLG Membership of Each Link That Has a Shared Risk with Another Link	176
Configuring the Routers That Automatically Create Backup Tunnels to Avoid MPLS TE SRLGs	177
Verifying the MPLS Traffic Engineering Shared Risk Link Groups Configuration	178
Configuration Examples for MPLS Traffic Engineering Shared Risk Link Groups	185
Configuring the SRLG Membership of Each Link That Has a Shared Risk with Another Link Example	185
Configuring the Routers That Automatically Create Backup Tunnels to Avoid SRLGs Example	185
Additional References	187
Feature Information for MPLS Traffic Engineering Shared Risk Link Groups	188
Glossary	189
<hr/>	
CHAPTER 9	MPLS Traffic Engineering Inter-AS TE 191

Finding Feature Information	191
Prerequisites for MPLS Traffic Engineering Inter-AS TE	192
Restrictions for MPLS Traffic Engineering Inter-AS TE	192
Information About MPLS Traffic Engineering Inter-AS TE	193
MPLS Traffic Engineering Tunnels	193
Multiarea Network Design	193
Fast Reroute	193
ASBR Node Protection	194
Loose Path Reoptimization	198
ASBR Forced Link Flooding	199
Link Flooding	201
How to Configure MPLS Traffic Engineering Inter-AS TE	202
Configuring Loose Hops	202
Configuring an Explicit Path on the Tunnel That Will Cross the Inter-AS Link	202
Configuring a Route to Reach the Remote ASBR	203
Configuring a Static Route from the MP to the PLR	204
Configuring ASBR Forced Link Flooding	204
Configuring the Inter-AS Link as a Passive Interface Between Two ASBRs	205
Creating LSPs Traversing the ASBRs	206
Configuring Multiple Neighbors on a Link	207
Verifying the Inter-AS TE Configuration	208
Configuration Examples for MPLS Traffic Engineering Inter-AS TE	211
Configuring Loose Hops Examples	211
Configuring an Explicit Path on the Tunnel That Will Cross the Inter-AS Link Example	211
Configuring a Route to Reach the Remote ASBR in the IP Routing Table Example	211
Configuring a Static Route from the MP to the PLR Example	211
Configuring ASBR Forced Link Flooding Examples	212
Configuring the Inter-AS Link as a Passive Interface Example	212
Creating LSPs Traversing the ASBRs Example	213
Configuring Multiple Neighbors on a Link Example	213
Additional References	214
Feature Information for MPLS Traffic Engineering Inter-AS TE	215
Glossary	216

CHAPTER 10	Configuring MPLS Traffic Engineering over GRE Tunnel Support	219
	Finding Feature Information	219
	Prerequisites for Configuring MPLS TE over GRE Tunnel Support	219
	Restrictions for Configuring MPLS TE Over GRE Tunnel Support	220
	Information About Configuring MPLS TE over GRE Tunnel Support	220
	MPLS TE over GRE Tunnel Support Overview	220
	Benefits of MPLS TE over GRE Tunnel Support	221
	How to Configure MPLS TE over GRE Tunnel Support	221
	Configuring Resource Reservation Protocol Bandwidth	221
	Configuring an MPLS TE Tunnel	223
	Configuring an MPLS TE Tunnel over GRE	225
	Configuration Examples for MPLS TE Over GRE Tunnel Support	226
	Example Configuring MPLS TE Over GRE Tunnel Support	226
	Example Configuring CBTS with MPLS over GRE	228
	Additional References for MPLS TE Over GRE Tunnel Support	231
	Feature Information for MPLS TE Over GRE Tunnel Support	232
CHAPTER 11	MPLS Traffic Engineering—RSVP Graceful Restart	233
	Finding Feature Information	233
	Prerequisites for MPLS TE—RSVP Graceful Restart	234
	Restrictions for MPLS TE—RSVP Graceful Restart	234
	Information About MPLS TE—RSVP Graceful Restart	234
	Graceful Restart Operation	234
	How to Configure MPLS TE—RSVP Graceful Restart	236
	Enabling Graceful Restart	236
	Setting a DSCP Value	238
	Setting a Hello Refresh Interval	238
	Setting a Missed Refresh Limit	239
	Verifying Graceful Restart Configuration	240
	Configuration Examples for MPLS TE—RSVP Graceful Restart	240
	MPLS TE—RSVP Graceful Restart Example	240
	Additional References	241
	Feature Information for MPLS Traffic Engineering—RSVP Graceful Restart	242

Glossary 243



CHAPTER 1

Read Me First

Important Information about Cisco IOS XE 16

Effective Cisco IOS XE Release 3.7.0E for Catalyst Switching and Cisco IOS XE Release 3.17S (for Access and Edge Routing) the two releases evolve (merge) into a single version of converged release—the Cisco IOS XE 16—providing one release covering the extensive range of access and edge products in the Switching and Routing portfolio.

Feature Information

Use [Cisco Feature Navigator](#) to find information about feature support, platform support, and Cisco software image support. An account on Cisco.com is not required.

Related References

- [Cisco IOS Command References, All Releases](#)

Obtaining Documentation and Submitting a Service Request

- To receive timely, relevant information from Cisco, sign up at [Cisco Profile Manager](#).
- To get the business impact you're looking for with the technologies that matter, visit [Cisco Services](#).
- To submit a service request, visit [Cisco Support](#).
- To discover and browse secure, validated enterprise-class apps, products, solutions and services, visit [Cisco Marketplace](#).
- To obtain general networking, training, and certification titles, visit [Cisco Press](#).
- To find warranty information for a specific product or product family, access [Cisco Warranty Finder](#).



CHAPTER 2

MPLS Traffic Engineering—Fast Reroute Link and Node Protection

The MPLS Traffic Engineering--Fast Reroute Link and Node Protection feature provides link protection (backup tunnels that bypass only a single link of the label-switched path (LSP)), node protection (backup tunnels that bypass next-hop nodes along LSPs), and Fast Reroute (FRR) features.

- [Finding Feature Information, on page 3](#)
- [Prerequisites for MPLS Traffic Engineering—Fast Reroute Link and Node Protection, on page 3](#)
- [Restrictions for MPLS Traffic Engineering—Fast Reroute Link and Node Protection, on page 4](#)
- [Information About MPLS Traffic Engineering—Fast Reroute Link and Node Protection, on page 5](#)
- [How to Configure MPLS Traffic Engineering—Fast Reroute Link and Node Protection, on page 17](#)
- [Configuration Examples for MPLS Traffic Engineering—Fast Reroute Link and Node Protection, on page 30](#)
- [Additional References, on page 35](#)
- [Feature Information for MPLS Traffic Engineering—Fast Reroute Link and Node Protection , on page 36](#)
- [Glossary, on page 37](#)

Finding Feature Information

Your software release may not support all the features documented in this module. For the latest caveats and feature information, see [Bug Search Tool](#) and the release notes for your platform and software release. To find information about the features documented in this module, and to see a list of the releases in which each feature is supported, see the feature information table.

Use Cisco Feature Navigator to find information about platform support and Cisco software image support. To access Cisco Feature Navigator, go to www.cisco.com/go/cfn. An account on Cisco.com is not required.

Prerequisites for MPLS Traffic Engineering—Fast Reroute Link and Node Protection

Your network must support the following Cisco IOS XE features:

- IP Cisco Express Forwarding

- Multiprotocol Label Switching (MPLS)

Your network must support at least one of the following protocols:

- Intermediate System-to-Intermediate System (IS-IS)
- Open Shortest Path First (OSPF)

Before configuring FRR link and node protection, it is assumed that you have done the following tasks but you do not have to already have configured MPLS traffic engineering (TE) tunnels:

- Enabled MPLS TE on all relevant routers and interfaces
- Configured MPLS TE tunnels

Restrictions for MPLS Traffic Engineering—Fast Reroute Link and Node Protection

- Interfaces must use MPLS Global Label Allocation.
- The router's physical interface for MPLS-TE and Fast RR for Gigabit Ethernet (GE), and Packet over SONET (POS) is supported for enabling a 50 millisecond (ms) failover. However, the GE subinterfaces, logical interfaces and copper interface (e.g. Fast Ethernet interface) are not supported for enabling a 50 ms failover (even though they may be configurable). Also, FRR is not configurable on ATM interface.
- The FRR link protect mode failover time is independent of the number of prefixes pointing to the link.
- Cisco IOS-XE does not support QoS on MPLS-TE tunnels.
- Backup tunnel headend and tailend routers must implement FRR as described in draft-pan-rsvp-fastreroute-00.txt.
- Backup tunnels are not protected. If an LSP is actively using a backup tunnel and the backup tunnel fails, the LSP is torn down.
- LSPs that are actively using backup tunnels are not considered for promotion. If an LSP is actively using a backup tunnel and a better backup tunnel becomes available, the active LSP is not switched to the better backup tunnel.
- You cannot enable FRR Hellos on a router that also has Resource Reservation Protocol (RSVP) Graceful Restart enabled.
- MPLS TE LSPs that are FRR cannot be successfully recovered if the LSPs are FRR active and the Point of Local Repair (PLR) router experiences a stateful switchover (SSO).
- The MPLS TE FRR feature is supported on Cisco 4000 Series ISRs; however, the convergence time of 50 milliseconds is not definite.

Information About MPLS Traffic Engineering—Fast Reroute Link and Node Protection

Fast Reroute

Fast Reroute (FRR) is a mechanism for protecting MPLS TE LSPs from link and node failures by locally repairing the LSPs at the point of failure, allowing data to continue to flow on them while their headend routers attempt to establish new end-to-end LSPs to replace them. FRR locally repairs the protected LSPs by rerouting them over backup tunnels that bypass failed links or node.

Link Protection

Backup tunnels that bypass only a single link of the LSP's path provide link protection. They protect LSPs if a link along their path fails by rerouting the LSP's traffic to the next hop (bypassing the failed link). These are referred to as next-hop (NHOP) backup tunnels because they terminate at the LSP's next hop beyond the point of failure. The figure below illustrates an NHOP backup tunnel.

Figure 1: NHOP Backup Tunnel

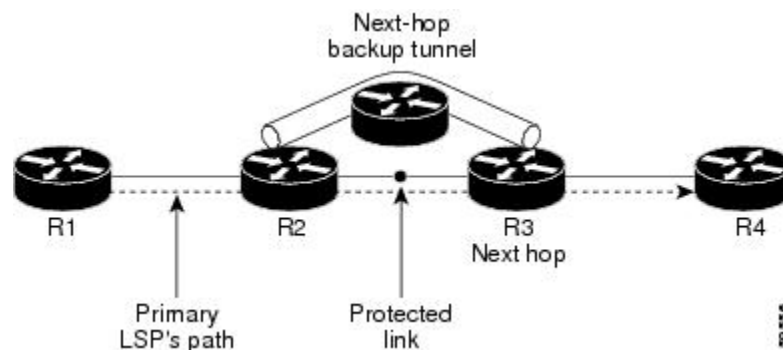

Node Protection

FRR provides node protection for LSPs. Backup tunnels that bypass next-hop nodes along LSP paths are called next-next-hop (NNHOP) backup tunnels because they terminate at the node following the next-hop node of the LSP paths, thereby bypassing the next-hop node. They protect LSPs if a node along their path fails by enabling the node upstream of the failure to reroute the LSPs and their traffic around the failed node to the next-next hop. FRR supports the use of RSVP Hellos to accelerate the detection of node failures. NNHOP backup tunnels also provide protection from link failures, because they bypass the failed link and the node.

The figure below illustrates an NNHOP backup tunnel.

Figure 2: NNHOP Backup Tunnel

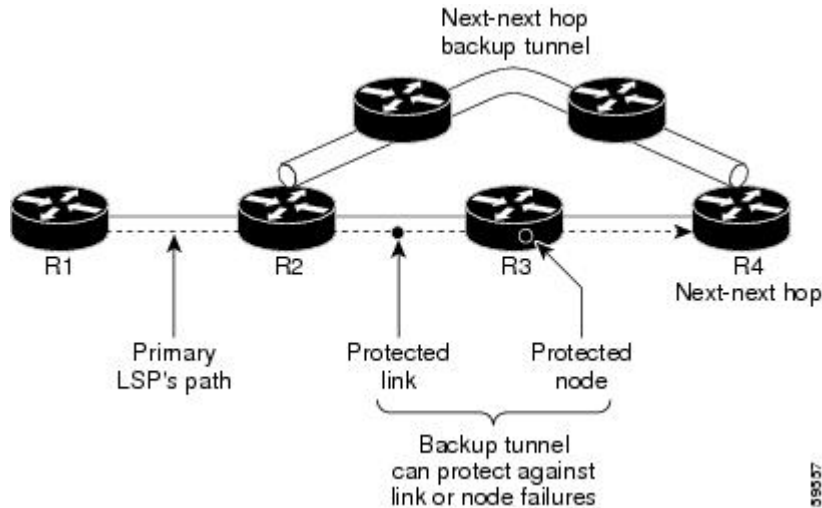

If an LSP is using a backup tunnel and something changes so that the LSP is no longer appropriate for the backup tunnel, the LSP is torn down. Such changes are the following:

- Backup bandwidth of the backup tunnel is reduced.
- Backup bandwidth type of backup tunnel is changed to a type that is incompatible with the primary LSP.
- Primary LSP is modified so that FRR is disabled. (The `no mpls traffic-eng fast-reroute` command is entered.)

Bandwidth Protection

NHOP and NNHOP backup tunnels can be used to provide bandwidth protection for rerouted LSPs. This is referred to as backup bandwidth. You can associate backup bandwidth with NHOP or NNHOP backup tunnels. This informs the router of the amount of backup bandwidth a particular backup tunnel can protect. When a router maps LSPs to backup tunnels, bandwidth protection ensures that an LSP uses a given backup tunnel only if there is sufficient backup bandwidth. The router selects which LSPs use which backup tunnels in order to provide maximum bandwidth protection. That is, the router determines the best way to map LSPs onto backup tunnels in order to maximize the number of LSPs that can be protected. For information about mapping tunnels and assigning backup bandwidth, see the "Backup Tunnel Selection Procedure" section.

LSPs that have the "bandwidth protection desired" bit set have a higher right to select backup tunnels that provide bandwidth protection; that is, those LSPs can preempt other LSPs that do not have that bit set. For more information, see the "Prioritizing Which LSPs Obtain Backup Tunnels with Bandwidth Protection" section.

RSVP Hello Operation

RSVP Hello enables RSVP nodes to detect when a neighboring node is not reachable. This provides node-to-node failure detection. When such a failure is detected, it is handled in a similar manner as a link-layer communication failure.

RSVP Hello can be used by FRR when notification of link-layer failures is not available (for example, with Fast Ethernet), or when the failure detection mechanisms provided by the link layer are not sufficient for the timely detection of node failures.

A node running Hello sends a Hello Request to a neighboring node every interval. If the receiving node is running Hello, it responds with Hello Ack. If four intervals pass and the sending node has not received an Ack or it receives a bad message, the sending node declares that the neighbor is down and notifies FRR.

There are two configurable parameters:

- Hello interval--Use the **ip rsvp signalling hello refresh interval** command.
- Number of acknowledgment messages that are missed before the sending node declares that the neighbor is down--Use the **ip rsvp signalling hello refresh misses** command

RSVP Hello Instance

A Hello instance implements RSVP Hello for a given router interface IP address and remote IP address. A large number of Hello requests are sent; this puts a strain on the router resources. Therefore, create a Hello instance only when it is necessary and delete it when it is no longer needed.

There are two types of Hello instances:

Active Hello Instances

If a neighbor is unreachable when an LSP is ready to be fast rerouted, an active Hello instance is needed. Create an active Hello instance for each neighbor with at least one LSP in this state.

Active Hello instances periodically send Hello Request messages, and expect Hello Ack messages in response. If the expected Ack message is not received, the active Hello instance declares that the neighbor (remote IP address) is unreachable (lost). LSPs traversing that neighbor may be fast rerouted.

If there is a Hello instance with no LSPs for an unreachable neighbor, do not delete the Hello instance. Convert the active Hello instance to a passive Hello instance because there may be an active instance on the neighboring router that is sending Hello requests to this instance.

Passive Hello Instances

Passive Hello instances respond to Hello Request messages (sending Ack messages), but do not initiate Hello Request messages and do not cause LSPs to be fast rerouted. A router with multiple interfaces can run multiple Hello instances to different neighbors or to the same neighbor.

A passive Hello instance is created when a Hello Request is received from a neighbor with a source IP address/destination IP address pair in the IP header for which a Hello instance does not exist.

Delete passive instances if no Hello messages are received for this instance within 10 minutes.

Backup Tunnel Support

Backup tunnel support has the following capabilities:

Backup Tunnels Can Terminate at the Next-Next Hop to Support FRR

Backup tunnels that terminate at the next-next hop protect both the downstream link and node. This provides protection for link and node failures. For more detailed information, see the [Node Protection, on page 5](#).

Multiple Backup Tunnels Can Protect the Same Interface

There is no limit (except memory limitations) to the number of backup tunnels that can protect a given interface. In many topologies, support for node protection requires supporting multiple backup tunnels per protected interface. These backup tunnels can terminate at the same destination or at different destinations. That is, for a given protected interface, you can configure multiple NHOP or NNHOP backup tunnels. This allows redundancy and load balancing.

In addition to being required for node protection, the protection of an interface by multiple backup tunnels provides the following benefits:

- Redundancy--If one backup tunnel is down, other backup tunnels protect LSPs.
- Increased backup capacity--If the protected interface is a high-capacity link and no single backup path exists with an equal capacity, multiple backup tunnels can protect that one high-capacity link. The LSPs using this link will fail over to different backup tunnels, allowing all of the LSPs to have adequate bandwidth protection during failure (rerouting). If bandwidth protection is not desired, the router spreads LSPs across all available backup tunnels (that is, there is load balancing across backup tunnels). For a more detailed explanation, see the [Backup Tunnel Selection Procedure, on page 11](#).

Examples are shown in the [Backup Tunnels Terminating at Different Destinations, on page 10](#) and the "Backup Tunnels Terminating at the Same Destination" section.

Backup Tunnels Provide Scalability

A backup tunnel can protect multiple LSPs. Furthermore, a backup tunnel can protect multiple interfaces. This is called many-to-one (N:1) protection. An example of N:1 protection is when one backup tunnel protects 5000 LSPs, each router along the backup path maintains one additional tunnel.

One-to-one protection is when a separate backup tunnel must be used for each LSP needing protection. N:1 protection has significant scalability advantages over one-to-one (1:1) protection. An example of 1:1 protection is when 5000 backup tunnels protect 5000 LSPs, each router along the backup path must maintain state for an additional 5000 tunnels.

Backup Bandwidth Protection

Backup bandwidth protection has the following capabilities:

Bandwidth Protection on Backup Tunnels

Rerouted LSPs not only have their packets delivered during a failure, but the quality of service can also be maintained.

Bandwidth Pool Specifications for Backup Tunnels

You can restrict the types of LSPs that can use a given backup tunnel. Backup tunnels can be restricted so that only LSPs using subpool bandwidth can use them or only LSPs that use global pool bandwidth can use them. This allows different backup tunnels to be used for voice and data. Example: The backup tunnel used for voice could provide bandwidth protection, and the backup tunnel used for data could (optionally) not provide bandwidth protection.

Semidynamic Backup Tunnel Paths

The path of a backup tunnel can be configured to be determined dynamically. This can be done by using the IP explicit address exclusion feature that was added in Release 12.0(14)ST. Using this feature, semidynamic NHOP backup tunnel paths can be specified simply by excluding the protected link; semidynamic NNHOP backup tunnel paths can be configured simply by excluding the protected node.

Prioritizing Which LSPs Obtain Backup Tunnels with Bandwidth Protection

In case there are not enough NHOP or NNHOP backup tunnels or they do not have enough backup bandwidth to protect all LSPs, you can give an LSP priority in obtaining backup tunnels with bandwidth protection. This is especially useful if you want to give LSPs carrying voice a higher priority than those carrying data.

To activate this feature, enter the **tunnel mpls traffic-eng fast-reroute bw-protect** command to set the “bandwidth protection desired” bit. See the configuration task Enabling Fast Reroute on LSPs. The LSPs do not necessarily *receive* bandwidth protection. They have a higher *chance* of receiving bandwidth protection if they need it.

LSPs that do not have the bandwidth protection bit set can be demoted. Demotion is when one or more LSPs are removed from their assigned backup tunnel to provide backup to an LSP that has its bandwidth protection bit set. Demotion occurs only when there is a scarcity of backup bandwidth.

When an LSP is demoted, it becomes unprotected (that is, it no longer has a backup tunnel). During the next periodic promotion cycle, an attempt is made to find the best possible backup tunnels for all LSPs that do not currently have protection, including the LSP that was demoted. The LSP may get protection at the same level or a lower level, or it may get no protection.

For information about how routers determine which LSPs to demote, see the "Backup Protection Preemption Algorithms" section.

RSVP Hello

RSVP Hello enables a router to detect when a neighboring node has gone down but its interface to that neighbor is still operational. This feature is useful when next-hop node failure is not detectable by link layer mechanisms, or when notification of link-layer failures is not available (for example, Gigabit Ethernet). This allows the router to switch LSPs onto its backup tunnels and avoid packet loss.

For a more detailed description of RSVP Hello, see the [RSVP Hello Operation, on page 6](#).

Fast Reroute Operation

Fast Reroute Activation

Two mechanisms cause routers to switch LSPs onto their backup tunnels:

- Interface down notification
- RSVP Hello neighbor down notification

When a router's link or neighboring node fails, the router often detects this failure by an interface down notification. On a GSR Packet over SONET (PoS) interface, this notification is very fast. When a router notices that an interface has gone down, it switches LSPs going out that interface onto their respective backup tunnels (if any).

RSVP Hellos can also be used to trigger FRR. If RSVP Hellos are configured on an interface, messages are periodically sent to the neighboring router. If no response is received, Hellos declare that the neighbor is down. This causes any LSPs going out that interface to be switched to their respective backup tunnels.

Backup Tunnels Terminating at Different Destinations

The figure below illustrates an interface that has multiple backup tunnels terminating at different destinations and demonstrates why, in many topologies, support for node protection requires supporting multiple backup tunnels per protected interface.

Figure 3: Backup Tunnels That Terminate at Different Destinations

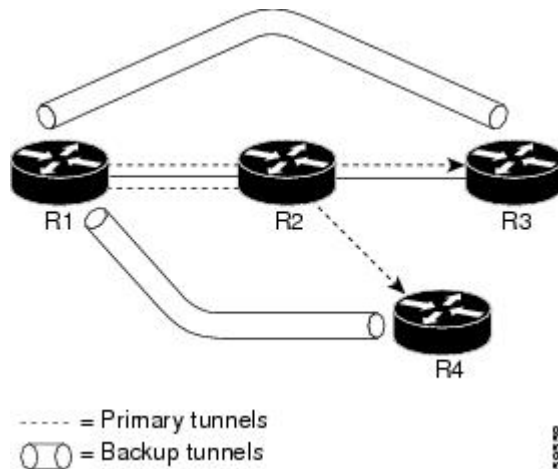

In this illustration, a single interface on R1 requires multiple backup tunnels. LSPs traverse the following routes:

- R1, R2, R3
- R1, R2, R4

To provide protection if node R2 fails, two NNHOP backup tunnels are required: one terminating at R3 and one terminating at R4.

Backup Tunnels Terminating at the Same Destination

The figure below shows how backup tunnels terminating at the same location can be used for redundancy and load balancing. Redundancy and load balancing work for both NHOP and NNHOP backup tunnels.

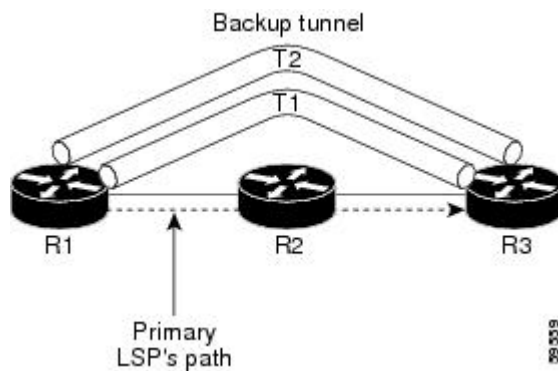

In this illustration, there are three routers: R1, R2, and R3. At R1, there are two NNHOP backup tunnels (T1 and T2) that go from R1 to R3 without traversing R2.

With redundancy, if R2 fails or the link from R1 to R2 fails, either backup tunnel can be used. If one backup tunnel is down, the other can be used. LSPs are assigned to backup tunnels when the LSPs are first established. This is done before a failure.

With load balancing, if neither backup tunnel has enough bandwidth to back up all LSPs, both tunnels can be used. Some LSPs will use one backup tunnel, other LSPs will use the other backup tunnel. The router decides the best way to fit the LSPs onto the backup tunnels.

Backup Tunnel Selection Procedure

When an LSP is signaled, each node along the LSP path that provides FRR protection for the LSP selects a backup tunnel for the LSP to use if either of the following events occurs:

- The link to the next hop fails.
- The next hop fails.

By having the node select the backup tunnel for an LSP before a failure occurs, the LSP can be rerouted onto the backup tunnel quickly if there is a failure.

For an LSP to be mapped to a backup tunnel, all of the following conditions must exist:

- The LSP is protected by FRR; that is, the LSP is configured with the **tunnel mpls traffic-eng fast-reroute** command.
- The backup tunnel is up.
- The backup tunnel is configured to have an IP address, typically a loopback address.
- The backup tunnel is configured to protect this LSP's outgoing interface; that is, the interface is configured with the **mpls traffic-eng backup-path** command.
- The backup tunnel does not traverse the LSP's protected interface.
- The backup tunnel terminates at the LSP's NHOP or NNHOP. If it is an NNHOP tunnel, it does not traverse the LSP's NHOP.
- The bandwidth protection requirements and constraints, if any, for the LSP and backup tunnel are met. For information about bandwidth protection considerations, see the [Bandwidth Protection, on page 11](#).

Bandwidth Protection

A backup tunnel can be configured to protect two types of backup bandwidth:

- Limited backup bandwidth--A backup tunnel provides bandwidth protection. The sum of the bandwidth of all LSPs using this backup tunnel cannot exceed the backup tunnel's backup bandwidth. When you assign LSPs to this type of backup tunnel, sufficient backup bandwidth must exist.
- Unlimited backup bandwidth--The backup tunnel does not provide any bandwidth protection (that is, best-effort protection exists). There is no limit to the amount of bandwidth used by the LSPs that are mapped to this backup tunnel. LSPs that allocate zero bandwidth can use only backup tunnels that have unlimited backup bandwidth.

Load Balancing on Limited-Bandwidth Backup Tunnels

There may be more than one backup tunnel that has sufficient backup bandwidth to protect a given LSP. In this case, the router chooses the one that has the least amount of backup bandwidth available. This algorithm limits fragmentation, maintaining the largest amount of backup bandwidth available.

Specifying limited backup bandwidth does not “guarantee” bandwidth protection if there is a link or node failure. For example, the set of NHOP and NNHOP backup tunnels that gets triggered when an interface fails may all share some link on the network topology, and this link may not have sufficient bandwidth to support all LSPs using this set of backup tunnels.

In the figure below, both backup tunnels traverse the same links and hop. When the link between routers R1 and R4 fails, backup tunnels for primary tunnel 1 and primary tunnel 2 are triggered simultaneously. The two backup tunnels may share a link in the network.

Figure 4: Backup Tunnels Share a Link

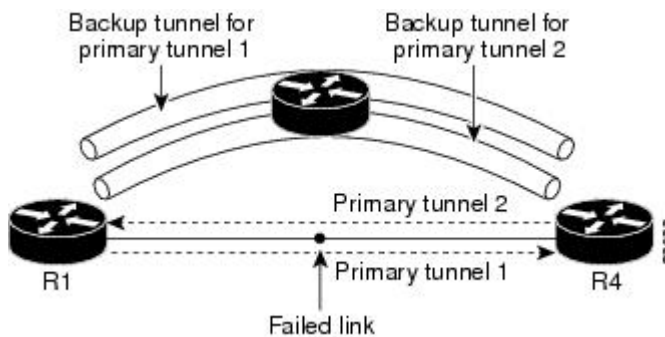

In the figure below, the backup tunnel for primary tunnel 1 may traverse routers R1-R2-R3-R4, and the backup tunnel for primary tunnel 2 may traverse routers R4-R2-R3-R1. In this case, the link R2-R3 may get overloaded if R1-R4 fails.

Figure 5: Overloaded Link

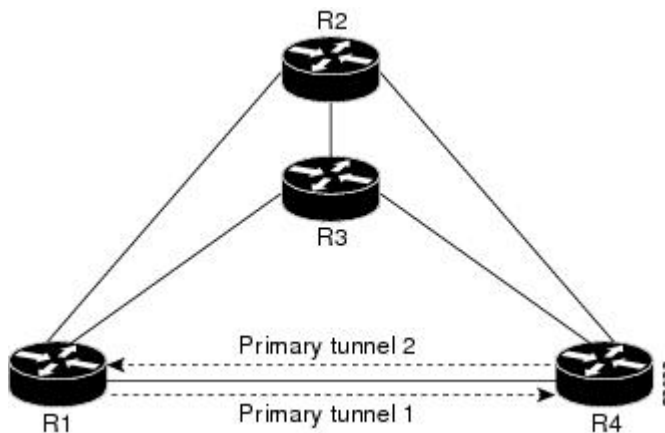

Load Balancing on Unlimited-Bandwidth Backup Tunnels

More than one backup tunnel, each having unlimited backup bandwidth, can protect a given interface. In this case, when choosing a backup tunnel for a given LSP, the router chooses the backup tunnel that has the least amount of backup bandwidth in use. This algorithm evenly distributes the LSPs across backup tunnels based

on an LSP's bandwidth. If an LSP is requesting zero bandwidth, the router chooses the backup tunnel that is protecting the fewest LSPs.

Pool Type and Backup Tunnels

By default, a backup tunnel provides protection for LSPs that allocate from any pool (that is, global or subpool). However, a backup tunnel can be configured to protect only LSPs that use global-pool bandwidth, or only those that use subpool bandwidth.

Tunnel Selection Priorities

This section describes the following:

NHOP Versus NNHOP Backup Tunnels

More than one backup tunnel can protect a given LSP, where one backup tunnel terminates at the LSP's NNHOP, and the other terminates at the LSP's NHOP. In this case, the router chooses the backup tunnel that terminates at the NNHOP (that is, FRR prefers NNHOP over NHOP backup tunnels).

The table below lists the tunnel selection priorities. The first choice is an NNHOP backup tunnel that acquires its bandwidth from a subpool or global pool, and has limited bandwidth. If there is no such backup tunnel, the next choice (2) is a next-next hop backup tunnel that acquires a limited amount of bandwidth from any pool. The preferences go from 1 (best) to 8 (worst), where choice 3 is for an NNHOP backup tunnel with an unlimited amount of subpool or global-pool bandwidth.

Table 1: Tunnel Selection Priorities

Preference	Backup Tunnel Destination	Bandwidth Pool	Bandwidth Amount
1 (Best)	NNHOP	Subpool or global pool	Limited
2	NNHOP	Any	Limited
3	NNHOP	Subpool or global pool	Unlimited
4	NNHOP	Any	Unlimited
5	NHOP	Subpool or global pool	Limited
6	NHOP	Any	Limited
7	NHOP	Subpool or global pool	Unlimited
8 (Worst)	NHOP	Any	Unlimited

The figure below shows an example of the backup tunnel selection procedure based on the designated amount of global pool and subpool bandwidth currently available.



Note If NHOP and NNHOP backup tunnels do not have sufficient backup bandwidth, no consideration is given to the type of data that the LSP is carrying. For example, a voice LSP may not be protected unless it is signaled before a data LSP. To prioritize backup tunnel usage, see the "Backup Protection Preemption Algorithms" section.

Figure 6: Choosing from Among Multiple Backup Tunnels

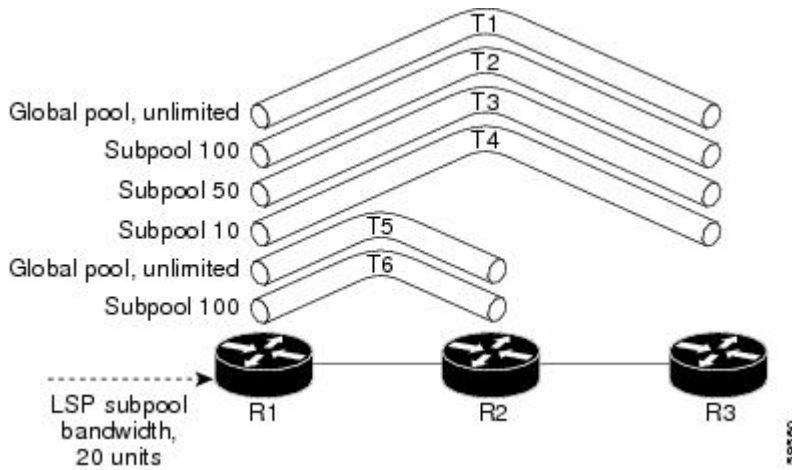

In this example, an LSP requires 20 units (kilobits per second) of sub-pool backup bandwidth. The best backup tunnel is selected as follows:

1. Backup tunnels T1 through T4 are considered first because they terminate at the NNHOP.
2. Tunnel T4 is eliminated because it has only ten units of sub-pool backup bandwidth.
3. Tunnel T1 is eliminated because it protects only LSPs using global-pool bandwidth.
4. Tunnel T3 is chosen over T2 because, although both have sufficient backup bandwidth, T3 has the least backup bandwidth available (leaving the most backup bandwidth available on T2).
5. Tunnels T5 and T6 need not be considered because they terminate at an NHOP, and therefore are less desirable than T3, which terminates at an NNHOP.

Promotion

After a backup tunnel has been chosen for an LSP, conditions may change that will cause us to reevaluate this choice. This reevaluation, if successful, is called promotion. Such conditions may include:

1. A new backup tunnel comes up.
2. The currently chosen backup tunnel for this LSP goes down.
3. A backup tunnel's available backup bandwidth increases. For example, an LSP protected by the tunnel has been reoptimized by the headend to use another path.

For cases 1 and 2, the LSP's backup tunnel is evaluated immediately. Case 3 is addressed by periodically reevaluating LSP-to-backup tunnel mappings. By default, background reevaluation is performed every 5 minutes. This interval is configurable via the **mpls traffic-eng fast-reroute timers** command.

Backup Protection Preemption Algorithms

When you set the "bandwidth protection desired" bit for an LSP, the LSP has a higher right to select backup tunnels that provide bandwidth protection and it can preempt other LSPs that do not have that bit set.

If there is insufficient backup bandwidth on NNHOP backup tunnels but not on NHOP backup tunnels, the bandwidth-protected LSP does not preempt NNHOP LSPs; it uses NHOP protection.

If there are multiple LSPs using a given backup tunnel and one or more must be demoted to provide bandwidth, there are two user-configurable methods (algorithms) that the router can use to determine which LSPs are demoted:

- Minimize amount of bandwidth that is wasted.
- Minimize the number of LSPs that are demoted.

For example, If you need ten units of backup bandwidth on a backup tunnel, you can demote one of the following:

- A single LSP using 100 units of bandwidth--Makes available more bandwidth than needed, but results in lots of waste
- Ten LSPs, each using one unit of bandwidth--Results in no wasted bandwidth, but affects more LSPs

The default algorithm is to minimize the number of LSPs that are demoted. To change the algorithm to minimize the amount of bandwidth that is wasted, enter the **mpls traffic-eng fast-reroute backup-prot-preemption optimize-bw** command.

Bandwidth Protection Considerations

There are numerous ways in which bandwidth protection can be ensured. The table below describes the advantages and disadvantages of three methods.

Table 2: Bandwidth Protection Methods

Method	Advantages	Disadvantages
Reserve bandwidth for backup tunnels explicitly.	It is simple.	It is a challenge to allow bandwidth sharing of backup tunnels protecting against independent failures.
Use backup tunnels that are signaled with zero bandwidth.	It provides a way to share bandwidth used for protection against independent failures, so it ensures more economical bandwidth usage.	It may be complicated to determine the proper placement of zero bandwidth tunnels.
Backup bandwidth protection.	It ensures bandwidth protection for voice traffic.	An LSP that does not have backup bandwidth protection can be demoted at any time if there is not enough backup bandwidth and an LSP that has backup bandwidth protection needs bandwidth.

Cisco implementation of FRR does not mandate a particular approach, and it provides the flexibility to use any of the above approaches. However, given a range of configuration choices, be sure that the choices are constant with a particular bandwidth protection strategy.

The following sections describe some important issues in choosing an appropriate configuration:

Using Backup Tunnels with Explicitly Signaled Bandwidth

Two bandwidth parameters must be set for a backup tunnel:

- Actual signaled bandwidth

- Backup bandwidth

To signal bandwidth requirements of a backup tunnel, configure the bandwidth of the backup tunnel by using the **tunnel mpls traffic-eng bandwidth** command.

To configure the backup bandwidth of the backup tunnel, use the **tunnel mpls traffic-eng backup-bw** command.

The signaled bandwidth is used by the LSRs on the path of the backup tunnel to perform admission control and do appropriate bandwidth accounting.

The backup bandwidth is used by the point of local repair (PLR) (that is, the headend of the backup tunnel) to decide how much primary traffic can be rerouted to this backup tunnel if there is a failure.

Both parameters need to be set to ensure proper operation. The numerical value of the signaled bandwidth and the backup bandwidth should be the same.

Protected Bandwidth Pools and the Bandwidth Pool from Which the Backup Tunnel Reserves Its Bandwidth

The **tunnel mpls traffic-eng bandwidth** command allows you to configure the following:

- Amount of bandwidth a backup tunnel reserves
- The DS-TE bandwidth pool from which the bandwidth needs to be reserved



Note Only one pool can be selected (that is, the backup tunnel can explicitly reserve bandwidth from either the global pool or the subpool, but not both).

The **tunnel mpls traffic-eng backup-bw** command allows you to specify the bandwidth pool to which the traffic must belong for the traffic to use this backup tunnel. Multiple pools are allowed.

There is no direct correspondence between the bandwidth pool that is protected and the bandwidth pool from which the bandwidth of the backup tunnel draws its bandwidth.

Bandwidth protection for 10 Kbps of subpool traffic on a given link can be achieved by configuring any of the following command combinations:

- **tunnel mpls traffic-eng bandwidth sub-pool 10**

tunnel mpls traffic-eng backup-bw sub-pool 10

- **tunnel mpls traffic-eng bandwidth global-pool 10**

tunnel mpls traffic-eng backup-bw sub-pool 10 global-pool unlimited

- **tunnel mpls traffic-eng bandwidth global-pool 40**

tunnel mpls traffic-eng backup-bw sub-pool 10 global-pool 30

Using Backup Tunnels Signaled with Zero Bandwidth

Frequently it is desirable to use backup tunnels with zero signaled bandwidth, even when bandwidth protection is required. It may seem that if no bandwidth is explicitly reserved, no bandwidth guarantees can be provided. However, that is not necessarily true.

In the following situation:

- Only link protection is desired.
- Bandwidth protection is desired only for sub-pool traffic.

For each protected link AB with a maximum reservable subpool value of n , there may be a path from node A to node B such that the difference between the maximum reservable global and the maximum reservable subpool is at least the value of n . If it is possible to find such paths for each link in the network, you can establish all the backup tunnels along such paths without any bandwidth reservations. If there is a single link failure, only one backup tunnel will use any link on its path. Because that path has at least n available bandwidth (in the global pool), assuming that marking and scheduling is configured to classify the subpool traffic into a priority queue, the subpool bandwidth is guaranteed.

This approach allows sharing of the global pool bandwidth between backup tunnels protecting independent link failures. The backup tunnels are expected to be used for only a short period of time after a failure (until the headends of affected LSPs reroute those LSPs to other paths with available subpool bandwidth). The probability of multiple unrelated link failures is very small (in the absence of node or shared risk link group (SRLG) failures, which result in multiple link failures). Therefore, it is reasonable to assume that link failures are in practice independent with high probability. This “independent failure assumption” in combination with backup tunnels signaled without explicit bandwidth reservation enables efficient bandwidth sharing that yields substantial bandwidth savings.

Backup tunnels protecting the subpool traffic do not draw bandwidth from any pool. Primary traffic using the global pool can use the entire global pool, and primary traffic using the subpool can use the entire subpool. Yet, subpool traffic has a complete bandwidth guarantee if there is a single link failure.

A similar approach can be used for node and SRLG protection. However, the decision of where to put the backup tunnels is more complicated because both node and SRLG failures effectively result in the simultaneous failure of several links. Therefore, the backup tunnels protecting traffic traversing all affected links cannot be computed independently of each other. The backup tunnels protecting groups of links corresponding to different failures can still be computed independently of each other, which results in similar bandwidth savings.

Signaled Bandwidth Versus Backup Bandwidth

Backup bandwidth is used locally (by the router that is the headend of the backup tunnel) to determine which, and how many, primary LSPs can be rerouted on a particular backup tunnel. The router ensures that the combined bandwidth requirement of these LSPs does not exceed the backup bandwidth.

Therefore, even when the backup tunnel is signaled with zero bandwidth, the backup bandwidth must be configured with the value corresponding to the actual bandwidth requirement of the traffic protected by this backup tunnel. Unlike the case when bandwidth requirements of the backup tunnels are explicitly signaled, the value of the signaled bandwidth (which is zero) is not the same value as the backup bandwidth.

How to Configure MPLS Traffic Engineering—Fast Reroute Link and Node Protection

This section assumes that you want to add FRR protection to a network in which MPLS TE LSPs are configured.

Enabling Fast Reroute on LSPs

LSPs can use backup tunnels only if they have been configured as fast reroutable. To do this, enter the following commands at the headend of each LSP.

SUMMARY STEPS

1. **enable**
2. **configure terminal**
3. **interface tunnel *number***
4. **tunnel mpls traffic-eng fast-reroute [bw-protect]**

DETAILED STEPS

	Command or Action	Purpose
Step 1	enable Example: <pre>Router> enable</pre>	Enables privileged EXEC mode. <ul style="list-style-type: none"> • Enter your password if prompted.
Step 2	configure terminal Example: <pre>Router# configure terminal</pre>	Enters global configuration mode.
Step 3	interface tunnel <i>number</i> Example: <pre>Router(config)# interface tunnel 1000</pre>	Enters interface configuration mode for the specified tunnel.
Step 4	tunnel mpls traffic-eng fast-reroute [bw-protect] Example: <pre>Router(config-if)# tunnel mpls traffic-eng fast-reroute bw-protect</pre>	Enables an MPLS TE tunnel to use an established backup tunnel if there is a link or node failure.

Creating a Backup Tunnel to the Next Hop or to the Next-Next Hop

Creating a backup tunnel is basically no different from creating any other tunnel. To create a backup tunnel to the next hop or to the next-next hop, enter the following commands on the node that will be the headend of the backup tunnel (that is, the node whose downstream link or node may fail). The node on which you enter these commands must be a supported platform. See the Finding Feature Information section.

SUMMARY STEPS

1. **enable**
2. **configure terminal**
3. **interface tunnel *number***

4. **ip unnumbered** *interface-type interface-number*
5. **tunnel destination** *ip-address*
6. **tunnel mode mpls traffic-eng**
7. **tunnel mpls traffic-eng path-option** [**protect**] *preference-number*{**dynamic** | **explicit**}{**name path-name** | *path-number*}**verbatim**}[**lockdown**]
8. **ip explicit-path name** *word*
9. **exclude-address** *ip-address*

DETAILED STEPS

	Command or Action	Purpose
Step 1	enable Example: <pre>Router> enable</pre>	Enables privileged EXEC mode. <ul style="list-style-type: none"> • Enter your password if prompted.
Step 2	configure terminal Example: <pre>Router# configure terminal</pre>	Enters global configuration mode.
Step 3	interface tunnel <i>number</i> Example: <pre>Router(config)# interface tunnel 1</pre>	Creates a new tunnel interface and enters interface configuration mode.
Step 4	ip unnumbered <i>interface-type interface-number</i> Example: <pre>Router(config-if)# ip unnumbered loopback 0</pre>	Gives the tunnel interface an IP address that is the same as that of interface Loopback0. Note This command is not effective until Loopback0 has been configured with an IP address.
Step 5	tunnel destination <i>ip-address</i> Example: <pre>Router(config-if)# tunnel destination 10.3.3.3</pre>	Specifies the IP address of the device where the tunnel will terminate. This address should be the router ID of the device that is the NHOP or NNHOP of LSPs to be protected.
Step 6	tunnel mode mpls traffic-eng Example: <pre>Router(config-if)# tunnel mode mpls traffic-eng</pre>	Sets the encapsulation mode of the tunnel to MPLS TE.
Step 7	tunnel mpls traffic-eng path-option [protect] <i>preference-number</i> { dynamic explicit }{ name path-name <i>path-number</i> } verbatim }[lockdown] Example: <pre>Router(config-if)# tunnel mpls traffic-eng path-option 10 explicit avoid-protected-link</pre>	Configures a path option for an MPLS TE tunnel. Enters router configuration mode.

	Command or Action	Purpose
Step 8	ip explicit-path name <i>word</i> Example: <pre>Router(config-router)# ip explicit-path name avoid-protected-link</pre>	Enters the command mode for IP explicit paths and creates the specified path. Enters explicit path command mode.
Step 9	exclude-address <i>ip-address</i> Example: <pre>Router(config-ip-expl-path)# exclude-address 3.3.3.3</pre>	<p>For link protection, specify the IP address of the link to be protected. For node protection, specify the router ID of the node to be protected.</p> <p>Note Backup tunnel paths can be dynamic or explicit and they do not have to use <code>exclude-address</code>. Because backup tunnels must avoid the protected link or node, it is convenient to use the exclude-address command.</p> <p>Note When using the exclude-address command to specify the path for a backup tunnel, you must exclude an interface IP address to avoid a link (for creating an NHOP backup tunnel), or a router ID address to avoid a node (for creating an NNHOP backup tunnel).</p>

Assigning Backup Tunnels to a Protected Interface

To assign one or more backup tunnels to a protected interface, enter the following commands on the node that will be the headend of the backup tunnel (that is, the node whose downstream link or node may fail). The node on which you enter these commands must be a supported platform. See the Finding Feature Information section.



Note You must configure the interface to have an IP address and to enable the MPLS TE tunnel feature.

SUMMARY STEPS

1. **enable**
2. **configure terminal**
3. **interface** *type slot / port*
4. **mpls traffic-eng backup-path tunnel** *interface*

DETAILED STEPS

	Command or Action	Purpose
Step 1	enable Example:	Enables privileged EXEC mode. <ul style="list-style-type: none"> • Enter your password if prompted.

	Command or Action	Purpose
	Router> enable	
Step 2	configure terminal Example: Router# configure terminal	Enters global configuration mode.
Step 3	interface <i>type slot / port</i> Example: Example: Example: Example: Router(config)# interface POS 5/0	Moves configuration to the physical interface level, directing subsequent configuration commands to the specific physical interface identified by the <i>type</i> value. The <i>slot</i> and <i>port</i> identify the slot and port being configured. The interface must be a supported interface. See the Finding Feature Information section. Enters interface configuration mode.
Step 4	mpls traffic-eng backup-path tunnel <i>interface</i> Example: Router(config-if)# mpls traffic-eng backup-path tunnel 2	Allows LSPs going out this interface to use this backup tunnel if there is a link or node failure. Note You can enter this command multiple times to associate multiple backup tunnels with the same protected interface.

Associating Backup Bandwidth and Pool Type with a Backup Tunnel

To associate backup bandwidth with a backup tunnel and designate the type of LSP that can use a backup tunnel, enter the following commands.

SUMMARY STEPS

1. enable
2. configure terminal
3. interface tunnel *number*
4. tunnel mpls traffic-eng backup-bw *{bandwidth | [sub-pool {bandwidth | Unlimited}] [global-pool {bandwidth | Unlimited}]*

DETAILED STEPS

	Command or Action	Purpose
Step 1	enable	Enables privileged EXEC mode.

	Command or Action	Purpose
	Example: <pre>Router> enable</pre>	<ul style="list-style-type: none"> Enter your password if prompted.
Step 2	configure terminal Example: <pre>Router# configure terminal</pre>	Enters global configuration mode.
Step 3	interface tunnel <i>number</i> Example: <pre>Router(config)# interface tunnel 2</pre>	Enters interface configuration mode for the specified tunnel.
Step 4	tunnel mpls traffic-eng backup-bw <i>{bandwidth [sub-pool {bandwidth Unlimited}] [global-pool {bandwidth Unlimited}]</i> Example: <pre>Router(config-if)# tunnel mpls traffic-eng backup-bw sub-pool 1000</pre>	Associates bandwidth with a backup tunnel and designates whether LSPs that allocate bandwidth from the specified pool can use the tunnel.

Configuring Backup Bandwidth Protection

SUMMARY STEPS

- enable
- configure terminal
- tunnel mpls traffic-eng fast-reroute [bw-protect]
- mpls traffic-eng fast-reroute backup-prot-preemption [optimize-bw]

DETAILED STEPS

	Command or Action	Purpose
Step 1	enable Example: <pre>Router> enable</pre>	Enables privileged EXEC mode. <ul style="list-style-type: none"> Enter your password if prompted.
Step 2	configure terminal Example: <pre>Router# configure terminal</pre>	Enters interface configuration mode.
Step 3	tunnel mpls traffic-eng fast-reroute [bw-protect] Example:	Enables an MPLS TE tunnel to use an established backup tunnel in the event of a link or node failure.

	Command or Action	Purpose
	<pre>Router(config-if)# tunnel mpls traffic-eng fast-reroute bw-protect</pre>	<ul style="list-style-type: none"> The bw-protect keyword gives an LSP priority for using backup tunnels with bandwidth protection. Enters global configuration mode.
Step 4	<p>mpls traffic-eng fast-reroute backup-prot-preemption [optimize-bw]</p> <p>Example:</p> <pre>Router(config)# mpls traffic-eng fast-reroute backup-prot-preemption optimize-bw</pre>	Changes the backup protection preemption algorithm from minimize the number of LSPs that are demoted to minimize the amount of bandwidth that is wasted.

Configuring an Interface for Fast Link and Node Failure Detection

SUMMARY STEPS

1. **enable**
2. **configure terminal**
3. **interface** *type slot / port*
4. **pos ais-shut**
5. **pos report** {**b1-tca** | **b2-tca** | **b3-tca** | **lais** | **lrdis** | **pais** | **plop** | **prdi** | **rdool** | **sd-ber** | **sf-ber** | **slof** | **slos**}

DETAILED STEPS

	Command or Action	Purpose
Step 1	<p>enable</p> <p>Example:</p> <pre>Router> enable</pre>	<p>Enables privileged EXEC mode.</p> <ul style="list-style-type: none"> Enter your password if prompted.
Step 2	<p>configure terminal</p> <p>Example:</p> <pre>Router# configure terminal</pre>	Enters global configuration mode.
Step 3	<p>interface <i>type slot / port</i></p> <p>Example:</p> <pre>Router(config)# interface pos0/0</pre>	Configures an interface type and enters interface configuration mode.
Step 4	<p>pos ais-shut</p> <p>Example:</p> <pre>Router(config-if)# pos ais-shut</pre>	Sends the line alarm indication signal (LAIS) when the POS interface is placed in any administrative shutdown state.

	Command or Action	Purpose
Step 5	<p>pos report {b1-tca b2-tca b3-tca lais lrldi pais plop prdi rdool sd-ber sf-ber slof slos}</p> <p>Example:</p> <pre>Router(config-if)# pos report lrldi</pre>	Permits selected SONET alarms to be logged to the console for a POS interface.

Verifying That Fast Reroute Is Operational

SUMMARY STEPS

1. show mpls traffic-eng tunnels brief
2. show ip rsvp sender detail
3. show mpls traffic-eng fast-reroute database
4. show mpls traffic-eng tunnels backup
5. show mpls traffic-eng fast-reroute database
6. show ip rsvp reservation

DETAILED STEPS

Step 1 show mpls traffic-eng tunnels brief

Use this command to verify that backup tunnels are up:

Example:

```
Router# show mpls traffic-eng tunnels brief
```

Following is sample output from the **show mpls traffic-eng tunnels brief** command:

Example:

```
Signalling Summary:
  LSP Tunnels Process:      running
  RSVP Process:            running
  Forwarding:              enabled
  Periodic reoptimization: every 3600 seconds, next in 1706 seconds
TUNNEL NAME                DESTINATION    UP IF    DOWN IF    STATE/PROT
Router_t1                  10.112.0.12   -        PO4/0/1   up/up
Router_t2                  10.112.0.12   -        unknown   up/down
Router_t3                  10.112.0.12   -        unknown   admin-down
Router_t1000               10.110.0.10   -        unknown   up/down
Router_t2000               10.110.0.10   -        PO4/0/1   up/up
Displayed 5 (of 5) heads, 0 (of 0) midpoints, 0 (of 0) tails
```

Step 2 show ip rsvp sender detail

Use this command to verify that LSPs are protected by the appropriate backup tunnels.

Following is sample output from the **show ip rsvp sender detail** command when the command is entered at the PLR before a failure.

Example:

```

Router# show ip rsvp sender detail

PATH:
Tun Dest: 10.10.0.6 Tun ID: 100 Ext Tun ID: 10.10.0.1
Tun Sender: 10.10.0.1 LSP ID: 31
Path refreshes:
  arriving: from PHOP 10.10.7.1 on Et0/0 every 30000 msec
Session Attr:
  Setup Prio: 7, Holding Prio: 7
  Flags: (0x7) Local Prot desired, Label Recording, SE Style
  session Name: R1_t100
ERO: (incoming)
  10.10.7.2 (Strict IPv4 Prefix, 8 bytes, /32)
  10.10.0.6 (Strict IPv4 Prefix, 8 bytes, /32)
RRO:
  10.10.7.1/32, Flags:0x0 (No Local Protection)
  10.10.4.1/32, Flags:0x9 (Local Prot Avail/to NNHOP) !Available to NNHOP
  10.10.1.1/32, Flags:0x0 (No Local Protection)
Traffic params - Rate: 10K bits/sec, Max. burst: 1K bytes
  Min Policed Unit: 0 bytes, Max Pkt Size 4294967295 bytes
Fast-Reroute Backup info:
  Inbound FRR: Not active
  Outbound FRR: No backup tunnel selected
Path ID handle: 50000416.
Incoming policy: Accepted. Policy source(s): MPLS/TE
Status: Proxy-terminated

```

Step 3 show mpls traffic-eng fast-reroute database

Enter the **clear ip rsvp hello instance counters** command to verify the following:

- MPLS TE FRR node protection has been enabled.
- A certain type of LSP can use a backup tunnel.

The following command output displays the LSPs that are protected:

Example:

```

Router# show mpls traffic-eng fast-reroute database
Tunnel head end item frr information:
Protected Tunnel      In-label  intf/label      FRR intf/label    Status
Tunnell0             Tun       pos5/0:Untagged Tu0:12304         ready
Prefix item frr information:
Prefix      Tunnel  In-label  Out intf/label  FRR intf/label    Status
10.0.0.11/32 Tu110  Tun hd   pos5/0:Untagged Tu0:12304         ready
LSP midpoint frr information:
LSP identifier      In-label  Out intf/label  FRR intf/label    Status
10.0.0.12 1 [459]    16          pos0/1:17        Tu2000:19         ready

```

If LDP is not enabled, separate prefix items are not shown because all prefixes then use a single rewrite. To confirm that a particular IP prefix is FRR protected, even though it is not shown in this display, enter it within the **show mpls forwarding-table ip-address detail** command. The final line of the display will tell whether that prefix is protected:

Example:

```

Router# show mpls forwarding-table 10.0.0.11 detail

Local  Outgoing  Prefix      Bytes tag  Outgoing  Next Hop
tag    tag or VC or Tunnel Id  switched  interface
Tun hd  Untagged  10.0.0.11/32  48         pos5/0    point2point
MAC/Encaps=4/8, MTU=1520, Tag Stack{22}

```

```

48D18847 00016000
No output feature configured
Fast Reroute Protection via (Tu0, outgoing label 12304)

```

Step 4 show mpls traffic-eng tunnels backup

For backup tunnels to be operational, the LSP must be reroutable. At the headend of the LSP, enter the **show run int tunnel tunnel-number** command. The output should include the **tunnel mpls traffic-eng fast-reroute** command. If it does not, enter this command for the tunnel.

On the router where the backup tunnels originate, enter the **show mpls traffic-eng tunnels backup** command. Following is sample command output:

Example:

```

Router# show mpls traffic-eng tunnels backup

Router_t578
LSP Head, Tunnel578, Admin: up, Oper: up
Src 10.55.55.55, Dest 10.88.88.88, Instance 1
Fast Reroute Backup Provided:
  Protected i/fs: PO1/0, PO1/1, PO3/3
  Protected lsps: 1
  Backup BW: any pool unlimited; inuse: 100 kbps
Router_t5710
LSP Head, Tunnel5710, Admin: admin-down, Oper: down
Src 10.55.55.55, Dest 10.7.7.7, Instance 0
Fast Reroute Backup Provided:
  Protected i/fs: PO1/1
  Protected lsps: 0
  Backup BW: any pool unlimited; inuse: 0 kbps
Router_t5711
LSP Head, Tunnel5711, Admin up, Oper: up
Src 10.55.55.55,, Dest 10.7.7.7, Instance 1
Fast Reroute Backup Provided:
  Protected i/fs: PO1/0
  Protected lsps: 2
  Backup BW: any pool unlimited; inuse: 6010 kbps

```

The command output will allow you to verify the following:

- Backup tunnel exists--Verify that there is a backup tunnel that terminates at this LSP's NHOP or NNHOP. Look for the LSP's NHOP or NNHOP in the Dest field.
- Backup tunnel is up--To verify that the backup tunnel is up, look for "Up" in the State field.
- Backup tunnel is associated with LSP's interface--Verify that the interface for the LSP is allowed to use this backup tunnel. Look for the LSP's output interface in the "protects" field list.
- Backup tunnel has sufficient bandwidth--If you restricted the amount of bandwidth a backup tunnel can hold, verify that the backup tunnel has sufficient bandwidth to hold the LSPs that would use this backup tunnel if there is a failure. The bandwidth of an LSP is defined by the line **tunnel mpls traffic-eng bandwidth** at the headend of the LSP. To determine the available bandwidth on a backup tunnel, look at the "cfg" and "inuse" fields. If there is insufficient backup bandwidth to accommodate the LSPs that would use this backup tunnel in the event of a failure, create an additional backup tunnel or increase the backup bandwidth of the existing tunnel by using the **tunnel mpls traffic-eng bandwidth** command.

Note To determine the sufficient amount of bandwidth, offline capacity planning may be required.

- Backup tunnel has appropriate bandwidth type--If you restricted the type of LSPs (subpool or global pool) that can use this backup tunnel, verify that the LSP is the appropriate type for the backup tunnel. The type of the LSP is defined by the line **tunnel mpls traffic-eng bandwidth** at the headend of this LSP. If this line contains the word “subpool”, then it uses sub-pool bandwidth; otherwise, it uses global pool bandwidth. Verify that the type matches the type the backup tunnel can hold by looking in the output of the **tunnel mpls traffic-eng bandwidth** command.

You also can enable debug by entering the **debug ip rsvp fast-reroute** command and the **debug mpls traffic-eng fast-reroute** command on the router that is the headend of the backup tunnel. Then do the following:

- Enter the **shutdown** command for the primary tunnel.
- Enter the **no shutdown** command for the primary tunnel.
- View the debug output.

Step 5 **show mpls traffic-eng fast-reroute database**

Enter the **clear ip rsvp hello instance counters** command to verify the following:

- MPLS TE FRR node protection has been enabled.
- A certain type of LSP can use a backup tunnel.

The following command output displays the LSPs that are protected:

Example:

```
Router# show mpls traffic-eng fast-reroute database
Tunnel head end item frr information:
Protected Tunnel   In-label   intf/label   FRR intf/label   Status
Tunne110          Tun        pos5/0:Untagged Tu0:12304        ready
Prefix item frr information:
Prefix            Tunnel     In-label    Out intf/label   FRR intf/label   Status
10.0.0.11/32     Tu110     Tun hd      pos5/0:Untagged Tu0:12304        ready
LSP midpoint frr information:
LSP identifier    In-label   Out intf/label   FRR intf/label   Status
10.0.0.12 1 [459] 16           pos0/1:17        Tu2000:19        ready
```

Note If LDP is not enabled, separate prefix items are not shown because all prefixes then use a single rewrite. To confirm that a particular IP prefix is FRR protected, even though it is not shown in this display, enter it within the **show mpls forwarding-table ip-address detail** command. The final line of the display will tell whether that prefix is protected:

Example:

```
Router# show mpls forwarding-table 10.0.0.11 detail

Local   Outgoing   Prefix           Bytes tag   Outgoing   Next Hop
tag     tag or VC  or Tunnel Id    switched   interface
Tun hd  Untagged  10.0.0.11/32    48         pos5/0     point2point
        MAC/Encaps=4/8, MTU=1520, Tag Stack{22}
        48D18847 00016000
        No output feature configured
        Fast Reroute Protection via (Tu0, outgoing label 12304)
```

Step 6 **show ip rsvp reservation**

Following is sample output from the **show ip rsvp reservation** command entered at the headend of a primary LSP. Entering the command at the headend of the primary LSP shows, among other things, the status of FRR (that is, local

protection) at each hop this LSP traverses. The per-hop information is collected in the Record Route Object (RRO) that travels with the Resv message from the tail to the head.

Example:

```
Router# show ip rsvp reservation detail
Reservation:
  Tun Dest: 10.1.1.1  Tun ID: 1  Ext Tun ID: 172.16.1.1
  Tun Sender: 172.16.1.1  LSP ID: 104
  Next Hop: 172.17.1.2 on POS1/0
  Label: 18 (outgoing)
  Reservation Style is Shared-Explicit, QoS Service is Controlled-Load
  Average Bitrate is 0 bits/sec, Maximum Burst is 1K bytes
  Min Policed Unit: 0 bytes, Max Pkt Size: 0 bytes
  RRO:
    172.18.1.1/32, Flags:0x1 (Local Prot Avail/to NHOP)
      Label subobject: Flags 0x1, C-Type 1, Label 18
    172.19.1.1/32, Flags:0x0 (Local Prot Avail/In Use/Has BW/to NHOP)
      Label subobject: Flags 0x1, C-Type 1, Label 16
    172.19.1.2/32, Flags:0x0 (No Local Protection)
      Label subobject: Flags 0x1, C-Type 1, Label 0
  Resv ID handle: CD000404.
  Policy: Accepted. Policy source(s): MPLS/TE
```

Notice the following about the primary LSP:

- It has protection that uses a NHOP backup tunnel at its first hop.
- It has protection and is actively using an NHOP backup tunnel at its second hop.
- It has no local protection at its third hop.

The RRO display shows the following information for each hop:

- Whether local protection is available (that is, whether the LSP has selected a backup tunnel)
- Whether local protection is in use (that is, whether the LSP is currently using its selected backup tunnel)
- Whether the selected backup tunnel is an NHOP or NNHOP backup tunnel
- Whether the backup tunnel used at this hop provides bandwidth protection

Troubleshooting Tips

This section describes the following:

LSPs Do Not Become Active; They Remain Ready

At a PLR, LSPs transition from Ready to Active if one of the following events occurs:

- Primary interface goes down--If the primary interface (LSP's outbound interface) goes down and the LSP is ready to use a backup tunnel, the LSP will transition to the active state causing its data to flow over the backup tunnel. On some platforms and interface types (for example, GSR POS interfaces), there is fast interface-down logic that detects this event very quickly. On other platforms where this logic does not exist, detection time is slower. On such platforms, it may be desirable to enable RSVP Hello (see the next bulleted item, "Hellos detect next hop is down").

- Hellos detect next hop is down--If Hellos are enabled on the primary interface (LSP's outbound interface), and the LSP's next hop is no longer reachable, the next hop is declared down. This event will cause the LSP to begin actively using its backup tunnel. Notice that a next hop will be declared down even if the primary interface does not go down. For example, if the next hop stops responding due to a reboot or software or hardware problem, Hellos will trigger the LSPs using this next hop to switch to their backup tunnels. Hellos can also help trigger FRR on interfaces such as Gigabit Ethernet where the interface remains up but is unusable (due to lack of link-layer liveness detection mechanisms).

Primary Tunnel Does Not Select Backup Tunnel That Is Up

If a backup tunnel is up, but it is not selected as a backup tunnel by the primary tunnel (LSP), enter the following commands for the backup tunnel:

- **shutdown**
- **no shutdown**



Note If you change the status of a backup tunnel, the backup tunnel selection algorithm is rerun for the backup tunnel. LSPs that have currently selected (that is, are ready to use) that backup tunnel will be disassociated from it, and then reassociated with that backup tunnel or another backup tunnel. This is generally harmless and usually results in mapping the same LSPs to that backup tunnel. However, if any LSPs are actively using that backup tunnel, shutting down the backup tunnel will tear down those LSPs.

Enhanced RSVP Commands Display Useful Information

The following RSVP commands have been enhanced to display information that can be helpful when you are examining the FRR state or troubleshooting FRR:

- **show ip rsvp request** --Displays upstream reservation state (that is, information related to the Resv messages that this node will send upstream).
- **show ip rsvp reservation** --Displays information about Resv messages received.
- **show ip rsvp sender** --Displays information about path messages being received.

These commands show control plane state; they do not show data state. That is, they show information about RSVP messages (Path and Resv) used to signal LSPs. For information about the data packets being forwarded along LSPs, use the **show mpls forwarding** command.

RSVP Hello Detects When a Neighboring Node Is Not Reachable

The RSVP Hello feature enables RSVP nodes to detect when a neighboring node is not reachable. Use this feature when notification of link-layer failures is not available and unnumbered links are not used, or when the failure detection mechanisms provided by the link layer are not sufficient for timely node failure detection. Hello must be configured both globally on the router and on the specific interface to be operational.

Hello Instances Have Not Been Created

If Hello instances have not been created, do the following:

- Determine if RSVP Hello has been enabled globally on the router. Enter the **ip rsvp signalling hello**(configuration) command.

- Determine if RSVP Hello has been enabled on an interface that the LSPs traverse. Enter the **ip rsvp signalling hello**(interface) command.
- Verify that at least one LSP has a backup tunnel by displaying the output of the **show ip rsvp sender** command. A value of “Ready” indicates that a backup tunnel has been selected.

“No entry at index” (error may self-correct, RRO may not yet have propagated from downstream node of interest)” Error Message Is Printed at the Point of Local Repair

FRR relies on a RRO in Resv messages arriving from downstream. Routers receiving path messages with the SESSION_ATTRIBUTE bit indicating that the LSP is fast-reroutable should include an RRO in the corresponding Resv messages.

If an LSP is configured for FRR, but the Resv arriving from a downstream router contains an incomplete RRO, the “No entry at index (error may self-correct, RRO may not yet have propagated from downstream node of interest)” message is printed. An incomplete RRO is one in which the NHOP or the NNHOP did not include an entry in the RRO.

This error typically means that backup tunnels to the NHOP or the NNHOP cannot be selected for this LSP because there is insufficient information about the NHOP or NNHOP due to the lack of an RRO entry.

Occasionally there are valid circumstances in which this situation occurs temporarily and the problem is self-corrected. If subsequent Resv messages arrive with a complete RRO, ignore the error message.

To determine whether the error has been corrected, display the RRO in Resv messages by entering the **clear ip rsvp hello instance counters** command. Use an output filter keyword to display only the LSP of interest.

“Couldn’t get rsbs” (error may self-correct when Resv arrives)” Error Message Is Printed at the Point of Local Repair

The PLR cannot select a backup tunnel for an LSP until a Resv message has arrived from downstream.

When this error occurs, it typically means that something is wrong. For example, no reservation exists for this LSP. You can troubleshoot this problem by using the **debug ip rsvp reservation** command to enable debug.

Occasionally there are valid circumstances in which this error message occurs and there is no need for concern. One such circumstance is when an LSP experiences a change before any Resv message has arrived from downstream. Changes can cause a PLR to try to select a backup tunnel for an LSP, and the selection will fail (causing this error message) if no Resv message has arrived for this LSP.

Configuration Examples for MPLS Traffic Engineering—Fast Reroute Link and Node Protection

The examples relate to the illustration shown in the figure below.

Figure 7: Backup Tunnels

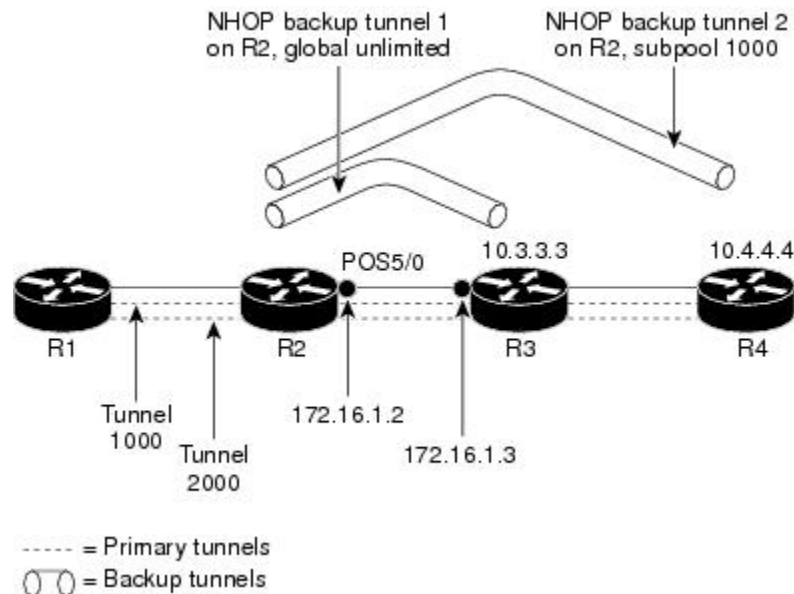

100906

Enabling Fast Reroute for all Tunnels Example

On router R1, enter interface configuration mode for each tunnel to be protected (Tunnel 1000 and Tunnel 2000). Enable these tunnels to use a backup tunnel in case of a link or node failure along their paths.

Tunnel 1000 will use 10 units of bandwidth from the subpool.

Tunnel 2000 will use five units of bandwidth from the global pool. The “bandwidth protection desired” bit has been set by specifying **bw-prot** in the **tunnel mpls traffic-eng fast-reroute** command.

```
Router(config)# interface Tunnel 1000
Router(config-if)# tunnel mpls traffic-eng fast-reroute
Router(config-if)# tunnel mpls traffic-eng bandwidth sub-pool 10
Router(config)# interface Tunnel2000
Router(config-if)# tunnel mpls traffic-eng fast-reroute bw-prot
Router(config-if)# tunnel mpls traffic-eng bandwidth 5
```

Creating an NHOP Backup Tunnel Example

On router R2, create an NHOP backup tunnel to R3. This backup tunnel should avoid using the link 172.1.1.2.

```
Router(config)# ip explicit-path name avoid-protected-link
Router(cfg-ip-expl-path)# exclude-address 172.1.1.2
Explicit Path name avoid-protected-link:
  1: exclude-address 172.1.1.2
Router(cfg-ip_expl-path)# end
Router(config)# interface Tunnel 1
Router(config-if)# ip unnumbered loopback0
Router(config-if)# tunnel destination 10.3.3.3
Router(config-if)# tunnel mode mpls traffic-eng
Router(config-if)# tunnel mpls traffic-eng path-option 10 explicit avoid-protected-link
```

Creating an NNHOP Backup Tunnel Example

On router R2, create an NNHOP backup tunnel to R4. This backup tunnel should avoid R3.

```
Router(config)# ip explicit-path name avoid-protected-node

Router(cfg-ip-expl-path)# exclude-address 10.3.3.3
Explicit Path name avoid-protected-node:
___1: exclude-address 10.3.3.3
Router(cfg-ip_expl-path)# end

Router(config)# interface Tunnel 2

Router(config-if)# ip unnumbered loopback0

Router(config-if)# tunnel destination 10.4.4.4

Router(config-if)# tunnel mode mpls traffic-eng

Router(config-if)# tunnel mpls traffic-eng path-option 10 explicit avoid-protected-node
```

Assigning Backup Tunnels to a Protected Interface

To assign one or more backup tunnels to a protected interface, enter the following commands on the node that will be the headend of the backup tunnel (that is, the node whose downstream link or node may fail). The node on which you enter these commands must be a supported platform. See the Finding Feature Information section.



Note You must configure the interface to have an IP address and to enable the MPLS TE tunnel feature.

SUMMARY STEPS

1. **enable**
2. **configure terminal**
3. **interface** *type slot / port*
4. **mpls traffic-eng backup-path tunnel** *interface*

DETAILED STEPS

	Command or Action	Purpose
Step 1	enable Example: Router> enable	Enables privileged EXEC mode. <ul style="list-style-type: none"> • Enter your password if prompted.
Step 2	configure terminal Example: Router# configure terminal	Enters global configuration mode.

	Command or Action	Purpose
Step 3	<p>interface <i>type slot / port</i></p> <p>Example:</p> <p>Example:</p> <p>Example:</p> <p>Example:</p> <p>Example:</p> <pre>Router(config)# interface POS 5/0</pre>	<p>Moves configuration to the physical interface level, directing subsequent configuration commands to the specific physical interface identified by the <i>type</i> value. The <i>slot</i> and <i>port</i> identify the slot and port being configured. The interface must be a supported interface. See the Finding Feature Information section. Enters interface configuration mode.</p>
Step 4	<p>mpls traffic-eng backup-path tunnel <i>interface</i></p> <p>Example:</p> <pre>Router(config-if)# mpls traffic-eng backup-path tunnel 2</pre>	<p>Allows LSPs going out this interface to use this backup tunnel if there is a link or node failure.</p> <p>Note You can enter this command multiple times to associate multiple backup tunnels with the same protected interface.</p>

Associating Backup Bandwidth and Pool Type with a Backup Tunnel

To associate backup bandwidth with a backup tunnel and designate the type of LSP that can use a backup tunnel, enter the following commands.

SUMMARY STEPS

1. **enable**
2. **configure terminal**
3. **interface tunnel** *number*
4. **tunnel mpls traffic-eng backup-bw** *{bandwidth | [sub-pool {bandwidth | Unlimited}] [global-pool {bandwidth | Unlimited}]*

DETAILED STEPS

	Command or Action	Purpose
Step 1	<p>enable</p> <p>Example:</p> <pre>Router> enable</pre>	<p>Enables privileged EXEC mode.</p> <ul style="list-style-type: none"> • Enter your password if prompted.
Step 2	<p>configure terminal</p> <p>Example:</p>	<p>Enters global configuration mode.</p>

	Command or Action	Purpose
	Router# configure terminal	
Step 3	interface tunnel <i>number</i> Example: Router(config)# interface tunnel 2	Enters interface configuration mode for the specified tunnel.
Step 4	tunnel mpls traffic-eng backup-bw { <i>bandwidth</i> [sub-pool { <i>bandwidth</i> Unlimited}] [global-pool { <i>bandwidth</i> Unlimited}] Example: Router(config-if)# tunnel mpls traffic-eng backup-bw sub-pool 1000	Associates bandwidth with a backup tunnel and designates whether LSPs that allocate bandwidth from the specified pool can use the tunnel.

Configuring Backup Bandwidth Protection Example

In the following example, backup bandwidth protection is configured:



Note

This global configuration is required only to change the backup protection preemption algorithm from minimize the number of LSPs that are demoted to minimize the amount of bandwidth that is wasted.

```
Router(config-if)# tunnel mpls traffic-eng fast-reroute bw-protect
Router(config)# mpls traffic-eng fast-reroute backup-prot-preemption optimize-bw
```

Configuring an Interface for Fast Link and Node Failure Detection Example

In the following example, pos ais-shut is configured:

```
Router(config)# interface pos 0/0
Router(config-if)# pos ais-shut
```

In the following example, report lrdi is configured on OS interfaces:

```
Router(config)# interface pos 0/0
Router(config-if)# pos report lrdi
```

Configuring RSVP Hello and POS Signals Example

Hello must be configured both globally on the router and on the specific interface on which you need FRR protection. To configure Hello, use the following configuration commands:

- **ip rsvp signalling hello** (configuration)--Enables Hello globally on the router.

- **ip rsvp signalling hello** (interface)--Enables Hello on an interface where you need FRR protection.

The following configuration commands are optional:

- **ip rsvp signalling hello dscp** --Sets the differentiated services code point (DSCP) value that is in the IP header of the Hello message.
- **ip rsvp signalling hello refresh misses** --Specifies how many acknowledgments a node can miss in a row before the node considers that communication with its neighbor is down.
- **ip rsvp signalling hello refresh interval** --Configures the Hello request interval.
- **ip rsvp signalling hello statistics** --Enables Hello statistics on the router.

For configuration examples, see the Hello command descriptions in the “Command Reference” section of *MPLS Traffic Engineering (TE): Link and Node Protection, with RSVP Hellos Support*, Release 12.0(24)S.

To configure POS signaling for detecting FRR failures, enter the **pos report all** command or enter the following commands to request individual reports:

```
pos ais-shut
pos report rdool
pos report lais
pos report lrldi
pos report pais
pos report prdi
pos report sd-ber
```

Additional References

The following sections provide references related to the MPLS TE: Link and Node Protection, with RSVP Hellos Support (with Fast Tunnel Interface Down Detection) feature.

Related Documents

Related Topic	Document Title
IS-IS	<ul style="list-style-type: none"> • <i>Cisco IOS IP Routing Protocols Command Reference</i> • Configuring a Basic IS-IS Network
MPLS traffic engineering commands	<i>Cisco IOS Multiprotocol Label Switching Command Reference</i>
OSPF	<ul style="list-style-type: none"> • <i>Cisco IOS IP Routing Protocols Command Reference</i> • Configuring OSPF
RSVP commands	<ul style="list-style-type: none"> • <i>Cisco IOS Multiprotocol Label Switching Command Reference</i> • <i>Cisco IOS Quality of Service Solutions Command Reference</i>

Standards

Standards	Title
No new or modified standards are supported by this feature, and support for existing standards has not been modified by this feature.	--

MIBs

MIBs	MIBs Link
No new or modified MIBs are supported by this feature, and support for existing MIBs has not been modified by this feature.	To locate and download MIBs for selected platforms, Cisco IOS XE software releases, and feature sets, use Cisco MIB Locator found at the following URL: http://www.cisco.com/go/mibs

RFCs

RFCs	Title
RFC 4090	Fast Reroute Extensions to RSVP-TE for LSP Tunnels

Technical Assistance

Description	Link
<p>The Cisco Support website provides extensive online resources, including documentation and tools for troubleshooting and resolving technical issues with Cisco products and technologies.</p> <p>To receive security and technical information about your products, you can subscribe to various services, such as the Product Alert Tool (accessed from Field Notices), the Cisco Technical Services Newsletter, and Really Simple Syndication (RSS) Feeds.</p> <p>Access to most tools on the Cisco Support website requires a Cisco.com user ID and password.</p>	http://www.cisco.com/techsupport

Feature Information for MPLS Traffic Engineering—Fast Reroute Link and Node Protection

The following table provides release information about the feature or features described in this module. This table lists only the software release that introduced support for a given feature in a given software release train. Unless noted otherwise, subsequent releases of that software release train also support that feature.

Use Cisco Feature Navigator to find information about platform support and Cisco software image support. To access Cisco Feature Navigator, go to www.cisco.com/go/cfn. An account on Cisco.com is not required.

Table 3: Feature Information for MPLS Traffic Engineering—Fast Reroute Link and Node Protection

Feature Name	Releases	Feature Information
MPLS Traffic Engineering--Fast Reroute Link and Node Protection		The MPLS Traffic Engineering--Fast Reroute Link and Node Protection feature supports link protection (backup tunnels that bypass only a single link of the label-switched path (LSP), node protection (backup tunnels that bypass next-hop nodes along LSPs), and the following FRR features: backup tunnel support, backup bandwidth protection, and RSVP Hellos.
		The following commands were introduced or modified: clear ip rsvp hello instance counters , clear ip rsvp hello instance statistics , clear ip rsvp hello statistics , debug ip rsvp hello , ip rsvp signalling hello (configuration) , ip rsvp signalling hello (interface) , ip rsvp signalling hello dscp , ip rsvp signalling hello refresh interval , ip rsvp signalling hello refresh misses , ip rsvp signalling hello statistics , mpls traffic-eng backup-path tunnel , mpls traffic-eng fast-reroute backup-prot-preemption , mpls traffic-eng fast-reroute timers , show ip rsvp fast bw-protect , show ip rsvp fast detail , show ip rsvp hello , show ip rsvp hello instance detail , show ip rsvp hello instance summary , show ip rsvp hello statistics , show ip rsvp interface detail , show ip rsvp request , show ip rsvp reservation , show ip rsvp sender , show mpls traffic tunnel backup , show mpls traffic-eng fast-reroute database , show mpls traffic-eng tunnels , show mpls traffic-eng tunnels summary , tunnel mpls traffic-eng backup-bw , tunnel mpls traffic-eng fast-reroute .

Glossary

backup bandwidth --The usage of NHOP and NNHOP backup tunnels to provide bandwidth protection for rerouted LSPs.

backup tunnel --An MPLS TE tunnel used to protect other (primary) tunnels' traffic when a link or node failure occurs.

bandwidth --The available traffic capacity of a link.

Cisco Express Forwarding --A means for accelerating the forwarding of packets within a router, by storing route lookup.

enterprise network --A large and diverse network connecting most major points in a company or other organization.

Fast Reroute --Procedures that enable temporary routing around a failed link or node while a new LSP is being established at the headend.

global pool --The total bandwidth allocated to an MPLS traffic engineering link or node.

headend --The router that originates and maintains a given LSP. This is the first router in the LSP's path.

hop --Passage of a data packet between two network nodes (for example, between two routers).

instance --A Hello instance implements the RSVP Hello extensions for a given router interface address and remote IP address. Active Hello instances periodically send Hello Request messages, expecting Hello ACK messages in response. If the expected ACK message is not received, the active Hello instance declares that

the neighbor (remote IP address) is unreachable (that is, it is lost). This can cause LSPs crossing this neighbor to be fast rerouted.

interface --A network connection.

Intermediate System-to-Intermediate System --IS-IS. Link-state hierarchical routing protocol that calls for intermediate system (IS) routers to exchange routing information based on a single metric to determine network topology.

link --A point-to-point connection between adjacent nodes. There can be more than one link between adjacent nodes. A link is a network communications channel consisting of a circuit or transmission path and all related equipment between a sender and a receiver. Sometimes referred to as a line or a transmission link.

limited backup bandwidth --Backup tunnels that provide bandwidth protection.

load balancing --A configuration technique that shifts traffic to an alternative link if a certain threshold is exceeded on the primary link. Load balancing is similar to redundancy in that if an event causes traffic to shift directions, alternative equipment must be present in the configuration. In load balancing, the alternative equipment is not necessarily redundant equipment that operates only in the event of a failure.

LSP --label-switched path. A connection between two routers in which MPLS forwards the packets.

merge point --The backup tunnel's tail.

MPLS --Multiprotocol Label Switching. Packet-forwarding technology, used in the network core, that applies data link layer labels to tell switching nodes how to forward data, resulting in faster and more scalable forwarding than network layer routing normally can do.

MPLS global label allocation --There is one label space for all interfaces in the router. For example, label 100 coming in one interface is treated the same as label 100 coming in a different interface.

NHOP --next hop. The next downstream node along an LSP's path.

NHOP backup tunnel --next-hop backup tunnel. Backup tunnel terminating at the LSP's next hop beyond the point of failure, and originating at the hop immediately upstream of the point of failure. It bypasses a failed link, and is used to protect primary LSPs that were using this link before the failure.

NNHOP --next-next hop. The node after the next downstream node along an LSP's path.

NNHOP backup tunnel --next-next-hop backup tunnel. Backup tunnel terminating at the LSP's next-next hop beyond the point of failure, and originating at the hop immediately upstream of the point of failure. It bypasses a failed link or node, and is used to protect primary LSPs that were using this link or node before the failure.

node --Endpoint of a network connection or a junction common to two or more lines in a network. Nodes can be interconnected by links, and serve as control points in the network. Nodes can be processors, controllers, or workstations.

OSPF --Open Shortest Path First. A link-state hierarchical Interior Gateway Protocol routing algorithm, derived from the IS-IS protocol. OSPF features include least-cost routing, multipath routing, and load balancing.

primary LSP --The last LSP originally signaled over the protected interface before the failure. The primary LSP is the LSP before the failure.

primary tunnel --Tunnel whose LSP may be fast rerouted if there is a failure. Backup tunnels cannot be primary tunnels.

promotion --Conditions, such as a new backup tunnel comes up, cause a reevaluation of a backup tunnel that was chosen for an LSP. If the reevaluation is successful, it is called a promotion.

protected interface --An interface that has one or more backup tunnels associated with it.

redundancy --The duplication of devices, services, or connections so that, in the event of a failure, the redundant devices, services, or connections can perform the work of those that failed.

RSVP --Resource Reservation Protocol. A protocol used for signaling requests (setting up reservations) for Internet services by a customer before that customer is permitted to transmit data over that portion of the network.

scalability --An indicator showing how quickly some measure of resource usage increases as a network gets larger.

SRLG --shared risk link group. Sets of links that are likely to go down together.

state --Information that a router must maintain about each LSP. The information is used for rerouting tunnels.

sub-pool --The more restrictive bandwidth in an MPLS traffic engineering link or node. The subpool is a portion of the link or node's overall global pool bandwidth.

tailend --The router upon which an LSP is terminated. This is the last router in the LSP's path.

topology --The physical arrangement of network nodes and media within an enterprise networking structure.

tunnel --Secure communications path between two peers, such as two routers.

unlimited backup bandwidth --Backup tunnels that provide no bandwidth (best-effort) protection (that is, they provide best-effort protection).



CHAPTER 3

MPLS TE Link and Node Protection with RSVP Hellos Support

The MPLS TE: Link and Node Protection, with RSVP Hellos Support (with Fast Tunnel Interface Down Detection) feature provides the following Fast Reroute (FRR) capabilities:

- Backup tunnel that terminates at the next-next hop router to protect both the downstream link and node to protect link and node failures. There is no limit (except memory limitations) to the number of backup tunnels that can protect a given interface. A backup tunnel is scalable because it can protect multiple label switched paths (LSPs) and multiple interfaces.
- Backup bandwidth protection allows a priority to be assigned to backup tunnels for LSPs carrying certain kinds of data (such as voice).
- Fast Tunnel Interface Down detection, which forces a “generic” interface tunnel (not specifically a Fast Reroute tunnel) to become disabled immediately if the headend router detects a failed link on an LSP.
- Resource Reservation Protocol (RSVP) Hellos, which are used to accelerate the detection of node failures.
- [Finding Feature Information, on page 41](#)
- [Prerequisites for MPLS TE Link and Node Protection with RSVP Hellos Support, on page 42](#)
- [Restrictions for MPLS TE Link and Node Protection with RSVP Hellos Support, on page 42](#)
- [Information About MPLS TE Link and Node Protection with RSVP Hellos Support, on page 42](#)
- [How to Configure MPLS TE Link and Node Protection with RSVP Hellos Support, on page 56](#)
- [Configuration Examples for Link and Node Protection with RSVP Hellos Support, on page 72](#)
- [Additional References, on page 76](#)
- [Feature Information for Link and Node Protection with RSVP Hellos Support, on page 77](#)
- [Glossary, on page 78](#)

Finding Feature Information

Your software release may not support all the features documented in this module. For the latest caveats and feature information, see [Bug Search Tool](#) and the release notes for your platform and software release. To find information about the features documented in this module, and to see a list of the releases in which each feature is supported, see the feature information table.

Use Cisco Feature Navigator to find information about platform support and Cisco software image support. To access Cisco Feature Navigator, go to www.cisco.com/go/cfn. An account on Cisco.com is not required.

Prerequisites for MPLS TE Link and Node Protection with RSVP Hellos Support

Your network must support the following Cisco IOS XE features to support features described in this document:

- IP Cisco Express Forwarding
- MPLS

Your network must support at least one of the following protocols:

- Intermediate System-to-Intermediate System (IS-IS)
- Open Shortest Path First (OSPF)

Restrictions for MPLS TE Link and Node Protection with RSVP Hellos Support

- Interfaces must use MPLS Global Label Allocation.
- Backup tunnel headend and tailend routers must implement FRR as described in this document.
- Backup tunnels are not protected. If an LSP is actively using a backup tunnel and the backup tunnel fails, the LSP is torn down.
- LSPs that are actively using backup tunnels are not considered for promotion. So, if an LSP is actively using a backup tunnel and a better backup tunnel becomes available, the active LSP is not switched to the better backup tunnel.

Information About MPLS TE Link and Node Protection with RSVP Hellos Support

Fast Reroute

Fast Reroute (FRR) is a mechanism for protecting MPLS TE LSPs from link and node failures by locally repairing the LSPs at the point of failure, allowing data to continue to flow on them while their headend routers attempt to establish new end-to-end LSPs to replace them. FRR locally repairs the protected LSPs by rerouting them over backup tunnels that bypass failed links or nodes.

Link Protection

Backup tunnels that bypass only a single link of the LSP's path provide Link Protection. They protect LSPs if a link along their path fails by rerouting the LSP's traffic to the next hop (bypassing the failed link). These

are referred to as next-hop (NHOP) backup tunnels because they terminate at the LSP's next hop beyond the point of failure. The figure below illustrates an NHOP backup tunnel.

Figure 8: NHOP Backup Tunnel

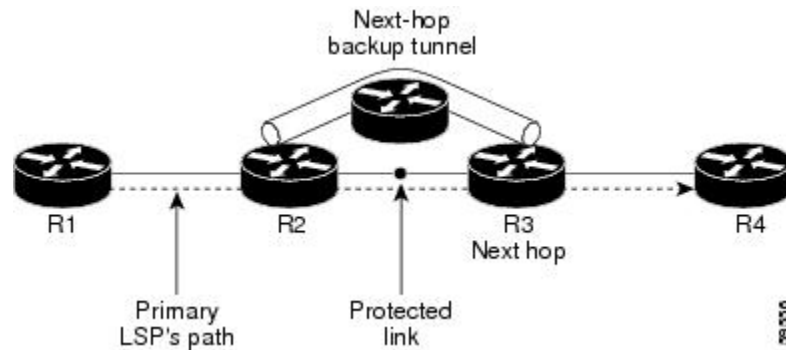

Node Protection

FRR provides Node Protection for LSPs. Backup tunnels that bypass next-hop nodes along LSP paths are called next-next-hop (NNHOP) backup tunnels because they terminate at the node following the next-hop node of the LSP paths, thereby bypassing the next-hop node. They protect LSPs if a node along their path fails by enabling the node upstream of the failure to reroute the LSPs and their traffic around the failed node to the next-next hop. FRR supports the use of RSVP Hellos to accelerate the detection of node failures. NNHOP backup tunnels also provide protection from link failures, because they bypass the failed link in addition to the node.

The figure below illustrates an NNHOP backup tunnel.

Figure 9: NNHOP Backup Tunnel

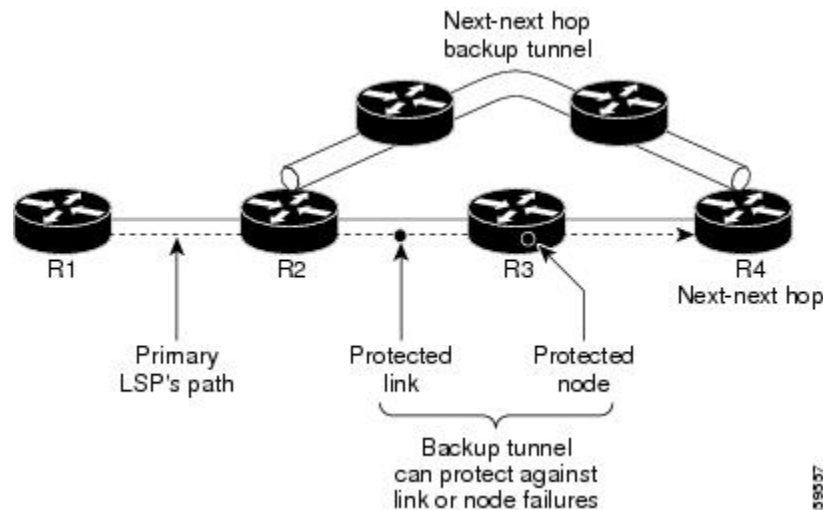

If an LSP is using a backup tunnel and something changes so that the LSP is no longer appropriate for the backup tunnel, the LSP is torn down. Such changes include the following:

- Backup bandwidth of the backup tunnel is reduced.
- Backup bandwidth type of backup tunnel is changed to a type that is incompatible with the primary LSP.

- Primary LSP is modified so that FRR is disabled. (The **no mpls traffic-eng fast-reroute** command is entered.)

Bandwidth Protection

NHOP and NNHOP backup tunnels can be used to provide bandwidth protection for rerouted LSPs. This is referred to as backup bandwidth. You can associate backup bandwidth with NHOP or NNHOP backup tunnels. This informs the router of the amount of backup bandwidth a particular backup tunnel can protect. When a router maps LSPs to backup tunnels, bandwidth protection ensures that an LSP uses a given backup tunnel only if there is sufficient backup bandwidth. The router selects which LSPs use which backup tunnels to provide maximum bandwidth protection. That is, the router determines the best way to map LSPs onto backup tunnels to maximize the number of LSPs that can be protected. .

LSPs that have the “bandwidth protection desired” bit set have a higher right to select backup tunnels that provide bandwidth protection; that is, those LSPs can preempt other LSPs that do not have that bit set. For more information, see the "Prioritizing Which LSPs Obtain Backup Tunnels with Bandwidth Protection" section.

Fast Tunnel Interface Down Detection

Fast Tunnel Interface Down detection forces a “generic” interface tunnel (not specifically a Fast Reroute tunnel) to become disabled immediately if the headend router detects a failed link on an LSP.

This feature is configured with the **tunnel mpls traffic-eng interface down delay** command. If this feature is not configured, there is a delay before the tunnel becomes unoperational and before the traffic uses an alternative path chosen by the headend/midpoint router to forward the traffic. This is acceptable for data traffic, but not for voice traffic because it relies on the TE tunnel to go down as soon as the LSP goes down.

RSVP Hello

RSVP Hellos are described in the following sections:

RSVP Hello Operation

RSVP Hello enables RSVP nodes to detect when a neighboring node is not reachable. This provides node-to-node failure detection. When such a failure is detected, it is handled in a similar manner as a link-layer communication failure.

RSVP Hello can be used by FRR when notification of link-layer failures is not available (for example, with Fast Ethernet), or when the failure detection mechanisms provided by the link layer are not sufficient for the timely detection of node failures.

A node running Hello sends a Hello Request to a neighboring node every interval. If the receiving node is running Hello, it responds with Hello Ack. If four intervals pass and the sending node has not received an Ack or it receives a bad message, the sending node declares that the neighbor is down and notifies FRR.

There are two configurable parameters:

- Hello interval, by using the **ip rsvp signalling hello refresh interval** command
- Number of acknowledgment messages that are missed before the sending node declares that the neighbor is down, by using the **ip rsvp signalling hello refresh misses** command



Note If a router's CPU utilization is high due to frequent RSVP Hello processing, there may be false failures due to Hello messages that are not transmitted.

Hello Instance

A Hello instance implements RSVP Hello for a given router interface address and remote IP address. A Hello instance is expensive because of the large number of Hello requests that are sent and the strains they put on the router resources. Therefore, create a Hello instance only when it is necessary and delete it when it is no longer needed.

There are two types of Hello instances:

- Active Hello Instances
- Passive Hello Instances

Active Hello Instances

If a neighbor is unreachable when an LSP is ready to be fast rerouted, an active Hello instance is needed. Create an active Hello instance for each neighbor with at least one LSP in this state.

Active Hello instances periodically send Hello Request messages, and expect Hello Ack messages in response. If the expected Ack message is not received, the active Hello instance declares that the neighbor (remote IP address) is unreachable (lost). LSPs traversing that neighbor may be fast rerouted.

If there is a Hello instance with no LSPs for an unreachable neighbor, do not delete the Hello instance. Convert the active Hello instance to a passive Hello instance because there may be an active instance on the neighboring router that is sending Hello requests to this instance.

Passive Hello Instances

Passive Hello instances respond to Hello Request messages (sending Ack messages), but do not initiate Hello Request messages and do not cause LSPs to be fast rerouted. A router with multiple interfaces can run multiple Hello instances to different neighbors or to the same neighbor.

A passive Hello instance is created when a Hello Request is received from a neighbor with a source IP address/destination IP address pair in the IP header for which a Hello instance does not exist.

Delete passive instances if no Hello messages are received for this instance within 10 minutes.

Hello Commands

RSVP Hello comprises the following commands. For detailed command descriptions, refer to Cisco IOS Multiprotocol Label Switching Command Reference.

- RSVP Hello configuration commands
- RSVP Hello statistics commands
- RSVP Hello show commands
- RSVP Hello debug commands

Features of MPLS TE Link and Node Protection with RSVP Hellos Support

MPLS TE Link and Node Protection, with RSVP Hellos Support (with Fast Tunnel Interface Down Detection) includes the following features:

Backup Tunnel Support

Backup tunnel support has the following capabilities:

Backup Tunnels Can Terminate at the Next-Next Hop to Support FRR

Backup tunnel that terminates at the next-next hop router to protect both the downstream link and node to protect link and node failures. .

Multiple Backup Tunnels Can Protect the Same Interface

There is no limit (except memory limitations) to the number of backup tunnels that can protect a given interface. In many topologies, support for Node Protection requires supporting multiple backup tunnels per protected interface. These backup tunnels can terminate at the same destination or at different destinations. That is, for a given protected interface, you can configure multiple NHOP or NNHOP backup tunnels. This allows redundancy and load balancing.

In addition to being required for Node Protection, this feature provides the following benefits:

- Redundancy--If one backup tunnel is down, other backup tunnels protect LSPs.
- Increased backup capacity--If the protected interface is a high-capacity link and no single backup path exists with an equal capacity, multiple backup tunnels can protect that one high-capacity link. The LSPs using this link will fail over to different backup tunnels, allowing all of the LSPs to have adequate bandwidth protection during failure (rerouting). If bandwidth protection is not desired, the router spreads LSPs across all available backup tunnels (that is, there is load balancing across backup tunnels). .

Scalability

A backup tunnel is scalable because it can protect multiple LSPs and multiple interfaces. It provides many-to-one (N:1) protection, which has significant scalability advantages over one-to-one (1:1) protection, where a separate backup tunnel must be used for each LSP needing protection.

Example of 1:1 protection: When 5,000 backup tunnels protect 5,000 LSPs, each router along the backup path must maintain state for an additional 5,000 tunnels.

Example of N:1 protection: When one backup tunnel protects 5,000 LSPs, each router along the backup path maintains one additional tunnel.

Backup Bandwidth Protection

Backup bandwidth protection has the following capabilities:

Bandwidth Protection on Backup Tunnels

Rerouted LSPs not only have their packets delivered during a failure, but the quality of service can also be maintained.

Bandwidth Pool Specifications for Backup Tunnels

You can restrict the types of LSPs that can use a given backup tunnel. Backup tunnels can be restricted so that only LSPs using subpool bandwidth can use them or only LSPs that use global pool bandwidth can use them. This allows different backup tunnels to be used for voice and data. Example: The backup tunnel used for voice could provide bandwidth protection, and the backup tunnel used for data could (optionally) not provide bandwidth protection.

Semidynamic Backup Tunnel Paths

The path of a backup tunnel can be configured to be determined dynamically. This can be done by using the IP explicit address exclusion feature that was added in Release 12.0(14)ST. Using this feature, semidynamic NHOP backup tunnel paths can be specified simply by excluding the protected link; semidynamic NNHOP backup tunnel paths can be configured simply by excluding the protected node.

Prioritizing Which LSPs Obtain Backup Tunnels with Bandwidth Protection

In case there are not enough NHOP or NNHOP backup tunnels or they do not have enough backup bandwidth to protect all LSPs, you can give an LSP priority in obtaining backup tunnels with bandwidth protection. This is especially useful if you want to give LSPs carrying voice a higher priority than those carrying data.

To activate this feature, enter the **tunnel mpls traffic-eng fast-reroute bw-protect** command to set the “bandwidth protection desired” bit. See the configuration task *Enabling Fast Reroute on LSPs*. The LSPs do not necessarily *receive* bandwidth protection. They have a higher *chance* of receiving bandwidth protection if they need it.

LSPs that do not have the bandwidth protection bit set can be demoted. Demotion is when one or more LSPs are removed from their assigned backup tunnel to provide backup to an LSP that has its bandwidth protection bit set. Demotion occurs only when there is a scarcity of backup bandwidth.

When an LSP is demoted, it becomes unprotected (that is, it no longer has a backup tunnel). During the next periodic promotion cycle, an attempt is made to find the best possible backup tunnels for all LSPs that do not currently have protection, including the LSP that was demoted. The LSP may get protection at the same level or a lower level, or it may get no protection.

For information about how routers determine which LSPs to demote, see the "Backup Protection Preemption Algorithms" section.

RSVP Hello

RSVP Hello enables a router to detect when a neighboring node has gone down but its interface to that neighbor is still operational. This feature is useful when next-hop node failure is not detectable by link layer mechanisms, or when notification of link-layer failures is not available. This allows the router to switch LSPs onto its backup tunnels and avoid packet loss.

For a more detailed description of RSVP Hello, see the [RSVP Hello, on page 44](#).

Fast Reroute Operation

This section describes the following:

Fast Reroute Activation

Three mechanisms cause routers to switch LSPs onto their backup tunnels:

- Interface down notification
- Loss of Signal
- RSVP Hello neighbor down notification

When a router's link or neighboring node fails, the router often detects this failure by an interface down notification. On a Packet over SONET (POS) interface, this notification is very fast. When a router notices that an interface has gone down, it switches LSPs going out that interface onto their respective backup tunnels (if any).

Unlike POS interfaces, Gigabit Ethernet does not have any alarms to detect link failures. If a link is down due to a cut cable or because the remote end shuts its laser, the optics module (GBIC or SFPs) on the Gigabit Ethernet card detects a loss of signal (LOS). The LOS is used as a mechanism to detect the failure and begin the switchover.

RSVP Hellos can also be used to trigger FRR. If RSVP Hellos are configured on an interface, messages are periodically sent to the neighboring router. If no response is received, Hellos declare that the neighbor is down. This causes any LSPs going out that interface to be switched to their respective backup tunnels.

Fast Reroute also works over ATM interfaces. The interfaces must use RSVP Hello to detect failures.

Backup Tunnels Terminating at Different Destinations

The figure below illustrates an interface that has multiple backup tunnels terminating at different destinations and demonstrates why, in many topologies, support for Node Protection requires supporting multiple backup tunnels per protected interface.

Figure 10: Backup Tunnels that Terminate at Different Destinations

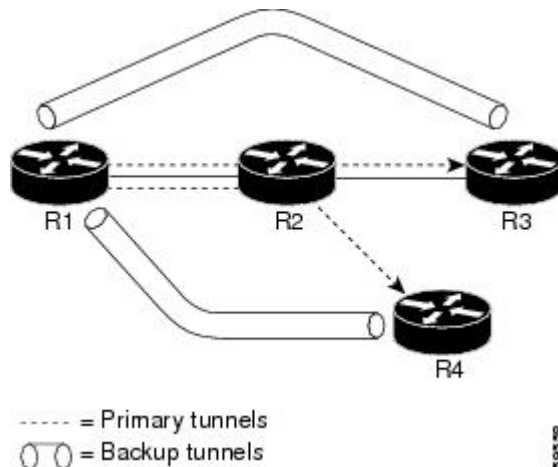

In this illustration, a single interface on R1 requires multiple backup tunnels. LSPs traverse the following routes:

- R1, R2, R3
- R1, R2, R4

To provide protection if node R2 fails, two NNHOP backup tunnels are required: one terminating at R3 and one terminating at R4.

Backup Tunnels Terminating at the Same Destination

The figure below shows how backup tunnels terminating at the same location can be used for redundancy and load balancing. Redundancy and load balancing work for both NHOP and NNHOP backup tunnels.

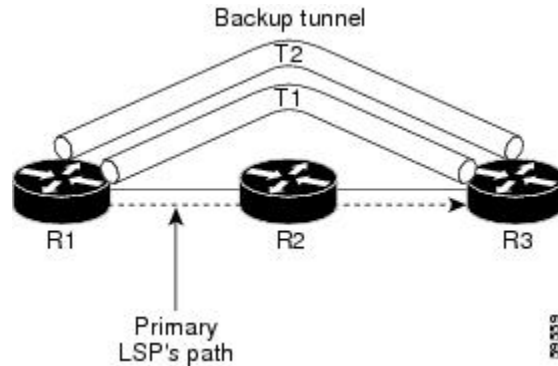

In this illustration, there are three routers: R1, R2, and R3. At R1, there are two NNHOP backup tunnels (T1 and T2) that go from R1 to R3 without traversing R2.

With redundancy, if R2 fails or the link from R1 to R2 fails, either backup tunnel can be used. If one backup tunnel is down, the other can be used. LSPs are assigned to backup tunnels when the LSPs are first established. This is done before a failure.

With load balancing, if neither backup tunnel has enough bandwidth to back up all LSPs, both tunnels can be used. Some LSPs will use one backup tunnel, other LSPs will use the other backup tunnel. The router decides the best way to fit the LSPs onto the backup tunnels.

Backup Tunnel Selection Procedure

When an LSP is signaled, each node along the LSP path that provides FRR protection for the LSP selects a backup tunnel for the LSP to use if either of the following events occurs:

- The link to the next hop fails.
- The next hop fails.

By having the node select the backup tunnel for an LSP before a failure occurs, the LSP can be rerouted onto the backup tunnel quickly if there is a failure.

For an LSP to be mapped to a backup tunnel, all of the following conditions must exist:

- The LSP is protected by FRR; that is, the LSP is configured with the **tunnel mpls traffic-eng fast-reroute** command.
- The backup tunnel is up.
- The backup tunnel is configured to have an IP address, typically a loopback address.
- The backup tunnel is configured to protect this LSP's outgoing interface; that is, the interface is configured with the **mpls traffic-eng backup-path** command.
- The backup tunnel does not traverse the LSP's protected interface.
- The backup tunnel terminates at the LSP's NHOP or NNHOP. If it is an NNHOP tunnel, it does not traverse the LSP's NHOP.

- The bandwidth protection requirements and constraints, if any, for the LSP and backup tunnel are met. For information about bandwidth protection considerations, see the [Bandwidth Protection, on page 11](#).

Bandwidth Protection

A backup tunnel can be configured to protect two types of backup bandwidth:

- Limited backup bandwidth--A backup tunnel provides bandwidth protection. The sum of the bandwidth of all LSPs using this backup tunnel cannot exceed the backup tunnel's backup bandwidth. When assigning LSPs to this type of backup tunnel, sufficient backup bandwidth must exist.
- Unlimited backup bandwidth--The backup tunnel does not provide any bandwidth protection (that is, best-effort protection exists). There is no limit to the amount of bandwidth used by the LSPs that are mapped to this backup tunnel. LSPs that allocate zero bandwidth can only use backup tunnels that have unlimited backup bandwidth.

Load Balancing on Limited-bandwidth Backup Tunnels

There may be more than one backup tunnel that has sufficient backup bandwidth to protect a given LSP. In this case, the router chooses the one that has the least amount of backup bandwidth available. This algorithm limits fragmentation, maintaining the largest amount of backup bandwidth available.

Specifying limited backup bandwidth does not “guarantee” bandwidth protection if there is a link or node failure. For example, the set of NHOP and NNHOP backup tunnels that gets triggered when an interface fails may all share some link on the network topology, and this link may not have sufficient bandwidth to support all LSPs using this set of backup tunnels.

In the figure below, both backup tunnels traverse the same links and hop. When the link between routers R1 and R4 fails, backup tunnels for primary tunnel 1 and primary tunnel 2 are triggered simultaneously. The two backup tunnels may share a link in the network.

Figure 11: Backup Tunnels Share a Link

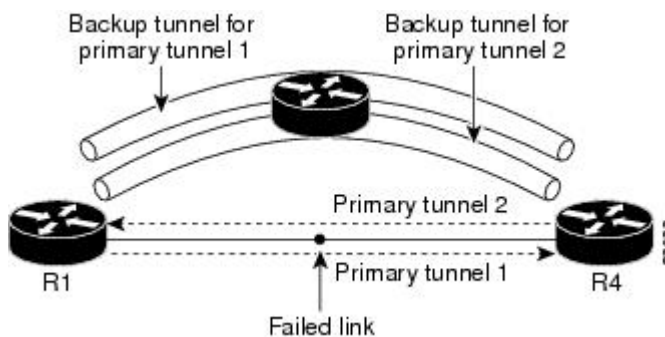

In the figure below, the backup tunnel for primary tunnel 1 may traverse routers R1-R2-R3-R4, and the backup tunnel for primary tunnel 2 may traverse routers R4-R2-R3-R1. In this case, the link R2-R3 may get overloaded if R1-R4 fails.

Figure 12: Overloaded Link

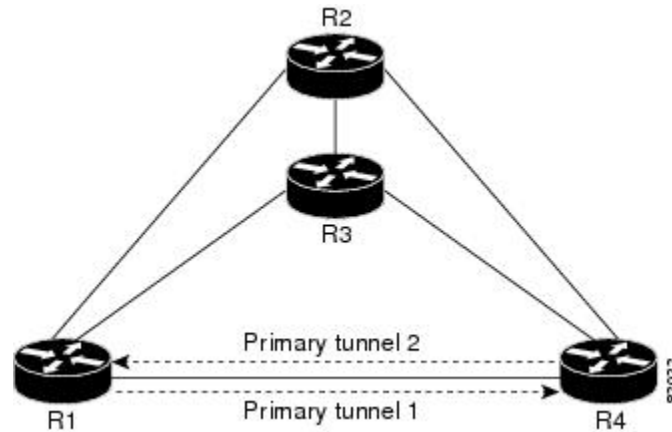

Load Balancing on Unlimited-bandwidth Backup Tunnels

More than one backup tunnel, each having unlimited backup bandwidth, can protect a given interface. In this case, when choosing a backup tunnel for a given LSP, the router chooses the backup tunnel that has the least amount of backup bandwidth in use. This algorithm evenly distributes the LSPs across backup tunnels based on LSP's bandwidth. If an LSP is requesting zero bandwidth, the router chooses the backup tunnel that is currently protecting the fewest LSPs.

Pool Type and Backup Tunnels

By default, a backup tunnel provides protection for LSPs that allocate from any pool (that is, global or subpool). However, a backup tunnel can be configured to protect only LSPs that use global pool bandwidth, or only those that use subpool bandwidth.

Tunnel Selection Priorities

This section describes the following:

NHOP Versus NNHOP Backup Tunnels

More than one backup tunnel can protect a given LSP, where one backup tunnel terminates at the LSP's NNHOP, and the other terminates at the LSP's NHOP. In this case, the router chooses the backup tunnel that terminates at the NNHOP (that is, FRR prefers NNHOP over NHOP backup tunnels).

The table below lists the tunnel selection priorities. The first choice is an NNHOP backup tunnel that acquires its bandwidth from a subpool or global pool, and has limited bandwidth. If there is no such backup tunnel, the next choice (2) is a next-next hop backup tunnel that acquires a limited amount of bandwidth from any pool. The preferences go from 1 (best) to 8 (worst), where choice 3 is for an NNHOP backup tunnel with an unlimited amount of subpool or global pool bandwidth.

Table 4: Tunnel Selection Priorities

Preference	Backup Tunnel Destination	Bandwidth Pool	Bandwidth Amount
1 (Best)	NNHOP	Subpool or global pool	Limited
2	NNHOP	Any	Limited

Preference	Backup Tunnel Destination	Bandwidth Pool	Bandwidth Amount
3	NNHOP	Subpool or global pool	Unlimited
4	NNHOP	Any	Unlimited
5	NHOP	Subpool or global pool	Limited
6	NHOP	Any	Limited
7	NHOP	Subpool or global pool	Unlimited
8 (Worst)	NHOP	Any	Unlimited

The figure below shows an example of the backup tunnel selection procedure based on the designated amount of global pool and subpool bandwidth currently available.



Note If NHOP and NNHOP backup tunnels do not have sufficient backup bandwidth, no consideration is given to the type of data that the LSP is carrying. For example, a voice LSP may not be protected unless it is signalled before a data LSP. To prioritize backup tunnel usage, see the "Backup Protection Preemption Algorithms" section.

Figure 13: Choosing from Among Multiple Backup Tunnels

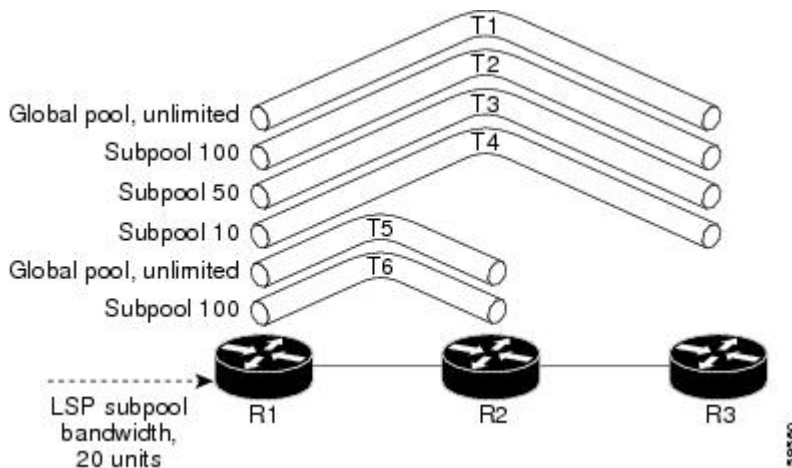

In this example, an LSP requires 20 units (kilobits per second) of subpool backup bandwidth. The best backup tunnel is selected as follows:

1. Backup tunnels T1 through T4 are considered first because they terminate at the NNHOP.
2. Tunnel T4 is eliminated because it only has 10 units of subpool backup bandwidth.
3. Tunnel T1 is eliminated because it protects only LSPs using global pool bandwidth.
4. Tunnel T3 is chosen over T2 because, although both have sufficient backup bandwidth, T3 has the least backup bandwidth available (leaving the most backup bandwidth available on T2).

5. Tunnels T5 and T6 need not be considered because they terminate at an NHOP, and therefore are less desirable than T3, which terminates at an NNHOP.

Promotion

After a backup tunnel has been chosen for an LSP, conditions may change that will cause us to reevaluate this choice. This reevaluation, if successful, is called promotion. Such conditions may include:

1. A new backup tunnel comes up.
2. The currently chosen backup tunnel for this LSP goes down.
3. A backup tunnel's available backup bandwidth increases. For example, an LSP protected by the tunnel has been reoptimized by the headend to use another path.
4. A backup tunnel's available backup-bandwidth decreases.

For cases 1 and 2, the LSP's backup tunnel is evaluated immediately. Cases 3 and 4 are addressed by periodically reevaluating LSP-to-backup tunnel mappings. By default, background reevaluation is performed every 5 minutes. This interval is configurable via the **mpls traffic-eng fast-reroute timers** command.

The response to case 4 is as follows:

When the backup tunnel's bandwidth is reduced, promotion will *not* be run so long as the remaining bandwidth is greater than the sum of the bandwidths of all primary paths for which this tunnel is the backup. This policy prevents unnecessary disruption of protection of the primary paths.

When the backup tunnel's bandwidth *does* fall below the required bandwidth needed for it to substitute for all primary paths to which it has been assigned, promotion is run.

Backup Protection Preemption Algorithms

When you set the "bandwidth protection desired" bit for an LSP, the LSP has a higher right to select backup tunnels that provide bandwidth protection and it can preempt other LSPs that do not have that bit set.

If there is insufficient backup bandwidth on NNHOP backup tunnels but not on NHOP backup tunnels, the bandwidth-protected LSP does not preempt NNHOP LSPs; it uses NHOP protection.

If there are multiple LSPs using a given backup tunnel and one or more must be demoted to provide bandwidth, there are two user-configurable methods (algorithms) that the router can use to determine which LSPs are demoted.

- Minimize amount of bandwidth that is wasted.
- Minimize the number of LSPs that are demoted.

For example, If you need 10 units of backup bandwidth on a backup tunnel, you can demote one of the following:

- A single LSP using 100 units of bandwidth--Makes available more bandwidth than needed, but results in lots of waste
- Ten LSPs, each using one unit of bandwidth--Results in no wasted bandwidth, but affects more LSPs

The default algorithm minimizes the number of LSPs that are demoted. To change the algorithm to minimize the amount of bandwidth that is wasted, enter the **mpls traffic-eng fast-reroute backup-prot-preemption optimize-bw** command.

Bandwidth Protection Considerations

There are numerous ways in which bandwidth protection can be ensured. The table below describes the advantages and disadvantages of three methods.

Table 5: Bandwidth Protection Methods

Method	Advantages	Disadvantages
Reserve bandwidth for backup tunnels explicitly.	It is simple.	It is a challenge to allow bandwidth sharing of backup tunnels protecting against independent failures.
Use backup tunnels that are signaled with zero bandwidth.	It provides a way to share bandwidth used for protection against independent failures, so it ensures more economical bandwidth usage.	It may be complicated to determine the proper placement of zero bandwidth tunnels.
Backup bandwidth protection	Ensures bandwidth protection for voice traffic.	An LSP that does not have backup bandwidth protection can be demoted at any time if there is not enough backup bandwidth and an LSP that has backup bandwidth protection needs bandwidth.

Cisco implementation of FRR does not mandate a particular approach, and it provides the flexibility to use any of the above approaches. However, given a range of configuration choices, be sure that the choices are constant with a particular bandwidth protection strategy.

The following sections describe some important issues in choosing an appropriate configuration:

Backup Tunnels with Explicitly Signaled Bandwidth

There are two bandwidth parameters that must be set for a backup tunnel:

- actual signaled bandwidth
- backup-bandwidth

To signal bandwidth requirements of a backup tunnel, configure the bandwidth of the backup tunnel by using the **tunnel mpls traffic-eng bandwidth** command.

To configure the backup bandwidth of the backup tunnel, use the **tunnel mpls traffic-eng backup-bw** command.

The signaled bandwidth is used by the LSRs on the path of the backup tunnel to perform admission control and do appropriate bandwidth accounting.

The backup bandwidth is used by the PLR (the headend of the backup tunnel) to decide how much primary traffic can be rerouted to this backup tunnel if there is a failure.

Both parameters need to be set to ensure proper operation. The numerical value of the signaled bandwidth and the backup-bandwidth should be the same.

Protected Bandwidth Pools and the Bandwidth Pool from Which the Backup Tunnel Reserves Its Bandwidth

The `tunnel mpls traffic-eng bandwidth` command allows you to configure the following:

- Amount of bandwidth a backup tunnel reserves
- The DS-TE bandwidth pool from which the bandwidth needs to be reserved



Note Only one pool can be selected (that is, the backup tunnel can explicitly reserve bandwidth from either the global pool or the subpool, but not both).

The `tunnel mpls traffic-eng backup-bw` command allows you to specify the bandwidth pool to which the traffic must belong for the traffic to use this backup tunnel. Multiple pools are allowed.

There is no direct correspondence between the bandwidth pool that is protected and the bandwidth pool from which the bandwidth of the backup tunnel draws its bandwidth.

Example: In this example, assume the following:

- Bandwidth protection is desired only for subpool traffic, but the best-effort traffic using the global pool does not require bandwidth protection.
- Scheduling is configured so that subpool traffic uses the priority queue, and global pool traffic is served at a lower priority.

Bandwidth protection for 10 Kbps of subpool traffic on a given link can be achieved by any of the following combinations:

- `tunnel mpls traffic-eng bandwidth sub-pool 10`

`tunnel mpls traffic-eng backup-bw sub-pool 10`

- `tunnel mpls traffic-eng bandwidth global-pool 10`

`tunnel mpls traffic-eng backup-bw sub-pool 10 global-pool unlimited`

- `tunnel mpls traffic-eng bandwidth global-pool 40`

`tunnel mpls traffic-eng backup-bw sub-pool 10 global-pool 30`

Backup Tunnels Signaled with Zero Bandwidth

Frequently it is desirable to use backup tunnels with zero signaled bandwidth, even when bandwidth protection is required. It may seem that if no bandwidth is explicitly reserved, no bandwidth guarantees can be provided. However, that is not necessarily true.

In the following situation:

- Only link protection is desired.
- Bandwidth protection is desired only for subpool traffic.

For each protected link AB with a max reservable subpool value of S, there may be a path from node A to node B such that the difference between max reservable global and max reservable subpool is at least S. If it is possible to find such paths for each link in the network, you can establish all the backup tunnels along such paths without any bandwidth reservations. If there is a single link failure, only one backup tunnel will use any

link on its path. Because that path has at least S of available bandwidth (in the global pool), assuming that marking and scheduling is configured to classify the subpool traffic into a priority queue, the subpool bandwidth is guaranteed.

The above approach allows sharing of the global pool bandwidth between backup tunnels protecting independent link failures. The backup tunnels are expected to be used for only a short period of time after a failure (until the headends of affected LSPs reroute those LSPs to other paths with available subpool bandwidth). The probability of multiple unrelated link failures is very small (in the absence of node or SRLG failures, which result in multiple link failures). Therefore, it is reasonable to assume that link failures are in practice independent with high probability. This “independent failure assumption” in combination with backup tunnels signaled without explicit bandwidth reservation enables efficient bandwidth sharing that yields substantial bandwidth savings.

Backup tunnels protecting the subpool traffic do not draw bandwidth from any pool. Primary traffic using the global pool can use the entire global pool, and primary traffic using the subpool can use the entire subpool. Yet, subpool traffic has a complete bandwidth guarantee if there is a single link failure.

A similar approach can be used for node and SRLG protection. However, the decision of where to put the backup tunnels is more complicated because both node and SRLG failures effectively result in the simultaneous failure of several links. Therefore, the backup tunnels protecting traffic traversing all affected links cannot be computed independently of each other. The backup tunnels protecting groups of links corresponding to different failures can still be computed independently of each other, which results in similar bandwidth savings.

Signaled Bandwidth Versus Backup Bandwidth

Backup bandwidth is used locally (by the router that is the headend of the backup tunnel) to determine which, and how many, primary LSPs can be rerouted on a particular backup tunnel. The router ensures that the combined bandwidth requirement of these LSPs does not exceed the backup bandwidth.

Therefore, even when the backup tunnel is signaled with zero bandwidth, the backup bandwidth must be configured with the value corresponding to the actual bandwidth requirement of the traffic protected by this backup tunnel. Unlike the case when bandwidth requirements of the backup tunnels are explicitly signaled, the value of the signaled bandwidth (which is zero) is not the same value as the backup bandwidth.

How to Configure MPLS TE Link and Node Protection with RSVP Hellos Support

This section assumes that you want to add FRR protection to a network in which MPLS TE LSPs are configured.

Make sure that the following tasks have been performed before you perform the configuration tasks, but you do not have to already have configured MPLS TE tunnels:

- Enabled MPLS TE on all relevant routers and interfaces
- Configured MPLS TE tunnels

To review how to configure MPLS TE tunnels, see the Cisco IOS XE Multiprotocol Label Switching Configuration Guide.

The following sections describe how to use FRR to protect LSPs in your network from link or node failures. Each task is identified as either required or optional.



Note You can perform the configuration tasks in any order.



Note An NNHOP backup tunnel must *not* go via the NHOP.

Enabling Fast Reroute on LSPs

LSPs can use backup tunnels only if they have been configured as fast reroutable. To enable fast reroute on an LSP, perform the following task. Enter the commands at the headend of each LSP.

SUMMARY STEPS

1. **enable**
2. **configure terminal**
3. **interface tunnel** *number*
4. **tunnel mpls traffic-eng fast-reroute** [bw-protect] [node-protect]
5. **end**

DETAILED STEPS

	Command or Action	Purpose
Step 1	enable Example: Router> enable	Enables privileged EXEC mode. <ul style="list-style-type: none"> • Enter your password if prompted.
Step 2	configure terminal Example: Router# configure terminal	Enters global configuration mode.
Step 3	interface tunnel <i>number</i> Example: Router(config)# interface tunnel 1000	Enters interface configuration mode for the specified tunnel.
Step 4	tunnel mpls traffic-eng fast-reroute [bw-protect] [node-protect] Example: Router(config-if)# tunnel mpls traffic-eng fast-reroute bw-protect node-protect	Enables an MPLS TE tunnel to use an established backup tunnel if there is a link or node failure.

	Command or Action	Purpose
Step 5	end Example: Router(config-if)# end	Exits to privileged EXEC mode.

Creating a Backup Tunnel to the Next Hop or to the Next-Next Hop

To create a backup tunnel to the next hop or to the next-next hop, perform the following task. Enter the commands on the node that will be the headend of the backup tunnel (that is, the node whose downstream link or node may fail).

Creating a backup tunnel is basically no different from creating any other tunnel. None of the commands below is new.



Note When using the **exclude-address** command to specify the path for a backup tunnel, you must exclude an interface address to avoid a link (for creating an NHOP backup tunnel), or a router-ID address to avoid a node (for creating an NNHOP backup tunnel).

SUMMARY STEPS

1. **enable**
2. **configure terminal**
3. **interface tunnel** *number*
4. **ip unnumbered** *type number*
5. **tunnel destination** *A.B.C.D*
6. **tunnel mode mpls traffic-eng**
7. **tunnel mpls traffic-eng path-option** *number* {**dynamic** | **explicit** {**name** *path-name* | *path-number*}}
8. **ip explicit-path name** *name*
9. **exclude-address** *address*
10. **end**

DETAILED STEPS

	Command or Action	Purpose
Step 1	enable Example: Router> enable	Enables privileged EXEC mode. <ul style="list-style-type: none"> • Enter your password if prompted.
Step 2	configure terminal Example: Router# configure terminal	Enters global configuration mode.

	Command or Action	Purpose
Step 3	interface tunnel <i>number</i> Example: <pre>Router(config)# interface tunnel 1</pre>	Creates a new tunnel interface and enters interface configuration mode.
Step 4	ip unnumbered <i>type number</i> Example: <pre>Router(config-if)# ip unnumbered loopback0</pre>	Gives the tunnel interface an IP address that is the same as that of interface Loopback0. Note This command is not effective until Loopback0 has been configured with an IP address.
Step 5	tunnel destination <i>A.B.C.D</i> Example: <pre>Router(config-if)# tunnel destination 10.3.3.3</pre>	Specifies the IP address of the device where the tunnel will terminate. <ul style="list-style-type: none"> • That address should be the router ID of the device that is the NHOP or NNHOP of LSPs to be protected.
Step 6	tunnel mode mpls traffic-eng Example: <pre>Router(config-if)# tunnel mode mpls traffic-eng</pre>	Sets encapsulation mode of the tunnel to MPLS TE.
Step 7	tunnel mpls traffic-eng path-option <i>number</i> { dynamic explicit { <i>name path-name</i> <i>path-number</i> }} [lockdown] Example: <pre>Router(config-if)# tunnel mpls traffic-eng path-option 300 explicit name avoid-protected-link</pre>	Configures a path option for an MPLS TE tunnel.
Step 8	ip explicit-path name <i>name</i> Example: <pre>Router(config)# ip explicit-path name avoid-protected-link</pre>	Enters the subcommand mode for IP explicit paths to create the named path.
Step 9	exclude-address <i>address</i> Example: <pre>Router(cfg-ip-expl-path)# exclude-address 10.3.3.3</pre>	For Link Protection, specifies the IP address of the link to be protected. <ul style="list-style-type: none"> • For Node Protection, this command specifies the router ID of the node to be protected. Note Backup tunnel paths can be dynamic or explicit and they do not have to use exclude-address. Because backup tunnels must avoid the protected link or node, it is convenient to use an exclude-address.
Step 10	end Example:	Exits to privileged EXEC mode.

	Command or Action	Purpose
	Router(cfg-ip-expl-path)# end	

Assigning Backup Tunnels to a Protected Interface

To assign one or more backup tunnels to a protected interface, perform the following task. Enter the following commands on the node that will be the headend of the backup tunnel (that is, the node whose downstream link or node may fail).



Note You must configure the interface to have an IP address and to enable the MPLS TE tunnel feature.

SUMMARY STEPS

1. **enable**
2. **configure terminal**
3. **interface** *type slot / subslot / port* [, *subinterface-number*]
4. **mpls traffic-eng backup-path tunnel** *tunnel-id*
5. **end**

DETAILED STEPS

	Command or Action	Purpose
Step 1	enable Example: Router> enable	Enables privileged EXEC mode. <ul style="list-style-type: none"> • Enter your password if prompted.
Step 2	configure terminal Example: Router# configure terminal	Enters global configuration mode.
Step 3	interface <i>type slot / subslot / port</i> [, <i>subinterface-number</i>] Example: Router(config)# interface POS1/0/0	Configures an interface type and enters interface configuration mode. <ul style="list-style-type: none"> • The <i>type</i> argument is the type of interface to be configured. • The <i>slot</i> argument is the chassis slot number. Refer to the appropriate hardware manual for slot information. For SIPs, refer to the platform-specific SPA hardware installation guide or the corresponding “Identifying Slots and Subslots for SIPs and SPAs” topic in the platform-specific SPA software configuration guide.

	Command or Action	Purpose
		<ul style="list-style-type: none"> The <code>/ subslot</code> keyword and argument pair is the secondary slot number on a SIP where a SPA is installed. The slash (<code>/</code>) is required. <p>Refer to the platform-specific SPA hardware installation guide and the corresponding “Specifying the Interface Address on a SPA” topic in the platform-specific SPA software configuration guide for subslot information.</p> <ul style="list-style-type: none"> The <code>/ port</code> keyword and argument pair is the port or interface number. The slash (<code>/</code>) is required. <p>Refer to the appropriate hardware manual for port information. For SPAs, refer to the corresponding “Specifying the Interface Address on a SPA” topics in the platform-specific SPA software configuration guide</p> <ul style="list-style-type: none"> The <code>. subinterface-number</code> keyword and argument pair is the subinterface number in the range 1 to 4294967293. The number that precedes the period (<code>.</code>) must match the number to which this subinterface belongs.
Step 4	<p>mpls traffic-eng backup-path tunnel <i>tunnel-id</i></p> <p>Example:</p> <pre>Router(config-if)# mpls traffic-eng backup-path tunnel2</pre>	<p>Allows LSPs going out this interface to use this backup tunnel if there is a link or node failure.</p> <p>Note You can enter this command multiple times to associate multiple backup tunnels with the same protected interface.</p>
Step 5	<p>end</p> <p>Example:</p> <pre>Router(config-if)# end</pre>	<p>Exits to privileged EXEC mode.</p>

Associating Backup Bandwidth and Pool Type with a Backup Tunnel

To associate backup bandwidth with a backup tunnel and designate the type of LSP that can use a backup tunnel, perform the following task.

SUMMARY STEPS

1. **enable**
2. **configure terminal**
3. **interface tunnel** *number*
4. **tunnel mpls traffic-eng backup-bw** *{bandwidth | [sub-pool {bandwidth | unlimited}] [global-pool {bandwidth | unlimited}]}* *[any {bandwidth | unlimited}]*
5. **end**

DETAILED STEPS

	Command or Action	Purpose
Step 1	enable Example: <pre>Router> enable</pre>	Enables privileged EXEC mode. <ul style="list-style-type: none"> • Enter your password if prompted.
Step 2	configure terminal Example: <pre>Router# configure terminal</pre>	Enters global configuration mode.
Step 3	interface tunnel <i>number</i> Example: <pre>Router(config)# interface tunnel 2</pre>	Enters interface configuration mode for the specified tunnel.
Step 4	tunnel mpls traffic-eng backup-bw <i>{bandwidth [sub-pool {bandwidth unlimited}][global-pool {bandwidth unlimited}]} [any {bandwidth unlimited}]</i> Example: <pre>Router(config-if)# tunnel mpls traffic-eng backup-bw sub-pool 1000</pre>	Associates bandwidth with a backup tunnel and designates whether LSPs that allocate bandwidth from the specified pool can use the tunnel.
Step 5	end Example: <pre>Router(config-if)# end</pre>	Exits to privileged EXEC mode.

Configuring Backup Bandwidth Protection

To configure the backup bandwidth protection, perform the following task.

SUMMARY STEPS

1. **enable**
2. **configure terminal**
3. **interface tunnel *number***
4. **tunnel mpls traffic-eng fast-reroute [bw-protect]**
5. **exit**
6. **mpls traffic-eng fast-reroute backup-prot-preemption [optimize-bw]**
7. **exit**

DETAILED STEPS

	Command or Action	Purpose
Step 1	enable Example: <pre>Router> enable</pre>	Enables privileged EXEC mode. <ul style="list-style-type: none"> • Enter your password if prompted.
Step 2	configure terminal Example: <pre>Router# configure terminal</pre>	Enters global configuration mode.
Step 3	interface tunnel <i>number</i> Example: <pre>Router(config)# interface tunnel 2</pre>	Enters interface configuration mode for the specified tunnel.
Step 4	tunnel mpls traffic-eng fast-reroute [bw-protect] Example: <pre>Router(config-if)# tunnel mpls traffic-eng fast-reroute bw-protect</pre>	Enables an MPLS TE tunnel to use an established backup tunnel in the event of a link or node failure. <ul style="list-style-type: none"> • The bw-protect keyword gives an LSP priority for using backup tunnels with bandwidth protection.
Step 5	exit Example: <pre>Router(config-if)# exit</pre>	Exits to global configuration mode.
Step 6	mpls traffic-eng fast-reroute backup-prot-preemption [optimize-bw] Example: <pre>Router(config)# mpls traffic-eng fast-reroute backup-prot-preemption optimize-bw</pre>	Changes the backup protection preemption algorithm from minimize the number of LSPs that are demoted to minimize the amount of bandwidth that is wasted.
Step 7	exit Example: <pre>Router(config-if)# exit</pre>	Exits to privileged EXEC mode.

Configuring an Interface for Fast Link and Node Failure Detection

To configure an interface for fast link and node failure detection, perform the following task.

SUMMARY STEPS

1. **enable**
2. **configure terminal**

3. `interface type slot / subslot / port [. subinterface-number]`
4. `pos ais-shut`
5. `pos report {b1-tca | b2-tca | b3-tca | lais | lrldi | pais | plop | prdi | rdool | sd-ber | sf-ber | slof | slo}`
6. `end`

DETAILED STEPS

	Command or Action	Purpose
Step 1	enable Example: <pre>Router> enable</pre>	Enables privileged EXEC mode. <ul style="list-style-type: none"> • Enter your password if prompted.
Step 2	configure terminal Example: <pre>Router# configure terminal</pre>	Enters global configuration mode.
Step 3	interface type slot / subslot / port [. subinterface-number] Example: <pre>Router(config)# interface pos0/0/0</pre>	Configures an interface type and enters interface configuration mode.
Step 4	pos ais-shut Example: <pre>Router(config-if)# pos ais-shut</pre>	Sends the line alarm indication signal (LAIS) when the Packet-over-SONET (POS) interface is placed in any administrative shutdown state.
Step 5	pos report {b1-tca b2-tca b3-tca lais lrldi pais plop prdi rdool sd-ber sf-ber slof slo} Example: <pre>Router(config-if)# pos report lrldi</pre>	Permits selected SONET alarms to be logged to the console for a POS interface.
Step 6	end Example: <pre>Router(config-if)# end</pre>	Exits to privileged EXEC mode.

Configuring an Interface for Fast Tunnel Interface Down

To configure an interface for fast tunnel interface down, perform the following steps.

SUMMARY STEPS

1. `enable`
2. `configure terminal`

3. **interface tunnel** *number*
4. **tunnel mpls traffic-eng interface down delay** *time*
5. **end**

DETAILED STEPS

	Command or Action	Purpose
Step 1	enable Example: <pre>Router> enable</pre>	Enables privileged EXEC mode. <ul style="list-style-type: none"> • Enter your password if prompted.
Step 2	configure terminal Example: <pre>Router# configure terminal</pre>	Enters global configuration mode.
Step 3	interface tunnel <i>number</i> Example: <pre>Router(config)# interface tunnel 1000</pre>	Configures an interface type and enters interface configuration mode.
Step 4	tunnel mpls traffic-eng interface down delay <i>time</i> Example: <pre>Router(config-if)# tunnel mpls traffic-eng interface down delay 0</pre>	Forces a tunnel to go down as soon as the headend router detects that the LSP is down.
Step 5	end Example: <pre>Router(config-if)# end</pre>	Exits to privileged EXEC mode.

Verifying That Fast Reroute Is Operational

To verify that FRR can function, perform the following task.

SUMMARY STEPS

1. **show mpls traffic-eng tunnels brief**
2. **show ip rsvp sender detail**
3. **show mpls traffic-eng fast-reroute database**
4. **show mpls traffic-eng tunnels backup**
5. **show mpls traffic-eng fast-reroute database**
6. **show ip rsvp reservation**

DETAILED STEPS

Step 1 show mpls traffic-eng tunnels brief

Use this command to verify that backup tunnels are up:

Example:

```
Router# show mpls traffic-eng tunnels brief

Signalling Summary:
  LSP Tunnels Process:      running
  RSVP Process:            running
  Forwarding:              enabled
  Periodic reoptimization: every 3600 seconds, next in 1706 seconds
TUNNEL NAME                DESTINATION    UP IF    DOWN IF    STATE/PROT
Router_t1                  10.112.0.12   -        PO2/0/1   up/up
Router_t2                  10.112.0.12   -        unknown   up/down
Router_t3                  10.112.0.12   -        unknown   admin-down
Router_t1000               10.110.0.10   -        unknown   up/down
Router_t2000               10.110.0.10   -        PO2/0/1   up/up
Displayed 5 (of 5) heads, 0 (of 0) midpoints, 0 (of 0) tails
```

Step 2 show ip rsvp sender detail

Use this command to verify that LSPs are protected by the appropriate backup tunnels.

Following is sample output from the **show ip rsvp sender detail** command when the command is entered at the PLR before a failure:

Example:

```
Router# show ip rsvp sender detail

PATH:
Tun Dest:  10.10.0.6  Tun ID: 100  Ext Tun ID: 10.10.0.1
Tun Sender: 10.10.0.1  LSP ID: 31
Path refreshes:
  arriving: from PHOP 10.10.7.1 on FE0/0/0 every 30000 msecs
Session Attr:
  Setup Prio: 7, Holding Prio: 7
  Flags: (0x7) Local Prot desired, Label Recording, SE Style
  session Name: Rl_t100
ERO: (incoming)
  10.10.7.2 (Strict IPv4 Prefix, 8 bytes, /32)
  10.10.0.6 (Strict IPv4 Prefix, 8 bytes, /32)
RRO:
  10.10.7.1/32, Flags:0x0 (No Local Protection)
  10.10.4.1/32, Flags:0x9 (Local Prot Avail/to NNHOP) !Available to NNHOP
  10.10.1.1/32, Flags:0x0 (No Local Protection)
Traffic params - Rate: 10K bits/sec, Max. burst: 1K bytes
  Min Policed Unit: 0 bytes, Max Pkt Size 4294967295 bytes
Fast-Reroute Backup info:
  Inbound FRR: Not active
  Outbound FRR: No backup tunnel selected
Path ID handle: 50000416.
Incoming policy: Accepted. Policy source(s): MPLS/TE
Status: Proxy-terminated
```

Step 3 show mpls traffic-eng fast-reroute database

Enter the **clear ip rsvp hello instance counters** command to verify the following:

- MPLS TE FRR Node Protection has been enabled.
- A certain type of LSP can use a backup tunnel.

The following command output displays the LSPs that are protected:

Example:

```
Router# show mpls traffic-eng fast-reroute database
Tunnel head end item frr information:
Protected tunnel      In-label Out intf/label      FRR intf/label      Status
Tunnel500            Tun hd   AT2/0/0.100:Untagg Tu501:20             ready
Prefix item frr information:
Prefix               Tunnel   In-label Out intf/label      FRR intf/label      Status
10.0.0.8/32          Tu500   18      AT2/0/0.100:Pop ta Tu501:20             ready
10.0.8.8/32          Tu500   19      AT2/0/0.100:Untagg Tu501:20             ready
10.8.9.0/24          Tu500   22      AT2/0/0.100:Untagg Tu501:20             ready
LSP midpoint item frr information:
LSP identifier       In-label Out intf/label      FRR intf/label      Status
```

If LDP is not enabled, separate prefix items are not shown because all prefixes then use a single rewrite. To confirm that a particular IP prefix is FRR protected, even though it is not shown in this display, enter it within the **show mpls forwarding-table ip-address detail** command. The final line of the display will tell whether that prefix is protected:

Example:

```
Router# show mpls forwarding-table 10.0.0.11 32 detail
Local   Outgoing   Prefix           Bytes tag   Outgoing   Next Hop
tag     tag or VC  or Tunnel Id    switched   interface
Tun hd  Untagged  10.0.0.11/32    48
      point2point
      MAC/Encaps=4/8, MTU=1520, Tag Stack(22)
      48D18847 00016000
      No output feature configured
      Fast Reroute Protection via (Tu0, outgoing label 12304)
```

The following command output displays the LSPs that are protected when the FRR *backup* tunnel is over an ATM interface:

Example:

```
Router# show mpls traffic-eng fast-reroute database
Tunnel head end item frr information:
Protected tunnel In-label Out intf/label FRR intf/label Status
Tunnel500 Tun hd PO0/2/0:Untagged Tu501:20 ready
Prefix item frr information:
Prefix Tunnel In-label Out intf/label FRR intf/label Status
10.0.0.8/32 Tu500 18 PO0/2/0:Pop tag Tu501:20 ready
10.0.8.8/32 Tu500 19 PO0/2/0:Untagged Tu501:20 ready
10.8.9.0/24 Tu500 22 PO0/2/0:Untagged Tu501:20 ready
LSP midpoint item frr information:
LSP identifier In-label Out intf/label FRR intf/label Status
```

Step 4 **show mpls traffic-eng tunnels backup**

The following conditions must exist for backup tunnels to be operational:

- **LSP is reroutable** --At the headend of the LSP, enter the **show run int tunnel tunnel-number** command. The output should include the **tunnel mpls traffic-eng fast-reroute** command. If it does not, enter this command for the tunnel.

On the router where the backup tunnels originate, enter the **show mpls traffic-eng tunnels backup** command. Following is sample command output:

Example:

```
Router# show mpls traffic-eng tunnels backup
Router_t578
  LSP Head, Tunnel578, Admin: up, Oper: up
  Src 10.55.55.55, Dest 10.88.88.88, Instance 1
  Fast Reroute Backup Provided:
    Protected i/fs:
    Protected lsps: 1
    Backup BW: any pool unlimited; inuse: 100 kbps
Router_t5710
  LSP Head, Tunnel5710, Admin: admin-down, Oper: down
  Src 10.55.55.55, Dest 10.7.7.7, Instance 0
  Fast Reroute Backup Provided:
    Protected i/fs:
    Protected lsps: 0
    Backup BW: any pool unlimited; inuse: 0 kbps
Router_t5711
  LSP Head, Tunnel5711, Admin: up, Oper: up
  Src 10.55.55.55, Dest 10.7.7.7, Instance 1
  Fast Reroute Backup Provided:
    Protected i/fs:
    Protected lsps: 2
    Backup BW: any pool unlimited; inuse: 6010 kbps
```

The command output will allow you to verify the following:

- Backup tunnel exists--Verify that there is a backup tunnel that terminates at this LSP's NHOP or NNHOP. Look for the LSP's NHOP or NNHOP in the Dest field.
- Backup tunnel is up--To verify that the backup tunnel is up, look for "Up" in the State field.
- Backup tunnel is associated with LSP's I/F--Verify that the interface for the LSP is allowed to use this backup tunnel. Look for the LSP's output interface in the "protects" field list.
- Backup tunnel has sufficient bandwidth--If you restricted the amount of bandwidth a backup tunnel can hold, verify that the backup tunnel has sufficient bandwidth to hold the LSPs that would use this backup tunnel if there is a failure. The bandwidth of an LSP is defined by the line **tunnel mpls traffic-eng bandwidth** at the headend of the LSP. To determine the available bandwidth on a backup tunnel, look at the "cfg" and "inuse" fields. If there is insufficient backup bandwidth to accommodate the LSPs that would use this backup tunnel in the event of a failure, create an additional backup tunnel or increase the backup bandwidth of the existing tunnel by using the **tunnel mpls traffic-eng bandwidth** command.

Note To determine how much bandwidth is sufficient, offline capacity planning may be required.

- Backup tunnel has appropriate bandwidth type--If you restricted the type of LSPs (subpool or global pool) that can use this backup tunnel, verify that the LSP is the appropriate type for the backup tunnel. The type of the LSP is defined by the line **tunnel mpls traffic-eng bandwidth** at the headend of this LSP. If this line contains the word "subpool", then it uses subpool bandwidth; otherwise, it uses global pool bandwidth. Verify that the type matches the type the backup tunnel can hold by looking in the output of the above command.

If none of the above actions works, enable debug by entering the **debug ip rsvp fast-reroute** command and the **debug mpls traffic-eng fast-reroute** command on the router that is the headend of the backup tunnel. Then do the following:

- a. Enter the **shutdown** command for the primary tunnel.
- b. Enter the **no shutdown** command for the primary tunnel.
- c. View the debug output.

Step 5 show mpls traffic-eng fast-reroute database

Enter the **clear ip rsvp hello instance counters** command to verify the following:

- MPLS TE FRR Node Protection has been enabled.
- A certain type of LSP can use a backup tunnel.

The following command output displays the LSPs that are protected:

Example:

```
Router# show mpls traffic-eng fast-reroute database
Tunnel head end item frr information:
Protected Tunnel  In-label  intf/label      FRR intf/label  Status
Tunne110         Tun       :Untagged      Tu0:12304      ready
Prefix item frr information:
Prefix           Tunnel  In-label  Out intf/label  FRR intf/label  Status
10.0.0.11/32    Tu110   Tun hd    :Untagged      Tu0:12304      ready
LSP midpoint frr information:
LSP identifier   In-label  Out intf/label  FRR intf/label  Status
10.0.0.12 1 [459]  16        :17            Tu2000:19      ready
```

Note If LDP is not enabled, separate prefix items are not shown because all prefixes then use a single rewrite. To confirm that a particular IP prefix is FRR protected, even though it is not shown in this display, enter it within the **show mpls forwarding-table ip-address detail** command. The final line of the display will tell whether that prefix is protected:

Example:

```
Router# show mpls forwarding-table 10.0.0.11 32 detail

Local   Outgoing  Prefix          Bytes tag  Outgoing     Next Hop
tag     tag or VC or Tunnel Id  switched   interface
Tun hd  Untagged  10.0.0.11/32   48         point2point
        MAC/Encaps=4/8, MTU=1520, Tag Stack{22}
        48D18847 00016000
        No output feature configured
        Fast Reroute Protection via (Tu0, outgoing label 12304)
```

Step 6 show ip rsvp reservation

Following is sample output from the **show ip rsvp reservation** command entered at the headend of a primary LSP. Entering the command at the head-end of the primary LSP shows, among other things, the status of FRR (that is, local protection) at each hop this LSP traverses. The per-hop information is collected in the Record Route Object (RRO) that travels with the Resv message from the tail to the head.

Example:

```
Router# show ip rsvp reservation detail
Reservation:
```

```

Tun Dest: 10.1.1.1 Tun ID: 1 Ext Tun ID: 10.1.1.1
Tun Sender: 10.1.1.1 LSP ID: 104
Next Hop: 10.1.1.2 on
Label: 18 (outgoing)
Reservation Style is Shared-Explicit, QoS Service is Controlled-Load
Average Bitrate is 0 bits/sec, Maximum Burst is 1K bytes
Min Policed Unit: 0 bytes, Max Pkt Size: 0 bytes
RRO:
  10.1.1.1/32, Flags:0x1 (Local Prot Avail/to NHOP)
    Label subobject: Flags 0x1, C-Type 1, Label 18
  10.1.1.1/32, Flags:0x0 (Local Prot Avail/In Use/Has BW/to NHOP)
    Label subobject: Flags 0x1, C-Type 1, Label 16
  10.1.1.2/32, Flags:0x0 (No Local Protection)
    Label subobject: Flags 0x1, C-Type 1, Label 0
Resv ID handle: CD000404.
Policy: Accepted. Policy source(s): MPLS/TE

```

Notice the following about the primary LSP:

- It has protection that uses a NHOP backup tunnel at its first hop.
- It has protection and is actively using an NHOP backup tunnel at its second hop.
- It has no local protection at its third hop.

The RRO display shows the following information for each hop:

- Whether local protection is available (that is, whether the LSP has selected a backup tunnel)
- Whether local protection is in use (that is, whether the LSP is currently using its selected backup tunnel)
- Whether the selected backup tunnel is an NHOP or NNHOP backup tunnel
- Whether the backup tunnel used at this hop provides bandwidth protection

Troubleshooting Tips

This section describes the following:

LSPs Do Not Become Active; They Remain Ready

At a PLR, LSPs transition from Ready to Active if one of the following events occurs:

- Primary interface goes down--If the primary interface (LSP's outbound interface) goes down and the LSP is ready to use a backup tunnel, the LSP will transition to the active state causing its data to flow over the backup tunnel. On some platforms and interface types (for example, GSR POS interfaces), fast interface-down logic has been added to detect this event very quickly. On other platforms where this logic does not exist, detection time is slower. On such platforms, it may be desirable to enable RSVP Hello (see the next bulleted item, "Hellos detect next hop is down").
- Hellos detect next hop is down--If Hellos are enabled on the primary interface (LSP's outbound interface), and the LSP's next hop is no longer reachable, the next hop is declared down. This event will cause the LSP to begin actively using its backup tunnel. Notice that a next hop will be declared down even if the primary interface does not go down. For example, if the next hop stops responding due to a reboot or software/hardware problem, Hellos will trigger the LSPs using this next hop to switch to their backup tunnels. Hellos can also help trigger FRR on interfaces such as Gigabit Ethernet where the interface remains up but is unusable (due to lack of link-layer liveness detection mechanisms).

Primary Tunnel Does Not Select Backup Tunnel That Is Up

If a backup tunnel is up, but it is not selected as a backup tunnel by the primary tunnel (LSP), enter the following commands for the backup tunnel:

- **shutdown**
- **no shutdown**



Note

If you change the status of a backup tunnel, the backup tunnel selection algorithm is rerun for the backup tunnel. LSPs that have currently selected (that is, are ready to use) that backup tunnel will be disassociated from it, and then reassociated with that backup tunnel or another backup tunnel. This is generally harmless and usually results in mapping the same LSPs to that backup tunnel. However, if any LSPs are actively using that backup tunnel, shutting down the backup tunnel will tear down those LSPs.

Enhanced RSVP Commands

The following RSVP commands have been enhanced to display information that can be helpful when examining FRR state or when troubleshooting FRR:

- **show ip rsvp request** --Displays upstream reservation state (that is, information related to the Resv messages that this node will send upstream).
- **show ip rsvp reservation** --Displays information about Resv messages received.
- **show ip rsvp sender** --Displays information about Path messages being received.

These commands show control plane state; they do not show data state. That is, they show information about RSVP messages (Path and Resv) used to signal LSPs. For information about the data packets being forwarded along LSPs, use the **show mpls forwarding** command.

RSVP Hello

The RSVP Hello feature enables RSVP nodes to detect when a neighboring node is not reachable. Use this feature when notification of link-layer failures is not available and unnumbered links are not used, or when the failure detection mechanisms provided by the link layer are not sufficient for timely node failure detection. Hello must be configured both globally on the router and on the specific interface to be operational.

Hello Instances Have Not Been Created

If Hello instances have not been created, do the following:

- Determine if RSVP Hello has been enabled globally on the router. Enter the **ip rsvp signalling hello(configuration)** command.
- Determine if RSVP Hello has been enabled on an interface that the LSPs traverse. Enter the **ip rsvp signalling hello(interface)** command.
- Verify that at least one LSP has a backup tunnel by viewing the output of the **show ip rsvp sender** command. A value of “Ready” indicates that a backup tunnel has been selected.

No entry at index (error may self-correct, RRO may not yet have propagated from downstream node of interest)" Error Message Is Printed at the Point of Local Repair

FRR relies on a Record Route Object (RRO) in Resv messages arriving from downstream. Routers receiving Path messages with the SESSION_ATTRIBUTE bit indicating that the LSP is fast-reroutable should include an RRO in the corresponding Resv messages.

If an LSP is configured for FRR, but the Resv arriving from a downstream router contains an incomplete RRO, the "No entry at index (error may self-correct, RRO may not yet have propagated from downstream node of interest)" message is printed. An incomplete RRO is one in which the NHOP or the NNHOP did not include an entry in the RRO.

This error typically means that backup tunnels to the NHOP or the NNHOP cannot be selected for this LSP because there is insufficient information about the NHOP or NNHOP due to the lack of an RRO entry.

Occasionally there are valid circumstances in which this situation occurs temporarily and the problem is self-corrected. If subsequent Resv messages arrive with a complete RRO, ignore the error message.

To determine whether the error has been corrected, view the RRO in Resv messages by entering the **clear ip rsvp hello instance counters** command. Use an output filter keyword to view only the LSP of interest.

Couldn't get rsbs (error may self-correct when Resv arrives)" Error Message Is Printed at the Point of Local Repair

The PLR cannot select a backup tunnel for an LSP until a Resv message has arrived from downstream.

When this error occurs, it typically means that something is truly wrong. For example, no reservation exists for this LSP. You can troubleshoot this problem by using the **debug ip rsvp reservation** command to enable debug.

Occasionally there are valid circumstances in which this error message occurs and there is no need for concern. One such circumstance is when an LSP experiences a change before any Resv message has arrived from downstream. Changes can cause a PLR to try to select a backup tunnel for an LSP, and the selection will fail (causing this error message) if no Resv message has arrived for this LSP.

Configuration Examples for Link and Node Protection with RSVP Hellos Support

The examples relate to the illustration shown in the figure below.

Figure 14: Backup Tunnels

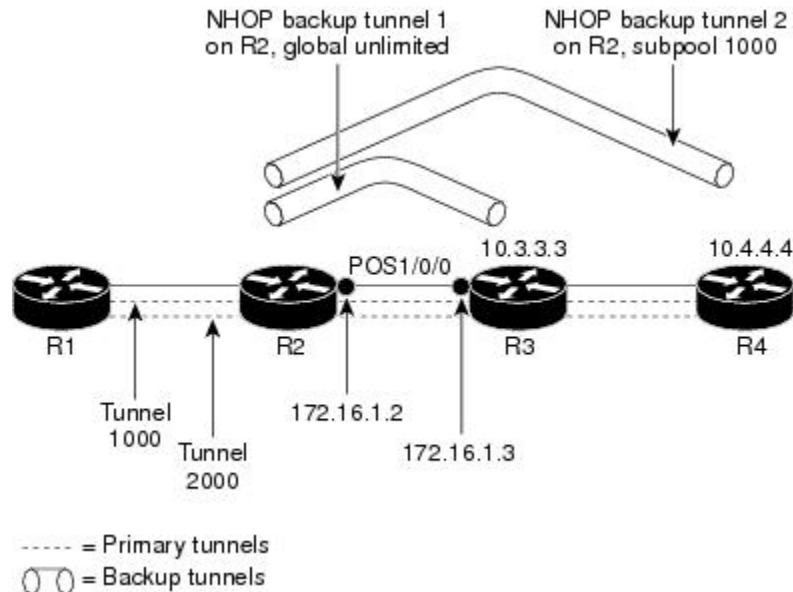

193747

Enabling Fast Reroute for All Tunnels Example

On router R1, enter interface configuration mode for each tunnel to be protected (Tunnel 1000 and Tunnel 2000). Enable these tunnels to use a backup tunnel in case of a link or node failure along their paths.

Tunnel 1000 will use 10 units of bandwidth from the subpool.

Tunnel 2000 will use 5 units of bandwidth from the global pool. The “bandwidth protection desired” bit and the “node protection desired bit” have been set by specifying **bw-prot** and **node-prot**, respectively, in the **tunnel mpls traffic-eng fast-reroute** command.

```
Router(config)# interface Tunnel1000
Router(config-if)# tunnel mpls traffic-eng fast-reroute
Router(config-if)# tunnel mpls traffic-eng bandwidth sub-pool 10
Router(config-if)# exit
Router(config)# interface Tunnel2000
Router(config-if)# tunnel mpls traffic-eng fast-reroute bw-prot node-prot
Router(config-if)# tunnel mpls traffic-eng bandwidth 5
Router(config-if)# end
```

Creating an NHOP Backup Tunnel Example

On router R2, create an NHOP backup tunnel to R3. This backup tunnel should avoid using the link 10.1.1.2.

```
Router(config)# ip explicit-path name avoid-protected-link
Router(cfg-ip-expl-path)# exclude-address 10.1.1.2

Explicit Path name avoid-protected-link:
__1: exclude-address 10.1.1.2
Router(cfg-ip_expl-path)# end

Router(config)# interface Tunnel1
```

```

Router(config-if)# ip unnumbered loopback0

Router(config-if)# tunnel destination 10.3.3.3
Router(config-if)# tunnel mode mpls traffic-eng0

Router(config-if)# tunnel mpls traffic-eng path-option explicit avoid-protected-link

```

Creating an NNHOP Backup Tunnel Example

On router R2, create an NNHOP backup tunnel to R4. This backup tunnel should avoid R3.

```

Router(config)# ip explicit-path name avoid-protected-node

Router(cfg-ip-expl-path)# exclude-address 10.3.3.3

Explicit Path name avoid-protected-node:
___1: exclude-address 10.3.3.3
Router(cfg-ip_expl-path)# end

Router(config)# interface Tunnel2

Router(config-if)# ip unnumbered loopback0

Router(config-if)# tunnel destination 10.4.4.4

Router(config-if)# tunnel mode mpls traffic-eng0

Router(config-if)# tunnel mpls traffic-eng path-option explicit avoid-protected-node

```

Assigning Backup Tunnels to a Protected Interface Example

On router R2, associate both backup tunnels with interface POS1/0/0.

```

Router(config)# interface POS1/0/0

Router(config-if)# mpls traffic-eng backup-path tunnel1

Router(config-if)# mpls traffic-eng backup-path tunnel2

```

Associating Backup Bandwidth and Pool Type with Backup Tunnels Example

Backup tunnel 1 is to be used only by LSPs that take their bandwidth from the global pool. It does not provide bandwidth protection. Backup tunnel 2 is to be used only by LSPs that take their bandwidth from the subpool. Backup tunnel 2 provides bandwidth protection for up to 1000 units.

```

Router(config)# interface Tunnel1

Router(config-if)# tunnel mpls traffic-eng backup-bw global-pool Unlimited

Router(config)# interface Tunnel2

Router(config-if)# tunnel mpls traffic-eng backup-bw sub-pool 1000

```

Configuring Backup Bandwidth Protection Example

In the following example, backup bandwidth protection is configured.



Note This global configuration is required only to change the backup protection preemption algorithm from minimize the number of LSPs that are demoted to minimize the amount of bandwidth that is wasted.

```
Router(config-if)# tunnel mpls traffic-eng fast-reroute bw-protect
Router(config)# mpls traffic-eng fast-reroute backup-prot-preemption optimize-bw
```

Configuring an Interface for Fast Link and Node Failure Detection Example

In the following example, pos ais-shut is configured:

```
Router(config)# interface pos0/0/0
Router(config-if)# pos ais-shut
```

In the following example, report lrdi is configured on OS interfaces:

```
Router(config)# interface pos0/0/0
Router(config-if)# pos report lrdi
```

Configuring an Interface for Fast Tunnel Interface Down Example

In the following example, tunnel 1000 goes down as soon as the headend router detects that the LSP is down:

```
Router(config)# interface tunnel 1000
Router(config-if)# tunnel mpls traffic-eng interface down delay 0
```

Configuring RSVP Hello and POS Signals Example

Hello must be configured both globally on the router and on the specific interface on which you need FRR protection. To configure Hello, use the following configuration commands:

- **ip rsvp signalling hello** (configuration)--Enables Hello globally on the router.
- **ip rsvp signalling hello** (interface)--Enables Hello on an interface where you need FRR protection.

The following configuration commands are optional:

- **ip rsvp signalling hello dscp** --Sets the DSCP value that is in the IP header of the Hello message.
- **ip rsvp signalling hello refresh misses** --Specifies how many acknowledgments a node can miss in a row before the node considers that communication with its neighbor is down.
- **ip rsvp signalling hello refresh interval** --Configures the Hello request interval.

- **ip rsvp signalling hello statistics** --Enables Hello statistics on the router.

To configure POS signaling for detecting FRR failures, enter **pos report all** or enter the following commands to request individual reports:

- **pos ais-shut**
- **pos report rdool**
- **pos report lais**
- **pos report lrdi**
- **pos report pais**
- **pos report prdi**
- **pos report sd-ber**

Additional References

The following sections provide references related to the MPLS TE: Link and Node Protection, with RSVP Hellos Support (with Fast Tunnel Interface Down Detection) feature.

Related Documents

Related Topic	Document Title
IS-IS	<ul style="list-style-type: none"> • <i>Cisco IOS IP Routing Protocols Command Reference</i> • Configuring a Basic IS-IS Network
MPLS traffic engineering commands	<i>Cisco IOS Multiprotocol Label Switching Command Reference</i>
OSPF	<ul style="list-style-type: none"> • <i>Cisco IOS IP Routing Protocols Command Reference</i> • Configuring OSPF
RSVP commands	<ul style="list-style-type: none"> • <i>Cisco IOS Multiprotocol Label Switching Command Reference</i> • <i>Cisco IOS Quality of Service Solutions Command Reference</i>

Standards

Standards	Title
No new or modified standards are supported by this feature, and support for existing standards has not been modified by this feature.	--

MIBs

MIBs	MIBs Link
No new or modified MIBs are supported by this feature, and support for existing MIBs has not been modified by this feature.	To locate and download MIBs for selected platforms, Cisco IOS XE software releases, and feature sets, use Cisco MIB Locator found at the following URL: http://www.cisco.com/go/mibs

RFCs

RFCs	Title
RFC 4090	Fast Reroute Extensions to RSVP-TE for LSP Tunnels

Technical Assistance

Description	Link
<p>The Cisco Support website provides extensive online resources, including documentation and tools for troubleshooting and resolving technical issues with Cisco products and technologies.</p> <p>To receive security and technical information about your products, you can subscribe to various services, such as the Product Alert Tool (accessed from Field Notices), the Cisco Technical Services Newsletter, and Really Simple Syndication (RSS) Feeds.</p> <p>Access to most tools on the Cisco Support website requires a Cisco.com user ID and password.</p>	http://www.cisco.com/techsupport

Feature Information for Link and Node Protection with RSVP Hellos Support

The following table provides release information about the feature or features described in this module. This table lists only the software release that introduced support for a given feature in a given software release train. Unless noted otherwise, subsequent releases of that software release train also support that feature.

Use Cisco Feature Navigator to find information about platform support and Cisco software image support. To access Cisco Feature Navigator, go to www.cisco.com/go/cfn. An account on Cisco.com is not required.

Table 6: Feature Information for MPLS TE: Link and Node Protection, with RSVP Hellos Support (with Fast Tunnel Interface Down Detection)

Feature Name	Releases	Feature Information
MPLS TE: Link and Node Protection, with RSVP Hellos Support (with Fast Tunnel Interface Down Detection)	Cisco IOS XE Release 2.3	<p>The MPLS TE: Link and Node Protection, with RSVP Hellos Support (with Fast Tunnel Interface Down Detection) feature provides the following Fast Reroute (FRR) capabilities:</p> <ul style="list-style-type: none"> • A backup tunnel terminates at the next-next hop router to protect both the downstream link and node to protect link and node failures. There is no limit (except memory limitations) to the number of backup tunnels that can protect a given interface. A backup tunnel is scalable because it can protect multiple LSPs and multiple interfaces. • Backup bandwidth protection allows a priority to be assigned to backup tunnels for LSPs carrying certain kinds of data (such as voice). • Fast Tunnel Interface Down detection, which forces a “generic” interface tunnel (not specifically a Fast Reroute tunnel) to become disabled immediately if the headend router detects a failed link on an LSP. • Resource Reservation Protocol (RSVP) Hellos, which are used to accelerate the detection of node failures. <p>In Cisco IOS Release XE 2.3, this feature was implemented on the Cisco ASR 1000 Series Aggregation Services Routers.</p> <p>The following command was introduced or modified: tunnel mpls traffic-eng interface down delay.</p>

Glossary

backup bandwidth --The usage of NHOP and NNHOP backup tunnels to provide bandwidth protection for rerouted LSPs.

backup tunnel --An MPLS TE tunnel used to protect other (primary) tunnels’ traffic when a link or node failure occurs.

bandwidth --The available traffic capacity of a link.

Cisco Express Forwarding --A means for accelerating the forwarding of packets within a router, by storing route lookup.

enterprise network --A large and diverse network connecting most major points in a company or other organization.

Fast Reroute --Procedures that enable temporary routing around a failed link or node while a new LSP is being established at the head end.

Gigabit Ethernet --Standard for a high-speed Ethernet, approved by the IEEE (Institute of Electrical and Electronics Engineers) 802.3z standards committee in 1996.

global pool --The total bandwidth allocated to an MPLS Traffic Engineering link or node.

headend --The router that originates and maintains a given LSP. This is the first router in the LSP's path.

hop --Passage of a data packet between two network nodes (for example, between two routers).

instance --A Hello instance implements the RSVP Hello extensions for a given router interface address and remote IP address. Active Hello instances periodically send Hello Request messages, expecting Hello ACK messages in response. If the expected Ack message is not received, the active Hello instance declares that the neighbor (remote IP address) is unreachable (that is, it is lost). This can cause LSPs crossing this neighbor to be fast rerouted.

interface --A network connection.

Intermediate System-to-Intermediate System --IS-IS. Link-state hierarchical routing protocol that calls for intermediate system (IS) routers to exchange routing information based on a single metric to determine network topology.

link --A point-to-point connection between adjacent nodes. There can be more than one link between adjacent nodes. A network communications channel consisting of a circuit or transmission path and all related equipment between a sender and a receiver. Sometimes referred to as a line or a transmission link.

limited backup bandwidth --Backup tunnels that provide bandwidth protection.

load balancing --A configuration technique that shifts traffic to an alternative link if a certain threshold is exceeded on the primary link. Load balancing is similar to redundancy in that if an event causes traffic to shift directions, alternative equipment must be present in the configuration. In load balancing, the alternative equipment is not necessarily redundant equipment that only operates in the event of a failure.

LSP --label switched path. A configured connection between two routers, in which label switching is used to carry the packets. The purpose of an LSP is to carry data packets.

merge point --The backup tunnel's tail.

MPLS --Multiprotocol Label Switching. Packet-forwarding technology, used in the network core, that applies data link layer labels to tell switching nodes how to forward data, resulting in faster and more scalable forwarding than network layer routing normally can do.

MPLS global label allocation --There is one label space for all interfaces in the router. For example, label 100 coming in one interface is treated the same as label 100 coming in a different interface.

NHOP --next hop. The next downstream node along an LSP's path.

NHOP backup tunnel --next-hop backup tunnel. Backup tunnel terminating at the LSP's next hop beyond the point of failure, and originating at the hop immediately upstream of the point of failure. It bypasses a failed link, and is used to protect primary LSPs that were using this link before the failure.

NNHOP --next-next hop. The node after the next downstream node along an LSP's path.

NNHOP backup tunnel --next-next-hop backup tunnel. Backup tunnel terminating at the LSP's next-next hop beyond the point of failure, and originating at the hop immediately upstream of the point of failure. It bypasses a failed link or node, and is used to protect primary LSPs that were using this link or node before the failure.

node --Endpoint of a network connection or a junction common to two or more lines in a network. Nodes can be interconnected by links, and serve as control points in the network. Computers on a network, or any endpoint or a junction common to two or more lines in a network. Nodes can be processors, controllers, or workstations.

OSPF --Open Shortest Path First. A link-state hierarchical Interior Gateway Protocol routing algorithm, derived from the IS-IS protocol. OSPF features include least-cost routing, multipath routing, and load balancing.

primary LSP --The last LSP originally signaled over the protected interface before the failure. The LSP before the failure.

primary tunnel --Tunnel whose LSP may be fast rerouted if there is a failure. Backup tunnels cannot be primary tunnels.

promotion --Conditions, such as a new backup tunnel comes up, cause a reevaluation of a backup tunnel that was chosen for an LSP. If the reevaluation is successful, it is called a promotion.

protected interface --An interface that has one or more backup tunnels associated with it.

redundancy --The duplication of devices, services, or connections so that, in the event of a failure, the redundant devices, services, or connections can perform the work of those that failed.

RSVP --Resource Reservation Protocol. An IETF protocol used for signaling requests (setting up reservations) for Internet services by a customer before that customer is permitted to transmit data over that portion of the network.

scalability --An indicator showing how quickly some measure of resource usage increases as a network gets larger.

state --Information that a router must maintain about each LSP. The information is used for rerouting tunnels.

subpool --The more restrictive bandwidth in an MPLS Traffic Engineering link or node. The subpool is a portion of the link or node's overall global pool bandwidth.

tailend --The router upon which an LSP is terminated. This is the last router in the LSP's path.

topology --The physical arrangement of network nodes and media within an enterprise networking structure.

tunnel --Secure communications path between two peers, such as two routers.

unlimited backup bandwidth --Backup tunnels that provide no bandwidth (best-effort) protection (that is, they provide best-effort protection).



CHAPTER 4

MPLS Traffic Engineering-Autotunnel Primary and Backup

The MPLS Traffic Engineering-Autotunnel Primary and Backup feature enables a router to dynamically build backup tunnels and to dynamically create one-hop primary tunnels on all interfaces that have been configured with Multiprotocol Label Switching (MPLS) traffic engineering (TE) tunnels.

A router with primary one-hop autotunnels and backup autotunnels can be configured with stateful switchover (SSO) redundancy.

- [Finding Feature Information, on page 81](#)
- [Prerequisites for MPLS Traffic Engineering-Autotunnel Primary and Backup, on page 81](#)
- [Restrictions for MPLS Traffic Engineering-Autotunnel Primary and Backup, on page 82](#)
- [Information About MPLS Traffic Engineering-Autotunnel Primary and Backup, on page 82](#)
- [How to Configure MPLS Traffic Engineering Autotunnel Primary and Backup, on page 88](#)
- [Configuration Examples for MPLS Traffic Engineering-Autotunnel Primary and Backup, on page 91](#)
- [Additional References, on page 96](#)
- [Feature Information for MPLS Traffic Engineering-Autotunnel Primary and Backup, on page 97](#)
- [Glossary, on page 98](#)

Finding Feature Information

Your software release may not support all the features documented in this module. For the latest caveats and feature information, see [Bug Search Tool](#) and the release notes for your platform and software release. To find information about the features documented in this module, and to see a list of the releases in which each feature is supported, see the feature information table.

Use Cisco Feature Navigator to find information about platform support and Cisco software image support. To access Cisco Feature Navigator, go to www.cisco.com/go/cfn. An account on Cisco.com is not required.

Prerequisites for MPLS Traffic Engineering-Autotunnel Primary and Backup

- Configure TE on the routers.

Restrictions for MPLS Traffic Engineering-Autotunnel Primary and Backup

- You cannot configure a static route to route traffic over TE autotunnels. For autotunnels, you should use only the autoroute for tunnel selection.

Information About MPLS Traffic Engineering-Autotunnel Primary and Backup

Overview of MPLS Traffic Engineering-Autotunnel Primary and Backup

The MPLS Traffic Engineering-Autotunnel Primary and Backup feature has the following features:

- Backup autotunnel-Enables a router to dynamically build backup tunnels.
- Primary one-hop autotunnel-Enables a router to dynamically create one-hop primary tunnels on all interfaces that have been configured with MPLS TE tunnels.

If no backup tunnels exist, the following types of backup tunnels are created:

- Next hop (NHOP)
- Next-next hop (NNHOP)

Benefits of MPLS Traffic Engineering-Autotunnel Primary and Backup Feature

- Backup tunnels are built automatically, eliminating the need for users to preconfigure each backup tunnel and then assign the backup tunnel to the protected interface.
- The dynamic creation of one-hop primary tunnels eliminates the need to configure an MPLS TE tunnel with the Fast Reroute (FRR) option for the tunnel to be protected.
- Protection is expanded; FRR does not protect IP traffic that is not using the TE tunnel or Label Distribution Protocol (LDP) labels that are not using the TE tunnel.

MPLS Traffic Engineering

MPLS is an Internet Engineering Task Force (IETF)-specified framework that provides for the efficient designation, routing, forwarding, and switching of traffic flows through the network.

TE is the process of adjusting bandwidth allocations to ensure that enough bandwidth is left for high-priority traffic.

In MPLS TE, the upstream router creates a network tunnel for a particular traffic stream, then sets the bandwidth available for that tunnel.

MPLS Traffic Engineering Backup Autotunnels

MPLS backup autotunnels protect fast reroutable TE label switched paths (LSPs). Without MPLS backup autotunnels to protect a LSP you had to do the following:

- Preconfigure each backup tunnel.
- Assign the backup tunnels to the protected interfaces.

An LSP requests backup protection from Resource Reservation Protocol (RSVP) FRR in the following situations:

- Receipt of the first RSVP Resv message
- Receipt of an RSVP path message with the protection attribute after the LSP has been established without the protection attribute
- Detection that a Record Route Object (RRO) changed

If there was no backup tunnel protecting the interface used by the LSP, the LSP remained unprotected.

Backup autotunnels enable a router to dynamically build backup tunnels when they are needed. This prevents you from having to build MPLS TE tunnels statically.

Backup tunnels may not be available for the following reasons:

- Static backup tunnels are not configured.
- Static backup tunnels are configured, but cannot protect the LSP. The backup tunnel may not have enough available bandwidth, the tunnel may protect a different pool, or the tunnel may be down.

If a backup tunnel is not available, the following two backup tunnels are created dynamically:

- NHOP--Protects against link failure
- NNHOP--Protects against node failure



Note At the penultimate hop, only an NHOP backup tunnel is created.



Note If two LSPs share the same output interface and NHOP, three (not four) backup tunnels are created. They share an NHOP backup tunnel.

Link Protection

Backup tunnels that bypass only a single link of the LSP's path provide Link Protection. They protect LSPs if a link along their path fails by rerouting the LSP's traffic to the next hop (bypassing the failed link). These are referred to as next-hop (NHOP) backup tunnels because they terminate at the LSP's next hop beyond the point of failure. The figure below illustrates an NHOP backup tunnel.

Figure 15: NHOP Backup Tunnel

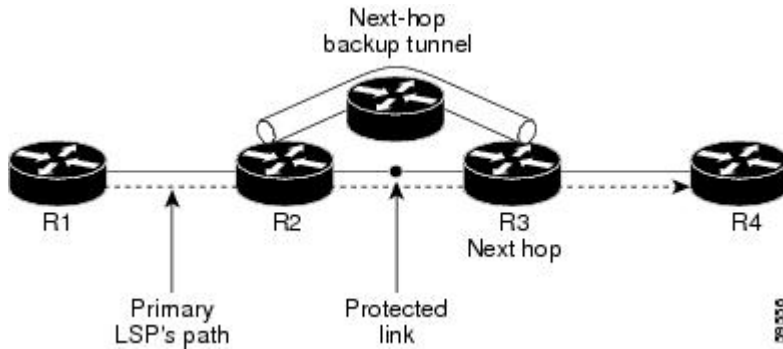

Node Protection

Backup tunnels that bypass next-hop nodes along LSP paths are called NNHOP backup tunnels because they terminate at the node following the next-hop node of the LSPs, thereby bypassing the next-hop node. They protect LSPs by enabling the node upstream of a link or node failure to reroute the LSPs and their traffic around the failure to the next-hop node. NNHOP backup tunnels also provide protection from link failures because they bypass the failed link and the node.

The figure below illustrates an NNHOP backup tunnel.

Figure 16: Next-Next Hop Backup Tunnel

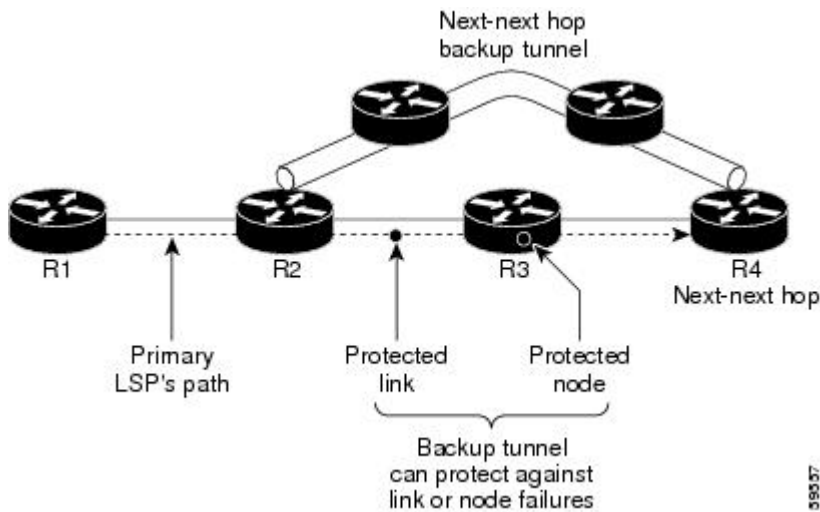

Explicit Paths

Explicit paths are used to create backup autotunnels as follows:

- NHOP excludes the protected link's IP address.
- NNHOP excludes the NHOP router ID.
- The explicit-path name is `_auto-tunnel_tunnelxxx`, where `xxx` matches the dynamically created backup tunnel ID.

- The interface used for the **ip unnumbered** command defaults to Loopback0. You can configure this to use a different interface.

Range for Backup Autotunnels

The tunnel range for backup autotunnels is configurable. By default, the last 100 TE tunnel IDs are used; that is 65,436 to 65,535. Autotunnels detect tunnel IDs that are being used. IDs are allocated starting with the lowest number.

For example, if you configure a tunnel range 1000 to 1100 and statically configured TE tunnels are in that range, routers do not use those IDs. If those static tunnels are removed, the MPLS TE dynamic tunnel software can use those IDs.

MPLS Traffic Engineering Primary Autotunnels

The MPLS Traffic Engineering-Autotunnel Primary and Backup feature enables a router to dynamically create one-hop primary tunnels on all interfaces that have been configured with MPLS traffic. The tunnels are created with zero bandwidth. The constraint-based shortest path first (CSPF) is the same as the shortest path first (SPF) when there is zero bandwidth, so the router's choice of the autorouted one-hop primary tunnel is the same as if there were no tunnel. Because it is a one-hop tunnel, the encapsulation is tag-implicit (that is, there is no tag header).

Explicit Paths

Explicit paths are used to create autotunnels as follows:

- The explicit path is dynamically created.
- The explicit path includes the IP address for the interface connected to the next hop.
- The explicit-path name is `_auto-tunnel_tunnelxxx`, where `xxx` matches the dynamically created one-hop tunnel ID.
- Interfaces used for the **ip unnumbered** command default to Loopback0. You can configure this to use a different interface.

Range for Autotunnels

The tunnel range is configurable. By default, the last 100 TE tunnel IDs are used; that is 65,436 to 65,535. Autotunnels detect tunnel IDs that are being used. IDs are allocated starting with the lowest number.

For example, if you configure a tunnel range 100 to 200 and statically configured TE tunnels are in that range, routers do not use those IDs. If those static tunnels are removed, the IDs become available for use by the MPLS TE dynamic tunnel software.

MPLS Traffic Engineering Label-Based Forwarding

Routers receive a packet, determine where it needs to go by examining some fields in the packet, and send it to the appropriate output device. A label is a short, fixed-length identifier that is used to forward packets. A label switching device normally replaces the label in a packet with a new value before forwarding the packet to the next hop. For this reason, the forwarding algorithm is called label swapping. A label switching device,

referred to as an LSR, runs standard IP control protocols (that is, routing protocols, RSVP, and so forth) to determine where to forward packets.

Benefits of MPLS Traffic Engineering Protection

The following sections describe the benefits of MPLS traffic engineering protection:

Delivery of Packets During a Failure

Backup tunnels that terminate at the NNHOP protect both the downstream link and node. This provides protection for link and node failures.

Multiple Backup Tunnels Protecting the Same Interface

In addition to being required for node protection, the autotunnel primary and backup feature provides the following benefits:

- Redundancy--If one backup tunnel is down, other backup tunnels protect LSPs.
- Increased backup capacity--If the protected interface is a high-capacity link and no single backup path exists with an equal capacity, multiple backup tunnels can protect that one high-capacity link. The LSPs using this link will fail over to different backup tunnels, allowing all of the LSPs to have adequate bandwidth protection during failure (rerouting). If bandwidth protection is not desired, the router spreads LSPs across all available backup tunnels (that is, there is load balancing across backup tunnels).

Scalability

A backup tunnel can protect multiple LSPs. Furthermore, a backup tunnel can protect multiple interfaces. This is called many-to-one (N:1) protection. N:1 protection has significant scalability advantages over one-to-one (1:1) protection, where a separate backup tunnel must be used for each LSP needing protection.

An example of N:1 protection is that when one backup tunnel protects 5000 LSPs, each router along the backup path maintains one additional tunnel.

An example of 1:1 protection is that when 5000 backup tunnels protect 5000 LSPs, each router along the backup path must maintain state for an additional 5000 tunnels.

RSVP Hello

RSVP Hello allows a router to detect when its neighbor has gone down but its interface to that neighbor is still operational. When Layer 2 link protocols are unable to detect that the neighbor is unreachable, Hellos provide the detection mechanism; this allows the router to switch LSPs onto its backup tunnels and avoid packet loss.

SSO Redundancy Overview

The SSO feature is an incremental step within an overall program to improve the availability of networks constructed with Cisco IOS routers.

SSO is particularly useful at the network edge. It provides protection for network edge devices with dual route processors (RPs) that represent a single point of failure in the network design, and where an outage might result in loss of service for customers.

In specific Cisco networking devices that support dual RPs, SSO takes advantage of RP redundancy to increase network availability. The feature establishes one of the RPs as the active processor while the other RP is designated as the standby processor, and then synchronizes critical state information between them. Following an initial synchronization between the two processors, SSO dynamically maintains RP state information between them.

A switchover from the active to the standby processor occurs when the active RP fails, is removed from the networking device, or is manually taken down for maintenance.

Affinity and Link Attributes with Autotunnel Backup

In Cisco IOS Release 15.1(1)S and later releases, you can use affinity and link attributes with the MPLS TE Autotunnel Backup feature to include or exclude links when configuring dynamic backup paths.

For a link, you can configure up to 32 bits of attribute flags, as shown in the following example:

```
Router> enable
Router# configure terminal
Router(config)# interface ethernet0/0
Router(config-if)# mpls traffic-eng attribute-flags 0x22
```

The attribute flags are compared to the tunnel's affinity bits during selection of the path.

When you enable the auto-tunnel backup feature, you can optionally specify the affinity and mask, as shown in the following example. If you do not specify an affinity and mask, the default for affinity is 0 and for the mask it is 0xFFFF is used. To ignore link affinity, use affinity and mask of 0. See the **mpls traffic-eng auto-tunnel backup config affinity** command for more information.

```
Router> enable
Router# configure terminal
Router(config)# mpls traffic-eng auto-tunnel backup

Router(config)# mpls traffic-eng auto-tunnel backup config affinity 0x13 mask 0x13
```

The affinity/mask configured by the **mpls traffic-eng auto-tunnel backup config affinity** command is used for all dynamically created backup tunnels. The attribute mask determines which link attributes are relevant. If a bit in the mask is 0, the attribute is irrelevant. If a bit in the mask is 1, the attribute value of a link and the configured affinity of the tunnel for that bit must match.

In the figure below, there are two primary tunnels. One tunnel travels from router A to router B. The other primary tunnel travels from router A to router B and then router D. All the the links are configured with attribute flags 0x22. Both tunnels require fast reroute protection. To automatically create backup tunnels, enable the autotunnel backup feature with the **mpls traffic-eng auto-tunnel backup** command. However, the dynamically created backup tunnels do not come up, because attribute flags are configured on the links. To enable the dynamically created backup tunnels, you must also issue the following command:

```
Router(config)# mpls traffic-eng auto-tunnel backup config affinity 0x22 mask 0x22
```

Figure 17: Specifying Link Attributes and Affinity with Autotunnel Backup

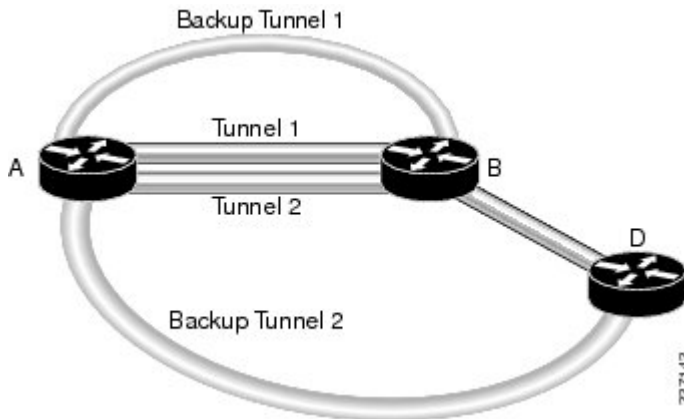

How to Configure MPLS Traffic Engineering Autotunnel Primary and Backup

Establishing MPLS Backup Autotunnels to Protect Fast Reroutable TE LSPs

To establish an MPLS backup autotunnel to protect fast reroutable TE LSPs, perform the following task.



Note Only Steps 1 through 3 are required. If you perform additional steps, you can perform them in any order after Step 3.

SUMMARY STEPS

1. `enable`
2. `configure terminal`
3. `mpls traffic-eng auto-tunnel backup`
4. `mpls traffic-eng auto-tunnel backup nhop-only`
5. `mpls traffic-eng auto-tunnel backup tunnel-num [min num] [max num]`
6. `mpls traffic-eng auto-tunnel backup timers removal unused sec`
7. `mpls traffic-eng auto-tunnel backup config unnumbered-interface interface`
8. `mpls traffic-eng auto-tunnel backup config affinity affinity-value mask mask-value]`

DETAILED STEPS

	Command or Action	Purpose
Step 1	<code>enable</code> Example:	Enables privileged EXEC mode. <ul style="list-style-type: none"> • Enter your password if prompted.

	Command or Action	Purpose
	Router> enable	
Step 2	configure terminal Example: Router# configure terminal	Enters global configuration mode.
Step 3	mpls traffic-eng auto-tunnel backup Example: Router(config)# mpls traffic-eng auto-tunnel backup	Automatically builds NHOP and NNHOP backup tunnels.
Step 4	mpls traffic-eng auto-tunnel backup nhop-only Example: Router(config)# mpls traffic-eng auto-tunnel backup nhop-only	Enables the creation of dynamic NHOP backup tunnels.
Step 5	mpls traffic-eng auto-tunnel backup tunnel-num [min num] [max num] Example: Router(config)# mpls traffic-eng auto-tunnel backup tunnel-num min 1000 max 1100	Configures the range of tunnel interface numbers for backup autotunnels.
Step 6	mpls traffic-eng auto-tunnel backup timers removal unused sec Example: Router(config)# mpls traffic-eng auto-tunnel backup timers removal unused 50	Configures how frequently a timer will scan backup autotunnels and remove tunnels that are not being used.
Step 7	mpls traffic-eng auto-tunnel backup config unnumbered-interface interface Example: Router(config)# mpls traffic-eng auto-tunnel backup config unnumbered-interface ethernet1/0	Enables IP processing on the specified interface without an explicit address.
Step 8	mpls traffic-eng auto-tunnel backup config affinity affinity-value mask mask-value] Example: Router(config)# mpls traffic-eng auto-tunnel backup config affinity 0x22 mask 0x22	Specifies the affinity values and mask flags. The affinity determines the attribute of the link that the tunnel will use. That is, the attribute for which the tunnel has an affinity. The mask determines which link attribute the router should check. If a bit in the mask is 0, an attribute value of a link or that bit is irrelevant. If a bit in the mask is 1, the attribute values of a link and the required affinity of the tunnel for that bit must match.

Establishing MPLS One-Hop Tunnels to All Neighbors

To establish MPLS one-hop tunnels to all neighbors, perform the following task.



Note Only Steps 1 through 3 are required. If you perform additional steps, you can perform them in any order after Step 3.

SUMMARY STEPS

1. **enable**
2. **configure terminal**
3. **mpls traffic-eng auto-tunnel primary onehop**
4. **mpls traffic-eng auto-tunnel primary tunnel-num [min num] [maxnum]**
5. **mpls traffic-eng auto-tunnel primary timers removal rerouted sec**
6. **mpls traffic-eng auto-tunnel primary config unnumbered interface**
7. **mpls traffic-eng auto-tunnel primary config mpls ip**

DETAILED STEPS

	Command or Action	Purpose
Step 1	enable Example: Router> enable	Enables privileged EXEC mode. <ul style="list-style-type: none"> • Enter your password if prompted.
Step 2	configure terminal Example: Router# configure terminal	Enters global configuration mode.
Step 3	mpls traffic-eng auto-tunnel primary onehop Example: Router(config)# mpls traffic-eng auto-tunnel primary onehop	Automatically creates primary tunnels to all next hops.
Step 4	mpls traffic-eng auto-tunnel primary tunnel-num [min num] [maxnum] Example: Router(config)# mpls traffic-eng auto-tunnel primary tunnel-num min 2000 max 2100	Configures the range of tunnel interface numbers for primary autotunnels.
Step 5	mpls traffic-eng auto-tunnel primary timers removal rerouted sec Example:	Configures how many seconds after a failure primary autotunnels will be removed.

	Command or Action	Purpose
	Router(config)# mpls traffic-eng auto-tunnel primary timers removal rerouted 400	
Step 6	mpls traffic-eng auto-tunnel primary config unnumbered interface Example: Router(config)# mpls traffic-eng auto-tunnel primary config unnumbered ethernet1/0	Enables IP processing on the specified interface without an explicit address.
Step 7	mpls traffic-eng auto-tunnel primary config mpls ip Example: Router(config)# mpls traffic-eng auto-tunnel primary config mpls ip	Enables LDP on primary autotunnels.

Configuration Examples for MPLS Traffic Engineering-Autotunnel Primary and Backup

Establishing MPLS Backup Autotunnels to Protect Fast Reroutable TE LSPs Example



Note This example does not include the **mpls traffic-eng auto-tunnel backup nhop-only** command because autotunneling would not be able to create any backup tunnels.

To determine if there are any backup tunnels, enter the **show ip rsvp fast-reroute** command. This example shows that there is a static configured primary tunnel and no backup tunnels.

```
Router(config)# show ip rsvp fast-reroute
Primary      Protect    BW          Backup
Tunnel       I/F        BPS:Type    Tunnel:Label  State  Level  Type
-----
R3-PRP_t0    PO3/1      0:G         None          None   None   ----
```

The following command causes autotunnels to automatically configure NHOP and NNHOP backup tunnels:

```
Router(config)# mpls traffic-eng auto-tunnel backup
```

As illustrated in the **show ip interface brief** command output, autotunneling created two backup tunnels that have tunnel IDs 65436 and 65437:

```
Router# show ip interface brief
```

```
Interface                IP-Address          OK? Method Status          Protocol
```

```

POS2/0          10.0.0.14      YES NVRAM  down          down
POS2/1          10.0.0.49      YES NVRAM  up            up
POS2/2          10.0.0.45      YES NVRAM  up            up
POS2/3          10.0.0.57      YES NVRAM  administratively down  down
POS3/0          10.0.0.18      YES NVRAM  down          down
POS3/1          10.0.0.33      YES NVRAM  up            up
POS3/2          unassigned     YES NVRAM  administratively down  down
POS3/3          unassigned     YES NVRAM  administratively down  down
GigabitEthernet4/0  10.0.0.37      YES NVRAM  up            up
GigabitEthernet4/1  unassigned     YES NVRAM  administratively down  down
GigabitEthernet4/2  unassigned     YES NVRAM  administratively down  down
Loopback0       10.0.3.1       YES NVRAM  up            up
Tunnel0         10.0.3.1       YES unset  up            up
Tunnel65436     10.0.3.1       YES unset  up            up
Tunnel65437     10.0.3.1       YES unset  up            up
Ethernet0       10.3.38.3      YES NVRAM  up            up
Ethernet1       unassigned     YES NVRAM  administratively down  down
R3-PRP#

```

The following command prevents autotunneling from creating NNHOP backup tunnels:

```
Router# mpls traffic-eng auto-tunnel backup nhop-only
```

The “Type” field in the following **show ip rsvp fast-reroute** command shows that there is only an NHOP tunnel:

```
Router# show ip rsvp fast-reroute
```

```

Primary   Protect  BW Backup
Tunnel    I/F      BPS:Type Tunnel:Label  State  Level  Type
-----
R3-PRP_t0 PO3/1    0:G      Tu65436:24   Ready  any-unl Nhop

```

The following command changes the minimum and maximum tunnel interface numbers to 1000 and 1100, respectively:

```
Router# mpls traffic-eng auto-tunnel backup tunnel-num min 1000 max 1100
```

You can verify the ID numbers and autotunnel backup range ID by entering the **show ip rsvp fast-reroute** and **show ip interface brief** commands. In this example, only one backup tunnel is protecting the primary tunnel:

```
Router# show ip rsvp fast-reroute
```

```

Primary   Protect  BW Backup
Tunnel    I/F      BPS:Type Tunnel:Label  State  Level  Type
-----
R3-PRP_t0 PO3/1    0:G      Tu1000:24    Ready  any-unl Nhop

```

```
Router# show ip interface brief
```

```

Interface      IP-Address      OK?  Method  Status      Protocol
-----
POS2/0         10.0.0.14      YES  NVRAM   down        down
POS2/1         10.0.0.49      YES  NVRAM   up          up
POS2/2         10.0.0.45      YES  NVRAM   up          up
POS2/3         10.0.0.57      YES  NVRAM   administratively down  down
POS3/0         10.0.0.18      YES  NVRAM   down        down
POS3/1         10.0.0.33      YES  NVRAM   up          up
POS3/2         unassigned     YES  NVRAM   administratively down  down
POS3/3         unassigned     YES  NVRAM   administratively down  down
GigabitEthernet4/0  10.0.0.37      YES  NVRAM   up          up
GigabitEthernet4/1  unassigned     YES  NVRAM   administratively down  down
GigabitEthernet4/2  unassigned     YES  NVRAM   administratively down  down

```



```

Loopback0          10.0.3.1      YES  NVRAM  up                up
Tunnel0            10.0.3.1      YES  unset  up                up
Tunnel65436        10.0.3.1      YES  unset  up                up
Ethernet0          10.3.38.3     YES  NVRAM  up                up
Ethernet1          unassigned    YES  NVRAM  administratively  down

```

The default tunnel range for autotunnel backup tunnels is 65,436 through 65,535. The following **show ip rsvp fast-reroute** command changes the tunnel range IDs:

```
Router# show ip rsvp fast-reroute
```

```

Primary   Protect  BW          Backup
Tunnel    I/F      BPS:Type    Tunnel:Label  State  Level  Type
-----
R3-PRP_t0 PO3/1    0:G         Tu1001:0     Ready any-unl N-Nhop

```

The results are shown in the **show ip interface brief** command:

```
Router# show ip interface
```

```
Router# show ip interface brief
```

```

Interface          UP-Address  OK?  Method  Status          Protocol
POS2/0             10.0.0.14   YES  NVRAM   down            down
POS2/1             10.0.0.49   YES  NVRAM   up              up
POS2/2             10.0.0.45   YES  NVRAM   up              up
POS2/3             10.0.0.57   YES  NVRAM   up              up
POS3/0             10.0.0.18   YES  NVRAM   up              up
POS3/1             10.0.0.33   YES  NVRAM   up              up
POS3/2             unassigned  YES  NVRAM   administratively down  down
POS3/3             unassigned  YES  NVRAM   administratively down  down
Loopback0          10.0.3.1    YES  NVRAM   up              up
Tunnel0            10.0.3.1    YES  unset   up              up
Tunnel1000         10.0.3.1    YES  unset   up              up
Tunnel1001         10.0.3.1    YES  unset   up              up
Ethernet0          10.3.38.3   YES  NVRAM   up              up
Ethernet1          unassigned  YES  NVRAM   administratively down  down

```

The following **mpls traffic-eng auto-tunnel backup timers removal unused** command specifies that a timer will scan backup autotunnels every 50 seconds and the timer will remove tunnels that are not being used:

```
Router(config)# mpls traffic-eng auto-tunnel backup timers removal unused 50
```

The following **mpls traffic-eng auto-tunnel backup config unnumbered-interface** command enables IP processing on POS interface 3/1:

```
Router(config)# mpls traffic-eng auto-tunnel backup config unnumbered-interface POS3/1
```

To verify that IP processing is enabled on POS3/1, enter the **show interfaces tunnel** command:

```
Router# show interfaces tunnel 1001
```

```

Tunnel1001 is up, line protocol is up
  Hardware is Tunnel
  Interface is unnumbered. Using address of POS3/1 (10.0.0.33)
  MTU 1514 bytes, BW 9 Kbit, DLY 500000 usec, rely 255/255, load 1/255
  Encapsulation TUNNEL, loopback not set
  Keepalive not set
  Tunnel source 10.0.0.0, destination 10.0.5.1
  Tunnel protocol/transport Label Switching, sequencing disabled
  Key disabled
  Checksumming of packets disabled
  Last input never, output never, output hang never

```

```

Last clearing of "show interface" counters never
Queueing strategy: fifo
Output queue 0/0, 0 drops; input queue 0/75, 0 drops
5 minute input rate 0 bits/sec, 0 packets/sec
5 minute output rate 0 bits/sec, 0 packets/sec
  0 packets input, 0 bytes, 0 no buffer
    Received 0 broadcasts, 0 runts, 0 giants, 0 throttles
  0 input errors, 0 CRC, 0 frame, 0 overrun, 0 ignored, 0 abort
  0 packets output, 0 bytes, 0 underruns
  0 output errors, 0 collisions, 0 interface resets
  0 output buffer failures, 0 output buffers swapped out

```

The following **mpls traffic-eng auto-tunnel backup config affinity** command specifies affinity and link attributes that help in the calculation of the dynamically created backup tunnel:

```
Router(config)# mpls traffic-eng auto-tunnel backup config affinity 0x22 mask 0x22
```

To display the affinity and link attributes assigned to a dynamically created backup tunnel, enter the **show mpls traffic-eng auto-tunnel backup** command:

```

Router# show mpls traffic-eng auto-tunnel backup

State: Enabled
  Tunnel Count: 3 (up:2, down: 1)
  Tunnel ID Range: 65436-65535
  Create Nhop only: Yes
  SRLG: Not configured
  Delete unused tunnels after: 50 Seconds
Config:
  Unnumbered i/f: Loopback0
  Affinity: 0x22/0x22

```

Establishing MPLS One-Hop Tunnels to Neighbors Example

For autotunneling to automatically create primary tunnels to all next hops, you must enter the following command:

```
Router(config)# mpls traffic-eng auto-tunnel primary onehop
```

In this example there are four primary tunnels and no backup tunnels. To verify that configuration, enter the **show ip rsvp fast-reroute** command and the **show ip interface brief** command:

```

Router# show ip rsvp fast-reroute
Primary
Tunnel          Protect BW      Backup
                I/F    BPS:Type  Tunnel:Label  State  Level  Type
-----
R3-PRP_t65337  PO2/2   0:G      None          None  None
R3-PRP_t65338  PO3/1   0:G      None          None  None
R3-PRP_t65339  Gi4/0   0:G      None          None  None
R3-PRP_t65336  PO2/1   0:G      None          None  None
Router# show ip interface brief
Interface      IP-Address  OK?  Method  Status  Protocol
POS2/0         10.0.0.14   YES  NVRAM   down    down
POS2/1         10.0.0.49   YES  NVRAM   up       up
POS2/2         10.0.0.45   YES  NVRAM   up       up
POS2/3         10.0.0.57   YES  NVRAM   administratively down  down
POS3/0         10.0.0.18   YES  NVRAM   down    down
POS3/1         10.0.0.33   YES  NVRAM   up       up
POS3/2         unassigned  YES  NVRAM   administratively down  down
POS3/3         unassigned  YES  NVRAM   administratively down  down

```

```

GigabitEthernet4/0      10.0.0.37      YES  NVRAM  up          up
GigabitEthernet4/1      unassigned     YES  NVRAM  administratively down  down
GigabitEthernet4/2      unassigned     YES  NVRAM  administratively down  down
Loopback0                10.0.3.1      YES  NVRAM  up          up
Tunnel0                  10.0.3.1      YES  unset  administratively down  down
Tunnel65336              10.0.3.1      YES  unset  up          up
Tunnel65337              10.0.3.1      YES  unset  up          up
Tunnel65338              10.0.3.1      YES  unset  up          up
Tunnel65339              10.0.3.1      YES  unset  up          up
Ethernet0                10.3.38.3     YES  NVRAM  up          up
Ethernet1                unassigned     YES  NVRAM  administratively down  down
R3-PRP#

```

The default tunnel range for primary autotunnels is 65,336 through 65,435. The following **mpls traffic-eng auto-tunnel primary tunnel-num** command changes the range to 2000 through 2100:

```
Router(config)# mpls traffic-eng auto-tunnel primary tunnel-num min 2000 max 2100
```

The following sample output from the **show ip rsvp fast-reroute** command and the **show ip interface brief** command shows that the tunnel IDs are 2000, 2001, 2002, and 2003:

```

Router# show ip rsvp fast-reroute
Primary          Protect BW      Backup
Tunnel          I/F    BPS:Type  Tunnel:Label  State  Level  Type
-----
R3-PRP_t2001    PO2/2  0:G       None          None  None
R3-PRP_t2002    PO3/1  0:G       None          None  None
R3-PRP_t2003    Gi4/0  0:G       None          None  None
R3-PRP_t2000    PO2/1  0:G       None          None  None
Router# show ip interface brief

Interface        IP-Address      OK? Method Status      Protocol
POS2/0           10.0.0.14       YES NVRAM  down        down
POS2/1           10.0.0.49       YES NVRAM  up          up
POS2/2           10.0.0.45       YES NVRAM  up          up
POS2/3           10.0.0.57       YES NVRAM  administratively down  down
POS3/0           10.0.0.18       YES NVRAM  down        down
POS3/1           10.0.0.33       YES NVRAM  up          up
POS3/2           unassigned      YES NVRAM  administratively down  down
POS3/3           unassigned      YES NVRAM  administratively down  down
GigabitEthernet4/0  10.0.0.37      YES NVRAM  up          up
GigabitEthernet4/1  unassigned     YES NVRAM  administratively down  down
GigabitEthernet4/2  unassigned     YES NVRAM  administratively down  down
Loopback0         10.0.3.1       YES NVRAM  up          up
Tunnel0           10.0.3.1       YES unset  administratively down  down
Tunnel2000        10.0.3.1       YES unset  up          up
Tunnel2001        10.0.3.1       YES unset  up          up
Tunnel2002        10.0.3.1       YES unset  up          up
Tunnel2003        10.0.3.1       YES unset  up          up
Ethernet0         10.3.38.3      YES NVRAM  up          up
Ethernet1         unassigned     YES NVRAM  administratively down  down

```

The following **mpls traffic-eng auto-tunnel primary timers** command specifies that a timer will scan backup autotunnels every 50 seconds and remove tunnels that are not being used:

```
Router(config)# mpls traffic-eng auto-tunnel primary timers removal rerouted 50
```

The following **mpls traffic-eng auto-tunnel primary config unnumbered** command enables IP processing on POS interface 3/1:

```
Router(config)# mpls traffic-eng auto-tunnel primary config unnumbered POS3/1
```

To specify that autotunneling remove all primary autotunnels and re-create them, enter the following command:

```
Router(config)# clear mpls traffic-eng auto-tunnel primary
```

Additional References

The following sections provide references related to the MPLS Traffic Engineering-Autotunnel Primary and Backup feature.

Additional References

Related Topic	Document Title
Backup tunnels	MPLS TE: Link and Node Protection, with RSVP Hellos Support (with Fast Tunnel Interface Down Detection)
Link protection	MPLS TE: Link and Node Protection, with RSVP Hellos Support (with Fast Tunnel Interface Down Detection)
MPLS traffic engineering commands	<i>Cisco IOS Multiprotocol Label Switching Command Reference</i>
SSO	<i>Cisco IOS High Availability Configuration Guide</i>

Standards

Standard	Title
No new or modified standards are supported by this feature, and support for existing standards has not been modified by this feature.	--

MIBs

MIB	MIBs Link
No new or modified MIBs are supported by this feature, and support for existing MIBs has not been modified by this feature.	To locate and download MIBs for selected platforms, Cisco IOS releases, and feature sets, use Cisco MIB Locator found at the following URL: http://www.cisco.com/go/mibs

RFCs

RFC	Title
No new or modified RFCs are supported by this feature, and support for existing RFCs has not been modified by this feature.	--

Technical Assistance

Description	Link
<p>The Cisco Support website provides extensive online resources, including documentation and tools for troubleshooting and resolving technical issues with Cisco products and technologies.</p> <p>To receive security and technical information about your products, you can subscribe to various services, such as the Product Alert Tool (accessed from Field Notices), the Cisco Technical Services Newsletter, and Really Simple Syndication (RSS) Feeds.</p> <p>Access to most tools on the Cisco Support website requires a Cisco.com user ID and password.</p>	http://www.cisco.com/techsupport

Feature Information for MPLS Traffic Engineering-Autotunnel Primary and Backup

The following table provides release information about the feature or features described in this module. This table lists only the software release that introduced support for a given feature in a given software release train. Unless noted otherwise, subsequent releases of that software release train also support that feature.

Use Cisco Feature Navigator to find information about platform support and Cisco software image support. To access Cisco Feature Navigator, go to www.cisco.com/go/cfn. An account on Cisco.com is not required.

Table 7: Feature Information for MPLS Traffic Engineering-Autotunnel Primary and Backup

Feature Name	Releases	Feature Configuration Information
MPLS Traffic Engineering-Autotunnel Primary and Backup	12.0(27)S 12.2(33)SRA 12.2(33)SXH 12.4(20)T 12.2(33)SRE 15.1(1)S Cisco IOS XE Release 2.3	<p>The MPLS Traffic Engineering-Autotunnel Primary and Backup feature enables a router to dynamically build backup tunnels and to dynamically create one-hop primary tunnels on all interfaces that have been configured with MPLS TE tunnels.</p> <p>In Cisco IOS Release 12.0(27)S, this feature was introduced.</p> <p>In Cisco IOS Release 12.2(33)SRA, this feature was integrated.</p> <p>In Cisco IOS Release 12.2(33)SXH, support was added.</p> <p>In Cisco IOS Release 12.4(20)T, this feature was integrated.</p> <p>In Cisco IOS Release 12.2(33)SRE, this feature was integrated. A router with primary one-hop autotunnels and backup autotunnels can be configured with SSO redundancy.</p> <p>In Cisco IOS Release 15.1(1)S, this feature was updated to allow you to specify affinity/mask for dynamically created MPLS TE backup tunnels.</p> <p>In Cisco IOS XE Release 2.3, this feature was implemented on the Cisco ASR 1000 Series Aggregation Services Routers.</p> <p>The following commands were introduced: affinity, mpls traffic-eng auto-tunnel backup config, show mpls traffic-eng auto-tunnel backup.</p>
MPLS TE - Autotunnel/Automesh SSO Coexistence	15.2(1)T Cisco IOS XE Release 3.5S	<p>In Cisco IOS XE Release 3.5S, this feature was integrated.</p> <p>In Cisco IOS Release 15.2(1)T, this feature was integrated.</p> <p>Note Starting with Cisco IOS Release 15.2(2)S and Cisco IOS XE Release 3.6S, the SSO Support for MPLS TE Autotunnel and Automesh feature replaces the MPLS TE - Autotunnel/Automesh SSO Coexistence feature. For more information, see the <i>MPLS High Availability Configuration Guide</i> for the new implementation.</p>

Glossary

backup tunnel --An MPLS traffic engineering tunnel used to protect other (primary) tunnel's traffic when a link or node failure occurs.

egress router --A router at the edge of the network where packets are leaving.

Fast Reroute --Fast Reroute (FRR) is a mechanism for protecting MPLS traffic engineering (TE) LSPs from link and node failure by locally repairing the LSPs at the point of failure, allowing data to continue to flow on them while their headend routers attempt to establish end-to-end LSPs to replace them. FRR locally repairs the protected LSPs by rerouting them over backup tunnels that bypass failed links or nodes.

hop --Passage of a data packet between two network nodes (for example, between two routers).

interface --A network connection.

IP address --A 32-bit address assigned to hosts using TCP/IP. An IP address belongs to one of five classes (A, B, C, D, or E) and is written as four octets separated by periods (dotted decimal format). Each address consists of a network number, an optional subnetwork number, and a host number. The network and subnetwork numbers together are used for routing, and the host number is used to address an individual host within the network or subnetwork. A subnet mask is used to extract network and subnetwork information from the IP address.

IP explicit path --A list of IP addresses, each representing a node or link in the explicit path.

LDP --Label Distribution Protocol. A standard protocol between MPLS-enabled routers to negotiate the labels (addresses) used to forward packets.

link --Point-to-point connection between adjacent nodes.

LSP --label switched path. A path that is followed by a labeled packet over several hops, starting at an ingress LSR and ending at an egress LSR.

LSR --label switch router. A Layer 3 router that forwards a packet based on the value of a label encapsulated in the packet.

MPLS --Multiprotocol Label Switching. A method for forwarding packets (frames) through a network. It enables routers at the edge of a network to apply labels to packets. ATM switches or existing routers in the network core can switch packets according to the labels with minimal lookup overhead.

node --Endpoint of a network connection or a junction common to two or more lines in a network. Nodes can be interconnected by links, and serve as control points in the network.

penultimate router --The second-to-last router; that is, the router that is immediately before the egress router.

primary tunnel --An MPLS tunnel whose LSP can be fast rerouted if there is a failure.

router --A network layer device that uses one or more metrics to determine the optimal path along which network traffic should be forwarded. Routers forward packets from one network to another based on network layer information.

router ID --Something by which a router originating a packet can be uniquely distinguished from all other routers. For example, an IP address from one of the router's interfaces.

scalability --An indicator showing how quickly some measure of resource usage increases as a network gets larger.

traffic engineering --The techniques and processes used to cause routed traffic to travel through the network on a path other than the one that would have been chosen if standard routing methods had been used.



CHAPTER 5

MPLS Traffic Engineering (TE) Path Protection

The MPLS Traffic Engineering (TE): Path Protection feature provides an end-to-end failure recovery mechanism (that is, full path protection) for Multiprotocol Label Switching (MPLS) traffic engineering (TE) tunnels.

- [Finding Feature Information, on page 101](#)
- [Prerequisites for MPLS Traffic Engineering \(TE\) Path Protection, on page 101](#)
- [Restrictions for MPLS Traffic Engineering \(TE\) Path Protection, on page 102](#)
- [Information About MPLS Traffic Engineering \(TE\) Path Protection, on page 102](#)
- [How to Configure MPLS Traffic Engineering \(TE\) Path Protection, on page 104](#)
- [Configuration Examples for MPLS Traffic Engineering \(TE\): Regular Path Protection, on page 116](#)
- [Configuration Examples for MPLS Traffic Engineering \(TE\): Enhanced Path Protection, on page 121](#)
- [Additional References, on page 127](#)
- [Feature Information for MPLS Traffic Engineering Path Protection, on page 128](#)
- [Glossary, on page 129](#)

Finding Feature Information

Your software release may not support all the features documented in this module. For the latest caveats and feature information, see [Bug Search Tool](#) and the release notes for your platform and software release. To find information about the features documented in this module, and to see a list of the releases in which each feature is supported, see the feature information table.

Use Cisco Feature Navigator to find information about platform support and Cisco software image support. To access Cisco Feature Navigator, go to www.cisco.com/go/cfn. An account on Cisco.com is not required.

Prerequisites for MPLS Traffic Engineering (TE) Path Protection

- Ensure that your network supports MPLS TE, Cisco Express Forwarding, and Intermediate System-to-Intermediate System (IS-IS) or Open Shortest Path First (OSPF).
- Enable MPLS.
- Configure TE on the routers.
- Configure a TE tunnel with a primary path option by using the **tunnel mpls traffic-eng path-option** command.

- If your router supports SSO, configure Resource Reservation Protocol (RSVP) Graceful Restart in full mode on the routers.
- If your router supports SSO, for NSF operation you must have configured SSO on the device.

Restrictions for MPLS Traffic Engineering (TE) Path Protection

- There can be only one secondary path for each primary path option.
- The secondary path will not be signaled with the Fast Reroute (FRR) flag.
- Dynamic diverse paths are not supported.
- Do not use link and node protection with path protection on the headend router.
- Do not configure path protection on an automesh tunnel template because the destinations are different and you cannot use the same path option to reach multiple destinations.
- A lockdown option is not supported in protected path options.
- After an SSO event, path protection will not be immediately available on tunnels. Only a single label switched path (LSP) is checkpointed and recovered for the tunnel; the path-protected LSP will not be signaled until the end of the RSVP High Availability (HA) recovery period.

Information About MPLS Traffic Engineering (TE) Path Protection

Traffic Engineering Tunnels

MPLS TE lets you build label switched paths (LSPs) across your network for forwarding traffic.

MPLS TE LSPs, also called TE tunnels, let the headend of a TE tunnel control the path its traffic takes to a particular destination. This method is more flexible than forwarding traffic based only on a destination address.

Some tunnels are more important than others. For example, you may have tunnels carrying VoIP traffic and tunnels carrying data traffic that are competing for the same resources. MPLS TE allows you to have some tunnels preempt others. Each tunnel has a priority, and more-important tunnels take precedence over less-important tunnels.

Path Protection

Path protection provides an end-to-end failure recovery mechanism (that is, full path protection) for MPLS TE tunnels. A secondary LSP is established, in advance, to provide failure protection for the protected LSP that is carrying a tunnel's TE traffic. When there is a failure on the protected LSP, the headend router immediately enables the secondary LSP to temporarily carry the tunnel's traffic. If there is a failure on the secondary LSP, the tunnel no longer has path protection until the failure along the secondary path is cleared. Path protection can be used with a single area (OSPF or IS-IS), or Inter-AS (Border Gateway Protocol (BGP), external BGP (eBGP), and static).

The failure detection mechanisms that trigger a switchover to a secondary tunnel include the following:

- Path error or resv tear from Resource Reservation Protocol (RSVP) signaling
- Notification from the RSVP hello that a neighbor is lost
- Notification from the Bidirectional Forwarding Detection (BFD) protocol that a neighbor is lost
- Notification from the Interior Gateway Protocol (IGP) that the adjacency is down
- Local teardown of the protected tunnel's LSP due to preemption in order to signal higher priority LSPs, a Packet over SONET (POS) alarm, online insertion and removal (OIR), and so forth

An alternate recovery mechanism is Fast Reroute (FRR), which protects MPLS TE LSPs only from link and node failures by locally repairing the LSPs at the point of failure.

Although not as fast as link or node protection, presignaling a secondary LSP is faster than configuring a secondary primary path option or allowing the tunnel's headend router to dynamically recalculate a path. The actual recovery time is topology-dependent, and affected by delay factors such as propagation delay or switch fabric latency.

Enhanced Path Protection

Enhanced path protection provides support of multiple backup path options per primary path option. You can configure up to eight backup path options for a given primary path option. Only one of the configured backup path options is actively signaled at any time.

After you enter the **mpls traffic-eng path-option list** command, you can enter the backup path priority in the *number* argument of the **path-option** command. A lower identifier represents a higher priority. Priorities are configurable for each backup path option. Multiple backup path options and a single backup path option cannot coexist to protect a primary path option.

ISSU

Cisco ISSU allows you to perform a Cisco IOS XE software upgrade or downgrade while the system continues to forward packets. ISSU takes advantage of the Cisco IOS XE high availability infrastructure--Cisco NSF with SSO and hardware redundancy--and eliminates downtime associated with software upgrades or version changes by allowing changes while the system remains in service. That lowers the impact that planned maintenance activities have on network service availability; there is less downtime and better access to critical systems.

When Path Protection is enabled and an ISSU upgrade is performed, path protection performance is similar to other TE features.

NSF/SSO

Cisco NSF with SSO provides continuous packet forwarding, even during a network processor hardware or software failure.

SSO takes advantage of Route Processor (RP) redundancy to increase network availability by establishing one of the RPs as the active processor while the other RP is designated as the secondary processor, and then synchronizing critical state information between them. Following an initial synchronization between the two processors, SSO dynamically maintains RP state information between them. A switchover from the active to the secondary processor occurs when the active RP fails, is removed from the networking device, or is manually taken down for maintenance.

Cisco NSF works with SSO to minimize the amount of time a network is unavailable to users after a switchover. The main purpose of NSF is to continue forwarding IP packets after an RP switchover. Cisco NSF helps to suppress routing flaps in SSO-enabled devices, thus reducing network instability.

The MPLS Traffic Engineering: Path Protection feature can recover after SSO. A tunnel configured for path protection may have two LSPs signaled simultaneously: the primary LSP that is carrying the traffic and the secondary LSP that carries traffic in case there is a failure along the primary path. Only information associated with one of those LSPs, the one that is currently carrying traffic, is synched to the standby RP. The standby RP, upon recovery, can determine from the checkpointed information whether the LSP was the primary or secondary.

If the primary LSP was active during the switchover, only the primary LSP is recovered. The secondary LSP that was signaled and that provided path protection is resignaled after the TE recovery period is complete. This does not impact traffic on the tunnel because the secondary LSP was not carrying traffic.

How to Configure MPLS Traffic Engineering (TE) Path Protection

Regular Path Protection Configuration Tasks

This section contains the following tasks which are shown in the figure below.

Figure 18: Network Topology--Path Protection

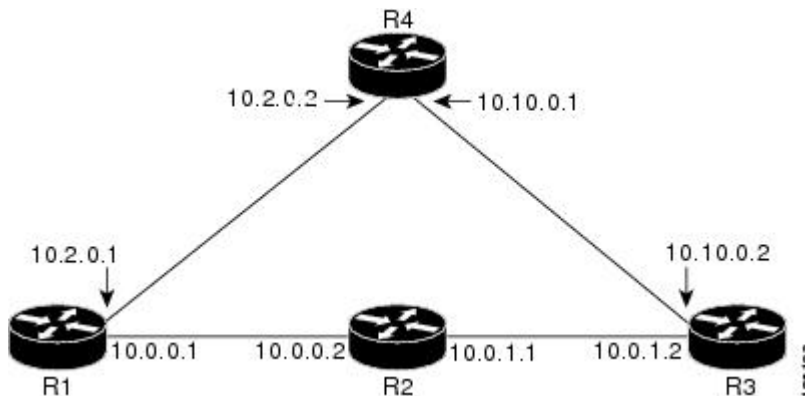

Configuring Explicit Paths for Secondary Paths

To specify a secondary path that does not include common links or nodes associated with the primary path in case those links or nodes go down, configure an explicit path by performing the following steps.

SUMMARY STEPS

1. **enable**
2. **configure terminal**
3. **ip explicit-path** {name *path-name*| *identifier number*} [**enable** | **disable**]
4. **index** *index* *command ip-address*
5. **exit**
6. **exit**

DETAILED STEPS

	Command or Action	Purpose
Step 1	enable Example: <pre>Router> enable</pre>	Enables privileged EXEC mode. <ul style="list-style-type: none"> • Enter your password if prompted.
Step 2	configure terminal Example: <pre>Router# configure terminal</pre>	Enters global configuration mode.
Step 3	ip explicit-path <i>{name path-name identifier number}</i> [enable disable] Example: <pre>Router(config)# ip explicit-path name path3441 enable</pre>	Creates or modifies the explicit path and enters IP explicit path command mode.
Step 4	index <i>index command ip-address</i> Example: <pre>Router(cfg-ip-expl-path)# index 1 next-address 10.0.0.1</pre>	Inserts or modifies a path entry at a specific index. The IP address represents the node ID. Note Enter this command once for each router.
Step 5	exit Example: <pre>Router(cfg-ip-expl-path)# exit</pre>	Exits IP explicit path command mode and enters global configuration mode.
Step 6	exit Example: <pre>Router(config)# exit</pre>	Exits global configuration mode and enters privileged EXEC mode.

Assigning a Secondary Path Option to Protect a Primary Path Option

Assign a secondary path option in case there is a link or node failure along a path and all interfaces in your network are not protected.

SUMMARY STEPS

1. **enable**
2. **configure terminal**
3. **interface tunnel** *number*
4. **tunnel mpls traffic-eng path-option protect** *number explicit {name path-name | identifier path-number}* *[verbatim] [attributes string] [bandwidth kb/s| sub-pool kb/s]*
5. **exit**

6. exit

DETAILED STEPS

	Command or Action	Purpose
Step 1	enable Example: Router> enable	Enables privileged EXEC mode. • Enter your password if prompted.
Step 2	configure terminal Example: Router# configure terminal	Enters global configuration mode.
Step 3	interface tunnel <i>number</i> Example: Router(config)# interface tunnel500	Configures a tunnel interface and enters interface configuration mode.
Step 4	tunnel mpls traffic-eng path-option protect <i>number</i> explicit {<i>name path-name</i> <i>identifier path-number</i>} [<i>verbatim</i>] [<i>attributes string</i>] [<i>bandwidth kb/s</i> <i>sub-pool kb/s</i>] Example: Router(config-if)# tunnel mpls traffic-eng path-option protect 10 explicit name path344	Configures a secondary path option for an MPLS TE tunnel.
Step 5	exit Example: Router(config-if)# exit	Exits interface configuration mode and returns to global configuration mode.
Step 6	exit Example: Router(config)# exit	Exits global configuration mode and returns to privileged EXEC mode.

Verifying the Configuration of MPLS Traffic Engineering Path Protection

To verify the configuration of path protection, perform the following steps. In Steps 1 and 2, refer to the figure below.

Figure 19: Network Topology Verification

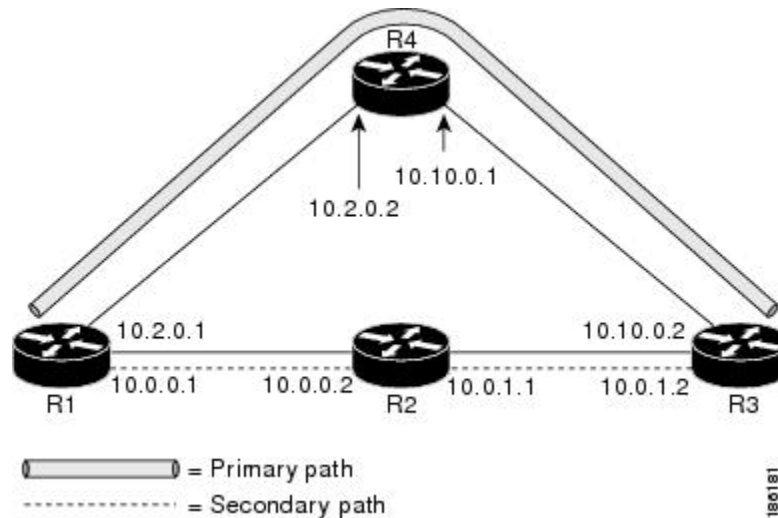

SUMMARY STEPS

1. `show running interface tunnel tunnel-number`
2. `show mpls traffic-eng tunnels tunnel-interface`
3. `show mpls traffic-eng tunnels tunnel-interface [brief] protection`
4. `show ip rsvp high-availability database {hello | link-management {interfaces | system} | lsp [filter destination ip-address/ filter lsp-id lsp-id/ filter source ip-address | filter tunnel-id tunnel-id] | lsp-head [filter number] | summary}`

DETAILED STEPS

Step 1 `show running interface tunnel tunnel-number`

This command shows the configuration of the primary path and protection path options.

Note To show the status of both LSPs (that is, both the primary path and the protected path), use the `show mpls traffic-eng tunnels protection` command.

Example:

```
Router# show running interface tunnel500

Building configuration...
Current configuration : 497 bytes
!
interface Tunnel500
 ip unnumbered Loopback0
 tunnel destination 10.0.0.9
 tunnel mode mpls traffic-eng
 tunnel mpls traffic-eng autoroute announce
 tunnel mpls traffic-eng priority 7 7
 tunnel mpls traffic-eng bandwidth 100
 tunnel mpls traffic-eng path-option 10 explicit name path344
 tunnel mpls traffic-eng path-option 20 explicit name path345
 tunnel mpls traffic-eng path-option protect 10 explicit name path3441
```

```
tunnel mpls traffic-eng path-option protect 20 explicit name path348
end
```

Step 2 `show mpls traffic-eng tunnels tunnel-interface`

This command shows tunnel path information.

The Common Link(s) field shows the number of links shared by both the primary and secondary paths, from the headend router to the tailend router.

The Common Node(s) field shows the number of nodes shared by both the primary and secondary paths, excluding the headend and tailend routers.

As shown in the following output, there are no common links or nodes:

Example:

```
Router# show mpls traffic-eng tunnels tunnel500
Name: R1_t500 (Tunnel500) Destination: 10.0.0.9
Status:
  Admin: up Oper: up Path: valid Signalling: connected
  path option 10, type explicit path344 (Basis for Setup, path weight 20)
  path option 20, type explicit path345
  Path Protection: 0 Common Link(s), 0 Common Node(s)
  path protect option 10, type explicit path3441 (Basis for Protect, path weight 20)
  path protect option 20, type explicit path348
Config Parameters:
  Bandwidth: 100 kb/s (Global) Priority: 7 7 Affinity: 0x0/0xFFFF
  Metric Type: TE (default)
  AutoRoute: enabled LockDown: disabled Loadshare: 100 bw-based
  auto-bw: disabled
Active Path Option Parameters:
  State: explicit path option 10 is active
  BandwidthOverride: disabled LockDown: disabled Verbatim: disabled
InLabel : -
OutLabel : FastEthernet1/0/0, 16
RSVP Signalling Info:
  Src 10.1.1.1, Dst 10.0.0.9, Tun_Id 500, Tun_Instance 19
RSVP Path Info:
  My Address: 10.2.0.1
  Explicit Route: 10.2.0.2 10.10.0.1 10.10.0.2 10.0.0.9
  Record Route: NONE
  Tspec: ave rate=100 kbits, burst=1000 bytes, peak rate=100 kbits
RSVP Resv Info:
  Record Route: NONE
  Fspec: ave rate=100 kbits, burst=1000 bytes, peak rate=100 kbits
Shortest Unconstrained Path Info:
  Path Weight: 20 (TE)
  Explicit Route: 10.2.0.1 10.2.0.2 10.10.0.1 10.10.0.2 10.0.0.9
History:
Tunnel:
  Time since created: 11 minutes, 17 seconds
  Time since path change: 8 minutes, 5 seconds
  Number of LSP IDs (Tun_Instances) used: 19
Current LSP:
  Uptime: 8 minutes, 5 seconds
```

Step 3 `show mpls traffic-eng tunnels tunnel-interface [brief] protection`

Use this command, with the **protection** keyword specified, to show the status of both LSPs (that is, both the primary path and the protected path).

Note Deleting a primary path option has the same effect as shutting down a link. Traffic will move to the protected path in use.

The following command output shows that the primary LSP is up, and the secondary LSP is up and providing protection:

Example:

```
Router# show mpls traffic-eng tunnels tunnel500 protection
R1_t500
LSP Head, Tunnel500, Admin: up, Oper: up
Src 10.1.1.1, Dest 10.0.0.9, Instance 19
Fast Reroute Protection: None
Path Protection: 0 Common Link(s), 0 Common Node(s)
Primary lsp path:10.2.0.1 10.2.0.2
                  10.10.0.1 10.10.0.2
                  10.0.0.9
Protect lsp path:10.0.0.1 10.0.0.2
                  10.0.1.1 10.0.1.2
                  10.0.0.9
Path Protect Parameters:
Bandwidth: 100 kbps (Global) Priority: 7 7 Affinity: 0x0/0xFFFF
Metric Type: TE (default)
InLabel : -
OutLabel : FastEthernet0/0/0, 16
RSVP Signalling Info:
Src 10.1.1.1, Dst 10.0.0.9, Tun_Id 500, Tun_Instance 27
RSVP Path Info:
My Address: 10.0.0.1
Explicit Route: 10.0.0.2 10.0.1.1 10.0.1.2 10.0.0.9
Record Route: NONE
Tspec: ave rate=100 kbits, burst=1000 bytes, peak rate=100 kbits
RSVP Resv Info:
Record Route: NONE
Fspec: ave rate=100 kbits, burst=1000 bytes, peak rate=100 kbits
```

The following command output shows that the primary LSP is down, and the secondary LSP is up and is actively carrying traffic:

Example:

```
Router# show mpls traffic-eng tunnels tunnel500 protection
R1_t500
LSP Head, Tunnel500, Admin: up, Oper: up
Src 10.1.1.1, Dest 10.0.0.9, Instance 27
Fast Reroute Protection: None
Path Protection: Backup lsp in use.
```

Step 4 **show ip rsvp high-availability database** {hello | link-management {interfaces | system} | lsp [filter destination ip-address/ filter lsp-id lsp-id/ filter source ip-address | filter tunnel-id tunnel-id] | lsp-head [filter number] | summary}

The **show ip rsvp high-availability database** command displays the contents of the RSVP high availability (HA) read and write databases used in TE. If you specify the **lsp-head** keyword, the command output includes path protection information.

Example:

```
Router# show ip rsvp high-availability database lsp-head
LSP_HEAD WRITE DB
Tun ID: 500
Header:
State: Checkpointed Action: Add
```

```

Seq #: 3           Flags: 0x0
Data:
lsp_id: 5, bandwidth: 100, thead_flags: 0x1, popt: 1
feature_flags: path protection active
output_if_num: 5, output_nhop: 10,0,0,1
RRR path setup info
Destination: 10.0.0.9, Id: 10.0.0.9 Router Node (ospf) flag:0x0
IGP: ospf, IGP area: 0, Number of hops: 5, metric: 2
Hop 0: 10.0.0.1, Id: 10.0.0.1 Router Node (ospf), flag:0x0
Hop 1: 10.0.0.2, Id: 10.0.0.7 Router Node (ospf), flag:0x0
Hop 2: 10.0.1.1, Id: 10.0.0.7 Router Node (ospf), flag:0x0
Hop 3: 10.0.1.2, Id: 10.0.0.9 Router Node (ospf), flag:0x0
Hop 4: 10.0.0.9, Id: 10.0.0.9 Router Node (ospf), flag:0x0

```

Enhanced Path Protection Configuration Tasks

This section contains the following tasks which are shown in the figure below.

Figure 20: Network Topology - Enhanced Path Protection

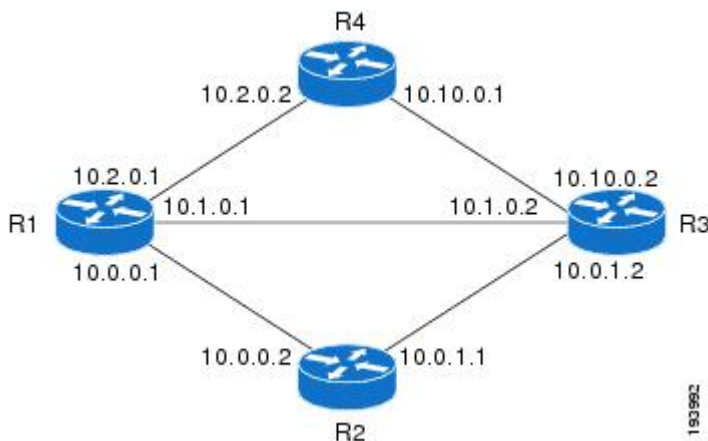

Creating a Path Option List

Perform the following task to create a path option list of backup paths for a primary path option.



Note To use a secondary path instead, perform the steps in the Configuring Explicit Paths for Secondary Paths section.

SUMMARY STEPS

1. **enable**
2. **configure terminal**
3. **mpls traffic-eng path-option list** [**name** *pathlist-name* | **identifier** *pathlist-number*]
4. **path-option** *number* **explicit** [**name** *pathoption-name* | **identifier***pathoption-number*]
5. **list**

6. **no** [*pathoption-name* | *pathoption-number*]
7. **exit**

DETAILED STEPS

	Command or Action	Purpose
Step 1	enable Example: <pre>Router> enable</pre>	Enables privileged EXEC mode. <ul style="list-style-type: none"> • Enter your password if prompted.
Step 2	configure terminal Example: <pre>Router# configure terminal</pre>	Enters global configuration mode.
Step 3	mpls traffic-eng path-option list [<i>name pathlist-name</i> <i>identifier pathlist-number</i>] Example: <pre>Router(config)# mpls traffic-eng path-option list name pathlist-01</pre>	Configures a path option list, and enters path-option list configuration mode. <ul style="list-style-type: none"> • You can enter the following commands: path-option, list, no, and exit.
Step 4	path-option number explicit [<i>name pathoption-name</i> <i>identifier pathoption-number</i>] Example: <pre>Router(cfg-pathoption-list)# path-option 10 explicit identifier 200</pre>	(Optional) Specifies the name or identification number of the path option to add, edit, or delete. The <i>pathoption-number</i> value can be from 1 through 65535.
Step 5	list Example: <pre>Router(cfg-pathoption-list)# list</pre>	(Optional) Lists all of the path options.
Step 6	no [<i>pathoption-name</i> <i>pathoption-number</i>] Example: <pre>Router(cfg-pathoption-list)# no 10</pre>	(Optional) Deletes a specified path option.
Step 7	exit Example: <pre>Router(cfg-pathoption-list)# exit</pre>	(Optional) Exits path-option list configuration mode and enters global configuration mode.

Assigning a Path Option List to Protect a Primary Path Option

Assign a path option list in case there is a link or node failure along a path and all interfaces in your network are not protected. See the third figure above.

SUMMARY STEPS

1. **enable**
2. **configure terminal**
3. **interface tunnel *number***
4. **tunnel mpls traffic-eng path-option protect *number* [attributes *lsp-attributes* | bandwidth {*kpbs* | subpool *kpbs*} | explicit {identifier *path-number* | name *path-name*} | list {*pathlist-name name* | identifier *pathlist-identifier*}]**
5. **exit**

DETAILED STEPS

	Command or Action	Purpose
Step 1	enable Example: Router> enable	Enables privileged EXEC mode. <ul style="list-style-type: none"> • Enter your password if prompted.
Step 2	configure terminal Example: Router# configure terminal	Enters global configuration mode.
Step 3	interface tunnel <i>number</i> Example: Router(config)# interface tunnel500	Configures a tunnel interface and enters interface configuration mode.
Step 4	tunnel mpls traffic-eng path-option protect <i>number</i> [attributes <i>lsp-attributes</i> bandwidth {<i>kpbs</i> subpool <i>kpbs</i>} explicit {identifier <i>path-number</i> name <i>path-name</i>} list {<i>pathlist-name name</i> identifier <i>pathlist-identifier</i>}] Example: Router(config-if)# tunnel mpls traffic-eng path-option protect 10 list name pathlist-01	Configures a path option list to protect primary path option 10.
Step 5	exit Example: Router(config-if)# exit	(Optional) Exits interface configuration mode and enters global configuration mode.

Verifying the Configuration of MPLS Traffic Engineering Path Protection

To verify the configuration of path protection, perform the following steps. In Steps 1 and 2, refer to the figure below.

Figure 21: Network Topology Verification

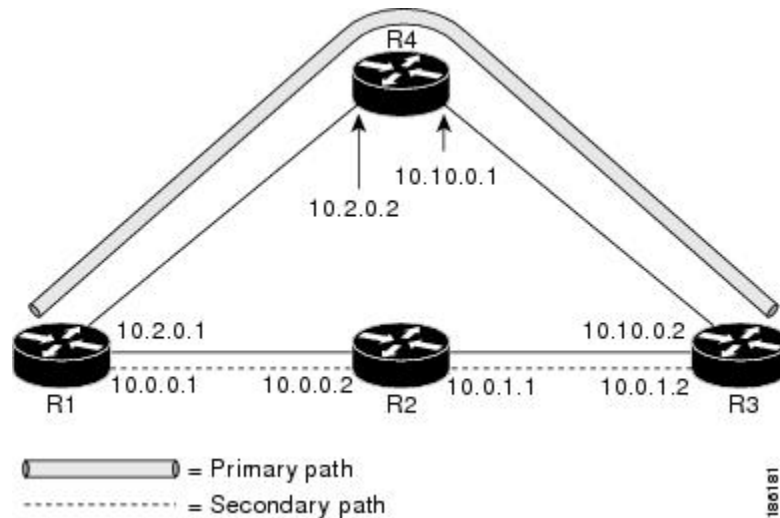

SUMMARY STEPS

1. `show running interface tunnel tunnel-number`
2. `show mpls traffic-eng tunnels tunnel-interface`
3. `show mpls traffic-eng tunnels tunnel-interface [brief] protection`
4. `show ip rsvp high-availability database {hello | link-management {interfaces | system} | lsp [filter destination ip-address/ filter lsp-id lsp-id/ filter source ip-address | filter tunnel-id tunnel-id] | lsp-head [filter number] | summary}`

DETAILED STEPS

Step 1 `show running interface tunnel tunnel-number`

This command shows the configuration of the primary path and protection path options.

Note To show the status of both LSPs (that is, both the primary path and the protected path), use the `show mpls traffic-eng tunnels protection` command.

Example:

```
Router# show running interface tunnel500

Building configuration...
Current configuration : 497 bytes
!
interface Tunnel500
 ip unnumbered Loopback0
 tunnel destination 10.0.0.9
 tunnel mode mpls traffic-eng
 tunnel mpls traffic-eng autoroute announce
 tunnel mpls traffic-eng priority 7 7
 tunnel mpls traffic-eng bandwidth 100
 tunnel mpls traffic-eng path-option 10 explicit name path344
 tunnel mpls traffic-eng path-option 20 explicit name path345
 tunnel mpls traffic-eng path-option protect 10 explicit name path3441
```

```
tunnel mpls traffic-eng path-option protect 20 explicit name path348
end
```

Step 2 `show mpls traffic-eng tunnels tunnel-interface`

This command shows tunnel path information.

The Common Link(s) field shows the number of links shared by both the primary and secondary paths, from the headend router to the tailend router.

The Common Node(s) field shows the number of nodes shared by both the primary and secondary paths, excluding the headend and tailend routers.

As shown in the following output, there are no common links or nodes:

Example:

```
Router# show mpls traffic-eng tunnels tunnel500
Name: R1_t500 (Tunnel500) Destination: 10.0.0.9
Status:
  Admin: up Oper: up Path: valid Signalling: connected
  path option 10, type explicit path344 (Basis for Setup, path weight 20)
  path option 20, type explicit path345
  Path Protection: 0 Common Link(s), 0 Common Node(s)
  path protect option 10, type explicit path3441 (Basis for Protect, path weight 20)
  path protect option 20, type explicit path348
Config Parameters:
  Bandwidth: 100 kb/s (Global) Priority: 7 7 Affinity: 0x0/0xFFFF
  Metric Type: TE (default)
  AutoRoute: enabled LockDown: disabled Loadshare: 100 bw-based
  auto-bw: disabled
Active Path Option Parameters:
  State: explicit path option 10 is active
  BandwidthOverride: disabled LockDown: disabled Verbatim: disabled
InLabel : -
OutLabel : FastEthernet1/0/0, 16
RSVP Signalling Info:
  Src 10.1.1.1, Dst 10.0.0.9, Tun_Id 500, Tun_Instance 19
RSVP Path Info:
  My Address: 10.2.0.1
  Explicit Route: 10.2.0.2 10.10.0.1 10.10.0.2 10.0.0.9
  Record Route: NONE
  Tspec: ave rate=100 kbits, burst=1000 bytes, peak rate=100 kbits
RSVP Resv Info:
  Record Route: NONE
  Fspec: ave rate=100 kbits, burst=1000 bytes, peak rate=100 kbits
Shortest Unconstrained Path Info:
  Path Weight: 20 (TE)
  Explicit Route: 10.2.0.1 10.2.0.2 10.10.0.1 10.10.0.2 10.0.0.9
History:
Tunnel:
  Time since created: 11 minutes, 17 seconds
  Time since path change: 8 minutes, 5 seconds
  Number of LSP IDs (Tun_Instances) used: 19
Current LSP:
  Uptime: 8 minutes, 5 seconds
```

Step 3 `show mpls traffic-eng tunnels tunnel-interface [brief] protection`

Use this command, with the **protection** keyword specified, to show the status of both LSPs (that is, both the primary path and the protected path).

Note Deleting a primary path option has the same effect as shutting down a link. Traffic will move to the protected path in use.

The following command output shows that the primary LSP is up, and the secondary LSP is up and providing protection:

Example:

```
Router# show mpls traffic-eng tunnels tunnel500 protection
R1_t500
LSP Head, Tunnel500, Admin: up, Oper: up
Src 10.1.1.1, Dest 10.0.0.9, Instance 19
Fast Reroute Protection: None
Path Protection: 0 Common Link(s), 0 Common Node(s)
Primary lsp path:10.2.0.1 10.2.0.2
                  10.10.0.1 10.10.0.2
                  10.0.0.9
Protect lsp path:10.0.0.1 10.0.0.2
                  10.0.1.1 10.0.1.2
                  10.0.0.9
Path Protect Parameters:
Bandwidth: 100 kbps (Global) Priority: 7 7 Affinity: 0x0/0xFFFF
Metric Type: TE (default)
InLabel : -
OutLabel : FastEthernet1/2/0, 16
RSVP Signalling Info:
Src 10.1.1.1, Dst 10.0.0.9, Tun_Id 500, Tun_Instance 27
RSVP Path Info:
My Address: 10.0.0.1
Explicit Route: 10.0.0.2 10.0.1.1 10.0.1.2 10.0.0.9
Record Route: NONE
Tspec: ave rate=100 kbits, burst=1000 bytes, peak rate=100 kbits
RSVP Resv Info:
Record Route: NONE
Fspec: ave rate=100 kbits, burst=1000 bytes, peak rate=100 kbits
```

The following command output shows that the primary LSP is down, and the secondary LSP is up and is actively carrying traffic:

Example:

```
Router# show mpls traffic-eng tunnels tunnel500 protection
R1_t500
LSP Head, Tunnel500, Admin: up, Oper: up
Src 10.1.1.1, Dest 10.0.0.9, Instance 27
Fast Reroute Protection: None
Path Protection: Backup lsp in use.
```

Step 4 **show ip rsvp high-availability database** {hello | link-management {interfaces | system} | lsp [filter destination ip-address/ filter lsp-id lsp-id/ filter source ip-address | filter tunnel-id tunnel-id] | lsp-head [filter number] | summary}

The **show ip rsvp high-availability database** command displays the contents of the RSVP high availability (HA) read and write databases used in TE. If you specify the **lsp-head** keyword, the command output includes path protection information.

Example:

```
Router# show ip rsvp high-availability database lsp-head
LSP_HEAD WRITE DB
Tun ID: 500
Header:
State: Checkpointed Action: Add
```

```

Seq #: 3           Flags: 0x0
Data:
lsp_id: 5, bandwidth: 100, thead_flags: 0x1, popt: 1
feature_flags: path protection active
output_if_num: 5, output_nhop: 10,0,0,1
RRR path setup info
Destination: 10.0.0.9, Id: 10.0.0.9 Router Node (ospf) flag:0x0
IGP: ospf, IGP area: 0, Number of hops: 5, metric: 2
Hop 0: 10.0.0.1, Id: 10.0.0.1 Router Node (ospf), flag:0x0
Hop 1: 10.0.0.2, Id: 10.0.0.7 Router Node (ospf), flag:0x0
Hop 2: 10.0.1.1, Id: 10.0.0.7 Router Node (ospf), flag:0x0
Hop 3: 10.0.1.2, Id: 10.0.0.9 Router Node (ospf), flag:0x0
Hop 4: 10.0.0.9, Id: 10.0.0.9 Router Node (ospf), flag:0x0

```

Configuration Examples for MPLS Traffic Engineering (TE): Regular Path Protection

Example Configuring Explicit Paths for Secondary Paths

The figure below illustrates a primary path and a secondary path. If there is a failure, the secondary path is used.

Figure 22: Primary Path and Secondary Path

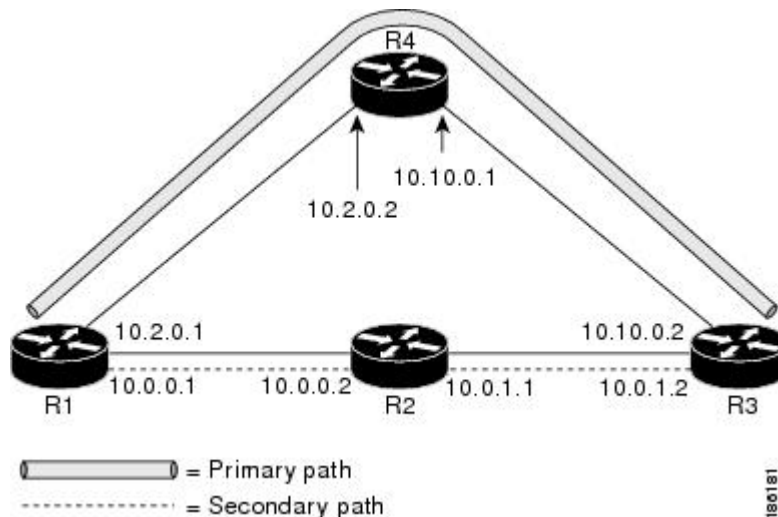

In the following example the explicit path is named path3441. There is an **index** command for each router. If there is failure, the secondary path is used.

```

Router(config)# ip explicit-path name path3441 enable
Router(cfg-ip-expl-path)# index 1 next 10.0.0.1
Explicit Path name path3441:
  1: next-address 10.0.0.1
Router(cfg-ip-expl-path)# index 2 next 10.0.0.2
Explicit Path name path3441:

```



```

1: next-address 10.0.0.1
2: next-address 10.0.0.2
Router(cfg-ip-expl-path)# index 3 next 10.0.1.1
Explicit Path name path3441:
1: next-address 10.0.0.1
2: next-address 10.0.0.2
3: next-address 10.0.1.1
Router(cfg-ip-expl-path)# index 4 next 10.0.1.2
Explicit Path name path3441:
1: next-address 10.0.0.1
2: next-address 10.0.0.2
3: next-address 10.0.1.1
4: next-address 10.0.1.2
Router(cfg-ip-expl-path)# exit

```

Example Assigning a Secondary Path Option to Protect a Primary Path Option

In the following example a traffic engineering tunnel is configured:

```

Router> enable
Router# configure terminal
Router(config-if)# interface tunnel500
Router(config-if)# tunnel mpls traffic-eng path-option protect 10 explicit name path344

```

The following **show running interface** command output shows that path protection has been configured. Tunnel 500 has path option 10 using path344 and protected by path 3441, and path option 20 using path345 and protected by path348.

```

Router# show running interface tunnel500
Router# interface tunnel 500
Building configuration...
Current configuration : 497 bytes
!
interface Tunnel500
 ip unnumbered Loopback0
 tunnel destination 10.0.0.9
 tunnel mode mpls traffic-eng
 tunnel mpls traffic-eng autoroute announce
 tunnel mpls traffic-eng priority 7 7
 tunnel mpls traffic-eng bandwidth 100
 tunnel mpls traffic-eng path-option 10 explicit name path344
 tunnel mpls traffic-eng path-option 20 explicit name path345
 tunnel mpls traffic-eng path-option protect 10 explicit name path3441
 tunnel mpls traffic-eng path-option protect 20 explicit name path348
end

```

Example Configuring Tunnels Before and After Path Protection

The **show mpls traffic-eng tunnels** command shows information about the primary (protected) path. The following sample output shows that path protection has been configured.

```

Router# show mpls traffic-eng tunnels tunnel500
Name: R1_t500 (Tunnel500) Destination: 10.0.0.9
Status:
Admin: up Oper: up Path: valid Signalling: connected
path option 10, type explicit path344 (Basis for Setup, path weight 20)
path option 20, type explicit path345
Path Protection: 0 Common Link(s), 0 Common Node(s)

```

Example Configuring Tunnels Before and After Path Protection

```

path protect option 10, type explicit path3441 (Basis for Protect, path weight 20)
path protect option 20, type explicit path348
Config Parameters:
Bandwidth: 100 kbps (Global) Priority: 7 7 Affinity: 0x0/0xFFFF
Metric Type: TE (default)
AutoRoute: enabled LockDown: disabled Loadshare: 100 bw-based
auto-bw: disabled
Active Path Option Parameters:
State: explicit path option 10 is active
BandwidthOverride: disabled LockDown: disabled Verbatim: disabled
InLabel : -
OutLabel : FastEthernet1/0/0, 16
RSVP Signalling Info:
Src 10.1.1.1, Dst 10.0.0.9, Tun_Id 500, Tun_Instance 43
RSVP Path Info:
My Address: 10.2.0.1
Explicit Route: 10.2.0.2 10.10.0.1 10.10.0.2 10.0.0.9
Record Route: NONE
Tspec: ave rate=100 kbits, burst=1000 bytes, peak rate=100 kbits
RSVP Resv Info:
Record Route: NONE
Fspec: ave rate=100 kbits, burst=1000 bytes, peak rate=100 kbits
Shortest Unconstrained Path Info:
Path Weight: 20 (TE)
Explicit Route: 10.0.0.1 10.0.0.2 10.0.1.1 10.0.1.2
                  10.0.0.9
History:
Tunnel:
Time since created: 18 minutes, 22 seconds
Time since path change: 19 seconds
Number of LSP IDs (Tun_Instances) used: 43
Current LSP:
Uptime: 22 seconds
Selection: reoptimization
Prior LSP:
ID: path option 10 [27]
Removal Trigger: reoptimization completed

```

The following **show mpls traffic-eng tunnels** command output shows information about the secondary path. Tunnel500 is protected. The protection path is used, and the primary path is down. The command output shows the IP explicit paths of the primary LSP and the secondary LSP.

```

Router# show mpls traffic-eng tunnels tunnel500 protection

R1_t500
LSP Head, Tunnel500, Admin: up, Oper: up
Src 10.1.1.1, Dest 10.0.0.9, Instance 43
Fast Reroute Protection: None
Path Protection: 0 Common Link(s), 0 Common Node(s)
Primary lsp path:10.2.0.1 10.2.0.2
                  10.10.0.1 10.10.0.2
                  10.0.0.9
Protect lsp path:10.0.0.1 10.0.0.2
                  10.0.1.1 10.0.1.2
                  10.0.0.9
Path Protect Parameters:
Bandwidth: 100 kbps (Global) Priority: 7 7 Affinity: 0x0/0xFFFF
Metric Type: TE (default)
InLabel : -
OutLabel : FastEthernet0/0/0, 17
RSVP Signalling Info:
Src 10.1.1.1, Dst 10.0.0.9, Tun_Id 500, Tun_Instance 44
RSVP Path Info:

```

```

My Address: 10.0.0.1
Explicit Route: 10.0.0.2 10.0.1.1 10.0.1.2 10.0.0.9
Record Route: NONE
Tspec: ave rate=100 kbits, burst=1000 bytes, peak rate=100 kbits
RSVP Resv Info:
Record Route: NONE
Espec: ave rate=100 kbits, burst=1000 bytes, peak rate=100 kbits
R1#

```

The following **shutdown** command shuts down the interface to use path protection:

```

Router# configure terminal

Enter configuration commands, one per line. End with CNTL/Z.
Router(config)# interface fastethernet1/0/0
Router(config-if)# shutdown
Router(config-if)# end
Router#

```

The following **show mpls traffic-eng tunnels** command shows that the protection path is used, and the primary path is down:

```

Router# show mpls traffic-eng tunnels tunnel500
Name: R1_t500 (Tunnel500) Destination: 10.0.0.9
Status:
  Admin: up Oper: up Path: valid Signalling: connected
  path protect option 10, type explicit path3441 (Basis for Protect, path weight 20)
  path option 10, type explicit path344
  path option 20, type explicit path345
  Path Protection: Backup lsp in use.
  path protect option 10, type explicit path3441 (Basis for Protect, path weight 20)
  path protect option 20, type explicit path348
Config Parameters:
  Bandwidth: 100 kbps (Global) Priority: 7 7 Affinity: 0x0/0xFFFF
  Metric Type: TE (default)
  AutoRoute: enabled LockDown: disabled Loadshare: 100 bw-based
  auto-bw: disabled
Active Path Option Parameters:
  State: explicit path option 10 is active
  BandwidthOverride: disabled LockDown: disabled Verbatim: disabled
InLabel : -
OutLabel : FastEthernet0/0/0, 17
RSVP Signalling Info:
  Src 10.1.1.1, Dst 10.0.0.9, Tun_Id 500, Tun_Instance 44
RSVP Path Info:
  My Address: 10.0.0.1
  Explicit Route: 10.0.0.2 10.0.1.1 10.0.1.2 10.0.0.9
  Record Route: NONE
  Tspec: ave rate=100 kbits, burst=1000 bytes, peak rate=100 kbits
RSVP Resv Info:
  Record Route: NONE
  Espec: ave rate=100 kbits, burst=1000 bytes, peak rate=100 kbits
Shortest Unconstrained Path Info:
  Path Weight: 20 (TE)
  Explicit Route: 10.0.0.1 10.0.0.2 10.0.1.1 10.0.1.2 10.0.0.9
History:
Tunnel:
  Time since created: 23 minutes, 28 seconds
  Time since path change: 50 seconds
  Number of LSP IDs (Tun_Instances) used: 44
Current LSP:
  Uptime: 5 minutes, 24 seconds
Selection:

```

```
Prior LSP:
  ID: path option 10 [43]
  Removal Trigger: path error
  Last Error: PCALC:: Explicit path has unknown address, 10.2.0.1
R1#
```

The "up" value in the Oper field of the **show mpls traffic-eng tunnels protection** command shows that protection is enabled:

```
Router# show mpls traffic-eng tunnels tunnel500 protection

R1_t500
  LSP Head, Tunnel500, Admin: up, Oper: up
  Src 10.1.1.1, Dest 10.0.0.9, Instance 44
  Fast Reroute Protection: None
  Path Protection: Backup lsp in use.
R1#
```

The **no shutdown** command in the following command sequence causes the interface to be up again and activates the primary path:

```
Router> enable

Router# configure terminal
Enter configuration commands, one per line. End with CNTL/Z.
Router(config)# interface fastethernet1/0/0
Router(config-if)# no shutdown
Router(config-if)# end
```

The following command output shows that path protection has been reestablished and the primary path is being used:

```
Router# show mpls traffic-eng tunnels tunnel500

Name: R1_t500 (Tunnel500) Destination: 10.0.0.9
Status:
  Admin: up Oper: up Path: valid Signalling: connected
  path option 10, type explicit path344 (Basis for Setup, path weight 20)
  path option 20, type explicit path345
  Path Protection: 0 Common Link(s), 0 Common Node(s)
  path protect option 10, type explicit path3441 (Basis for Protect, path weight 20)
  path protect option 20, type explicit path348
Config Parameters:
  Bandwidth: 100 kbps (Global) Priority: 7 7 Affinity: 0x0/0xFFFF
  Metric Type: TE (default)
  AutoRoute: enabled LockDown: disabled Loadshare: 100 bw-based
  auto-bw: disabled
Active Path Option Parameters:
  State: explicit path option 10 is active
  BandwidthOverride: disabled LockDown: disabled Verbatim: disabled
InLabel : -
OutLabel : FastEthernet1/0/0, 16
RSVP Signalling Info:
  Src 10.1.1.1, Dst 10.0.0.9, Tun_Id 500, Tun_Instance 52
RSVP Path Info:
  My Address: 10.2.0.1
  Explicit Route: 10.2.0.2 10.10.0.1 10.10.0.2 10.0.0.9
  Record Route: NONE
  Tspec: ave rate=100 kbits, burst=1000 bytes, peak rate=100 kbits
RSVP Resv Info:
  Record Route: NONE
  Fspec: ave rate=100 kbits, burst=1000 bytes, peak rate=100 kbits
```

```

Shortest Unconstrained Path Info:
Path Weight: 20 (TE)
Explicit Route: 10.0.0.1 10.0.0.2 10.0.1.1 10.0.1.2 10.0.0.9
History:
Tunnel:
  Time since created: 25 minutes, 26 seconds
  Time since path change: 23 seconds
  Number of LSP IDs (Tun_Instances) used: 52
Current LSP:
Uptime: 26 seconds
  Selection: reoptimization
Prior LSP:
  ID: path option 10 [44]
  Removal Trigger: reoptimization completed
R1#

```

Following is sample **show mpls traffic-eng tunnels** command output. Tunnel500 is protected. After a failure, the primary LSP is protected.

```

Router# show mpls traffic-eng tunnels tunnel500 protection

R1_t500
LSP Head, Tunnel500, Admin: up, Oper: up
Src 10.1.1.1, Dest 10.0.0.9, Instance 52
Fast Reroute Protection: None
Path Protection: 0 Common Link(s), 0 Common Node(s)
Primary lsp path:10.2.0.1 10.2.0.2
                  10.10.0.1 10.10.0.2
                  10.0.0.9
Protect lsp path:10.0.0.1 10.0.2
                  10.0.1.1 10.0.1.2
                  10.0.0.9
Path Protect Parameters:
Bandwidth: 100 kbps (Global) Priority: 7 7 Affinity: 0x0/0xFFFF
Metric Type: TE (default)
InLabel : -
OutLabel : FastEthernet0/0/0, 16
RSVP Signalling Info:
  Src 10.1.1.1, Dst 10.0.0.9, Tun_Id 500, Tun_Instance 53
RSVP Path Info:
  My Address: 10.0.0.1
  Explicit Route: 10.0.0.2 10.0.1.1 10.0.1.2 10.0.0.9
  Record Route: NONE
  Tspec: ave rate=100 kbits, burst=1000 bytes, peak rate=100 kbits
RSVP Resv Info:
  Record Route: NONE
  Tspec: ave rate=100 kbits, burst=1000 bytes, peak rate=100 kbits
R1#

```

Configuration Examples for MPLS Traffic Engineering (TE): Enhanced Path Protection

Creating a Path Option List: Example

The figure below shows the network topology for enhanced path protection.

p Network Topology for Enhanced Path Protection

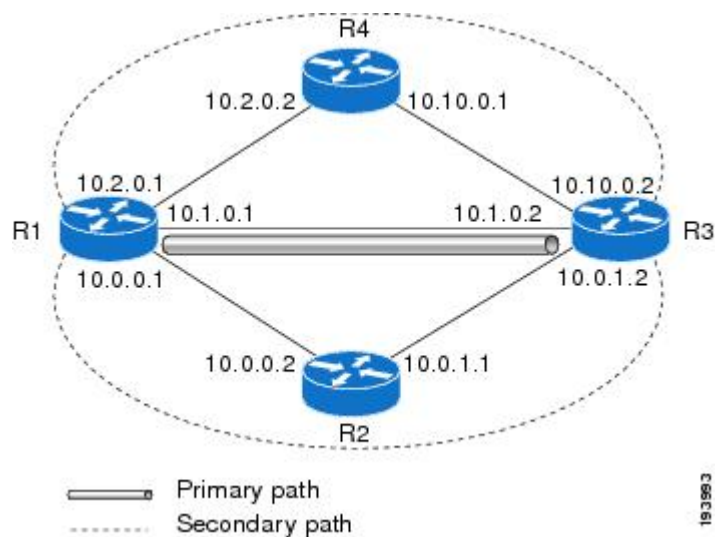

The following example configures two explicit paths named **secondary1** and **secondary2**.

```
Router(config)# ip explicit-path name secondary1

Router(cfg-ip-expl-path)# index 1 next 10.0.0.2

Explicit Path name secondary1:
  1: next-address 10.0.0.2
Router(cfg-ip-expl-path)# index 2 next 10.0.1.2

Explicit Path name secondary1:
  1: next-address 10.0.0.2
  2: next-address 10.0.1.2
Router(cfg-ip-expl-path)# ip explicit-path name secondary2

Router(cfg-ip-expl-path)# index 1 next 10.2.0.2

Explicit Path name secondary2:
  1: next-address 10.2.0.2
Router(cfg-ip-expl-path)# index 2 next 10.10.0.2

Explicit Path name secondary2:
  1: next-address 10.2.0.2
  2: next-address 10.10.0.2
Router(cfg-ip-expl-path)# exit
```

In the following example a path option list of backup paths is created. You define the path option list by using the explicit paths.

```
Router(config)# mpls traffic-eng path-option list name pathlist-01

Router(cfg-pathoption-list)# path-option 10 explicit name secondary1

path-option 10 explicit name secondary1
Router(cfg-pathoption-list)# path-option 20 explicit name secondary2

path-option 10 explicit name secondary1
path-option 20 explicit name secondary2
Router(cfg-pathoption-list)# exit
```

Assigning a Path Option List to Protect a Primary Path Option: Example

In the following example, a traffic engineering tunnel is configured:

```
Router# configure terminal

Enter configuration commands, one per line. End with CNTL/Z.
Router(config)# interface tunnel 2

Router(config-if)# tunnel mpls traffic-eng path-option protect 10 list name secondary-list
```

The following **show running interface** command output shows that path protection has been configured. Tunnel 2 has path option 10 using path primary1 and protected by secondary-list.

```
Router# show running-config interface tunnel 2

Building configuration...
Current configuration : 296 bytes
!
interface Tunnel2
 ip unnumbered Loopback0
 tunnel mode mpls traffic-eng
 tunnel destination 103.103.103.103
 tunnel mpls traffic-eng autoroute announce
 tunnel mpls traffic-eng path-option 10 explicit name primary1
 tunnel mpls traffic-eng path-option protect 10 list name secondary-list
```

Example Configuring Tunnels Before and After Path Protection

The **show mpls traffic-eng tunnels** command shows information about the primary (protected) path. The following sample output shows that path protection has been configured.

```
Router# show mpls traffic-eng tunnels tunnel500
Name: R1_t500 (Tunnel500) Destination: 10.0.0.9
Status:
  Admin: up Oper: up Path: valid Signalling: connected
  path option 10, type explicit path344 (Basis for Setup, path weight 20)
  path option 20, type explicit path345
  Path Protection: 0 Common Link(s), 0 Common Node(s)
  path protect option 10, type explicit path3441 (Basis for Protect, path weight 20)
  path protect option 20, type explicit path348
Config Parameters:
  Bandwidth: 100 kbps (Global) Priority: 7 7 Affinity: 0x0/0xFFFF
  Metric Type: TE (default)
  AutoRoute: enabled LockDown: disabled Loadshare: 100 bw-based
  auto-bw: disabled
Active Path Option Parameters:
  State: explicit path option 10 is active
BandwidthOverride: disabled LockDown: disabled Verbatim: disabled
InLabel : -
OutLabel : FastEthernet1/0/0, 16
RSVP Signalling Info:
  Src 10.1.1.1, Dst 10.0.0.9, Tun_Id 500, Tun_Instance 43
RSVP Path Info:
  My Address: 10.2.0.1
  Explicit Route: 10.2.0.2 10.10.0.1 10.10.0.2 10.0.0.9
  Record Route: NONE
  Tspec: ave rate=100 kbits, burst=1000 bytes, peak rate=100 kbits
```

Example Configuring Tunnels Before and After Path Protection

```

RSVP Resv Info:
  Record Route: NONE
  Fspec: ave rate=100 kbits, burst=1000 bytes, peak rate=100 kbits
Shortest Unconstrained Path Info:
  Path Weight: 20 (TE)
  Explicit Route: 10.0.0.1 10.0.0.2 10.0.1.1 10.0.1.2
                  10.0.0.9

History:
Tunnel:
  Time since created: 18 minutes, 22 seconds
  Time since path change: 19 seconds
  Number of LSP IDs (Tun_Instances) used: 43
Current LSP:
  Uptime: 22 seconds
  Selection: reoptimization
Prior LSP:
  ID: path option 10 [27]
  Removal Trigger: reoptimization completed

```

The following **show mpls traffic-eng tunnels** command output shows information about the secondary path. Tunnel500 is protected. The protection path is used, and the primary path is down. The command output shows the IP explicit paths of the primary LSP and the secondary LSP.

```

Router# show mpls traffic-eng tunnels tunnel500 protection

R1_t500
LSP Head, Tunnel500, Admin: up, Oper: up
Src 10.1.1.1, Dest 10.0.0.9, Instance 43
Fast Reroute Protection: None
Path Protection: 0 Common Link(s), 0 Common Node(s)
  Primary lsp path:10.2.0.1 10.2.0.2
                    10.10.0.1 10.10.0.2
                    10.0.0.9
  Protect lsp path:10.0.0.1 10.0.0.2
                    10.0.1.1 10.0.1.2
                    10.0.0.9

Path Protect Parameters:
  Bandwidth: 100 kbps (Global) Priority: 7 7 Affinity: 0x0/0xFFFF
  Metric Type: TE (default)
InLabel : -
OutLabel : FastEthernet0/0/0, 17
RSVP Signalling Info:
  Src 10.1.1.1, Dst 10.0.0.9, Tun_Id 500, Tun_Instance 44
RSVP Path Info:
  My Address: 10.0.0.1
  Explicit Route: 10.0.0.2 10.0.1.1 10.0.1.2 10.0.0.9
  Record Route: NONE
  Tspec: ave rate=100 kbits, burst=1000 bytes, peak rate=100 kbits
RSVP Resv Info:
  Record Route: NONE
  Fspec: ave rate=100 kbits, burst=1000 bytes, peak rate=100 kbits
R1#

```

The following **shutdown** command shuts down the interface to use path protection:

```

Router# configure terminal

Enter configuration commands, one per line. End with CNTL/Z.
Router(config)# interface fastethernet1/0/0
Router(config-if)# shutdown
Router(config-if)# end
Router#

```

The following **show mpls traffic-eng tunnels** command shows that the protection path is used, and the primary path is down:

```

Router# show mpls traffic-eng tunnels tunnel500
Name: R1_t500 (Tunnel500) Destination: 10.0.0.9
Status:
  Admin: up Oper: up Path: valid Signalling: connected
  path protect option 10, type explicit path3441 (Basis for Protect, path weight 20)
  path option 10, type explicit path344
  path option 20, type explicit path345
  Path Protection: Backup lsp in use.
  path protect option 10, type explicit path3441 (Basis for Protect, path weight 20)
  path protect option 20, type explicit path348
Config Parameters:
  Bandwidth: 100 kbps (Global) Priority: 7 7 Affinity: 0x0/0xFFFF
  Metric Type: TE (default)
  AutoRoute: enabled LockDown: disabled Loadshare: 100 bw-based
  auto-bw: disabled
Active Path Option Parameters:
  State: explicit path option 10 is active
  BandwidthOverride: disabled LockDown: disabled Verbatim: disabled
InLabel : -
OutLabel : FastEthernet0/0/0, 17
RSVP Signalling Info:
  Src 10.1.1.1, Dst 10.0.0.9, Tun_Id 500, Tun_Instance 44
RSVP Path Info:
  My Address: 10.0.0.1
  Explicit Route: 10.0.0.2 10.0.1.1 10.0.1.2 10.0.0.9
  Record Route: NONE
  Tspec: ave rate=100 kbits, burst=1000 bytes, peak rate=100 kbits
RSVP Resv Info:
  Record Route: NONE
  Fspec: ave rate=100 kbits, burst=1000 bytes, peak rate=100 kbits
Shortest Unconstrained Path Info:
  Path Weight: 20 (TE)
  Explicit Route: 10.0.0.1 10.0.0.2 10.0.1.1 10.0.1.2 10.0.0.9
History:
  Tunnel:
    Time since created: 23 minutes, 28 seconds
    Time since path change: 50 seconds
    Number of LSP IDs (Tun_Instances) used: 44
  Current LSP:
    Uptime: 5 minutes, 24 seconds
  Selection:
  Prior LSP:
    ID: path option 10 [43]
    Removal Trigger: path error
    Last Error: PCALC:: Explicit path has unknown address, 10.2.0.1
R1#

```

The "up" value in the Oper field of the **show mpls traffic-eng tunnels protection** command shows that protection is enabled:

```

Router# show mpls traffic-eng tunnels tunnel500 protection

R1_t500
LSP Head, Tunnel500, Admin: up, Oper: up
Src 10.1.1.1, Dest 10.0.0.9, Instance 44
Fast Reroute Protection: None
Path Protection: Backup lsp in use.
R1#

```

The **no shutdown** command in the following command sequence causes the interface to be up again and activates the primary path:

```
Router> enable

Router# configure terminal
Enter configuration commands, one per line. End with CNTL/Z.
Router(config)# interface fastethernet1/0/0
Router(config-if)# no shutdown
Router(config-if)# end
```

The following command output shows that path protection has been reestablished and the primary path is being used:

```
Router# show mpls traffic-eng tunnels tunnel500

Name: R1_t500 (Tunnel500) Destination: 10.0.0.9
Status:
  Admin: up Oper: up Path: valid Signalling: connected
  path option 10, type explicit path344 (Basis for Setup, path weight 20)
  path option 20, type explicit path345
  Path Protection: 0 Common Link(s), 0 Common Node(s)
  path protect option 10, type explicit path3441 (Basis for Protect, path weight 20)
  path protect option 20, type explicit path348
Config Parameters:
  Bandwidth: 100 kbps (Global) Priority: 7 7 Affinity: 0x0/0xFFFF
  Metric Type: TE (default)
  AutoRoute: enabled LockDown: disabled Loadshare: 100 bw-based
  auto-bw: disabled
Active Path Option Parameters:
  State: explicit path option 10 is active
  BandwidthOverride: disabled LockDown: disabled Verbatim: disabled
InLabel : -
OutLabel : FastEthernet1/0/0, 16
RSVP Signalling Info:
  Src 10.1.1.1, Dst 10.0.0.9, Tun_Id 500, Tun_Instance 52
RSVP Path Info:
  My Address: 10.2.0.1
  Explicit Route: 10.2.0.2 10.10.0.1 10.10.0.2 10.0.0.9
  Record Route: NONE
  Tspec: ave rate=100 kbits, burst=1000 bytes, peak rate=100 kbits
RSVP Resv Info:
  Record Route: NONE
  Fspec: ave rate=100 kbits, burst=1000 bytes, peak rate=100 kbits
Shortest Unconstrained Path Info:
  Path Weight: 20 (TE)
  Explicit Route: 10.0.0.1 10.0.0.2 10.0.1.1 10.0.1.2 10.0.0.9
History:
Tunnel:
  Time since created: 25 minutes, 26 seconds
  Time since path change: 23 seconds
  Number of LSP IDs (Tun_Instances) used: 52
Current LSP:
  Uptime: 26 seconds
  Selection: reoptimization
Prior LSP:
  ID: path option 10 [44]
  Removal Trigger: reoptimization completed
R1#
```

Following is sample **show mpls traffic-eng tunnels** command output. Tunnel500 is protected. After a failure, the primary LSP is protected.

```

Router# show mpls traffic-eng tunnels tunnel500 protection

R1_t500
LSP Head, Tunnel500, Admin: up, Oper: up
Src 10.1.1.1, Dest 10.0.0.9, Instance 52
Fast Reroute Protection: None
Path Protection: 0 Common Link(s), 0 Common Node(s)
  Primary lsp path:10.2.0.1  10.2.0.2
                    10.10.0.1 10.10.0.2
                    10.0.0.9
  Protect lsp path:10.0.0.1  10.0.2
                    10.0.1.1 10.0.1.2
                    10.0.0.9

Path Protect Parameters:
  Bandwidth: 100 kbps (Global) Priority: 7 7 Affinity: 0x0/0xFFFF
  Metric Type: TE (default)
  InLabel : -
  OutLabel : FastEthernet0/0/0, 16
  RSVP Signalling Info:
    Src 10.1.1.1, Dst 10.0.0.9, Tun_Id 500, Tun_Instance 53
  RSVP Path Info:
    My Address: 10.0.0.1
    Explicit Route: 10.0.0.2 10.0.1.1 10.0.1.2 10.0.0.9
    Record Route: NONE
    Tspec: ave rate=100 kbits, burst=1000 bytes, peak rate=100 kbits
  RSVP Resv Info:
    Record Route: NONE
    Tspec: ave rate=100 kbits, burst=1000 bytes, peak rate=100 kbits
R1#

```

Additional References

Related Documents

Related Topic	Document Title
Cisco IOS commands	Cisco IOS Master Commands List, All Releases
MPLS traffic engineering commands	<i>Cisco IOS Multiprotocol Label Switching Command Reference</i>
RSVP commands	<i>Cisco IOS Quality of Service Solutions Command Reference</i>
IS-IS	<ul style="list-style-type: none"> • <i>Cisco IOS IP Routing Protocols Command Reference</i> • Configuring a Basic IS-IS Network
OSPF	<ul style="list-style-type: none"> • <i>Cisco IOS IP Routing Protocols Command Reference</i> • Configuring OSPF
ISSU	Cisco IOS XE In Service Software Upgrade Support
NSF/SSO	<ul style="list-style-type: none"> • Cisco Nonstop Forwarding • Stateful Switchover

Standards

Standard	Title
No new or modified standards are supported by this feature, and support for existing standards has not been modified by this feature.	--

MIBs

MIB	MIBs Link
No new or modified MIBs are supported by this feature, and support for existing MIBs has not been modified by this feature.	To locate and download MIBs for selected platforms, Cisco software releases, and feature sets, use Cisco MIB Locator found at the following URL: http://www.cisco.com/go/mibs

RFCs

RFC	Title
No new or modified RFCs are supported by this feature, and support for existing RFCs has not been modified by this feature.	--

Technical Assistance

Description	Link
The Cisco Support and Documentation website provides online resources to download documentation, software, and tools. Use these resources to install and configure the software and to troubleshoot and resolve technical issues with Cisco products and technologies. Access to most tools on the Cisco Support and Documentation website requires a Cisco.com user ID and password.	http://www.cisco.com/cisco/web/support/index.html

Feature Information for MPLS Traffic Engineering Path Protection

The following table provides release information about the feature or features described in this module. This table lists only the software release that introduced support for a given feature in a given software release train. Unless noted otherwise, subsequent releases of that software release train also support that feature.

Use Cisco Feature Navigator to find information about platform support and Cisco software image support. To access Cisco Feature Navigator, go to www.cisco.com/go/cfn. An account on Cisco.com is not required.

Table 8: Feature Information for MPLS Traffic Engineering Path Protection

Feature Name	Releases	Feature Information
MPLS Traffic Engineering Path Protection	Cisco IOS XE Release 2.3	The MPLS Traffic Engineering (TE): Path Protection feature provides an end-to-end failure recovery mechanism (that is, full path protection) for MPLS TE tunnels. This feature was integrated into Cisco IOS XE Release 2.3. The following commands were introduced or modified: show ip rsvp high-availability database , tunnel mpls traffic-eng path-option , tunnel mpls traffic-eng path-option protect .
ISSU--MPLS Traffic Engineering (TE)--Path Protection	Cisco IOS XE Release 2.3	Cisco ISSU allows you to perform a Cisco IOS XE software upgrade or downgrade while the system continues to forward packets. This feature was integrated into Cisco IOS XE Release 2.3.
NSF/SSO--MPLS Traffic Engineering (TE)--Path Protection	Cisco IOS XE Release 2.3	Cisco NSF with SSO provides continuous packet forwarding, even during a network processor hardware or software failure. This feature was integrated into Cisco IOS XE Release 2.3.
MPLS TE--Enhanced Path Protection	Cisco IOS XE Release 3.5S	Enhanced path protection provides support of multiple backup path options per primary path option. This feature was integrated into Cisco IOS XE Release 3.5S. The following commands were added or modified: mpls traffic-eng path-option list , show mpls traffic-eng path-option list , show mpls traffic-eng tunnels , and tunnel mpls traffic-eng path-option protect .

Glossary

autotunnel mesh group --An autotunnel mesh group (referred to as a mesh group) is a set of connections between edge LSRs in a network.

backup tunnel --An MPLS TE tunnel used to protect other (primary) tunnels' traffic when a link or node failure occurs.

BGP --Border Gateway Protocol. An interdomain routing protocol designed to provide loop-free routing between separate routing domains that contain independent routing policies (autonomous systems).

Cisco Express Forwarding --A means for accelerating the forwarding of packets within a router, by storing route lookup.

Fast Reroute --Procedures that enable temporary routing around a failed link or node while a new LSP is being established at the headend.

graceful restart --A process for helping an RP restart after a node failure has occurred.

headend --The router that originates and maintains a given LSP. This is the first router in the LSP's path.

hop --Passage of a data packet between two network nodes (for example, between two routers).

interface --A network connection.

IS-IS --Intermediate System-to-Intermediate System. Link-state hierarchical routing protocol that calls for intermediate system (IS) routers to exchange routing information based on a single metric to determine network topology.

ISSU --In Service Software Upgrade. The ISSU process allows Cisco IOS XE software at the router level to be updated or otherwise modified while packet forwarding continues.

link --A point-to-point connection between adjacent nodes. There can be more than one link between adjacent nodes. A link is a network communications channel consisting of a circuit or transmission path and all related equipment between a sender and a receiver. Sometimes referred to as a line or a transmission link.

LSP --label switched path. A configured connection between two routers, in which label switching is used to carry the packets. The purpose of an LSP is to carry data packets.

MPLS --Multiprotocol Label Switching. Packet-forwarding technology, used in the network core, that applies data link layer labels to tell switching nodes how to forward data, resulting in faster and more scalable forwarding than network layer routing normally can do.

NHOP --next hop. The next downstream node along an LSP's path.

NHOP backup tunnel --next-hop backup tunnel. The backup tunnel terminating at the LSP's next hop beyond the point of failure, and originating at the hop immediately upstream of the point of failure. It bypasses a failed link, and is used to protect primary LSPs that were using this link before the failure.

NNHOP --next-next hop. The node after the next downstream node along an LSP's path.

NNHOP backup tunnel --next-next-hop backup tunnel. The backup tunnel terminating at the LSP's next-next hop beyond the point of failure, and originating at the hop immediately upstream of the point of failure. It bypasses a failed link or node, and is used to protect primary LSPs that were using this link or node before the failure.

node --The endpoint of a network connection or a junction common to two or more lines in a network. Nodes can be interconnected by links, and serve as control points in the network. Nodes can be processors, controllers, or workstations.

NSF --Cisco nonstop forwarding. Cisco NSF always runs with stateful switchover (SSO) and provides redundancy for Layer 3 traffic. NSF works with SSO to minimize the amount of time that a network is unavailable to its users following a switchover. The main purpose of NSF is to continue forwarding IP packets following a supervisor engine switchover.

OSPF --Open Shortest Path First. A link-state hierarchical Interior Gateway Protocol routing algorithm, derived from the IS-IS protocol. OSPF features include least-cost routing, multipath routing, and load balancing.

primary LSP --The last LSP originally signaled over the protected interface before the failure. A primary LSP is signaled by configuring a primary path option.

primary tunnel --A tunnel whose LSP may be fast rerouted if there is a failure. Backup tunnels cannot be primary tunnels.

protected interface --An interface that has one or more backup tunnels associated with it.

router --A network layer device that uses one or more metrics to determine the optimal path along which network traffic should be forwarded. Routers forward packets from one network to another based on network layer information.

RP --Route Processor. A generic term for the centralized control unit in a chassis.

RSVP --Resource Reservation Protocol. An IETF protocol used for signaling requests (setting up reservations) for Internet services by a customer before that customer is permitted to transmit data over that portion of the network.

secondary LSP --The LSP that is signaled to provide path protection. A secondary LSP protects a primary LSP.

secondary path option --Configuration of the path option that provides protection.

SRLG --Shared Risk Link Group. Sets of links that are likely to go down together (for example, because they have the same underlying fiber).

state --Information that a router must maintain about each LSP. The information is used for rerouting tunnels.

tailend --The router upon which an LSP is terminated. This is the last router in the LSP's path.

TE --traffic engineering. The techniques and processes used to cause routed traffic to travel through the network on a path other than the one that would have been chosen if standard routing methods had been used.

topology --The physical arrangement of network nodes and media within an enterprise networking structure.

tunnel --Secure communications path between two peers, such as two routers.

VoIP --Voice over IP. The capability of a router to carry voice traffic (for example, telephone calls and faxes) over an IP network. Cisco's voice support is implemented by using voice packet technology.



CHAPTER 6

MPLS Traffic Engineering BFD-triggered Fast Reroute

The MPLS Traffic Engineering: BFD-triggered Fast Reroute feature allows you to obtain link and node protection by using the Bidirectional Forwarding Detection (BFD) protocol to provide fast forwarding path failure detection times for all media types, encapsulations, topologies, and routing protocols. In addition to fast forwarding path failure detection, BFD provides a consistent failure detection method for network administrators.

To obtain link and node protection by using the Resource Reservation Protocol (RSVP) with Hellos support, refer to the [MPLS TE: Link and Node Protection, with RSVP Hellos Support \(with Fast Tunnel Interface Down Detection\)](#) process module. RSVP Hellos enable a router to detect when a neighboring node has gone down but its interface to that neighbor is still operational.

- [Finding Feature Information, on page 133](#)
- [Prerequisites for MPLS Traffic Engineering BFD-triggered Fast Reroute, on page 134](#)
- [Restrictions for MPLS Traffic Engineering BFD-triggered Fast Reroute, on page 134](#)
- [Information About MPLS Traffic Engineering BFD-triggered Fast Reroute, on page 134](#)
- [How to Configure MPLS Traffic Engineering BFD-triggered Fast Reroute, on page 135](#)
- [Configuration Examples for MPLS Traffic Engineering BFD-triggered Fast Reroute, on page 153](#)
- [Additional References, on page 156](#)
- [Feature Information for MPLS Traffic Engineering BFD-triggered Fast Reroute, on page 157](#)
- [Glossary, on page 158](#)

Finding Feature Information

Your software release may not support all the features documented in this module. For the latest caveats and feature information, see [Bug Search Tool](#) and the release notes for your platform and software release. To find information about the features documented in this module, and to see a list of the releases in which each feature is supported, see the feature information table.

Use Cisco Feature Navigator to find information about platform support and Cisco software image support. To access Cisco Feature Navigator, go to www.cisco.com/go/cfn. An account on Cisco.com is not required.

Prerequisites for MPLS Traffic Engineering BFD-triggered Fast Reroute

- Configure BFD. Refer to the *Bidirectional Forwarding Detection* process module.
- Enable MPLS TE on all relevant routers and interfaces.
- Configure MPLS TE tunnels.
- For additional prerequisites, refer to the MPLS TE: Link and Node Protection, with RSVP Hellos Support (with Fast Tunnel Interface Down Detection) process module.

Restrictions for MPLS Traffic Engineering BFD-triggered Fast Reroute

- You cannot configure BFD and RSVP Hellos on the same interface.
- BFD may not be supported on some interfaces.
- For additional restrictions, refer to the MPLS TE: Link and Node Protection, with RSVP Hellos Support (with Fast Tunnel Interface Down Detection) process module.

Information About MPLS Traffic Engineering BFD-triggered Fast Reroute

Bidirectional Forwarding Detection

Bidirectional Forwarding Detection (BFD) is a detection protocol designed to provide fast forwarding path failure detection times for all media types, encapsulations, topologies, and routing protocols. In addition to fast forwarding path failure detection, BFD provides a consistent failure detection method for network administrators. Because the network administrator can use BFD to detect forwarding path failures at a uniform rate, rather than the variable rates for different routing protocol Hello mechanisms, network profiling and planning will be easier, and reconvergence time will be consistent and predictable.

Fast Reroute

Fast Reroute (FRR) is a mechanism for protecting Multiprotocol Label Switching (MPLS) traffic engineering (TE) label switched paths (LSPs) from link and node failures by locally repairing the LSPs at the point of failure, allowing data to continue to flow on them while their headend routers attempt to establish new end-to-end LSPs to replace them. FRR locally repairs the protected LSPs by rerouting them over backup tunnels that bypass failed links or nodes.

Link Protection

Backup tunnels that bypass only a single link of the LSP's path provide link protection. They protect LSPs if a link along their path fails by rerouting the LSP's traffic to the next hop (bypassing the failed link). These are referred to as next-hop (NHOP) backup tunnels because they terminate at the LSP's next hop beyond the point of failure.

Node Protection

FRR provides node protection for LSPs. Backup tunnels that bypass next-hop nodes along LSP paths are called next-next-hop (NNHOP) backup tunnels because they terminate at the node following the next-hop node of the LSP paths, thereby bypassing the next-hop node. They protect LSPs if a node along their path fails by enabling the node upstream of the failure to reroute the LSPs and their traffic around the failed node to the next-next hop. FRR supports the use of RSVP Hellos to accelerate the detection of node failures. NNHOP backup tunnels also provide protection from link failures, because they bypass the failed link as well as the node.

Bandwidth Protection

NHOP and NNHOP backup tunnels can be used to provide bandwidth protection for rerouted LSPs. This is referred to as backup bandwidth. You can associate backup bandwidth with NHOP or NNHOP backup tunnels. This informs the router of the amount of backup bandwidth a particular backup tunnel can protect. When a router maps LSPs to backup tunnels, bandwidth protection ensures that an LSP uses a given backup tunnel only if there is sufficient backup bandwidth. The router selects which LSPs use which backup tunnels in order to provide maximum bandwidth protection. That is, the router determines the best way to map LSPs onto backup tunnels in order to maximize the number of LSPs that can be protected.

How to Configure MPLS Traffic Engineering BFD-triggered Fast Reroute

This section shows you how to add FRR protection to a network in which MPLS TE LSPs are configured.

The following sections describe how to use FRR to protect LSPs in your network from link or node failures. Each task is identified as either required or optional.



Note You can perform the configuration tasks in any order.



Note An NNHOP backup tunnel must *not* go via the NHOP backup tunnel.

Enabling BFD Support on the Router

SUMMARY STEPS

1. **enable**
2. **configure terminal**
3. **ip rsvp signalling hello bfd**
4. **exit**

DETAILED STEPS

	Command or Action	Purpose
Step 1	enable Example: Router> enable	Enables privileged EXEC mode. <ul style="list-style-type: none"> • Enter your password if prompted.
Step 2	configure terminal Example: Router# configure terminal	Enters global configuration mode.
Step 3	ip rsvp signalling hello bfd Example: Router(config)# ip rsvp signalling hello bfd	Enables the BFD protocol on the router for MPLS TE link and node protection.
Step 4	exit Example: Router(config)# exit	Exits to privileged EXEC mode.

Enabling Fast Reroute on LSPs

LSPs can use backup tunnels only if the LSPs have been configured as fast reroutable. To enable FRR on the LSP, enter the following commands at the headend of each LSP.

SUMMARY STEPS

1. **enable**
2. **configure terminal**
3. **interface tunnel *number***
4. **tunnel mpls traffic-eng fast-reroute [bw-protect] [node-protect]**
5. **exit**
6. **exit**

DETAILED STEPS

	Command or Action	Purpose
Step 1	enable Example: <pre>Router> enable</pre>	Enables privileged EXEC mode. <ul style="list-style-type: none"> • Enter your password if prompted.
Step 2	configure terminal Example: <pre>Router# configure terminal</pre>	Enters global configuration mode.
Step 3	interface tunnel <i>number</i> Example: <pre>Router(config)# interface tunnel 1000</pre>	Enters interface configuration mode for the specified tunnel. <ul style="list-style-type: none"> • The <i>number</i> argument is the number of the tunnel.
Step 4	tunnel mpls traffic-eng fast-reroute [bw-protect] [node-protect] Example: <pre>Router(config-if)# tunnel mpls traffic-eng fast-reroute bw-protect node-protect</pre>	Enables an MPLS TE tunnel to use an established backup tunnel if there is a link or node failure. <ul style="list-style-type: none"> • The bw-protect keyword sets the “bandwidth protection desired” bit so that backup bandwidth protection is enabled. • The node-protect keyword sets the “node protection desired” bit so that backup bandwidth protection is enabled.
Step 5	exit Example: <pre>Router(config-if)# exit</pre>	Exits interface configuration mode and returns to global configuration mode.
Step 6	exit Example: <pre>Router(config)# exit</pre>	Exits global configuration mode and returns to privileged EXEC mode.

Creating a Backup Tunnel to the Next Hop or to the Next-Next Hop

To create a backup tunnel to the next hop or to the next-next hop, perform the following task.

Enter the commands on the node that will be the headend of the backup tunnel (that is, the node whose downstream link or node may fail). The node on which you enter the commands must be a supported platform. See the Finding Feature Information section.

Creating a backup tunnel is basically no different from creating any other tunnel.



Note When using the **exclude-address** command to specify the path for a backup tunnel, you must exclude an interface address to avoid a link (for creating an NHOP backup tunnel), or a router-ID address to avoid a node (for creating an NNHOP backup tunnel).

SUMMARY STEPS

1. **enable**
2. **configure terminal**
3. **interface tunnel** *number*
4. **ip unnumbered** *type number*
5. **tunnel destination** *ip-address*
6. **tunnel mode mpls traffic-eng**
7. **tunnel mpls traffic-eng path-option** *number* {**dynamic** | **explicit** {**name** *path-name* | *path-number*}} [**lockdown**]
8. **exit**
9. **ip explicit-path name** *name*
10. **exclude-address** *address*
11. **exit**
12. **exit**

DETAILED STEPS

	Command or Action	Purpose
Step 1	enable Example: Router> enable	Enables privileged EXEC mode. • Enter your password if prompted.
Step 2	configure terminal Example: Router# configure terminal	Enters global configuration mode.
Step 3	interface tunnel <i>number</i> Example: Router(config)# interface tunnel 1	Creates a new tunnel interface and enters interface configuration mode. • The <i>number</i> argument is the number of the tunnel.
Step 4	ip unnumbered <i>type number</i> Example: Router(config-if)# ip unnumbered loopback 0	Enables IP processing on an interface without assigning an explicit IP address to the interface. • The <i>type</i> and <i>number</i> arguments name the type and number of another interface on which the router has an assigned IP address. It cannot be another unnumbered interface.

	Command or Action	Purpose
		<p>Note The ip unnumbered loopback 0 command gives the tunnel interface an IP address that is the same as that of interface loopback 0. This command is not effective until loopback 0 has been configured with an IP address.</p>
Step 5	<p>tunnel destination <i>ip-address</i></p> <p>Example:</p> <pre>Router(config-if)# tunnel destination 10.3.3.3</pre>	<p>Specifies the destination for a tunnel interface.</p> <ul style="list-style-type: none"> The <i>ip-address</i> argument specifies the IP address of the device, expressed in dotted decimal notation, where the tunnel will terminate. That address should be the router ID of the device that is the NHOP or NNHOP of LSPs to be protected.
Step 6	<p>tunnel mode mpls traffic-eng</p> <p>Example:</p> <pre>Router(config-if)# tunnel mode mpls traffic-eng</pre>	<p>Sets encapsulation mode of the tunnel to MPLS TE.</p>
Step 7	<p>tunnel mpls traffic-eng path-option <i>number</i> {dynamic explicit {name <i>path-name</i> <i>path-number</i>}} [lockdown]</p> <p>Example:</p> <pre>Router(config-if)# tunnel mpls traffic-eng path-option 10 explicit name avoid-protected-link</pre>	<p>Configures the tunnel to use a named IP explicit path or a path dynamically calculated from the traffic engineering topology database.</p> <ul style="list-style-type: none"> The <i>number</i> argument is the preference for this path option. When you configure multiple path options, lower numbered options are preferred. Valid values are from 1 to 1000. The dynamic keyword indicates that the path of the label switched path (LSP) is dynamically calculated. The explicit keyword indicates that the path of the LSP is an IP explicit path. The name <i>path-name</i> keyword and argument are the path name of the IP explicit path that the tunnel uses with this option. The identifier <i>path-number</i> keyword and argument pair names the path number of the IP explicit path that the tunnel uses with this option. The range is from 1 to 65535. The lockdown keyword specifies that The LSP cannot be reoptimized. <p>Note A dynamic path is used if an explicit path is currently unavailable.</p>
Step 8	<p>exit</p> <p>Example:</p>	<p>Exits interface configuration mode and enter global configuration mode.</p>

	Command or Action	Purpose
	<pre>Router(config-if)# exit</pre>	
Step 9	<p>ip explicit-path name <i>name</i></p> <p>Example:</p> <pre>Router(config)# ip explicit-path name avoid-protected-link</pre>	<p>Enters IP explicit path mode for IP explicit paths to create the named path.</p> <ul style="list-style-type: none"> The <i>name</i> argument is the name of the explicit path.
Step 10	<p>exclude-address <i>address</i></p> <p>Example:</p> <pre>Router(cfg-ip-expl-path)# exclude-address 10.3.3.3</pre>	<p>Excludes an address from an explicit-path.</p> <ul style="list-style-type: none"> The <i>address</i> argument specifies the IP address of the link to be protected for link protection. For node protection, it specifies the router ID of the node to be protected. <p>Note Backup tunnel paths can be dynamic or explicit and they do not have to use an excluded address. Because backup tunnels must avoid the protected link or node, it is convenient to use an excluded address.</p>
Step 11	<p>exit</p> <p>Example:</p> <pre>Router(cfg-ip-expl-path)# exit</pre>	Exits IP explicit path configuration mode and returns to global configuration mode.
Step 12	<p>exit</p> <p>Example:</p> <pre>Router(config)# exit</pre>	Exits global configuration mode and returns to privileged EXEC mode.

Assigning Backup Tunnels to a Protected Interface

To assign one or more backup tunnels to a protected interface, perform the following task.

Enter the commands on the node that will be the headend of the backup tunnel (that is, the node whose downstream link or node may fail). The node on which you enter the commands must be a supported platform. See the Finding Feature Information section.



Note You must configure the interface to have an IP address and to enable the MPLS TE tunnel feature.

SUMMARY STEPS

- enable**
- configure terminal**
- interface** *type slot/subslot / port[. subinterface]*

4. `mpls traffic-eng backup-path tunnel` *tunnel-id*
5. `exit`
6. `exit`

DETAILED STEPS

	Command or Action	Purpose
Step 1	<p>enable</p> <p>Example:</p> <pre>Router> enable</pre>	<p>Enables privileged EXEC mode.</p> <ul style="list-style-type: none"> • Enter your password if prompted.
Step 2	<p>configure terminal</p> <p>Example:</p> <pre>Router# configure terminal</pre>	<p>Enters global configuration mode.</p>
Step 3	<p>interface <i>type slot/subslot / port[. subinterface]</i></p> <p>Example:</p> <pre>Router(config)# interface GigabitEthernet 2/1/0</pre>	<p>Configures an interface type and enters interface configuration mode.</p> <ul style="list-style-type: none"> • The <i>type</i> argument is the type of interface to be configured. • The <i>slot</i> argument is the chassis slot number. Refer to the appropriate hardware manual for slot information. For SIPs, refer to the platform-specific SPA hardware installation guide or the corresponding “Identifying Slots and Subslots for SIPs and SPAs” topic in the platform-specific SPA software configuration guide. • The <i>/ subslot</i> keyword and argument pair is the secondary slot number on a SIP where a SPA is installed. The slash (/) is required. <p>Refer to the platform-specific SPA hardware installation guide and the corresponding “Specifying the Interface Address on a SPA” topic in the platform-specific SPA software configuration guide for subslot information.</p> <ul style="list-style-type: none"> • The <i>/ port</i> keyword and argument pair is the port or interface number. The slash (/) is required. <p>Refer to the appropriate hardware manual for port information. For SPAs, refer to the corresponding “Specifying the Interface Address on a SPA” topics in the platform-specific SPA software configuration guide</p> <ul style="list-style-type: none"> • The <i>. subinterface-number</i> keyword and argument pair is the subinterface number in the range 1 to 4294967293. The number that precedes the period (.) must match the number to which this subinterface belongs.

	Command or Action	Purpose
Step 4	mpls traffic-eng backup-path tunnel <i>tunnel-id</i> Example: <pre>Router(config-if)# mpls traffic-eng backup-path tunnel12</pre>	Configures the physical interface to use for a backup tunnel in the event of a detected failure on that interface. <ul style="list-style-type: none"> The <i>tunnel-id</i> argument is a string that identifies a backup tunnel to use if there is a link or node failure for LSPs going out the configured interface. Note You can enter this command multiple times to associate multiple backup tunnels with the same protected interface.
Step 5	exit Example: <pre>Router(config-if)# exit</pre>	Exits interface configuration mode and returns to global configuration mode.
Step 6	exit Example: <pre>Router(config)# exit</pre>	Exits global configuration mode and returns to privileged EXEC mode.

Enabling BFD on the Protected Interface

SUMMARY STEPS

1. **enable**
2. **configure terminal**
3. **interface** *type slot/subslot / port[. subinterface]*
4. **ip rsvp signalling hello bfd**
5. **bfd interval** *milliseconds min_rx milliseconds multiplier interval-multiplier*
6. **exit**
7. **exit**

DETAILED STEPS

	Command or Action	Purpose
Step 1	enable Example: <pre>Router> enable</pre>	Enables privileged EXEC mode. <ul style="list-style-type: none"> Enter your password if prompted.
Step 2	configure terminal Example: <pre>Router# configure terminal</pre>	Enters global configuration mode.

	Command or Action	Purpose
Step 3	<p>interface <i>type</i> <i>slot/subslot / port</i>[. <i>subinterface</i>]</p> <p>Example:</p> <pre>Router(config)# interface GigabitEthernet 2/1/0</pre>	<p>Configures an interface type and enters interface configuration mode.</p> <ul style="list-style-type: none"> The <i>type</i> argument is the type of interface to be configured. The <i>slot</i> argument is the chassis slot number. Refer to the appropriate hardware manual for slot information. For SIPs, refer to the platform-specific SPA hardware installation guide or the corresponding “Identifying Slots and Subslots for SIPs and SPAs” topic in the platform-specific SPA software configuration guide. The <i>/ subslot</i> keyword and argument pair is the secondary slot number on a SIP where a SPA is installed. The slash (/) is required. <p>Refer to the platform-specific SPA hardware installation guide and the corresponding “Specifying the Interface Address on a SPA” topic in the platform-specific SPA software configuration guide for subslot information.</p> <ul style="list-style-type: none"> The <i>/ port</i> keyword and argument pair is the port or interface number. The slash (/) is required. <p>Refer to the appropriate hardware manual for port information. For SPAs, refer to the corresponding “Specifying the Interface Address on a SPA” topics in the platform-specific SPA software configuration guide</p> <ul style="list-style-type: none"> The <i>. subinterface-number</i> keyword and argument pair is the subinterface number in the range 1 to 4294967293. The number that precedes the period (.) must match the number to which this subinterface belongs.
Step 4	<p>ip rsvp signalling hello bfd</p> <p>Example:</p> <pre>Router(config-if)# ip rsvp signalling hello bfd</pre>	<p>Enables the BFD protocol on an interface for MPLS TE link and node protection.</p>
Step 5	<p>bfd interval <i>milliseconds</i> min_rx <i>milliseconds</i> multiplier <i>interval-multiplier</i></p> <p>Example:</p> <pre>Router(config-if)# bfd interval 100 min_rx 100 multiplier 4</pre>	<p>Sets the BFD session parameters for an interface.</p> <ul style="list-style-type: none"> The interval <i>milliseconds</i> keyword and argument pair specifies the rate at which BFD control packets will be sent to BFD peers. The configurable time period for the <i>milliseconds</i> argument is from 50 to 999. The min_rx <i>millisecond</i> keyword and argument pair specifies the rate at which BFD control packets will be expected to be received from BFD peers. The

	Command or Action	Purpose
		<p>configurable time period for the milliseconds argument is from 1 to 999.</p> <ul style="list-style-type: none"> The multiplier <i>interval-multiplier</i> keyword and argument pair specifies the number of consecutive BFD control packets that must be missed from a BFD peer before BFD declares that the peer is unavailable and the Layer 3 BFD peer is informed of the failure. The configurable value range for the multiplier-value argument is from 3 to 50.
Step 6	<p>exit</p> <p>Example:</p> <pre>Router(config-if)# exit</pre>	Exits interface configuration mode and returns to global configuration mode.
Step 7	<p>exit</p> <p>Example:</p> <pre>Router(config)# exit</pre>	Exits global configuration mode and returns to privileged EXEC mode.

Associating Backup Bandwidth and Pool Type with a Backup Tunnel

To associate backup bandwidth with a backup tunnel and designate the type of LSP that can use a backup tunnel, enter the following tasks.

SUMMARY STEPS

1. **enable**
2. **configure terminal**
3. **interface tunnel** *number*
4. **tunnel mpls traffic-eng backup-bw** *{bandwidth | [sub-pool {bandwidth | Unlimited}] [global-pool {bandwidth | Unlimited}]}* *[any {bandwidth | Unlimited}]*
5. **exit**
6. **exit**

DETAILED STEPS

	Command or Action	Purpose
Step 1	<p>enable</p> <p>Example:</p> <pre>Router> enable</pre>	<p>Enables privileged EXEC mode.</p> <ul style="list-style-type: none"> • Enter your password if prompted.
Step 2	<p>configure terminal</p> <p>Example:</p>	Enters global configuration mode.

	Command or Action	Purpose
	Router# configure terminal	
Step 3	interface tunnel <i>number</i> Example: Router(config)# interface tunnel 2	Enters interface configuration mode for the specified tunnel. • The <i>number</i> argument is the number of the tunnel.
Step 4	tunnel mpls traffic-eng backup-bw { <i>bandwidth</i> [sub-pool { <i>bandwidth</i> Unlimited}] [global-pool { <i>bandwidth</i> Unlimited}]} [any { <i>bandwidth</i> Unlimited}] Example: Router(config-if)# tunnel mpls traffic-eng backup-bw sub-pool 1000	Associates bandwidth with a backup tunnel and designates whether LSPs that allocate bandwidth from the specified pool can use the tunnel.
Step 5	exit Example: Router(config-if)# exit	Exits interface configuration mode and returns to global configuration mode.
Step 6	exit Example: Router(config)# exit	Exits global configuration mode and returns to privileged EXEC mode.

Configuring Backup Bandwidth Protection

SUMMARY STEPS

1. enable
2. configure terminal
3. interface tunnel *number*
4. tunnel mpls traffic-eng fast-reroute [bw-protect]
5. exit
6. mpls traffic-eng fast-reroute backup-prot-preemption optimize-bw
7. exit

DETAILED STEPS

	Command or Action	Purpose
Step 1	enable Example: Router> enable	Enables privileged EXEC mode. • Enter your password if prompted.

	Command or Action	Purpose
Step 2	configure terminal Example: Router# configure terminal	Enters global configuration mode.
Step 3	interface tunnel <i>number</i> Example: Router(config)# interface tunnel 2	Enters interface configuration mode for the specified tunnel. <ul style="list-style-type: none"> The <i>number</i> argument is the number of the tunnel.
Step 4	tunnel mpls traffic-eng fast-reroute [bw-protect] Example: Router(config-if)# tunnel mpls traffic-eng fast-reroute bw-protect	Enables an MPLS TE tunnel to use an established backup tunnel in the event of a link or node failure. <ul style="list-style-type: none"> The bw-protect keyword gives an LSP priority for using backup tunnels with bandwidth protection.
Step 5	exit Example: Router(config-if)# exit	Exits interface configuration mode.
Step 6	mpls traffic-eng fast-reroute backup-prot-preemption optimize-bw Example: Router(config)# mpls traffic-eng fast-reroute backup-prot-preemption optimize-bw	Changes the backup protection preemption algorithm from minimize the number of LSPs that are demoted to minimize the amount of bandwidth that is wasted.
Step 7	exit Example: Router(config)# exit	Exits global configuration mode and returns to privileged EXEC mode.

Verifying That Fast Reroute Is Operational

SUMMARY STEPS

1. show mpls traffic-eng tunnels brief
2. show ip rsvp sender detail
3. show mpls traffic-eng fast-reroute database
4. show mpls traffic-eng tunnels backup
5. show mpls traffic-eng fast-reroute database
6. show ip rsvp reservation detail
7. show ip rsvp hello
8. show ip rsvp interface detail
9. show ip rsvp hello bfd nbr

10. **show ip rsvp hello bfd nbr detail**
11. **show ip rsvp hello bfd nbr summary**

DETAILED STEPS

Step 1 **show mpls traffic-eng tunnels brief**

Use this command to verify that backup tunnels are up:

Example:

```
Router# show mpls traffic-eng tunnels brief

Signalling Summary:
  LSP Tunnels Process:      running
  RSVP Process:            running
  Forwarding:              enabled
  Periodic reoptimization: every 3600 seconds, next in 1706 seconds
TUNNEL NAME                DESTINATION    UP IF    DOWN IF    STATE/PROT
Router_t1                  10.112.0.12   -        Gi4/0/1   up/up
Router_t2                  10.112.0.12   -        unknown   up/down
Router_t3                  10.112.0.12   -        unknown   admin-down
Router_t1000               10.110.0.10   -        unknown   up/down
Router_t2000               10.110.0.10   -        Gi4/0/1   up/up
Displayed 5 (of 5) heads, 0 (of 0) midpoints, 0 (of 0) tails
```

Step 2 **show ip rsvp sender detail**

Use this command to verify that LSPs are protected by the appropriate backup tunnels.

Following is sample output from the **show ip rsvp sender detail** command when the command is entered at the router acting as the point of local repair (PLR) before a failure:

Example:

```
Router# show ip rsvp sender detail

PATH:
Tun Dest:  10.10.0.6  Tun ID: 100  Ext Tun ID: 10.10.0.1
Tun Sender: 10.10.0.1  LSP ID: 31
Path refreshes:
  arriving: from PHOP 10.10.7.1 on Et0/0 every 30000 msecs
Session Attr:
  Setup Prio: 7, Holding Prio: 7
  Flags: (0x7) Local Prot desired, Label Recording, SE Style
  session Name: R1_t100
ERO: (incoming)
  10.10.7.2 (Strict IPv4 Prefix, 8 bytes, /32)
  10.10.0.6 (Strict IPv4 Prefix, 8 bytes, /32)
RRO:
  10.10.7.1/32, Flags:0x0 (No Local Protection)
  10.10.4.1/32, Flags:0x9 (Local Prot Avail/to NNHOP) !Available to NNHOP
  10.10.1.1/32, Flags:0x0 (No Local Protection)
Traffic params - Rate: 10K bits/sec, Max. burst: 1K bytes
Min Policed Unit: 0 bytes, Max Pkt Size 4294967295 bytes
Fast-Reroute Backup info:
  Inbound FRR: Not active
  Outbound FRR: No backup tunnel selected
Path ID handle: 50000416.
```

```
Incoming policy: Accepted. Policy source(s): MPLS/TE
Status: Proxy-terminated
```

Step 3 show mpls traffic-eng fast-reroute database

Enter the **clear ip rsvp hello instance counters** command to verify the following:

- MPLS TE FRR Node Protection has been enabled.
- A certain type of LSP can use a backup tunnel.

The following command output displays the LSPs that are protected:

Example:

```
Router# show mpls traffic-eng fast-reroute database
Tunnel head end item frr information:
Protected tunnel      In-label Out intf/label  FRR intf/label  Status
Tunnel500            Tun hd   AT4/0.100:Untag Tu501:20        ready
Prefix item frr information:
Prefix              Tunnel  In-label Out intf/label  FRR intf/label  Status
10.0.0.8/32         Tu500  18      AT4/0.100:Pop ta Tu501:20        ready
10.0.8.8/32         Tu500  19      AT4/0.100:Untag Tu501:20        ready
10.8.9.0/24         Tu500  22      AT4/0.100:Untag Tu501:20        ready
LSP midpoint item frr information:
LSP identifier      In-label Out  intf/label  FRR intf/label  Status
```

If Label Distribution Protocol (LDP) is not enabled, separate prefix items are not shown because all prefixes then use a single rewrite. To confirm that a particular IP prefix is FRR protected, even though it is not shown in this display, enter it within the **show mpls forwarding-table ip-address detail** command. The final line of the display will tell whether that prefix is protected:

Example:

```
Router# show mpls forwarding-table 10.0.0.11 32 detail
Local   Outgoing   Prefix      Bytes tag   Outgoing           Next Hop
tag     tag or VC  or Tunnel Id  switched   interface
Tun hd  Untagged  10.0.0.11/32  48 5/0     Gi5/0              point2point
MAC/Encaps=4/8, MTU=1520, Tag Stack{22}
48D18847 00016000
No output feature configured
Fast Reroute Protection via (Tu0, outgoing label 12304)
```

The following command output displays the LSPs that are protected when the FRR primary tunnel is over a Gigabit Ethernet interface and the backup tunnel is over a Gigabit Ethernet interface. As shown in the figure below, interface Gigabit Ethernet 2/1/0 is protected by backup tunnel 501.

Figure 23: Protected LSPs

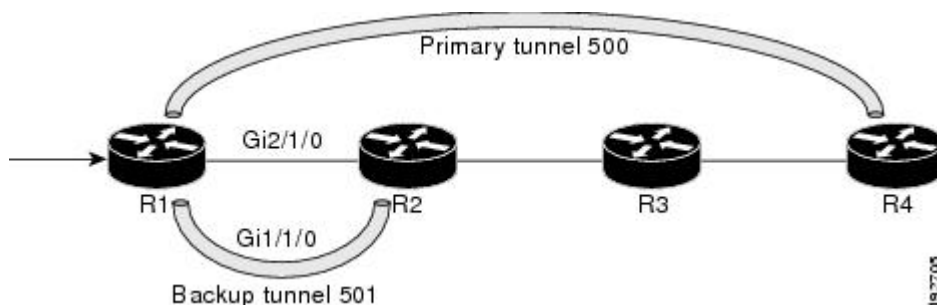

The figure above shows the following:

- Primary tunnel 500--Path is R1 via Gigabit Ethernet2/1/0 to R2 to R3 to R4.
- FRR backup tunnel 501--Path is R1 via Gigabit Ethernet1/1/0 to R2.
- Interface Gigabit Ethernet1/1/0--Protected by backup tunnel 501.

Example:

```
Router# show mpls traffic-eng fast-reroute database
Tunnel head end item frr information:
Protected tunnel In-label Out intf/label FRR intf/label Status
Tunnel500 Tun hd AT4/0.100:Untagg Tu501:20 ready
Prefix item frr information:
Prefix Tunnel In-label Out intf/label FRR intf/label Status
10.0.0.8/32 Tu500 18 AT4/0.100:Pop ta Tu501:20 ready
10.0.8.8/32 Tu500 19 AT4/0.100:Untagg Tu501:20 ready
10.8.9.0/24 Tu500 22 AT4/0.100:Untagg Tu501:20 ready
LSP midpoint item frr information:
LSP identifier In-label Out intf/label FRR intf/label Status
```

The following command output displays the LSPs that are protected when the FRR backup tunnel is over a Gigabit Ethernet interface.

Example:

```
Router# show mpls traffic-eng fast-reroute database
Tunnel head end item frr information:
Protected tunnel In-label Out intf/label FRR intf/label Status
Tunnel500 Tun hd PO2/0:Untagged Tu501:20 ready
Prefix item frr information:
Prefix Tunnel In-label Out intf/label FRR intf/label Status
10.0.0.8/32 Tu500 18 PO2/0:Pop tag Tu501:20 ready
10.0.8.8/32 Tu500 19 PO2/0:Untagged Tu501:20 ready
10.8.9.0/24 Tu500 22 PO2/0:Untagged Tu501:20 ready
LSP midpoint item frr information:
LSP identifier In-label Out intf/label FRR intf/label Status
```

Step 4 show mpls traffic-eng tunnels backup

For backup tunnels to be operational, the LSP must be reroutable. At the headend of the LSP, enter the **show run interface tunnel *tunnel-number*** command. The output should include the **tunnel mpls traffic-eng fast-reroute** command. If it does not, enter this command for the tunnel.

On the router where the backup tunnels originate, enter the **show mpls traffic-eng tunnels backup** command. Following is sample command output:

Example:

```
Router# show mpls traffic-eng tunnels backup
Router_t578
  LSP Head, Tunnel578, Admin: up, Oper: up
  Src 10.55.55.55, Dest 10.88.88.88, Instance 1
  Fast Reroute Backup Provided:
    Protected i/fs: PO1/0, PO1/1, PO3/3
    Protected lsp: 1
    Backup BW: any pool unlimited; inuse: 100 kbps
Router_t5710
  LSP Head, Tunnel5710, Admin: admin-down, Oper: down
  Src 10.55.55.55, Dest 10.7.7.7, Instance 0
```

```

Fast Reroute Backup Provided:
  Protected i/fs: PO1/1
  Protected lsp: 0
  Backup BW: any pool unlimited; inuse: 0 kbps
Router_t5711
LSP Head, Tunnel5711, Admin: up, Oper: up
Src 10.55.55.55, Dest 10.7.7.7, Instance 1
Fast Reroute Backup Provided:
  Protected i/fs: PO1/0
  Protected lsp: 2
  Backup BW: any pool unlimited; inuse: 6010 kbps

```

The command output will allow you to verify the following:

- Backup tunnel exists--Verify that there is a backup tunnel that terminates at this LSP's NHOP or NNHOP. Look for the LSP's NHOP or NNHOP in the Dest field.
- Backup tunnel is up--To verify that the backup tunnel is up, look for "Up" in the Oper field.
- Backup tunnel is associated with the LSP's interface--Verify that the interface for the LSP is allowed to use this backup tunnel. Look for the LSP's output interface in the protected i/fs field list.
- Backup tunnel has sufficient bandwidth--If you restricted the amount of bandwidth a backup tunnel can hold, verify that the backup tunnel has sufficient bandwidth to hold the LSPs that would use this backup tunnel if there is a failure. The bandwidth of an LSP is defined by the line **tunnel mpls traffic-eng bandwidth** at the headend of the LSP. To determine the available bandwidth on a backup tunnel, look at the "cfg" and "inuse" fields. If there is insufficient backup bandwidth to accommodate the LSPs that would use this backup tunnel in the event of a failure, create an additional backup tunnel or increase the backup bandwidth of the existing tunnel by using the **tunnel mpls traffic-eng bandwidth** command.

Note In order to determine how much bandwidth is sufficient, offline capacity planning may be required.

Backup tunnel has appropriate bandwidth type--If you restricted the type of LSPs (subpool or global pool) that can use this backup tunnel, verify that the LSP is the appropriate type for the backup tunnel. The type of the LSP is defined by the line **tunnel mpls traffic-eng bandwidth** at the headend of this LSP. If this line contains the word "sub pool", then it uses subpool bandwidth; otherwise, it uses global pool bandwidth. Verify that the type matches the type the backup tunnel can hold by looking in the output of the **tunnel mpls traffic-eng bandwidth** command.

If none of the verification actions described succeed, enable debug by entering the **debug ip rsvp fast-reroute** command and the **debug mpls traffic-eng fast-reroute** command on the router that is the headend of the backup tunnel. Then do the following:

- Enter the **shutdown** command for the primary tunnel.
- Enter the **no shutdown** command for the primary tunnel.
- View the debug output.

Step 5 **show mpls traffic-eng fast-reroute database**

Enter the **clear ip rsvp hello instance counters** command to verify the following:

- MPLS TE FRR node protection has been enabled.
- A certain type of LSP can use a backup tunnel.

The following command output displays the LSPs that are protected:

Example:

```
Router# show mpls traffic-eng fast-reroute database
Tunnel head end item frr information:
Protected Tunnel  In-label  intf/label      FRR intf/label  Status
Tunnell0         Tun       Gi0/1/0:Untagged Tu0:12304       ready
Prefix item frr information:
Prefix           Tunnel  In-label  Out intf/label  FRR intf/label  Status
10.0.0.11/32    Tu110  Tun hd    Gi0/1/0:Untagged Tu0:12304       ready
LSP midpoint frr information:
LSP identifier   In-label  Out intf/label  FRR intf/label  Status
10.0.0.12 1 [459]  16        Gi0/1/1:17     Tu2000:19       ready
```

Note If Label Distribution Protocol (LDP) is not enabled, separate prefix items are not shown because all prefixes then use a single rewrite. To confirm that a particular IP prefix is FRR protected, even though it is not shown in this display, enter it within the **show mpls forwarding-table ip-address detail** command. The final line of the display will tell whether that prefix is protected.

Example:

```
Router# show mpls forwarding-table 10.0.0.11 32 detail

Local   Outgoing   Prefix          Bytes tag   Outgoing     Next Hop
tag     tag or VC  or Tunnel Id   switched   interface
Tun hd  Untagged   10.0.0.11/32   48 Gi0/1/0   point2point
        MAC/Encaps=4/8, MTU=1520, Tag Stack{22}
        48D18847 00016000
        No output feature configured
        Fast Reroute Protection via (Tu0, outgoing label 12304)
```

Step 6 **show ip rsvp reservation detail**

Following is sample output from the **show ip rsvp reservation detail** command entered at the headend of a primary LSP. Entering the command at the headend of the primary LSP shows, among other things, the status of FRR (that is, local protection) at each hop this LSP traverses. The per-hop information is collected in the Record Route Object (RRO) that travels with the Resv message from the tail to the head.

Example:

```
Router# show ip rsvp reservation detail
Reservation:
  Tun Dest: 10.1.1.1 Tun ID: 1 Ext Tun ID: 10.1.1.1
  Tun Sender: 10.1.1.1 LSP ID: 104
  Next Hop: 10.1.1.2 on Gi1/0/2
  Label: 18 (outgoing)
  Reservation Style is Shared-Explicit, QoS Service is Controlled-Load
  Average Bitrate is 0 bits/sec, Maximum Burst is 1K bytes
  Min Policed Unit: 0 bytes, Max Pkt Size: 0 bytes
  RRO:
    10.1.1.1/32, Flags:0x1 (Local Prot Avail/to NHOP)
      Label subobject: Flags 0x1, C-Type 1, Label 18
    10.1.1.1/32, Flags:0x0 (Local Prot Avail/In Use/Has BW/to NHOP)
      Label subobject: Flags 0x1, C-Type 1, Label 16
    10.1.1.2/32, Flags:0x0 (No Local Protection)
      Label subobject: Flags 0x1, C-Type 1, Label 0
  Resv ID handle: CD000404.
  Policy: Accepted. Policy source(s): MPLS/TE
```

Notice the following about the primary LSP:

- It has protection that uses an NHOP backup tunnel at its first hop.

- It has protection and is actively using an NHOP backup tunnel at its second hop.
- It has no local protection at its third hop.

The RRO display shows the following information for each hop:

- Whether local protection is available (that is, whether the LSP has selected a backup tunnel)
- Whether local protection is in use (that is, whether the LSP is using its selected backup tunnel)
- Whether the selected backup tunnel is an NHOP or NNHOP backup tunnel
- Whether the backup tunnel used at this hop provides bandwidth protection

Step 7 **show ip rsvp hello**

Use this command to display hello status and statistics for FRR, reroute (hello state timer), and graceful restart. Following is sample output:

Example:

```
Router# show ip rsvp hello

Hello:
  RSVP Hello for Fast-Reroute/Reroute: Enabled
  Statistics: Disabled
  BFD for Fast-Reroute/Reroute: Enabled
  RSVP Hello for Graceful Restart: Disabled
```

Step 8 **show ip rsvp interface detail**

Use this command to display the interface configuration for Hello. Following is sample output:

Example:

```
Router# show ip rsvp interface detail

Gi2/1/1:
  RSVP: Enabled
  Interface State: Up
  Bandwidth:
    Curr allocated: 0 bits/sec
    Max. allowed (total): 0 bits/sec
    Max. allowed (per flow): 0 bits/sec
    Max. allowed for LSP tunnels using sub-pools (pool 1): 0 bits/sec
    Set aside by policy (total): 0 bits/sec
  Signalling:
    DSCP value used in RSVP msgs: 0x3F
    Number of refresh intervals to enforce blockade state: 4
  Authentication: disabled
    Key chain: <none>
    Type: md5
    Window size: 1
    Challenge: disabled
  FRR Extension:
    Backup Path: Configured (or "Not Configured")
  BFD Extension:
    State: Disabled
    Interval: Not Configured
  RSVP Hello Extension:
```

```

State: Disabled
Refresh Interval: FRR: 200 , Reroute: 2000
Missed Acks: FRR: 4 , Reroute: 4
DSCP in HELLOs: FRR: 0x30 , Reroute: 0x30

```

Step 9 **show ip rsvp hello bfd nbr**

Use this command to display information about all MPLS traffic engineering link and node protected neighbors that use the BFD protocol. Following is sample output. The command output is the same as the **show ip rsvp hello bfd nbr summary** command output.

Example:

```

Router# show ip rsvp hello bfd nbr

Client Neighbor I/F State LostCnt LSPs
FRR 10.0.0.6 Gi2/1/1 Up 0 1

```

Step 10 **show ip rsvp hello bfd nbr detail**

Use this command to display detailed information about all MPLS traffic engineering link and node protected neighbors that use the BFD protocol:

Example:

```

Router# show ip rsvp hello bfd nbr detail

Hello Client Neighbors
Remote addr 10.0.0.6, Local addr 10.0.0.7
Type: Active
I/F: Gi2/1/1
State: Up (for 00:09:41)
Clients: FRR
LSPs protecting: 1 (frr: 1, hst upstream: 0 hst downstream: 0)
Communication with neighbor lost: 0

```

Step 11 **show ip rsvp hello bfd nbr summary**

Use this command to display summarized information about all MPLS traffic engineering link and node protected neighbors that use the BFD protocol. The command output is the same as the **show ip rsvp hello bfd nbr summary** command output.

Example:

```

Router# show ip rsvp hello bfd nbr summary

Client Neighbor I/F State LostCnt LSPs
FRR 10.0.0.6 Gi2/1/1 Up 0 1

```

Configuration Examples for MPLS Traffic Engineering BFD-triggered Fast Reroute

The examples in this section are based on the backup tunnels shown in the figure below.

Figure 24: Backup Tunnels

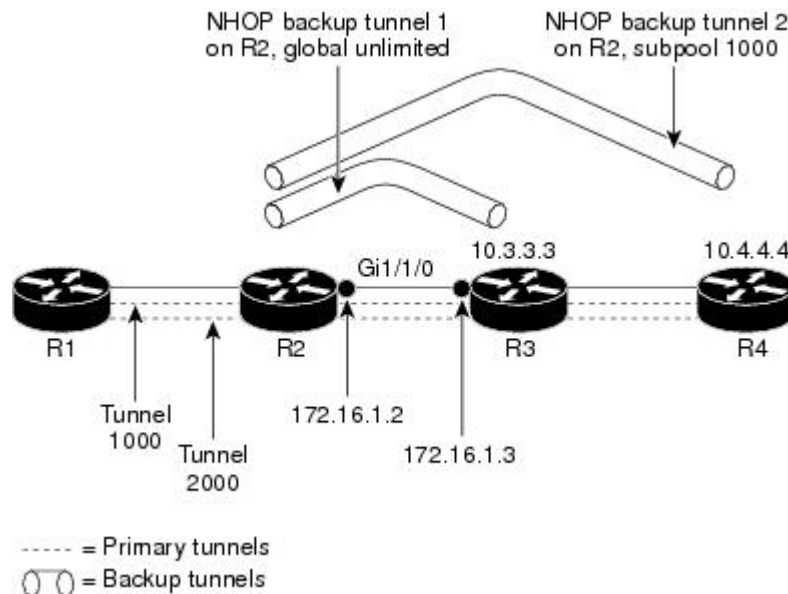

Example Enabling BFD Support on the Router

The following example enables the BFD protocol on the router:

```
Router(config)# ip rsvp signalling hello bfd
```

Example Enabling Fast Reroute on LSPs

On router R1 in the figure above, enter interface configuration mode for each tunnel to be protected (Tunnel 1000 and Tunnel 2000). Enable these tunnels to use a backup tunnel in case of a link or node failure along their paths.

Tunnel 1000 will use ten units of bandwidth from the subpool.

Tunnel 2000 will use five units of bandwidth from the global pool. The “bandwidth protection desired” bit and the “node protection desired bit” have been set by specifying **bw-prot** and **node-prot**, respectively, in the **tunnel mpls traffic-eng fast-reroute** command.

```
Router(config)# interface tunnel 1000
Router(config-if)# tunnel mpls traffic-eng fast-reroute
Router(config-if)# tunnel mpls traffic-eng bandwidth sub-pool 10
Router(config)# interface tunnel 2000
Router(config-if)# tunnel mpls traffic-eng fast-reroute bw-protect node-protect
Router(config-if)# tunnel mpls traffic-eng bandwidth 5
```

Example Creating a Backup Tunnel to the Next Hop

On router R2 in the figure above, create an NHOP backup tunnel to R3. This backup tunnel should avoid using the link 10.1.1.2.

```

Router(config)# ip explicit-path name avoid-protected-link
Router(cfg-ip-expl-path)# exclude-address 10.1.1.2

Explicit Path name avoid-protected-link:
___1: exclude-address 10.1.1.2
Router(cfg-ip_expl-path)# exit

Router(config)# interface tunnel 1

Router(config-if)# ip unnumbered loopback 0

Router(config-if)# tunnel destination 10.3.3.3
Router(config-if)# tunnel mode mpls traffic-eng

Router(config-if)# tunnel mpls traffic-eng path-option 1 explicit avoid-protected-link

```

Example Creating an NNHOP Backup Tunnel

On router R2 in the figure above, create an NNHOP backup tunnel to R4. This backup tunnel should avoid R3.

```

Router(config)# ip explicit-path name avoid-protected-node

Router(cfg-ip-expl-path)# exclude-address 10.3.3.3

Explicit Path name avoid-protected-node:
___1: exclude-address 10.3.3.3
Router(cfg-ip_expl-path)# end

Router(config)# interface tunnel2

Router(config-if)# ip unnumbered loopback0

Router(config-if)# tunnel destination 10.4.4.4

Router(config-if)# tunnel mode mpls traffic-eng0

Router(config-if)# tunnel mpls traffic-eng path-option 1 explicit avoid-protected-node

```

Example Assigning Backup Tunnels to a Protected Interface

On router R2 in the figure above, both backup tunnels are associated with interface Gigabit Ethernet 0/1/0:

```

Router(config)# interface Gi0/1/0

Router(config-if)# mpls traffic-eng backup-path tunnel 1

Router(config-if)# mpls traffic-eng backup-path tunnel 2

```

Example Enabling BFD on the Protected Interface

In the figure above, BFD is enabled on interface Gigabit Ethernet 2/1/1:

```
Router(config)# interface Gi2/1/1

Router(config-if)# ip rsvp signalling hello bfd

Router(config-if)# bfd interval 100 min_rx 100 multiplier 4
```

Example Associating Backup Bandwidth and Pool Type with Backup Tunnels

In the figure above, backup tunnel 1 is to be used only by LSPs that take their bandwidth from the global pool. It does not provide bandwidth protection. Backup tunnel 2 is to be used only by LSPs that take their bandwidth from the subpool. Backup tunnel 2 provides bandwidth protection for up to 1000 units.

```
Router(config)# interface tunnel 1

Router(config-if)# tunnel mpls traffic-eng backup-bw global-pool Unlimited

Router(config)# interface tunnel 2

Router(config-if)# tunnel mpls traffic-eng backup-bw sub-pool 1000
```

Example Configuring Backup Bandwidth Protection



Note This global configuration is required only to change the backup protection preemption algorithm from minimize the number of LSPs that are demoted to minimize the amount of bandwidth that is wasted.

```
Router(config-if)# tunnel mpls traffic-eng fast-reroute bw-protect
Router(config)# mpls traffic-eng fast-reroute backup-prot-preemption optimize-bw
```

Additional References

Related Documents

Related Topic	Document Title
Cisco IOS commands	Cisco IOS Master Commands List, All Releases
Link and node protection	MPLS TE: Link and Node Protection, with RSVP Hellos Support (with Fast Tunnel Interface Down Detection)
Multiprotocol Label Switching commands	<i>Cisco IOS Multiprotocol Label Switching Command Reference</i>
Bidirectional Forwarding Direction configuration information	“Bidirectional Forwarding Detection” chapter in the <i>Cisco IOS IP Routing Configuration Guide</i>

Standards

Standard	Title
No new or modified standards are supported by this feature, and support for existing standards has not been modified by this feature.	--

MIBs

MIB	MIBs Link
No new or modified MIBs are supported by this feature, and support for existing MIBs has not been modified by this feature.	To locate and download MIBs for selected platforms, Cisco software releases, and feature sets, use Cisco MIB Locator found at the following URL: http://www.cisco.com/go/mibs

RFCs

RFC	Title
No new or modified RFCs are supported by this feature, and support for existing RFCs has not been modified by this feature.	—

Technical Assistance

Description	Link
The Cisco Support and Documentation website provides online resources to download documentation, software, and tools. Use these resources to install and configure the software and to troubleshoot and resolve technical issues with Cisco products and technologies. Access to most tools on the Cisco Support and Documentation website requires a Cisco.com user ID and password.	http://www.cisco.com/cisco/web/support/index.html

Feature Information for MPLS Traffic Engineering BFD-triggered Fast Reroute

The following table provides release information about the feature or features described in this module. This table lists only the software release that introduced support for a given feature in a given software release train. Unless noted otherwise, subsequent releases of that software release train also support that feature.

Use Cisco Feature Navigator to find information about platform support and Cisco software image support. To access Cisco Feature Navigator, go to www.cisco.com/go/cfn. An account on Cisco.com is not required.

Table 9: Feature Information for MPLS Traffic Engineering: BFD-triggered Fast Reroute

Feature Name	Releases	Feature Information
MPLS Traffic Engineering: BFD-triggered Fast Reroute	Cisco IOS XE Release 2.3	<p>The MPLS Traffic Engineering: BFD-triggered Fast Reroute feature allows you to obtain link and node protection by using the Bidirectional Forwarding Detection (BFD) protocol to provide fast forwarding path failure detection times for all media types, encapsulations, topologies, and routing protocols. In addition to fast forwarding path failure detection, BFD provides a consistent failure detection method for network administrators.</p> <p>In Cisco IOS XE Release 2.3, this feature was introduced on the Cisco ASR 1000 Series Aggregation Services Routers.</p> <p>The following commands were introduced or modified by this feature: clear ip rsvp hello bfd, ip rsvp signalling hello bfd (configuration), ip rsvp signalling hello bfd (interface), show ip rsvp hello, show ip rsvp hello bfd nbr, show ip rsvp hello bfd nbr detail, show ip rsvp hello bfd nbr summary, and show ip rsvp interface detail.</p>

Glossary

backup bandwidth --The usage of NHOP and NNHOP backup tunnels to provide bandwidth protection for rerouted LSPs.

backup tunnel --An MPLS TE tunnel used to protect other (primary) tunnels' traffic when a link or node failure occurs.

bandwidth --The available traffic capacity of a link.

fast reroute --Procedures that enable temporary routing around a failed link or node while a new LSP is being established at the headend.

global pool --The total bandwidth allocated to an MPLS traffic engineering link or node.

headend --The router that originates and maintains a given LSP. This is the first router in the LSP's path.

hop --Passage of a data packet between two network nodes (for example, between two routers).

instance --A Hello instance implements the RSVP Hello extensions for a given router interface address and remote IP address. Active Hello instances periodically send Hello Request messages, expecting Hello ACK messages in response. If the expected Ack message is not received, the active Hello instance declares that the neighbor (remote IP address) is unreachable (that is, it is lost). This can cause LSPs crossing this neighbor to be fast rerouted.

interface --A network connection.

link --A point-to-point connection between adjacent nodes. There can be more than one link between adjacent nodes. A network communications channel consisting of a circuit or transmission path and all related equipment between a sender and a receiver. Sometimes referred to as a line or a transmission link.

LSP --label-switched path. A configured connection between two routers, in which label switching is used to carry the packets. The purpose of an LSP is to carry data packets.

MPLS --Multiprotocol Label Switching. Packet-forwarding technology, used in the network core, that applies data link layer labels to tell switching nodes how to forward data, resulting in faster and more scalable forwarding than network layer routing normally can do.

NHOP --next hop. The next downstream node along an LSP's path.

NHOP backup tunnel --next-hop backup tunnel. Backup tunnel terminating at the LSP's next hop beyond the point of failure, and originating at the hop immediately upstream of the point of failure. It bypasses a failed link, and is used to protect primary LSPs that were using this link before the failure.

NNHOP --next-next hop. The node after the next downstream node along an LSP's path.

NNHOP backup tunnel --next-next-hop backup tunnel. Backup tunnel terminating at the LSP's next-next hop beyond the point of failure, and originating at the hop immediately upstream of the point of failure. It bypasses a failed link or node, and is used to protect primary LSPs that were using this link or node before the failure.

node --Endpoint of a network connection or a junction common to two or more lines in a network. Nodes can be interconnected by links, and serve as control points in the network. Computers on a network, or any endpoint or a junction common to two or more lines in a network. Nodes can be processors, controllers, or workstations.

primary LSP --The last LSP originally signaled over the protected interface before the failure. The LSP before the failure.

primary tunnel --Tunnel whose LSP may be fast rerouted if there is a failure. Backup tunnels cannot be primary tunnels.

protected interface --An interface that has one or more backup tunnels associated with it.

redundancy --The duplication of devices, services, or connections so that, in the event of a failure, the redundant devices, services, or connections can perform the work of those that failed.

RSVP --Resource Reservation Protocol. An IETF protocol used for signaling requests (setting up reservations) for Internet services by a customer before that customer is permitted to transmit data over that portion of the network.

state --Information that a router must maintain about each LSP. The information is used for rerouting tunnels.

subpool --The more restrictive bandwidth in an MPLS traffic engineering link or node. The subpool is a portion of the link or node's overall global pool bandwidth.

tailend --The router upon which an LSP is terminated. This is the last router in the LSP's path.

tunnel --Secure communications path between two peers, such as two routers.



CHAPTER 7

MPLS Traffic Engineering (TE)--IP Explicit Address Exclusion

The MPLS Traffic Engineering (TE)--IP Explicit Address Exclusion feature provides a means to exclude a link or node from the path for a Multiprotocol Label Switching (MPLS) TE label switched path (LSP).

The feature is enabled through the **ip explicit-path** command that allows you to create an IP explicit path and enter a configuration submode for specifying the path. The feature adds to the submode commands the **exclude-address** command for specifying addresses to exclude from the path.

If the excluded address for an MPLS TE LSP identifies a flooded link, the constraint-based shortest path first (CSPF) routing algorithm does not consider that link when computing paths for the LSP. If the excluded address specifies a flooded MPLS TE router ID, the CSPF routing algorithm does not allow paths for the LSP to traverse the node identified by the router ID.

- [Finding Feature Information, on page 161](#)
- [Prerequisites for MPLS Traffic Engineering \(TE\)--IP Explicit Address Exclusion, on page 162](#)
- [Restrictions for MPLS Traffic Engineering \(TE\)--IP Explicit Address Exclusion, on page 162](#)
- [Information About MPLS Traffic Engineering \(TE\)--IP Explicit Address Exclusion, on page 162](#)
- [How to Configure MPLS Traffic Engineering \(TE\)--IP Explicit Address Exclusion, on page 163](#)
- [Configuration Examples for MPLS Traffic Engineering \(TE\)--IP Explicit Address Exclusion, on page 166](#)
- [Additional References, on page 167](#)
- [Feature Information for MPLS Traffic Engineering \(TE\)--IP Explicit Address Exclusion, on page 168](#)
- [Glossary, on page 168](#)

Finding Feature Information

Your software release may not support all the features documented in this module. For the latest caveats and feature information, see [Bug Search Tool](#) and the release notes for your platform and software release. To find information about the features documented in this module, and to see a list of the releases in which each feature is supported, see the feature information table.

Use Cisco Feature Navigator to find information about platform support and Cisco software image support. To access Cisco Feature Navigator, go to www.cisco.com/go/cfn. An account on Cisco.com is not required.

Prerequisites for MPLS Traffic Engineering (TE)--IP Explicit Address Exclusion

Your network must support the following Cisco IOS XE features in order to support IP explicit address exclusion:

- MPLS
- IP Cisco Express Forwarding
- Intermediate System-to-Intermediate System (IS-IS) or Open Shortest Path First (OSPF)

Restrictions for MPLS Traffic Engineering (TE)--IP Explicit Address Exclusion

MPLS TE will accept an IP explicit path comprised of either all excluded addresses configured by the **exclude-address** command or all included addresses configured by the **next-address** command, but not a combination of both.

Information About MPLS Traffic Engineering (TE)--IP Explicit Address Exclusion

MPLS Traffic Engineering

MPLS is an Internet Engineering Task Force (IETF)-specified framework that provides for the efficient designation, routing, forwarding, and switching of traffic flows through the network. MPLS is a method that forwards IP traffic using a label. This label instructs the routers and the switches in the network where to forward the packets based on preestablished IP routing information.

Traffic engineering (TE) is the process of adjusting bandwidth allocations to ensure that enough is left for high-priority traffic.

In MPLS TE, the upstream router creates a network tunnel for a particular traffic stream, then fixes the bandwidth available for that tunnel.

Cisco Express Forwarding

Cisco Express Forwarding is an advanced, Layer 3 switching technology inside a router. It defines the fastest method by which a Cisco router forwards packets from ingress to egress interfaces. The **ip cef** command enables Cisco Express Forwarding globally, and the **ip route-cache cef** command enables Cisco Express Forwarding on an interface.

How to Configure MPLS Traffic Engineering (TE)--IP Explicit Address Exclusion

Configuring IP Explicit Address Exclusion

SUMMARY STEPS

1. **enable**
2. **configure terminal**
3. **ip explicit-path** {name *path-name* | identifier *number*} [**enable** | **disable**]
4. **exclude-address** *ip-address*
5. **exit**
6. **exit**
7. **show ip explicit-path**

DETAILED STEPS

	Command or Action	Purpose
Step 1	enable Example: Router> enable	Enables privileged EXEC mode. <ul style="list-style-type: none"> • Enter your password if prompted.
Step 2	configure terminal Example: Router# configure terminal	Enters global configuration mode.
Step 3	ip explicit-path {name <i>path-name</i> identifier <i>number</i> } [enable disable] Example: Router(config)# ip explicit-path name OmitR12	Specifies the name or number of the explicit path, and enables the path, and enters explicit-path configuration mode.
Step 4	exclude-address <i>ip-address</i> Example: Router(cfg-ip-expl-path)# exclude-address 10.12.12.12	Excludes the specified link or node from consideration by the constraint-based SPF. <ul style="list-style-type: none"> • The <i>ip-address</i> is a link address or the router ID for a node.
Step 5	exit Example: Router(cfg-ip-expl-path)# exit	Exits from explicit-path configuration mode, and returns to global configuration mode.

	Command or Action	Purpose
Step 6	exit Example: <pre>Router(config)# exit</pre>	Exits from global configuration mode, and returns to privileged EXEC mode.
Step 7	show ip explicit-path Example: <pre>Router# show ip explicit-path</pre>	Displays information about configured IP explicit paths.

Configuring an MPLS Traffic Engineering Tunnel

SUMMARY STEPS

1. **enable**
2. **configure terminal**
3. **interface tunnel *number***
4. **ip unnumbered loopback0**
5. **tunnel destination *ip-address***
6. **tunnel mode mpls traffic-eng**
7. **tunnel mpls traffic-eng bandwidth *bandwidth***
8. **tunnel mpls traffic-eng path-option *number* {dynamic | explicit {name *path-name* | ID *path-number*}}** [*lockdown*]
9. **exit**
10. **exit**
11. **show mpls traffic eng tunnels**

DETAILED STEPS

	Command or Action	Purpose
Step 1	enable Example: <pre>Router> enable</pre>	Enables privileged EXEC mode. <ul style="list-style-type: none"> • Enter your password if prompted.
Step 2	configure terminal Example: <pre>Router# configure terminal</pre>	Enters global configuration mode.
Step 3	interface tunnel <i>number</i> Example: <pre>Router(config)# interface tunnel11</pre>	Configures an interface type and enters interface configuration mode.

	Command or Action	Purpose
Step 4	<p>ip unnumbered loopback0</p> <p>Example:</p> <pre>Router(config-if)# ip unnumbered loopback0</pre>	<p>Assigns the tunnel interface an IP address.</p> <ul style="list-style-type: none"> An MPLS traffic engineering tunnel interface should be unnumbered because it represents a unidirectional link.
Step 5	<p>tunnel destination <i>ip-address</i></p> <p>Example:</p> <pre>Router(config-if)# tunnel destination 10.11.11.11</pre>	<p>Specifies the destination for a tunnel.</p> <ul style="list-style-type: none"> The destination of the tunnel must be the MPLS traffic engineering router ID of the destination device.
Step 6	<p>tunnel mode mpls traffic-eng</p> <p>Example:</p> <pre>Router(config-if)# tunnel mode mpls traffic-eng</pre>	<p>Sets the tunnel encapsulation mode to MPLS traffic engineering.</p>
Step 7	<p>tunnel mpls traffic-eng bandwidth <i>bandwidth</i></p> <p>Example:</p> <pre>Router(config-if)# tunnel mpls traffic-eng bandwidth 100</pre>	<p>Configures the bandwidth for the MPLS traffic engineering tunnel.</p>
Step 8	<p>tunnel mpls traffic-eng path-option <i>number</i> {dynamic explicit {<i>name path-name</i> <i>ID path-number</i>}} [<i>lockdown</i>]</p> <p>Example:</p> <pre>Router(config-if)# tunnel mpls traffic-eng path-option 2 dynamic</pre>	<p>Configures the tunnel to use a named IP explicit path or a path dynamically calculated from the traffic engineering topology database.</p> <ul style="list-style-type: none"> A dynamic path is used if an explicit path is unavailable. <p>Note To configure a path option that specifies an exclude address, specify the explicit keyword (not the dynamic keyword) and specify an IP explicit path configured according to the steps in the “Configuring IP Explicit Address Exclusion, on page 163” section.</p>
Step 9	<p>exit</p> <p>Example:</p> <pre>Router(config-if)# exit</pre>	<p>Exits from interface configuration mode.</p>
Step 10	<p>exit</p> <p>Example:</p> <pre>Router(config)# exit</pre>	<p>Exits to privileged EXEC mode.</p>
Step 11	<p>show mpls traffic eng tunnels</p> <p>Example:</p>	<p>Shows information about tunnels, including the current tunnel path if a tunnel is operational.</p>

	Command or Action	Purpose
	Router# show mpls traffic eng tunnels	<ul style="list-style-type: none"> By viewing the command output, you can determine the path that was used to build a tunnel. If you entered the exclude-address command, the specified link or node should not be listed.

Configuration Examples for MPLS Traffic Engineering (TE)--IP Explicit Address Exclusion

Example Configuring IP Explicit Address Exclusion

The following example shows how to configure an MPLS TE tunnel with two path options: a preferred explicit path with an excluded address and a backup dynamic path.

Configure the IP explicit path named OmitR12, which excludes the router with router ID 10.12.12.12:

```
ip explicit-path name OmitR12
exclude-address 10.12.12.12
  Explicit Path name OmitR12:
  1: exclude-address 10.12.12.12
exit
```

To verify the configuration of the explicit path, use the **show ip explicit-path** command.

```
show ip explicit-paths name OmitR12
PATH OmitR12 (loose source route, path complete, generation 3)
  1: exclude-address 10.12.12.12
```



Note You must know the router IDs for LSRs (nodes) in the network; in this example, that 10.12.12.12 is a router ID. Otherwise, it will not be apparent whether the specified address is the IP address of a link or a router ID.

Example Configuring an MPLS Traffic Engineering Tunnel

The following example configures Tunnel11 with its two options, where the preferred path option is the IP explicit path OmitR2:

```
interface tunnel11
ip unnumbered loopback0
tunnel destination 10.11.11.11
tunnel mode mpls traffic-eng
tunnel mpls traffic-eng path-option 1 explicit name OmitR12
tunnel mpls traffic-eng path-option 2 dynamic
```



Note There are additional commands for configuring properties for TE tunnels such as bandwidth and priority. For descriptions of those commands, refer to the Cisco IOS Multiprotocol Label Switching Command Reference.

Additional References

Related Documents

Related Topic	Document Title
Cisco IOS commands	Cisco IOS Master Commands List, All Releases
MPLS commands	<i>Cisco IOS Multiprotocol Label Switching Command Reference</i>
MPLS configuration information	<i>Cisco IOS XE Multiprotocol Label Switching Configuration Guide</i>

Standards

Standard	Title
No new or modified standards are supported by this feature, and support for existing standards has not been modified by this feature.	--

MIBs

MIB	MIBs Link
No new or modified MIBs are supported by this feature, and support for existing MIBs has not been modified by this feature.	To locate and download MIBs for selected platforms, Cisco software releases, and feature sets, use Cisco MIB Locator found at the following URL: http://www.cisco.com/go/mibs

RFCs

RFC	Title
No new or modified RFCs are supported by this feature, and support for existing RFCs has not been modified by this feature.	--

Technical Assistance

Description	Link
The Cisco Support and Documentation website provides online resources to download documentation, software, and tools. Use these resources to install and configure the software and to troubleshoot and resolve technical issues with Cisco products and technologies. Access to most tools on the Cisco Support and Documentation website requires a Cisco.com user ID and password.	http://www.cisco.com/cisco/web/support/index.html

Feature Information for MPLS Traffic Engineering (TE)--IP Explicit Address Exclusion

The following table provides release information about the feature or features described in this module. This table lists only the software release that introduced support for a given feature in a given software release train. Unless noted otherwise, subsequent releases of that software release train also support that feature.

Use Cisco Feature Navigator to find information about platform support and Cisco software image support. To access Cisco Feature Navigator, go to www.cisco.com/go/cfn. An account on Cisco.com is not required.

Table 10: Feature Information for MPLS Traffic Engineering (TE)--IP Explicit Address Exclusion

Feature Name	Releases	Feature Configuration Information
MPLS Traffic Engineering (TE)--IP Explicit Address Exclusion	Cisco IOS XE Release 2.3	<p>The MPLS Traffic Engineering (TE)--IP Explicit Address Exclusion feature provides a means to exclude a link or node from the path for Multiprotocol Label Switching (MPLS) TE label switched path (LSP).</p> <p>This feature was integrated into Cisco IOS XE Release 2.3.</p> <p>The following command was introduced by this feature: exclude-address.</p>

Glossary

Cisco Express Forwarding --A means for accelerating the forwarding of packets within a router, by storing route lookup information in several data structures instead of in a route cache.

IP explicit path --A list of IP addresses, each representing a node or link in the explicit path.

link --Network communications channel consisting of a circuit or transmission path and all related equipment between a sender and a receiver. Sometimes referred to as a line or a transmission link.

MPLS --Multiprotocol Label Switching. Switching method that forwards IP traffic using a label. This label instructs the routers and the switches in the network where to forward the packets based on preestablished IP routing information.

node --Endpoint of a network connection or a junction common to two or more lines in a network. Nodes can be interconnected by links, and serve as control points in the network.



CHAPTER 8

MPLS Traffic Engineering Shared Risk Link Groups

The MPLS Traffic Engineering: Shared Risk Link Groups feature enhances backup tunnel path selection so that a backup tunnel avoids using links that are in the same Shared Risk Link Group (SRLG) as interfaces the backup tunnel is protecting.

SRLGs refer to situations where links in a network share a common fiber (or a common physical attribute). If one link fails, other links in the group may fail too. Links in the group have a shared risk.

- [Finding Feature Information, on page 171](#)
- [Prerequisites for MPLS Traffic Engineering Shared Risk Link Groups, on page 171](#)
- [Restrictions for MPLS Traffic Engineering Shared Risk Link Groups, on page 172](#)
- [Information About MPLS Traffic Engineering Shared Risk Link Groups, on page 172](#)
- [How to Configure MPLS Traffic Engineering Shared Risk Link Groups, on page 176](#)
- [Configuration Examples for MPLS Traffic Engineering Shared Risk Link Groups, on page 185](#)
- [Additional References, on page 187](#)
- [Feature Information for MPLS Traffic Engineering Shared Risk Link Groups, on page 188](#)
- [Glossary, on page 189](#)

Finding Feature Information

Your software release may not support all the features documented in this module. For the latest caveats and feature information, see [Bug Search Tool](#) and the release notes for your platform and software release. To find information about the features documented in this module, and to see a list of the releases in which each feature is supported, see the feature information table.

Use Cisco Feature Navigator to find information about platform support and Cisco software image support. To access Cisco Feature Navigator, go to www.cisco.com/go/cfn. An account on Cisco.com is not required.

Prerequisites for MPLS Traffic Engineering Shared Risk Link Groups

- You must configure Fast Reroutable tunnels.

- You must enable the autotunnel backup.

Restrictions for MPLS Traffic Engineering Shared Risk Link Groups

- The backup tunnel must be within a single area.
- Manually created backup tunnels do not automatically avoid SRLGs of protected interfaces.
- A primary tunnel cannot be specified to avoid links belonging to specified SRLGs.

Information About MPLS Traffic Engineering Shared Risk Link Groups

MPLS Traffic Engineering Brief Overview

Multiprotocol Label Switching (MPLS) is an Internet Engineering Task Force (IETF)-specified framework that provides for the efficient designation, routing, forwarding, and switching of traffic flows through the network.

Traffic engineering (TE) is the process of adjusting bandwidth allocations to ensure that enough is left for high-priority traffic.

In MPLS TE, the upstream router creates a network tunnel for a particular traffic stream, then fixes the bandwidth available for that tunnel.

MPLS Traffic Engineering Shared Risk Link Groups

SRLGs refer to situations where links in a network share a common fiber (or a common physical attribute). If one link fails, other links in the group may fail too. Links in the group have a shared risk.

Backup tunnels should avoid using links in the same SRLG as interfaces they are protecting. Otherwise, when the protected link fails the backup tunnel fails too.

The figure below shows a primary label-switched path (LSP) from router R1 to router R5. The LSP protects against the failure of the R2-R3 link at R2 via a backup tunnel to R4. If the R2-R3 link fails, link protection reroutes the LSP along the backup tunnel. However, the R2-R3 link and one of the backup tunnel links are in the same SRLG. So if the R2-R3 link fails, the backup tunnel may fail too.

Figure 25: Backup Tunnel in the Same SRLG as the Interface It Is Protecting

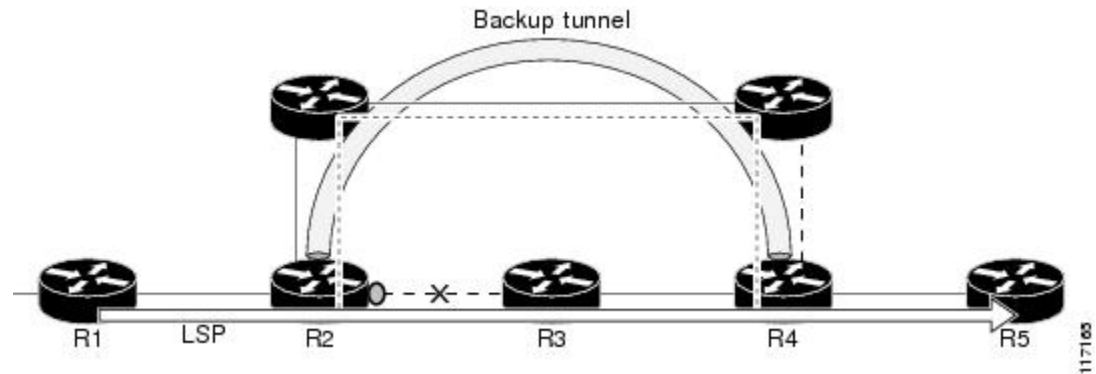

The MPLS TE SRLG feature enhances backup tunnel path selection so a backup tunnel can avoid using links that are in the same SRLG as the interfaces it is protecting.

There are two ways for a backup tunnel to avoid the SRLGs of its protected interface:

- The router does not create the backup tunnel unless it avoids SRLGs of the protected interface.
- The router *tries* to avoid SRLGs of the protected interface, but if that is not possible the router creates the backup tunnel anyway. In this case there are two explicit paths. The first explicit path *tries* to avoid the SRLGs of the protected interface. If that does not work, the backup tunnel uses the second path (which ignores SRLGs).



Note Only backup tunnels that routers create automatically (called autotunnel backup) can avoid SRLGs of protected interfaces. For more information about these backup tunnels, see the [Autotunnel Backup for MPLS TE SRLGs, on page 175](#).

To activate the MPLS TE SRLG feature, you must do the following:

- Configure the SRLG membership of each link that has a shared risk with another link.
- Configure the routers to automatically create backup tunnels that avoid SRLGs of the protected interfaces.

For a detailed explanation of the configuration steps, see the [How to Configure MPLS Traffic Engineering Shared Risk Link Groups, on page 176](#).

Open Shortest Path First (OSPF) and Intermediate System-to-Intermediate System (IS-IS) flood the SRLG membership information (including other TE link attributes such as bandwidth availability and affinity) so that all routers in the network have the SRLG information for each link. With this topology information, routers can compute backup tunnel paths that exclude links having SRLGs in common with their protected interfaces. As shown in the figure below, the backup tunnel avoids the link between R2 and R3, which shares an SRLG with the protected interface.

Figure 26: Backup Tunnel That Avoids SRLG of Protected Interface

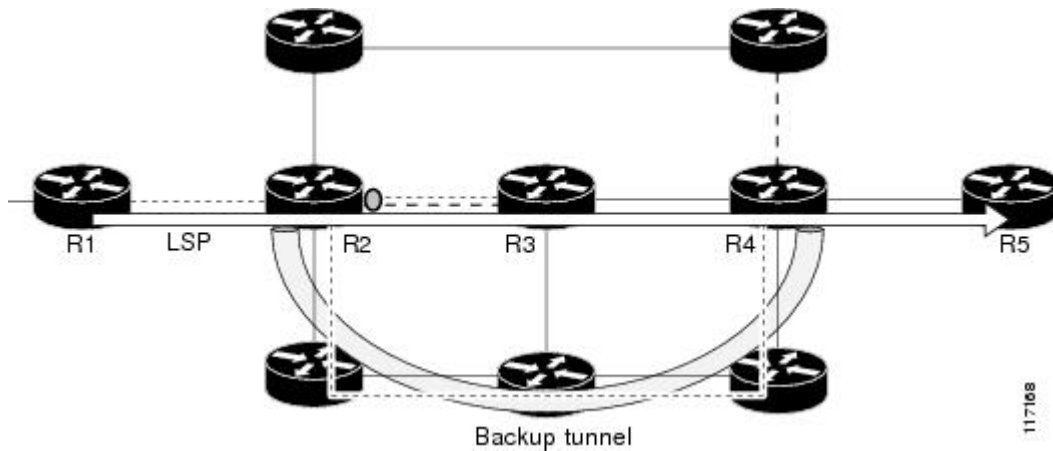

Fast Reroute Protection for MPLS TE SRLGs

Fast Reroute (FRR) protects MPLS TE LSPs from link and node failures by locally repairing the LSPs at the point of failure. This protection allows data to continue to flow on LSPs while their headend routers attempt to establish new end-to-end LSPs to replace them. FRR locally repairs the protected LSPs by rerouting them over backup tunnels that bypass failed links or nodes.

Backup tunnels that bypass only a single link of the LSP's path provide link protection. They protect LSPs if a link along their path fails by rerouting the LSP's traffic to the next hop (bypassing the failed link). These are referred to as next-hop (NHOP) backup tunnels because they terminate at the LSP's next hop beyond the point of failure. The figure below illustrates an NHOP backup tunnel.

Figure 27: NHOP Backup Tunnel

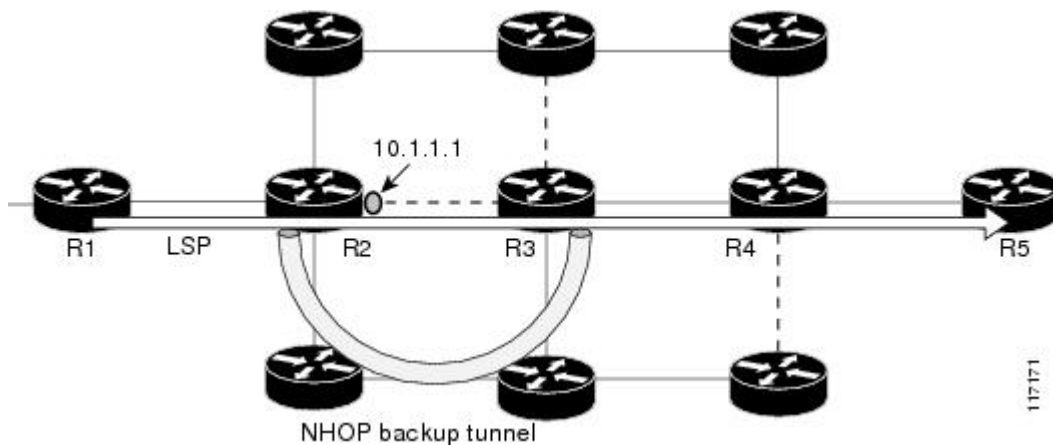

FRR provides node protection for LSPs. Backup tunnels that bypass next-hop nodes along LSP paths are called next-next-hop (NNHOP) backup tunnels because they terminate at the node following the next-hop node of the LSP paths, thereby bypassing the next-hop node. They protect LSPs if a node along their path fails by enabling the node upstream of the failure to reroute the LSPs and their traffic around the failed node to the next-next hop. FRR supports the use of Resource Reservation Protocol (RSVP) hellos to accelerate the detection of node failures. NNHOP backup tunnels also provide protection from link failures, because they bypass the failed link and the node.

The figure below illustrates an NNHOP backup tunnel.

Figure 28: NNHOP Backup Tunnel

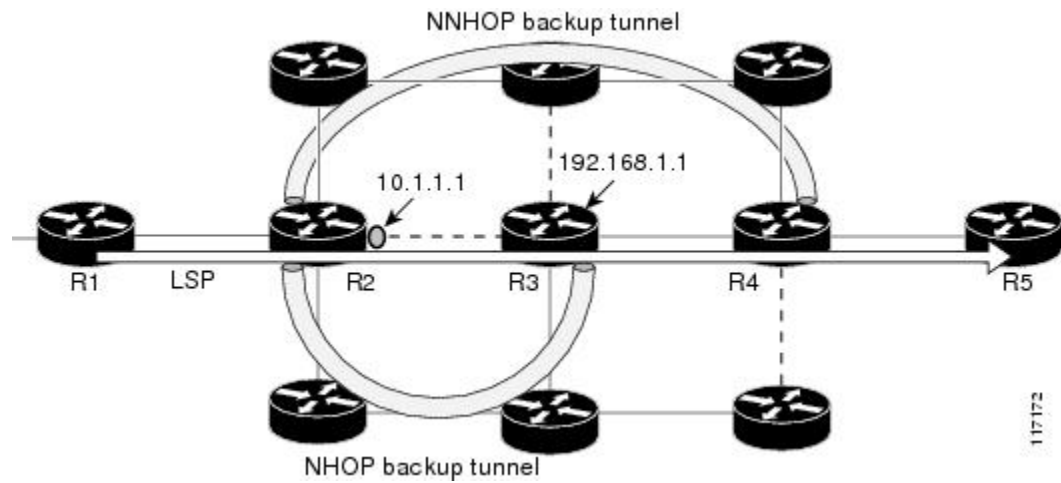

Autotunnel Backup for MPLS TE SRLGs

Autotunnel backup is the ability of routers to create backup tunnels automatically. Therefore, you do not need to preconfigure each backup tunnel and then assign the backup tunnel to the protected interface. Only automatically created backup tunnels can avoid SRLGs or their protected interfaces.

For information about backup tunnels, see the [Fast Reroute Protection for MPLS TE SRLGs, on page 174](#).

For detailed information about autotunnel backup and how you can change the default command values, see [MPLS Traffic Engineering \(TE\)--AutoTunnel Primary and Backup](#).

To globally activate the autotunnel backup feature, enter the **mpls traffic-eng auto-tunnel backup** command.

The figure below illustrates an NNHOP automatically generated backup tunnel that excludes the router 192.168.1.1 and terminates at router R4. The backup tunnel must avoid touching any links of 192.168.1.1.

Figure 29: Autotunnel Backup for NNHOP

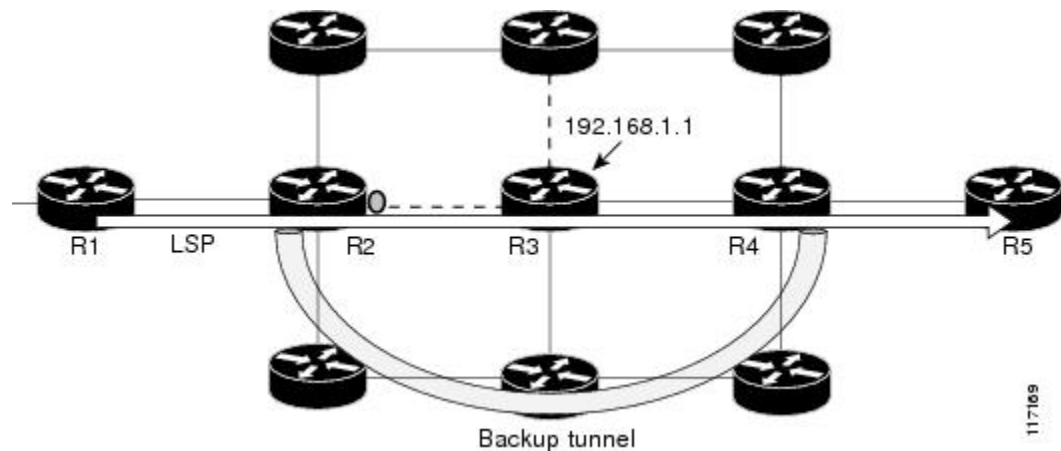

The figure below illustrates an NHOP automatically generated backup tunnel that terminates at router R3 and avoids the link 10.1.1.1, not the entire node.

Figure 30: Autotunnel Backup for NHOP

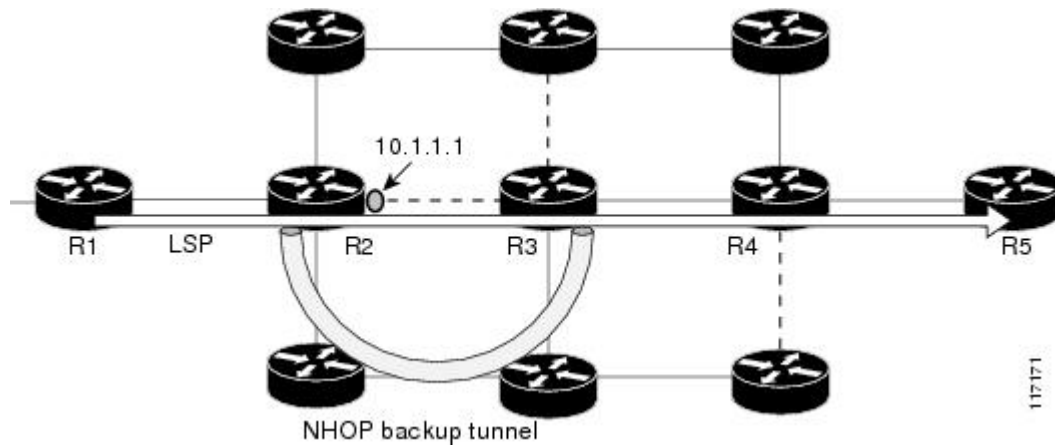

Note NNHOP excludes the router ID (the entire router must be excluded; that is, no link of the router can be included in the backup tunnel's path). NHOP excludes only the link when the backup tunnel's path is computed.

How to Configure MPLS Traffic Engineering Shared Risk Link Groups

Configuring MPLS TE SRLG Membership of Each Link That Has a Shared Risk with Another Link

Perform the following task to configure MPLS TE SRLG membership of each link that has a shared risk with another link. Configuring SRLG membership enhances backup tunnel path selection so that a backup tunnel avoids using links that are in the same SRLG as interfaces the backup tunnel is protecting.

Enter the commands on the physical interface.

SUMMARY STEPS

1. **enable**
2. **configure terminal**
3. **interface** *type slot/port*
4. **mpls traffic-eng srlg** [*number*] []
5. **mpls traffic-eng srlg end**

DETAILED STEPS

	Command or Action	Purpose
Step 1	enable	Enables privileged EXEC mode.

	Command or Action	Purpose
	Example: <pre>Router> enable</pre>	<ul style="list-style-type: none"> Enter your password if prompted.
Step 2	configure terminal Example: <pre>Router# configure terminal</pre>	Enters global configuration mode.
Step 3	interface <i>type slot/port</i> Example: <pre>Router(config)# interface pos 1/1/1</pre>	Specifies an interface and enters interface configuration mode. <ul style="list-style-type: none"> The <i>type</i> argument is the type of interface to be configured. The <i>slot</i> argument is the slot number. Refer to the appropriate hardware manual for slot and port information. The <i>port</i> argument is the port number. Refer to the appropriate hardware manual for slot and port information. The slash (/) is required.
Step 4	mpls traffic-eng srlg [<i>number</i>] [Example: <pre>Router(config-if)# mpls traffic-eng srlg 5</pre>	Configures the SRLG membership of a link (interface). <ul style="list-style-type: none"> The <i>number</i> argument is an SRLG identifier. Valid values are 0 to 4,294,967,295. <p>Note To make the link a member of multiple SRLGs, enter the mpls traffic-eng srlg command multiple times.</p>
Step 5	mpls traffic-eng srlg end Example: <pre>Router(config-if)# end</pre>	Exits to privileged EXEC mode.

Configuring the Routers That Automatically Create Backup Tunnels to Avoid MPLS TE SRLGs

Perform the following task to configure routers that automatically create backup tunnels to avoid MPLS TE SRLGs of their protected interfaces. Backup tunnels provide link protection by rerouting traffic to the next hop bypassing failed links or in this instance by avoiding SRLGs.

SUMMARY STEPS

- enable
- configure terminal
- mpls traffic-eng auto-tunnel backup srlg exclude [force | preferred]

4. end

DETAILED STEPS

	Command or Action	Purpose
Step 1	enable Example: <pre>Router> enable</pre>	Enables privileged EXEC mode. <ul style="list-style-type: none"> • Enter your password if prompted.
Step 2	configure terminal Example: <pre>Router# configure terminal</pre>	Enters global configuration mode.
Step 3	mpls traffic-eng auto-tunnel backup srlg exclude [force preferred] Example: <pre>Router(config)# mpls traffic-eng auto-tunnel backup srlg exclude force</pre>	Specifies that autocreated backup tunnels should avoid SRLGs of its protected interface. <ul style="list-style-type: none"> • The force keyword forces the backup tunnel to avoid SRLGs of its protected interface or interfaces. • The preferred keyword causes the backup tunnel to <i>try</i> to avoid SRLGs of its protected interface or interfaces, but the backup tunnel can be created if SRLGs cannot be avoided.
Step 4	end Example: <pre>Router(config)# end</pre>	Returns to privileged EXEC mode.

Verifying the MPLS Traffic Engineering Shared Risk Link Groups Configuration

SUMMARY STEPS

1. enable
2. show running-config
3. show mpls traffic-eng link-management interfaces *interface slot/port*
4. show mpls traffic-eng topology
5. show mpls traffic-eng topology srlg
6. show mpls traffic-eng topology brief
7. show mpls traffic-eng link-management advertisements
8. show ip rsvp fast-reroute
9. mpls traffic-eng auto-tunnel backup srlg exclude force
10. show ip explicit-paths
11. show mpls traffic-eng tunnels tunnel *num*
12. mpls traffic-eng auto-tunnel backup srlg exclude preferred

13. **show ip explicit-paths**
14. **show ip rsvp fast-reroute**
15. **exit**

DETAILED STEPS

Step 1 **enable**

Use this command to enable privileged EXEC mode. Enter your password, if prompted. For example:

Example:

```
Router> enable
Router#
```

Step 2 **show running-config**

Use the following commands to configure the SRLG membership of the interface pos 1/3/1 and to verify that the configuration is as expected. For example:

Example:

```
Router# configure terminal
Router(config)# interface pos 1/3/1
Router(config-if)# mpls traffic-eng srlg 1
Router(config-if)# mpls traffic-eng srlg 2
Router(config-if)# end
Router# show running-config

interface POS 1/3/1
 ip address 10.0.0.33 255.255.255.255
 no ip directed-broadcast
 ip router isis
 encapsulation ppp
 no ip mroute-cache
 mpls traffic-eng tunnels
 mpls traffic-eng backup-path Tunnel5000
 mpls traffic-eng srlg 1
 mpls traffic-eng srlg 2
 tag-switching ip
 crc 32
 clock source internal
 pos ais-shut
 pos report rdool
 pos report lais
 pos report lrldi
 pos report pais
 pos report prdi
 pos report sd-ber
 isis circuit-type level-2-only
 ip rsvp bandwidth 20000 20000 sub-pool 5000
```

This verifies that the Packet over SONET (POS) interface pos 1/3/1 is associated that SRLG 1 and SRLG 2.

Step 3 **show mpls traffic-eng link-management interfaces***interface slot/port*

Use this command to show the SRLG membership configured on interface pos 1/3/1. For example:

Example:

```

Router# show mpls traffic-eng link-management interfaces pos 1/3/1
System Information::
  Links Count:          11
Link ID:: PO1/3/1 (10.0.0.33)
  Link Status:
    SRLGs:              1 2
    Physical Bandwidth: 2488000 kbits/sec
    Max Res Global BW:  20000 kbits/sec (reserved:0% in, 0% out)
    Max Res Sub BW:     5000 kbits/sec (reserved:0% in, 0% out)
    MPLS TE Link State: MPLS TE on, RSVP on, admin-up, flooded
    Inbound Admission:  allow-all
    Outbound Admission: allow-if-room
    Admin. Weight:      10 (IGP)
    IGP Neighbor Count: 1
    IGP Neighbor:       ID 0000.0000.0004.00, IP 10.0.0.34 (Up)
  Flooding Status for each configured area [1]:
    IGP Area[1]: isis level-2: flooded

```

Step 4 show mpls traffic-eng topology

Use this command to show the SRLG link membership flooded via the Interior Gateway Protocol (IGP). For example:

Example:

```

Router# show mpls traffic-eng topology

My_System_id:0000.0000.0003.00 (isis level-2)
Signalling error holddown:10 sec Global Link Generation 9
IGP Id:0000.0000.0003.00, MPLS TE Id:10.0.3.1 Router Node (isis
level-2)
  link[0]:Point-to-Point, Nbr IGP Id:0000.0000.0004.00,
nbr_node_id:2, gen:9
  frag_id 0, Intf Address:10.0.0.33, Nbr Intf Address:10.0.0.34
  TE metric:10, IGP metric:10, attribute_flags:0x0
  SRLGs:1 2
  physical_bw:2488000 (kbps), max_reservable_bw_global:20000
(kbps)
  max_reservable_bw_sub:5000 (kbps)

```

	Total Allocated BW (kbps)	Global Pool Reservable BW (kbps)	Sub Pool Reservable BW (kbps)
bw[0]:	0	20000	5000
bw[1]:	0	20000	5000
bw[2]:	0	20000	5000
bw[3]:	0	20000	5000
bw[4]:	0	20000	5000
bw[5]:	0	20000	5000

Step 5 show mpls traffic-eng topology srlg

Use this command to display all the links in the network that are members of a given SRLG. For example:

Example:

```

Router# show mpls traffic-eng topology srlg
MPLS TE Id:0000.0000.0003.00 (isis level-2)
  SRLG:1
    10.0.0.33
  SRLG:2
    10.0.0.33

```

The following command shows that there are two links in SRLG 1:

Example:

```
Router# show mpls traffic-eng topology srlg
MPLS TE Id:0000.0000.0003.00 (isis level-2)
  SRLG:1
    10.0.0.33
    10.0.0.49
```

Step 6 show mpls traffic-eng topology brief

Use this command to display brief topology information:

Example:

```
Router# show mpls traffic-eng topology brief
My_System_id:0000.0000.0003.00 (isis level-2)
Signalling error holddown:10 sec Global Link Generation 9
IGP Id:0000.0000.0003.00, MPLS TE Id:10.0.3.1 Router Node (isis
level-2)
  link[0]:Point-to-Point, Nbr IGP Id:0000.0000.0004.00,
nbr_node_id:2, gen:9
    frag_id 0, Intf Address:10.0.0.33, Nbr Intf Address:10.0.0.34
    TE metric:10, IGP metric:10, attribute_flags:0x0
    SRLGs:1 2
```

Step 7 show mpls traffic-eng link-management advertisements

Use this command to show local link information that MPLS TE link management is currently flooding into the global TE topology. For example:

Example:

```
Router# show mpls traffic-eng link-management advertisements

Flooding Status:      ready
Configured Areas:    1
IGP Area[1] ID:: isis level-2
  System Information::
    Flooding Protocol:  ISIS
  Header Information::
    IGP System ID:      0000.0000.0003.00
    MPLS TE Router ID:  10.0.3.1
    Flooded Links:      2
  Link ID:: 0
    Link Subnet Type:   Point-to-Point
    Link IP Address:    10.0.0.49
    IGP Neighbor:       ID 0000.0000.0007.00, IP 10.0.0.50
    TE metric:          80000
    IGP metric:         80000
    SRLGs:              None
    Physical Bandwidth: 622000 kbits/sec
    Res. Global BW:     20000 kbits/sec
    Res. Sub BW:        5000 kbits/sec
    Downstream::
                                Global Pool  Sub Pool
                                -----
    Reservable Bandwidth[0]: 20000          5000 kbits/sec
    Reservable Bandwidth[1]: 20000          5000 kbits/sec
    Reservable Bandwidth[2]: 20000          5000 kbits/sec
    Reservable Bandwidth[3]: 20000          5000 kbits/sec
    Reservable Bandwidth[4]: 20000          5000 kbits/sec
    Reservable Bandwidth[5]: 20000          5000 kbits/sec
    Reservable Bandwidth[6]: 20000          5000 kbits/sec
```

```

    Reservable Bandwidth[7]: 20000          5000 kbits/sec
    Attribute Flags:          0x00000000
Link ID:: 1
Link Subnet Type:           Point-to-Point
Link IP Address:            10.0.0.33
IGP Neighbor:               ID 0000.0000.0004.00, IP 10.0.0.34
TE metric:                  10
IGP metric:                 10
SRLGs:                      1
Physical Bandwidth:         2488000 kbits/sec
Res. Global BW:             20000 kbits/sec
Res. Sub BW:                5000 kbits/sec
Downstream::

                                Global Pool  Sub Pool
                                -----
    Reservable Bandwidth[0]: 20000          5000 kbits/sec
    Reservable Bandwidth[1]: 20000          5000 kbits/sec
    Reservable Bandwidth[2]: 20000          5000 kbits/sec
    Reservable Bandwidth[3]: 20000          5000 kbits/sec
    Reservable Bandwidth[4]: 20000          5000 kbits/sec
    Reservable Bandwidth[5]: 20000          5000 kbits/sec
    Reservable Bandwidth[6]: 20000          5000 kbits/sec
    Reservable Bandwidth[7]: 20000          5000 kbits/sec
    Attribute Flags:          0x00000000

```

Step 8 show ip rsvp fast-reroute

Use this command to show that the primary tunnel is going over Pos1/3/1 on R3, on which SLRG 1 is configured. For example:

Example:

```

Router# show ip rsvp fast-reroute
Primary   Protect   BW      Backup
Tunnel    I/F        BPS:Type Tunnel:Label State  Level  Type
-----
R3-PRP_t0 PO1/3/1 0:G    None      None      None   None   None

```

Step 9 mpls traffic-eng auto-tunnel backup srlg exclude force

Use the following commands to configure autotunnel backup with the **force** keyword. For example:

Example:

```

Router# configure terminal
Router(config)# mpls traffic-eng auto-tunnel backup
Router(config)# mpls traffic-eng auto-tunnel backup srlg exclude force
Router(config)# exit

```

Step 10 show ip explicit-paths

Use the following command to verify that the **force** keyword is configured with the pos1/3/1 link excluded from the IP explicit path. For example:

Example:

```

Router# show ip explicit-paths

PATH __dynamic_tunnel65436 (loose source route, path complete,
generation 24, status non-configured)
  1:exclude-address 10.0.0.33
  2:exclude-srlg   10.0.0.33

```

Step 11 **show mpls traffic-eng tunnels tunnel num**

Use the following command to show that autotunnel backup is configured but is down because the headend router does not have any other path to signal and it cannot use pos1/2/1 because it belongs in the same SRLG; that is, SRLG 1. For example:

Example:

```
Router# show mpls traffic-eng tunnels tunnel 65436
Name:R3-PRP_t65436                (Tunnel65436) Destination:
10.0.4.1
  Status:
    Admin:up          Oper:down   Path:not valid   Signalling:Down
    path option 1, type explicit __dynamic_tunnel65436
  Config Parameters:
    Bandwidth:0       kbps (Global) Priority:7 7 Affinity:
0x0/0xFFFF
    Metric Type:TE (default)
    AutoRoute: disabled LockDown:disabled Loadshare:0
  bw-based
    auto-bw:disabled
  Shortest Unconstrained Path Info:
    Path Weight:10 (TE)
    Explicit Route:10.0.0.34 10.0.4.1
  History:
    Tunnel:
      Time since created:5 minutes, 29 seconds
    Path Option 1:
      Last Error:PCALC::No path to destination, 0000.0000.0004.00
```

Step 12 **mpls traffic-eng auto-tunnel backup srlg exclude preferred**

The following commands configure autotunnel backup with the **preferred** keyword. For example:

Example:

```
Router# configure terminal
Router(config)# mpls traffic-eng auto-tunnel backup
Router(config)# mpls traffic-eng auto-tunnel backup srlg exclude preferred
Router(config)# exit
```

Step 13 **show ip explicit-paths**

The following command shows two explicit paths. The first path avoids the SRLGs of the protected interface. The second path does not avoid the SRLGs. For example:

Example:

```
Router# show ip explicit-paths

PATH __dynamic_tunnel65436 (loose source route, path complete,
generation 30, status non-configured)
  1:exclude-address 10.0.0.33
  2:exclude-srlg    10.0.0.33
PATH __dynamic_tunnel65436_pathopt2 (loose source route, path complete,
generation 33, status non-configured)
  1:exclude-address 10.0.0.33
```

Step 14 **show ip rsvp fast-reroute**

The following command shows that the primary tunnel is protected with autotunnel backup using the second path option (see Step 10) that does not avoid the SRLGs. For example:

Example:

```
Router# show ip rsvp fast-reroute
Primary   Protect   BW       Backup
Tunnel    I/F        BPS:Type Tunnel:Label  State   Level   Type
-----
R3-PRP_t0 PO1/3/1 0:G  0:G      Tu65436:0    Ready  any-unl nhop
```

The following command shows the path options for the tunnel Tu65436:

Example:

```
Router# show mpls traffic-eng tunnels tunnel 65436
Name:R3-PRP_t65436 (Tunnel65436) Destination:
10.0.4.1
  Status:
    Admin:up      Oper:up      Path:valid      Signalling:connected
    path option 2, type explicit __dynamic_tunnel65436_pathopt2 (Basis
for Setup, path weight 80020)
    path option 1, type explicit __dynamic_tunnel65436
  Config Parameters:
    Bandwidth:0      kbps (Global) Priority:7 7 Affinity:
0x0/0xFFFF
    Metric Type:TE (default)
    AutoRoute: disabled LockDown:disabled Loadshare:0
  bw-based
    auto-bw:disabled
  Active Path Option Parameters:
    State:explicit path option 2 is active
    BandwidthOverride:disabled LockDown:disabled Verbatim:disabled
InLabel : -
OutLabel :POS1/2/1, 23
RSVP Signalling Info:
  Src 10.0.3.1, Dst 10.0.4.1, Tun_Id 65436, Tun_Instance 3
RSVP Path Info:
  My Address:10.0.3.1
  Explicit Route:10.0.0.50 10.0.0.66 10.0.0.113 10.0.4.1
  Record Route: NONE
  Tspec:ave rate=0 kbits, burst=1000 bytes, peak rate=0 kbits
RSVP Resv Info:
  Record Route: NONE
  Fspec:ave rate=0 kbits, burst=1000 bytes, peak rate=0 kbits
Shortest Unconstrained Path Info:
  Path Weight:10 (TE)
  Explicit Route:10.0.0.34 10.0.4.1
```

Step 15 **exit**

Use this command to exit to user EXEC mode. For example:

Example:

```
Router# exit
Router>
```

Configuration Examples for MPLS Traffic Engineering Shared Risk Link Groups

Configuring the SRLG Membership of Each Link That Has a Shared Risk with Another Link Example

The following example shows how to specify that the SRLG membership of each link has a shared risk with another link.

As shown in the figure below and in the following commands:

- link R2-R3 = SRLG5
- link R2-R3 = SRLG6
- link R7-R4 = SRLG5
- link R1-R2 = SRLG6

```
Router1# configure terminal
Router1# interface pos 1/0
Router1(config-if)# mpls traffic-eng srlg 6

Router2# configure terminal
Router2# interface pos 1/1
Router2(config-if)# mpls traffic-eng srlg 5
Router2(config-if)# mpls traffic-eng srlg 6

Router7# configure terminal
Router7# interface pos 3/0
Router7(config-if)# mpls traffic-eng srlg 5
```

Figure 31: SRLG Membership

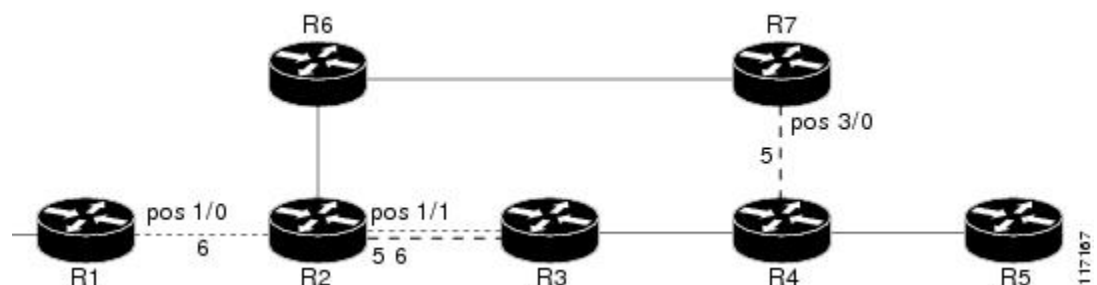

Configuring the Routers That Automatically Create Backup Tunnels to Avoid SRLGs Example

The following example shows how to specify that automatically created backup tunnels are forced to avoid SRLGs of their protected interfaces:

```

Router# configure terminal
Router(config)# mpls traffic-eng auto-tunnel backup
Router(config)# mpls traffic-eng auto-tunnel backup srlg exclude force

```

The figure below illustrates the automatically created NNHOP backup tunnel that would be created to avoid SRLGs of the protected interface if the following conditions exist:

The exclude address is 192.168.1.1.

The link at R2 has an IP address of 10.1.1.1.

The backup tunnel's explicit path avoids links that have a membership in the same SRLG as the link whose IP address is 10.1.1.1.

Figure 32: srlg exclude force--NNHOP Autobackup Tunnel

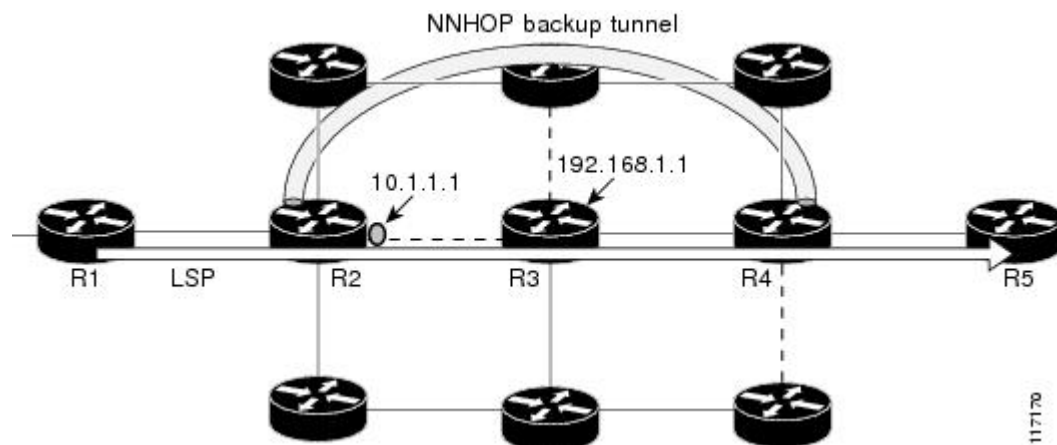

The figure below illustrates the automatically created NHOP backup tunnel that would be created.

Figure 33: srlg exclude force--NHOP Autobackup Tunnel

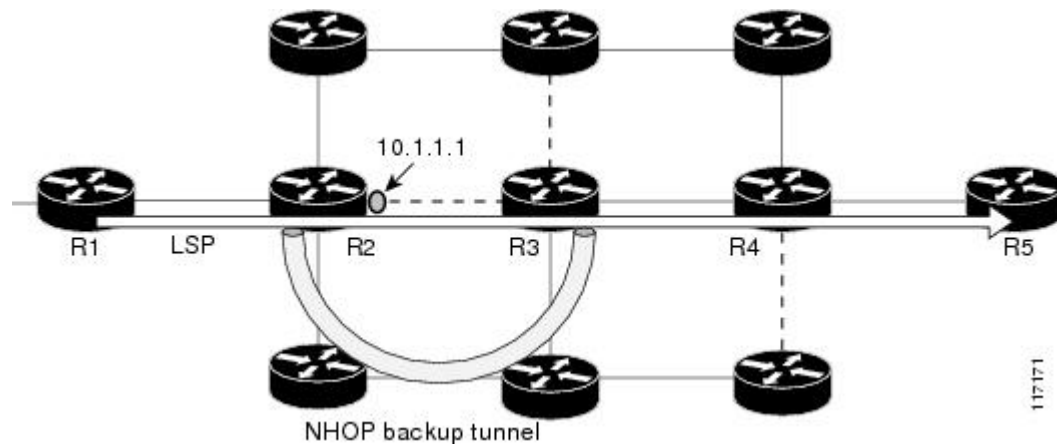

Additional References

Related Documents

Related Topic	Document Title
Fast Reroute	MPLS TE: Link and Node Protection, with RSVP Hellos Support (with Fast Tunnel Interface Down Detection)
IS-IS	Integrated IS-IS Routing Protocol Overview
OSPF	Configuring OSPF
Autotunnel backups	MPLS Traffic Engineering AutoTunnel Primary and Backup

Standards

Standard	Title
None	--

MIBs

MIB	MIBs Link
None	To locate and download MIBs for selected platforms, Cisco IOS releases, and feature sets, use Cisco MIB Locator found at the following URL: http://www.cisco.com/go/mibs

RFCs

RFC	Title
draft-ietf-isis-gmpls-extensions-16.txt	<i>IS-IS Extensions in Support of Generalized MPLS</i>

Technical Assistance

Description	Link
<p>The Cisco Support website provides extensive online resources, including documentation and tools for troubleshooting and resolving technical issues with Cisco products and technologies.</p> <p>To receive security and technical information about your products, you can subscribe to various services, such as the Product Alert Tool (accessed from Field Notices), the Cisco Technical Services Newsletter, and Really Simple Syndication (RSS) Feeds.</p> <p>Access to most tools on the Cisco Support website requires a Cisco.com user ID and password.</p>	<p>http://www.cisco.com/techsupport</p>

Feature Information for MPLS Traffic Engineering Shared Risk Link Groups

The following table provides release information about the feature or features described in this module. This table lists only the software release that introduced support for a given feature in a given software release train. Unless noted otherwise, subsequent releases of that software release train also support that feature.

Use Cisco Feature Navigator to find information about platform support and Cisco software image support. To access Cisco Feature Navigator, go to www.cisco.com/go/cfn. An account on Cisco.com is not required.

Table 11: Feature Information for MPLS Traffic Engineering Shared Risk Link Groups

Feature Name	Releases	Feature Information
MPLS Traffic Engineering: Shared Risk Link Groups	12.0(28)S 12.0(29)S 12.2(33)SRA 12.2(33)SXH 12.4(20)T Cisco IOS XE Release 3.5S	<p>The MPLS Traffic Engineering: Shared Risk Link Groups feature enhances backup tunnel path selection so that a backup tunnel avoids using links that are in the same Shared Risk Link Group (SRLG) as interfaces the backup tunnel is protecting.</p> <p>SRLGs refer to situations where links in a network share a common fiber (or a common physical attribute). If one link fails, other links in the group may fail too. Links in the group have a shared risk.</p> <p>This document contains information about and instructions for configuring the MPLS Traffic Engineering Shared Risk Link Groups feature</p> <p>In 12.0(28)S, this feature was introduced.</p> <p>In 12.0(29)S, support was added for Open Shortest Path First (OSPF).</p> <p>In 12.2(33)SRA, this feature was integrated into a Cisco IOS 12.2SRA release</p> <p>In 12.2(33)SXH, this feature was integrated into a Cisco IOS 12.2SXH release.</p> <p>In 12.4(20)T, this feature was integrated into a Cisco IOS 12.4T release.</p> <p>In Cisco IOS XE Release 3.5S, this feature was integrated into Cisco IOS XE Release 3.5S.</p> <p>The following commands were introduced or modified: mpls traffic-eng auto-tunnel backup srlg exclude, mpls traffic-eng srlg, show ip explicit-paths, show mpls traffic-eng link-management advertisements, show mpls traffic-eng link-management interfaces, and show mpls traffic-eng topology.</p>

Glossary

Fast Reroute --A mechanism for protecting MPLS traffic engineering (TE) LSPs from link and node failure by locally repairing the LSPs at the point of failure. This protection allows data to continue to flow on them while their headend routers attempt to establish end-to-end LSPs to replace them. FRR locally repairs the protected LSPs by rerouting them over backup tunnels that bypass failed links or nodes.

hop --Passage of a data packet between two network nodes (for example, between two routers).

IGP --Interior Gateway Protocol. An Internet protocol used to exchange routing information within an autonomous system.

interface --A network connection.

IP address --A 32-bit address assigned to hosts using TCP/IP. An IP address belongs to one of five classes (A, B, C, D, or E) and is written as four octets separated by periods (dotted decimal format). Each address consists of a network number, an optional subnetwork number, and a host number. The network and subnetwork numbers together are used for routing, and the host number is used to address an individual host within the

network or subnetwork. A subnet mask is used to extract network and subnetwork information from the IP address.

IP explicit path --A list of IP addresses, each representing a node or link in the explicit path.

IS-IS --Intermediate System-to-Intermediate System. OSI link-state hierarchical routing protocol based on DECnet Phase V routing, where intermediate system (IS) routers exchange routing information based on a single metric to determine the network topology.

LDP --Label Distribution Protocol. A standard protocol between MPLS-enabled routers to negotiate the labels (addresses) used to forward packets.

link --A point-to-point connection between adjacent nodes.

LSP --label-switched path. A path that is followed by a labeled packet over several hops, starting at an ingress LSR and ending at an egress LSR.

LSR --label switching router. A Layer 3 router that forwards a packet based on the value of a label encapsulated in the packet.

MPLS --Multiprotocol Label Switching. A method for forwarding packets (frames) through a network. It enables routers at the edge of a network to apply labels to packets. ATM switches or existing routers in the network core can switch packets according to the labels with minimal lookup overhead.

node --An endpoint of a network connection or a junction common to two or more lines in a network. Nodes can be interconnected by links, and serve as control points in the network.

OSPF --Open Shortest Path First. A link-state hierarchical Interior Gateway Protocol (IGP) routing algorithm, derived from the IS-IS protocol. OSPF features include least-cost routing, multipath routing, and load balancing.

router --A network layer device that uses one or more metrics to determine the optimal path along which network traffic should be forwarded. Routers forward packets from one network to another based on network layer information.

router ID --Something by which a router originating a packet can be uniquely distinguished from all other routers; for example, an IP address from one of the router's interfaces.

traffic engineering --The techniques and processes used to cause routed traffic to travel through the network on a path other than the one that would have been chosen if standard routing methods had been used.

tunnel --A secure communication path between two peers, such as two routers. A traffic engineering tunnel is a label-switched tunnel that is used for traffic engineering. Such a tunnel is set up through means other than normal Layer 3 routing; it is used to direct traffic over a path different from the one that Layer 3 routing could cause the tunnel to take.



CHAPTER 9

MPLS Traffic Engineering Inter-AS TE

The MPLS Traffic Engineering: Inter-AS TE feature provides Autonomous System Boundary Router (ASBR) node protection, loose path reoptimization, stateful switchover (SSO) recovery of label-switched paths (LSPs) that include loose hops, ASBR forced link flooding, Cisco IOS Resource Reservation Protocol (RSVP) local policy extensions for interautonomous system (Inter-AS), and per-neighbor keys:

- ASBR node protection--Protects interarea and Inter-AS TE label-switched paths (LSPs) from the failure of an Area Border Router (ABR) or ASBR.
 - Loose path reoptimization--Allows a Multiprotocol Label Switching (MPLS) traffic engineering (TE) tunnel's LSPs to traverse hops that are not in the tunnel headend router's topology database (that is, they are not in the same Open Shortest Path First (OSPF) area, Intermediate System-to-Intermediate System (IS-IS) level, or autonomous system as the tunnel's headend router).
 - Loose hop recovery--Supports SSO recovery of LSPs that include loose hops.
 - ASBR forced link flooding--Helps an LSP cross a boundary into another domain when information in the other domain is not available to the headend router.
 - Cisco IOS RSVP local policy extensions for Inter-AS--Allows network administrators to create controlled policies for TE tunnels that function across multiple autonomous systems.
 - Per-neighbor keys--Allows cryptographic authentication to be accomplished on a per-neighbor basis.
- [Finding Feature Information, on page 191](#)
 - [Prerequisites for MPLS Traffic Engineering Inter-AS TE, on page 192](#)
 - [Restrictions for MPLS Traffic Engineering Inter-AS TE, on page 192](#)
 - [Information About MPLS Traffic Engineering Inter-AS TE, on page 193](#)
 - [How to Configure MPLS Traffic Engineering Inter-AS TE, on page 202](#)
 - [Configuration Examples for MPLS Traffic Engineering Inter-AS TE, on page 211](#)
 - [Additional References, on page 214](#)
 - [Feature Information for MPLS Traffic Engineering Inter-AS TE, on page 215](#)
 - [Glossary, on page 216](#)

Finding Feature Information

Your software release may not support all the features documented in this module. For the latest caveats and feature information, see [Bug Search Tool](#) and the release notes for your platform and software release. To

find information about the features documented in this module, and to see a list of the releases in which each feature is supported, see the feature information table.

Use Cisco Feature Navigator to find information about platform support and Cisco software image support. To access Cisco Feature Navigator, go to www.cisco.com/go/cfn. An account on Cisco.com is not required.

Prerequisites for MPLS Traffic Engineering Inter-AS TE

- Enable MPLS.
- Configure TE on routers.
- Ensure that your network supports the following Cisco features:
 - MPLS
 - Cisco Express Forwarding
 - IS-IS or OSPF
- For loose path reoptimization, know how to configure the following:
 - IP explicit paths for MPLS TE tunnels
 - Loose hops
 - Interarea and Inter-AS tunnels

Restrictions for MPLS Traffic Engineering Inter-AS TE

Loose Path Reoptimization

- Midpoint reoptimization is not supported.

ASBR Forced Link Flooding

- The TE metric and affinity attributes that are known at a headend router (and used as constraints when an LSP's path is computed) are not currently signaled. Consequently, explicit router (ERO) expansions do not consider these constraints.
- Each node in an autonomous system must have a unique router ID.
- The router ID configured on a link must not conflict with the router ID within the autonomous system.
- If a link is configured for forced link flooding, the link's neighbors are not learned by regular Interior Gateway Protocol (IGP) updates. If a link is already learned about neighbors by IGP on a link, you cannot configure the link as passive. Therefore, to configure a link for forced flooding, be sure that the node does not already have a neighbor on that link.

Information About MPLS Traffic Engineering Inter-AS TE

MPLS Traffic Engineering Tunnels

MPLS TE lets you build LSPs across your network that you then forward traffic down.

MPLS TE LSPs, also called TE tunnels, let the headend of a TE tunnel control the path its traffic takes to a particular destination. This method is more flexible than forwarding traffic based only on a destination address.

Interarea tunnels allow you to do the following:

- Build TE tunnels between areas (interarea tunnels)
- Build TE tunnels that start and end in the same area, on multiple areas on a router (intra-area tunnels)

Some tunnels are more important than others. For example, you may have tunnels carrying Voice over IP (VoIP) traffic and tunnels carrying data traffic that are competing for the same resources. Or you may simply have some data tunnels that are more important than others. MPLS TE allows you to have some tunnels preempt others. Each tunnel has a priority, and more-important tunnels take precedence over less-important tunnels.

Multiarea Network Design

You can establish MPLS TE tunnels that span multiple IGP areas and levels. The tunnel headend routers and tailend routers do not have to be in the same area. The IGP can be either IS-IS or OSPF.

To configure an interarea tunnel, use the **next-address loose** command to specify on the headend router a loosely routed explicit path of the LSP that identifies each ABR the LSP should traverse. The headend router and the ABRs along the specified explicit path expand the loose hops, each computing the path segment to the next ABR or tunnel destination.

Fast Reroute

MPLS Fast Reroute (FRR) is a fast recovery local protection technique that protects TE LSPs from link, shared risk link group (SRLG), and node failure. One or more TE LSPs (called backup LSPs) are preestablished to protect against the failure of a link, node, or SRLG. If there is a failure, each protected TE LSP traversing the failed resource is rerouted onto the appropriate backup tunnels.

The backup tunnel must meet the following requirements:

- It should not pass through the element it protects.
- It should intersect with a primary tunnel at a minimum of two nodes: point of local repair (PLR) and merge point (MP). The PLR should be the headend LSR of the backup tunnel, and the MP should be the tailend LSR of the backup tunnel. The PLR is where FRR is triggered when a link, node, or SRLG failure occurs.
- FRR protection can be performed for an Inter-AS tunnel only if the backup tunnel's merge point can route packets to the PLR's backup tunnel's egress interface. You can configure a static route or you can configure Border Gateway Protocol (BGP) to export the backup tunnel's egress interface to other autonomous systems.

- If the preferred link is a passive link, you must assign an administrative-weight for it. To assign an administrative weight, use the **mpls traffic-eng administrative-weight** command in interface configuration mode.
- Each router must be configured with the **mpls traffic-eng reoptimize events link-up** command in global configuration mode.

ASBR Node Protection

A TE LSP that traverses an ASBR needs a special protection mechanism (ASBR node protection) because the MP and PLR will be in different autonomous systems that have different IGPs.

A PLR ensures that the backup tunnel intersects with the primary tunnel at the MP by examining the Record Route Object (RRO) of the primary tunnel to see if any addresses specified in the RRO match the destination of the backup tunnel.

Addresses specified in RRO IPv4 and IPv6 subobjects can be node-IDs and interface addresses. The traffic engineering RFC 3209 specifies that you can use a router address or interface address, but recommends using the interface address of outgoing path messages. Therefore, in the figure below router R2 is more likely to specify interface addresses in the RRO objects carried in the resv messages of the primary tunnel (T1) and the backup tunnel.

Node IDs allow the PLR to select a suitable backup tunnel by comparing node IDs in the resv RRO to the backup tunnel's destination.

RSVP messages that must be routed and forwarded to the appropriate peer (for example, an resv message) require a route from the MP back to the PLR for the RSVP messages to be delivered. The MP needs a route to the PLR backup tunnel's outgoing interface for the resv message to be delivered. Therefore, you must configure a static route from the MP to the PLR. For the configuration procedure, see the [Configuring a Static Route from the MP to the PLR, on page 204](#).

The figure below illustrates ASBR node protection. Router R4 is node-protected with a backup tunnel from R2-R3-R5-R6.

Figure 34: ASBR Node Protection

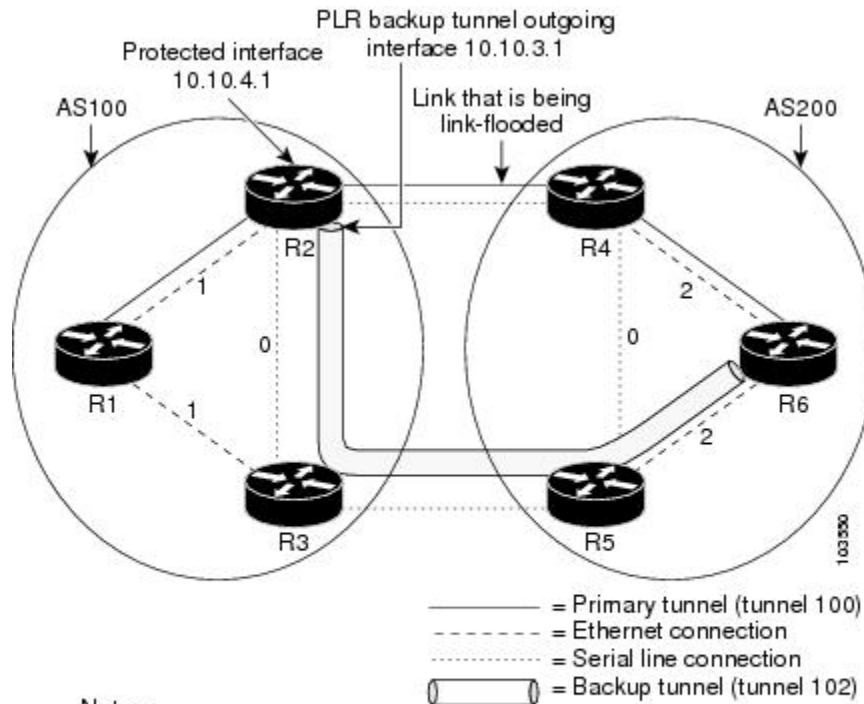
**Notes:**

- There are two autonomous systems.
- The numbers within the Ethernet serial connection indicate the OSPF area number.
- There is no IGP between R2 and R4, and R3 and R5.

In this configuration, IP addresses are as follows:

- R1--Loopback0 10.10.0.1
 - Ethernet 0--IP address of 10.10.1.1 is connected to R2 Ethernet 0
 - Ethernet 1--IP address of 10.10.2.1 is connected to R3 Ethernet 1
- R2--Loopback0 10.10.0.2
 - Ethernet 0--IP address of 10.10.1.2 is connected to R1 Ethernet 0
 - Ethernet 1--IP address of 10.10.3.1 is connected to R3 Ethernet 1
 - Serial 2--IP address of 10.10.4.1 is connected to R4 serial 2
- R3--Loopback0 10.10.0.3
 - Ethernet 0--IP address of 10.10.2.2 is connected to R1 Ethernet 1
 - Ethernet 1--IP address of 10.10.3.2 is connected to R2 Ethernet 1
 - Serial 2--IP address of 10.10.5.1 is connected to R5 serial 2
- R4--Loopback0 10.10.0.4
 - Ethernet 0--IP address of 10.10.7.1 is connected to R6 Ethernet 0
 - Ethernet 1--IP address of 10.10.6.1 is connected to R5 Ethernet 1
 - Serial 2--IP address of 10.10.4.2 is connected to R2 serial 2

- R5--Loopback0 10.10.0.5
 - Ethernet 0--IP address of 10.10.8.1 is connected to R6 Ethernet 0
 - Ethernet 1--IP address of 10.10.6.2 is connected to R4 Ethernet 1
 - Serial 2--IP address of 10.10.5.2 is connected to R3 serial 2
- R6--Loopback0 10.10.0.6
 - Ethernet 0--IP address of 10.10.7.2 is connected to R4 Ethernet 0
 - Ethernet 1--IP address of 10.10.8.2 is connected to R5 Ethernet 1

In the figure above, the following situations exist:

- Routers R1, R2, and R3 are in AS 100. The R1-R2 and R1-R3 links are in OSPF area 1.
- Routers R4, R5, and R6 are in AS200. The R4-R6 and R5-R6 links are in OSPF area 2.
- The link R2-R3 is in AS100, and link R4-R5 is in AS200. The links R2-R3 and R4-R5 are in OSPF area 0.
- The links R2-R4 and R3-R5 are not running an IGP because they cross the Inter-AS boundary between AS100 and AS200. Because they are not running IGP, you must configure an administrative weight for each passive interface for FRR to work. Use the **mpls traffic-eng administrative-weight** command in interface configuration mode.
- There is a primary tunnel, tunnel 100, from R1-R2-R4-R6.
- There is a backup tunnel, tunnel 102, from R2-R3-R5-R6.
- There is a TE tunnel, tunnel 101, from R6-R5-R3-R1 for returning data traffic for tunnel 100.
- There is a TE tunnel, tunnel 103, from R6-R5-R3-R2 for returning data traffic for tunnel 102.
- The explicit paths of all the tunnels use loose hops.
- The R2-R4 link is configured to be link flooded in both R2's and R4's IGP. The R3-R5 link is configured to be link flooded in both R3's and R5's IGP.

Router R2 needs to ensure the following:

- Backup tunnel intersects with the primary tunnel at the MP, and therefore has a valid MP address. In the figure above, R2 needs to determine that tunnel 100 and backup tunnel 102 share MP node R6.
- Backup tunnel satisfies the request of the primary LSP for bandwidth protection. For example, the amount of bandwidth guaranteed for the primary tunnel during a failure, and the type of protection (preferably protecting against a node failure rather than a link failure).

Node-IDs Signaling in RROs

ASBR node protection includes a node-ID flag (0x20), which is also called a node-ID subobject. When it is set, the flag indicates that the address specified in the RRO object in the resv message is the node-ID address. The node-ID address refers to the traffic engineering router ID.

A node must always use the same address in the RRO (that is, it must use IPv4 or IPv6, but not both).

To display all the hops, enter the following command on the headend router. Sample command output is as follows:

```

Router(config)# show ip rsvp reservations detail
Reservation:
  Tun Dest: 10.10.0.6  Tun ID: 100  Ext Tun ID: 10.10.0.1
  Tun Sender: 10.10.0.1  LSP ID: 31
  Next Hop: 10.10.1.2 on Ethernet0/0
  Label: 17 (outgoing)
  Reservation Style is Shared-Explicit, QoS Service is Controlled-Load
  Average Bitrate is 10K bits/sec, Maximum Burst is 1K bytes
  Min Policed Unit: 0 bytes, Max Pkt Size: 0 bytes
RRO:
  10.10.0.2/32, Flags:0x29 (Local Prot Avail/to NNHOP, Is Node-id)
  10.10.4.1/32, Flags:0x9 (Local Prot Avail/to NNHOP)
  Label subobject: Flags 0x1, C-Type 1, Label 17
  10.10.0.4/32, Flags:0x20 (No Local Protection, Is Node-id)
  10.10.7.1/32, Flags:0x0 (No Local Protection)
  Label subobject: Flags 0x1, C-Type 1, Label 17
  10.10.0.6/32, Flags:0x20 (No Local Protection, Is Node-id)
  10.10.7.2/32, Flags:0x0 (No Local Protection)
  Label subobject: Flags 0x1, C-Type 1, Label 0
Resv ID handle: 0100040E.
Status:
Policy: Accepted. Policy source(s): MPLS/TE

```

For a description of the fields, see the Cisco IOS Quality of Service Solutions Command Reference.

Addition of the Node-ID Subobject

When a fast reroutable LSP is signaled, the following actions occur:

- An LSR adds a node-ID subobject and an incoming label subobject in the resv message.
- If there is an RRO object in the path message, an LSR adds a node-ID subobject, an RRO IPv4 subobject that records the interface address, and an incoming label subobject in the resv message.

If you enable record-route on the headend LSR, the interface addresses for the LSP are included in the RRO object of the resv message.

To enable record-route, enter the following command with the **record-route** keyword:

```
tunnel mpls traffic-eng record-route
```

Processing of an RRO with Node-ID Subobjects

The node-ID subobject is added to the RECORD_ROUTE object before the label route subobject. If RECORD_ROUTE is turned on, the RRO object consists of the following in this order: node-ID, interface address, and label.

Merge Point Location

The destination of the backup tunnel is the node-ID of the MP. A PLR can find the MP and appropriate backup tunnel by comparing the destination address of the backup tunnel with the node-ID subobjects included in the resv RRO for the primary tunnel.

When both the IPv4 node-ID and IPv6 node-ID subobjects are present, a PLR can use either or both of them to find the MP address.

Determination of Backward Compatibility

To remain compatible with nodes that do not support RRO IPv4 or IPv6 node-ID subobjects, a node can ignore those objects. Those nodes cannot be the MP in a network with interarea or Inter-AS traffic engineering.

Loose Path Reoptimization

Interarea and Inter-AS LSPs

If the LSP of an MPLS TE tunnel traverses hops that are not in the headend router's topology database (that is, the hops are in a different OSPF area or IS-IS level), the LSP is called an *interarea TE LSP*.

If the LSP of the tunnel traverses hops that are in a different autonomous system (AS) from the tunnel's headend router, the LSP is called an *Inter-AS TE LSP*.

Interarea LSPs and Inter-AS TE LSPs can be signaled using loose hop subobjects in their EROs. The headend does not have "strict" knowledge of hops beyond its area, so the LSP's path is "loosely" specified at the headend. Downstream routers processing these loose hop subobjects (which do have the knowledge) are relied upon to expand them into strict hops.

Loose Hop Configuration

Beyond the headend area, configure hops as loose hops. Typically you specify only the ABRs and the tailend router of a tunnel, but any other combination is allowed.

Loose Hop Expansion

Loose hop expansion is the conversion of a single ERO loose hop subobject into one or more strict hop subobjects.

Interarea and Inter-AS TE LSPs can be signaled using loose hop subobjects in their EROs. When a router receives a path message containing an ERO that has a loose hop as the next address, the router typically expands the ERO by converting the single loose hop subobject into one or more strict hop subobjects. The router typically has the knowledge, in its topology database, of the best way to reach the loose hop and computes this path by using constraint-based shortest path first (CSPF). So the router substitutes this more specific information for the loose hop subobject found in the ERO. This process is called loose hop expansion or ERO expansion.

Loose hop expansions can occur at one or more hops along an LSP's path. This process is referred to as loose path reoptimization.

Tunnel Reoptimization Procedure

Tunnel reoptimization is the signaling of an LSP that is more optimal than the LSP a TE tunnel is currently using (for example, it may be shorter or may have a lower cost), and the switching over of the tunnel's data to use this new LSP.

The new more optimal TE LSP is always established and the data moved onto it before the original LSP is torn down (so it is called the "make before break" procedure). This ensures that no data packets are lost during the transition to the new LSP.

For tunnel reoptimization to function:

- Each router must be configured with the **mpls traffic-eng reoptimize events link-up** command.

- Each passive link must have an assigned administrative weight. To configure an administrative weight, use the **mpls traffic-eng administrative-weight** command in interface configuration mode.

The TE LSPs reoptimization process is triggered under the following circumstances:

- Periodically (based on a timer)
- User entered a command (**mpls traffic-eng reoptimize**) requesting reoptimization
- Network event, such as a link-up

Regardless of how reoptimization is triggered, the headend router reoptimizes a tunnel only if it can find a better path than the one the tunnel currently uses. If there is not a better path in the local topology database, no new LSP is signaled and reoptimization does not occur.

Prior to the addition of loose path reoptimization, interarea TE LSPs were not reoptimized if a better path became available in any area beyond the headend area. This is because the headend router was not capable of finding a better path when the better path existed in an area beyond its view (that is, it was not in its local topology database).

With the addition of loose path reoptimization, a tunnel's headend can reoptimize LSPs even if they span multiple areas, levels, or autonomous systems. This is done via the implementation of a query and response protocol defined in *draft-vasseur-mpls-loose-path-reopt-02.txt*. This draft defines a protocol whereby a tunnel's headend may query downstream routers to perform ERO expansion for this tunnel's LSP. These downstream routers respond in the affirmative if they can find a more optimal path than the one in use. (This is done via a new ERO expansion.) Having received an affirmative answer to its query, a headend signals a new LSP for the tunnel, and the new LSP benefits from a new ERO expansion along the better path.

Loose path reoptimization is on by default, and cannot be disabled. Whenever an LSP reoptimization is attempted but the headend fails to find a better path, if the LSP contains loose ERO subobjects, a query is sent downstream to determine whether downstream routers can find a better path. If an affirmative answer comes back, the LSP is reoptimized. That is, a new LSP is signaled (which will follow the better path), the tunnel's data packets are switched over to use this new LSP, and the original LSP is torn down.

For details on this query and response protocol, see *draft-vasseur-mpls-loose-path-reopt-02.txt*.

ASBR Forced Link Flooding

When you configure forced link flooding on an interface, the MPLS TE link management module advertises the link to all nodes. As a result of this advertisement, the TE topology database on all the nodes within the Inter-AS is updated with this information.

ASBR forced link flooding allows the links to be advertised even if IGP adjacencies are not running over these links. TE LSPs can traverse these links at the edge of a network between two nodes running BGP (or static routes) even if the exit ASBR is not listed in the IP explicit path. Therefore, a headend LSR can consider that link when it computes its TE LSP path.

Configuration of ASBR Forced Link Flooding

To activate ASBR forced link flooding, configure a link as passive and provide neighbor information (that is, the neighbor IGP ID and the neighbor TE ID). The required configuration tasks are described in the [Configuring a Static Route from the MP to the PLR, on page 204](#).

Link Flooding

A passive link is configured on an interface of an ASBR. The link is flooded in the ASBR's IGP. All the links are flooded as point-to-point links.

Flooding notifications are also sent when there is a change to a link's property.

OSPF Flooding

OSPF floods opaque link-state advertisement (LSA) Type 10 link information.

If a multiaccess link has more than one neighbor, a Type 10 LSA is advertised for each neighbor. In the topology database, neighbors are represented by point-to-point neighbor relationships.

Link TLV

A link TLV describes a single link and contains multiple sub-TLVs.

An opaque LSA contains a single link TLV.

For each ASBR-to-ASBR link, an ASBR must flood an opaque LSA containing one link TLV that has the link's attributes.

A link TLV comprises the following sub-TLVs:

- Link type (1 octet)--(Required) Defines the type of the link. The link type of a passive interface always is 1 (point-to-point), even for a multiaccess subnetwork.
- Link ID (4 octets)--(Required) Identifies the other end of the link for a point-to-point link. Includes the system ID of the neighbor, requires static configuration for a multiaccess ASBR-to-ASBR link, and includes the system ID of the neighbor.
- Local interface IP address (4 octets)--Specifies the IP addresses of the neighbor's interface corresponding to this link.
- Remote interface IP address (4 octets)--Specifies the IP addresses of the neighbor's interface corresponding to this link. The remote interface IP address is set to the router ID of the next hop. There must be a static configuration for the ASBR-to-ASBR link.
- Traffic engineering metric (4 octets)
- Maximum bandwidth (4 octets)
- Maximum reservable bandwidth (4 octets)
- Unreserved bandwidth (32 octets)
- Administrative group (4 octets)

IS-IS TLV

In IS-IS, when autonomous system A1 floods its LSP, it includes the system ID and a pseudonode number.

If three autonomous systems are connected to a multiaccess network LAN, each link is considered to be a point-to-point link. The links are marked with the maximum metric value so that the inter-ASBR links are considered by CSPF and not by shortest path first (SPF).

TE uses the protocol TLV type 22, which has the following data structure:

- System ID and pseudonode number node (7 octets)

- Default metric (3 octets)
- Length of sub-TLVs (1 octet)
- Sub-TLVs (0 to 244 octets), where each sub-TLV consists of a sequence of the following: 1 octet for subtype, 1 octet for the length of the value field of the sub-TLV, and 0 to 242 octets for the value

The table below defines the sub-TLVs.

Table 12: Sub-TLVs

Sub-TLV	Length (Octets)	Name
3	4	Administrative group (color).
6	4	IPv4 address for the interface described by the main TLV.
8	4	IPv4 address for a neighboring router on this link. This will be set to the router ID of the next hop.
9	4	Maximum link bandwidth.
10	4	Reservable link bandwidth.
11	32	Unreserved bandwidth.
18	3	TE default metric.
250 to 254	--	Reserved for Cisco-specific extensions.
255	--	Reserved for future expansion.



Note The TE router ID is TLV type 134.

Topology Database

When the topology database module receives a link-state advertisement (LSA), the module scans the LSA to find the neighbors of the links. The ASBR link is part of the same LSA and is installed in the TE topology database like any other link.

During the CSPF operation, the TE headend module uses the TE topology database to find a path to the destination. Because the Inter-AS links are part of the TE topology database, the CSPF operation uses these links to compute the LSP path.

Link Flooding

The IGP floods information about a link in the following situations:

- When a link goes down
- When a link's configuration is changed (for example, when the link cost is modified)
- When it is time to periodically reflowd the router's IGP information

- When link bandwidth changes significantly

Flooding is a little different in IS-IS and OSPF. In OSPF, only information about the link that has changed is flooded, because a Type 10 LSA contains a single link advertisement. In IS-IS, information about all links on a node is flooded even if only one has changed, because the Type 22 TLV contains a list of all links on the router.

How to Configure MPLS Traffic Engineering Inter-AS TE



Note There is no configuration procedure for loose path reoptimization.

Configuring Loose Hops

The section describes how to do the following so that there can be loose hops:

Configuring an Explicit Path on the Tunnel That Will Cross the Inter-AS Link

If you want a tunnel to span multiple networks, configure an explicit path on the tunnel that will cross the Inter-AS link by performing the following steps.

SUMMARY STEPS

1. **enable**
2. **configure terminal**
3. **ip explicit-path {name *path-name* | identifier *number*} [enable | disable]**
4. **next-address loose *A.B.C.D***
5. **interface tunnel *number***
6. **tunnel mpls traffic-eng fast-reroute**
7. **mpls traffic-eng reoptimize events link-up**

DETAILED STEPS

	Command or Action	Purpose
Step 1	enable Example: Router> enable	Enables privileged EXEC mode. <ul style="list-style-type: none"> • Enter your password if prompted.
Step 2	configure terminal Example: Router# configure terminal	Enters global configuration mode.

	Command or Action	Purpose
Step 3	ip explicit-path {name <i>path-name</i> identifier <i>number</i> } [enable disable] Example: <pre>Router(config)# ip explicit-path identifier 2 enable</pre>	Enters the subcommand mode for IP explicit paths and creates or modifies the explicit path. This command places the router in IP explicit path configuration mode.
Step 4	next-address loose <i>A.B.C.D</i> Example: <pre>Router(cfg-ip-expl-path)# next-address loose 10.10.0.2</pre>	Specifies the next loose IP address in the explicit path. Each area border router (ABR) the path must traverse should be specified in a next-address loose command. This command places the router in global configuration mode.
Step 5	interface tunnel <i>number</i> Example: <pre>Router(config)# interface tunnel 100</pre>	Configures a tunnel interface. This command places the router in interface configuration mode.
Step 6	tunnel mpls traffic-eng fast-reroute Example: <pre>Router(config-if)# tunnel mpls traffic-eng fast-reroute</pre>	Enables an MPLS traffic engineering tunnel to use an established backup tunnel in the event of a link failure.
Step 7	mpls traffic-eng reoptimize events link-up Example: <pre>Router(config)# mpls traffic-eng reoptimize events link-up</pre>	Enables automatic reoptimization of MPLS traffic engineering when an interface becomes operational.

Configuring a Route to Reach the Remote ASBR

SUMMARY STEPS

1. enable
2. configure terminal
3. ip route *prefix mask* {*ip-address* | *interface-type interface-number*}

DETAILED STEPS

	Command or Action	Purpose
Step 1	enable Example: <pre>Router> enable</pre>	Enables privileged EXEC mode. <ul style="list-style-type: none"> • Enter your password if prompted.

	Command or Action	Purpose
Step 2	configure terminal Example: <pre>Router# configure terminal</pre>	Enters global configuration mode.
Step 3	ip route <i>prefix mask {ip-address interface-type interface-number}</i> Example: <pre>Router(config)# ip route 10.10.0.1 255.255.255.255 tunnel 101</pre>	Establishes static routes.

Configuring a Static Route from the MP to the PLR

To enable Fast Reroute protection that spans across different autonomous systems, configure a static route from the MP to the PLR by performing the following steps.

SUMMARY STEPS

1. **enable**
2. **configure terminal**
3. **ip route *prefix mask ip-address outgoing-interface***

DETAILED STEPS

	Command or Action	Purpose
Step 1	enable Example: <pre>Router> enable</pre>	Enables privileged EXEC mode. <ul style="list-style-type: none"> • Enter your password if prompted.
Step 2	configure terminal Example: <pre>Router# configure terminal</pre>	Enters global configuration mode.
Step 3	ip route <i>prefix mask ip-address outgoing-interface</i> Example: <pre>Router(config)# ip route 10.10.3.1 255.255.255.255 10.0.0.0 FastEthernet0/0</pre>	Establishes static routes. Refer to the appropriate hardware manual for interface information. Note Enter this command on the MP. The destination is the PLR.

Configuring ASBR Forced Link Flooding

This section describes how to do the following so that you can configure ASBR forced link flooding:

Configuring the Inter-AS Link as a Passive Interface Between Two ASBRs

SUMMARY STEPS

1. **enable**
2. **configure terminal**
3. **interface** *type slot/port*
4. **ip address** *ip-address mask [secondary]*
5. **mpls traffic-eng passive-interface** *nbr-te-id te-router-id [nbr-if-addr if-addr] [nbr-igp-id {isis sysid | ospf sysid}]*
6. **mpls traffic-eng administrative-weight** *weight*

DETAILED STEPS

	Command or Action	Purpose
Step 1	enable Example: <pre>Router> enable</pre>	Enables privileged EXEC mode. <ul style="list-style-type: none"> • Enter your password if prompted.
Step 2	configure terminal Example: <pre>Router# configure terminal</pre>	Enters global configuration mode.
Step 3	interface <i>type slot/port</i> Example: <pre>Router(config)# interface serial 2/0</pre>	Specifies an interface and enters interface configuration mode. Refer to the appropriate hardware manual for interface information.
Step 4	ip address <i>ip-address mask [secondary]</i> Example: <pre>Router(config-if)# ip address 10.10.4.1 255.255.255.0</pre>	Sets a primary or secondary IP address for an interface.
Step 5	mpls traffic-eng passive-interface <i>nbr-te-id te-router-id [nbr-if-addr if-addr] [nbr-igp-id {isis sysid ospf sysid}]</i> Example: <pre>Router(config-if)# mpls traffic-eng passive-interface nbr-te-id 10.10.11.12 nbr-igp-id ospf 10.10.15.18</pre>	Configures a link as a passive interface between two ASBRs. Note For an RSVP Hello configuration on the Inter-AS link, all fields are required.
Step 6	mpls traffic-eng administrative-weight <i>weight</i> Example: <pre>Router(config-if)# mpls traffic-eng administrative-weight 20</pre>	Overrides the Interior Gateway Protocol (IGP) administrative weight (cost) of the link and assigns a specific weight for the link.

Creating LSPs Traversing the ASBRs

To create LSPs traversing the ASBRs, perform the following steps.



Note Perform Steps 3 through 7 for the primary LSP and then for the backup LSP.

SUMMARY STEPS

1. **enable**
2. **configure terminal**
3. **ip explicit path *name* enable**
4. **next-address loose *A.B.C.D***
5. **interface tunnel *number***
6. **tunnel mpls traffic-eng fast-reroute**
7. **tunnel mpls traffic-eng path-option *number* {dynamic | explicit | {name *path-name* | *path-number*}}**
[lockdown]

DETAILED STEPS

	Command or Action	Purpose
Step 1	enable Example: Router> enable	Enables privileged EXEC mode. <ul style="list-style-type: none"> • Enter your password if prompted.
Step 2	configure terminal Example: Router# configure terminal	Enters global configuration mode.
Step 3	ip explicit path <i>name</i> enable Example: Router(config)# ip explicit path routel enable	Specifies the name of the explicit path and enables the path.
Step 4	next-address loose <i>A.B.C.D</i> Example: Router(config)# next-address loose 10.10.10.2	Configures a loose hop.
Step 5	interface tunnel <i>number</i> Example: Router(config)# interface tunnel 100	Configures a tunnel interface and enters interface configuration mode.

	Command or Action	Purpose
Step 6	tunnel mpls traffic-eng fast-reroute Example: <pre>Router(config-if)# tunnel mpls traffic-eng fast-reroute</pre>	Enables an MPLS traffic engineering tunnel to use an established backup tunnel in the event of a link failure.
Step 7	tunnel mpls traffic-eng path-option <i>number</i> { dynamic explicit { name <i>path-name</i> <i>path-number</i> }} [lockdown] Example: <pre>Router(config-if)# tunnel mpls traffic-eng path-option 1 route1</pre>	Configures a path option for an MPLS traffic engineering tunnel.

Configuring Multiple Neighbors on a Link

SUMMARY STEPS

1. **enable**
2. **configure terminal**
3. **interface** *type slot/port*
4. **mpls traffic-eng passive-interface** [**nbr-te-id**] [*router-id* | *te-id*] [**nbr-igp-id**] [**isis** *sysid* | **ospf** *sysid*]
5. **mpls traffic-eng administrative-weight** *weight*

DETAILED STEPS

	Command or Action	Purpose
Step 1	enable Example: <pre>Router> enable</pre>	Enables privileged EXEC mode. <ul style="list-style-type: none"> • Enter your password if prompted.
Step 2	configure terminal Example: <pre>Router# configure terminal</pre>	Enters global configuration mode.
Step 3	interface <i>type slot/port</i> Example: <pre>Router(config)# interface serial 2/0</pre>	Specifies an interface and enters interface configuration mode. Refer to the appropriate hardware manual for interface information.
Step 4	mpls traffic-eng passive-interface [nbr-te-id] [<i>router-id</i> <i>te-id</i>] [nbr-igp-id] [isis <i>sysid</i> ospf <i>sysid</i>] Example: <pre>Router(config-if)# mpls traffic-eng</pre>	Configures a link as a passive link.

	Command or Action	Purpose
	<code>passive-interface nbr-te-id 10.10.0.4 nbr-igp-id ospf 10.10.0.4</code>	
Step 5	mpls traffic-eng administrative-weight <i>weight</i> Example: <pre>Router(config-if)# mpls traffic-eng administrative-weight 20</pre>	Overrides the Interior Gateway Protocol (IGP) administrative weight (cost) of the link and assigns a specific weight for the link.

Troubleshooting Tips

The following debug commands are useful for troubleshooting issues with MPLS Traffic Engineering: Inter-AS TE.

Debugging Headend of TE LSPs

```
debug mpls traffic-eng path lookup
debug mpls traffic-eng path verify
debug mpls traffic-eng path spf
```

Debugging Head and Midpoint (Link-Related Debugs)

```
debug mpls traffic-eng link-management igp-neighbors
debug mpls traffic-eng link-management advertisements
debug mpls traffic-eng link-management bandwidth-allocation
debug mpls traffic-eng link-management routing
```

Verifying the Inter-AS TE Configuration

To verify the Inter-AS TE configuration, perform the following steps.



Note

Perform Step 1 for Fast Reroute ready, and Step 2 for Fast Reroute active.

SUMMARY STEPS

1. `show ip rsvp sender detail`
2. `show ip rsvp sender detail`
3. `show mpls traffic-eng link-management advertisements`

DETAILED STEPS

Step 1 `show ip rsvp sender detail`

Use this command to display the MP sender display for the primary tunnel when Fast Reroute is ready.

Example:

```

Router# show ip rsvp sender detail
PATH:
Tun Dest: 10.10.0.6 Tun ID: 100 Ext Tun ID: 10.10.0.1
Tun Sender: 10.10.0.1 LSP ID: 31
Path refreshes:
  arriving: from PHOP 10.10.7.1 on Et0/0 every 30000 msec
Session Attr:
  Setup Prio: 7, Holding Prio: 7
  Flags: (0x7) Local Prot desired, Label Recording, SE Style
  session Name: R1_t100
ERO: (incoming)
  10.10.7.2 (Strict IPv4 Prefix, 8 bytes, /32)
  10.10.0.6 (Strict IPv4 Prefix, 8 bytes, /32)
RRO:
  10.10.7.1/32, Flags:0x0 (No Local Protection)
  10.10.4.1/32, Flags:0x9 (Local Prot Avail/to NNHOP) !Available to NNHOP
  10.10.1.1/32, Flags:0x0 (No Local Protection)
Traffic params - Rate: 10K bits/sec, Max. burst: 1K bytes
  Min Policed Unit: 0 bytes, Max Pkt Size 4294967295 bytes
Fast-Reroute Backup info:
  Inbound FRR: Not active
  Outbound FRR: No backup tunnel selected
Path ID handle: 50000416.
Incoming policy: Accepted. Policy source(s): MPLS/TE
Status: Proxy-terminated

```

Step 2 show ip rsvp sender detail

Use this command to display the MP sender display when the primary tunnel is Fast Reroute active:

Example:

```

Router# show ip rsvp sender detail
PATH:
Tun Dest: 10.10.0.6 Tun ID: 100 Ext Tun ID: 10.10.0.1
Tun Sender: 10.10.0.1 LSP ID: 31
Path refreshes:
  arriving: from PHOP 10.10.3.1 on Et1/0 every 30000 msec
Session Attr:
  Setup Prio: 7, Holding Prio: 7
  Flags: (0x7) Local Prot desired, Label Recording, SE Style
  Session Name: R1_t100
ERO: (incoming)
  10.10.0.4 (Strict IPv4 Prefix, 8 bytes, /32)
  10.10.0.6 (Loose IPv4 Prefix, 8 bytes, /32)
RRO:
  10.10.3.1/32, Flags:0xB (Local Prot Avail/In Use/to NNHOP) !Ready
  10.10.1.1/32, Flags:0x0 (No Local Protection)
Traffic params - Rate: 10K bits/sec, Max. burst: 1K bytes
  Min Policed Unit: 0 bytes, Max Pkt Size 4294967295 bytes
Fast-Reroute Backup info:
  Inbound FRR: Active
  Orig Input I/F: Et0/0
  Orig PHOP: 10.10.7.1
  Now using Bkup Filterspec w/ sender: 10.10.3.1 LSP ID: 31
  Outbound FRR: No backup tunnel selected
Path ID handle: 50000416.
Incoming policy: Accepted. Policy source(s): MPLS/TE
Status: Proxy-terminated

```

Step 3 show mpls traffic-eng link-management advertisements

Use this command to display the influence of a passive link. On R2, the passive link to R4 is in the Link ID:: 1 section.

Example:

```
Router# show mpls traffic-eng link-management advertisements
```

```

Flooding Status: ready
Configured Areas: 2
IGP Area[1] ID:: ospf 1 area 0
System Information::
  Flooding Protocol: OSPF
Header Information::
  IGP System ID: 10.10.0.2
  MPLS TE Router ID: 10.10.0.2
  Flooded Links: 2
Link ID:: 1
Link Subnet Type: Point-to-Point
Link IP Address: 10.10.4.1
IGP Neighbor: ID 0-0-0-0-0-0, IP 10.10.0.4
Physical Bandwidth: 1544 kbits/sec
Res. Global BW: 1158 kbits/sec
Res. Sub BW: 0 kbits/sec
Downstream::

```

	Global Pool	Sub Pool
	-----	-----
Reservable Bandwidth[0]:	1158	0 kbits/sec
Reservable Bandwidth[1]:	1158	0 kbits/sec
Reservable Bandwidth[2]:	1158	0 kbits/sec
Reservable Bandwidth[3]:	1158	0 kbits/sec
Reservable Bandwidth[4]:	1158	0 kbits/sec
Reservable Bandwidth[5]:	1158	0 kbits/sec
Reservable Bandwidth[6]:	1158	0 kbits/sec
Reservable Bandwidth[7]:	1148	0 kbits/sec

```

Attribute Flags: 0x00000000
IGP Area[1] ID:: ospf 1 area 1
System Information::
  Flooding Protocol: OSPF
Header Information::
  IGP System ID: 10.10.0.2
  MPLS TE Router ID: 10.10.0.2
  Flooded Links: 2
Link ID:: 1
Link Subnet Type: Point-to-Point
Link IP Address: 10.10.4.1
IGP Neighbor: ID 0-0-0-0-0-0, IP 10.10.0.4
Physical Bandwidth: 1544 kbits/sec
Res. Global BW: 1158 kbits/sec
Res. Sub BW: 0 kbits/sec
Downstream::

```

	Global Pool	Sub Pool
	-----	-----
Reservable Bandwidth[0]:	1158	0 kbits/sec
Reservable Bandwidth[1]:	1158	0 kbits/sec
Reservable Bandwidth[2]:	1158	0 kbits/sec
Reservable Bandwidth[3]:	1158	0 kbits/sec
Reservable Bandwidth[4]:	1158	0 kbits/sec
Reservable Bandwidth[5]:	1158	0 kbits/sec
Reservable Bandwidth[6]:	1158	0 kbits/sec
Reservable Bandwidth[7]:	1148	0 kbits/sec

```

Attribute Flags: 0x00000000

```

Configuration Examples for MPLS Traffic Engineering Inter-AS TE

Configuring Loose Hops Examples

Configuring an Explicit Path on the Tunnel That Will Cross the Inter-AS Link Example

The following commands configure a loose IP explicit path named `route1` suitable for use as a path option with Inter-AS TE with the destination 10.10.10.6 that is to traverse ABRs 10.10.0.2 and 10.10.0.4. The tunnel headend and the specified ABRs will find a path from the source AS100 to the destination 10.10.0.6 in AS200. See the figure above.

```
Router(config)# ip explicit-path name route1 enable
Router(cfg-ip-expl-path)# next-address loose 10.10.0.2
Router(cfg-ip-expl-path)# next-address loose 10.10.0.4
Router(cfg-ip-expl-path)# next-address loose 10.10.0.6
```

Note that the explicit path for an interarea TE tunnel need not specify the destination router because the tunnel configuration specifies it in the tunnel destination command. The following commands configure an explicit path named `path-without-tailend` that would work equally well for the interarea tunnel created in the previous example:

```
Router(config)# ip explicit-path name path-without-tailend
Router(cfg-ip-expl-path)# next-address loose 10.10.0.2
Router(cfg-ip-expl-path)# next-address loose 10.10.0.4
```

Configuring a Route to Reach the Remote ASBR in the IP Routing Table Example

In the following example, packets for the ASBR whose router ID is 10.10.0.1 will be forwarded via tunnel 101:

```
Router> enable
Router# configure terminal
Router(config)# ip route 10.10.0.1 255.255.255.255 tunnel 101
```

Configuring a Static Route from the MP to the PLR Example

In the following example, a static route is configured from the MP to the PLR. The outgoing interface is tunnel 103.

```
Router> enable
Router# configure terminal
Router(config)# ip route 10.10.3.1 255.255.255.255 tunnel 103
```

Configuring ASBR Forced Link Flooding Examples

Configuring the Inter-AS Link as a Passive Interface Example

For this example, see the figure above.

Routers R2 and R4 have the following router IDs:

- Router R2--10.10.0.2
- Router R4--10.10.0.4

```
Router> enable
Router# configure terminal
Router(config)# interface serial 2/0
```

Configures OSPF on Router R2 When Its Neighbor Is Running OSPF Too

```
Router(config-if)# mpls traffic-end passive-interface nbr-te-id 10.10.0.4
```



Note Because both routers are running OSPF, the **nbr-igp-id** keyword is not specified.

Specifies That Both Router R2 and Its Neighbor Are Running OSPF (the nbr-igp-id Keyword Is Specified)

```
Router(config-if)# mpls traffic-eng passive-interface nbr-te-id 10.10.0.4 nbr-igp-id ospf
10.10.0.4
```

Configures IS-IS on Router R1

```
Router(config-if)# mpls traffic-eng passive-interface nbr-te-id 10.10.0.4 nbr-igp-id isis
40.0000.0002.0001.00
```

Configures the Neighbor IGP ID (nbr-igp-id) When There Is More than One Neighbor Specified on a Link

```
Router(config-if)# mpls traffic-end passive-interface nbr-te-id 10.10.0.4 nbr-igp-id ospf
10.10.0.4
Router(config-if)# mpls traffic-eng passive-interface nbr-te-id 10.10.0.7 nbr-igp-id ospf
10.10.0.7
```

Overrides the Interior Gateway Protocol (IGP) Administrative Weight of the Link and Assigns a Specific Weight

```
Router(config-if)# mpls traffic-eng administrative-weight 20
```



Note The ID is unique for each neighbor.

Configures a Link as a Passive Interface (Includes Global TE Commands)

```
interface serial 2/0
ip address 10.10.4.1.255.255.255.0
mpls traffic-eng tunnels
mpls traffic-eng administrative-weight 10
mpls traffic-eng passive-interface nbr-te-id 10.10.0.4 nbr-igp-id ospf 10.10.0.4
ip rsvp bandwidth 1000
mpls traffic-eng administrative-weight 20
```

Creating LSPs Traversing the ASBRs Example

In the following example, a primary LSP is created:

```
Router> enable
Router# configure terminal
Router(config)# ip explicit path routel enable
Router(config)# next-address loose 10.10.0.2
Router(config)# next-address loose 10.10.0.4
Router(config)# next-address loose 10.10.0.6
Router(config)# interface tunnel 100
Router(config-if)# tunnel mpls traffic-eng fast reroute
Router(config-if)# tunnel mpls traffic-eng path-option 1 routel
```

In the following example, a backup LSP is created:

```
Router> enable
Router# configure terminal
Router(config)# ip explicit path backpath1 enable
Router(config)# next-address loose 10.10.0.3
Router(config)# next-address loose 10.10.0.5
Router(config)# next-address loose 10.10.0.6
Router(config)# interface tunnel 102
Router(config)# mpls traffic-eng backup path tunnel 102
Router(config-if)# tunnel mpls traffic-eng path-option 1 backpath1
```

Configuring Multiple Neighbors on a Link Example

In the following example, there is more than one neighbor on a link:

```
Router> enable
Router# configure terminal
Router(config)# interface ethernet 2/0
Router(config-if)# mpls traffic-eng passive-interface nbr-te-id 10.10.0.4 nbr-igp-id ospf 10.10.0.4
Router(config-if)# mpls traffic-eng administrative-weight 20
```

Additional References

Related Documents

Related Topic	Document Title
MPLS traffic engineering commands: complete command syntax, command mode, command history, defaults, usage guidelines, and examples	<i>Cisco IOS Multiprotocol Label Switching Command Reference</i>
Fast Reroute	MPLS TE: Link and Node Protection, with RSVP Hellos Support (with Fast Tunnel Interface Down Detection)
Link flooding and node protection	MPLS Traffic Engineering: Interarea Tunnels
IS-IS configuration tasks	Configuring a Basic IS-IS Network
OSPF configuration tasks	Configuring OSPF
IS-IS and OSPF commands: complete command syntax, command mode, command history, defaults, usage guidelines, and examples	<i>Cisco IOS IP Routing Protocols Command Reference</i>
RSVP	RSVP Message Authentication

Standards

Standards	Title
No new or modified standards are supported by this feature, and support for existing standards has not been modified by this feature.	--

MIBs

MIBs	MIBs Link
No new or modified MIBs are supported by this feature, and support for existing MIBs has not been modified by this feature.	To locate and download MIBs for selected platforms, Cisco IOS releases, and feature sets, use Cisco MIB Locator found at the following URL: http://www.cisco.com/go/mibs

RFCs

RFCs	Title
RFC 3209	Extensions to RSVP for LSP Tunnels
draft-ietf-mpls-rsvp-lsp-fasteroute-02.txt	<i>Fast Reroute Extensions to RSVP-TE for LSP Tunnels</i>

RFCs	Title
draft-vasseur-mpls-loose-path-reopt-02.txt	<i>Reoptimization of an Explicitly Loosely Routed MPLS TE Path</i>
draft-vasseur-mpls-inter-as-te-00.txt	<i>MPLS Inter-AS Traffic Engineering</i>
draft-ietf-mpls-soft-preemption-00.txt	<i>MPLS Traffic Engineering Soft Preemption</i>

Technical Assistance

Description	Link
<p>The Cisco Support website provides extensive online resources, including documentation and tools for troubleshooting and resolving technical issues with Cisco products and technologies.</p> <p>To receive security and technical information about your products, you can subscribe to various services, such as the Product Alert Tool (accessed from Field Notices), the Cisco Technical Services Newsletter, and Really Simple Syndication (RSS) Feeds.</p> <p>Access to most tools on the Cisco Support website requires a Cisco.com user ID and password.</p>	http://www.cisco.com/techsupport

Feature Information for MPLS Traffic Engineering Inter-AS TE

The following table provides release information about the feature or features described in this module. This table lists only the software release that introduced support for a given feature in a given software release train. Unless noted otherwise, subsequent releases of that software release train also support that feature.

Use Cisco Feature Navigator to find information about platform support and Cisco software image support. To access Cisco Feature Navigator, go to www.cisco.com/go/cfn. An account on Cisco.com is not required.

Table 13: Feature Information for MPLS Traffic Engineering: Inter-AS TE

Feature Name	Releases	Feature Information
MPLS Traffic Engineering: Inter-AS TE	12.0(29)S 12.2(33)SRA 12.2(33)SRB 12.2(33)SXH 12.4(20)T Cisco IOS XE Release 3.5S	The MPLS Traffic Engineering: Inter-AS TE feature provides ASBR node protection, loose path reoptimization, SSO recovery of LSPs that include loose hops, ASBR forced link flooding, Cisco IOS RSVP local policy extensions for Inter-AS, and per-neighbor key capabilities. In 12.0(29)S, this feature was introduced. In 12.2(33)SRA, the nbr-if-addr keyword was added to the mpls traffic-eng passive-interface command. In 12.2(33)SRB, support was added for SSO recovery of LSPs that include loose hops. In 12.2(33)SXH, this feature was integrated into Cisco IOS Release 12.2(33)SXH. In 12.4(20)T, this feature was integrated into Cisco IOS Release 12.4(20)T. In Cisco IOS XE Release 3.5S, this feature was integrated into Cisco IOS XE Release 3.5S.

Glossary

ABR --Area Border Router. A routers connecting two areas.

adjacency --The MPLS TE Forwarding Adjacency feature allows a network administrator to handle a traffic engineering, label-switched path (LSP) tunnel as a link in an Interior Gateway Protocol (IGP) network based on the Shortest Path First (SPF) algorithm. A forwarding adjacency can be created between routers regardless of their location in the network. The routers can be located multiple hops from each other.

area --A logical set of network segments (for example, one that is OSPF-based) and their attached devices. Areas usually are connected to other areas by routers, making up a single autonomous system. OSPF and IS-IS define their areas differently. OSPF area borders are marked by routers. Some interfaces are in one area, and other interfaces are in another area. With IS-IS, all the routers are completely within an area, and the area borders are on links, not on routers. The routers that connect the areas are level-2 routers, and routers that have no direct connectivity to another area are level-1 routers.

ASBR --Autonomous System Boundary Router. The router is located between an OSPF autonomous system and a non-OSPF network. ASBRs run both OSPF and another routing protocol, such as RIP. ASBRs must reside in a nonstub OSPF area.

autonomous system --A collection of networks under a common administration sharing a common routing strategy. Autonomous systems are subdivided by areas.

backup tunnel --An MPLS traffic engineering tunnel used to protect other (primary) tunnel's traffic when a link or node failure occurs.

BGP --Border Gateway Protocol. Interdomain routing protocol that replaces EGP. BGP exchanges reachability information with other BGP systems.

border router --A router at the edge of a provider network that interfaces to another provider's border router using extended BGP procedures.

Cisco Express Forwarding --A means for accelerating the forwarding of packets within a router, by storing route lookup information in several data structures instead of in a route cache.

Fast Reroute --A mechanism for protecting MPLS traffic engineering (TE) LSPs from link and node failure by locally repairing the LSPs at the point of failure, allowing data to continue to flow on them while their headend routers attempt to establish end-to-end LSPs to replace them. FRR locally repairs the protected LSPs by rerouting them over backup tunnels that bypass failed links or nodes.

flooding --A traffic-passing technique used by switches and bridges in which traffic received on an interface is sent out all the interfaces of that device except the interface on which the information was received originally.

forwarding adjacency --A traffic engineering link (or LSP) into an IS-IS or OSPF network.

headend --The router that originates and maintains a given LSP. This is the first router in the LSP's path.

hop --Passage of a data packet between two network nodes (for example, between two routers).

IGP --Interior Gateway Protocol. Internet protocol used to exchange routing information within an autonomous system. Examples of common IGP include Interior Gateway Routing Protocol (IGRP), Open Shortest Path First (OSPF), and Routing Information Protocol (RIP).

Inter-AS LSP --An MPLS traffic engineering label-switched path (LSP) that traverses hops that are not in the headend's topology database (that is, it is not in the same OSPF area, IS-IS area, or autonomous system as the headend).

interface --A network connection.

IP explicit path --A list of IP addresses, each representing a node or link in the explicit path.

IS-IS --Intermediate System-to-Intermediate System. OSI link-state hierarchical routing protocol based on DECnet Phase V routing, where intermediate system (IS) routers exchange routing information based on a single metric to determine the network topology.

link --A point-to-point connection between adjacent nodes.

LSA --link-state advertisement. A broadcast packet used by link-state protocols that contains information about neighbors and path costs. LSAs are used by the receiving routers to maintain their routing tables.

LSP --label-switched path. A configured connection between two routers, in which MPLS is used to carry packets. An LSP is a path created by the concatenation of one or more label-switched hops, allowing a packet to be forwarded by swapping labels from an MPLS node to another MPLS node.

midpoint --A transit router for a given LSP.

midpoint reoptimization --Ability of a midpoint to trigger a headend reoptimization.

MP --merge point. The LSR where one or more backup tunnels rejoin the path of the protected LSP, downstream of the potential failure. An LSR can be both an MP and a PLR simultaneously.

MPLS --Multiprotocol Label Switching. Packet-forwarding technology, used in the network core, that applies data link layer labels to tell switching nodes how to forward data, resulting in faster and more scalable forwarding than network layer routing normally can do.

multicast --Single packets are copied by the network and sent to a specific subset of network addresses. These addresses are specified in the Destination address field. (Multicast is an efficient paradigm for transmitting the same data to multiple receivers, because of its concept of a Group address. This allows a group of receivers to listen to the single address.)

node --Endpoint of a network connection or a junction common to two or more lines in a network. Nodes can be interconnected by links, and serve as control points in the network.

OSPF --Open Shortest Path First. A link-state, hierarchical Interior Gateway Protocol routing algorithm, derived from the IS-IS protocol. OSPF features include least-cost routing, multipath routing, and load balancing.

opaque LSA --If a router understands LSA Type 10 link information, the router continues flooding the link throughout the network.

passive link --When IGP is not running on the link between two ASBRs, traffic engineering informs the IGP to flood link information on behalf of that link (that is, it advertises that link).

PLR --point of local repair. The headend LSR of a backup tunnel.

router --A network layer device that uses one or more metrics to determine the optimal path along which network traffic should be forwarded. Routers forward packets from one network to another based on network layer information.

RSVP --Resource Reservation Protocol. An IETF protocol used for signaling requests (setting up reservations) for Internet services by a customer before that customer is permitted to transmit data over that portion of the network.

SPF --shortest path first. A routing algorithm used as the basis for OSPF operations. When an SPF router is powered up, it initializes its routing-protocol data structures and then waits for indications from lower-layer protocols that its interfaces are functional.

SRLG --Shared Risk Link Group. Sets of links that are likely to go down together (for example, because they have the same underlying fiber).

tailend --The router upon which an LSP is terminated. This is the last router in the LSP's path.

TE --traffic engineering. The techniques and processes used to cause routed traffic to travel through the network on a path other than the one that would have been chosen if standard routing methods had been used.

TLV --type, length, values. A block of information embedded in Cisco Discovery Protocol advertisements.



CHAPTER 10

Configuring MPLS Traffic Engineering over GRE Tunnel Support

The MPLS Traffic Engineering (TE) over Generic Routing Encapsulation (GRE) Tunnel Support feature enables applications to establish TE tunnels over virtual interfaces.

- [Finding Feature Information, on page 219](#)
- [Prerequisites for Configuring MPLS TE over GRE Tunnel Support, on page 219](#)
- [Restrictions for Configuring MPLS TE Over GRE Tunnel Support, on page 220](#)
- [Information About Configuring MPLS TE over GRE Tunnel Support, on page 220](#)
- [How to Configure MPLS TE over GRE Tunnel Support, on page 221](#)
- [Configuration Examples for MPLS TE Over GRE Tunnel Support, on page 226](#)
- [Additional References for MPLS TE Over GRE Tunnel Support, on page 231](#)
- [Feature Information for MPLS TE Over GRE Tunnel Support, on page 232](#)

Finding Feature Information

Your software release may not support all the features documented in this module. For the latest caveats and feature information, see [Bug Search Tool](#) and the release notes for your platform and software release. To find information about the features documented in this module, and to see a list of the releases in which each feature is supported, see the feature information table.

Use Cisco Feature Navigator to find information about platform support and Cisco software image support. To access Cisco Feature Navigator, go to www.cisco.com/go/cfn. An account on Cisco.com is not required.

Prerequisites for Configuring MPLS TE over GRE Tunnel Support

Your network must support the following:

- Cisco Express Forwarding
- External data encryptors
- Intermediate System-to-Intermediate System (IS-IS) or Open Shortest Path First (OSPF)
- IPsec that is enabled on the GRE nodes to implement GRE traffic encryption
- MPLS TE that is configured on the interface and on GRE tunnels

- MPLS TE tunnels

If GRE tunnels and TE tunnels coexist within the same routing domain, routing loops will occur. Create separate routing domains by either configuring GRE overlay with static routing for GRE packets or using two separate routing processes, one for the GRE overlay and another for TE tunnels.

Restrictions for Configuring MPLS TE Over GRE Tunnel Support

The following TE features are not supported over GRE tunnels, so they should not be configured for TE tunnels that may traverse GRE tunnels:

- The following TE features are not supported over GRE tunnels. They should not be configured for TE tunnels that may traverse GRE tunnels:
 - Autoroute destinations
 - Automatic bandwidth adjustment
 - Autotunnel primary one-hop tunnels
 - Diff-Serve Aware TE (DS-TE)
 - Explicit path options that identify excluded nodes
 - Interarea/autonomous systems MPLS TE
 - Point-to-multipoint TE
 - Shared Risk Link Groups (SRLGs)
 - Tunnel-Based Admission Control (TBAC)
- GRE tunnels do not support Cisco nonstop forwarding with stateful switchover (NSF with SSO). If a switchover occurs, traffic loss occurs for TE over GRE, and the TE tunnels are resigned.
- Fast Reroute (FRR) is not supported.

Information About Configuring MPLS TE over GRE Tunnel Support

MPLS TE over GRE Tunnel Support Overview

MPLS TE tunnels provide transport for label switching data through an MPLS network using a path, which is constraint-based, and is not restricted to the IGP shortest cost path. The TE tunnels are usually established over physical links between adjacent routers. However, some applications require establishing TE tunnels over virtual interfaces such as GRE tunnels. Federal Information Processing Standard (FIPS) 140-2 compliance mandates that federal customers require traffic encryption throughout their network infrastructure, which is referred to as Type-I encryption level of security. Type-I encryption environments differentiate between encrypted and unencrypted networks. The encrypted network is the secure part of the network that is in a

secure facility, where encryption is not required. The unencrypted network is the unsecured part of the network where traffic encryption is required.

Two common methods of traffic encryption are as follows:

- External crypto devices
- Cisco IOS IPsec, which is the encryption embedded into Cisco IOS software

External crypto devices operate in Layer 2 (L2), providing link layer encryption of ATM and SONET traffic. Due to the migration of L2 networks to IP network, there is an increasing adoption of IP crypto devices and IPsec. This transition requires that the traffic encryption happens at the IP layer. The IP-based forwarding of service traffic, such as IP or Layer 3 (L3)/L2 VPN MPLS traffic, is implemented only through GRE tunnels.

The following MPLS TE features are supported when enabled over GRE tunnel:

- MPLS TE over GRE (Tunnel establishment and data traffic)
- Metrics (admin weight)
- Attribute flag and affinities
- Explicit path
- BFD
- ECMP without Class Based Tunnel Selection (CBTS)

Benefits of MPLS TE over GRE Tunnel Support

The MPLS TE Over GRE Tunnel Support feature enables you to leverage MPLS segmentation capabilities, such as Layer 2 and Layer 3 VPN, on GRE tunnel transport. This feature enables you to deploy MPLS TE to implement explicit path forwarding, FRR, and bandwidth management of traffic over GRE tunnels. Also, this feature helps maintain the TE capabilities currently supported by ATM legacy networks.

How to Configure MPLS TE over GRE Tunnel Support

Configuring Resource Reservation Protocol Bandwidth

SUMMARY STEPS

1. **enable**
2. **configure terminal**
3. **interface** *type number*
4. **bandwidth** *kbps*
5. **ip address** *ip-address mask*
6. **mpls traffic-eng tunnels**
7. **tunnel source** *type number*
8. **tunnel destination** *{host-name | ip-address | ipv6-address}*
9. **ip rsvp bandwidth**

10. end

DETAILED STEPS

	Command or Action	Purpose
Step 1	enable Example: Router> enable	Enables privileged EXEC mode. • Enter your password if prompted.
Step 2	configure terminal Example: Router# configure terminal	Enters global configuration mode.
Step 3	interface <i>type</i> <i>number</i> Example: Router(config)# interface tunnel 0	Configures a tunnel interface and enters interface configuration mode for the specified tunnel interface.
Step 4	bandwidth <i>kbps</i> Example: Router(config-if)# bandwidth 100000	Sets the total bandwidth for a bandwidth pool.
Step 5	ip address <i>ip-address</i> <i>mask</i> Example: Router(config-if)# ip address 172.16.0.0 255.255.255.254	Configures a primary IP address for an interface.
Step 6	mpls traffic-eng tunnels Example: Router(config-if)# mpls traffic-eng tunnels	Enables traffic engineering tunnel signaling on the interface.
Step 7	tunnel source <i>type</i> <i>number</i> Example: Router(config-if)# tunnel source loopback 1	Configures the source address for the tunnel interface.
Step 8	tunnel destination <i>{host-name ip-address ipv6-address}</i> Example: Router(config-if)# tunnel destination 192.168.1.1	Specifies the destination for a tunnel. • <i>ip-address</i> —IP address of the host destination expressed in dotted decimal notation.
Step 9	ip rsvp bandwidth Example:	Enables Resource Reservation Protocol (RSVP) for IP on an interface.

	Command or Action	Purpose
	<code>Router(config-if)# ip rsvp bandwidth</code>	
Step 10	end Example: <code>Router(config-if)# end</code>	(Optional) Exits interface configuration mode and returns to privileged EXEC mode.

Configuring an MPLS TE Tunnel

SUMMARY STEPS

1. **enable**
2. **configure terminal**
3. **interface** *tunnel number*
4. **ip unnumbered** *type number*
5. **tunnel destination** *{host-name | ip-address | ipv6-address}*
6. **mpls traffic-eng tunnels**
7. **tunnel mpls traffic-eng priority** *setup-priority [hold-priority]*
8. **tunnel mpls traffic-eng bandwidth** *kbps*
9. **tunnel mpls traffic-eng path-option** *number dynamic*
10. **tunnel mpls traffic-eng fast-reroute**
11. **end**

DETAILED STEPS

	Command or Action	Purpose
Step 1	enable Example: <code>Router> enable</code>	Enables privileged EXEC mode. <ul style="list-style-type: none"> • Enter your password if prompted.
Step 2	configure terminal Example: <code>Router# configure terminal</code>	Enters global configuration mode.
Step 3	interface <i>tunnel number</i> Example: <code>Router(config)# interface tunnel 10</code>	Configures a tunnel interface and enters interface configuration mode for the specified tunnel interface.
Step 4	ip unnumbered <i>type number</i> Example:	Assigns an IP address to the tunnel interface. <ul style="list-style-type: none"> • An MPLS TE tunnel interface should be unnumbered because it represents a unidirectional link.

	Command or Action	Purpose
	Router(config-if)# ip unnumbered loopback 0	
Step 5	<p>tunnel destination {<i>host-name</i> <i>ip-address</i> <i>ipv6-address</i>}</p> <p>Example:</p> <pre>Router(config-if)# tunnel destination 192.168.2.2</pre>	<p>Specifies the destination for a tunnel.</p> <ul style="list-style-type: none"> <i>ip-address</i>—IP address of the host destination expressed in dotted decimal notation.
Step 6	<p>mpls traffic-eng tunnels</p> <p>Example:</p> <pre>Router(config-if)# mpls traffic-eng tunnels</pre>	Enables traffic engineering tunnel signaling on the interface.
Step 7	<p>tunnel mpls traffic-eng priority <i>setup-priority</i> [<i>hold-priority</i>]</p> <p>Example:</p> <pre>Router(config-if)# tunnel mpls traffic-eng priority 7 7</pre>	Configures the setup and reservation priority for the tunnel.
Step 8	<p>tunnel mpls traffic-eng bandwidth <i>kbps</i></p> <p>Example:</p> <pre>Router(config-if)# tunnel mpls traffic-eng bandwidth 10</pre>	Configures the bandwidth required for the tunnel.
Step 9	<p>tunnel mpls traffic-eng path-option <i>number</i> dynamic</p> <p>Example:</p> <pre>Router(config-if)# tunnel mpls traffic-eng path-option 10 dynamic</pre>	Configures the path option for the tunnel.
Step 10	<p>tunnel mpls traffic-eng fast-reroute</p> <p>Example:</p> <pre>Router(config-if)# tunnel mpls traffic-eng fast-reroute</pre>	Enables an MPLS TE tunnel to use an established backup tunnel in the event of a link or node failure.
Step 11	<p>end</p> <p>Example:</p> <pre>Router(config-if)# end</pre>	(Optional) Exits interface configuration mode and returns to privileged EXEC mode.

Configuring an MPLS TE Tunnel over GRE

SUMMARY STEPS

1. **enable**
2. **configure terminal**
3. **interface *tunnel number***
4. **ip unnumbered loopback *number***
5. **tunnel destination *ip-address***
6. **tunnel mpls traffic-eng autoroute announce**
7. **tunnel mpls traffic-eng**
8. **tunnel mpls traffic-eng path-option *number* dynamic**
9. **end**

DETAILED STEPS

	Command or Action	Purpose
Step 1	enable Example: <pre>Router> enable</pre>	Enables privileged EXEC mode. <ul style="list-style-type: none"> • Enter your password if prompted.
Step 2	configure terminal Example: <pre>Router# configure terminal</pre>	Enters global configuration mode.
Step 3	interface <i>tunnel number</i> Example: <pre>Router(config)# interface tunnel 100</pre>	Configures an interface type and enters interface configuration mode
Step 4	ip unnumbered loopback <i>number</i> Example: <pre>Router(config-if)# ip unnumbered loopback 0</pre>	Assigns an IP address to the tunnel interface. <ul style="list-style-type: none"> • An MPLS TE tunnel interface should be unnumbered because it represents a unidirectional link.
Step 5	tunnel destination <i>ip-address</i> Example: <pre>Router(config-if)# tunnel destination 10.255.1.2</pre>	Specifies the destination for a tunnel. <ul style="list-style-type: none"> • <i>ip-address</i>—IP address of the host destination expressed in dotted decimal notation.
Step 6	tunnel mpls traffic-eng autoroute announce Example: <pre>Router(config-if)# tunnel mpls traffic-eng autoroute announce</pre>	Specifies that the IGP should use the tunnel in its enhanced shortest path first (SPF) calculation.

	Command or Action	Purpose
Step 7	tunnel mpls traffic-eng Example: Router(config-if)# tunnel mpls traffic-eng	Sets the encapsulation mode of the tunnel to MPLS TE.
Step 8	tunnel mpls traffic-eng path-option <i>number</i> dynamic Example: Router(config-if)# tunnel mpls traffic-eng path-option 10 dynamic	Configures a path option for the MPLS TE tunnel. <ul style="list-style-type: none"> If you specify the dynamic keyword, the Cisco IOS software checks both the physical bandwidth of the interface and the available TE bandwidth to make sure that the requested amount of bandwidth does not exceed the physical bandwidth of any link.
Step 9	end Example: Router(config-if)# end	(Optional) Exits interface configuration mode and returns to privileged EXEC mode.

Configuration Examples for MPLS TE Over GRE Tunnel Support

Example Configuring MPLS TE Over GRE Tunnel Support

The following example shows how to configure MPLS TE over a GRE tunnel between two routers: Router 1 and Router 2. The first loopback interface is used for router identification, and the other for reachability. One OSPF is used for TE and the other for reachability.

Router 1

```

configure terminal
no logging console
mpls traffic-eng tunnels
interface Loopback 0
 ip address 172.16.1.1 255.255.255.255
 no shutdown
!
interface Loopback 1
 ip address 10.255.1.1 255.255.255.0
 no shutdown
!
interface gigabitethernet 1/1
 ip address 172.16.1.1 255.255.255.255
 ip rsvp bandwidth 100000
 no shutdown
!
router ospf 172
 router-id 172.16.1.1
 network 172.16.0.0 0.0.255.255 area 0
 mpls traffic-eng router-id Loopback 0
 mpls traffic-eng area 0
 no shutdown

```

```
!  
router ospf 10  
  router-id 10.255.1.1  
  network 10.255.0.0 0.0.255.255 area 0  
  no shutdown  
!  
interface Tunnel 10  
  bandwidth 20000  
  ip address 172.16.0.1 255.255.255.252  
  mpls traffic-eng tunnels  
  keepalive 10 3  
  tunnel source Loopback 1  
  tunnel destination 10.255.1.2  
  ip rsvp bandwidth 15000 sub-pool 5000  
!  
!  
interface tunnel 100  
  ip unnumbered loopback 0  
  tunnel mode mpls traffic-eng  
  tunnel destination 192.168.10.10  
  tunnel mpls traffic-eng autoroute announce  
  tunnel mpls traffic-eng path-option 10 dynamic  
!  
end  
Router 2  
configure terminal  
no logging console  
mpls traffic-eng tunnels  
interface Loopback 0  
  ip address 172.16.1.2 255.255.255.255  
  no shutdown  
!  
interface Loopback 1  
  ip address 10.255.1.2 255.255.255.255  
  no shutdown  
!  
interface gigabitethernet 1/1  
  ip address 10.255.0.2 255.255.255.252  
  ip rsvp bandwidth 100000  
  no shutdown  
!  
router ospf 172  
  router-id 172.16.1.2  
  network 172.16.0.0 0.0.255.255 area 0  
  mpls traffic-eng router-id Loopback 0  
  mpls traffic-eng area 0  
  no shutdown  
!  
router ospf 10  
  router-id 10.255.1.2  
  network 10.255.0.0 0.0.255.255 area 0  
  no shutdown  
!  
!  
interface Tunnel0  
  bandwidth 20000  
  ip address 172.16.0.2 255.255.255.252  
  mpls traffic-eng tunnels  
  keepalive 10 3  
  tunnel source Loopback 1  
  tunnel destination 10.255.1.1  
  ip rsvp bandwidth 15000 sub-pool 5000  
!  
!
```

```

interface tunnel 100
ip unnumbered loopback 0
tunnel mode mpls traffic-eng
tunnel destination 172.16.1.1
tunnel mpls traffic-eng autoroute announce
tunnel mpls traffic-eng path-option 10 dynamic
!
end

```

Example Configuring CBTS with MPLS over GRE

The following example shows how to configure Class-Based Tunnel Selection (CBTS) with MPLS Traffic Engineering (TE) over GRE.

Figure 35: The Network Structure of CBTS with MPLS over GRE

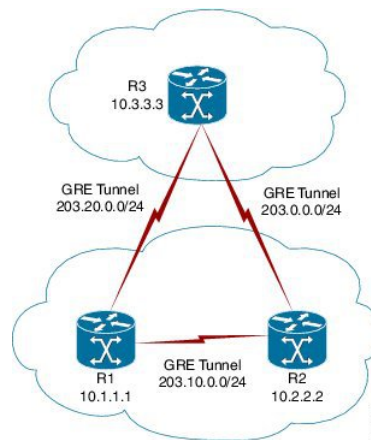

Configuration of the Midpoint Router (R1)

```

mpls traffic-eng tunnels
!
interface Tunnel 102
ip address 203.20.0.1 255.255.255.0
mpls ip
mpls traffic-eng tunnels
tunnel source GigabitEthernet 0/0/0
tunnel destination 192.168.0.1
tunnel key 22
tunnel checksum
ip rsvp bandwidth 500000
!
interface Tunnel 103
ip address 203.10.0.1 255.255.255.0
mpls ip
mpls traffic-eng tunnels
tunnel source GigabitEthernet 0/0/0
tunnel destination 192.168.10.1
tunnel key 33
tunnel checksum
ip rsvp bandwidth 500000
mpls traffic-eng tunnels
!
router ospf 1
router-id 10.1.1.1

```



```

network 10.1.1.1 0.0.0.0 area 1
network 203.20.0.1 0.0.0.0 area 1
network 203.10.0.1 0.0.0.0 area 1
mpls traffic-eng router-id Loopback 0
mpls traffic-eng area 1

```

Configuration of the Head Router (R2)

```

mpls traffic-eng tunnels
!
interface Tunnel 203
 ip address 203.0.0.1 255.255.255.0
 mpls ip
 mpls traffic-eng tunnels
 tunnel source GigabitEthernet 0/0/0
 tunnel destination 192.168.10.1
 tunnel key 6
 tunnel checksum
 ip rsvp bandwidth 500000
!
interface Tunnel 211
 ip address 172.16.0.2 255.255.255.0
 mpls ip
 mpls traffic-eng tunnels
 tunnel source GigabitEthernet 0/0/0
 tunnel destination 192.168.20.1
 tunnel key 22
 tunnel checksum
 ip rsvp bandwidth 500000
!
interface Tunnel 2300
 ip unnumbered Loopback 0
 tunnel mode mpls traffic-eng
 tunnel destination 10.3.3.3
 tunnel mpls traffic-eng autoroute announce
 tunnel mpls traffic-eng autoroute metric relative -5
 tunnel mpls traffic-eng priority 7 7
 tunnel mpls traffic-eng bandwidth 1000
 tunnel mpls traffic-eng path-option 10 dynamic
 tunnel mpls traffic-eng exp-bundle master
 tunnel mpls traffic-eng exp-bundle member Tunnel 2301
 tunnel mpls traffic-eng exp-bundle member Tunnel 2302
!
interface Tunnel 2301
 ip unnumbered Loopback 0
 tunnel mode mpls traffic-eng
 tunnel destination 10.3.3.3
 tunnel mpls traffic-eng autoroute announce
 tunnel mpls traffic-eng autoroute metric relative -5
 tunnel mpls traffic-eng priority 7 7
 tunnel mpls traffic-eng bandwidth 1000
 tunnel mpls traffic-eng path-option 10 explicit name TE2301
 tunnel mpls traffic-eng exp 6 7
!
interface Tunnel 2302
 ip unnumbered Loopback 0
 tunnel mode mpls traffic-eng
 tunnel destination 10.3.3.3
 tunnel mpls traffic-eng autoroute announce
 tunnel mpls traffic-eng autoroute metric relative -5
 tunnel mpls traffic-eng priority 7 7
 tunnel mpls traffic-eng bandwidth 1000
 tunnel mpls traffic-eng path-option 10 explicit name TE2302

```

```

    tunnel mpls traffic-eng exp default
    !
router ospf 1
  router-id 10.2.2.2
  network 10.2.2.2 0.0.0.0 area 1
  network 203.20.0.2 0.0.0.0 area 1
  network 172.16.0.2 0.0.0.0 area 1
  network 203.0.0.1 0.0.0.0 area 1
  mpls traffic-eng router-id Loopback0
  mpls traffic-eng area 1
  !
ip explicit-path name TE2301 enable
  next-address 203.0.0.2
ip explicit-path name TE2302 enable
  next-address 172.16.0.1
  next-address 172.26.0.2

```

Configuration of the Tail Router (R3)

```

mpls traffic-eng tunnels
!
interface Tunnel 302
  ip address 203.0.0.2 255.255.255.0
  mpls ip
  mpls traffic-eng tunnels
  tunnel source GigabitEthernet 0/0/0
  tunnel destination 192.168.0.1
  tunnel key 6
  tunnel checksum
  ip rsvp bandwidth 500000
  !
interface Tunnel 311
  ip address 172.26.0.2 255.255.255.0
  mpls ip
  mpls traffic-eng tunnels
  tunnel source GigabitEthernet 0/0/0
  tunnel destination 192.168.20.1
  tunnel key 33
  tunnel checksum
  ip rsvp bandwidth 500000
  !
router ospf 1
  router-id 10.3.3.3
  network 10.3.3.3 0.0.0.0 area 1
  network 203.10.0.2 0.0.0.0 area 1
  network 172.26.0.2 0.0.0.0 area 1
  network 203.0.0.2 0.0.0.0 area 1
  mpls traffic-eng router-id Loopback0
  mpls traffic-eng area 1
  !

```

Additional References for MPLS TE Over GRE Tunnel Support

Related Documents

Related Topic	Document Title
Cisco IOS commands	Cisco IOS Master Commands List, All Releases
MPLS commands	Cisco IOS Multiprotocol Label Switching Command Reference

Standards

Standard	Title
FIPS 140-2	Security Requirements for Cryptographic Modules.

MIBs

MIB	MIBs Link
MPLS-TE-STD-MIB	To locate and download MIBs for selected platforms, Cisco IOS releases, and feature sets, use Cisco MIB Locator found at the following URL: http://www.cisco.com/go/mibs

RFCs

RFC	Title
RFC 3812	MPLS TE Management Information Base (MIB)

Technical Assistance

Description	Link
The Cisco Support and Documentation website provides online resources to download documentation, software, and tools. Use these resources to install and configure the software and to troubleshoot and resolve technical issues with Cisco products and technologies. Access to most tools on the Cisco Support and Documentation website requires a Cisco.com user ID and password.	http://www.cisco.com/cisco/web/support/index.html

Feature Information for MPLS TE Over GRE Tunnel Support

The following table provides release information about the feature or features described in this module. This table lists only the software release that introduced support for a given feature in a given software release train. Unless noted otherwise, subsequent releases of that software release train also support that feature.

Use Cisco Feature Navigator to find information about platform support and Cisco software image support. To access Cisco Feature Navigator, go to www.cisco.com/go/cfn. An account on Cisco.com is not required.

Table 14: Feature Information for MPLS TE over GRE Tunnel Support

Feature Name	Releases	Feature Information
MPLS TE over GRE Tunnel Support	Cisco IOS XE Release 3.3S 15.2(1)T Cisco IOS XE Release 3.12S Cisco IOS XE Release 3.16S	<p>The MPLS TE over GRE Tunnel Support feature enables applications to establish traffic engineering tunnels over virtual interfaces.</p> <p>The following commands were introduced or modified: mpls traffic-eng tunnels, tunnel mpls traffic-eng autoroute announce, tunnel mpls traffic-eng bandwidth, tunnel mpls traffic-eng fast-reroute, tunnel mpls traffic-eng path-option, tunnel mpls traffic-eng priority.</p> <p>In Cisco IOS XE 3.12S release, CBTS support was added for GRE interface type on the Cisco ASR 1000 Series Aggregation Services Routers.</p> <p>In Cisco IOS XE 3.16S release, CBTS support was added for GRE interface type on Cisco ISR4451/4431/4351 series Integrated Services Routers.</p>



CHAPTER 11

MPLS Traffic Engineering—RSVP Graceful Restart

The MPLS Traffic Engineering—RSVP Graceful Restart feature allows a neighboring Route Processor (RP) to recover from disruption in control plane service (specifically, the Label Distribution Protocol (LDP) component) without losing its Multiprotocol Label Switching (MPLS) forwarding state. This feature has the following benefits:

- Graceful restart allows a node to recover state information from its neighbor when there is an RP failure or the device has undergone a stateful switchover (SSO).
- Graceful restart allows session information recovery with minimal disruption to the network.
- A node can perform a graceful restart to help a neighbor recover its state by keeping the label bindings and state information to provide a quick recovery of the failed node and not affect the traffic that is currently forwarded.
- [Finding Feature Information, on page 233](#)
- [Prerequisites for MPLS TE—RSVP Graceful Restart, on page 234](#)
- [Restrictions for MPLS TE—RSVP Graceful Restart, on page 234](#)
- [Information About MPLS TE—RSVP Graceful Restart, on page 234](#)
- [How to Configure MPLS TE—RSVP Graceful Restart, on page 236](#)
- [Configuration Examples for MPLS TE—RSVP Graceful Restart, on page 240](#)
- [Additional References, on page 241](#)
- [Feature Information for MPLS Traffic Engineering—RSVP Graceful Restart, on page 242](#)
- [Glossary, on page 243](#)

Finding Feature Information

Your software release may not support all the features documented in this module. For the latest caveats and feature information, see [Bug Search Tool](#) and the release notes for your platform and software release. To find information about the features documented in this module, and to see a list of the releases in which each feature is supported, see the feature information table.

Use Cisco Feature Navigator to find information about platform support and Cisco software image support. To access Cisco Feature Navigator, go to www.cisco.com/go/cfn. An account on Cisco.com is not required.

Prerequisites for MPLS TE—RSVP Graceful Restart

Perform the following tasks on routers before configuring the MPLS Traffic Engineering—RSVP Graceful Restart feature:

- Configure the Resource Reservation Protocol (RSVP).
- Enable MPLS.
- Configure traffic engineering (TE).
- Enable graceful restart.

Restrictions for MPLS TE—RSVP Graceful Restart

- Graceful restart supports node failure only.
- Cisco recommends that you configure interface hellos only if the neighbor router does not support node hellos.
- Unnumbered interfaces are not supported.
- You cannot configure an interface hello for graceful restart and an interface hello for Fast ReRoute or hello state timeout (HST) on the same interface.

Information About MPLS TE—RSVP Graceful Restart

Graceful Restart Operation

RSVP graceful restart allows RSVP TE enabled nodes to recover gracefully following a node failure in the network such that the RSVP state after the failure is restored as quickly as possible. The node failure may be completely transparent to other nodes in the network.

RSVP graceful restart preserves the label values and forwarding information and works with third-party or Cisco routers seamlessly.

RSVP graceful restart depends on RSVP hello messages to detect that a neighbor went down. Hello messages include Hello Request or Hello Acknowledgment (ACK) objects between two neighbors.

A node hello is transmitted when graceful restart is globally configured and the first LSP to the neighbor is created.

Interface hello is an optional configuration. If you configure the graceful restart Hello command on an interface, the interface hello is considered to be an additional hello instance with the neighbor.

The router transmits an interface hello for graceful restart when all of the following conditions are met:

- Graceful restart is configured globally.
- Graceful restart is configured on the interface.

- An LSP to the neighboring router is created and goes over the interface.

Cisco recommends that you use node hellos if the neighbor supports node hellos, and configure interface hellos only if the neighbor router does not support node hellos.

Interface hellos differ from node hellos, as follows:

- **Interface hello**—The source address in the IP header of the hello message has an IP address that matches the interface that the Hello message sent out. The destination address in the IP header is the interface address of the neighbor on the other side of the link. A TTL of 1 is used for per-interface hellos as it is destined for the directly-connected neighbor.
- **Node hello**—The source address in the IP header of the Hello message includes the TE router ID of the sending router. The destination address of the IP header has the router ID of the neighbor to which this message is sent. A TTL of more than 1 is used.

The figure below shows the graceful restart extension to these messages that an object called `Restart_Cap`, which tells neighbors that a node, may be capable of restarting if a failure occurs. The time-to-live (TTL) in these messages is set to 255 so that adjacencies can be maintained through alternate paths even if the link between two neighbors goes down.

Figure 36: How Graceful Restart Works

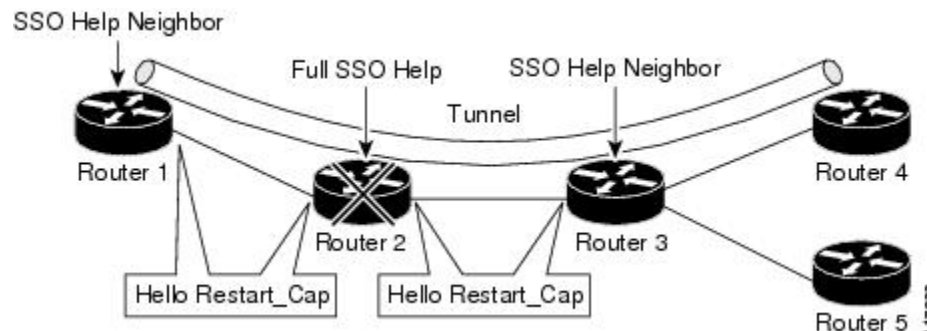

The `Restart_Cap` object has two values—the restart time, which is the sender’s time to restart the `RSVP_TE` component and exchange hello messages after a failure; and the recovery time, which is the desired time that the sender wants the receiver to synchronize the `RSVP` and `MPLS` databases.

In the figure above, graceful restart is enabled on Router 1, Router 2, Router 3, and Router 4. For simplicity, assume that all routers are restart capable. A TE label switched path (LSP) is signaled from Router 1 to Router 4.

Router 2 and Router 3 exchange periodic graceful restart hello messages every 10000 ms (10 seconds), and so do Router 2 and Router 1 and Router 3 and Router 4. Assume that Router 2 advertises its restart time as 60000 ms (60 seconds) and its recovery time as 60000 ms (60 seconds) as shown in the following example:

```
23:33:36: Outgoing Hello:
23:33:36:   version:1 flags:0000 cksum:883C ttl:255 reserved:0 length:32
23:33:36:   HELLO                               type HELLO REQUEST length 12:
23:33:36:   Src_Instance: 0x6EDA8BD7, Dst_Instance: 0x00000000
23:33:36:   RESTART_CAP                           type 1 length 12:
23:33:36:   Restart_Time: 0x0000EA60
, Recovery_Time: 0x0000EA60
```



Note The restart and recovery time are shown in **bold** in the last entry.

Router 3 records this into its database. Also, both neighbors maintain the neighbor status as UP. However, Router 3's control plane fails at some point (for example, a Primary Route Processor failure). As a result, RSVP and TE lose their signaling information and states although data packets continue to be forwarded by the line cards.

When four ACK messages are missed from Router 2 (40 seconds), Router 3 declares communication with Router 2 lost "indicated by LOST" and starts the restart time to wait for the duration advertised in Router 2's restart time previously and recorded (60 seconds). Router 1 and Router 2 suppress all RSVP messages to Router 3 except hellos. Router 3 keeps sending the RSVP Path and Resv refresh messages to Router 4 and Router 5 so that they do not expire the state for the LSP; however, Router 3 suppresses these messages for Router 2.



Note A node restarts if it misses four ACKs or its hello src_instance (last source instance sent to its neighbor) changes so that its restart time = 0.

Before the restart time expires, Router 2 restarts and loads its configuration and graceful restart makes the configuration of Router 2 send the hello messages with a new source instance to all the data links attached. However, because Router 2 has lost the neighbor states, it does not know what destination instance it should use in those messages; therefore, all destination instances are set to 0.

When Router 3 sees the hello from Router 2, Router 3 stops the restart time for Router 2 and sends an ACK message back. When Router 3 sees a new source instance value in Router 2's hello message, Router 3 knows that Router 2 had a control plane failure. Router 2 gets Router 3's source instance value and uses it as the destination instance going forward.

Router 3 also checks the recovery time value in the hello message from Router 2. If the recovery time is 0, Router 3 knows that Router 2 was not able to preserve its forwarding information and Router 3 deletes all RSVP state that it had with Router 2.

If the recovery time is greater than 0, Router 1 sends Router 2 Path messages for each LSP that it had previously sent through Router 2. If these messages were previously refreshed in summary messages, they are sent individually during the recovery time. Each of these Path messages includes a Recovery_Label object containing the label value received from Router 2 before the failure.

When Router 3 receives a Path message from Router 2, Router 3 sends a Resv message upstream. However, Router 3 suppresses the Resv message until it receives a Path message.

How to Configure MPLS TE—RSVP Graceful Restart

Enabling Graceful Restart



Note It is optional that you configure graceful restart on an interface.

SUMMARY STEPS

1. **enable**
2. **configure terminal**
3. **ip rsvp signalling hello graceful-restart mode help-neighbor**
4. **interface *type number***
5. **ip rsvp signalling hello graceful-restart**
6. **exit**

DETAILED STEPS

	Command or Action	Purpose
Step 1	enable Example: Router> enable	Enables privileged EXEC mode. <ul style="list-style-type: none"> • Enter your password if prompted.
Step 2	configure terminal Example: Router# configure terminal	Enters global configuration mode.
Step 3	ip rsvp signalling hello graceful-restart mode help-neighbor Example: Router(config)# ip rsvp signalling hello graceful-restart mode help-neighbor	Sets the number of DSCP hello messages on a neighboring router with restart capability.
Step 4	interface <i>type number</i> Example: Router(config)# interface POS 1/0/0	(Optional) Configures the interface type and number and enters interface configuration mode.
Step 5	ip rsvp signalling hello graceful-restart Example: Router(config-if)# ip rsvp signalling hello graceful-restart	(Optional) Enables RSVP TE graceful restart capability on a neighboring router.
Step 6	exit Example: Router(config)# exit	Exits to privileged EXEC mode.

Setting a DSCP Value

SUMMARY STEPS

1. `enable`
2. `configure terminal`
3. `ip rsvp signalling hello graceful-restart dscp num`
4. `end`

DETAILED STEPS

	Command or Action	Purpose
Step 1	enable Example: <pre>Router> enable</pre>	Enables privileged EXEC mode. <ul style="list-style-type: none"> • Enter your password if prompted.
Step 2	configure terminal Example: <pre>Router# configure terminal</pre>	Enters global configuration mode.
Step 3	ip rsvp signalling hello graceful-restart dscp num Example: <pre>Router(config)# ip rsvp signalling hello graceful-restart dscp 30</pre>	Sets the number of DSCP hello messages on a graceful restart-enabled router.
Step 4	end Example: <pre>Router(config)# end</pre>	Exits to privileged EXEC mode.

Setting a Hello Refresh Interval

SUMMARY STEPS

1. `enable`
2. `configure terminal`
3. `ip rsvp signalling hello graceful-restart refresh interval interval-value`
4. `end`

DETAILED STEPS

	Command or Action	Purpose
Step 1	enable	Enables privileged EXEC mode.

	Command or Action	Purpose
	Example: <pre>Router> enable</pre>	<ul style="list-style-type: none"> Enter your password if prompted.
Step 2	configure terminal Example: <pre>Router# configure terminal</pre>	Enters global configuration mode.
Step 3	ip rsvp signalling hello graceful-restart refresh interval interval-value Example: <pre>Router(config)# ip rsvp signalling hello graceful-restart refresh interval 5000</pre>	Sets a hello refresh interval on a router with graceful restart enabled.
Step 4	end Example: <pre>Router(config)# end</pre>	Exits to privileged EXEC mode.

Setting a Missed Refresh Limit

SUMMARY STEPS

- enable
- configure terminal
- ip rsvp signalling hello graceful-restart refresh misses *msg-count*
- end

DETAILED STEPS

	Command or Action	Purpose
Step 1	enable Example: <pre>Router> enable</pre>	Enables privileged EXEC mode. <ul style="list-style-type: none"> Enter your password if prompted.
Step 2	configure terminal Example: <pre>Router# configure terminal</pre>	Enters global configuration mode.
Step 3	ip rsvp signalling hello graceful-restart refresh misses msg-count Example:	Sets a refresh limit on a router with graceful restart enabled.

	Command or Action	Purpose
	Router(config)# ip rsvp signalling hello graceful-restart refresh misses 5	
Step 4	end Example: Router(config)# end	Exits to privileged EXEC mode.

Verifying Graceful Restart Configuration

SUMMARY STEPS

1. enable
2. show ip rsvp hello graceful-restart
3. end

DETAILED STEPS

	Command or Action	Purpose
Step 1	enable Example: Router> enable	Enables privileged EXEC mode. <ul style="list-style-type: none"> • Enter your password if prompted.
Step 2	show ip rsvp hello graceful-restart Example: Router# show ip rsvp hello graceful-restart	Displays information about the status of graceful restart and related parameters.
Step 3	end Example: Router# end	Exits to user EXEC mode.

Configuration Examples for MPLS TE—RSVP Graceful Restart

MPLS TE—RSVP Graceful Restart Example

In the following example, graceful restart is enabled, and related parameters, including a DSCP value, a refresh interval, and a missed refresh limit are set:

```
Router# configure terminal
Enter configuration commands, one per line. End with CNTL/Z.
```

```

Router(config)# ip rsvp signalling hello graceful-restart mode help-neighbor
Router(config)# ip rsvp signalling hello graceful-restart dscp 30
Router(config)# ip rsvp signalling hello graceful-restart refresh interval 10000
Router(config)# ip rsvp signalling hello graceful-restart refresh misses 4
Router(config)# end

```

The following example verifies the status of graceful restart and the configured parameters:

```

Router# show ip rsvp hello graceful-restart
Graceful Restart:Enabled (help-neighbor only)
  Refresh interval:10000 msec
  Refresh misses:4
  DSCP:0x30
  Advertised restart time:0 secs
  Advertised recovery time:0 secs
  Maximum wait for recovery:3600000 secs

```

Additional References

Related Documents

Related Topic	Document Title
RSVP commands: complete command syntax, command mode, defaults, usage guidelines, and examples	Cisco IOS Quality of Service Solutions Command Reference
Quality of service (QoS) classification	Classification Overview
QoS signalling	Signalling Overview
QoS congestion management	Congestion Management Overview
Stateful switchover	Stateful Switchover
MPLS Label Distribution Protocol	MPLS Label Distribution Protocol (LDP)
Information on stateful switchover, Cisco nonstop forwarding, graceful restart	NSF/SSO—MPLS TE and RSVP Graceful Restart
RSVP hello state timer	MPLS Traffic Engineering: RSVP Hello State Timer

Standards

Standards	Title
No new or modified standards are supported by this feature, and support for existing standards has not been modified by this feature.	—

MIBs

MIBs	MIBs Link
No new or modified MIBs are supported by this feature, and support for existing MIBs has not been modified by this feature.	To locate and download MIBs for selected platforms, Cisco IOS releases, and feature sets, use Cisco MIB Locator found at the following URL: http://www.cisco.com/go/mibs

RFCs

RFCs	Title
RFC 3209	<i>RSVP-TE: Extensions to RSVP for LSP Tunnels</i>
RFC 3473	<i>Generalized Multi-Protocol Label Switching (GMPLS) Signaling Resource Reservation Protocol-Traffic Engineering (RSVP-TE) Extensions</i>
RFC 3478	<i>Graceful Restart Mechanism for Label Distribution</i>

Technical Assistance

Description	Link
The Cisco Support and Documentation website provides online resources to download documentation, software, and tools. Use these resources to install and configure the software and to troubleshoot and resolve technical issues with Cisco products and technologies. Access to most tools on the Cisco Support and Documentation website requires a Cisco.com user ID and password.	http://www.cisco.com/cisco/web/support/index.html

Feature Information for MPLS Traffic Engineering—RSVP Graceful Restart

The following table provides release information about the feature or features described in this module. This table lists only the software release that introduced support for a given feature in a given software release train. Unless noted otherwise, subsequent releases of that software release train also support that feature.

Use Cisco Feature Navigator to find information about platform support and Cisco software image support. To access Cisco Feature Navigator, go to www.cisco.com/go/cfn. An account on Cisco.com is not required.

Table 15: Feature Information for MPLS Traffic Engineering—RSVP Graceful Restart

Feature Name	Releases	Feature Information
MPLS Traffic Engineering—RSVP Graceful Restart	12.0(29)S 12.2(33)SRE 12.4(20)T Cisco IOS XE Release 2.3	<p>The MPLS TE—RSVP Graceful Restart feature allows a neighboring Route Processor (RP) to recover from disruption in control plane service (specifically, the Label Distribution Protocol (LDP) component) without losing its MPLS forwarding state.</p> <p>In Cisco IOS Release 12.0(29)S, this feature was introduced.</p> <p>In Cisco IOS Release 12.4(20)T, this feature was integrated.</p> <p>The following commands were introduced or modified: ip rsvp signalling hello graceful-restart dscp, ip rsvp signalling hello graceful-restart mode help-neighbor, ip rsvp signalling hello graceful-restart refresh interval, ip rsvp signalling hello graceful-restart refresh misses, show ip rsvp counters, show ip rsvp counters state teardown, show ip rsvp hello, show ip rsvp hello client lsp detail, show ip rsvp hello client lsp summary, show ip rsvp hello client neighbor detail, show ip rsvp hello client neighbor summary, show ip rsvp hello graceful-restart, show ip rsvp hello instance detail, show ip rsvp hello instance summary.</p> <p>In Cisco IOS Release 12.2(33)SRE, per node hellos allow interoperability with Cisco IOS Release 12.0S.</p>

Glossary

autonomous system—A collection of networks that share the same routing protocol and that are under the same system administration.

ASBR—Autonomous System Boundary Router. A router that connects and exchanges information between two or more autonomous systems.

backup tunnel—An MPLS traffic engineering tunnel used to protect other (primary) tunnels' traffic when a link or node failure occurs.

DSCP—differentiated services code point. Six bits in the IP header, as defined by the IETF. These bits determine the class of service provided to the IP packet.

Fast Reroute—A mechanism for protecting MPLS traffic engineering (TE) LSPs from link and node failure by locally repairing the LSPs at the point of failure, allowing data to continue to flow on them while their headend routers attempt to establish end-to-end LSPs to replace them. FRR locally repairs the protected LSPs by rerouting them over backup tunnels that bypass failed links or nodes.

graceful restart—A process for helping a neighboring Route Processor restart after a node failure has occurred.

headend—The router that originates and maintains a given LSP. This is the first router in the LSP's path.

IGP—Interior Gateway Protocol. Internet protocol used to exchange routing information within an autonomous system. Examples of common Internet IGPs include IGRP, OSPF, and RIP.

instance—A mechanism that implements the RSVP hello extensions for a given router interface address and remote IP address. Active hello instances periodically send Hello Request messages, expecting Hello ACK messages in response. If the expected ACK message is not received, the active hello instance declares that

the neighbor (remote IP address) is unreachable (that is, it is lost). This can cause LSPs crossing this neighbor to be fast rerouted.

label—A short, fixed-length data identifier that tells switching nodes how to forward data (packets or cells).

LDP—Label Distribution Protocol. The protocol that supports MPLS hop-by-hop forwarding by distributing bindings between labels and network prefixes. The Cisco proprietary version of this protocol is the Tag Distribution Protocol (TDP).

LSP—label switched path. A configured connection between two routers, in which MPLS is used to carry packets. A path created by the concatenation of one or more label switched hops, allowing a packet to be forwarded by swapping labels from an MPLS node to another MPLS node.

merge point—The tail of the backup tunnel.

MPLS—Multiprotocol Label Switching. A method for forwarding packets (frames) through a network. MPLS enables routers at the edge of a network to apply labels to packets (frames). ATM switches or existing routers in the network core can switch packets according to the labels.

PLR—point of local repair. The headend of the backup tunnel.

RSVP—Resource Reservation Protocol. A protocol that supports the reservation of resources across an IP network. Applications running on IP end systems can use RSVP to indicate to other nodes the nature (bandwidth, jitter, maximum burst, and so on) of the packet streams they want to receive.

RP—Route processor. Processor module in routers that contains the CPU, system software, and most of the memory components that are used in the router. Sometimes called a supervisory processor.

state—Information that a router must maintain about each LSP. The information is used for rerouting tunnels.

tailend—The router upon which an LSP is terminated. This is the last router in the LSP's path.

TE—traffic engineering. The techniques and processes used to cause routed traffic to travel through the network on a path other than the one that would have been chosen if standard routing methods had been used.

topology—The physical arrangement of network nodes and media within an enterprise networking structure.

tunnel—Secure communications path between two peers, such as two routers.