



IP Addresses and Services Configuration Guide for Cisco NCS 5500 Series Routers, IOS XR Release 7.1.x

First Published: 2020-01-01

Last Modified: 2019-08-28

Americas Headquarters

Cisco Systems, Inc.
170 West Tasman Drive
San Jose, CA 95134-1706
USA
<http://www.cisco.com>
Tel: 408 526-4000
800 553-NETS (6387)
Fax: 408 527-0883

THE SPECIFICATIONS AND INFORMATION REGARDING THE PRODUCTS IN THIS MANUAL ARE SUBJECT TO CHANGE WITHOUT NOTICE. ALL STATEMENTS, INFORMATION, AND RECOMMENDATIONS IN THIS MANUAL ARE BELIEVED TO BE ACCURATE BUT ARE PRESENTED WITHOUT WARRANTY OF ANY KIND, EXPRESS OR IMPLIED. USERS MUST TAKE FULL RESPONSIBILITY FOR THEIR APPLICATION OF ANY PRODUCTS.

THE SOFTWARE LICENSE AND LIMITED WARRANTY FOR THE ACCOMPANYING PRODUCT ARE SET FORTH IN THE INFORMATION PACKET THAT SHIPPED WITH THE PRODUCT AND ARE INCORPORATED HEREIN BY THIS REFERENCE. IF YOU ARE UNABLE TO LOCATE THE SOFTWARE LICENSE OR LIMITED WARRANTY, CONTACT YOUR CISCO REPRESENTATIVE FOR A COPY.

The Cisco implementation of TCP header compression is an adaptation of a program developed by the University of California, Berkeley (UCB) as part of UCB's public domain version of the UNIX operating system. All rights reserved. Copyright © 1981, Regents of the University of California.

NOTWITHSTANDING ANY OTHER WARRANTY HEREIN, ALL DOCUMENT FILES AND SOFTWARE OF THESE SUPPLIERS ARE PROVIDED "AS IS" WITH ALL FAULTS. CISCO AND THE ABOVE-NAMED SUPPLIERS DISCLAIM ALL WARRANTIES, EXPRESSED OR IMPLIED, INCLUDING, WITHOUT LIMITATION, THOSE OF MERCHANTABILITY, FITNESS FOR A PARTICULAR PURPOSE AND NON-INFRINGEMENT OR ARISING FROM A COURSE OF DEALING, USAGE, OR TRADE PRACTICE.

IN NO EVENT SHALL CISCO OR ITS SUPPLIERS BE LIABLE FOR ANY INDIRECT, SPECIAL, CONSEQUENTIAL, OR INCIDENTAL DAMAGES, INCLUDING, WITHOUT LIMITATION, LOST PROFITS OR LOSS OR DAMAGE TO DATA ARISING OUT OF THE USE OR INABILITY TO USE THIS MANUAL, EVEN IF CISCO OR ITS SUPPLIERS HAVE BEEN ADVISED OF THE POSSIBILITY OF SUCH DAMAGES.

Any Internet Protocol (IP) addresses and phone numbers used in this document are not intended to be actual addresses and phone numbers. Any examples, command display output, network topology diagrams, and other figures included in the document are shown for illustrative purposes only. Any use of actual IP addresses or phone numbers in illustrative content is unintentional and coincidental.

All printed copies and duplicate soft copies of this document are considered uncontrolled. See the current online version for the latest version.

Cisco has more than 200 offices worldwide. Addresses and phone numbers are listed on the Cisco website at www.cisco.com/go/offices.

The documentation set for this product strives to use bias-free language. For purposes of this documentation set, bias-free is defined as language that does not imply discrimination based on age, disability, gender, racial identity, ethnic identity, sexual orientation, socioeconomic status, and intersectionality. Exceptions may be present in the documentation due to language that is hardcoded in the user interfaces of the product software, language used based on standards documentation, or language that is used by a referenced third-party product.

Cisco and the Cisco logo are trademarks or registered trademarks of Cisco and/or its affiliates in the U.S. and other countries. To view a list of Cisco trademarks, go to this URL: <https://www.cisco.com/c/en/us/about/legal/trademarks.html>. Third-party trademarks mentioned are the property of their respective owners. The use of the word partner does not imply a partnership relationship between Cisco and any other company. (1721R)

© 2020 Cisco Systems, Inc. All rights reserved.



CONTENTS

PREFACE

Preface xi

Changes to This Document xi

Communications, Services, and Additional Information xi

CHAPTER 1

New and Changed IP Addresses and Services Features 1

IP Addresses and Services Features Added or Modified in IOS XR Release 7.1.x 1

CHAPTER 2

Implementing Network Stack IPv4 and IPv6 3

Implementing Network Stack IPv4 and IPv6 3

Implementing Fallback VRF 3

Network Stack IPv4 and IPv6 Exceptions 4

IPv4 and IPv6 Functionality 4

IPv6 for Cisco IOS XR Software 5

How to Implement Network Stack IPv4 and IPv6 5

Configuring IPv4 Addressing 5

Configuring IPv6 Addressing 6

IPv6 Multicast Groups 7

Configure Fallback VRF 11

Assigning Multiple IP Addresses to Network Interfaces 11

Configuring IPv4 and IPv6 Protocol Stacks 13

Enabling IPv4 Processing on an Unnumbered Interface 14

IPv4 ICMP Rate Limiting 15

IPv6 ICMP Rate Limiting 17

Selecting Flexible Source IP 18

Configuring IPARM Conflict Resolution 18

Static Policy Resolution 18

Longest Prefix Address Conflict Resolution	19
Highest IP Address Conflict Resolution	20
Route-Tag Support for Connected Routes	20
Larger IPv6 Address Space	21
IPv6 Address Formats	21
IPv6 Address Type: Unicast	22
Aggregatable Global Address	23
Link-Local Address	24
IPv4-Compatible IPv6 Address	24
Simplified IPv6 Packet Header	25
Path MTU Discovery for IPv6	28
IPv6 Neighbor Discovery	28
IPv6 Neighbor Solicitation Message	28
IPv6 Router Advertisement Message	30
IPv6 Neighbor Redirect Message	31
Address Repository Manager	33
Address Conflict Resolution	33

CHAPTER 3**Configuring ARP 35**

Configuring ARP	35
ARP Cache Entries	36
Defining a Static ARP Cache Entry	36
Proxy ARP and Local Proxy ARP	36
Enabling Proxy ARP	37
Enabling Local Proxy ARP	38
Configure Learning of Local ARP Entries	39
Information About Configuring ARP	40
Addressing Resolution Overview	40
Address Resolution on a Single LAN	40
Address Resolution When Interconnected by a Router	41

CHAPTER 4**Implementing the Dynamic Host Configuration Protocol 43**

Introduction to DHCP Relay	43
Prerequisites for Configuring DHCP Relay Agent	44

Limitations for DHCP Relay Feature	44
How to Configure and Enable DHCP Relay Agent	45
Configuring and Enabling the DHCP Relay Agent	45
Enabling DHCP Relay Agent on an Interface	46
Disabling DHCP Relay on an Interface	46
Enabling DHCP Relay on a VRF	46
Configure a DHCP Relay Profile with Multiple Helper Addresses	46
DHCP Relay Agent Notification for Prefix Delegation	47
Configuring DHCP Stateful Relay Agent for Prefix Delegation	48
DHCPv6 Relay Over BVI for IANA Address Allocation	48
DHCP Relay Profile: Example	52
DHCP Relay on an Interface: Example	52
DHCP Relay on a VRF: Example	52
Relay Agent Information Option Support: Example	52
Relay Agent Giaddr Policy: Example	52
Configure a DHCP Proxy Profile	53
DHCP Server	53
Configuring DHCP Server Profile	54
Configuring Multiple Classes with a Pool	55
Configuring a Server Profile DAPS with Class Match Option	55
Configuring Server Profile without DAPS Pool Match Option	56
Configuring an Address Pool for Each ISP on DAPS	57
DHCP Client	58
Enabling DHCP Client on an Interface	58
DHCP Proxy Binding Table Reload Persistency	58
Configuring DHCP Relay Binding Database Write to System Persistent Memory	59

CHAPTER 5**Implementing Host Services and Applications 61**

Implementing Host Services and Applications	61
Network Connectivity Tools	61
Ping	61
Checking Network Connectivity	62
Checking Network Connectivity for Multiple Destinations	63
Traceroute	64

Checking Packet Routes	65
Domain Services	65
Configuring Domain Services	66
File Transfer Services	67
FTP	67
Configuring a Router to Use FTP Connections	67
TFTP	68
TFTP Server	68
Configuring a Router as a TFTP Server	68
Configuring a Router to Use TFTP Connections	69
SCP	70
Transferring Files Using SCP	70
Cisco inetd	70
Telnet	71
Syslog source-interface	71

CHAPTER 6**Implementing Access Lists and Prefix Lists 73**

Understanding Access Lists	73
Display Access Lists	77
User-Defined TCAM Keys for IPv4 and IPv6	80
User-Defined Fields	81
IPv4 and IPv6 Key Formats for Traditional Ingress ACL	81
Configuring IPv4 ACLs	83
Configuring IPv6 ACLs	86
Modifying ACLs	91
Configuring ACL-based Forwarding	92
ACLs on Bridge Virtual Interfaces	94
Configuring ACLs with Fragment Control	97
Configuring an IPv4 ACL to Match on Fragment Type	99
Matching by Fragment Offset in ACLs	100
Configuring ACL Matching by Fragment Offset	101
Configuring ACL Filtering by IP Packet Length	102
Configuring Simple IPv4 ACLs to Filter by Packet Length	103
Configuring Scaled IPv4 ACLs to Filter by Packet Length	104

Configuring Scaled IPv6 ACLs to Filter by Packet Length	105
Understanding Object-Group ACLs	106
Configuring an Object-Group ACL	107
Configuring a Network Object-Group ACL	107
Configuring a Port Object-Group ACL	109
Verifying Object-Group ACL Compression	110
Configuring TTL Matching and Rewriting for IPv4 ACLs	111
Configuring Interface-Based Unique IPv4 ACLs	112
Configuring TTL Matching and Rewriting for IPv6 ACLs	114
Configuring Interface-Based Unique IPv6 ACLs	115
Filtering Packets with IPv6 Extension Headers	116
Configuring Extended Access Lists	117
Understanding IP Access List Logging Messages	118
Understanding Prefix Lists	120
Configuring Prefix Lists	120
Sequencing Prefix List Entries and Revising the Prefix List	121

CHAPTER 7**Implementing Cisco Express Forwarding 123**

Implementing Cisco Express Forwarding	123
Verifying CEF	124
Unicast Reverse Path Forwarding	128
Configure Unicast Reverse Path Forwarding	130
Per-Flow Load Balancing	131
Configuring Static Route	138
BGP Attributes Download	140
Proactive Address Resolution Protocol and Neighbor Discovery	141

CHAPTER 8**Implementing HSRP 143**

Implementing HSRP	143
Prerequisites for Implementing HSRP	143
Restrictions for Implementing HSRP	144
Information About Implementing HSRP	144
HSRP Overview	144
HSRP Groups	144

HSRP and ARP	146
Preemption	147
ICMP Redirect Messages	147
How to Implement HSRP	147
Enabling HSRP	147
Enabling HSRP for IPv6	148
Configuring HSRP Group Attributes	150
Configuring the HSRP Activation Delay	152
Disabling HSRP Support for ICMP Redirect Messages	153
Multiple Group Optimization (MGO) for HSRP	155
Customizing HSRP	155
Configuring a Primary Virtual IPv4 Address	156
Configuring a Secondary Virtual IPv4 Address	157
Configuring the Subordinate Group to Inherit its State from a Specified Group	158
Configuring a Subordinate Primary Virtual IPv4 Address	159
Configuring a Secondary Virtual IPv4 address for the Subordinate Group	159
Configuring a Subordinate Virtual MAC Address	160
Configuring an HSRP Session Name	161
BFD for HSRP	162
Advantages of BFD	162
BFD Process	162
Configuring BFD	162
Enabling BFD	162
Modifying BFD timers (minimum interval)	162
Modifying BFD timers (multiplier)	163
Enhanced Object Tracking for HSRP and IP Static	163
Configuring object tracking for HSRP	163
Hot Restartability for HSRP	164
Configuration Examples for HSRP Implementation on Software	164
Configuring an HSRP Group: Example	164
Configuring a Router for Multiple HSRP Groups: Example	165
CHAPTER 9	Implementing LPTS
	167
	LPTS Overview
	167

LPTS Policers	167
Per Port Rate Limiting of Multicast and Broadcast Punt Packets	172
Configuring a Rate Limit to the Multicast and Broadcast Punted Traffic	172
LPTS Domain Based Policers	179
Defining Dynamic LPTS Flow Type	180

CHAPTER 10
Implementing VRRP 183

Configuring VRRP	183
Understanding VRRP	183
Understanding VRRP over BVI	187
Configuring VRRP for IPv4 Networks	187
Configuring VRRP for IPv6 Networks	189
Configure VRRP over BVI	192
BFD for VRRP	196
Advantages of BFD	196
BFD Process	196
Configuring BFD	197
Disabling State Change Logging	198
Enabling Multiple Group Optimization (MGO) for VRRP	198
Configuring SNMP Server Notifications for VRRP Events	199

CHAPTER 11
Configuring Transports 201

Information About Configuring NSR, TCP, UDP Transports	201
NSR Overview	201
TCP Overview	201
UDP Overview	202
Configuring Failover as a Recovery Action for NSR	202



Preface



Note This product has reached end-of-life status. For more information, see the [End-of-Life and End-of-Sale Notices](#).

This preface contains these sections:

- [Changes to This Document, on page xi](#)
- [Communications, Services, and Additional Information, on page xi](#)

Changes to This Document

Table 1: Changes to This Document

Date	Change Summary
January 2020	Initial release of this document.
April 2020	Republished for Release 7.1.15.

Communications, Services, and Additional Information

- To receive timely, relevant information from Cisco, sign up at [Cisco Profile Manager](#).
- To get the business impact you're looking for with the technologies that matter, visit [Cisco Services](#).
- To submit a service request, visit [Cisco Support](#).
- To discover and browse secure, validated enterprise-class apps, products, solutions and services, visit [Cisco Marketplace](#).
- To obtain general networking, training, and certification titles, visit [Cisco Press](#).
- To find warranty information for a specific product or product family, access [Cisco Warranty Finder](#).

Cisco Bug Search Tool

[Cisco Bug Search Tool](#) (BST) is a web-based tool that acts as a gateway to the Cisco bug tracking system that maintains a comprehensive list of defects and vulnerabilities in Cisco products and software. BST provides you with detailed defect information about your products and software.



CHAPTER

1

New and Changed IP Addresses and Services Features

This table summarizes the new and changed feature information for the *IP Addresses and Services Configuration Guide for Cisco NCS 5500 Series Routers*, and tells you where they are documented.

- [IP Addresses and Services Features Added or Modified in IOS XR Release 7.1.x, on page 1](#)

IP Addresses and Services Features Added or Modified in IOS XR Release 7.1.x

This section describes the new and changed IP addresses features for Cisco IOS XR.

IP Addresses Features Added or Modified in IOS XR Release 7.1.x

Table 2: New and Changed Features

Feature	Description	Changed in Release	Where Documented
Support for HSRP v4/v6	This feature was introduced in this release.	Release 7.1.1	Implementing HSRP, on page 143
Show CEF Enhancements	This feature was introduced in this release.	Release 7.1.1	Configuring Static Route, on page 138



CHAPTER 2

Implementing Network Stack IPv4 and IPv6

- [Implementing Network Stack IPv4 and IPv6, on page 3](#)
- [Implementing Fallback VRF , on page 3](#)
- [Network Stack IPv4 and IPv6 Exceptions, on page 4](#)
- [IPv4 and IPv6 Functionality, on page 4](#)
- [IPv6 for Cisco IOS XR Software, on page 5](#)
- [How to Implement Network Stack IPv4 and IPv6, on page 5](#)

Implementing Network Stack IPv4 and IPv6

The Network Stack IPv4 and IPv6 features are used to configure and monitor Internet Protocol Version 4 (IPv4) and Internet Protocol Version 6 (IPv6).

Restrictions

In any Cisco IOS XR software release with IPv6 support, multiple IPv6 global addresses can be configured on an interface. However, multiple IPv6 link-local addresses on an interface are not supported.

Implementing Fallback VRF

Virtual Routing and Forwarding (VRF) is an IP technology that allows multiple instances of a routing table to coexist simultaneously on the same router. Because the routing instances are independent, the same IP addresses can be used without conflict.

If the destination prefix of a data packet does not match any route in the configured VRF, a default route is identified from the global routing table. However, using a default route needs an explicit next hop and that may not be efficient. A better option is to configure a fallback VRF route. If the destination does not have a match in the VRF table, the fallback VRF table is used. The fallback VRF can either be the global routing table or a non-global VRF table.

Restrictions

The following restrictions apply if you configure a fallback VRF route:

- You can configure only one fallback VRF route for each address family of each primary VRF.
- Ping, traceroute, or any slow path application is not supported on fallback VRF because there is no support for LPTS receive trap.

- Only 255 VRFs and 1 global table are supported on the router.
- If you configure a static default route to a VRF, the static default route takes precedence over the fallback VRF. If you configure the default route for a VRF, the global routing table is used for a route lookup. The default route is always directed to the configured next hop.
- If a route lookup for a packet fails in the primary VRF, the packet is recycled to do route lookup in the fallback VRF. Therefore, the routing performance of the packet goes down by up to 50 percent.
- If you configure both ACL-based forwarding (ABF) VRF redirect and VRF fallback for a packet, then the packet is recycled twice. Therefore, the routing performance of the packet goes down by up to 33 percent.
- If a route for a packet is found in the fallback VRF, only the Glean IPv4 and Glean IPv6 adjacency packets are punted successfully.
- In a looped configuration, if the route for a packet is not found in both the primary and fallback VRF, the packet loops in the recycle path. Eventually, the packet is dropped in the recycle egress queue. The recycle queue is of highest priority. Therefore, if there is a high rate of looped traffic, other good recycled packets may be dropped.

Network Stack IPv4 and IPv6 Exceptions

The Network Stack feature in the Cisco IOS XR software has the following exceptions:

- In Cisco IOS XR software, the **clear ipv6 neighbors** and **show ipv6 neighbors** commands include the **location node-id** keyword. If a location is specified, only the neighbor entries in the specified location are displayed.
- The **ipv6 nd scavenge-timeout** command sets the lifetime for neighbor entries in the stale state. When the scavenge-timer for a neighbor entry expires, the entry is cleared.
- In Cisco IOS XR software, the **show ipv4 interface** and **show ipv6 interface** commands include the **location node-id** keyword. If a location is specified, only the interface entries in the specified location are displayed.
- Cisco IOS XR software allows conflicting IP address entries at the time of configuration. If an IP address conflict exists between two interfaces that are active, Cisco IOS XR software brings down the interface according to the configured conflict policy, the default policy being to bring down the higher interface instance.

For example, if HundredGigE 0/0/0/1 conflicts with HundredGigE 0/0/0/2, then the IPv4 protocol on HundredGigE 0/0/0/2, is brought down and IPv4 remains active on HundredGigE 0/0/0/1.

IPv4 and IPv6 Functionality

When Cisco IOS XR software is configured with both an IPv4 and an IPv6 address, the interface can send and receive data on both IPv4 and IPv6 networks.

The architecture of IPv6 has been designed to allow existing IPv4 users to make the transition easily to IPv6 while providing services such as end-to-end security, quality of service (QoS), and globally unique addresses. The larger IPv6 address space allows networks to scale and provide global reachability. The simplified IPv6

packet header format handles packets more efficiently. IPv6 prefix aggregation, simplified network renumbering, and IPv6 site multihoming capabilities provide an IPv6 addressing hierarchy that allows for more efficient routing. IPv6 supports widely deployed routing protocols such as Open Shortest Path First (OSPF), and multiprotocol Border Gateway Protocol (BGP).

The IPv6 neighbor discovery (nd) process uses Internet Control Message Protocol (ICMP) messages and solicited-node multicast addresses to determine the link-layer address of a neighbor on the same network (local link), verify the reachability of a neighbor, and keep track of neighboring routers.

IPv6 for Cisco IOS XR Software

IPv6, formerly named IPng (next generation) is the latest version of the Internet Protocol (IP). IP is a packet-based protocol used to exchange data, voice, and video traffic over digital networks. IPv6 was proposed when it became clear that the 32-bit addressing scheme of IP version 4 (IPv4) was inadequate to meet the demands of Internet growth. After extensive discussion, it was decided to base IPng on IP but add a much larger address space and improvements such as a simplified main header and extension headers. IPv6 is described initially in RFC 2460, *Internet Protocol, Version 6 (IPv6) Specification* issued by the Internet Engineering Task Force (IETF). Further RFCs describe the architecture and services supported by IPv6.

How to Implement Network Stack IPv4 and IPv6

This section contains the following procedures:

Configuring IPv4 Addressing

A basic and required task for configuring IP is to assign IPv4 addresses to network interfaces. Doing so enables the interfaces and allows communication with hosts on those interfaces using IPv4. An IP address identifies a location to which IP datagrams can be sent. An interface can have one primary IP address and multiple secondary addresses. Packets generated by the software always use the primary IPv4 address. Therefore, all networking devices on a segment should share the same primary network number.

Associated with this task are decisions about subnetting and masking the IP addresses. A mask identifies the bits that denote the network number in an IP address. When you use the mask to subnet a network, the mask is then referred to as a *subnet mask*.



Note Cisco supports only network masks that use contiguous bits that are flush left against the network field.

Configuration Example

An IPv4 address of 192.168.1.27 and a network mask of "/8" is assigned to the **interface HundredGigE 0/0/0/1**.



Note The network mask can be a four-part dotted decimal address. For example, 255.0.0.0 indicates that each bit equal to 1 means the corresponding address bit belongs to the network address. The network mask can be indicated as a slash (/) and a number- a prefix length. The prefix length is a decimal value that indicates how many of the high-order contiguous bits of the address comprise the prefix (the network portion of the address). A slash must precede the decimal value, and there is no space between the IP address and the slash.

```
Router#configure HundredGigE0/0/0/1
Router(config)#interface HundredGigE 0/0/0/1
Router(config-if)#ipv4 address 192.168.1.27/8
Router(config-if)#commit
```

Running Configuration

```
Router#show running-config interface HundredGigE0/0/0/1
  ipv4 address 192.168.1.27 255.0.0.0
!
```

Verification

Verify that the HundredGigE interface is active and IPv4 is enabled.

```
Router# show ipv4 interface HundredGigE0/0/0/1

interface HundredGigE0/0/0/1 is Up, ipv4 protocol is Up
  Vrf is default (vrfid 0x60000000)
  Internet address is 192.168.1.27/8
  MTU is 1514 (1500 is available to IP)
  Helper address is not set
  Multicast reserved groups joined: 224.0.0.2 224.0.0.1
  Directed broadcast forwarding is disabled
  Outgoing access list is not set
  Inbound access list is not set
  Proxy ARP is disabled
  ICMP redirects are never sent
  ICMP unreachable are always sent
  ICMP mask replies are never sent
  Table Id is 0xe0000000
```

Associated Commands

- ipv4 address
- show ipv4 interface

Configuring IPv6 Addressing

IPv6 addresses are configured to individual router interfaces in order to enable the forwarding of IPv6 traffic globally on the router. By default, IPv6 addresses are not configured.



Note The *ipv6-prefix* argument in the **ipv6 address** command must be in the form documented in RFC 2373 in which the address is specified in hexadecimal using 16-bit values between colons.

The **/prefix-length** argument in the **ipv6 address** command is a decimal value that indicates how many of the high-order contiguous bits of the address comprise the prefix (the network portion of the address). A slash must precede the decimal value.

The *ipv6-address* argument in the **ipv6 address link-local** command must be in the form documented in RFC 2373 where the address is specified in hexadecimal using 16-bit values between colons.

IPv6 Multicast Groups

An IPv6 address must be configured on an interface for the interface to forward IPv6 traffic. Configuring a global IPv6 address on an interface automatically configures a link-local address and activates IPv6 for that interface.

Additionally, the configured interface automatically joins the following required multicast groups for that link:

- Solicited-node multicast group FF02:0:0:0:1:FF00::/104 for each unicast address assigned to the interface
- All-nodes link-local multicast group FF02::1
- All-routers link-local multicast group FF02::2



Note The solicited-node multicast address is used in the neighbor discovery process.

Configuration Example

An IPv6 address of 2001:0DB8:0:1::1/64 is assigned to the **interface HundredGigE 0/0/0/1**:

```
Router#configure
Router(config)#interface HundredGigE 0/0/0/1
Router(config-if)#ipv6 address 2001:0DB8:0:1::1/64
Router(config-if)#commit
```

Running Configuration

```
Router#show running-config interface HundredGigE0/0/0/1
```

```
interface HundredGigE0/0/0/1
  ipv4 address 192.168.1.27 255.0.0.0
  ipv4 address 1.0.0.1 255.255.255.0 secondary
  ipv4 address 2.0.0.1 255.255.255.0 secondary
  ipv6 address 2001:db8:0:1::1/64
!
```

Verification

Verify that the HundredGigE interface is active and IPv6 is enabled.

```
Router#show ipv6 interface HundredGigE0/0/0/1
HundredGigE0/0/0/1 is Up, ipv6 protocol is Up, Vrfid is default (0x60000000)
  IPv6 is enabled, link-local address is fe80::c672:95ff:fea6:1c75
  Global unicast address(es):
    2001:db8:0:1::1, subnet is 2001:db8:0:1::/64
  Joined group address(es): ff02::1:ff00:1 ff02::1:ffa6:1c75 ff02::2
    ff02::1
```

```

MTU is 1514 (1500 is available to IPv6)
ICMP redirects are disabled
ICMP unreachable are enabled
ND DAD is enabled, number of DAD attempts 1
ND reachable time is 0 milliseconds
ND cache entry limit is 1000000000
ND advertised retransmit interval is 0 milliseconds
Hosts use stateless autoconfig for addresses.
Outgoing access list is not set
Inbound access list is not set
Table Id is 0xe0800000
Complete protocol adjacency: 0
Complete glean adjacency: 0
Incomplete protocol adjacency: 0
Incomplete glean adjacency: 0
Dropped protocol request: 0
Dropped glean request: 0

```

Associated Commands

- ipv6 address
- interface
- show ipv6 interface

Configuration Example

An IPv6 address of 2001:0DB8:0:1::/64 is assigned to the **interface HundredGigE 0/0/0/1**. The **eui-64** keyword configures site-local and global IPv6 addresses with an interface identifier (ID) in the low-order 64 bits of the IPv6 address. Only the 64-bit network prefix for the address needs to be specified; the last 64 bits are automatically computed from the interface ID.

```

Router#configure
Router(config)#interface HundredGigE 0/0/0/1
Router(config-if)#ipv6 address 2001:0DB8:0:1::/64 eui-64
Router(config-if)#commit

```

Running Configuration

```

Router#show running-config interface HundredGigE0/0/0/1

interface HundredGigE0/0/0/1
  ipv4 address 192.168.1.27 255.0.0.0
  ipv4 address 1.0.0.1 255.255.255.0 secondary
  ipv4 address 2.0.0.1 255.255.255.0 secondary
  ipv6 address 2001:db8:0:1::/64 eui-64
!
```

Verification

Verify that the HundredGigE interface is active and IPv6 is enabled.

```

Router#show ipv6 interface HundredGigE0/0/0/1
HundredGigE0/0/0/1 is Up, ipv6 protocol is Up, Vrfid is default (0x60000000)
  IPv6 is enabled, link-local address is fe80::c672:95ff:fea6:1c75
  Global unicast address(es):
    2001:db8:0:1:c672:95ff:fea6:1c75, subnet is 2001:db8:0:1::/64
  Joined group address(es): ff02::1:ffa6:1c75 ff02::2 ff02::1
  MTU is 1514 (1500 is available to IPv6)
  ICMP redirects are disabled

```

```

ICMP unreachable are enabled
ND DAD is enabled, number of DAD attempts 1
ND reachable time is 0 milliseconds
ND cache entry limit is 1000000000
ND advertised retransmit interval is 0 milliseconds
Hosts use stateless autoconfig for addresses.
Outgoing access list is not set
Inbound access list is not set
Table Id is 0xe0800000
Complete protocol adjacency: 0
Complete glean adjacency: 0
Incomplete protocol adjacency: 0
Incomplete glean adjacency: 0
Dropped protocol request: 0
Dropped glean request: 0

```

Associated Commands

- `ipv6 address`
- `interface`
- `show ipv6 interface`

Configuration Example

An IPv6 address of FE80::260:3EFF:FE11:6770 is assigned to the **interface HundredGigE 0/0/0/1**. The link-local keyword configures a link-local address on the interface that is used instead of the link-local address that is automatically configured when IPv6 is enabled on the interface.

```

Router#configure
Router(config)#interface HundredGigE 0/0/0/1
Router(config-if)#ipv6 address FE80::260:3EFF:FE11:6770 link-local
Router(config-if)#commit

```

Running Configuration

```

Router#show running-config interface HundredGigE0/0/0/1
interface HundredGigE0/0/0/1
  ipv6 address fe80::260:3eff:fe11:6770 link-local
!

```

Verification

Verify that the HundredGigE interface is active and IPv6 is enabled with link-local address.

```

Router#show ipv6 interface HundredGigE0/0/0/1
HundredGigE0/0/0/1 is Up, ipv6 protocol is Up, Vrfid is default (0x60000000)
  IPv6 is enabled, link-local address is fe80::260:3eff:fe11:6770
  Global unicast address(es):
    2001:db8:0:1:260:3eff:fe11:6770, subnet is 2001:db8:0:1::/64
  Joined group address(es): ff02::1:ff11:6770 ff02::2 ff02::1
  MTU is 1514 (1500 is available to IPv6)
  ICMP redirects are disabled
  ICMP unreachable are enabled
  ND DAD is enabled, number of DAD attempts 1
  ND reachable time is 0 milliseconds
  ND cache entry limit is 1000000000
  ND advertised retransmit interval is 0 milliseconds
  Hosts use stateless autoconfig for addresses.
  Outgoing access list is not set

```

```
Inbound access list is not set
Table Id is 0xe0800000
Complete protocol adjacency: 0
Complete glean adjacency: 0
Incomplete protocol adjacency: 0
Incomplete glean adjacency: 0
Dropped protocol request: 0
Dropped glean request: 0
```

Associated Commands

- ipv6 address
- interface
- show ipv6 interface

Configuration Example

Enable IPv6 processing on the **interface HundredGigE 0/0/0/1**; that has not been configured with an explicit IPv6 address.

```
Router#configure
Router(config)#interface HundredGigE 0/0/0/1
Router(config-if)#ipv6 enable
Router(config-if)#commit
```

Running Configuration

```
Router#show running-config interface HundredGigE0/0/0/1
interface HundredGigE0/0/0/1

ipv6 enable
!
```

Verification

Verify that the HundredGigE interface is active and IPv6 is enabled.

```
Router#show ipv6 interface HundredGigE0/0/0/1
HundredGigE0/0/0/1 is Up, ipv6 protocol is Up, Vrfid is default (0x60000000)
  IPv6 is enabled, link-local address is fe80::c672:95ff:fea6:1c75
  No global unicast address is configured
  Joined group address(es): ff02::1:ffa6:1c75 ff02::2 ff02::1
  MTU is 1514 (1500 is available to IPv6)
  ICMP redirects are disabled
  ICMP unreachable are enabled
  ND DAD is enabled, number of DAD attempts 1
  ND reachable time is 0 milliseconds
  ND cache entry limit is 1000000000
  ND advertised retransmit interval is 0 milliseconds
  Hosts use stateless autoconfig for addresses.
  Outgoing access list is not set
  Inbound access list is not set
  Table Id is 0xe0800000
  Complete protocol adjacency: 0
  Complete glean adjacency: 0
  Incomplete protocol adjacency: 0
  Incomplete glean adjacency: 0
  Dropped protocol request: 0
  Dropped glean request: 0
```

Associated Commands

- `ipv6 enable`
- `interface`
- `show ipv6 interface`

Configure Fallback VRF

You can configure a fallback VRF for a destination route that does not match any routes in the configured VRF.

The following example shows how to configure the **fallback-vrf** command for a destination that does not match any routes in the configured VRF.

```
Router# configure
Router(config)# vrf vrf1
Router(config-vrf)# fallback-vrf vrf2
```

Verification

To verify the fallback VRF details, use the **show cef vrf vrf-name ipv4-prefix/ipv6-prefix hardware egress location line-card-location** command:

```
Router# show cef vrf vrf100 192.0.2.1 hardware egress location 0/1/CPU0
0.0.0.0/0, version 0, proxy default, internal 0x1200011 0x0 (ptr 0x8983f534) [1], 0x0
(0x894fa728), 0x0 (0x0)
Updated Mar 21 14:01:43.765
Prefix Len 0, traffic index 0, precedence n/a, priority 15
  via 0.0.0.0/32, 0 dependencies, weight 0, class 0 [flags 0x0]
  path-idx 0 NHID 0x0 [0x8871b168 0x0]
  next hop VRF - 'vrf200', table - 0xe0000008
  next hop 0.0.0.0/32
LEAF - HAL pd context :
sub-type : IPV4, ecd_marked:0, has_collapsed_ldi:0
collapse_bwalk_required:0, ecdv2_marked:0,
HW Walk:
```

Assigning Multiple IP Addresses to Network Interfaces

The Cisco IOS XR software supports multiple IP addresses (secondary addresses) per interface. You can specify an unlimited number of secondary addresses. Secondary IP addresses can be used in a variety of situations. The following are the most common applications:

- There might not be enough host addresses for a particular network segment. For example, suppose your subnetting allows up to 254 hosts per logical subnet, but on one physical subnet you must have 300 host addresses. Using secondary IP addresses on the routers or access servers allows you to have two logical subnets using one physical subnet.
- Many older networks were built using Level 2 bridges, and were not subnetted. The judicious use of secondary addresses can aid in the transition to a subnetted, router-based network. Routers on an older, bridged segment can easily be made aware that many subnets are on that segment.

- Two subnets of a single network might otherwise be separated by another network. You can create a single network from subnets that are physically separated by another network by using a secondary address. In these instances, the first network is *extended*, or layered on top of the second network. Note that a subnet cannot appear on more than one active interface of the router at a time.



Note If any router on a network segment uses a secondary IPv4 address, all other routers on that same segment must also use a secondary address from the same network or subnet.



Caution Inconsistent use of secondary addresses on a network segment can quickly cause routing loops.

Configuration Example

A secondary IPv4 address of 192.168.1.27 is assigned to the Hundredgige interface-0/0/0/1.

Note: For IPv6, an interface can have multiple IPv6 addresses without specifying the **secondary** keyword.

```
Router# configure
Router(config)# interface HundredGigE 0/0/0/1
Router(config-if)# ipv4 address 192.168.1.27 255.255.255.0 secondary
Router(config-if)# commit
```

Running Configuration

```
Router#show running-config interface HundredGigE0/0/0/1
interface HundredGigE0/0/0/1
  ipv4 address 192.168.1.27 255.255.255.0 secondary
!
```

Verification

```
Router#show ipv4 interface HundredGigE0/0/0/1
HundredGigE0/0/0/1 is Up, ipv4 protocol is Up
  Vrf is default (vrfid 0x60000000)
  Internet address is unassigned
  Secondary address 192.168.1.27/24
  MTU is 1514 (1500 is available to IP)
  Helper address is not set
  Multicast reserved groups joined: 224.0.0.2 224.0.0.1
  Directed broadcast forwarding is disabled
  Outgoing access list is not set
  Inbound access list is not set
  Proxy ARP is disabled
  ICMP redirects are never sent
  ICMP unreachable are always sent
  ICMP mask replies are never sent
  Table Id is 0xe0000000
```

Associated Commands

- ipv4 address
- show ipv4 interface

Configuring IPv4 and IPv6 Protocol Stacks

This task configures an interface in a Cisco networking device to support both the IPv4 and IPv6 protocol stacks.

When an interface in a Cisco networking device is configured with both an IPv4 and an IPv6 address, the interface forwards both IPv4 and IPv6 traffic—the interface can send and receive data on both IPv4 and IPv6 networks.

Configuration Example

An IPv4 address of 192.168.99.1 and an IPv6 address of 2001:0DB8:c18:1::3/64 is configured on the **interface HundredGigE 0/0/0/1**.

```
Router#configure
Router(config)#interface HundredGigE 0/0/0/1
Router(config-if)#ipv4 address 192.168.99.1 255.255.255.0
Router(config-if)#ipv6 address 2001:0DB8:c18:1::3/64
Router(config-if)#commit
```

Running Configuration

```
Router# show running-config interface HundredGigE0/0/0/1
  ipv4 address 192.168.99.1 255.255.255.0
  ipv6 address 2001:db8:c18:1::3/64
!
```

Verification

Verify that the HundredGigE interface is active and IPv4 and IPv6 are enabled.

```
Router#show ipv4 interface HundredGigE0/0/0/1
HundredGigE0/0/0/1 is Up, ipv4 protocol is Up
  Vrf is default (vrfid 0x60000000)
  Internet address is 192.168.99.1/24
  MTU is 1514 (1500 is available to IP)
  Helper address is not set
  Multicast reserved groups joined: 224.0.0.2 224.0.0.1
  Directed broadcast forwarding is disabled
  Outgoing access list is not set
  Inbound access list is not set
  Proxy ARP is disabled
  ICMP redirects are never sent
  ICMP unreachable are always sent
  ICMP mask replies are never sent
  Table Id is 0xe0000000

Router#show ipv6 interface HundredGigE0/0/0/1
HundredGigE0/0/0/1 is Up, ipv6 protocol is Up, Vrfid is default (0x60000000)
  IPv6 is enabled, link-local address is fe80::c672:95ff:fea6:1c75
  Global unicast address(es):
    2001:db8:c18:1::3, subnet is 2001:db8:c18:1::/64
  Joined group address(es): ff02::1:ff00:3 ff02::1:ffa6:1c75 ff02::2
    ff02::1
  MTU is 1514 (1500 is available to IPv6)
  ICMP redirects are disabled
  ICMP unreachable are enabled
  ND DAD is enabled, number of DAD attempts 1
  ND reachable time is 0 milliseconds
  ND cache entry limit is 1000000000
  ND advertised retransmit interval is 0 milliseconds
```

```

Hosts use stateless autoconfig for addresses.
Outgoing access list is not set
Inbound access list is not set
Table Id is 0xe0800000
Complete protocol adjacency: 0
Complete glean adjacency: 0
Incomplete protocol adjacency: 0
Incomplete glean adjacency: 0
Dropped protocol request: 0
Dropped glean request: 0

```

Associated Commands

- `ipv4 address`
- `ipv6 address`
- `show ipv4 interface`
- `show ipv6 interface`

Enabling IPv4 Processing on an Unnumbered Interface

This section describes the process of enabling an IPv4 point-to-point interface without assigning an explicit IP address to the interface. Whenever the unnumbered interface generates a packet (for example, for a routing update), it uses the address of the interface you specified as the source address of the IP packet. It also uses the specified interface address in determining which routing processes are sending updates over the unnumbered interface. Restrictions are as follows:

- Interfaces using High-Level Data Link Control (HDLC), PPP, and Frame Relay encapsulations can be unnumbered. Serial interfaces using Frame Relay encapsulation can also be unnumbered, but the interface must be a point-to-point sub-interface.
- You cannot use the **ping EXEC** command to determine whether the interface is up, because the interface has no IP address. The Simple Network Management Protocol (SNMP) can be used to remotely monitor interface status.
- You cannot support IP security options on an unnumbered interface.

If you are configuring Intermediate System-to-Intermediate System (IS-IS) across a serial line, you should configure the serial interfaces as unnumbered, which allows you to conform with RFC 1195, which states that IP addresses are not required on each interface.

Configuration Example

Enables an IPv4 point-to-point interface without assigning an explicit IP address to the interface.

```

Router#configure
Router(config)#interface HundredGigE 0/0/0/1
Router(config-if)#ipv4 unnumbered loopback 0
Router(config-if)#commit

```

Running Configuration

```

Router#show running-config interface HundredGigE0/0/0/1
interface HundredGigE0/0/0/1
  ipv4 point-to-point

```

```

ipv4 unnumbered Loopback0
!

```

Verification

```

Router#show interface HundredGigE0/0/0/1
HundredGigE0/0/0/1 is up, line protocol is up
  Interface state transitions: 5
  Hardware is HundredGige, address is 00e2.2a33.445b (bia 00e2.2a33.445b)
  Layer 1 Transport Mode is LAN
  Internet address is 10.0.0.2/32
  MTU 1514 bytes, BW 10000000 Kbit (Max: 10000000 Kbit)
    reliability 255/255, txload 194/255, rxload 0/255
  Encapsulation ARPA,
  Full-duplex, 10000Mb/s, link type is force-up
  output flow control is off, input flow control is off
  Carrier delay (up) is 10 msec
  loopback not set,
  Last link flapped 01:38:49
  ARP type ARPA, ARP timeout 04:00:00
  Last input 00:00:00, output 00:00:00
  Last clearing of "show interface" counters 02:34:16
  5 minute input rate 0 bits/sec, 0 packets/sec
  5 minute output rate 7647051000 bits/sec, 12254894 packets/sec
    1061401410 packets input, 82789675614 bytes, 0 total input drops
    0 drops for unrecognized upper-level protocol
    Received 5 broadcast packets, 19429 multicast packets
      0 runts, 0 giants, 0 throttles, 0 parity
    0 input errors, 0 CRC, 0 frame, 0 overrun, 0 ignored, 0 abort
    76895885948 packets output, 6192569128048 bytes, 0 total output drops
  Output 7 broadcast packets, 18916 multicast packets
  0 output errors, 0 underruns, 0 applique, 0 resets
  0 output buffer failures, 0 output buffers swapped out
  2 carrier transitions

Router #show run int lo 0
interface Loopback0
  ipv4 address 10.0.0.2 255.255.255.255

```

Associated Commands

- ipv4 unnumbered
- show interfaces

IPv4 ICMP Rate Limiting

The IPv4 ICMP rate limiting feature limits the rate that IPv4 ICMP destination unreachable messages are generated. The Cisco IOS XR software maintains two timers: one for general destination unreachable messages and one for DF destination unreachable messages. Both share the same time limits and defaults. If the DF keyword is not configured, the `icmp ipv4 rate-limit unreachable` command sets the time values for DF destination unreachable messages. If the DF keyword is configured, its time values remain independent from those of general destination unreachable messages.

Configuration Example

Limits the rate that IPv4 ICMP destination unreachable messages are generated every 1000 millisecond.

The **DF** keyword, which is optional limits the rate at which ICMP destination unreachable messages are sent when code 4 fragmentation is needed and Don't Fragment (DF) is set, as specified in the IP header of the ICMP destination unreachable message.

```
Router#configure
Router(config)#icmp ipv4 rate-limit unreachable 1000
Router(config)#icmp ipv4 rate-limit unreachable DF 1000
Router(config)#commit
```

Running Configuration

```
Router#show running-config | in icmp
Building configuration...
icmp ipv4 rate-limit unreachable DF 1000
icmp ipv4 rate-limit unreachable 1000
```

Verification

```
Router#show ipv4 interface HundredGigE0/0/0/2
HundredGigE0/0/0/2 is Up, ipv4 protocol is Up
  Vrf is default (vrfid 0x60000000)
  Internet address is 192.85.1.1/24
  MTU is 1514 (1500 is available to IP)
  Helper address is not set
  Multicast reserved groups joined: 224.0.0.2 224.0.0.1 224.0.0.2
    224.0.0.5 224.0.0.6
  Directed broadcast forwarding is disabled
  Outgoing access list is not set
  Inbound common access list is not set, access list is not set
  Proxy ARP is disabled
  ICMP redirects are never sent
  ICMP unreachables are always sent
  ICMP mask replies are never sent
  Table Id is 0xe0000000
```

The number of ICMP unreachable messages that were we sent or received can be identified using the **show ipv4 traffic** command.

```
Router# show ipv4 traffic
ICMP statistics:
  Sent: 0 admin unreachable, 5 network unreachable
        0 host unreachable, 0 protocol unreachable
        0 port unreachable, 0 fragment unreachable
        0 time to live exceeded, 0 reassembly ttl exceeded
        0 echo request, 0 echo reply
        0 mask request, 0 mask reply
        0 parameter error, 0 redirects
        5 total
  Rcvd: 0 admin unreachable, 0 network unreachable
        0 host unreachable, 0 protocol unreachable
        0 port unreachable, 0 fragment unreachable
        0 time to live exceeded, 0 reassembly ttl exceeded
        0 echo request, 0 echo reply
        0 mask request, 0 mask reply
        0 redirect, 0 parameter error
        0 source quench, 0 timestamp, 0 timestamp reply
        0 router advertisement, 0 router solicitation
        0 total, 0 checksum errors, 0 unknown
```

Associated Commands

- icmp ipv4 rate-limit unreachable

- show ipv4 traffic

IPv6 ICMP Rate Limiting

The IPv6 ICMP rate limiting feature implements a token bucket algorithm for limiting the rate at which IPv6 ICMP error messages are sent out on the network. The initial implementation of IPv6 ICMP rate limiting defined a fixed interval between error messages, but some applications, such as traceroute, often require replies to a group of requests sent in rapid succession. The fixed interval between error messages is not flexible enough to work with applications such as traceroute and can cause the application to fail. Implementing a token bucket scheme allows a number of tokens—representing the ability to send one error message each—to be stored in a virtual bucket. The maximum number of tokens allowed in the bucket can be specified, and for every error message to be sent, one token is removed from the bucket. If a series of error messages is generated, error messages can be sent until the bucket is empty. When the bucket is empty of tokens, IPv6 ICMP error messages are not sent until a new token is placed in the bucket. The token bucket algorithm does not increase the average rate limiting time interval, and it is more flexible than the fixed time interval scheme.

Configuration Example

Configure the interval for 50 milliseconds and the bucket size for 20 tokens, for IPv6 ICMP error messages.

- The milliseconds argument specifies the interval between tokens being added to the bucket.
- The optional bucketsize argument defines the maximum number of tokens stored in the bucket.

```
Router#configure
Router(config)#ipv6 icmp error-interval 50 20
Router(config)#commit
```

Running Configuration

```
Router#show running-config
Building configuration...
!! IOS XR Configuration version = 6.0.0.26I
!! Last configuration change at Mon Dec 14 22:07:35 2015 by root
!
hostname test-83
logging console debugging
username root
  group root-lr
  group cisco-support
  secret 5 $1$d2NC$RbAdqdU7kw/kEJoMP/IJG1
!
cdp
ipv6 icmp error-interval 50 20
icmp ipv4 rate-limit unreachable DF 1000
icmp ipv4 rate-limit unreachable 1000
ipv4 conflict-policy static
```

Associated Commands

- ipv6 icmp error-interval

Selecting Flexible Source IP

You can select flexible source IP address in the Internet Control Message Protocol (ICMP) response packet to respond to a failure.

Configuration Example

Enables RFC compliance for source address selection.

```
Router#configure
Router(config)#icmp ipv4 source rfc
Router(config)#commit
```

Running Configuration

```
Router#show running-config | in source rfc
Building configuration...
icmp ipv4 source rfc
```

Associated Commands

Configuring IPARM Conflict Resolution

This task sets the IP Address Repository Manager (IPARM) address conflict resolution parameters:

- Static Policy Resolution
- Longest Prefix Address Conflict Resolution
- Highest IP Address Conflict Resolution
- Route-Tag Support for Connected Routes

Static Policy Resolution

The static policy resolution configuration prevents new address configurations from affecting interfaces that are currently running.

Configuration Example

Sets the conflict policy to static, that is, prevents new interface addresses from affecting the currently running interface.

```
Router#configure
Router(config)#ipv4 conflict-policy static
*/For IPv6, use the ipv6 conflict-policy static command/*
Router(config)#commit
```

Running Configuration

```
Router#show running-config | in ipv4 config
Building configuration...
!! IOS XR Configuration version = 6.0.0.26I
!! Last configuration change at Mon Dec 14 21:57:27 2015 by root
!
hostname sample-83
logging console debugging
```

```

username root
  group root-lr
  group test
  secret 5 $1$d2NC$RbAdqdU7kw/eKJpMo/GJI1
!
cdp
ipv4 conflict-policy static
interface Loopback0
  ipv4 address 1.1.1.1 255.255.255.255
!
....

```

Verification

```

Router#show arm ipv4 conflicts
F Forced down
| Down interface & addr                Up interface & addr VRF

F Te0/0/0/19 192.85.1.2/24   HundredGigE0/0/0/1  192.85.1.1/24 default

Forced down interface        Up interface                VRF

```

Associated Commands

- ipv4 conflict-policy
- ipv6 conflict-policy

Longest Prefix Address Conflict Resolution

This conflict resolution policy attempts to give highest precedence to the IP address that has the longest prefix length, that is, all addresses within the conflict-set that do not conflict with the longest prefix address of the currently running interface are allowed to run as well.

Configuration Example

Configures longest prefix address conflict resolution.

```

Router# configure
Router(config)# ipv4 conflict-policy longest-prefix
*/For IPv6, use the ipv6 conflict-policy command*/
Router(config)# commit

```

Running Configuration

```

Router# show running-config | in longest-prefix
Building configuration...
ipv4 conflict-policy longest-prefix

```

Verification

```

Router#show arm ipv4 conflicts
F Forced down
| Down interface & addr                Up interface & addr VRF

F Te0/0/0/19 192.85.1.2/24   HundredGigE0/0/0/1  192.85.1.1/24 default

Forced down interface        Up interface                VRF

```

Highest IP Address Conflict Resolution

This conflict resolution policy attempts to give highest precedence to the IP address that has the highest value, that is, the IP address with the highest value gets precedence.

Configuration

Configures highest IP address conflict resolution.

```
Router# configure
Router(config)#ipv4 conflict-policy highest-ip
*/For IPv6, use the ipv6 conflict-policy highest-ip command/*
Router(config)#commit
```

Running Configuration

```
Router#show running-config | in highest-ip
Building configuration...
ipv4 conflict-policy highest-ip
```

Verification

```
Router#show arm ipv4 conflicts
F Forced down
| Down interface & addr          Up interface & addr VRF

F Te0/0/0/19 192.85.1.2/24   HundredGigE0/0/0/1  192.85.1.1/24 default

Forced down interface          Up interface          VRF
```

Route-Tag Support for Connected Routes

The Route-Tag Support for Connected Routes feature attaches a tag with all IPv4 and IPv6 addresses of an interface. The tag is propagated from the IPv4 and IPv6 management agents (MA) to the IPv4 and IPv6 address repository managers (ARM) to routing protocols, thus enabling the user to control the redistribution of connected routes by looking at the route tags, by using routing policy language (RPL) scripts. This prevents the redistribution of some interfaces, by checking for route tags in a route policy. The route tag feature is already available for static routes and connected routes (interfaces) wherein the route tags are matched to policies and redistribution can be prevented.

Configuration Example

Specifies an IPv4 address 10.0.54.2/30 that has a route tag of 20 to the **interface HundredGigE 0/0/0/1**.

```
Router#configure
Router(config)#interface HundredGigE 0/0/0/1
Router(config-if)#ipv4 address 10.0.54.2/30 route-tag 1899
Router(config)#commit
```

Running Configuration

```
Router#show running-config interface HundredGigE0/0/0/1
interface HundredGigE0/0/0/1
  ipv4 address 10.0.54.2/30 route-tag 1899
!
```

Verification

Verify the parameters of the route.

```

Router#show route 10.0.54.2
Routing entry for 10.0.54.2/32
  Known via "local", distance 0, metric 0 (connected)
  Tag 1899
Routing Descriptor Blocks
  directly connected, via HundredGigE0/0/0/1
    Route metric is 0
  No advertising protos.

```

Associated Commands

- route-tag

Larger IPv6 Address Space

The primary motivation for IPv6 is the need to meet the anticipated future demand for globally unique IP addresses. Applications such as mobile Internet-enabled devices (such as personal digital assistants [PDAs], telephones, and cars), home-area networks (HANs), and wireless data services are driving the demand for globally unique IP addresses. IPv6 quadruples the number of network address bits from 32 bits (in IPv4) to 128 bits, which provides more than enough globally unique IP addresses for every networked device on the planet. By being globally unique, IPv6 addresses inherently enable global reachability and end-to-end security for networked devices, functionality that is crucial to the applications and services that are driving the demand for the addresses. Additionally, the flexibility of the IPv6 address space reduces the need for private addresses and the use of Network Address Translation (NAT); therefore, IPv6 enables new application protocols that do not require special processing by border routers at the edge of networks.

IPv6 Address Formats

IPv6 addresses are represented as a series of 16-bit hexadecimal fields separated by colons (:) in the format: x:x:x:x:x:x:x. Following are two examples of IPv6 addresses:

```
2001:0DB8:7654:3210:FEDC:BA98:7654:3210
```

```
2001:0DB8:0:0:8:800:200C:417A
```

It is common for IPv6 addresses to contain successive hexadecimal fields of zeros. To make IPv6 addresses less cumbersome, two colons (::) can be used to compress successive hexadecimal fields of zeros at the beginning, middle, or end of an IPv6 address. (The colons represent successive hexadecimal fields of zeros.) [Table 3: Compressed IPv6 Address Formats, on page 22](#) lists compressed IPv6 address formats.

A double colon may be used as part of the *ipv6-address* argument when consecutive 16-bit values are denoted as zero. You can configure multiple IPv6 addresses per interfaces, but only one link-local address.



Note Two colons (::) can be used only once in an IPv6 address to represent the longest successive hexadecimal fields of zeros.

The hexadecimal letters in IPv6 addresses are not case-sensitive.

Table 3: Compressed IPv6 Address Formats

IPv6 Address Type	Preferred Format	Compressed Format
Unicast	2001:0:0:0:0DB8:800:200C:417A	1080::0DB8:800:200C:417A
Multicast	FF01:0:0:0:0:0:101	FF01::101
Loopback	0:0:0:0:0:0:1	::1
Unspecified	0:0:0:0:0:0:0	::

The loopback address listed in [Table 3: Compressed IPv6 Address Formats, on page 22](#) may be used by a node to send an IPv6 packet to itself. The loopback address in IPv6 functions the same as the loopback address in IPv4 (127.0.0.1).



Note The IPv6 loopback address cannot be assigned to a physical interface. A packet that has the IPv6 loopback address as its source or destination address must remain within the node that created the packet. IPv6 routers do not forward packets that have the IPv6 loopback address as their source or destination address.

The unspecified address listed in [Table 3: Compressed IPv6 Address Formats, on page 22](#) indicates the absence of an IPv6 address. For example, a newly initialized node on an IPv6 network may use the unspecified address as the source address in its packets until it receives its IPv6 address.



Note The IPv6 unspecified address cannot be assigned to an interface. The unspecified IPv6 addresses must not be used as destination addresses in IPv6 packets or the IPv6 routing header.

An IPv6 address prefix, in the format *ipv6-prefix/prefix-length*, can be used to represent bit-wise contiguous blocks of the entire address space. The *ipv6-prefix* argument must be in the form documented in RFC 2373, in which the address is specified in hexadecimal using 16-bit values between colons. The prefix length is a decimal value that indicates how many of the high-order contiguous bits of the address compose the prefix (the network portion of the address). For example, 2001:0DB8:8086:6502::/32 is a valid IPv6 prefix.

IPv6 Address Type: Unicast

An IPv6 unicast address is an identifier for a single interface, on a single node. A packet that is sent to a unicast address is delivered to the interface identified by that address. Cisco IOS XR software supports the following IPv6 unicast address types:

- Global aggregatable address
- Site-local address (proposal to remove by IETF)
- Link-local address
- IPv4-compatible IPv6 address

Aggregatable Global Address

An aggregatable global address is an IPv6 address from the aggregatable global unicast prefix. The structure of aggregatable global unicast addresses enables strict aggregation of routing prefixes that limits the number of routing table entries in the global routing table. Aggregatable global addresses are used on links that are aggregated upward through organizations, and eventually to the Internet service providers (ISPs).

Aggregatable global IPv6 addresses are defined by a global routing prefix, a subnet ID, and an interface ID. Except for addresses that start with binary 000, all global unicast addresses have a 64-bit interface ID. The current global unicast address allocation uses the range of addresses that start with binary value 001 (2000::/3). This figure below shows the structure of an aggregatable global address.

Figure 1: Aggregatable Global Address Format

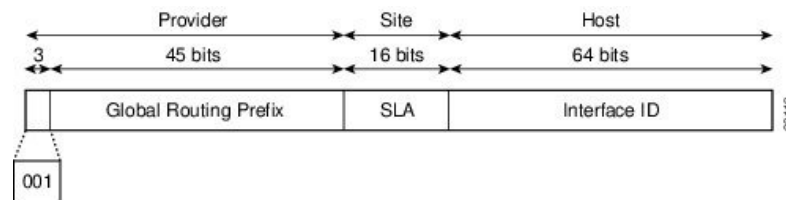

Addresses with a prefix of 2000::/3 (001) through E000::/3 (111) are required to have 64-bit interface identifiers in the extended universal identifier (EUI)-64 format. The Internet Assigned Numbers Authority (IANA) allocates the IPv6 address space in the range of 2000::/16 to regional registries.

The aggregatable global address typically consists of a 48-bit global routing prefix and a 16-bit subnet ID or Site-Level Aggregator (SLA). In the IPv6 aggregatable global unicast address format document (RFC 2374), the global routing prefix included two other hierarchically structured fields named Top-Level Aggregator (TLA) and Next-Level Aggregator (NLA). The IETF decided to remove the TLA and NLA fields from the RFCs, because these fields are policy-based. Some existing IPv6 networks deployed before the change might still be using networks based on the older architecture.

A 16-bit subnet field called the subnet ID could be used by individual organizations to create their own local addressing hierarchy and to identify subnets. A subnet ID is similar to a subnet in IPv4, except that an organization with an IPv6 subnet ID can support up to 65,535 individual subnets.

An interface ID is used to identify interfaces on a link. The interface ID must be unique to the link. It may also be unique over a broader scope. In many cases, an interface ID is the same as or based on the link-layer address of an interface. Interface IDs used in aggregatable global unicast and other IPv6 address types must be 64 bits long and constructed in the modified EUI-64 format.

Interface IDs are constructed in the modified EUI-64 format in one of the following ways:

- For all IEEE 802 interface types (for example, Ethernet interfaces and FDDI interfaces), the first three octets (24 bits) are taken from the Organizationally Unique Identifier (OUI) of the 48-bit link-layer address (MAC address) of the interface, the fourth and fifth octets (16 bits) are a fixed hexadecimal value of FFFE, and the last three octets (24 bits) are taken from the last three octets of the MAC address. The construction of the interface ID is completed by setting the Universal/Local (U/L) bit—the seventh bit of the first octet—to a value of 0 or 1. A value of 0 indicates a locally administered identifier; a value of 1 indicates a globally unique IPv6 interface identifier.
- For tunnel interface types that are used with IPv6 overlay tunnels, the interface ID is the IPv4 address assigned to the tunnel interface with all zeros in the high-order 32 bits of the identifier.



Note For interfaces using Point-to-Point Protocol (PPP), given that the interfaces at both ends of the connection might have the same MAC address, the interface identifiers used at both ends of the connection are negotiated (picked randomly and, if necessary, reconstructed) until both identifiers are unique. The first MAC address in the router is used to construct the identifier for interfaces using PPP.

If no IEEE 802 interface types are in the router, link-local IPv6 addresses are generated on the interfaces in the router in the following sequence:

1. The router is queried for MAC addresses (from the pool of MAC addresses in the router).
2. If no MAC address is available, the serial number of the Route Processor (RP) or line card (LC) is used to form the link-local address.

Link-Local Address

A link-local address is an IPv6 unicast address that can be automatically configured on any interface using the link-local prefix FE80::/10 (1111 1110 10) and the interface identifier in the modified EUI-64 format. Link-local addresses are used in the neighbor discovery protocol and the stateless autoconfiguration process. Nodes on a local link can use link-local addresses to communicate; the nodes do not need site-local or globally unique addresses to communicate. This figure below shows the structure of a link-local address.

IPv6 routers must not forward packets that have link-local source or destination addresses to other links.

Figure 2: Link-Local Address Format

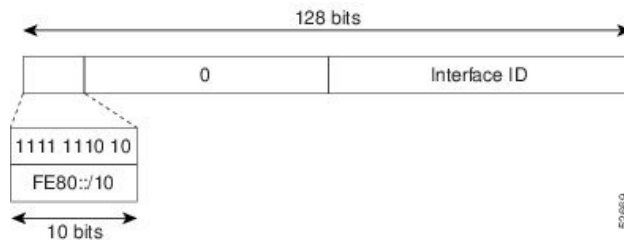

IPv4-Compatible IPv6 Address

An IPv4-compatible IPv6 address is an IPv6 unicast address that has zeros in the high-order 96 bits of the address and an IPv4 address in the low-order 32 bits of the address. The format of an IPv4-compatible IPv6 address is 0:0:0:0:0:A.B.C.D or ::A.B.C.D. The entire 128-bit IPv4-compatible IPv6 address is used as the IPv6 address of a node and the IPv4 address embedded in the low-order 32 bits is used as the IPv4 address of the node. IPv4-compatible IPv6 addresses are assigned to nodes that support both the IPv4 and IPv6 protocol stacks and are used in automatic tunnels. This figure below shows the structure of an IPv4-compatible IPv6 address and a few acceptable formats for the address.

Figure 3: IPv4-Compatible IPv6 Address Format

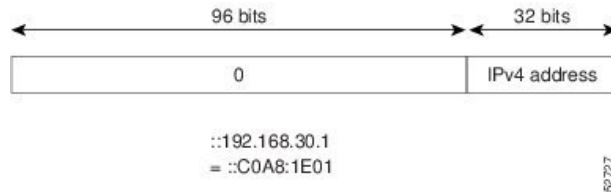

Simplified IPv6 Packet Header

The basic IPv4 packet header has 12 fields with a total size of 20 octets (160 bits). The 12 fields may be followed by an Options field, which is followed by a data portion that is usually the transport-layer packet. The variable length of the Options field adds to the total size of the IPv4 packet header. The shaded fields of the IPv4 packet header are not included in the IPv6 packet header.

Figure 4: IPv4 Packet Header Format

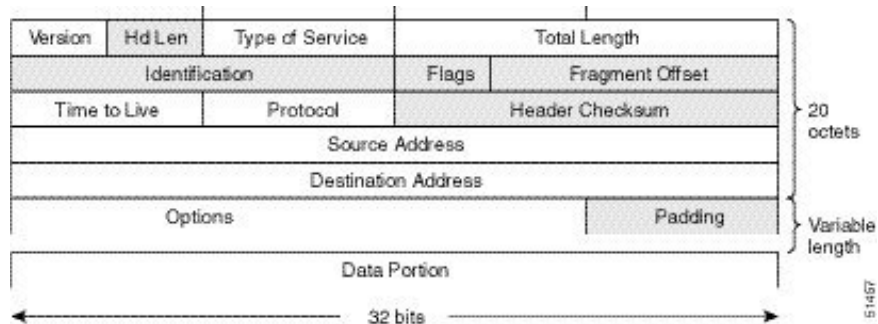

The basic IPv6 packet header has 8 fields with a total size of 40 octets (320 bits). Fields were removed from the IPv6 header because, in IPv6, fragmentation is not handled by routers and checksums at the network layer are not used. Instead, fragmentation in IPv6 is handled by the source of a packet and checksums at the data link layer and transport layer are used. (In IPv4, the User Datagram Protocol (UDP) transport layer uses an optional checksum. In IPv6, use of the UDP checksum is required to check the integrity of the inner packet.) Additionally, the basic IPv6 packet header and Options field are aligned to 64 bits, which can facilitate the processing of IPv6 packets.

Figure 5: IPv6 Packet Header Format

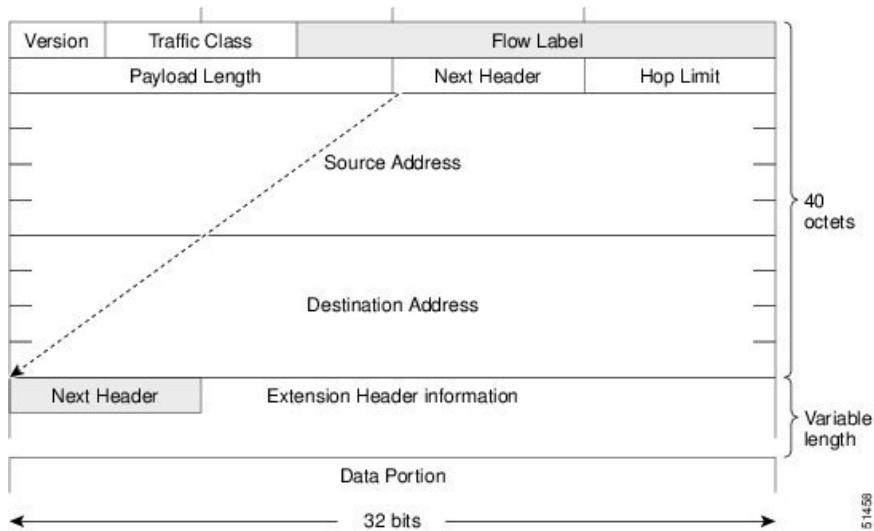

This table lists the fields in the basic IPv6 packet header.

Table 4: Basic IPv6 Packet Header Fields

Field	Description
Version	Similar to the Version field in the IPv4 packet header, except that the field lists number 6 for IPv6 instead of number 4 for IPv4.
Traffic Class	Similar to the Type of Service field in the IPv4 packet header. The Traffic Class field tags packets with a traffic class that is used in differentiated services.
Flow Label	A new field in the IPv6 packet header. The Flow Label field tags packets with a specific flow that differentiates the packets at the network layer.
Payload Length	Similar to the Total Length field in the IPv4 packet header. The Payload Length field indicates the total length of the data portion of the packet.
Next Header	Similar to the Protocol field in the IPv4 packet header. The value of the Next Header field determines the type of information following the basic IPv6 header. The type of information following the basic IPv6 header can be a transport-layer packet, for example, a TCP or UDP packet, or an Extension Header.
Hop Limit	Similar to the Time to Live field in the IPv4 packet header. The value of the Hop Limit field specifies the maximum number of routers that an IPv6 packet can pass through before the packet is considered invalid. Each router decrements the value by one. Because no checksum is in the IPv6 header, the router can decrement the value without needing to recalculate the checksum, which saves processing resources.
Source Address	Similar to the Source Address field in the IPv4 packet header, except that the field contains a 128-bit source address for IPv6 instead of a 32-bit source address for IPv4.

Field	Description
Destination Address	Similar to the Destination Address field in the IPv4 packet header, except that the field contains a 128-bit destination address for IPv6 instead of a 32-bit destination address for IPv4.

Following the eight fields of the basic IPv6 packet header are optional extension headers and the data portion of the packet. If present, each extension header is aligned to 64 bits. There is no fixed number of extension headers in an IPv6 packet. Together, the extension headers form a chain of headers. Each extension header is identified by the Next Header field of the previous header. Typically, the final extension header has a Next Header field of a transport-layer protocol, such as TCP or UDP. This figure below shows the IPv6 extension header format.

Figure 6: IPv6 Extension Header Format

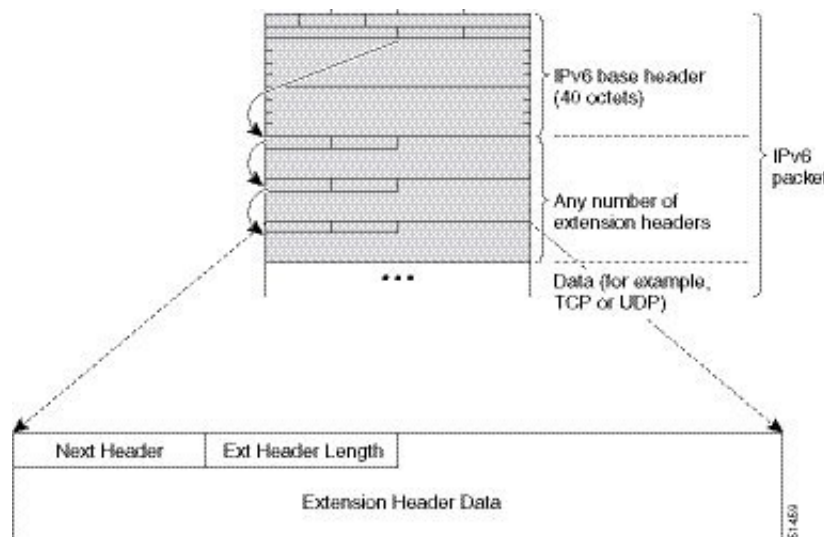

This table lists the extension header types and their Next Header field values.

Table 5: IPv6 Extension Header Types

Header Type	Next Header Value	Description
Hop-by-hop options header	0	This header is processed by all hops in the path of a packet. When present, the hop-by-hop options header always follows immediately after the basic IPv6 packet header.
Destination options header	60	The destination options header can follow any hop-by-hop options header, in which case the destination options header is processed at the final destination and also at each visited address specified by a routing header. Alternatively, the destination options header can follow any Encapsulating Security Payload (ESP) header, in which case the destination options header is processed only at the final destination.
Routing header	43	The routing header is used for source routing.

Header Type	Next Header Value	Description
Fragment header	44	The fragment header is used when a source must fragment a packet that is larger than the maximum transmission unit (MTU) for the path between itself and a destination. The Fragment header is used in each fragmented packet.
Authentication header and ESP header	51 50	The Authentication header and the ESP header are used within IP Security Protocol (IPSec) to provide authentication, integrity, and confidentiality of a packet. These headers are identical for both IPv4 and IPv6.
Upper-layer header	6 (TCP) 17 (UDP)	The upper-layer (transport) headers are the typical headers used inside a packet to transport the data. The two main transport protocols are TCP and UDP.
Mobility header	To be done by IANA	Extension headers used by mobile nodes, correspondent nodes, and home agents in all messaging related to the creation and management of bindings.

Path MTU Discovery for IPv6

As in IPv4, path MTU discovery in IPv6 allows a host to dynamically discover and adjust to differences in the MTU size of every link along a given data path. In IPv6, however, fragmentation is handled by the source of a packet when the path MTU of one link along a given data path is not large enough to accommodate the size of the packets. Having IPv6 hosts handle packet fragmentation saves IPv6 router processing resources and helps IPv6 networks run more efficiently.

In IPv4, the minimum link MTU is 68 octets, which means that the MTU size of every link along a given data path must support an MTU size of at least 68 octets. In IPv6, the minimum link MTU is 1280 octets. We recommend using an MTU value of 1500 octets for IPv6 links.



Note Path MTU discovery is supported only for applications using TCP.

IPv6 Neighbor Discovery

The IPv6 neighbor discovery (ND) process uses ICMP messages and solicited-node multicast addresses to determine the link-layer address of a neighbor on the same network (local link), verify the reachability of a neighbor, and keep track of neighboring routers.

As all incoming control traffic goes through LPTS policer, if the ND packets come in a burst they are policed according to the configuration. For more details on LPTS, see [LPTS Overview, on page 167](#).

IPv6 Neighbor Solicitation Message

A value of 135 in the Type field of the ICMP packet header identifies a neighbor solicitation message. Neighbor solicitation messages are sent on the local link when a node wants to determine the link-layer address of another node on the same local link. When a node wants to determine the link-layer address of another node,

the source address in a neighbor solicitation message is the IPv6 address of the node sending the neighbor solicitation message. The destination address in the neighbor solicitation message is the solicited-node multicast address that corresponds to the IPv6 address of the destination node. The neighbor solicitation message also includes the link-layer address of the source node.

Figure 7: IPv6 Neighbor Discovery—Neighbor Solicitation Message

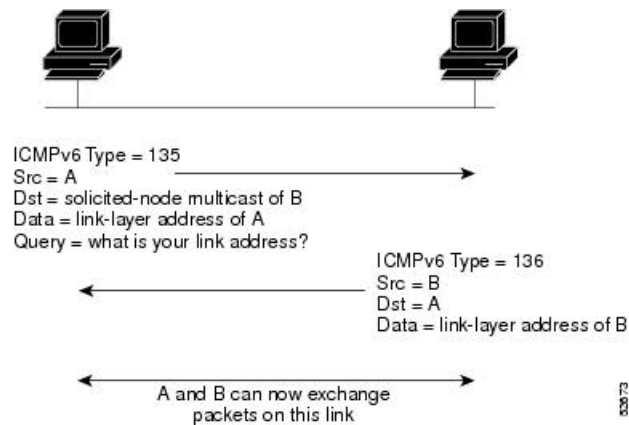

After receiving the neighbor solicitation message, the destination node replies by sending a neighbor advertisement message, which has a value of 136 in the Type field of the ICMP packet header, on the local link. The source address in the neighbor advertisement message is the IPv6 address of the node (more specifically, the IPv6 address of the node interface) sending the neighbor advertisement message. The destination address in the neighbor advertisement message is the IPv6 address of the node that sent the neighbor solicitation message. The data portion of the neighbor advertisement message includes the link-layer address of the node sending the neighbor advertisement message.

After the source node receives the neighbor advertisement, the source node and destination node can communicate.

Neighbor solicitation messages are also used to verify the reachability of a neighbor after the link-layer address of a neighbor is identified. When a node wants to verify the reachability of a neighbor, the destination address in a neighbor solicitation message is the unicast address of the neighbor.

Neighbor advertisement messages are also sent when there is a change in the link-layer address of a node on a local link. When there is such a change, the destination address for the neighbor advertisement is the all-nodes multicast address.

Neighbor solicitation messages are also used to verify the reachability of a neighbor after the link-layer address of a neighbor is identified. Neighbor unreachability detection identifies the failure of a neighbor or the failure of the forward path to the neighbor, and is used for all paths between hosts and neighboring nodes (hosts or routers). Neighbor unreachability detection is performed for neighbors to which only unicast packets are being sent and is not performed for neighbors to which multicast packets are being sent.

A neighbor is considered reachable when a positive acknowledgment is returned from the neighbor (indicating that packets previously sent to the neighbor have been received and processed). A positive acknowledgment—from an upper-layer protocol (such as TCP)—indicates that a connection is making forward progress (reaching its destination) or that a neighbor advertisement message in response to a neighbor solicitation message has been received. If packets are reaching the peer, they are also reaching the next-hop neighbor of the source. Therefore, forward progress is also a confirmation that the next-hop neighbor is reachable.

For destinations that are not on the local link, forward progress implies that the first-hop router is reachable. When acknowledgments from an upper-layer protocol are not available, a node probes the neighbor using unicast neighbor solicitation messages to verify that the forward path is still working. The return of a solicited neighbor advertisement message from the neighbor is a positive acknowledgment that the forward path is still working. (Neighbor advertisement messages that have the solicited flag set to a value of 1 are sent only in response to a neighbor solicitation message.) Unsolicited messages confirm only the one-way path from the source to the destination node; solicited neighbor advertisement messages indicate that a path is working in both directions.



Note A neighbor advertisement message that has the solicited flag set to a value of 0 must not be considered as a positive acknowledgment that the forward path is still working.

Neighbor solicitation messages are also used in the stateless autoconfiguration process to verify the uniqueness of unicast IPv6 addresses before the addresses are assigned to an interface. Duplicate address detection is performed first on a new, link-local IPv6 address before the address is assigned to an interface. (The new address remains in a tentative state while duplicate address detection is performed.) Specifically, a node sends a neighbor solicitation message with an unspecified source address and a tentative link-local address in the body of the message. If another node is already using that address, the node returns a neighbor advertisement message that contains the tentative link-local address. If another node is simultaneously verifying the uniqueness of the same address, that node also returns a neighbor solicitation message. If no neighbor advertisement messages are received in response to the neighbor solicitation message and no neighbor solicitation messages are received from other nodes that are attempting to verify the same tentative address, the node that sent the original neighbor solicitation message considers the tentative link-local address to be unique and assigns the address to the interface.

Every IPv6 unicast address (global or link-local) must be checked for uniqueness on the link; however, until the uniqueness of the link-local address is verified, duplicate address detection is not performed on any other IPv6 addresses associated with the link-local address. The Cisco implementation of duplicate address detection in the Cisco IOS XR software does not check the uniqueness of anycast or global addresses that are generated from 64-bit interface identifiers.

IPv6 Router Advertisement Message

Router advertisement (RA) messages, which have a value of 134 in the Type field of the ICMP packet header, are periodically sent out each configured interface of an IPv6 router. The router advertisement messages are sent to the all-nodes multicast address.

Figure 8: IPv6 Neighbor Discovery—Router Advertisement Message

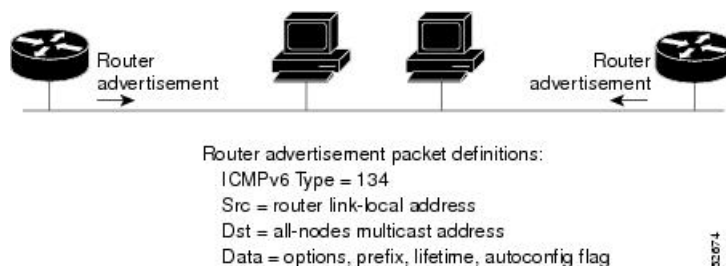

Router advertisement messages typically include the following information:

- One or more onlink IPv6 prefixes that nodes on the local link can use to automatically configure their IPv6 addresses

- Lifetime information for each prefix included in the advertisement
- Sets of flags that indicate the type of autoconfiguration (stateless or statefull) that can be completed
- Default router information (whether the router sending the advertisement should be used as a default router and, if so, the amount of time, in seconds, that the router should be used as a default router)
- Additional information for hosts, such as the hop limit and MTU a host should use in packets that it originates

Router advertisements are also sent in response to router solicitation messages. Router solicitation messages, which have a value of 133 in the Type field of the ICMP packet header, are sent by hosts at system startup so that the host can immediately autoconfigure without needing to wait for the next scheduled router advertisement message. Given that router solicitation messages are usually sent by hosts at system startup (the host does not have a configured unicast address), the source address in router solicitation messages is usually the unspecified IPv6 address (0:0:0:0:0:0:0:0). If the host has a configured unicast address, the unicast address of the interface sending the router solicitation message is used as the source address in the message. The destination address in router solicitation messages is the all-routers multicast address with a scope of the link. When a router advertisement is sent in response to a router solicitation, the destination address in the router advertisement message is the unicast address of the source of the router solicitation message.

The following router advertisement message parameters can be configured:

- The time interval between periodic router advertisement messages
- The “router lifetime” value, which indicates the usefulness of a router as the default router (for use by all nodes on a given link)
- The network prefixes in use on a given link
- The time interval between neighbor solicitation message retransmissions (on a given link)
- The amount of time a node considers a neighbor reachable (for use by all nodes on a given link)

The configured parameters are specific to an interface. The sending of router advertisement messages (with default values) is automatically enabled on Ethernet and FDDI interfaces. For other interface types, the sending of router advertisement messages must be manually configured by using the **no ipv6 nd suppress-ra** command in interface configuration mode. The sending of router advertisement messages can be disabled on individual interfaces by using the **ipv6 nd suppress-ra** command in interface configuration mode.



Note For stateless autoconfiguration to work properly, the advertised prefix length in router advertisement messages must always be 64 bits.

IPv6 Neighbor Redirect Message

A value of 137 in the Type field of the ICMP packet header identifies an IPv6 neighbor redirect message. Routers send neighbor redirect messages to inform hosts of better first-hop nodes on the path to a destination.

Figure 9: IPv6 Neighbor Discovery—Neighbor Redirect Message

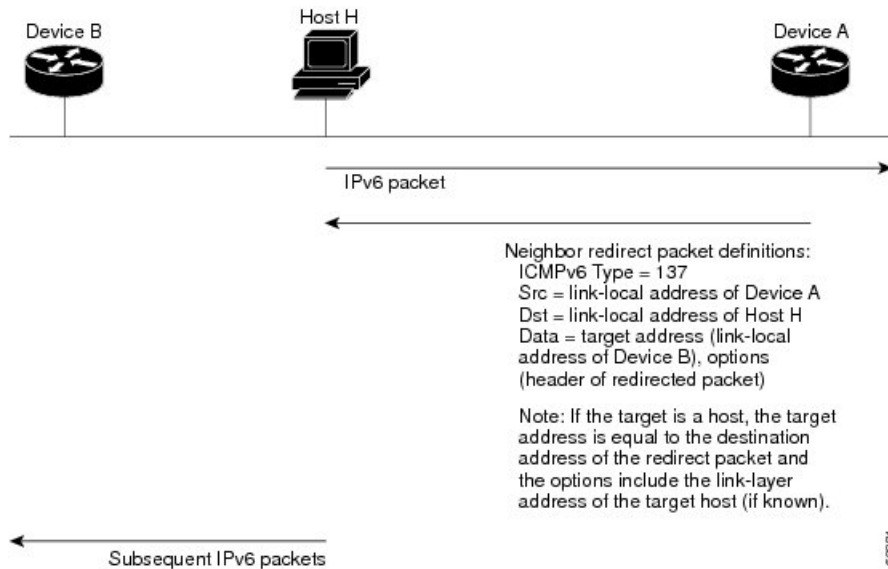

Note A router must be able to determine the link-local address for each of its neighboring routers to ensure that the target address (the final destination) in a redirect message identifies the neighbor router by its link-local address. For static routing, the address of the next-hop router should be specified using the link-local address of the router; for dynamic routing, all IPv6 routing protocols must exchange the link-local addresses of neighboring routers.

After forwarding a packet, a router should send a redirect message to the source of the packet under the following circumstances:

- The destination address of the packet is not a multicast address.
- The packet was not addressed to the router.
- The packet is about to be sent out the interface on which it was received.
- The router determines that a better first-hop node for the packet resides on the same link as the source of the packet.
- The source address of the packet is a global IPv6 address of a neighbor on the same link, or a link-local address.

Use the **ipv6 icmp error-interval** global configuration command to limit the rate at which the router generates all IPv6 ICMP error messages, including neighbor redirect messages, which ultimately reduces link-layer congestion.



Note A router must not update its routing tables after receiving a neighbor redirect message, and hosts must not originate neighbor redirect messages.

Address Repository Manager

IPv4 and IPv6 Address Repository Manager (IPARM) enforces the uniqueness of global IP addresses configured in the system, and provides global IP address information dissemination to processes on route processors (RPs) and line cards (LCs) using the IP address consumer application program interfaces (APIs), which includes unnumbered interface information.

Address Conflict Resolution

There are two parts to conflict resolution; the conflict database and the conflict set definition.

Conflict Database

IPARM maintains a global conflict database. IP addresses that conflict with each other are maintained in lists called conflict sets. These conflict sets make up the global conflict database.

A set of IP addresses are said to be part of a conflict set if at least one prefix in the set conflicts with every other IP address belonging to the same set. For example, the following four addresses are part of a single conflict set.

address 1: 10.1.1.1/16

address 2: 10.2.1.1/16

address 3: 10.3.1.1/16

address 4: 10.4.1.1/8

When a conflicting IP address is added to a conflict set, an algorithm runs through the set to determine the highest precedence address within the set.

This conflict policy algorithm is deterministic, that is, the user can tell which addresses on the interface are enabled or disabled. The address on the interface that is enabled is declared as the highest precedence ip address for that conflict set.

The conflict policy algorithm determines the highest precedence ip address within the set.



CHAPTER 3

Configuring ARP

- [Configuring ARP, on page 35](#)
- [Information About Configuring ARP, on page 40](#)

Configuring ARP

Address resolution is the process of mapping network addresses to Media Access Control (MAC) addresses, which is typically done dynamically by the system using the ARP protocol, but can also be done by Static ARP entry configuration. This process is accomplished using the Address Resolution Protocol (ARP).

ARP is used to associate IP addresses with media or MAC addresses. Taking an IP address as input, ARP determines the associated media address. After a media or MAC address is determined, the IP address or media address association is stored in an ARP cache for rapid retrieval. Then the IP datagram is encapsulated in a link-layer frame and sent over the network.

As all incoming control traffic goes through LPTS policer, if the ARP packets come in a burst they are policed according to the configuration. For more details on LPTS, see [LPTS Overview, on page 167](#).

For more details on ARP, see [Information About Configuring ARP, on page 40](#)

ARP and Proxy ARP

Two forms of address resolution are supported by Cisco IOS XR software: Address Resolution Protocol (ARP) and proxy ARP, as defined in RFC 826 and RFC 1027, respectively. Cisco IOS XR software also supports a form of ARP called local proxy ARP.

For more details on Proxy ARP and Local Proxy ARP, see [Proxy ARP and Local Proxy ARP, on page 36](#)

Restrictions

The following restrictions apply to configuring ARP :

- Reverse Address Resolution Protocol (RARP) is not supported.
- ARP throttling, which is the rate limiting of ARP packets in Forwarding Information Base (FIB), is not supported.

ARP Cache Entries

ARP establishes correspondences between network addresses (an IP address, for example) and Ethernet hardware addresses. A record of each correspondence is kept in a cache for a predetermined amount of time and then discarded.

You can also add a static (permanent) entry to the ARP cache that persists until explicitly removed.

Defining a Static ARP Cache Entry

ARP and other address resolution protocols provide a dynamic mapping between IP addresses and media addresses. Because most hosts support dynamic address resolution, generally you need not specify static ARP entries. If you must define them, you can do so globally. Performing this task installs a permanent entry in the ARP cache. Cisco IOS XR software uses this entry to translate 32-bit IP addresses into 48-bit hardware addresses.

Optionally, you can specify that the software responds to ARP requests as if the software was identified by the specified IP address, by making an alias entry in the ARP cache.

Configuration Example

A cache entry is created to establish connection between an IP address **203.0.1.2** and the MAC address **0010.9400.000c**. Additionally, the cache entry is created as an alias entry such that the interface to which the entry is attached will respond to ARP request packets for this network layer address with the data link layer address in the entry.

```
Router#config
Router(config)#arp 203.0.1.2 0010.9400.000c arPA
Router(config)#commit
```

Running Configuration

```
Router#show run arp 203.0.1.2 0010.9400.000c arPA
arp vrf default 203.0.1.2 0010.9400.000c ARPA
```

Verification

Verify that the State is static for proper functioning:

```
Router#show arp location 0/0/CPU0
Address      Age      Hardware Addr  State      Type  Interface
203.0.1.1    -        ea28.5f0b.8024 Interface  ARPA  HundredGigE0/0/0/9
203.0.1.2    -        0010.9400.000c Static ARPA  HundredGigE0/0/0/9
```

Proxy ARP and Local Proxy ARP

When proxy ARP is disabled, the networking device responds to ARP requests received on an interface only if one of the following conditions is met:

- The target IP address in the ARP request is the same as the interface IP address on which the request is received.
- The target IP address in the ARP request has a statically configured ARP alias.

When proxy ARP is enabled, the networking device also responds to ARP requests that meet all the following conditions:

- The target IP address is not on the same physical network (LAN) on which the request is received.
- The networking device has one or more routes to the target IP address.
- All of the routes to the target IP address go through interfaces other than the one on which the request is received.

When local proxy ARP is enabled, the networking device responds to ARP requests that meet all the following conditions:

- The target IP address in the ARP request, the IP address of the ARP source, and the IP address of the interface on which the ARP request is received are on the same Layer 3 network.
- The next hop for the target IP address is through the same interface as the request is received.

Typically, local proxy ARP is used to resolve MAC addresses to IP addresses in the same Layer 3 network. Local proxy ARP supports all types of interfaces supported by ARP and unnumbered interfaces.

Enabling Proxy ARP

Cisco IOS XR software uses proxy ARP (as defined in RFC 1027) to help hosts with no knowledge of routing determine the media addresses of hosts on other networks or subnets. For example, if the router receives an ARP request for a host that is not on the same interface as the ARP request sender, and if the router has all of its routes to that host through other interfaces, then it generates a proxy ARP reply packet giving its own local data-link address. The host that sent the ARP request then sends its packets to the router, which forwards them to the intended host. Proxy ARP is disabled by default; this task describes how to enable proxy ARP if it has been disabled.

Configuration Example

Proxy ARP is enabled on the HundredGigE interface-0/0/0/0:

```
Router#configure
Router(config)#interface HundredGigE0/0/0/0
Router(config-if)#proxy-arp
Router(config-if)#commit
```

Running Configuration

```
Router# show running-config interface HundredGigE0/0/0/0
mtu 4000
ipv4 address 1.0.0.1 255.255.255.0
proxy-arp
!
!
```

Verification

Verify that proxy ARP is configured and enabled:

```
Router# show arp idb interface HundredGigE0/0/0/0 location 0/0/CPU0(0x08000038):
  IPv4 address 1.0.0.1, Vrf ID 0x60000000
  VRF Name default
  Dynamic learning: Enable
  Dynamic entry timeout: 14400 secs
  Purge delay: off
  IPv4 caps added (state up)
  MPLS caps not added
  Interface not virtual, not client fwd ref,
```

```

Proxy arp is configured, is enabled
Local Proxy arp not configured
Packet IO layer is NetIO
Srg Role : DEFAULT
Idb Flag : 262332
IDB is Complete

```

Enabling Local Proxy ARP

Local proxy ARP is used to resolve MAC addresses to IP addresses in the same Layer 3 network such as, private VLANs that are Layer 2-separated. Local proxy ARP supports all types of interfaces supported by ARP and unnumbered interfaces.

Configuration Example

Local proxy ARP is enabled on the HundredGigE interface-0/0/0/0

```

Router#configure
Router(config)#interface HundredGigE0/0/0/0
Router(config-if)#local-proxy-arp
Router(config-if)#commit

```

Running Configuration

```

Router#show running-config interface HundredGigE0/0/0/0

ipv4 address 1.0.0.1 255.255.255.0
local-proxy-arp
!

```

Verification

Verify that local proxy ARP is configured:

```

Router# show arp idb interface HundredGigE0/0/0/0 location 0/0/CPU0
(0x08000038):
  IPv4 address 1.0.0.1, Vrf ID 0x60000000
  VRF Name default
  Dynamic learning: Enable
  Dynamic entry timeout: 14400 secs
  Purge delay: off
  IPv4 caps added (state up)
  MPLS caps not added
  Interface not virtual, not client fwd ref,
  Proxy arp not configured, not enabled
Local Proxy arp is configured
  Packet IO layer is NetIO
  Srg Role : DEFAULT
  Idb Flag : 264332
  IDB is Complete

```

Associated Commands

- [local-proxy-arp](#)
- [show arp idb](#)

Configure Learning of Local ARP Entries

You can configure an interface or a sub-interface to learn only the ARP entries from its local subnet.

Use the following procedure to configure local ARP learning on an interface.

1. Enter the interface configuration mode.

```
Router(config)# interface GigabitEthernet 0/0/0/1
```

2. Configure the IPv4/IPv6 address for the interface.

```
Router(config-if)# ipv4 address 12.1.3.4 255.255.255.0
```

3. Configure local ARP learning on the interface.

```
Router(config-if)# arp learning local
```

4. Enable the interface and commit your configuration.

```
Router(config-if)# no shut
Router(config-if)# commit
RP/0/0/CPU0:Dec 12 13:41:16.580 : ifmgr[397]: %PKT_INFRA-LINK-3-UPDOWN : interface
GigabitEthernet 0/0/0/1, changed state to Down
RP/0/0/CPU0:Dec 12 13:41:16.683 : ifmgr[397]: %PKT_INFRA-LINK-3-UPDOWN : interface
GigabitEthernet 0/0/0/1 changed state to Up
```

5. Confirm your configuration.

```
Router(config-if)# show running-configuration
..
Building configuration...
!! IOS XR Configuration 0.0.0
!! Last configuration change at Mon Dec 12 13:41:16 2016
!interface GigabitEthernet 0/0/0/1
  ipv4 address 12.1.3.4 255.255.255.0
  arp learning local
!
```

6. Verify if local ARP learning is working as configured on the interface.

```
Router(config-if)# do show arp idb gigabitEthernet 0/0/0/1 location 0/0/CPU0
Thu Dec 15 10:00:11.733 IST
```

```
GigabitEthernet 0/0/0/1 (0x00000040):
  IPv4 address 12.1.3.4, Vrf ID 0x60000000
  VRF Name default
  Dynamic learning: Local
  Dynamic entry timeout: 14400 secs
  Purge delay: off
  IPv4 caps added (state up)
  MPLS caps not added
  Interface not virtual, not client fwd ref,
  Proxy arp not configured, not enabled
  Local Proxy arp not configured
  Packet IO layer is NetIO
  Srg Role : DEFAULT
  Idb Flag : 2146444
  IDB is Complete
```

7. (Optional) You can monitor the ARP traffic on the interface.

```
Router(config-if)# do show arp idb gigabitEthernet 0/0/0/1 location 0/0/CPU0
Thu Dec 15 10:13:28.964 IST
```

ARP statistics:

```

Recv: 0 requests, 0 replies
Sent: 0 requests, 1 replies (0 proxy, 0 local proxy, 1 gratuitous)
Subscriber Interface:
    0 requests rcv, 0 replies sent, 0 gratuitous replies sent
Resolve requests rcvd: 0
Resolve requests dropped: 0
Errors: 0 out of memory, 0 no buffers, 0 out of sunbet

```

ARP cache:

```

Total ARP entries in cache: 1
Dynamic: 0, Interface: 1, Standby: 0
Alias: 0, Static: 0, DHCP: 0

IP Packet drop count for GigabitEthernet0_0_0_1: 0

```

Information About Configuring ARP

Addressing Resolution Overview

A device in the IP can have both a local address (which uniquely identifies the device on its local segment or LAN) and a network address (which identifies the network to which the device belongs). The local address is more properly known as a *data link address*, because it is contained in the data link layer (Layer 2 of the OSI model) part of the packet header and is read by data-link devices (bridges and all device interfaces, for example). The more technically inclined person will refer to local addresses as *MAC addresses*, because the MAC sublayer within the data link layer processes addresses for the layer.

To communicate with a device on Ethernet, for example, Cisco IOS XR software first must determine the 48-bit MAC or local data-link address of that device. The process of determining the local data-link address from an IP address is called address resolution.

Address Resolution on a Single LAN

The following process describes address resolution when the source and destination devices are attached to the same LAN:

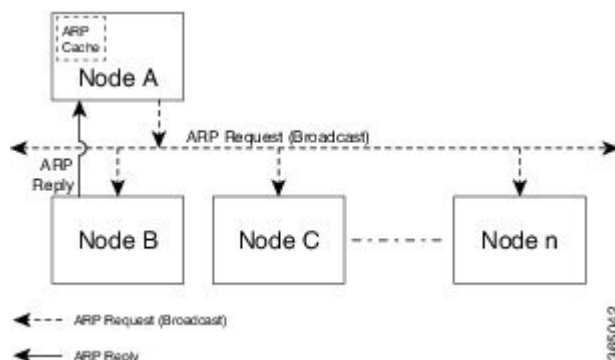

1. End System A (Node A) broadcasts an ARP request onto the LAN, attempting to learn the MAC address of End System B (Node B).
2. The broadcast is received and processed by all devices on the LAN, including End System B.

3. Only End System B replies to the ARP request. It sends an ARP reply containing its MAC address to End System A (Node A).
4. End System A (Node A) receives the reply and saves the MAC address of End System B in its ARP cache. (The ARP cache is where network addresses are associated with MAC addresses.)
5. Whenever End System A (Node A) needs to communicate with End System B, it checks the ARP cache, finds the MAC address of System B, and sends the frame directly, without needing to first use an ARP request.

Address Resolution When Interconnected by a Router

The following process describes address resolution when the source and destination devices are attached to different LANs that are interconnected by a router (only if proxy-arp is turned on):

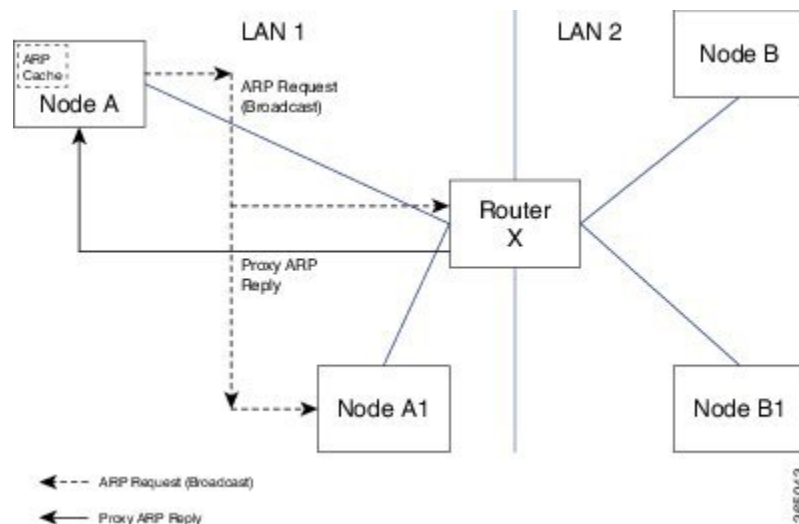

1. End System Y (Node A) broadcasts an ARP request onto the LAN, attempting to learn the MAC address of End System Z (Node B).
2. The broadcast is received and processed by all devices on the LAN, including Router X.
3. Router X checks its routing table and finds that End System Z (Node B) is located on a different LAN.
4. Router X therefore acts as a proxy for End System Z (Node B). It replies to the ARP request from End System Y (Node A), sending an ARP reply containing its own MAC address as if it belonged to End System Z (Node B).
5. End System Y (Node A) receives the ARP reply and saves the MAC address of Router X in its ARP cache, in the entry for End System Z (Node B).
6. When End System Y (Node A) needs to communicate with End System Z (Node B), it checks the ARP cache, finds the MAC address of Router X, and sends the frame directly, without using ARP requests.
7. Router X receives the traffic from End System Y (Node A) and forwards it to End System Z (Node B) on the other LAN.



CHAPTER 4

Implementing the Dynamic Host Configuration Protocol

This module describes the concepts and tasks you will use to configure Dynamic Host Configuration Protocol (DHCP).



Note For a complete description of the DHCP commands listed in this module, refer to the *IP Addresses and Services Command Reference for Cisco NCS 5500 Series, Cisco NCS 540 Series, and Cisco NCS 560 Series Routers* publication.

- [Introduction to DHCP Relay, on page 43](#)
- [Prerequisites for Configuring DHCP Relay Agent, on page 44](#)
- [Limitations for DHCP Relay Feature , on page 44](#)
- [How to Configure and Enable DHCP Relay Agent, on page 45](#)
- [Configure a DHCP Proxy Profile, on page 53](#)
- [DHCP Server, on page 53](#)
- [DHCP Client, on page 58](#)
- [DHCP Proxy Binding Table Reload Persistency, on page 58](#)

Introduction to DHCP Relay

A DHCP relay agent is a host that forwards DHCP packets between clients and servers that do not reside on a shared physical subnet. Relay agent forwarding is distinct from the normal forwarding of an IP router where IP datagrams are switched between networks transparently.

DHCP clients use User Datagram Protocol (UDP) broadcasts to send DHCPDISCOVER messages when they lack information about the network to which they belong.

If a client is on a network segment that does not include a server, a relay agent is needed on that network segment to ensure that DHCP packets reach the servers on another network segment. UDP broadcast packets are not forwarded, because most routers are not configured to forward broadcast traffic. You can configure a DHCP relay agent to forward DHCP packets to a remote server by configuring a DHCP relay profile and configure one or more helper addresses in it. You can assign the profile to an interface or a VRF.

The figure below demonstrates the process. The DHCP client broadcasts a request for an IP address and additional configuration parameters on its local LAN. Acting as a DHCP relay agent, Router B picks up the

broadcast, changes the destination address to the DHCP server's address and sends the message out on another interface. The relay agent inserts the IP address of the interface, on which the DHCP client's packets are received into the gateway address (giaddr) field of the DHCP packet, which enables the DHCP server to determine which subnet should receive the offer and identify the appropriate IP address range. The relay agent unicasts the messages to the server address, in this case 172.16.1.2 (which is specified by the helper address in the relay profile).

Figure 10: Forwarding UDP Broadcasts to a DHCP Server Using a Helper Address

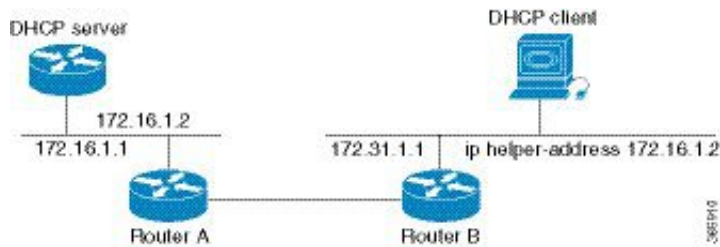

Prerequisites for Configuring DHCP Relay Agent

The following are the prerequisites to configure a DHCP relay agent:

- You must be in a user group associated with a task group that includes the proper task IDs. The command reference guides include the task IDs required for each command. If you suspect user group assignment is preventing you from using a command, contact your AAA administrator for assistance.
- A configured and running DHCP client and DHCP server.
- Connectivity between the relay agent and DHCP server

Limitations for DHCP Relay Feature

These are the limitations for implementing DHCP relay feature:

- The multicast addresses are not supported. The **helper-address** command in DHCP relay profile submode supports valid unicast IP address as the helper address.



Note Configuring the **helper-address** command directly (not using profile) under a interface (such as BVI interface) is not supported.

- Only interface-id and remote-id DHCP option code are added by a relay agent while forwarding the packet to a DHCP server.



Note Configuring DHCP option code is not supported in DHCP relay profile submode.

How to Configure and Enable DHCP Relay Agent

This section contains the following tasks:

Configuring and Enabling the DHCP Relay Agent

Configuration Example

```
Router# configure
/* Enters the global configuration mode */

Router(config)# dhcp ipv4
/* Configures DHCP for IPv4 and enters the DHCPv4 configuration submode. */

Router(config-dhcpv4)# profile r1 relay
/* Enables DHCP relay profile */

Router(config-dhcpv4-relay-profile)# helper-address vrf A 10.10.10.1 giaddr 40.1.1.2
Router(config-dhcpv4-relay-profile)# broadcast-flag policy check
/* Configures VRF addresses for forwarding UDP broadcasts, including DHCP. */

Router(config-dhcpv4-relay-profile)# relay information option vpn
Router(config-dhcpv4-relay-profile)# relay information option vpn-mode rfc
/* Inserts the DHCP relay agent information option (option-82 field) in forwarded BOOTREQUEST
messages to a DHCP server. */

Router(config-dhcpv4-relay-profile)# relay information option allow-untrusted
/* (Optional) Configures the DHCP IPv4 Relay not to discard BOOTREQUEST packets
that have an existing relay information option and the giaddr set to zero. */

Router(config-dhcpv4-relay-profile)# exit
Router(config-dhcpv4)# interface BVI 1 relay profile r1
Router(config-dhcpv4)# commit
/* Configures DHCP relay on a BVI interface and commits the configuration */
```

Running Configuration

```
Router#show running-config
Tue May 23 10:56:14.463 IST
Building configuration...
!! IOS XR Configuration 0.0.0
!! Last configuration change at Tue May 23 10:56:08 2017 by annseque
!
dhcp ipv4
  vrf vrf1 relay profile client
  profile r1 relay
    helper-address vrf A 10.10.10.1 giaddr 40.1.1.2
    broadcast-flag policy check
    relay information option vpn
    relay information option vpn-mode rfc
    relay information option allow-untrusted
!
```

Enabling DHCP Relay Agent on an Interface

This section describes how to enable the Cisco IOS XR DHCP relay agent on an interface.

Configuration Example

The DHCP relay agent is disabled by default.

```
router#configure

router(config)#dhcp ipv4
/* Configures DHCP for IPv4 and enters the DHCPv4 configuration submode. */

router(config-dhcpv4)#interface HundredGigE 0/2/0/2 relay profile client
/* Attaches a relay profile to an interface.
To disable the DHCP relay on the interface, use the 'no interface HundredGigE 0/2/0/2 none'
command. */

router(config-dhcpv4-if)#commit
```

Running Configuration

```
Router#show running-config dhcp ipv4
dhcp ipv4
interface HundredGigE 0/2/0/2 relay profile client
!
```

Disabling DHCP Relay on an Interface

This task describes how to disable the DHCP relay on an interface by using the **no** keyword on the interface.

```
Router# configure terminal
Router(config)# dhcp ipv6
Router(config-dhcpv6)# no interface type name relay profile profile-name
Router(config-dhcpv6-if)# commit
```

Enabling DHCP Relay on a VRF

This task describes how to enable DHCP relay on a VRF.

```
/CPU0:router# configure terminal
Router(config)# dhcp ipv6
Router(config-dhcpv6)# vrf vrf-name relay profile profile-name
Router(config-dhcpv6-if)# commit
```

Configure a DHCP Relay Profile with Multiple Helper Addresses

You can configure up to 16 helper IPv4 and IPv6 addresses for a DHCPv4 or DHCPv6 relay profile.

1. Enter the DHCPv4 or DHCPv6 configuration mode.

```
Router(config)# dhcp ipv6
```

2. Configure the DHCPv4 or DHCPv6 relay profile.

```
Router(config-dhcpv6)# profile helper relay
```

3. Configure helper addresses.



Note You can configure up to 16 IPv4 and IPv6 addresses.

```
Router(config-dhcpv6-relay-profile)# helper-address vrf default 2001:1:1::2
```

4. Confirm your configuration.

```
Router(config-dhcpv6-relay-profile)# show configuration

!! IOS XR Configuration 0.0.0
dhcp ipv6
  profile helper relay
    helper-address vrf default 2001:1:1::2
  !
!
end
```

5. Commit your configuration.

```
Router(config-dhcpv6-relay-profile)# commit
```

6. Exit the configuration mode and verify the configured helper addresses.

```
Router# show dhcp ipv6 relay profile name helper
...
!
Profile: helper
Helper Addresses:
    2001:1:1::2, vrf default
Information Option: Disabled
Information Option Allow Untrusted: Disabled
Information Option VPN: Disabled
Information Option VPN Mode: RFC
Information Option Policy: Replace
Information Option Check: Disabled
GIADDR Policy: Keep
Broadcast-flag Policy: Ignore
VRF References:
Interface References:
```

You have successfully configured the DHCPv6 relay helper address.

DHCP Relay Agent Notification for Prefix Delegation

DHCP relay agent notification for prefix delegation allows the router working as a DHCPv6 relay agent to find prefix delegation options by reviewing the contents of a DHCP RELAY-REPLY packet that is being relayed by the relay agent to the client. When the relay agent finds the prefix delegation option, the relay agent extracts the information about the prefix being delegated and inserts an IPv4 or IPv6 subscriber route matching the prefix delegation information onto the relay agent. Future packets destined to that prefix via relay are forwarded based on the information contained in the prefix delegation. The IPv4 or IPv6 subscriber route remains in the routing table until the prefix delegation lease time expires or the relay agent receives a release packet from the client releasing the prefix delegation.

The relay agent automatically does the subscriber route management.

The IPv4 or IPv6 routes are added when the relay agent relays a RELAY-REPLY packet, and the IPv4 or IPv6 routes are deleted when the prefix delegation lease time expires or the relay agent receives a release message. An IPv4 or IPv6 subscriber route in the routing table of the relay agent can be updated when the prefix delegation lease time is extended.

This feature leaves an IPv4 or IPv6 route on the routing table of the relay agent. This registered IPv4 or IPv6 address allows unicast reverse packet forwarding (uRPF) to work by allowing the router doing the reverse lookup to confirm that the IPv4 or IPv6 address on the relay agent is not malformed or spoofed. The IPv6 route in the routing table of the relay agent can be redistributed to other routing protocols to advertise the subnets to other nodes. When the client sends a DHCP_DECLINE message, the routes are removed.

Configuring DHCP Stateful Relay Agent for Prefix Delegation

Perform this task to configure Dynamic Host Configuration Protocol DHCP relay agent notification for prefix delegation.

Configuration Example

1. Configure a DHCP profile.
2. Configure the DHCP relay agent.
3. Enable IPv4 or IPv6 DHCP on an interface that acts as an IPv4 or IPv6 DHCP stateful relay agent.
4. Configure the profile name.



Note Prefix Delegation is supported with both DHCP Proxy and DHCP Relay configuration.

Configuration

```

/* Enter the global configuration mode and then enter the DHCPv6 configuration mode. */
Router# config
Router(config)# dhcp ipv6
Router(config-dhcpv6)#

/* Enter the proxy profile configuration mode and configure the DHCPv6 relay agent. */
Router(config-dhcpv6)# profile downstream proxy
Router(config-dhcpv6-profile)# helper-address 2001:db8::1 GigabitEthernet 0/1/0/1

/* Exits from the proxy profile configuration mode and enable IPv6 DHCP on an interface.
*/
Router(config-dhcpv6-profile)# exit
Router(config-dhcpv6-if)# interface GigabitEthernet 0/1/0/0 proxy

/* Configure a profile name. */

Router(config-dhcpv6-if)# profile downstream
Router(config-dhcpv6-if)# commit

```

DHCPv6 Relay Over BVI for IANA Address Allocation

DHCPv6 Relay agents relay all packets that are coming from DHCPv6 clients over the access-interfaces towards external DHCPv6 servers to request IP addresses (::/128) through IANA allocation for the DHCPv6

clients. DHCPv6 Relay agents also receive response packets from the DHCPv6 servers and forward the packets towards DHCPv6 clients over BVI interfaces. DHCPv6 Relay agents acts as stateless, by default, for DHCPv6 clients by not maintaining any DHCPv6 binding and respective route entry for the allocated IP addresses. You can enable a DHCPv6 client to get a particular IPv6 address assigned by the DHCPv6 server over a Bridge Virtual Interface (BVI) through Internet Assigned Numbers Authority (IANA) address allocation. Thereby, the DHCPv6 relay agent acts as a stateful relay agents and maintains DHCPv6 binding and respective route entry for the allocated IPv6 addresses.

Restrictions

- You can configure up to 500 client sessions over a BVI interface for DHCP relay.
- Each DHCPv6 relay profile can be configured with upto 8 DHCPv6 server addresses.

Configuration Example

To configure DHCPv6 Relay Over BVI for IANA Address Allocation, use the following steps.

1. Enter the interface configuration mode and configure a BVI interface.
2. Assign an IPv6 address to the BVI interface.
3. Route the L2 access interface to the L3 BVI interface of the relay agent.
4. Enter the DHCP IPv6 configuration mode and then create a DHCP IPv6 Stateful relay profile.
5. Attach the relay profile to a server address.
6. Configure a stateful relay agent by enabling route allocation through IANA.
7. Attach the BVI Interface to the DHCPv6 relay profile.

Configuration

```

/* Enter the interface configuration mode and configure a BVI interface. */
Router# configure
Router(config)# interface BVI1

Assign an IPv6 address to the BVI interface.
Router(config-if)# ipv6 address 2001:db8::2/64
Router(config-if)# commit
Router(config-if)# exit

/* Route the L2 access interface to the L3 BVI interface of the relay agent. */
Router(config)# l2vpn bridge group 1
Router(config-l2vpn-bg)# bridge-domain 1
Router(config-l2vpn-bg-bd)# interface hundredGigE 0/0/0/1.100
Router(config-l2vpn-bg-bd-ac)# commit
Router(config-l2vpn-bg-bd-ac)# exit
Router(config-l2vpn-bg-bd)# routed interface BVI1
Router(config-l2vpn-bg-bd)# exit
Router(config-l2vpn-bg)# exit
Router(config-l2vpn-bg)# exit
Router(config-l2vpn)# exit
Router(config)#

/* Enter the DHCP IPv6 configuration mode and then create a DHCP IPv6 Stateful relay profile.
*/
Router(config)# dhcp ipv6

```

```

Router(config-dhcpv6)# profile RELAY1 relay

/* Attach the relay profile to a server address. */
Router(config-dhcpv6-relay-profile)# helper-address vrf default 2001:DB8::1

/* Configure a stateful relay agent by enabling route allocation through IANA. */
Router(config-dhcpv6-relay-profile)# iana-route-add
Router(config-dhcpv6-relay-profile)# exit

/* Attach the BVI Interface to the DHCPv6 relay profile. */
Router(config-dhcpv6-relay-profile)# interface BVI1 relay profile RELAY1
Router(config-dhcpv6-relay-profile)# commit

```

Running Configuration

```

Router# show running configuration
interface BVI1
  ipv6 address 2001:db8::2/64
  !
l2vpn
  bridge group 1
    bridge-domain 1
      interface HundredGigE0/0/0/1.100
        !
        routed interface BVI1
        !
      !
    !
  !
dhcp ipv6
  profile RELAY1 relay
  helper-address vrf default 2001:db8::1
  iana-route-add
  !
  interface BVI1 relay profile RELAY1
  !

```

Verification

Use the following command to verify that more than one DHCP client is bridged over BVI:

```

Router# show dhcp ipv6 relay binding
Thu Nov 21 05:48:38.463 UTC

Summary:
Total number of clients: 500

IPv6 Address: 2000::418f/128 (BVI31)
  Client DUID: 000100015dcf28de001094003295
  MAC Address: 0010.9400.3295
  IAID: 0x0
  VRF: default
  Lifetime: 600 secs (00:10:00)
  Expiration: 533 secs (00:08:53)
  L2Intf AC: Bundle-Ether3.1
  SERG State: NONE
  SERG Intf State: SERG-NONE

```

```

IPv6 Address: 2000::4190/128 (BVI31)
Client DUID: 000100015dcf28de001094003296
MAC Address: 0010.9400.3296
IAID: 0x0
VRF: default
Lifetime: 600 secs (00:10:00)
Expiration: 531 secs (00:08:51)
L2Intf AC: Bundle-Ether3.1
SERG State: NONE
SERG Intf State: SERG-NONE
IPv6 Address: 2000::4191/128 (BVI31)
Client DUID: 000100015dcf28de001094003297
MAC Address: 0010.9400.3297
IAID: 0x0
VRF: default
Lifetime: 600 secs (00:10:00)
Expiration: 448 secs (00:07:28)
L2Intf AC: Bundle-Ether3.1
SERG State: NONE
SERG Intf State: SERG-NONE
IPv6 Address: 2000::4192/128 (BVI31)
Client DUID: 000100015dcf28de001094003298
MAC Address: 0010.9400.3298
IAID: 0x0
VRF: default
Lifetime: 600 secs (00:10:00)
Expiration: 439 secs (00:07:19)
L2Intf AC: Bundle-Ether3.1
SERG State: NONE
SERG Intf State: SERG-NONE

```

Use the following command to verify that unique IPv6 address is assigned to a client due to IANA allocation:

```

Router# show route ipv6
Mon Oct 21 06:16:43.617 UTC

Codes: C - connected, S - static, R - RIP, B - BGP, (>) - Diversion path
D - EIGRP, EX - EIGRP external, O - OSPF, IA - OSPF inter area
N1 - OSPF NSSA external type 1, N2 - OSPF NSSA external type 2
E1 - OSPF external type 1, E2 - OSPF external type 2, E - EGP
i - ISIS, L1 - IS-IS level-1, L2 - IS-IS level-2
ia - IS-IS inter area, su - IS-IS summary null, * - candidate default
U - per-user static route, o - ODR, L - local, G - DAGR, l - LISP
A - access/subscriber, a - Application route
M - mobile route, r - RPL, t - Traffic Engineering, (!) - FRR Backup path

Gateway of last resort is not set

A    2000::/64
     [1/0] via fe80::1, 00:00:37, BVI700
A    2000::1/128
     [1/0] via fe80::210:94ff:fe00:8, 00:00:12, BVI700
C    2007:3019::/64 is directly connected,
     00:00:37, Loopback1
L    2007:3019::1/128 is directly connected,
     00:00:37, Loopback1
C    7001:6018::/64 is directly connected,
     00:00:37, BVI700
L    7001:6018::1/128 is directly connected,
     00:00:37, BVI700
C    7001:6019::/64 is directly connected,
     00:00:37, TenGigE0/0/0/2.2
L    7001:6019::1/128 is directly connected,
     00:00:37, TenGigE0/0/0/2.2

```

DHCP Relay Profile: Example

The following example shows how to configure the DHCP relay profile:

```
dhcp ipv4
  profile client relay
  helper-address vrf foo 10.10.1.1
!
! ...
```

DHCP Relay on an Interface: Example

The following example shows how to enable the DHCP relay agent on an interface:

```
dhcp ipv4
  interface GigabitEthernet 0/1/1/0 relay profile client
!
```

DHCP Relay on a VRF: Example

The following example shows how to enable the DHCP relay agent on a VRF:

```
dhcp ipv4
  vrf default relay profile client
!
```

Relay Agent Information Option Support: Example

The following example shows how to enable the relay agent and the insertion and removal of the DHCP relay information option:

```
dhcp ipv4
  profile client relay
  relay information option
!
!
```

Relay Agent Giaddr Policy: Example

The following example shows how to configure relay agent giaddr policy:

```
dhcp ipv4
  profile client relay
  giaddr policy drop
!
!
```

Configure a DHCP Proxy Profile

The DHCP proxy performs all the functions of a relay and also provides some additional functions. The DHCP proxy conceals DHCP server details from DHCP clients. The DHCP proxy modifies the DHCP replies such that the client considers the proxy to be the server. In this state, the client interacts with the proxy as if it is the DHCP server.

Configuration Example

1. Enter DHCP IPv4 or DHCP IPv6 profile proxy submode.
2. Forward UDP broadcasts, including DHCP.



Note

- The value of the *address* argument can be a specific DHCP server address or a network address (if other DHCP servers are on the destination network segment). Using the network address enables other servers to respond to DHCP requests.
- For multiple servers, configure one helper address for each server.

Configuration

```
/* Enter the DHCP IPv4 profile proxy submode. */
Router(config)# dhcp ipv4
Router(config-dhcpv4)# profile client proxy

/* Forward UDP broadcasts, including DHCP */
Router(config-dhcpv4-proxy-profile)# helper-address vrf vrf1 foo 10.10.1.1
Router(config-dhcpv4-proxy-profile)# commit
```

DHCP Server

A DHCP server accepts address assignment requests and renewals, and assigns the IP addresses from predefined groups of addresses contained within Distributed Address Pools (DAPS). DHCP servers can also be configured to supply additional information to the requesting client such as subnet mask, domain-name, the IP address of the DNS server, the default router, and other configuration parameters. DHCP servers can accept broadcasts from locally attached LAN segments or from DHCP requests that have been forwarded by other DHCP relay agents within the network.

The DHCP proxy performs all the functions of a relay and also provides some additional functions. The DHCP proxy conceals DHCP server details from DHCP clients. The DHCP proxy modifies the DHCP replies such that the client considers the proxy to be the server. In this state, the client interacts with the proxy as if it is the DHCP server.

When the DHCP server receives an address assignment request, it assigns the IP addresses from groups of IP addresses for DHCP in Distributed Address Pools (DAPS). The IP address used by the DHCP server to complete such requests is automatically excluded from the DAPS so that the DHCP server can safely assume that all the IP addresses available for its use in the DAPS are free.

DHCP Service-based Mode Selection

As part of DHCP service-based mode selection feature, a new mode called DHCP base is introduced. If an interface is configured in the DHCP base mode, then the DHCP selects either the DHCP proxy or the DHCP server mode to process the client request by matching option 60 (class-identifier) value of the client request with the configured value under the DHCP base profile.

The pool is configured under server-profile mode and server-profile-class submode. The class-based pool selection is always given priority over profile pool selection.

The DHCPv6 server-profile-class submode supports configuring DHCP options except few (0, 12, 50, 52, 53, 54, 58, 59, 61, 82, and 255).

```
dhcp ipv6
profile DHCP_BASE base
  match option 60 41424344 profile DHCPv6_PROXY proxy
  match option 60 41424355 profile DHCPv6_SERVER server
  default profile DEFAULT_PROFILE server
  relay information authenticate inserted
  !
profile DHCPv6_PROXY proxy
  helper-address vrf default 10.10.10.1 giaddr 0.0.0.0
  !
profile DHCPv6_SERVER server
  lease 1 0 0
  pool IP_POOL
  !
profile DEFAULT_PROFILE server
  lease 1 0 0
  pool IP_POOL
  !
  !
interface gigabitEthernet 0/0/0/0 base profile DHCP_BASE
```

Configuring DHCP Server Profile

You can configure routers with DHCPv4 or DHCPv6 server profile.

Perform this task to configure the DHCPv6 server profile.

```
Router# configure
Router(config)# dhcp ipv6
Router(config-dhcpv6)# profile profile-name server
Router(config-dhcpv6-server-profile)# bootfile boot-file-name
Router(config-dhcpv6-server-profile)# broadcast-flag policy unicast-always
Router(config-dhcpv6-server-profile)# class class-name
Router(config-dhcpv6-server-profile-class)# exit
Router(config-dhcpv6-server-profile)# default-router address1 address2 ... address8
Router(config-dhcpv6-server-profile)# lease {infinite | days minutes seconds }
Router(config-dhcpv6-server-profile)# limit lease {per-circuit-id | per-interface|
per-remote-id} value
Router(config-dhcpv6-server-profile)# netbios-name server address1 address2 ... address8
Router(config-dhcpv6-server-profile)# netbios-node-type {number |b-node|h-node |m-node
|p-node}
Router(config-dhcpv6-server-profile)# option option-code {ascii string | hex string |ip
address}
Router(config-dhcpv6-server-profile)# pool pool-name
Router(config-dhcpv6-server-profile)# requested-ip-address-check disable
Router(config-dhcpv6-server-profile)# commit
```

Configuring Multiple Classes with a Pool

Perform this task to configure multiple classes with a pool.

```
RP/0/RSP0/CPU0:router# configure
RP/0/RSP0/CPU0:router(config)# dhcp ipv6
RP/0/RSP0/CPU0:router(config-dhcpv6)# profile profile-name server
RP/0/RSP0/CPU0:router(config-dhcpv6-server-profile)# pool pool-name
RP/0/RSP0/CPU0:router(config-dhcpv6-server-profile)# class class-name
RP/0/RSP0/CPU0:router(config-dhcpv6-server-class)# pool pool-name
RP/0/RSP0/CPU0:router(config-dhcpv6-server-class)# match option option [ sub-option
sub-option] [ ascii asciiString | hex hexString ]
RP/0/RSP0/CPU0:router(config-dhcpv6-server-class)# exit
RP/0/RSP0/CPU0:router(config-dhcpv6-server-profile)# class class-name
RP/0/RSP0/CPU0:router(config-dhcpv6-server-class)# pool pool-name
RP/0/RSP0/CPU0:router(config-dhcpv6-server-class)# match vrf vrf-name
RP/0/RSP0/CPU0:router(config-dhcpv6-server-class)# commit
```

Configuring a Server Profile DAPS with Class Match Option

This section discusses configuring a server profile DAPS with class match option.

Configuration Example

```
router#configure

router(config)#dhcp ipv4
/* The 'dhcp ipv6' command configures DHCP for IPv6 and enters the DHCPv6 configuration
submode. */

router(config-dhcpv4)#profile ISP1 server
/* Enters the server profile configuration mode. */

router(config-dhcpv4-server-profile)#pool ISP1_POOL
/* Configures the DAPS pool name. */

router(config-dhcpv4-server-profile)#class ISP1_CLASS
/* Creates and enters server profile class configuration submode. */

router(config-dhcpv4-server-profile-class)#pool ISP1_CLASS_POOL
/* Configures the pool name. */

router(config-dhcpv4-server-profile-class)#match option 60 hex PEXClient_1
/* DHCP server selects a pool from a class by matching options in the received DISCOVER
packet with the match option. */

router(config-dhcpv4-server-profile-class)#exit

router(config-dhcpv4-server-profile)#exit

router(config-dhcpv4)#profile ISP2 server
/* Enters the server profile configuration mode. */

router(config-dhcpv4-server-profile)#dns-server 10.20.3.4
/* Configures the name of the DNS server or the IP address. */

router(config-dhcpv4-server-profile)#pool ISP2_POOL
/* Configures the pool name. */

router(config-dhcpv4-server-profile)#class ISP2_CLASS
/* Creates and enters the server profile class. */
```

```

router(config-dhcpv4-server-profile-class)#pool ISP2_CLASS_POOL
/* Configures the pool name. */

router(config-dhcpv4-server-profile-class)#match option 60 hex PXEClient_2
/* DHCP server selects a pool from a class by matching options in the received DISCOVER
packet with the match option. */

router(config-dhcpv4-server-profile-class)#exit

router(config-dhcpv4-server-profile)#exit

router(config-dhcpv4)#commit

```

Running Configuration

```

Router#show running-config dhcp ipv4
dhcp ipv4
profile ISP1 server
pool ISP1_POOL
class ISP1_CLASS
pool ISP1_CLASS_POOL
match option 60 hex PXEClient_1
exit
exit
profile ISP2 server
dns-server 10.20.3.4
pool ISP2_POOL
class ISP2_CLASS
pool ISP2_CLASS_POOL
match option 60 hex PXEClient_2
exit
exit
!

```

Configuring Server Profile without DAPS Pool Match Option

This section discusses configuring a server profile without DAPS pool match option.

Configuration Example

```

router#configure

router(config)#dhcp ipv4
/* The 'dhcp ipv6' command configures DHCP for IPv6 and enters the DHCPv6 configuration
submode. */

router(config-dhcpv4)#profile ISP1 server
/* Enters the server profile configuration mode. */

router(config-dhcpv4-server-profile)#dns-server ISP1.com
/* Configures the name of the DNS server or IP address. */

router(config-dhcpv4-server-profile)#exit

router(config-dhcpv4)#profile ISP2 server
/* Enters the server profile configuration mode. */

router(config-dhcpv4-server-profile)#dns-server ISP2.com

```

```
/* Configures the name of the DNS server or IP address. */  
  
router(config-dhcpv4-server-profile)#exit  
  
router(config-dhcpv4)#commit
```

Running Configuration

```
Router#show running-config dhcp ipv4  
dhcp ipv4  
  profile ISP1 server  
    dns-server ISP1.com  
  
  exit  
  profile ISP2 server  
    dns-server ISP2.com  
  
  exit  
!
```

Configuring an Address Pool for Each ISP on DAPS

This section discusses configuring an address pool for each ISP on DAPS.

Configuration Example

```
router#configure  
  
router(config)#pool vrf ISP_1 ipv4 ISP1_POOL  
/* Configures an IPv4 pool for the specified VRF or all VRFs. Use the 'ipv6' keyword for  
IPv6 pool. */  
  
router(config-pool-ipv4)#network 10.10.10.0  
/* Specifies network for allocation. */  
  
router(config-pool-ipv4)#exit  
  
router(config)#pool vrf ISP_2 ipv4 ISP2_POOL  
/* Configures an IPv4 pool for the specified VRF or all VRFs. */  
  
router(config-pool-ipv4)#network 10.20.20.0  
/* Specifies network for allocation. */  
  
router(config-pool-ipv4)#exit  
  
router(config-dhcpv4)#commit
```

Running Configuration

```
Router#show running-config pool  
pool vrf ISP_1 ipv4 ISP1_POOL  
  network 10.10.10.0  
  exit  
pool vrf ISP_2 ipv4 ISP2_POOL  
  network 10.20.20.0  
!
```

DHCP Client

The Dynamic Host Configuration Protocol (DHCP) client functionality enables the router interfaces to dynamically acquire the IPv4 or DHCPv4 or DHCPv6 server, and forwards the responses back to the correct Layer 2 address so that the correct device gets the correct configuration information.

DHCP has the ability to allocate IP addresses only for a configurable period of time, called the lease period. If the client is required to retain this IP address for a longer period beyond the lease period, the lease period must be renewed before the IP address expires. The client renews the lease based on configuration that was sent from the server. The client unicasts a REQUEST message using the IP address of the server. When a server receives the REQUEST message and responds with an ACK message. The lease period of the client is extended by the lease time configured in the ACK message.

Restrictions and Limitations

- DHCPv4 or DHCPv6 client can be enabled only on management interfaces.
- Either DHCPv4, DHCPv6, static IPv4, or static IPv6 can be configured on an interface.

Enabling DHCP Client on an Interface

The DHCPv4 or DHCPv6 client can be enabled at an interface level. The DHCP component receives a notification when DHCPv4 or DHCPv6 is enabled or disabled on an interface.

```
Router# configure
Router(config)# interface MgmtEth rack/slot/CPU0/port
Router(config)# interface interface_name ipv6 address dhcp
```

Associated Commands

- [ipv6 address dhcp-client-options](#)
- [clear dhcp ipv6 client](#)
- [show dhcp ipv6 client](#)
- [show tech-support dhcp ipv6 client](#)

DHCP Proxy Binding Table Reload Persistency

The Cisco IOS-XR Dynamic Host Configuration Protocol (DHCP) application is responsible for maintaining the DHCP binding state for the DHCP leases allocated to clients by the DHCP application. These binding states are learned by the DHCP application (proxy/relay/snooping). DHCP clients expect to maintain a DHCP lease regardless of the events that occur to the DHCP application.



Note From Release 6.2.2 onwards, 200K sessions are supported on a proxy or server running DHCPv4 or DHCPv6.

This feature enables the DHCP application to maintain bind state through the above events:

- Process restart – Local checkpoint
- RP failover – Hot standby RP through checkpoint
- LC IMDR – Local checkpoint
- LC OIR – Shadow table on RP
- System restart – Bindings saved on local disk

Configuring DHCP Relay Binding Database Write to System Persistent Memory

Perform this task to configure the DHCP relay binding database write to the system persistent memory. This helps to recover the DHCP relay binding table after a system reload. The file names used for a full persistent file write are `dhcpv4_srp_{nodeid}_odd` or `dhcpv6_srp_{nodeid}_odd` and `dhcpv4_srp_{nodeid}_even` or `dhcpv6_srp_{nodeid}_even`. The `nodeid` is the actual node ID of the node where the file is written. The incremental file is named the same way as the full file, with a `_inc` appended to it.

```
Router# configure
Router(config)# dhcp ipv6
Router(config-dhcpv6)# database [relay] [full-write-interval full-write-interval]
[incremental-write-interval incremental-write-interval]
Router(config-dhcpv6)# commit
```



CHAPTER 5

Implementing Host Services and Applications

- [Implementing Host Services and Applications, on page 61](#)
- [Network Connectivity Tools, on page 61](#)
- [Domain Services, on page 65](#)
- [File Transfer Services, on page 67](#)
- [Cisco inetd, on page 70](#)
- [Telnet, on page 71](#)
- [Syslog source-interface, on page 71](#)

Implementing Host Services and Applications

Cisco IOS XR software Host Services and Applications features on the router are used primarily for checking network connectivity and the route a packet follows to reach a destination, mapping a hostname to an IP address or an IP address to a hostname, and transferring files between routers and UNIX workstations.

Network Connectivity Tools

Network connectivity tools enable you to check device connectivity by running traceroutes and pinging devices on the network:

Ping

The **ping** command is a common method for troubleshooting the accessibility of devices. It uses two Internet Control Message Protocol (ICMP) query messages, ICMP echo requests, and ICMP echo replies to determine whether a remote host is active. The **ping** command also measures the amount of time it takes to receive the echo reply.

The **ping** command first sends an echo request packet to an address, and then it waits for a reply. The ping is successful only if the echo request gets to the destination, and the destination is able to get an echo reply (hostname is alive) back to the source of the ping within a predefined time interval.

The bulk option has been introduced to check reachability to multiple destinations. The destinations are directly input through the CLI. This option is supported for ipv4 destinations only.

Checking Network Connectivity

As an aid to diagnosing basic network connectivity, many network protocols support an echo protocol. The protocol involves sending a special datagram to the destination host, then waiting for a reply datagram from that host. Results from this echo protocol can help in evaluating the path-to-host reliability, delays over the path, and whether the host can be reached or is functioning.

Configuration for Checking Network Connectivity

The following configuration shows an extended **ping** command sourced from the Router A HundredGigE interface and destined for the Router B HundredGigE interface. If this ping succeeds, it is an indication that there is no routing problem. Router A knows how to get to the HundredGigE interface of Router B, and Router B knows how to get to the HundredGigE interface of Router A. Also, both hosts have their default gateways set correctly.

If the extended **ping** command from Router A fails, it means that there is a routing problem. There could be a routing problem on any of the three routers: Router A could be missing a route to the subnet of Router B's interface, or to the subnet between Router C and Router B; Router B could be missing a route to the subnet of Router A's subnet, or to the subnet between Router C and Router A; and Router C could be missing a route to the subnet of Router A's or Router B's Ethernet segments. You should correct any routing problems, and then Host 1 should try to ping Host 2. If Host 1 still cannot ping Host 2, then both hosts' default gateways should be checked. The connectivity between the HundredGigE interface of Router A and the HundredGigE interface of Router B is checked with the extended **ping** command.

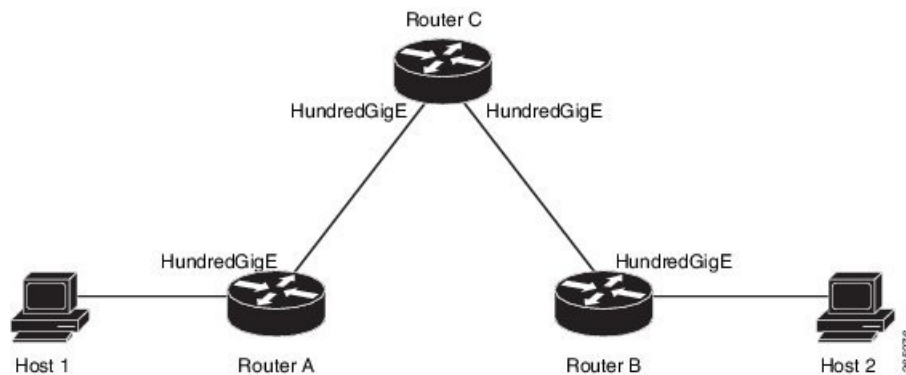

With a normal ping from Router A to Router B's HundredGigE interface, the source address of the ping packet would be the address of the outgoing interface; that is the address of the HundredGigE interface, (10.0.0.2). When Router B replies to the ping packet, it replies to the source address (that is, 10.0.0.2). This way, only the connectivity between the HundredGigE interface of Router A (10.0.0.2) and the 10gige interface of Router B (10.0.0.1) is tested.

To test the connectivity between Router A's HundredGigE interface (10.0.0.2) and Router B's interface (10.0.0.1), we use the extended **ping** command. With extended **ping**, we get the option to specify the source address of the **ping** packet.

Configuration Example

In this use case, the extended **ping** command verifies the IP connectivity between the two IP addresses Router A (10.0.0.2) and Router B (10.0.0.1).

```

Router# ping 10.0.0.1
Type escape sequence to abort.
Sending 5, 100-byte ICMP Echos to 10.0.0.1, timeout is 2 seconds:
  
```

```
!!!!
Success rate is 100 percent (5/5)
Router#!!!!

*/If you do not enter a hostname or an IP address on the same line as the ping command,
the system prompts you to specify the target IP address and several other command parameters.

After specifying the target IP address, you can specify alternate values for the
remaining parameters or accept the displayed default for each parameter /*

Router# ping
Protocol [ipv4]:
Target IP address: 10.0.0.1
Repeat count [5]: 5
Datagram size [100]: 1000
Timeout in seconds [2]: 1
Interval in milliseconds [10]: 1
Extended commands? [no]: no
Sweep range of sizes? [no]:
Type escape sequence to abort.
Sending 5, 1000-byte ICMP Echos to 10.0.0.1, timeout is 1 seconds:
!!!!
Success rate is 100 percent (5/5)
Router#!!!!
```

Associated Commands

- [ping](#)

Checking Network Connectivity for Multiple Destinations

The bulk option enables you to check reachability to multiple destinations. The destinations are directly input through the CLI. This option is supported for ipv4 destinations only.

Configuration Example

Check reachability and network connectivity to multiple hosts on IP networks with the following IP addresses:

- 1: 1.1.1.1
- 2: 2.2.2.2
- 3: 3.3.3.3

```
Router# ping bulk ipv4 input cli batch
*/You must hit the Enter button and then specify one destination address per line*/
Please enter input via CLI with one destination per line and when done Ctrl-D/(exit) to
initiate pings:
1: 1.1.1.1
2: 2.2.2.2
3: 3.3.3.3
4:
Starting pings...
Target IP address: 1.1.1.1
Repeat count [5]: 5
Datagram size [100]: 1
% A decimal number between 36 and 18024.
Datagram size [100]: 1
% A decimal number between 36 and 18024.
Datagram size [100]: 1000
Timeout in seconds [2]: 1
```

```

Interval in milliseconds [10]: 10
Extended commands? [no]: no
Sweep range of sizes? [no]: q
% Please answer 'yes' or 'no'.
Sweep range of sizes? [no]: q
% Please answer 'yes' or 'no'.
Sweep range of sizes? [no]:
Type escape sequence to abort.
Sending 5, 1000-byte ICMP Echos to 1.1.1.1, vrf is default, timeout is 1 seconds:
!!!!
Success rate is 100 percent (5/5),
Target IP address: 2.2.2.2
Repeat count [5]:
Datagram size [100]: q
% A decimal number between 36 and 18024.
Datagram size [100]:
Timeout in seconds [2]:
Interval in milliseconds [10]:
Extended commands? [no]:
Sweep range of sizes? [no]:
Sending 5, 100-byte ICMP Echos to 1.1.1.1, vrf is default, timeout is 2 seconds:
!!!!
Success rate is 100 percent (5/5),
Target IP address: 3.3.3.3
Repeat count [5]: 4
Datagram size [100]: 100
Timeout in seconds [2]: 1
Interval in milliseconds [10]: 10
Extended commands? [no]: no
Sweep range of sizes? [no]: no
Sending 4, 100-byte ICMP Echos to 1.1.1.1, vrf is default, timeout is 1 seconds:
!!!!
Success rate is 100 percent (4/5),

```

Associated Commands

- [ping bulk ipv4](#)

Traceroute

Where the **ping** command can be used to verify connectivity between devices, the **traceroute** command can be used to discover the paths packets take to a remote destination and where routing breaks down.

The **traceroute** command records the source of each ICMP "time-exceeded" message to provide a trace of the path that the packet took to reach the destination. You can use the IP **traceroute** command to identify the path that packets take through the network on a hop-by-hop basis. The command output displays all network layer (Layer 3) devices, such as routers, that the traffic passes through on the way to the destination.

The **traceroute** command uses the Time To Live (TTL) field in the IP header to cause routers and servers to generate specific return messages. The **traceroute** command sends a User Datagram Protocol (UDP) datagram to the destination host with the TTL field set to 1. If a router finds a TTL value of 1 or 0, it drops the datagram and sends back an ICMP time-exceeded message to the sender. The traceroute facility determines the address of the first hop by examining the source address field of the ICMP time-exceeded message.

To identify the next hop, the **traceroute** command sends a UDP packet with a TTL value of 2. The first router decrements the TTL field by 1 and sends the datagram to the next router. The second router sees a TTL value of 1, discards the datagram, and returns the time-exceeded message to the source. This process continues until the TTL increments to a value large enough for the datagram to reach the destination host (or until the maximum TTL is reached).

To determine when a datagram reaches its destination, the **tracert** command sets the UDP destination port in the datagram to a very large value that the destination host is unlikely to be using. When a host receives a datagram with an unrecognized port number, it sends an ICMP port unreachable error to the source. This message indicates to the traceroute facility that it has reached the destination.

Checking Packet Routes

The **tracert** command allows you to trace the routes that packets actually take when traveling to their destinations.

Configuration Example

Trace the route from 10.0.0.2 to 20.1.1.1:

```
Router# tracert 20.1.1.1
Type escape sequence to abort.
Tracing the route to 20.1.1.1
  1  10.0.0.1 39 msec *  3 msec
```

/If you do not enter a hostname or an IP address on the same line as the traceroute command, the system prompts you to specify the target IP address and several other command parameters. After specifying the target IP address, you can specify alternate values for the remaining parameters or accept the displayed default for each parameter/

```
Router #tracert
Protocol [ipv4]:
Target IP address: 20.1.1.1
Source address: 10.0.0.2
Numeric display? [no]:
Timeout in seconds [3]:
Probe count [3]:
Minimum Time to Live [1]:
Maximum Time to Live [30]:
Port Number [33434]:
Loose, Strict, Record, Timestamp, Verbose[none]:
```

```
Type escape sequence to abort.
Tracing the route to 20.1.1.1
  1  10.0.0.1 3 msec *  3 msec
```

Associated Commands

- [tracert](#)

Domain Services

Cisco IOS XR software domain services acts as a Berkeley Standard Distribution (BSD) domain resolver. The domain services maintains a local cache of hostname-to-address mappings for use by applications, such as Telnet, and commands, such as **ping** and **tracert**. The local cache speeds the conversion of host names to addresses. Two types of entries exist in the local cache: static and dynamic. Entries configured using the **domain ipv4 host** or **domain ipv6 host** command are added as static entries, while entries received from the name server are added as dynamic entries.

The name server is used by the World Wide Web (WWW) for translating names of network nodes into addresses. The name server maintains a distributed database that maps hostnames to IP addresses through the

DNS protocol from a DNS server. One or more name servers can be specified using the **domain name-server** command.

When an application needs the IP address of a host or the hostname of an IP address, a remote-procedure call (RPC) is made to the domain services. The domain service looks up the IP address or hostname in the cache, and if the entry is not found, the domain service sends a DNS query to the name server.

You can specify a default domain name that Cisco IOS XR software uses to complete domain name requests. You can also specify either a single domain or a list of domain names. Any IP hostname that does not contain a domain name has the domain name you specify appended to it before being added to the host table. To specify a domain name or names, use either the **domain name** or **domain list** command.

Configuring Domain Services

DNS-based hostname-to-address translation is enabled by default. If hostname-to-address translation has been disabled using the **domain lookup disable** command, re-enable the translation using the **no domain lookup disable** command.

Configuration Example

Define a static hostname-to-address mapping. Associate (or map) the IPv4 addresses (192.168.7.18 and 10.2.0.2 192.168.7.33) with two hosts. The host names are host1 and host2.

```

Defining the Domain Host
=====
Router# configure
Router(config)#domain ipv4 host host1 192.168.7.18
Router(config)#domain ipv4 host host2 10.2.0.2 192.168.7.33
Router(config)#commit

Defining the Domain Name
=====
*/Define cisco.com as the default domain name/*
Router#configure
Router(config)#domain name cisco.com
Router(config)#commit

Specifying the Addresses of the Name Servers
=====
*/Specify host 192.168.1.111 as the primary name server
and host 192.168.1.2 as the secondary server/*
Router#configure
Router(config)#domain name-server 192.168.1.111
Router(config)#domain name-server 192.168.1.2
Router(config)#commit

```

Verification

```

Router#show hosts
Default domain is cisco.com
Name/address lookup uses domain service
Name servers: 192.168.1.111, 192.168.1.2

```

Host	Flags	Age (hr)	Type	Address (es)
host2	(perm, OK)	0	IP	10.2.0.2
				192.168.7.33
host1	(perm, OK)	0	IP	192.168.7.18

Associated Commands

- [domain name](#)
- [domain list](#)
- [domain name-server](#)
- [domain ipv4 host](#)
- [domain ipv6 host](#)

File Transfer Services

File Transfer Protocol (FTP), Trivial File Transfer Protocol (TFTP), remote copy protocol (rcp) rcp clients, and Secure Copy Protocol (SCP) are implemented as file systems or resource managers. For example, path names beginning with `tftp://` are handled by the TFTP resource manager.

The file system interface uses URLs to specify the location of a file. URLs commonly specify files or locations on the WWW. However, on Cisco routers, URLs also specify the location of files on the router or remote file servers.

When a router crashes, it can be useful to obtain a copy of the entire memory contents of the router (called a core dump) for your technical support representative to use to identify the cause of the crash. SCP, FTP, TFTP, rcp can be used to save the core dump to a remote server.

FTP

File Transfer Protocol (FTP) is part of the TCP/IP protocol stack, which is used for transferring files between network nodes. FTP is defined in RFC 959.

Configuring a Router to Use FTP Connections

You can configure the router to use FTP connections for transferring files between systems on the network. You can set the following FTP characteristics:

- Passive-mode FTP
- Password
- IP address

Configuration Example

Enable the router to use FTP connections. Configure the software to use passive FTP connections, a password for anonymous users, and also specify the source IP address for FTP connections.

```
Router#configure
Router(config)#ftp client passive
(Optional) Router(config)#ftp client vrf vrfA
Router(config)#ftp client anonymous-password xxxx
Router(config)#ftp client source-interface HundredGigE 0/0/0/0
Router(config)#commit
```

Running Configuration

```
Router#show running-config ftp client passive
ftp client passive
ftp client vrf vrfa
Router#show running-config ftp client anonymous-password xxxx
ftp client anonymous-password xxxx
Router#show running-config ftp client source-interface HundredGigE 0/0/0/0
ftp client source-interface HundredGigE 0/0/0/0
```

Associated Commands

- ftp client passive
- ftp client anonymous-password
- ftp client source-interface

TFTP

Trivial File Transfer Protocol (TFTP) is a simplified version of FTP that allows files to be transferred from one computer to another over a network, usually without the use of client authentication (for example, username and password).

TFTP Server

It is expensive and inefficient to have a machine that acts only as a server on every network segment. However, when you do not have a server on every segment, your network operations can incur substantial time delays across network segments. You can configure a router to serve as a TFTP server to reduce costs and time delays in your network while you use your router for its regular functions.

Typically, a router that you configure as a TFTP server enables the router to serve requests from client routers. This includes services such as providing client routers with system image or router configuration files from its flash memory. You can also configure the router to respond to other types of service requests.

Configuring a Router as a TFTP Server

The server and client router must be able to reach each other before the TFTP function can be implemented. Verify this connection by testing the connection between the server and client router (in either direction) using the **ping** command.

This task allows you to configure the router as a TFTP server so other devices acting as TFTP clients are able to read and write files from and to the router under a specific directory, such as slot0:, /tmp, and so on (TFTP home directory).



Note For security reasons, the TFTP server requires that a file must already exist for a write request to succeed.

The server and client router must be able to reach each other before the TFTP function can be implemented. Verify this connection by testing the connection between the server and client router (in either direction) using the **ping** command.

Configuration Example

Configure the router (home directory disk0:) as the TFTP server.

```
Router#configure
Router(config)#tftp ipv4 server homedir disk0
Router(config)#commit
```

Running Configuration

```
Router#show running-config tftp ipv4 server homedir disk0:
tftp vrf default ipv4 server homedir disk0:
```

Verification

```
Router#show cinetd services
Vrf Name Family Service Proto Port ACL max_cnt curr_cnt wait Program Client Option
default v4 tftp udp 69 unlimited 0 wait tftpd sysdb disk0:
default v4 telnet tcp 23 10 0 nowait telnetd sysdb
```

Associated Commands

Configuring a Router to Use TFTP Connections

Configuration Example

Configure the router to use TFTP connections and set the IP address of the HundredGigE 0/0/0/0 as the source address for TFTP connections:

```
Router#configure
Router(config)#tftp client source-interface HundredGigE 0/0/0/0
Router(config)#commit
```

Running Configuration

```
Router#show running-config tftp client source-interface HundredGigE 0/0/0/0
tftp client source-interface HundredGigE 0/0/0/0
```

Verification

```
Router#show cinetd services
Vrf Name Family Service Proto Port ACL max_cnt curr_cnt wait Program Client Option
default v4 tftp udp 69 unlimited 0 wait tftpd sysdb disk0:
default v4 telnet tcp 23 10 0 nowait telnetd sysdb
```

Associated Commands

- tftp client source-interface type
- show cinetd services

SCP

Secure Copy Protocol (SCP) is a file transfer protocol which provides a secure and authenticated method for transferring files. SCP relies on SSHv2 to transfer files from a remote location to a local location or from local location to a remote location.

Cisco IOS XR software supports SCP server and client operations. If a device receives an SCP request, the SSH server process spawns the SCP server process which interacts with the client. For each incoming SCP subsystem request, a new SCP server instance is spawned. If a device sends a file transfer request to a destination device, it acts as the client.

When a device starts an SSH connection to a remote host for file transfer, the remote device can either respond to the request in Source Mode or Sink Mode. In Source Mode, the device is the file source. It reads the file from its local directory and transfers the file to the intended destination. In Sink Mode, the device is the destination for the file to be transferred.

Using SCP, you can copy a file from the local device to a destination device or from a destination device to the local device.

Using SCP, you can only transfer individual files. You cannot transfer a file from a destination device to another destination device.

Transferring Files Using SCP

Secure Copy Protocol (SCP) allows you to transfer files between source and destination devices. You can transfer one file at a time. If the destination is a server, SSH server process must be running.

Configuration Example

Transfers the file "test123.txt" from the local directory to the remote directory.

```
Router#scp /harddisk:/test123.txt xyz@1.75.55.1:/auto/remote/test123.txt
Connecting to 1.75.55.1...
Password:
Router#commit
```

Verification

Verify if the file "test123.txt" is copied:

```
xyz-lnx-v1:/auto/remote> ls -altr test123.txt
-rw-r--r-- 1 xyz eng 0 Nov 23 09:46 test123.txt
```

Associated Commands

- scp

Cisco inetd

Cisco Internet services process daemon (Cinetd) is a multithreaded server process that is started by the system manager after the system has booted. Cinetd listens for Internet services such as Telnet service, TFTP service, and so on. Whether Cinetd listens for a specific service depends on the router configuration. For example, when the **tftp server** command is entered, Cinetd starts listening for the TFTP service. When a request arrives, Cinetd runs the server program associated with the service.

Telnet

Enabling Telnet allows inbound Telnet connections into a networking device.

Configuration Example

Enable telnet and limit the number of simultaneous users that can access the router to 10.

```
Router# configure
Router(config)# telnet ipv4 server max-servers 10
Router(config)# commit
```

Verification

```
Router# show cinetd services
Vrf Name  Family  Service  Proto Port ACL max_cnt curr_cnt wait Program Client Option
default  v4      tftp     udp  69      unlimited 0      wait  tftpd  sysdb
disk0:
default  v4      telnet   tcp  23      10 0      nowait telnetd sysdb
```

Associated Commands

Syslog source-interface

You can configure the logging source interface to identify the syslog traffic, originating in a VRF from a particular router, as coming from a single device.

Configuration Example

Enable a source interface for the remote syslog server. Configure interface loopback 2 to be the logging source interface for the default vrf.

```
Router#configure
Router(config)#logging source-interface Loopback2
Router(config)#logging source-interface Loopback3 vrf vrfa
Router(config)#commit
```

Running Configuration

```
Router#show running-config logging
/*Logging configuration after changing the source into loopback2 interface.
logging console debugging
logging monitor debugging
logging facility local4
logging 123.100.100.189 vrf default severity info port default
logging source-interface Loopback2
logging source-interface Loopback3 vrf vrfa
```

Associated Commands

- logging source-interface
- show running-configuration logging



CHAPTER 6

Implementing Access Lists and Prefix Lists

- [Understanding Access Lists](#) , on page 73
- [User-Defined TCAM Keys for IPv4 and IPv6](#), on page 80
- [Configuring IPv4 ACLs](#), on page 83
- [Configuring IPv6 ACLs](#), on page 86
- [Modifying ACLs](#), on page 91
- [Configuring ACL-based Forwarding](#), on page 92
- [ACLs on Bridge Virtual Interfaces](#), on page 94
- [Configuring ACLs with Fragment Control](#), on page 97
- [Configuring ACL Filtering by IP Packet Length](#), on page 102
- [Understanding Object-Group ACLs](#), on page 106
- [Configuring TTL Matching and Rewriting for IPv4 ACLs](#), on page 111
- [Configuring Interface-Based Unique IPv4 ACLs](#), on page 112
- [Configuring TTL Matching and Rewriting for IPv6 ACLs](#), on page 114
- [Configuring Interface-Based Unique IPv6 ACLs](#), on page 115
- [Filtering Packets with IPv6 Extension Headers](#), on page 116
- [Configuring Extended Access Lists](#), on page 117
- [Understanding IP Access List Logging Messages](#), on page 118
- [Understanding Prefix Lists](#), on page 120
- [Configuring Prefix Lists](#), on page 120
- [Sequencing Prefix List Entries and Revising the Prefix List](#), on page 121

Understanding Access Lists

Access lists perform packet filtering to control which packets move through the network and where. Such controls help to limit network traffic and restrict the access of users and devices to the network. Access lists have many uses, and therefore many commands accept a reference to an access list in their command syntax. Access lists can be used to do the following:

An access control list (ACL) consists of one or more access control entries (ACE) that collectively define the network traffic profile. This profile can then be referenced by Cisco IOS XR software features such as traffic filtering, route filtering, QoS classification, and access control.

Traditional ACLs don't support compression. Object-group ACLs use compression to accommodate the large number of ACEs.

Purpose of IP Access Lists

- Filter incoming or outgoing packets on an interface.
- Filter packets for mirroring.
- Redirect traffic as required.
- Restrict the contents of routing updates.
- Limit debug output based on an address or protocol.
- Control vty access.
- Identify or classify traffic for advanced features, such as congestion avoidance, congestion management, and priority and custom queueing.

How an IP Access List Works

An access list is a sequential list consisting of permit and deny statements that apply to IP addresses and possibly upper-layer IP protocols. The access list has a name by which it is referenced. Many software commands accept an access list as part of their syntax.

An access list can be configured and named, but it is not in effect until the access list is referenced by a command that accepts an access list. Multiple commands can reference the same access list. An access list can control traffic arriving at the router or leaving the router, but not traffic originating at the router.

Source address and destination addresses are two of the most typical fields in an IP packet on which to base an access list. Specify source addresses to control packets from certain networking devices or hosts. Specify destination addresses to control packets being sent to certain networking devices or hosts.

You can also filter packets on the basis of transport layer information, such as whether the packet is a TCP, UDP, ICMP, or IGMP packet.

ACL Workflow

The following image illustrates the workflow of an ACL.

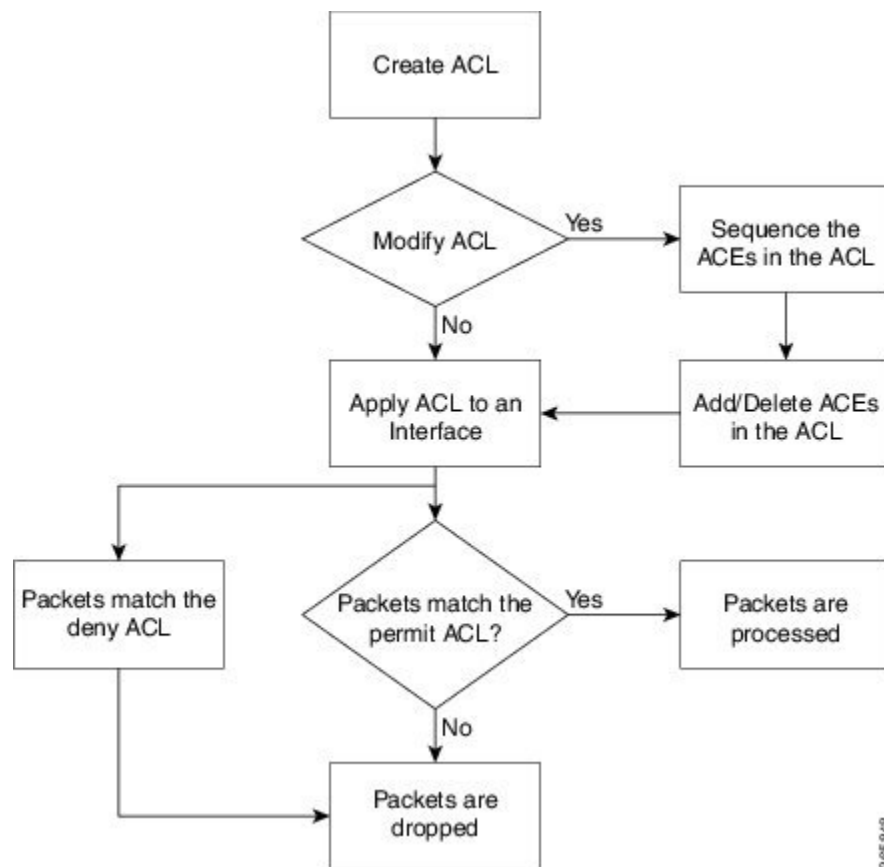

IP Access List Process and Rules

Use the following process and rules when configuring an IP access list:

- The software tests the source or destination address or the protocol of each packet being filtered against the conditions in the access list, one condition (permit or deny statement) at a time.
- If a packet does not match an access list statement, the packet is then tested against the next statement in the list.
- If a packet and an access list statement match, the remaining statements in the list are skipped and the packet is permitted or denied as specified in the matched statement. The first entry that the packet matches determines whether the software permits or denies the packet. That is, after the first match, no subsequent entries are considered.
- If the access list denies the address or protocol, the software discards the packet and returns an Internet Control Message Protocol (ICMP) Host Unreachable message. ICMP is configurable in the Cisco IOS XR software.
- If no conditions match, the software drops the packet because each access list ends with an unwritten or implicit deny statement. That is, if the packet has not been permitted or denied by the time it was tested against each statement, it is denied.
- The access list should contain at least one permit statement or else all packets are denied.

- Because the software stops testing conditions after the first match, the order of the conditions is critical. The same permit or deny statements specified in a different order could result in a packet being passed under one circumstance and denied in another circumstance.
- Only one access list per interface, per protocol, per direction is allowed.
- Inbound access lists process packets arriving at the router. Incoming packets are processed before being routed to an outbound interface. An inbound access list is efficient because it saves the overhead of routing lookups if the packet is to be discarded because it is denied by the filtering tests. If the packet is permitted by the tests, it is then processed for routing. For inbound lists, permit means continue to process the packet after receiving it on an inbound interface; **deny** means to discard the packet.
- Outbound access lists process packets before they leave the router. Incoming packets are routed to the outbound interface and then processed through the outbound access list. For outbound lists, permit means send it to the output buffer; deny means discard the packet.
- An access list cannot be removed if that access list is being applied by an access group in use. To remove an access list, remove the access group that is referencing the access list and then remove the access list.
- Before removing an interface, which is configured with an ACL that denies certain traffic, you must remove the ACL and commit your configuration. If this is not done, then some packets are leaked through the interface as soon as the **no interface <interface-name>** command is configured and committed.
- An access list must exist before you can use the **ipv4 access group** command.
- ACL-based Forwarding (ABF) is not supported in common ACLs.
- Filtering of MPLS packets with the explicit-null or de-aggregation label is supported on the ingress direction.
- If the Ternary Content-Addressable Memory (TCAM) utilization is high and large ACLs are modified, then an error may occur. During such instances, remove the ACL from the interface and reconfigure the ACL. Later, reapply the ACL to the interface.
- You can configure an ACL name with a maximum of 64 characters.
- You can configure an ACL name to comprise of only letters and numbers.

ACL Filtering by Wildcard Mask and Implicit Wildcard Mask

Address filtering uses wildcard masking to indicate whether the software checks or ignores corresponding IP address bits when comparing the address bits in an access-list entry to a packet being submitted to the access list. By carefully setting wildcard masks, an administrator can select a single or several IP addresses for permit or deny tests.

Wildcard masking for IP address bits uses the number 1 and the number 0 to specify how the software treats the corresponding IP address bits. A wildcard mask is sometimes referred to as an *inverted mask*, because a 1 and 0 mean the opposite of what they mean in a subnet (network) mask.

- A wildcard mask bit 0 means *check* the corresponding bit value.
- A wildcard mask bit 1 means *ignore* that corresponding bit value.

You do not have to supply a wildcard mask with a source or destination address in an access list statement. If you use the **host** keyword, the software assumes a wildcard mask of 0.0.0.0.

Unlike subnet masks, which require contiguous bits indicating network and subnet to be ones, wildcard masks allow noncontiguous bits in the mask.

You can also use CIDR format (/x) in place of wildcard bits. For example, the IPv4 address 1.2.3.4 0.255.255.255 corresponds to 1.2.3.4/8 and for IPv6 address 2001:db8:abcd:0012:0000:0000:0000:0000 corresponds to 2001:db8:abcd:0012::0/64.

Including Comments in Access Lists

You can include comments (remarks) about entries in any named IP access list using the `remark access-list` configuration command. The remarks make the access list easier for the network administrator to understand and scan. Each remark line is limited to 255 characters.

The remark can go before or after a **permit** or **deny** statement. You should be consistent about where you put the remark so it is clear which remark describes which **permit** or **deny** statement. For example, it would be confusing to have some remarks before the associated **permit** or **deny** statements and some remarks after the associated statements. Remarks can be sequenced.

Remember to apply the access list to an interface or terminal line after the access list is created.

Display Access Lists

You can display the contents of the access lists access using the **show access-lists** command. Use the **show access-lists ipv4** command to display the contents of all IPv4 access lists and for IPv6 access lists, use the **show access-lists ipv6** command.

In the following example, the contents of all IPv4 access lists are displayed:

```
Router# show access-lists ipv4
ipv4 access-list test_ipv4
 10 permit ipv4 any any
 20 deny tcp any eq 2000 any eq 2000
 30 permit tcp any eq 3000 any eq 3000
```

In the following example, the contents of all IPv6 access lists are displayed:

```
Router# show access-lists ipv6
ipv6 access-list test_ipv6
 10 permit ipv6 any any
 20 permit tcp any eq 3000 any eq 3000
```

To display the contents of a specific access list, use the *name* argument. Use the *sequence-number* argument to specify the sequence number of the access list.

In the following example, the contents of an access list named Internetfilter is displayed:

```
Router# show access-lists ipv6 Internetfilter
ipv6 access-list Internetfilter
 3 remark Block BGP traffic from a given host
 4 deny tcp host 6666:1:2:3::10 eq bgp host 7777:1:2:3::20 range 1300 1404 deny tcp host
171.69.2.88 255.255.0.0 any eq telnet
 20 permit ipv6 3333:1:2:3::/64 any
 25 permit ipv6 4444:1:2:3::/64 any
 30 permit ipv6 5555:1:2:3::/64 any
```

You can use the **hardware**, **ingress**, and **location** keywords to display the access list hardware contents and counters for all interfaces that use the specified access list in a given direction. To display the contents of a specific access list entry, use the *sequencenumber* keyword and argument. The access group for an interface must be configured using the **ipv4/ipv6 access-group** command for access list hardware counters to be enabled.

In the following example, the contents of an access list named Test that has ACL-based policing is configured is displayed:

```
Router(config)# show ipv4 access-list Test hardware ingress location 0/1/CPU0
10 permit 192.168.34.0 0.0.0.255 (Accepted: 130 packets, Dropped: 0 packets)
20 permit 172.16.0.0 0.0.255.255 (Accepted: 1005 packets, Dropped: 0 packets)
30 permit 10.0.0.0 0.255.255.255 (Accepted: 10303 packets, Dropped: 7 packets)
```

In the following example, the contents of an access list named Test that has ACL-based policing is configured is displayed:

```
Router# show ipv6 access-lists Test hardware ingress location 0/1/CPU0
10 permit fec0:0:0:2::/64 any (Accepted: 24303 packets, Dropped: 0 packets)
20 permit any any (Accepted: 13 packets, Dropped: 0 packets)
```

The following example displays the ACL contents:

```
Router# show access-lists IPv4-ABF hardware ingress location 0/6/CPU0
Wed Feb 19 13:36:26.663 PST
ipv4 access-list IPv4-ABF
100 permit tcp host 27.0.0.2 any eq 8080 (6854367 matches) (next-hop: addr=21.0.0.2, vrf
name=vrf1)
110 permit tcp any eq https any (6858321 matches) (next-hop: addr=200.1.1.2, vrf name=vrf2)
120 permit ipv4 any any (6940396 matches) (next-hop: addr=50.0.0.1, vrf name=default)
```

In the following example, the contents of all IPv6 access lists are displayed:

```
Router# show access-lists ipv6
ipv6 access-list test_ipv6
 10 permit ipv6 any any
 20 permit tcp any eq 3000 any eq 3000
```

In the following example, the details of a IPv4 access list for a hardware interface in ingress direction are displayed:

```
Router# show access-lists ipv4 objv4acl hardware ingress detail location 0/0/CPU0
objv4acl Details:
Sequence Number: 10
NPU ID: 0
Number of DPA Entries: 1
ACL ID: 2
ACE Action: PERMIT
ACE Logging: DISABLED
ABF Action: 0 (ABF_NONE)
Hit Packet Count: 477 Byte Count: 30528
Source Address: 0.0.0.1 (Mask 255.255.255.254)
Destination Address: 0.0.0.1 (Mask 255.255.255.254)
DPA Entry: 1
  Entry Index: 0
  DPA Handle: 0x8E08F0A8
  DSCP: 0x28 (Mask 0xFC)
Sequence Number: IMPLICIT DENY
NPU ID: 0
Number of DPA Entries: 1
ACL ID: 2
ACE Action: DENY
ACE Logging: DISABLED
ABF Action: 0 (ABF_NONE)
Hit Packet Count: 0 Byte Count: 0
Source Address: 0.0.0.2 (Mask 255.255.255.253)
Destination Address: 0.0.0.2 (Mask 255.255.255.253)
DPA Entry: 1
```

```
Entry Index: 0
DPA Handle: 0x8E08F390
```

In the following example, the details of a IPv6 access list for a hardware interface in ingress direction are displayed:

```
Router# show access-lists ipv6 v6t1 hardware ingress detail location 0/0/CPU0
v6t1 Details:
Sequence Number: 10
NPU ID: 0
Number of DPA Entries: 1
ACL ID: 1
ACE Action: PERMIT
ACE Logging: DISABLED
ABF Action: 0 (ABF_NONE)
Hit Packet Count: 0 Byte Count: 0
Source Address: 0:0:0:0::
  Source Address Mask: 0:0:0:0::
Destination Address: 2222:0:0:0::
  Destination Address Mask: ffff:ffff:ffff:ffff::
DPA Entry: 1
  Entry Index: 0
  DPA Handle: 0x8E3000A8
  DSCP: 0x28 (Mask 0xFC)
Sequence Number: 20
NPU ID: 0
Number of DPA Entries: 1
ACL ID: 1
ACE Action: PERMIT
ACE Logging: DISABLED
ABF Action: 0 (ABF_NONE)
Hit Packet Count: 0 Byte Count: 0
TCP Flags: 0x01 (Mask 0x01)
Protocol: 0x06 (Mask 0xFF)
Source Address: 0:0:0:0::
  Source Address Mask: 0:0:0:0::
Destination Address: 2222:0:0:0::
  Destination Address Mask: ffff:ffff:ffff:ffff::
DPA Entry: 1
  Entry Index: 0
  DPA Handle: 0x8E300390
Sequence Number: IMPLICIT NDNA PERMIT
NPU ID: 0
Number of DPA Entries: 1
ACL ID: 1
ACE Action: PERMIT
ACE Logging: DISABLED
ABF Action: 0 (ABF_NONE)
Hit Packet Count: 0 Byte Count: 0
Protocol: 0x3A (Mask 0xFF)
Source Address: 0:0:0:0::
  Source Address Mask: 0:0:0:0::
Destination Address: 0:0:0:0::
  Destination Address Mask: 0:0:0:0::
DPA Entry: 1
  Entry Index: 0
  DPA Handle: 0x8E300678
Sequence Number: IMPLICIT NDNS PERMIT
NPU ID: 0
Number of DPA Entries: 1
ACL ID: 1
ACE Action: PERMIT
ACE Logging: DISABLED
ABF Action: 0 (ABF_NONE)
Hit Packet Count: 0 Byte Count: 0
```

```

Protocol: 0x3A (Mask 0xFF)
Source Address: 0:0:0:0::
  Source Address Mask: 0:0:0:0::
Destination Address: 0:0:0:0::
  Destination Address Mask: 0:0:0:0::
DPA Entry: 1
  Entry Index: 0
  DPA Handle: 0x8E300960
Sequence Number: IMPLICIT DENY
NPU ID: 0
Number of DPA Entries: 1
ACL ID: 1
ACE Action: DENY
ACE Logging: DISABLED
ABF Action: 0 (ABF_NONE)
Hit Packet Count: 0 Byte Count: 0
Source Address: 0:0:0:0::
  Source Address Mask: 0:0:0:0::
Destination Address: 0:0:0:0::
  Destination Address Mask: 0:0:0:0::
DPA Entry: 1
  Entry Index: 0
  DPA Handle: 0x8E300C48

Router# show ipv6 access-lists Test hardware ingress location 0/1/CPU0
ipv6 access-list Test
10 permit fec0:0:0:2::/64 any (24303 matches) (2459695 byte matches)
20 permit any any (13 matches) (246 byte matches)

```

User-Defined TCAM Keys for IPv4 and IPv6

Access-lists on the Cisco NCS 5500 Series Routers use a TCAM (internal and external) to perform the lookup and action resolution on each packet. The TCAM is a valuable and constrained resource in hardware, which must be shared by multiple features. Therefore, the space (key width) available for these key definitions is also constrained. A key definition specifies which qualifier and action fields are available to the ACL feature when performing the lookup. Not all available qualifier and action fields can be included in each key definition.

The key definitions are specific to a given ACL type, which can depend on the following attributes of the access-list:

- Direction of attachment, whether ingress or egress
- Protocol type (IPv4/IPv6/L2)
- Compression level (0:uncompressed, 3:compressed)

Because the default key definitions are constrained (do not include all qualifier/action fields), User-Defined Key (UDK) definitions are supported for the following types:

- Traditional Ingress IPv4 ACL (uncompressed)
- Traditional Ingress IPv6 ACL (uncompressed)

The User-Defined TCAM Key (UDK) functionality provides the flexibility to define your own TCAM key for one of the three possible reasons (for ingress, traditional, IPv4/IPv6 ACL only):

- To include qualifier fields which are not included in the default TCAM key

- To change the ACL mode from *shared* to *unique* to support a greater number of unique ACLs, unique counters, etc.
- To reduce the size of the TCAM key (number of banks consumed)

A UDK can be configured using the following command:

```
hw-module profile tcam format access-list [ipv4 | ipv6] qualifiers [location rack/slot/cpu0]
```

User-Defined Fields

A TCAM key consists of several qualifiers, where the set of qualifiers are used to filter packets for a given ACL. The User-Defined Field (UDF) allows you to define a custom qualifier by specifying the location and size of the field, using the following UDF command:



Note • Up to 8 UDFs can be defined system wide. Currently, UDFs are globally defined.

```
udf udf-name header [ inner | outer ] [ 12 | 13 | 14 ] offset byte-offset length no  
of bytes
```

The UDF can then be added to a UDK as follows.

```
hw-module profile tcam format access-list [ipv4 | ipv6] qualifiers [udf1 udf-name udf2  
udf-name] [location rack/slot/cpu0]
```

IPv4 and IPv6 Key Formats for Traditional Ingress ACL

User-defined TCAM key (UDK) definition is supported for ingress, traditional (uncompressed) IPv4 and IPv6 ACLs.

The following table shows the qualifier fields that are supported in the IPv4 and IPv6 key formats. If the default TCAM key is set as *Enabled*, then the Qualifier field is enabled by default. If the default TCAM key is set as *Disabled*, then the Qualifier field must use a UDK.

Table 6: Qualifier Fields Supported in IPv4 and IPv6 Key Formats

Parameter	Default TCAM Key	
	IPv4	IPv6
Source Address	Enabled	Enabled
Destination Address	Enabled	Enabled
Source Port	Enabled	Enabled
Destination Port	Enabled	Enabled
Port Range	Enabled	Not supported
Protocol/Next Header	Enabled	Enabled
Fragment bit	Enabled	Not supported

Parameter	Default TCAM Key	
	IPv4	IPv6
Packet length	Disabled	Disabled
Precedence/DSCP	Disabled	Enabled
TCP Flags	Enabled	Enabled
TTL Match	Disabled	Disabled
Interface based	Disabled	Not supported
UDF 1-7	Disabled	Disabled
ACL ID	Enabled	Enabled
common ACL bit	Enabled by default for IPv4/IPv6 on shared mode. Disabled by default for IPv4/IPv6 on unique mode.	Enabled by default for IPv4/IPv6 on shared mode. Disabled by default for IPv4/IPv6 on unique mode.
Interface-based (RIF)	Disabled	Disabled

The following table shows the action fields supported in the IPv4 and IPv6 key formats.



Note You cannot configure QoS groups for ingress ACLs after a User-Defined TCAM Key (UDK) is configured because the command, **permit ipv4 any any set qos-group**, is not supported.

Table 7: Action Fields Supported in IPv4 and IPv6 Key Formats

Parameter	Default Action Field	
	IPv4	IPv6
Permit	Enabled	Enabled
Deny	Enabled	Enabled
Log	Enabled	Enabled
Capture	Enabled	Enabled
Stats Counter	Deny stats is always Enabled (permit stats has its own hw-module command)	Deny stats is always Enabled
TTL Set	Enabled	Enabled

To enable the monitoring of the packet count that is permitted based on the ACL rules, use the following configuration, and then reload the line card or router as required:

```
/* Enable an egress ACL on on a hardware module profile. */
Router(config)# hw-module profile acl egress layer3 interface-based
/* Enable permit statistics for the egress ACL (by default, only deny statistics are shown)
*/
Router(config)# hw-module profile stats acl-permit
Router(config)# commit
Router(config)# end
Router# reload location all
Wed Apr 5 23:05:46.193 UTC
Proceed with reload? [confirm]
```

**Note**

- The Capture parameter is not supported on NC57-24DD and NC57-18DD-SE line cards.
- For NC57-24DD and NC57-18DD-SE line cards, both the Permit and Deny statistics are always enabled. Therefore, there is no need to use the `hw-module profile stats acl-permit` command to enable Permit statistics. Permit and Deny stats are also enabled by default on egress ACLs.

Configuring IPv4 ACLs

This section describes the basic configuration of IPv4 ingress and egress ACLs.

Notes and Restrictions for Configuring IPv4 Ingress ACLs

IPv4 ingress ACLs are characterized by the following behavior.

- Ingress IPv4 ACLs are supported on all interfaces except management interfaces.
- ACL-based Forwarding (ABF) is supported only in the ingress direction.
- The following line card limits apply for traditional and hybrid ingress ACLs:
 - A maximum of 127 different traditional ingress ACLs per LC in shared ACL mode.
 - A maximum of 255 different hybrid ingress ACLs per LC in shared ACL mode.
 - Unique ACL mode allows you to configure more than 128 different traditional ingress ACLs per LC.
- The number of attached ACEs allowed per line card is 4096.

Notes and Restrictions for Configuring IPv4 Egress ACLs

IPv4 egress ACLs are characterized by the following behavior.

- Egress IPv4 ACLs are supported on main physical interfaces and bundle interfaces.



Note Egress ACLs are not directly supported on sub-interfaces. However, If you configure an egress ACL on a main interface that has sub-interfaces, the ACL action is also applied to the sub-interface traffic. This egress ACL behavior holds true even if the sub-interfaces are configured after the ACL is applied to the main interface.

- The total number of egress ACLs allowed per NPU is 255.
- ACL is not supported on Management interface on egress direction.
- Apart from the throughput limitation, router-generated traffic is not be affected by egress IPv4 ACLs.
- The number of attached ACEs allowed per line card is 4096.
- When hierarchical QoS is enabled, egress ACLs are supported on the sub-interfaces. However, an egress ACL configured on the main interfaces is not be applied to the sub-interface traffic.
- Filtering for egress IPv4 multicast traffic is not supported if H-QoS is configured on the router.

Configuring an Ingress IPv4 ACL on a Gigabit Ethernet Interface

Use the following configuration to configure an ingress IPv4 ACL on a GigE interface.

```
/* Configure a GigE interface with an IPv4 address */
Router(config)# interface gigabitEthernet 0/0/0/0
Router(config-if)# ipv4 address 10.1.1.1 255.255.255.0
Router(config-if)# no shut
Router(config-if)# commit
Thu Jan 25 10:07:54.700 IST
Router(config-if)# exit

/* Verify if the interface is up */
Router(config)# do show ipv4 interface brief
Thu Jan 25 10:08:49.087 IST

Interface                IP-Address      Status          Protocol Vrf-Name
GigabitEthernet0/0/0/0  10.1.1.1        Up              Up       default

/* Configure an IPv4 ingress ACL */
Router(config)# ipv4 access-list V4-ACL-INGRESS
Router(config-ipv4-acl)# 10 permit tcp 10.2.1.1 0.0.0.255 any
Router(config-ipv4-acl)# 20 deny udp any any
Router(config-ipv4-acl)# 30 permit ipv4 10.2.0.0 0.255.255.255 any
Router(config-ipv4-acl)# commit
Thu Jan 25 10:16:11.473 IST

/* Verify the ingress ACL creation */
Router(config)# do show access-lists ipv4
Thu Jan 25 10:25:19.896 IST
...
ipv4 access-list V4-ACL-INGRESS
 10 permit tcp 10.2.1.0 0.0.0.255 any
 20 deny udp any any
 30 permit ipv4 10.0.0.0 0.255.255.255 any

/* Apply the ingress ACL to the GigE interface */
```



```

Router(config)# interface GigabitEthernet0/0/0/0
Router(config-if)# ipv4 access-group V4-ACL-INGRESS ingress
Router(config-if)# commit
Thu Jan 25 10:28:19.671 IST
Router(config-if)# exit

/* Verify if the ingress ACL has been successfully applied to the interface */
Router(config)# do show ipv4 interface
Thu Jan 25 10:29:44.944 IST
GigabitEthernet0/0/0/0 is Up, ipv4 protocol is Up
  Vrf is default (vrfid 0x60000000)
  Internet address is 10.1.1.1/24
  MTU is 1514 (1500 is available to IP)
  Helper address is not set
  Directed broadcast forwarding is disabled
  Outgoing access list is not set
  Inbound common access list is not set, access list is V4-ACL-INGRESS
  Proxy ARP is disabled
  ICMP redirects are never sent
  ICMP unreachable are always sent
  ICMP mask replies are never sent
  Table Id is 0xe0000000

```

You have successfully configured an IPv4 ingress ACL on a Gigabit Ethernet interface.

Configuring an Egress IPv4 ACL on a Gigabit Ethernet Interface

Use the following configuration to configure an egress IPv4 ACL on a GigE interface.

```

/* Configure a GigE interface with an IPv4 address */
Router(config)# interface gigabitEthernet 0/0/0/0
Router(config-if)# ipv4 address 20.1.1.1 255.255.255.0
Router(config-if)# no shut
Router(config-if)# commit
Thu Jan 25 10:08:38.767 IST
Router(config-if)# exit

/* Verify if the interface is up */
Router(config)# do show ipv4 interface brief
Thu Jan 25 10:08:49.087 IST

Interface                IP-Address      Status          Protocol Vrf-Name
GigabitEthernet0/0/0/0   10.1.1.1        Up              Up       default
GigabitEthernet0/0/0/0   20.1.1.1        Up              Up       default

/* Configure an IPv4 egress ACL */
Router(config)# ipv4 access-list V4-ACL-EGRESS
Router(config-ipv4-acl)# 10 permit ipv4 10.2.0.0 0.255.255.255 20.2.0.0 0.255.255.255
Router(config-ipv4-acl)# 20 deny ipv4 any any
Router(config-ipv4-acl)# commit
Thu Jan 25 10:25:04.655 IST

/* Verify the egress ACL creation */
Router(config)# do show access-lists ipv4
Thu Jan 25 10:25:19.896 IST
ipv4 access-list V4-ACL-EGRESS
  10 permit ipv4 10.0.0.0 0.255.255.255 20.0.0.0 0.255.255.255
  20 deny ipv4 any any
...

/* Apply the egress ACL to the GigE interface */
Router(config)# interface gigabitEthernet 0/0/0/1

```

```

Router(config-if)# ipv4 access-group V4-ACL-EGRESS egress
Router(config-if)# commit
Thu Jan 25 10:28:45.937 IST
Router(config-if)# exit

/* Verify if the egress ACL has been successfully applied to the interface */
Router(config)# do show ipv4 interface
Thu Jan 25 10:29:44.944 IST
GigabitEthernet 0/0/0/1 is Up, ipv4 protocol is Up
  Vrf is default (vrfid 0x60000000)
  Internet address is 20.1.1.1/24
  MTU is 1514 (1500 is available to IP)
  Helper address is not set
  Directed broadcast forwarding is disabled
  Outgoing access list is V4-ACL-EGRESS
  Inbound common access list is not set, access list is not set
  Proxy ARP is disabled
  ICMP redirects are never sent
  ICMP unreachable are always sent
  ICMP mask replies are never sent
  Table Id is 0xe0000000
...

```

You have successfully configured an IPv4 egress ACL on a Gigabit Ethernet interface.

Configuring IPv6 ACLs

This section describes the steps to configure ingress and egress IPv6 ACLs over gigabit ethernet and bundle interfaces.

Notes and Restrictions for Configuring IPv6 Ingress ACLs

IPv6 ingress ACLs are characterized by the following behavior.

- Ingress IPv6 ACLs are supported on all interfaces.
- ACL-based Forwarding (ABF) is supported only in the ingress direction.
- The following line card limits apply for traditional and hybrid ingress ACLs:
- The number of attached ACEs allowed per line card is 2048 in the ingress direction.
- Packet Length (using the **pkt-length** keyword) is not supported.



Note Packet Length using the **pkt-length** keyword) is supported on the NC57-24DD and NC57-18DD-SE line cards for IPv6 ingress ACLs.

Notes and Restrictions for Configuring IPv6 Egress ACLs

IPv6 egress ACLs are characterized by the following behavior:

- Configuring packet length is not supported on egress ACLs.
- TCP flags are not supported on egress ACLs.

- Egress ACLs are not supported on BVI interfaces and L2 interfaces.
- Configuring qos-group is not supported on egress ACLs.
- A throughput of 50% or less is supported on egress ACLs.



Note For the NC57-24DD and NC57-18DD-SE line cards, 100% throughput is supported on IPv6 egress ACLs.

- Apart from the throughput limitation, router-generated traffic is not be affected by egress IPv6 ACLs.
- The total number of egress ACLs allowed per NPU is 255.
- The total number of attached ACEs allowed per line card is 2048 in the egress direction.
- Configuring dynamic TCAM key is not supported on egress ACLs.
- Upto 160GB of total IPv6 egress ACL is supported per NPU because the Egress IPv6 ACLs take the recycle path.



Note For the NC57-24DD and NC57-18DD-SE line cards, 100% throughput for IPv6 egress ACL is supported per NPU.

- When hierarchical QoS is enabled, egress ACLs are supported on the sub-interfaces. However, an egress ACL configured on the main interfaces is not be applied to the sub-interface traffic.
- Filtering for egress IPv6 multicast traffic is not supported if H-QoS is configured on the router.

Configuring an Ingress IPv6 ACL on a Gigabit Ethernet Interface

Use the following configuration to configure an ingress IPv6 ACL on a GigE interface.

```

/* Configure a GigE interface with an IPv6 address */
Router(config)# interface gigabitEthernet 0/0/0/0
Router(config-if)# ipv6 address 1001::1/64
Router(config-if)# no shut
Router(config-if)# commit
Thu Jan 25 10:07:54.700 IST
Router(config-if)# exit

/* Verify if the interface is up */
Router(config)# do show ipv6 interface brief
Thu Jan 25 12:38:35.742 IST
GigabitEthernet 0/0/0/0 [Up/Up]
    fe80::bd:b9ff:fea9:5606
    1001::1
...

/* Configure an IPv6 ingress ACL */
Router(config)# ipv6 access-list V6-INGRESS-ACL
Router(config-ipv6-acl)# 10 permit ipv6 any any
Router(config-ipv6-acl)# 20 deny udp any any
Router(config-ipv6-acl)# commit
Thu Jan 25 11:31:24.488 IST
Router(config-ipv6-acl)# exit

```

```

/* Verify the ingress ACL creation */
Router(config)# do show access-lists ipv6
Thu Jan 25 11:34:56.911 IST
ipv6 access-list V6-INGRESS-ACL
  10 permit ipv6 any any
  20 deny udp any any

/* Apply the ingress ACL to the GigE interface */
Router(config)# interface gigabitEthernet 0/0/0/0
Router(config-if)# ipv6 access-group V6-INGRESS-ACL ingress
Router(config-if)# commit
Thu Jan 25 11:32:55.194 IST
Router(config-if)# exit

/* Verify if the ingress ACL has been successfully applied to the interface */
Router(config)# do show ipv6 interface
Thu Jan 25 11:34:08.028 IST
GigabitEthernet 0/0/0/0 is Up, ipv6 protocol is Up, Vrfid is default (0x60000000)
IPv6 is enabled, link-local address is fe80::bd:b9ff:fea9:5606
Global unicast address(es):
  1001::1, subnet is 1001::/64
  Joined group address(es): ff02::1:ff00:1 ff02::1:ffa9:5606 ff02::2
    ff02::1
  MTU is 1514 (1500 is available to IPv6)
  ICMP redirects are disabled
  ICMP unreachable are enabled
  ND DAD is enabled, number of DAD attempts 1
  ND reachable time is 0 milliseconds
  ND cache entry limit is 1000000000
  ND advertised retransmit interval is 0 milliseconds
  Hosts use stateless autoconfig for addresses.
  Outgoing access list is not set
Inbound common access list is not set, access list is V6-INGRESS-ACL
  Table Id is 0xe0800000
  Complete protocol adjacency: 0
  Complete glean adjacency: 0
  Incomplete protocol adjacency: 0
  Incomplete glean adjacency: 0
  Dropped protocol request: 0
  Dropped glean request: 0
...

```

You have successfully configured an IPv6 ingress ACL on a Gigabit Ethernet interface.

Configuring an Egress IPv6 ACL on a Gigabit Ethernet Interface

Use the following configuration to configure an egress IPv6 ACL on a GigE interface.

```

/* Configure a GigE interface with an IPv6 address */
Router(config)# interface gigabitEthernet 0/0/0/1
Router(config-if)# ipv6 address 2001::1/64
Router(config-if)# no shut
Router(config-if)# commit
Thu Jan 25 11:41:25.778 IST
Router(config-if)# exit

/* Verify if the interface is up */
Router(config)# do show ipv6 interface brief
Thu Jan 25 12:38:35.742 IST

```

```

GigabitEthernet 0/0/0/0 [Up/Up]
  fe80::bd:b9ff:fea9:5606
  1001::1
GigabitEthernet 0/0/0/1 [Up/Up]
  fe80::23:e9ff:fea8:a44e
  2001::1

/* Configure an IPv6 egress ACL */
Router(config)# ipv6 access-list V6-EGRESS-ACL
Router(config-ipv6-acl)# 10 permit ipv6 any any
Router(config-ipv6-acl)# 20 deny udp any any
Router(config-ipv6-acl)# commit
Thu Jan 25 11:44:03.969 IST
Router(config-ipv6-acl)# exit

/* Verify the egress ACL creation */
Router(config)# do show access-lists ipv6
Thu Jan 25 11:45:53.823 IST
ipv6 access-list V6-EGRESS-ACL
  10 permit ipv6 any any
  20 deny udp any any
...

/* Apply the egress ACL to the GigE interface */
Router(config)# interface gigabitEthernet 0/0/0/1
Router(config-if)# ipv6 access-group V6-EGRESS-ACL egress
Router(config-if)# commit
Thu Jan 25 11:45:12.682 IST
Router(config-if)# exit

/* Verify if the egress ACL has been successfully applied to the interface */
Router(config)# do show ipv6 interface
Thu Jan 25 11:46:43.234 IST
...
GigabitEthernet 0/0/0/1 is Up, ipv6 protocol is Up, Vrfid is default (0x60000000)
  IPv6 is enabled, link-local address is fe80::23:e9ff:fea8:a44e
  Global unicast address(es):
    2001::1, subnet is 2001::/64
  Joined group address(es): ff02::1:ff00:1 ff02::1:ffa8:a44e ff02::2
    ff02::1
  MTU is 1514 (1500 is available to IPv6)
  ICMP redirects are disabled
  ICMP unreachable are enabled
  ND DAD is enabled, number of DAD attempts 1
  ND reachable time is 0 milliseconds
  ND cache entry limit is 1000000000
  ND advertised retransmit interval is 0 milliseconds
  Hosts use stateless autoconfig for addresses.
Outgoing access list is V6-EGRESS-ACL
  Inbound common access list is not set, access list is not set
  Table Id is 0xe0800000
  Complete protocol adjacency: 0
  Complete glean adjacency: 0
  Incomplete protocol adjacency: 0
  Incomplete glean adjacency: 0
  Dropped protocol request: 0
  Dropped glean request: 0
...

```

You have successfully configured an IPv6 egress ACL on a Gigabit Ethernet interface.

Configuring Ingress and Egress IPv6 ACLs on Bundle Interfaces

Use the following configuration to configure ingress and egress IPv6 ACLs on a bundle interface.

```

/* Configure a bundle interface with an IPv6 address */
Router(config)# interface Bundle-Ether 1
Router(config-if)# ipv6 address 3001::1/64
Router(config-if)# no shut
Router(config-if)# commit
Thu Jan 25 13:53:47.435 IST
Router(config-if)# exit

/* Configure an IPv6 egress ACL */
Router(config)# ipv6 access-list V6-EGRESS-ACL-bundle interface
Router(config-ipv6-acl)# 100 permit tcp any any eq www
Router(config-ipv6-acl)# 110 permit tcp any any eq https
Router(config-ipv6-acl)# 120 permit tcp any any eq ssh
Router(config-ipv6-acl)# 130 permit udp any any eq snmp
Router(config-ipv6-acl)# commit
Thu Jan 25 13:57:14.960 IST
Router(config-ipv6-acl)# exit

/* Configure an IPv6 ingress ACL to deny ingress traffic on the bundle interface */
Router(config)# ipv6 access-list V6-DENY-INGRESS-ACL
Router(config-ipv6-acl)# 10 deny ipv6 any any
Router(config-ipv6-acl)# commit
Thu Jan 25 13:59:23.198 IST
Router(config-ipv6-acl)# exit

/* Verify the egress and ingress ACL creation */
Router(config)# do show access-lists ipv6
Thu Jan 25 14:00:24.055 IST
ipv6 access-list V6-DENY-INGRESS-ACL
  10 deny ipv6 any any
ipv6 access-list V6-EGRESS-ACL-bundle
  100 permit tcp any any eq www
  110 permit tcp any any eq https
  120 permit tcp any any eq ssh
  130 permit udp any any eq snmp
...

/* Apply the egress and ingress ACLs to the bundle interface */
Router(config)# interface Bundle-Ether 1
Router(config-if)# ipv6 access-group V6-EGRESS-ACL-bundle egress
Router(config-if)# ipv6 access-group V6-DENY-INGRESS-ACL ingress
Router(config-if)# commit
Thu Jan 25 14:04:19.536 IST
Router(config-if)# exit

/* Verify if the ACLs have been successfully applied to the interface */
Router(config)# do show ipv6 interface
Thu Jan 25 11:46:43.234 IST
...
Thu Jan 25 14:04:51.322 IST
Bundle-Ether1 is Down, ipv6 protocol is Down, Vrfid is default (0x60000000)
IPv6 is enabled, link-local address is fe80::1:10ff:fe87:8d04 [TENTATIVE]
Global unicast address(es):
  3001::1, subnet is 3001::/64 [TENTATIVE]
  Joined group address(es): ff02::2 ff02::1
  MTU is 1514 (1500 is available to IPv6)
  ICMP redirects are disabled
  ICMP unreachable are enabled
  ND DAD is enabled, number of DAD attempts 1

```

```

ND reachable time is 0 milliseconds
ND cache entry limit is 1000000000
ND advertised retransmit interval is 0 milliseconds
ND router advertisements are sent every 160 to 240 seconds
ND router advertisements live for 1800 seconds
Hosts use stateless autoconfig for addresses.
Outgoing access list is V6-EGRESS-ACL-BI
Inbound common access list is not set, access list is V6-DENY-INGRESS-ACL
Table Id is 0xe0800000
Complete protocol adjacency: 0
Complete glean adjacency: 0
Incomplete protocol adjacency: 0
Incomplete glean adjacency: 0
Dropped protocol request: 0
Dropped glean request: 0

```

You have successfully configured ingress and egress IPv6 ACLs on a bundle interface.

Modifying ACLs

This section describes a sample configuration for modification of ACLs.

```

*/ Create an Access List*/
Router(config)#ipv4 access-list acl_1

*/Add entries (ACEs) to the ACL*/
Router(config-ipv4-acl)#10 permit ip host 10.3.3.3 host 172.16.5.34
Router(config-ipv4-acl)#20 permit icmp any any
Router(config-ipv4-acl)#30 permit tcp any host 10.3.3.3
Router(config-ipv4-acl)#end

*/Verify the entries of the ACL*/:
Router#show access-lists ipv4 acl_1
ipv4 access-list acl_1
10 permit ip host 10.3.3.3 host 172.16.5.34
20 permit icmp any any
30 permit tcp any host 10.3.3.3

*/Add new entries, one with a sequence number "15" and another without a sequence number
to the ACL. Delete an entry with the sequence number "30":*/
Router(config)#ipv4 access-list acl_1
Router(config-ipv4-acl)# 15 permit 10.5.5.5 0.0.0.255
Router(config-ipv4-acl)# no 30
Router(config-ipv4-acl)# permit 10.4.4.4 0.0.0.255
Router(config-ipv4-acl)# commit

*/When an entry is added without a sequence number, it is automatically given a sequence
number
that puts it at the end of the access list. Because the default increment is 10, the entry
will have a sequence
number 10 higher than the last entry in the existing access list*/

*/Verify the entries of the ACL:*/
Router(config)#show access-lists ipv4 acl_1
ipv4 access-list acl_1
10 permit ipv4 host 10.3.3.3 host 172.16.5.34
15 permit 10.5.5.5 0.0.0.255---*/newly added ACE (with the sequence number)*/
20 permit icmp any any

```

```
30 permit ipv4 10.4.4.0 0.0.0.255 any ---*/newly added ACE (without the sequence number)*/
*/The entry with the sequence number 30, that is, "30 permit tcp any host 10.3.3.3" is
deleted from the ACL*/
```

You have successfully modified ACLs in operation.

Configuring ACL-based Forwarding

Converged networks carry voice, video and data. Users may need to route certain traffic through specific paths instead of using the paths computed by routing protocols. This is achieved by specifying the next-hop address in ACL configurations, so that the configured next-hop address from ACL is used for forwarding packet towards its destination instead of routing packet-based destination address lookup. This feature of using next-hop in ACL configurations for forwarding is called ACL Based Forwarding (ABF).

ACL-based forwarding enables you to choose service from multiple providers for broadcast TV over IP, IP telephony, data, and so on, which provides a cafeteria-like access to the Internet. Service providers can divert user traffic to various content providers.

Feature Highlights

- ABF is only supported on ingress ACL.
- ABF supports nexthop modifications. You can modify a nexthop, remove a nexthop, or make changes between existing nexthops.



Note While defining an ACE rule, you must specify the VRF for all nexthops unless the nexthop is in the default VRF. This will ensure that the packets take the right path towards the nexthop.

- VRF-aware ABF is supported for IPv4 and IPv6 with up to three next hops.
- IPv4 ABF nexthops routed over GRE interfaces are supported.
- As ABF is ACL-based, packets that do not match an existing rule (ACE) in the ACL are subject to the default ACL rule (drop all). If the ACL is being used for ABF-redirect only (not for security), then include an explicit ACE rule at the end of the ACL (lowest user priority) to match and "permit" all traffic. This ensures that all traffic that does not match an ABF rule is permitted and forwarded as normal.
- ABF is supported on permit rules only.
- VRF-select (where only the VRF is configured for the nexthop) is supported in ABF for IPv4 and IPv6 addresses, where up to three VRF next hops are allowed.
- ABF default route is not supported.
- Packets punted in the ingress direction from the NPU to the linecard CPU are not subjected to ABF treatment due to lack of ABF support in the slow path. These packets will be forwarded normally based on destination-address lookup by the software dataplane. Some examples of these types of packets are (but are not limited to) packets with IPv4 options, IPv6 extension headers, and packets destined for glean (unresolved/incomplete) adjacencies.

- Packets destined to the local IP interface ("for-us" packets) are subjected to redirect if they match the rule containing the ABF action. This can be avoided by either designing the rule to be specific enough to avoid matching the "for-us" packets or placing an explicit permit ACE rule (with higher priority) into the ACL before the matching ABF rule.

Configuration Example

To configure ACL-based forwarding, use the following configuration example:

```
/* Enter IPv4 access list configuration mode and configure an ACL: */
Router# configure
Router(config)# ipv4 access-list abf-acl

/* Set the conditions for the ACL and configure ABF: */
/* The next hop for this entry is specified. */
Router(config-ipv4-acl)# 10 permit ipv4 192.168.18.0 0.255.255.255 any nexthop1 ipv4 192.168.20.2
Router(config-ipv4-acl)# 15 permit ipv4 192.168.21.0 0.0.0.255 any
Router(config-ipv4-acl)# 20 permit ipv4 192.168.22.0 0.0.255.255 any nexthop1 ipv4 192.168.23.2
/* More than two nexthops */
Router(config-ipv4-acl)# 25 permit tcp any range 2000 3000 any range 4000 5000 nexthop1 ipv4 192.168.23.1 nexthop2 ipv4 192.168.24.1 nexthop3 ipv4 192.168.25.1

/* VRF support on ABF */
Router(config-ipv4-acl)# 30 permit tcp any eq www host 192.168.12.2 precedence immediate nexthop1 vrf vrf1_ipv4 ipv4 192.168.13.2 nexthop2 vrf vrf1_ipv4 ipv4 192.168.14.2

Router(config-ipv4-acl)# 35 permit ipv4 any any

Router(config-ipv4-acl)# commit

/* (Optional) Display ACL information: */
Router# show access-lists ipv4 abf-acl
```

To configure ABF with VRF-select with three next hops, use the following configuration example:

```
/* Enter IPv4 access list configuration mode and configure an ACL. */
Router# configure
Router(config)# ipv4 access-list abf-vrf-select

/* Set the conditions for the ACL and configure ABF with VRF-select with three next hops. */
Router(config-ipv4-acl)# 10 permit ipv4 60.1.1.5 0.0.0.255 any nexthop1 vrf VRF1 nexthop2 vrf VRF2 nexthop3 vrf VRF3
Router(config-ipv4-acl)# commit
```

Running Configuration

```
ipv4 access-list abf-acl
10 permit ipv4 192.168.18.0 0.255.255.255 any nexthop1 192.168.20.2
15 permit ipv4 192.168.21.0 0.0.0.255 any
20 permit ipv4 192.168.22.0 0.0.255.255 any nexthop1 192.168.23.2
25 permit tcp any range 2000 3000 any range 4000 5000 nexthop1 ipv4 192.168.23.1 nexthop2
  ipv4 192.168.24.1 nexthop3 ipv4 192.168.25.1
30 permit tcp any eq www host 192.168.12.2 precedence immediate nexthop1 vrf vrf1_ipv4 ipv4
  192.168.13.2 nexthop2 vrf vrf1_ipv4 ipv4 192.168.14.2
35 permit ipv4 any any
commit
!
```

```

ipv4 access-list TEST
 10 permit ipv4 60.1.1.5 0.0.0.255 any nexthop1 vrf VRF1 nexthop2 vrf VRF2 nexthop3 vrf
VRF3
!
```

Verification

Use the following command to verify the IP nexthop state in ABF to ensure that the expected nexthop is up:

```

router# show access-lists ipv4 abf nexthops client pfilter_ea location 0/3/CPU0
Tue May 17 22:25:05.940 UTC
```

```

ACL name : abf-acl
ACE seq.      NH-1      NH-2      NH-3
-----
      20      Global 192.168.23.2      Not present      Not present
      status      UP      Not present      Not present
      exist      No      Not present      Not present
      pd ctx      Present      Not present      Not present
      Track not present      Track not present      --
      25      Global 192.168.23.1      Global 192.168.24.1      Global 192.168.25.1
      status      UP      UP      UP
      exist      Yes      Yes      Yes
      pd ctx      Present      Present      Present
      Track not present      Track not present      Track not present
```

Use the following command to verify if ABF is currently attached to any interfaces at any linecard:

```

show access-lists usage pfilter location all
```

ACLs on Bridge Virtual Interfaces

Bridge Virtual Interfaces (BVI) provide a bridge between the routing and bridging domains on a router. A BVI is configured with an IP address and operates as a regular routed interface. You can configure an ACL on a BVI to filter the traffic for the network that uses the interface.



Note Do not delete an ACL attached to a BVI interface when the BVI interface is not part of a bridge domain. Later, if you add the BVI interface to the bridge domain then the traffic is dropped.

Increased TCAM Consumption with Configuring ACLs on BVIs

The consumption of TCAM resources is impacted in the following manner when ACLs are configured on BVIs.

- When an ACL is attached to a BVI interface, TCAM entries are programmed on all line cards regardless of physical interface membership. This leads to greater consumption of TCAM resources even on line cards that do not have BVI member interfaces.
- When an ACL is attached to a BVI interface, TCAM entries are programmed on all NPUs in a line card, regardless of physical interface membership. This leads to greater consumption of TCAM resources even on NPUs that do not have BVI member interfaces.

- For ingress ACLs, the TCAM entries for the same ACL are shared across interfaces on the same NPU.
- For egress ACLs, the TCAM entries for the same ACL are unique for all interfaces. This leads to greater consumption of TCAM resources.

Restrictions for Configuring ACLs on BVIs

You must be aware of the following restrictions before proceeding to configure ACLs on BVIs.

- When an egress ACL is enabled on a BVI through the **hw-module** command, no other interface types are supported for the ACL (non-BVI interfaces are not supported for the ACL in this mode).
- ACLs on BVIs are not supported on NC57-24DD and NC57-18DD-SE line cards.

Prerequisites for Configuring Egress ACLs on BVIs

By default, an egress ACL on a BVI is disabled, and ACL filtering does not take place even when the ACL is attached to the BVI. Hence, we use the **hw-module** command, which enables the ACL when the line cards are reloaded.



Note IPv4 and IPv6 ingress ACLs do not require this configuration.

Configuration

The following section describes the procedure for configuring IPv4 ingress and egress ACLs on BVIs.

To configure IPv4 ingress and egress ACLs on a BVI, use the following procedure with sample configuration.

1. Enter the Global Configuration mode, and configure an IPv4 ingress ACL.

```
Router(config)# ipv4 access-list v4-acl-ingress
Router(config-ipv4-acl)# 10 permit tcp any 10.1.1.0/24 dscp cs6
Router(config-ipv4-acl)# 20 deny udp any any eq ssh
Router(config-ipv4-acl)# 30 permit ipv4 any any
Router(config-ipv4-acl)# commit
Router(config-ipv4-acl)# exit
```

2. Configure an IPv4 egress ACL.

```
Router(config)# ipv4 access-list v4-acl-egress
Router(config-ipv4-acl)# 10 deny ipv4 any any fragments log
Router(config-ipv4-acl)# 20 deny tcp any any ack
Router(config-ipv4-acl)# 30 permit ipv4 any any
Router(config-ipv4-acl)# commit
Router(config-ipv4-acl)# exit
```

3. Configure the Gigabit Ethernet interface that must be mapped to the BVI, and enable it for Layer 2 transport.

```
Router(config)# interface GigabitEthernet 0/0/0/0
Router(config-if)# l2transport
Router(config-if-12)# commit
```

4. Attach the ingress and egress ACLs to the BVI.

```

Router(config)# interface BVI1
Router(config-if)# ipv4 access-group v4-acl-ingress ingress
Router(config-if)# ipv4 access-group v4-acl-egress egress
Router(config-if)# commit
Router(config-if)# exit

```

5. Configure the bridge domain with the Gigabit Ethernet interface and BVI.

```

Router(config)# l2vpn
Router(config-l2vpn)# bridge group BG1
Router(config-l2vpn-bg)# bridge-domain B1
Router(config-l2vpn-bg-bd)# interface GigabitEthernet 0/0/0/0
Router(config-l2vpn-bg-bd-ac)# routed interface BVI1
Router(config-l2vpn-bg-bd)# commit
Router(config-l2vpn-bg-bd)# exit
Router(config-l2vpn-bg)# exit
Router(config-l2vpn)# exit

```

6. Confirm that your configuration has been successfully committed.

```

Router(config)# show run
...
!
!
ipv4 access-list v4-acl-egress
 10 deny ipv4 any any fragments log
 20 deny tcp any any ack
 30 permit ipv4 any any
!
ipv4 access-list v4-acl-ingress
 10 permit tcp any 10.1.1.0/24 dscp cs6
 20 deny udp any any eq ssh
 30 permit ipv4 any any
!
interface GigabitEthernet0/0/0/0
  l2transport
  !
  !
interface BVI1
  ipv4 address 209.165.200.224/27
  ipv4 access-group v4-acl-ingress ingress
  ipv4 access-group v4-acl-egress egress
!
!
l2vpn
  bridge group BG1
  bridge-domain B1
    interface GigabitEthernet0/0/0/0
      !
      routed interface BVI1
    !
  !
!
end

```

7. Exit to the Executive Privileged mode and confirm that the ACLs are in operation.

```

Router# show access-lists interface bvi1
Tue May 9 10:01:25.732 EDT
Input ACL (common): GigabitEthernet 0/0/0/0 (interface): v4-acl-ingress
Output ACL: v4-acl-egress

```

```
Router# show access-lists summary
Tue May 9 10:02:01.167 EDT
ACL Summary:
Total ACLs configured: 2
Total ACEs configured: 6
```

```
Router# show access-lists ipv4 v4-acl-egress hardware egress location 0/0/CPU0
ipv4 access-list v4-acl-egress
10 deny ipv4 any any fragments log (15214 matches)
20 deny tcp any any ack (15214 matches)
30 permit ipv4 any any (15214 matches)
```

The output clearly shows the configured ACLs, the total number of ACEs (three per ACL), and also the ACE matches in hardware.

You have successfully configured and enabled IPv4 ingress and egress ACL on a BVI.

Configuring ACLs with Fragment Control

The non-fragmented packets and the initial fragments of a packet were processed by IP extended access lists (if you apply this access list), but non-initial fragments were permitted, by default. However, now, the IP Extended Access Lists with Fragment Control feature allows more granularity of control over non-initial fragments of a packet. Using this feature, you can specify whether the system examines non-initial IP fragments of packets when applying an IP extended access list.

As non-initial fragments contain only Layer 3 information, these access-list entries containing only Layer 3 information, can now be applied to non-initial fragments also. The fragment has all the information the system requires to filter, so the access-list entry is applied to the fragments of a packet.

This feature adds the optional **fragments** keyword for IPv4 ACLs to the following IP access list commands: **deny** and **permit**. By specifying the **fragments** keyword in an access-list entry, that particular access-list entry applies only to non-initial fragments of packets; the fragment is either permitted or denied accordingly.

The behavior of access-list entries regarding the presence or absence of the **fragments** keyword can be summarized as follows:

If the Access-List Entry has...	Then...
...no fragments keyword and all of the access-list entry information matches	<p>For an access-list entry containing only Layer 3 information:</p> <ul style="list-style-type: none"> The entry is applied to non-fragmented packets, initial fragments, and non-initial fragments. <p>For an access-list entry containing Layer 3 and Layer 4 information:</p> <ul style="list-style-type: none"> The entry is applied to non-fragmented packets and initial fragments. <ul style="list-style-type: none"> If the entry matches and is a permit statement, the packet or fragment is permitted. If the entry matches and is a deny statement, the packet or fragment is denied. The entry is also applied to non-initial fragments in the following manner. Because non-initial fragments contain only Layer 3 information, only the Layer 3 portion of an access-list entry can be applied. If the Layer 3 portion of the access-list entry matches, and <ul style="list-style-type: none"> If the entry is a permit statement, the non-initial fragment is permitted. If the entry is a deny statement, the next access-list entry is processed. <p>Note The deny statements are handled differently for non-initial fragments versus non-fragmented or initial fragments.</p>
...the fragments keyword and all of the access-list entry information matches	<p>The access-list entry is applied only to non-initial fragments.</p> <p>Note The fragments keyword cannot be configured for an access-list entry that contains any Layer 4 information.</p>

You should not add the **fragments** keyword to every access-list entry, because the first fragment of the IP packet is considered a non-fragment and is treated independently of the subsequent fragments. Because an initial fragment will not match an access list permit or deny entry that contains the **fragments** keyword, the packet is compared to the next access list entry until it is either permitted or denied by an access list entry that does not contain the **fragments** keyword. Therefore, you may need two access list entries for every deny entry. The first deny entry of the pair will not include the **fragments** keyword, and applies to the initial fragment. The second deny entry of the pair will include the **fragments** keyword and applies to the subsequent fragments. In the cases where there are multiple **deny** access list entries for the same host but with different Layer 4 ports, a single deny access-list entry with the **fragments** keyword for that host is all that has to be added. Thus all the fragments of a packet are handled in the same manner by the access list.

Packet fragments of IP datagrams are considered individual packets and each fragment counts individually as a packet in access-list accounting and access-list violation counts.



Note The **fragments** keyword cannot solve all cases involving access lists and IP fragments.



Note Within the scope of ACL processing, Layer 3 information refers to fields located within the IPv4 header; for example, source, destination, protocol. Layer 4 information refers to other data contained beyond the IPv4 header; for example, source and destination ports for TCP or UDP, flags for TCP, type and code for ICMP.

Configuration

You can use the following configuration to configure the **fragments** keyword for an IPv4 access list:

```
/* Configure an Access List */
Router# configure
Router(config)# ipv4 access-list IPv4_Fragments

/* Configure the fragments keyword for the IPv4 access list */
Router(config-ipv4-acl)# 10 permit ipv4 any any fragments
Router(config-ipv4-acl)# commit
```

Associated Commands

- [deny \(IPv4\)](#)
- [deny \(IPv6\)](#)
- [permit \(IPv4\)](#)
- [permit \(IPv6\)](#)

Associated Topics

- [Configuring an IPv4 ACL to Match on Fragment Type](#)
- [Matching by Fragment Offset in ACLs](#)

Configuring an IPv4 ACL to Match on Fragment Type

Most DoS (Denial of Service) attacks work by flooding the network with fragmented packets. By filtering the incoming fragments of the packet in a network, an extra layer of protection can be added against such attacks.

You can configure an IPv4 ACL to match on the fragment type, and perform an appropriate action. You can use the following sample configuration with the different fragment options:

```
/* Enter the global configuraton mode and configure an IPv4 access list */
Router# config
Router(config)# ipv4 access-list TEST
Router(config-ipv4-acl)# 10 permit tcp any any

/* Configure an ACE to match on the dont-fragment flag (indicates a non-fragmented packet)
and forward the packet to the default (pre-configured) next hop */
Router(config-ipv4-acl)# 20 permit tcp any any fragment-type dont-fragment default

/* Configure an ACE to match on the is-fragment flag (indicates a fragmented packet)
and forward the packet to a next hop of 10.10.10.1 */
Router(config-ipv4-acl)# 30 permit udp any any fragment-type is-fragment nexthop1 ipv4
10.10.10.1
```

```

/* Configure an ACE to match on the first-fragment flag (indicates the first fragment of a
fragmented packet)
and forward the packet to a next hop of 20.20.20.1 */
Router(config-ipv4-acl)# 40 permit ospf any any fragment-type first-fragment nexthop1 ipv4
20.20.20.1

/* Configure an ACE to match on the last-fragment flag (indicates the last fragment of a
fragmented packet)
and forward the packet to a next hop of 30.30.30.1 */
Router(config-ipv4-acl)# 50 permit icmp any any fragment-type last-fragment nexthop1 ipv4
30.30.30.1
Router(config-ipv4-acl)# commit

```

Use Case: Configuring an IPv4 ACL to Match on the First Fragment and Last Fragment

This section describes an use case, where you configure an ACL to forward a fragment if it is the first fragment of the packet and discard a fragment if it is the last fragment of the packet.

In this configuration, the ACL checks the fragment offset value ('0' for the first fragment). If the fragment is the first fragment of the packet, the packet is forwarded. If the fragment is the last fragment of the packet, it is dropped at the interface.

```

/* Enter the global configuraton mode and configure an IPv4 access list */
Router# config
Thu Jan 11 11:56:27.221 IST
Router(config)# ipv4 access-list ACLFIRSTFRAG

/* Configure an ACE to match on the first fragment.
If the fragment offset value equals 0, the fragment is forwarded to the 192.168.1.2 next
hop */
Router(config-ipv4-acl)# 10 permit tcp any any fragment-type first-fragment nexthop1 ipv4
192.168.1.2

/* Configure an ACE to match on the last fragment, and drop the fragment at the interface.
*/
Router(config-ipv4-acl)# 20 deny tcp any any fragment-type last-fragment
Router(config-ipv4-acl)# commit
Thu Jan 11 12:01:33.297 IST

/* Validate the configuration */
Router(config-ipv4-acl)# do show access-lists
Thu Jan 11 12:05:23.646 IST
ipv4 access-list ACLFIRSTFRAG
 10 permit tcp any any fragment-type first-fragment nexthop1 ipv4 192.168.1.20
 20 deny tcp any any fragment-type last-fragment

```

You have successfully configured an IPv4 ACL to match on the fragment type.

Associated Commands

- [fragment-type](#)

Matching by Fragment Offset in ACLs

You can configure an access control list (ACL) rule to filter packets by the fragment-offset value. Depending on whether a packet matches the criteria in a permit or deny statement, the packet is either processed or dropped

respectively at the interface. Fragment-offset filtering is supported only on ingress direction with compression mode of an ACL.

For more information about this feature, see the *Implementing Access Lists and Prefix Lists* chapter in the *IP Addresses and Services Configuration Guide for Cisco NCS 5500 Series Routers*. For complete command reference, see the *Access List Commands* chapter in *IP Addresses and Services Command Reference for Cisco NCS 5500 Series and NCS 540 and NCS 560 Series Routers*

Associated Commands

- [fragment-offset](#)

Configuring ACL Matching by Fragment Offset

To configure fragment-offset match in ACL, use the **fragment-offset** option in **permit** or **deny** command in IPv4 or IPv6 access-list configuration mode.



Note For fragment-offset filtering, you must attach the particular ACL to an interface with compression level 3. Else, the configuration is rejected.

Configuration

This example shows how to specify an ACL rule based on the fragment-offset per IPv4 header. Here, the packet is permitted only if the fragment-offset in the IPv4 header of the packet is within the range of 300-400. The value *300-400* is based on the 8-byte unit, which is same as fragment-offset of *2400-3200* bytes.

```
/* Configure ACL */
Router# configure
Router(config)# ipv4 access-list fragment-offset-acl
Router(config-ipv4-acl)# 10 permit ipv4 any any fragment-offset range 300 400
Router# commit

/* Attach the ACL to the interface */
Router# configure
Router(config)# interface Bundle-Ether70
Router(config-if)# ipv4 access-group fragment-offset-acl ingress compress level 3
Router# commit
```

Running Configuration

```
ipv4 access-list fragment-offset-acl
 10 permit ipv4 any any fragment-offset range 300 400
!

interface Bundle-Ether70
 ipv4 address 192.0.2.1 255.255.255.0
 ipv6 address 2001:DB8::1:1::1/48
 ipv4 access-group fragment-offset-acl ingress compress level 3
!
```

Verify Fragment-offset Match in ACL

```
Router# show access-lists ipv4 fragment-offset-acl usage pfilter loc 0/4/CPU0
```

```
Wed Apr 12 19:49:54.457 UTC
Interface : Bundle-Ether70
  Input  ACL : Common-ACL : N/A  ACL : fragment-offset-acl  (comp-lvl 3)
  Output ACL : N/A
```

```
Router# show access-lists ipv4 fragment-offset-acl hardware ing int Bundle-Ether70 loc
0/4/CPU0
```

```
Wed Apr 12 19:51:07.837 UTC
ipv4 access-list fragment-offset-acl
  10 permit ipv4 any any fragment-offset range 300 400
```

Associated Commands

- ipv4 access-list
- ipv6 access-list
- deny (IPv4)
- deny (IPv6)
- fragment-offset
- permit (IPv4)
- permit (IPv6)

Configuring ACL Filtering by IP Packet Length

You can configure an access control list to filter packets by the packet length at an ingress interface. Depending on whether a packet matches the packet-length condition in a permit or deny statement, the packet is either processed or dropped respectively at the interface.

To configure packet length filtering in ACL, use the **packet-length** option in **permit** or **deny** command in IPv4 or IPv6 access-list configuration mode.

Restrictions

Packet length filtering feature in ACL is subjected to these restrictions:

- Packet length filtering is supported only on ingress direction, for both traditional (non-compression) and hybrid (compression) ACLs.
- IPv6 packet length filtering is supported only for hybrid ACLs; not for traditional ACLs.
- Only quantized (value divisible by 16) packet length filtering is supported for traditional ACLs on IPv4.

- Packet length filtering is not supported in the default TCAM key, but instead requires a User-Defined TCAM Key (UDK) that can be specified using the `hw-module profile tcam format` command as described in the configuration section.

Associated Commands

- [deny \(IPv4\)](#)
- [deny \(IPv6\)](#)
- [packet-length](#)
- [permit \(IPv4\)](#)
- [permit \(IPv6\)](#)

Configuring Simple IPv4 ACLs to Filter by Packet Length

To configure a simple ACL to filter by packet length in IPv4 networks, use the following steps.

1. Enable packet length filtering in the global configuration mode by using the `hw-module` command.

```
Router# config
Router(/config)# hw-module profile tcam format access-list ipv4 dst-addr dst-port proto
packet-length frag-bit port-range
```

2. Enter the global configuration mode and configure a simple IPv4 access list to filter packets by the packet length value.

In this particular example, we configure a set of statements to process only those packets that match the specified packet length condition. All other packets are dropped when this ACL is applied to an ingress interface.

```
Router# config
Router(config)# ipv4 access-list pktlen-v4
Router(config-ipv4-acl)# 10 permit tcp any any packet-length eq 1664
Router(config-ipv4-acl)# 20 permit udp any any packet-length range 1600 2000
Router(config-ipv4-acl)# 30 deny ipv4 any any
```

3. Commit the ACL and exit the IPv4 ACL configuration mode.

```
Router(config-ipv4-acl)# commit
Router(config-ipv4-acl)# end
```

4. Apply the ACL to the required Gigabit Ethernet interface.

```
Router(config)# interface TenGigE0/5/0/3
Router(config-if)# ipv4 access-group pktlen-v4 ingress
```

5. Commit the configuration and exit the interface configuration mode.

```
Router(config-if)# commit
Router(config-if)# end
```

6. Verify your configuration.

```
Router# show access-lists pktlen-v4

ipv4 access-list pktlen-v4
10 permit tcp any any packet-length eq 1664
20 permit udp any any packet-length range 1600 2000
30 deny ipv4 any any
```

7. Verify the ACL matches in hardware.

```
Router# show access-lists pktlen-v4 hardware ingress location 0/5/CPU0
ipv4 access-list pktlen-v4
10 permit tcp any any packet-length eq 1664
20 permit udp any any packet-length range 1600 2000 (1286 hw matches)
30 deny ipv4 any any
```

You have successfully configured a simple IPv4 ACL to filter by packet length.

Configuring Scaled IPv4 ACLs to Filter by Packet Length

To configure a scaled ACL to filter by packet length in IPv4 networks, use the following steps.

1. Enable packet length filtering in the global configuration mode by using the `hw-module` command.

```
Router# config
Router(/config)# hw-module profile tcam format access-list ipv4 dst-addr dst-port proto
packet-length frag-bit port-range
```

2. Enter the global configuration mode and create an object group for configuring a scaled ACL.

```
Router(config)# object-group network ipv4 netobject1
Router(config-object-group-ipv4)# 50.0.0.0/24
Router(config-object-group-ipv4)# commit
```

3. From the global configuration mode, configure an IPv4 access list to filter packets by the packet length value.

In this particular example, we configure a statement to process only those packets that match the specified packet length condition. All other packets are dropped when this ACL is applied to an ingress interface.

```
Router# configure
Router(config)# ipv4 access-list scaled_acl1
Router(config-ipv4-acl)# 10 permit ipv4 net-group netobject1 any packet-length eq 1000
```

4. Commit the ACL and exit the IPv4 ACL configuration mode.

```
Router(config-ipv4-acl)# commit
Router(config-ipv4-acl)# end
```

5. Apply the ACL to the required Gigabit Ethernet interface.

```
Router(config)# interface TenGigE0/5/0/3
Router(config-if)# ipv4 access-group scaled_acl1 ingress compress level 3
```

6. Commit the configuration and exit the interface configuration mode.

```
Router(config-if)# commit
Router(config-if)# end
```

7. Verify your configuration.

```
Router# show access-lists scaled_acl1
ipv4 access-list scaled_acl1
10 permit ipv4 net-group netobject1 any packet-length eq 1000
```

8. Verify the ACL matches in hardware.

```
Router# show access-lists scaled_acl1 hardware ingress location 0/5/CPU0
ipv4 access-list scaled_acl1
10 permit ipv4 net-group netobject1 any packet-length eq 1000 (1500 hw matches)
```

You have successfully configured a scaled IPv4 ACL to filter by packet length.

Configuring Scaled IPv6 ACLs to Filter by Packet Length

To configure a scaled ACL to filter by packet length in IPv6 networks, use the following steps.

1. Enable packet length filtering in the global configuration mode by using the `hw-module` command.

```
Router# config
Router(/config)# hw-module profile tcam format access-list ipv4 dst-addr dst-port proto
packet-length frag-bit port-range
```

2. Enter the global configuration mode and create an object group for configuring a scaled ACL.

```
Router(config)# object-group network ipv6 netobject2
Router(config-object-group-ipv6)# 2001::0/128
Router(config-object-group-ipv6)# commit
```

3. From the global configuration mode, configure a scaled IPv6 access list to filter packets by the packet length value.

In this particular example, we configure a statement to process only those packets that match the specified packet length condition. All other packets are dropped when this ACL is applied to an ingress interface.

```
Router(config)# ipv6 access-list scaled_acl2
Router(config-ipv6-acl)# 10 permit ipv6 net-group netobject2 any packet-length eq 1000
Router(config-ipv6-acl)# commit
```

4. Commit the ACL and exit the IPv6 ACL configuration mode.

```
Router(config-ipv6-acl)# commit
Router(config-ipv6-acl)# end
```

5. Apply the ACL to the required Gigabit Ethernet interface.

```
Router# config
Router(config)# interface TenGigE0/5/0/3
Router(config-if)# ipv6 access-group scaled_acl2 ingress compress level 3
```

6. Commit the configuration and exit the interface configuration mode.

```
Router(config-if)# commit
Router(config-if)# end
```

7. Verify your configuration.

```
Router# show access-lists ipv6 scaled_acl2
ipv6 access-list scaled_acl2
10 permit ipv6 net-group netobject2 any packet-length eq 1000
```

8. Verify the ACL matches in hardware.

```
Router# show access-lists ipv6 scaled_acl2 hardware ingress location 0/5/CPU0
ipv6 access-list scaled_acl2
10 permit ipv6 net-group netobject2 any packet-length eq 1000 (2000 hw matches)
```

You have successfully configured a scaled IPv6 ACL to filter by packet length.

Understanding Object-Group ACLs

You can use object-group ACLs to classify users, devices, or protocols into groups so you can have a group-level access control policy. Instead of specifying individual IP addresses, protocols, and port numbers in multiple ACEs, you can specify just the object group in a single ACL.

This feature is very beneficial in large scale networks which currently contain hundreds of ACLs. By using the object-group ACL feature, the number of ACEs per ACL are significantly reduced. Object-group ACLs are also more readable, and easier to manage than conventional ACLs. Using object-group ACLs instead of conventional ACLs optimizes the storage needed in TCAM.

Types of Object-Group ACLs

You can create two types of object-group ACLs on Cisco IOS XR:

- **Network object-group ACLs:** Consist of groups of host IP Addresses and network IP addresses.
- **Port object-group ACLs:** Consist of groups of ports and supporting Layer 3/Layer 4 protocols.

Compressing ACLs

Object-group ACLs use compression to accommodate the large number of ACEs. Compression is achieved by compressing the following three fields of an ACE:

- Source IP prefix
- Destination IP prefix
- Source port number

From IOS XR Release 7.7.1 onwards, you can enable egress, which allows you to separate address prefixes and ports into network object groups and port object groups respectively.

For the Cisco NCS-57B1-5DSE and NCS-57C3-MODS-SYS routers and, NC57-18DD-SE and NC57-36H-SE line cards:

- you can enable ingress compression by using the `hw-module profile acl ingress compress enable location <location>` command.
-

For more information on the command(s), see chapter *Access List Commands* in the *IP Addresses and Services Command Reference for Cisco NCS 5500 Series and NCS 540 and NCS 560 Series Routers*.

There are only two compression levels in the access-group configuration for an ACL on an ingress interface:

- **Compress level 0:** No compression is done on the ACE fields.

In this mode, the object-group ACL behaves like a traditional ACL. Internal TCAM resources are utilized and there will be a huge impact on system resources and time taken for processing the ACL.

- **Compress level 3:** All three fields (source IP, destination IP, and source port) in an ACE are compressed.

In this mode, external TCAM is used for prefix lookup, and internal TCAM is used for ACE lookup. This mode supports 16-bit based packet length filtering and fragment offset filtering.

Configuring an Object-Group ACL

Before You Begin

You must be aware of the following information that apply to object-group ACLs:

- You can configure ACLs that contain both conventional and object-group ACEs.
- You can modify the objects in an object group dynamically without redefining the object group or the ACE that references the object group.
- You can configure an object-group ACL multiple times with a source group, or a destination group, or both source and destination groups.

Restrictions

Configuring object-group ACLs involves the following restrictions:

- Object-group ACLs can only be configured to an interface. They cannot be used or referenced by applications like SSH, SNMP, NTP.
- To delete an object-group, you must first delete it from all ACLs.
- You cannot configure object-group ACLs along with QoS policies.
- Object-group ACLs are not supported in any policy based configuration.
- Object-group is not supported in common ACLs.
- Nested object-groups are not supported from Release 6.2.1.
- Any inline ACE update to an object group ACL clears complete stats of the ACL.

Configuring a Network Object-Group ACL

A network object group can contain a single or multiple network objects.

Configuration

Use the following set of configuration statements to configure a network object-group ACL for an IPv4 address.

```

/* From the global configuration mode, create a network object group. */
Router(config)# object-group network ipv4 netobj1
Router(config-object-group-ipv4)# description my-network-object
Router(config-object-group-ipv4)# host 10.1.1.1
Router(config-object-group-ipv4)# 10.2.1.0 255.255.255.0
Router(config-object-group-ipv4)# range 10.3.1.10 10.3.1.50

/* Create an access list referencing the object group. */
Router(config)# ipv4 access-list network-object-acl permit ipv4 net-group netobj1 any

/* Apply the access list containing the object group to the desired interface and commit
your configuration. */
Router(config)# interface TenGigE0/0/0/10/3
Router(config-if)# ipv4 address 1.1.1.1/24
Router(config-if)# no shut
Router(config-if)# ipv4 access-group network-object-acl ingress compress level 3
Router(config-if)# commit
Tue Mar 28 10:23:34.106 IST

RP/0/RP0/CPU0:Mar 28 10:37:48.570 : ifmgr[397]: %PKT_INFRA-LINK-3-UPDOWN : interface
TenGigE0/0/0/10/3, changed state to Down
RP/0/RP0/CPU0:Mar 28 10:37:48.608 : ifmgr[397]: %PKT_INFRA-LINK-3-UPDOWN : interface
TenGigE0/0/0/10/3, changed state to Up

Router(config-if)# exit

```

Use the following set of configuration statements to configure a network object-group ACL for an IPv6 address.

```

/* From the global configuration mode, create a network object group. */
Router(config)# object-group network ipv6 netobj1
Router(config-object-group-ipv6)# description my-network-object
Router(config-object-group-ipv6)# host 2001:DB8:1::1
Router(config-object-group-ipv6)# 2001:DB8::1 2001:DB8:0:ABCD::1
Router(config-object-group-ipv6)# range 2001:DB8::2 2001:DB8::5

/* Create an access list referencing the object group. */
Router(config)# ipv6 access-list network-object-acl permit ipv6 net-group netobj1 any

/* Apply the access list containing the object group to the desired interface and commit
your configuration. */
Router(config)# interface TenGigE0/0/0/10/3
Router(config-if)# ipv6 address 2001:DB8::1/32
Router(config-if)# no shut
Router(config-if)# ipv6 access-group network-object-acl ingress compress level 3
Router(config-if)# commit
Tue Mar 28 10:23:34.106 IST

RP/0/RP0/CPU0:Mar 28 10:37:48.570 : ifmgr[397]: %PKT_INFRA-LINK-3-UPDOWN : interface
TenGigE0/0/0/10/3, changed state to Down
RP/0/RP0/CPU0:Mar 28 10:37:48.608 : ifmgr[397]: %PKT_INFRA-LINK-3-UPDOWN : interface
TenGigE0/0/0/10/3, changed state to Up

Router(config-if)# exit

```

Running Configuration

Confirm your configuration.

```

Router(config)# show run
Tue Mar 28 10:37:55.737 IST

Building configuration...
!! IOS XR Configuration 0.0.0
...

!
object-group network ipv4 netobj1
  10.2.1.0/24
  host 10.1.1.1
  range 10.3.1.10 10.3.1.50
  description my-network-object
!
!
ipv4 access-list network-object-acl
  10 permit ipv4 net-group netobj1 any
!
interface TenGigE0/0/0/10/3
  ipv4 address 1.1.1.1 255.255.255.0
  ipv4 access-group network-object-acl ingress compress level 3
!

```

You have successfully configured a network object-group ACL.

Configuring a Port Object-Group ACL

A port object group can contain a single or multiple port objects.

Configuration

Use the following set of configuration statements to configure a port object-group ACL.

```

/* From the global configuration mode, create a port object group, and commit your
configuration. */
RP/0/RP0/CPU0:router(config)# object-group port portobj1
RP/0/RP0/CPU0:router(config-object-group-ipv4)# description my-port-object
RP/0/RP0/CPU0:router(config-object-group-ipv4)# eq bgp
RP/0/RP0/CPU0:router(config-object-group-ipv4)# range 100 200
RP/0/RP0/CPU0:router(config-object-group-ipv4)# commit
RP/0/RP0/CPU0:router(config-object-group-ipv4)# exit

/* Create an access list referencing the object group. */
RP/0/RP0/CPU0:router(config)# ipv4 access-list port-object-acl permit ipv4 net-group portobj1

/* Apply the access list containing the object group to the desired interface and commit
your configuration. */
RP/0/RP0/CPU0:router(config)# interface TenGigE0/0/0/10/3
RP/0/RP0/CPU0:router(config-if)# ipv4 address 2.2.2.2/24
RP/0/RP0/CPU0:router(config-if)# ipv4 access-group port-obj-acl ingress compress level 3
RP/0/RP0/CPU0:router(config-if)# no shut
RP/0/RP0/CPU0:router(config-if)# commit
Tue Mar 28 10:23:34.106 IST

RP/0/RP0/CPU0:Mar 28 10:37:48.570 : ifmgr[397]: %PKT_INFRA-LINK-3-UPDOWN : interface
TenGigE0/0/0/10/3, changed state to Down
RP/0/RP0/CPU0:Mar 28 10:37:48.608 : ifmgr[397]: %PKT_INFRA-LINK-3-UPDOWN : interface
TenGigE0/0/0/10/3, changed state to Up

```

```
RP/0/RP0/CPU0:router(config-if)# exit
```

Running Configuration

Confirm your configuration.

```
RP/0/RP0/CPU0:router(config)# show run
Tue Mar 28 10:37:55.737 IST

Building configuration...
!! IOS XR Configuration 0.0.0
...
object-group port portobj1
  eq bgp
  range 100 200
!

ipv4 access-list port-object-acl
  10 permit tcp net-group portobj1
!
interface TenGigE0/0/0/10/3
  ipv4 access-group port-obj-acl ingress compress level 3
!
end
!
```

You have successfully configured a port object-group ACL.

Verifying Object-Group ACL Compression

You can use the commands described in this section to verify the configured object-group ACLs in operation and the compression of the ACEs in the ACL.



Note The outputs provided in this section are a standalone sample and are not related to the configurations provided in the preceding sections.

Verification

Use the following set of verification commands to verify object-group ACL compression.

/* Verify the entries of the ACL in operation. */

```
Router# show access-lists ipv4 network-object-acl hardware ingress location 0/0/CPU0
ipv4 access-list network-object-acl
40 permit ospf net-group n_192.168.0.0_16 any (20898463272 matches)
70 permit tcp any net-group CORP_ALL_V4 established
100 permit udp net-group INTERNAL port-group KERBEROS_UDP net-group CORP_ALL_V4
130 permit udp net-group INTERNAL port-group DNS_UDP net-group CORP_ALL_V4
160 permit udp net-group INTERNAL port-group NTP net-group CORP_ALL_V4
190 permit udp net-group INTERNAL port-group LDAP_UDP net-group CORP_ALL_V4
...
1500 permit udp net-group VLAN60_SECURITY net-group h_192.168.77.242 port-group
UDP_50000-50100
1530 deny ipv4 net-group VLAN60_SECURITY any log (20891956640 matches)
...
```

```

/* Verify the ACE compression in the ACL. */
Router# show access-lists ipv4 network-object-acl hardware ingress verify location 0/0/CPU0
Verifying TCAM entries for network-object-acl
Please wait...

```

INTF	NPU lookup	ACL #	intf	Total	compression	Total	result	failed(Entry)	TCAM
entries	type	ID	shared	ACES	prefix-type	Entries	ACE SEQ #		verified

TenGigE0_0_0_10_3 (ifhandle: 0x1c8)									
	1	IPV4	2	1	247	COMPRESSED	810	passed	
	810					SRC IP	2746	passed	
	2746					DEST IP	3413	passed	
	3413					SRC PORT	340	passed	
	340								

You have successfully verified the compression of ACEs within an ACL.



Note The command `show access-lists access-list-name hardware ingress detail location location` displays compressed output for source and destination IP addresses when the `detail` keyword is used while attaching ACLs to interfaces.

Configuring TTL Matching and Rewriting for IPv4 ACLs

You can configure ACLs to match on the TTL value specified in the IPv4 header. You can specify the TTL match condition to be based on a single value, or multiple values. You can also rewrite the TTL value in the IPv4 header by using the `set ttl` command.

Limitations for using TTL matching and rewriting for IPv4 ACLs

Using TTL matching and rewriting for IPv4 ACLs is known to have the following limitations.

- TTL matching is supported only for ingress ACLs.
- ACL logging is not supported for ingress ACLs after a User-Defined TCAM Key (UDK) is configured with the `enable-set-ttl` option.
- If a TTL rewrite is applied to the outer IPv4 header of an IP-in-IP header, then when the outer IPv4 header is decapsulated, (by GRE decapsulation) the TTL rewrite is also applied to the inner IPv4 header.
- TTL matching is not supported in the default TCAM key, but instead requires a User-Defined TCAM Key (UDK) using the `hw-module profile tcam format` command as described in the configuration section.

Configuration

Use the following steps to configure TTL matching and rewriting for IPv4 ACLs.

```
/* Enable TTL matching and rewriting in the global configuration mode by using the hw-module
  command */
Router(config)# hw-module profile tcam format access-list ipv4 dst-addr dst-port proto
port-range enable-set-ttl ttl-match

/* Configure an IPv4 ACL with the TTL parameters */
Router(config)# ipv4 access-list acl-v4
Router(config-ipv4-acl)# 10 deny tcp any any ttl eq 100
Router(config-ipv4-acl)# 20 permit tcp any any ttl range 1 50 set ttl 200
Router(config-ipv4-acl)# 30 permit tcp any any ttl neq 100 set ttl 255
Router(config-ipv4-acl)# commit
Thu Nov  2 12:22:58.948 IST

/* Attach the IPv4 ACL to the GigE interface */
Router(config)# interface GigabitEthernet 0/0/0/0
Router(config-if)# ipv4 address 15.1.1.1 255.255.255.0
Router(config-if)# ipv4 access-group acl-v4 ingress
Router(config-if)# commit
```

Running Configuration

Validate your configuration by using the **show run** command.

```
Router(config)# show run
Thu Nov  2 14:01:53.376 IST
Building configuration...
!! IOS XR Configuration 0.0.0
!! Last configuration change at Thu Nov  2 12:22:59 2017 by annseque
!
hw-module profile tcam format access-list ipv4 dst-addr dst-port proto port-range
enable-set-ttl ttl-match
!
ipv4 access-list acl-v4
 10 deny tcp any any ttl eq 100
 20 permit tcp any any ttl range 1 50 set ttl 200
 30 permit tcp any any ttl neq 100 set ttl 255
!
interface GigabitEthernet0/0/0/0
  ipv4 address 15.1.1.1 255.255.255.0
  ipv4 access-group acl-v4 ingress
!
```

You have successfully configured TTL matching and rewriting for IPv4 ACLs.

Configuring Interface-Based Unique IPv4 ACLs

ACLs that are shared across interfaces and use the same TCAM space are known as shared ACLs. However, you can configure only 127 unique, shared ACLs. To configure more unique ACLs, ACL sharing must be disabled by using the **interface-based** command. By making the ACLs unique for an interface, you can configure more than 127 ACLs.

Configuration Using UDK on Internal TCAM

Use the following configuration to enable unique, interface-based IPv4 ACLs on internal TCAMs.

**Note**

- A reboot of the line cards is required after entering the **hw-module profile** command to activate the command.
- TCAM is allocated for each ACL on an interface, and is not shared across ACLs. Hence, for instance, if an ACL utilizes 10 TCAM entries, and is applied to 100 interfaces, the total number of TCAM entries will be 1000.

```

/* Enable interface-based, unique IPv4 ACLs on internal TCAMs*/
Router(config)# hw-module profile tcam format access-list ipv4 src-addr dst-addr src-port
dst-port proto precedence ttl-match tcp-flags frag-bit enable-set-ttl interface-based

/* Configure an IPv4 ACL with the TTL parameters */
Router(config)# ipv4 access-list acl-v4
Router(config-ipv4-acl)# 10 deny tcp any any ttl eq 100
Router(config-ipv4-acl)# 20 permit tcp any any ttl range 1 50 set ttl 200
Router(config-ipv4-acl)# 30 permit tcp any any ttl neq 100 set ttl 255
Router(config-ipv4-acl)# commit
Thu Nov  2 12:22:58.948 IST

/* Attach the IPv4 ACL to the GigE interface */
Router(config)# interface GigabitEthernet 0/0/0/0
Router(config-if)# ipv4 address 15.1.1.1 255.255.255.0
Router(config-if)# ipv4 access-group acl-v4 ingress
Router(config-if)# commit

```

Running Configuration

Validate your configuration by using the **show run** command.

```

Router(config)# show run
Thu Nov  2 14:01:53.376 IST
Building configuration...
!! IOS XR Configuration 0.0.0
!! Last configuration change at Thu Nov  2 12:22:59 2017 by annseque
!
hw-module profile tcam format access-list ipv4 src-addr dst-addr src-port dst-port proto
precedence ttl-match tcp-flags frag-bit enable-set-ttl interface-based
!
ipv4 access-list acl-v4
 10 deny tcp any any ttl eq 100
 20 permit tcp any any ttl range 1 50 set ttl 200
 30 permit tcp any any ttl neq 100 set ttl 255
!
interface GigabitEthernet0/0/0/0
  ipv4 address 15.1.1.1 255.255.255.0
  ipv4 access-group acl-v4 ingress
!

```

You have successfully configured unique, interface-based IPv4 ACLs.

Configuring TTL Matching and Rewriting for IPv6 ACLs

You can configure ACLs to match on the TTL value specified in the IPv6 header. You can specify the TTL match condition to be based on a single value, or multiple values. You can also rewrite the TTL value in the IPv6 header by using the **set ttl** command.



Note A reboot of the line cards is required after entering the **hw-module profile** command to activate the command.

Limitations for using TTL matching and rewriting for IPv6 ACLs

Using TTL matching and rewriting for IPv6 ACLs is known to have the following limitations.

- TTL matching is supported only for ingress ACLs.
- ACL logging is not supported for ingress ACLs after a User-Defined TCAM Key (UDK) is configured with the **enable-set-ttl** option.
- If a TTL rewrite is applied to the outer IPv6 header of an IP-in-IP header, then when the outer IPv6 header is decapsulated, (by GRE decapsulation) the TTL rewrite is also applied to the inner IPv6 header.
- TTL matching is not supported in the default TCAM key, but instead requires a User-Defined TCAM Key (UDK) using the **hw-module profile tcam format** command as described in the Configuration section.

Configuration

Use the following steps to configure TTL matching and rewriting for IPv6 ACLs.

```
/* Enable TTL matching and rewriting in the global configuration mode by using the hw-module
command */
Router(config)# hw-module profile tcam format access-list ipv6 dst-addr dst-port src-port
next-hdr enable-set-ttl ttl-match

/* Configure an IPv6 ACL with the TTL parameters */
Router(config)# ipv6 access-list acl-v6
Router(config-ipv6-acl)# 10 deny tcp any any ttl eq 50
Router(config-ipv6-acl)# 20 permit tcp any any ttl lt 50 set ttl 255
Router(config-ipv6-acl)# 30 permit tcp any any ttl gt 50 set ttl 200
Router(config-ipv6-acl)# commit
Thu Nov  2 12:22:58.948 IST

/* Attach the IPv6 ACL to the GigE interface */
Router(config)# interface GigabitEthernet 0/0/0/0
Router(config-if)# ipv6 address 2001:2:1::1/64
Router(config-if)# ipv6 access-group acl-v6 ingress
Router(config-if)# commit
```

Running Configuration

Validate your configuration by using the **show run** command.

```
Router(config)# show run
Thu Nov  2 14:01:53.376 IST
Building configuration...
```

```

!! IOS XR Configuration 0.0.0
!! Last configuration change at Thu Nov  2 12:22:59 2017 by annseque
!hw-module profile tcam format access-list ipv6 dst-addr dst-port src-port next-hdr
enable-set-ttl ttl-match
!
ipv6 access-list acl-v6
 10 deny tcp any any ttl eq 50
20 permit tcp any any ttl lt 50 set ttl 255
30 permit tcp any any ttl gt 50 set ttl 200
!
interface GigabitEthernet0/0/0/0
 ipv6 address 2001:2:1::1/64
 ipv6 access-group acl-v6 ingress
!

```

You have successfully configured TTL matching and rewriting for IPv6 ACLs.

Configuring Interface-Based Unique IPv6 ACLs

ACLs that are shared across interfaces and use the same TCAM space are known as shared ACLs. However, you can configure only 127 unique, shared ACLs. To configure more unique ACLs, ACL sharing must be disabled by using the **interface-based** command. By making the ACLs unique for an interface, you can configure more than 127 ACLs.

Configuration

Use the following configuration to enable unique, interface-based IPv6 ACLs on internal TCAMs.



Note

- A reboot of the line cards is required after entering the hw-module profile command to activate the command.
- TCAM is allocated for each ACL on an interface, and is not shared across ACLs. Hence, for instance, if an ACL utilizes 10 TCAM entries, and is applied to 100 interfaces, the total number of TCAM entries will be 1000.

```

/* Enable interface-based, unique IPv6 ACLs on internal TCAMs*/
Router(config)# hw-module profile tcam format access-list ipv6 src-addr src-port dst-addr
dst-port next-hdr traffic-class enable-capture enable-set-ttl ttl-match interface-based

/* Configure an IPv6 ACL with the TTL parameters */
Router(config)# ipv6 access-list acl-v6
Router(config-ipv6-acl)# 10 deny tcp any any ttl eq 100
Router(config-ipv6-acl)# 20 permit tcp any any ttl range 1 50 set ttl 200
Router(config-ipv6-acl)# 30 permit tcp any any ttl neq 100 set ttl 255
Router(config-ipv6-acl)# commit
Thu Nov  2 12:22:58.948 IST

/* Attach the IPv6 ACL to the GigE interface */
Router(config)# interface GigabitEthernet 0/0/0/0
Router(config-if)# ipv6 address 2001:2:1::1/64
Router(config-if)# ipv6 access-group acl-v6 ingress
Router(config-if)# commit

```

Running Configuration

Validate your configuration by using the **show run** command.

```
Router(config)# show run
Thu Nov  2 14:01:53.376 IST
Building configuration...
!! IOS XR Configuration 0.0.0
!! Last configuration change at Thu Nov  2 12:22:59 2017 by annseque
!
hw-module profile tcam format access-list ipv6 src-addr src-port dst-addr dst-port next-hdr
traffic-class enable-capture enable-set-ttl ttl-match interface-based
!
ipv6 access-list acl-v6
 10 deny tcp any any ttl eq 100
 20 permit tcp any any ttl range 1 50 set ttl 200
 30 permit tcp any any ttl neq 100 set ttl 255
!
interface GigabitEthernet0/0/0/0
 ipv6 address 2001:2:1::1/64
 ipv6 access-group acl-v6 ingress
!
```

You have successfully configured unique, interface-based IPv6 ACLs.

Filtering Packets with IPv6 Extension Headers

When the following IPv6 extensions headers are present in the ACL, by default, the control plane CPU filters the packets and applies security ACLs:

- Hop-by-Hop
- Destination-Options
- Routing
- Fragment
- Mobility
- Host-Identity
- SHIM6



Note

Filtering of these packets in CPU reduces the packet rate to 100 packets/sec and later leads to packet drop. Any extension headers that are not identified are not detected as extension header and ACLs may not work properly.

You can use the following command to verify the number of packets dropped using the following command:

```
Router # show controllers npu stats traps-all instance all location 0/2/cpu0 | i EXT_HDR
```

You can add ACL permit and deny rules with right priority to process the packets at full rate. Adding the rules avoids the packets being sent to the CPU. But bypasses the security ACLs at layer 4.



Note You can use Layer 3 information to filter these packets.

For example, to permit or deny AH packets, you can add the following ACL rule:

```
10 permit ahp any
Or
10 deny ahp any
```

To disable the default behaviour of filtering the packets in the CPU and yet permit the extension headers, configure the IPv6 extension header.

With this, you need not include permit rules in each ACL. All the packets with extension headers bypass the security ACLs and permit the extension header.

You can enable or disable the IPv6 extension header option anytime without restarting the device.

Configuration Example

```
Router# configure
Router(config)# hw-module profile acl IPv6 ext-header permit

Router(config)# commit
```

Associated Commands

- [acl ipv6 ext-header](#)

Configuring Extended Access Lists

Configuration Example

Creates an IPv4 named access list "acl_1". This access list permits ICMP protocol packets with any source and destination IPv4 address and denies TCP protocol packets with any source and destination IPv4 address and port greater than 5000.

```
Router#configure
Router(config)#ipv4 access-list acl_1

Router(config-ipv4-acl)#20 permit icmp any any
Router(config-ipv4-acl)#30 deny tcp any any gt 5000
Router(config-ipv4-acl)#commit
```

Running Configuration

```
Router# show running-config ipv4 access-list acl_1
ipv4 access-list acl_1
 20 permit icmp any any
 30 deny tcp any any gt 5000
!
```

Verification

Verify that the permit and deny settings are according to the set configuration.

```
Router# show access-lists acl_1
ipv4 access-list acl_1
 20 permit icmp any any
 30 deny tcp any any gt 5000
Router#
```

Associated Commands

- [ipv4 access-list](#)
- [ipv6 access-list](#)
- [permit \(IPv4\)](#)
- [permit \(IPv6\)](#)
- [remark \(IPv4\)](#)
- [remark \(IPv6\)](#)
- [deny \(IPv4\)](#)
- [deny \(IPv6\)](#)

What to Do Next

After creating an access list, you must apply it to a line or an interface. ACL commit fails while adding and removing unique Access List Entries (ACE). This happens due to the absence of an assigned manager process. The user has to exit the ACL configuration mode and re-enter it before adding the first ACE.

Understanding IP Access List Logging Messages

Cisco IOS XR software can provide logging messages about packets permitted or denied by a standard IP access list. That is, any packet that matches the access list causes an informational logging message about the packet to be sent to the console. The level of messages logged to the console is controlled by the **logging console** command in global configuration mode.



Note ACL logging isn't supported for ingress MPLS packets with the explicit-null or deaggregation label.

The first packet that triggers the access list causes an immediate logging message, and subsequent packets are collected over 5-minute intervals before they are displayed or logged.

However, you can use the { **ipv4 | ipv6** } **access-list log-update threshold** command to set the number of packets that, when they match an access list (and are permitted or denied), cause the system to generate a log message. You might do this to receive log messages more frequently than at 5-minute intervals.



Caution If you set the *update-number* argument to 1, a log message is sent right away, rather than caching it; every packet that matches an access list causes a log message. A setting of 1 isn't recommended because the volume of log messages could overwhelm the system.

Even if you use the { **ipv4 | ipv6** } **access-list log-update threshold** command, the 5-minute timer remains in effect, so each cache is emptied at the end of 5 minutes, regardless of the number of messages in each cache. Regardless of when the log message is sent, the cache is flushed and the count reset to 0 for that message the same way it's when a threshold isn't specified.



Note The logging facility might drop some logging message packets if there are too many to be handled or if more than one logging message is handled in 1 second. This behavior prevents the router from using excessive CPU cycles because of too many logging packets. Therefore, the logging facility shouldn't be used as a billing tool or as an accurate source of the number of matches to an access list.

Enable Logging on ACE

This section shows you how to enable the ACE of an ACL to log informational messages when it matches incoming packets, using the optional keyword **log**. The router supports this feature only for IPv4 or IPv6 ingress ACLs. The logging message includes the access list number, whether the packet was permitted or denied, the source IP address of the packet, and the number of packets from that source permitted or denied in the prior 5-minute interval.

```
Router#configure
Router(config)#ipv4 access-list test
Router(config-ipv4-acl)#10 permit udp 10.85.1.0 255.255.255.0 log
Router(config-ipv4-acl)#exit
Router(config)# interface FortyGigE0/0/0/22
Router(config-if)# ipv4 access-group test ingress
Router(config-if)# commit
```



Note Set log-level to **informational** or higher with the **logging console** command, so that the router displays the ACL log-messages on the console.

```
Router#configure
Router(config)#logging console informational
Router(config)# commit
```

For more information on log-levels, see section *Syslog Message Severity Levels* in the *Implementing System Logging* chapter of the *System Monitoring Configuration Guide for Cisco NCS 5500 Series Routers*.

The following snippet shows a sample log message:

```
Router: ipv4_acl_mgr[350]: %ACL-IPV4_ACL-6-IPACCESSLOGP : access-list test (10) permit udp
10.85.1.2(0) -> 10.0.0.1(0), 1 packet
```

Understanding Prefix Lists

Prefix lists are used in route maps and route filtering operations and can be used as an alternative to access lists in many Border Gateway Protocol (BGP) route filtering commands. A prefix is a portion of an IP address, starting from the far left bit of the far left octet. By specifying exactly how many bits of an address belong to a prefix, you can then use prefixes to aggregate addresses and perform some function on them, such as redistribution (filter routing updates).

BGP Filtering Using Prefix Lists

Prefix lists can be used as an alternative to access lists in many BGP route filtering commands. It is configured under the Global configurations of the BGP protocol. The advantages of using prefix lists are as follows:

- Significant performance improvement in loading and route lookup of large lists.
- Incremental updates are supported.
- More user friendly CLI. The CLI for using access lists to filter BGP updates is difficult to understand and use because it uses the packet filtering format.
- Greater flexibility.

Before using a prefix list in a command, you must set up a prefix list, and you may want to assign sequence numbers to the entries in the prefix list.

How the System Filters Traffic by Prefix List

Filtering by prefix list involves matching the prefixes of routes with those listed in the prefix list. When there is a match, the route is used. More specifically, whether a prefix is permitted or denied is based upon the following rules:

- An empty prefix list permits all prefixes.
- An implicit deny is assumed if a given prefix does not match any entries of a prefix list.
- When multiple entries of a prefix list match a given prefix, the longest, most specific match is chosen.

Sequence numbers are generated automatically unless you disable this automatic generation. If you disable the automatic generation of sequence numbers, you must specify the sequence number for each entry using the *sequence-number* argument of the **permit** and **deny** commands in IPv4 prefix list configuration command. Use the **no** form of the **permit** or **deny** command with the *sequence-number* argument to remove a prefix-list entry.

The **show** commands include the sequence numbers in their output.

Configuring Prefix Lists

Configuration Example

Creates a prefix-list "pfx_2" with a remark "Deny all routes with a prefix of 10/8". This prefix-list denies all prefixes matching /24 in 128.0.0.0/8.

```
Router#configure
Router(config)#ipv4 prefix-list pfx_2

Router(config-ipv4_pfx)#10 remark Deny all routes with a prefix of 10/8
Router(config-ipv4_pfx)#20 deny 128.0.0.0/8 eq 24
/* Repeat the above step as necessary. Use the no sequence-number command to delete an
entry. */

Router(config-ipv4_pfx)#commit
```

Running Configuration

```
Router#show running-config ipv4 prefix-list pfx_2
ipv4 prefix-list pfx_2
 10 remark Deny all routes with a prefix of 10/8
 20 deny 128.0.0.0/8 eq 24
!
```

Verification

Verify that the permit and remark settings are according to the set configuration.

```
Router# show prefix-list pfx_2
ipv4 prefix-list pfx_2
 10 remark Deny all routes with a prefix of 10/8
 20 deny 128.0.0.0/8 eq 24
RP/0/RP0/CPU0:ios#
```

Associated Commands

- [ipv4 prefix-list](#)
- [ipv6 prefix-list](#)
- [show prefix-list ipv4](#)
- [show prefix-list ipv6](#)

Sequencing Prefix List Entries and Revising the Prefix List

Configuration Example

Assigns sequence numbers to entries in a named prefix list and how to add or delete an entry to or from a prefix list. It is assumed a user wants to revise a prefix list. Resequencing a prefix list is optional.



Note It is possible to resequence ACLs for prefix-list but not for security ACLs.

```
Router#config
Router(config)#ipv4 prefix-list cl_1

Router(config)#10 permit 172.16.0.0 0.0.255.255
/* Repeat the above step as necessary adding statements by sequence number where you planned;
use the no sequence-number command to delete an entry */
```

```
Router(config)#commit
end
Router#resequence prefix-list ipv4 cl_1 20 15
```

Running Configuration

```
/*Before resequencing*/
Router#show running-config ipv4 prefix-list cl_1
ipv4 prefix-list cl_1
 10 permit 172.16.0.0/16
!
/* After resequencing using the resequence prefix-list ipv4 cl_1 20 15 command: */
Router#show running-config ipv4 prefix-list cl_1
ipv4 prefix-list cl_1
 20 permit 172.16.0.0/16
!
```

Verification

Verify that the prefix list has been resequenced:

```
Router#show prefix-list cl_1
ipv4 prefix-list cl_1
 20 permit 172.16.0.0/16
```

Associated Commands

- [resequence prefix-list ipv4](#)
- [resequence prefix-list ipv6](#)
- [ipv4 prefix-list](#)
- [ipv6 prefix-list](#)
- [show prefix-lists ipv4](#)
- [show prefix-lists ipv6](#)



CHAPTER 7

Implementing Cisco Express Forwarding

- [Implementing Cisco Express Forwarding, on page 123](#)

Implementing Cisco Express Forwarding

Cisco Express Forwarding (CEF) is an advanced, Layer 3 IP switching technology. CEF optimizes network performance and scalability for networks with large and dynamic traffic patterns, such as the Internet, on networks characterized by intensive web-based applications, or interactive sessions. CEF is an inherent feature and the users need not perform any configuration to enable it. If required, the users can change the default route purge delay and static routes. Cisco NCS 5500 Series Routers supports only single stage forwarding.

Components

Cisco IOS XR software CEF always operates in CEF mode with two distinct components:

- Forwarding Information Base (FIB) database: The protocol-dependent FIB process maintains the forwarding tables for IPv4 and IPv6 unicast in the route processor and line card (LC). The FIB on each node processes Routing Information Base (RIB) updates, performing route resolution and maintaining FIB tables independently in the route processor and line card (LC). FIB tables on each node can be slightly different.
- Adjacency table—a protocol-independent adjacency information base (AIB)

CEF is a primary IP packet-forwarding database for Cisco IOS XR software. CEF is responsible for the following functions:

- Software switching path
- Maintaining forwarding table and adjacency tables (which are maintained by the AIB) for software and hardware forwarding engines

The following features are supported for CEF on Cisco IOS XR software:

- Bundle interface support
- Multipath support
- Route consistency
- High availability features such as packaging, restartability, and Out of Resource (OOR) handling
- OSPFv2 SPF prefix prioritization

- BGP attributes download

CEF Benefits

- Improved performance—CEF is less CPU-intensive than fast-switching route caching. More CPU processing power can be dedicated to Layer 3 services such as quality of service (QoS) and encryption.
- Scalability—CEF offers full switching capacity at each line card.
- Resilience—CEF offers an unprecedented level of switching consistency and stability in large dynamic networks. In dynamic networks, fast-switched cache entries are frequently invalidated due to routing changes. These changes can cause traffic to be process switched using the routing table, rather than fast switched using the route cache. Because the Forwarding Information Base (FIB) lookup table contains all known routes that exist in the routing table, it eliminates route cache maintenance and the fast-switch or process-switch forwarding scenario. CEF can switch traffic more efficiently than typical demand caching schemes.

The following CEF forwarding tables are maintained in Cisco IOS XR software:

- IPv4 CEF database—Stores IPv4 Unicast routes for forwarding IPv4 unicast packets
- IPv6 CEF database—Stores IPv6 Unicast routes for forwarding IPv6 unicast packets
- MPLS LFD database—Stores MPLS Label table for forwarding MPLS packets

Verifying CEF

To view the details of the IPv4 or IPv6 CEF tables, use the following commands:

- `show cef {ipv4 address | ipv6 address} hardware egress`

Displays the IPv4 or IPv6 CEF table. The next hop and forwarding interface are displayed for each prefix. The output of the **show cef** command varies by location.

```
Router# show cef 203.0.1.2 hardware egress
 203.0.1.2/32, version 0, internal 0x1020001 0x0 (ptr 0x8d7db7f0) [1], 0x0 (0x8daeedf0),
0x0 (0x0)
Updated Nov 20 13:33:23.557
local adjacency 203.0.1.2
Prefix Len 32, traffic index 0, Adjacency-prefix, precedence n/a, priority 15
  via 203.0.1.2/32, HundredGigE0/0/0/9, 3 dependencies, weight 0, class 0 [flags 0x0]
  path-idx 0 NHID 0x0 [0x8cfc81a0 0x0]
  next hop 203.0.1.2/32
  local adjacency
```

- `show cef {ipv4 | ipv6} summary`

Displays a summary of the IPv4 or IPv6 CEF table.

```
Router#show cef ipv4 summary
Fri Nov 20 13:50:45.239 UTC

Router ID is 216.1.1.1

IP CEF with switching (Table Version 0) for node0_RP0_CPU0

Load balancing: L4
Tableid 0xe0000000 (0x8cf5b368), Vrfid 0x60000000, Vrid 0x20000000, Flags 0x1019
Vrfname default, Refcount 4129
```



```

56 routes, 0 protected, 0 reresolve, 0 unresolved (0 old, 0 new), 7616 bytes
13 rib, 0 lsd, 0:27 aib, 1 internal, 10 interface, 4 special, 1 default routes
56 load sharing elements, 24304 bytes, 1 references
1 shared load sharing elements, 432 bytes
55 exclusive load sharing elements, 23872 bytes
0 route delete cache elements
13 local route bufs received, 1 remote route bufs received, 0 mix bufs received
13 local routes, 0 remote routes
13 total local route updates processed
0 total remote route updates processed
0 pkts pre-routed to cust card
0 pkts pre-routed to rp card
0 pkts received from core card
0 CEF route update drops, 0 revisions of existing leaves
0 CEF route update drops due to version mis-match
Resolution Timer: 15s
0 prefixes modified in place
0 deleted stale prefixes
0 prefixes with label imposition, 0 prefixes with label information
0 LISP EID prefixes, 0 merged, via 0 rlocs
28 next hops
1 incomplete next hop

0 PD backwalks on LDIs with backup path

```

- `show cef { ipv4 address | ipv6 address } detail`

Displays the details of the IPv4 or IPv6 CEF table.

```

Router#show cef 203.0.1.2 detail
203.0.1.2/32, version 0, internal 0x1020001 0x0 (ptr 0x8d7db7f0) [1], 0x0 (0x8daeef0), 0x0
(0x0)
Updated Nov 20 13:33:23.556
local adjacency 203.0.1.2
Prefix Len 32, traffic index 0, Adjacency-prefix, precedence n/a, priority 15
gateway array (0x8d84beb0) reference count 1, flags 0x0, source aib (10), 0 backups
[2 type 3 flags 0x8401 (0x8d99a598) ext 0x0 (0x0)]
LW-LDI[type=3, refc=1, ptr=0x8daeef0, sh-ldi=0x8d99a598]
gateway array update type-time 1 Nov 20 13:33:23.556
LDI Update time Nov 20 13:33:23.556
LW-LDI-TS Nov 20 13:33:23.556
via 203.0.1.2/32, HundredGigE0/0/0/9, 3 dependencies, weight 0, class 0 [flags 0x0]
path-idx 0 NHID 0x0 [0x8cfc81a0 0x0]
next hop 203.0.1.2/32
local adjacency
Load distribution: 0 (refcount 2)

Hash OK Interface Address
0 Y HundredGigE0/0/0/9 203.0.1.2

```

- `show adjacency detail`

Displays detailed adjacency information, including Layer 2 information for each interface. The output of the `show adjacency` command varies by location.

```

Router#show adjacency detail

-----
0/5/CPU0
-----
Interface Address Version Refcount Protocol
Hu0/5/0/12 (interface) 13 1( 0)

```

```

          (interface entry)
          mtu: 1500, flags 1 4

Hu0/5/0/30      (interface)          31      1( 0)
                (interface entry)
                mtu: 1500, flags 1 4

Hu0/5/0/19      (interface)          20      1( 0)
                (interface entry)
                mtu: 1500, flags 1 4

Hu0/5/0/16      (interface)          17      1( 0)
                (interface entry)
                mtu: 1500, flags 1 4

Hu0/5/0/23      (interface)          24      1( 0)
                (interface entry)
                mtu: 1500, flags 1 4

Hu0/5/0/22      (interface)          23      1( 0)
                (interface entry)
                mtu: 1500, flags 1 4

Hu0/5/0/1       (interface)           2      1( 0)
                (interface entry)
                mtu: 1500, flags 1 4

Hu0/5/0/6       (interface)           7      1( 0)
                (interface entry)
                mtu: 1500, flags 1 4

Hu0/5/0/10      (interface)          11      1( 0)
                (interface entry)
                mtu: 1500, flags 1 4

Hu0/5/0/31      (interface)          32      1( 0)
                (interface entry)
                mtu: 1500, flags 1 4

Hu0/5/0/28      (interface)          29      1( 0)
                (interface entry)
                mtu: 1500, flags 1 4

Hu0/5/0/35      (interface)          36      1( 0)
                (interface entry)
                mtu: 1500, flags 1 4

Hu0/5/0/32      (interface)          33      1( 0)
                (interface entry)
                mtu: 1500, flags 1 4

```

Hu0/5/0/15	(interface) (interface entry) mtu: 1500, flags 1 4	16	1 (0)
Hu0/5/0/34	(interface) (interface entry) mtu: 1500, flags 1 4	35	1 (0)
Hu0/5/0/2	(interface) (interface entry) mtu: 1500, flags 1 4	3	1 (0)
Hu0/5/0/26	(interface) (interface entry) mtu: 1500, flags 1 4	27	1 (0)
Hu0/0/0/9	203.0.1.2 00109400000cea285f0b80248847 mtu: 8986, flags 1 0	50	2 (0) mpls
Hu0/0/0/9	203.0.1.2 00109400000cea285f0b80240800 mtu: 8986, flags 1 0	49	2 (0) ipv4
Hu0/5/0/29	(interface) (interface entry) mtu: 1500, flags 1 4	30	1 (0)
Hu0/5/0/33	(interface) (interface entry) mtu: 1500, flags 1 4	34	1 (0)
Hu0/5/0/20	(interface) (interface entry) mtu: 1500, flags 1 4	21	1 (0)
Hu0/5/0/24	(interface) (interface entry) mtu: 1500, flags 1 4	25	1 (0)
Hu0/5/0/0	(interface) (interface entry) mtu: 1500, flags 1 4	1	1 (0)
Hu0/5/0/4	(interface) (interface entry) mtu: 1500, flags 1 4	5	1 (0)
Hu0/5/0/8	(interface) (interface entry) mtu: 1500, flags 1 4	9	1 (0)

```

Hu0/5/0/3          (interface)          4          1( 0)
                   (interface entry)
                   mtu: 1500, flags 1 4

Hu0/5/0/27         (interface)          28         1( 0)
                   (interface entry)
                   mtu: 1500, flags 1 4

Hu0/5/0/7          (interface)          8          1( 0)
                   (interface entry)
                   mtu: 1500, flags 1 4

Hu0/5/0/14         (interface)          15         1( 0)
                   (interface entry)
                   mtu: 1500, flags 1 4

Hu0/5/0/11         (interface)          12         1( 0)
                   (interface entry)
                   mtu: 1500, flags 1 4

Hu0/5/0/18         (interface)          19         1( 0)
                   (interface entry)

```

Unicast Reverse Path Forwarding

Configuration of Unicast IPv4 and IPv6 Reverse Path Forwarding (uRPF) enables a router to verify the reachability of the source address in packets being forwarded. Configuring uRPF, both strict and loose modes, helps to mitigate problems caused by the introduction of spoofed IP source addresses into a network. Configuration of uRPF discards IP packets that lack a verifiable IP source address after a reverse lookup in the CEF table.

When **strict uRPF** is enabled, the source address of the packet is checked in the FIB. If the packet is received on the same interface that would be used to forward the traffic to the source of the packet, the packet passes the check and is further processed. Otherwise, the packet is dropped. Configure strict uRPF only where there is natural or configured symmetry. Internal interfaces are likely to have a routing asymmetry, that is, multiple routes to the source of a packet. Therefore, you should not implement strict uRPF on interfaces that are internal to the network.

Implementation of strict mode uRPF requires maintenance of a uRPF interfaces list for the prefixes. The list contains only the interfaces configured with strict mode uRPF. The interfaces are provided by the prefix path. The uRPF interface list is shared among the prefixes wherever possible.

When **loose uRPF** is enabled, the source address of the packet is checked in the FIB. If the source address exists and matches a valid forwarding entry, the packet passes the check and is further processed. Otherwise, the packet is dropped.



Note The behavior of strict uRPF varies slightly on the basis of platforms, the number of recursion levels, and the number of paths in Equal-Cost Multipath (ECMP) scenarios. A platform may switch to loose uRPF check for some or all prefixes, even though strict uRPF is configured. For example, if ECMP Path is eight or more, strict mode is converted to loose mode.

Loose and strict uRPF supports two options: **allow self-ping** and **allow default**. The **allow self-ping** option allows the source of the packet to ping itself. The **allow default** option allows the lookup result to match a default routing entry. When the **allow default** option is enabled with the strict mode of the uRPF, the packet is processed further only if it arrives through the default interface.

Restrictions

Consider the following restrictions when you configure uRPF:

- Global configuration followed by cold reload is required to enable or disable uRPF on the router.
- Configuration of uRPF per interface enables or disables uRPF mode in the hardware of the corresponding interface.
- Configuration of uRPF reduces the route scale to half. Half of the routing table is used for destination lookup and the other half is used for source lookup of received packets.
- Unicast RPF allows packets with 0.0.0.0 source addresses and 255.255.255.255 destination addresses to pass so that Bootstrap Protocol and Dynamic Host Configuration Protocol (DHCP) functions properly.
- Unicast RPF allows packets whose destination IP address is not a unicast address.
- The behavior of strict uRPF varies slightly on the basis of platforms, the number of recursion levels, and the number of paths in Equal-Cost Multipath (ECMP) scenarios. A platform may switch to loose uRPF check for some or all prefixes, even though strict uRPF is configured.
- The **allow self-ping** option is the default option in uRPF configuration for both strict and loose mode. You cannot disable the **allow-self-ping** option. The **allow-default** option needs to be configured specifically per interface.

Figure 11: uRPF Topology

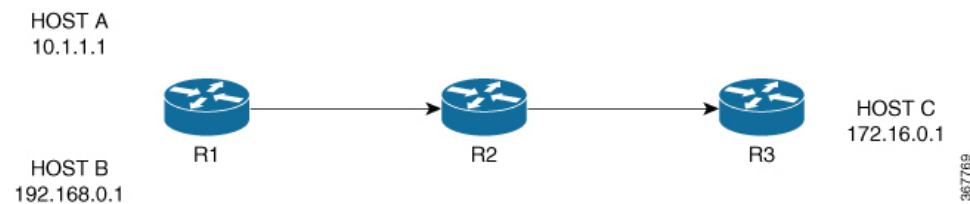

In Figure 1, uRPF is enabled on Router R2 and R2 has the following FIB table entries:

- 10.1.1.0/24 [110/3] via 10.25.24.1, 2d08h, HundredGigE0/0/0/24
- 12.1.1.0/24 [110/3] via 10.25.24.1, 2d08h, HundredGigE0/0/0/25
- 14.0.5.0/24 [110/3] via 20.0.0.2, 2d08h, HundredGigE0/0/0/1

R2 allows the packet from Host 1 to be routed because Host 1 subnet is available in R2's FIB table. However, R2 does not allow Host 3 to be routed because Host 3 subnet is not available in R2's FIB table. If strict uRPF is enabled on R2, then the source address 10.1.1.1/24 should be reachable through the same interface from which it is received. If loose uRPF is enabled on R2, then it is not mandatory that the source address 10.1.1.1/24 be reachable through the same interface from which it is received. The only criteria for a packet to be forwarded is that the host address should be present in R2's FIB table.

Configure Unicast Reverse Path Forwarding

Configuring Unicast Reverse Path Forwarding (uRPF) enables a router to verify the reachability of the source address of packets being forwarded. If the source IP address is not valid, the packet is discarded. This capability can limit the appearance of spoofed addresses in a network.

To configure uRPF on a hardware module, use the following steps:

1. Configure a hardware module in the global configuration mode and enable uRPF.
2. Reboot the router.
3. Configure an interface.
4. Configure IPv4 or IPv6 uRPF through strict or loose mode under the interface.

Configuration

Use the following configuration to configure uRPF in strict mode:

```
/* Configure a hardware module in the global configuration mode and enable uRPF. */
Router# configure
Router(config)# hw-module urpf enable
Mon Sep 17 09:34:00.945 UTC
In order to activate/deactivate urpf, you must manually reboot the box.
Router(config)# commit

/* Reboot the router manually. */

/* Configure an interface. */
Router(config)# interface BVI1
Router(config-ipv6-acl)# description BVI INTERFACE
Router(config-ipv6-acl)# commit

/* Configure IPv4 or IPv6 uRPF through strict or loose mode under the interface. */
Router(config)# ipv4 address 11.1.1.1 255.255.255.0
Router(config-pifib-policer-global)# ipv4 verify unicast source reachable-via rx
Router(config-pifib-policer-global)# commit
```

Use the following configuration to configure uRPF in loose mode:

```
/* Configure a hardware module in the global configuration mode and enable uRPF. */
Router# configure
Router(config)# hw-module urpf enable
Mon Sep 17 09:34:00.945 UTC
In order to activate/deactivate urpf, you must manually reboot the box.
Router(config)# commit

/* Reboot the router manually. */

/* Configure an interface. */
Router(config)# interface BVI1
Router(config-ipv6-acl)# description BVI INTERFACE
Router(config-ipv6-acl)# commit

/* Configure IPv4 or IPv6 uRPF through strict or loose mode under the interface. */
Router(config)# ipv4 address 11.1.1.1 255.255.255.0
```

```
Router(config-pifib-policer-global)# ipv4 verify unicast source reachable-via any
Router(config-pifib-policer-global)# commit
```

Verification

Use the following command to check the uRPF status:

```
Router#show prm server profile-status software
Software PROFILE STATUS VARIABLES
*****
BGP-3107 LB           : 0
LB Seed               : 0x65c5208d
LB Seed Cfg           : NO
LB Sub-Sel-Offset Cfg : NO
LB SubSel             : Hash Field B1
LB Offset              : 13
SR-PE Mode            : 0
Current URPF         : YES
Configured URPF    : YES
Current HW Profile    : SP-Profile
Configured HW Profile : SP-Profile
*****
```

Per-Flow Load Balancing

The system inherently supports the 7-tuple hash algorithm. Load balancing describes the functionality in a router that distributes packets across multiple links based on Layer 3 (network layer) and Layer 4 (transport layer) routing information. If the router discovers multiple paths to a destination, the routing table is updated with multiple entries for that destination.

Per-flow load balancing performs these functions:

- Incoming data traffic is evenly distributed over multiple equal-cost connections.
- Incoming data traffic is evenly distributed over multiple equal-cost connections member links within a bundle interface.
- Layer 2 bundle and Layer 3 (network layer) load balancing decisions are taken on IPv4, IPv6, and MPLS flows. If it is an IPv4 or an IPv6 payload, then a 7-tuple hashing is done. If it is an MPLS payload with three or less labels, then the hardware parses the payload underneath and identifies whether the payload packet has an IPv4 or an IPv6 header. If it is an IPv4 or IPv6 header, then a 4-tuple hashing is performed based on the IP source, IP destination, router ID, and label stack; otherwise, an MPLS label based hashing is performed. In case of MPLS label-based hashing, the top 4 labels are used in hash computation. However, for Cisco NC57 line cards, all the labels are used for MPLS label-based hashing.
- A 7-tuple hash algorithm provides more granular load balancing and used for load balancing over multiple equal-cost Layer 3 (network layer) paths. The Layer 3 (network layer) path is on a physical interface or on a bundle interface. In addition, load balancing over member links can occur within a Layer 2 bundle interface.
- The 7-tuple load-balance hash calculation contains:
 - Source IP address
 - Destination IP address
 - IP Protocol type
 - Router ID

- Source port
- Destination port
- Input interface



Note Cisco NC57 line cards support 6-tuple load-balance hash calculation because input interface is not considered as a parameter for load-balance hash calculations.

Load balancing decisions are taken based on a packet header, type of load balancing, type of scenario and platform specifics as follows:

- Packet header can contain one or many MAC, MPLS, IPv4 or IPv6 address, TCP or UDP headers, and so on.
- Load balancing can be done during ECMP or LAG (Bundle-Ether) forwarding.
- Scenarios can include IP forwarding, IP tunnel forwarding or decapsulation, MPLS forwarding or disaggregation, or Ethernet forwarding.
- The chipset type contains a packet's fields. These fields are considered for load balancing.

The following tables include detailed list of options, list of scenarios, and header fields to specify how ECMP or LAG load balancing is done.

Note:

- For Jericho/Qumran-AX/Qumran-MX line cards, the fields superscripted with * are used for load balancing through LAG only. For the Jericho+ line cards, the fields superscripted with * are used for load balancing through ECMP and LAG both. For example, in an MPLS forwarding scenario for Jericho line cards, for an MPLS packet with three labels, with an IPv4 or IPv6 header, and with L4 (TCP or UDP) ECMP load balancing is done based on:
 - All label values in the MPLS label stack
 - Source and destination IPv4 or IPv6 addresses

However, for the same MPLS packet, LAG load balancing is done based on:

- All label values in the MPLS label stack
- Source and destination IPv4 or IPv6 addresses
- L4 source and destination ports
- Only the fields that are highlighted in bold font are used for load balancing hash calculations. For example, for IP forwarding for IPv4 or IPv6 header and L4 (TCP or UDP) header, ECMP or LAG load balancing is done based on:
 - Source and destination IPv4 or IPv6 addresses
 - L4 source and destination ports

Table 8: ECMP or LAG Load Balancing for IP Forwarding

Header 4	Header 3	Header 2	Header 1
		IPv4	ETH
		IPv6	ETH
	L4	IPv4	ETH
	L4	IPv6	ETH
GTP	L4	IPv4	ETH
GTP	L4	IPv6	ETH

Table 9: ECMP or LAG Load Balancing for IP Tunnel Forwarding

Header 5	Header 4	Header 3	Header 2	Header 1
		IPv4	IPv4	ETH
	L4*	IPv4	IPv4	ETH
		IPv6	IPv4	ETH
		IPv6	IPv4	ETH
	IPv4	MPLS[1..3]	IPv4	ETH
L4	IPv4	MPLS[1..3]	IPv4	ETH
	IPv6	MPLS[1..3]	IPv4	ETH
L4	IPv6	MPLS[1..3]	IPv4	ETH
IPv4	MPLS[4..6]*	MPLS[1..3]	IPv4	ETH
IPv6	MPLS[4..6]*	MPLS[1..3]	IPv4	ETH
MPLS[7..9]	MPLS[4..6]*	MPLS[1..3]	IPv4	ETH
		IPv4	IPv6	ETH
	L4*	IPv4	IPv6	ETH
		IPv6	IPv6	ETH
	L4*	IPv6	IPv6	ETH



Note For MPLS packets, up to four labels are used for hash calculation.

Table 10: ECMP or LAG Load Balancing for IP Tunnel Decapsulation

Header 5	Header 4	Header 3	Header 2	Header 1
		IPv4	IPv4	ETH
	L4	IPv4	IPv4	ETH
		IPv6	IPv4	ETH
	L4	IPv6	IPv4	ETH
	IPv4	MPLS[1..3]	IPv4	ETH
L4	IPv4	MPLS[1..3]	IPv4	ETH
	IPv6	MPLS[1..3]	IPv4	ETH
L4	IPv6	MPLS[1..3]	IPv4	ETH
IPv4	MPLS[4..6]	MPLS[1..3]	IPv4	ETH
IPv6	MPLS[4..6]	MPLS[1..3]	IPv4	ETH
MPLS[7..9]	MPLS[4..6]	MPLS[1..3]	IPv4	ETH



Note For MPLS packets, up to four labels are used for hash calculation.

Table 11: ECMP or LAG Load Balancing for MPLS Forwarding

Header 5	Header 4	Header 3	Header 2	Header 1
			MPLS[1..3]	ETH
	IPv4	ETH	MPLS[1..3]	ETH
	IPv6	ETH	MPLS[1..3]	ETH
		IPv4	MPLS[1..3]	ETH
		IPv6	MPLS[1..3]	ETH
	L4*	IPv4	MPLS[1..3]	ETH
	L4*	IPv6	MPLS[1..3]	ETH
	IPv4	IPv4	MPLS[1..3]	ETH
	IPv6	IPv4	MPLS[1..3]	ETH
L4	IPv4	IPv4	MPLS[1..3]	ETH
L4	IPv6	IPv4	MPLS[1..3]	ETH

Header 5	Header 4	Header 3	Header 2	Header 1
		MPLS[4..6]	MPLS[1..3]	ETH
IPv4	ETH	MPLS[4..6]	MPLS[1..3]	ETH
IPv6	ETH	MPLS[4..6]	MPLS[1..3]	ETH
	IPv4	MPLS[4..6]	MPLS[1..3]	ETH
	IPv6	MPLS[4..6]	MPLS[1..3]	ETH
L4	IPv4	MPLS[4..6]	MPLS[1..3]	ETH
L4	IPv6	MPLS[4..6]	MPLS[1..3]	ETH
IPv4	IPv4	MPLS[4..6]	MPLS[1..3]	ETH
IPv6	IPv4	MPLS[4..6]	MPLS[1..3]	ETH
IPv4	MPLS[7..9]	MPLS[4..6]	MPLS[1..3]	ETH
IPv6	MPLS[7..9]	MPLS[4..6]	MPLS[1..3]	ETH



Note For MPLS packets with multiple labels, hash calculation is done based on the first five labels along other headers.

Table 12: ECMP or LAG Load Balancing for MPLS Deaggregation

Header 5	Header 4	Header 3	Header 2	Header 1
		IPv4	MPLS1	ETH
		IPv6	MPLS1	ETH
	L4*	IPv4	MPLS1	ETH
	L4*	IPv6	MPLS1	ETH
	IPv4	IPv4	MPLS1	ETH
	IPv6	IPv4	MPLS1	ETH
L4	IPv4	IPv4	MPLS1	ETH
L4	IPv6	IPv4	MPLS1	ETH
	IPv4	ETH	MPLS1	ETH
	IPv6	ETH	MPLS1	ETH
L4	IPv4	ETH	MPLS1	ETH

Header 5	Header 4	Header 3	Header 2	Header 1
L4	IPv6	ETH	MPLS1	ETH

Table 13: ECMP or LAG Load Balancing for Ethernet Forwarding for IPoE Packets

Header 3	Header 2	Header 1
	IPv4	ETH
	IPv6	ETH
L4*	IPv4	ETH
L4*	IPv6	ETH

Table 14: ECMP or LAG Load Balancing Ethernet Forwarding for IPoE Packets with Complex Headers

Header 5	Header 4	Header 3	Header 2	Header 1
		IPv4*	IPv4	ETH
	L4	IPv4*	IPv4	ETH
		IPv6*	IPv4	ETH
	L4	IPv6*	IPv4	ETH
	IPv4	MPLS[1..3]*	IPv4	ETH
L4	IPv4	MPLS[1..3]*	IPv4	ETH
	IPv6	MPLS[1..3]*	IPv4	ETH
L4	IPv6	MPLS[1..3]*	IPv4	ETH
IPv4	MPLS[4..6]	MPLS[1..3]*	IPv4	ETH
IPv6	MPLS[4..6]	MPLS[1..3]*	IPv4	ETH
MPLS[7..9]	MPLS[4..6]	MPLS[1..3]*	IPv4	ETH



Note For MPLS packets with one through three labels, only the first label is used for load balancing along with other headers.

Table 15: ECMP or LAG Load Balancing Ethernet Forwarding for MPLS packets

Header 5	Header 4	Header 3	Header 2	Header 1
			MPLS[1..3]	ETH

Header 5	Header 4	Header 3	Header 2	Header 1
		IPv4*	MPLS[1..3]	ETH
		IPv6*	MPLS[1..3]	ETH
	L4	IPv4*	MPLS[1..3]	ETH
	L4	IPv6*	MPLS[1..3]	ETH
	IPv4	IPv4*	MPLS[1..3]	ETH
	IPv6	IPv4*	MPLS[1..3]	ETH
L4	IPv4	IPv4*	MPLS[1..3]	ETH
L4	IPv6	IPv4*	MPLS[1..3]	ETH
		MPLS[4..6]*	MPLS[1..3]	ETH
	IPv4	MPLS[4..6]*	MPLS[1..3]	ETH
	IPv6	MPLS[4..6]*	MPLS[1..3]	ETH
L4	IPv4	MPLS[4..6]*	MPLS[1..3]	ETH
L4	IPv6	MPLS[4..6]*	MPLS[1..3]	ETH
IPv4	IPv4	MPLS[4..6]*	MPLS[1..3]	ETH
IPv6	IPv4	MPLS[4..6]*	MPLS[1..3]	ETH
IPv4	MPLS[7..9]	MPLS[4..6]*	MPLS[1..3]	ETH
IPv6	MPLS[7..9]	MPLS[4..6]*	MPLS[1..3]	ETH



Note For MPLS packets with multiple labels, hash calculation is done based on first five labels along with other headers.

Per-Destination Load Balancing

Per destination load balancing is used for packets that transit over a recursive MPLS path (for example, learned through BGP 3107). Per-destination load balancing means the router distributes the packets based on the destination of the route. Given two paths to the same network, all packets for destination1 on that network go over the first path, all packets for destination2 on that network go over the second path, and so on. This preserves packet order, with potential unequal usage of the links. If one host receives the majority of the traffic all packets use one link, which leaves bandwidth on other links unused. A larger number of destination addresses leads to more equally used links.

Configuring Static Route

Routers forward packets using either route information from route table entries that you manually configure or the route information that is calculated using dynamic routing algorithms. Static routes, which define explicit paths between two routers, cannot be automatically updated; you must manually reconfigure static routes when network changes occur. Static routes use less bandwidth than dynamic routes. Use static routes where network traffic is predictable and where the network design is simple. You should not use static routes in large, constantly changing networks because static routes cannot react to network changes. Most networks use dynamic routes to communicate between routers but might have one or two static routes configured for special cases. Static routes are also useful for specifying a gateway of last resort (a default router to which all unroutable packets are sent).

Configuration Example

Create a static route between Router A and B over a HundredGigE interface. The destination IP address is 203.0.1.2/32 and the next hop address is 1.0.0.2.



```
Router(config)#router static address-family ipv4 unicast
Router(config-static-afi)#203.0.1.2/32 HundredGigE 0/0/0/9 1.0.0.2
Router(config-static-afi)#commit
```

Running Configuration

```
Router#show running-config router static address-family ipv4 unicast
router static
  address-family ipv4 unicast
    203.0.1.2/32 HundredGigE 0/0/0/9 1.0.0.2
  !
!
```

Verification

Verify that the Next Hop Flags fields indicate COMPLETE for accurate functioning of the configuration.

The database, such as LPM, EXT-TCAM, and LEM, in which a prefix is updated is also provided through the output. Therefore, you can efficiently manage your network resources because you can understand the scaling of prefixes. You can also understand why a particular IP address configuration for a device fails and thereby debug easily.

```
Router#show cef 203.0.1.2/32 hardware egress details location 0/0/CPU0
Wed Nov  6 10:09:23.548 UTC
111.0.0.1/32, version 221, attached, internal 0x1000041 0x0 (ptr 0x8b00ea80) [1], 0x0
(0x8afd9768), 0x0 (0x0)
Updated Nov  6 10:08:07.424
Prefix Len 32, traffic index 0, precedence n/a, priority 2
  gateway array (0x8ae4baf0) reference count 1, flags 0x0, source rib (7), 0 backups
    [2 type 3 flags 0x40008441 (0x8af020c0) ext 0x0 (0x0)]
  LW-LDI[type=3, refc=1, ptr=0x8afd9768, sh-ldi=0x8af020c0]
  gateway array update type-time 1 Nov  6 10:08:07.423
LDI Update time Nov  6 10:08:07.423
LW-LDI-TS Nov  6 10:08:07.424
  via tunnel-ip1, 0 dependencies, recursive [flags 0x8]
  path-idx 0 NHID 0x0 [0x8ae0d728 0x0]
  local adjacency
```

```

LEAF - HAL pd context :
sub-type : IPV4, ecd_marked:0, has_collapsed_ldi:0
collapse_bwalk_required:0, ecdv2_marked:0,
HW Walk:
LEAF:
  PI:0x308b00ea80 PD:0x308b00eb20 rev:293 type: IPV4 (0)
  LEAF location: LEM
  FEC key: 0x1640000dc6

  LWLDI:
    PI:0x308afd9768 PD:0x308afd97a8 rev:292 p-rev:291 ldi type:IP
    FEC key: 0x1640000dc6 fec index: 0x0(0) num paths:1, bkup paths: 0

REC-SHLDI HAL PD context :
ecd_marked:0, collapse_bwalk_required:0, load_shared_lb:0

RSHLDI:
  PI:0x308af020c0 PD:0x308af02190 rev:291 dpa-rev:2448 flag:0x1
  FEC key: 0x1640000dc6 fec index: 0x2001ffd8(131032) num paths: 1
  p-rev:
  Path:0 fec index: 0x2001ffd8(131032) DSP fec index: 0x20000001(1),
  TEP Encap Id: 0x40013801

LEAF - HAL pd context :
sub-type : IPV4, ecd_marked:0, has_collapsed_ldi:0
collapse_bwalk_required:0, ecdv2_marked:0,
HW Walk:
LEAF:
  PI:0x308b00e558 PD:0x308b00e5f8 rev:270 type: IPV4 (0)
  LEAF location: LEM
  FEC key: 0x1240000dc6

  LWLDI:
    PI:0x308afd9128 PD:0x308afd9168 rev:269 p-rev:268 268 ldi type:IP
    FEC key: 0x1240000dc6 fec index: 0x0(0) num paths:2, bkup paths: 0

  SHLDI:
    PI:0x308af00d88 PD:0x308af00e58 rev:268 dpa-rev:2433 cbf_enabled:0 pbts_enabled:0
flag:0x0
    FEC key: 0x1240000dc6 fec index: 0x20000001(1) num paths: 2 bkup paths: 0
    p-rev:265 262
    Path:0 fec index: 0x2001ffdc(131036) DSP:0x15 Dest fec index: 0x0(0)
    Path:1 fec index: 0x2001ffdd(131037) DSP:0x16 Dest fec index: 0x0(0)

  TX-NHINFO:
    PI: 0x308c8d8298 PD: 0x308c8d8318 rev:265 dpa-rev:2431 Encap hdl: 0x308c84c350

    Encap id: 0x40010001 Remote: 0 L3 int: 1552 flags: 0x3
    npu_mask: 0x1 DMAC: f0:78:16:62:f6:a7

  TX-NHINFO:
    PI: 0x308c8d80b0 PD: 0x308c8d8130 rev:262 dpa-rev:2429 Encap hdl: 0x308c84c968

    Encap id: 0x40010000 Remote: 0 L3 int: 1551 flags: 0x3
    npu_mask: 0x1 DMAC: f0:78:16:62:f6:a6

Load distribution: 0 (refcount 2)

Hash OK Interface Address
0 Y tunnel-ip1 10.10.10.1

```

Associated Commands

- router static
- [show cef](#)

BGP Attributes Download

The BGP Attributes Download feature enables you to display the installed BGP attributes in CEF.

- The **show cef bgp-attribute** command displays the installed BGP attributes in CEF.
- The **show cef bgp-attribute *attribute-id*** command and the **show cef bgp-attribute *local-attribute-id*** command are used to view the specific BGP attributes by attribute ID and local attribute ID.

Verification

```
Router# show cef bgp-attribute
Router ID is 216.1.1.1

IP CEF with switching (Table Version 0) for node0_RP0_CPU0

Load balancing: L4
Tableid 0xe0000000 (0x8cf5b368), Vrfid 0x60000000, Vrid 0x20000000, Flags 0x1019
Vrfname default, Refcount 4129
56 routes, 0 protected, 0 reresolve, 0 unresolved (0 old, 0 new), 7616 bytes
13 rib, 0 lsd, 0:27 aib, 1 internal, 10 interface, 4 special, 1 default routes
56 load sharing elements, 24304 bytes, 1 references
1 shared load sharing elements, 432 bytes
55 exclusive load sharing elements, 23872 bytes
0 route delete cache elements
13 local route bufs received, 1 remote route bufs received, 0 mix bufs received
13 local routes, 0 remote routes
13 total local route updates processed
0 total remote route updates processed
0 pkts pre-routed to cust card
0 pkts pre-routed to rp card
0 pkts received from core card
0 CEF route update drops, 0 revisions of existing leaves
0 CEF route update drops due to version mis-match
Resolution Timer: 15s
0 prefixes modified in place
0 deleted stale prefixes
0 prefixes with label imposition, 0 prefixes with label information
0 LISP EID prefixes, 0 merged, via 0 rlocs
28 next hops
1 incomplete next hop

0 PD backwalks on LDIs with backup path

VRF: default

Table ID: 0xe0000000. Total number of entries: 0
OOR state: GREEN. Number of OOR attributes: 0
```

Associated Commands

- [show cef bgp-attribute](#)

Proactive Address Resolution Protocol and Neighbor Discovery

When CEF installs a route for which there is no layer 2 adjacency information, CEF creates an incomplete layer 3 next-hop and programs it on the hardware. Because of this incomplete programming, the first packet will be forwarded to the software forwarding path. The software forwarding in turn strips off the layer 2 header from the packet and forwards it to ARP (Address Resolution Protocol) or ND (Neighbor Discovery) in order to resolve the layer 2 adjacency information. In such a packet, if there is feature specific information present in the layer 2 header, the software forwarding path fails to strip off the layer 2 header completely and thus ARP or ND is unable to resolve the missing layer 2 adjacency information and thereby this results in traffic being dropped.

Proactive ARP and ND feature solves the above problem by ensuring that CEF proactively triggers ARP or ND in order to resolve the missing layer 2 adjacency information, retrying every 15 seconds until the next-hop information is resolved. Thus, when you configure a static route which has an incomplete next-hop information, this feature automatically triggers ARP or ND resolution.

Configuration

```
/* Enter the configuration mode and configure Proactive ARP/ND */
Router# configure
Router(config)# cef proactive-arp-nd enable
Router(config)# commit
```

Running Config

```
Show running-config
cef proactive-arp-nd enable
end
```



CHAPTER 8

Implementing HSRP

- [Implementing HSRP, on page 143](#)
- [Prerequisites for Implementing HSRP , on page 143](#)
- [Restrictions for Implementing HSRP , on page 144](#)
- [Information About Implementing HSRP, on page 144](#)
- [How to Implement HSRP, on page 147](#)
- [BFD for HSRP, on page 162](#)
- [Enhanced Object Tracking for HSRP and IP Static, on page 163](#)
- [Hot Restartability for HSRP, on page 164](#)
- [Configuration Examples for HSRP Implementation on Software, on page 164](#)

Implementing HSRP

The Hot Standby Router Protocol (HSRP) is an IP routing redundancy protocol designed to allow for transparent failover at the first-hop IP router. HSRP provides high network availability, because it routes IP traffic from hosts on networks without relying on the availability of any single router. HSRP is used in a group of routers for selecting an active router and a standby router. (An active router is the router of choice for routing packets; a standby router is a router that takes over the routing duties when an active router fails, or when preset conditions are met.)

Feature History for Implementing HSRP

Release 7.1.1	This feature was introduced.
------------------	------------------------------

Prerequisites for Implementing HSRP

You must be in a user group associated with a task group that includes the proper task IDs. The command reference guides include the task IDs required for each command. If you suspect user group assignment is preventing you from using a command, contact your AAA administrator for assistance.

Restrictions for Implementing HSRP

HSRP is supported on Ethernet interfaces, Ethernet sub-interfaces, Ethernet link bundles, and Bridge Virtual Interfaces (BVI).

The following are restrictions for implementing HSRP:

- HSRP sessions are not up by default. You can configure up to 255 (IPv4 and IPv6 combined) HSRP sessions per router using the **hw-module vrrpscale enable** command. When more than 255 HSRP sessions are configured per router, the HSRP sessions may become inactive.

For more information about the command, see *VRRP Commands* in the *IP Addresses and Services Command Reference for Cisco NCS 5500 Series and NCS 540 and NCS 560 Series Routers*.

- Only one redundancy protocol supported at any time – either HSRP or VRRP.

Information About Implementing HSRP

To implement HSRP on Cisco IOS XR software, you need to understand the following concepts:

HSRP Overview

HSRP is useful for hosts that do not support a router discovery protocol (such as Internet Control Message Protocol [ICMP] Router Discovery Protocol [IRDP]) and cannot switch to a new router when their selected router reloads or loses power. Because existing TCP sessions can survive the failover, this protocol also provides a more transparent recovery for hosts that dynamically choose a next hop for routing IP traffic.

When HSRP is configured on a network segment, it provides a virtual MAC address and an IP address that is shared among a group of routers running HSRP. The address of this HSRP group is referred to as the *virtual IP address*. One of these devices is selected by the protocol to be the *active router*. The active router receives and routes packets destined for the MAC address of the group. For n routers running HSRP, $n + 1$ IP and MAC addresses are assigned.

HSRP detects when the designated active router fails, at which point a selected standby router assumes control of the MAC and IP addresses of the HSRP group. A new *standby router* is also selected at that time.

Devices that are running HSRP send and receive multicast User Datagram Protocol (UDP) based hello packets to detect router failure and to designate active and standby routers.

HSRP Groups

An HSRP group consists of two or more routers running HSRP that are configured to provide hot standby services for one another. HSRP uses a priority scheme to determine which HSRP-configured router is to be the default active router. To configure a router as the active router, you assign it a priority that is higher than the priority of all the other HSRP-configured routers. The default priority is 100, so if you configure just one router to have a higher priority, that router will be the default active router.

HSRP works by the exchange of multicast messages that advertise priority among the HSRP group. When the active router fails to send a hello message within a configurable period of time, the standby router with

the highest priority becomes the active router. The transition of packet-forwarding functions between routers is completely transparent to all hosts on the network.

The following figure shows routers configured as members of a single HSRP group.

Figure 12: Routers Configured as an HSRP Group

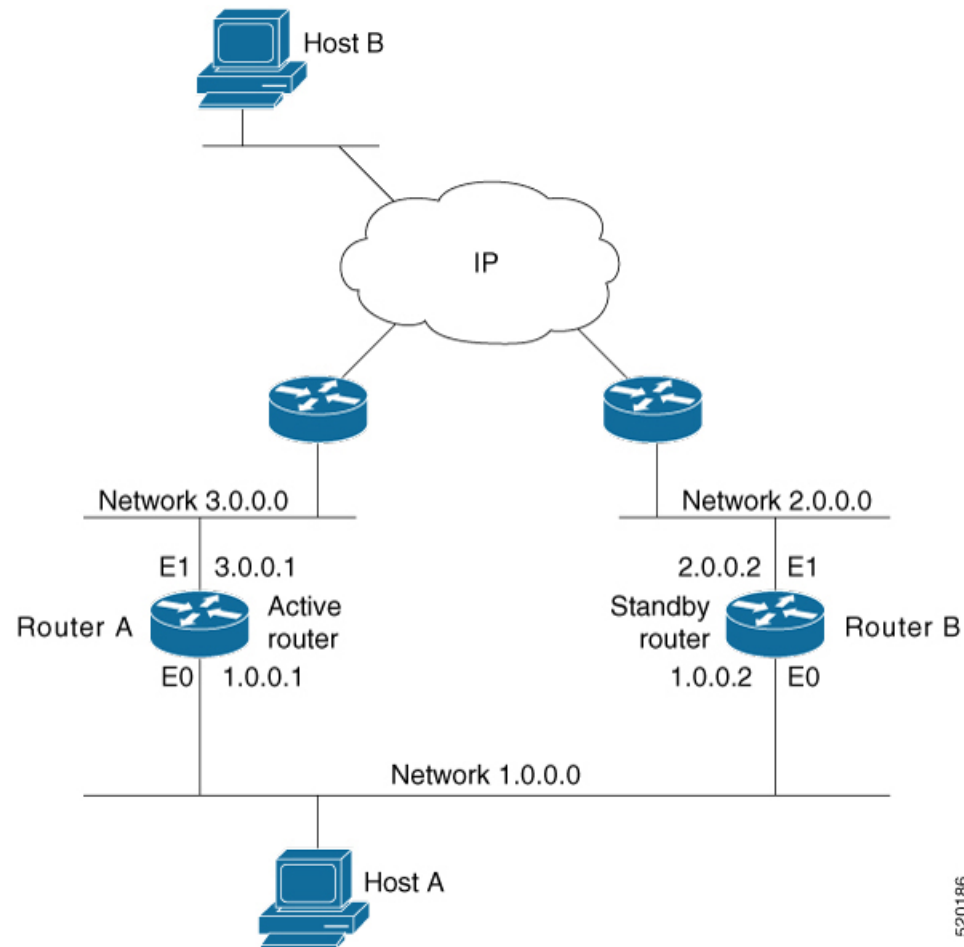

All hosts on the network are configured to use the IP address of the virtual router (in this case, 1.0.0.3) as the default gateway.

A single router interface can also be configured to belong to more than one HSRP group. The following figure shows routers configured as members of multiple HSRP groups.

Figure 13: Routers Configured as Members of Multiple HSRP Groups

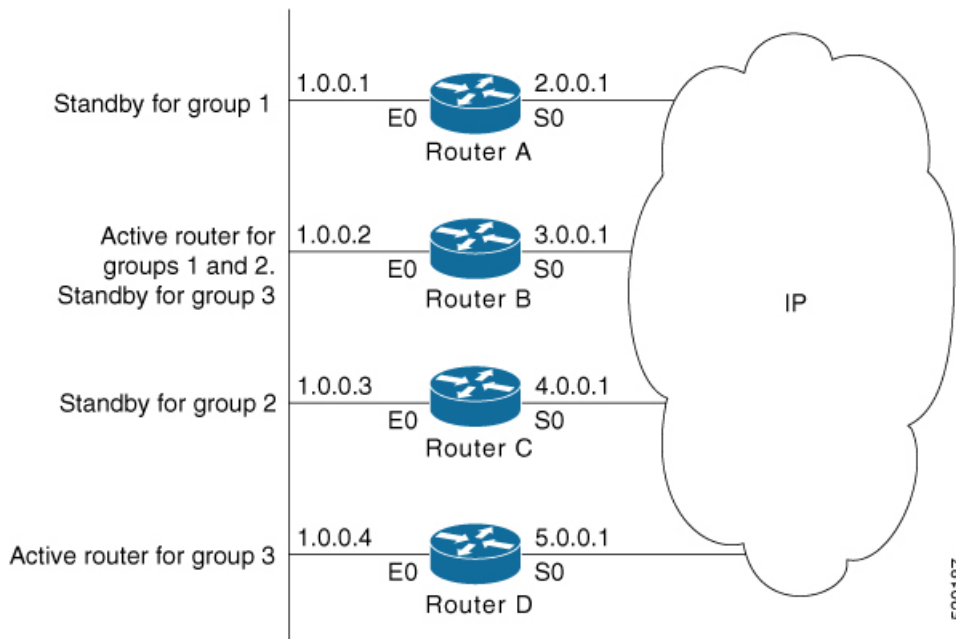

In the figure above, the Ethernet interface 0 of Router A belongs to group 1. Ethernet interface 0 of Router B belongs to groups 1, 2, and 3. The Ethernet interface 0 of Router C belongs to group 2, and the Ethernet interface 0 of Router D belongs to group 3. When you establish groups, you might want to align them along departmental organizations. In this case, group 1 might support the Engineering Department, group 2 might support the Manufacturing Department, and group 3 might support the Finance Department.

Router B is configured as the active router for groups 1 and 2 and as the standby router for group 3. Router D is configured as the active router for group 3. If Router D fails for any reason, Router B assumes the packet-transfer functions of Router D and maintains the ability of users in the Finance Department to access data on other subnets.



Note A different virtual MAC address (VMAC) is required for each sub interface. VMAC is determined from the group ID. Therefore, a unique group ID is required for each sub interface configured, unless the VMAC is configured explicitly.



Note We recommend that you disable Spanning Tree Protocol (STP) on switch ports to which the virtual routers are connected. Enable RSTP or rapid-PVST on the switch interfaces if the switch supports these protocols.

HSRP and ARP

When a router in an HSRP group goes active, it sends a number of ARP responses containing its virtual IP address and the virtual MAC address. These ARP responses help switches and learning bridges update their port-to-MAC maps. These ARP responses also provide routers configured to use the burned-in address of the interface as its virtual MAC address (instead of the preassigned MAC address or the functional address) with

a means to update the ARP entries for the virtual IP address. Unlike the gratuitous ARP responses sent to identify the interface IP address when an interface comes up, the HSRP router ARP response packet carries the virtual MAC address in the packet header. The ARP data fields for IP address and media address contain the virtual IP and virtual MAC addresses.

Preemption

The HSRP preemption feature enables the router with highest priority to immediately become the active router. Priority is determined first by the priority value that you configure, and then by the IP address. In each case, a higher value is of greater priority.

When a higher-priority router preempts a lower-priority router, it sends a coup message. When a lower-priority active router receives a coup message or hello message from a higher-priority active router, it changes to the speak state and sends a resign message.

ICMP Redirect Messages

Internet Control Message Protocol (ICMP) is a network layer Internet protocol that provides message packets to report errors and other information relevant to IP processing. ICMP provides many diagnostic functions and can send and redirect error packets to the host. When running HSRP, it is important to prevent hosts from discovering the interface (or real) MAC addresses of routers in the HSRP group. If a host is redirected by ICMP to the real MAC address of a router, and that router later fails, then packets from the host are lost.

ICMP redirect messages are automatically enabled on interfaces configured with HSRP. This functionality works by filtering outgoing ICMP redirect messages through HSRP, where the next-hop IP address may be changed to an HSRP virtual IP address.

To support ICMP redirects, redirect messages are filtered through HSRP, where the next-hop IP address is changed to an HSRP virtual address. When HSRP redirects are turned on, ICMP interfaces with HSRP do this filtering. HSRP keeps track of all HSRP routers by sending advertisements and maintaining a real IP address to virtual IP address mapping to perform the redirect filtering.

How to Implement HSRP

This section contains instructions for the following tasks:

Enabling HSRP

The **hsrp ipv4** command activates HSRP on the configured interface. If an IP address is specified, that address is used as the designated address for the Hot Standby group. If no IP address is specified, the virtual address is learned from the active router. For HSRP to elect a designated router, at least one router in the Hot Standby group must have been configured with, or learned, the designated address. Configuring the designated address on the active router always overrides a designated address that is currently in use.

Configuration Steps

1. Enable HSRP interface configuration mode on a specific interface.
2. Enable HSRP address-family configuration mode on a specific interface.
3. Enable HSRP group submode.



Note The **version** keyword is available only if IPv4 address-family is selected. By default, version is set to 2 for IPv6 address families.

4. Activate HSRP on the configured interface.



Note

- If an IP address is specified, that address is used as the designated address for the Hot Standby group. If no IP address is specified, the virtual address is learned from the active router.
- If you configure HSRP for IPv6, you must configure a link local IPv6 address or enable it using the **autoconfig** keyword. If you do not configure a linklocal IPv6 address, the router does not accept the configuration when you commit your changes using the **commit** keyword.

Configuration

```
/* Enable HSRP interface configuration mode on a specific interface. */
Router# configure
Router(config)# router hsrp
Router(config-hsrp)# interface <type> <interface-path-id>

/* Enable HSRP address-family configuration mode on a specific interface. */
Router(config-hsrp-if)# address-family ipv4

/* Enable HSRP group submode. */
Router(config-hsrp-ipv4)# hsrp <group-number> version <version-no>

/* Activate HSRP on the configured interface. */
Router(config-hsrp-gp)# address {learn|address[secondary]}
Router(config-hsrp-gp)# commit
```

Running Configuration

```
Router# show running-configuration
router hsrp
interface GigabitEthernet0/2/0/1
address-family ipv4
hsrp 1 version 1
address learn
!
```

Running Configuration for Extended Group Range

```
Router# show running-configuration
router hsrp
interface TenGigE 0/0/0/2
address-family ipv4
hsrp <1-4095> version <1-2>
address 10.20.30.1
address 10.20.30.2 secondary
!
```

Enabling HSRP for IPv6

Use the following steps to enable HSRP for IPv6.

1. Enable HSRP interface configuration mode on a specific interface.
2. Enable HSRP address-family configuration mode on a specific interface.
3. Enable HSRP group submode.



Note The **version** keyword is available only if IPv4 address-family is selected. By default, version is set to 2 for IPv6 address families.

4. Activate HSRP on the configured interface and assigns a linklocal IPv6 address..



Note

- The virtual linklocal address must not match any other virtual linklocal address that is already configured for a different group.
- The virtual linklocal address must not match the interface linklocal IPv6 address.
- If you use the **autoconfig** keyword, the linklocal address is calculated using the EUI-64 format.
- Use the **legacy-compatible** keyword to be compatible with Cisco IOS and other legacy Cisco devices.

5. Activate HSRP on the configured interface and assigns a global IPv6 address.



Note If you configure HSRP for IPv6, you must configure a link local IPv6 address or enable it using the **autoconfig** keyword. If you do not configure a linklocal IPv6 address, the router does not accept the configuration when you commit your changes using the **commit** keyword.

Configuration

```

/* Enable HSRP interface configuration mode on a specific interface. */
Router# configure
Router(config)# router hsrp
Router(config-hsrp)# interface <type> <interface-path-id>

/* Enable HSRP address-family configuration mode on a specific interface. */
Router(config-hsrp-if)# address-family ipv4

/* Enable HSRP group submode. */
Router(config-hsrp-ipv4)# hsrp <group-number>

/* Activate HSRP on the configured interface. */
Router(config-hsrp-gp)# address global <ipv6-address>
Router(config-hsrp-gp)# commit

```

Running Configuration

```

Router# show running-configuration
configure
router hsrp
interface GigabitEthernet0/2/0/1
address-family ipv4
hsrp 1
address linklocal autoconfig

```

```

    address global 2001:DB8:A:B::1
    !

```

Running Configuration for Expanded Group Range

```

Router# show running-configuration
router hsrp
interface TenGigE 0/0/0/2
  address-family ipv6
    hsrp <1-4095>
    address global 1:1::1
    address linklocal autoconfig
  !

```

Configuring HSRP Group Attributes

To configure other Hot Standby group attributes that affect how the local router participates in HSRP, use the following procedure in interface configuration mode as needed:

Configuration Example

1. Enable HSRP configuration mode.
2. Enable HSRP interface configuration mode on a specific interface.
3. Enable HSRP address-family configuration mode on a specific interface.
4. Enable HSRP group submode.



Note The **version** keyword is available only if IPv4 address-family is selected. By default, version is set to 2 for IPv6 address families.

5. (Optional) Configure HSRP priority.
 - The assigned priority is used to help select the active and standby routers. Assuming that preemption is enabled, the router with the highest priority becomes the designated active router. In case of ties, the primary IP addresses are compared, and the higher IP address has priority.
 - The priority of the device can change dynamically if an interface is configured with the **track** command and another interface on the device goes down.
 - If preemption is not enabled using the **preempt** command, the router may not become active even though it might have a higher priority than other HSRP routers.
 - To restore the default HSRP priority values, use the **no priority** command.
6. (Optional) Configure an interface so that the Hot Standby priority changes on the basis of the availability of other interfaces.
 - When a tracked interface goes down, the Hot Standby priority decreases by 10. If an interface is not tracked, its state changes do not affect the Hot Standby priority. For each interface configured for Hot Standby, you can configure a separate list of interfaces to be tracked.
 - The optional *priority-decrement* argument specifies by how much to decrement the Hot Standby priority when a tracked interface goes down. When the tracked interface comes back up, the priority is incrementally increased by the same amount.

- When multiple tracked interfaces are down and the *priority-decrement* argument has been configured, these configured priority decrements are cumulative. If tracked interfaces are down, but none of them were configured with priority decrements, the default decrement is 10 and it is cumulative.
- The **preempt** command must be used in conjunction with this command on all routers in the group whenever the best available router should be used to forward packets. If the **preempt** command is not used, the active router stays active, regardless of the current priorities of the other HSRP routers.
- To remove the tracking, use the **no preempt** command.

7. (Optional) Configure HSRP preemption and preemption delay.

- When you configure preemption and preemption delay with the **preempt** command, the local router attempts to assume control as the active router when the local router has a Hot Standby priority higher than the current active router. If the **preempt** command is not configured, the local router assumes control as the active router only if it receives information indicating that no router is currently in the active state (acting as the designated router).
- When a router first comes up, it does not have a complete routing table. If it is configured to preempt, it becomes the active router, yet it is unable to provide adequate routing services. This problem can be solved by configuring a delay before the preempting router actually preempts the currently active router.
- The *preempt delay seconds* value does not apply if there is no router currently in the active state. In this case, the local router becomes active after the appropriate timeouts (see the **timers** command), regardless of the preempt delay seconds value.
- To restore the default HSRP preemption and preemption delay values, use the **no preempt** command.

8. (Optional) Configure an authentication string for the Hot Standby Router Protocol (HSRP).

- The authentication string is sent unencrypted in all HSRP messages. The same authentication string must be configured on all routers and access servers on a LAN to ensure interoperation.
- Authentication mismatch prevents a device from learning the designated Hot Standby IP address and the Hot Standby timer values from other routers configured with HSRP.
- Authentication mismatch does not prevent protocol events such as one router taking over as the designated router.
- To delete an authentication string, use the **no authentication** command.

Configuration

```

/* Enable HSRP configuration mode. */
Router# configure
Router(config)# router hsrp

/* Enable HSRP interface configuration mode on a specific interface. */
Router(config-hsrp)# interface <type> <interface-path-id>

/* Enable HSRP address-family configuration mode on a specific interface. */
Router(config-hsrp-if)# address-family ipv4

/* Enable HSRP group submode. */
Router(config-hsrp-ipv4)# hsrp <group-number> version <version-no>

/* (Optional) Configure HSRP priority. */

```

```

Router(config-hsrp-gp)# priority <priority>

/* (Optional) Configure an interface so that the Hot Standby priority changes on the basis
of the availability of other interfaces. */
Router(config-hsrp-gp)# track <type> instance <priority-decrement>

/* (Optional) Configure an authentication string for the Hot Standby Router Protocol (HSRP).
*/
Router(config-hsrp-gp)# authentication <string>

```

Running Configuration

```

Router# show running-configuration
configure
router hsrp
  interface TenGigE0/2/0/1
    address-family ipv4
      hsrp 1 version 1
        priority 100
        track TenGigE0/3/0/1
        preempt
        authentication company1
    !
  !
!
!

```

Configuring the HSRP Activation Delay

The activation delay for HSRP is designed to delay the startup of the state machine when an interface comes up. This gives the network time to settle and avoids unnecessary state changes early after the link comes up.

Configuration Example

1. Enable HSRP configuration mode.
2. Enable HSRP interface configuration mode on a specific interface.
3. Configure the delay of startup of the state machine.



Note The reload delay is the delay applied after the first interface up event. The minimum delay is the delay that is applied after any subsequent interface up event (if the interface flaps).

4. Enable HSRP address-family configuration mode on a specific interface.
5. Enable HSRP group submode.
6. Activate HSRP on the configured interface.



Note

- If an IP address is specified, that address is used as the designated address for the Hot Standby group. If no IP address is specified, the virtual address is learned from the active router.
- If you configure HSRP for IPv6, you must configure a link local IPv6 address or enable it using the **autoconfig** keyword. If you do not configure a linklocal IPv6 address, the router does not accept the configuration when you commit your changes using the **commit** keyword.

Configuration

```

/* Enable HSRP configuration mode. */
Router# configure
Router(config)# router hsrp

/* Enable HSRP interface configuration mode on a specific interface. */
Router(config-hsrp)# interface <type> <interface-path-id>

/* Configure the delay of startup of the state machine. */
Router(config-hsrp-if)# hsrp delay minimum <seconds> reload <seconds>

/* Enable HSRP address-family configuration mode on a specific interface. */
Router(config-hsrp-if)# address-family ipv4

/* Enable HSRP group submode. */
Router(config-hsrp-ipv4)# hsrp <group-number> version <version-no>

/* Activate HSRP on the configured interface. */
Router(config-hsrp-gp)# address { learn | address [secondary] }
Router(config-hsrp-gp)# commit

```

Running Configuration

```

Router# show running-configuration
configure
router hsrp
  interface TenGigE0/2/0/1
    hsrp delay minimum 2 reload 10
    address-family ipv4
      hsrp 1
        address learn
    !

```

Disabling HSRP Support for ICMP Redirect Messages

By default, HSRP filtering of ICMP redirect messages is enabled on routers running HSRP.

To configure the reenabling of this feature on your router if it is disabled, use the **hsrp redirects** command in interface configuration mode.

Configuration Example

1. Enable HSRP interface configuration mode on a specific interface.
2. Enable HSRP address-family configuration mode on a specific interface.
3. Enable HSRP group submode.



Note The **version** keyword is available only if IPv4 address-family is selected. By default, version is set to 2 for IPv6 address families.

4. Activate HSRP on the configured interface.



-
- Note**
- If an IP address is specified, that address is used as the designated address for the Hot Standby group. If no IP address is specified, the virtual address is learned from the active router.
 - If you configure HSRP for IPv6, you must configure a link local IPv6 address or enable it using the **autoconfig** keyword. If you do not configure a linklocal IPv6 address, the router does not accept the configuration when you commit your changes using the **commit** keyword.
-

5. Configure Internet Control Message Protocol (ICMP) redirect messages to be sent when the Hot Standby Router Protocol (HSRP) is configured on an interface.



-
- Note**
- The **hsrp redirects** command can be configured on a per-interface basis. When HSRP is first configured on an interface, the setting for that interface inherits the global value. If ICMP redirects have been explicitly disabled on an interface, then the global command cannot reenables the functionality.
 - With the **hsrp redirects** command enabled, ICMP redirect messages are filtered by replacing the real IP address in the next-hop address of the redirect packet with a virtual IP address, if it is known to HSRP.
 - To revert to the default, which is that ICMP messages are enabled, use the **no hsrp redirects** command.
-

Configuration

```

/* Enable HSRP interface configuration mode on a specific interface. */
Router# configure
Router(config)# router hsrp
Router(config-hsrp)# interface <type> <interface-path-id>

/* Configure Internet Control Message Protocol (ICMP) redirect messages to be sent when the
   Hot Standby Router Protocol (HSRP) is configured on an interface. */
Router(config-hsrp-gp)# hsrp redirects disable

/* Enable HSRP address-family configuration mode on a specific interface. */
Router(config-hsrp-if)# address-family ipv4

/* Enable HSRP group submode. */
Router(config-hsrp-ipv4)# hsrp <group-number> version <version-no>

/* Activate HSRP on the configured interface. */
Router(config-hsrp-gp)# address {learn|address[secondary]}

```

Running Configuration

```

Router# show running-configuration
router hsrp
  interface TenGigE 0/2/0/1
    address-family ipv4
      hsrp 1 version 1
      address learn
    !
  hsrp redirects disable
  !
!
```

Multiple Group Optimization (MGO) for HSRP

Multiple Group Optimization provides a solution for reducing control traffic in a deployment consisting of many subinterfaces. By running the HSRP control traffic for just one of the sessions, the control traffic is reduced for the subinterfaces with identical redundancy requirements. All other sessions are subordinates of this primary session, and inherit their states from it.

Customizing HSRP

Customizing the behavior of HSRP is optional. Be aware that as soon as you enable a HSRP group, that group is in operation.

Configuration Example

1. Enable HSRP interface configuration mode on a specific interface.
2. Enable HSRP address-family configuration mode on a specific interface.
3. Enable HSRP group submode.



Note The **version** keyword is available only if IPv4 address-family is selected. By default, version is set to 2 for IPv6 address families.

4. Configure an HSRP session name.
5. Enables hot standby protocol for IP.



Note If an IP address is specified, that address is used as the designated address for the Hot Standby group. If no IP address is specified, the virtual address is learned from the active router.

6. Configure the secondary virtual IPv4 address for a router.
7. Configure an authentication string for the Hot Standby Router Protocol (HSRP).
8. Enable HSRP slave configuration mode on a specific interface.
9. Configure the subordinate group to inherit its state from a specified group.
10. Configure the primary virtual IPv4 address for the subordinate group.

Configuration

```
/* Enable HSRP interface configuration mode on a specific interface. */
Router# configure
Router(config)# router hsrp
Router(config-hsrp)# interface <type> <interface-path-id>

/* Enable HSRP address-family configuration mode on a specific interface. */
Router(config-hsrp-if)# address-family ipv4

/* Enable HSRP group configuration mode on a specific interface. */
Router(config-hsrp-ipv4)# hsrp <group-no> version <version-no>

/* Configure an HSRP session name. */
```

```

Router(config-hsrp-gp)# name <name>

/* Enable hot standby protocol for IP. */
Router(config-hsrp-gp)# address { learn | address}

/* Configure the secondary virtual IPv4 address for a router. */
Router(config-hsrp-gp)# address <address> secondary

/* Configures an authentication string for the Hot Standby Router Protocol (HSRP). */
Router(config-hsrp-gp)# authentication <string>

/* Enables HSRP slave configuration mode on a specific interface. */
Router(config-hsrp-gp)# hsrp <group-no> slave

/* Configure the subordinate group to inherit its state from a specified group. */
Router(config-hsrp-slave)# follow mgo-session-name

/* Configure the primary virtual IPv4 address for the subordinate group.
Router(config-hsrp-slave)# address <ip-address>

```

Running Configuration

```

Router# show running-configuration
router hsrp
 interface TenGigE0/2/0/1
  address-family ipv4
  hsrp 1 version 1
  name s1
  address learn
  address 1198.51.100.1 secondary
  authentication company1
  hsrp 2 slave
  follow s1
  address 192.0.2.1
  !
!
!
!

```

Configuring a Primary Virtual IPv4 Address

To enable hot standby protocol for IP, use the **address (hsrp)** command in the HSRP group submode.

Configuration Example

1. Enable HSRP interface configuration mode on a specific interface.
2. Enable HSRP address-family configuration mode on a specific interface.
3. Enable HSRP group configuration mode on a specific interface.



Note

- The **version** keyword is available only if IPv4 address-family is selected. By default, version is set to 2 for IPv6 address families.
- The HSRP version 2 extended group range must be restricted to 0-255, even though the configuration up to 0-4095 is accepted.

4. Enable hot standby protocol for IP.

Configuration

```
/* Enable HSRP interface configuration mode on a specific interface. */
Router# configure
Router(config)# router hsrp
Router(config-hsrp)# interface <type> <interface-path-id>

/* Enable HSRP address-family configuration mode on a specific interface. */
Router(config-hsrp-if)# address-family ipv4

/* Enable HSRP group configuration mode on a specific interface. */
Router(config-hsrp-ipv4)# hsrp <group-number> version <version-no>

/* Enable hot standby protocol for IP. */
Router(config-hsrp-ipv4)# address { learn | address }
```

Running Configuration

```
Router# show running-configuration
router hsrp
  interface TenGigE 0/2/0/1
    address-family ipv4
      hsrp 1 version 1
      address learn
  !
!
!
!
```

Configuring a Secondary Virtual IPv4 Address

To configure the secondary virtual IPv4 address for a router, use the **address secondary** command in the Hot Standby Router Protocol (HSRP) virtual router submode.

Configuration Example

1. Enable HSRP interface configuration mode on a specific interface.
2. Enable HSRP address-family configuration mode on a specific interface.
3. Enable HSRP group configuration mode on a specific interface.



Note

- The **version** keyword is available only if IPv4 address-family is selected. By default, version is set to 2 for IPv6 address families.
- The HSRP version 2 extended group range must be restricted to 0-255, even though the configuration up to 0-4095 is accepted.

4. Configure the secondary virtual IPv4 address for a router.

Configuration

```
/* Enable HSRP interface configuration mode on a specific interface. */
Router# configure
Router(config)# router hsrp
```

```

Router(config-hsrp)# interface <type> <interface-path-id>

/* Enable HSRP address-family configuration mode on a specific interface. */
Router(config-hsrp-if)# address-family ipv4

/* Enable HSRP group configuration mode on a specific interface. */
Router(config-hsrp-ipv4)# hsrp <group-number> version <version-no>

/* Configure the secondary virtual IPv4 address for a router. */
Router(config-hsrp-ipv4)# address <address> secondary

```

Running Configuration

```

Router# show running-configuration
router hsrp
  interface TenGigE 0/2/0/1
    address-family ipv4
      hsrp 1 version 1
        192.0.2.1
    !
  !
!
!
!

```

Configuring the Subordinate Group to Inherit its State from a Specified Group

To instruct the subordinate group to inherit its state from a specified group, use the **hsrp slave follow** command in HSRP slave submode mode.

Configuration Example

1. Enable HSRP interface configuration mode on a specific interface.
2. Enable HSRP address-family configuration mode on a specific interface.
3. Enable HSRP slave configuration mode on a specific interface.
4. Configure the subordinate group to inherit its state from a specified group.

Configuration

```

/* Enable HSRP interface configuration mode on a specific interface. */
Router# configure
Router(config)# router hsrp
Router(config-hsrp)# interface <type> <interface-path-id>

/* Enable HSRP address-family configuration mode on a specific interface. */
Router(config-hsrp-if)# address-family ipv4

/* Enable HSRP slave configuration mode on a specific interface. */
Router(config-hsrp-ipv4)# hsrp <group-no> slave

/* Configure the subordinate group to inherit its state from a specified group. */
Router(config-hsrp-slave)# address <ip-address>

```

Running Configuration

```

Router# show running-configuration
router hsrp
  interface TenGigE 0/2/0/1
    address-family ipv4
      hsrp 1 slave
        address 192.0.2.1
    !

```

```
!
!
!
```

Configuring a Subordinate Primary Virtual IPv4 Address

To configure the primary virtual IPv4 address for the subordinate group, use the **subordinate primary virtual IPv4 address** command in the HSRP slave submode.

Configuration Example

1. Enable HSRP interface configuration mode on a specific interface.
2. Enable HSRP address-family configuration mode on a specific interface.
3. Enable HSRP slave configuration mode on a specific interface.
4. Configure the primary virtual IPv4 address for the subordinate group.

Configuration

```
/* Enable HSRP interface configuration mode on a specific interface. */
Router# configure
Router(config)# router hsrp
Router(config-hsrp)# interface <type> <interface-path-id>

/* Enable HSRP address-family configuration mode on a specific interface. */
Router(config-hsrp-if)# address-family ipv4

/* Enable HSRP slave configuration mode on a specific interface. */
Router(config-hsrp-ipv4)# hsrp <group-no> slave

/* Configure the primary virtual IPv4 address for the subordinate group. */
Router(config-hsrp-slave)# address <ip-address>
```

Running Configuration

```
Router# show running-configuration
router hsrp
 interface TenGigE 0/2/0/1
   address-family ipv4
     hsrp 1 slave
     address 192.0.2.1
   !
 !
 !
```

Configuring a Secondary Virtual IPv4 address for the Subordinate Group

Perform this task to configure the secondary virtual IPv4 address for the subordinate group.

Configuration Example

1. Enable HSRP interface configuration mode on a specific interface.
2. Enable HSRP address-family configuration mode on a specific interface.
3. Enable HSRP slave configuration mode on a specific interface.
4. Configure the secondary virtual IPv4 address for a router.

Configuration

```

/* Enable HSRP interface configuration mode on a specific interface. */
Router# configure
Router(config)# router hsrp
Router(config-hsrp)# interface <type> <interface-path-id>

/* Enable HSRP address-family configuration mode on a specific interface. */
Router(config-hsrp-if)# address-family ipv4

/* Enable HSRP slave configuration mode on a specific interface. */
Router(config-hsrp-ipv4)# hsrp <group-no> slave

/* Configure the secondary virtual IPv4 address for the subordinate group. */
Router(config-hsrp-slave)# address <ip-address> secondary

```

Running Configuration

```

Router# show running-configuration
router hsrp
  interface TenGigE 0/2/0/1
    address-family ipv4
      hsrp 1 slave
      address 192.0.2.1 secondary
    !
  !
!

```

Configuring a Subordinate Virtual MAC Address

To configure the virtual MAC address for the subordinate group, use the **subordinate virtual mac address** command in the HSRP slave submode.

Configuration Example

1. Enable HSRP interface configuration mode on a specific interface.
2. Enable HSRP address-family configuration mode on a specific interface.
3. Enable HSRP slave configuration mode on a specific interface.

Configuration

```

/* Enable HSRP interface configuration mode on a specific interface. */
Router# configure
Router(config)# router hsrp
Router(config-hsrp)# interface <type> <interface-path-id>

/* Enable HSRP address-family configuration mode on a specific interface. */
Router(config-hsrp-if)# address-family ipv4

/* Enable HSRP slave configuration mode on a specific interface. */
Router(config-hsrp-ipv4)# hsrp <group-no> slave

```

Running Configuration

```

Router# show running-configuration
router hsrp
  interface TenGigE 0/2/0/1
    address-family ipv4
      hsrp 1 slave
    !
  !
!

```

```
!
!
!
```

Configuring an HSRP Session Name

To configure an HSRP session name, use the **session name** command in the HSRP group submode.

Configuration Example

1. Enable HSRP interface configuration mode on a specific interface.
2. Enable HSRP address-family configuration mode on a specific interface.
3. Enable HSRP group configuration mode on a specific interface.



Note

- The **version** keyword is available only if IPv4 address-family is selected. By default, version is set to 2 for IPv6 address families.
- The HSRP version 2 extended group range must be restricted to 0-255, even though the configuration up to 0-4095 is accepted.

4. Configure the subordinate group to inherit its state from a specified group.

Configuration

```
/* Enable HSRP interface configuration mode on a specific interface. */
Router# configure
Router(config)# router hsrp
Router(config-hsrp)# interface <type> <interface-path-id>

/* Enable HSRP address-family configuration mode on a specific interface. */
Router(config-hsrp-if)# address-family ipv4

/* Enable HSRP group configuration mode on a specific interface. */
Router(config-hsrp-ipv4)# hsrp <group-no> hsrp <version-no>

/* Configure the subordinate group to inherit its state from a specified group. */
Router(config-hsrp-ipv4)# name <name>
```

Running Configuration

```
Router# show running-configuration
router hsrp
  interface TenGigE 0/2/0/1
    address-family ipv4
      hsrp 1 version 2
      name s1  !
  !
!
```

BFD for HSRP

Bidirectional Forwarding Detection (BFD) is a network protocol used to detect faults between two forwarding engines. BFD sessions operate in asynchronous mode. In asynchronous mode, both endpoints periodically send hello packets to each other. If a number of those packets are not received, the session is considered down.

Advantages of BFD

- BFD provides failure detection in less than one second.
- BFD supports all types of encapsulation.
- BFD is not tied to any particular routing protocol, supports almost all routing protocols.

BFD Process

HSRP uses BFD to detect link failure and facilitate fast failover times without excessive control packet overhead.

The HSRP process creates BFD sessions as required. When a BFD session goes down, each Standby group monitoring the session transitions to Active state.

HSRP doesn't participate in any state elections for 10 seconds, after a transition to Active state that a BFD session going down triggers.

Configuring BFD

Enabling BFD

```
Router# configure
Router(config)# router hsrp
Router(config-hsrp)# interface <type> <interface-path-id>
Router(config-hsrp-if)# address-family ipv4
Router(config-hsrp-ipv4)# hsrp[group number] version <version-no> bfd
fast-detect [peer ipv4 <ipv4-address> <interface-type> <interface-path-id>]
commit
```

Modifying BFD timers (minimum interval)

Minimum interval determines the frequency of sending BFD packets to BFD peers (in milliseconds). The default minimum interval is 15ms.

```
Router# configure
Router(config)# router hsrp
Router(config-hsrp)# interface <type> <interface-path-id>
```

```
Router(config-hsrp-if)# hsrp bfd minimum-interval <interval>
router(config-hsrp-if)# address-family ipv4
commit
```

Modifying BFD timers (multiplier)

```
Router# configure
Router(config)# router hsrp
Router(config-hsrp)# interface <type> <interface-path-id>
Router(config-hsrp-if)# hsrp bfd multiplier <multiplier>
Router(config-hsrp-if)# address-family ipv4
commit
```

Enhanced Object Tracking for HSRP and IP Static

A failure between the active router and the core network cannot be detected using standard HSRP failure detection mechanisms. Object tracking is used to detect such failures. When such a failure occurs, the active router applies a priority decrement to its HSRP session. If this causes its priority to fall below that of the standby router, it will detect this from the HSRP control traffic, and then use this as a trigger to preempt and take over the active role.

Cisco IOS XR software supports up to 512 tracked objects.

The enhanced object tracking for HSRP and IP Static feature provides first-hop redundancy as well as default gateway selection based on IP Service Level Agreement (IPSLA).

See the *Routing Configuration Guide for Cisco NCS 5500 Series Routers*, for more information about enhanced object tracking for static routes.

Configuring object tracking for HSRP

To enable tracking of the named object with the specified decrement, use the following configuration in the HSRP group sub mode.

Configuration Example

1. Enable HSRP interface configuration mode on a specific interface.
2. Enable HSRP address-family configuration mode on a specific interface.
3. Enable HSRP group sub-mode on a specific interface.



Note The **version** keyword is available only if IPv4 address-family is selected. By default, version is set to 2 for IPv6 address families.

4. Enable tracking of the named object with the specified decrement.

Configuration

```

/* Enable HSRP interface configuration mode on a specific interface. */
Router# configure
Router(config)# router hsrp
Router(config-hsrp)# interface <type> <interface-path-id>

/* Enable HSRP address-family configuration mode on a specific interface. */
Router(config-hsrp-if)# address-family ipv4

/* Enable HSRP group sub-mode on a specific interface. */
Router(config-hsrp-ipv4)# hsrp <group-no> hsrp <version-no>

/* Enable tracking of the named object with the specified decrement. */
Router(config-hsrp-gp)# track object <name> [priority-decrement]

```

Running Configuration

```

Router# show running-configuration
router hsrp
  interface TenGigE 0/2/0/1
    address-family ipv4
      hsrp 1 version 1
      track object t1 2
    !
  !
!
!
!

```

Hot Restartability for HSRP

In the event of failure of a HSRP process in one active group, forced failovers in peer HSRP active router groups should be prevented. Hot restartability supports warm RP failover without incurring forced failovers to peer HSRP routers for active groups.

Configuration Examples for HSRP Implementation on Software

This section provides the following HSRP configuration examples:

Configuring an HSRP Group: Example

The following is an example of enabling HSRP on an interface and configuring HSRP group attributes:

```

configure
router hsrp
interface 0/2/0/1
hsrp 1 ipv4 1.0.0.5
commit
hsrp 1 timers 100 200
hsrp 1 preempt delay 500
hsrp priority 20
hsrp track 0/2/0/2
hsrp 1 authentication company0
hsrp use-bia
commit

```

Configuring a Router for Multiple HSRP Groups: Example

The following is an example of configuring a router for multiple HSRP groups:

```
configure
router hsrp
interface 0/2/0/3
hsrp 1 ipv4 1.0.0.5
hsrp 1 priority 20
hsrp 1 preempt
hsrp 1 authentication sclara
hsrp 2 ipv4 1.0.0.6
hsrp 2 priority 110
hsrp 2 preempt
hsrp 2 authentication mtview
hsrp 3 ipv4 1.0.0.7
hsrp 3 preempt
hsrp 3 authentication svale
commit
```



CHAPTER 9

Implementing LPTS

- [LPTS Overview, on page 167](#)
- [LPTS Policers, on page 167](#)
- [Per Port Rate Limiting of Multicast and Broadcast Punt Packets, on page 172](#)
- [LPTS Domain Based Policers, on page 179](#)
- [Defining Dynamic LPTS Flow Type , on page 180](#)

LPTS Overview

Local Packet Transport Services (LPTS) maintains tables describing all packet flows destined for the secure domain router (SDR), making sure that packets are delivered to their intended destinations.

LPTS uses two components to accomplish this task: the port arbitrator and flow managers. The port arbitrator and flow managers are processes that maintain the tables that describe packet flows for a logical router, known as the Internal Forwarding Information Base (IFIB). The IFIB is used to route received packets to the correct Route Processor for processing.

LPTS interfaces internally with all applications that receive packets from outside the router. LPTS functions without any need for customer configuration. However, the policer values can be customized if required. The LPTS show commands are provided that allow customers to monitor the activity and performance of LPTS flow managers and the port arbitrator.

LPTS Policers

In Cisco IOS XR, the control packets, which are destined to the Route Processor (RP), are policed using a set of ingress policers in the incoming ports. These policers are programmed statically during bootup by LPTS components. The policers are applied based on the flow type of the incoming control traffic. The flow type is determined by looking at the packet headers. The policer rates for these static ingress policers are defined in a configuration file, which are programmed on the route processor during bootup. You can change the policer values based on the flow types of these set of ingress policers. You are able to configure the rate per policer per node.

**Note**

- You can get the default policer values and the current rates of the flow types from the output of the following show command:

```
show lpts pifib hardware police
```

- For quick file transfer through a data port, you can configure LPTS policer rate for SSH flow.

Verify that the LPTS drops using the command, **show lpts pifib hardware entry brief location node-id |inc SSH**. If there are any LPTS drops, increase the rate up to a maximum of 50000 pps.

Increase the value to the maximum only if required, as the CPU cycles usage increases with higher PPS.

For example,

```
Router#configure
Router(config)#lpts pifib hardware police location 0/0/CPU0
Router(config-pifib-policer-per-node)# flow ssh known rate 50000
Router(config-pifib-policer-per-node)#commit
```

Configuration Example

Configure the LPTS policer for the OSPF and BGP flow types with the following values globally for all nodes:

- ospf unicast default rate 3000
- bgp default rate 4000

```
Router#configure
Router(config)#lpts pifib hardware police
Router(config-pifib-policer-global)#flow ospf unicast default rate 3000
Router(config-pifib-policer-global)#flow bgp default rate 4000
Router (config-pifib-policer-global)#commit
```

Running Configuration

```
lpts pifib hardware police
flow ospf unicast default rate 3000
flow bgp default rate 4000
!
```

Verification

```
Router#show run lpts pifib hardware police
lpts pifib hardware police
flow ospf unicast default rate 3000
flow bgp default rate 4000
```

Configuration Example

Configure the LPTS policer for the OSPF and BGP flow types with the following values on an individual node - 0/0/CPU0:

- ospf unicast default rate 3000
- flow bgp default rate 4000

```

Router#configure
Router(config)#lpts pifib hardware police location 0/0/CPU0
Router(config-pifib-policer-per-node)#flow ospf unicast default rate 3000
Router(config-pifib-policer-per-node)#flow bgp default rate 4000
Router(config-pifib-policer-per-node)#commit

```

Running Configuration

```

lpts pifib hardware police location 0/0/CPU0
flow ospf unicast default rate 3000
flow bgp default rate 4000

```

Verification

The **show lpts pifib hardware police location 0/0/CPU0** command displays pre-Internal Forwarding Information Base (IFIB) information for the designated node.

```

Router#show lpts pifib hardware police location 0/0/CPU0
-----
Node 0/0/CPU0:
-----
Burst = 100ms for all flow types
-----
FlowType           Policer Type   Cur. Rate Burst   npu
-----
OSPF-uc-default    32106  np       3000   1000   0
BGP-default        32118  np       4000   1250   0

```

Verification

The **show controllers npu stats traps-all instance all location 0/0/CPU0** command displays packets that are locally processed and packets that are dropped by the CPU.

```

Router# show controllers npu stats traps-all instance all location 0/0/CPU0

```

Trap Type	NPU ID	Trap ID	TrapStats ID	Policer	Packet Accepted	Packet Dropped
RxTrapMimSaMove (CFM_DOWNM_MEP_DMM)	0	6	0x6	32037	0	0
RxTrapMimSaUnknown (RCY_CFM_DOWN_MEP_DMM)	0	7	0x7	32037	0	0
RxTrapAuthSaLookupFail (IPMC default)	0	8	0x8	32033	0	0
RxTrapSaMulticast	0	11	0xb	32018	0	0
RxTrapArpMyIp	0	13	0xd	32001	0	0
RxTrapArp	0	14	0xe	32001	11	0
RxTrapDhcpv4Server	0	18	0x12	32022	0	0
RxTrapDhcpv4Client	0	19	0x13	32022	0	0
RxTrapDhcpv6Server	0	20	0x14	32022	0	0
RxTrapDhcpv6Client	0	21	0x15	32022	0	0
RxTrapL2Cache_LACP	0	23	0x17	32003	0	0
RxTrapL2Cache_LLDP1	0	24	0x18	32004	0	0

RxTrapL2Cache_LLDP2	0	25	0x19	32004	1205548	0
RxTrapL2Cache_LLDP3	0	26	0x1a	32004	0	0
RxTrapL2Cache_ELMI	0	27	0x1b	32005	0	0
RxTrapL2Cache_BPDU	0	28	0x1c	32027	0	0
RxTrapL2Cache_BUNDLE_BPDU	0	29	0x1d	32027	0	0
RxTrapL2Cache_CDP	0	30	0x1e	32002	0	0
RxTrapHeaderSizeErr	0	32	0x20	32018	0	0
RxTrapIpCompMcInvalidIp	0	35	0x23	32018	0	0
RxTrapMyMacAndIpDisabled	0	36	0x24	32018	0	0
RxTrapMyMacAndMplsDisable	0	37	0x25	32018	0	0
RxTrapArpReply	0	38	0x26	32001	2693	0
RxTrapFibDrop	0	41	0x29	32018	0	0
RxTrapMTU	0	42	0x2a	32020	0	0
RxTrapMiscDrop	0	43	0x2b	32018	0	0
RxTrapL2AclDeny	0	44	0x2c	32034	0	0
Rx_UNKNOWN_PACKET	0	46	0x2e	32018	0	0
RxTrapL3AclDeny	0	47	0x2f	32034	0	0
RxTrapOamY1731MplsTp (OAM_SWOFF_DN_CCM)	0	57	0x39	32029	0	0
RxTrapOamY1731Pwe (OAM_SWOFF_DN_CCM)	0	58	0x3a	32030	0	0
RxTrapOamLevel	0	64	0x40	32023	0	0
RxTrapRedirectToCpuOamPacket	0	65	0x41	32025	0	0
RxTrapOamPassive	0	66	0x42	32024	0	0
RxTrap1588	0	67	0x43	32038	0	0
RxTrapExternalLookupError	0	72	0x48	32018	0	0
RxTrapArplookupFail	0	73	0x49	32001	0	0
RxTrapUcLooseRpfFail	0	84	0x54	32035	0	0
RxTrapMplsControlWordTrap	0	88	0x58	32015	0	0
RxTrapMplsControlWordDrop	0	89	0x59	32015	0	0
RxTrapMplsUnknownLabel	0	90	0x5a	32018	0	0
RxTrapIpv4VersionError	0	98	0x62	32018	0	0
RxTrapIpv4ChecksumError	0	99	0x63	32018	0	0
RxTrapIpv4HeaderLengthError	0	100	0x64	32018	0	0

RxTrapIpv4TotalLengthError	0	101	0x65	32018	0	0
RxTrapIpv4Ttl0	0	102	0x66	32008	0	0
RxTrapIpv4Ttl1	0	104	0x68	32008	0	0
RxTrapIpv4DipZero	0	106	0x6a	32018	0	0
RxTrapIpv4SipIsMc	0	107	0x6b	32018	0	0
RxTrapIpv6VersionError	0	109	0x6d	32018	0	0
RxTrapIpv6HopCount0	0	110	0x6e	32011	0	0
RxTrapIpv6LoopbackAddress	0	113	0x71	32018	0	0
RxTrapIpv6MulticastSource	0	114	0x72	32018	0	0
RxTrapIpv6NextHeaderNull	0	115	0x73	32010	0	0
RxTrapIpv6Ipv4CompatibleDestination	0	121	0x79	32018	0	0
RxTrapMplsTtl1	0	125	0x7d	32012	316278	2249
RxTrapUcStrictRpfFail	0	137	0x89	32035	0	0
RxTrapMcExplicitRpfFail	0	138	0x8a	32033	0	0
RxTrapOamp (OAM_BDL_DN_NON_CCM)	0	141	0x8d	32031	0	0
RxTrapOamEthUpAccelerated (OAM_BDL_UP_NON_CCM)	0	145	0x91	32032	0	0
RxTrapReceive	0	150	0x96	32017	125266112	0
RxTrapUserDefine_FIB_IPV4_NULL0	0	151	0x97	32018	0	0
RxTrapUserDefine_FIB_IPV6_NULL0	0	152	0x98	32018	0	0
RxTrapUserDefine_FIB_IPV4_GLEAN	0	153	0x99	32016	0	0
RxTrapUserDefine_FIB_IPV6_GLEAN	0	154	0x9a	32016	0	0
RxTrapUserDefine_IPV4_OPTIONS	0	155	0x9b	32006	0	0
RxTrapUserDefine_IPV4_RSVP_OPTIONS	0	156	0x9c	32007	0	0
RxTrapUserDefine	0	157	0x9d	32026	0	0
RxTrapUserDefine_BFD	0	163	0xa3	32028	0	0
RxTrapMC	0	181	0xb5	32033	0	0
RxNetflowSnoopTrap0	0	182	0xb6	32018	0	0
RxNetflowSnoopTrap1	0	183	0xb7	32018	0	0
RxTrapMimSaMove (CFM_DOWM_MEP_DMM)	1	6	0x6	32037	0	0
RxTrapMimSaUnknown (RCY_CFM_DOWN_MEP_DMM)	1	7	0x7	32037	0	0
RxTrapAuthSaLookupFail (IPMC default)	1	8	0x8	32033	0	0
RxTrapSaMulticast	1	11	0xb	32018	0	0

```
RxTrapArpMyIp          1    13   0xd          32001   0          0
```

Associated Commands

- lpts pifib hardware police
- flow ospf
- flow bgp
- show lpts pifib hardware police

Per Port Rate Limiting of Multicast and Broadcast Punt Packets

This feature enables rate limiting of multicast and broadcast punted traffic at the interface level. Currently, a rate limit is supported per NPU level. This feature supports rate limiting at the interface level so as to protect a port from receiving the multicast and broadcast storm of punted traffic. Rate limiting for all the L3 protocol punt packets and L2 protocol packets (only ERPS, and DOT1x) is supported on physical and bundle main interfaces.

Configuring a Rate Limit to the Multicast and Broadcast Punted Traffic

You can configure the multicast and broadcast rate limit in four levels:

- Interface level
- Global level
- Domain level

Along with rate limiting the multicast and broadcast punted traffic, you can configure rate limit to these protocol punted traffic:

- ARP
- CDP
- LACP

The protocol specific configurations are explained in the below section.

Limitation

- When broadcast and multicast rate limit is configured along with ARP rate limit, the ARP packets increment broadcast and multicast counters.
- The router does not support rate limiting the multicast and broadcast punted traffic at subinterface level.

Interface Level

This example shows how to configure the rate limit of 1000 pps for the multicast and broadcast punted traffic at the TenGig interface:



Note A interface level rate limit configuration has the highest priority over a global and domain level configurations.

1. `Router# configure`
Enters the configuration mode.
2. `Router(config)# lpts punt police`
Enters punt configuration mode.
3. `Router(config-lpts-punt-policer)# interface TenGigE0/0/0/8/0`
Enters per interface level policer configuration.
4. `Router(config-lpts-punt-policer-global-if)# mcast rate 1000`
Configures a rate limit of 1000 pps for multicast punted traffic.
5. `Router(config-lpts-punt-policer-global-if)# bcast rate 1000`
Configures a rate limit of 1000 pps for broadcast punted traffic.
6. `Router(config-lpts-punt-policer-global-if)# commit`
Commit the configuration.

Global Level

This example shows how to configure the rate limit of:

- 1000 pps for the multicast and broadcast punted traffic

1. `Router# configure`
Enters the configuration mode.
2. `Router(config)# lpts punt police`
Enters punt configuration mode.
3. `Router(config-punt-policer-global)# mcast rate 1000`
Configures multicast rate limit of 1000 pps.
4. `Router(config-punt-policer-global)# bcast rate 1000`
Configures broadcast rate limit of 1000 pps.
5. `Router(config-punt-policer-global)# commit`
Commit the configuration.

Domain Level

This example shows how to configure the LPTS domain and apply a rate limit of:

- 1000 pps for the multicast and broadcast punted traffic

1. `Router# configure`

- Enters the configuration mode.
2. Router(config)# lpts punt police domain ACCESS
Enters LPTS punt domain configuration mode.
 3. Router(config-lpts-punt-policer-global-ACCESS)# mcast 5000
Configures multicast rate limit of 5000 pps.
 4. Router(config-lpts-punt-policer-global-ACCESS)# bcast 5000
Configures broadcast rate limit of 5000 pps.
 5. Router(config-lpts-punt-policer-global-ACCESS)# exit
Exits the domain ACCESS mode.
 6. Router(config-lpts-punt-policer)# exit
Exits the LPTS punt configuration mode.
 7. Router(config)# lpts pifib hardware domain ACCESS
Enters LPTS hardware domain configuration mode.
 8. Router(config-pifib-domain-ACCESS)# interface TenGigE0/0/0/8/1
Applies the domain ACCESS to the TenGigE0/0/0/8/1 interface node.
 9. Router(config-pifib-domain-ACCESS)# exit
Exits LPTS domain mode.
 10. Router(config)# lpts punt police location 0/0/CPU0
Enters LPTS punt police configuration mode.
 11. Router(config-lpts-punt-policer)# protocol arp rate 500
Configures the rate limit of 500 pps for the ARP protocol packets.
 12. Router(config-lpts-punt-policer)# protocol cdp rate 500
Configures the rate limit of 500 pps for the CDP protocol packets.
 13. Router(config-lpts-punt-policer)# exit
Exits the LPTS punt policer configuration mode.
 14. Router(config)# lpts punt police location 0/4/CPU0
Configures LPTS punt police at the node location 0/4/CPU0.
 15. Router(config)# commit
Commits the configuration



Note After committing the configuration, verify if an error message is captured in the syslog regarding the multicast and broadcast rate limit.

Protocol Punted Traffic

You can configure a rate limit to these protocol punted traffic - ARP, CDP, and LACP.

This example shows how to configure the following rate limit for protocol punted traffic at the global level:

- 500 pps for ARP and CDP protocols

1. Router(config-punt-policer-global)# protocol arp rate 500
Configures rate limit of 500 pps for protocol ARP packets.
2. Router(config-punt-policer-global)# protocol cdp rate 500
Configures rate limit of 500 pps for protocol CDP packets.
3. Router(config-punt-policer-global)# commit
Commit the configuration.

This example shows how to configure the following rate limit for protocol punted traffic at the domain level:

- 500 pps for ARP and CDP protocols

1. Router(config)# lpts pifib hardware domain ACCESS
Enters LPTS hardware domain configuration mode.
2. Router(config-pifib-domain-ACCESS)# interface TenGigE0/0/0/8/1
Applies the domain ACCESS to the TenGigE0/0/0/8/1 interface node.
3. Router(config-pifib-domain-ACCESS)# exit
Exits LPTS domain mode.
4. Router(config)# lpts punt police location 0/0/CPU0
Enters LPTS punt police configuration mode.
5. Router(config-lpts-punt-policer)# protocol arp rate 500
Configures the rate limit of 500 pps for the ARP protocol packets.
6. Router(config-lpts-punt-policer)# protocol cdp rate 500
Configures the rate limit of 500 pps for the CDP protocol packets.
7. Router(config-lpts-punt-policer)# exit
Exits the LPTS punt policer configuration mode.
8. Router(config)# lpts punt police location 0/4/CPU0
Configures LPTS punt police at the node location 0/4/CPU0.
9. Router(config)# commit
Commits the configuration

Running Config

```
lpts punt police
interface TenGigE0/0/0/8/0
```

```

    mcast rate 1000
    bcast rate 1000
  !
mcast rate 1000
bcast rate 1000
protocol arp rate 700
protocol cdp rate 700
domain ACCESS
  mcast rate 5000
  bcast rate 5000
!
!
lpts pifib hardware domain ACCESS
interface TenGigE0/0/0/8/1
!
lpts punt police location 0/0/CPU0
protocol arp rate 500
protocol cdp rate 500
!
lpts punt police location 0/4/CPU0
!

```

Verification

In the below show command output, you should look for highlighted fields that confirms the rate limit configuration at domain, interface, and subinterface level:

```

Router# show lpts punt statistics location 0/0/CPU0
Fri Nov 15 06:23:20.410 UTC

Lpts Punt Policer Statistics:
-----
Punt_Reason - Ingress Packets type to be Punt policed
Scope        - Configured scope - Global/Domain/IFH
State        - Current config state
Rate         - Policer rate in PPS
Accepted     - No of Packets Accepted
Dropped      - No of Packets Dropped
Domain       - Domain name

-----
Interface Name      : any
Punt Reason       : ARP
Domain           : ACCESS
Scope              : Default
State              : Active
Configured Rate  : 1000
Operational Rate   : 986
Accepted           : 0
Dropped            : 0
Last Update (if any):
Punt Type          : ARP
Interface Handle    : 0x00000000
Is Virtual         : 0
Is Enabled         : 1
Packet Rate        : 1000
Domain             : 1
CreateTime         : Fri Nov 15 2019 06:22:42.237.188
Platform:
  PolicerID        : 32398
  NPU: TCAM-entry  StatsID
    0:             172 0x80001d54
    1:             297 0x80001dd0

```

```

2:      172 0x80001d54
3:      172 0x80001d54
4:      172 0x80001d54
5:      172 0x80001d54

```

```

-----
Interface Name      : any
Punt Reason        : CDP
Domain             : ACCESS
Scope              : Default
State              : Active
Configured Rate    : 1000
Operational Rate   : 986
Accepted           : 0
Dropped            : 0
Last Update (if any):
Punt Type          : CDP
Interface Handle    : 0x00000000
Is Virtual         : 0
Is Enabled         : 1
Packet Rate        : 1000
Domain             : 1
CreateTime         : Fri Nov 15 2019 06:22:42.258.192
Platform:
  PolicerID        : 32404
  NPU: TCAM-entry  StatsID
0:      173 0x80001d55
1:      298 0x80001dd1
2:      173 0x80001d55
3:      173 0x80001d55
4:      173 0x80001d55
5:      173 0x80001d55

```

```

-----
Interface Name      : any
Punt Reason        : ARP
Domain             : default
Scope              : Local
State              : Active
Configured Rate    : 500
Operational Rate   : 515
Accepted           : 980
Dropped            : 0
Last Update (if any):
Punt Type          : ARP
Interface Handle    : 0x00000000
Is Virtual         : 0
Is Enabled         : 1
Packet Rate        : 500
Domain             : 0
CreateTime         : Tue Nov 12 2019 06:31:25.136.800
Platform:
  PolicerID        : 32306
  NPU: TCAM-entry  StatsID
0:      41 0x80001cd2
1:      41 0x80001cd2
2:      41 0x80001cd2
3:      41 0x80001cd2
4:      41 0x80001cd2
5:      41 0x80001cd2

```

```

-----
Interface Name      : any
Punt Reason        : CDP
Domain             : default
Scope              : Local
State              : Active

```

```

Configured Rate      : 500
Operational Rate    : 515
Accepted            : 4292
Dropped             : 0
Last Update (if any):
Punt Type          : CDP
Interface Handle    : 0x00000000
Is Virtual          : 0
Is Enabled          : 1
Packet Rate       : 500
Domain              : 0
CreateTime         : Tue Nov 12 2019 06:31:25.513.897

```

```

Platform:
  PolicerID      : 32312
  NPU: TCAM-entry  StatsID
    0:           42 0x80001cd3
    1:           42 0x80001cd3
    2:           42 0x80001cd3
    3:           42 0x80001cd3
    4:           42 0x80001cd3
    5:           42 0x80001cd3

```

```

-----
Interface Name    : TenGigE0
Punt Reason      : MCAST
Domain             : default
Scope             : Global
State             : Active
Configured Rate  : 1000
Operational Rate  : 986
Accepted          : 0
Dropped          : 0
Last Update (if any):
Punt Type        : MCAST
Interface Handle  : 0x0800001c
Is Virtual        : 1
Is Enabled        : 1
Packet Rate       : 1000
Domain           : 0
CreateTime       : Tue Nov 12 2019 06:32:43.210.014

```

```

Platform:
  PolicerID      : 32396
  NPU: TCAM-entry  StatsID
    0:           170 0x80001d52
    1:           172 0x80001d53
    2:           170 0x80001d52
    3:           170 0x80001d52
    4:           170 0x80001d52
    5:           170 0x80001d52

```

```

-----
Interface Name    : TenGigE0
Punt Reason      : BCAST
Domain             : default
Scope             : Global
State             : Active
Configured Rate  : 1000
Operational Rate  : 986
Accepted          : 0
Dropped          : 0
Last Update (if any):
Punt Type        : BCAST
Interface Handle  : 0x0800001c
Is Virtual        : 1
Is Enabled        : 1

```

```

Packet Rate      : 1000
Domain           : 0
CreateTime      : Tue Nov 12 2019 06:32:43.227.279
Platform:
  PolicerID      : 32397
  NPU: TCAM-entry  StatsID
  0:             171 0x80001d53
  1:             173 0x80001d54
  2:             171 0x80001d53
  3:             171 0x80001d53
  4:             171 0x80001d53
  5:             171 0x80001d53
-----

```

LPTS Domain Based Policers

You can configure a particular port, a group of ports, or a line card of a router with LPTS policers of a single domain. Configuration of port-based policers that belong to a particular domain enables better categorisation and control of different types of ingress traffic. For example, since iBGP traffic has a higher rate of traffic flow, the ports that handle iBGP traffic can be configured with higher policer rates compared to the ports that handle eBGP traffic.

Restrictions

- The policer rates that are configured for ports or line cards are carried forwards as policer rates of the domain after configuring the ports or line cards as part of a domain. For example, if port hundredGigE 0/0/0/1 and port hundredGigE 0/0/0/2 have policer rate of 3000 for ospf unicast known flow and if the ports are configured as part of domain CORE, then the policer rate of domain CORE for ospf unicast known flow is 3000 unless it is configured otherwise.
- You can configure only one domain per router.
- A Domain name can be any word but can have up to a maximum of 32 characters.

Configuration Example

To configure LPTS domain based policers, use the following steps:

1. Enter the LPTS hardware configuration mode and create a domain.
2. Configure the interfaces for the domain.
3. Enter the LPTS hardware configuration mode for the domain CORE, and then configure the ingress policer rates for the domain CORE at the global level.
4. Enter the LPTS hardware configuration mode for the domain CORE, and then configure the ingress policer rates for the domain CORE at the line card level.

Configuration

```

/* Enter the LPTS hardware ingress policer configuration mode and create a domain named
CORE. */
Router# config
Router(config)# lpts pifib hardware domain CORE

```

```

/* Configure the interfaces for the domain CORE. */
Router(config-lpts-domains-CORE)# interface hundredGigE 0/0/0/1
Router(config-lpts-domains-CORE)# interface hundredGigE 0/0/0/2
Router(config-lpts-domains-CORE)# commit
Router(config-lpts-domains-CORE)# exit

/* Enter the LPTS hardware configuration mode for the domain CORE, and then configure the
ingress policer rates for the domain CORE at the global level. */
Router(config)# lpts pifib hardware police domain CORE
Router(config-lpts-policer-global-CORE)# flow ospf unicast known rate 6000
Router(config-lpts-policer-global-CORE)# flow ospf unicast default rate 7000
Router(config-lpts-policer-global-CORE)# commit
Router(config-lpts-policer-global-CORE)# exit
Router(config-lpts-policer-global)# exit

/* Enter the LPTS hardware configuration mode for the domain CORE, and then configure the
ingress policer rates for the domain CORE at the line card level. */
Router(config)# lpts pifib hardware police location 0/0/CPU0 domain CORE
Router(config-lpts-policer-global-CORE)# flow ospf unicast known rate 7000
Router(config-lpts-policer-global-CORE)# flow ospf unicast default rate 8000
Router(config-lpts-policer-global-CORE)# commit

```

Running Configuration

```

lpts pifib hardware domain CORE
  interface HundredGigE0/0/0/1
  interface HundredGigE0/0/0/2
!
lpts pifib hardware police
  domain CORE
    flow ospf unicast known rate 6000
    flow ospf unicast default rate 7000
!

lpts pifib hardware police location 0/0/CPU0 domain CORE
  flow ospf unicast known rate 7000
  flow ospf unicast default rate 8000
!

```

Verification

Use the following command to verify information about the LPTS domains configured:

```

Router# show lpts pifib domains
Thu Nov 21 15:49:31.334 IST

Domains Information: 1 Configured
-----
Domain: [1] CORE
-----
interface [-----] HundredGigE0/0/0/1
interface [-----] HundredGigE0/0/0/2
                0 local of total 2 interfaces

```

Defining Dynamic LPTS Flow Type

The Dynamic LPTS flow type feature enables you to configure LPTS flow types and also enables you to define the maximum LPTS entries for each flow type in the TCAM. The dynamic LPTS flow type configuration is per line card basis, hence you can have multiple profiles configured across line cards.

When the router boots, the default LPTS flow types are programmed in the TCAM. For each flow type, the maximum flow entries are predefined. Later, at runtime, you have an option to choose the flow type based on network requirements and also configure the maximum flow entry value. The maximum flow entry value of zero denotes that a flow type is not configured.



Note You can get the default maximum flow values for both configurable flow and non-configurable flow from the output of the following show command:

```
show lpts pifib dynamic-flows statistics location <location specification>
```

The list of configurable and non-configurable flow types are listed in below tables. You can also use **show lpts pifib dynamic-flows statistics location** command to view the list of configurable and non-configurable flow types:



Note The sum of maximum LPTS entries that are configured for all flow types must not exceed 8000 entries per line card.

Configuration Example

In this example you will configure the BGP-known and ISIS-known LPTS flow type in the TCAM and define the maximum flow entries as 1800 and 500 for node location 0/1/CPU0 . As the new maximum values are more than the default values, we have to create space in the TCAM by disabling other flow types so that the sum of maximum entries for all flow types per line card does not exceed 8000 entries. Hence RSVP-known flow type is set to zero in our example:

```
Router#configure
Router(config)#lpts pifib hardware dynamic-flows location 0/1/CPU0
Router(config-pifib-flows-per-node)#flow bgp known max 1800
Router(config-pifib-flows-per-node)#flow ISIS known max 500
Router(config-pifib-flows-per-node)#flow RSVP known max 0
Router(config-pifib-flows-per-node)#commit
```

Running Configuration

```
Router#show run lpts pifib hardware dynamic-flows location 0/1/CPU0
flow bgp known max 1800
flow isis known 500
flow RSVP known 0
```

Verification

This show command displays dynamic flow statistics. You can see that the flow types BGP-known and ISIS-known are configured in the TCAM with newly configured maximum flow entry value. You can also see that the RSVP-known flow type is disabled:

```
Router#show lpts pifib dynamic-flows statistics location 0/1/CPU0

Dynamic-flows Statistics:
-----
(C - Configurable, T - TRUE, F - FALSE, * - Configured)
Def_Max  - Default Max Limit
Conf_Max - Configured Max Limit
HWCnt    - Hardware Entries Count
```

ActLimit - Actual Max Limit
 SWCnt - Software Entries Count
 P, (+) - Pending Software Entries

FLOW-TYPE	C	Def_Max	Conf_Max	HWCnt/ActLimit	SWCnt P
Fragment	F	2	--	2/2	2
OSPF-mc-known	T	600	--	2/600	2
OSPF-mc-default	F	4	--	4/4	4
OSPF-uc-known	T	300	--	1/300	1
OSPF-uc-default	F	2	--	2/2	2
ISIS-known	T	300	500	500/300	0
ISIS-default	F	1	--	1/1	1
BGP-known	T	900	1800	1800/900	0
BGP-cfg-peer	T	900	--	0/900	0
BGP-default	F	4	--	4/4	4
PIM-mcast-default	F	40	--	0/40	0
PIM-mcast-known	T	300	--	0/300	0
PIM-ucast	F	40	--	2/40	2
IGMP	T	1200	--	0/1200	0
ICMP-local	F	4	--	4/4	4
ICMP-control	F	5	--	5/5	5
ICMP-default	F	9	--	9/9	9
ICMP-app-default	F	2	--	2/2	2
LDP-TCP-known	T	300	--	0/300	0
LDP-TCP-cfg-peer	T	300	--	0/300	0
LDP-TCP-default	F	40	--	0/40	0
LDP-UDP	T	300	--	0/300	0
All-routers	T	300	--	0/300	0
RSVP-default	F	4	--	1/4	1
RSVP-known	T	300	0	0/300	0
SNMP	T	300	--	0/300	0
SSH-known	T	150	--	0/150	0
SSH-default	F	40	--	0/40	0
TELNET-known	T	150	--	0/150	0
TELNET-default	F	4	--	0/4	0
UDP-default	F	2	--	2/2	2
TCP-default	F	2	--	2/2	2
Raw-default	F	2	--	2/2	2
GRE	F	4	--	0/4	0
VRRP	T	150	--	150/150	0
DNS	T	40	--	0/40	0
NTP-default	F	4	--	0/4	0
NTP-known	T	150	--	0/150	0
TPA	T	5	--	0/5	0

Local Limit : **7960**/8000 /*The sum of maximum flow entries configured for all flow types per line card is less than 8000*/

HWCnt/SWCnt : 45/51

In the above show command output, the last column **P** specifies the pending software flow entries for the flow type.



CHAPTER 10

Implementing VRRP

- [Configuring VRRP, on page 183](#)
- [Enabling Multiple Group Optimization \(MGO\) for VRRP, on page 198](#)
- [Configuring SNMP Server Notifications for VRRP Events, on page 199](#)

Configuring VRRP

The Virtual Router Redundancy Protocol (VRRP) feature allows for transparent failover at the first-hop IP router, enabling a group of routers to form a single virtual router. For more information on VRRP and related concepts, see [Understanding VRRP, on page 183](#).

Restrictions for Configuring VRRP

- If you configure the command `hw-module vrrpscale enable` on the router, upto 255 VRRP groups (IPv4 and IPv6 combined) are supported on Cisco NCS 5500 Series Routers and Cisco NCS 540 Series routers. By default, 16 VRRP groups (IPv4 and IPv6 combined) are supported on Cisco NCS 5500 Series Routers and Cisco NCS 540 Series routers.
- The VRRP scale is reduced to 13 if all the following conditions occur:
 - If you do not configure the command `hw-module vrrpscale enable` on the router
 - If you configure BFD along with BVI
 - If all the BVIs are sharing the same Chassis (default) MAC

You cannot use any custom BVI MAC in this mode until VRRP scale is reduced to 11.

- ICMP redirects are not supported.
- Protocol Independent Multicast (PIM) is not supported with VRRP.
- If you configure the command `hw-module vrrpscale enable` on the router, VRRP is only supported on sub-interfaces with dot1q encapsulation.

Understanding VRRP

The Virtual Router Redundancy Protocol (VRRP) feature allows for transparent failover at the first-hop IP router, enabling a group of routers to form a single virtual router.



Note VRRP is supported over VRF.

VRRP Overview

A LAN client can use a dynamic process or static configuration to determine which router should be the first hop to a particular remote destination. The client examples of dynamic router discovery are as follows:

- Proxy ARP—The client uses Address Resolution Protocol (ARP) to get the destination it wants to reach, and a router responds to the ARP request with its own MAC address.
- Routing protocol—The client listens to dynamic routing protocol updates (for example, from Routing Information Protocol [RIP]) and forms its own routing table.
- IRDP (ICMP Router Discovery Protocol) client—The client runs an Internet Control Message Protocol (ICMP) router discovery client.

The drawback to dynamic discovery protocols is that they incur some configuration and processing overhead on the LAN client. Also, in the event of a router failure, the process of switching to another router can be slow.

An alternative to dynamic Cisco Discovery Protocols is to statically configure a default router on the client. This approach simplifies client configuration and processing, but creates a single point of failure. If the default gateway fails, the LAN client is limited to communicating only on the local IP network segment and is cut off from the rest of the network.

The Virtual Router Redundancy Protocol (VRRP) feature can solve the static configuration problem. VRRP is an IP routing redundancy protocol designed to allow for transparent failover at the first-hop IP router. VRRP enables a group of routers to form a single *virtual router*. The LAN clients can then be configured with the virtual router as their default gateway. The virtual router, representing a group of routers, is also known as a *VRRP group*.

When the virtual router group IP address is the same as the IP address of the physical interface of any router in the VRRP group, then such router becomes the *IP address owner* and the VRRP group operates in the *Owner* mode. When a VRRP group operates in Owner mode, the IP address owner is responsible for forwarding packets that are sent to the VRRP group.

For operating in Owner mode in case of IPv6 VRRP sessions, the link-local address that is configured for the VRRP session must be the same as the link-local address of the physical interface in a router. The link-local address can be autoconfigured by the router or can be an address that is configured by the administrator.

For example, [Figure 14: Basic VRRP Topology, on page 185](#) shows a LAN topology in which VRRP is configured. In this example, Routers A, B, and C are *VRRP routers* (routers running VRRP) that compose a virtual router. The IP address of the virtual router is the same as that configured for the interface of Router A (10.0.0.1).

Figure 14: Basic VRRP Topology

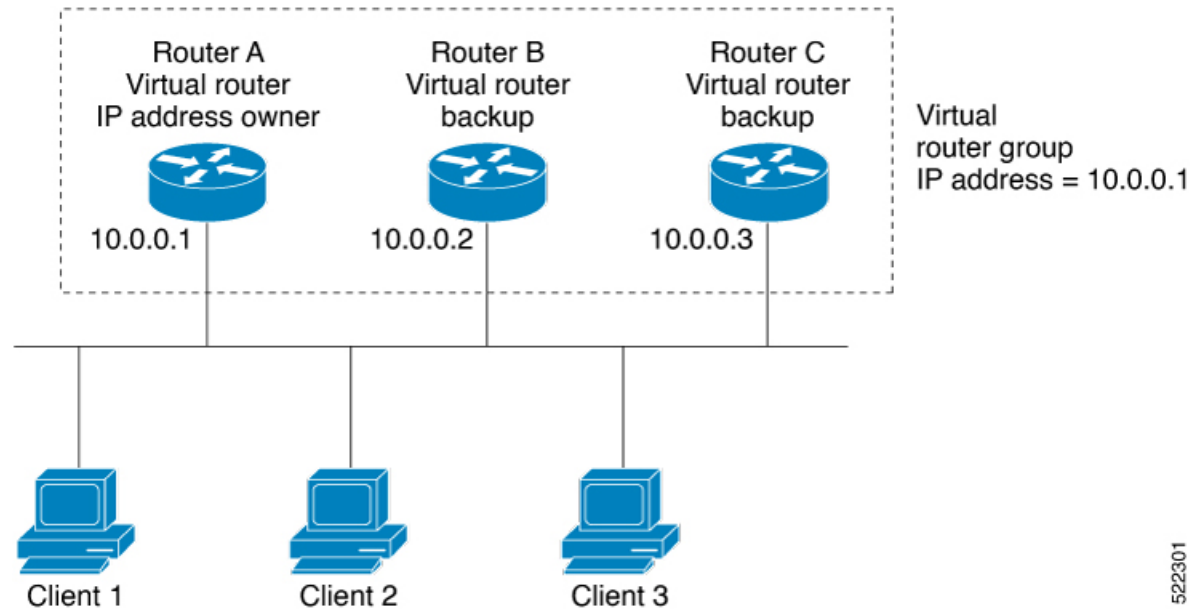

Because the virtual router uses the IP address of the physical interface of Router A, Router A assumes the role of the *IP address owner* and is responsible for forwarding packets that are sent to the VRRP group IP address. Clients 1 through 3 are configured with the default gateway IP address of 10.0.0.1.

Routers B and C function as *backup virtual routers*. If the router that is IP address owner fails, the router that is configured with the higher priority becomes the IP address owner and provides uninterrupted service for the LAN hosts. When Router A recovers, it becomes the IP address owner again.



Note We recommend that you disable Spanning Tree Protocol (STP) on switch ports to which the virtual routers are connected. Enable RSTP or rapid-PVST on the switch interfaces if the switch supports these protocols.

Multiple Virtual Router Support

You can configure up to 100 virtual routers on a router interface. You can configure up to 256 virtual routers on a router interface. The actual number of virtual routers that a router interface can support depends on the following factors:

- Router processing capability
- Router memory capability
- Router interface support of multiple MAC addresses

In a topology where multiple virtual routers are configured on a router interface, the interface can act as an IP address owner for one or more virtual routers and as a backup for one or more virtual routers.

VRRP Router Priority

An important aspect of the VRRP redundancy scheme is VRRP router priority. Priority determines the role that each VRRP router plays and what happens if the IP address owner virtual router fails.

If a VRRP router owns the IP address of the virtual router and the IP address of the physical interface, this router functions as a IP address owner virtual router.

If no VRRP router owns the IP address, the priority of a VRRP router, combined with the preempt settings, determines if a VRRP router functions as an IP address owner router or a backup virtual router. By default, the highest priority VRRP router functions as IP address owner router, and all the others function as backups. Priority also determines the order of ascendancy to becoming an IP address owner virtual router if the IP address owner virtual router fails. You can configure the priority of each backup virtual router with a value of 1 through 254, using the `vrrp priority` command.

For example, if Router A, the IP address owner virtual router in a LAN topology, fails, an election process takes place to determine if backup virtual Routers B or C should take over. If Routers B and C are configured with the priorities of 101 and 100, respectively, Router B is elected to become IP address owner virtual router because it has the higher priority. If Routers B and C are both configured with the priority of 100, the backup virtual router with the higher IP address is elected to become the IP address owner virtual router.

By default, a preemptive scheme is enabled whereby a higher-priority backup virtual router that becomes available takes over from the current IP address owner virtual router. You can disable this preemptive scheme using the `vrrp preempt disable` command. If preemption is disabled, the backup virtual router that is elected to become IP address owner router upon the failure of the original higher priority IP address owner router, remains the IP address owner router even if the original IP address owner virtual router recovers and becomes available again.

VRRP Advertisements

The IP address owner virtual router sends VRRP advertisements to other VRRP routers in the same group. The advertisements communicate the priority and state of the IP address owner virtual router. The VRRP advertisements are encapsulated in IP packets and sent to the IP Version 4 multicast address assigned to the VRRP group. The advertisements are sent every second by default; the interval is configurable.

Benefits of VRRP

The benefits of VRRP are as follows:

- **Redundancy**— VRRP enables you to configure multiple routers as the default gateway router, which reduces the possibility of a single point of failure in a network.
- **Load Sharing**—You can configure VRRP in such a way that traffic to and from LAN clients can be shared by multiple routers, thereby sharing the traffic load more equitably among available routers.
- **Multiple Virtual Routers**—VRRP supports up to 100 virtual routers (VRRP groups) on a router interface, subject to the platform supporting multiple MAC addresses. You can configure up to 256 virtual routers on a router interface. Multiple virtual router support enables you to implement redundancy and load sharing in your LAN topology.
- **Multiple IP Addresses**—The virtual router can manage multiple IP addresses, including secondary IP addresses. Therefore, if you have multiple subnets configured on an Ethernet interface, you can configure VRRP on each subnet.

- **Preemption**—The redundancy scheme of VRRP enables you to preempt a backup virtual router that has taken over for a failing IP address owner virtual router with a higher-priority backup virtual router that has become available.
- **Text Authentication**—You can ensure that VRRP messages received from VRRP routers that comprise a virtual router are authenticated by configuring a simple text password.
- **Advertisement Protocol**—VRRP uses a dedicated Internet Assigned Numbers Authority (IANA) standard multicast address (224.0.0.18) for VRRP advertisements. This addressing scheme minimizes the number of routers that must service the multicasts and allows test equipment to accurately identify VRRP packets on a segment. The IANA assigns VRRP the IP protocol number 112.

Hot Restartability for VRRP

In the event of failure of a VRRP process in one group, forced failovers in peer VRRP IP address owner router groups should be prevented. Hot restartability supports warm RP failover without incurring forced failovers to peer VRRP routers.

Understanding VRRP over BVI

The Virtual Router Redundancy Protocol (VRRP) protocol provides default gateway redundancy. It allows a group of routers to behave as a single virtual default gateway router in which one router acts as the IP address owner router and others routers act as Backup routers.

BVI (Bridge-Group Virtual Interface) is a virtual interface which provides L3 or routed functionality to a Bridge Group. L2 functionality is applicable to the interfaces which are part of a Bridge Group and BVI is the routed interface for that Bridge Group.

Usually, VRRP sessions run on top of interfaces of the multiple routers which are in the same home network. However, you can configure VRRP session over BVI. Thereby, instead of physical interfaces, VRRP sessions can run between BVI interfaces of multiple routers.

Configuring VRRP for IPv4 Networks

This section describes the procedure for configuring and verifying VRRP for IPv4 networks.

Configuration

Use the following configuration for configuring VRRP for IPv4 networks.



Note Certain customizations (as mentioned) are recommended to control the behavior of the VRRP group on committing the VRRP configuration on the Router. If the following customizations are not configured, then the Router seizes control of the VRRP group, and immediately assumes the role of the IP address owner virtual Router.

```

/* Enter the interface configuration mode and configure an IPv4 address for the interface.
*/
Router(config)# interface gigabitEthernet 0/0/0/1
Router(config-if)# ipv4 address 10.10.10.1 255.255.255.0
Router(config-if)# no shut
Router(config-if)# commit

```

```

Fri Dec 8 13:49:24.142 IST
Router:Dec 8 13:49:24.285 : ifmgr[402]: %PKT_INFRA-LINK-3-UPDOWN : Interface
GigabitEthernet0/0/0/1, changed state to Down
Router:Dec 8 13:49:24.711 : ifmgr[402]: %PKT_INFRA-LINK-3-UPDOWN : Interface
GigabitEthernet0/0/0/1, changed state to Up

Router(config-if)# exit
Router(config)# do show ip int brief
Fri Dec 8 13:50:05.505 IST

Interface                               IP-Address      Status          Protocol        Vrf-Name
GigabitEthernet0/0/0/0                  unassigned     Shutdown        Down            default

GigabitEthernet0/0/0/1                 10.10.10.1    Up             Up             default
GigabitEthernet0/0/0/2                  unassigned     Shutdown        Down            default

GigabitEthernet0/0/0/3                  unassigned     Shutdown        Down            default

GigabitEthernet0/0/0/4                  unassigned     Shutdown        Down            default

/* Enter the VRRP configuration mode and add the configured interface. */
Router(config)# router vrrp
Router(config-vrrp)# interface GigabitEthernet 0/0/0/1

/* CUSTOMIZATION: Configure a delay for the startup of the state machine when the interface
comes up. */
Router(config-vrrp)# delay minimum 2 reload 10 */

/* Configure VRRP version 3 for IPv4 */
Router(config-vrrp-if)# address-family ipv4 vrrp 100 version 3
Router(config-vrrp-virtual-router)# address 10.10.10.1

/* CUSTOMIZATION: Disable the installation of routes for the VRRP virtual addresses. */
Router(config-vrrp-virtual-Router)# accept-mode disable

/* CUSTOMIZATION: Set a priority for the virtual Router. */
Router(config-vrrp-virtual-Router)# priority 254

/* CUSTOMIZATION: Configure a preempt delay value that controls the selection of the IP
address owner virtual Router. */
Router(config-vrrp-virtual-Router)# preempt delay 15

/* CUSTOMIZATION: Configure the interval between successive advertisements by the IP address
owner virtual Router. */
Router(config-vrrp-virtual-Router)#timer 4

/* CUSTOMIZATION: Configure VRRP to track an interface. */
Router(config-vrrp-virtual-Router)# track interface GigabitEthernet0/0/0/1 30

/* Commit the configuration */
Router(config-vrrp-virtual-Router)# commit

```

You have successfully configured VRRP for IPv4 networks.

Validation

Use the following commands to validate the configuration.

```

/* Validate the configuration */
Router(config-vrrp-virtual-router)# do show run interface GigabitEthernet 0/0/0/1

```



```
Fri Dec 8 15:04:38.140 IST
interface GigabitEthernet0/0/0/1
  ipv4 address 10.10.10.1 255.255.255.0
!
```

```
Router(config)# show running-config router vrrp
Fri Dec 8 13:50:18.959 IST
router vrrp
  interface GigabitEthernet0/0/0/1
    delay minimum 2 reload 10
    address-family ipv4
      vrrp 100 version 3
        priority 254
        preempt delay 15
        timer 4
        track interface GigabitEthernet0/0/0/2 30
        address 10.10.10.1
        accept-mode disable
    !
  !
!
```

```
Router(config-vrrp-virtual-router)# do show vrrp ipv4 interface gigabitEthernet 0/0/0/1
Fri Dec 8 15:02:56.952 IST
IPv4 Virtual Routers:
          A indicates IP address owner
          | P indicates configured to preempt
          | |
Interface  vrID Prio A P State   Master addr   VRouter addr
Gi0/0/0/1   100 255 A P Master   local         10.10.10.1
```

```
Router(config-vrrp-virtual-router)# end
Router# show vrrp detail
Fri Dec 8 15:08:36.469 IST
GigabitEthernet0/0/0/1 - IPv4 vrID 100
  State is Master, IP address owner
    1 state changes, last state change 01:19:06
  State change history:
    Dec 8 13:49:30.147 IST Init      -> Master   Delay timer expired
  Last resign sent:      Never
  Last resign received:  Never
  Virtual IP address is 10.10.10.1
  Virtual MAC address is 0000.5E00.0164, state is active
  Master router is local
  Version is 3
  Advertise time 1 secs
    Master Down Timer 3.003 (3 x 1 + (1 x 1/256))
  Minimum delay 1 sec, reload delay 5 sec
  Current priority 255
    Configured priority 100, may preempt
    minimum delay 0 secs
```

You have successfully validated VRRP for IPv4 networks.

Configuring VRRP for IPv6 Networks

This section describes the procedure for configuring and verifying VRRP for IPv6 networks.

Configuration

The following sample includes the configuration and customization of VRRP for IPv6 networks.



Note Certain customizations (as mentioned) are recommended to control the behavior of the VRRP group on committing the VRRP configuration on the Router. If the following customizations are not configured, then the Router seizes control of the VRRP group, and immediately assumes the role of the IP address owner virtual Router.

```

/* Enter the interface configuration mode and configure an IPv6 address */
Router# interface GigabitEthernet 0/0/0/2
Router(config-if)# ipv6 address 10::1/64
Router(config-if)# no shut

/* Exit the interface configuration mode and enter the vrrp configuration mode */
Router(config-if)# exit
Router(config)# Router vrrp

/* Add the configured interface for VRRP */
Router(config-vrrp)# interface GigabitEthernet 0/0/0/2

/* CUSTOMIZATION: Configure a delay for the startup of the state machine when the interface
comes up. */
Router(config-vrrp)# delay minimum 2 reload 10 */

/* Enable the IPv6 global and link local address family on the interface */
Router(config-vrrp-if)# address-family ipv6 vrrp 50
Router(config-vrrp-virtual-Router)# address linklocal autoconfig

/* CUSTOMIZATION: Disable the installation of routes for the VRRP virtual addresses. */
Router(config-vrrp-virtual-Router)# accept-mode disable

/* CUSTOMIZATION: Set a priority for the virtual Router. */
Router(config-vrrp-virtual-Router)# priority 254

/* CUSTOMIZATION: Configure a preempt delay value that controls the selection of the IP
address owner virtual Router. */
Router(config-vrrp-virtual-Router)# preempt delay 15

/* CUSTOMIZATION: Configure the interval between successive advertisements by the IP address
owner virtual Router. */
Router(config-vrrp-virtual-Router)#timer 4

/* CUSTOMIZATION: Configure VRRP to track an interface. */
Router(config-vrrp-virtual-Router)# track interface GigabitEthernet0/0/0/2 30

/* Commit the configuration */
Router(config-vrrp-virtual-Router)# commit

```

You have successfully configured VRRP for IPv6 networks.

Validation

Use the following commands to validate the configuration.

```

/* Validate the configuration */
Router(config-vrrp-virtual-router)# do show run interface GigabitEthernet 0/0/0/2
Fri Dec 8 14:55:48.378 IST

```

```

interface GigabitEthernet0/0/0/2
  ipv6 address 10::1/64
  !
-----
Router(config-vrrp-virtual-router)# do show running-config router vrrp
...
router vrrp
interface GigabitEthernet0/0/0/2
  delay minimum 2 reload 10
  address-family ipv6
  vrrp 50
  priority 254
  preempt delay 15
  timer 4
  track interface GigabitEthernet0/0/0/2 30
  address linklocal autoconfig
  accept-mode disable
  !
!
!
!
-----
Router(config-vrrp-virtual-router)# do show vrrp ipv6 interface gigabitEthernet 0/0/0/2
Fri Dec 8 14:59:25.547 IST
IPv6 Virtual Routers:
                A indicates IP address owner
                | P indicates configured to preempt
                | |
Interface   vrID Prio A P State   Master addr   VRouter addr
Gi0/0/0/2      50 254 P Master   local         fe80::200:5eff:fe00:203
-----
Router(config-vrrp-virtual-router)# end
Router# show vrrp detail
Fri Dec 8 15:08:36.469 IST
GigabitEthernet0/0/0/2 - IPv6 vrID 50
  State is Master
    2 state changes, last state change 00:18:01
  State change history:
    Dec 8 14:50:23.326 IST  Init      -> Backup  Virtual IP configured
    Dec 8 14:50:35.365 IST  Backup   -> Master  Master down timer expired
  Last resign sent:      Never
  Last resign received:  Never
Virtual IP address is fe80::200:5eff:fe00:203
Virtual MAC address is 0000.5E00.0203, state is active
Master router is local

  Advertise time 4 secs
    Master Down Timer 12.031 (3 x 4 + (2 x 4/256))
  Minimum delay 2 sec, reload delay 10 sec
  Current priority 254
    Configured priority 254, may preempt
    minimum delay 15 secs
  Tracked items: 1/1 up: 0 decrement
    Object name          State      Decrement
    GigabitEthernet0/0/0/2  Up        30

```

You have successfully validated VRRP for IPv6 networks.

Configure VRRP over BVI

To configure VRRP sessions over BVI, you must complete the following configurations:

1. Configure a set of interfaces as L2 interfaces and a set of VLAN sub-interfaces.
2. Configure a bridge group.
3. Configure a BVI.
4. Configure VRRP over BVI.

Configuration Example

```

/* Enter the global configuration mode and Configure a set of interfaces as L2 interfaces
and a set of VLAN sub-interfaces */
Router# configure
Router(config)# interface HundredGigE0/0/1/0.1 l2transport
Router(config-subif)# encapsulation dot1q 1
Router(config-subif)# rewrite ingress tag pop 1 symmetric
Router(config-subif)# commit
Router(config-subif)# exit
Router(config)# interface HundredGigE0/0/1/1.1 l2transport
Router(config-subif)# encapsulation dot1q 1
Router(config-subif)# rewrite ingress tag pop 1 symmetric
Router(config-subif)# commit
Router(config-subif)# exit

/* Enter the Layer 2 VPN configuration mode and Configure a bridge group */
Router(config)# l2vpn
Router(config-l2vpn)# bridge group 5
Router(config-l2vpn-bg)# bridge-domain 5
Router(config-l2vpn-bg-bd)# interface HundredGigE 0/0/0/0.1
Router(config-l2vpn-bg-bd-ac)# exit
Router(config-l2vpn-bg-bd)# interface HundredGigE 0/0/0/1.1
Router(config-l2vpn-bg-bd-ac)# exit
Router(config-l2vpn-bg-bd)# routed interface BVI 10
Router(config-l2vpn-bg-bd-bvi)# commit
Router(config-l2vpn-bg-bd-bvi)# exit

/* Configure a BVI in the global configuration mode*/
Router(config-l2vpn-bg-bd)# interface BVI 10

Router(config-if)# ipv4 address 209.165.200.225 255.255.255.0
Router(config-if)# ipv6 address 2001:DB8:A:B::1/64
Router(config-if)# commit

/* Configure VRRP over BVI in the global configuration mode for IPv4 address*/
Router(config)# router VRRP
Router(config-vrrp)# interface BVI 10
Router(config-vrrp-if)# address-family ipv4
Router(config-vrrp-address-family)# VRRP 10
Router(config-vrrp-virtual-router)# priority 101
Router(config-vrrp-virtual-router)# address 209.165.200.226
Router(config-vrrp-virtual-router)# commit

/* Configure VRRP over BVI in the global configuration mode for IPv6 address*/
Router(config)# router VRRP
Router(config-vrrp)# interface BVI 10

```

```

Router(config-vrrp-if)# address-family ipv6
Router(config-vrrp-address-family)# VRRP 11
Router(config-vrrp-virtual-router)# address global 2001:DB8:A:B::2
Router(config-vrrp-virtual-router)# address linklocal autoconfig
Router(config-vrrp-virtual-router)# commit

```

Verification

Use the following command to verify the bridge domain details:

```
Router# show l2vpn bridge-domain detail
```

```

Legend: pp = Partially Programmed.
Bridge group: 5, bridge-domain: 5, id: 1, state: up, ShgId: 0, MSTi: 0
Coupled state: disabled
VINE state: BVI Resolved
MAC learning: enabled
MAC withdraw: enabled
MAC withdraw for Access PW: enabled
MAC withdraw sent on: bridge port up
MAC withdraw relaying (access to access): disabled
Flooding:
Broadcast & Multicast: enabled
Unknown unicast: enabled
MAC aging time: 300 s, Type: inactivity
MAC limit: 32768, Action: none, Notification: syslog
MAC limit reached: no, threshold: 75%
MAC port down flush: enabled
MAC Secure: disabled, Logging: disabled
Split Horizon Group: none
Dynamic ARP Inspection: disabled, Logging: disabled
IP Source Guard: disabled, Logging: disabled
DHCPv4 Snooping: disabled
DHCPv4 Snooping profile: none
IGMP Snooping: disabled
IGMP Snooping profile: none
MLD Snooping profile: none
Storm Control: disabled
Bridge MTU: 1500
MIB cvplsConfigIndex: 2
Filter MAC addresses:
P2MP PW: disabled
Multicast Source: Not Set
Create time: 26/05/2020 17:08:54 (00:11:30 ago)
No status change since creation
ACs: 3 (3 up), VFIs: 0, PWs: 0 (0 up), PBBs: 0 (0 up), VNIs: 0 (0 up)
List of ACs:
AC: BVI10, state is up
Type Routed-Interface
MTU 1514; XC ID 0x80000001; interworking none
BVI MAC address:
c472.95a6.8b90
Virtual MAC addresses:
0000.5e00.010a
0000.5e00.020b
Split Horizon Group: Access
AC: HundredGigE0/0/1/0.1, state is up
Type VLAN; Num Ranges: 1
Rewrite Tags: []
VLAN ranges: [1, 1]
MTU 1500; XC ID 0x1; interworking none
MAC learning: enabled
Flooding:

```

```

Broadcast & Multicast: enabled
Unknown unicast: enabled
MAC aging time: 300 s, Type: inactivity
MAC limit: 32768, Action: none, Notification: syslog
MAC limit reached: no, threshold: 75%
MAC port down flush: enabled
MAC Secure: disabled, Logging: disabled
Split Horizon Group: none
E-Tree: Root
Dynamic ARP Inspection: disabled, Logging: disabled
IP Source Guard: disabled, Logging: disabled
DHCPv4 Snooping: disabled
DHCPv4 Snooping profile: none
IGMP Snooping: disabled
IGMP Snooping profile: none
MLD Snooping profile: none
Storm Control: bridge-domain policer
Static MAC addresses:
Statistics:
packets: received 0 (multicast 0, broadcast 0, unknown unicast 0, unicast 0), sent 1435
bytes: received 0 (multicast 0, broadcast 0, unknown unicast 0, unicast 0), sent 114828
MAC move: 0
Storm control drop counters:
packets: broadcast 0, multicast 0, unknown unicast 0
bytes: broadcast 0, multicast 0, unknown unicast 0
Dynamic ARP inspection drop counters:
packets: 0, bytes: 0
IP source guard drop counters:
packets: 0, bytes: 0
AC: HundredGigE0/0/1/1.1, state is up
Type VLAN; Num Ranges: 1
Rewrite Tags: []
VLAN ranges: [1, 1]
MTU 1500; XC ID 0x2; interworking none
MAC learning: enabled
Flooding:
Broadcast & Multicast: enabled
Unknown unicast: enabled
MAC aging time: 300 s, Type: inactivity
MAC limit: 32768, Action: none, Notification: syslog
MAC limit reached: no, threshold: 75%
MAC port down flush: enabled
MAC Secure: disabled, Logging: disabled
Split Horizon Group: none
E-Tree: Root
Dynamic ARP Inspection: disabled, Logging: disabled
IP Source Guard: disabled, Logging: disabled
DHCPv4 Snooping: disabled
DHCPv4 Snooping profile: none
IGMP Snooping: disabled
IGMP Snooping profile: none
MLD Snooping profile: none
Storm Control: bridge-domain policer
Static MAC addresses:
Statistics:
packets: received 0 (multicast 0, broadcast 0, unknown unicast 0, unicast 0), sent 1435
bytes: received 0 (multicast 0, broadcast 0, unknown unicast 0, unicast 0), sent 114828
MAC move: 0
Storm control drop counters:
packets: broadcast 0, multicast 0, unknown unicast 0
bytes: broadcast 0, multicast 0, unknown unicast 0
Dynamic ARP inspection drop counters:
packets: 0, bytes: 0
IP source guard drop counters:

```

```

packets: 0, bytes: 0
List of Access PWs:
List of VFIs:
List of Access VFIs:

```

Use the following command to show the VRRP details:

```
Router# show vrrp ipv4 detail
```

```

BVI10 - IPv4 vrID 10
State is Master
2 state changes, last state change 00:11:57
State change history:
May 26 17:08:59.470 UTC Init -> Backup Delay timer expired
May 26 17:09:03.075 UTC Backup -> Master Master down timer expired
Last resign sent: Never
Last resign received: Never
Virtual IP address is 209.165.200.226
Virtual MAC address is 0000.5E00.010a, state is active
Master router is local
Version is 2
Advertise time 1 secs
Master Down Timer 3.605 (3 x 1 + (155 x 1/256))
Minimum delay 1 sec, reload delay 5 sec
Current priority 101
Configured priority 101, may preempt
minimum delay 0 secs

```

```
Router# show vrrp ipv6 detail
```

```

BVI10 - IPv6 vrID 11
State is Master
2 state changes, last state change 00:04:29
State change history:
May 26 17:16:43.476 UTC Init -> Backup Virtual IP configured
May 26 17:16:47.085 UTC Backup -> Master Master down timer expired
Last resign sent: Never
Last resign received: Never
Virtual IP address is fe80::200:5eff:fe00:20b
Secondary Virtual IP address is 2001:db8:a:b::2
Virtual MAC address is 0000.5E00.020b, state is active
Master router is local
Version is 3
Advertise time 1 secs
Master Down Timer 3.609 (3 x 1 + (156 x 1/256))
Minimum delay 1 sec, reload delay 5 sec
Current priority 100
Configured priority 100, may preempt
minimum delay 0 secs

```

```
Router# show vrrp interface BVI10 detail
```

```

BVI10 - IPv4 vrID 10
State is Master
2 state changes, last state change 00:12:35
State change history:
May 26 17:08:59.470 UTC Init -> Backup Delay timer expired
May 26 17:09:03.075 UTC Backup -> Master Master down timer expired
Last resign sent: Never
Last resign received: Never
Virtual IP address is 209.165.200.226
Virtual MAC address is 0000.5E00.010a, state is active
Master router is local
Version is 2
Advertise time 1 secs

```

```

Master Down Timer 3.605 (3 x 1 + (155 x 1/256))
Minimum delay 1 sec, reload delay 5 sec
Current priority 101
Configured priority 101, may preempt
minimum delay 0 secs

BVI10 - IPv6 vrID 11
State is Master
2 state changes, last state change 00:04:51
State change history:
May 26 17:16:43.476 UTC Init -> Backup Virtual IP configured
May 26 17:16:47.085 UTC Backup -> Master Master down timer expired
Last resign sent: Never
Last resign received: Never
Virtual IP address is fe80::200:5eff:fe00:20b
Secondary Virtual IP address is 2001:db8:a:b::2
Virtual MAC address is 0000.5E00.020b, state is active
Master router is local
Version is 3
Advertise time 1 secs
Master Down Timer 3.609 (3 x 1 + (156 x 1/256))
Minimum delay 1 sec, reload delay 5 sec
Current priority 100
Configured priority 100, may preempt
minimum delay 0 secs

```

BFD for VRRP

Bidirectional Forwarding Detection (BFD) is a network protocol used to detect faults between two forwarding engines. BFD sessions operate in asynchronous mode. In asynchronous mode, both endpoints periodically send hello packets to each other. If a number of those packets are not received, the session is considered down.

Advantages of BFD

- BFD provides failure detection in less than one second.
- BFD supports all types of encapsulation.
- BFD is not tied to any particular routing protocol, supports almost all routing protocols.

BFD Process

VRRP uses BFD to detect a link failure and facilitate fast failover times without excessive control packet overhead.

The VRRP process creates BFD sessions as required. When a BFD session goes down, each backup group monitoring the session transitions to the active state.

After a transition to active state triggered by a BFD session going down, VRRP does not participate in any state elections for 10 seconds.



Note IPv4 only supports BFD for VRRP.

Configuring BFD

Enabling BFD

```
Router# configure
Router(config)# router vrrp
Router(config-vrrp)# interface <type> <interface-path-id>
Router(config-vrrp-if)# address-family ipv4
Router(config-vrrp-if-ipv4)# vrrp[group number] version <version-no> bfd
fast-detect [peer ipv4 <ipv4-address> <interface-type> <interface-path-id>]
commit
```

Verifying BFD on VRRP

```
router vrrp
interface TenGigE0/0/0/3.1
bfd minimum-interval 4
bfd multiplier 3
address-family ipv4
vrrp 1
priority 200
address 41.41.1.3
bfd fast-detect peer ipv4 41.41.1.2
```

Modifying BFD timers (minimum interval)

Minimum interval determines the frequency of sending BFD packets to BFD peers (in milliseconds). The default minimum interval is 15ms.

```
Router# configure
Router(config)# router vrrp
Router(config-vrrp)# interface <type> <interface-path-id>
Router(config-vrrp-if)# bfd minimum-interval <interval>
Router(config-vrrp-if)# bfd multiplier <multiplier>
router(config-vrrp-if)# address-family ipv4
commit
```

Modifying BFD timers (multiplier)

Multiplier is the number of consecutive BFD packets which must be missed from a BFD peer before declaring that peer unavailable. The default multiplier is 3.

```
Router# configure
```

```

Router(config)# router vrrp

Router(config-vrrp)# interface <type> <interface-path-id>

Router(config-vrrp-if)# bfd multiplier <multiplier>

router(config-vrrp-if)# address-family ipv4

commit

```

Disabling State Change Logging

Configuration Example

Disables the task of logging the VRRP state change events via syslog.

```

Router#configure
Router(config)#router vrrp
router(config-vrrp)#message state disable
router(config-vrrp)#commit

```

Enabling Multiple Group Optimization (MGO) for VRRP

Configuration Examples

Multiple Group Optimization for Virtual Router Redundancy Protocol (VRRP) provides a solution for reducing control traffic in a deployment consisting of many subinterfaces. By running the VRRP control traffic for just one session, the control traffic is reduced for the subinterfaces with identical redundancy requirements. All other sessions are subordinates of this primary session, and inherit their states from it.

Configuring VRRP Session Name

```

Router#configure
Router(config)#router vrrp
router(config-vrrp)#interface TenGigE 0/0/0/2
router(config-vrrp-if)#address-family ipv4
router(config-vrrp-address-family)#vrrp 1
/* Enables VRRP group configuration mode on a specific interface. */

router(config-vrrp-vritual-router)#name m1
/* Specifies the VRRP session name. */

router(config-vrrp-gp)#commit

```

Configuring the Subordinate Group to Inherit its State from a Specified Group

```

Router#configure
Router(config)#router vrrp
router(config-vrrp)#interface TenGigE 0/0/0/2
router(config-vrrp-if)#address-family ipv4

router(config-vrrp-address-family)#vrrp 2 slave
/* Enables VRRP slave configuration mode on a specific interface. */

router(config-vrrp-slave)#follow m1
/* Instructs the subordinate group to inherit its state from the specified group, m1 (MGO session name). */

```

```

router(config-vrrp-slave)#address 10.2.3.2
/* Specifies the primary virtual IPv4 address for subordinate group. */

router(config-vrrp-slave)#address 10.2.3.3 secondary
/* Specifies the secondary virtual IPv4 address for subordinate group. */

router(config-vrrp-gp)#commit

```

Primary and Secondary Virtual IPv4 Addresses for the Subordinate Group

```

Router#configure
Router(config)#router vrrp
router(config-vrrp)#interface TenGigE 0/0/0/2
router(config-vrrp-if)#address-family ipv4

router(config-vrrp-address-family)#vrrp 2 slave
/* Enables VRRP slave configuration mode on a specific interface. */

router(config-vrrp-slave)#address 10.2.3.2
/* Specifies the primary virtual IPv4 address for subordinate group. */

router(config-vrrp-slave)#address 10.2.3.3 secondary
/* Specifies the secondary virtual IPv4 address for subordinate group. */

router(config-vrrp-slave)#commit

```

Running Configuration

```

Router#show running-config router vrrp 1
router vrrp
interface TenGigE 0/0/0/2
address-family ipv4
vrrp 1
name m1
!

/* Subordinate group */
Router#show running-config router vrrp 2
router vrrp
interface TenGigE 0/0/0/2
address-family ipv4
vrrp 2 slave
follow m1
address 10.2.3.2
address 10.2.3.3 secondary
!

```

Configuring SNMP Server Notifications for VRRP Events

MIB support for VRRP

VRRP enables one or more IP addresses to be assumed by a router when a failure occurs. For example, when IP traffic from a host reaches a failed router because the failed router is the default gateway, the traffic is transparently forwarded by the VRRP router that has assumed control. VRRP does not require configuration of dynamic routing or router discovery protocols on every end host. The VRRP router controlling the IP address(es) associated with a virtual router is called the IP address owner router, and forwards packets sent to these IP addresses. The election process provides dynamic fail over (standby) in the forwarding responsibility

should the IP address owner router become unavailable. This allows any of the virtual router IP addresses on the LAN to be used as the default first hop router by end-hosts.

The advantage gained from using VRRP is a higher availability default path without requiring configuration of dynamic routing or router discovery protocols on every end-host. Simple Network Management Protocol (SNMP) traps provide information of the state changes, when the virtual routers (in standby) are moved to IP address owner router's state or if the standby router is made IP address owner router.

Configuration Example

Enables SNMP server notifications (traps) for VRRP.

```
Router#configure  
Router(config)#snmp-server traps vrrp events  
router(config)#commit
```

Use the **show snmp traps details** command to view details of SNMP server notifications.



CHAPTER 11

Configuring Transports

- [Information About Configuring NSR, TCP, UDP Transports, on page 201](#)

Information About Configuring NSR, TCP, UDP Transports

To configure NSR, TCP, UDP, and RAW transports, you must understand the following concepts:

NSR Overview

Nonstop Routing (NSR) is provided for Open Shortest Path First (OSPF), Border Gateway Protocol (BGP), and Label Distribution Protocol (LDP) protocols for the following events:

- Route Processor (RP) failover
- Process restart for either OSPF, LDP, or TCP
- Online insertion removal (OIR)

In the case of the RP failover, NSR is achieved by for both TCP and the applications (OSPF, BGP, or LDP).

NSR is a method to achieve High Availability (HA) of the routing protocols. TCP connections and the routing protocol sessions are migrated from the active RP to standby RP after the RP failover without letting the peers know about the failover. Currently, the sessions terminate and the protocols running on the standby RP reestablish the sessions after the standby RP goes active. Graceful Restart (GR) extensions are used in place of NSR to prevent traffic loss during an RP failover but GR has several drawbacks.

You can use the **nsr process-failures switchover** command to let the RP failover be used as a recovery action when the active TCP or active LDP restarts. When standby TCP or LDP restarts, only the NSR capability is lost till the standby instances come up and the sessions are resynchronized but the sessions do not go down. In the case of the process failure of an active OSPF, a fault-management policy is used. For more information, refer to *Implementing OSPF on Routing Configuration Guide for Cisco NCS 5500 Series Routers* .

TCP Overview

TCP is a connection-oriented protocol that specifies the format of data and acknowledgments that two computer systems exchange to transfer data. TCP also specifies the procedures the computers use to ensure that the data arrives correctly. TCP allows multiple applications on a system to communicate concurrently, because it handles all demultiplexing of the incoming traffic among the application programs.

UDP Overview

The User Datagram Protocol (UDP) is a connectionless transport-layer protocol that belongs to the IP family. UDP is the transport protocol for several well-known application-layer protocols, including Network File System (NFS), Simple Network Management Protocol (SNMP), Domain Name System (DNS), and TFTP.

Any IP protocol other than TCP and UDP is known as a RAW protocol.

For most sites, the default settings for the TCP, UDP, and RAW transports need not be changed.

Configuring Failover as a Recovery Action for NSR

When the active TCP or the NSR client of the active TCP terminates or restarts, the TCP sessions go down. To continue to provide NSR, failover is configured as a recovery action. If failover is configured, a switchover is initiated if the active TCP or an active application (for example, LDP, OSPF, and so forth) restarts or terminates.

For information on how to configure MPLS Label Distribution Protocol (LDP) for NSR, refer to the MPLS Configuration Guide for Cisco NCS 5500 Series Routers .

For information on how to configure NSR on a per-process level for each process, refer to the Routing Configuration Guide for Cisco NCS 5500 Series Routers .

Configuration Example

Configure failover as a recovery action for active instances to switch over to a standby to maintain nonstop routing.

```
Router#configure
Router(config)#nsr process-failures switchover
Router(config)#commit
```

Running Configuration

```
Router#show running-configuration nsr process-failures switchover
nsr process-failures switchover
```

Associated Commands

- nsr process-failures switchover