



Interface and Hardware Component Configuration Guide for Cisco NCS 560 Series Routers, IOS XR Release 24.1.x, 24.2.x, 24.3.x

First Published: 2024-03-14

Last Modified: 2024-09-02

Americas Headquarters

Cisco Systems, Inc.
170 West Tasman Drive
San Jose, CA 95134-1706
USA
<http://www.cisco.com>
Tel: 408 526-4000
800 553-NETS (6387)
Fax: 408 527-0883

THE SPECIFICATIONS AND INFORMATION REGARDING THE PRODUCTS IN THIS MANUAL ARE SUBJECT TO CHANGE WITHOUT NOTICE. ALL STATEMENTS, INFORMATION, AND RECOMMENDATIONS IN THIS MANUAL ARE BELIEVED TO BE ACCURATE BUT ARE PRESENTED WITHOUT WARRANTY OF ANY KIND, EXPRESS OR IMPLIED. USERS MUST TAKE FULL RESPONSIBILITY FOR THEIR APPLICATION OF ANY PRODUCTS.

THE SOFTWARE LICENSE AND LIMITED WARRANTY FOR THE ACCOMPANYING PRODUCT ARE SET FORTH IN THE INFORMATION PACKET THAT SHIPPED WITH THE PRODUCT AND ARE INCORPORATED HEREIN BY THIS REFERENCE. IF YOU ARE UNABLE TO LOCATE THE SOFTWARE LICENSE OR LIMITED WARRANTY, CONTACT YOUR CISCO REPRESENTATIVE FOR A COPY.

The Cisco implementation of TCP header compression is an adaptation of a program developed by the University of California, Berkeley (UCB) as part of UCB's public domain version of the UNIX operating system. All rights reserved. Copyright © 1981, Regents of the University of California.

NOTWITHSTANDING ANY OTHER WARRANTY HEREIN, ALL DOCUMENT FILES AND SOFTWARE OF THESE SUPPLIERS ARE PROVIDED "AS IS" WITH ALL FAULTS. CISCO AND THE ABOVE-NAMED SUPPLIERS DISCLAIM ALL WARRANTIES, EXPRESSED OR IMPLIED, INCLUDING, WITHOUT LIMITATION, THOSE OF MERCHANTABILITY, FITNESS FOR A PARTICULAR PURPOSE AND NON-INFRINGEMENT OR ARISING FROM A COURSE OF DEALING, USAGE, OR TRADE PRACTICE.

IN NO EVENT SHALL CISCO OR ITS SUPPLIERS BE LIABLE FOR ANY INDIRECT, SPECIAL, CONSEQUENTIAL, OR INCIDENTAL DAMAGES, INCLUDING, WITHOUT LIMITATION, LOST PROFITS OR LOSS OR DAMAGE TO DATA ARISING OUT OF THE USE OR INABILITY TO USE THIS MANUAL, EVEN IF CISCO OR ITS SUPPLIERS HAVE BEEN ADVISED OF THE POSSIBILITY OF SUCH DAMAGES.

Any Internet Protocol (IP) addresses and phone numbers used in this document are not intended to be actual addresses and phone numbers. Any examples, command display output, network topology diagrams, and other figures included in the document are shown for illustrative purposes only. Any use of actual IP addresses or phone numbers in illustrative content is unintentional and coincidental.

All printed copies and duplicate soft copies of this document are considered uncontrolled. See the current online version for the latest version.

Cisco has more than 200 offices worldwide. Addresses and phone numbers are listed on the Cisco website at www.cisco.com/go/offices.

Cisco and the Cisco logo are trademarks or registered trademarks of Cisco and/or its affiliates in the U.S. and other countries. To view a list of Cisco trademarks, go to this URL: <https://www.cisco.com/c/en/us/about/legal/trademarks.html>. Third-party trademarks mentioned are the property of their respective owners. The use of the word partner does not imply a partnership relationship between Cisco and any other company. (1721R)

© 2024 Cisco Systems, Inc. All rights reserved.



CONTENTS

CHAPTER 1	Preconfiguring Physical Interfaces	1
	Physical Interface Preconfiguration Overview	1
	Prerequisites for Preconfiguring Physical Interfaces	2
	Benefits of Interface Preconfiguration	2
	How to Preconfigure Physical Interfaces	2
	Use of the Interface Preconfigure Command	4

CHAPTER 2	Configuring Management Ethernet Interface	5
	Information About Configuring Management Ethernet Interfaces	5
	Prerequisites for Configuring Management Ethernet Interfaces	5
	How to Perform Advanced Management Ethernet Interface Configuration	6
	IPv6 Stateless Address Auto Configuration on Management Interface	6
	Configuring a Management Ethernet Interface	8
	Verifying Management Ethernet Interface Configuration	11

CHAPTER 3	Configuring Ethernet Interfaces	13
	Configuring Physical Ethernet Interfaces	14
	Information About Configuring Ethernet	16
	Default Configuration Values for 1-Gigabit, 10-Gigabit, 100-Gigabit Ethernet	17
	Network Interface Speed	17
	Configuring Network Interface Speed	18
	Using the speed command	18
	Using the negotiation auto command	20
	Using speed and negotiation auto command	22
	Ethernet MTU	24
	Link Layer Discovery Protocol (LLDP)	25

Enabling LLDP Globally 25

CHAPTER 4

Configuring Ethernet OAM 27

Ethernet OAM 27

Ethernet Link OAM 27

Neighbor Discovery 28

EFD 28

Link Monitoring 29

MIB Retrieval 29

Remote Loopback 29

SNMP Traps 29

Unidirectional Link Detection Protocol 30

How to Configure Ethernet OAM 30

Configuring Ethernet Link OAM 30

Configuration Examples for Ethernet OAM 39

Ethernet CFM 41

Maintenance Domains 42

Services 44

Maintenance Points 44

MIP Creation 44

MEP and CFM Processing Overview 45

CFM Protocol Messages 47

Continuity Check (IEEE 802.1ag and ITU-T Y.1731) 47

Maintenance Association Identifier (MAID) 48

Loopback (IEEE 802.1ag and ITU-T Y.1731) 51

Linktrace (IEEE 802.1ag and ITU-T Y.1731) 51

Configurable Logging 53

Flexible VLAN Tagging for CFM 53

Configuring Ethernet CFM 54

Configuring a CFM Maintenance Domain 55

Configuring Services for a CFM Maintenance Domain 56

Enabling and Configuring Continuity Check for a CFM Service 57

Configuring Automatic MIP Creation for a CFM Service 59

Configuring Cross-Check on a MEP for a CFM Service 61

Configuring Other Options for a CFM Service	62
Configuring CFM MEPs	64
Configuring Y.1731 AIS	66
Configuring AIS in a CFM Domain Service	66
Configuring AIS on a CFM Interface	68
Configuring EFD for a CFM Service	69
Verifying the EFD Configuration	70
Configuring Flexible VLAN Tagging for CFM	71
Verifying the CFM Configuration	72
Configuration Examples for Ethernet CFM	72
Ethernet CFM Domain Configuration: Example	73
Ethernet CFM Service Configuration: Example	73
Flexible Tagging for an Ethernet CFM Service Configuration: Example	73
Continuity Check for an Ethernet CFM Service Configuration: Example	73
MIP Creation for an Ethernet CFM Service Configuration: Example	73
Cross-check for an Ethernet CFM Service Configuration: Example	73
Other Ethernet CFM Service Parameter Configuration: Example	74
MEP Configuration: Example	74
Ethernet CFM Show Command: Examples	74
AIS for CFM Configuration: Examples	77
AIS for CFM Show Commands: Examples	78
show ethernet cfm interfaces ais Command: Example	78
show ethernet cfm local meps Command: Examples	78
show ethernet cfm local meps detail Command: Example	80
Troubleshooting Tips	80
CFM Over Bundles	81
CFM Adaptive Bandwidth Notifications	82
Bandwidth Notification Messages	83
Restrictions for CFM Bandwidth Notifications	83
Bandwidth Reporting	84
Damping Algorithm	85
Conformance Testing Algorithm	86
Embedded Event Manager	86
Event Publishing	87

- CFM with SAT and EDPL 88
- Unidirectional Link Detection Protocol 88
 - UDLD Operation 88
 - Types of Fault Detection 89
 - UDLD Modes of Operation 89
 - UDLD Aging Mechanism 89
 - State Machines 90
 - Main FSM 90
 - Detection FSM 90
- Y.1731 Performance Monitoring 91
 - Two-Way Delay Measurement for Scalability 91
 - Configuring Two-Way Delay Measurement 91
 - Synthetic Loss Measurement 95
 - Configuring Synthetic Loss Measurement 95

CHAPTER 5

- Integrated Routing and Bridging 99**
 - Supported Features on a BVI 99
 - BVI Interface and Line Protocol States 100
 - Prerequisites for Configuring IRB 100
 - Restrictions for Configuring IRB 101
 - How to Configure IRB 101
 - Configuring the Bridge Group Virtual Interface 101
 - Configuration Guidelines 101
 - Configuring the Layer 2 AC Interfaces 103
 - Configuring a Bridge Group and Assigning Interfaces to a Bridge Domain 104
 - Associating the BVI as the Routed Interface on a Bridge Domain 105
 - Displaying Information About a BVI 107
 - Additional Information on IRB 107
 - Packet Flows Using IRB 107
 - Packet Flows When Host A Sends to Host B on the Bridge Domain 108
 - Packet Flows When Host A Sends to Host C From the Bridge Domain to a Routed Interface 108
 - Packet Flows When Host C Sends to Host B From a Routed Interface to the Bridge Domain 108
 - Configuration Examples for IRB 109
 - Basic IRB Configuration: Example 109

IRB With BVI and VRRP Configuration: Example 109

CHAPTER 6

Configuring Link Bundling 111

Compatible Characteristics of Ethernet Link Bundles 112

Information About Configuring Link Bundling 114

IEEE 802.3ad Standard 114

Link Bundle Configuration Overview 115

Link Switchover 115

LACP Fallback 116

Configuring Ethernet Link Bundles 116

Configuring LACP Fallback 119

Configuring EFP Load Balancing on an Ethernet Link Bundle 120

VLANs on an Ethernet Link Bundle 122

Configuring VLAN over Bundles 123

123

LACP Short Period Time Intervals 126

Configuring the Default LACP Short Period Time Interval 127

Configuring Custom LACP Short Period Time Intervals 128

Configuring Bundle Interfaces under VPWS Cross-Connect 133

Configuring Bundle Interface under VPLS 134

Bundle Consistency Checker 136

CHAPTER 7

Configuring Traffic Mirroring 141

Introduction to Traffic Mirroring 142

Traffic Mirroring Terminology 142

Traffic Mirroring Types 143

Characteristics of Source Port 143

Characteristics of Monitor Session 143

Characteristics of Destination Port 144

Supported Scale 144

Restrictions 144

SPAN Types, Supported Features, and Configurations 148

Local SPAN 148

Remote SPAN 148

Configure Remote Traffic Mirroring	148
SPAN on Subinterfaces	151
VLAN Subinterface as Ingress or Egress Source for Traffic Mirroring	151
Monitoring Traffic Mirroring on a Layer 2 Interface	152
ACL-based SPAN	153
Configuring Security ACLs for Traffic Mirroring	153
Configuring UDF-Based Security ACL for Traffic Mirroring	154
DSCP Bitmask to Filter Ingress SPAN Traffic	156
SPAN Using 7-Tuples ACL	157
Multiple SPAN ACL Sessions in Single Interface	159
Monitor Multiple SPAN ACL and Security ACL Sessions	162
Attaching the Configurable Source Interface	163
ERSPAN	165
Introduction to ERSPAN Egress Rate Limit	165
ERSPAN Traffic to a Destination Tunnel in a Non-Default VRF	168
DSCP Marking on Egress GRE Tunnel in ERSPAN	170
SPAN over Pseudowire	170
Configure SPAN over Pseudowire	170
Verify SPAN over Pseudowire	171
Traffic Mirroring for Incoming and Outgoing Traffic Separately over Pseudowire	172
SPAN-to-File	176
SPAN-to-File Enhancements	176
File Mirroring	179
Configure File Mirroring	179
Forward-Drop Packets Mirroring	180
Mirror Forward-Drop Packets	181
Troubleshoot Traffic Mirroring	182
CHAPTER 8	Configuring Virtual Loopback and Null Interfaces
	187
Information About Configuring Virtual Interfaces	187
Virtual Loopback Interface Overview	187
Prerequisites for Configuring Virtual Interfaces	188
Configuring Virtual Loopback Interfaces	188
Null Interface Overview	189

Configuring Null Interfaces	190
Configuring Virtual IPv4 Interfaces	192

CHAPTER 9**Configuring 802.1Q VLAN Interfaces 195**

Configuring 802.1Q VLAN Interfaces	195
Information About Configuring 802.1Q VLAN Interfaces	196
Subinterfaces	196
Subinterface MTU	196
EFPs	196
Layer 2 VPN on VLANs	196
How to Configure 802.1Q VLAN Interfaces	197
Configuring 802.1Q VLAN Subinterfaces	197
Verification	199
Configuring an Attachment Circuit on a VLAN	199
Removing an 802.1Q VLAN Subinterface	201

CHAPTER 10**Configuring GRE Tunnels 203**

Configuring GRE Tunnels	203
Configuring GRE Tunnels	203
IP-in-IP Decapsulation	204
Single Pass GRE Encapsulation Allowing Line Rate Encapsulation	207
Configure GRE Single-Pass Entropy	207
Running Configuration	211
Verification	214

CHAPTER 11**Using YANG Data Models 217**



CHAPTER 1

Preconfiguring Physical Interfaces

This module describes the preconfiguration of physical interfaces.

Preconfiguration is supported for these types of interfaces and controllers:

- 1-Gigabit Ethernet
- 10-Gigabit Ethernet
- 25-Gigabit Ethernet
- 40-Gigabit Ethernet
- 100-Gigabit Ethernet
- Management Ethernet

Preconfiguration allows you to configure interface modules before they are inserted into the router. When the interface modules are inserted, they are instantly configured. The preconfiguration information is created in a different system database tree (known as the *preconfiguration directory* on the route processor), rather than with the regularly configured interfaces.

There may be some preconfiguration data that cannot be verified unless the interface modules are present, because the verifiers themselves run only on the interface modules. Such preconfiguration data is verified when the interface modules is inserted and the verifiers are initiated. A configuration is rejected if errors are found when the configuration is copied from the preconfiguration area to the active area.

- [Physical Interface Preconfiguration Overview, on page 1](#)
- [Prerequisites for Preconfiguring Physical Interfaces, on page 2](#)
- [Benefits of Interface Preconfiguration, on page 2](#)
- [How to Preconfigure Physical Interfaces, on page 2](#)
- [Use of the Interface Preconfigure Command, on page 4](#)

Physical Interface Preconfiguration Overview

Preconfiguration is the process of configuring interfaces before they are present in the system. Preconfigured interfaces are not verified or applied until the actual interface with the matching location (rack/slot/module) is inserted into the router. When the anticipated interface module is inserted and the interfaces are created, the precreated configuration information is verified and, if successful, immediately applied to the running configuration of the router.



Note When you plug the anticipated interface module in, make sure to verify any preconfiguration with the appropriate **show** commands.

Use the **show run** command to see interfaces that are in the preconfigured state.



Note We recommend filling out preconfiguration information in your site planning guide, so that you can compare that anticipated configuration with the actual preconfigured interfaces when that interface module is installed and the interfaces are up.



Tip Tip Use the **commit best-effort** command to save the preconfiguration to the running configuration file. The **commit best-effort** command merges the target configuration with the running configuration and commits only valid configuration (best effort). Some configuration might fail due to semantic errors, but the valid configuration still comes up.

Prerequisites for Preconfiguring Physical Interfaces

Before preconfiguring physical interfaces, ensure that this condition is met:

- Preconfiguration drivers and files are installed. Although it may be possible to preconfigure physical interfaces without a preconfiguration driver installed, the preconfiguration files are required to set the interface definition file on the router that supplies the strings for valid interface names.

Benefits of Interface Preconfiguration

Preconfigurations reduce downtime when you add new interface modules to the system. With preconfiguration, the new interface modules can be instantly configured and actively running during interface modules bootup.

Another advantage of performing a preconfiguration is that during a interface modules replacement, when the interface modules is removed, you can still see the previous configuration and make modifications.

How to Preconfigure Physical Interfaces

This task describes only the most basic preconfiguration of an interface.

Procedure

Step 1 **configure**

Example:

```
RP/0/RP0/CPU0:router#configure
```

Enters global configuration mode.

Step 2 **interface preconfigure** *type interface-path-id*

Example:

```
RP/0/RP0/CPU0:router(config)# interface preconfigure HundredGigE 0/0/1/0
```

Enters interface preconfiguration mode for an interface, where *type* specifies the supported interface type that you want to configure and *interface-path-id* specifies the location where the interface will be located in *rack/slot/module/port* notation.

Step 3 Use one of the following commands:

- **ipv4 address** *ip-address subnet-mask*
- **ipv4 address** *ip-address /prefix*

Example:

```
RP/0/RP0/CPU0:router(config-if-pre)# ipv4 address 192.168.1.2/31
```

Assigns an IP address and mask to the interface.

Step 4 Configure additional interface parameters, as described in this manual in the configuration chapter that applies to the type of interface that you are configuring.

Step 5 **end** or **commit best-effort**

Example:

```
RP/0/RP0/CPU0:router(config-if-pre)# end
```

or

```
RP/0/RP0/CPU0:router(config-if-pre)# commit
```

Saves configuration changes.

- When you issue the **end** command, the system prompts you to commit changes: `Uncommitted changes found, commit them before exiting (yes/no/cancel)?`
- Entering **yes** saves configuration changes to the running configuration file, exits the configuration session, and returns the router to EXEC mode.
- Entering **no** exits the configuration session and returns the router to EXEC mode without committing the configuration changes.
- Entering **cancel** leaves the router in the current configuration session without exiting or committing the configuration changes.
- Use the **commit best-effort** command to save the configuration changes to the running configuration file and remain within the configuration session. The **commit best-effort** command merges the target configuration with the running configuration and commits only valid changes (best effort). Some configuration changes might fail due to semantic errors.

Step 6 **show running-config**

Example:

```
RP/0/RP0/CPU0:router# show running-config
```

(Optional) Displays the configuration information currently running on the router.

Example

This example shows how to preconfigure a basic Ethernet interface:

```
RP/0/RP0/CPU0:router# configure
RP/0/RP0/CPU0:router (config)# interface preconfigure HundredGigE 0/0/1/0
RP/0/RP0/CPU0:router (config-if)# ipv4 address 192.168.1.2/31
RP/0/RP0/CPU0:router (config-if-pre)# commit
```

Use of the Interface Preconfigure Command

Interfaces that are not yet present in the system can be preconfigured with the **interface preconfigure** command in global configuration mode.

The **interface preconfigure** command places the router in interface configuration mode. Users should be able to add any possible interface commands. The verifiers registered for the preconfigured interfaces verify the configuration. The preconfiguration is complete when the user enters the **end** command, or any matching exit or global configuration mode command.



Note It is possible that some configurations cannot be verified until the interface module is inserted.

Do not enter the **no shutdown** command for new preconfigured interfaces, because the no form of this command removes the existing configuration, and there is no existing configuration.

Users are expected to provide names during preconfiguration that will match the name of the interface that will be created. If the interface names do not match, the preconfiguration cannot be applied when the interface is created. The interface names must begin with the interface type that is supported by the router and for which drivers have been installed. However, the slot, port, subinterface number, and channel interface number information cannot be validated.



Note Specifying an interface name that already exists and is configured (or an abbreviated name like Hu0/3/0/0) is not permitted.



CHAPTER 2

Configuring Management Ethernet Interface

This module describes the configuration of Management Ethernet interfaces.

Before you can use Telnet to access the router through the LAN IP address, you must set up a Management Ethernet interface and enable Telnet servers.



Note Although the Management Ethernet interfaces on the system are present by default, you must configure these interfaces to use them for accessing the router, using protocols and applications such as Simple Network Management Protocol (SNMP), HTTP, extensible markup language (XML), TFTP, Telnet, and command-line interface (CLI).



Note In a High Availability setup, when an active RP interface is shut the ping to gateway fails, though standby RP or virtual RP is up and running. RSP4 does not support inject packets from a standby RP management interface.

- [Information About Configuring Management Ethernet Interfaces, on page 5](#)
- [Prerequisites for Configuring Management Ethernet Interfaces, on page 5](#)
- [How to Perform Advanced Management Ethernet Interface Configuration, on page 6](#)

Information About Configuring Management Ethernet Interfaces

To configure Management Ethernet interfaces, you must understand the following concept:

Prerequisites for Configuring Management Ethernet Interfaces

Before performing the Management Ethernet interface configuration procedures that are described in this chapter, be sure that the following tasks and conditions are met:

- You have performed the initial configuration of the Management Ethernet interface.
- You know how to apply the generalized interface name specification *rack/slot/module/port*.



Note For transparent switchover, both active and standby Management Ethernet interfaces are expected to be physically connected to the same LAN or switch.

How to Perform Advanced Management Ethernet Interface Configuration

This section contains the following procedures:

IPv6 Stateless Address Auto Configuration on Management Interface

Perform this task to enable IPv6 stateless auto configuration on Management interface.

Procedure

Step 1 **configure**

Example:

```
RP/0/RP0/CPU0:router# configure
```

Enters global configuration mode.

Step 2 **interface MgmtEth *interface-path-id***

Example:

```
RP/0/RP0/CPU0:router(config)# interface MgmtEth 0/RP0/CPU0/0
```

Enters interface configuration mode and specifies the Ethernet interface name and notation *rack/slot/module/port*.

The example indicates port 0 on the RP card that is installed in slot 0.

Step 3 **ipv6 address autoconfig**

Example:

```
RP/0/RP0/CPU0:router(config-if)# ipv6 address autoconfig
```

Enable IPv6 stateless address auto configuration on the management port.

Step 4 **end** or **commit**

Example:

```
RP/0/RP0/CPU0:router(config-if)# end
```

OR

```
RP/0/RP0/CPU0:router(config-if)# commit
```

Saves configuration changes.

- When you issue the **end** command, the system prompts you to commit changes:

```
Uncommitted changes found, commit them before exiting(yes/no/cancel)?
[cancel]:
```

- Entering **yes** saves configuration changes to the running configuration file, exits the configuration session, and returns the router to EXEC mode.
- Entering **no** exits the configuration session and returns the router to EXEC mode without committing the configuration changes.
- Entering **cancel** leaves the router in the current configuration session without exiting or committing the configuration changes.
- Use the **commit** command to save the configuration changes to the running configuration file and remain within the configuration session.

Step 5 **show ipv6 interfaces** *interface-path-id*

Example:

```
RP/0/RP0/CPU0:router# show ipv6 interfaces gigabitEthernet 0/0/0/0
```

(Optional) Displays statistics for interfaces on the router.

Example

This example displays :

```
RP/0/RP0/CPU0:router# configure
RP/0/RP0/CPU0:router(config)# interface MgmtEth 0/RP0/CPU0/0
RP/0/RP0/CPU0:router(config-if)# ipv6 address autoconfig
RP/0/RP0/CPU0:router(config-if)# commit
RP/0/RP0/CPU0:router# show ipv6 interfaces gigabitEthernet 0/0/0/0

Fri Nov  4 16:48:14.372 IST
GigabitEthernet0/2/0/0 is Up, ipv6 protocol is Up, Vrfid is default (0x60000000)
  IPv6 is enabled, link-local address is fe80::d1:1eff:fe2b:baf
  Global unicast address(es):
    5::d1:1eff:fe2b:baf [AUTO CONFIGURED], subnet is 5::/64 <<<<<< auto configured address

  Joined group address(es): ff02::1:ff2b:baf ff02::2 ff02::1
  MTU is 1514 (1500 is available to IPv6)
  ICMP redirects are disabled
  ICMP unreachablees are enabled
  ND DAD is enabled, number of DAD attempts 1
  ND reachable time is 0 milliseconds
  ND cache entry limit is 1000000000
  ND advertised retransmit interval is 0 milliseconds
  Hosts use stateless autoconfig for addresses.
  Outgoing access list is not set
```

```

Inbound common access list is not set, access list is not set
Table Id is 0xe0800000
Complete protocol adjacency: 0
Complete glean adjacency: 0
Incomplete protocol adjacency: 0
Incomplete glean adjacency: 0
Dropped protocol request: 0
Dropped glean request: 0

```

Configuring a Management Ethernet Interface

Perform this task to configure a Management Ethernet interface. This procedure provides the minimal configuration required for the Management Ethernet interface.

Procedure

Step 1 **configure**

Example:

```
RP/0/RP0/CPU0:router# configure
```

Enters global configuration mode.

Step 2 **interface MgmtEth *interface-path-id***

Example:

```
RP/0/RP0/CPU0:router(config)# interface MgmtEth 0/RP0/CPU0/0
```

Enters interface configuration mode and specifies the Ethernet interface name and notation *rack/slot/module/port*.

The example indicates port 0 on the RP card that is installed in slot 0.

Step 3 **ipv4 address *ip-address mask***

Example:

```
RP/0/RP0/CPU0:router(config-if)# ipv4 address 1.76.18.150/16 (or)
ipv4 address 1.76.18.150 255.255.0.0
```

Assigns an IP address and subnet mask to the interface.

- Replace *ip-address* with the primary IPv4 address for the interface.
- Replace *mask* with the mask for the associated IP subnet. The network mask can be specified in either of two ways:
 - The network mask can be a four-part dotted decimal address. For example, 255.255.0.0 indicates that each bit equal to 1 means that the corresponding address bit belongs to the network address.
 - The network mask can be indicated as a slash (/) and number. For example, /16 indicates that the first 16 bits of the mask are ones, and the corresponding bits of the address are network address.

Step 4 **no ipv6 address autoconfig**

Example:

```
RP/0/RP0/CPU0:router(config-if)# no ipv6 address autoconfig
```

(Optional) Disables IPv6 address on the interface.

Step 5 **mtu bytes****Example:**

```
RP/0/RP0/CPU0:router(config-if)# mtu 1488
```

(Optional) Sets the maximum transmission unit (MTU) byte value for the interface. The default is 1514.

- The default is 1514 bytes.
- The range for the Management Ethernet interface Interface **mtu** values is 64 to 1514 bytes.

Step 6 **no shutdown****Example:**

```
RP/0/RP0/CPU0:router(config-if)# no shutdown
```

Removes the shutdown configuration, which removes the forced administrative down on the interface, enabling it to move to an up or down state.

Step 7 **end or commit****Example:**

```
RP/0/RP0/CPU0:router(config-if)# end
```

or

```
RP/0/RP0/CPU0:router(config-if)# commit
```

Saves configuration changes.

- When you issue the **end** command, the system prompts you to commit changes:

```
Uncommitted changes found, commit them before exiting(yes/no/cancel)?  
[cancel]:
```

- Entering **yes** saves configuration changes to the running configuration file, exits the configuration session, and returns the router to EXEC mode.
- Entering **no** exits the configuration session and returns the router to EXEC mode without committing the configuration changes.
- Entering **cancel** leaves the router in the current configuration session without exiting or committing the configuration changes.
- Use the **commit** command to save the configuration changes to the running configuration file and remain within the configuration session.

Step 8 **show interfaces MgmtEth interface-path-id****Example:**

```
RP/0/RP0/CPU0:router# show interfaces MgmtEth 0/RP0/CPU0/0
```

(Optional) Displays statistics for interfaces on the router.

Example

This example displays advanced configuration and verification of the Management Ethernet interface on the RP:

```
RP/0/RP0/CPU0:router# configure
RP/0/RP0/CPU0:router(config)# interface MgmtEth 0/RP0/CPU0/0
RP/0/RP0/CPU0:router(config-if)# ipv4 address 1.76.18.150/16
RP/0/RP0/CPU0:router(config-if)# no ipv6 address autoconfig
RP/0/RP0/CPU0:router(config-if)# no shutdown
RP/0/RP0/CPU0:router(config-if)# commit
RP/0/RP0/CPU0:router:Mar 26 01:09:28.685 :ifmgr[190]:%LINK-3-UPDOWN :Interface
MgmtEth0/RP0/CPU0/0, changed state to Up
RP/0/RP0/CPU0:router(config-if)# end

RP/0/RP0/CPU0:router# show interfaces MgmtEth 0/RP0/CPU0/0

MgmtEth0/RP0/CPU0/0 is up, line protocol is up
  Interface state transitions: 3
  Hardware is Management Ethernet, address is 1005.cad8.4354 (bia 1005.cad8.4354)
  Internet address is 1.76.18.150/16
  MTU 1488 bytes, BW 1000000 Kbit (Max: 1000000 Kbit)
    reliability 255/255, txload 0/255, rxload 0/255
  Encapsulation ARPA,
  Full-duplex, 1000Mb/s, 1000BASE-T, link type is autonegotiation
  loopback not set,
  Last link flapped 00:00:59
  ARP type ARPA, ARP timeout 04:00:00
  Last input 00:00:00, output 00:00:02
  Last clearing of "show interface" counters never
  5 minute input rate 4000 bits/sec, 3 packets/sec
  5 minute output rate 0 bits/sec, 0 packets/sec
    21826 packets input, 4987886 bytes, 0 total input drops
    0 drops for unrecognized upper-level protocol
    Received 12450 broadcast packets, 8800 multicast packets
      0 runts, 0 giants, 0 throttles, 0 parity
    0 input errors, 0 CRC, 0 frame, 0 overrun, 0 ignored, 0 abort
    1192 packets output, 217483 bytes, 0 total output drops
    Output 0 broadcast packets, 0 multicast packets
    0 output errors, 0 underruns, 0 applique, 0 resets
    0 output buffer failures, 0 output buffers swapped out
    3 carrier transitions

RP/0/RP0/CPU0:router# show running-config interface MgmtEth 0/RP0/CPU0/0

interface MgmtEth0/RP0/CPU0/0
  mtu 1488
  ipv4 address 1.76.18.150/16
  ipv6 address 2002::14c:125a/64
  ipv6 enable
!
```

The following example displays VRF configuration and verification of the Management Ethernet interface on the RP with source address:

```
RP/0/RP0/CPU0:router# show run interface MgmtEth 0/RP0/CPU0/0
interface MgmtEth0/RP0/CPU0/0
  vrf httpupload
  ipv4 address 10.8.67.20 255.255.0.0
  ipv6 address 2001:10:8:67::20/48
!

RP/0/RP0/CPU0:router# show run http
Wed Jan 30 14:58:53.458 UTC
http client vrf httpupload
http client source-interface ipv4 MgmtEth0/RP0/CPU0/0

RP/0/RP0/CPU0:router# show run vrf
Wed Jan 30 14:59:00.014 UTC
vrf httpupload
!
```

Verifying Management Ethernet Interface Configuration

Perform this task to verify configuration modifications on the Management Ethernet interfaces.

Procedure

Step 1 show interfaces MgmtEth *interface-path-id*

Example:

```
RP/0/RP0/CPU0:router# show interfaces MgmtEth 0/RP0/CPU0/0
```

Displays the Management Ethernet interface configuration.

Step 2 show running-config interface MgmtEth *interface-path-id*

Example:

```
RP/0/RP0/CPU0:router# show running-config interface MgmtEth 0/RP0/CPU0/0
```

Displays the running configuration.



CHAPTER 3

Configuring Ethernet Interfaces

This module describes the configuration of Ethernet interfaces.

The following distributed ethernet architecture delivers network scalability and performance, while enabling service providers to offer high-density, high-bandwidth networking solutions.

- 1-Gigabit
- 10-Gigabit
- 25-Gigabit
- 40-Gigabit
- 100-Gigabit



Tip You can programmatically configure and manage the Ethernet interfaces using `openconfig-ethernet-if.yang` and `openconfig-interfaces.yang` OpenConfig data models. To get started with using data models, see the *Programmability Configuration Guide*.

These solutions are designed to interconnect the router with other systems in point-of-presence (POP)s, including core and edge routers and Layer 2 and Layer 3 switches.

Restrictions for Configuring Ethernet Interfaces

- As per design, traffic logs for incoming CRC error packets don't display packets per second (PPS) and other packet-specific information, as highlighted below.

```
Router# show interface tenGigE 0/0/0/10 | include packets

5 minute input rate 541242000 bits/sec, 0 packets/sec
5 minute output rate 0 bits/sec, 0 packets/sec
  0 packets input, 7718374402816 bytes, 0 total input drops
  Received 0 broadcast packets, 0 multicast packets
  2952 packets output, 389664 bytes, 0 total output drops
  Output 0 broadcast packets, 2952 multicast packets
```

- The router doesn't support connecting a 1Gig copper cable to a 25GbE or higher speed QSFP ports.
- For 1Gig fibre cable, the router doesn't support auto-negotiation for 25GbE or higher speed QSFP ports.

- [Configuring Physical Ethernet Interfaces, on page 14](#)
- [Information About Configuring Ethernet, on page 16](#)
- [Link Layer Discovery Protocol \(LLDP\), on page 25](#)
- [Enabling LLDP Globally, on page 25](#)

Configuring Physical Ethernet Interfaces

Use this procedure to create a basic Ethernet interface configuration.

Procedure

Step 1 **show version**

Example:

```
RP/0/RP0/CPU0:router# show version
```

(Optional) Displays the current software version, and can also be used to confirm that the router recognizes the interface module.

Step 2 **show interfaces [GigE | TenGigE | TwentyFiveGigE | FortyGigE | HundredGigE] interface-path-id**

Example:

```
RP/0/RP0/CPU0:router# show interface HundredGigE 0/0/1/0
```

(Optional) Displays the configured interface and checks the status of each interface port.

Step 3 **configure**

Example:

```
RP/0/RP0/CPU0:router# configure terminal
```

Enters global configuration mode.

Step 4 **interface [GigE | TenGigE | TwentyFiveGigE | FortyGigE | HundredGigE] interface-path-id**

Example:

```
RP/0/RP0/CPU0:router(config)# interface HundredGigE 0/0/1/0
```

Enters interface configuration mode and specifies the Ethernet interface name and notation *rack/slot/module/port*. Possible interface types for this procedure are:

- GigE
- 10GigE
- 25GigE
- 40GigE
- 100GigE

- Note**
- The example indicates a 100-Gigabit Ethernet interface in the interface module in slot 1.

Step 5 **ipv4 address** *ip-address mask*

Example:

```
RP/0/RP0/CPU0:router(config-if)# ipv4 address 172.18.189.38 255.255.255.224
```

Assigns an IP address and subnet mask to the interface.

- Replace *ip-address* with the primary IPv4 address for the interface.
- Replace *mask* with the mask for the associated IP subnet. The network mask can be specified in either of two ways:
 - The network mask can be a four-part dotted decimal address. For example, 255.0.0.0 indicates that each bit equal to 1 means that the corresponding address bit belongs to the network address.
 - The network mask can be indicated as a slash (/) and number. For example, /8 indicates that the first 8 bits of the mask are ones, and the corresponding bits of the address are network address.

Step 6 **mtu** *bytes*

Example:

```
RP/0/RP0/CPU0:router(config-if)# mtu 2000
```

(Optional) Sets the MTU value for the interface.

- The configurable range for MTU values is 1514 bytes to 9646 bytes.
- The default is 1514 bytes for normal frames and 1518 bytes for 802.1Q tagged frames.

Step 7 **no shutdown**

Example:

```
RP/0/RP0/CPU0:router(config-if)# no shutdown
```

Removes the shutdown configuration, which forces an interface administratively down.

Step 8 **show interfaces** [**GigE TenGigE TwentyFiveGigE TwentyFiveGigE FortyGigE HundredGigE**]
interface-path-id

Example:

```
RP/0/RP0/CPU0:router# show interfaces HundredGigE  
0/0/1/0
```

(Optional) Displays statistics for interfaces on the router.

Example

This example shows how to configure an interface for a 100-Gigabit Ethernet interface module:

```

RP/0/RP0/CPU0:router# configure
RP/0/RP0/CPU0:router(config)# interface HundredGigE 0/7/0/0
RP/0/RP0/CPU0:router(config-if)# ipv4 address 172.18.189.38 255.255.255.224

RP/0/RP0/CPU0:router(config-if)# mtu 2000

RP/0/RP0/CPU0:router(config-if)# no shutdown
RP/0/RP0/CPU0:router(config-if)# end
Uncommitted changes found, commit them? [yes]: yes

RP/0/RP0/CPU0:router# show interface HundredGigE 0/7/0/0
HundredGigE0/7/0/0 is up, line protocol is up
  Interface state transitions: 1
  Hardware is HundredGigE, address is 6219.8864.e330 (bia 6219.8864.e330)
  Internet address is 3.24.1.1/24
  MTU 9216 bytes, BW 100000000 Kbit (Max: 100000000 Kbit)
    reliability 255/255, txload 3/255, rxload 3/255
  Encapsulation ARPA,
  Full-duplex, 100000Mb/s, link type is force-up
  output flow control is off, input flow control is off
  Carrier delay (up) is 10 msec
  loopback not set,
  Last link flapped 10:05:07
  ARP type ARPA, ARP timeout 04:00:00
  Last input 00:08:56, output 00:00:00
  Last clearing of "show interface" counters never
  5 minute input rate 1258567000 bits/sec, 1484160 packets/sec
  5 minute output rate 1258584000 bits/sec, 1484160 packets/sec
    228290765840 packets input, 27293508436038 bytes, 0 total input drops
      0 drops for unrecognized upper-level protocol
    Received 15 broadcast packets, 45 multicast packets
      0 runts, 0 giants, 0 throttles, 0 parity
    0 input errors, 0 CRC, 0 frame, 0 overrun, 0 ignored, 0 abort
    212467849449 packets output, 25733664696650 bytes, 0 total output drops
    Output 23 broadcast packets, 15732 multicast packets
    39 output errors, 0 underruns, 0 applique, 0 resets
    0 output buffer failures, 0 output buffers swapped out
    0 carrier transitions

RP/0/RP0/CPU0:router# show running-config interface HundredGigE 0/0/1/0

interface HundredGigE 0/7/0/0
  mtu 9216

  ipv4 address 3.24.1.1 255.255.255.0
  ipv6 address 3:24:1::1/64
  flow ipv4 monitor perfv4 sampler fsm ingress
!
```

Information About Configuring Ethernet

This section provides the following information sections:

Default Configuration Values for 1-Gigabit, 10-Gigabit,100-Gigabit Ethernet

This table describes the default interface configuration parameters that are present when an interface is enabled on a 1-Gigabit, 10-Gigabit,10-Gigabit Ethernet or 100-Gigabit Ethernet interface module.



Note You must use the **shutdown** command to bring an interface administratively down. The interface default is **no shutdown**. When a interface module is first inserted into the router, if there is no established preconfiguration for it, the configuration manager adds a shutdown item to its configuration. This shutdown can be removed only by entering the **no shutdown** command.

Table 1: 100-Gigabit Ethernet interface module Default Configuration Values

Parameter	Configuration File Entry	Default Value
MTU	mtu	<ul style="list-style-type: none"> • 1514 bytes for normal frames • 1518 bytes for 802.1Q tagged frames. • 1522 bytes for Q-in-Q frames.
MAC address	mac address	Hardware burned-in address (BIA)

Network Interface Speed

1Gig interfaces connected through copper or fiber cable can have interface speed of either 100 Mbps or 1000 Mbps. This is applicable on 1Gig interface with a 1000Base-T module (GLC-TE). By default 1G interface has following capabilities:

- Speed—1000 Mbps for fiber cable and autonegotiate for copper cable
- Duplex—Full
- Pause—Receive Part (RX) and Transmit Part (TX)

The copper and fiber cables have same default values as mentioned above but autonegotiation is default for copper cable.

The speed can either configured or set to autonegotiate with remote end interface. When in autonegotiation mode, an interface is capable of negotiating the speed of 100 Mbps or 1000 Mbps depending on the speed at the remote end interface; and other parameters such as full duplex and pause are also autonegotiated.

Autonegotiation is an optional function of the Fast Ethernet standard that enables devices to automatically exchange information over a link about speed and duplex abilities. Autonegotiation is very useful for ports where devices with different capabilities are connected and disconnected on a regular basis.



Note Autonegotiation is disabled by default, but it's mandatory on QSFP-100G-CUxM link. You must enable autonegotiation manually when you use 100GBASE-CR4 DAC cable.

Configuring Network Interface Speed

You can configure the network interface speed by using one of the following methods:

- Using the **speed** command
- Using the **negotiation auto** command
- Using both **speed** and **negotiation auto** command



Note Cisco recommends configuring network interface speed in autonegotiation mode.

Using the speed command

When you configure the speed of the network interface (1G) using the **speed** command, the interface speed is forced to the configured speed by limiting the speed value of the auto negotiated parameter to the configured speed.

This sample configuration forces the Gig interface speed to 100Mbps.



Note The interface speed at remote end is also set to 100Mbps.

```
#configuration
(config)#interface GigabitEthernet 0/0/0/31
(config-if)#speed 100
(config-if)#commit
(config-if)#end
```

Use the **show controller GigE** and **show interface GigE** commands to verify if the speed is configured to 100Mbps and autonegotiation is disabled:

```
#show controllers GigabitEthernet 0/0/0/31
Operational data for interface GigabitEthernet0/0/0/31:
State:
  Administrative state: enabled
  Operational state: Up
  LED state: Green On
Phy:
  Media type: Four-pair Category 5 UTP PHY, full duplex
  Optics:
    Vendor: CISCO
    Part number: SBCU-5740ARZ-CS1
    Serial number: AVC194525HW
    Wavelength: 0 nm
  Digital Optical Monitoring:
    Transceiver Temp: 0.000 C
    Transceiver Voltage: 0.000 V
```

Alarms key: (H) Alarm high, (h) Warning high
(L) Alarm low, (l) Warning low

Lane	Wavelength (nm)	Tx Power		Rx Power		Laser Bias (mA)
		(dBm)	(mW)	(dBm)	(mW)	
0	n/a	0.0	1.0000	0.0	1.0000	0.000

DOM alarms:
No alarms

Alarm Thresholds	Alarm High	Warning High	Warning Low	Alarm Low
Transceiver Temp (C):	0.000	0.000	0.000	0.000
Transceiver Voltage (V):	0.000	0.000	0.000	0.000
Laser Bias (mA):	0.000	0.000	0.000	0.000
Transmit Power (mW):	1.000	1.000	1.000	1.000
Transmit Power (dBm):	0.000	0.000	0.000	0.000
Receive Power (mW):	1.000	1.000	1.000	1.000
Receive Power (dBm):	0.000	0.000	0.000	0.000

Statistics:

FEC:
Corrected Codeword Count: 0
Uncorrected Codeword Count: 0

MAC address information:
Operational address: 0035.1a00.e67c
Burnt-in address: 0035.1a00.e62c
Autonegotiation disabled.

Operational values:

Speed: 100Mbps /*Gig interface speed is set to 100Mbps */
Duplex: Full Duplex
Flowcontrol: None
Loopback: None (or external)
MTU: 1514
MRU: 1514
Forward error correction: Disabled

#show interfaces GigabitEthernet 0/0/0/31

GigabitEthernet0/0/0/31 is up, line protocol is up

Interface state transitions: 7
Hardware is GigabitEthernet, address is 0035.1a00.e62c (bia 0035.1a00.e62c)
Internet address is Unknown
MTU 1514 bytes, BW 100000 Kbit (Max: 100000 Kbit)
reliability 255/255, txload 0/255, rxload 0/255
Encapsulation ARPA,
Full-duplex, 100Mb/s, TFD, link type is force-up
output flow control is off, input flow control is off
Carrier delay (up) is 10 msec
loopback not set,
Last link flapped 00:00:30
Last input 00:00:00, output 00:00:00
Last clearing of "show interface" counters never
30 second input rate 1000 bits/sec, 1 packets/sec
30 second output rate 0 bits/sec, 1 packets/sec
90943 packets input, 11680016 bytes, 0 total input drops
0 drops for unrecognized upper-level protocol
Received 0 broadcast packets, 90943 multicast packets
0 runts, 0 giants, 0 throttles, 0 parity
0 input errors, 0 CRC, 0 frame, 0 overrun, 0 ignored, 0 abort
61279 packets output, 4347618 bytes, 0 total output drops

```

Output 0 broadcast packets, 8656 multicast packets
0 output errors, 0 underruns, 0 applique, 0 resets
0 output buffer failures, 0 output buffers swapped out
8 carrier transitions

```

In the above show output you will observe that the state of the GigabitEthernet0/0/0/31 is up, and line protocol is up. This is because the speed at both ends is 100Mbps.

Using the negotiation auto command

When you configure the network interface speed using **negotiation auto** command, the speed is autonegotiated with the remote end interface. This command enhances the speed capability to 100M or 1G to be negotiated with the peer.

Table 2: Feature History Table

Feature Name	Release	Description
Autonegotiation support on the A900-IMA-8CS1Z Interface Module	Release 24.1.1	<p>The A900-IMA-8CS1Z Interface Module now supports autonegotiation on the 1G interface.</p> <p>Previously, for devices with less than 1G speed, the autonegotiation remains disabled by default. Now, with 1G support, you can enable autonegotiation on the Gigabit Ethernet interface using the negotiation auto command.</p> <p>Autonegotiation helps to connect the devices with the highest performance mode that they both support.</p>

This sample configuration sets the interface speed to autonegotiate:



Note The interface speed at remote end is set to 100Mbps.



Note From Cisco IOS XR Software Release 7.3.2 onwards, autonegotiation is not enabled by default. Use the **negotiation auto** command to enable autonegotiation.

```

#configuration
(config)#interface GigabitEthernet 0/0/0/31
(config-if)#negotiation auto
(config-if)#commit
(config-if)#end

```

Use the **show controller GigE** and **show interface GigE** commands to verify if the speed is autonegotiated:

```
#show interfaces GigabitEthernet 0/0/0/31
GigabitEthernet0/0/0/31 is up, line protocol is up
  Interface state transitions: 10
  Hardware is GigabitEthernet, address is 0035.1a00.e62c (bia 0035.1a00.e62c)
  Internet address is Unknown
  MTU 1514 bytes, BW 100000 Kbit (Max: 100000 Kbit)
    reliability 255/255, txload 0/255, rxload 0/255
  Encapsulation ARPA,
  Full-duplex, 100Mb/s, TFD, link type is autonegotiation
  output flow control is off, input flow control is off
  Carrier delay (up) is 10 msec
  loopback not set,
  Last link flapped 00:00:01
  Last input 00:00:00, output 00:00:00
  Last clearing of "show interface" counters never
  30 second input rate 1000 bits/sec, 1 packets/sec
  30 second output rate 0 bits/sec, 0 packets/sec
  91005 packets input, 11687850 bytes, 0 total input drops
  0 drops for unrecognized upper-level protocol
  Received 0 broadcast packets, 91005 multicast packets
    0 runts, 0 giants, 0 throttles, 0 parity
  0 input errors, 0 CRC, 0 frame, 0 overrun, 0 ignored, 0 abort
  61307 packets output, 4350024 bytes, 0 total output drops
  Output 0 broadcast packets, 8668 multicast packets
  0 output errors, 0 underruns, 0 applique, 0 resets
  0 output buffer failures, 0 output buffers swapped out
  15 carrier transitions
```

In the above show output you see that GigabitEthernet0/0/0/31 is up, and line protocol is up.

```
#show controllers GigabitEthernet 0/0/0/31
Operational data for interface GigabitEthernet0/0/0/31:

State:
  Administrative state: enabled
  Operational state: Up
  LED state: Green On

Phy:
  Media type: Four-pair Category 5 UTP PHY, full duplex
  Optics:
    Vendor: CISCO
    Part number: SBCU-5740ARZ-CS1
    Serial number: AVC194525HW
    Wavelength: 0 nm
  Digital Optical Monitoring:
    Transceiver Temp: 0.000 C
    Transceiver Voltage: 0.000 V

  Alarms key: (H) Alarm high, (h) Warning high
              (L) Alarm low, (l) Warning low
              Wavelength Tx Power Rx Power Laser Bias
              Lane (nm) (dBm) (mW) (dBm) (mW) (mA)
              -- -----
              0 n/a 0.0 1.0000 0.0 1.0000 0.000

  DOM alarms:
    No alarms

  Alarm Thresholds
  Alarm High Warning High Warning Low Alarm Low
  -----
  Transceiver Temp (C): 0.000 0.000 0.000 0.000
  Transceiver Voltage (V): 0.000 0.000 0.000 0.000
```

```

Laser Bias (mA):          0.000      0.000      0.000      0.000
Transmit Power (mW):      1.000      1.000      1.000      1.000
Transmit Power (dBm):     0.000      0.000      0.000      0.000
Receive Power (mW):       1.000      1.000      1.000      1.000
Receive Power (dBm):     0.000      0.000      0.000      0.000
Statistics:
  FEC:
    Corrected Codeword Count: 0
    Uncorrected Codeword Count: 0

MAC address information:
  Operational address: 0035.1a00.e67c
  Burnt-in address: 0035.1a00.e62c

Autonegotiation enabled:
  No restricted parameters

Operational values:
Speed: 100Mbps
Duplex: Full Duplex
Flowcontrol: None
Loopback: None (or external)
MTU: 1514
MRU: 1514
Forward error correction: Disabled

```

Using speed and negotiation auto command

When you configure the speed of the network interface (1G) using the **speed** and **negotiation auto** command, the interface autonegotiates all the params (full-duplex and pause) except speed. The speed is forced to the configured value.

This sample shows how to configure Gig interface speed to 100Mbps and autonegotiate other parameters:



Note The interface speed at remote end is set to 100Mbps.

```

#configuration
(config)#interface GigabitEthernet 0/0/0/31
(config-if)#negotiation auto
(config-if)#speed 100
(config-if)#end

```

Use the **show controller GigE** and **show interface GigE** command to verify if the link is up, speed is forced to 100Mbps and autonegotiation is enabled:

```

#show interfaces GigabitEthernet 0/0/0/31
GigabitEthernet0/0/0/31 is up, line protocol is up
Interface state transitions: 9
Hardware is GigabitEthernet, address is 0035.1a00.e62c (bia 0035.1a00.e62c)
Internet address is Unknown
MTU 1514 bytes, BW 100000 Kbit (Max: 100000 Kbit)
  reliability 255/255, txload 0/255, rxload 0/255
Encapsulation ARPA,
Full-duplex, 100Mb/s, TFD, link type is autonegotiation
output flow control is off, input flow control is off
Carrier delay (up) is 10 msec
loopback not set,
Last link flapped 00:00:03

```



```

Last input 00:00:00, output 00:00:00
Last clearing of "show interface" counters never
30 second input rate 0 bits/sec, 1 packets/sec
30 second output rate 0 bits/sec, 0 packets/sec
90968 packets input, 11683189 bytes, 0 total input drops
0 drops for unrecognized upper-level protocol
Received 0 broadcast packets, 90968 multicast packets
0 runts, 0 giants, 0 throttles, 0 parity
0 input errors, 0 CRC, 0 frame, 0 overrun, 0 ignored, 0 abort
61287 packets output, 4348541 bytes, 0 total output drops
Output 0 broadcast packets, 8664 multicast packets
0 output errors, 0 underruns, 0 applique, 0 resets
0 output buffer failures, 0 output buffers swapped out
12 carrier transitions
    
```

In the above show output you will observe that the GigabitEthernet0/0/0/31 is up, and line protocol is up This is because the speed at both ends is 100Mbps.

#show controllers GigabitEthernet 0/0/0/31

Operational data for interface GigabitEthernet0/0/0/31:

State:

```

Administrative state: enabled
Operational state: Up
LED state: Green On
    
```

Phy:

```

Media type: Four-pair Category 5 UTP PHY, full duplex
Optics:
    
```

```

Vendor: CISCO
Part number: SBCU-5740ARZ-CS1
Serial number: AVC194525HW
Wavelength: 0 nm
    
```

Digital Optical Monitoring:

```

Transceiver Temp: 0.000 C
Transceiver Voltage: 0.000 V
    
```

```

Alarms key: (H) Alarm high, (h) Warning high
            (L) Alarm low, (l) Warning low
    
```

Wavelength	Tx Power		Rx Power		Laser Bias
Lane (nm)	(dBm)	(mW)	(dBm)	(mW)	(mA)
0 n/a	0.0	1.0000	0.0	1.0000	0.000

DOM alarms:

No alarms

Alarm	Alarm	Warning	Warning	Alarm
Thresholds	High	High	Low	Low
Transceiver Temp (C):	0.000	0.000	0.000	0.000
Transceiver Voltage (V):	0.000	0.000	0.000	0.000
Laser Bias (mA):	0.000	0.000	0.000	0.000
Transmit Power (mW):	1.000	1.000	1.000	1.000
Transmit Power (dBm):	0.000	0.000	0.000	0.000
Receive Power (mW):	1.000	1.000	1.000	1.000
Receive Power (dBm):	0.000	0.000	0.000	0.000

Statistics:

FEC:

```

Corrected Codeword Count: 0
Uncorrected Codeword Count: 0
    
```

```

MAC address information:
  Operational address: 0035.1a00.e67c
  Burnt-in address: 0035.1a00.e62c

Autonegotiation enabled:
  Speed restricted to: 100Mbps /* autonegotiation is enabled and speed is forced to
  100Mbps*/

Operational values:
  Speed: 100Mbps
  Duplex: Full Duplex
  Flowcontrol: None
  Loopback: None (or external)
  MTU: 1514
  MRU: 1514
  Forward error correction: Disabled

```

Ethernet MTU

The Ethernet maximum transmission unit (MTU) is the size of the largest frame, minus the 4-byte frame check sequence (FCS), that can be transmitted on the Ethernet network. Every physical network along the destination of a packet can have a different MTU.

Cisco IOS XR software supports two types of frame forwarding processes:

- Fragmentation for IPV4 packets—In this process, IPv4 packets are fragmented as necessary to fit within the MTU of the next-hop physical network.



Note IPv6 does not support fragmentation.

- MTU discovery process determines largest packet size—This process is available for all IPV6 devices, and for originating IPv4 devices. In this process, the originating IP device determines the size of the largest IPv6 or IPv4 packet that can be sent without being fragmented. The largest packet is equal to the smallest MTU of any network between the IP source and the IP destination devices. If a packet is larger than the smallest MTU of all the networks in its path, that packet will be fragmented as necessary. This process ensures that the originating device does not send an IP packet that is too large.



Note To enable hashing for L3 header only when the majority of traffic is fragmented, use the [hw-module profile load-balance algorithm L3-Only](#) command.

Jumbo frame support is automatically enable for frames that exceed the standard frame size. The default value is 1514 for standard frames and 1518 for 802.1Q tagged frames. These numbers exclude the 4-byte frame check sequence (FCS).

The following list describes the properties of MTUs:

- Each physical port can have a different MTU.
- Main interface of each bundle can have one MTU value.

- L3 sub-interface (bundle or physical) shares MTU profiles and can have a maximum of 3 unique configured MTUs per NPU.



Note L2 sub-interface MTU is not supported.

Link Layer Discovery Protocol (LLDP)

Cisco Discovery Protocol (CDP) is a device discovery protocol that runs over Layer 2. Layer 2 is also known as the data link layer that runs on all Cisco-manufactured devices, such as routers, bridges, access servers, and switches. CDP allows the network management applications to automatically discover and learn about other Cisco devices that connect to the network.

To support non-Cisco devices and to allow for interoperability between other devices, it also supports the IEEE 802.1AB LLDP. LLDP is also a neighbor discovery protocol that is used for network devices to advertise information about themselves to other devices on the network. This protocol runs over the data link layer, which allows two systems running different network layer protocols to learn about each other.

With LLDP, you can also access the information about a particular physical network connection. If you use a non-Cisco monitoring tool (via SNMP), LLDP helps you identify the Object Identifiers (OIDs) that the system supports. The following are the supported OIDs:

- 1.0.8802.1.1.2.1.4.1.1.4
- 1.0.8802.1.1.2.1.4.1.1.5
- 1.0.8802.1.1.2.1.4.1.1.6
- 1.0.8802.1.1.2.1.4.1.1.7
- 1.0.8802.1.1.2.1.4.1.1.8
- 1.0.8802.1.1.2.1.4.1.1.9
- 1.0.8802.1.1.2.1.4.1.1.10
- 1.0.8802.1.1.2.1.4.1.1.11
- 1.0.8802.1.1.2.1.4.1.1.12

Enabling LLDP Globally

To run LLDP on the router, you must enable it globally. When you enable LLDP globally, all interfaces that support LLDP are automatically enabled for both transmit and receive operations.

You can override this default operation at the interface to disable receive or transmit operations.

The following table describes the global attributes that you can configure:

Attribute	Default	Range	Description
Holdtime	120	0-65535	Specifies the holdtime (in sec) that are sent in packets
Reinit	2	2-5	Delay (in sec) for LLDP initialization on any interface
Timer	30	5-65534	Specifies the rate at which LLDP packets are sent (in sec)

To enable LLDP globally, complete the following steps:

1. RP/0/RP0/CPU0:router # configure
2. RP/0/RP0/CPU0:router(config) #lldp
3. end or commit

Running configuration

```
RP/0/RP0/CPU0:router-5#show run lldp
Fri Dec 15 20:36:49.132 UTC
lldp
!
```

```
RP/0/RP0/CPU0:router#show lldp neighbors
Fri Dec 15 20:29:53.763 UTC
Capability codes:
```

```
(R) Router, (B) Bridge, (T) Telephone, (C) DOCSIS Cable Device
(W) WLAN Access Point, (P) Repeater, (S) Station, (O) Other
```

```
Device ID      Local Intf          Hold-time  Capability  Port ID
SW-NOSTG-I11-PUB.cis Mg0/RP0/CPU0/0    120       N/A         Fa0/28
```

Total entries displayed: 1

```
RP/0/RP0/CPU0:router#show lldp neighbors mgmtEth 0/RP0/CPU0/0
Fri Dec 15 20:30:54.736 UTC
```

Capability codes:

```
(R) Router, (B) Bridge, (T) Telephone, (C) DOCSIS Cable Device
(W) WLAN Access Point, (P) Repeater, (S) Station, (O) Other
```

```
Device ID      Local Intf          Hold-time  Capability  Port ID
SW-NOSTG-I11-PUB.cis Mg0/RP0/CPU0/0    120       N/A         Fa0/28
```

Total entries displayed: 1



CHAPTER 4

Configuring Ethernet OAM

This module describes the configuration of Ethernet Operations, Administration, and Maintenance (OAM).

Feature History for Configuring Ethernet OAM

- [Ethernet OAM, on page 27](#)
- [Ethernet CFM, on page 41](#)
- [CFM Over Bundles, on page 81](#)
- [CFM Adaptive Bandwidth Notifications, on page 82](#)
- [CFM with SAT and EDPL, on page 88](#)
- [Unidirectional Link Detection Protocol, on page 88](#)
- [Y.1731 Performance Monitoring, on page 91](#)

Ethernet OAM

To configure Ethernet OAM, you should understand the following concepts:

Ethernet Link OAM

Table 3: Feature History Table

Feature Name	Release	Description
Ethernet Link OAM on Physical Interface— (802.3ah) Link Monitoring and Remote Loopback	Release 7.5.2	Ethernet link OAM operates on a single, physical link and it can be configured to monitor either side or both sides of that link. Ethernet OAM supports: <ul style="list-style-type: none">• Link Monitoring, on page 29• Remote Loopback, on page 29

Ethernet as a Metro Area Network (MAN) or a Wide Area Network (WAN) technology benefits greatly from the implementation of Operations, Administration and Maintenance (OAM) features. Ethernet link OAM

features allow Service Providers to monitor the quality of the connections on a MAN or WAN. Service providers can monitor specific events. Ethernet link OAM operates on a single, physical link and it can be configured to monitor either side or both sides of that link.

Ethernet link OAM can be configured in the following ways:

- A Link OAM profile can be configured, and this profile can be used to set the parameters for multiple interfaces.
- Link OAM can be configured directly on an interface.

When an interface is also using a link OAM profile, specific parameters that are set in the profile can be overridden by configuring a different value directly on the interface.

An Ethernet Link OAM profile simplifies the process of configuring EOAM features on multiple interfaces. An Ethernet OAM profile, and all of its features, can be referenced by other interfaces, allowing other interfaces to inherit the features of that Ethernet OAM profile.

Individual Ethernet link OAM features can be configured on individual interfaces without being part of a profile. In these cases, the individually configured features always override the features in the profile.

The preferred method of configuring custom EOAM settings is to create an EOAM profile in Ethernet configuration mode and then attach it to an individual interface or to multiple interfaces.

When an EOAM packet is received on any one of the AC interfaces on which EOAM is not configured, the AC interface multicasts the received EOAM packets to other AC interfaces that are part of EVPN-BD to reach the peer. When an EOAM is enabled on the bundle member in the peer, it punts the packet to the CPU in the peer. Also, the EOAM flaps the bundle member as the local or remote Key of the received EOAM does not match.

These standard Ethernet Link OAM features are supported on the router:

Neighbor Discovery

Neighbor discovery enables each end of a link to learn the OAM capabilities of the other end and establish an OAM peer relationship. Each end also can require that the peer have certain capabilities before it will establish a session. You can configure certain actions to be taken if there is a capabilities conflict or if a discovery process times out, using the **action capabilities-conflict** or **action discovery-timeout** commands.

EFD

Ethernet Fault Detection (EFD) is a mechanism that allows Ethernet OAM protocols, such as CFM, to control the `line protocol` state of an interface.

Unlike many other interface types, Ethernet interfaces do not have a line protocol, whose state is independent from that of the interface. For Ethernet interfaces, this role is handled by the physical-layer Ethernet protocol itself, and therefore if the interface is physically up, then it is available and traffic can flow.

EFD changes this to allow CFM to act as the line protocol for Ethernet interfaces. This allows CFM to control the interface state so that if a CFM defect (such as AIS or loss of continuity) is detected with an expected peer MEP, the interface can be shut down. This not only stops traffic flow, but also triggers actions in any higher-level protocols to route around the problem. For example, in the case of Layer 2 interfaces, the MAC table would be cleared and MSTP would reconverge. For Layer 3 interfaces, the ARP cache would be cleared and potentially the IGP would reconverge.



Note EFD can only be used for down MEPs. When EFD is used to shut down the interface, the CFM frames continue to flow. This allows CFM to detect when the problem has been resolved, and thus bring the interface backup automatically.

This figure shows CFM detection of an error on one of its sessions EFD signaling an error to the corresponding MAC layer for the interface. This triggers the MAC to go to a down state, which further triggers all higher level protocols (Layer 2 pseudowires, IP protocols, and so on) to go down and also trigger a reconvergence where possible. As soon as CFM detects there is no longer any error, it can signal to EFD and all protocols will once again go active.

Figure 1: CFM Error Detection and EFD Trigger

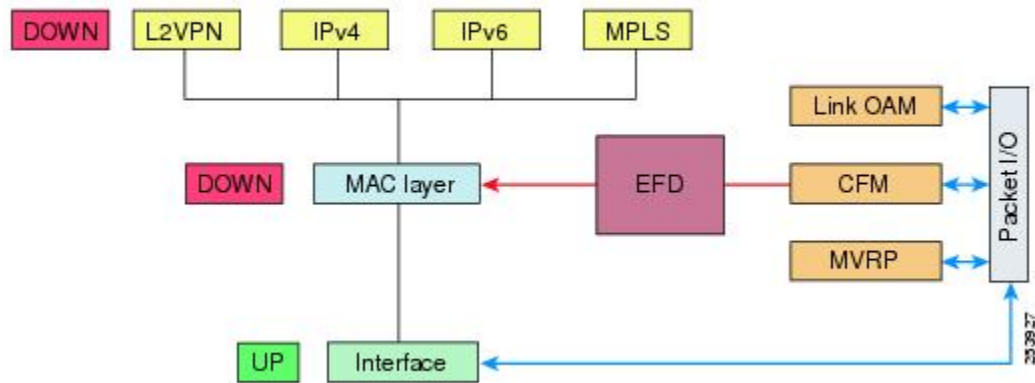

Link Monitoring

Link monitoring enables an OAM peer to monitor faults that cause the quality of a link to deteriorate over time. When link monitoring is enabled, an OAM peer can be configured to take action when the configured thresholds are exceeded.

MIB Retrieval

MIB retrieval enables an OAM peer on one side of an interface to get the MIB variables from the remote side of the link. The MIB variables that are retrieved from the remote OAM peer are READ ONLY.

Remote Loopback

Remote loopback enables one side of a link to put the remote side of the link into loopback mode for testing. When remote loopback is enabled, all packets initiated by the primary side of the link are looped back to the primary side, unaltered by the remote side. In remote loopback mode, the remote side is not allowed to inject any data into the packets.

SNMP Traps

SNMP traps can be enabled or disabled on an Ethernet OAM interface.

Unidirectional Link Detection Protocol

Unidirectional Link Detection (UDLD) is a single-hop physical link protocol for monitoring an ethernet link, including both point-to-point and shared media links. This is a Cisco-proprietary protocol to detect link problems, which are not detected at the physical link layer. This protocol is specifically targeted at possible wiring errors, when using unbundled fiber links, where there can be a mismatch between the transmitting and receiving connections of a port.

How to Configure Ethernet OAM

This section provides these configuration procedures:

Configuring Ethernet Link OAM

Custom EOAM settings can be configured and shared on multiple interfaces by creating an EOAM profile in Ethernet configuration mode and then attaching the profile to individual interfaces. The profile configuration does not take effect until the profile is attached to an interface. After an EOAM profile is attached to an interface, individual EOAM features can be configured separately on the interface to override the profile settings when desired.

This section describes how to configure an EOAM profile and attach it to an interface in these procedures:

Configuring an Ethernet OAM Profile

Perform these steps to configure an Ethernet OAM profile.

Procedure

	Command or Action	Purpose
Step 1	configure Example: RP/0/RP0/CPU0:router# configure terminal	Enters global configuration mode.
Step 2	ethernet oam profile <i>profile-name</i> Example: RP/0/RP0/CPU0:router(config)# ethernet oam profile Profile_1	Creates a new Ethernet Operations, Administration and Maintenance (OAM) profile and enters Ethernet OAM configuration mode.
Step 3	link-monitor Example: RP/0/RP0/CPU0:router(config-eoam)# link-monitor	Enters the Ethernet OAM link monitor configuration mode.
Step 4	symbol-period window <i>window</i> Example:	(Optional) Configures the window size (in milliseconds) for an Ethernet OAM symbol-period error event. The IEEE 802.3

	Command or Action	Purpose
	<pre>RP/0/RP0/CPU0:router(config-eoam-lm)# symbol-period window 60000</pre>	<p>standard defines the window size as a number of symbols rather than a time duration. These two formats can be converted either way by using a knowledge of the interface speed and encoding.</p> <p>The range is 1000 to 60000.</p> <p>The default value is 1000.</p>
Step 5	<p>symbol-period threshold low <i>threshold</i> high <i>threshold</i> symbol-period threshold { ppm [low <i>threshold</i>] [high <i>threshold</i>] symbols [low <i>threshold</i> [thousand million billion]] [high <i>threshold</i> [thousand million billion]] }</p> <p>Example:</p> <pre>RP/0/RP0/CPU0:router(config-eoam-lm)# symbol-period threshold ppm low 1 high 1000000</pre>	<p>(Optional) Configures the thresholds (in symbols) that trigger an Ethernet OAM symbol-period error event. The high threshold is optional and is configurable only in conjunction with the low threshold.</p> <p>The range is 1 to 1000000.</p> <p>The default low threshold is 1.</p>
Step 6	<p>frame window <i>window</i></p> <p>Example:</p> <pre>RP/0/RP0/CPU0:router(config-eoam-lm)# frame window 6000</pre>	<p>(Optional) Configures the frame window size (in milliseconds) of an OAM frame error event.</p> <p>The range is from 1000 to 60000.</p> <p>The default value is 1000.</p>
Step 7	<p>frame threshold low <i>threshold</i> high <i>threshold</i></p> <p>Example:</p> <pre>RP/0/RP0/CPU0:router(config-eoam-lm)# frame threshold low 10000000 high 60000000</pre>	<p>(Optional) Configures the thresholds (in symbols) that triggers an Ethernet OAM frame error event. The high threshold is optional and is configurable only in conjunction with the low threshold.</p> <p>The range is from 0 to 60000000.</p> <p>The default low threshold is 1.</p>
Step 8	<p>frame-period window <i>window</i></p> <p>Example:</p> <pre>RP/0/RP0/CPU0:router(config-eoam-lm)# frame-period window 60000 RP/0/RP0/CPU0:router(config-eoam-lm)# frame-period window milliseconds 60000</pre>	<p>(Optional) Configures the window size (in milliseconds) for an Ethernet OAM frame-period error event. The IEEE 802.3 standard defines the window size as number of frames rather than a time duration. These two formats can be converted either way by using a knowledge of the interface speed. Note that the conversion assumes that all frames are of the minimum size.</p> <p>The range is from 1000 to 60000.</p> <p>The default value is 1000.</p>

	Command or Action	Purpose
		<p>Note The only accepted values are multiples of the line card interface module-specific polling interval, that is, 1000 milliseconds for most line card interface modules.</p>
Step 9	<p>frame-period threshold lowthreshold high threshold frame-period threshold { ppm [low threshold] [high threshold] frames [low threshold [thousand million billion]] [high threshold [thousand million billion]] }</p> <p>Example:</p> <pre>RP/0/RP0/CPU0:router(config-eoam-lm)# frame-period threshold ppm low 100 high 1000000</pre>	<p>(Optional) Configures the thresholds (in errors per million frames) that trigger an Ethernet OAM frame-period error event. The frame period window is defined in the IEEE specification as a number of received frames, in our implementation it is x milliseconds. The high threshold is optional and is configurable only in conjunction with the low threshold.</p> <p>The range is from 1 to 1000000.</p> <p>The default low threshold is 1.</p> <p>To obtain the number of frames, the configured time interval is converted to a window size in frames using the interface speed. For example, for a 1Gbps interface, the IEEE defines minimum frame size as 512 bits. So, we get a maximum of approximately 1.5 million frames per second. If the window size is configured to be 8 seconds (8000ms) then this would give us a Window of 12 million frames in the specification's definition of Errored Frame Window.</p> <p>The thresholds for frame-period are measured in errors per million frames. Hence, if you configure a window of 8000ms (that is a window of 12 million frames) and a high threshold of 100, then the threshold would be crossed if there are 1200 errored frames in that period (that is, 100 per million for 12 million).</p>
Step 10	<p>frame-seconds window window</p> <p>Example:</p> <pre>RP/0/RP0/CPU0:router(config-eoam-lm)# frame-seconds window 900000</pre>	<p>(Optional) Configures the window size (in milliseconds) for the OAM frame-seconds error event.</p> <p>The range is 10000 to 900000.</p> <p>The default value is 60000.</p> <p>Note The only accepted values are multiples of the line card interface module-specific polling interval, that is, 1000 milliseconds for most line card interface modules.</p>

	Command or Action	Purpose
Step 11	<p>frame-seconds threshold low <i>threshold</i> high <i>threshold</i></p> <p>Example:</p> <pre>RP/0/RP0/CPU0:router(config-eoam-lm)# frame-seconds threshold low 3 high 900</pre>	<p>(Optional) Configures the thresholds (in seconds) that trigger a frame-seconds error event. The high threshold value can be configured only in conjunction with the low threshold value.</p> <p>The range is 1 to 900</p> <p>The default value is 1.</p>
Step 12	<p>exit</p> <p>Example:</p> <pre>RP/0/RP0/CPU0:router(config-eoam-lm)# exit</pre>	Exits back to Ethernet OAM mode.
Step 13	<p>mib-retrieval</p> <p>Example:</p> <pre>RP/0/RP0/CPU0:router(config-eoam)# mib-retrieval</pre>	Enables MIB retrieval in an Ethernet OAM profile or on an Ethernet OAM interface.
Step 14	<p>connection timeout <<i>timeout</i>></p> <p>Example:</p> <pre>RP/0/RP0/CPU0:router(config-eoam)# connection timeout 30</pre>	<p>Configures the connection timeout period for an Ethernet OAM session, as a multiple of the hello interval.</p> <p>The range is 2 to 30.</p> <p>The default value is 5.</p>
Step 15	<p>hello-interval {100ms 1s}</p> <p>Example:</p> <pre>RP/0/RP0/CPU0:router(config-eoam)# hello-interval 100ms</pre>	Configures the time interval between hello packets for an Ethernet OAM session. The default is 1 second (1s).
Step 16	<p>mode {active passive}</p> <p>Example:</p> <pre>RP/0/RP0/CPU0:router(config-eoam)# mode passive</pre>	Configures the Ethernet OAM mode. The default is active.
Step 17	<p>require-remote mode {active passive}</p> <p>Example:</p> <pre>RP/0/RP0/CPU0:router(config-eoam)# require-remote mode active</pre>	Requires that active mode or passive mode is configured on the remote end before the OAM session becomes active.

	Command or Action	Purpose
Step 18	require-remote mib-retrieval Example: <pre>RP/0/RP0/CPU0:router(config-eoam)# require-remote mib-retrieval</pre>	Requires that MIB-retrieval is configured on the remote end before the OAM session becomes active.
Step 19	action capabilities-conflict {disable efd error-disable-interface} Example: <pre>RP/0/RP0/CPU0:router(config-eoam)# action capabilities-conflict efd</pre>	<p>Specifies the action that is taken on an interface when a capabilities-conflict event occurs. The default action is to create a syslog entry.</p> <p>Note</p> <ul style="list-style-type: none"> If you change the default, the log keyword option is available in Interface Ethernet OAM configuration mode to override the profile setting and log the event for the interface when it occurs.
Step 20	action critical-event {disable error-disable-interface} Example: <pre>RP/0/RP0/CPU0:router(config-eoam)# action critical-event error-disable-interface</pre>	<p>Specifies the action that is taken on an interface when a critical-event notification is received from the remote Ethernet OAM peer. The default action is to create a syslog entry.</p> <p>Note</p> <ul style="list-style-type: none"> If you change the default, the log keyword option is available in Interface Ethernet OAM configuration mode to override the profile setting and log the event for the interface when it occurs.
Step 21	action discovery-timeout {disable efd error-disable-interface} Example: <pre>RP/0/RP0/CPU0:router(config-eoam)# action discovery-timeout efd</pre>	<p>Specifies the action that is taken on an interface when a connection timeout occurs. The default action is to create a syslog entry.</p> <p>Note</p> <ul style="list-style-type: none"> If you change the default, the log keyword option is available in Interface Ethernet OAM configuration mode to override the profile setting and log the event for the interface when it occurs.
Step 22	action dying-gasp {disable error-disable-interface} Example: <pre>RP/0/RP0/CPU0:router(config-eoam)#</pre>	Specifies the action that is taken on an interface when a dying-gasp notification is received from the remote Ethernet OAM peer. The default action is to create a syslog entry.

	Command or Action	Purpose
	<pre>action dying-gasp error-disable-interface</pre>	<p>Note</p> <ul style="list-style-type: none"> If you change the default, the log keyword option is available in Interface Ethernet OAM configuration mode to override the profile setting and log the event for the interface when it occurs.
Step 23	<p>action high-threshold {error-disable-interface log}</p> <p>Example:</p> <pre>RP/0/RP0/CPU0:router(config-eoam)# action high-threshold error-disable-interface</pre>	<p>Specifies the action that is taken on an interface when a high threshold is exceeded. The default is to take no action when a high threshold is exceeded.</p> <p>Note</p> <ul style="list-style-type: none"> If you change the default, the disable keyword option is available in Interface Ethernet OAM configuration mode to override the profile setting and take no action at the interface when the event occurs.
Step 24	<p>action session-down {disable efd error-disable-interface}</p> <p>Example:</p> <pre>RP/0/RP0/CPU0:router(config-eoam)# action session-down efd</pre>	<p>Specifies the action that is taken on an interface when an Ethernet OAM session goes down.</p> <p>Note</p> <ul style="list-style-type: none"> If you change the default, the log keyword option is available in Interface Ethernet OAM configuration mode to override the profile setting and log the event for the interface when it occurs.
Step 25	<p>action session-up disable</p> <p>Example:</p> <pre>RP/0/RP0/CPU0:router(config-eoam)# action session-up disable</pre>	<p>Specifies that no action is taken on an interface when an Ethernet OAM session is established. The default action is to create a syslog entry.</p> <p>Note</p> <ul style="list-style-type: none"> If you change the default, the log keyword option is available in Interface Ethernet OAM configuration mode to override the profile setting and log the event for the interface when it occurs.
Step 26	<p>action uni-directional link-fault {disable efd error-disable-interface}</p>	<p>Specifies the action that is taken on an interface when a link-fault notification is received from the remote Ethernet OAM peer. The default action is to create a syslog entry.</p>

	Command or Action	Purpose
		<p>Note</p> <ul style="list-style-type: none"> If you change the default, the log keyword option is available in Interface Ethernet OAM configuration mode to override the profile setting and log the event for the interface when it occurs.
Step 27	<p>action wiring-conflict {disable efd log}</p> <p>Example:</p> <pre>RP/0/RP0/CPU0:router(config-eoam)# action session-down efd</pre>	<p>Specifies the action that is taken on an interface when a wiring-conflict event occurs. The default is to put the interface into error-disable state.</p> <p>Note</p> <ul style="list-style-type: none"> If you change the default, the error-disable-interface keyword option is available in Interface Ethernet OAM configuration mode to override the profile setting and put the interface into error-disable state when the event occurs.
Step 28	<p>uni-directional link-fault detection</p> <p>Example:</p> <pre>RP/0/RP0/CPU0:router(config-eoam)# uni-directional link-fault detection</pre>	<p>Enables detection of a local, unidirectional link fault and sends notification of that fault to an Ethernet OAM peer.</p>
Step 29	<p>commit</p> <p>Example:</p> <pre>RP/0/RP0/CPU0:router(config-if)# commit</pre>	<p>Saves the configuration changes to the running configuration file and remains within the configuration session.</p>
Step 30	<p>end</p> <p>Example:</p> <pre>RP/0/RP0/CPU0:router(config-if)# end</pre>	<p>Ends the configuration session and exits to the EXEC mode.</p>

Attaching an Ethernet OAM Profile to an Interface

Perform these steps to attach an Ethernet OAM profile to an interface:

Procedure

	Command or Action	Purpose
Step 1	configure Example: RP/0/RP0/CPU0:router# configure terminal	Enters global configuration mode.
Step 2	interface [HundredGigE TenGigE] <i>interface-path-id</i> Example: RP/0/RP0/CPU0:router(config)# interface TenGigE 0/0/0/0	Enters interface configuration mode and specifies the Ethernet interface name and notation <i>rack/slot/module/port</i> .
Step 3	ethernet oam Example: RP/0/RP0/CPU0:router(config-if)# ethernet oam	Enables Ethernet OAM and enters interface Ethernet OAM configuration mode.
Step 4	profile profile-name Example: RP/0/RP0/CPU0:router(config-if-eoam)# profile Profile_1	Attaches the specified Ethernet OAM profile (<i>profile-name</i>), and all of its configuration, to the interface.
Step 5	commit Example: RP/0/RP0/CPU0:router(config-if)# commit	Saves the configuration changes to the running configuration file and remains within the configuration session.
Step 6	end Example: RP/0/RP0/CPU0:router(config-if)# end	Ends the configuration session and exits to the EXEC mode.

Configuring Ethernet OAM at an Interface and Overriding the Profile Configuration

Using an EOAM profile is an efficient way of configuring multiple interfaces with a common EOAM configuration. However, if you want to use a profile but also change the behavior of certain functions for a particular interface, then you can override the profile configuration. To override certain profile settings that are applied to an interface, you can configure that command in interface Ethernet OAM configuration mode to change the behavior for that interface.

In some cases, only certain keyword options are available in interface Ethernet OAM configuration due to the default settings for the command. For example, without any configuration of the **action** commands, several forms of the command have a default behavior of creating a syslog entry when a profile is created and applied to an interface. Therefore, the **log** keyword is not available in Ethernet OAM configuration for these commands

in the profile because it is the default behavior. However, the **log** keyword is available in Interface Ethernet OAM configuration if the default is changed in the profile configuration so you can retain the action of creating a syslog entry for a particular interface.

To see all of the default Ethernet OAM configuration settings, see the [Verifying the Ethernet OAM Configuration](#).

To configure Ethernet OAM settings at an interface and override the profile configuration, perform these steps:

Procedure

	Command or Action	Purpose
Step 1	configure Example: <pre>RP/0/RP0/CPU0:router# configure terminal</pre>	Enters global configuration mode.
Step 2	interface [HundredGigE TenGigE] <i>interface-path-id</i> Example: <pre>RP/0/RP0/CPU0:router(config)# interface TenGigE 0/0/0/0</pre>	Enters interface configuration mode and specifies the Ethernet interface name and notation <i>rack/slot/module/port</i> . Note <ul style="list-style-type: none"> The example indicates an 8-port 10-Gigabit Ethernet interface in modular services card slot 1.
Step 3	ethernet oam Example: <pre>RP/0/RP0/CPU0:router(config-if)# ethernet oam</pre>	Enables Ethernet OAM and enters interface Ethernet OAM configuration mode.
Step 4	<i>interface-Ethernet-OAM-command</i> Example: <pre>RP/0/RP0/CPU0:router(config-if-eoam)# action capabilities-conflict error-disable-interface</pre>	Configures a setting for an Ethernet OAM configuration command and overrides the setting for the profile configuration, where <i>interface-Ethernet-OAM-command</i> is one of the supported commands on the platform in interface Ethernet OAM configuration mode.
Step 5	commit Example: <pre>RP/0/RP0/CPU0:router(config-if)# commit</pre>	Saves the configuration changes to the running configuration file and remains within the configuration session.
Step 6	end Example: <pre>RP/0/RP0/CPU0:router(config-if)# end</pre>	Ends the configuration session and exits to the EXEC mode.

Verifying the Ethernet OAM Configuration

Use the **show ethernet oam configuration** command to display the values for the Ethernet OAM configuration for a particular interface, or for all interfaces. The following example shows the default values for Ethernet OAM settings:

```
RP/0/RP0/CPU0:router# show ethernet oam configuration
Thu Aug 5 22:07:06.870 DST
GigabitEthernet0/0/0/0:
  Hello interval:                1s
  Mib retrieval enabled:         N
  Uni-directional link-fault detection enabled: N
  Configured mode:              Active
  Connection timeout:           5
  Symbol period window:         0
  Symbol period low threshold:   1
  Symbol period high threshold: None
  Frame window:                 1000
  Frame low threshold:          1
  Frame high threshold:         None
  Frame period window:          1000
  Frame period low threshold:    1
  Frame period high threshold:  None
  Frame seconds window:         60000
  Frame seconds low threshold:   1
  Frame seconds high threshold: None
  High threshold action:        None
  Link fault action:            Log
  Dying gasp action:            Log
  Critical event action:         Log
  Discovery timeout action:      Log
  Capabilities conflict action:  Log
  Wiring conflict action:       Error-Disable
  Session up action:            Log
  Session down action:          Log
  Require remote mode:          Ignore
  Require remote MIB retrieval:  N
```

Configuration Examples for Ethernet OAM

This section provides the following configuration examples:

Configuration Examples for EOAM Interfaces

This section provides the following configuration examples:

Configuring an Ethernet OAM Profile Globally: Example

This example shows how to configure an Ethernet OAM profile globally:

```
configure terminal
ethernet oam profile Profile_1
  link-monitor
  symbol-period window 60000
  symbol-period threshold ppm low 10000000 high 60000000
  frame window 60
  frame threshold ppm low 10000000 high 60000000
  frame-period window 60000
  frame-period threshold ppm low 100 high 12000000
  frame-seconds window 900000
```

```

    frame-seconds threshold low 3 high 900
  exit
mib-retrieval
connection timeout 30
require-remote mode active
require-remote mib-retrieval
action dying-gasp error-disable-interface
action critical-event error-disable-interface
action discovery-timeout error-disable-interface
action session-down error-disable-interface
action capabilities-conflict error-disable-interface
action wiring-conflict error-disable-interface
action remote-loopback error-disable-interface
commit

```

Configuring Ethernet OAM Features on an Individual Interface: Example

This example shows how to configure Ethernet OAM features on an individual interface:

```

configure terminal
interface TenGigE 0/0/0/0
  ethernet oam
  link-monitor
  symbol-period window 60000
  symbol-period threshold ppm low 10000000 high 60000000
  frame window 60
  frame threshold ppm low 10000000 high 60000000
  frame-period window 60000
  frame-period threshold ppm low 100 high 12000000
  frame-seconds window 900000
  frame-seconds threshold low 3 high 900
  exit
mib-retrieval
connection timeout 30
require-remote mode active
require-remote mib-retrieval
action link-fault error-disable-interface
action dying-gasp error-disable-interface
action critical-event error-disable-interface
action discovery-timeout error-disable-interface
action session-down error-disable-interface
action capabilities-conflict error-disable-interface
action wiring-conflict error-disable-interface
action remote-loopback error-disable-interface
commit

```

Configuring Ethernet OAM Features to Override the Profile on an Individual Interface: Example

This example shows the configuration of Ethernet OAM features in a profile followed by an override of that configuration on an interface:

```

configure terminal
ethernet oam profile Profile_1
mode passive
action dying-gasp disable
action critical-event disable
action discovery-timeout disable
action session-up disable
action session-down disable
action capabilities-conflict disable
action wiring-conflict disable
action remote-loopback disable

```

```

action uni-directional link-fault error-disable-interface
commit

configure terminal
interface TenGigE 0/0/0/0
  ethernet oam
  profile Profile_1
  mode active
  action dying-gasp log
  action critical-event log
  action discovery-timeout log
  action session-up log
  action session-down log
  action capabilities-conflict log
  action wiring-conflict log
  action remote-loopback log
  action uni-directional link-fault log
  uni-directional link-fault detection
commit

```

Clearing Ethernet OAM Statistics on an Interface: Example

This example shows how to clear Ethernet OAM statistics on an interface:

```
RP/0/RP0/CPU0:router# clear ethernet oam statistics interface gigabitethernet 0/0/0/1
```

Enabling SNMP Server Traps on a Router: Example

This example shows how to enable SNMP server traps on a router:

```

configure terminal
snmp-server traps ethernet oam events

```

Ethernet CFM

Ethernet Connectivity Fault Management (CFM) is a service-level OAM protocol that provides tools for monitoring and troubleshooting end-to-end Ethernet services per VLAN. This includes proactive connectivity monitoring, fault verification, and fault isolation. CFM uses standard Ethernet frames and can be run on any physical media that is capable of transporting Ethernet service frames. Unlike most other Ethernet protocols which are restricted to a single physical link, CFM frames can transmit across the entire end-to-end Ethernet network.

CFM is defined in two standards:

- IEEE 802.1ag—Defines the core features of the CFM protocol.
- ITU-T Y.1731—Redefines, but maintains compatibility with the features of IEEE 802.1ag, and defines some additional features.

Ethernet CFM supports these functions of ITU-T Y.1731:

- ETH-CC, ETH-RDI, ETH-LB, ETH-LT, ETH-BNM, ETH-CSF—These are equivalent to the corresponding features defined in IEEE 802.1ag.



Note The Linktrace responder procedures defined in IEEE 802.1ag are used rather than the procedures defined in Y.1731; however, these are interoperable.

- ETH-AIS—The reception of ETH-LCK messages is also supported.

To understand how the CFM maintenance model works, you need to understand these concepts and features:

Maintenance Domains

A maintenance domain describes a management space for the purpose of managing and administering a network. A domain is owned and operated by a single entity and defined by the set of interfaces internal to it and at its boundary, as shown in this figure.

Figure 2: CFM Maintenance Domain

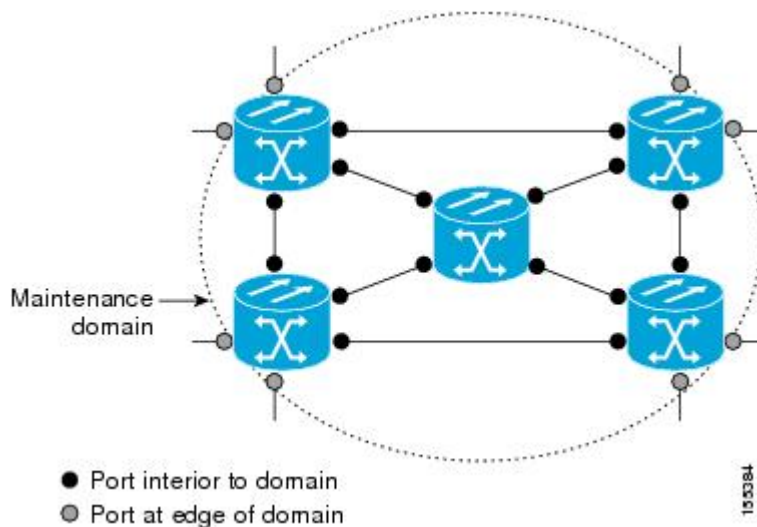

A maintenance domain is defined by the bridge ports that are provisioned within it. Domains are assigned maintenance levels, in the range of 0 to 7, by the administrator. The level of the domain is useful in defining the hierarchical relationships of multiple domains.

CFM maintenance domains allow different organizations to use CFM in the same network, but independently. For example, consider a service provider who offers a service to a customer, and to provide that service, they use two other operators in segments of the network. In this environment, CFM can be used in the following ways:

- The customer can use CFM between their CE devices, to verify and manage connectivity across the whole network.
- The service provider can use CFM between their PE devices, to verify and manage the services they are providing.
- Each operator can use CFM within their operator network, to verify and manage connectivity within their network.

Each organization uses a different CFM maintenance domain.

This figure shows an example of the different levels of maintenance domains in a network.



Note In CFM diagrams, the conventions are that triangles represent MEPs, pointing in the direction that the MEP sends CFM frames, and circles represent MIPs.

Figure 3: Different CFM Maintenance Domains Across a Network

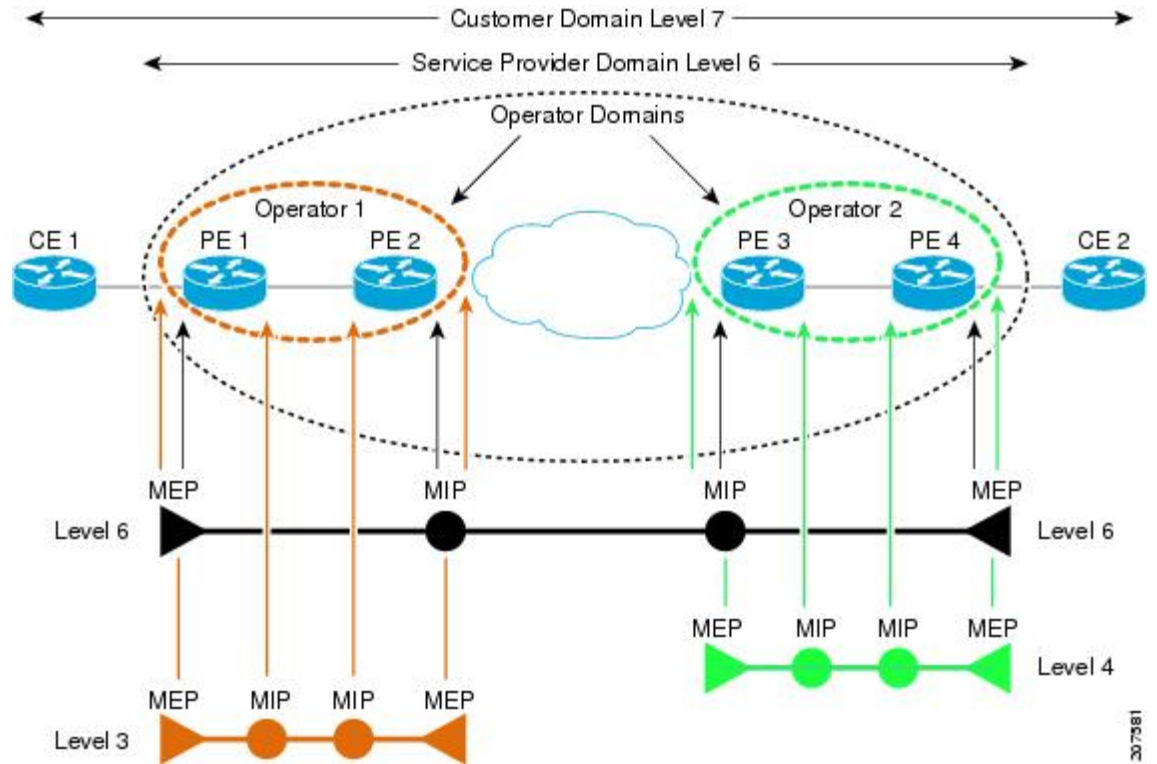

To ensure that the CFM frames for each domain do not interfere with each other, each domain is assigned a maintenance level, between 0 and 7. Where domains are nested, as in this example, the encompassing domain must have a higher level than the domain it encloses. In this case, the domain levels must be negotiated between the organizations involved. The maintenance level is carried in all CFM frames that relate to that domain.

CFM maintenance domains may touch or nest, but cannot intersect. This figure illustrates the supported structure for touching and nested domains, and the unsupported intersection of domains.

Figure 4: Supported CFM Maintenance Domain Structure

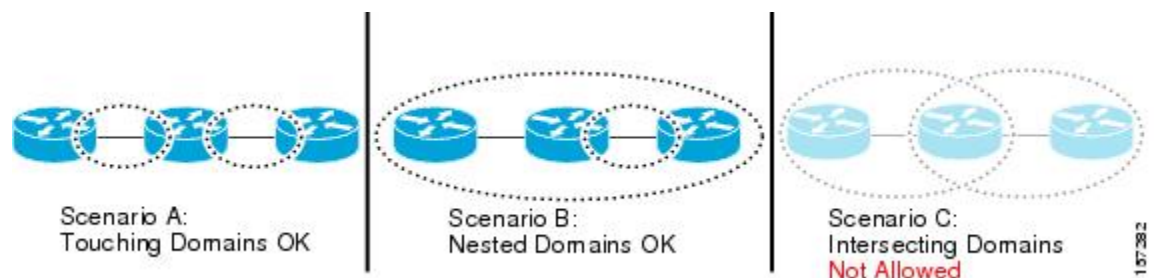

Services

A CFM service allows an organization to partition its CFM maintenance domain, according to the connectivity within the network. For example, if the network is divided into a number of virtual LANs (VLANs), a CFM service is created for each of these. CFM can then operate independently in each service. It is important that the CFM services match the network topology, so that CFM frames relating to one service cannot be received in a different service. For example, a service provider may use a separate CFM service for each of their customers, to verify and manage connectivity between that customer's end points.

A CFM service is always associated with the maintenance domain that it operates within, and therefore with that domain's maintenance level. All CFM frames relating to the service carry the maintenance level of the corresponding domain.



Note CFM Services are referred to as *Maintenance Associations* in IEEE 802.1ag and as *Maintenance Entity Groups* in ITU-T Y.1731.

Maintenance Points

A CFM Maintenance Point (MP) is an instance of a particular CFM service on a specific interface. CFM only operates on an interface if there is a CFM maintenance point on the interface; otherwise, CFM frames are forwarded transparently through the interface.

A maintenance point is always associated with a particular CFM service, and therefore with a particular maintenance domain at a particular level. Maintenance points generally only process CFM frames at the same level as their associated maintenance domain. Frames at a higher maintenance level are always forwarded transparently, while frames at a lower maintenance level are normally dropped. This helps enforce the maintenance domain hierarchy, and ensures that CFM frames for a particular domain cannot leak out beyond the boundary of the domain.

There are two types of MP:

- Maintenance End Points (MEPs)—Created at the edge of the domain. Maintenance end points (MEPs) are members of a particular service within a domain and are responsible for sourcing and sinking CFM frames. They periodically transmit continuity check messages and receive similar messages from other MEPs within their domain. They also transmit traceroute and loopback messages at the request of the administrator. MEPs are responsible for confining CFM messages within the domain.
- Maintenance Intermediate Points (MIPs)—Created in the middle of the domain. Unlike MEPS, MIPs do allow CFM frames at their own level to be forwarded.

MIP Creation

Unlike MEPs, MIPs are not explicitly configured on each interface. MIPs are created automatically according to the algorithm specified in the CFM 802.1ag standard. The algorithm, in brief, operates as follows for each interface:

- The bridge-domain or cross-connect for the interface is found, and all services associated with that bridge-domain or cross-connect are considered for MIP auto-creation.

- The level of the highest-level MEP on the interface is found. From among the services considered above, the service in the domain with the lowest level that is higher than the highest MEP level is selected. If there are no MEPs on the interface, the service in the domain with the lowest level is selected.
- The MIP auto-creation configuration (**mip auto-create** command) for the selected service is examined to determine whether a MIP should be created.



Note Configuring a MIP auto-creation policy for a service does not guarantee that a MIP will automatically be created for that service. The policy is only considered if that service is selected by the algorithm first.

MEP and CFM Processing Overview

The boundary of a domain is an interface, rather than a bridge or host. Therefore, MEPs can be sub-divided into two categories:

- Down MEPs—Send CFM frames from the interface where they are configured, and process CFM frames received on that interface. Down MEPs transmit AIS messages upward (toward the cross-connect).
- Up MEPs—Send frames into the bridge relay function, as if they had been received on the interface where the MEP is configured. They process CFM frames that have been received on other interfaces, and have been switched through the bridge relay function as if they are going to be sent out of the interface where the MEP is configured. Up MEPs transmit AIS messages downward (toward the wire). However, AIS packets are only sent when there is a MIP configured on the same interface as the MEP and at the level of the MIP.



Note The terms *Down MEP* and *Up MEP* are defined in the IEEE 802.1ag and ITU-T Y.1731 standards, and refer to the direction that CFM frames are sent from the MEP. The terms should not be confused with the operational status of the MEP.

This figure illustrates the monitored areas for Down and Up MEPs.

Figure 5: Monitored Areas for Down and Up MEPs

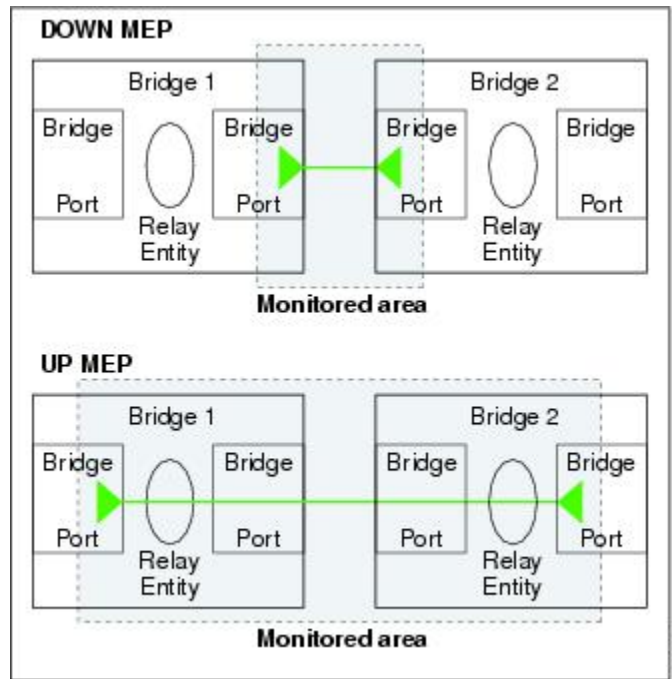

This figure shows maintenance points at different levels. Because domains are allowed to nest but not intersect (see [Supported CFM Maintenance Domain Structure](#)), a MEP at a low level always corresponds with a MEP or MIP at a higher level. In addition, only a single MIP is allowed on any interface—this is generally created in the lowest domain that exists at the interface and that does not have a MEP.

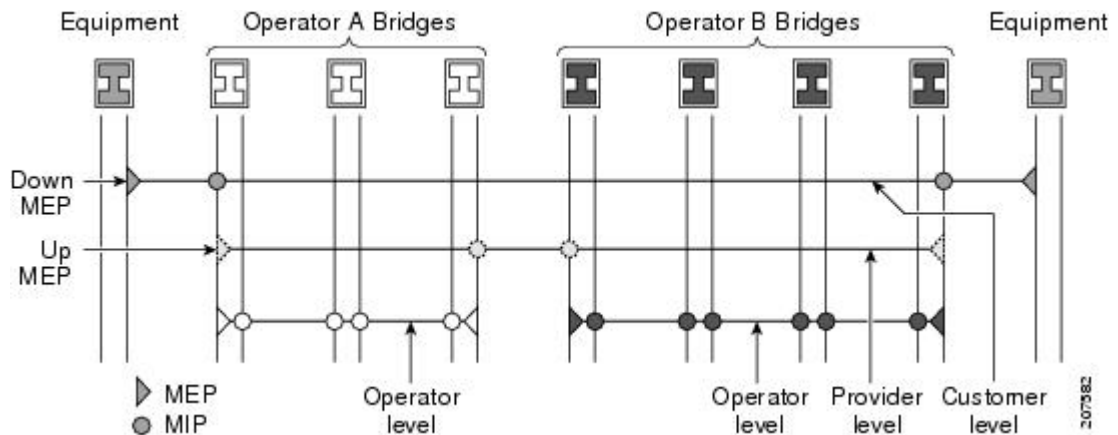

MIPs and Up MEPs can only exist on switched (Layer 2) interfaces, because they send and receive frames from the bridge relay function. Down MEPs can be created on switched (Layer 2) interfaces.

MEPs continue to operate normally if the interface they are created on is blocked by the Spanning Tree Protocol (STP); that is, CFM frames at the level of the MEP continue to be sent and received, according to the direction of the MEP. MEPs never allow CFM frames at the level of the MEP to be forwarded, so the STP block is maintained.

MIPs also continue to receive CFM frames at their level if the interface is STP blocked, and can respond to any received frames. However, MIPs do not allow CFM frames at the level of the MIP to be forwarded if the interface is blocked.



Note A separate set of CFM maintenance levels is created every time a VLAN tag is pushed onto the frame. Therefore, if CFM frames are received on an interface which pushes an additional tag, so as to “tunnel” the frames over part of the network, the CFM frames will not be processed by any MPs within the tunnel, even if they are at the same level. For example, if a CFM MP is created on an interface with an encapsulation that matches a single VLAN tag, any CFM frames that are received at the interface that have two VLAN tags will be forwarded transparently, regardless of the CFM level.

CFM Protocol Messages

The CFM protocol consists of a number of different message types, with different purposes. All CFM messages use the CFM EtherType, and carry the CFM maintenance level for the domain to which they apply.

This section describes the following CFM messages:

Continuity Check (IEEE 802.1ag and ITU-T Y.1731)

Continuity Check Messages (CCMs) are “heartbeat” messages exchanged periodically between all the MEPs in a service. Each MEP sends out multicast CCMs, and receives CCMs from all the other MEPs in the service—these are referred to as *peer MEPs*. This allows each MEP to discover its peer MEPs, and to verify that there is connectivity between them.

MIPs also receive CCMs. MIPs use the information to build a MAC learning database that is used when responding to Linktrace. For more information about Linktrace, see the [Linktrace \(IEEE 802.1ag and ITU-T Y.1731\)](#).

Figure 6: Continuity Check Message Flow

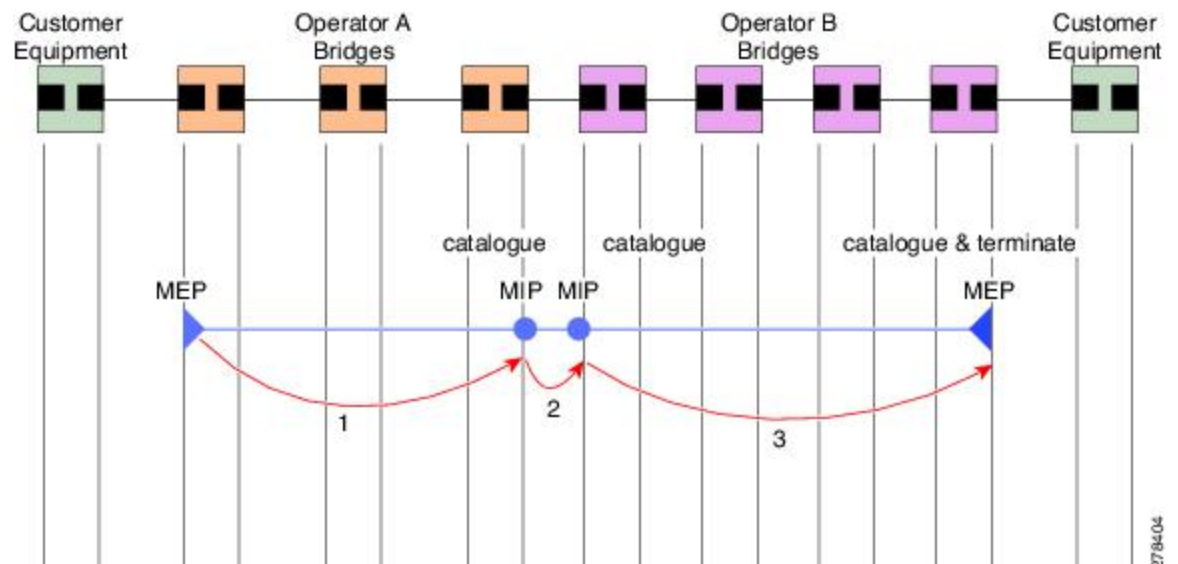

278404

All the MEPs in a service must transmit CCMs at the same interval. The interval at which CCMs are being transmitted is called CCM interval. IEEE 802.1ag defines 7 possible intervals that can be used:

- 3.3ms
- 10ms
- 100ms
- 1s
- 10s
- 1 minute
- 10 minutes

A MEP detects a loss of connectivity with one of its peer MEPs when a certain number of CCMs have been missed. This occurs when sufficient time has passed during which a certain number of CCMs were expected, given the CCM interval. This number is called the *loss threshold*, and is usually set to 3.

CFM is supported only on interfaces which have Layer 2 transport feature enabled.

Maintenance Association Identifier (MAID)

Table 4: Feature History Table

Feature Name	Release	Description
String-based MAID formats for Hardware Offload CFM Sessions	Release 7.5.2	<p>You can now use the Invalid and String format for hardware-offloaded Connectivity Fault Management (CFM) sessions using the Maintenance Association Identifier (MAID) functionality. Earlier releases supported numerical and ICC formats for hardware-offloaded sessions.</p> <p>The router continues to support 1000 CFM sessions which include 500 hardware offload CFM sessions.</p>

Continuity Check Messages (CCM) are essential for detecting various defects in network services. They carry critical information that helps in the identification and maintenance of the service. This is a breakdown of the information contained in CCM messages:

- **Maintenance Domain Identifier (MDID):** A configured identifier unique to the domain of the transmitting Maintenance End Point (MEP). It is crucial for the identification of the maintenance domain.
- **Short MA Name (SMAN):** A configured identifier specific to the service of the transmitting MEP. It is used to identify the service within the maintenance domain.

- **Maintenance Association Identifier (MAID):** A combination of MDID and SMAN. Together, these identifiers form the MAID, which is a composite identifier that must be uniformly configured across all MEPs within the same service.



Note MDID supports **null** value and SMAN only supports ITU Carrier Code (ICC) or a numerical. Starting with Release 7.5.2, MDID and SMAN support the **Invalid** and **String** format values.

Supported MAID Formats for Offloaded MEPs (applicable for NCS 5700 line cards only)

- No Domain Name Format
 - MD Name Format = 1-NoDomainName
 - Short MA Name Format = 3 - 2 bytes integer value
 - Short MA NAmE Length = 2 - fixed length
 - Short MA Name = 2 bytes of integer
- 1731 Maid Format
 - MD Name Format = 1-NoDomainName
 - MA Name Format(MEGID Format) = 32
 - MEGID Length = 13 - fixed length
 - MEGID(ICCCode) = 6 Bytes
 - MEGID(UMC) = 7 Bytes
 - ITU Carrier Code (ICC) - Number of different configurable ICC code - 15 (for each NPU)
 - Unique MEG ID Code (UMC) - 4

These are some examples:

- String format: **ethernet cfm domain domain-1 level 3 service service-1 string string_D1**
- Invalid format:**ethernet cfm invalid**
- Configuring domain ID null: **ethernet cfm domain SMB level 3 id null**
- Configuring SMAN: **ethernet cfm domain SMB level 3 id null service 901234AB xconnect group 99999 p2p 99999 id number 1**

This table summarizes the supported values and parameters for MDID and SMAN. This table only details the MAID restriction on the hardware offload feature. There is no MAID restriction for software offload or non-offloaded MEPs.

Format	MDID	SMAN	Support	Comment
	No	2 byte integer	Yes	Up to 2000 entries

Format	MDID	SMAN	Support	Comment
	No	13 bytes ICCCode (6 bytes) and UMC (7 bytes)	Yes	Up to 15 unique ICC Up to 4K UMC values
48 bytes string based	1-48 bytes of MDID and SMAN		Yes	CFM HW endpoint ID is between 0 to 4095 and in multiples of 4

Guidelines and Restrictions for MAID

- Configure each MEP within the service with a distinct MEP ID, which is a unique numeric identifier.
- Configure MEP CrossCheck for all MEPs with intervals of less than 10s, as Dynamic Remote MEPs are not supported for these.
- In a Remote Defect Indication (RDI), each MEP includes sequence number in the CCMs it is sending, if it has detected a defect relating to the CCMs it is receiving. This notifies all the MEPs in the service that a defect has been detected somewhere in the service. Sequence numbering is not supported for MEPs with CCM intervals of less than 10s.
- CCM Tx/Rx statistics counters are not supported for MEPs with less than 10s intervals.
- Sender TLV and Cisco Proprietary TLVs are not supported for MEPs with less than 10s intervals.
- The status of the interface where the MEP is operating (for example, up - when the interface is up, or down - when the interface is down) should not be confused with the direction of any MEPs on the interface (Up MEPs/Down MEPs).

Defect Identification using CCM Analysis

These defects can be detected from the received CCMs:

- Interval mismatch: The CCM interval in the received CCM does not match the interval that the MEP is configured to send CCMs.
- Level mismatch: A MEP receives a CCM carrying a lower maintenance level than the MEP's own configured level.
- Loop: A CCM is received with a source MAC address that matches the MAC address of the MEP's operating interface, indicating a loop.
- Configuration error: A received CCM contains a MEP ID that duplicates the MEP ID of the receiving MEP, signaling a configuration issue.
- Cross-connect error: A CCM with a non-matching MAID is received, often pointing to a VLAN misconfiguration that causes service leakage.
- Peer interface down: A CCM is received that indicates the interface on the peer is down.
- Remote defect indication: A CCM is received carrying a remote defect indication. This does not trigger the local MEP to send out CCMs with a remote defect indication.

By monitoring the sequence numbers in CCMs from peer MEPs, out-of-sequence CCMs can be identified, although these are not classified as CCM defects.

Loopback (IEEE 802.1ag and ITU-T Y.1731)

Loopback Messages (LBM) and Loopback Replies (LBR) are used to verify connectivity between a local MEP and a particular remote MP. At the request of the administrator, a local MEP sends unicast LBMs to the remote MP. On receiving each LBM, the target maintenance point sends an LBR back to the originating MEP. Loopback indicates whether the destination is reachable or not—it does not allow hop-by-hop discovery of the path. It is similar in concept to an ICMP Echo (ping). Since loopback messages are destined for unicast addresses, they are forwarded like normal data traffic, while observing the maintenance levels. At each device that the loopback reaches, if the outgoing interface is known (in the bridge's forwarding database), then the frame is sent out on that interface. If the outgoing interface is not known, then the message is flooded on all interfaces.

This figure shows an example of CFM loopback message flow between a MEP and MIP.

Figure 7: Loopback Messages

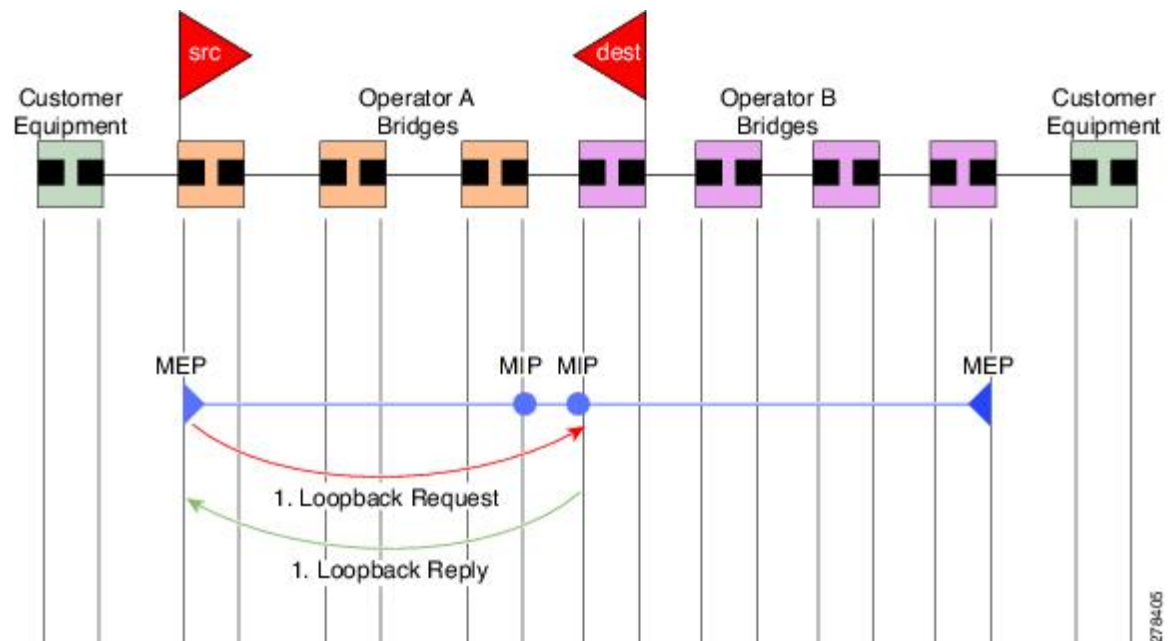

Loopback messages can be padded with user-specified data. This allows data corruption to be detected in the network. They also carry a sequence number which allows for out-of-order frames to be detected.

Linktrace (IEEE 802.1ag and ITU-T Y.1731)

Linktrace Messages (LTM) and Linktrace Replies (LTR) are used to track the path (hop-by-hop) to a unicast destination MAC address. At the request of the operator, a local MEP sends an LTM. Each hop where there is a maintenance point sends an LTR back to the originating MEP. This allows the administrator to discover connectivity data about the path. It is similar in concept to IP traceroute, although the mechanism is different. In IP traceroute, successive probes are sent, whereas CFM Linktrace uses a single LTM which is forwarded by each MP in the path. LTMs are multicast, and carry the unicast target MAC address as data within the

frame. They are intercepted at each hop where there is a maintenance point, and either retransmitted or dropped to discover the unicast path to the target MAC address.

This figure shows an example of CFM linktrace message flow between MEPs and MIPs.

Figure 8: Linktrace Message Flow

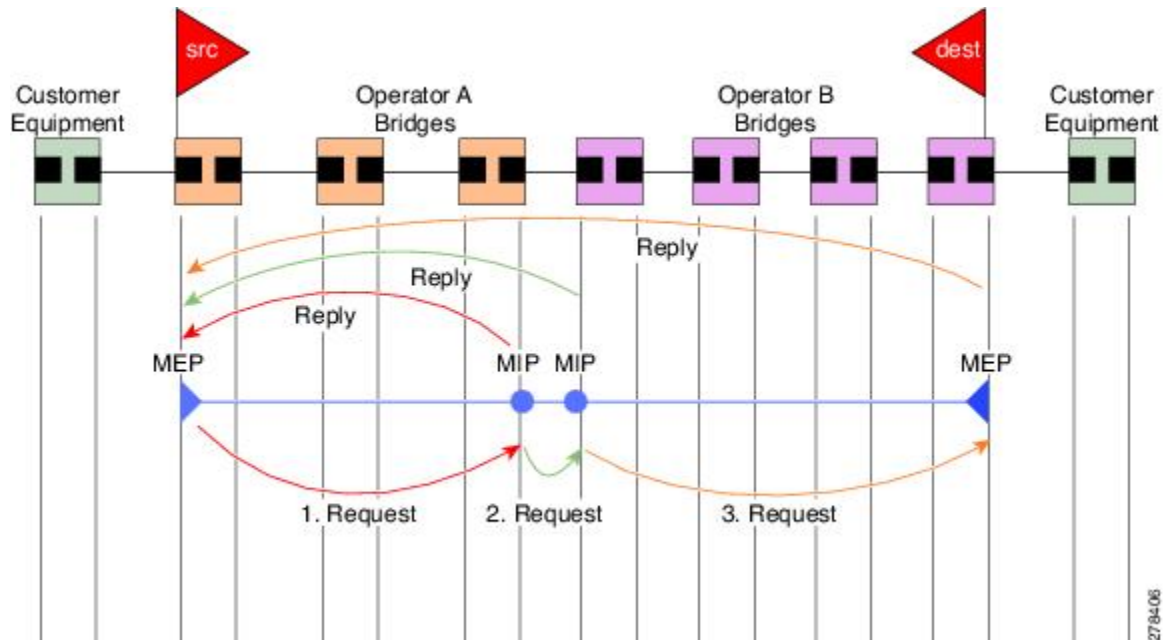

The linktrace mechanism is designed to provide useful information even after a network failure. This allows it to be used to locate failures, for example after a loss of continuity is detected. To achieve this, each MP maintains a CCM Learning Database. This maps the source MAC address for each received CCM to the interface through which the CCM was received. It is similar to a typical bridge MAC learning database, except that it is based only on CCMs and it times out much more slowly—on the order of days rather than minutes.



Note In IEEE 802.1ag, the CCM Learning Database is referred to as the MIP CCM Database. However, it applies to both MIPs and MEPs.

In IEEE 802.1ag, when an MP receives an LTM message, it determines whether to send a reply using the following steps:

1. The target MAC address in the LTM is looked up in the bridge MAC learning table. If the MAC address is known, and therefore the egress interface is known, then an LTR is sent.
2. If the MAC address is not found in the bridge MAC learning table, then it is looked up in the CCM learning database. If it is found, then an LTR is sent.
3. If the MAC address is not found, then no LTR is sent (and the LTM is not forwarded).

If the target MAC has never been seen previously in the network, the linktrace operation will not produce any results.



Note IEEE 802.1ag and ITU-T Y.1731 define slightly different linktrace mechanisms. In particular, the use of the CCM learning database and the algorithm described above for responding to LTM messages are specific to IEEE 802.1ag. IEEE 802.1ag also specifies additional information that can be included in LTRs. Regardless of the differences, the two mechanisms are interoperable.

Configurable Logging

CFM supports logging of various conditions to syslog. Logging can be enabled independently for each service, and when the following conditions occur:

- New peer MEPs are detected, or loss of continuity with a peer MEP occurs.
- Changes to the CCM defect conditions are detected.
- Cross-check “missing” or “unexpected” conditions are detected.
- AIS condition detected (AIS messages received) or cleared (AIS messages no longer received).
- EFD used to shut down an interface, or bring it back up.

Flexible VLAN Tagging for CFM

The Flexible VLAN Tagging for CFM feature ensures that CFM packets are sent with the right VLAN tags so that they are appropriately handled as a CFM packet by the remote device. When packets are received by an edge router, they are treated as either CFM packets or data packets, depending on the number of tags in the header. The system differentiates between CFM packets and data packets based on the number of tags in the packet, and forwards the packets to the appropriate paths based on the number of tags in the packet.

CFM frames are normally sent with the same VLAN tags as the corresponding customer data traffic on the interface, as defined by the configured encapsulation and tag rewrite operations. Likewise, received frames are treated as CFM frames if they have the correct number of tags as defined by the configured encapsulation and tag rewrite configuration, and are treated as data frames (that is, they are forwarded transparently) if they have more than this number of tags.

In most cases, this behavior is as desired, since the CFM frames are then treated in exactly the same way as the data traffic flowing through the same service. However, in a scenario where multiple customer VLANs are multiplexed over a single multipoint provider service (for example, N:1 bundling), a different behavior might be desirable.

This figure shows an example of a network with multiple VLANS using CFM.

Figure 9: Service Provider Network With Multiple VLANs and CFM

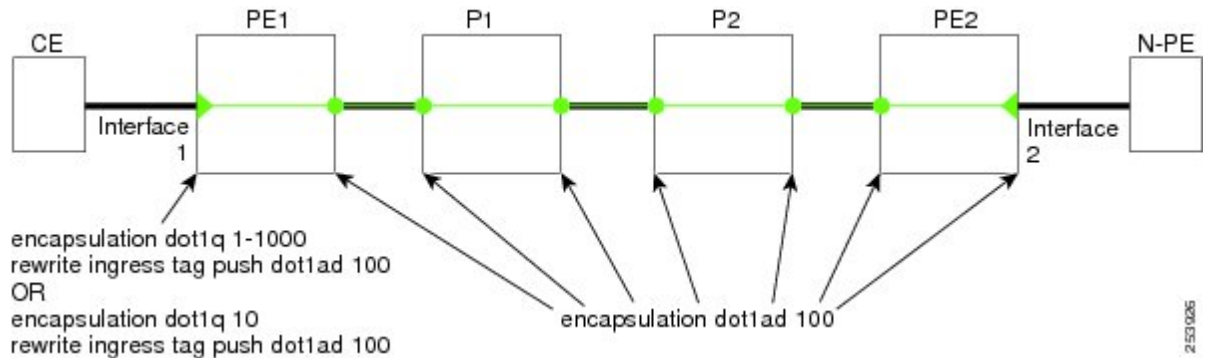

This figure shows a provider's access network, where the S-VLAN tag is used as the service delimiter. PE1 faces the customer, and PE2 is at the edge of the access network facing the core. N:1 bundling is used, so the interface encapsulation matches a range of C-VLAN tags. This could potentially be the full range, resulting in all:1 bundling. There is also a use case where only a single C-VLAN is matched, but the S-VLAN is nevertheless used as the service delimiter—this is more in keeping with the IEEE model, but limits the provider to 4094 services.

CFM is used in this network with a MEP at each end of the access network, and MIPs on the boxes within the network (if it is native Ethernet). In the normal case, CFM frames are sent by the up MEP on PE1 with two VLAN tags, matching the customer data traffic. This means that at the core interfaces and at the MEP on PE2, the CFM frames are forwarded as if they were customer data traffic, since these interfaces match only on the S-VLAN tag. So, the CFM frames sent by the MEP on PE1 are not seen by any of the other MIPs.

Flexible VLAN tagging changes the encapsulation for CFM frames that are sent and received at Up MEPs. Flexible VLAN tagging allows the frames to be sent from the MEP on PE1 with just the S-VLAN tag that represents the provider service. If this is done, the core interfaces will treat the frames as CFM frames and they will be seen by the MIPs and by the MEP on PE2. Likewise, the MEP on PE1 should handle received frames with only one tag, as this is what it will receive from the MEP on PE2.

To ensure that CFM packets from Up MEPs are routed to the appropriate paths successfully, tags may be set to a specific number in a domain service, using the **tags** command. Currently, tags can only be set to one (1).

Configuring Ethernet CFM



Note CFM is not supported for the following:

- L3 Interfaces and Sub-Interfaces
- Bundle Member Ports
- EVPN-FXC
- Bridge Domain
- VPLS

Configuring a CFM Maintenance Domain

To configure a CFM maintenance domain, perform the following steps:

Procedure

	Command or Action	Purpose
Step 1	configure Example: RP/0/RP0/CPU0:router# configure	Enters global configuration mode.
Step 2	ethernet cfm Example: RP/0/RP0/CPU0:router(config)# ethernet cfm	Enters Ethernet Connectivity Fault Management (CFM) configuration mode.
Step 3	traceroute cache hold-time <i>minutes</i> size <i>entries</i> Example: RP/0/RP0/CPU0:router(config-cfm)# traceroute cache hold-time 1 size 3000	(Optional) Sets the maximum limit of traceroute cache entries or the maximum time limit to hold the traceroute cache entries. The default is 100 minutes and 100 entries.
Step 4	domain <i>domain-name</i> level <i>level-value</i> [<i>id</i> [null] [<i>dns</i> <i>DNS-name</i>] [<i>mac</i> <i>H.H.H</i>] [<i>string</i> string]] Example: RP/0/RP0/CPU0:router(config-cfm)# domain Domain_One level 1 id string D1	<p>Creates and names a container for all domain configurations and enters CFM domain configuration mode.</p> <p>The level must be specified.</p> <p>The id is the maintenance domain identifier (MDID) and is used as the first part of the maintenance association identifier (MAID) in CFM frames. If the MDID is not specified, the domain name is used as the MDID by default.</p>
Step 5	end or commit Example: RP/0/RP0/CPU0:router(config-cfm-dmn)# commit	<p>Saves configuration changes.</p> <ul style="list-style-type: none"> When you use the end command, the system prompts you to commit changes: <pre>Uncommitted changes found, commit them before exiting(yes/no/cancel)? [cancel]:</pre> Entering yes saves configuration changes to the running configuration file, exits the configuration session, and returns the router to EXEC mode. Entering no exits the configuration session and returns the router to EXEC mode.

	Command or Action	Purpose
		<p>without committing the configuration changes.</p> <ul style="list-style-type: none"> • Entering cancel leaves the router in the current configuration session without exiting or committing the configuration changes. • Use the commit command to save the configuration changes to the running configuration file and remain within the configuration session.

Configuring Services for a CFM Maintenance Domain

You can configure up to 2000 CFM services for a maintenance domain. To configure services for a CFM maintenance domain, perform the following steps:

Procedure

	Command or Action	Purpose
Step 1	<p>configure</p> <p>Example:</p> <pre>RP/0/RP0/CPU0:router# configure</pre>	Enters global configuration mode.
Step 2	<p>ethernet cfm</p> <p>Example:</p> <pre>RP/0/RP0/CPU0:router(config)# ethernet cfm</pre>	Enters Ethernet CFM configuration mode.
Step 3	<p>domain <i>domain-name</i> level <i>level-value</i> [id [null] [dns <i>DNS-name</i>] [mac <i>H.H.H</i>] [string <i>string</i>]]</p> <p>Example:</p> <pre>RP/0/RP0/CPU0:router(config-cfm)# domain Domain_One level 1 id string D1</pre>	<p>Creates and names a container for all domain configurations at a specified maintenance level, and enters CFM domain configuration mode.</p> <p>The id is the maintenance domain identifier (MDID) and is used as the first part of the maintenance association identifier (MAID) in CFM frames. If the MDID is not specified, the domain name is used as the MDID by default.</p>
Step 4	<p>service <i>service-name</i> {down-meps xconnect group <i>xconnect-group-name</i> m2mp p2p <i>xconnect-name</i>} [id [icc-based <i>icc-string umc-string</i>] [number <i>number</i>]]</p> <p>Example:</p>	Configures and associates a service with the domain and enters CFM domain service configuration mode. You can specify that the service is used only for down MEPs, or associate the service with a bridge domain where MIPs and up MEPs will be created.

	Command or Action	Purpose
	RP/0/RP0/CPU0:router(config-cfm-dmn)# service ABC xconnect group X1 p2p ADB	The id sets the short MA name.
Step 5	end or commit Example: RP/0/RP0/CPU0:router(config-cfm-dmn-svc)# commit	Saves configuration changes. <ul style="list-style-type: none"> When you use the end command, the system prompts you to commit changes: Uncommitted changes found, commit them before exiting(yes/no/cancel)? [cancel]: Entering yes saves configuration changes to the running configuration file, exits the configuration session, and returns the router to EXEC mode. Entering no exits the configuration session and returns the router to EXEC mode without committing the configuration changes. Entering cancel leaves the router in the current configuration session without exiting or committing the configuration changes. Use the commit command to save the configuration changes to the running configuration file and remain within the configuration session.

Enabling and Configuring Continuity Check for a CFM Service

To configure Continuity Check for a CFM service, complete the following steps:

Procedure

	Command or Action	Purpose
Step 1	configure Example: RP/0/RP0/CPU0:router# configure	Enters global configuration mode.
Step 2	ethernet cfm Example: RP/0/RP0/CPU0:router(config)# ethernet cfm	Enters Ethernet Connectivity Fault Management (CFM) configuration mode.

	Command or Action	Purpose
Step 3	<p>domain <i>domain-name</i> level <i>level-value</i> [id [null] [dns <i>DNS-name</i>] [mac <i>H.H.H</i>] [string <i>string</i>]]</p> <p>Example:</p> <pre>RP/0/RP0/CPU0:router(config-cfm)# domain Domain_One level 1 id string D1</pre>	<p>Creates and names a container for all domain configurations and enters the CFM domain configuration mode.</p> <p>The level must be specified.</p> <p>The id is the maintenance domain identifier (MDID) and is used as the first part of the maintenance association identifier (MAID) in CFM frames. If the MDID is not specified, the domain name is used as the MDID by default.</p>
Step 4	<p>service <i>service-name</i> {down-meps xconnect group <i>xconnect-group-name</i> p2p <i>xconnect-name</i>} [id [icc-based <i>icc-string</i> <i>umc-string</i>] [number <i>number</i>]</p> <p>Example:</p> <pre>RP/0/RP0/CPU0:router(config-cfm-dmn)# service ABC xconnect group X1 p2p ADB</pre>	<p>Configures and associates a service with the domain and enters CFM domain service configuration mode. You can specify that the service is used only for down MEPs, or associate the service with a bridge domain or xconnect where MIPs and up MEPs will be created.</p> <p>The id sets the short MA name.</p>
Step 5	<p>continuity-check interval <i>time</i> [loss-threshold <i>threshold</i>]</p> <p>Example:</p> <pre>RP/0/RP0/CPU0:router(config-cfm-dmn-svc)# continuity-check interval 100m loss-threshold 10</pre>	<p>(Optional) Enables Continuity Check and specifies the time interval at which CCMs are transmitted or to set the threshold limit for when a MEP is declared down.</p>
Step 6	<p>continuity-check archive hold-time <i>minutes</i></p> <p>Example:</p> <pre>RP/0/RP0/CPU0:router(config-cfm-dmn-svc)# continuity-check archive hold-time 100</pre>	<p>(Optional) Configures how long information about peer MEPs is stored after they have timed out.</p>
Step 7	<p>continuity-check loss auto-traceroute</p> <p>Example:</p> <pre>RP/0/RP0/CPU0:router(config-cfm-dmn-svc)# continuity-check loss auto-traceroute</pre>	<p>(Optional) Configures automatic triggering of a traceroute when a MEP is declared down.</p>
Step 8	<p>end or commit</p> <p>Example:</p> <pre>RP/0/RP0/CPU0:router(config-cfm-dmn-svc)# commit</pre>	<p>Saves configuration changes.</p> <ul style="list-style-type: none"> When you use the end command, the system prompts you to commit changes: <pre>Uncommitted changes found, commit them before exiting(yes/no/cancel)? [cancel]:</pre>

	Command or Action	Purpose
		<ul style="list-style-type: none"> • Entering yes saves configuration changes to the running configuration file, exits the configuration session, and returns the router to EXEC mode. • Entering no exits the configuration session and returns the router to EXEC mode without committing the configuration changes. • Entering cancel leaves the router in the current configuration session without exiting or committing the configuration changes. • Use the commit command to save the configuration changes to the running configuration file and remain within the configuration session.

Configuring Automatic MIP Creation for a CFM Service

For more information about the algorithm for creating MIPs, see the **MIP Creation** section.

To configure automatic MIP creation for a CFM service, complete the following steps:

Procedure

	Command or Action	Purpose
Step 1	configure Example: RP/0/RP0/CPU0:router# configure	Enters global configuration mode.
Step 2	ethernet cfm Example: RP/0/RP0/CPU0:router# ethernet cfm	Enters the Ethernet Connectivity Fault Management (CFM) configuration mode.
Step 3	domain <i>domain-name</i> level <i>level-value</i> [id [null] [dns <i>DNS-name</i>] [mac <i>H.H.H</i>] [string <i>string</i>]] Example: RP/0/RP0/CPU0:router(config-cfm)# domain Domain_One level 1 id string D1	Creates and names a container for all domain configurations and enters the CFM domain configuration mode. The level must be specified. The only supported option is id [null] for less than 1min interval MEPS. The id is the maintenance domain identifier (MDID) and is used as the first part of the maintenance association identifier (MAID) in

	Command or Action	Purpose
		CFM frames. If the MDID is not specified, the domain name is used as the MDID by default.
Step 4	<p>service <i>service-name</i> {down-meps xconnect group <i>xconnect-group-name</i> p2p <i>xconnect-name</i>} [id [icc-based <i>icc-string umc-string</i>] [number <i>number</i>]</p> <p>Example:</p> <pre>RP/0/RP0/CPU0:router(config-cfm-dmn)# service ABC xconnect group X1 p2p ADB</pre>	<p>Configures and associates a service with the domain and enters CFM domain service configuration mode. You can specify that the service is used only for down MEPs, or associate the service with a bridge domain where MIPs and up MEPs will be created.</p> <p>The id sets the short MA name.</p>
Step 5	<p>mip auto-create {all lower-mep-only} {ccm-learning}</p> <p>Example:</p> <pre>RP/0/RP0/CPU0:router(config-cfm-dmn-svc)# mip auto-create all ccm-learning</pre>	<p>(Optional) Enables the automatic creation of MIPs in a bridge domain. ccm-learning option enables CCM learning for MIPs created in this service. This must be used only in services with a relatively long CCM interval of at least 100 ms. CCM learning at MIPs is disabled by default.</p>
Step 6	<p>end or commit</p> <p>Example:</p> <pre>RP/0/RP0/CPU0:router(config-cfm-dmn-svc)# commit</pre>	<p>Saves configuration changes.</p> <ul style="list-style-type: none"> When you use the end command, the system prompts you to commit changes: <pre>Uncommitted changes found, commit them before exiting(yes/no/cancel)? [cancel]:</pre> Entering yes saves configuration changes to the running configuration file, exits the configuration session, and returns the router to EXEC mode. Entering no exits the configuration session and returns the router to EXEC mode without committing the configuration changes. Entering cancel leaves the router in the current configuration session without exiting or committing the configuration changes. Use the commit command to save the configuration changes to the running configuration file and remain within the configuration session.

Configuring Cross-Check on a MEP for a CFM Service

To configure cross-check on a MEP for a CFM service and specify the expected set of MEPs, complete the following steps:

Procedure

	Command or Action	Purpose
Step 1	configure Example: RP/0/RP0/CPU0:router# configure	Enters global configuration mode.
Step 2	ethernet cfm Example: RP/0/RP0/CPU0:router# ethernet cfm	Enters the Ethernet Connectivity Fault Management (CFM) configuration mode.
Step 3	domain domain-name level level-value [id [null] [dns DNS-name] [mac H.H.H] [string string]] Example: RP/0/RP0/CPU0:router(config-cfm)# domain Domain_One level 1 id string D1	Creates and names a container for all domain configurations and enters the CFM domain configuration mode. The level must be specified. The id is the maintenance domain identifier (MDID) and is used as the first part of the maintenance association identifier (MAID) in CFM frames. If the MDID is not specified, the domain name is used as the MDID by default.
Step 4	service service-name {bridge group bridge-domain-group bridge-domain bridge-domain-name down-meps xconnect group xconnect-group-name p2p xconnect-name} [id [icc-based icc-string umc-string] [string text] [number number] [vlan-id id-number] [vpn-id oui-vpnid]] Example: RP/0/RP0/CPU0:router(config-cfm-dmn)# service Bridge_Service bridge group BD1 bridge-domain B1	Configures and associates a service with the domain and enters CFM domain service configuration mode. You can specify that the service is used only for down MEPs, or associate the service with a bridge domain or xconnect where MIPs and up MEPs will be created. The id sets the short MA name.
Step 5	mep crosscheck Example: RP/0/RP0/CPU0:router(config-cfm-xcheck)# mep crosscheck mep-id 10	Enters CFM MEP crosscheck configuration mode.
Step 6	mep-id mep-id-number [mac-address mac-address]	Enables cross-check on a MEP.

	Command or Action	Purpose
	Example: RP/0/RP0/CPU0:router(config-cfm-xcheck)# mep-id 10	Note <ul style="list-style-type: none"> Repeat this command for every MEP that you want included in the expected set of MEPs for cross-check.
Step 7	end or commit Example: RP/0/RP0/CPU0:router(config-cfm-xcheck)# commit	Saves configuration changes. <ul style="list-style-type: none"> When you use the end command, the system prompts you to commit changes: Uncommitted changes found, commit them before exiting (yes/no/cancel)? [cancel]: Entering yes saves configuration changes to the running configuration file, exits the configuration session, and returns the router to EXEC mode. Entering no exits the configuration session and returns the router to EXEC mode without committing the configuration changes. Entering cancel leaves the router in the current configuration session without exiting or committing the configuration changes. Use the commit command to save the configuration changes to the running configuration file and remain within the configuration session.

Configuring Other Options for a CFM Service

To configure other options for a CFM service, complete the following steps:

Procedure

	Command or Action	Purpose
Step 1	configure Example: RP/0/RP0/CPU0:router# configure	Enters global configuration mode.
Step 2	ethernet cfm Example:	Enters the Ethernet Connectivity Fault Management (CFM) configuration mode.

	Command or Action	Purpose
	RP/0/RP0/CPU0:router# ethernet cfm	
Step 3	<p>domain <i>domain-name</i> level <i>level-value</i> [id [null] [dns <i>DNS-name</i>] [mac <i>H.H.H</i>] [string <i>string</i>]]</p> <p>Example:</p> <pre>RP/0/RP0/CPU0:router(config-cfm)# domain Domain_One level 1 id string D1</pre>	<p>Creates and names a container for all domain configurations and enters the CFM domain configuration mode.</p> <p>The level must be specified.</p> <p>The id is the maintenance domain identifier (MDID) and is used as the first part of the maintenance association identifier (MAID) in CFM frames. If the MDID is not specified, the domain name is used as the MDID by default.</p>
Step 4	<p>service <i>service-name</i> {bridge group <i>bridge-domain-group</i> bridge-domain <i>bridge-domain-name</i> down-meps xconnect group <i>xconnect-group-name</i> p2p <i>xconnect-name</i>} [id [icc-based <i>icc-string</i> <i>umc-string</i>] [string <i>text</i>] [number <i>number</i>] [vlan-id <i>id-number</i>] [vpn-id <i>oui-vpnid</i>]]</p> <p>Example:</p> <pre>RP/0/RP0/CPU0:router(config-cfm-dmn)# service Bridge_Service bridge group BD1 bridge-domain B1</pre>	<p>Configures and associates a service with the domain and enters CFM domain service configuration mode. You can specify that the service is used only for down MEPS, or associate the service with a bridge domain or xconnect where MIPs and up MEPS will be created.</p> <p>The id sets the short MA name.</p>
Step 5	<p>maximum-meps <i>number</i></p> <p>Example:</p> <pre>RP/0/RP0/CPU0:router(config-cfm-dmn-svc)# maximum-meps 1000</pre>	<p>(Optional) Configures the maximum number (2 to 8190) of MEPS across the network, which limits the number of peer MEPS recorded in the database.</p>
Step 6	<p>log {ais continuity-check errors continuity-check mep changes crosscheck errors efd}</p> <p>Example:</p> <pre>RP/0/RP0/CPU0:router(config-cfm-dmn-svc)# log continuity-check errors</pre>	<p>(Optional) Enables logging of certain types of events.</p>
Step 7	<p>end or commit</p> <p>Example:</p> <pre>RP/0/RP0/CPU0:router(config-cfm-dmn-svc)# commit</pre>	<p>Saves configuration changes.</p> <ul style="list-style-type: none"> When you use the end command, the system prompts you to commit changes: <pre>Uncommitted changes found, commit them before exiting(yes/no/cancel)? [cancel]:</pre> Entering yes saves configuration changes to the running configuration file, exits the

	Command or Action	Purpose
		<p>configuration session, and returns the router to EXEC mode.</p> <ul style="list-style-type: none"> • Entering no exits the configuration session and returns the router to EXEC mode without committing the configuration changes. • Entering cancel leaves the router in the current configuration session without exiting or committing the configuration changes. • Use the commit command to save the configuration changes to the running configuration file and remain within the configuration session.

Configuring CFM MEPs

Procedure

	Command or Action	Purpose
Step 1	<p>configure</p> <p>Example:</p> <pre>RP/0/RP0/CPU0:router# configure</pre>	Enters global configuration mode.
Step 2	<p>interface {HundredGigE TenGigE} interface-path-id</p> <p>Example:</p> <pre>RP/0/RP0/CPU0:router(config)# interface TenGigE 0/0/0/1</pre>	<p>Type of Ethernet interface on which you want to create a MEP. Enter HundredGigE or TenGigE and the physical interface or virtual interface.</p> <p>Note</p> <ul style="list-style-type: none"> • Use the show interfaces command to see a list of all interfaces currently configured on the router.
Step 3	<p>interface {HundredGigE TenGigE Bundle-Ether} interface-path-id.subinterface</p> <p>Example:</p> <pre>RP/0/RP0/CPU0:router(config)# interface TenGigE 0/0/0/1.1</pre>	<p>Type of Ethernet interface on which you want to create a MEP. Enter HundredGigE, TenGigE, or Bundle-Ether and the physical interface or virtual interface followed by the subinterface path ID.</p> <p>Naming convention is <i>interface-path-id.subinterface</i>. The period in front of the subinterface value is required as part of the notation.</p>

	Command or Action	Purpose
Step 4	interface { HundredGigE TenGigE } <i>interface-path-id</i> Example: <pre>RP/0/RP0/CPU0:router(config)# interface TenGigE 0/0/0/1</pre>	Type of Ethernet interface on which you want to create a MEP. Enter HundredGigE or TenGigE and the physical interface or virtual interface. Note <ul style="list-style-type: none"> Use the show interfaces command to see a list of all interfaces currently configured on the router.
Step 5	ethernet cfm Example: <pre>RP/0/RP0/CPU0:router(config-if)# ethernet cfm</pre>	Enters interface Ethernet CFM configuration mode.
Step 6	mep domain <i>domain-name</i> service <i>service-name</i> mep-id <i>id-number</i> Example: <pre>RP/0/RP0/CPU0:router(config-if-cfm)# mep domain Dm1 service Sv1 mep-id 1</pre>	Creates a maintenance end point (MEP) on an interface and enters interface CFM MEP configuration mode.
Step 7	cos <i>cos</i> Example: <pre>RP/0/RP0/CPU0:router(config-if-cfm-mep)# cos 7</pre>	(Optional) Configures the class of service (CoS) (from 0 to 7) for all CFM packets generated by the MEP on an interface. If not configured, the CoS is inherited from the Ethernet interface. Note For Ethernet interfaces, the CoS is carried as a field in the VLAN tag. Therefore, CoS only applies to interfaces where packets are sent with VLAN tags. If the cos (CFM) command is executed for a MEP on an interface that does not have a VLAN encapsulation configured, it will be ignored.
Step 8	end or commit Example: <pre>RP/0/RP0/CPU0:router(config-if-cfm-mep)# commit</pre>	Saves configuration changes. <ul style="list-style-type: none"> When you use the end command, the system prompts you to commit changes: <pre>Uncommitted changes found, commit them before exiting(yes/no/cancel)? [cancel]:</pre> Entering yes saves configuration changes to the running configuration file, exits the

	Command or Action	Purpose
		<p>configuration session, and returns the router to EXEC mode.</p> <ul style="list-style-type: none"> • Entering no exits the configuration session and returns the router to EXEC mode without committing the configuration changes. • Entering cancel leaves the router in the current configuration session without exiting or committing the configuration changes. • Use the commit command to save the configuration changes to the running configuration file and remain within the configuration session.

Configuring Y.1731 AIS

This section has the following step procedures:

Configuring AIS in a CFM Domain Service

Use the following procedure to configure Alarm Indication Signal (AIS) transmission for a CFM domain service and configure AIS logging.

Procedure

	Command or Action	Purpose
Step 1	<p>configure</p> <p>Example:</p> <pre>RP/0/RP0/CPU0:router# configure</pre>	Enters global configuration mode.
Step 2	<p>ethernet cfm</p> <p>Example:</p> <pre>RP/0/RP0/CPU0:router(config)# ethernet cfm</pre>	Enters Ethernet CFM global configuration mode.
Step 3	<p>domain <i>name level level</i></p> <p>Example:</p> <pre>RP/0/RP0/CPU0:router(config-cfm)# domain D1 level 1</pre>	Specifies the domain and domain level.

	Command or Action	Purpose
Step 4	<p>service name bridge group name bridge-domain name</p> <p>Example:</p> <pre>RP/0/RP0/CPU0:router(config-cfm-dmn)# service S1 bridge group BG1 bridge-domain BD2</pre>	Specifies the service, bridge group, and bridge domain.
Step 5	<p>service name xconnect group xconnect-group-name p2p xconnect-name</p> <p>Example:</p> <pre>RP/0/RP0/CPU0:router(config-cfm-dmn)# service S1 xconnect group XG1 p2p X2</pre>	Specifies the service and cross-connect group and name.
Step 6	<p>ais transmission [interval {1s 1m}][cos cos]</p> <p>Example:</p> <pre>RP/0/RP0/CPU0:router(config-cfm-dmn-svc)# ais transmission interval 1m cos 7</pre>	Configures Alarm Indication Signal (AIS) transmission for a Connectivity Fault Management (CFM) domain service.
Step 7	<p>log ais</p> <p>Example:</p> <pre>RP/0/RP0/CPU0:router(config-cfm-dmn-svc)# log ais</pre>	Configures AIS logging for a Connectivity Fault Management (CFM) domain service to indicate when AIS or LCK packets are received.
Step 8	<p>no domain namelevel level</p> <p>Example:</p> <pre>RP/0/RP0/CPU0:router(config-cfm-dmn-svc)# no domain D1 level 1</pre>	Disables the domain and domain level.
Step 9	<p>end or commit</p> <p>Example:</p> <pre>RP/0/RP0/CPU0:router(config-sla-prof-stat-cfg)# commit</pre>	<p>Saves configuration changes.</p> <ul style="list-style-type: none"> When you issue the end command, the system prompts you to commit changes: <pre>Uncommitted changes found, commit them before exiting(yes/no/cancel)? [cancel]:</pre> Entering yes saves configuration changes to the running configuration file, exits the configuration session, and returns the router to EXEC mode. Entering no exits the configuration session and returns the router to EXEC mode without committing the configuration changes.

	Command or Action	Purpose
		<ul style="list-style-type: none"> • Entering cancel leaves the router in the current configuration session without exiting or committing the configuration changes. • Use the commit command to save the configuration changes to the running configuration file and remain within the configuration session.

Configuring AIS on a CFM Interface

To configure AIS on a CFM interface, perform the following steps:

Procedure

	Command or Action	Purpose
Step 1	configure Example: RP/0/RP0/CPU0:router# configure	Enters global configuration mode.
Step 2	interface gigabitethernet <i>interface-path-id</i> Example: RP/0/RP0/CPU0:router# interface TenGigE 0/0/0/2	Enters interface configuration mode.
Step 3	ethernet cfm Example: RP/0/RP0/CPU0:router(config)# ethernet cfm	Enters Ethernet CFM interface configuration mode.
Step 4	ais transmission up interval 1m cos <i>cos</i> Example: RP/0/RP0/CPU0:router(config-if-cfm)# ais transmission up interval 1m cos 7	Configures Alarm Indication Signal (AIS) transmission on a Connectivity Fault Management (CFM) interface.
Step 5	end or commit Example: RP/0/RP0/CPU0:router(config-sla-prof-stat-cfg)# commit	Saves configuration changes. <ul style="list-style-type: none"> • When you issue the end command, the system prompts you to commit changes: Uncommitted changes found, commit them before exiting(yes/no/cancel)? [cancel]:

	Command or Action	Purpose
		<ul style="list-style-type: none"> • Entering yes saves configuration changes to the running configuration file, exits the configuration session, and returns the router to EXEC mode. • Entering no exits the configuration session and returns the router to EXEC mode without committing the configuration changes. • Entering cancel leaves the router in the current configuration session without exiting or committing the configuration changes. • Use the commit command to save the configuration changes to the running configuration file and remain within the configuration session.

Configuring EFD for a CFM Service

To configure EFD for a CFM service, complete the following steps.

Procedure

	Command or Action	Purpose
Step 1	configure Example: RP/0/RP0/CPU0:router# configure	Enters global configuration mode.
Step 2	ethernet cfm Example: RP/0/RP0/CPU0:router(config)# ethernet cfm	Enters CFM configuration mode.
Step 3	domain <i>domain-name</i> level <i>level-value</i> Example: RP/0/RP0/CPU0:router(config-cfm-dmn)# domain D1 level 1	Specifies or creates the CFM domain and enters CFM domain configuration mode.
Step 4	service <i>service-name</i> down-meps Example: RP/0/RP0/CPU0:router(config-cfm-dmn)# service S1 down-meps	Specifies or creates the CFM service for down MEPS and enters CFM domain service configuration mode.

	Command or Action	Purpose
Step 5	efd Example: <pre>RP/0/RP0/CPU0:router(config-cfm-dmn-svc)# efd</pre>	Enables EFD on all down MEPs in the down MEPS service.
Step 6	log efd Example: <pre>RP/0/RP0/CPU0:router(config-cfm-dmn-svc)# log efd</pre>	(Optional) Enables logging of EFD state changes on an interface.
Step 7	end or commit Example: <pre>RP/0/RP0/CPU0:router(config-cfm-dmn-svc)# commit</pre>	<p>Saves configuration changes.</p> <ul style="list-style-type: none"> • When you issue the end command, the system prompts you to commit changes: Uncommitted changes found, commit them before exiting (yes/no/cancel)? [cancel]: • Entering yes saves configuration changes to the running configuration file, exits the configuration session, and returns the router to EXEC mode. • Entering no exits the configuration session and returns the router to EXEC mode without committing the configuration changes. • Entering cancel leaves the router in the current configuration session without exiting or committing the configuration changes. • Use the commit command to save the configuration changes to the running configuration file and remain within the configuration session.

Verifying the EFD Configuration

This example shows how to display all interfaces that are shut down because of Ethernet Fault Detection (EFD):

```
RP/0/RP0/CPU0:router# show efd interfaces
```

```
Server VLAN MA
=====
Interface          Clients
```

 TenGigE0/0/0/0.0 CFM

Configuring Flexible VLAN Tagging for CFM

Use this procedure to set the number of tags in CFM packets in a CFM domain service.

Procedure

	Command or Action	Purpose
Step 1	configure Example: RP/0/RP0/CPU0:router# configure	Enters global configuration mode.
Step 2	ethernet cfm Example: RP/0/RP0/CPU0:router(config)# ethernet cfm	Enters Ethernet CFM global configuration mode.
Step 3	domain <i>name level level</i> Example: RP/0/RP0/CPU0:router(config-cfm)# domain D1 level 1	Specifies the domain and domain level.
Step 4	service <i>name</i> bridge group <i>name</i> bridge-domain <i>name</i> Example: RP/0/RP0/CPU0:router(config-cfm-dmn)# service S2 bridge group BG1 bridge-domain BD2	Specifies the service, bridge group, and bridge domain.
Step 5	tags <i>number</i> Example: RP/0/RP0/CPU0:router(config-cfm-dmn-svc)# tags 1	Specifies the number of tags in CFM packets. Currently, the only valid value is 1.
Step 6	end or commit Example: RP/0/RP0/CPU0:router(config-cfm-dmn-svc)# commit	Saves configuration changes. <ul style="list-style-type: none"> When you issue the end command, the system prompts you to commit changes: Uncommitted changes found, commit them before exiting(yes/no/cancel)? [cancel]: Entering yes saves configuration changes to the running configuration file, exits the

	Command or Action	Purpose
		<p>configuration session, and returns the router to EXEC mode.</p> <ul style="list-style-type: none"> • Entering no exits the configuration session and returns the router to EXEC mode without committing the configuration changes. • Entering cancel leaves the router in the current configuration session without exiting or committing the configuration changes. • Use the commit command to save the configuration changes to the running configuration file and remain within the configuration session.

Verifying the CFM Configuration

To verify the CFM configuration, use one or more of the following commands:

show ethernet cfm configuration-errors [domain <i>domain-name</i>] [interface <i>interface-path-id</i>]	Displays information about errors that are preventing configured CFM operations from becoming active, as well as any warnings that have occurred.
show ethernet cfm local maintenance-points domain <i>name</i> [service <i>name</i>] interface <i>type interface-path-id</i>] [mep mip]	Displays a list of local maintenance points.



Note After you configure CFM, the error message, *cfmd[317]: %L2-CFM-5-CCM_ERROR_CCMS_MISSED : Some received CCMs have not been counted by the CCM error counters*, may display. This error message does not have any functional impact and does not require any action from you.



Note After reloading a line card, you may briefly see the following CFM error messages:

- *cfmd[1125]: %L2-CFM-6-MEP_CHANGE : Peer MEP change: remote MEP timed out*
- *cfmd[1125]: %L2-CFM-6-MEP_CHANGE : Peer MEP change: new remote MEP detected*

These error messages are expected and do not require any action from you.

Configuration Examples for Ethernet CFM

This section includes the following examples:

Ethernet CFM Domain Configuration: Example

This example shows how to configure a basic domain for Ethernet CFM:

```
configure
 ethernet cfm
  traceroute cache hold-time 1 size 3000
  domain Domain_One level 1 id string D1
commit
```

Ethernet CFM Service Configuration: Example

This example shows how to create a service for an Ethernet CFM domain:

```
service Bridge_Service bridge group BD1 bridge-domain B1
service Cross_Connect_1 xconnect group XG1 p2p X1
commit
```

Flexible Tagging for an Ethernet CFM Service Configuration: Example

This example shows how to set the number of tags in CFM packets from down MEPs in a CFM domain service:

```
configure
 ethernet cfm
  domain D1 level 1
  service S2 bridge group BG1 bridge-domain BD2
  tags 1
commit
```

Continuity Check for an Ethernet CFM Service Configuration: Example

This example shows how to configure continuity-check options for an Ethernet CFM service:

```
continuity-check archive hold-time 100
continuity-check loss auto-traceroute
continuity-check interval 100ms loss-threshold 10
commit
```

MIP Creation for an Ethernet CFM Service Configuration: Example

This example shows how to enable MIP auto-creation for an Ethernet CFM service:

```
RP/0/RP0/CPU0:router(config-cfm-dmn-svc)# mip auto-create all
RP/0/RP0/CPU0:router(config-cfm-dmn-svc)# commit
```

Cross-check for an Ethernet CFM Service Configuration: Example

This example shows how to configure cross-check for MEPs in an Ethernet CFM service:

```
mep crosscheck
mep-id 10
mep-id 20
commit
```

Other Ethernet CFM Service Parameter Configuration: Example

This example shows how to configure other Ethernet CFM service options:

```

maximum-meps 4000
log continuity-check errors
commit
exit
exit
exit

```

MEP Configuration: Example

This example shows how to configure a MEP for Ethernet CFM on an interface:

```

interface TenGigE 0/0/0/1
 ethernet cfm
 mep domain Dm1 service Sv1 mep-id 1
 commit

```

Ethernet CFM Show Command: Examples

These examples show how to verify the configuration of Ethernet Connectivity Fault Management (CFM):

Example 1

This example shows how to display all the maintenance points that have been created on an interface:

```
RP/0/RP0/CPU0:router# show ethernet cfm local maintenance-points
```

Domain/Level	Service	Interface	Type	ID	MAC
fig/5	bay	Gi0/10/0/12	Dn MEP	2	44:55:66
fig/5	bay	Gi0/0/1/0	MIP		55:66:77
fred/3	barney	Gi0/1/0/0	Dn MEP	5	66:77:88!

Example 2

This example shows how to display all the CFM configuration errors on all domains:

```
RP/0/RP0/CPU0:router# show ethernet cfm configuration-errors
```

```

Domain fig (level 5), Service bay
* MIP creation configured using bridge-domain blort, but bridge-domain blort does not exist.

* An Up MEP is configured for this domain on interface TenGigE0/0/0/3 and an Up MEP is
also configured for domain blort, which is at the same level (5).
* A MEP is configured on interface TenGigE0/0/0/1 for this domain/service, which has CC
interval 100ms, but the lowest interval supported on that interface is 1s

```

Example 3

This example shows how to display operational state for local maintenance end points (MEPs):

```
RP/0/RP0/CPU0:router# show ethernet cfm local meps
```

```

A - AIS received          I - Wrong interval

```

```
R - Remote Defect received      V - Wrong Level
L - Loop (our MAC received)    T - Timed out (archived)
C - Config (our ID received)   M - Missing (cross-check)
X - Cross-connect (wrong MAID) U - Unexpected (cross-check)
P - Peer port down
```

```
Domain foo (level 6), Service bar
  ID Interface (State)      Dir MEPS/Err RD Defects AIS
-----
  100 Gi1/1/0/1 (Up)       Up    0/0  N  A      L7
```

```
Domain fred (level 5), Service barney
  ID Interface (State)      Dir MEPS/Err RD Defects AIS
-----
   2 Gi0/1/0/0 (Up)       Up    3/2  Y  RPC     L6
```

```
Domain foo (level 6), Service bar
  ID Interface (State)      Dir MEPS/Err RD Defects AIS
-----
  100 Gi1/1/0/1 (Up)       Up    0/0  N  A
```

```
Domain fred (level 5), Service barney
  ID Interface (State)      Dir MEPS/Err RD Defects AIS
-----
   2 Gi0/1/0/0 (Up)       Up    3/2  Y  RPC
```

Example 4

This example shows how to display operational state of other maintenance end points (MEPs) detected by a local MEP:

```
RP/0/RP0/CPU0:router# show ethernet cfm peer meps
```

```
Flags:
> - Ok                      I - Wrong interval
R - Remote Defect received  V - Wrong level
L - Loop (our MAC received) T - Timed out
C - Config (our ID received) M - Missing (cross-check)
X - Cross-connect (wrong MAID) U - Unexpected (cross-check)
```

```
Domain fred (level 7), Service barney
Down MEP on TenGigE0/0/0/1, MEP-ID 2
=====
St   ID MAC address  Port  Up/Downtime  CcmRcvd SeqErr  RDI Error
-----
>   1 0011.2233.4455 Up    00:00:01    1234      0      0      0
R>  4 4455.6677.8899 Up    1d 03:04    3456      0     234     0
L   2 1122.3344.5566 Up    3w 1d 6h    3254      0      0    3254
C   2 7788.9900.1122 Test  00:13      2345      6     20    2345
X   3 2233.4455.6677 Up    00:23        30       0      0      30
I   3 3344.5566.7788 Down  00:34     12345     0     300    1234
V   3 8899.0011.2233 Blocked 00:35        45       0      0      45
T   5 5566.7788.9900      00:56        20       0      0      0
M   6                          0          0       0      0      0
U>  7 6677.8899.0011 Up    00:02      456      0      0      0
```

```
Domain fred (level 7), Service fig
Down MEP on TenGigE0/0/0/12, MEP-ID 3
=====
St   ID MAC address  Port  Up/Downtime  CcmRcvd SeqErr  RDI Error
-----
>   1 9900.1122.3344 Up    03:45     4321     0      0      0
```

Example 5

This example shows how to display operational state of other maintenance end points (MEPs) detected by a local MEP with details:

```
RP/0/RP0/CPU0:router# show ethernet cfm peer meps detail
Domain dom3 (level 5), Service ser3
Down MEP on TenGigE0/0/0/1 MEP-ID 1
=====
Peer MEP-ID 10, MAC 0001.0203.0403
  CFM state: Wrong level, for 00:01:34
  Port state: Up
  CCM defects detected:      V - Wrong Level
  CCMs received: 5
    Out-of-sequence:          0
    Remote Defect received:    5
    Wrong Level:              0
    Cross-connect (wrong MAID): 0
    Wrong Interval:          5
    Loop (our MAC received):   0
    Config (our ID received):  0
Last CCM received 00:00:06 ago:
  Level: 4, Version: 0, Interval: 1min
  Sequence number: 5, MEP-ID: 10
  MAID: String: dom3, String: ser3
  Port status: Up, Interface status: Up

Domain dom4 (level 2), Service ser4
Down MEP on TenGigE0/0/0/2 MEP-ID 1
=====
Peer MEP-ID 20, MAC 0001.0203.0402
  CFM state: Ok, for 00:00:04
  Port state: Up
  CCMs received: 7
    Out-of-sequence:          1
    Remote Defect received:    0
    Wrong Level:              0
    Cross-connect (wrong MAID): 0
    Wrong Interval:          0
    Loop (our MAC received):   0
    Config (our ID received):  0
Last CCM received 00:00:04 ago:
  Level: 2, Version: 0, Interval: 10s
  Sequence number: 1, MEP-ID: 20
  MAID: String: dom4, String: ser4
  Chassis ID: Local: ios; Management address: 'Not specified'
  Port status: Up, Interface status: Up

Peer MEP-ID 21, MAC 0001.0203.0403
  CFM state: Ok, for 00:00:05
  Port state: Up
  CCMs received: 6
    Out-of-sequence:          0
    Remote Defect received:    0
    Wrong Level:              0
    Cross-connect (wrong MAID): 0
    Wrong Interval:          0
    Loop (our MAC received):   0
    Config (our ID received):  0
Last CCM received 00:00:05 ago:
  Level: 2, Version: 0, Interval: 10s
  Sequence number: 1, MEP-ID: 21
```

```

MAID: String: dom4, String: ser4
Port status: Up, Interface status: Up

Peer MEP-ID 601, MAC 0001.0203.0402
CFM state: Timed Out (Standby), for 00:15:14, RDI received
Port state: Down
CCM defects detected:      Defects below ignored on local standby MEP
                          I - Wrong Interval
                          R - Remote Defect received
                          T - Timed Out
                          P - Peer port down

CCMs received: 2
  Out-of-sequence:          0
  Remote Defect received:  2
  Wrong Level:              0

  Wrong Interval:          2
  Loop (our MAC received): 0
  Config (our ID received): 0
Last CCM received 00:15:49 ago:
  Level: 2, Version: 0, Interval: 10s
  Sequence number: 1, MEP-ID: 600
  MAID: DNS-like: dom5, String: ser5
  Chassis ID: Local: ios; Management address: 'Not specified'
  Port status: Up, Interface status: Down

```

AIS for CFM Configuration: Examples

Example 1

This example shows how to configure Alarm Indication Signal (AIS) transmission for a CFM domain service:

```

RP/0/RP0/CPU0:router# configure
RP/0/RP0/CPU0:router(config)# ethernet cfm
RP/0/RP0/CPU0:router(config-cfm)# domain D1 level 1
RP/0/RP0/CPU0:router(config-cfm-dmn)# service S1 bridge group BG1 bridge-domain BD2
RP/0/RP0/CPU0:router(config-cfm-dmn-svc)# ais transmission interval 1m cos 7

RP/0/RP0/CPU0:router# configure
RP/0/RP0/CPU0:router(config)# ethernet cfm
RP/0/RP0/CPU0:router(config-cfm)# domain D1 level 1
RP/0/RP0/CPU0:router(config-cfm-dmn)# service Cross_Connect_1 xconnect group XG1 p2p X1
RP/0/RP0/CPU0:router(config-cfm-dmn-svc)# ais transmission interval 1m cos 7

```

Example 2

This example shows how to configure AIS logging for a Connectivity Fault Management (CFM) domain service to indicate when AIS or LCK packets are received:

```

RP/0/RP0/CPU0:router# configure
RP/0/RP0/CPU0:router(config)# ethernet cfm
RP/0/RP0/CPU0:router(config-cfm)# domain D1 level 1
RP/0/RP0/CPU0:router(config-cfm-dmn)# service S2 bridge group BG1 bridge-domain BD2
RP/0/RP0/CPU0:router(config-cfm-dmn-svc)# log ais

RP/0/RP0/CPU0:router# configure
RP/0/RP0/CPU0:router(config)# ethernet cfm
RP/0/RP0/CPU0:router(config-cfm)# domain D1 level 1

```

```
RP/0/RP0/CPU0:router(config-cfm-dmn)# service Cross_Connect_1 xconnect group XG1 p2p X1
RP/0/RP0/CPU0:router(config-cfm-dmn-svc)# log ais
```

This example shows how to configure AIS transmission on a CFM interface.

```
RP/0/RP0/CPU0:router# configure
RP/0/RP0/CPU0:router(config)# interface TenGigE 0/0/0/2
RP/0/RP0/CPU0:router(config-if)# ethernet cfm
RP/0/RP0/CPU0:router(config-if-cfm)# ais transmission up interval 1m cos 7
```

AIS for CFM Show Commands: Examples

This section includes the following examples:

show ethernet cfm interfaces ais Command: Example

This example shows how to display the information published in the Interface AIS table:

```
RP/0/RP0/CPU0:router# show ethernet cfm interfaces ais

Defects (from at least one peer MEP):
A - AIS received           I - Wrong interval
R - Remote Defect received V - Wrong Level
L - Loop (our MAC received) T - Timed out (archived)
C - Config (our ID received) M - Missing (cross-check)
X - Cross-connect (wrong MAID) U - Unexpected (cross-check)
P - Peer port down        D - Local port down
```

Interface (State)	AIS Dir	Trigger		Via Levels	Transmission		
		L Defects			L Int	Last started	Packets
TenGigE0/0/0/0 (Up)	Dn	5 RPC		6	7 1s	01:32:56 ago	5576
TenGigE0/0/0/0 (Up)	Up	0 M		2,3	5 1s	00:16:23 ago	983
TenGigE0/0/0/1 (Dn)	Up	D			7 60s	01:02:44 ago	3764
TenGigE0/0/0/2 (Up)	Dn	0 RX		1!			

show ethernet cfm local meps Command: Examples

Example 1: Default

This example shows how to display statistics for local maintenance end points (MEPs):

```
RP/0/RP0/CPU0:router# show ethernet cfm local meps

A - AIS received           I - Wrong interval
R - Remote Defect received V - Wrong Level
L - Loop (our MAC received) T - Timed out (archived)
C - Config (our ID received) M - Missing (cross-check)
X - Cross-connect (wrong MAID) U - Unexpected (cross-check)
P - Peer port down
```

```
Domain foo (level 6), Service bar
  ID Interface (State)      Dir MEPs/Err RD Defects AIS
-----
  100 Gi1/1/0/1 (Up)       Up    0/0  N A    7

Domain fred (level 5), Service barney
  ID Interface (State)      Dir MEPs/Err RD Defects AIS
```



```
-----
2 Gi0/1/0/0 (Up)      Up      3/2   Y  RPC   6
-----
```

Example 2: Domain Service

This example shows how to display statistics for MEPs in a domain service:

```
RP/0/RP0/CPU0:router# show ethernet cfm local meps domain foo service bar detail
```

```
Domain foo (level 6), Service bar
Down MEP on TenGigE0/0/0/1, MEP-ID 100
=====
Interface state: Up      MAC address: 1122.3344.5566
Peer MEPs: 0 up, 0 with errors, 0 timed out (archived)

CCM generation enabled: No
AIS generation enabled: Yes (level: 7, interval: 1s)
Sending AIS:           Yes (started 01:32:56 ago)
Receiving AIS:         Yes (from lower MEP, started 01:32:56 ago)

Domain fred (level 5), Service barney
Down MEP on TenGigE0/0/0/1, MEP-ID 2
=====
Interface state: Up      MAC address: 1122.3344.5566
Peer MEPs: 3 up, 2 with errors, 0 timed out (archived)
Cross-check defects: 0 missing, 0 unexpected

CCM generation enabled: Yes (Remote Defect detected: Yes)
CCM defects detected:   R - Remote Defect received
                       P - Peer port down
                       C - Config (our ID received)
AIS generation enabled: Yes (level: 6, interval: 1s)
Sending AIS:           Yes (to higher MEP, started 01:32:56 ago)
Receiving AIS:         No
```

Example 4: Detail

This example shows how to display detailed statistics for MEPs in a domain service:

```
RP/0/RP0/CPU0:router# show ethernet cfm local meps detail

Domain foo (level 6), Service bar
Down MEP on TenGigE0/0/0/1, MEP-ID 100
=====
Interface state: Up      MAC address: 1122.3344.5566
Peer MEPs: 0 up, 0 with errors, 0 timed out (archived)

CCM generation enabled: No
AIS generation enabled: Yes (level: 7, interval: 1s)
Sending AIS:           Yes (started 01:32:56 ago)
Receiving AIS:         Yes (from lower MEP, started 01:32:56 ago)

Domain fred (level 5), Service barney
Down MEP on TenGigE0/0/0/1, MEP-ID 2
=====
Interface state: Up      MAC address: 1122.3344.5566
Peer MEPs: 3 up, 2 with errors, 0 timed out (archived)
Cross-check defects: 0 missing, 0 unexpected

CCM generation enabled: Yes (Remote Defect detected: Yes)
CCM defects detected:   R - Remote Defect received
                       P - Peer port down
```

show ethernet cfm local meps detail Command: Example

```

C - Config (our ID received)
AIS generation enabled: Yes (level: 6, interval: 1s)
Sending AIS:           Yes (to higher MEP, started 01:32:56 ago)
Receiving AIS:        No

```

show ethernet cfm local meps detail Command: Example

Use the **show ethernet cfm local meps detail** command to display MEP-related EFD status information. This example shows that EFD is triggered for MEP-ID 100:

```

RP/0/RP0/CPU0:router# show ethernet cfm local meps detail

Domain foo (level 6), Service bar
Down MEP on TenGigE0/0/0/1, MEP-ID 100
=====
Interface state: Up      MAC address: 1122.3344.5566
Peer MEPS: 0 up, 0 with errors, 0 timed out (archived)
Cross-check errors: 2 missing, 0 unexpected

CCM generation enabled: No
AIS generation enabled: Yes (level: 7, interval: 1s)
Sending AIS:           Yes (started 01:32:56 ago)
Receiving AIS:        Yes (from lower MEP, started 01:32:56 ago)
EFD triggered:        Yes

Domain fred (level 5), Service barney
Down MEP on TenGigE0/0/0/1, MEP-ID 2
=====
Interface state: Up      MAC address: 1122.3344.5566
Peer MEPS: 3 up, 0 with errors, 0 timed out (archived)
Cross-check errors: 0 missing, 0 unexpected

CCM generation enabled: Yes (Remote Defect detected: No)
AIS generation enabled: Yes (level: 6, interval: 1s)
Sending AIS:           No
Receiving AIS:        No
EFD triggered:        No

```



Note You can also verify that EFD has been triggered on an interface using the **show interfaces** and **show interfaces brief** commands. When an EFD trigger has occurred, these commands will show the interface status as *up* and the line protocol state as *down*.

Troubleshooting Tips

To troubleshoot problems within the CFM network, perform these steps:

Procedure

Step 1 To verify connectivity to a problematic MEP, use the **ping ethernet cfm** command as shown in this example:

```

RP/0/RP0/CPU0:router# ping ethernet cfm domain D1 service S1 mep-id 16 source
interface TenGigE 0/0/0/1

```

```
Type escape sequence to abort.
Sending 5 CFM Loopbacks, timeout is 2 seconds -
Domain foo (level 2), Service foo
Source: MEP ID 1, interface TenGigE0/0/0/1
Target: 0001.0002.0003 (MEP ID 16):
  Running (5s) ...
Success rate is 60.0 percent (3/5), round-trip min/avg/max = 1251/1349/1402 ms
Out-of-sequence: 0.0 percent (0/3)
Bad data: 0.0 percent (0/3)
Received packet rate: 1.4 pps
```

- Step 2** If the results of the **ping ethernet cfm** command show a problem with connectivity to the peer MEP, use the **traceroute ethernet cfm** command to help further isolate the location of the problem as shown in the following example:

```
RP/0/RP0/CPU0:router# traceroute ethernet cfm domain D1 service S1 mep-id 16
source interface TenGigE 0/0/0/2
```

```
Traceroutes in domain D1 (level 4), service S1
Source: MEP-ID 1, interface TenGigE0/0/0/2
=====
Traceroute at 2009-05-18 12:09:10 to 0001.0203.0402,
TTL 64, Trans ID 2:
```

Hop	Hostname/Last	Ingress MAC/name	Egress MAC/Name	Relay
1	ios 0000-0001.0203.0400	0001.0203.0400 [Down] TenGigE0/0/0/2		FDB
2	abc ios		0001.0203.0401 [Ok] Not present	FDB
3	bcd abc	0001.0203.0402 [Ok] TenGigE0/0		Hit

```
Replies dropped: 0
```

If the target was a MEP, verify that the last hop shows “Hit” in the Relay field to confirm connectivity to the peer MEP.

If the Relay field contains “MPDB” for any of the hops, then the target MAC address was not found in the bridge MAC learning table at that hop, and the result is relying on CCM learning. This result can occur under normal conditions, but it can also indicate a problem. If you used the **ping ethernet cfm** command before using the **traceroute ethernet cfm** command, then the MAC address should have been learned. If “MPDB” is appearing in that case, then this indicates a problem at that point in the network.

CFM Over Bundles

CFM over bundle supports the following:

- CFM Maintenance Points—Up Maintenance-association End Points (MEP), Down MEP, and MIP, which includes L2 bundle main and sub-interfaces.
- CCM interval of 100 microsecond, 1second, 10 seconds, and 1 minute. CCM interval of 10 minutes is supported only in the versions earlier than IOS XR 7.3.2.
- RP OIR/VM reload, without impacting learned CFM peer MEPs.
- Process restart without impacting CFM sessions.

- CFM MEPs on bundle interfaces as software-offloaded-MEPs with all possible rewrite and encapsulation combinations supported by L2 sub-interfaces.
- CCM learning on MIP over bundle interfaces. CCM database learning supports investigation of one CCM out of 50 that goes over MIP.
- Static and dynamic Remote MEPs.

Restrictions for Configuration of CFM on Bundles

Following are the restrictions for configuring CFM:

- Only Layer 2 bundle Ethernet interfaces and sub-interfaces are supported except for those matching the VLAN tag `any`.
- CCM interval of 3.3 milliseconds and 10 milliseconds are not supported.
- CCM interval of 10 minutes is not supported from IOS XR 7.3.2.
- Supports 5000 pps rates of CCM traffic for bundle interfaces. For example, for CCM interval of 100 milliseconds, the number of MEPs can be 500.
- Ethernet CFM is not supported with MEP that are configured on default and untagged encapsulated sub-interfaces that are part of a single physical interface.

CFM Adaptive Bandwidth Notifications

Microwave links are used in carrier ethernet networks, because they are cheaper than laying fibre either in dense metro areas or rural locations. However, the disadvantage of microwave links is that the signal is affected by atmospheric conditions and can degrade.

Modern microwave devices support adaptive modulation schemes to prevent a complete loss of signal. This allows them to continue to operate during periods of degradation, but at a reduced bandwidth. However, to fully take advantage of this, it's necessary to convey the decrease in bandwidth to the head-end router so that appropriate actions can be taken. Otherwise, the link may become saturated and traffic dropped arbitrarily as shown in the following figure:

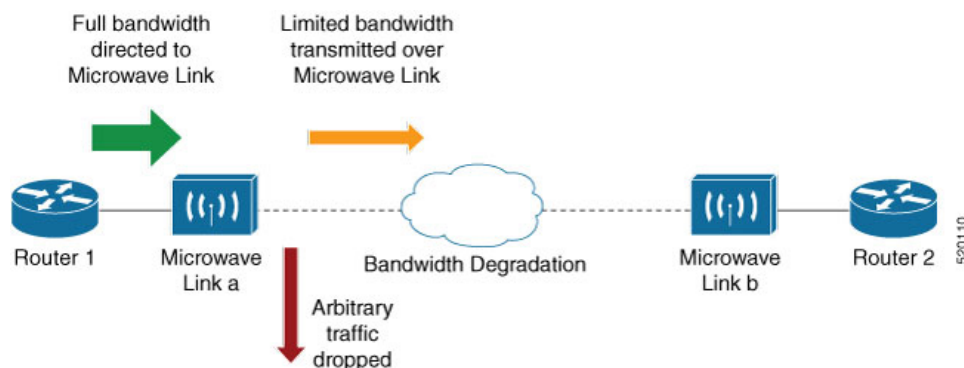

A generic solution to this is a Connectivity Fault Management (CFM) extension to send Bandwidth Notifications Messages (BNM) to Maintenance Endpoints (MEPs) on the corresponding interface on the head-end router. To be flexible in the actions taken, the choice of solution uses Embedded Event Manager (EEM) to invoke operator written TCL scripts. For information on EEM, see [Embedded Event Manager, on page 86](#).

Bandwidth Notification Messages

The two types of messages used to notify the head-end router are:

- G.8013 Bandwidth Notification Messages (G.8013 BNM)
- Cisco proprietary Bandwidth Vendor-Specific Messages (Cisco BW-VSM)

Both the message types contain the following information:

- Source MAC
- Port ID
- Maintenance Domain (MD) Level
- Transmission period
- Nominal Bandwidth
- Current Bandwidth

During signal degradation, periodic BNMs are sent to the head-end router containing the current bandwidth (sampled over a period of time) and nominal bandwidth (full bandwidth when there is no degradation). This allows the router to reduce the bandwidth directed to the link as shown in the figure below:

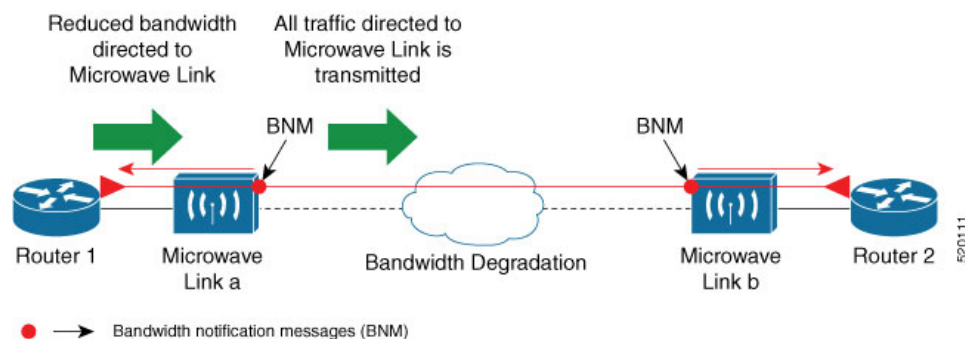

When degradation in bandwidth is detected, depending on the topology, the degradation may affect one or more paths in the network. Therefore, in more complex topologies, the head-end router may need information about links in each affected path. The BNM transmission period and a Link ID are used to differentiate between messages from the same source MAC address which refer to different links.

Restrictions for CFM Bandwidth Notifications

The list of restrictions for CFM Bandwidth Notifications is:

- Up to 200 unique BNM enabled links learnt from BNMs are supported per line card. Any BNMs for links over this limit will be discarded.

To reset CFM BNM enabled links for the specified interfaces, use the `clear ethernet cfm interface [<interface>] bandwidth-notifications { all | state <state> } [location { all | <node> }]` command. An archive timer is used to clean up any BNM enabled links whose loss timer expired at least 24 hours ago.

- Over process restart:

- Loss threshold, wait-to-restore, and hold-off timers are restarted. This may cause links to take longer to transition between states than they would have otherwise.
- Archive timers are restarted. This may cause historical statistics for links to persist longer than they would have otherwise.
- Queued events for EEM scripts which have been rate-limited are not preserved. Scripts with at least one link in DEGRADED state, or BNM's have changed over process restart, and are invoked. Rate-limit timers are restarted. This may cause scripts to be invoked when they would otherwise have been filtered by the damping or conformance-testing algorithms. If the last link returns to its nominal bandwidth within the rate-limit period but before the process restart, then the script will not be invoked after the process restart. Thus, actions taken by the script may not reflect the (increased) latest bandwidths of any links which returned to their nominal bandwidths within the rate-limit period.

Bandwidth Reporting

Received BNM's are used to identify BNM enabled links within a Maintenance Entity Group (MEG), and should be uniquely identifiable within the MEG by Port-ID or MAC address. Each link has an associated nominal bandwidth, and a Reported Bandwidth (RBW), which are notified to the operator. The link is considered to be in OK state when the RBW is equal to the nominal bandwidth and DEGRADED if RBW is less than nominal.

Devices sending BNM's can detect changes in bandwidth many times a second. For example, changes caused by an object passing through a microwave link's line of sight. The protocol for sending BNM's is designed to mitigate fluctuating current bandwidth by sampling across a 'monitoring-interval' and applying basic damping to degradation events. To help mitigate this further, a damping algorithm is used. This algorithm is applied on the receiving device, and is distinct from any damping performed by the sender. For more information on this, see [Damping Algorithm, on page 85](#).

An operator may be interested in more than one BNM enabled link, and needs the ability to register on a set of BNM enabled links which affect the path to a node in the network. To do this, the state and RBW for each link of interest are put into a conformance testing algorithm, which both filters and rate-limits changes to publish events notifying the operator only of significant changes. For more information on this, see [Conformance Testing Algorithm, on page 86](#).

The following diagram shows how a received BNM flows through the damping and conformance testing algorithm to invoke operator scripts:

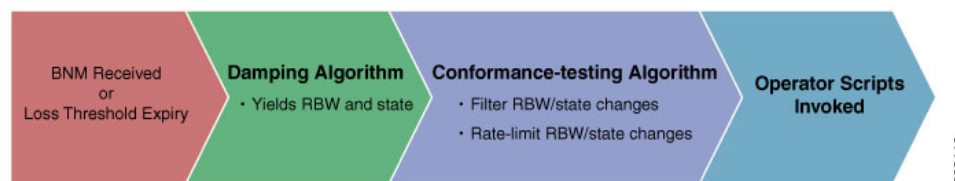

**Note**

- Port ID takes precedence over MAC address. This means that BNM with same port ID but different MAC addresses are counted as same BNM.
- If BNM reported bandwidth is equal to the threshold, then EEM will not be invoked.
- If a degraded link having bandwidth higher than the threshold receives BNM with bandwidth less than the threshold, it doesn't wait for the hold-off timer and instantly changes the bandwidth by invoking EEM script.

Damping Algorithm

A damping algorithm is applied to each unique BNM enabled link for which BNM are received. The table below describes the timers used for this purpose:

Timers	Description
loss threshold (in packet numbers)	This timer handles the case when BNM stop being received. This timer is (re)started whenever any BNM is received for the link. The value is equal to the expected period between BNM (as indicated by the last BNM) multiplied by the configured loss threshold. When the loss threshold timer expires, as the link may have changed or been removed entirely, bandwidth information is no longer available, therefore the link is considered to have been restored to its previously notified nominal bandwidth.
hold-off (in seconds)	This timer is used to damp transient transitions from OK to DEGRADED state. It is started when the first degraded BNM is received, and is stopped if the loss threshold timer expires or the current bandwidth returns to the nominal bandwidth. If the timer expires, then the BNM enabled link enters DEGRADED state. The value of this timer is configurable. If it is zero, then the link immediately enters degraded state and the timer is not started.
wait-to-restore (WTR, in seconds)	This timer is used to damp transient transitions from DEGRADED to OK state. It is started when a BNM Enabled Link is in DEGRADED state and either the loss threshold timer expires or a BNM is received that indicates the current bandwidth has returned to the nominal bandwidth. If a degraded BNM is received while the timer is running then it is stopped and the BNM Enabled Link remains in DEGRADED state. If this timer expires then the link returns to OK state.

The following internal state transition diagram shows how damping algorithm takes place:

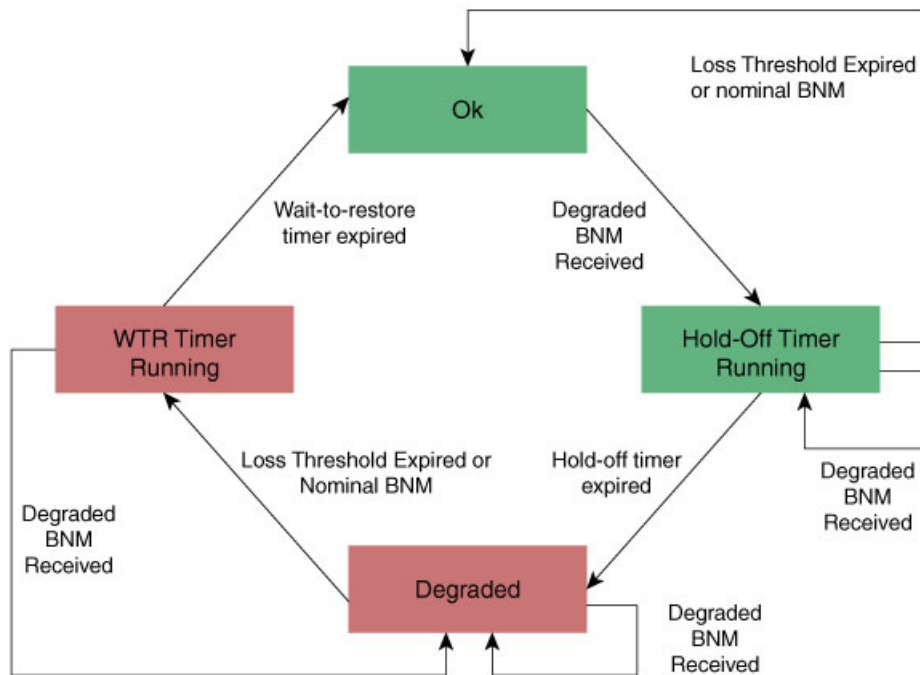

Conformance Testing Algorithm

The conformance testing algorithm comprises of two parts:

1. Filtering bandwidth changes.

Filtering is done so that events are published whenever either:

- Any link which was in OK state or had a RBW more than or equal to the specified threshold, has transitioned to DEGRADED state and has a RBW less than the specified threshold.
- Any link which was in DEGRADED state and had a RBW less than the specified threshold, is still in DEGRADED state and has a RBW less than the specified threshold, but the old and new RBWs are different.
- Any link which was in DEGRADED state and had a RBW less than the specified threshold, has transitioned to OK state or has a RBW more than or equal to the specified threshold.

2. Rate-limiting bandwidth changes

Rate-limiting is done by only publishing events at most once within any rate-limit period. If there is a change in bandwidth (which passes the filter) within this rate-limit period, a timer is started to expire at the end of the period. Upon timer expiry, an event is published which reflects the latest state and bandwidth of all links of interest which are in DEGRADED state.

Embedded Event Manager

The Embedded Event Manager (EEM) consists of an EEM server that monitors various real-time events in the system using programs called Event Detectors (EDs) and triggers registered policies (for example, TCLscripts) to run. The EEM supports at least 200 script registrations.

Typical actions taken in response to signal degradation events include:

- Signaling to G.8032 to switch some flows to alternative paths
- Modifying QoS configuration to adjust traffic shaping to the new bandwidth
- Adjusting IGP metrics to switch some traffic to an alternative path

The following variables can be queried within the TCL script:

EEM Variables	Comment
<code>interface, level, direction</code>	Identify the MEP in the registration
<code>min_reported_bandwidth</code>	Minimum reported bandwidth across all links in the registration that are currently in DEGRADED state, and below the specified threshold
<code>bnm_enabled_links [{ MAC address Port ID }]</code>	Array of BNM enabled links, with each one containing the following elements: <ul style="list-style-type: none"> • <code>reported_bw</code>: Reported Bandwidth • <code>nominal_bw</code>: Nominal BW in last BNM
<code>event_type</code>	Either 'DEGRADED' or 'OK' DEGRADED indicates that at least one BNM enabled link in the registration is in DEGRADED state with a reported bandwidth less than the threshold. This means that the <code>event_type</code> could be 'OK' if all BNM enabled links in the registration which are in DEGRADED state have a reported bandwidth greater than or equal to the threshold.

The command for EEM TCL scripts registering for CFM Bandwidth Notification events is `interface <interface name> level <level> direction <direction> {mac-addresses { <addr1> [, ..., <addr20>] } | port-ids { <id1> [, ..., <id20>] } threshold <bandwidth> [ratelimit <time>]`.

To configure EEM, use the following commands:

```
event manager directory user policy disk0:/
event manager directory user library disk0:/
event manager policy EEMscript7.tcl username root persist-time 3600
aaa authorization eventmanager default local
```

Individual scripts located in the specified directory can then be configured with:

```
event manager policy <script_name> username lab persist-time <time>
```

Event Publishing

CFM publishes events for a given EEM registration after applying the damping and conformance testing algorithms as described in [Damping Algorithm, on page 85](#) and [Conformance Testing Algorithm, on page 86](#) respectively. The set of BNM Enabled Links published in an event are those in DEGRADED state and whose RBW is less than the specified threshold.

CFM with SAT and EDPL

CFM can run along with SAT (Service Activation Test) session on the same interface. Both works independent of each other.

However, other OAM sessions like SLM and DMM will go down during the SAT session. They get restored once the SAT session is completed. This is expected as per requirements.

Limitations and Restrictions

- SAT session works similar to MD-level 7 session. So, CFM sessions, on same interface, will have to be at levels lower than 7, i.e 0 to 6.

Example:

The below setup is an example:

Interface 1	-----	Interface 2
CFM (MDL 0 to 6)	-----	CFM (MDL 0 to 6)
DMM/SLM	-----	DMM/SLM
SAT	-----	EDPL (with DestMac)



Note

- DMM/SLM goes down when SAT is active. They get restored once SAT session is completed.
- Ethernet Data Plane Loopback functionality (EDPL) does not support multicast destination MAC address packets for NCS 5700 line cards. So, it is recommended to use EDPL on peer node with filter - Destination_MAC (same as the destination of the SAT session).
- CCM have multicast destination MAC(0180.c200.003x).

Unidirectional Link Detection Protocol

Unidirectional Link Detection (UDLD) is a single-hop physical link protocol for monitoring an ethernet link, including both point-to-point and shared media links. This is a Cisco-proprietary protocol to detect link problems, which are not detected at the physical link layer. This protocol is specifically targeted at possible wiring errors, when using unbundled fiber links, where there can be a mismatch between the transmitting and receiving connections of a port.

UDLD Operation

UDLD works by exchanging protocol packets between the neighboring devices. In order for UDLD to work, both devices on the link must support UDLD and have it enabled on respective ports.

UDLD sends an initial PROBE message on the ports where it is configured. Once UDLD receives a PROBE message, it sends periodic ECHO (hello) messages. Both messages identify the sender and its port, and also contain some information about the operating parameters of the protocol on that port. They also contain the device and port identifiers on the port for any neighbor devices that the local device has heard from. Similarly, each device gets to know where it is connected and where its neighbors are connected. This information can then be used to detect faults and miswiring conditions.

The protocol operates an aging mechanism where information from neighbors that is not periodically refreshed is eventually timed out. This mechanism can also be used to detect fault.

A FLUSH message is used to indicate that UDLD is disabled on a port, which causes the peers to remove the local device from their neighbor cache to prevent a time out.

If a problem is detected, UDLD disables the affected interface and also notifies the user. This is to avoid further network problems beyond traffic loss, such as loops which are not detected or prevented by Spanning Tree Protocol (STP).

Types of Fault Detection

UDLD can detect these types of faults:

- **Transmit faults** — These are cases where there is a failure in transmitting packets from the local port to the peer device, but packets are being received from the peer. These faults are caused by failure of the physical link (where notification at layer 1 of unidirectional link faults is not supported by the media) as well as packet path faults on the local or peer device.
- **Miswiring faults** — These are cases where the receiving and transmitting sides of a port on the local device are connected to different peer ports (on the same device or on different devices). This can occur when using unbundled fibers to connect fiber optic ports.
- **Loopback faults** — These are cases where the receiving and transmitting sides of a port are connected to each other, creating a loopback condition. This can be an intentional mode of operation, for certain types of testing, but UDLD must not be used in these cases.
- **Receive faults** — The protocol includes a heartbeat signal that is transmitted at a negotiated periodic interval to the peer device. Missed heartbeats can therefore be used to detect failures on the receiving side of the link (where they do not result in interface state changes). These could be caused by a unidirectional link with a failure only affecting the receiving side, or by a link which has developed a bidirectional fault. This detection depends on reliable, regular packet transmission by the peer device. For this reason, the UDLD protocol has two (configurable) modes of operation which determine the behavior on a heartbeat timeout. These modes are described in the section [UDLD Modes of Operation, on page 89](#).

UDLD Modes of Operation

UDLD can operate in these modes:

- **Normal mode:** In this mode, if a `Receive Fault` is detected, the user is informed and no further action is taken.
- **Aggressive mode:** In this mode, if a `Receive Fault` is detected, the user is informed and the affected port is disabled.

UDLD Aging Mechanism

This is a scenario that happens in a `Receive Fault` condition. Aging of UDLD information happens when the port that runs UDLD does not receive UDLD packets from the neighbor port for a duration of the hold time. The hold time for the port is dictated by the remote port and depends on the message interval at the

remote side. The shorter the message interval, the shorter is the hold time and the faster the detection of the fault. The hold time is three times the message interval in Cisco IOS XR Software.

UDLD information can age out due to the high error rate on the port caused by a physical issue or duplex mismatch. Packet drops due to age out does not mean that the link is unidirectional. UDLD in normal mode does not disable such link.

It is important to choose the right message interval in order to ensure proper detection time. The message interval should be fast enough to detect the unidirectional link before the forwarding loop is created. The default message interval is 60 seconds. The detection time is equal to approximately three times the message interval. So, when using default UDLD timers, UDLD does not timeout the link faster than the STP aging time.

State Machines

UDLD uses two types of finite state machines (FSMs), generally referred as state machines. The `Main FSM` deals with all the phases of operation of the protocol while the `Detection FSM` handles only the phases that determine the status of a port.

Main FSM

The Main FSM can be in one of these states:

- **Init:** Protocol is initializing.
- **UDLD inactive:** Port is down or UDLD is disabled.
- **Linkup:** Port is up and running, and UDLD is in the process of detecting a neighbor.
- **Detection:** A hello message from a new neighbor is received and the Detection FSM determines the status of the port.
- **Advertisement:** The Detection FSM concludes that the port is operating correctly, periodic hello messages will continue to be sent and monitored from neighbors.
- **Port shutdown:** The Detection FSM detected a fault, or all neighbors were timed out in Aggressive mode, and as a result, the port is disabled.

Detection FSM

The Detection FSM can be in one of these states:

- **Unknown:** Detection has not yet been performed or UDLD has been disabled.
- **Unidirectional detected:** A unidirectional link condition has been detected because a neighbor does not see the local device. The port will be disabled.
- **Tx/Rx loop:** A loopback condition has been detected by receiving a TLV with the ports own identifiers. The port will be disabled.
- **Neighbor mismatch:** A miswiring condition has been detected in which a neighbor can identify other devices than those the local device can see. The port will be disabled.

- **Bidirectional detected:** UDLD hello messages are exchanged successfully in both directions. The port is operating correctly.

Y.1731 Performance Monitoring

Y.1731 Performance Monitoring (PM) provides a standard Ethernet PM function that includes measurement of Ethernet frame delay, frame delay variation, frame loss, and frame throughput measurements. This is specified by the ITU-T Y-1731 standard and interpreted by the Metro Ethernet Forum (MEF) standards group.

The router supports the following:

- Delay Measurement (DM)
- Synthetic Loss Measurement (SLM)

Two-Way Delay Measurement for Scalability

Use the Ethernet frame delay measurement to measure frame delay and frame delay variations. The system measures the Ethernet frame delay by using the Delay Measurement Message (DMM) method.

Restrictions for Configuring Two-Way Delay Measurement

Follow the guidelines and restrictions listed here when you configure two-way delay measurement:

-

Configuring Two-Way Delay Measurement

Perform the following steps to configure two-way delay measurement:

```
RP/0/RP0/CPU0:router (config) # ethernet sla
profile DMM type cfm-delay-measurement
  probe
  send burst every 5 seconds packet count 5 interval 1 seconds
  !
  schedule
  every 1 minutes for 40 seconds
  !
  statistics
  measure round-trip-delay
  buckets size 1 probes
  buckets archive 5
  !
  measure round-trip-jitter
  buckets size 1 probes
  buckets archive 1
  !
  !
  !
interface TenGigE0/0/0/10.1 12transport
encapsulation dot1q 1
ethernet cfm
mep domain DOWN0 service s10 mep-id 2001
```

```
sla operation profile DMM target mep-id 6001
!
```

Configuring an On-Demand Ethernet SLA Operation for CFM Delay Measurement

To configure an on-demand Ethernet SLA operation for CFM delay measurement, use this command in privileged EXEC configuration mode:

```
RP/0/RP0/CPU0:router (config) #
```

```
ethernet sla on-demand operation type cfm-synthetic-loss-measurement probe domain D1 source
interface TenGigE 0/6/1/0 target mac-address 2.3.4
```

Running Configuration

```
RP/0/RP0/CPU0:router# show ethernet cfm peer meps
```

```
Mon Sep 11 12:09:44.534 UTC
```

```
Flags:
```

```
> - Ok                               I - Wrong interval
R - Remote Defect received           V - Wrong level
L - Loop (our MAC received)         T - Timed out
C - Config (our ID received)        M - Missing (cross-check)
X - Cross-connect (wrong MAID)      U - Unexpected (cross-check)
* - Multiple errors received        S - Standby
```

```
Domain UP6 (level 6), Service s6
```

```
Up MEP on FortyGigE0/0/1/2.1 MEP-ID 1
```

```
=====
St   ID MAC Address      Port   Up/Downtime   CcmRcvd SeqErr   RDI Error
---
> 4001 70e4.227c.2865 Up      00:01:27      0       0       0       0
```

```
Domain DOWN0 (level 0), Service s10
```

```
Down MEP on TenGigE0/0/0/10.1 MEP-ID 2001
```

```
=====
St   ID MAC Address      Port   Up/Downtime   CcmRcvd SeqErr   RDI Error
---
> 6001 70e4.227c.287a Up      00:02:11      0       0       0       0
```

```
RP/0/RP0/CPU0:router#
```

```
RP/0/RP0/CPU0:router# show running-config
```

```
Mon Sep 11 12:10:18.467 UTC
```

```
interface FortyGigE0/0/1/2.1 l2transport
encapsulation dot1q 1
ethernet cfm
  mep domain UP6 service s6 mep-id 1
  sla operation profile DMM target mep-id 6001
  sla operation profile test-slm target mep-id 6001
!
!
!
l2vpn
xconnect group g1
  p2p p1
  interface TenGigE0/0/0/10.1
  interface FortyGigE0/0/1/2.1
!
!
!
end
```

Verification

One-way Delay (Source->Dest)

~~~~~

1 probes per bucket

Bucket started at 12:11:19 UTC Mon 11 September 2017 lasting 10s

Pkts sent: 10; Lost: 0 (0.0%); Corrupt: 0 (0.0%);  
Misordered: 0 (0.0%); Duplicates: 0 (0.0%)

Result count: 10

Min: 1912765.961ms; Max: 1912765.961ms; Mean: 1912765.961ms; StdDev: -2147483.648ms

One-way Delay (Dest->Source)

~~~~~

1 probes per bucket

Bucket started at 12:11:19 UTC Mon 11 September 2017 lasting 10s

Pkts sent: 10; Lost: 0 (0.0%); Corrupt: 0 (0.0%);
Misordered: 0 (0.0%); Duplicates: 0 (0.0%)

Result count: 10

Min: -1912765.952ms; Max: -1912765.951ms; Mean: -1912765.951ms; StdDev: -2147483.648ms

Round Trip Jitter

~~~~~

1 probes per bucket

Bucket started at 12:11:19 UTC Mon 11 September 2017 lasting 10s

Pkts sent: 10; Lost: 0 (0.0%); Corrupt: 0 (0.0%);  
Misordered: 0 (0.0%); Duplicates: 0 (0.0%)

Result count: 9

Min: 0.000ms; Max: 0.001ms; Mean: 0.000ms; StdDev: 0.000ms

One-way Jitter (Source->Dest)

~~~~~

1 probes per bucket

Bucket started at 12:11:19 UTC Mon 11 September 2017 lasting 10s

Pkts sent: 10; Lost: 0 (0.0%); Corrupt: 0 (0.0%);
Misordered: 0 (0.0%); Duplicates: 0 (0.0%)

Result count: 9

Min: 0.000ms; Max: 0.000ms; Mean: 0.000ms; StdDev: 0.000ms

One-way Jitter (Dest->Source)

~~~~~

1 probes per bucket

Bucket started at 12:11:19 UTC Mon 11 September 2017 lasting 10s

Pkts sent: 10; Lost: 0 (0.0%); Corrupt: 0 (0.0%);  
Misordered: 0 (0.0%); Duplicates: 0 (0.0%)

Result count: 9

Min: 0.000ms; Max: 0.001ms; Mean: 0.000ms; StdDev: 0.000ms

RP/0/RP0/CPU0:ios#ethernet sla on-demand operation type cfm-syn probe domain DOWN0 source  
interface tenGigE 0/0/0/10.1 target mep-id 6001

Mon Sep 11 12:12:39.259 UTC

Warning: Burst configuration is present and so this profile cannot be represented in the  
MEF-SOAM-PM-MIB configuration tables. However, the statistics are still collected

On-demand operation 2 succesfully created

/ - Completed - statistics will be displayed shortly.

```

RP/0/RP0/CPU0:ios#show ethernet sla statistics on-demand id 2

Mon Sep 11 12:13:24.825 UTC
Source: Interface TenGigE0/0/0/10.1, Domain DOWN0
Destination: Target MEP-ID 6001
=====
On-demand operation ID #2, packet type 'cfm-synthetic-loss-measurement'
Started at 12:12:41 UTC Mon 11 September 2017, runs once for 10s
Frame Loss Ratio calculated every 10s

One-way Frame Loss (Source->Dest)
~~~~~
1 probes per bucket

Bucket started at 12:12:41 UTC Mon 11 September 2017 lasting 10s
 Pkts sent: 100; Lost: 0 (0.0%); Corrupt: 0 (0.0%);
 Misordered: 0 (0.0%); Duplicates: 0 (0.0%)
 Result count: 1
 Min: 0.000%; Max: 0.000%; Mean; 0.000%; StdDev: 0.000%; Overall: 0.000%

One-way Frame Loss (Dest->Source)
~~~~~
1 probes per bucket

Bucket started at 12:12:41 UTC Mon 11 September 2017 lasting 10s
  Pkts sent: 100; Lost: 0 (0.0%); Corrupt: 0 (0.0%);
    Misordered: 0 (0.0%); Duplicates: 0 (0.0%)
  Result count: 1
  Min: 0.000%; Max: 0.000%; Mean; 0.000%; StdDev: 0.000%; Overall: 0.000%

RP/0/RP0/CPU0:ios#show ethernet cfm local meps verbose
Mon Sep 11 12:13:04.461 UTC
Domain UP6 (level 6), Service s6
Up MEP on FortyGigE0/0/1/2.1 MEP-ID 1
=====
Interface state: Up      MAC address: 008a.960f.c4a8
Peer MEPS: 1 up, 0 with errors, 0 timed out (archived)
Cross-check errors: 0 missing, 0 unexpected

CCM generation enabled: Yes, 1s (Remote Defect detected: No)
                        CCM processing offloaded to hardware
AIS generation enabled: No
Sending AIS:           No
Receiving AIS:        No

No packets sent/received

Domain DOWN0 (level 0), Service s10
Down MEP on TenGigE0/0/0/10.1 MEP-ID 2001
=====
Interface state: Up      MAC address: 008a.960f.c428
Peer MEPS: 1 up, 0 with errors, 0 timed out (archived)
Cross-check errors: 0 missing, 0 unexpected

CCM generation enabled: Yes, 1s (Remote Defect detected: No)
                        CCM processing offloaded to hardware
AIS generation enabled: No
Sending AIS:           No
Receiving AIS:        No

Packet      Sent      Received
-----
DMM          10          0

```



|     |     |     |
|-----|-----|-----|
| DMR | 0   | 10  |
| SLM | 100 | 0   |
| SLR | 0   | 100 |

## Synthetic Loss Measurement

The synthetic loss measurement mechanism defined in Y.1731 can only be used in point-to-point networks, and only works when there is sufficient flow of data traffic. The difficulties with the Y.1731 loss measurement mechanism was recognized across the industry and hence an alternative mechanism has been defined and standardized for measuring loss of traffic.

This alternative mechanism does not measure the loss of the actual data traffic, but instead injects synthetic CFM frames and measures the loss of these synthetic frames. You can perform a statistical analysis to give an approximation of the loss of data traffic. This technique is called Synthetic Loss Measurement (SLM). SLM has been included in the latest version of the Y.1731 standard. Use SLA to perform the following measurements:

- One-way loss (Source to Destination)
- One-way loss (Destination to Source)

Starting with Cisco IOS XR Release 7.1.1, SLM is supported on the routers.

SLM supports the following:

- All Layer 2 transport interfaces, such as physical, bundle interfaces, Layer2 sub-interfaces, pseudowire Head-end interfaces or attachment circuits.
- Up and Down MEPs.
- Transparent passing of the SLM packets through the MIP without punting it to the software.

## Configuring Synthetic Loss Measurement

The following section describes how you can configure Synthetic Loss Measurement:

```
RP/0/RP0/CPU0:router (config)# ethernet sla
profile test-slm type cfm-synthetic-loss-measurement
  probe
    send packet every 1 seconds
    synthetic loss calculation packets 24
  !
  schedule
    every 3 minutes for 120 seconds
  !
  statistics
    measure one-way-loss-sd
      buckets size 1 probes
      buckets archive 5
    !
    measure one-way-loss-ds
      buckets size 1 probes
      buckets archive 5
  !
  !
  !
  !
interface TenGigE0/0/0/10.1 l2transport
```

```
encapsulation dot1q 1
ethernet cfm
  mep domain DOWN0 service s10 mep-id 2001
  sla operation profile test-slm target mep-id 6001
!
```

### Configuring an On-Demand Ethernet SLA Operation for CFM Synthetic Loss Measurement

To configure an on-demand Ethernet SLA operation for CFM synthetic loss measurement, use this command in privileged EXEC configuration mode:

```
RP/0/RP0/CPU0:router (config) # ethernet sla on-demand operation type
cfm-synthetic-loss-measurement probe domain D1 source interface TenGigE
0/0/0/0 target mac-address 2.3.4
```

### Running Configuration

```
RP/0/RP0/CPU0:router# show ethernet sla statistics on-demand id 1
Mon Sep 11 12:12:00.699 UTC
Source: Interface TenGigE0/0/0/10.1, Domain DOWN0
Destination: Target MEP-ID 6001
=====
On-demand operation ID #1, packet type 'cfm-delay-measurement'
RP/0/RP0/CPU0:router#
RP/0/RP0/CPU0:router# show running-config
Mon Sep 11 12:10:18.467 UTC
Building configuration...
!! IOS XR Configuration version = 6.4.1.14I
!! Last configuration change at Mon Sep 11 12:08:16 2017 by root
!
logging console disable
telnet vrf default ipv4 server max-servers 10
username root
group root-lr
group cisco-support
secret 5 $1$QJT3$94M5/wK5J0v/lpAu/wz31/
!
line console
exec-timeout 0 0
!
ethernet cfm
domain UP6 level 6 id null
  service s6 xconnect group g1 p2p p1 id number 6
  mip auto-create all ccm-learning
  continuity-check interval 1s
  mep crosscheck
  mep-id 4001
  !
!
domain DOWN0 level 0 id null
  service s10 down-meps id number 10
  continuity-check interval 1s
  mep crosscheck
  mep-id 6001
  !
!
!
profile test-slm type cfm-synthetic-loss-measurement
probe
```

```

    send packet every 1 seconds
    synthetic loss calculation packets 24
    !
  schedule
    every 3 minutes for 120 seconds
    !
  statistics
    measure one-way-loss-sd
      buckets size 1 probes
      buckets archive 5
    !
    measure one-way-loss-ds
      buckets size 1 probes
      buckets archive 5
  !

interface TenGigE0/0/0/10.1 l2transport
encapsulation dot1q 1
ethernet cfm
  mep domain DOWN0 service s10 mep-id 2001
  sla operation profile DMM target mep-id 6001
  sla operation profile test-slm target mep-id 6001
  !
!
!

interface FortyGigE0/0/1/2.1 l2transport
encapsulation dot1q 1
ethernet cfm
  mep domain UP6 service s6 mep-id 1
  sla operation profile DMM target mep-id 6001
  sla operation profile test-slm target mep-id 6001
  !
!
!
l2vpn
xconnect group g1
  p2p pl
    interface TenGigE0/0/0/10.1
    interface FortyGigE0/0/1/2.1
  !
!
end

```

## Verification

Round Trip Delay

```

~~~~~
1 probes per bucket

```

```

Bucket started at 12:11:19 UTC Mon 11 September 2017 lasting 10s
 Pkts sent: 10; Lost: 0 (0.0%); Corrupt: 0 (0.0%);
 Misordered: 0 (0.0%); Duplicates: 0 (0.0%)
 Result count: 10
 Min: 0.009ms; Max: 0.010ms; Mean: 0.009ms; StdDev: 0.000ms

```

One-way Delay (Source->Dest)

```

~~~~~
1 probes per bucket

```

```

Bucket started at 12:11:19 UTC Mon 11 September 2017 lasting 10s
  Pkts sent: 10; Lost: 0 (0.0%); Corrupt: 0 (0.0%);

```

```

                Misordered: 0 (0.0%); Duplicates: 0 (0.0%)
Result count: 10
Min: 1912765.961ms; Max: 1912765.961ms; Mean: 1912765.961ms; StdDev: -2147483.648ms

One-way Delay (Dest->Source)
~~~~~
1 probes per bucket

Bucket started at 12:11:19 UTC Mon 11 September 2017 lasting 10s
 Pkts sent: 10; Lost: 0 (0.0%); Corrupt: 0 (0.0%);
 Misordered: 0 (0.0%); Duplicates: 0 (0.0%)
Result count: 10
Min: -1912765.952ms; Max: -1912765.951ms; Mean: -1912765.951ms; StdDev: -2147483.648ms

Round Trip Jitter
~~~~~
1 probes per bucket

Bucket started at 12:11:19 UTC Mon 11 September 2017 lasting 10s
  Pkts sent: 10; Lost: 0 (0.0%); Corrupt: 0 (0.0%);
                Misordered: 0 (0.0%); Duplicates: 0 (0.0%)
Result count: 9
Min: 0.000ms; Max: 0.001ms; Mean: 0.000ms; StdDev: 0.000ms

One-way Jitter (Source->Dest)
~~~~~
1 probes per bucket

Bucket started at 12:11:19 UTC Mon 11 September 2017 lasting 10s
 Pkts sent: 10; Lost: 0 (0.0%); Corrupt: 0 (0.0%);
 Misordered: 0 (0.0%); Duplicates: 0 (0.0%)
Result count: 9
Min: 0.000ms; Max: 0.000ms; Mean: 0.000ms; StdDev: 0.000ms

One-way Jitter (Dest->Source)
~~~~~
1 probes per bucket

Bucket started at 12:11:19 UTC Mon 11 September 2017 lasting 10s
  Pkts sent: 10; Lost: 0 (0.0%); Corrupt: 0 (0.0%);
                Misordered: 0 (0.0%); Duplicates: 0 (0.0%)
Result count: 9
Min: 0.000ms; Max: 0.001ms; Mean: 0.000ms; StdDev: 0.000ms

```



## CHAPTER 5

# Integrated Routing and Bridging

The BVI is a virtual interface within the router that acts like a normal routed interface. The BVI does not support bridging itself, but acts as a gateway for the corresponding bridge-domain to a routed interface within the router.

Aside from supporting a configurable MAC address, a BVI supports only Layer 3 attributes, and has the following characteristics:

- Uses a MAC address taken from the local chassis MAC address pool, unless overridden at the BVI interface.
- Is configured as an interface type using the **interface bvi** command and uses an IPv4 address that is in the same subnet as the hosts on the segments of the bridged domain.
- The BVI identifier is independent of the bridge-domain identifier. These identifiers do not need to correlate like they do in Cisco IOS software.
- Is associated to a bridge group using the **routed interface bvi** command.
- [Supported Features on a BVI, on page 99](#)
- [BVI Interface and Line Protocol States, on page 100](#)
- [Prerequisites for Configuring IRB, on page 100](#)
- [Restrictions for Configuring IRB, on page 101](#)
- [How to Configure IRB, on page 101](#)
- [Additional Information on IRB, on page 107](#)
- [Packet Flows Using IRB, on page 107](#)
- [Configuration Examples for IRB, on page 109](#)

## Supported Features on a BVI

- These interface commands are supported on a BVI:
  - **arp purge-delay**
  - **arp timeout**
  - **bandwidth** (The default is 10 Gbps and is used as the cost metric for routing protocols for the BVI)
  - **ipv4**

- **ipv6**
  - **mac-address**
  - **shutdown**
- The BVI supports IP helper addressing and secondary IP addressing.
  - Bi-directional egress traffic accounting is not supported on the BVI interfaces.
  - BVI does not support MTU configuration using **mtu** command, which is for physical interfaces. However, **ip mtu** and **ipv6 mtu** commands, which are logical interface commands, are supported.

## BVI Interface and Line Protocol States

Like typical interface states on the router, a BVI has both an Interface and Line Protocol state.

- The BVI interface state is Up when the following occurs:
  - The BVI interface is created.
  - The bridge-domain that is configured with the **routed interface bvi** command has at least one available active bridge port (Attachment circuit [AC] or pseudowire [PW]).



---

**Note** A BVI will be moved to the Down state if all of the bridge ports (Ethernet flow points [EFPs]) associated with the bridge domain for that BVI are down. However, the BVI will remain up if at least one bridgeport is up, even if all EFPs are down.

---

- These characteristics determine when the the BVI line protocol state is up:
  - The bridge-domain is in Up state.
  - The BVI IP address is not in conflict with any other IP address on another active interface in the router.

## Prerequisites for Configuring IRB

You must be in a user group associated with a task group that includes the proper task IDs. The command reference guides include the task IDs required for each command. If you suspect user group assignment is preventing you from using a command, contact your AAA administrator for assistance.

Before configuring IRB, be sure that these tasks and conditions are met:

- Know the IP addressing and other Layer 3 information to be configured on the bridge virtual interface (BVI).
- Complete MAC address planning if you decide to override the common global MAC address for all BVIs.

- Be sure that the BVI network address is being advertised by running static or dynamic routing on the BVI interface.

## Restrictions for Configuring IRB

Before configuring IRB, consider these restrictions:

- Only one BVI can be configured in any bridge domain.
- The same BVI can not be configured in multiple bridge domains.
- MTU configuration and fragmentation of packets is not supported on BVI interfaces.
- The following areas are *not* supported on the Layer2 bridging (with BVI):
  - Static mac entry configuration in Bridge.
  - Mac ageing configuration at global config mode.
  - MAC Learning Disable.
  - Vlan rewrite.
- QOS configuration on BVI interface is not supported for egress.
- Label allocation mode per-CE with BVI is not supported in an access network along with PE-CE protocols enabled.

## How to Configure IRB

This section includes the following configuration tasks:

### Configuring the Bridge Group Virtual Interface

To configure a BVI, complete the following steps.

#### Configuration Guidelines

Consider the following guidelines when configuring the BVI:

- The BVI must be assigned an IPv4 or IPv6 address that is in the same subnet as the hosts in the bridged segments.
- If the bridged network has multiple IP networks, then the BVI must be assigned secondary IP addresses for each network.

#### Procedure

---

**Step 1**      **configure**

**Example:**

```
Router# configure
```

Enters the global configuration mode.

**Step 2** **interface bvi** *identifier***Example:**

```
Router(config)# interface bvi 1
```

Specifies or creates a BVI, where *identifier* is a number from 1 to 65535.

**Step 3** **ipv4 address** *ipv4-address mask* [**secondary**] **ipv6 address** *ipv6-prefix/prefix-length* [**eui-64**] [**route-tag** *route-tag value*]**Example:**

```
Router(config-if)# ipv4 address 10.10.0.4 255.255.255.0
```

Specifies a primary or secondary IPv4 address or an IPv6 address for an interface.

**Step 4** **arp purge-delay** *seconds***Example:**

```
Router(config-if)#arp purge-delay 120
```

(Optional) Specifies the amount of time (in *seconds*) to delay purging of Address Resolution Protocol (ARP) table entries when the interface goes down.

The range is 1 to 65535. By default purge delay is not configured.

**Step 5** **arp timeout** *seconds***Example:**

```
Router(config-if)# arp timeout 12200
```

(Optional) Specifies how long dynamic entries learned on the interface remain in the ARP cache.

The range is 30 to 2144448000 seconds. The default is 14,400 seconds (4 hours).

**Step 6** **bandwidth** *rate***Example:**

```
Router(config-if)# bandwidth 1000000
```

(Optional) Specifies the amount of bandwidth (in kilobits per second) to be allocated on the interface. This number is used as the cost metric in routing protocols for the BVI.

The range is 0 to 4294967295. The default is 10000000 (10 Gbps).

**Step 7** **end** or **commit****Example:**

```
Router(config-if)# end
```



or

```
Router(config-if)# commit
```

Saves configuration changes.

- When you issue the **end** command, the system prompts you to commit changes:

```
Uncommitted changes found, commit them before exiting(yes/no/cancel)?
[cancel]:
```

Entering **yes** saves configuration changes to the running configuration file, exits the configuration session, and returns the router to EXEC mode.

Entering **no** exits the configuration session and returns the router to EXEC mode without committing the configuration changes.

Entering **cancel** leaves the router in the current configuration session without exiting or committing the configuration changes.

- Use the **commit** command to save the configuration changes to the running configuration file and remain within the configuration session.

## Configuring the Layer 2 AC Interfaces

To configure the Layer 2 AC interfaces for routing by a BVI, complete the following steps.

### Procedure

#### Step 1 **configure**

##### Example:

```
RP/0/RP0/CPU0:router# configure
```

Enters global configuration mode.

#### Step 2 **interface [HundredGigE | TenGigE] l2transport**

##### Example:

```
RP/0/RP0/CPU0:router(config)# interface TenGigE 0/0/0/0.1 l2transport
```

Enables Layer 2 transport mode on a Gigabit Ethernet or 10-Gigabit Ethernet interface or subinterface and enters interface or subinterface configuration mode.

#### Step 3 **end or commit**

##### Example:

```
RP/0/RP0/CPU0:router(config-if)# end
```

or

```
RP/0/RP0/CPU0:router(config-if)# commit
```

Saves configuration changes.

- When you issue the **end** command, the system prompts you to commit changes:

```
Uncommitted changes found, commit them before exiting(yes/no/cancel)?
[cancel]:
```

- Entering **yes** saves configuration changes to the running configuration file, exits the configuration session, and returns the router to EXEC mode.
- Entering **no** exits the configuration session and returns the router to EXEC mode without committing the configuration changes.
- Entering **cancel** leaves the router in the current configuration session without exiting or committing the configuration changes.
- Use the **commit** command to save the configuration changes to the running configuration file and remain within the configuration session.

## Configuring a Bridge Group and Assigning Interfaces to a Bridge Domain

To configure a bridge group and assign interfaces to a bridge domain, complete the following steps.

### Procedure

#### Step 1 **configure**

##### Example:

```
RP/0/RP0/CPU0:router# configure
```

Enters global configuration mode.

#### Step 2 **l2vpn**

##### Example:

```
RP/0/RP0/CPU0:router(config)# l2vpn
```

Enters L2VPN configuration mode.

#### Step 3 **bridge group** *bridge-group-name*

##### Example:

```
RP/0/RP0/CPU0:router(config-l2vpn)# bridge group 10
```

Creates a bridge group and enters L2VPN bridge group configuration mode.

#### Step 4 **bridge-domain** *bridge-domain-name*

**Example:**

```
RP/0/RP0/CPU0:router(config-l2vpn-bg)# bridge-domain BD_1
```

Creates a bridge domain and enters L2VPN bridge group bridge domain configuration mode.

**Step 5** interface [HundredGigE | TenGigE**Example:**

```
RP/0/RP0/CPU0:router(config-l2vpn-bg-bd)# interface HundredGigE 0/0/1/0.1
```

Associates the 100-Gigabit Ethernet or 10-Gigabit Ethernet interface with the specified bridge domain and enters L2VPN bridge group bridge domain attachment circuit configuration mode.

Repeat this step for as many interfaces as you want to associate with the bridge domain.

**Step 6** end or commit**Example:**

```
RP/0/RP0/CPU0:router(config-l2vpn-bg-bd-ac)# end
```

or

```
RP/0/RP0/CPU0:router(config-l2vpn-bg-bd-ac)# commit
```

Saves configuration changes.

- When you issue the **end** command, the system prompts you to commit changes:

```
Uncommitted changes found, commit them before exiting(yes/no/cancel)?  
[cancel]:
```

- Entering **yes** saves configuration changes to the running configuration file, exits the configuration session, and returns the router to EXEC mode.
- Entering **no** exits the configuration session and returns the router to EXEC mode without committing the configuration changes.
- Entering **cancel** leaves the router in the current configuration session without exiting or committing the configuration changes.
- Use the **commit** command to save the configuration changes to the running configuration file and remain within the configuration session.

---

## Associating the BVI as the Routed Interface on a Bridge Domain

To associate the BVI as the routed interface on a bridge domain, complete the following steps.

**Procedure**

---

**Step 1** configure

**Example:**

```
RP/0/RP0/CPU0:router# configure
```

Enters global configuration mode.

**Step 2 l2vpn****Example:**

```
RP/0/RP0/CPU0:router(config)# l2vpn
```

Enters L2VPN configuration mode.

**Step 3 bridge group *bridge-group-name*****Example:**

```
RP/0/RP0/CPU0:router(config-l2vpn)# bridge group BG_test
```

Creates a bridge group and enters L2VPN bridge group configuration mode.

**Step 4 bridge-domain *bridge-domain-name*****Example:**

```
RP/0/RP0/CPU0:router(config-l2vpn-bg)# bridge-domain 1
```

Creates a bridge domain and enters L2VPN bridge group bridge domain configuration mode.

**Step 5 routed interface *bvi identifier*****Example:**

```
RP/0/RP0/CPU0:router(config-l2vpn-bg-bd)# routed interface bvi 1
```

Associates the specified BVI as the routed interface for the interfaces assigned to the bridge domain.

**Step 6 end or commit****Example:**

```
RP/0/RP0/CPU0:router(config-l2vpn-bg-bd)# end
```

or

```
RP/0/RP0/CPU0:router(config-l2vpn-bg-bd)# commit
```

Saves configuration changes.

- When you issue the **end** command, the system prompts you to commit changes:

```
Uncommitted changes found, commit them before exiting(yes/no/cancel)?
[cancel]:
```

- Entering **yes** saves configuration changes to the running configuration file, exits the configuration session, and returns the router to EXEC mode.
- Entering **no** exits the configuration session and returns the router to EXEC mode without committing the configuration changes.

- Entering **cancel** leaves the router in the current configuration session without exiting or committing the configuration changes.
- Use the **commit** command to save the configuration changes to the running configuration file and remain within the configuration session.

## Displaying Information About a BVI

To display information about BVI status and packet counters, use the following commands:

|                                                                                                                        |                                                                                            |
|------------------------------------------------------------------------------------------------------------------------|--------------------------------------------------------------------------------------------|
| <b>show interfaces bvi</b> <i>identifier</i> [ <b>accounting</b>   <b>brief</b>   <b>description</b>   <b>detail</b> ] | Displays interface status, line protocol state, and packet counters for the specified BVI. |
| <b>show adjacency bvi</b> <i>identifier</i> [ <b>detail</b>   <b>remote</b> ]                                          | Displays packet and byte transmit counters per adjacency to the specified BVI.             |
| <b>show l2vpn bridge-domain detail</b>                                                                                 | Displays the reason that a BVI is down.                                                    |

## Additional Information on IRB

### Packet Flows Using IRB

This figure shows a simplified functional diagram of an IRB implementation to describe different packet flows between Host A, B, and C. In this example, Host C is on a network with a connection to the same router. In reality, another router could be between Host C and the router shown.

**Figure 10: IRB Packet Flows Between Hosts**

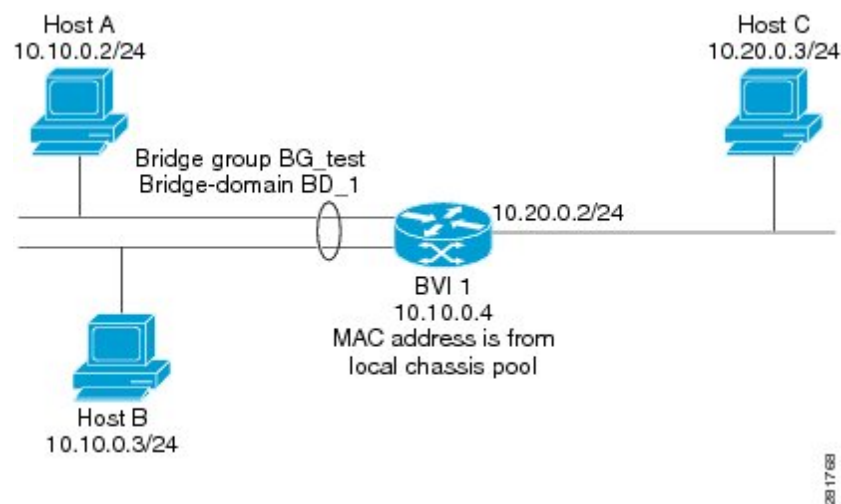

When IRB is configured on a router, the following processing happens:

- ARP requests are resolved between the hosts and BVI that are part of the bridge domain.
- All packets from a host on a bridged interface go to the BVI if the destination MAC address matches the BVI MAC address. Otherwise, the packets are bridged.
- For packets destined for a host on a routed network, the BVI forwards the packets to the routing engine before sending them out a routed interface.
- All packets either from or destined to a host on a bridged interface go to the BVI first (unless the packet is destined for a host on the bridge domain).
- For packets that are destined for a host on a segment in the bridge domain that come in to the router on a routed interface, the BVI forwards the packet to the bridging engine, which forwards it through the appropriate bridged interface.

## Packet Flows When Host A Sends to Host B on the Bridge Domain

When Host A sends data to Host B in the bridge domain on the 10.10.0.0 network, no routing occurs. The hosts are on the same subnet and the packets are bridged between their segment interfaces on the router.

## Packet Flows When Host A Sends to Host C From the Bridge Domain to a Routed Interface

Using host information from this figure, the following occurs when Host A sends data to Host C from the IRB bridging domain to the routing domain:

- Host A sends the packet to the BVI (as long any ARP request the is resolved between the host and the BVI). The packet has the following information:
  - Source MAC address of host A.
  - Destination MAC address of the BVI.
- Since Host C is on another network and needs to be routed, the BVI forwards the packet to the routed interface with the following information:
  - IP source MAC address of Host A (10.10.0.2) is changed to the MAC address of the BVI (10.10.0.4).
  - IP destination address is the IP address of Host C (10.20.0.3).
- Interface 10.20.0.2 sees receipt of a packet from the routed BVI 10.10.0.4. The packet is then routed through interface 10.20.0.2 to Host C.

## Packet Flows When Host C Sends to Host B From a Routed Interface to the Bridge Domain

Using host information from this figure, the following occurs when Host C sends data to Host B from the IRB routing domain to the bridging domain:

- The packet comes into the routing domain with the following information:
  - MAC source address—MAC of Host C.

- MAC destination address—MAC of the 10.20.0.2 ingress interface.
  - IP source address—IP address of Host C (10.20.0.3).
  - IP destination address—IP address of Host B (10.10.0.3).
- When interface 10.20.0.2 receives the packet, it looks in the routing table and determines that the packet needs to be forwarded to the BVI at 10.10.0.4.
  - The routing engine captures the packet that is destined for the BVI and forwards it to the BVI's corresponding bridge domain. The packet is then bridged through the appropriate interface if the destination MAC address for Host B appears in the bridging table, or is flooded on all interfaces in the bridge group if the address is not in the bridging table.

## Configuration Examples for IRB

This section provides the following configuration examples:

### Basic IRB Configuration: Example

The following example shows how to perform the most basic IRB configuration:

```

! Configure the BVI and its IPv4 address
!
RP/0/RP0/CPU0:router# configure
RP/0/RP0/CPU0:router(config)#interface bvi 1
RP/0/RP0/CPU0:router(config-if)#ipv4 address 10.10.0.4 255.255.255.0
RP/0/RP0/CPU0:router(config-if)# exit
!
! Configure the Layer 2 AC interface
!
RP/0/RP0/CPU0:router(config)#interface HundredGigE 0/0/1/0 l2transport
RP/0/RP0/CPU0:router(config-if)# exit
!
! Configure the L2VPN bridge group and bridge domain and assign interfaces
!
RP/0/RP0/CPU0:router(config)#l2vpn
RP/0/RP0/CPU0:router(config-l2vpn)#bridge group 10
RP/0/RP0/CPU0:router(config-l2vpn-bg)#bridge-domain 1
RP/0/RP0/CPU0:router(config-l2vpn-bg-bd)#interface HundredGigE 0/0/1/0
RP/0/RP0/CPU0:router(config-l2vpn-bg-bd-if)# exit
!
! Associate a BVI to the bridge domain
!
RP/0/RP0/CPU0:router(config-l2vpn-bg-bd)# routed interface bvi 1
RP/0/RP0/CPU0:router(config-l2vpn-bg-bd)# commit

```

### IRB With BVI and VRRP Configuration: Example

This example shows a partial router configuration for the relevant configuration areas for IRB support of a BVI and VRRP:



---

**Note** VRRPv6 is also supported.

---

```
l2vpn
 bridge group IRB
   bridge-domain IRB-EDGE
   interface TenGigE0/0/0/8
   !
   routed interface BVI 100
   !
 interface TenGigE0/0/0/8
   l2transport
   !
 interface BVI 100
   ipv4 address 10.21.1.1 255.255.255.0
   !
 router vrrp
   interface BVI 100
   address-family ipv4
   vrrp 1
   address 10.21.1.100
   priority 100
   !
```





## CHAPTER 6

# Configuring Link Bundling

The Link Bundling feature allows you to group multiple point-to-point links together into one logical link and provide higher bidirectional bandwidth, redundancy, and load balancing between two routers. A virtual interface is assigned to the bundled link. The component links can be dynamically added and deleted from the virtual interface.

The virtual interface is treated as a single interface on which one can configure an IP address and other software features used by the link bundle. Packets sent to the link bundle are forwarded to one of the links in the bundle.

A link bundle is simply a group of ports that are bundled together and act as a single link. The advantages of link bundles are as follows:

- Multiple links can span several interface modules to form a single interface. Thus, the failure of a single link does not cause a loss of connectivity.
- Bundled interfaces increase bandwidth availability, because traffic is forwarded over all available members of the bundle. Therefore, traffic can flow on the available links if one of the links within a bundle fails. Bandwidth can be added without interrupting packet flow.

Cisco IOS XR software supports the following method of forming bundles of Ethernet interfaces:

- IEEE 802.3ad—Standard technology that employs a Link Aggregation Control Protocol (LACP) to ensure that all the member links in a bundle are compatible. Links that are incompatible or have failed are automatically removed from a bundle.
- [Compatible Characteristics of Ethernet Link Bundles, on page 112](#)
- [Information About Configuring Link Bundling, on page 114](#)
- [Configuring Ethernet Link Bundles, on page 116](#)
- [Configuring LACP Fallback, on page 119](#)
- [Configuring EFP Load Balancing on an Ethernet Link Bundle, on page 120](#)
- [VLANs on an Ethernet Link Bundle, on page 122](#)
- [Configuring VLAN over Bundles, on page 123](#)
- [LACP Short Period Time Intervals, on page 126](#)
- [Configuring the Default LACP Short Period Time Interval, on page 127](#)
- [Configuring Custom LACP Short Period Time Intervals, on page 128](#)
- [Configuring Bundle Interfaces under VPWS Cross-Connect, on page 133](#)
- [Configuring Bundle Interface under VPLS, on page 134](#)
- [Bundle Consistency Checker, on page 136](#)

## Compatible Characteristics of Ethernet Link Bundles

This list describes the properties of ethernet link bundles:

**Table 5: Feature History**

| Feature Name                     | Release Information | Feature Description                                                                                                                                                                                  |
|----------------------------------|---------------------|------------------------------------------------------------------------------------------------------------------------------------------------------------------------------------------------------|
| 16 bundle members in LAG or LACP | Release 7.3.1       | The bundle members on the router are increased to 16. Also, the maximum number of supported sub-interfaces per system is increased. This feature increases the performance and memory of the router. |

- The router supports mixed speed bundles. Mixed speed bundles allow member links of different bandwidth to be configured as active members in a single bundle. The ratio of the bandwidth for bundle members must not exceed 10. Also, the total weight of the bundle must not exceed 64. For example, 100Gbps link and 10Gbps links can be active members in a bundle and load-balancing on member links is based on bandwidth weightage.
- The weight of each bundle member is the ratio of its bandwidth to the lowest bandwidth member. Total weight of the bundle is the sum of weights or relative bandwidth of each bundle member. Since the weight for a bundle member is greater than or equal to 1 and less than or equal to 10, the total member of links in a bundle is less than 64 in mixed bundle case.
- Any type of Ethernet interfaces can be bundled, with or without the use of LACP (Link Aggregation Control Protocol).
- A single router can support a maximum of 256 bundle interfaces. Link bundles of only physical interfaces are supported.
- Physical layer and link layer configuration are performed on individual member links of a bundle.
- Configuration of network layer protocols and higher layer applications is performed on the bundle itself.
- IPv4 and IPv6 addressing is supported on ethernet link bundles.
- A bundle can be administratively enabled or disabled.
- Each individual link within a bundle can be administratively enabled or disabled.
- Ethernet link bundles are created in the same way as Ethernet channels, where the user enters the same configuration on both end systems.
- Prior to Cisco IOS XR Release 7.3.1, the router supported 8 bundle members. The maximum number of supported sub-interfaces for Link Aggregation Group (LAG) or LACP are:
  - Layer 3 sub-interfaces is 1000.
  - Layer 2 sub-interfaces is 4000 per bundle.
  - Member links per bundle is 8.

Starting with Cisco IOS XR Release 7.3.1, the router supports 16 bundle members, and the database entries are optimized to use one entry per bundle sub-interface, regardless of the number of members in a bundle. The maximum number of supported sub-interfaces for LAG or LACP are:

- Layer 3 sub-interfaces is 1000.
  - Layer 2 sub-interfaces is 16000 per router.
  - Layer 2 sub-interfaces is 4000 per bundle.
  - Member links per bundle is 16.
- QoS is supported and is applied proportionally on each bundle member.
  - If the HQoS profile is enabled, the maximum available trunks by default (physical+sub-interfaces) are 256. If more trunks are required, you can configure the **hw-module profile bundle-scale <256/512/1024>** command. With HQoS enabled on bundle interfaces, a maximum of 4 priority levels are supported.

The maximum number of supported bundle members with HQoS profile on Layer2 and Layer3 interfaces:

- Maximum of 1024 trunks (128 physical interfaces + 896 sub-interfaces) and 16 bundle members.
  - Maximum of 256 trunks (128 physical interfaces + 128 sub-interfaces) and 64 bundle members.
  - Maximum of 512 trunks (128 physical interfaces + 384 sub-interfaces) and 32 bundle members.
- In case static MAC address is configured on a bundle-ether interface, the following limitations are applied:
    - Locally generated packets, such as ICMP, BGP, and so on, going out from the interface have the source MAC address as the statically configured MAC address.
    - Transit (forwarded) packets going out of the interface do not have the configured static MAC as source MAC address. In such a scenario, the upper 36-bits come from the system MAC address (or the original/dynamic MAC address) and the lower 12-bits come from the MAC address configured on the bundle. To check the dynamic pool of MAC addresses included, use the `show ethernet mac-allocation detail` command.

For example, if the dynamic MAC address was 008A.9624.48D8 and the configured static MAC address is 0011.2222.ABCD. Then, the source MAC for transit (forwarded) traffic will be 008A.9624.4BCD.



---

**Note** This limitation can cause traffic blackholing for the transit traffic, in case there is L2 ACL applied for security purpose. In such case, it is necessary to add permit statement for both MAC addresses in the L2 ACL.

---

- Load balancing (the distribution of data between member links) is done by flow instead of by packet. Data is distributed to a link in proportion to the bandwidth of the link in relation to its bundle.
- All links within a single bundle must terminate on the same two systems.
- Bundled interfaces are point-to-point.
- A link must be in the up state before it can be in distributing state in a bundle.
- Only physical links can be bundle members.

- Multicast traffic is load balanced over the members of a bundle. For a given flow, the internal processes selects the member link, and the traffic for the flow is sent over that member.
- Ensure the load interval of the bundle interface is configured to 300 seconds (default value) on router to prevent fluctuation in the outgoing interface packet and packet mismatch in the interface statistics.

### Limitations

- Configuration of egress traffic on fixed members of a bundle flowing through the same physical member link is *not* supported.
- The **bundle load-balance hash auto** command is *not* supported.
- MC-LAG is *not* supported.
- Bundle fast convergence is *not* supported.

## Information About Configuring Link Bundling

To configure link bundling, you must understand the following concepts:

### IEEE 802.3ad Standard

The IEEE 802.3ad standard typically defines a method of forming Ethernet link bundles.

For each link configured as bundle member, the following information is exchanged between the systems that host each end of the link bundle:

- A globally unique local system identifier
- An identifier (operational key) for the bundle of which the link is a member
- An identifier (port ID) for the link
- The current aggregation status of the link

This information is used to form the link aggregation group identifier (LAG ID). Links that share a common LAG ID can be aggregated. Individual links have unique LAG IDs.

The system identifier distinguishes one router from another, and its uniqueness is guaranteed through the use of a MAC address from the system. The bundle and link identifiers have significance only to the router assigning them, which must guarantee that no two links have the same identifier, and that no two bundles have the same identifier.

The information from the peer system is combined with the information from the local system to determine the compatibility of the links configured to be members of a bundle.

The MAC address of the first link attached to a bundle becomes the MAC address of the bundle itself. The bundle uses this MAC address until that link (the first link attached to the bundle) is detached from the bundle, or until the user configures a different MAC address. The bundle MAC address is used by all member links when passing bundle traffic. Any unicast or multicast addresses set on the bundle are also set on all the member links.



---

**Note** We recommend that you avoid modifying the MAC address, because changes in the MAC address can affect packet forwarding.

---

## Link Bundle Configuration Overview

The following steps provide a general overview of the link bundle configuration. Keep in mind that a link must be cleared of all previous network layer configuration before it can be added to a bundle:

1. In global configuration mode, create a link bundle. To create an Ethernet link bundle, enter the **interface Bundle-Ether** command.
2. Assign an IP address and subnet mask to the virtual interface using the **ipv4 address** command.
3. Add interfaces to the bundle you created in Step 1 with the **bundle id** command in the interface configuration submode.

You can add up to 32 links to a single bundle.

4. You can optionally implement 1:1 link protection for the bundle by setting the **bundle maximum-active links** command to 1. Performing this configuration causes the highest-priority link in the bundle to become active and the second-highest-priority link to become the standby. (The link priority is based on the value of the **bundle port-priority** command.) If the active link fails, the standby link immediately becomes the active link.



---

**Note** A link is configured as a member of a bundle from the interface configuration submode for that link.

---

## Link Switchover

By default, a maximum of 64 links in a bundle can actively carry traffic. If one member link in a bundle fails, traffic is redirected to the remaining operational member links.

You can optionally implement 1:1 link protection for a bundle by setting the **bundle maximum-active links** command to 1. By doing so, you designate one active link and one or more dedicated standby links. If the active link fails, a switchover occurs and a standby link immediately becomes active, thereby ensuring uninterrupted traffic.

If the active and standby links are running LACP, you can choose between an IEEE standard-based switchover (the default) or a faster proprietary optimized switchover. If the active and standby links are not running LACP, the proprietary optimized switchover option is used.

Regardless of the type of switchover you are using, you can disable the wait-while timer, which expedites the state negotiations of the standby link and causes a faster switchover from a failed active link to the standby link.

## LACP Fallback

The LACP Fallback feature allows an active LACP interface to establish a Link Aggregation Group (LAG) port-channel before the port-channel receives the Link Aggregation and Control Protocol (LACP) protocol data units (PDU) from its peer. With the LACP Fallback feature configured, the router allows the server to bring up the LAG, before receiving any LACP PDUs from the server, and keeps one port active. This allows the server to establish a connection to PXE server over one Ethernet port, download its boot image and then continue the booting process. When the server boot process is complete, the server fully forms an LACP port-channel.

## Configuring Ethernet Link Bundles

This section describes how to configure an Ethernet link bundle.



**Note** In order for an Ethernet bundle to be active, you must perform the same configuration on both connection endpoints of the bundle.



**Tip** You can programmatically perform the configuration using `openconfig-if-aggregate.yang` OpenConfig data model. To get started with using data models, see the *Programmability Configuration Guide*.

### Procedure

#### Step 1

**configure**

**Example:**

```
RP/0/RP0/CPU0:router# configure
```

Enters global configuration mode.

#### Step 2

**interface Bundle-Ether *bundle-id***

**Example:**

```
RP/0/RP0/CPU0:router(config)# interface Bundle-Ether 3
```

Creates a new Ethernet link bundle with the specified bundle-id. The range is 1 to 65535.

#### Step 3

**ipv4 address *ipv4-address mask***

**Example:**

```
RP/0/RP0/CPU0:router(config-if)# ipv4 address 10.1.2.3 255.0.0.0
```

Assigns an IP address and subnet mask to the virtual interface using the **ipv4 address** configuration subcommand.

**Note** • Only a Layer 3 bundle interface requires an IP address.

**Step 4** **bundle minimum-active bandwidth** *kbps***Example:**

```
RP/0/RP0/CPU0:router(config-if)# bundle minimum-active bandwidth 580000
```

(Optional) Sets the minimum amount of bandwidth required before a user can bring up a bundle.

**Step 5** **bundle minimum-active links** *links***Example:**

```
RP/0/RP0/CPU0:router(config-if)# bundle minimum-active links 2
```

(Optional) Sets the number of active links required before you can bring up a specific bundle.

**Step 6** **bundle maximum-active links** *links* [**hot-standby**]**Example:**

```
RP/0/RP0/CPU0:router(config-if)# bundle maximum-active links 1 hot-standby
```

(Optional) Implements 1:1 link protection for the bundle, which causes the highest-priority link in the bundle to become active and the second-highest-priority link to become the standby. Also, specifies that a switchover between active and standby LACP-enabled links is implemented per a proprietary optimization.

The **bundle port-priority** command determines the priority of the active and standby links for the bundle.

**Step 7** **exit****Example:**

```
RP/0/RP0/CPU0:router(config-if)# exit
```

Exits interface configuration submode for the Ethernet link bundle.

**Step 8** **interface HundredGigE** *interface-path-id***Example:**

```
RP/0/RP0/CPU0:router(config)# interface HundredGigE 0/0/1/0
```

Enters interface configuration mode for the specified interface.

Enter the **HundredGigE** keyword to specify the interface type. Replace the *interface-path-id* argument with the node-id in the *rack/slot/module* format.

**Step 9** **bundle id** *bundle-id* [**mode** {**active** | **on** | **passive**}]**Example:**

```
RP/0/RP0/CPU0:router(config-if)# bundle id 3 mode on
```

Adds the link to the specified bundle.

To enable active or passive LACP on the bundle, include the optional **mode active** or **mode passive** keywords in the command string.

To add the link to the bundle without LACP support, include the optional **mode on** keywords with the command string.

**Note** • If you do not specify the **mode** keyword, the default mode is **on** (LACP is not run over the port).

**Step 10** **bundle port-priority** *priority*

**Example:**

```
RP/0/RP0/CPU0:router(config-if)# bundle port-priority 1
```

(Optional) If you set the **bundle maximum-active links** command to 1, you must also set the priority of the active link to the highest priority (lowest value) and the standby link to the second-highest priority (next lowest value). For example, you can set the priority of the active link to 1 and the standby link to 2.

**Step 11** **no shutdown**

**Example:**

```
RP/0/RP0/CPU0:router(config-if)# no shutdown
```

(Optional) If a link is in the down state, bring it up. The **no shutdown** command returns the link to an up or down state depending on the configuration and state of the link.

**Step 12** **exit**

**Example:**

```
RP/0/RP0/CPU0:router(config-if)# exit
```

Exits interface configuration submode for the Ethernet interface.

**Step 13** **bundle id** *bundle-id* [**mode** {**active** | **passive** | **on**}]

**Example:**

```
RP/0/RP0/CPU0:router(config)# interface TenGigE 0/0/1/0
```

```
RP/0/RP0/CPU0:router(config-if)# bundle id 3
```

```
RP/0/RP0/CPU0:router(config-if)# bundle port-priority 2
```

```
RP/0/RP0/CPU0:router(config-if)# no shutdown
```

```
RP/0/RP0/CPU0:router(config-if)# exit
```

```
RP/0/RP0/CPU0:router(config)# interface TenGigE 0/0/1/0
```

```
RP/0/RP0/CPU0:router(config-if)# bundle id 3
```

```
RP/0/RP0/CPU0:router(config-if)# no shutdown
```

```
RP/0/RP0/CPU0:router(config-if)# exit
```

(Optional) Repeat Step 8 through Step 11 to add more links to the bundle.

**Step 14** **exit**

**Example:**

```
RP/0/RP0/CPU0:router(config-if)# exit
```

Exits interface configuration mode.



**Step 15**     **exit****Example:**

```
RP/0/RP0/CPU0:router(config)# exit
```

Exits global configuration mode.

**Step 16**     Perform Step 1 through Step 15 on the remote end of the connection.

Brings up the other end of the link bundle.

**Step 17**     **show bundle Bundle-Ether *bundle-id*****Example:**

```
RP/0/RP0/CPU0:router# show bundle Bundle-Ether 3
```

(Optional) Shows information about the specified Ethernet link bundle.

**Step 18**     **show lacp Bundle-Ether *bundle-id*****Example:**

```
RP/0/RP0/CPU0:router# show lacp Bundle-Ether 3
```

(Optional) Shows detailed information about LACP ports and their peers.

---

## Configuring LACP Fallback

This section describes how to configure the LACP Fallback feature.

### Procedure

---

**Step 1**     **configure****Example:**

```
RP/0/RP0/CPU0:router# configure
```

Enters global configuration mode.

**Step 2**     **interface Bundle-Ether *bundle-id*****Example:**

```
RP/0/RP0/CPU0:router(config)# interface Bundle-Ether 3
```

Creates and names a new Ethernet link bundle.

**Step 3**     **bundle lacp-fallback timeout *timeout value*****Example:**

```
RP/0/RP0/CPU0:router(config-if)# bundle lacp-fallback timeout 4
```

Enables the LACP Fallback feature.

**Step 4** **end** or **commit**

**Example:**

```
RP/0/RP0/CPU0:router(config-subif)# commit
```

Saves configuration changes.

**Step 5** **show bundle infrastructure database ma bdl-info Bundle-e1010 | inc text**

**Example:**

```
RP/0/RP0/CPU0:router# show bundle infrastructure database ma bdl-info Bundle-e1010 | inc
"fallback"
```

(Optional) Shows the MA information of the bundle manager.

**Step 6** **show bundle infrastructure database ma bdl-info Bundle-e1015 | inc text**

**Example:**

```
RP/0/RP0/CPU0:router# show bundle infrastructure database ma bdl-info Bundle-e1015 | inc
"fallback"
```

(Optional) Shows the MA information of the bundle manager.

## Configuring EFP Load Balancing on an Ethernet Link Bundle

This section describes how to configure Ethernet flow point (EFP) Load Balancing on an Ethernet link bundle.

By default, Ethernet flow point (EFP) load balancing is enabled. However, the user can choose to configure all egressing traffic on the fixed members of a bundle to flow through the same physical member link. This configuration is available only on an Ethernet Bundle subinterface with Layer 2 transport (**I2transport**) enabled.



**Note** If the active members of the bundle change, the traffic for the bundle may get mapped to a different physical link that has a hash value that matches the configured value.

### Procedure

**Step 1** **configure**

**Example:**

```
RP/0/RP0/CPU0:router# configure
```

Enters global configuration mode.

**Step 2** **interface Bundle-Ether *bundle-id* I2transport**

**Example:**

```
RP/0/RP0/CPU0:router#(config)# interface Bundle-Ether 3.1 l2transport
```

Creates a new Ethernet link bundle with the specified *bundle-id* and with Layer 2 transport enabled.

The range is 1 to 65535.

**Example**

This example shows how to configure all egress traffic on the fixed members of a bundle to flow through the same physical member link automatically.

```
RP/0/RP0/CPU0:router# configuration terminal
RP/0/RP0/CPU0:router(config)# interface bundle-ether 1.1 l2transport
(config-subif)#
RP/0/RP0/CPU0:router(config-subif)#
```

This example shows how to configure all egress traffic on the fixed members of a bundle to flow through a specified physical member link.

```
RP/0/RP0/CPU0:router# configuration terminal
RP/0/RP0/CPU0:router(config)# interface bundle-ether 1.1 l2transport
(config-subif)#
RP/0/RP0/CPU0:router(config-subif)#
```

This example shows output for show bundle load-balancing detail location command:

```
RP/0/RP0/CPU0:router#show bundle load-balancing detail location 0/0/cpu0
Fri Nov 1 17:54:20.417 UTC
```

```
Bundle-Ether1
```

```
Type: Ether (L3)
Members <current/max>: 1/64
Total Weighting: 1
Load balance: Default
Locality threshold: 65
Avoid rebalancing? False
Sub-interfaces: 2
```

```
Member Information:
```

| Port:      | LON | ULID | BW |
|------------|-----|------|----|
| Te0/0/0/26 | 0   | 0    | 1  |

```
Sub-interface Information:
```

| Sub-interface     | Type | Load Balance Hash | Locality Threshold |
|-------------------|------|-------------------|--------------------|
| Bundle-Ether1.99  | L3   | Default           | 65                 |
| Bundle-Ether1.100 | L2   | Default           | 65                 |

```
DNX Platform Data Bundle-IFH : 0x800301c
BMA Index : 0 Ver : 2
BMA-Entry : 0x308c51d048 Flag : 0
Aib-Ref : 5
```

```

Num-members: 1          Num-of-bmt : 1
Slowpath-Tb: 0x308d610160

DNX Platform Slowpath Data:
Member-IFH : 0x220      Local-IFH : 0x220
  npu_id    : 0          mp_id     : 0
  voq       : 1200      nodeid   : 0
  amba_mac_ls: 0.0.11

DNX Platform DPA Data:
lag_id      : 12        gport     : 0xc00000c
key/ifh     : 0x800301c Num-members: 64
  Member id : 0
    is_local : 1          is_active : 1
    sys_port : 0x2c      npu_id   : 0
    weight   : 1
    entry_indic: 0
  Member id : 1
    is_local : 1          is_active : 0
    sys_port : 0x2a      npu_id   : 0
    weight   : 0
    entry_indic: 1

DNX Platform VLAN Interface Data : Count 2
Sub-IFH     : 0x8003114  is Active : 1          Wait Count : 0
Sub-IFH     : 0x80030b6  is Active : 1          Wait Count : 0

```

## VLANs on an Ethernet Link Bundle

802.1Q VLAN subinterfaces can be configured on 802.3ad Ethernet link bundles. Keep the following information in mind when adding VLANs on an Ethernet link bundle:



---

**Note** The memory requirement for bundle VLANs is slightly higher than standard physical interfaces.

---

To create a VLAN subinterface on a bundle, include the VLAN subinterface instance with the **interface Bundle-Ether** command, as follows:

```
interface Bundle-Ether interface-bundle-id.subinterface
```

After you create a VLAN on an Ethernet link bundle, all VLAN subinterface configuration is supported on that link bundle.

VLAN subinterfaces can support multiple Layer 2 frame types and services, such as Ethernet Flow Points - EFPs) and Layer 3 services.

Layer 2 EFPs are configured as follows:

```
interface bundle-ether instance.subinterface l2transport. encapsulation dot1q xxxxx
```

Layer 3 VLAN subinterfaces are configured as follows:

```
interface bundle-ether instance.subinterface, encapsulation dot1q xxxxx
```



---

**Note** The difference between the Layer 2 and Layer 3 interfaces is the **l2transport** keyword. Both types of interfaces use **dot1q encapsulation**.

---

## Configuring VLAN over Bundles

This section describes how to configure a VLAN bundle. The creation of a VLAN bundle involves three main tasks:

### Procedure

---

- Step 1** Create an Ethernet bundle.
  - Step 2** Create VLAN subinterfaces and assign them to the Ethernet bundle.
  - Step 3** Assign Ethernet links to the Ethernet bundle.
- 

These tasks are describe in detail in the procedure that follows.



---

**Note** In order for a VLAN bundle to be active, you must perform the same configuration on both ends of the bundle connection.

---

### Procedure

---

**Step 1** **configure**

**Example:**

```
RP/0/RP0/CPU0:router# configure
```

Enters global configuration mode.

**Step 2** **interface Bundle-Ether** *bundle-id*

**Example:**

```
RP/0/RP0/CPU0:router#(config)# interface Bundle-Ether 3
```

Creates and names a new Ethernet link bundle.

**Step 3** **ipv4 address** *ipv4-address mask*

**Example:**

```
RP/0/RP0/CPU0:router(config-if)# ipv4 address 10.1.2.3 255.0.0.0
```

Assigns an IP address and subnet mask to the virtual interface using the **ipv4 address** configuration subcommand.

**Step 4** **bundle minimum-active bandwidth** *kbps*

**Example:**

```
RP/0/RP0/CPU0:router(config-if)# bundle minimum-active bandwidth 580000
```

(Optional) Sets the minimum amount of bandwidth required before a user can bring up a bundle.

**Step 5** **bundle minimum-active links** *links*

**Example:**

```
RP/0/RP0/CPU0:router(config-if)# bundle minimum-active links 2
```

(Optional) Sets the number of active links required before you can bring up a specific bundle.

**Step 6** **bundle maximum-active links** *links* [**hot-standby**]

**Example:**

```
RP/0/RP0/CPU0:router(config-if)# bundle maximum-active links 1 hot-standby
```

(Optional) Implements 1:1 link protection for the bundle, which causes the highest-priority link in the bundle to become active and the second-highest-priority link to become the standby. Also, specifies that a switchover between active and standby LACP-enabled links is implemented per a proprietary optimization.

The **bundle port-priority** command determines the priority of the active and standby links for the bundle.

**Step 7** **exit**

**Example:**

```
RP/0/RP0/CPU0:router(config-if)# exit
```

Exits the interface configuration submode.

**Step 8** **interface Bundle-Ether** *bundle-id.vlan-id*

**Example:**

```
RP/0/RP0/CPU0:router#(config)# interface Bundle-Ether 3.1
```

Creates a new VLAN, and assigns the VLAN to the Ethernet bundle you created in Step 2.

Replace the *bundle-id* argument with the *bundle-id* you created in Step 2.

Replace the *vlan-id* with a subinterface identifier.

Range is from 1 to 4094 inclusive (0 and 4095 are reserved).

Range is from 1 to 4093 inclusive (0, 4094, and 4095 are reserved).

**Note** When you include the *.vlan-id* argument with the **interface Bundle-Ether** *bundle-id* command, you enter subinterface configuration mode.

**Step 9** **encapsulation dot1q***vlan-id*

**Example:**

```
RP/0/RP0/CPU0:router(config-subif)# encapsulation dot1q 100
```

Sets the Layer 2 encapsulation of an interface.

**Step 10**     **ipv4 address** *ipv4-address mask*

**Example:**

```
RP/0/RP0/CPU0:router#(config-subif)# ipv4 address 10.1.2.3/24
```

Assigns an IP address and subnet mask to the subinterface.

**Step 11**     **no shutdown**

**Example:**

```
RP/0/RP0/CPU0:router#(config-subif)# no shutdown
```

(Optional) If a link is in the down state, bring it up. The **no shutdown** command returns the link to an up or down state depending on the configuration and state of the link.

**Step 12**     **exit**

**Example:**

```
RP/0/RP0/CPU0:router(config-subif)# exit
```

Exits subinterface configuration mode for the VLAN subinterface.

**Step 13**     Repeat Step 9 through Step 12 to add more VLANs to the bundle you created in Step 2.

(Optional) Adds more subinterfaces to the bundle.

**Step 14**     **end** or **commit**

**Example:**

```
RP/0/RP0/CPU0:router(config-subif)# end
```

or

```
RP/0/RP0/CPU0:router(config-subif)# commit
```

Saves configuration changes.

- When you issue the **end** command, the system prompts you to commit changes:

```
Uncommitted changes found, commit them before
exiting(yes/no/cancel)?
[cancel]:
```

- Entering **yes** saves configuration changes to the running configuration file, exits the configuration session, and returns the router to EXEC mode.

- Entering **no** exits the configuration session and returns the router to EXEC mode without committing the configuration changes.

- Entering **cancel** leaves the router in the current configuration session without exiting or committing the configuration changes.

- Use the **commit** command to save the configuration changes to the running configuration file and remain within the configuration session.

**Step 15**    **exit****Example:**

```
RP/0/RP0/CPU0:router(config-subif)# end
```

Exits interface configuration mode.

**Step 16**    **exit****Example:**

```
RP/0/RP0/CPU0:router(config)# exit
```

Exits global configuration mode.

**Step 17**    **configure****Example:**

```
RP/0/RP0/CPU0:router # configure
```

Enters global configuration mode.

**Step 18**    **interface** {**TenGigE** | **FortyGigE** | **HundredGigE**} *interface-path-id***Example:**

```
RP/0/RP0/CPU0:router(config)# interface TenGigE 0/0/0/0
```

Enters interface configuration mode for the Ethernet interface you want to add to the Bundle.

Enter the **GigabitEthernet** or **TenGigE** keyword to specify the interface type. Replace the *interface-path-id* argument with the node-id in the rack/slot/module format.

**Note**    A VLAN bundle is not active until you add an Ethernet interface on both ends of the link bundle.

---

## LACP Short Period Time Intervals

As packets are exchanged across member links of a bundled interface, some member links may slow down or time-out and fail. LACP packets are exchanged periodically across these links to verify the stability and reliability of the links over which they pass. The configuration of short period time intervals, in which LACP packets are sent, enables faster detection and recovery from link failures.

Short period time intervals are configured as follows:

- In milliseconds
- In increments of 100 milliseconds
- In the range 100 to 1000 milliseconds
- The default is 1000 milliseconds (1 second)



- Up to 8 member links
- Up to 1280 packets per second (pps)

After 3 missed packets, the link is detached from the bundle.

When the short period time interval is *not* configured, LACP packets are transmitted over a member link every 30 seconds by default.

When the short period time interval is configured, LACP packets are transmitted over a member link once every 1000 milliseconds (1 second) by default. Optionally, both the transmit and receive intervals can be configured to less than 1000 milliseconds, independently or together, in increments of 100 milliseconds (100, 200, 300, and so on).

When you configure a custom LACP short period *transmit* interval at one end of a link, you must configure the same time period for the *receive* interval at the other end of the link.



---

**Note** You must always configure the *transmit* interval at both ends of the connection before you configure the *receive* interval at either end of the connection. Failure to configure the *transmit* interval at both ends first results in route flapping (a route going up and down continuously). When you remove a custom LACP short period, you must do it in reverse order. You must remove the *receive* intervals first and then the *transmit* intervals.

---

## Configuring the Default LACP Short Period Time Interval

This section describes how to configure the default short period time interval for sending and receiving LACP packets on a Gigabit Ethernet interface. This procedure also enables the LACP short period.

### Procedure

---

#### Step 1 **configure**

##### Example:

```
RP/0/RP0/CPU0:router# configure
```

Enters global configuration mode.

#### Step 2 **interface HundredGigE***interface-path*

##### Example:

```
RP/0/RP0/CPU0:router(config)# interface HundredGigE 0/0/1/0
```

Creates a Gigabit Ethernet interface and enters interface configuration mode.

#### Step 3 **bundle id** *number* **mode active**

##### Example:

```
RP/0/RP0/CPU0:router(config-if)# bundle id 1 mode active
```

Specifies the bundle interface and puts the member interface in active mode.

#### Step 4 **lacp period short**

##### **Example:**

```
RP/0/RP0/CPU0:router(config-if)# lacp period short
```

Configures a short period time interval for the sending and receiving of LACP packets, using the default time period of 1000 milliseconds or 1 second.

##### **Example**

This example shows how to configure the LACP short period time interval to the default time of 1000 milliseconds (1 second):

```
config
interface HundredGigE 0/0/1/0
  bundle id 1 mode active
  lacp period short
  commit
```

The following example shows how to configure custom LACP short period transmit and receive intervals to *less than* the default of 1000 milliseconds (1 second):

```
config
interface HundredGigE 0/0/1/0
  bundle id 1 mode active
  lacp period short
  commit

config
interface HundredGigE 0/0/1/0
  lacp period short transmit 100
  commit

config
interface HundredGigE 0/0/1/0
  lacp period short receive 100
  commit
```

## Configuring Custom LACP Short Period Time Intervals

This section describes how to configure custom short period time intervals (less than 1000 milliseconds) for sending and receiving LACP packets on a Gigabit Ethernet interface.



**Note** You must always configure the *transmit* interval at both ends of the connection before you configure the *receive* interval at either end of the connection. Failure to configure the *transmit* interval at both ends first results in route flapping (a route going up and down continuously). When you remove a custom LACP short period, you must do it in reverse order. You must remove the *receive* intervals first and then the *transmit* intervals.

## Procedure

### Step 1 **configure**

#### **Example:**

```
RP/0/RP0/CPU0:router# configure
```

Enters global configuration mode.

### Step 2 **interface Bundle-Ether *bundle-id***

#### **Example:**

```
RP/0/RP0/CPU0:router(config)# interface Bundle-Ether 3
```

Creates and names a new Ethernet link bundle.

### Step 3 **ipv4 address *ipv4-address mask***

#### **Example:**

```
RP/0/RP0/CPU0:router(config-if)# ipv4 address 10.1.2.3 255.0.0.0
```

Assigns an IP address and subnet mask to the virtual interface using the **ipv4 address** configuration subcommand.

### Step 4 **bundle minimum-active bandwidth *kbps***

#### **Example:**

```
RP/0/RP0/CPU0:router(config-if)# bundle minimum-active bandwidth 580000
```

(Optional) Sets the minimum amount of bandwidth required before a user can bring up a bundle.

### Step 5 **bundle minimum-active links *links***

#### **Example:**

```
RP/0/RP0/CPU0:router(config-if)# bundle minimum-active links 2
```

(Optional) Sets the number of active links required before you can bring up a specific bundle.

### Step 6 **bundle maximum-active links *links***

#### **Example:**

```
RP/0/RP0/CPU0:router(config-if)# bundle maximum-active links 1
```

(Optional) Designates one active link and one link in standby mode that can take over immediately for a bundle if the active link fails (1:1 protection).

- Note**
- The default number of active links allowed in a single bundle is 8.
  - If the **bundle maximum-active** command is issued, then only the highest-priority link within the bundle is active. The priority is based on the value from the **bundle port-priority** command, where a lower value is a higher priority. Therefore, we recommend that you configure a higher priority on the link that you want to be the active link.

**Step 7**      **exit**

**Example:**

```
RP/0/RP0/CPU0:router(config-if)# exit
```

Exits the interface configuration submenu.

**Step 8**      **interface Bundle-Ether** *bundle-id.vlan-id*

**Example:**

```
RP/0/RP0/CPU0:router#(config)# interface Bundle-Ether 3.1
```

Creates a new VLAN, and assigns the VLAN to the Ethernet bundle you created in Step 2.

Replace the *bundle-id* argument with the *bundle-id* you created in Step 2.

Replace the *vlan-id* with a subinterface identifier. Range is from 1 to 4093 inclusive (0, 4094, and 4095 are reserved).

- Note**
- When you include the *vlan-id* argument with the **interface Bundle-Ether** *bundle-id* command, you enter subinterface configuration mode.

**Step 9**      **dot1q vlan** *vlan-id*

**Example:**

```
RP/0/RP0/CPU0:router(config-subif)# dot1q vlan 10
```

Assigns a VLAN to the subinterface.

Replace the *vlan-id* argument with a subinterface identifier. Range is from 1 to 4093 inclusive (0, 4094, and 4095 are reserved).

**Step 10**     **ipv4 address** *ipv4-address mask*

**Example:**

```
RP/0/RP0/CPU0:router(config-subif)# ipv4 address 10.1.2.3/24
```

Assigns an IP address and subnet mask to the subinterface.

**Step 11**     **no shutdown**

**Example:**

```
RP/0/RP0/CPU0:router(config-subif)# no shutdown
```

(Optional) If a link is in the down state, bring it up. The **no shutdown** command returns the link to an up or down state depending on the configuration and state of the link.

**Step 12**      **exit**

**Example:**

```
RP/0/RP0/CPU0:router(config-subif)# exit
```

Exits subinterface configuration mode for the VLAN subinterface.

**Step 13**      Repeat Step 7 through Step 12 to add more VLANs to the bundle you created in Step 2.

(Optional) Adds more subinterfaces to the bundle.

**Step 14**      **exit**

**Example:**

```
RP/0/RP0/CPU0:router(config-subif)# exit
```

Exits interface configuration mode.

**Step 15**      **exit**

**Example:**

```
RP/0/RP0/CPU0:router(config)# exit
```

Exits global configuration mode.

**Step 16**      **show ethernet trunk bundle-ether** *instance*

**Example:**

```
RP/0/RP0/CPU0:router# show ethernet trunk bundle-ether 5
```

(Optional) Displays the interface configuration.

The Ethernet bundle instance range is from 1 through 65535.

**Step 17**      **configure**

**Example:**

```
RP/0/RP0/CPU0:router # configure
```

Enters global configuration mode.

**Step 18**      **interface {HundredGigE } interface-path-id**

**Example:**

```
RP/0/RP0/CPU0:router(config)# interface HundredGigE 0/0/1/0
```

Enters the interface configuration mode for the Ethernet interface you want to add to the Bundle.

Enter the **HundredGigE** keyword to specify the interface type. Replace the *interface-path-id* argument with the node-id in the rack/slot/module format.

**Note**      • A VLAN bundle is not active until you add an Ethernet interface on both ends of the link bundle.

**Step 19**     **bundle id** *bundle-id* [**mode** {**active** | **on** | **passive**}]

**Example:**

```
RP/0/RP0/CPU0:router(config-if)# bundle-id 3
```

Adds an Ethernet interface to the bundle you configured in Step 2 through Step 13.

To enable active or passive LACP on the bundle, include the optional **mode active** or **mode passive** keywords in the command string.

To add the interface to the bundle without LACP support, include the optional **mode on** keywords with the command string.

**Step 20**     **no shutdown**

**Example:**

```
RP/0/RP0/CPU0:router(config-if)# no shutdown
```

(Optional) If a link is in the down state, bring it up. The **no shutdown** command returns the link to an up or down state depending on the configuration and state of the link.

**Step 21**     Repeat Step 19 through Step 21 to add more Ethernet interfaces to the VLAN bundle.

—

**Step 22**     Perform Step 1 through Step 23 on the remote end of the VLAN bundle connection.

Brings up the other end of the link bundle.

**Step 23**     **show bundle Bundle-Ether** *bundle-id* [**reasons**]

**Example:**

```
RP/0/RP0/CPU0:router# show bundle Bundle-Ether 3 reasons
```

(Optional) Shows information about the specified Ethernet link bundle.

The **show bundle Bundle-Ether** command displays information about the specified bundle. If your bundle has been configured properly and is carrying traffic, the State field in the **show bundle Bundle-Ether** command output will show the number “4,” which means the specified VLAN bundle port is “distributing.”

**Step 24**     **show ethernet trunk bundle-ether** *instance*

**Example:**

```
RP/0/RP0/CPU0:router# show ethernet trunk bundle-ether 5
```

(Optional) Displays the interface configuration.

The Ethernet bundle instance range is from 1 through 65535.

# Configuring Bundle Interfaces under VPWS Cross-Connect

## Procedure

---

**Step 1****configure****Example:**

```
RP/0/RP0/CPU0:router# configure
```

Enters global configuration mode.

**Step 2****l2vpn****Example:**

```
RP/0/RP0/CPU0:router(config)# l2vpn
```

Enters L2VPN configuration mode.

**Step 3****pw-status****Example:**

```
RP/0/RP0/CPU0:router(config-l2vpn)# pw-status
```

Enables pseudowire status.

- Note**
- When the attachment circuit changes redundancy state to Active, Active pw-status is sent over the primary and backup pseudowires.
  - When the attachment circuit changes redundancy state to Standby, Standby pw-status is sent over the primary and backup pseudowires.

**Step 4****xconnect group** *group-name***Example:**

```
RP/0/RP0/CPU0:router(config-l2vpn)# xconnect group grp_1
```

Enters the name of the cross-connect group.

**Step 5****p2p** *xconnect-name***Example:**

```
RP/0/RP0/CPU0:router(config-l2vpn-xc)# p2p p1
```

Enters a name for the point-to-point cross-connect.

**Step 6****interface** *type interface-path-id***Example:**

```
RP/0/RP0/CPU0:router(config-l2vpn-xc-p2p)# interface Bundle-Ether 1.1
```

Specifies the interface type ID.

**Step 7** **neighbor** *A.B.C.D* **pw-id** *pseudowire-id*

**Example:**

```
RP/0/RP0/CPU0:router(config-l2vpn-xc-p2p)# neighbor 10.2.2.2 pw-id 2000
```

Configures the pseudowire segment for the cross-connect.

Optionally, you can disable the control word or set the transport-type to Ethernet or VLAN.

**Step 8** **pw-class** *{class-name}*

**Example:**

```
RP/0/RP0/CPU0:router(config-l2vpn-xc-p2p-pw)# pw-class c1
```

Configures the pseudowire class template name to use for the pseudowire.

**Step 9** **backup neighbor** *A.B.C.D* **pw-id** *pseudowire-id*

**Example:**

```
RP/0/RP0/CPU0:router(config-l2vpn-xc-p2p-pw)# backup neighbor 10.2.2.2 pw-id 2000
```

Adds a backup pseudowire.

**Step 10** **pw-class** *{class-name}*

**Example:**

```
RP/0/RP0/CPU0:router(config-l2vpn-xc-p2p-pw-backup)# pw-class c2
```

Configures the pseudowire class template name to use for the backup pseudowire.

## Configuring Bundle Interface under VPLS

### Procedure

**Step 1** **configure**

**Example:**

```
RP/0/RP0/CPU0:router# configure
```

Enters global configuration mode.

**Step 2** **l2vpn**

**Example:**

```
RP/0/RP0/CPU0:router(config)# l2vpn
```



Enters L2VPN configuration mode.

**Step 3** **pw-status**

**Example:**

```
RP/0/RP0/CPU0:router(config-l2vpn)# pw-status
```

(Optional) Enables pseudowire status.

All the pseudowires in the VFI are always active, independent of the attachment circuit redundancy state.

**Step 4** **bridge group** *bridge-group-name*

**Example:**

```
RP/0/RP0/CPU0:router(config-l2vpn)# bridge group csco
RP/0/RP0/CPU0:router(config-l2vpn-bg)#
```

Creates a bridge group so that it can contain bridge domains and then assigns network interfaces to the bridge domain.

**Step 5** **bridge-domain** *bridge-domain-name*

**Example:**

```
RP/0/RP0/CPU0:router(config-l2vpn-bg)# bridge-domain abc
RP/0/RP0/CPU0:router(config-l2vpn-bg-bd)#
```

Establishes a bridge domain and enters L2VPN bridge group bridge domain configuration mode.

**Step 6** **interface** *type interface-path-id*

**Example:**

```
RP/0/RP0/CPU0:router(config-l2vpn-bg-bd)# interface Bundle-Ether 1.1
```

Specifies the interface type ID.

**Step 7** **vfi** *{vfi-name}*

**Example:**

```
RP/0/RP0/CPU0:router(config-l2vpn-bg-bd)# vfi vfi-east
```

Enters virtual forwarding instance (VFI) configuration mode.

**Step 8** **neighbor** *A.B.C.D pw-id pseudowire-id*

**Example:**

```
RP/0/RP0/CPU0:router(config-l2vpn-bg-bd-vfi)# neighbor 10.2.2.2 pw-id 2000
```

Configures the pseudowire segment for the cross-connect.

Optionally, you can disable the control word or set the transport-type to Ethernet or VLAN.

**Step 9** **pw-class** *{class-name}*

**Example:**

```
RP/0/RP0/CPU0:router(config-l2vpn-bg-bd-vfi-pw)# pw-class canada
```

Configures the pseudowire class template name to use for the pseudowire.

## Bundle Consistency Checker

*Table 6: Feature History Table*

| Feature Name                     | Release Information | Feature Description                                                                                                                                                                                                                                                                                                                                                                              |
|----------------------------------|---------------------|--------------------------------------------------------------------------------------------------------------------------------------------------------------------------------------------------------------------------------------------------------------------------------------------------------------------------------------------------------------------------------------------------|
| Bundle Consistency Checker (BCC) | Release 7.3.1       | From the running configuration, Bundle Consistency Checker (BCC) fetches information about the ingress/egress traffic from the bundle, sub-bundle, and active member nodes and saves it in the database. BCC also collects data from all the running nodes and then compares it with the information saved in the database. Any inconsistencies, programming errors, stale entries are reported. |

In a scaled setup, a bundle programming check is difficult to perform and time consuming. Moreover, an issue is reported only when the user detects it, and not automatically. During multiple test executions, it isn't possible to detect the initial failure, which causes other subsequent failures. Bundle Consistency Checker (BCC) implements bundle programming and consistency check by using the following steps:

1. BCC uses the running configuration to detect discrepancies.
2. BCC forms a Bundle Consistency Checker Data Base (BCCDB) with the bundle, sub-bundle, or member information fetched from the running configuration.
3. BCC dumps the required data from all available nodes. It then uses BCCDB as a source to verify bundle programming and consistency in all other layer dumps.
4. BCC reports inconsistencies, programming errors, stale entries, and deletes any pending objects.

### Supporting Interfaces

The following interfaces support BCC:

- Bundle
- Bundle sub-interface

The following table lists BCC behaviour during inconsistencies in bundle configuration or programming errors.

| Case                                                      | BCC Behaviour                                                                                                                                                                                                                                                                                                                                                                                                                                                                                                                                                             |
|-----------------------------------------------------------|---------------------------------------------------------------------------------------------------------------------------------------------------------------------------------------------------------------------------------------------------------------------------------------------------------------------------------------------------------------------------------------------------------------------------------------------------------------------------------------------------------------------------------------------------------------------------|
| <p>When no bundle is configured</p>                       | <pre> Router# show bundle consistency Building configuration... Dumping Data..... Done Parsing Data..... Not Done  BCC Stopped: Found 3 info/exceptions/errors  Logs Preview:  2020-07-13 10:34:22,774: INFO: Bundlemgr PD dont have any bundle data  2020-07-13 10:34:22,832: INFO: BMPI dont have any bundle data  2020-07-13 10:34:23,728: INFO: No Bundle is configured/No member is added to Bundle  Logs: /var/log/bcc_exception.log /var/log/bcc_debug.log                     </pre>                                                                              |
| <p>When a bundle is configured but no member is added</p> | <pre> Router# show bundle consistency Building configuration... Dumping Data..... Done Parsing Data..... Not Done  BCC Stopped: Found 4 info/exceptions/errors  Logs Preview:  2020-07-13 10:36:32,513: INFO: Bundlemgr PD dont have any bundle data  2020-07-13 10:36:32,566: INFO: No member is added to bundle BE1(0x3c00400c)  2020-07-13 10:36:32,566: INFO: BMPI dont have any bundle data  2020-07-13 10:36:33,453: INFO: No Bundle is configured/No member is added to Bundle  Logs: /var/log/bcc_exception.log /var/log/bcc_debug.log                     </pre> |

| Case                                              | BCC Behaviour                                                                                                                                                                                                                                                                                                                                                                                                                                                                                                                                                                                         |
|---------------------------------------------------|-------------------------------------------------------------------------------------------------------------------------------------------------------------------------------------------------------------------------------------------------------------------------------------------------------------------------------------------------------------------------------------------------------------------------------------------------------------------------------------------------------------------------------------------------------------------------------------------------------|
| When a bundle is configured and members are added | <pre> Router# show bundle consistency Building configuration... Dumping Data..... Done Parsing Data..... Done Bundle Consistency Check..... Done Bundle Programming Check..... Done Stale Entry Check..... Done Bundle Health Check..... Done  Overall Results:  Inconsistencies           : 0           Stale Entries       : 0 BCM Programming Error      : 0           Delete Pending DPA Objects      : 0 Info/Error/Python Exception : 0           Overall Bundle Health       Status : WARNING  Execute 'show bundle status' to see detailed reason for 'WARNING' in bundle health check </pre> |

| Case                                                                                                   | BCC Behaviour                                                                                                                                                                                                                                                                                                                                                                                                                                                                                                                                                                                                                                                                                                                                                                                                                                                                                                                                                                                                                                                                                                                                                                  |
|--------------------------------------------------------------------------------------------------------|--------------------------------------------------------------------------------------------------------------------------------------------------------------------------------------------------------------------------------------------------------------------------------------------------------------------------------------------------------------------------------------------------------------------------------------------------------------------------------------------------------------------------------------------------------------------------------------------------------------------------------------------------------------------------------------------------------------------------------------------------------------------------------------------------------------------------------------------------------------------------------------------------------------------------------------------------------------------------------------------------------------------------------------------------------------------------------------------------------------------------------------------------------------------------------|
| <p>When there is no encapsulation configuration for L2 or L3 sub-bundle or no member for L2 bundle</p> | <pre> Router# show bundle consistency Building configuration... Dumping Data..... Done Parsing Data..... Done Bundle Consistency Check..... Done Bundle Programming Check..... Done Stale Entry Check..... Done Bundle Health Check..... Done  Overall Results:  Inconsistencies          : 0          Stale Entries       : 0 BCM Programming Error     : 0          Delete Pending DPA Objects      : 0 Info/Error/Python Exception : 3          Overall Bundle Health       Status : WARNING  Execute 'show bundle status' to see detailed reason for 'WARNING' in bundle health check  Logs Preview:  2020-07-12 17:38:26,568: INFO: No member is added to bundle BE2(0x80042bc) ==&gt; 12 bundle main  2020-07-12 17:38:32,573: interface Bundle-Ether1.1: Dont have any encapsulation config. ==&gt; 13 sub  2020-07-12 17:38:32,574: interface Bundle-Ether1.130: Dont have any encapsulation config. ==&gt; 12sub  Logs:  /var/log/bcc_inconsistencies.log /var/log/bcc_programming_error.log /var/log/bcc_stale_entries.log /var/log/bcc_delay_delete.log /var/log/bcc_bundle_health.log /var/log/bcc_exception.log /var/log/bcc_debug.log                     </pre> |

| Case                      | BCC Behaviour                                                                                                                                                                                                                                                                                                                                                                                                                                                                                                                                                                                                                                                                                                                                                                                                                                                                                                                                                                      |
|---------------------------|------------------------------------------------------------------------------------------------------------------------------------------------------------------------------------------------------------------------------------------------------------------------------------------------------------------------------------------------------------------------------------------------------------------------------------------------------------------------------------------------------------------------------------------------------------------------------------------------------------------------------------------------------------------------------------------------------------------------------------------------------------------------------------------------------------------------------------------------------------------------------------------------------------------------------------------------------------------------------------|
| During programming errors | <pre> Router# show bundle consistency  Building configuration... Dumping Data..... Done Parsing Data..... Done Bundle Consistency Check..... Done Bundle Programming Check..... Done Stale Entry Check..... Done Bundle Health Check..... Done  Overall Results:  Inconsistencies           : 0           Stale Entries       : 0 BCM Programming Error     : 1           Delete Pending DPA Objects      : 0 Info/Error/Python Exception : 0           Overall Bundle Health Status : WARNING  Execute 'show bundle status' to see detailed reason for 'WARNING' in bundle health check  Logs Preview:  2020-07-12 18:48:22,658: Programming Error 1: BE1(0x80041ec) NPU 0,0/RP0/CPU0 Vlan Domain 0x33 != GigabitEthernet0_0_0_2 Vlan Domain 0xa  Logs:  /var/log/bcc_inconsistencies.log /var/log/bcc_programming_error.log /var/log/bcc_stale_entries.log /var/log/bcc_delay_delete.log /var/log/bcc_bundle_health.log /var/log/bcc_exception.log /var/log/bcc_debug.log </pre> |



## CHAPTER 7

# Configuring Traffic Mirroring

This module describes the configuration of the traffic mirroring feature. Traffic mirroring is sometimes called port mirroring, or switched port analyzer (SPAN). You can then pass this traffic to a destination port on the same router.

### Feature Release History

| Release       | Modification                                                                                                                                                                                                                                                                                                                                                                                                                                    |
|---------------|-------------------------------------------------------------------------------------------------------------------------------------------------------------------------------------------------------------------------------------------------------------------------------------------------------------------------------------------------------------------------------------------------------------------------------------------------|
| Release 7.0.2 | SPAN over Pseudo-Wire was introduced.                                                                                                                                                                                                                                                                                                                                                                                                           |
| Release 7.1.2 | SPAN to File was introduced.                                                                                                                                                                                                                                                                                                                                                                                                                    |
| Release 7.2.1 | File Mirroring was introduced.                                                                                                                                                                                                                                                                                                                                                                                                                  |
| Release 7.3.1 | PCAPng file format was introduced.                                                                                                                                                                                                                                                                                                                                                                                                              |
| Release 7.5.2 | Mirror first option in global configuration mode was introduced.                                                                                                                                                                                                                                                                                                                                                                                |
| Release 7.5.3 | ERSPAN Traffic to a Destination Tunnel in a Non-Default VRF was introduced.                                                                                                                                                                                                                                                                                                                                                                     |
| Release 7.5.4 | <ul style="list-style-type: none"><li>• Multiple SPAN ACL Sessions in a Single Interface was introduced.</li><li>• Monitor Multiple SPAN ACL and Security ACL Sessions was introduced.</li><li>• SPAN Using 7-Tuples ACL was introduced.</li><li>• DSCP Marking on Egress GRE Tunnel in ERSPAN was introduced.</li><li>• DSCP Bitmask to filter Ingress SPAN was introduced.</li><li>• Mirroring Forward-Drop Packets was introduced.</li></ul> |
| Release 7.6.1 | VLAN Sub-interface as Ingress or Egress Source for Traffic Mirroring was introduced.                                                                                                                                                                                                                                                                                                                                                            |

| Release        | Modification                                                                                  |
|----------------|-----------------------------------------------------------------------------------------------|
| Release 7.11.1 | Traffic Mirroring of Incoming and Outgoing Traffic Separately over Pseudowire was introduced. |

- [Introduction to Traffic Mirroring, on page 142](#)
- [SPAN Types, Supported Features, and Configurations, on page 148](#)
- [Troubleshoot Traffic Mirroring, on page 182](#)

## Introduction to Traffic Mirroring

Traffic mirroring, also referred to as Port mirroring or Switched Port Analyzer (SPAN), is a Cisco proprietary feature that enables you to monitor network traffic passing in or out of a set of ports on a router. You can then mirror this traffic to a remote destination or a destination port on the same router.

Traffic mirroring copies traffic from one or more source ports and sends the copied traffic to one or more destinations for analysis by a network analyzer or other monitoring devices. Traffic mirroring does not affect the flow of traffic on the source interfaces or sub-interfaces. It allows the mirrored traffic to be sent to a destination interface or sub-interface.

For example, you can attach a traffic or network analyzer to the router and capture the ethernet traffic that is sent by host A to host B.

**Figure 11: Traffic Mirroring Operation**

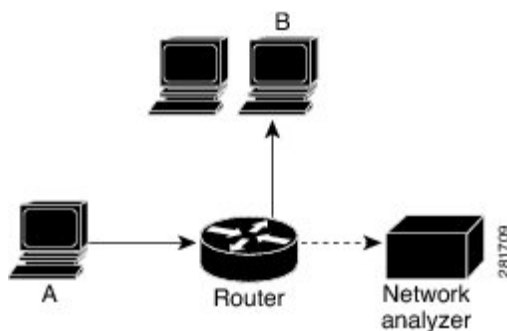

## Traffic Mirroring Terminology

- Ingress Traffic — Traffic that comes into the router.
- Egress Traffic — Traffic that goes out of the router.
- Source port—A port that is monitored with the use of traffic mirroring. It is also called a monitored port.
- Destination port—A port that monitors source ports, usually where a network analyzer is connected. It is also called a monitoring port.
- Monitor session—A designation for a collection of SPAN configurations consisting of a single destination and, potentially, one or many source ports.



## Traffic Mirroring Types

These are the supported traffic mirroring types.

- [Local SPAN](#)
- [Remote SPAN](#)
- [SPAN on Subinterfaces](#)
- [ACL-based SPAN](#)
- [ERSPAN](#)
- [SPAN over Pseudowire](#)
- [SPAN-to-File, on page 176](#)
- [Forward-Drop Packets Mirroring](#)
- [File Mirroring](#)

## Characteristics of Source Port

A source port, also called a monitored port, is a routed port that you monitor for network traffic analysis. In a single traffic mirroring session, you can monitor source port traffic. The routers support a maximum of up to 800 source ports.

A source port has these characteristics:

- It can be any data port type, such as Bundle Interface, 100 Gigabit Ethernet physical port, or 10 Gigabit Ethernet physical port.
- Each source port can be monitored in only one traffic mirroring session.
- When a port is used as a source port, the same port cannot be used as a destination port.
- Each source port can be configured with a direction (ingress, egress, or both) to monitor local traffic mirroring. Remote traffic mirroring is supported both in the ingress and egress directions. For bundles, the monitored direction applies to all physical ports in the group.

## Characteristics of Monitor Session

A monitor session is a collection of traffic mirroring configurations consisting of a single destination and, potentially, many source interfaces. For any given monitor session, the traffic from the source interfaces (called *source ports*) is sent to the monitoring port or destination port. If there are more than one source port in a monitoring session, the traffic from the several mirrored traffic streams is combined at the destination port. The result is that the traffic that comes out of the destination port is a combination of the traffic from one or more source ports.

Monitor sessions have these characteristics:

- A single monitor session can have only one destination port.
- A single destination port can belong to only one monitor session.

- A monitor session can have a maximum of 800 source ports. This maximum limit is applicable only when the maximum number of source ports from all monitoring sessions does not exceed 800.

## Characteristics of Destination Port

Each session must have a destination port or file that receives a copy of the traffic from the source ports.

A destination port has these characteristics:

- A destination port cannot be a source port.
- A destination port must reside on the same router as the source port for local traffic mirroring. For remote mirroring, the destination is always a GRE tunnel.
- For remote mirroring, the destination is a GRE tunnel.
- A destination port for local mirroring can be any Ethernet physical port, EFP, GRE tunnel interface, or bundle interface. It can be a Layer 2 or Layer 3 transport interface.
- A destination port on router cannot be a VLAN subinterface.
- At any time, a destination port can participate in only one traffic mirroring session. A destination port in one traffic mirroring session cannot be a destination port for a second traffic mirroring session. In other words, no two monitor sessions can have the same destination port.

## Supported Scale

This list provides scale supported on the NCS 560 routers for traffic mirroring.

- Prior to Cisco IOS XR Software Release 7.8.1, a single router could support up to four monitor sessions. However, configuring SPAN and CFM on the router reduced the maximum number of monitor sessions to two, as both shared the mirror profiles.
- Starting Cisco IOS XR Software Release 7.8.1, up to three monitor sessions on are supported on the NCS 560 router. But, if you configure SPAN and CFM on the router, the maximum number of monitor sessions decreases to one, as both functions use the same mirror profiles.

## Restrictions

### Generic Restrictions

The following are the generic restrictions related to traffic mirroring:

- Partial mirroring and sampled mirroring are not supported.
- Sub-interface configured as source interface is not supported on SPAN.
- The destination bundle interfaces flap when:
  - both the mirror source and destination are bundle interfaces in the Link Aggregation Control Protocol (LACP) mode.
  - mirror packets next-hop is a router or a switch instead of a traffic analyzer.

This behavior is observed due to a mismatch of LACP packets on the next-hop bundle interface due to the mirroring of LACP packets on the source bundle interface.

- Subinterface with only one VLAN is supported as source for traffic mirroring.
- Bridge group virtual interfaces (BVI) are not supported as source ports or destination ports.
- Bundle members cannot be used as destination ports.
- Fragmentation of mirror copies is not handled by SPAN when SPAN destination MTU is less than the packet size. Existing behaviour if the MTU of destination interface is less than the packet size is as below:

| Platforms | Rx SPAN                                                                    | Tx SPAN                       |
|-----------|----------------------------------------------------------------------------|-------------------------------|
| NCS 560   | Mirror copies are not fragmented. Receives whole packets as mirror copies. | Mirror copies are fragmented. |

You can configure the SPAN destination with an MTU which is greater than the packet size.

- Until Cisco IOS XR Software Release 7.6.1, SPAN only supports port-level source interfaces.

#### VLAN Sub-interface as Source Restrictions

- Supports a maximum of 24 reception and transmission sessions together for mirroring. This restriction is applicable for sub-interfaces and ports as source.
- When the port is in Egress Traffic Management (ETM) mode, the outbound or transmission mirroring is possible only on the sub-interface for which outbound traffic mirroring is configured.
- Transmission mirroring is applicable on ETM mode only. Reception mirroring is applicable on both the ETM and non-ETM modes.

#### ACL-based SPAN Restrictions

The following restrictions apply to SPAN-ACL:

*Table 7: SPAN-ACL Support*

| Platforms | Rx Direction                                                                          | Tx Direction   |
|-----------|---------------------------------------------------------------------------------------|----------------|
| NCS 540   | Supported at the port level, that is, in the ingress direction for IPv4 or IPv6 ACLs. | Not supported. |

- MPLS traffic cannot be captured with SPAN-ACL.
  - ACL for any MPLS traffic is not supported.
- Traffic mirroring counters are not supported.
- ACL-based traffic mirroring is not supported with Layer 2 (ethernet-services) ACLs.
- Main interface as span source interface and ACL with the **capture** keyword on same main interface's sub-interface are not supported.

- If a SPAN session with the **acl** keyword is applied on an interface with no ACL rule attached to that interface, SPAN happens without any filtering.

### ERSPAN Restrictions

This section provides the restrictions that apply to ERSPAN and multiple ERSPAN sessions.

The following restrictions apply to ERSPAN:

- The value of ERSPAN session-ID is always zero. IOS XR command for configuring ERSPAN is not available.
- ERSPAN next-hop must have ARP resolved. Any other traffic or protocol will trigger ARP.
- ERSPAN packets with outgoing interface having MPLS encapsulation are not supported.
  - Additional routers may encapsulate in MPLS.
- ERSPAN sessions can be created only on physical interfaces. The sessions cannot be created on sub-interfaces.
- ERSPAN supports a maximum of three sessions.
- ERSPAN decapsulation is not supported.
- ERSPAN does not work if the GRE next hop is reachable over sub-interface. For ERSPAN to work, the next hop must be reachable over the main interface.
- ERSPAN decapsulation is not supported. Tunnel destination should be network analyzer.

### Multiple ERSPAN Restrictions

- All sessions under the source port should have SPAN access control list (ACL) enabled.
- A few sessions with SPAN ACL and a few without SPAN ACLs in the same source interface are not supported.
- No two sessions should have the same ACL in the same source interface. Each session should have a different ACL.
- Multiple sessions without ACL in the same interface are not supported.
- Multi-SPAN ACL does not support the **Deny** action.
- One SPAN session with the keyword ACL (use security acl as the keyword) and other SPAN sessions with the keyword SPAN ACL are not supported.
- At a time, you can make only one mirror copy of a packet.
- Capturing keywords is not required.
- Multiple sessions under the same interface cannot have a combination of directions. Only RX is supported.

### SPAN over Pseudowire Restrictions

SPAN over Pseudowire (PW-SPAN) does not support the listed functionalities:

-

- Monitor session statistics
- Partial packet SPAN
- Sampled SPAN

### SPAN-to-File Restrictions

SPAN to File has the following restrictions:

- A maximum of 1000 source ports are supported across the system. Individual platforms may support lower numbers. The SPAN session may be any of these currently supported classes: Ethernet, IPv4, IPv6, MPLS-IPv4, and MPLS-IPv6.
- Provides a buffer range of 1000-1000000 KB. The default buffer size is set to 1000 KB.
- Provides support for SPAN source.
  - Each source port can be monitored in only one traffic mirroring session.
  - Each source port can be configured with a direction (ingress, egress, or both) to monitor local traffic mirroring.
- Only port-level is supported.
- VLAN interface as source port is not supported.
- Bundle members as source interfaces are not supported.
- Filtering based on Egress ACL is not supported.
- Source port statistics is not supported.
- Span to file mirror packets are punted from NPU to CPU at a maximum shaper rate of 40 mbps.

### File Mirroring Restrictions

The following restrictions apply to file mirroring:

- Supported only on Dual RP systems.
- Supports syncing only from active to standby RP. If files are copied into standby `/harddisk:/mirror` location, it won't be synced to active RP.
- A slight delay is observed in `show mirror` command output when mirror checksum configuration is enabled.
- Not supported on multichassis systems.

### Forward-Drop Packets Mirroring Restrictions

These are some restrictions for Forward-Drop packets mirroring:

- Only one global forward-drop session can be configured on a router.
- When traffic-class is configured under monitor-session for forward-drop, the type of service (ToS) byte of the outgoing ERSPAN packet is overwritten with the configured traffic-class value.

- In-band traffic destined to router management interface cannot be captured using this functionality.

# SPAN Types, Supported Features, and Configurations

## Local SPAN

This is the most basic form of traffic mirroring. The network analyzer or sniffer is attached directly to the destination interface. In other words, all monitored ports are located on the same router as the destination port.

## Remote SPAN

### Configure Remote Traffic Mirroring

#### Procedure

---

**Step 1**     **configure**

**Example:**

```
RP/0/RP0/CPU0:router# configure
Enters global configuration mode.
```

**Step 2**     **monitor-session *session-name***

**Example:**

```
RP/0/RP0/CPU0:router(config)# monitor-session mon1 ethernet
RP/0/RP0/CPU0:router(config-mon)#
```

Defines a monitor session and enters monitor session configuration mode.

**Step 3**     **destination interface *subinterface***

**Example:**

```
RP/0/RP0/CPU0:router(config-mon)# destination interface TenGigE 0/2/0/4.1
```

Specifies the destination subinterface to which traffic is replicated.

**Step 4**     **exit**

**Example:**

```
RP/0/RP0/CPU0:router(config-mon)# exit
RP/0/RP0/CPU0:router(config)#
```

Exits monitor session configuration mode and returns to global configuration mode.

**Step 5**     **interface *type number***

**Example:**

```
RP/0/RP0/CPU0:router(config)# interface HundredGigE 0/0/1/0
```

Enters interface configuration mode for the specified source interface. The interface number is entered in *rack/slot/module/port* notation. For more information about the syntax for the router, use the question mark (?) online help function.

**Step 6**    **monitor-session** *session-name* **ethernet direction rx-only****port-only**

**Example:**

```
RP/0/RP0/CPU0:router(config-if)# monitor-session mon1 ethernet
direction rx-only port-only
```

Specifies the monitor session to be used on this interface. Use the **direction** keyword to specify that only ingress or egress traffic is mirrored.

**Step 7**    **end** or **commit**

**Example:**

```
RP/0/RP0/CPU0:router(config-if)# end
```

or

```
RP/0/RP0/CPU0:router(config-if)# commit
```

Saves configuration changes.

- When you issue the **end** command, the system prompts you to commit changes:

```
Uncommitted changes found, commit them before exiting (yes/no/cancel)?
[cancel]:
```

- Entering **yes** saves configuration changes to the running configuration file, exits the configuration session, and returns the router to EXEC mode.

- Entering **no** exits the configuration session and returns the router to EXEC mode without committing the configuration changes.

- Entering **cancel** leaves the router in the current configuration session without exiting or committing the configuration changes.

- Use the **commit** command to save the configuration changes to the running configuration file and remain within the configuration session.

Use the **commit** command to save the configuration changes to the running configuration file and remain within the configuration session.

**Step 8**    **show monitor-session** [*session-name*] **status** [*detail*] [*error*]

**Example:**

```
RP/0/RP0/CPU0:router# show monitor-session
```

Displays information about the traffic mirroring session.

## Example

This example shows the basic configuration for traffic mirroring with physical interfaces.

```
RP/0/RP0/CPU0:router# configure
RP/0/RP0/CPU0:router(config)# monitor-session ms1
RP/0/RP0/CPU0:router(config-mon)# destination interface HundredGigE0/2/0/15
RP/0/RP0/CPU0:router(config-mon)# commit

RP/0/RP0/CPU0:router# configure
RP/0/RP0/CPU0:router(config)# interface TenGigE0/2/0/19
RP/0/RP0/CPU0:router(config-if)# monitor-session ms1 port-level
RP/0/RP0/CPU0:router(config-if)# commit

RP/0/RP0/CPU0:router# configure
RP/0/RP0/CPU0:router(config)# interface TenGigE0/2/0/19
RP/0/RP0/CPU0:router(config-if)# monitor-session ms1 direction rx-only port-level
RP/0/RP0/CPU0:router(config-if)# commit

RP/0/RP0/CPU0:router# configure
RP/0/RP0/CPU0:router(config)# interface TenGigE0/2/0/19
RP/0/RP0/CPU0:router(config-if)# monitor-session ms1 direction tx-only port-level
RP/0/RP0/CPU0:router(config-if)# commit
```

This example shows sample output of the show monitor-session command with the status keyword:

```
RP/0/RSP0/CPU0:router# show monitor-session status
Monitor-session cisco-rtpl
Destination interface HundredGigE 0/5/0/38
=====
Source Interface Dir Status
-----
TenGigE0/5/0/4 Both Operational
TenGigE0/5/0/17 Both Operational
RP/0/RSP0/CPU0:router# show monitor-session status detail
Monitor-session sess1
Destination interface is not configured
Source Interfaces
-----
TenGigE0/1/0/0
Direction: Both
ACL match: Disabled
Portion: Full packet
Status: Not operational (destination interface not known).
TenGigE0/1/0/1
Direction: Both
ACL match: Disabled
Portion: First 100 bytes

RP/0/RSP0/CPU0:router# show monitor-session status error
Monitor-session ms1
Destination interface TenGigE0/2/0/15 is not configured
=====
Source Interface Dir Status
-----
Monitor-session ms2
Destination interface is not configured
=====
Source Interface Dir Status
-----
RP/0/RP0/CPU0:router# show monitor-session test status
Monitor-session test (ipv4)
Destination Nexthop 255.254.254.4
=====
```



```

Source Interface Dir Status
-----
Gi0/0/0/2.2 Rx Not operational (source same as destination)
Gi0/0/0/2.3 Rx Not operational (Destination not active)
Gi0/0/0/2.4 Rx Operational
Gi0/0/0/4 Rx Error: see detailed output for explanation
RP/0/RP0/CPU0:router# show monitor-session test status error
Monitor-session test
Destination Nexthop ipv4 address 255.254.254.4
=====
Source Interface Status
-----
Gi0/0/0/4 < Error: FULL Error Details >

```

## SPAN on Subinterfaces

### VLAN Subinterface as Ingress or Egress Source for Traffic Mirroring

*Table 8: Feature History Table*

| Feature Name                                                        | Release Information | Feature Description                                                                                                                                                                                                                                                                                                    |
|---------------------------------------------------------------------|---------------------|------------------------------------------------------------------------------------------------------------------------------------------------------------------------------------------------------------------------------------------------------------------------------------------------------------------------|
| VLAN Subinterface as Ingress or Egress Source for Traffic Mirroring | Release 7.6.1       | <p>You can now configure the VLAN subinterface as an egress or ingress source for traffic mirroring. This feature enables the monitoring of traffic mirrored on either egress or ingress or both directions.</p> <p>You could configure mirror functionality only at the main interface level in earlier releases.</p> |

VLAN subinterface provides the flexibility to monitor ingress or egress, or both ingress/egress traffic from all the active subinterfaces of the source VLAN. The active subinterfaces in the source VLAN are considered as source subinterfaces. When subinterfaces are added or removed from the source VLAN, the corresponding traffic is added or removed from the monitoring sources.

### VLAN Interface as Ingress Source for Traffic Mirroring

#### Configuration Example

```

Router# configure
Router(config)# monitor-session mon1 ethernet
Router(config-mon)# destination interface tunnel-ip 3
Router(config-mon)# exit
Router(config)# interface HundredGigE 0/1/0/1.10
Router(config-subif)#
Router(config-if-mon)# commit

```

#### Running Configuration

```

Router# show run monitor-session mon1
monitor-session mon1 ethernet
  destination interface tunnel-ip3
!
```

```
Router# show run interface HundredGigE 0/1/0/1.10
interface HundredGigE0/1/0/1.10
 encapsulation dot1q 10
  ipv4 address 101.1.2.1 255.255.255.252
  monitor-session mon1 ethernet
  !
  !
  !
```

### Verification

```
Router# show monitor-session status
Monitor-session mon1
Destination interface tunnel-ip3
=====
Source Interface Dir Status
-----
HundredGigE 0/1/0/1.10 Both Operational
```

## VLAN Interface as Egress Source for Traffic Mirroring

### Configuration Example

#### Running Configuration

```
Router# show run monitor-session mon1
monitor-session mon1 ethernet
 destination interface tunnel-ip3
 !
```

```
Router# show run interface HundredGigE 0/1/0/1.10
interface HundredGigE0/1/0/1.10
 encapsulation dot1q 20
  ipv4 address 102.1.2.1 255.255.255.252
  monitor-session mon1 ethernet
  !
  !
  !
```

### Verification

```
Router# show monitor-session status
Monitor-session mon1
Destination interface tunnel-ip3
=====
Source Interface Dir Status
-----
HundredGigE 0/1/0/1.10 Both Operational
```

## Monitoring Traffic Mirroring on a Layer 2 Interface

This section describes the configuration for monitoring traffic on a Layer 2 interface.

### Configuration

To monitor traffic mirroring on a Layer 2 interface, configure the monitor under `l2transport` sub-config of the interface:

```
RP/0/RP0/CPU0:router(config)# interface TenGigE0/0/0/42
RP/0/RP0/CPU0:router(config-if)# l2transport
RP/0/RP0/CPU0:router(config-if-l2)# monitor-session EASTON ethernet port-level
```

### Verification

```
RP/0/RP0/CPU0:router# show monitor-session status
Thu Aug 29 21:42:22.829 UTC
Monitor-session EASTON
Destination interface TenGigE0/0/0/20
=====
Source Interface      Dir      Status
-----
Te0/0/0/42 (port)    Both    Operational
```

## ACL-based SPAN

Traffic is mirrored based on the configuration of the interface ACL.

You can mirror traffic based on the definition of an interface access control list. When you mirror Layer 3 traffic, the ACL is configured using the **ipv4 access-list** or the **ipv6 access-list** command with the **capture** option. The **permit** and **deny** commands determine if the packets in the traffic are permitted or denied. The **capture** option designates the packet is to be mirrored to the destination port, and it is supported only on permit type of Access Control Entries (ACEs).



---

**Note** Prior to Release 6.5.1, ACL-based traffic mirroring required the use of UDK (User-Defined TCAM Key) with the **enable-capture** option so that the **capture** option can be configured in the ACL.

---

## Configuring Security ACLs for Traffic Mirroring

This section describes the configuration for creating security ACLs for traffic mirroring.

In ACL-based traffic mirroring, traffic is mirrored based on the configuration of the interface ACL. You can mirror traffic based on the definition of an interface access control list. When you're mirroring Layer 3 or Layer 2 traffic, the ACL is configured using the **ipv4 access-list** or the **ipv6 access-list** command with the **capture** option. The **permit** and **deny** commands determine the behavior of the regular traffic.

### Configure an IPv4 ACL for Traffic Mirroring

Use the following steps to configure ACLs for traffic mirroring.

```
/* Create an IPv4 ACL (TM-ACL) for traffic mirroring */
Router(config)# ipv4 access-list TM-ACL
Router(config-ipv4-acl)# 10 permit udp 10.1.1.0 0.0.0.255 eq 10 any capture
Router(config-ipv4-acl)# 20 permit udp 10.1.1.0 0.0.0.255 eq 20 any
Router(config-ipv4-acl)# exit
Router(config)# commit

/* Validate the configuration */
Router(config)# show run
Thu May 17 11:17:49.968 IST
Building configuration...
!! IOS XR Configuration 0.0.0
!! Last configuration change at Thu May 17 11:17:47 2018 by user
...
```

```

ipv4 access-list TM-ACL
 10 permit udp 10.1.1.0 0.0.0.255 eq 10 any capture
 20 permit udp 10.1.1.0 0.0.0.255 eq 20 any
!
...

```

You have successfully configured an IPv4 ACL for traffic mirroring.

## Configuring UDF-Based Security ACL for Traffic Mirroring

### Before you begin

This section describes the configuration steps for UDF-based security ACLs for traffic mirroring.

### Procedure

#### Step 1 **configure**

##### Example:

```

RP/0/RP0/CPU0:router# configure
Enters global configuration mode.

```

#### Step 2 **udf udf-name header {inner | outer} {12 | 13 | 14} offset offset-in-bytes length length-in-bytes**

##### Example:

```

RP/0/RP0/CPU0:router(config)# udf udf3 header outer 14 offset 0 length 1
(config-mon)#

```

##### Example:

```

RP/0/RP0/CPU0:router(config)# udf udf3 header inner 14 offset 10 length 2
(config-mon)#

```

##### Example:

```

RP/0/RP0/CPU0:router(config)# udf udf3 header outer 14 offset 50 length 1
(config-mon)#

```

Configures individual UDF definitions. You can specify the name of the UDF, the networking header from which offset, and the length of data to be extracted.

The **inner** or **outer** keywords indicate the start of the offset from the unencapsulated Layer 3 or Layer 4 headers, or if there is an encapsulated packet, they indicate the start of offset from the inner L3/L4.

**Note** The maximum offset allowed, from the start of any header, is 63 bytes

The **length** keyword specifies, in bytes, the length from the offset. The range is from 1 to 4.

#### Step 3 **ipv4 access-list acl-name**

##### Example:

```

RP/0/RP0/CPU0:router(config)# ipv4 access-list acl1

```

Creates ACL and enters IP ACL configuration mode. The length of the *acl-name* argument can be up to 64 characters.

**Step 4** **permit** *regular-ace-match-criteria* **udf** *udf-name1 value1 ... udf-name8 value8*

**Example:**

```
RP/0/RP0/CPU0:router(config-ipv4-acl)# 10 permit ipv4 any any udf udf1 0x1234 0xffff udf3
0x56 0xff capture
RP/0/RP0/CPU0:router(config-ipv4-acl)# 30 permit ipv4 any any dscp af11 udf udf5 0x22 0x22
capture
```

Configures ACL with UDF match.

**Step 5** **exit**

**Example:**

```
RP/0/RP0/CPU0:router(config-ipv4-acl)# exit
```

Exits IP ACL configuration mode and returns to global configuration mode.

**Step 6** **interfacetype** *number*

**Example:**

```
RP/0/RP0/CPU0:router(config)# interface HundredGigE 0/0/1/0
```

Configures interface and enters interface configuration mode.

**Step 7** **ipv4 access-group** *acl-name* **ingress**

**Example:**

```
RP/0/RP0/CPU0:router(config-if)# ipv4 access-group acl1 ingress
```

Applies access list to an interface.

**Step 8** **commit**

**Example:**

```
RP/0/RP0/CPU0:router(config-if)# commit
```

Applies access list to an interface.

## Verifying UDF-based Security ACL

Use the **show monitor-session status detail** command to verify the configuration of UDF on security ACL.

```
RP/0/RP0/CPU0:leaf1# show monitor-session 1 status detail
```

```
Fri May 12 19:40:39.429 UTC
Monitor-session 1
  Destination interface tunnel-ip3
  Source Interfaces
  -----
  TenGigE0/0/0/15
  Direction: Rx-only
```

```

Port level: True
ACL match: Enabled
Portion: Full packet
Interval: Mirror all packets
Status: Not operational (destination not active)

```

## DSCP Bitmask to Filter Ingress SPAN Traffic

**Table 9: Feature History Table**

| Feature Name | Release Information | Feature Description                                                                                                                                                                                                                                                                                                                                                                                                                                                                                                                                                                                                                                                                                |
|--------------|---------------------|----------------------------------------------------------------------------------------------------------------------------------------------------------------------------------------------------------------------------------------------------------------------------------------------------------------------------------------------------------------------------------------------------------------------------------------------------------------------------------------------------------------------------------------------------------------------------------------------------------------------------------------------------------------------------------------------------|
|              | Release 7.5.4       | <p>You can now mirror multiple traffic flows for matched Differentiated Service Code Point (DSCP) value of IP header on the SPAN. The matched DSCP value is based on the DSCP value and the bitmask configured in Access Control List (ACL) rule.</p> <p>Earlier, you could monitor single traffic flow by setting the <a href="#">RFC 4594</a> defined DSCP values in the IP header.</p> <p>This feature introduces the following changes:</p> <ul style="list-style-type: none"> <li>• <b>YANG DATA Model:</b> New XPaths for Cisco-IOS-XR-um-ipv4-access-list-cfg and Cisco-IOS-XR-um-ipv6-access-list-cfg (see <a href="#">Github</a>, <a href="#">YANG Data Models Navigator</a>).</li> </ul> |

Starting Release 7.5.4, You can configure an ACL rule with DSCP bitmask on the SPAN to mirror specific traffic flows.

Without ACL rule, SPAN mirrors all the traffic on the incoming port. When ACL is configured with DSCP and DSCP mask on the SPAN, SPAN mirrors the traffic whose DSCP value lies within the combination of DSCP value and the specified mask.

A DSCP value is mapped to a single traffic class as per the defined value in [RFC2474](#). Masking the DSCP value in ACL rule allows to mirror multiple traffic flows. DSCP value and mask operate similar to IPv4 address and mask.

### Configure DSCP Bitmask to Filter Ingress SPAN Traffic

#### Configuration Example for IPv4

This example shows how you can configure DSCP bitmask on ingress SPAN for IPv4 traffic.

#### Running Configuration

```

Router(config)# show running-config ipv4 access-list
ipv4 access-list acl1
 10 permit ipv4 host 192.0.2.1 any dscp af22 bitmask 0x3f
!

interface HundredGigE0/0/0/6
 ipv4 address 192.0.2.51 255.255.255.0
 monitor-session TEST ethernet direction rx-only port-level acl ipv4 acl1

```

```
!
!
```

### Configuration Example for IPv6

This example shows how you can configure DSCP bitmask on ingress SPAN for IPv6 traffic.

```
/*configure the ACL*/
Router# config
Router(config)# ipv6 access-list acl1
Router(config-ipv6-acl)# 10 permit ipv6 host 2001:DB8::2/32 any dscp 33 bitmask 0x3f
Router(config-ipv6-acl)# commit
Router(config-ipv6-acl)# exit

/* Perform the following configurations to attach the created ACL to an interface*/
Router(config)# interface HundredGigE 0/0/10/3
Router(config-if)# ipv6 address 2001:DB8::1/32

/* Monitor the ingress ACL applied and DSCP masked IPv4 traffic on ERSPAN*/
Router(config-if)# monitor-session TEST ethernet direction rx-only port-level acl ipv6 acl1
Router(config-if)# commit
```

### Running Configuration

```
Router(config)# show running-config ipv6 access-list
ipv6 access-list acl1
 10 permit ipv6 acl1 host 2001:DB8::2/32 any dscp 33 bitmask 0x3f
!
interface HundredGigE0/0/10/3
  ipv6 address 2001:db8::1/32
  monitor-session TEST ethernet direction rx-only port-level acl ipv6 acl1
!
!
```

## SPAN Using 7-Tuples ACL

Table 10: Feature History Table

| Feature Name            | Release Information | Description                                                                                                                                                                                                                                                                                                                                                                                                                                                                                                                                                                                                                                                                                                                                        |
|-------------------------|---------------------|----------------------------------------------------------------------------------------------------------------------------------------------------------------------------------------------------------------------------------------------------------------------------------------------------------------------------------------------------------------------------------------------------------------------------------------------------------------------------------------------------------------------------------------------------------------------------------------------------------------------------------------------------------------------------------------------------------------------------------------------------|
| SPAN Using 7-Tuples ACL | Release 7.5.4       | <p>With this release, you can perform packet capturing with 7-tuple access control lists (ACL). This capability allows you to define seven specific attributes in the ACL and apply it to an interface using the <b>monitor-session</b> command.</p> <p>The 7-tuple parameters include source and destination IP addresses, source and destination port numbers, and so on. When the 7-tuples are configured in the ACL, only the matching packets are captured and mirrored. The administrators can examine the captured packets and identify issues such as network congestion and security threats. This analysis helps in diagnosing and resolving network problems, enhancing network performance, and ensuring robust security measures.</p> |

Packet capturing functionality enables the network administrators to capture and analyze packets that pass through a router. By defining the seven parameters in the ACL, known as the 7-tuples, data packets can be

matched and captured. Only packets that satisfy any or all of the seven parameters are mirrored. The captured packets can be analyzed locally or can be saved and exported for offline analysis.

The following parameters can be included in a 7-tuple ACL:

- Source IP Address (`source ip prefix`)
- Destination IP Address (`dest ip prefix`)
- Protocol (`protocol`, for example, TCP, UDP)
- Differentiated services code point `DSCP`
- Source Port (`source port`)
- Destination Port (`dest port`)
- Multiple TCP flags

By leveraging this level of granularity, you can fine-tune the packet capturing process to focus on the data relevant to your monitoring objectives.

### Configuration Example

You can define the ACL with the seven tuples and apply it to the interface. Use the following sample configuration:

```
RP/0/RP0/CPU0:ios#config
Tue Jul 23 08:35:18.506 UTC
RP/0/RP0/CPU0:ios(config)#ipv4 access-list v4-monitor-acl2
RP/0/RP0/CPU0:ios(config-ipv4-acl)#80 permit tcp 80.1.1.0 0.0.0.255 eq www 30.30.30.0
0.0.0.255 eq www fin dscp af11
RP/0/RP0/CPU0:ios(config-ipv4-acl)#commit
Tue Jul 23 08:37:05.265 UTC
RP/0/RP0/CPU0:ios(config-ipv4-acl)#exit
RP/0/RP0/CPU0:ios(config)#ipv6 access-list v6-monitor-acl2
RP/0/RP0/CPU0:ios(config-ipv6-acl)#80 permit tcp 8010::/64 eq www 3010::/64 eq www fin dscp
af11
RP/0/RP0/CPU0:ios(config-ipv6-acl)#commit
Tue Jul 23 08:37:39.689 UTC
RP/0/RP0/CPU0:ios(config-ipv6-acl)#exit
RP/0/RP0/CPU0:ios(config)#exit
RP/0/RP0/CPU0:ios#
```

The following example shows ERSPAN with QoS Configuration:

```
Router#configure
/* GRE Tunnel Interface */
Router(config)#interface Loopback49
Router(config-if)#ipv4 address 172.16.0.1 255.240.0.0
Router(config-if)#exit
Router(config)#interface tunnel-ip100
Router(config-if)#ipv4 address 192.168.0.1 255.255.0.0
Router(config-if)#tunnel mode gre ipv4
Router(config-if)#tunnel source 49.49.49.49
Router(config-if)#tunnel destination 10.0.0.2
Router(config-if)#exit
/* ERSPAN Monitor Session with GRE tunnel as the Destination Interface, and with QoS
configuration */
Router(config)#monitor-session FOO ethernet
Router(config-mon)#destination interface tunnel-ip100
```



```

Router(config-mon)#traffic-class 5
Router(config-mon)#discard-class 1
Router(config-mon)#exit
/* ERSPAN Source Interface */
Router(config)#interface TenGigE0/6/0/4/0
Router(config-if)#description connected to TGEN 9/5
Router(config-if)#ipv4 address 10.0.0.1 255.0.0.0
Router(config-if)#monitor-session FOO ethernet port-level
Router(config-if-mon)#acl ipv4 v4-monitor-acl2
Router(config-if-mon)#acl ipv6 v6-monitor-acl2
Router(config-if-mon)#exit
Router(config-if)#exit
/* ERSPAN Destination ip-tunnel00's underlying interface, with egress policy-map shape-foo
attached */
Router(config)#interface TenGigE0/6/0/9/0
Router(config-if)#service-policy output shape-foo
Router(config-if)#ipv4 address 10.0.0.3 255.0.0.0
Router(config-if)#commit

```

### Verification

Use **show monitor-session status** command to get the details of the monitor session.

```
Router# show monitor-session status
```

Displays information about the monitor session.

## Multiple SPAN ACL Sessions in Single Interface

Table 11: Feature History Table

| Feature Name                                     | Release Information | Description                                                                                                                                                                                                                                                                                                                                                                                                                                                                                                                                                                                                                                                                                                                                                                        |
|--------------------------------------------------|---------------------|------------------------------------------------------------------------------------------------------------------------------------------------------------------------------------------------------------------------------------------------------------------------------------------------------------------------------------------------------------------------------------------------------------------------------------------------------------------------------------------------------------------------------------------------------------------------------------------------------------------------------------------------------------------------------------------------------------------------------------------------------------------------------------|
| Multiple SPAN ACL Sessions in a Single Interface | Release 7.5.4       | <p>With this release, you can configure multiple SPAN ACL sessions under a single interface. A maximum of three sessions can be configured simultaneously.</p> <p>This feature, which is supported on layer 3 interfaces, helps you in monitoring traffic from different parts of your network simultaneously to see the network's overall performance.</p> <p>In addition, using this feature, you can get a better network visibility, more efficient use of network resources, and flexibility.</p> <p>You should specify the monitor sessions to be used on the interface. Use the <b>monitor-session session name ethernet direction rx-only port-level</b> command to specify that only the ingress traffic is mirrored. This feature is not supported on subinterfaces.</p> |

This feature allows you to configure multiple SPAN ACL sessions in the same source interface. The maximum number of sessions that are supported under an interface is three. The ACL is applicable only in the ingress direction (direction Rx). This configuration is supported only on Layer 3 interfaces.

To differentiate multiple SPAN sessions under the same source interface, span session ID is used. When a packet matches multiple entries at the router, priority attribute is used to choose the correct destination for the packet. When a single packet tries to match multiple SPAN sessions, you should configure correct priority fields to identify the correct destination. The ACL with the lowest priority is chosen.

For Cisco NCS 540 routers, the merge group value is always 1, and the priority value can be of any value within the supported range of 1 to 1000.

Multiple SPAN ACL sessions in a single interface help the administrators in the following ways:

- Monitor traffic from different parts of your network simultaneously to see the overall network performance.
- Isolate traffic from specific networks for troubleshooting network issues.
- Segment traffic for different purposes, such as security, compliance, or performance analysis.

## Configure Multiple SPAN ACL Sessions

### Configure Multiple SPAN ACL Sessions

Specify the monitor sessions to be used on the interface. Use the direction keyword to specify that only ingress traffic is mirrored. See the following example:

```
Router(config)#interface TenGigE0/0/0/26
Router(config-if)#monitor-session ses1 ethernet direction rx-only port-level
Router(config-if)#acl ipv4 acl1
!
Router(config-if)#monitor-session ses2 ethernet direction rx-only port-level
Router(config-if)#acl ipv4 acl2
!
Router(config-if)#monitor-session ses3 ethernet direction rx-only port-level
Router(config-if)#acl ipv4 acl3
!
Router(config-if)#monitor-session ses4 ethernet direction rx-only port-level
Router(config-if)#acl ipv4 acl4
!
!
```

### Verify the Sessions

The following example shows the details of the monitor sessions.

```
Router##sh monitor-session status
Tue Mar 21 16:14:15.879 UTC
Monitor-session ses1
Destination interface TenGigE0/0/0/9
=====
Source Interface      Dir   Status
-----
Te0/0/0/0 (port)     Rx    Operational

Monitor-session ses2
Destination interface TenGigE0/0/0/1
=====
Source Interface      Dir   Status
-----
Te0/0/0/0 (port)     Rx    Operational

Monitor-session ses3
Destination interface TenGigE0/0/0/2
=====
Source Interface      Dir   Status
-----
Te0/0/0/0 (port)     Rx    Operational

RP/0/RP0/CPU0:ios#
```

### Configuring the Correct Priority

When one packet tries to match more than one SPAN session, the priority field helps in identifying the correct destination.



**Note** Merge group and priority fields are not mandatory. But if used, configure both fields.

```
Router(config)#interface tenGigE 0/0/0/24
Router(config-if)#monitor-session ses1 ethernet port-level
Router(config-if)#acl ipv4 acl1 merge-group 1 priority 30
```

To verify the traffic, use the following sample **show monitor-session** command:

```
Router#show monitor-session status detail
Tue Mar 21 16:15:02.741 UTC
Monitor-session ses1
  Destination interface TenGigE0/0/0/9
  Source Interfaces
  -----
  TenGigE0/0/0/0
    Direction:    Rx-only
    Port level:   True
    ACL match:    Disabled
    IPv4 ACL:     Enabled (acl1, merge-group: 1,priority: 1)
    IPv6 ACL:     Disabled
    Portion:      Full packet
    Interval:     Mirror all packets
    Mirror drops: Disabled
    Status:       Operational

Monitor-session ses2
  Destination interface TenGigE0/0/0/1
  Source Interfaces
  -----
  TenGigE0/0/0/0
    Direction:    Rx-only
    Port level:   True
    ACL match:    Disabled
    IPv4 ACL:     Enabled (acl2)
    IPv6 ACL:     Disabled
    Portion:      Full packet
    Interval:     Mirror all packets
    Mirror drops: Disabled
    Status:       Operational

Monitor-session ses3
  Destination interface TenGigE0/0/0/2
  Source Interfaces
  -----
  TenGigE0/0/0/0
    Direction:    Rx-only
    Port level:   True
    ACL match:    Disabled
    IPv4 ACL:     Enabled (acl3)
    IPv6 ACL:     Disabled
    Portion:      Full packet
    Interval:     Mirror all packets
    Mirror drops: Disabled
    Status:       Operational

Monitor-session ses4
  Destination interface TenGigE0/0/0/6
  Source Interfaces
```

```

-----
TenGigE0/0/0/0
  Direction:    Rx-only
  Port level:   True
  ACL match:    Disabled
  IPv4 ACL:     Enabled (acl4)
  IPv6 ACL:     Disabled
  Portion:      Full packet
  Interval:     Mirror all packets
  Mirror drops: Disabled
  Status:       Operational
Router#

```

## Monitor Multiple SPAN ACL and Security ACL Sessions

**Table 12: Feature History Table**

| Feature Name                                        | Release Information | Feature Description                                                                                                                                                                                                                                                                |
|-----------------------------------------------------|---------------------|------------------------------------------------------------------------------------------------------------------------------------------------------------------------------------------------------------------------------------------------------------------------------------|
| Monitor Multiple SPAN ACL and Security ACL Sessions | Release 7.5.4       | With this feature, you can use SPAN and security ACLs together to monitor multiple SPAN ACL sessions under the same source interface. SPAN ACL helps you to distribute the mirrored traffic over different destination interfaces. Security ACL allows selective incoming traffic. |

Starting Cisco IOS XR Software Release 7.5.4 you can monitor multiple ERSPAN sessions using GREv4 under the same source interface. Multiple SPAN ACL monitor sessions configured on an interface allow you to choose the destination interface for the mirrored traffic. For the configuration of monitor sessions, you can use SPAN and security ACLs together.

The SPAN and security ACLs apply only in the ingress traffic.

### Configure Multiple SPAN ACL and Security ACL Monitor Sessions

#### Configuration example

Use the following configuration to attach SPAN and security ACLs for traffic mirroring.

```

Router# config
/*Perform the following configurations to attach the SPAN ACL to an interface*/
Router(config-if)#monitor-session always-on-v4 ethernet direction rx-only port-level
Router(config-if-mon)#acl ipv4 v4-monitor-acl1
Router(config-if-mon)#acl ipv6 v6-monitor-acl1
Router(config-if-mon)#exit
Router(config-if)#monitor-session on-demand-v4 ethernet direction rx-only port-level
Router(config-if-mon)#acl ipv4 v4-monitor-acl2
Router(config-if-mon)#acl ipv6 v6-monitor-acl2
Router(config-if-mon)#exit
/*Perform the following configurations to attach the security ACL to an interface*/
Router(config-if)#ipv4 access-group sec_aclv4 ingress
Router(config-if)#ipv6 access-group sec_aclv6 ingress
Router(config-if)#commit

```

**Running configuration**

```
Router(config)#show running-config interface
monitor-session always-on-v4 ethernet direction rx-only port-level
  acl ipv4 v4-monitor-acl2
  acl ipv6 v6-monitor-acl2
!
monitor-session on-demand-v4 ethernet direction rx-only port-level
  acl ipv4 v4-monitor-acl2
  acl ipv6 v6-monitor-acl2
!
ipv4 access-group sec_aclv4 ingress
ipv6 access-group sec_aclv6 ingress
!
!
```

**Attaching the Configurable Source Interface****Procedure****Step 1****configure****Example:**

```
RP/0/RP0/CPU0:router# configure
```

Enters global configuration mode.

**Step 2****interface** *type number***Example:**

```
RP/0/RP0/CPU0:router(config)# interface HundredGigE 0/0/1/0
```

Enters interface configuration mode for the specified source interface. The interface number is entered in *rack/slot/module/port* notation. For more information about the syntax for the router, use the question mark (?) online help function.

**Step 3****ipv4 access-group** *acl-name* {**ingress** | **egress**}**Example:**

```
RP/0/RP0/CPU0:router(config-if)# ipv4 access-group acl1 ingress
```

Controls access to an interface.

**Step 4****monitor-session** *session-name* **ethernet direction rx-only****port-level acl****Example:**

```
RP/0/RP0/CPU0:router(config-if)# monitor-session mon1 ethernet direction rx-only port-level
acl
RP/0/RP0/CPU0:router(config-if-mon)#
```

Attaches a monitor session to the source interface and enters monitor session configuration mode.

**Note** **rx-only** specifies that only ingress traffic is replicated.

**Step 5**    **acl****Example:**

```
RP/0/RP0/CPU0:router(config-if-mon)# acl
```

Specifies that the traffic mirrored is according to the defined ACL.

**Note** If an ACL is configured by name, then this step overrides any ACL that may be configured on the interface.

**Step 6**    **exit****Example:**

```
RP/0/RP0/CPU0:router(config-if-mon)# exit
RP/0/RP0/CPU0:router(config-if)#
```

Exits monitor session configuration mode and returns to interface configuration mode.

**Step 7**    **end** or **commit****Example:**

```
RP/0/RP0/CPU0:router(config-if)# end
```

or

```
RP/0/RP0/CPU0:router(config-if)# commit
```

Saves configuration changes.

- When you issue the **end** command, the system prompts you to commit changes:

```
Uncommitted changes found, commit them before exiting (yes/no/cancel)?
[cancel]:
```

- Entering **yes** saves configuration changes to the running configuration file, exits the configuration session, and returns the router to EXEC mode.
- Entering **no** exits the configuration session and returns the router to EXEC mode without committing the configuration changes.
- Entering **cancel** leaves the router in the current configuration session without exiting or committing the configuration changes.

- Use the **commit** command to save the configuration changes to the running configuration file and remain within the configuration session.

**Step 8**    **show monitor-session [session-name] status [detail] [error]****Example:**

```
RP/0/RP0/CPU0:router# show monitor-session status
```

Displays information about the monitor session.

## ERSPAN

Encapsulated Remote Switched Port Analyzer (ERSPAN) transports mirrored traffic over an IP network. The traffic is encapsulated at the source router and is transferred across the network. The packet is decapsulated at the destination router and then sent to the destination interface.

Encapsulated Remote SPAN (ERSPAN) enables generic routing encapsulation (GRE) for all captured traffic and allows it to be extended across Layer 3 domains.

ERSPAN involves mirroring traffic through a GRE tunnel to a remote site. For more information on configuring the GRE tunnel that is used as the destination for the monitor sessions, see the chapter *Configuring GRE Tunnels*.



---

**Note** A copy of every packet includes the Layer 2 header if the ethernet keyword is configured. As this renders the mirrored packets unroutable, the end point of the GRE tunnel must be the network analyzer.

---

### Introduction to ERSPAN Egress Rate Limit

With ERSPAN egress rate limit feature, you can monitor traffic flow through any IP network. This includes third-party switches and routers.

ERSAPN operates in the following modes:

- ERSPAN Source Session – box where the traffic originates (is SPANned).
- ERSPAN Termination Session or Destination Session – box where the traffic is analyzed.

This feature provides rate limiting of the mirroring traffic or the egress traffic. With rate limiting, you can limit the amount of egress traffic to a specific rate, which prevents the network and remote ERSPAN destination traffic overloading. Be informed, if the egress rate-limit exceeds then the system may cap or drop the monitored traffic.

You can configure the QoS parameters on the traffic monitor session.

- Traffic Class (0 through 7)
  - Traffic class 0 has the lowest priority and 7 the highest.
  - The default traffic class is the same as that of the original traffic class.
- The Discard Class (0 through 2):
  - The default is 0.
  - The discard class configuration is used in WRED.

#### Benefits

With ERSPAN Egress rate limit feature, you can limit the egress traffic or the mirrored and use the mirrored traffic for data analysis.

## Topology

Figure 12: Topology for ERSPAN Egress Rate Limit

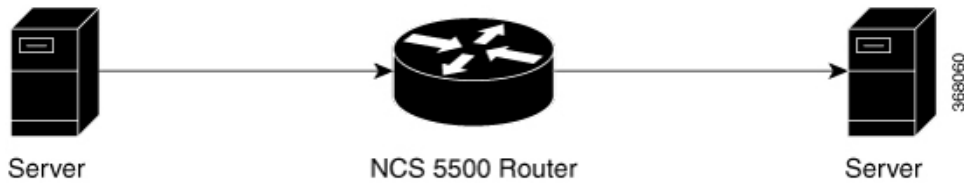

The encapsulated packet for ERSPAN is in ARPA/IP format with GRE encapsulation. The system sends the GRE tunneled packet to the destination box identified by an IP address. At the destination box, SPAN-ASIC decodes this packet and sends out the packets through a port. ERSPAN egress rate limit feature is applied on the router egress interface to rate limit the monitored traffic.

The intermediate switches carrying ERSPAN traffic from source session to termination session can belong to any L3 network.

## Configure ERSPAN Egress Rate Limit

Use the following steps to configure ERSPAN egress rate limit:

```

monitor-session ERSPAN ethernet
destination interface tunnel-ip1
!

RP/0/RP0/CPU0:pyke-008#sh run int tunnel-ip 1

interface tunnel-ip1
ipv4 address 4.4.4.1 255.255.255.0
tunnel mode gre ipv4
tunnel source 20.1.1.1
tunnel destination 20.1.1.2
!

RP/0/RP0/CPU0:pyke-008#sh run int hundredGigE 0/0/0/16

interface HundredGigE0/0/0/16
ipv4 address 215.1.1.1 255.255.255.0
ipv6 address 3001::2/64
monitor-session ERSPAN ethernet direction rx-only port-level
  acl
!
ipv4 access-group ACL6 ingress
  
```

## Running Configuration

```

!! Policy-map to be used with the ERSPAN Destination (egress interface)
!! Traffic class is set to 5. For packets in this class, apply shaping
!! as well as WRED.
class-map match-any TC5
  match traffic-class 5
end-class-map
!
policy-map shape-foo
  class TC5
    random-detect discard-class 0 10000 bytes 40000 bytes
    random-detect discard-class 1 40000 bytes 80000 bytes
    random-detect discard-class 2 80000 bytes 200000 bytes
    shape average percent 15
  !
class class-default
  
```



```

!
end-policy-map
!
!!GRE Tunnel Interface
interface Loopback49
  ipv4 address 49.49.49.49 255.255.255.255
!
interface tunnel-ip100
  ipv4 address 130.100.1.1 255.255.255.0
  tunnel mode gre ipv4
  tunnel source 49.49.49.49
  tunnel destination 10.8.1.2
!
!!ERSPAN Monitor Session with GRE tunnel as the Destination Interface, and with QoS
configuration
monitor-session FOO ethernet
  destination interface tunnel-ip100
  traffic-class 5
  discard-class 1
!
!!ERSPAN Source Interface
interface TenGigE0/6/0/4/0
  description connected to TGEN 9/5
  ipv4 address 10.4.90.1 255.255.255.0
  monitor-session FOO ethernet port-level
!
!
!!ERSPAN Destination ip-tunnel00's underlying interface, with egress policy-map shape-foo
attached
interface TenGigE0/6/0/9/0
  service-policy output shape-foo
  ipv4 address 10.8.1.1 255.255.255.0

```

## Verification

```

RP/0/RP0/CPU0:ios#show monitor-session FOO status detail
Wed May  2 15:14:05.762 UTC
Monitor-session FOO
  Destination interface tunnel-ip100
  Source Interfaces
  -----
  TenGigE0/6/0/4/0
    Direction: Both
    Port level: True
    ACL match: Disabled
    Portion: Full packet
    Interval: Mirror all packets
    Status: Operational
RP/0/RP0/CPU0:ios#
show monitor-session <sess-id> status internal

RP/0/RP0/CPU0:ios#show monitor-session FOO status internal
Wed May  2 15:13:06.063 UTC
Information from SPAN Manager and MA on all nodes:
Monitor-session FOO (ID 0x00000001) (Ethernet)
SPAN Mgr: Destination interface tunnel-ip100 (0x0800001c)
  Last error: Success
  Tunnel data:
    Mode: GREoIPv4
    Source IP: 49.49.49.49
    Dest IP: 10.8.1.2
    VRF:
    ToS: 0 (copied)
    TTL: 255

```

```

DFbit: Not set
0/6/CPU0: Destination interface tunnel-ip100 (0x0800001c)
Tunnel data:
  Mode: GREoIPv4
  Source IP: 49.49.49.49
  Dest IP: 10.8.1.2
  VRF:
  ToS: 0 (copied)
  TTL: 255
  DFbit: Not set

Information from SPAN EA on all nodes:
Monitor-session 0x00000001 (Ethernet)
0/6/CPU0: Name 'FOO', destination interface tunnel-ip100 (0x0800001c)
Platform, 0/6/CPU0:

  Dest Port: 0xe7d

ERSPAN Encap:
  Tunnel ID: 0x4001380b
  ERSPAN Tunnel ID: 0x4001380c
  IP-NH Grp key: 0x3140000cc5
  IP-NH hdl: 0x308a5fa5e0
  IP-NH IFH: 0x30002a0
  IP-NH IPAddr: 10.4.91.2

NPU   MirrorRx   MirrorTx
00    0x00000003 0x00000004
01    0x00000003 0x00000004
02    0x00000003 0x00000004
03    0x00000003 0x00000004
04    0x00000003 0x00000004
05    0x00000003 0x00000004
RP/0/RP0/CPU0:ios#

```

## ERSPAN Traffic to a Destination Tunnel in a Non-Default VRF

Table 13: Feature History Table

| Feature Name                                                | Release Information | Description                                                                                                                                                                                                                                                                                                                                                                                                                                |
|-------------------------------------------------------------|---------------------|--------------------------------------------------------------------------------------------------------------------------------------------------------------------------------------------------------------------------------------------------------------------------------------------------------------------------------------------------------------------------------------------------------------------------------------------|
| ERSPAN Traffic to a Destination Tunnel in a Non-Default VRF | Release 7.5.3       | <p>The tunnels are grouped under the VRFs and you can segregate the traffic towards a specific VRF domain.</p> <p>Encapsulated Remote Switched Port Analyzer (ERSPAN) now transports mirrored traffic through GRE tunnels with multiple VRFs, helping you design your network with multiple Layer 3 partitions.</p> <p>In earlier releases, ERSPAN transported mirrored traffic through GRE tunnels that belonged to only default VRF.</p> |

Here, the tunnel interface, where the traffic mirroring is destined, is now in a VRF.

The traffic coming out of the interfaces of a router do not have any grouping. By configuring a specific VRF, you can now identify the incoming traffic group.

### Configuration

Use the following command to configure a specific VRF:

```
RP/0/RP0/CPU0:router# configure
RP/0/RP0/CPU0:router(config)# interface tunnel-ip 2
RP/0/RP0/CPU0:router(config)# tunnel vrf red
```

For more information on enabling the tunnel mode in GRE, see [Configuring GRE Tunnels](#).

### Configuration example

The following example shows a tunnel interface configured with endpoints in a non-default VRF (**vrf: red**):

```
Router#show run int tunnel-ip 2
Thu Feb  3 06:18:28.075 UTC
interface tunnel-ip2
  ipv4 address 102.1.1.100 255.255.255.0
  tunnel tos 32
  tunnel mode gre ipv4
  tunnel source 120.1.1.100
  tunnel vrf red
  tunnel destination 120.1.1.1
```

```
Router#show monitor-session status
```

```
Thu Feb  3 06:18:11.061 UTC
```

```
Monitor-session ERSPAN-2
```

```
Destination interface tunnel-ip2
```

```
=====
Source Interface      Dir      Status
-----
Te0/0/0/5 (port)    Rx      Operational
```

### Verification

The following CLI output shows how to verify, if the configured tunnel VRF is programmed in the session:

```
Router#show monitor-session ERSPAN-2 status internal
```

```
Thu Feb  3 06:19:50.014 UTC
```

```
Information from SPAN Manager and MA on all nodes:
```

```
Monitor-session ERSPAN-2 (ID 0x00000003) (Ethernet)
```

```
SPAN Mgr: Destination interface tunnel-ip2 (0x20008024)
```

```
Last error: Success
```

```
Tunnel data:
```

```
Mode: GREoIPv4
```

```
Source IP: 120.1.1.100
```

```
Dest IP: 120.1.1.1
```

```
VRF: red
```

```
VRF TBL ID: 0
```

```
ToS: 32
```

```
TTL: 255
```

```
DFbit: Not set
```

## DSCP Marking on Egress GRE Tunnel in ERSPAN

Table 14: Feature History Table

| Feature Name                                | Release Information | Feature Description                                                                                                                                                                                                                                                                  |
|---------------------------------------------|---------------------|--------------------------------------------------------------------------------------------------------------------------------------------------------------------------------------------------------------------------------------------------------------------------------------|
| DSCP Marking on Egress GRE Tunnel in ERSPAN | Release 7.5.4       | You can now set or modify Differentiated Service Code Point (DSCP) value on the ERSPAN GRE tunnel header. This feature allows you to control the QoS for your network's ERSPAN GRE tunnel traffic and eases the effort to control your customers' bandwidth across next-hop routers. |

Starting Cisco IOS XR Release 7.5.4, you can set or modify DSCP marking on ERSPAN GRE tunnels. ERSPAN uses GRE encapsulation to route SPAN capture traffic.

## SPAN over Pseudowire

Pseudo-wire traffic mirroring (known as PW-SPAN) is an extra functionality on the existing SPAN solutions. The existing SPAN solutions are monitored on a destination interface or through a GRE tunnel or RSPAN. In PW-SPAN, the traffic mirroring destination port is configured to be a pseudo-wire rather than a physical port. Here, the designated traffic on the source port is mirrored over the pseudo-wire to a central location. This allows the centralization of expensive network traffic analysis tools.

Because the pseudo-wire carries only mirrored traffic, this traffic is unidirectional. Incoming traffic from the remote provider edge is not allowed. Typically, a monitor session should be created with a destination pseudo-wire. This monitor session is one of the L2VPN xconnect segments. The other segment of the L2VPN VPWS is a pseudowire.



**Note** Only port-level source interfaces are supported.

## Configure SPAN over Pseudowire

Use the following steps to configure SPAN over Pseudowire:

### Configure SPAN monitor session

```
RP/0/RP0/CPU0:router#config
RP/0/RP0/CPU0:router(config)#monitor-session M1
RP/0/RP0/CPU0:router(config-mon)#destination pseudowire
RP/0/RP0/CPU0:router(config-mon)#commit
```

### Configure SPAN source

```
RP/0/RP0/CPU0:router#config
Fri Sep 6 03:49:59.312 UTC
RP/0/RP0/CPU0:router(config)#interface Bundle-Ether100
RP/0/RP0/CPU0:router(config-if)#monitor-session M1 ethernet port-level
RP/0/RP0/CPU0:router(config-if-mon)#commit
```

### Configure l2vpn xconnect

```
RP/0/RP0/CPU0:router(config)#l2vpn
RP/0/RP0/CPU0:router(config-l2vpn)#pw-class span
RP/0/RP0/CPU0:router(config-l2vpn-pwc)#encapsulation mpls
RP/0/RP0/CPU0:router(config-l2vpn-pwc-mpls)#transport-mode ethernet
RP/0/RP0/CPU0:router(config-l2vpn)#xconnect group 1
RP/0/RP0/CPU0:router(config-l2vpn-xc)#p2p 2
RP/0/RP0/CPU0:router(config-l2vpn-xc-p2p)#monitor-session M1
RP/0/RP0/CPU0:router(config-l2vpn-xc-p2p)#neighbor ipv4 10.10.10.1 pw-id 2
RP/0/RP0/CPU0:router(config-l2vpn-xc-p2p)#pw-class span
RP/0/RP0/CPU0:router(config-l2vpn-xc-p2p)#commit
```

## Verify SPAN over Pseudowire

The following examples show how to verify SPAN over Pseudowire configuration.

To check monitor session status:

```
RP/0/RP0/CPU0:router#show run monitor-session M1
monitor-session M1 ethernet
  destination pseudowire
```

```
RP/0/RP0/CPU0:router#show monitor-session M1 status
Monitor-session M1
Destination pseudowire
Source Interface      Dir   Status
BE100 (port)         Both Operational
BE400 (port)         Both Operational
```

```
RP/0/RP0/CPU0:router#show monitor-session M1 status detail
Monitor-session M1
  Destination pseudowire
  Source Interfaces
  -----
  Bundle-Ether100
    Direction: Both
    Port level: True
    ACL match: Disabled
    Portion: Full packet
    Interval: Mirror all packets
    Status: Operational
  Bundle-Ether400
    Direction: Both
    Port level: True
    ACL match: Disabled
    Portion: Full packet
    Interval: Mirror all packets
    Status: Operational
```

To check underlying l2vpn xconnect:

```
RP/0/RP0/CPU0:router#show run l2vpn
l2vpn
  pw-class span
    encapsulation mpls
    transport-mode ethernet
  !
  !
  p2p 2
    monitor-session M1
    neighbor ipv4 10.10.10.1 pw-id 2
    pw-class span
  !
```

```

!
p2p 10
 monitor-session M2
 neighbor ipv4 10.10.10.1 pw-id 10
 pw-class span
!
!
!
RP/0/RP0/CPU0:router#show l2vpn xconnect
Fri Sep  6 03:41:15.691 UTC
Legend: ST = State, UP = Up, DN = Down, AD = Admin Down, UR = Unresolved,
       SB = Standby, SR = Standby Ready, (PP) = Partially Programmed

XConnect
Group      Name      ST      Segment 1
          Description      ST      Segment 2
          Description      ST
-----
1          2          UP      M1
          UP      10.10.10.1      2      UP
-----
1          10         UP      M2
          UP      10.10.10.1      10     UP
-----
-----

```

## Traffic Mirroring for Incoming and Outgoing Traffic Separately over Pseudowire

Table 15: Feature History Table

| Feature Name                                                                   | Release        | Description                                                                                                                                                                                                                                                                                                                                                                                                                                                                                                                                                                                                                                                                                                                                                             |
|--------------------------------------------------------------------------------|----------------|-------------------------------------------------------------------------------------------------------------------------------------------------------------------------------------------------------------------------------------------------------------------------------------------------------------------------------------------------------------------------------------------------------------------------------------------------------------------------------------------------------------------------------------------------------------------------------------------------------------------------------------------------------------------------------------------------------------------------------------------------------------------------|
| Traffic Mirroring for Incoming and Outgoing Traffic Separately over Pseudowire | Release 7.11.1 | <p>You can now distribute the monitoring load by separating the Rx and Tx traffic mirroring over the pseudowire. Earlier, you could mirror the entire traffic without distinguishing between Rx and Tx directions.</p> <p>The separation of traffic direction gives the flexibility of monitoring and analyzing the nature of data being sent and received using independent network traffic analysis tools. The separation also helps in distributing the monitoring load and eases troubleshooting.</p> <p>The feature modifies the <b>monitor-session</b> command. The keywords <b>destination rx</b> and <b>destination tx</b> of the command are extended to monitor session configuration mode. Earlier, this configuration resulted in verification failure.</p> |

Pseudowire Traffic Mirroring also known as PW-SPAN involves replicating designated traffic from the source port to a central location through the pseudowire. The transmission within the pseudowire follows a unidirectional flow, originating from the source port and terminating at the destination network analyzer. Previously, you could not send Rx and Tx mirrored traffic to separate Rx and Tx PW-SPAN destinations. The entire traffic is mirrored to the destination through pseudowire, which is less effective in monitoring and troubleshooting network issues. Resource allocation of monitoring tools is also not optimized, especially when the monitoring requirement for one direction is different from the other direction.

This feature allows separate Rx and Tx mirror destinations within a single session to optimize resource allocation when the monitoring requirement for one direction is different from the other direction.

### Topology

Using this topology, let's understand how incoming and outgoing traffic are mirrored separately over pseudowire.

**Figure 13: Mirroring Topology**

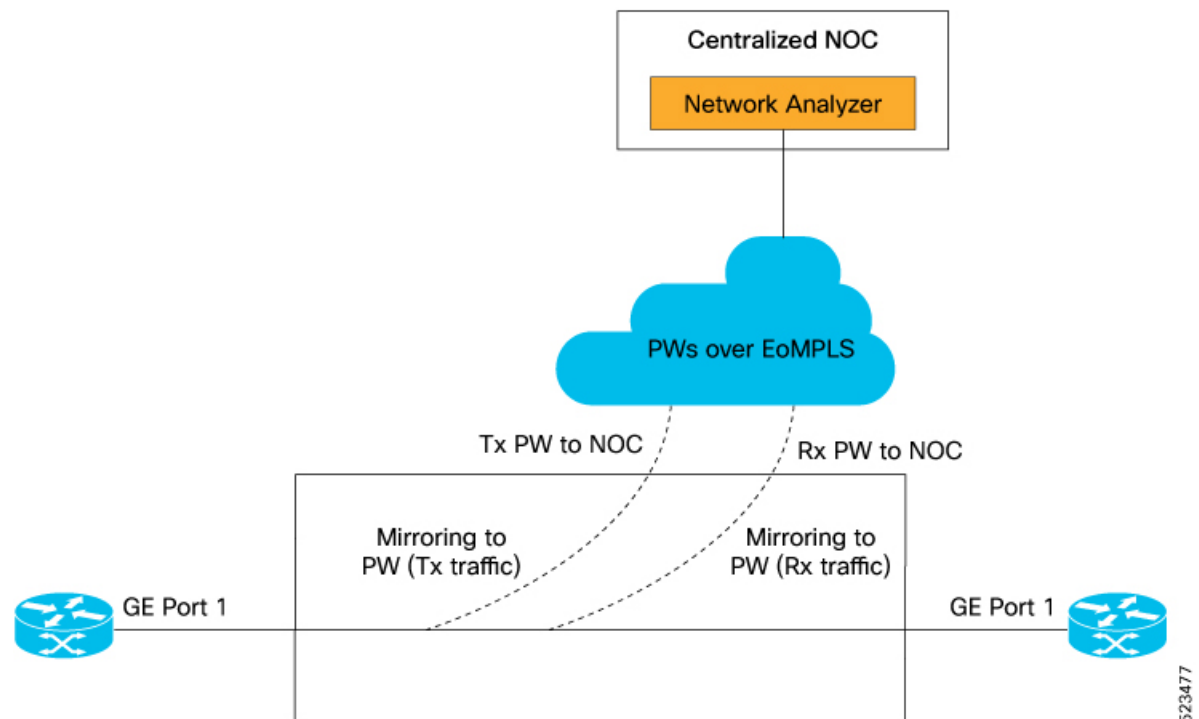

- This topology uses pseudowires provisioned over EoMPLS.
- Two pseudowires, Rx PW and Tx PW, mirror incoming (Rx) and outgoing (Tx) traffic separately to a centralized Network Operations Center (NOC).
- The network analyzer hosted in the NOC receives the separately mirrored traffic for analysis.

You can provision pseudowires using L2VPN point-to-point cross-connect. The SPAN session supports configuring the session ID and traffic direction to allow multiple mirror destinations within the same SPAN session. After you configure traffic mirroring, traffic is duplicated from the selected pseudowires to the specified destination port without affecting the normal traffic forwarding in the network.

The destination port or monitoring tool captures mirrored traffic from the specified pseudowires, facilitating pseudowire traffic monitoring, analysis, and troubleshooting. The segregation of Rx and Tx monitoring enhances the ability to identify and isolate differences or performance problems. By identifying the root cause network problems can be resolved with greater efficiency and effectiveness.

### Configure Traffic Mirroring for Incoming and Outgoing Traffic Separately over Pseudowire

Perform the following tasks to configure Rx and Tx pseudowire destinations:

- Create a pseudowire monitor session to replicate Ethernet traffic.
- Configure the destination for Rx and Tx traffic.
- Create an L2VPN cross-connect corresponding to the monitor session and define point-to-point forwarding details for Rx and Tx.
- Define bundle-ether interfaces for Rx and Tx directions.

```

Router (config) #monitor-session pw-span2 ethernet
Router (config-mon) #destination rx pseudowire
Router (config-mon) #destination tx pseudowire
Router (config-mon) #exit

Router (config) #l2vpn
Router (config-l2vpn) #xconnect group pw-span2
Router (config-l2vpn-xc) #p2p rx2
Router (config-l2vpn-xc-p2p) #monitor-session pw-span2 rx
Router (config-l2vpn-xc-p2p) #neighbor ipv4 100.2.1.11 pw-id 21
Router (config-l2vpn-xc-p2p-pw) #mpls static label local 1421 remote 1521
Router (config-l2vpn-xc-p2p-pw) #pw-class pw
Router (config-l2vpn-xc-p2p-pw) #exit
Router (config-l2vpn-xc-p2p) #exit
Router (config-l2vpn-xc) #p2p tx2
Router (config-l2vpn-xc-p2p) #monitor-session pw-span2 tx
Router (config-l2vpn-xc-p2p) #neighbor ipv4 100.1.1.22 pw-id 22
Router (config-l2vpn-xc-p2p-pw) #mpls static label local 1422 remote 1522
Router (config-l2vpn-xc-p2p-pw) #pw-class pw
Router (config-l2vpn-xc-p2p-pw) #exit
Router (config-l2vpn-xc-p2p) #exit
Router (config-l2vpn-xc) #exit
Router (config-l2vpn) #exit

Router (config) #interface Bundle-Ether1
Router (config-if) #ipv4 address 20.1.1.1 255.255.255.252
Router (config-if) #ipv6 address abc::20:1:1:1/126
Router (config-if) #lacp mode active
Router (config-if) #lacp period short

Router (config-if) #monitor-session pw-span2
Router (config-if-mon) #exit
Router (config-if) #exit

Router (config) #interface Bundle-Ether101
Router (config-if) #ipv4 address 20.1.4.1 255.255.255.252
Router (config-if) #ipv6 address abc::20:1:4:1/126
Router (config-if) #lacp mode active
Router (config-if) #lacp period short

Router (config-if) #monitor-session pw-span2
Router (config-if-mon) #exit
Router (config-if) #exit

```



```
Router(config-if)#load-interval 30
Router(config)#exit
```

### Running Configuration

The following example shows the running configuration.

```
Router#sh run monitor-session pw-span2
Wed Sep 23 11:06:28.607 UTC
monitor-session pw-span2 ethernet
  destination rx pseudowire
  destination tx pseudowire
!

Router#sh run l2vpn xconnect group pw-span2
!l2vpn
l2vpn
  xconnect group pw-span2
  p2p rx2
    monitor-session pw-span2 rx
    neighbor ipv4 100.2.1.11 pw-id 21
    mpls static label local 1421 remote 1521
    pw-class pw
  !
!
  p2p tx2
    monitor-session pw-span2 tx
    neighbor ipv4 100.1.1.22 pw-id 22
    mpls static label local 1422 remote 1522
    pw-class pw
  !
!
!

Router#sh run interface bundle-ether 1
interface Bundle-Ether1
  ipv4 address 20.1.1.1 255.255.255.252
  ipv6 address abc::20:1:1:1/126
  lacp mode active
  lacp period short
  monitor-session pw-span2
!
!

Router#sh run interface bundle-ether 101
interface Bundle-Ether101
  ipv4 address 20.1.4.1 255.255.255.252
  ipv6 address abc::20:1:4:1/126
  lacp mode active
  lacp period short
  monitor-session pw-span2
!
load-interval 30
!
```

### Verification

Verify that both Rx and Tx traffic is operational.

```
show monitor-session status
Monitor-session pw-span2
rx destination pseudowire
tx destination pseudowire
=====
```

| Source Interface | Dir  | Status      |
|------------------|------|-------------|
| BE1              | both | Operational |
| BE101            | both | Operational |

## SPAN-to-File

SPAN-to-File is an extension of the pre-existing SPAN feature that allows network packets to be mirrored to a file instead of an interface. This simplifies the analysis of the packets at a later stage. The file format is PCAP, which helps that data to be used by tools, such as tcpdump or Wireshark.



**Warning** Be cautious when you apply this feature to files located on interfaces with high traffic.

When a file is configured as a destination for a SPAN session, a buffer is created on each node to which the network packets are logged. The buffer is for all packets on the node regardless of which interface they are from, that is, multiple interfaces may be providing packets for the same buffer. The buffers are deleted when the session configuration is removed. The file is written by each node to a location on the active RP which contains the node ID of the node on which the buffer was located.

If multiple interfaces are attached to a session, then interfaces on the same node are expected to have their packets sent to the same file. Bundle interfaces can be attached to a session with a file destination, which is similar to attaching individual interfaces.

## SPAN-to-File Enhancements

*Table 16: Feature History Table*

### Configure SPAN-to-File

Use the following command to configure SPAN to File:

```
monitor-session <name> [ethernet|ipv4|ipv6|mpls-ipv4|mpls-ipv6]
  destination file [size <kbytes>] [buffer-type linear]
```

The `monitor-session <name> [ethernet|ipv4|ipv6|mpls-ipv4|mpls-ipv6]` part of the command creates a monitor-session with the specified name and class and is a pre-existing chain point from the current SPAN feature. The `destination file [size <kbytes>] [buffer-type linear]` part of the command adds a new “file” option to the existing “destination”.

`destination file` has the following configuration options:

- Buffer size.
- Two types of buffer:
  - Circular: Once the buffer is full, the start is overwritten.
  - Linear: Once the buffer is full, no further packets are logged.



**Note** The default buffer-type is circular. Only linear buffer is explicitly configurable. Changing any of the parameters (buffer size or type) recreates the session, and clears any buffers of packets.

All configuration options which are applied to an attachment currently supported for other SPAN types should also be supported by SPAN to file. This may include:

- ACLs
- Write only first X bytes of packet.
- Mirror interval from 512 to 16k.



---

**Note** These options are implemented by the platform when punting the packet.

---

Once a session has been created, then interfaces may be attached to it using the following configuration:

```
interface GigabitEthernet 0/0/0/0
  monitor-session <name> [ethernet|ipv4|ipv6|mpls-ipv4|mpls-ipv6]
```

The attachment configuration is unchanged by SPAN-to-File feature.



---

**Note** Once the SPAN-to-File session is attached to source interface, mirroring starts and packets are punted from NPU to CPU and dropped at CPU until the **packet-collection start action** command is executed.

---

### Configuration Examples

To configure a `mon1` monitor session, use these commands:

```
monitor-session mon1 ethernet
  destination file size 230000
  !
```

In the above example, omitting the `buffer-type` option results in default circular buffer.

To configure a `mon2` monitor session with the `linear` buffer type, use these commands:

```
monitor-session mon2 ethernet
  destination file size 1000 buffer-type linear
  !
```

To attach monitor session to a physical or bundle interface, use these commands:

```
interface Bundle-Ether1
  monitor-session ms7 ethernet
  !
```

### Running Configuration

```
!! IOS XR Configuration 7.1.1.124I
!! Last configuration change at Tue Nov 26 19:29:05 2019 by root
!
hostname OC
logging console informational
!
monitor-session mon2 ethernet
  destination file size 1000 buffer-type linear

!
interface Bundle-Ether1
  monitor-session ms7 ethernet
end
```

## Verification

To verify packet collection status:

```
RP/0/RP0/CPU0:router#show monitor-session status
Monitor-session mon1
Destination File - Packet collecting
=====
Source Interface      Dir      Status
-----
Hu0/9/0/2            Rx      Operational

Monitor-session mon2
Destination File - Packet collecting
=====
Source Interface      Dir      Status
-----
BE2.1                Rx      Operational
```

If packet collection is not active, the following line is displayed:

```
Monitor-session mon2
Destination File - Not collecting
```

Here, `Status-Operational` and `Destination File - Not collecting` indicates that mirroring has started and packets are being punted from NPU to CPU but getting dropped at CPU until the **packet-collection start action** command is executed.

## Action Commands for SPAN-to-File

Action commands are added to start and stop network packet collection. The commands may only be run on sessions where the destination is a file. The action command auto-completes names of globally configured SPAN to File sessions. See the table below for more information on action commands.

**Table 17: Action Commands for SPAN-to-File**

| Action | Command                                                         | Description                                                                                                                                                                                                                                                                                                  |
|--------|-----------------------------------------------------------------|--------------------------------------------------------------------------------------------------------------------------------------------------------------------------------------------------------------------------------------------------------------------------------------------------------------|
| Start  | <pre>monitor-session &lt;name&gt; packet-collection start</pre> | <p>Issue this command to start writing packets for the specified session to the configured buffer.</p> <p>Once the SPAN is configured and operational, the packets are punted to CPU and dropped by CPU until the <code>monitor-session &lt;name&gt; packet-collection start</code> command is executed.</p> |

| Action | Command                                                                                                                                 | Description                                                                                                                                                                                                                                                                                                                                                                                                                                                                                                                                                                                |
|--------|-----------------------------------------------------------------------------------------------------------------------------------------|--------------------------------------------------------------------------------------------------------------------------------------------------------------------------------------------------------------------------------------------------------------------------------------------------------------------------------------------------------------------------------------------------------------------------------------------------------------------------------------------------------------------------------------------------------------------------------------------|
| Stop   | <pre>monitor-session &lt;name&gt; packet-collection stop [ discard-data   write directory &lt;dir&gt; filename &lt;filename&gt; ]</pre> | <p>Issue this command to stop writing packets to the configured buffer.</p> <ul style="list-style-type: none"> <li>• <code>discard-data</code>: Specify this option to clear the buffer.</li> <li>• <code>discard-data</code>: Specify this option to write the buffer to the disk before it is cleared.</li> </ul> <p>The buffer is written in .pcap format in this location:<br/> <code>/&lt;directory&gt;/&lt;node_id&gt;/&lt;filename&gt;.pcap.</code></p> <p>The .pcap extension that the user adds to the filename is removed automatically to avoid a duplicate file extension.</p> |

## File Mirroring

Prior to Cisco IOS XR Software Release , the router did not support file mirroring from active RP to standby RP. Administrators had to manually perform the task or use EEM scripts to sync files across active RP and standby RP. Starting with Cisco IOS XR Software Release , the file mirroring feature enables the router to copy files or directories automatically from `/harddisk:/mirror` location in active RP to `/harddisk:/mirror` location in standby RP or RSP without user intervention or EEM scripts.

Two new CLIs have been introduced for the file mirroring feature:

- **mirror enable**

The `/harddisk:/mirror` directory is created by default, but file mirroring functionality is only enabled by executing the `mirror enable` command from configuration terminal. Status of the mirrored files can be viewed with `show mirror status` command.

- **mirror enable checksum**

The `mirror enable checksum` command enables MD5 checksum across active to standby RP to check integrity of the files. This command is optional.

## Configure File Mirroring

File mirroring has to be enabled explicitly on the router. It is not enabled by default.

```
RP/0/RSP0/CPU0:router#show run mirror
```

```
Thu Jun 25 10:12:17.303 UTC
mirror enable
mirror checksum
```

Following is an example of copying running configuration to `harddisk:/mirror` location:

```
RP/0/RSP0/CPU0:router#copy running-config harddisk:/mirror/run_config
Wed Jul 8 10:25:51.064 PDT
Destination file name (control-c to abort): [/mirror/run_config]?
Building configuration..
```

```
32691 lines built in 2 seconds (16345)lines/sec
[OK]
```

### Verification

To verify the syncing of file copied to mirror directory, use the `show mirror` command.

```
RP/0/RSP0/CPU0:router#show mirror
Wed Jul  8 10:31:21.644 PDT
% Mirror rsync is using checksum, this show command may take several minutes if you have
many files. Use Ctrl+C to abort
MIRROR DIR: /harddisk:/mirror/
% Last sync of this dir ended at Wed Jul  8 10:31:11 2020
Location  |Mirrored |MD5 Checksum                |Modification Time
-----|-----|-----|-----
run_config |yes      |76fc1b906bec4fe08ecda0c93f6c7815 |Wed Jul  8 10:25:56 2020
```

If checksum is disabled, `show mirror` command displays the following output:

```
RP/0/RSP0/CPU0:router#show mirror
Wed Jul  8 10:39:09.646 PDT
MIRROR DIR: /harddisk:/mirror/
% Last sync of this dir ended at Wed Jul  8 10:31:11 2020
Location  |Mirrored |Modification Time
-----|-----|-----
run_config |yes      |Wed Jul  8 10:25:56 2020
```

If there is a mismatch during the syncing process, use `show mirror mismatch` command to verify.

```
RP/0/RP0/CPU0:router# show mirror mismatch
Wed Jul  8 10:31:21.644 PDT
MIRROR DIR: /harddisk:/mirror/
% Last sync of this dir ended at Wed Jul  8 10:31:11 2020
Location  |Mismatch Reason      |Action Needed
-----|-----|-----
test.txt  |newly created item.  |send to standby
```

## Forward-Drop Packets Mirroring

In a network, packets are forwarded from one device to another until they reach their destination. However, in some cases, routers may drop packets during this forwarding process. These packets are known as forward-drop packets.

Packets can be dropped for several reasons such as congestion on the network, errors in the packet header or payload, blocking by firewall or access control lists (ACL), and so on. These forward-drop packets are typically discarded before they can reach their intended destination, and may have to be re-transmitted by the source device. This feature supports mirroring of these forward-drop packets at the ingress (Rx direction) to another destination. When a global forward-drop session is configured for the router, the forward-drop packets at the ingress are mirrored or copied to the configured destination. You can configure the mirror destination as a file (for SPAN-to-file sessions) or an IPv4 GRE tunnel ID (for ERSPAN).

## Mirror Forward-Drop Packets

Table 18: Feature History Table

| Feature Name                | Release Information | Description                                                                                                                                                                                                                                                                                                                                                                                                                                                                                                                                                                                                                                                                                                                                                                |
|-----------------------------|---------------------|----------------------------------------------------------------------------------------------------------------------------------------------------------------------------------------------------------------------------------------------------------------------------------------------------------------------------------------------------------------------------------------------------------------------------------------------------------------------------------------------------------------------------------------------------------------------------------------------------------------------------------------------------------------------------------------------------------------------------------------------------------------------------|
| Mirror Forward-Drop Packets | Release 7.5.4       | <p>Mirroring forward-drop packets feature copies or mirrors the packets that are dropped during the forwarding process at the router ingress to a configured destination. These mirrored packets can be captured and analyzed using network monitoring tools. The analysis of dropped packets helps you understand the types of traffic that are blocked, analyze potential security threats, troubleshoot, and optimize network performance.</p> <p>This feature introduces the following changes:</p> <ul style="list-style-type: none"> <li>• <b>CLI:</b> <a href="#">forward-drop rx</a></li> <li>• <b>YANG Data Model:</b> New XPath for Cisco-IOS-XR-um-monitor-session-cfg.yang (see <a href="#">GitHub</a>, <a href="#">YANG Data Models Navigator</a>)</li> </ul> |

Mirroring forward-drop packets to a suitable destination for analysis can help in the following:

- **Network visibility:** By mirroring and analyzing forward-drop packets, network administrators gain better visibility into the types of traffic that are blocked by the firewalls and access control lists (ACL).
- **Threat detection:** As the original dropped packet is forwarded without any change, it helps in identifying the source of potential security threats.
- **Troubleshooting:** Analyzing forward-drop packets helps in troubleshooting network issues that may be causing the packet drop. This helps in taking proactive measures to avoid escalation of the issue.

### Configure Forward-Drop Mirroring

Perform the following tasks on the router to configure a global session for mirroring forward-drop packets:

1. Configure the tunnel mode.
2. Configure the tunnel source.
3. Configure the tunnel destination.
4. Configure a traffic mirroring session.
5. Associate a destination interface with the traffic mirroring session.
6. Run **forward-drop rx** command to start mirroring forward-drop packets.

This example shows how to configure a global traffic mirroring session for forward-drop packets.

```
Router(config)# interface tunnel-ip 2
Router(config-if)# tunnel mode gre ipv4
Router(config-if)# tunnel source 20.20.20.20
Router(config-if)# tunnel destination 192.1.1.3
Router(config-if)!
Router(config)# monitor-session mon2 ethernet
```

```
Router(config)#destination interface tunnel-ip2
Router(config)#forward-drop rx
Router(config)#!
```

### Running Configuration

This section shows forward-drop running configuration.

```
RP/0/RSP0/CPU0:router#sh running-config
interface tunnel-ip 2
 tunnel mode gre ipv4
 tunnel source 20.20.20.20
 tunnel destination 192.1.1.3
 !
 monitor-session mon2 ethernet
 destination interface tunnel-ip2
 forward-drop rx
 !
```

### Verification

Verify the forward-drop packets are mirrored using the **show monitor-session** command.

```
Router#show monitor-session mon2 status detail
Mon Aug 15 19:14:31.975 UTC
Monitor-session mon2
  Destination interface tunnel-ip2
  All forwarding drops:
    Direction: Rx
  Source Interfaces
  -----
```

## Troubleshoot Traffic Mirroring

When you encounter any issue with traffic mirroring, begin troubleshooting by checking the output of the **show monitor-session status** command. This command displays the recorded state of all sessions and source interfaces:

```
# show monitor-session status
Monitor-session 5
rx destination interface tunnel-ip5
tx destination is not specified
=====
Source Interface  Dir  Status
-----
Te0/0/0/23 (port) Rx   Operational
```

In the preceding example, the line marked as `<Session status>` can indicate one of these configuration errors:

| Session Status                     | Explanation                                                                                                                                             |
|------------------------------------|---------------------------------------------------------------------------------------------------------------------------------------------------------|
| Session is not configured globally | The session does not exist in global configuration. Review the <b>show</b> command output and ensure that a session with a correct name has configured. |



| Session Status                              | Explanation                                                                                                                                                                                                                                                                                                             |
|---------------------------------------------|-------------------------------------------------------------------------------------------------------------------------------------------------------------------------------------------------------------------------------------------------------------------------------------------------------------------------|
| Destination interface <intf> (<down-state>) | The destination interface is not in Up state in the Interface Manager. You can verify the state using the <b>show interfaces</b> command. Check the configuration to determine what might be keeping the interface from coming up (for example, a sub-interface needs to have an appropriate encapsulation configured). |

The <Source interface status> can report these messages:

| Source Interface Status                              | Explanation                                                                                                                                                                                                                                                                             |
|------------------------------------------------------|-----------------------------------------------------------------------------------------------------------------------------------------------------------------------------------------------------------------------------------------------------------------------------------------|
| Operational                                          | Everything appears to be working correctly in traffic mirroring. If you are having issues, follow up with the platform teams in the first instance, if mirrored traffic is not operating as expected.                                                                                   |
| Not operational (Session is not configured globally) | The session does not exist in global configuration. Check the <b>show monitor-session</b> command output to ensure that a session with the right name has been configured.                                                                                                              |
| Not operational (destination not known)              | The session exists, but it either does not have a destination interface configured or the destination interface named for the session does not exist. If the destination is a sub-interface that has not been created.                                                                  |
| Not operational (source same as destination)         | The session exists, but the destination and source are the same interface. Traffic mirroring does not work.                                                                                                                                                                             |
| Not operational (destination not active)             | The destination interface or pseudowire is not in the Up state. See the corresponding <i>Session status</i> error messages for suggested resolutions.                                                                                                                                   |
| Not operational (source state <down-state>)          | The source interface is not in the Up state. You can verify the state using the <b>show interfaces</b> command. Check the configuration to see what might be keeping the interface from coming up (for example, a sub-interface needs to have an appropriate encapsulation configured). |
| Error: see detailed output for explanation           | Traffic mirroring has encountered an error. Run the <b>show monitor-session status detail</b> command to display more information.                                                                                                                                                      |

The **show monitor-session status detail** command displays full details of the configuration parameters and any errors encountered. For example:

```
RP/0/RP0/CPU0:router show monitor-session status detail
```

```
Monitor-session sess1
Destination interface is not configured
Source Interfaces
-----
TenGigE0/0/0/1
Direction: Both
ACL match: Disabled
Portion: Full packet
Status: Not operational (destination interface not known)
TenGigE0/0/0/2
Direction: Both
ACL match: Disabled
Portion: First 100 bytes
```

```

    Status: Not operational (destination interface not known). Error: 'Viking SPAN PD' detected
    the 'warning' condition 'PRM connection
      creation failure'.
Monitor-session foo
Destination next-hop TenGigE 0/0/0/0
Source Interfaces
-----
TenGigE 0/0/0/1.100:
  Direction: Both
  Status: Operating
TenGigE 0/0/0/2.200:
  Direction: Tx
  Status: Error: <blah>

Monitor session bar
No destination configured
Source Interfaces
-----
TenGigE 0/0/0/3.100:
  Direction: Rx
  Status: Not operational(no destination)

```

Here are additional trace and debug commands:

```

RP/0/RP0/CPU0:router# show monitor-session trace ?

platform  Enable platform trace
process   Filter debug by process(cisco-support)

RP/0/RP0/CPU0:router# show monitor-session trace platform ?

errors    Display error traces(cisco-support)
events    Display event traces(cisco-support)

RP/0/RP0/CPU0:router#show monitor-session trace platform events location all ?

usrtdir   Specify directory to collect unsorted traces(cisco-support)
|         Output Modifiers
<cr>

RP/0/RP0/CPU0:router#show monitor-session trace platform errors location all ?

usrtdir   Specify directory to collect unsorted traces(cisco-support)
|         Output Modifiers
<cr>

#

RP/0/RP0/CPU0:router# debug monitor-session process all

RP/0/RP0/CPU0:router# debug monitor-session process ea

RP/0/RP0/CPU0:router# debug monitor-session process ma

RP/0/RP0/CPU0:router# show monitor-session process mgr

detail    Display detailed output
errors    Display only attachments which have errors
internal  Display internal monitor-session information
|         Output Modifiers

```

```
RP/0/RP0/CPU0:router# show monitor-session status
```

```
RP/0/RP0/CPU0:router# show monitor-session status errors
```

```
RP/0/RP0/CPU0:router# show monitor-session status internal
```

```
RP/0/RP0/CPU0:router# show tech-support span ?
```

```
file          Specify a valid file name (e.g. disk0:tmp.log)
list-CLIs     list the commands that would be run (don't execute) (cisco-support)
location      Specify a location (cisco-support)
rack          Specify a rack (cisco-support)
time-out      per show command timeout configuration (cisco-support)
<cr>
```





## CHAPTER 8

# Configuring Virtual Loopback and Null Interfaces

This module describes the configuration of loopback and null interfaces. Loopback and null interfaces are considered virtual interfaces.

A virtual interface represents a logical packet switching entity within the router. Virtual interfaces have a global scope and do not have an associated location. Virtual interfaces have instead a globally unique numerical ID after their names. Examples are Loopback 0, Loopback 1, and Loopback 99999. The ID is unique per virtual interface type to make the entire name string unique such that you can have both Loopback 0 and Null 0.

Loopback and null interfaces have their control plane presence on the active route switch processor (RSP). The configuration and control plane are mirrored onto the standby RSP and, in the event of a failover, the virtual interfaces move to the ex-standby, which then becomes the newly active RSP.

- [Information About Configuring Virtual Interfaces, on page 187](#)

## Information About Configuring Virtual Interfaces

To configure virtual interfaces, you must understand the following concepts:

### Virtual Loopback Interface Overview

A virtual loopback interface is a virtual interface with a single endpoint that is always up. Any packet transmitted over a virtual loopback interface is immediately received by the same interface. Loopback interfaces emulate a physical interface.

In Cisco IOS XR Software, virtual loopback interfaces perform these functions:

- Loopback interfaces can act as a termination address for routing protocol sessions. This allows routing protocol sessions to stay up even if the outbound interface is down.
- You can ping the loopback interface to verify that the router IP stack is working properly.

In applications where other routers or access servers attempt to reach a virtual loopback interface, you must configure a routing protocol to distribute the subnet assigned to the loopback address.

Packets routed to the loopback interface are rerouted back to the router or access server and processed locally. IP packets routed out to the loopback interface but not destined to the loopback interface are dropped. Under these two conditions, the loopback interface can behave like a null interface.

## Prerequisites for Configuring Virtual Interfaces

You must be in a user group associated with a task group that includes the proper task IDs. The command reference guides include the task IDs required for each command. If you suspect user group assignment is preventing you from using a command, contact your AAA administrator for assistance.

## Configuring Virtual Loopback Interfaces

This task explains how to configure a basic loopback interface.

### Restrictions

The IP address of a loopback interface must be unique across all routers on the network. It must not be used by another interface on the router, and it must not be used by an interface on any other router on the network.

### Procedure

---

#### Step 1 **configure**

##### Example:

```
RP/0/RP0/CPU0:router# configure
```

Enters global configuration mode.

#### Step 2 **interface loopback *instance***

##### Example:

```
RP/0/RP0/CPU0:router(config)# interface Loopback 3
```

Enters interface configuration mode and names the new loopback interface.

#### Step 3 **ipv4 address *ip-address***

##### Example:

```
RP/0/RP0/CPU0:router(config-if)# ipv4 address 100.100.100.69 255.255.255.255
```

Assigns an IP address and subnet mask to the virtual loopback interface using the **ipv4 address** configuration command.

#### Step 4 **end** or **commit**

##### Example:

```
RP/0/RP0/CPU0:router(config-if)# end
```

or

```
RP/0/RP0/CPU0:router(config-if)# commit
```

Saves configuration changes.

- When you issue the **end** command, the system prompts you to commit changes:

```
Uncommitted changes found, commit them before exiting(yes/no/cancel)?
[cancel]:
```

- Entering **yes** saves configuration changes to the running configuration file, exits the configuration session, and returns the router to EXEC mode.
- Entering **no** exits the configuration session and returns the router to EXEC mode without committing the configuration changes.
- Entering **cancel** leaves the router in the current configuration session without exiting or committing the configuration changes.
- Use the **commit** command to save the configuration changes to the running configuration file and remain within the configuration session.

#### Step 5 `show interface type instance`

##### Example:

```
RP/0/RP0/CPU0:router# show interfaces Loopback0
```

(Optional) Displays the configuration of the loopback interface.

##### Example

This example shows how to configure a loopback interface:

```
RP/0/RP0/CPU0:router# configure
RP/0/RP0/CPU0:router(config)# interface Loopback0
RP/0/RP0/CPU0:router(config-if)# ipv4 address 100.100.100.69 255.255.255.255
RP/0/RP0/CPU0:router(config-if)# ipv6 address 100::69/128
RP/0/RP0/CPU0:router(config-if)# end
Uncommitted changes found, commit them? [yes]: yes
RP/0/RP0/CPU0:router# show interfaces Loopback0

Loopback0 is up, line protocol is up
  Interface state transitions: 1
  Hardware is Loopback interface(s)
  Internet address is 100.100.100.69/32
  MTU 1500 bytes, BW 0 Kbit
    reliability Unknown, txload Unknown, rxload Unknown
  Encapsulation Loopback, loopback not set,
  Last link flapped 01:57:47
  Last input Unknown, output Unknown
  Last clearing of "show interface" counters Unknown
  Input/output data rate is disabled.
```

## Null Interface Overview

A null interface functions similarly to the null devices available on most operating systems. This interface is always up and can never forward or receive traffic; encapsulation always fails. The null interface provides an alternative method of filtering traffic. You can avoid the overhead involved with using access lists by directing undesired network traffic to the null interface.

The only interface configuration command that you can specify for the null interface is the **ipv4 unreachable** command. With the **ipv4 unreachable** command, if the software receives a non-broadcast packet destined for itself that uses a protocol it does not recognize, it sends an Internet Control Message Protocol (ICMP) protocol unreachable message to the source. If the software receives a datagram that it cannot deliver to its ultimate destination because it knows of no route to the destination address, it replies to the originator of that datagram with an ICMP host unreachable message. By default **ipv4 unreachable** command is enabled. If we do not want ICMP to send protocol unreachable, then we need to configure using the **ipv4 icmp unreachable disable** command.

The Null 0 interface is created by default during boot process and cannot be removed. The **ipv4 unreachable** command can be configured for this interface, but most configuration is unnecessary because this interface just discards all the packets sent to it.

The Null 0 interface can be displayed with the **show interfaces null0** command.

## Configuring Null Interfaces

This task explains how to configure a basic null interface.

### Procedure

#### Step 1 **configure**

##### Example:

```
RP/0/RP0/CPU0:router# configure
```

Enters global configuration mode.

#### Step 2 **interface null 0**

##### Example:

```
RP/0/RP0/CPU0:router(config)# interface null 0
```

Enters the null 0 interface configuration mode.

#### Step 3 **ipv4 icmp unreachables disable**

##### Example:

```
RP/0/RP0/CPU0:router(config-null0)# ipv4 icmp unreachables disable
```

This command disables the generation of IPv4 Internet Control Message Protocol (ICMP) unreachable messages.

#### Step 4 **end** or **commit**

##### Example:

```
RP/0/RP0/CPU0:router(config-null0)# end
```

or

```
RP/0/RP0/CPU0:router(config-null0)# commit
```

Saves configuration changes.



- When you issue the **end** command, the system prompts you to commit changes:

```
Uncommitted changes found, commit them before
exiting(yes/no/cancel)?
[cancel]:
```

- Entering **yes** saves configuration changes to the running configuration file, exits the configuration session, and returns the router to EXEC mode.
- Entering **no** exits the configuration session and returns the router to EXEC mode without committing the configuration changes.
- Entering **cancel** leaves the router in the current configuration session without exiting or committing the configuration changes.
- Use the **commit** command to save the configuration changes to the running configuration file and remain within the configuration session.

### Step 5 **show interfaces null 0**

#### Example:

```
RP/0/RP0/CPU0:router# show interfaces null 0
```

Verifies the configuration of the null interface.

#### Example

This example shows how to configure a null interface:

```
RP/0/RP0/CPU0:router# configure
RP/0/RP0/CPU0:router(config)# interface Null 0
RP/0/RP0/CPU0:router(config-null0)# ipv4 icmp unreachable disable
RP/0/RP0/CPU0:router(config-null0)# end
Uncommitted changes found, commit them? [yes]: yes
RP/0/RP0/CPU0:router# show interfaces Null 0
```

```
Null0 is up, line protocol is up
Interface state transitions: 1
Hardware is Null interface
Internet address is Unknown
MTU 1500 bytes, BW 0 Kbit
reliability 255/255, txload Unknown, rxload Unknown
Encapsulation Null, loopback not set,
Last link flapped 4d20h
Last input never, output never
Last clearing of "show interface" counters 05:42:04
5 minute input rate 0 bits/sec, 0 packets/sec
5 minute output rate 0 bits/sec, 0 packets/sec
0 packets input, 0 bytes, 0 total input drops
0 drops for unrecognized upper-level protocol
Received 0 broadcast packets, 0 multicast packets
0 packets output, 0 bytes, 0 total output drops
Output 0 broadcast packets, 0 multicast packets
```

## Configuring Virtual IPv4 Interfaces

This task explains how to configure an IPv4 virtual interface.

### Procedure

---

#### Step 1 **configure**

##### Example:

```
RP/0/RP0/CPU0:router# configure
```

Enters global configuration mode.

#### Step 2 **ipv4 virtual address *ipv4-***

##### Example:

```
RP/0/RP0/CPU0:router(config)# ipv4 virtual address 10.3.32.154/8
```

Defines an IPv4 virtual address for the management Ethernet interface.

**Note** While configuring the IPv4 virtual address, ensure that you match the IP address on the Management interface in the same network.

#### Step 3 **end or commit**

##### Example:

```
RP/0/RP0/CPU0:router(config-null0)# end
```

or

```
RP/0/RP0/CPU0:router(config-null0)# commit
```

Saves configuration changes.

- When you issue the **end** command, the system prompts you to commit changes:

```
Uncommitted changes found, commit them before
exiting(yes/no/cancel)?
[cancel]:
```

- Entering **yes** saves configuration changes to the running configuration file, exits the configuration session, and returns the router to EXEC mode.
  - Entering **no** exits the configuration session and returns the router to EXEC mode without committing the configuration changes.
  - Entering **cancel** leaves the router in the current configuration session without exiting or committing the configuration changes.
  - Use the **commit** command to save the configuration changes to the running configuration file and remain within the configuration session.
-

### Example

This is an example for configuring a virtual IPv4 interface:

```
RP/0/RP0/CPU0:router# configure  
RP/0/RP0/CPU0:router(config)# ipv4 virtual address 10.3.32.154/8  
RP/0/RP0/CPU0:router(config-null10)# commit
```





## CHAPTER 9

# Configuring 802.1Q VLAN Interfaces

A VLAN is a group of devices on one or more LANs that are configured so that they can communicate as if they were attached to the same wire, when in fact they are located on a number of different LAN segments. VLANs are very flexible for user and host management, bandwidth allocation, and resource optimization because they are based on logical grouping instead of physical connections.

The IEEE 802.1Q protocol standard addresses the problem of dividing large networks into smaller parts so broadcast and multicast traffic does not consume more bandwidth than necessary. The standard also helps provide a higher level of security between segments of internal networks.

### 802.1Q Tagged Frames

The IEEE 802.1Q tag-based VLAN uses an extra tag in the MAC header to identify the VLAN membership of a frame across bridges. This tag is used for VLAN and quality of service (QoS) priority identification. The VLAN ID associates a frame with a specific VLAN and provides the information that switches must process the frame across the network. A tagged frame is four bytes longer than an untagged frame and contains two bytes of Tag Protocol Identifier (TPID) residing within the type and length field of the Ethernet frame and two bytes of Tag Control Information (TCI) which starts after the source address field of the Ethernet frame.

- [Configuring 802.1Q VLAN Interfaces, on page 195](#)
- [Information About Configuring 802.1Q VLAN Interfaces, on page 196](#)
- [How to Configure 802.1Q VLAN Interfaces, on page 197](#)

## Configuring 802.1Q VLAN Interfaces

A VLAN is a group of devices on one or more LANs that are configured so that they can communicate as if they were attached to the same wire, when in fact they are located on a number of different LAN segments. VLANs are very flexible for user and host management, bandwidth allocation, and resource optimization because they are based on logical grouping instead of physical connections.

The IEEE 802.1Q protocol standard addresses the problem of dividing large networks into smaller parts so broadcast and multicast traffic does not consume more bandwidth than necessary. The standard also helps provide a higher level of security between segments of internal networks.

### 802.1Q Tagged Frames

The IEEE 802.1Q tag-based VLAN uses an extra tag in the MAC header to identify the VLAN membership of a frame across bridges. This tag is used for VLAN and quality of service (QoS) priority identification. The VLAN ID associates a frame with a specific VLAN and provides the information that switches must process

the frame across the network. A tagged frame is four bytes longer than an untagged frame and contains two bytes of Tag Protocol Identifier (TPID) residing within the type and length field of the Ethernet frame and two bytes of Tag Control Information (TCI) which starts after the source address field of the Ethernet frame.

## Information About Configuring 802.1Q VLAN Interfaces

To configure 802.1Q VLAN interfaces, you must understand these concepts:

### Subinterfaces

Subinterfaces are logical interfaces created on a hardware interface. These software-defined interfaces allow for segregation of traffic into separate logical channels on a single hardware interface as well as allowing for better utilization of the available bandwidth on the physical interface.

Subinterfaces are distinguished from one another by adding an extension on the end of the interface name and designation. For instance, the Ethernet subinterface 23 on the physical interface designated TenGigE 0/0/0/0 would be indicated by TenGigE 0/0/0/0.23.

Before a subinterface is allowed to pass traffic it must have a valid tagging protocol encapsulation and VLAN identifier assigned. All Ethernet subinterfaces always default to the 802.1Q VLAN encapsulation. However, the VLAN identifier must be explicitly defined.

### Subinterface MTU

The subinterface maximum transmission unit (MTU) is inherited from the physical interface with an additional four bytes allowed for the 802.1Q VLAN tag. By default subinterface inherits MTU of physical interface if the MTU is not configured. We can have maximum 3 different MTU for a subinterface per NPU. .

### EFPs

An Ethernet Flow Point (EFP) is a Metro Ethernet Forum (MEF) term describing abstract router architecture. An EFP is implemented by an Layer 2 subinterface with a VLAN encapsulation. The term EFP is used synonymously with an VLAN tagged L2 subinterface. .

### Layer 2 VPN on VLANs

The Layer 2 Virtual Private Network (L2VPN) feature enables Service Providers (SPs) to provide Layer 2 services to geographically disparate customer sites.

The configuration model for configuring VLAN attachment circuits (ACs) is similar to the model used for configuring basic VLANs, where the user first creates a VLAN subinterface, and then configures that VLAN in subinterface configuration mode. To create an AC, you need to include the **l2transport** keyword in the **interface** command string to specify that the interface is a Layer 2 interface.

VLAN ACs support these modes of L2VPN operation:

- Basic Dot1Q AC—The AC covers all frames that are received and sent with a specific VLAN tag.
- QinQ AC—The AC covers all frames received and sent with a specific outer VLAN tag and a specific inner VLAN tag. QinQ is an extension to Dot1Q that uses a stack of two tags.

Each VLAN on a CE-to-PE link can be configured as a separate L2VPN connection (using either VC type 4 or VC type 5).

## How to Configure 802.1Q VLAN Interfaces

This section contains the following procedures:

### Configuring 802.1Q VLAN Subinterfaces

This task explains how to configure 802.1Q VLAN subinterfaces. To remove these subinterfaces, see the “Removing an 802.1Q VLAN Subinterface” section.

#### Procedure

---

**Step 1** **configure****Example:**

```
RP/0/RP0/CPU0:router# configure
```

Enters global configuration mode.

**Step 2** **interface {TenGigE | FortyGigE | HundredGigE | Bundle-Ether} interface-path-id.subinterface****Example:**

```
RP/0/RP0/CPU0:router(config)# interface TenGigE 0/0/0/4.10
```

Enters subinterface configuration mode and specifies the interface type, location, and subinterface number.

- Replace the *interface-path-id* argument with one of the following instances:
- Physical Ethernet interface instance, or with an Ethernet bundle instance. Naming notation is *rack/slot/module/port*, and a slash between values is required as part of the notation.
- Ethernet bundle instance. Range is from 1 through 65535.
- Replace the *subinterface* argument with the subinterface value. Range is from 0 through 2147483647.
- Naming notation is *interface-path-id.subinterface*, and a period between arguments is required as part of the notation.

**Step 3** **encapsulation dot1q****Example:**

```
RP/0/RP0/CPU0:router(config-subif)# encapsulation dot1q 100
```

Sets the Layer 2 encapsulation of an interface.

**Step 4** **ipv4 address ip-address mask****Example:**

```
RP/0/RP0/CPU0:router(config-subif)# ipv4 address 178.18.169.23/24
```

Assigns an IP address and subnet mask to the subinterface.

- Replace *ip-address* with the primary IPv4 address for an interface.
- Replace *mask* with the mask for the associated IP subnet. The network mask can be specified in either of two ways:
  - The network mask can be a four-part dotted decimal address. For example, 255.0.0.0 indicates that each bit equal to 1 means that the corresponding address bit belongs to the network address.
  - The network mask can be indicated as a slash (/) and number. For example, /8 indicates that the first 8 bits of the mask are ones, and the corresponding bits of the address are network address.

#### Step 5 **exit**

##### Example:

```
RP/0/RP0/CPU0:router(config-subif)# exit
```

(Optional) Exits the subinterface configuration mode.

- The **exit** command is not explicitly required.

#### Step 6 Repeat Step 2 through Step 5 to define the rest of the VLAN subinterfaces.

—

#### Step 7 **end** or **commit**

##### Example:

```
RP/0/RP0/CPU0:router(config)# end
```

or

```
RP/0/RP0/CPU0:router(config)# commit
```

Saves configuration changes.

- When you issue the **end** command, the system prompts you to commit changes:

```
Uncommitted changes found, commit them before exiting(yes/no/cancel)?
[cancel]:
```

- Entering **yes** saves configuration changes to the running configuration file, exits the configuration session, and returns the router to EXEC mode.
  - Entering **no** exits the configuration session and returns the router to EXEC mode without committing the configuration changes.
  - Entering **cancel** leaves the router in the current configuration session without exiting or committing the configuration changes.
- Use the **commit** command to save the configuration changes to the running configuration file and remain within the configuration session.



**Step 8** `show ethernet trunk bundle-ether instance`**Example:**

```
RP/0/RP0/CPU0:router# show ethernet trunk bundle-ether 5
```

(Optional) Displays the interface configuration.

The Ethernet bundle instance range is from 1 through 65535.

## Verification

This example shows how to verify the configuration of Ethernet interfaces :

```
# show ethernet trunk be 1020 Wed May 17 16:43:32.804 EDT
```

| Trunk<br>Interface | St Ly | MTU  | Subs | Sub types |    | Sub states |      |         |
|--------------------|-------|------|------|-----------|----|------------|------|---------|
|                    |       |      |      | L2        | L3 | Up         | Down | Ad-Down |
| BE1020             | Up L3 | 9100 | 3    | 3         | 0  | 3          | 0    | 0       |
| Summary            |       |      | 3    | 3         | 0  | 3          | 0    | 0       |

## Configuring an Attachment Circuit on a VLAN

Use the following procedure to configure an attachment circuit on a VLAN.

**Procedure****Step 1** `configure`**Example:**

```
RP/0//CPU0:router# configure
```

Enters global configuration mode.

**Step 2** `interface [GigabitEthernet | TenGigE | Bundle-Ether | FortyGigE] interface-path id.subinterface l2transport`**Example:**

```
RP/0//CPU0:router(config)# interface TenGigE 0/0/0/1.1 l2transport
```

Enters subinterface configuration and specifies the interface type, location, and subinterface number.

- Replace the *interface-path-id* argument with one of the following instances:
- Physical Ethernet interface instance, or with an Ethernet bundle instance. Naming notation is *rack/slot/module/port*, and a slash between values is required as part of the notation.
- Ethernet bundle instance. Range is from 1 through 65535.
- Replace the *subinterface* argument with the subinterface value. Range is from 0 through 4095.

- Naming notation is *instance.subinterface*, and a period between arguments is required as part of the notation.
- You must include the **l2transport** keyword in the command string; otherwise, the configuration creates a Layer 3 subinterface rather than an AC.

### Step 3 encapsulation dot1q 100

#### Example:

```
RP/0//CPU0:router (config-subif)# encapsulation dot1q 100
```

Sets the Layer 2 encapsulation of an interface.

**Note** The **dot1q vlan** command is replaced by the **encapsulation dot1q** command. It is still available for backward-compatibility, but only for Layer 3 interfaces.

### Step 4 end or commit

#### Example:

```
RP/0//CPU0:router (config-if-12)# end
```

or

```
RP/0//CPU0:router (config-if-12)# commit
```

Saves configuration changes.

- When you issue the **end** command, the system prompts you to commit changes:

```
Uncommitted changes found, commit them before exiting(yes/no/cancel)?
[cancel]:
```

- Entering **yes** saves configuration changes to the running configuration file, exits the configuration session, and returns the router to EXEC mode.
  - Entering **no** exits the configuration session and returns the router to EXEC mode without committing the configuration changes.
  - Entering **cancel** leaves the router in the current configuration session without exiting or committing the configuration changes.
- Use the **commit** command to save the configuration changes to the running configuration file and remain within the configuration session.

### Step 5 show interfaces [GigabitEthernet |FortyGigE|Bundle-Ether | TenGigE] interface-path-id.subinterface

#### Example:

```
RP/0//CPU0:router# show interfaces TenGigE 0/0/0/3.1
```

(Optional) Displays statistics for interfaces on the router.

## Removing an 802.1Q VLAN Subinterface

This task explains how to remove 802.1Q VLAN subinterfaces that have been previously configured using the Configuring 802.1Q VLAN subinterfaces section in this module.

### Procedure

#### Step 1

**configure**

**Example:**

```
RP/0/RP0/CPU0:router# configure
```

Enters global configuration mode.

#### Step 2

**no interface** {**TenGigE** | **FortyGigE** | **HundredGigE** | **Bundle-Ether**} *interface-path-id.subinterface*

**Example:**

```
RP/0/RP0/CPU0:router(config)# no interface TenGigE 0/0/0/4.10
```

Removes the subinterface, which also automatically deletes all the configuration applied to the subinterface.

- Replace the *instance* argument with one of the following instances:
  - Physical Ethernet interface instance, or with an Ethernet bundle instance. Naming notation is *rack/slot/module/port*, and a slash between values is required as part of the notation.
  - Ethernet bundle instance. Range is from 1 through 65535.
- Replace the *subinterface* argument with the subinterface value. Range is from 0 through 2147483647.

Naming notation is *instance.subinterface*, and a period between arguments is required as part of the notation.

#### Step 3

Repeat Step 2 to remove other VLAN subinterfaces.

#### Step 4

**end** or **commit**

**Example:**

```
RP/0/RP0/CPU0:router(config)# end
```

or

```
RP/0/RP0/CPU0:router(config)# commit
```

Saves configuration changes.

- When you issue the **end** command, the system prompts you to commit changes:

```
Uncommitted changes found, commit them before exiting(yes/no/cancel)?  
[cancel]:
```

- Entering **yes** saves configuration changes to the running configuration file, exits the configuration session, and returns the router to EXEC mode.

- Entering **no** exits the configuration session and returns the router to EXEC mode without committing the configuration changes.
  - Entering **cancel** leaves the router in the current configuration session without exiting or committing the configuration changes.
  - Use the **commit** command to save the configuration changes to the running configuration file and remain within the configuration session.
-



## CHAPTER 10

# Configuring GRE Tunnels

Generic Routing Encapsulation (GRE) is a tunneling protocol that provides a simple generic approach to transport packets of one protocol over another protocol by means of encapsulation. This module provides information about how to configure a GRE tunnel.

- [Configuring GRE Tunnels, on page 203](#)
- [Configuring GRE Tunnels, on page 203](#)
- [IP-in-IP Decapsulation, on page 204](#)
- [Single Pass GRE Encapsulation Allowing Line Rate Encapsulation, on page 207](#)

## Configuring GRE Tunnels

Generic Routing Encapsulation (GRE) is a tunneling protocol that provides a simple generic approach to transport packets of one protocol over another protocol by means of encapsulation. This module provides information about how to configure a GRE tunnel.

## Configuring GRE Tunnels

Tunneling provides a mechanism to transport packets of one protocol within another protocol. Generic Routing Encapsulation (GRE) is a tunneling protocol that provides a simple generic approach to transport packets of one protocol over another protocol with encapsulation. GRE encapsulates a payload, that is, an inner packet that needs to be delivered to a destination network inside an outer IP packet. The GRE tunnel behave as virtual point-to-point link that have two endpoints identified by the tunnel source and tunnel destination address. The tunnel endpoints send payloads through GRE tunnels by routing encapsulated packets through intervening IP networks. Other IP routers along the way do not parse the payload (the inner packet); they only parse the outer IP packet as they forward it towards the GRE tunnel endpoint. Upon reaching the tunnel endpoint, GRE encapsulation is removed and the payload is forwarded to the packet's ultimate destination.

### Guidelines and Restrictions for Configuring GRE Tunnels

The following restrictions apply while configuring GRE tunnels:

- The router supports 1000 GRE tunnels without statistics, and 500 GRE tunnels with statistics on the router.
- Only up to 16 unique source IP addresses are supported for the tunnel source.

- 2-pass to Single-pass migration, which means converting the same GRE tunnel, is not possible in a single configuration step. You must first delete the 2-pass tunnel and then add the Single-pass tunnel.
- Configurable MTU is not supported on Single-pass GRE interface, but supported on 2-pass GRE interface.
- To use the outer IPv4 GRE header for IP tunnel decapsulation in the hashing algorithm for ECMP and bundle member selection, use the `hw-module profile load-balance algorithm` command.

### Configuration Example

Configuring a GRE tunnel involves creating a tunnel interface and defining the tunnel source and destination. This example shows how to configure a GRE tunnel between Router1 and Router2. You need to configure tunnel interfaces on both the routers. Tunnel source IP address on Router1 will be configured as the tunnel destination IP address on Router2. Tunnel destination IP address on Router1 will be configured as the tunnel source IP address on Router2. In this example, OSPF is used as the routing protocol between the two routers. You can also configure BGP or IS-IS as the routing protocol.

```
RP/0/RP0/CPU0:Router1# configure
RP/0/RP0/CPU0:Router1(config)# interface tunnel-ip 30
RP/0/RP0/CPU0:Router1(config-if)# tunnel mode gre ipv4
RP/0/RP0/CPU0:Router1(config-if)# ipv4 address 10.1.1.1 255.255.255.0
RP/0/RP0/CPU0:Router1(config-if)# tunnel source 192.168.1.1
RP/0/RP0/CPU0:Router1(config-if)# tunnel destination 192.168.2.1
RP/0/RP0/CPU0:Router1(config-if)# exit
RP/0/RP0/CPU0:Router1(config)# interface Loopback 0
RP/0/RP0/CPU0:Router1(config-if)# ipv4 address 10.10.10.1
RP/0/RP0/CPU0:Router1(config-if)# exit
RP/0/RP0/CPU0:Router1(config)# router ospf 1
RP/0/RP0/CPU0:Router1(config-ospf)# router-id 192.168.4.1
RP/0/RP0/CPU0:Router1(config-ospf)# area 0
RP/0/RP0/CPU0:Router1(config-ospf-ar)# interface tunnel-ip 30
RP/0/RP0/CPU0:Router1(config-ospf-ar)# interface Loopback 0
RP/0/RP0/CPU0:Router1(config-ospf-ar)# commit

RP/0/RP0/CPU0:Router2# configure
RP/0/RP0/CPU0:Router2(config)# interface tunnel-ip 30
RP/0/RP0/CPU0:Router2(config-if)# tunnel mode gre ipv4
RP/0/RP0/CPU0:Router2(config-if)# ipv4 address 10.1.1.2 255.255.255.0
RP/0/RP0/CPU0:Router2(config-if)# tunnel source 192.168.2.1
RP/0/RP0/CPU0:Router2(config-if)# tunnel destination 192.168.1.1
RP/0/RP0/CPU0:Router2(config-if)# exit
RP/0/RP0/CPU0:Router2(config)# interface Loopback 0
RP/0/RP0/CPU0:Router2(config-if)# ipv4 address 2.2.2.2
RP/0/RP0/CPU0:Router2(config)# router ospf 1
RP/0/RP0/CPU0:Router2(config-ospf)# router-id 192.168.3.1
RP/0/RP0/CPU0:Router2(config-ospf)# area 0
RP/0/RP0/CPU0:Router2(config-ospf-ar)# interface tunnel-ip 30
RP/0/RP0/CPU0:Router2(config-ospf-ar)# interface Loopback 0
RP/0/RP0/CPU0:Router2(config-ospf-ar)# commit
```

## IP-in-IP Decapsulation

Encapsulation of datagrams in a network is done for multiple reasons, such as when a source server wants to influence the route that a packet takes to reach the destination host. The source server is also known as the encapsulation server.

IP-in-IP encapsulation involves the insertion of an outer IP header over the existing IP header. The source and destination address in the outer IP header point to the endpoints of the IP-in-IP tunnel. The stack of IP

headers is used to direct the packet over a predetermined path to the destination, provided the network administrator knows the loopback addresses of the routers transporting the packet. This tunneling mechanism can be used for determining availability and latency for most network architectures. It is to be noted that the entire path from source to the destination does not have to be included in the headers, but a segment of the network can be chosen for directing the packets.

The following illustration describes the basic IP-in-IP encapsulation and decapsulation model.

**Figure 14: Basic Encapsulation and Decapsulation with an IP-in-IP**

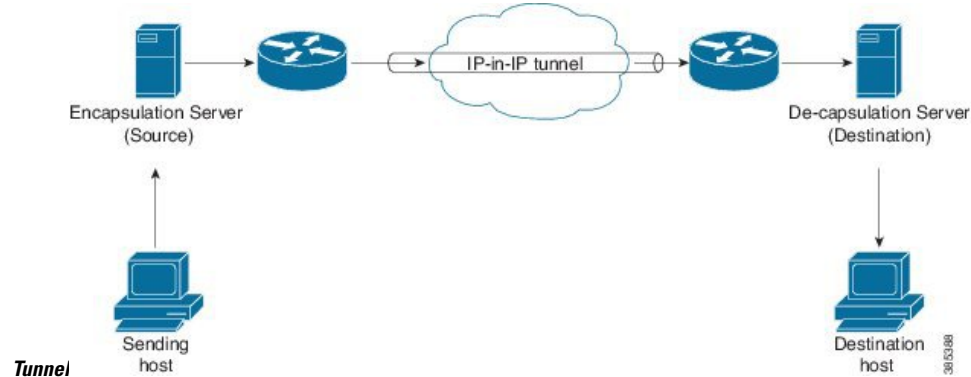

**Use Case: Configure IP-in-IP Decapsulation**

The following topology describes a use case where IP-in-IP encapsulation and decapsulation are used for different segments of the network from source to destination. The IP-in-IP tunnel consists of multiple routers that are used to decapsulate and direct the packet through the data center fabric network.

**Figure 15: IP-in-IP Decapsulation Through a Data Center Network**

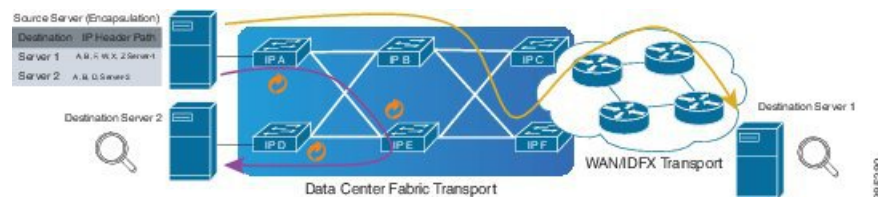

The following illustration shows how the stacked IPv4 headers are de-capsulated as they traverse through the de-capsulating routers.

**Figure 16: IP Header Decapsulation**

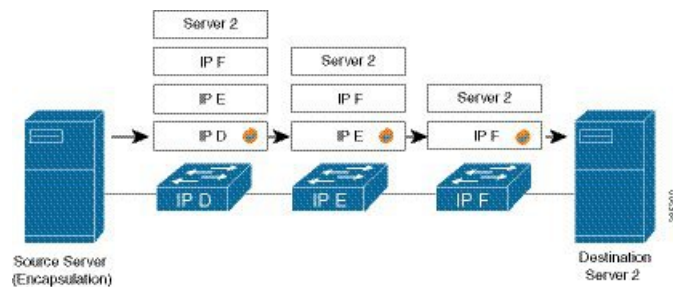

### Stacked IP Header in an Encapsulated Packet

The encapsulated packet has an outer IPv4 header that is stacked over the original IPv4 header, as shown in the following illustration.

#### Encapsulated Packet

|                       |                    |
|-----------------------|--------------------|
| [-] Frame             |                    |
| [-] EthernetII        |                    |
| Preamble (hex)        | fb555555555555d5   |
| Destination MAC       | 62:19:88:64:E2:68  |
| Source MAC            | 00:10:94:00:00:02  |
| EtherType (hex)       | <auto> Internet IP |
| [-] IPv4 Header       |                    |
| Version (int)         | <auto> 4           |
| Header length (int)   | <auto> 5           |
| ToS/DiffServ          | tos (0x00)         |
| Total length (int)    | <auto> calculated  |
| Identification (int)  | 0                  |
| [-] Control Flags     |                    |
| Reserved (bit)        | 0                  |
| DF Bit (bit)          | 0                  |
| MF Bit (bit)          | 0                  |
| Fragment Offset (int) | 0                  |
| Time to live (int)    | 255                |
| Protocol (int)        | <auto> IP          |
| Checksum (int)        | <auto> 33492       |
| Source                | 192.xx.xx.xx       |
| Destination           | 127.0.0.1          |
| Header Options        |                    |
| Gateway               | 192.0.2.10         |
| [-] IPv4 Header       |                    |
| Version (int)         | <auto> 4           |
| Header length (int)   | <auto> 5           |
| ToS/DiffServ          | tos (0x00)         |
| Total length (int)    | <auto> calculated  |
| Identification (int)  | 0                  |
| [-] Control Flags     |                    |
| Reserved (bit)        | 0                  |

385413

#### Configuration

You can use the following sample configuration on the routers to decapsulate the packet as it traverses the IP-in-IP tunnel:



```
RP/0/RP0/CPU0:router(config)# interface tunnel-ip 10
RP/0/RP0/CPU0:router(config-if)# tunnel mode ipv4 decap
RP/0/RP0/CPU0:router(config-if)# tunnel source loopback 0
RP/0/RP0/CPU0:router(config-if)# tunnel destination 10.10.1.2/32
```

- **tunnel-ip**: configures an IP-in-IP tunnel interface.
- **ipv4 unnumbered loopback address**: enables ipv4 packet processing without an explicit address, except for loopback address.
- **tunnel mode ipv4 decap**: enables IP-in-IP decapsulation.
- **tunnel source**: indicates the source address for the IP-in-IP decap tunnel w.r.t the router interface.
- **tunnel destination**: indicates the destination address for the IP-in-IP decap tunnel w.r.t the router interface.

### Running Configuration

```
RP/0/RP0/CPU0:router# show running-config interface tunnel-ip 10
...
interface tunnel-ip 10
tunnel mode ipv4 decap
tunnel source Loopback 0
tunnel destination 10.10.1.2/32
```

This completes the configuration of IP-in-IP decapsulation.

## Single Pass GRE Encapsulation Allowing Line Rate Encapsulation

Single Pass GRE Encapsulation Allowing Line Rate Encapsulation feature, also known as Prefix-based GRE Tunnel Destination for Load Balancing feature, enables line rate GRE encapsulation traffic and enables flow entropy. Data-plane forwarding performance supports full line rate, which is adjusted to consider added encapsulation. GRE tunnel goes down if the destination is not available in RIB. Routing over GRE Single-pass tunnel is not supported in Release 6.3.2, so the traffic that is eligible for GRE encapsulation is identified using an ACL filter that is based on GRE encapsulation. GRE tunnel destination address is an anycast address. All of the GRE encapsulation must be assigned based upon either an ACL or a policy-map, or both. Destinations may be individual addresses or /28 prefixes.

## Configure GRE Single-Pass Entropy

Perform the following tasks to configure the GRE Single-Pass Entropy feature:

- GRE Single-pass
- GRE Entropy(ECMP/UCMP)

```
/* GRE Single-Pass */

Router# configure
Router(config)# interface tunnel-ip30016
Router(config-if)# ipv4 address 216.1.1.1 255.255.255.0
Router(config-if)# ipv6 address 216:1:1::1/64
Router(config-if)# ipv6 enable
```

```

Router(config-if)# tunnel mode gre ipv4 encap
Router(config-if)# tunnel source Loopback22
Router(config-if)# tunnel destination 170.170.170.22
Router(config-if)# commit
Router(config-if)# exit

/* GRE Entropy (ECMP/UCMP) */

ECMP (ISIS)

Router# configure
Router(config)# router isis core
Router(config)# apply-group ISIS-INTERFACE
Router(config-isis)# is-type level-2-only
Router(config-isis)# net 49.1111.0000.0000.002.00
Router(config-isis)# nsr
Router(config-isis)# log adjacency changes
Router(config-isis)# address-family ipv4 unicast
Router(config-isis-af)# metric-style wide
Router(config-isis-af)# metric 2
Router(config-isis-af)# mpls traffic-eng level-2-only
Router(config-isis-af)# mpls traffic-eng router-id Loopback0
Router(config-isis-af)# maximum-paths 5
Router(config-isis-af)# commit
!

/* UCMP (ISIS) */

Router# configure
Router(config)# router isis core
Router(config)# apply-group ISIS-INTERFACE
Router(config-isis)# is-type level-2-only
Router(config-isis)# net 49.1111.0000.0000.002.00
Router(config-isis)# nsr
Router(config-isis)# log adjacency changes
Router(config-isis)# address-family ipv4 unicast
Router(config-isis-af)# metric-style wide
Router(config-isis-af)# ucmp
Router(config-isis-af)# metric 2
Router(config-isis-af)# mpls traffic-eng level-2-only
Router(config-isis-af)# mpls traffic-eng router-id Loopback0
Router(config-isis-af)# maximum-paths 5
Router(config-isis-af)# redistribute connected
Router(config-isis-af)# commit
Router(config-isis-af)# exit
!

Router# configure
Router(config)# interface Bundle-Ether3
Router(config-if)# apply-group ISIS-INTERFACE
Router(config-if)# address-family ipv4 unicast
Router(config-af)# metric 20
Router(config-af)# commit
Router(config-af)# exit
!

Router# configure
Router(config)# interface Bundle-Ether111
Router(config-if)# apply-group ISIS-INTERFACE
Router(config-if)# address-family ipv4 unicast
Router(config-af)# metric 15
Router(config-af)# commit
Router(config-af)# exit

```

```

!

/* ECMP (OSPF) */

Router# configure
Router(config)# router ospf 3
Router(config-ospf)# nsr
Router(config-ospf)# maximum paths 5
Router(config-ospf)# address-family ipv4 unicast
Router(config-ospf-af)# area 0
Router(config-ospf-af-ar)# interface Bundle-Ether3
Router(config-ospf-af-ar-if)# exit
!
Router(config-ospf-af-ar)# interface Bundle-Ether4
Router(config-ospf-af-ar-if)# exit
!
Router(config-ospf-af-ar)# interface Bundle-Ether111
Router(config-ospf-af-ar-if)# exit
!
Router(config-ospf-af-ar)# interface Bundle-Ether112
Router(config-ospf-af-ar-if)# exit
!
Router(config-ospf-af-ar)# interface Loopback23
Router(config-ospf-af-ar-if)# exit
!
Router(config-ospf-af-ar)# interface HundredGigE0/7/0/23interface HundredGigE0/0/1/0interface
HundredGigE 0/9/0/0
Router(config-ospf-af-ar-if)# commit
Router(config-ospf-af-ar-if)# exit

/* UCMP (OSPF) */

Router# configure
Router(config)# router ospf 3
Router(config-ospf)# nsr
Router(config-ospf)# maximum paths 5
Router(config-ospf)# ucmp
Router(config-ospf)# address-family ipv4 unicast
Router(config-ospf-af)# area 0
Router(config-ospf-af-ar)# interface Bundle-Ether3 cost 2
Router(config-ospf-af-ar-if)# exit
!
Router(config-ospf-af-ar)# interface Bundle-Ether4
Router(config-ospf-af-ar-if)# exit
!
Router(config-ospf-af-ar)# interface Bundle-Ether111
Router(config-ospf-af-ar-if)# exit
!
Router(config-ospf-af-ar)# interface Bundle-Ether112 cost 2
Router(config-ospf-af-ar-if)# exit
!
Router(config-ospf-af-ar)# interface Loopback23
Router(config-ospf-af-ar-if)# exit
!
Router(config-ospf-af-ar)# interface HundredGigE0/7/0/23interface HundredGigE0/0/1/0interface
HundredGigE 0/9/0/0
Router(config-ospf-af-ar-if)# commit
Router(config-ospf-af-ar-if)# exit

/* ECMP (BGP) */
Router# configure

```

```

Router(config)# router bgp 800
Router(config-bgp)# bgp bestpath as-path multipath-relax
Router(config-bgp)# address-family ipv4 unicast
Router(config-bgp-af)# network 170.170.170.3/32
Router(config-bgp-af)# network 170.170.170.10/32
Router(config-bgp-af)# network 170.170.170.11/32
Router(config-bgp-af)# network 170.170.172.3/32
Router(config-bgp-af)# network 180.180.180.9/32
Router(config-bgp-af)# network 180.180.180.20/32
Router(config-bgp-af)# network 180.180.180.21/32
Router(config-bgp-af)# network 180.180.180.24/32
Router(config-bgp-af)# network 180.180.180.25/32
Router(config-bgp-af)# commit
!
Router# configure
Router(config)# router bgp 800
Router(config-bgp)# neighbor 4.1.1.2
Router(config-bgp-nbr)# remote-as 300
Router(config-bgp-nbr)# address-family ipv4 unicast
Router(config-bgp-nbr-af)# address-family ipv4 unicast
Router(config-bgp-nbr-af)# route-policy pass-all in
Router(config-bgp-nbr-af)# route-policy pass-all out
Router(config-bgp-nbr-af)# commit
!

/* UCMP (BGP) */

Router# configure
Router(config)# router bgp 800
Router(config-bgp)# bgp bestpath as-path multipath-relax
Router(config-bgp)# address-family ipv4 unicast
Router(config-bgp-af)# maximum-paths ebgp 5
Router(config-bgp-af)# network 180.180.180.9/32
Router(config-bgp-af)# network 180.180.180.20/32
Router(config-bgp-af)# network 180.180.180.21/32
Router(config-bgp-af)# network 180.180.180.24/32
Router(config-bgp-af)# network 180.180.180.25/32
Router(config-bgp-af)# commit
!
Router# configure
Router(config)# router bgp 800
Router(config-bgp)# neighbor 7.1.5.2
Router(config-bgp-nbr)# remote-as 4000
Router(config-bgp-nbr)# address-family ipv4 unicast
Router(config-bgp-nbr-af)# address-family ipv4 unicast
Router(config-bgp-nbr-af)# route-policy TRANSITO_IN in
Router(config-bgp-nbr-af)# route-policy pass-all out
Router(config-bgp-nbr-af)# next-hop-self
Router(config-bgp-nbr-af)# commit
!
Router# configure
Router(config)# router bgp 800
Router(config-bgp)# 4.1.111.2
Router(config-bgp-nbr)# remote-as 4000
Router(config-bgp-nbr)# address-family ipv4 unicast
Router(config-bgp-nbr-af)# address-family ipv4 unicast
Router(config-bgp-nbr-af)# route-policy TRANSITO_IN in
Router(config-bgp-nbr-af)# route-policy pass-all out
Router(config-bgp-nbr-af)# next-hop-self
Router(config-bgp-nbr-af)# commit
!

```

```

/* Configure rouverte policy */

Router# configure
Router(config)# route-policy TRANSITO_IN
Router(config-rpl)# if destination in (170.170.170.24/32) then
Router(config-rpl-if)# set extcommunity bandwidth (2906:1250000)
Router(config-rpl-if)# else
Router(config-rpl-else)# pass
Router(config-rpl-else)# endif
Router(config-rpl)# end-policy
!

Router# configure
Router(config)# route-policy TRANSIT1_IN
Router(config-rpl)# if destination in (170.170.170.24/32) then
Router(config-rpl-if)# set extcommunity bandwidth (2906:37500000)
Router(config-rpl-if)# else
Router(config-rpl-else)# pass
Router(config-rpl-else)# endif
Router(config-rpl)# end-policy

```

## Running Configuration

```

/* GRE Single-Pass configuration */

interface tunnel-ip30016
ipv4 address 216.1.1.1 255.255.255.0
ipv6 address 216:1:1::1/64
ipv6 enable
tunnel mode gre ipv4 encap
tunnel source Loopback22
tunnel destination 170.170.170.22
!

/* GRE Entropy(ECMP/UCMP) */

ECMP (ISIS)

router isis core
apply-group ISIS-INTERFACE
is-type level-2-only
net 49.1111.0000.0000.002.00
nsr
log adjacency changes
address-family ipv4 unicast
metric-style wide
metric 2
mpls traffic-eng level-2-only
mpls traffic-eng router-id Loopback0
maximum-paths 5
!

/* UCMP(ISIS) */

router isis core
apply-group ISIS-INTERFACE
is-type level-2-only
net 49.1111.0000.0000.002.00
nsr
log adjacency changes

```

```

address-family ipv4 unicast
metric-style wide
ucmp
metric 2
mpls traffic-eng level-2-only
mpls traffic-eng router-id Loopback0
maximum-paths 5
redistribute connected
!
interface Bundle-Ether3
apply-group ISIS-INTERFACE
address-family ipv4 unicast
metric 20
!

interface Bundle-Ether111
apply-group ISIS-INTERFACE
address-family ipv4 unicast
metric 15
!

!

/* ECMP(OSPF) */

router ospf 3
nsr
maximum paths 5
address-family ipv4 unicast
area 0
interface Bundle-Ether3
!
interface Bundle-Ether4
!
interface Bundle-Ether111
!
interface Bundle-Ether112
!
interface Loopback23
!
interface HundredGigE0/7/0/23HundredGigE0/0/1/0hundredGigE0/9/0/0
!
!
!
/* UCMP (OSPF) */

router ospf 3
nsr
maximum paths 5
ucmp
address-family ipv4 unicast
area 0
interface Bundle-Ether3
cost 2
!
interface Bundle-Ether4
!
interface Bundle-Ether111
!
interface Bundle-Ether112
cost 2
!
interface Loopback23
!

```

```

interface HundredGigE0/7/0/23HundredGigE0/0/1/0hundredGigE0/9/0/0
!
!
!

/* ECMP(BGP)*/

router bgp 800
  bgp bestpath as-path multipath-relax
  address-family ipv4 unicast
  maximum-paths ebgp 5
  network 170.170.170.3/32
  network 170.170.170.10/32
  network 170.170.170.11/32
  network 170.170.172.3/32
  network 180.180.180.9/32
  network 180.180.180.20/32
  network 180.180.180.21/32
  network 180.180.180.24/32
  network 180.180.180.25/32
  !
  neighbor 4.1.1.2
  remote-as 300
  address-family ipv4 unicast
  route-policy PASS-ALL in
  route-policy PASS-ALL out
  next-hop-self
  !
  !

/* UCMP(BGP) */

router bgp 800
  bgp bestpath as-path multipath-relax
  address-family ipv4 unicast
  maximum-paths ebgp 5
  network 180.180.180.9/32
  network 180.180.180.20/32
  network 180.180.180.21/32
  network 180.180.180.24/32
  network 180.180.180.25/32
  !

  neighbor 7.1.5.2
  remote-as 4000
  address-family ipv4 unicast
  route-policy TRANSIT0_IN in
  route-policy PASS-ALL out
  next-hop-self
  !
  !
  neighbor 4.1.111.2
  remote-as 4000
  address-family ipv4 unicast
  route-policy TRANSIT1_IN in
  route-policy PASS-ALL out
  next-hop-self
  !
  !

/* Configure rounte policy */

route-policy TRANSIT0_IN
  if destination in (170.170.170.24/32) then

```

```

set extcommunity bandwidth (2906:1250000)
else
pass
endif
end-policy
!
route-policy TRANSIT1_IN
if destination in (170.170.170.24/32) then
set extcommunity bandwidth (2906:37500000)
else
pass
endif
end-policy
!

```

## Verification

Verify if the tunnel mode GRE encapsulation is enabled.

```
Router# show int tunnel-ip2
```

```

interface tunnel-ip2
  ipv4 address 80.80.82.1 255.255.255.0
  ipv6 address 2000:80:80:82::1/64
  load-interval 30
  tunnel mode gre ipv4 encap
  tunnel source Loopback4
  tunnel destination 11.4.2.2
!

```

```

RP/0/RP0/CPU0:PE1_5516#show int tunnel-ip2
tunnel-ip2 is up, line protocol is up
  Interface state transitions: 1
  Hardware is Tunnel
  Internet address is 80.80.82.1/24
  MTU 1500 bytes, BW 100 Kbit (Max: 100 Kbit)
    reliability 255/255, txload 0/255, rxload 0/255
  Encapsulation TUNNEL_IP, loopback not set,
  Last link flapped 1d18h
  Tunnel TOS 0
  Tunnel mode GRE IPV4, encap
  Keepalive is disabled.
  Tunnel source 11.11.12.1 (Loopback4), destination 11.4.2.2/32
  Tunnel TTL 255
  Last input never, output never
  Last clearing of "show interface" counters 14:53:37
  30 second input rate 0 bits/sec, 0 packets/sec
  30 second output rate 0 bits/sec, 0 packets/sec
    0 packets input, 0 bytes, 0 total input drops
    0 drops for unrecognized upper-level protocol
    Received 0 broadcast packets, 0 multicast packets
    0 packets output, 0 bytes, 0 total output drops
    Output 0 broadcast packets, 0 multicast packets

```

Verify if the recycle of the packets are not done under Recycle VoQ: 48:

```
Router# show tunnel ip ea summary location 0/7/CPU00/RP0/CPU0
```

```

Number of tunnel updates to retry: 0
Number of tunnel updates retried: 0
Number of tunnel retries failed: 0
Platform:
Recycle VoQ: 48

```



```

                ReceivedBytes  ReceivedPackets  ReceivedKbps
                DroppedBytes  DroppedPackets  DroppedKbps
NPU 0:0        0                0                0
                0                0                0
1              0                0                0
                0                0                0
2              0                0                0
                0                0                0
3              0                0                0
                0                0                0
...
NPU 1:0        0                0                0
                0                0                0
1              0                0                0
                0                0                0
2              0                0                0
                0                0                0
3              0                0                0
                0                0                0

NPU 2:0        0                0                0
                0                0                0
1              0                0                0
                0                0                0
2              0                0                0
                0                0                0
3              0                0                0
                0                0                0
    
```

Verify if the tunnel mode GRE encapsulation is enabled.

Router# **show interfaces tunnel-ip \* brief**

```

Thu Sep 7 00:04:39.125 PDT
Intf Intf LineP Encap MTU BW
Name  State  State  Type      (byte) (Kbps)
-----
ti30001 down    down    TUNNEL_IP 1500 100
ti30002 up      up      TUNNEL_IP 1500 100
    
```

Verify the tunnel endpoint route in RIB.

Router# **show route 10.1.1.1**

```

Routing entry for 10.0.0.0/8
Known via "static", distance 1, metric 0 (connected)
Installed Oct 2 15:50:56.755 for 00:39:24
Routing Descriptor Blocks
directly connected, via tunnel-ip109
Route metric is 0, Wt is 1
No advertising protos.
    
```

Verify if the tunnel mode GRE encapsulation is enabled.

Router# **show tunnel ip ea database tunnel-ip 109 location 0/7/CPU00/RP0/CPU0**

```

----- node0_0_CPU0 -----
tunnel ifhandle 0x80022cc
tunnel source 161.115.1.2
tunnel destination 162.1.1.1/32
tunnel transport vrf table id 0xe0000000
tunnel mode gre ipv4, encap
tunnel bandwidth 100 kbps
tunnel platform id 0x0
tunnel flags 0x40003400
    
```

```

IntfStateUp
BcStateUp
Ipv4Caps
Encap
tunnel mtu 1500
tunnel tos 0
tunnel ttl 255
tunnel adjacency flags 0x1
tunnel o/p interface handle 0x0
tunnel key 0x0, entropy length 0 (mask 0xffffffff)
tunnel QT next 0x0
tunnel platform data (nil)
Platform:
Handle: (nil)
Decap ID: 0
Decap RIF: 0
Decap Recycle Encap ID: 0x00000000
Encap RIF: 0
Encap Recycle Encap ID: 0x00000000
Encap IPv4 Encap ID: 0x4001381b
Encap IPv6 Encap ID: 0x00000000
Encap MPLS Encap ID: 0x00000000
DecFEC DecRcyLIF DecStatsId EncRcyLIF

```

Verify if the QoS table is updated properly.

```

Router# show controllers npu stats voq base 48 instance all location
0/0/CPU00/RP0/CPU0
Asic Instance = 0
VOQ Base = 48

```

|        | ReceivedPkts | ReceivedBytes | DroppedPkts | DroppedBytes |
|--------|--------------|---------------|-------------|--------------|
| COS0 = | 0            | 0             | 0           | 0            |
| COS1 = | 0            | 0             | 0           | 0            |
| COS2 = | 0            | 0             | 0           | 0            |
| COS3 = | 0            | 0             | 0           | 0            |

```

Asic Instance = 1
VOQ Base = 48

```

|        | ReceivedPkts | ReceivedBytes | DroppedPkts | DroppedBytes |
|--------|--------------|---------------|-------------|--------------|
| COS0 = | 0            | 0             | 0           | 0            |
| COS1 = | 0            | 0             | 0           | 0            |
| COS2 = | 0            | 0             | 0           | 0            |
| COS3 = | 0            | 0             | 0           | 0            |

```

Asic Instance = 2
VOQ Base = 48

```

|        | ReceivedPkts | ReceivedBytes | DroppedPkts | DroppedBytes |
|--------|--------------|---------------|-------------|--------------|
| COS0 = | 0            | 0             | 0           | 0            |
| COS1 = | 0            | 0             | 0           | 0            |
| COS2 = | 0            | 0             | 0           | 0            |
| COS3 = | 0            | 0             | 0           | 0            |



## CHAPTER 11

# Using YANG Data Models

---

Cisco IOS XR supports a programmatic way of configuring and collecting operational data of a network device using YANG data models. Although configurations using CLIs are easier and human-readable, automating the configuration using model-driven programmability results in scalability.

The data models are available in the release image, and are also published in the [Github](#) repository. Navigate to the release folder of interest to view the list of supported data models and their definitions. Each data model defines a complete and cohesive model, or augments an existing data model with additional XPath. To view a comprehensive list of the data models supported in a release, navigate to the **Available-Content.md** file in the repository.

You can also view the data model definitions using the [YANG Data Models Navigator](#) tool. This GUI-based and easy-to-use tool helps you explore the nuances of the data model and view the dependencies between various containers in the model. You can view the list of models supported across Cisco IOS XR releases and platforms, locate a specific model, view the containers and their respective lists, leaves, and leaf lists presented visually in a tree structure. This visual tree form helps you get insights into nodes that can help you automate your network.

To get started with using the data models, see the *Programmability Configuration Guide*.

