



MPLS Configuration Guide for Cisco NCS 560 Series Routers, Cisco IOS XR Release 7.4.x

First Published: 2021-05-06

Americas Headquarters

Cisco Systems, Inc.
170 West Tasman Drive
San Jose, CA 95134-1706
USA
<http://www.cisco.com>
Tel: 408 526-4000
800 553-NETS (6387)
Fax: 408 527-0883

THE SPECIFICATIONS AND INFORMATION REGARDING THE PRODUCTS IN THIS MANUAL ARE SUBJECT TO CHANGE WITHOUT NOTICE. ALL STATEMENTS, INFORMATION, AND RECOMMENDATIONS IN THIS MANUAL ARE BELIEVED TO BE ACCURATE BUT ARE PRESENTED WITHOUT WARRANTY OF ANY KIND, EXPRESS OR IMPLIED. USERS MUST TAKE FULL RESPONSIBILITY FOR THEIR APPLICATION OF ANY PRODUCTS.

THE SOFTWARE LICENSE AND LIMITED WARRANTY FOR THE ACCOMPANYING PRODUCT ARE SET FORTH IN THE INFORMATION PACKET THAT SHIPPED WITH THE PRODUCT AND ARE INCORPORATED HEREIN BY THIS REFERENCE. IF YOU ARE UNABLE TO LOCATE THE SOFTWARE LICENSE OR LIMITED WARRANTY, CONTACT YOUR CISCO REPRESENTATIVE FOR A COPY.

The Cisco implementation of TCP header compression is an adaptation of a program developed by the University of California, Berkeley (UCB) as part of UCB's public domain version of the UNIX operating system. All rights reserved. Copyright © 1981, Regents of the University of California.

NOTWITHSTANDING ANY OTHER WARRANTY HEREIN, ALL DOCUMENT FILES AND SOFTWARE OF THESE SUPPLIERS ARE PROVIDED "AS IS" WITH ALL FAULTS. CISCO AND THE ABOVE-NAMED SUPPLIERS DISCLAIM ALL WARRANTIES, EXPRESSED OR IMPLIED, INCLUDING, WITHOUT LIMITATION, THOSE OF MERCHANTABILITY, FITNESS FOR A PARTICULAR PURPOSE AND NON-INFRINGEMENT OR ARISING FROM A COURSE OF DEALING, USAGE, OR TRADE PRACTICE.

IN NO EVENT SHALL CISCO OR ITS SUPPLIERS BE LIABLE FOR ANY INDIRECT, SPECIAL, CONSEQUENTIAL, OR INCIDENTAL DAMAGES, INCLUDING, WITHOUT LIMITATION, LOST PROFITS OR LOSS OR DAMAGE TO DATA ARISING OUT OF THE USE OR INABILITY TO USE THIS MANUAL, EVEN IF CISCO OR ITS SUPPLIERS HAVE BEEN ADVISED OF THE POSSIBILITY OF SUCH DAMAGES.

Any Internet Protocol (IP) addresses and phone numbers used in this document are not intended to be actual addresses and phone numbers. Any examples, command display output, network topology diagrams, and other figures included in the document are shown for illustrative purposes only. Any use of actual IP addresses or phone numbers in illustrative content is unintentional and coincidental.

All printed copies and duplicate soft copies of this document are considered uncontrolled. See the current online version for the latest version.

Cisco has more than 200 offices worldwide. Addresses and phone numbers are listed on the Cisco website at www.cisco.com/go/offices.

Cisco and the Cisco logo are trademarks or registered trademarks of Cisco and/or its affiliates in the U.S. and other countries. To view a list of Cisco trademarks, go to this URL: <https://www.cisco.com/c/en/us/about/legal/trademarks.html>. Third-party trademarks mentioned are the property of their respective owners. The use of the word partner does not imply a partnership relationship between Cisco and any other company. (1721R)

© 2021 Cisco Systems, Inc. All rights reserved.



CONTENTS

CHAPTER 1

Implementing MPLS Label Distribution Protocol 1

| | |
|--|----|
| Prerequisites for Implementing MPLS Label Distribution Protocol | 1 |
| Restrictions for MPLS LDP | 2 |
| Overview of Label Distribution Protocol | 2 |
| Configuring Label Distribution Protocol | 2 |
| Configuring Label Distribution Protocol | 3 |
| Configuring Label Distribution Protocol Discovery Parameters | 3 |
| Label Distribution Protocol Discovery for Targeted Hellos | 4 |
| Label Advertisement Control | 4 |
| Configuring Local Label Allocation Control | 5 |
| Configuring Downstream on Demand | 6 |
| Configuring Explicit Null Label | 6 |
| Label Distribution Protocol Auto-configuration | 7 |
| Configuring Session Protection | 7 |
| Configuring Label Distribution Protocol- Interior Gateway Protocol (IGP) Synchronization | 7 |
| Configuring Label Distribution Protocol Graceful Restart | 8 |
| Configuring Label Distribution Protocol Nonstop Routing | 9 |
| MPLS Label Distribution Protocol : Details | 10 |
| Setting Up Label Switched Paths | 10 |
| Details of Label Distribution Protocol Graceful Restart | 12 |
| Details of Session Protection | 15 |
| Controlling State Advertisements In An mLDP-Only Setup | 15 |
| Use Cases For Controlling State Advertisements | 17 |
| Disable Prefix-LSPs On An L2VPN/PW tLDP Session | 17 |
| mLDP-Based MVPN | 19 |

| | | |
|------------------|---|-----------|
| CHAPTER 2 | MPLS Static Labeling | 23 |
| | Restrictions For MPLS | 24 |
| | Define Label Range and Enable MPLS Encapsulation | 24 |
| | Identify and Clear Label Discrepancy | 25 |
| | Configuring Static LSP Next Hop Resolve with Recursive Prefix | 27 |
| | Configuring MPLS Static over BVI | 27 |
| | MPLS Over Single-Pass GRE Tunnels | 28 |

| | | |
|------------------|---|-----------|
| CHAPTER 3 | Implementing MPLS Traffic Engineering | 33 |
| | Overview of MPLS-TE Features | 34 |
| | How MPLS-TE Works | 35 |
| | Configuring MPLS-TE | 36 |
| | Building MPLS-TE Topology | 36 |
| | Creating an MPLS-TE Tunnel | 37 |
| | Configuring Fast Reroute | 40 |
| | Configuring Auto-Tunnel Backup | 41 |
| | Configuring Next Hop Backup Tunnel | 42 |
| | Configuring SRLG Node Protection | 42 |
| | Configuring Pre-Standard DS-TE | 43 |
| | Configuring an IETF DS-TE Tunnel Using RDM | 44 |
| | Configuring an IETF DS-TE Tunnel Using MAM | 45 |
| | Configuring Flexible Name-Based Tunnel Constraints | 45 |
| | Configuring Automatic Bandwidth | 46 |
| | Configuring Auto-Tunnel Mesh | 47 |
| | Configuring an MPLS Traffic Engineering Interarea Tunneling | 48 |
| | Configure Policy-Based Tunnel Selection | 48 |
| | Configuring LDP over MPLS-TE | 50 |
| | Configuring MPLS-TE Path Protection | 51 |
| | MPLS-TE Features - Details | 53 |
| | Policy-Based Tunnel Selection | 56 |
| | UCMP Over MPLS-TE | 58 |
| | Configuring Performance Measurement | 62 |

| | | |
|------------------|--|-----------|
| CHAPTER 4 | Implementing RSVP for MPLS-TE | 65 |
| | Setting up MPLS LSP Using RSVP | 65 |
| | Overview of RSVP for MPLS-TE Features | 66 |
| | Configuring RSVP for MPLS-TE | 66 |
| | Configuring RSVP Message Authentication Globally | 66 |
| | Configuring RSVP Authentication for an Interface | 67 |
| | Configuring RSVP Authentication on a Neighbor | 68 |
| | Configuring Graceful Restart | 69 |
| | Configuring Refresh Reduction | 70 |
| | Configuring ACL Based Prefix Filtering | 71 |
| | Configuring RSVP Packet Dropping | 71 |
| | Enabling RSVP Traps | 72 |
| | RSVP for MPLS-TE Features- Details | 72 |
| <hr/> | | |
| CHAPTER 5 | Implementing MPLS OAM | 77 |
| | MPLS LSP Ping | 77 |
| | MPLS LSP Traceroute | 79 |
| <hr/> | | |
| CHAPTER 6 | Configuring Global Weighted SRLG Protection | 81 |
| <hr/> | | |
| CHAPTER 7 | Configuring Auto-bandwidth Bundle TE++ | 85 |
| <hr/> | | |
| CHAPTER 8 | Configuring Point to Multipoint Traffic Engineering | 89 |



CHAPTER 1

Implementing MPLS Label Distribution Protocol

MPLS (Multi Protocol Label Switching) is a forwarding mechanism based on label switching. In an MPLS network, data packets are assigned labels and packet-forwarding decisions are taken based on the contents of the label. To switch labeled packets across the MPLS network, predetermined paths are established for various source-destination pairs. These predetermined paths are known as Label Switched Paths (LSPs). To establish LSPs, MPLS signaling protocols are used. Label Distribution Protocol (LDP) is an MPLS signaling protocol used for establishing LSPs. This module provides information about how to configure MPLS LDP.

To allow hashing for the Label Edge Router (LER) and Label Switched Routers (LSRs) with MPLS traffic or algorithm to use the inner ethernet fields of the source MAC and destination MAC addresses, use the [hw-module profile load-balance algorithm](#) command with a suitable load-balancing profile.

- [Prerequisites for Implementing MPLS Label Distribution Protocol, on page 1](#)
- [Restrictions for MPLS LDP, on page 2](#)
- [Overview of Label Distribution Protocol, on page 2](#)
- [Configuring Label Distribution Protocol, on page 2](#)
- [MPLS Label Distribution Protocol : Details, on page 10](#)
- [Controlling State Advertisements In An mLDP-Only Setup, on page 15](#)
- [Use Cases For Controlling State Advertisements, on page 17](#)

Prerequisites for Implementing MPLS Label Distribution Protocol

The following are the prerequisites to implement MPLS LDP:

- You must be in a user group associated with a task group that includes the proper task IDs. The command reference guides include the task IDs required for each command. If you suspect user group assignment is preventing you from using a command, contact your AAA administrator for assistance.
- You must be running Cisco IOS XR software.
- You must install a composite mini-image and the MPLS package.
- You must activate IGP.
- We recommend to use a lower session holdtime bandwidth such as neighbors so that a session down occurs before an adjacency-down on a neighbor. Therefore, the following default values for the hello times are listed:
 - Holdtime is 15 seconds.

- Interval is 5 seconds.

For example, the LDP session holdtime can be configured as 30 seconds by using the **holdtime** command.

Restrictions for MPLS LDP

- LDP statistics is not displayed in **show mpls forwarding command** output.
- When paths of different technologies are resolved over ECMP, it results in *heterogeneous* ECMP, leading to severe network traffic issues. Don't use ECMP for any combination of the following technologies:
 - LDP.
 - BGP-LU, including services over BGP-LU loopback peering or recursive services at Level-3.
 - VPNv4.
 - 6PE and 6VPE.
 - EVPN.
 - Recursive static routing.

Overview of Label Distribution Protocol

In IP forwarding, when a packet arrives at a router the router looks at the destination address in the IP header, performs a route lookup, and then forwards the packet to the next hop. MPLS is a forwarding mechanism in which packets are forwarded based on labels. Label Distribution Protocols assign, distribute, and install the labels in an MPLS environment. It is the set of procedures and messages by which Label Switched Routers (LSRs) establish LSPs through a network by mapping network-layer routing information directly to data-link layer switched paths. These LSPs may have an endpoint at a directly attached neighbor (comparable to IP hop-by-hop forwarding), or may have an endpoint at a network egress node, enabling switching via all intermediary nodes.

LSPs can be created statically, by RSVP traffic engineering (TE), or by LDP. LSPs created by LDP perform hop-by-hop path setup instead of an end-to-end path. LDP enables LSRs to discover their potential peer routers and to establish LDP sessions with those peers to exchange label binding information. Once label bindings are learned, the LDP is ready to set up the MPLS forwarding plane.

For more information about setting up LSPs, see [MPLS Label Distribution Protocol : Details, on page 10](#).

Configuring Label Distribution Protocol

Depending on the requirements, LDP requires some basic configuration tasks described in the following topics:

Configuring Label Distribution Protocol

This section explains the basic LDP configuration. LDP should be enabled on all interfaces that connects the router to potential LDP peer routers. You can enable LDP on an interface by specifying the interface under `mpls ldp` configuration mode.

Configuration Example

This example shows how to enable LDP over an interface.

```
RP/0/RP0/CPU0:Router(config)# mpls ldp
RP/0/RP0/CPU0:Router(config-ldp)# router-id 192.168.70.1
RP/0/RP0/CPU0:Router(config-ldp)# interface HundredGigE 0/9/0/0
RP/0/RP0/CPU0:Router(config-ldp-if)# commit
```

Configuring Label Distribution Protocol Discovery Parameters

LSRs that are running LDP send hello messages on all the LDP enabled interfaces to discover each other. So, the LSR that receives the LDP hello message on an interface is aware of the presence of the LDP router on that interface. If LDP hello messages are sent and received on an interface, there's an LDP adjacency across the link between the two LSRs that are running LDP. By default, hello messages are sent every 5 seconds with a hold time of 15 seconds. If the LSR doesn't receive a discovery hello from peer before the hold time expires, the LSR removes the peer LSR from the list of discovered LDP neighbors. The LDP discovery parameters can be configured to change the default parameters.

LDP session between LSRs that aren't directly connected is known as targeted LDP session. For targeted LDP sessions, LDP uses targeted hello messages to discover the extended neighbors. By default, targeted hello messages are sent every 10 seconds with a hold time of 90 seconds.

Configuration Example

This example shows how to configure the following LDP discovery parameters:

- hello hold time
- hello interval
- targeted hello hold time
- targeted hello interval

```
RP/0/RP0/CPU0:Router(config)# mpls ldp
RP/0/RP0/CPU0:Router(config-ldp)# router-id 192.168.70.1
RP/0/RP0/CPU0:Router(config-ldp)# discovery hello holdtime 30
RP/0/RP0/CPU0:Router(config-ldp)# discovery hello interval 10
RP/0/RP0/CPU0:Router(config-ldp)# discovery targeted-hello holdtime 120
RP/0/RP0/CPU0:Router(config-ldp)# discovery targeted-hello interval 15
RP/0/RP0/CPU0:Router(config-ldp)# commit
```

Verification

This section verifies the MPLS LDP discovery parameters configuration.

```
RP/0/RP0/CPU0:Router# show mpls ldp parameters
```

```

LDP Parameters:
Role: Active
Protocol Version: 1
Router ID: 192.168.70.1
Discovery:
Link Hellos:      Holdtime:30 sec, Interval:10 sec
Targeted Hellos: Holdtime:120 sec, Interval:15 sec
Quick-start: Enabled (by default)
Transport address:      IPv4: 192.168.70.1

```

Label Distribution Protocol Discovery for Targeted Hellos

LDP session between LSRs that aren't directly connected is known as targeted LDP session. For LDP neighbors which aren't directly connected, you should manually configure the LDP neighborship on both the routers.

Configuration Example

This example shows how to configure LDP for non-directly connected routers, Router 1, and Router 2.

```

RP/0/RP0/CPU0:Router1(config)# mpls ldp
RP/0/RP0/CPU0:Router1(config-ldp)# router-id 192.168.70.1
RP/0/RP0/CPU0:Router2(config-ldp)# address-family ipv4
RP/0/RP0/CPU0:Router2(config-ldp-af)# discovery targeted-hello accept
RP/0/RP0/CPU0:Router1(config-ldp-af)# neighbor 172.20.10.10 targeted
RP/0/RP0/CPU0:Router1(config-ldp-af)# interface HundredGigE 0/9/0/0
RP/0/RP0/CPU0:Router1(config-ldp-if)# commit

```

```

RP/0/RP0/CPU0:Router2(config)# mpls ldp
RP/0/RP0/CPU0:Router2(config-ldp)# router-id 172.20.10.10
RP/0/RP0/CPU0:Router2(config-ldp)# address-family ipv4
RP/0/RP0/CPU0:Router2(config-ldp-af)# discovery targeted-hello accept
RP/0/RP0/CPU0:Router2(config-ldp-af)# neighbor 192.168.70.1 targeted
RP/0/RP0/CPU0:Router2(config-ldp-af)# commit

```

Label Advertisement Control

LDP allows you to control the advertising and receiving of labels. You can control the exchange of label binding information by using label advertisement control (outbound filtering) or label acceptance control (inbound filtering).

Label Advertisement Control (Outbound Filtering)

Label Distribution Protocol advertises labels for all the prefixes to all its neighbors. When this is not desirable (for scalability and security reasons), you can configure LDP to perform outbound filtering for local label advertisement for one or more prefixes to one more peers. This feature is known as LDP outbound label filtering, or local label advertisement control. You can control the exchange of label binding information using the **mpls ldp label advertise** command. Using the optional keywords, you can advertise selective prefixes to all neighbors, advertise selective prefixes to defined neighbors, or disable label advertisement to all peers for all prefixes. Prefixes and peers advertised selectively are defined in the access list.

Configuration Example: Label Advertisement Control

This example shows how to configure outbound label advertisement control. In this example, neighbors are specified to advertise and receive label advertisements. Also an interface is specified for label advertisement.

```
RP/0/RP0/CPU0:Router(config)# mpls ldp
RP/0/RP0/CPU0:Router(config-ldp)# address-family ipv4
RP/0/RP0/CPU0:Router(config-ldp-af)# label local advertise to 10.0.0.1:0 for pfx_acl1
RP/0/RP0/CPU0:Router(config-ldp-af)# label local advertise interface TenGigE 0/0/0/5

RP/0/RP0/CPU0:Router(config-ldp-af)# commit
```

Label Acceptance Control (Inbound Filtering)

LDP accepts labels (as remote bindings) for all prefixes from all peers. LDP operates in liberal label retention mode, which instructs LDP to keep remote bindings from all peers for a given prefix. For security reasons, or to conserve memory, you can override this behavior by configuring label binding acceptance for set of prefixes from a given peer. The ability to filter remote bindings for a defined set of prefixes is also referred to as LDP inbound label filtering or label acceptance control.

Configuration Example : Label Acceptance Control (Inbound Filtering)

This example shows how to configure label acceptance control. In this example, an LSR is configured to accept and retain label bindings from neighbors for prefixes defined in access list .

```
RP/0/RP0/CPU0:Router(config)# mpls ldp
RP/0/RP0/CPU0:Router(config-ldp)# address-family ipv4
RP/0/RP0/CPU0:Router(config-ldp-af)# label remote accept from 192.168.1.1:0 for acl_1
RP/0/RP0/CPU0:Router(config-ldp-af)# label remote accept from 192.168.2.2:0 for acl_2
RP/0/RP0/CPU0:Router(config-ldp-af)# commit
```

Configuring Local Label Allocation Control

LDP creates label bindings for all IGP prefixes and receives label bindings for all IGP prefixes from all its peers. If an LSR receives label bindings from several peers for thousands of IGP prefixes, it consumes significant memory and CPU. In some scenarios, most of the LDP label bindings may not useful for any application and you may required to limit the allocation of local labels. This is accomplished using LDP local label allocation control, where an access list can be used to limit allocation of local labels to a set of prefixes. Limiting local label allocation provides several benefits, including reduced memory usage requirements, fewer local forwarding updates, and fewer network and peer updates.

Configuration Example

This example shows how to configure local label allocation using an IP access list to specify a set of prefixes that local labels can allocate and advertise.

```
RP/0/RP0/CPU0:Router(config)# mpls ldp
RP/0/RP0/CPU0:Router(config-ldp)# address-family ipv4
RP/0/RP0/CPU0:Router(config-ldp-af)# label local allocate for pfx_acl_1
RP/0/RP0/CPU0:Router(config-ldp-af)# commit
```

Configuring Downstream on Demand

By default, LDP uses downstream unsolicited mode in which label advertisements for all routes are received from all LDP peers. The downstream on demand feature adds support for downstream-on-demand mode, where the label is not advertised to a peer, unless the peer explicitly requests it. At the same time, since the peer does not automatically advertise labels, the label request is sent whenever the next-hop points out to a peer that no remote label has been assigned.

In downstream on demand configuration, an ACL is used to specify the set of peers for downstream on demand mode. For downstream on demand to be enabled, it needs to be configured on both peers of the session. If only one peer in the session has downstream-on-demand feature configured, then the session does not use downstream-on-demand mode.

Configuration Example

This example shows how to configure LDP Downstream on Demand.

```
RP/0/RP0/CPU0:Router(config)# mpls ldp
RP/0/RP0/CPU0:Router(config-ldp)# session downstream-on-demand with ACL1
RP/0/RP0/CPU0:Router(config-ldp)# commit
```

Configuring Explicit Null Label

Cisco MPLS LDP uses implicit or explicit null label as local label for routes or prefixes that terminate on the given LSR. These routes include all local, connected, and attached networks. By default, the null label is **implicit-null** that allows LDP control plane to implement penultimate hop popping (PHP) mechanism. When this is not desirable, you can configure **explicit-null** label that allows LDP control plane to implement ultimate hop popping (UHP) mechanism. You can configure explicit-null feature on the ultimate hop LSR. Access-lists can be used to specify the IP prefixes for which PHP is desired.

You can enforce implicit-null local label for a specific prefix by using the **implicit-null-override** command even if the prefix requires a non-null label to be allocated by default. For example, by default, an LSR allocates and advertises a non-null label for an IGP route. If you wish to terminate LSP for this route on penultimate hop of the LSR, you can enforce implicit-null label allocation and advertisement for this prefix using the **implicit-null-override** command.

Configuration Example: Explicit Null

This example shows how to configure explicit null label.

```
RP/0/RP0/CPU0:Router(config)# mpls ldp
RP/0/RP0/CPU0:Router(config-ldp)# address-family ipv4
RP/0/RP0/CPU0:Router(config-ldp-af)# label local advertise explicit-null
RP/0/RP0/CPU0:Router(config-ldp-af)# commit
```

Configuration Example: Implicit Null Override

This example shows how to configure implicit null override for a set of prefixes.

```
RP/0/RP0/CPU0:Router(config)# mpls ldp
RP/0/RP0/CPU0:Router(config-ldp)# address-family ipv4
```

```
RP/0/RP0/CPU0:Router(config-ldp-af)# label local advertise implicit-null-override for acl-1
RP/0/RP0/CPU0:Router(config-ldp-af)# commit
```

Label Distribution Protocol Auto-configuration

LDP auto-configuration allows you to automatically configure LDP on all interfaces for which the IGP protocol is enabled. Typically, LDP assigns and advertises labels for IGP routes and must often be enabled on all active interfaces by an IGP. During LDP manual configuration, you must define the set of interfaces under LDP which is a time-intensive procedure. LDP auto-configuration eliminates the need to specify the same list of interfaces under LDP and simplifies the configuration tasks.

Configuration Example: Enabling LDP Auto-Configuration for OSPF

This example shows how to enable LDP auto-configuration for a specified OSPF instance.

```
RP/0/RP0/CPU0:Router(config)# router ospf 190
RP/0/RP0/CPU0:Router(config-ospf)# mpls ldp auto-config
RP/0/RP0/CPU0:Router(config-ospf)# area 8
RP/0/RP0/CPU0:Router(config-ospf-ar)# interface HundredGigE 0/9/0/0
RP/0/RP0/CPU0:Router(config-ospf-ar-if)# commit
```

Configuring Session Protection

When a new link or node comes up after a link failure, IP converges earlier and much faster than MPLS LDP and may result in MPLS traffic loss until the MPLS convergence. If a link flaps, the LDP session also flaps due to loss of link discovery. LDP session protection minimizes traffic loss, provides faster convergence, and protects existing LDP (link) sessions. When session protection is enabled for a peer, LDP starts sending targeted hello (directed discovery) in addition to basic discovery link hellos. When the direct link goes down, the targeted hellos can still be forwarded to the peer LSR over an alternative path as long as there is one. So, the LDP session stays up after the link goes down.

You can configure LDP session protection to automatically protect sessions with all or a given set of peers (as specified by peer-acl). When configured, LDP initiates backup targeted hellos automatically for neighbors for which primary link adjacencies already exist. These backup targeted hellos maintain LDP sessions when primary link adjacencies go down.

Configuration Example

This example shows how to configure LDP session protection for peers specified by the access control list peer-acl-1 for a maximum duration of 60 seconds.

```
RP/0/RP0/CPU0:Router(config)# mpls ldp
RP/0/RP0/CPU0:Router(config-ldp)# session protection for peer-acl-1 duration 60
RP/0/RP0/CPU0:Router(config-ldp)# commit
```

Configuring Label Distribution Protocol- Interior Gateway Protocol (IGP) Synchronization

Lack of synchronization between LDP and Interior Gateway Protocol (IGP) can cause MPLS traffic loss. Upon link up, for example, IGP can advertise and use a link before LDP convergence has occurred or, a link may continue to be used in IGP after an LDP session goes down.

LDP IGP synchronization coordinates LDP and IGP so that IGP advertises links with regular metrics only when MPLS LDP is converged on that link. LDP considers a link converged when at least one LDP session is up and running on the link for which LDP has sent its applicable label bindings and received at least one label binding from the peer. LDP communicates this information to IGP upon link up or session down events and IGP acts accordingly, depending on sync state.

LDP-IGP synchronization is supported for both OSPF and ISIS protocols and is configured under the corresponding IGP protocol configuration mode. Under certain circumstances, it might be required to delay declaration of re-synchronization to a configurable interval. LDP provides a configuration option to delay declaring synchronization up for up to 60 seconds. LDP communicates this information to IGP upon linkup or session down events.

From the 7.1.1 release, you can configure multiple MPLS-TE tunnel end points on an LER using the TLV 132 function in IS-IS. You can configure a maximum of 63 IPv4 addresses or 15 IPv6 addresses on an LER.

Configuring LDP IGP Synchronization: MPLS

This example shows how to configure LDP-IGP synchronization for MPLS.

```
RP/0/RP0/CPU0:Router(config)# mpls ldp
RP/0/RP0/CPU0:Router(config-ldp)# igp interface
RP/0/RP0/CPU0:Router(config-ldp)# igp sync delay {on-proc-restart | on-session-up}
```

Configuring LDP IGP Synchronization: Open Shortest Path First (OSPF) Example

This example shows how to configure LDP-IGP synchronization for an OSPF instance. The synchronization delay is configured as 30 seconds.

```
RP/0/RP0/CPU0:Router(config)# router ospf 100
RP/0/RP0/CPU0:Router(config-ospf)# mpls ldp sync
RP/0/RP0/CPU0:Router(config-ospf)# commit
```

Configuring LDP IGP Synchronization: Intermediate System to Intermediate System (IS-IS)

This example shows how to configure LDP-IGP synchronization for IS-IS.

```
RP/0/RP0/CPU0:Router(config)# router isis 100
RP/0/RP0/CPU0:Router(config-isis)# interface HundredGigE 0/9/0/0
RP/0/RP0/CPU0:Router(config-isis-if)# address-family ipv4 unicast
RP/0/RP0/CPU0:Router(config-isis-if-af)# mpls ldp sync
RP/0/RP0/CPU0:Router(config-isis-if-af)# commit
```

Configuring Label Distribution Protocol Graceful Restart

LDP Graceful Restart provides a mechanism for LDP peers to preserve the MPLS forwarding state when the LDP session goes down. Without LDP Graceful Restart, when an established session fails, the corresponding forwarding states are cleaned immediately from the restart and peer nodes. In this case, LDP forwarding has to restart from the beginning, causing a potential loss of data and connectivity. If LDP graceful restart is configured, traffic can continue to be forwarded without interruption, even when the LDP session restarts. The LDP graceful restart capability is negotiated between two peers during session initialization time. During session initialization, a router advertises its ability to perform LDP graceful restart by sending the graceful restart typed length value (TLV). This TLV contains the reconnect time and recovery time. The values of the reconnect and recovery times indicate the graceful restart capabilities supported by the router. The reconnect

time is the amount of time the peer router waits for the restarting router to establish a connection. When a router discovers that a neighboring router is restarting, it waits until the end of the recovery time before attempting to reconnect. Recovery time is the amount of time that a neighboring router maintains its information about the restarting router.

Configuration Example

This example shows how to configure LDP graceful restart. In this example, the amount of time that a neighboring router maintains the forwarding state about the gracefully restarting router is specified as 180 seconds. The reconnect time is configured as 169 seconds.

```
RP/0/RP0/CPU0:Router(config)# mpls ldp
RP/0/RP0/CPU0:Router(config-ldp)# interface HundredGigE 0/9/0/0
RP/0/RP0/CPU0:Router(config-ldp-if)# exit
RP/0/RP0/CPU0:Router(config-ldp)# graceful-restart
RP/0/RP0/CPU0:Router(config-ldp)# graceful-restart forwarding-state-holdtime 180
RP/0/RP0/CPU0:Router(config-ldp)# graceful-restart reconnect-timeout 169
RP/0/RP0/CPU0:Router(config-ldp)# commit
```

Configuring Label Distribution Protocol Nonstop Routing

LDP nonstop routing (NSR) functionality makes failures, such as Route Processor (RP) or Distributed Route Processor (DRP) fail over, invisible to routing peers with minimal to no disruption of convergence performance. By default, NSR is globally enabled on all LDP sessions except AToM.

A disruption in service may include any of these events:

- Route processor (RP) or distributed route processor (DRP) failover
- LDP process restart
- Minimum disruption restart (MDR)



Note Unlike graceful restart functionality, LDP NSR does not require protocol extensions and does not force software upgrades on other routers in the network, nor does LDP NSR require peer routers to support NSR. L2VPN configuration is not supported on NSR. Process failures of active LDP results in session loss and, as a result, NSR cannot be provided unless RP switchover is configured as a recovery action.

Configuration Example

This example shows how to configure LDP Non-Stop Routing.

```
RP/0/RP0/CPU0:Router(config)# mpls ldp
RP/0/RP0/CPU0:Router(config-ldp)# nsr
RP/0/RP0/CPU0:Router(config-ldp)# commit
```

Verification

```
RP/0/RP0/CPU0:Router# show mpls ldp nsr summary
Mon Dec 7 04:02:16.259 UTC
```

```
Sessions:
Total: 1, NSR-eligible: 1, Sync-ed: 0
(1 Ready)
```

MPLS Label Distribution Protocol : Details

This section provides detailed conceptual information about setting up LSPs, LDP graceful restart, and LDP session protection.

Setting Up Label Switched Paths

MPLS packets are forwarded between the nodes on the MPLS network using Label Switched Paths(LSPs). LSPs can be created statically or by using a label distribution protocol like LDP. Label Switched Paths created by LDP performs hop-by-hop path setup instead of an end-to-end path. LDP enables label switched routers (LSRs) to discover their potential peer routers and to establish LDP sessions with those peers to exchange label binding information.

The following figure illustrates the process of label binding exchange for setting up LSPs.

Figure 1: Setting Up Label Switched Paths

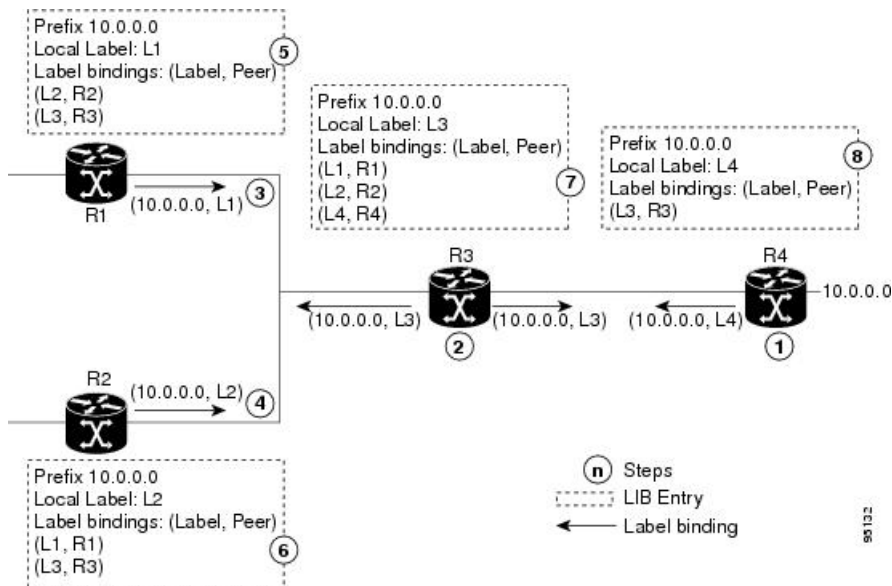

For a given network (10.0.0.0), hop-by-hop LSPs are set up between each of the adjacent routers (or, nodes) and each node allocates a local label and passes it to its neighbor as a binding:

1. R4 allocates local label L4 for prefix 10.0.0.0 and advertises it to its neighbors (R3).
2. R3 allocates local label L3 for prefix 10.0.0.0 and advertises it to its neighbors (R1, R2, R4).
3. R1 allocates local label L1 for prefix 10.0.0.0 and advertises it to its neighbors (R2, R3).
4. R2 allocates local label L2 for prefix 10.0.0.0 and advertises it to its neighbors (R1, R3).
5. R1's label information base (LIB) keeps local and remote labels bindings from its neighbors.
6. R2's LIB keeps local and remote labels bindings from its neighbors.

7. R3's LIB keeps local and remote labels bindings from its neighbors.
8. R4's LIB keeps local and remote labels bindings from its neighbors.

MPLS Forwarding

Once the label bindings are learned, MPLS forwarding plane is setup and packets are forwarded as shown in the following figure.

Figure 2: MPLS Forwarding

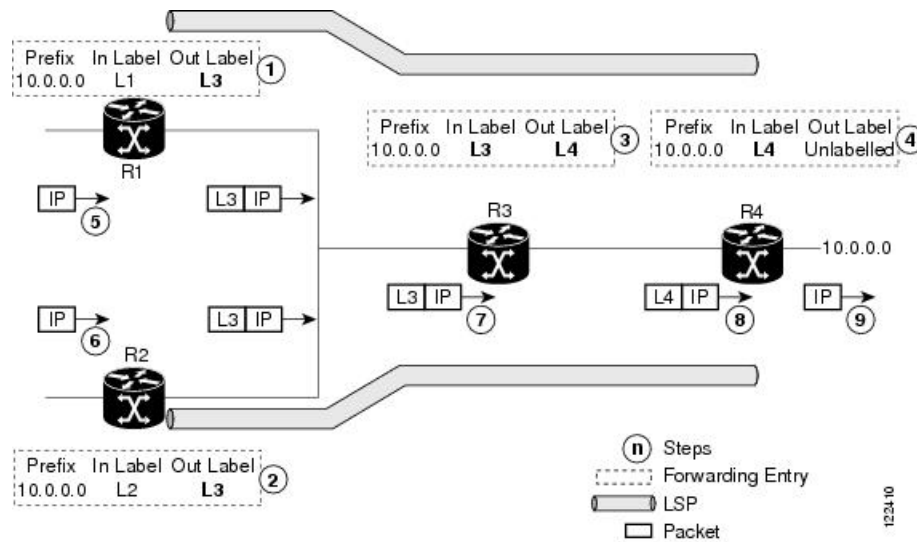

1. Because R3 is next hop for 10.0.0.0 as notified by the FIB, R1 selects label binding from R3 and installs forwarding entry (Layer 1, Layer 3).
2. Because R3 is next hop for 10.0.0.0 (as notified by FIB), R2 selects label binding from R3 and installs forwarding entry (Layer 2, Layer 3).
3. Because R4 is next hop for 10.0.0.0 (as notified by FIB), R3 selects label binding from R4 and installs forwarding entry (Layer 3, Layer 4).
4. Because next hop for 10.0.0.0 (as notified by FIB) is beyond R4, R4 uses NO-LABEL as the outbound and installs the forwarding entry (Layer 4); the outbound packet is forwarded IP-only.
5. Incoming IP traffic on ingress LSR R1 gets label-imposed and is forwarded as an MPLS packet with label L3.
6. Incoming IP traffic on ingress LSR R2 gets label-imposed and is forwarded as an MPLS packet with label L3.
7. R3 receives an MPLS packet with label L3, looks up in the MPLS label forwarding table and switches this packet as an MPLS packet with label L4.
8. R4 receives an MPLS packet with label L4, looks up in the MPLS label forwarding table and finds that it should be Unlabeled, pops the top label, and passes it to the IP forwarding plane.
9. IP forwarding takes over and forwards the packet onward.

Details of Label Distribution Protocol Graceful Restart

LDP (Label Distribution Protocol) graceful restart provides a control plane mechanism to ensure high availability and allows detection and recovery from failure conditions while preserving Nonstop Forwarding (NSF) services. Graceful restart is a way to recover from signaling and control plane failures without impacting forwarding.

Without LDP graceful restart, when an established session fails, the corresponding forwarding states are cleaned immediately from the restarting and peer nodes. In this case LDP forwarding restarts from the beginning, causing a potential loss of data and connectivity.

The LDP graceful restart capability is negotiated between two peers during session initialization time, in FT SESSION TLV. In this typed length value (TLV), each peer advertises the following information to its peers:

Reconnect time

Advertises the maximum time that other peer will wait for this LSR to reconnect after control channel failure.

Recovery time

Advertises the maximum time that the other peer has on its side to reinstate or refresh its states with this LSR. This time is used only during session reestablishment after earlier session failure.

FT flag

Specifies whether a restart could restore the preserved (local) node state for this flag.

Once the graceful restart session parameters are conveyed and the session is up and running, graceful restart procedures are activated.

When configuring the LDP graceful restart process in a network with multiple links, targeted LDP hello adjacencies with the same neighbor, or both, make sure that graceful restart is activated on the session before any hello adjacency times out in case of neighbor control plane failures. One way of achieving this is by configuring a lower session hold time between neighbors such that session timeout occurs before hello adjacency timeout. It is recommended to set LDP session hold time using the following formula:

```
Session Holdtime <= (Hello holdtime - Hello interval) * 3
```

This means that for default values of 15 seconds and 5 seconds for link Hello holdtime and interval respectively, session hold time should be set to 30 seconds at most.

Phases in Graceful Restart

The graceful restart mechanism is divided into different phases:

Control communication failure detection

Control communication failure is detected when the system detects either:

- Missed LDP hello discovery messages
- Missed LDP keepalive protocol messages
- Detection of Transmission Control Protocol (TCP) disconnection with a peer

Forwarding state maintenance during failure

Persistent forwarding states at each LSR are achieved through persistent storage (checkpoint) by the LDP control plane. While the control plane is in the process of recovering, the forwarding plane keeps the forwarding states, but marks them as stale. Similarly, the peer control plane also keeps (and marks as stale) the installed forwarding rewrites associated with the node that is restarting. The combination of local node forwarding and remote node forwarding plane states ensures NSF and no disruption in the traffic.

Control state recovery

Recovery occurs when the session is reestablished and label bindings are exchanged again. This process allows the peer nodes to synchronize and to refresh stale forwarding states.

Control Plane Failure

When a control plane failure occurs, connectivity can be affected. The forwarding states installed by the router control planes are lost, and the in-transit packets could be dropped, thus breaking NSF. The following figure illustrates control plane failure and recovery with graceful restart and shows the process and results of a control plane failure leading to loss of connectivity and recovery using graceful restart.

Figure 3: Control Plane Failure

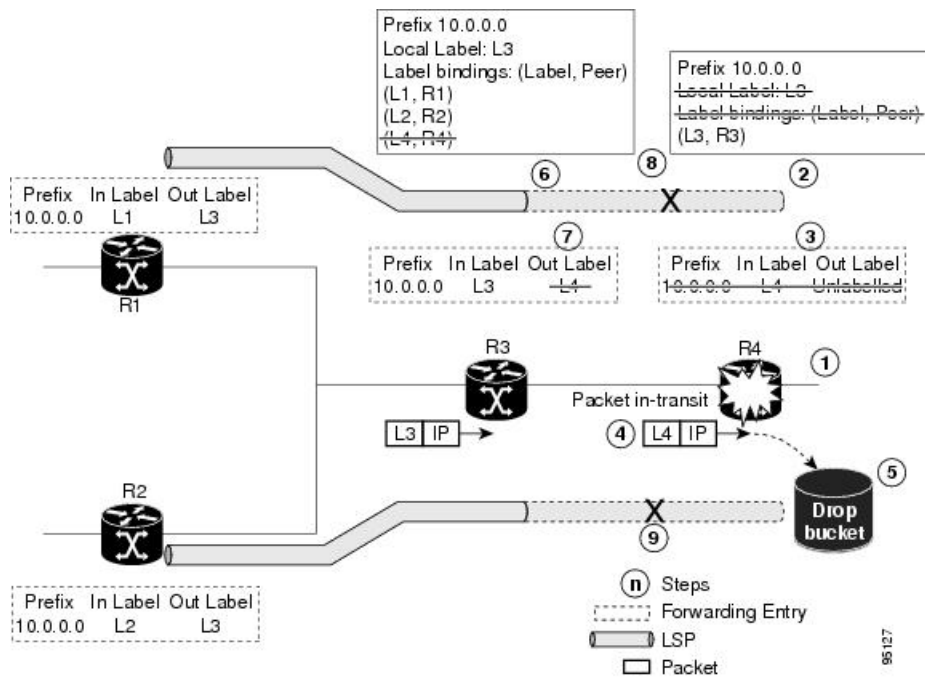

Recovery with Graceful Restart

Figure 4: Recovering with Graceful Restart

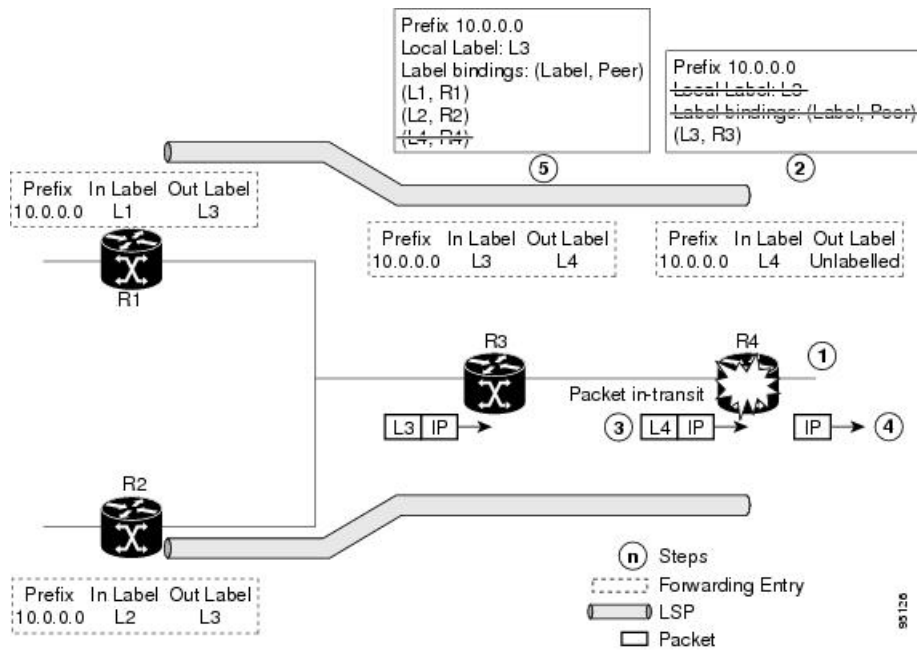

1. The R4 LSR control plane restarts.
2. LIB is lost when the control plane restarts.
3. The forwarding states installed by the R4 LDP control plane are immediately deleted.
4. Any in-transit packets flowing from R3 to R4 (still labeled with L4) arrive at R4.
5. The MPLS forwarding plane at R4 performs a lookup on local label L4 which fails. Because of this failure, the packet is dropped and NSF is not met.
6. The R3 LDP peer detects the failure of the control plane channel and deletes its label bindings from R4.
7. The R3 control plane stops using outgoing labels from R4 and deletes the corresponding forwarding state (rewrites), which in turn causes forwarding disruption.
8. The established LSPs connected to R4 are terminated at R3, resulting in broken end-to-end LSPs from R1 to R4.
9. The established LSPs connected to R4 are terminated at R3, resulting in broken LSPs end-to-end from R2 to R4.

When the LDP control plane recovers, the restarting LSR starts its forwarding state hold timer and restores its forwarding state from the checkpointed data. This action reinstates the forwarding state and entries and marks them as old.

The restarting LSR reconnects to its peer, indicated in the FT Session TLV, that it either was or was not able to restore its state successfully. If it was able to restore the state, the bindings are resynchronized.

The peer LSR stops the neighbor reconnect timer (started by the restarting LSR), when the restarting peer connects and starts the neighbor recovery timer. The peer LSR checks the FT Session TLV if the restarting

peer was able to restore its state successfully. It reinstates the corresponding forwarding state entries and receives binding from the restarting peer. When the recovery timer expires, any forwarding state that is still marked as stale is deleted.

If the restarting LSR fails to recover (restart), the restarting LSR forwarding state and entries will eventually timeout and is deleted, while neighbor-related forwarding states or entries are removed by the Peer LSR on expiration of the reconnect or recovery timers.

Details of Session Protection

LDP session protection lets you configure LDP to automatically protect sessions with all or a given set of peers (as specified by peer-acl). When configured, LDP initiates backup targeted hellos automatically for neighbors for which primary link adjacencies already exist. These backup targeted hellos maintain LDP sessions when primary link adjacencies go down.

The Session Protection figure illustrates LDP session protection between neighbors R1 and R3. The primary link adjacency between R1 and R3 is directly connected link and the backup; targeted adjacency is maintained between R1 and R3. If the direct link fails, LDP link adjacency is destroyed, but the session is kept up and running using targeted hello adjacency (through R2). When the direct link comes back up, there is no change in the LDP session state and LDP can converge quickly and begin forwarding MPLS traffic.

Figure 5: Session Protection

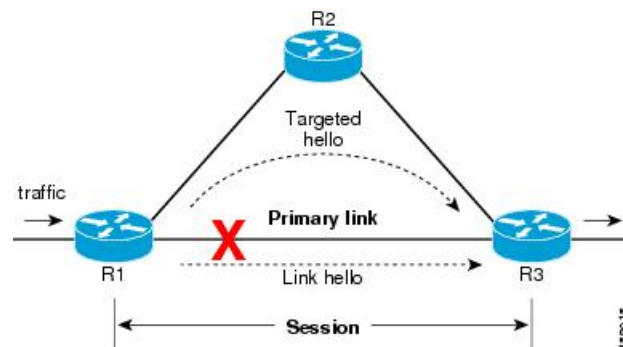

Note When LDP session protection is activated (upon link failure), protection is maintained for an unlimited period time.

Controlling State Advertisements In An mLDP-Only Setup

This function explains the controlling of state advertisements of non-negotiated Label Distribution Protocol (LDP) applications. This implementation is in conformance with RFC 7473 (Controlling State Advertisements of Non-negotiated LDP Applications).

The main purpose of documenting this function is to use it in a Multipoint LDP (mLDP)-only environment, wherein participating routers don't need to exchange any unicast binding information.

Non-Negotiated LDP Applications

The LDP capabilities framework enables LDP applications' capabilities exchange and negotiation, thereby enabling LSRs to send necessary LDP state. However, for the applications that existed prior to the definition of the framework (called *non-negotiated* LDP applications), there is no capability negotiation done. When an LDP session comes up, an LDP speaker may unnecessarily advertise its local state (without waiting for any capabilities exchange and negotiation). In other words, even when the peer session is established for Multipoint LDP (mLDP), the LSR advertises the state for these early LDP applications.

One example is *IPv4/IPv6 Prefix LSPs Setup* (used to set up Label Switched Paths [LSPs] for IP prefixes). Another example is *L2VPN P2P FEC 128 and FEC 129 PWs Signaling* (an LDP application that signals point-to-point [P2P] Pseudowires [PWs] for Layer 2 Virtual Private Networks [L2VPNs]).

In an mLDP-only setup, you can disable these non-negotiated LDP applications and avoid unnecessary LDP state advertisement. An LDP speaker that only runs mLDP announces to its peer(s) its disinterest (or non-support) in non-negotiated LDP applications. That is, it announces to its peers its disinterest to set up IP Prefix LSPs or to signal L2VPN P2P PW, at the time of session establishment.

Upon receipt of such a capability, the receiving LDP speaker, if supporting the capability, disables the advertisement of the state related to the application towards the sender of the capability. This new capability can also be sent later in a Capability message, either to disable a previously enabled application's state advertisement, or to enable a previously disabled application's state advertisement.

As a result, the flow of LDP state information in an mLDP-only setup is faster. When routers come up after a network event, the network convergence time is fast too.

IP Address Bindings In An mLDP Setup

An LSR typically uses peer IP address(es) to map an IP routing next hop to an LDP peer in order to implement its control plane procedures. mLDP uses a peer's IP address(es) to determine its upstream LSR to reach the root node, and to select the forwarding interface towards its downstream LSR. Hence, in an mLDP-only network, while it is desirable to disable advertisement of label bindings for IP (unicast) prefixes, disabling advertisement of IP address bindings will break mLDP functionality.

Uninteresting State - For the *Prefix-LSP* LDP application, *uninteresting* state refers to any state related to IP Prefix FEC, such as FEC label bindings and LDP Status. IP address bindings are not considered as an *uninteresting* state.

For the P2P-PW application LDP application, *uninteresting* state refers to any state related to P2P PW FEC 128 or FEC 129, such as FEC label bindings, MAC address withdrawal, and LDP PW status.

Control State Advertisement

To control advertisement of *uninteresting* state of non-negotiated LDP applications, the capability parameter TLV *State Advertisement Control Capability* is used. This TLV is only present in the Initialization and Capability messages, and the TLV can hold one or more State Advertisement Control (SAC) Elements.

As an example, consider two LSRs, S (LDP speaker) and P (LDP peer), that support all non-negotiated applications. S is participating (or set to participate) in an mLDP-only setup. Pointers for this scenario:

- By default, the LSRs will advertise state for all LDP applications to their peers, as soon as an LDP session is established.
- The **capabilities sac mldp-only** function is enabled on S.
- P receives an update from S via a Capability message that specifies to disable all four non-negotiated applications states.

- P's outbound policy towards S blocks and disables state for the unneeded applications.
- S only receives mLDP advertisements from specific mLDP-participating peers.

Use Cases For Controlling State Advertisements

Two use cases are explained, **mLDP-Based MVPN** and **Disable Prefix-LSPs On An L2VPN/PW tLDP Session**.

Disable Prefix-LSPs On An L2VPN/PW tLDP Session

A sample topology and relevant configurations are noted below.

Figure 6: L2VPN Xconnect Service Over Segment Routing

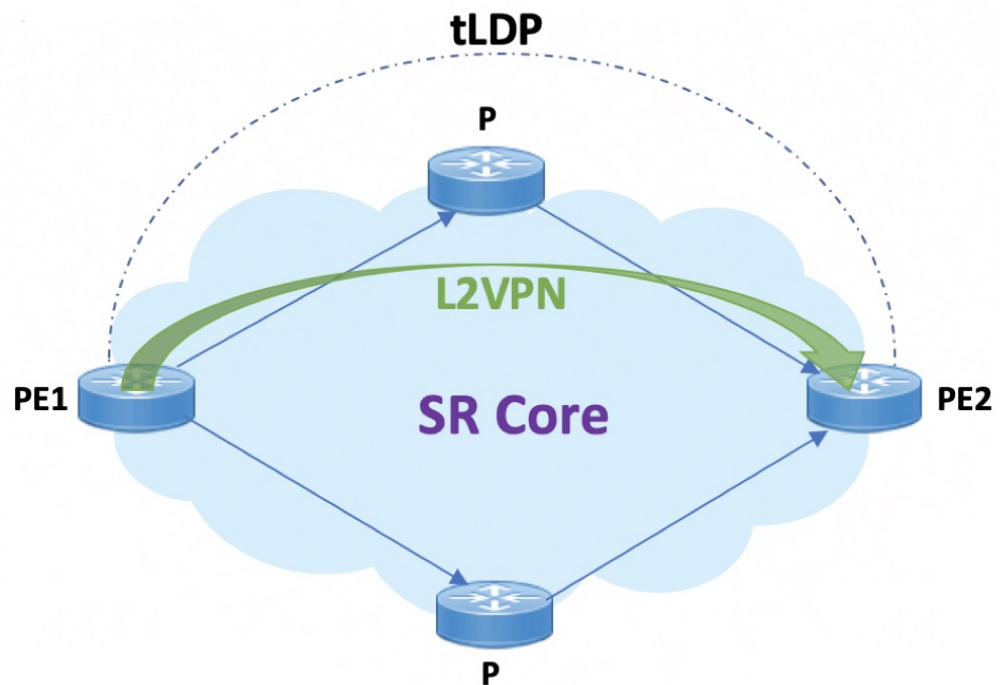

- The topology represents an L2VPN Xconnect service over a Segment Routing core setup.
- By default, Xconnect uses tLDP to signal service labels to remote PEs.
- By default, tLDP not only signals the service label, but also known (IPv4 and IPv6) label bindings to the tLDP peer, which is not required.
- The LDP SAC capabilities is an optional configuration enabled under LDP, and users can block IPv4 and IPv6 label bindings by applying configurations on PE1 and PE2.

Configuration

PE1 Configuration

Disable IPv4 prefix LSP binding advertisements on PE1:

```
PE1(config)# mpls ldp capabilities sac ipv4-disable
PE1(config)# commit
```

Disable IPv6-prefix LSP binding advertisements on PE1:

```
PE1(config)# mpls ldp capabilities sac ipv4-disable ipv6-disable
PE1(config)# commit
```



Note Whenever you disable a non-negotiated LDP application state on a router, you must include previously disabled non-negotiated LDP applications too, in the same command line. If not, the latest configuration overwrites the existing ones. You can see that `ipv4-disable` is added again, though it was already disabled.

PE2 Configuration

Enable SAC capability awareness on PE2, and make PE2 stop sending IPv4 prefix LSP binding advertisements to PE1:

```
PE2(config)#mpls ldp capabilities sac
PE2(config)#commit
```

Verification

On PE1, verify PE2's SAC capabilities:

```
PE1# show mpls ldp neighbor 198.51.100.1 detail

Peer LDP Identifier: 198.51.100.1:0
  TCP connection: 198.51.100.1:29132 - 192.0.2.1:646
  Graceful Restart: No
  Session Holdtime: 180 sec
  State: Oper; Msgs sent/rcvd: 14/14; Downstream-Unsolicited
  Up time: 00:03:30
  LDP Discovery Sources:
    IPv4: (1)
      Targeted Hello (192.0.2.1 -> 198.51.100.1, active)
    IPv6: (0)
  Addresses bound to this peer:
    IPv4: (3)
      203.0.113.1      209.165.201.1      10.0.0.1      198.51.100.1
      172.16.0.1
    IPv6: (0)
  Peer holdtime: 180 sec; KA interval: 60 sec; Peer state: Estab
  NSR: Disabled
  Clients: AToM
  Capabilities:
  Sent:
    0x508 (MP: Point-to-Multipoint (P2MP))
    0x509 (MP: Multipoint-to-Multipoint (MP2MP))
    0x50b (Typed Wildcard FEC)
    0x50d (State Advertisement Control)
      [ {IPv4-disable} ] (length 1)
  Received:
    0x508 (MP: Point-to-Multipoint (P2MP))
    0x509 (MP: Multipoint-to-Multipoint (MP2MP))
```



```
0x50b (Typed Wildcard FEC)
0x50d (State Advertisement Control)
```

Capabilities Sent SAC capability **ipv4-disable** is sent, and local IPv4 label bindings are not generated.

Capabilities Received The peer (PE2) understands SAC capability and won't send its local IPv4 label bindings to local PE.

On PE1, verify SAC capabilities:

```
PE1# show mpls ldp capabilities detail
```

| Type | Description | Owner |
|--------|---|------------|
| 0x50b | Typed Wildcard FEC Capability data: None | LDP |
| 0x3eff | Cisco IOS-XR Capability data: Length: 12 Desc : [host=PE1; platform=NCS 560; release=07.01.01] | LDP |
| 0x508 | MP: Point-to-Multipoint (P2MP) Capability data: None | mLDP |
| 0x509 | MP: Multipoint-to-Multipoint (MP2MP) Capability data: None | mLDP |
| 0x50d | State Advertisement Control Capability data: Length: 1 Desc : [{IPv4-disable}] | LDP |
| 0x703 | P2MP PW Capability data: None | L2VPN-AToM |

On PE1, verify that local and remote FEC bindings are removed.

```
PE1# show mpls ldp neighbor 198.51.100.1
Wed March 3 13:42:13.359 EDTs
```

mLDP-Based MVPN

A sample topology and relevant configurations are noted below.

Figure 7: mLDP-Based MVPN Over Segment Routing

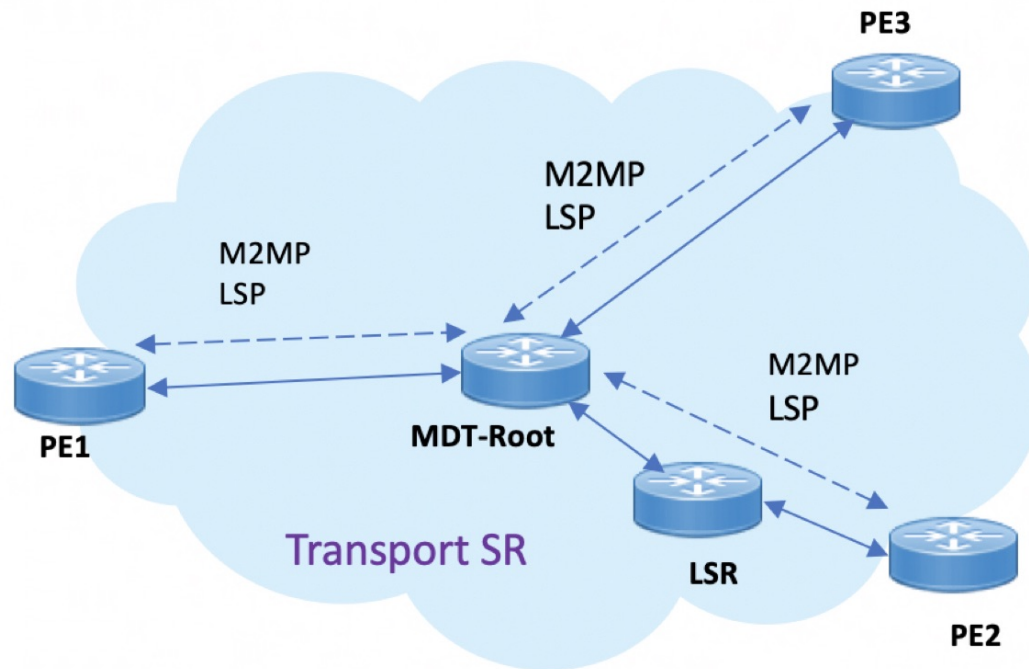

- The topology represents an MVPN profile 1 where an mLDP-based MVPN service is deployed over a Segment Routing core setup
- mLDP is required to signal MP2MP LSPs, whereas SR handles the transport.
- SAC capabilities are used to signal *mLDP-only* capability, which blocks unrequired unicast IPv4, IPv6, FEC128, and FEC129 related label binding advertisements.
- The **mldp-only** option is enabled on PE routers and P routers to remove unwanted advertisements.

Configuration

PE1 Configuration

Configure mLDP SAC capability on PE1.

```
PE1(config)# mpls ldp
PE1(config-ldp)# capabilities sac mldp-only
PE1(config-ldp)# commit
```

PE2 Configuration

Configure mLDP SAC capability on PE2.

```
PE2(config)# mpls ldp
PE2(config-ldp)# capabilities sac mldp-only
PE2(config-ldp)# commit
```

Verification

LDP peers (PE1 and PE2) are configured with **mldp-only** option, disabling all other SAC capabilities.

```
PE1# show running-config mpls ldp
```

```
mpls ldp
  capabilities sac mldp-only
  mldp
    address-family ipv4
    !
```

```
PE2# show running-config mpls ldp
```

```
mpls ldp
  capabilities sac mldp-only
  mldp
    address-family ipv4
    !
```

On PE1, verify PE2's SAC capabilities:

```
PE1# show mpls ldp neighbor 209.165.201.20 capabilities detail
```

```
Peer LDP Identifier: 209.165.201.20:0
Capabilities:
  Sent:
    0x508 (MP: Point-to-Multipoint (P2MP))
    0x509 (MP: Multipoint-to-Multipoint (MP2MP))
    0x50b (Typed Wildcard FEC)
    0x50d (State Advertisement Control)
    [ {IPv4-disable}{IPv6-disable}{FEC128-disable}{FEC129-disable} ] (length 4)
  Received:
    0x508 (MP: Point-to-Multipoint (P2MP))
    0x509 (MP: Multipoint-to-Multipoint (MP2MP))
    0x50b (Typed Wildcard FEC)
    0x50d (State Advertisement Control)
    [ {IPv4-disable}{IPv6-disable}{FEC128-disable}{FEC129-disable} ] (length 4)
```

Capabilities Sent shows that **mldp-only** option disables all other advertisements.

Capabilities Received shows that **mldp-only** is enabled on peer PE2 too.



CHAPTER 2

MPLS Static Labeling

The MPLS static feature enables you to statically assign local labels to an IPv4 prefix. Also, Label Switched Paths (LSPs) can be provisioned for these static labels by specifying the next-hop information that is required to forward the packets containing static label.

If there is any discrepancy between labels assigned statically and dynamically, the router issues a warning message in the console log. By means of this warning message, the discrepancy can be identified and resolved.

The advantages of static labels over dynamic labels are:

- Improve security because the risk of receiving unwanted labels from peers (running a compromised MPLS dynamic labeling protocol) is reduced.
- Gives users full control over defined LSPs.
- Utilize system resources optimally because dynamic labeling is not processed.
- Static labeling on IPv6 packets is supported.

Restrictions

- The router does not prevent label discrepancy at the time of configuring static labels. Any generated discrepancy needs to be subsequently cleared.
- Equal-cost multi-path routing (ECMP) is not supported.
- Interfaces must be explicitly configured to handle traffic with static MPLS labels.
- When paths of different technologies are resolved over ECMP, it results in *heterogeneous* ECMP, leading to severe network traffic issues. Don't use ECMP for any combination of the following technologies:
 - LDP.
 - BGP-LU, including services over BGP-LU loopback peering or recursive services at Level-3.
 - VPNv4.
 - 6PE and 6VPE.
 - EVPN.
 - Recursive static routing.
- [Restrictions For MPLS , on page 24](#)

- [Define Label Range and Enable MPLS Encapsulation, on page 24](#)
- [Identify and Clear Label Discrepancy, on page 25](#)
- [Configuring Static LSP Next Hop Resolve with Recursive Prefix, on page 27](#)
- [Configuring MPLS Static over BVI, on page 27](#)
- [MPLS Over Single-Pass GRE Tunnels, on page 28](#)

Restrictions For MPLS

- MPLS statistics is not supported.

Define Label Range and Enable MPLS Encapsulation

By default, MPLS encapsulation is disabled on all interfaces. MPLS encapsulation has to be explicitly enabled on all ingress and egress MPLS interfaces through which the static MPLS labeled traffic travels.

Also, the dynamic label range needs to be defined. Any label that falls outside this dynamic range is available for manually allocating as static labels. The router does not verify statically-configured labels against the specified label range. Therefore, to prevent label discrepancy, ensure that you do not configure static MPLS labels that fall within the dynamic label range.



Note For Cisco IOS XR software release 7.5.2 onwards, MPLS static supports 200G Ethernet.

Configuration Example

You have to accomplish the following to complete the MPLS static labeling configuration. Values are provided as an example.

1. Define a dynamic label range, which in this task is set between 17000 and 18000.
2. Enable MPLS encapsulation on the required interface.
3. Setup a static MPLS LSP for a specific ingress label 24035.
4. Specify the forwarding information so that for packets that are received with the label, 24035, the MPLS protocol swaps labels and applies the label, 24036. After applying the new label, it forwards the packets to the next hop, 10.2.2.2, through the specified interface.

```
RP/0/RP0/CPU0:router(config)#mpls label range table 0 17000 18000
RP/0/RP0/CPU0:router(config)#commit

RP/0/RP0/CPU0:router(config)#mpls static

RP/0/RP0/CPU0:router(config-mpls-static)# interface HundredGigE 0/9/0/0
RP/0/RP0/CPU0:router(config-mpls-static)#address-family ipv4 unicast
RP/0/RP0/CPU0:router(config-mpls-static-af)#local-label 24035 allocate

RP/0/RP0/CPU0:router(config-mpls-static-af-lbl)#forward
RP/0/RP0/CPU0:router(config-mpls-static-af-lbl-fwd)#
```

```
RP/0/RP0/CPU0:router(config-mpls-static-af-lbl-fwd)# commit
```

Verification

Verify the interfaces on which MPLS is enabled

```
RP/0/RP0/CPU0:router# show mpls interfaces
Mon May 12 06:21:30.937 DST
Interface                LDP          Tunnel      Static      Enabled
-----
TenGigE0/0/0/5          No           No          Yes        Yes
```

Verify that the status is "Created" for the specified label value.

```
RP/0/RP0/CPU0:router#show mpls static local-label all
Tue Apr 22 18:21:55.764 UTC
Label  VRF          Type          Prefix          RW Configured  Status
-----
24035  default     X-Connect     NA              Yes            Created
```

Check the dynamic range and ensure that the specified local-label value is outside this range.

```
RP/0/RP0/CPU0:router#show mpls label range
Mon Apr 28 19:56:00.596 IST
Range for dynamic labels: Min/Max: 17000/18000
```

Verify that the MPLS static configuration has taken effect, and the label forwarding is taking place.

```
RP/0/RP0/CPU0:router#show mpls lsd forwarding
Wed Nov 25 21:40:57.918 UTC
In_Label, (ID), Path_Info: <Type>
24035, (Static), 1 Paths
  1/1: IPv4, 'default':4U, BE1.2, nh=10.20.3.1, lbl=35001, flags=0x0, ext_flags=0x0
```

Associated Commands

- mpls static
- mpls label range
- show mpls interfaces

Identify and Clear Label Discrepancy

During configuring or de-configuring static labels or a label range, a label discrepancy can get generated when:

- A static label is configured for an IP prefix that already has a binding with a dynamic label.
- A static label is configured for an IP prefix, when the same label value is dynamically allocated to another IP prefix.

Verification

Identify label discrepancy by using these show commands.

```
Router#show mpls static local-label discrepancy
Tue Apr 22 18:36:31.614 UTC
Label  VRF          Type          Prefix          RW Configured  Status
-----
24000  default        X-Connect     NA              Yes            Discrepancy
```

```
Router#show mpls static local-label all
Tue Apr 22 18:36:31.614 UTC
Label  VRF          Type          Prefix          RW Configured  Status
-----
24000  default        X-Connect     N/A            Yes            Discrepancy
24035  default        X-Connect     N/A            Yes            Created
```

```
RP/0/RP0/CPU0:router#show log
Thu Apr 24 14:18:57.655 UTC
Syslog logging: enabled (0 messages dropped, 0 flushes, 0 overruns)
  Console logging: level warnings, 199 messages logged
  Monitor logging: level debugging, 0 messages logged
  Trap logging: level informational, 0 messages logged
  Buffer logging: level debugging, 2 messages logged

Log Buffer (307200 bytes):

RP/0/RSP0/CPU0:Apr 24 14:18:53.743 : mpls_static[1043]:
%ROUTING-MPLS_STATIC-7-ERR_STATIC_LABEL_DISCREPANCY :
The system detected 1 label discrepancies (static label could not be allocated due to
conflict with other applications).
Please use 'clear mpls static local-label discrepancy' to fix this issue.
RP/0/RSP0/CPU0:Apr 24 14:18:53.937 : config[65762]: %MGBL-CONFIG-6-DB_COMMIT : Configuration
committed by user 'cisco'.
Use 'show configuration commit changes 1000000020' to view the changes.
```

Rectification

Label discrepancy is cleared by allocating a new label to those IP prefixes that are allocated dynamic label. The static label configuration takes precedence while clearing discrepancy. Clearing label discrepancy may result in traffic loss for the dynamic label which got cleared.

```
Router# clear mpls static local-label discrepancy all
```

Verify that the discrepancy is cleared.

```
Router# show mpls static local-label all
Wed Nov 25 21:45:50.368 UTC
Label  VRF          Type          Prefix          RW Configured  Status
-----
24000  default        X-Connect     N/A            Yes            Created
24035  default        X-Connect     N/A            Yes            Created
```

Associated Commands

- show mpls static local-label discrepancy
- clear mpls static local-label discrepancy all

Configuring Static LSP Next Hop Resolve with Recursive Prefix

When a routing table entry references to another IP address and not to a directly connected exit interface, the next-hop IP address is resolved using another route with an exit interface. This is known as a recursive lookup because multiple lookups are required to resolve the next-hop IP address. Static LSP next hop resolve with recursive prefix feature supports resolution of recursive routes for static LSPs. In this feature, you can specify a next hop which is not directly connected using the **resolve-nexthop** command for a static LSP.

Restrictions

The following restrictions apply for this feature:

- Only eBGP routes are supported.

Configuration Example

This example shows how to configure the static LSP next hop resolve with recursive prefix. Here 192.168.2.1 is a recursive route learnt through eBGP.

```
RP/0/0/CPU0:Router# configure terminal
RP/0/0/CPU0:Router(config)# mpls static
RP/0/0/CPU0:Router(config-mpls-static)# lsp anycast_5001
RP/0/0/CPU0:Router(config-mpls-static-lsp)# in-label 5001 allocate
RP/0/0/CPU0:Router(config-mpls-static-lsp)# forward
RP/0/0/CPU0:Router(config-mpls-static-lsp-fwd)# path 1 resolve-nexthop 192.168.2.1 out-label
pop
RP/0/0/CPU0:Router(config-mpls-static-lsp-fwd)# exit
```

Verification

This example shows how to verify the static LSP next hop resolve with recursive prefix configuration.

```
RP/0/0/CPU0:Router# show mpls static lsp anycast_5001 detail
Tue Sep 12 20:00:09.248 UTC
LSP Name          Label  VRF      AFI  Type      Prefix      RW Configured
Status
-----
anycast_5001      5001  default  N/A  X-Connect  N/A         Yes
Created
PRIMARY SET:
[resolve-mode: nexthop 192.168.2.1]
Path 0 : nexthop BVI1 10.1.1.3, out-label Pop, Role: primary, Path-id: 0, Status: valid
Path 1 : nexthop BVI1 10.1.1.4, out-label Pop, Role: primary, Path-id: 0, Status: valid
Path 2 : nexthop BVI1 10.1.1.5, out-label Pop, Role: primary, Path-id: 0, Status: valid
Path 3 : nexthop BVI1 10.1.1.6, out-label Pop, Role: primary, Path-id: 0, Status: valid
```

Configuring MPLS Static over BVI

A Bridge-group virtual interface (BVI) is a routed interface that represents a set of interfaces that gets bridged. By using BVI, you can convert multiple interfaces as members of a common broadcast domain. MPLS static over BVI feature allows you to specify a BVI interface as next hop while setting up a static LSP.

Only static MPLS tunnels can use BVI as a next hop. Also, a BVI next hop can be a static route, a directly connected route (IP address, not a subnet prefix), or a route resolved through BGP or IGP. The router will do an MPLS label lookup on incoming MPLS traffic, perform a label operation such as SWAP/PHP/POP, and forward the MPLS/IP traffic through the BVI next hop. The router can perform switching for Layer 2 traffic and routing for incoming Layer 3 MPLS traffic.

Restrictions

- If a BVI has multiple peers within a subnet, then the subnet prefix cannot be specified as the next hop IP address (though IP addresses within the subnet are BVI peers). You have to specify one of the peers (with a specific IP address) as the next hop.
- Back up paths over BVI (IPv4 or IPv6) are not supported.
- Fast Reroute (FRR) is not supported.
- Dynamic MPLS configuration is not supported. For example, label distribution using LDP is not supported.

Configuration Example

This example shows how to configure a BVI interface as next hop for a static LSP.

```
RP/0/0/CPU0:Router# configure terminal
RP/0/0/CPU0:Router(config)# mpls static
RP/0/0/CPU0:Router(config-mpls-static)# interface TenGig 0/0/0/0
RP/0/0/CPU0:Router(config-mpls-static)# lsp bvi
RP/0/0/CPU0:Router(config-mpls-static-lsp)# in-label 5001 allocate
RP/0/0/CPU0:Router(config-mpls-static-lsp)# forward
RP/0/0/CPU0:Router(config-mpls-static-lsp-fwd)# path 1 nexthop BVI1 192.168.2.1 out-label
pop
RP/0/0/CPU0:Router(config-mpls-static-lsp-fwd)# path 1 nexthop BVI1 192.168.2.1 out-label
4444
RP/0/0/CPU0:Router(config-mpls-static-lsp-fwd)# exit
```

Verification Example

The following example shows the output for verifying the MPLS Static over BVI.

```
RP/0/RP0/CPU0:router# show mpls interfaces
Mon May 12 06:21:30.937 DST
Interface                LDP      Tunnel   Static   Enabled
-----
TenGigE0/0/0/5          No       No       Yes      Yes
```

You can verify that the status is "Created" for the specified label value.

```
RP/0/RP0/CPU0:router#show mpls static local-label all
Tue Apr 22 18:21:55.764 UTC
Label  VRF                Type           Prefix           RW Configured   Status
-----
24035  default            X-Connect      NA                Yes              Created
```

MPLS Over Single-Pass GRE Tunnels

This feature supports MPLS static forwarding over a single-pass GRE tunnel at line rate. One use case is of a Provider router sending incoming customer traffic over the GRE tunnel, addressed to an anycast virtual IP address (VIP) destination shared by a set of load balancing servers.

Figure 8: MPLS Over a Single-Pass GRE Tunnel

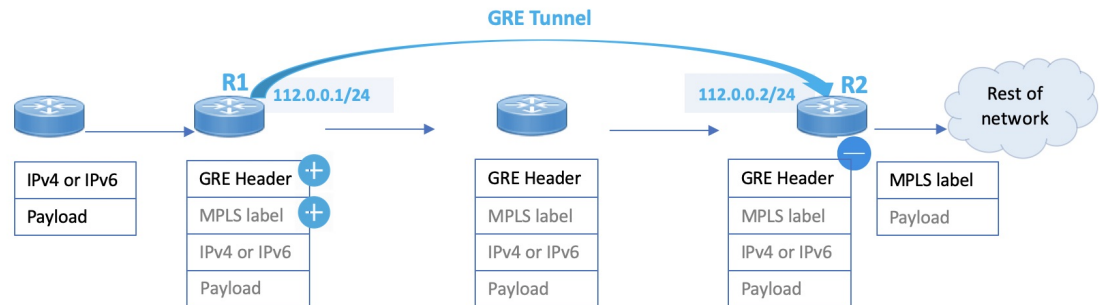

In the image, you can see that the GRE tunnel begins at R1. R1 checks ACL configurations, adds an MPLS label to the incoming packet, and then adds a GRE header. Then it sends the traffic towards R2.

R2 uses the PBR process for GRE tunnel decapsulation, and based on the MPLS label, it forwards the traffic towards its destination.

Configuration Example

This example shows how to enable MPLS static forwarding over a single-pass GRE tunnel at line rate.

GRE Tunnel Configuration on R1

The single-pass GRE tunnel starts on R1.

```
R1# configure
R1(config)# interface tunnel-ip1
R1(config-if)# ipv4 address 112.0.0.1 255.255.255.0
R1(config-if)# tunnel mode gre ipv4 encap
R1(config-if)# tunnel source TenGigE0/0/0/2
R1(config-if)# tunnel destination 50.0.0.1
R1(config-if)# commit
```

GRE tunnel destination address is an anycast address. GRE encapsulation must be based on an ACL or a policy-map, or both. A destination can be an individual address or a /28 prefix.

MPLS Static Configuration on R1

```
R1# configure
R1(config)# router static
R1(config-static)# address-family ipv4 unicast
R1(config-static-afi)# 111.0.0.1/32 tunnel-ip1
R1(config-static-afi)# commit

R1(config)# mpls static
R1(config-mpls-static)# lsp test
R1(config-mpls-static-lsp)# in-label 10000 allocate per-prefix 111.0.0.1/32
R1(config-mpls-static-lsp)# forward
R1(config-mpls-static-lsp-fwd)# path 1 nexthop tunnel-ip1 out-label 12000
R1(config-mpls-static-lsp-fwd)# commit
```

GRE Tunnel Configuration on R2

The single-pass GRE tunnel terminates on R2.

```

R2 # configure
R2(config)# interface tunnel-ip1
R2(config-if)# ipv4 address 112.0.0.2 255.255.255.0
R2(config-if)# tunnel mode gre ipv4 decap
R2(config-if)# tunnel source TenGigE0/0/0/2
R2(config-if)# tunnel destination 10.0.0.1
R2(config-if)# commit

```

Verification

Tunnel-IP configuration on R1

```

R1# show running-config interface tunnel-ip 1

interface tunnel-ip1
  ipv4 address 112.0.0.1 255.255.255.0
  tunnel mode gre ipv4 encap
  tunnel source TenGigE0/0/0/2
  tunnel destination 50.0.0.1
!

```

MPLS Static Configuration on R1

```

R1# show running-config router static

router static
  address-family ipv4 unicast
    111.0.0.1/32 tunnel-ip1
  !
!

R1# show running-config mpls static

mpls static
  lsp test
    in-label 1000 allocate per-prefix 111.0.0.1/32
    forward
      path 1 nexthop tunnel-ip1 out-label 12000
    !
!

```

Tunnel-IP Configuration on R2

```

R2# show running-config int tunnel-ip 1

interface tunnel-ip1
  ipv4 address 112.0.0.2 255.255.255.0
  tunnel mode gre ipv4
  tunnel source TenGigE0/0/0/2
  tunnel destination 10.0.0.1
!

```

PBR Configuration for GRE Tunnel Decapsulation on R2

```

R2# show running-config class-map type traffic match-all

class-map type traffic match-all test_gre1
  match protocol gre
  match destination-address ipv4 50.0.0.1 255.255.255.255
  match source-address ipv4 10.0.0.1 255.255.255.255
end-class-map
!
policy-map type pbr P1-test

```

```
class type traffic test_gre1
decapsulate gre
!
class type traffic class-default
!
end-policy-map
!

vrf-policy
vrf default address-family ipv4 policy type pbr input P1-test
!
```



CHAPTER 3

Implementing MPLS Traffic Engineering

Traditional IP routing emphasizes on forwarding traffic to the destination as fast as possible. As a result, the routing protocols find out the least-cost route according to its metric to each destination in the network and every router forwards the packet based on the destination IP address and packets are forwarded hop-by-hop. Thus, traditional IP routing does not consider the available bandwidth of the link. This can cause some links to be over-utilized compared to others and bandwidth is not efficiently utilized. Traffic Engineering (TE) is used when the problems result from inefficient mapping of traffic streams onto the network resources. Traffic engineering allows you to control the path that data packets follow and moves traffic flows from congested links to non-congested links that would not be possible by the automatically computed destination-based shortest path.

Multiprotocol Label Switching (MPLS) with its label switching capabilities, eliminates the need for an IP route look-up and creates a virtual circuit (VC) switching function, allowing enterprises the same performance on their IP-based network services as with those delivered over traditional networks such as Frame Relay or Asynchronous Transfer Mode (ATM). MPLS traffic engineering (MPLS-TE) relies on the MPLS backbone to replicate and expand upon the TE capabilities of Layer 2 ATM and Frame Relay networks.

MPLS-TE learns the topology and resources available in a network and then maps traffic flows to particular paths based on resource requirements and network resources such as bandwidth. MPLS-TE builds a unidirectional tunnel from a source to a destination in the form of a label switched path (LSP), which is then used to forward traffic. The point where the tunnel begins is called the tunnel headend or tunnel source, and the node where the tunnel ends is called the tunnel tailend or tunnel destination. A router through which the tunnel passes is called the mid-point of the tunnel.

MPLS uses extensions to a link-state based Interior Gateway Protocol (IGP), such as Intermediate System-to-Intermediate System (IS-IS) or Open Shortest Path First (OSPF). MPLS calculates TE tunnels at the LSP head based on required and available resources (constraint-based routing). If configured, the IGP automatically routes the traffic onto these LSPs. Typically, a packet that crosses the MPLS-TE backbone travels on a single LSP that connects the ingress point to the egress point. MPLS TE automatically establishes and maintains the LSPs across the MPLS network by using the Resource Reservation Protocol (RSVP).



Note Combination of unlabelled paths protected by labelled paths is not supported.

- [Overview of MPLS-TE Features, on page 34](#)
- [How MPLS-TE Works, on page 35](#)
- [Configuring MPLS-TE, on page 36](#)
- [MPLS-TE Features - Details, on page 53](#)
- [Configuring Performance Measurement, on page 62](#)

Overview of MPLS-TE Features

In MPLS traffic engineering, IGP extensions flood the TE information across the network. Once the IGP distributes the link attributes and bandwidth information, the headend router calculates the best path from head to tail for the MPLS-TE tunnel. This path can also be configured explicitly. Once the path is calculated, RSVP-TE is used to set up the TE LSP (Labeled Switch Path).

To forward the traffic, you can configure autoroute, forward adjacency, or static routing. The autoroute feature announces the routes assigned by the tailend router and its downstream routes to the routing table of the headend router and the tunnel is considered as a directly connected link to the tunnel.

If forward adjacency is enabled, MPLS-TE tunnel is advertised as a link in an IGP network with the link's cost associated with it. Routers outside of the TE domain can see the TE tunnel and use it to compute the shortest path for routing traffic throughout the network.

MPLS-TE provides protection mechanism known as fast reroute to minimize packet loss during a failure. For fast reroute, you need to create back up tunnels. The autotunnel backup feature enables a router to dynamically build backup tunnels when they are needed instead of pre-configuring each backup tunnel and then assign the backup tunnel to the protected interfaces.

DiffServ Aware Traffic Engineering (DS-TE) enables you to configure multiple bandwidth constraints on an MPLS-enabled interface to support various classes of service (CoS). These bandwidth constraints can be treated differently based on the requirement for the traffic class using that constraint.

The MPLS traffic engineering autotunnel mesh feature allows you to set up full mesh of TE tunnels automatically with a minimal set of MPLS traffic engineering configurations. The MPLS-TE auto bandwidth feature allows you to automatically adjust bandwidth based on traffic patterns without traffic disruption.

The MPLS-TE interarea tunneling feature allows you to establish TE tunnels spanning multiple Interior Gateway Protocol (IGP) areas and levels, thus eliminating the requirement that headend and tailend routers should reside in a single area.

For detailed information about MPLS-TE features, see [MPLS-TE Features - Details, on page 53](#).



Note MPLS-TE Nonstop Routing (NSR) is enabled by default without any user configuration and cannot be disabled. MPLS-TE NSR means the application is in hot-standby mode and standby MPLS-TE instance is ready to take over from the active instance quickly on RP failover.

Note that the MPLS-TE does not do routing. If there is standby card available then the MPLS-TE instance is in a hot-standby position.

The following output shows the status of MPLS-TE NSR:

```
Router#show mpls traffic-eng nsr status

TE Process Role          : V1 Active
Current Status           : Ready
  Ready since            : Tue Nov 01 10:42:34 UTC 2022 (1w3d ago)
  IDT started            : Tue Nov 01 03:28:48 UTC 2022 (1w3d ago)
  IDT ended              : Tue Nov 01 03:28:48 UTC 2022 (1w3d ago)
Previous Status          : Not ready
  Not ready reason       : Collaborator disconnected
  Not ready since        : Tue Nov 01 10:42:34 UTC 2022 (1w3d ago)
```

During any issues with the MPLS-TE, the NSR on the router gets affected which is displayed in the show redundancy output as follows:

```
Router#show mpls traffic-eng nsr status details
.
.
.

Current active rmf state: 4 (I_READY)
All standby not-ready bits clear - standby should be ready

Current active rmf state for NSR: Not ready
<jid> <node> <name> Reason for standby not NSR-ready
1082 0/RP0/CPU0 te_control TE NSR session not synchronized
Not ready set Wed Nov 19 17:28:14 2022: 5 hours, 23 minutes ago
1082 0/RP1/CPU0 te_control Standby not connected
Not ready set Wed Nov 19 17:29:11 2022: 5 hours, 22 minutes ago
```

How MPLS-TE Works

MPLS-TE automatically establishes and maintains label switched paths (LSPs) across the backbone by using RSVP. The path that an LSP uses is determined by the LSP resource requirements and network resources, such as bandwidth. Available resources are flooded by extensions to a link state based Interior Gateway Protocol (IGP). MPLS-TE tunnels are calculated at the LSP headend router, based on a fit between the required and available resources (constraint-based routing). The IGP automatically routes the traffic to these LSPs. Typically, a packet crossing the MPLS-TE backbone travels on a single LSP that connects the ingress point to the egress point.

The following sections describe the components of MPLS-TE:

Tunnel Interfaces

From a Layer 2 standpoint, an MPLS tunnel interface represents the headend of an LSP. It is configured with a set of resource requirements, such as bandwidth and media requirements, and priority. From a Layer 3 standpoint, an LSP tunnel interface is the headend of a unidirectional virtual link to the tunnel destination.

MPLS-TE Path Calculation Module

This calculation module operates at the LSP headend. The module determines a path to use for an LSP. The path calculation uses a link-state database containing flooded topology and resource information.

RSVP with TE Extensions

RSVP operates at each LSP hop and is used to signal and maintain LSPs based on the calculated path.

MPLS-TE Link Management Module

This module operates at each LSP hop, performs link call admission on the RSVP signaling messages, and keep track on topology and resource information to be flooded.

Link-state IGP

Either Intermediate System-to-Intermediate System (IS-IS) or Open Shortest Path First (OSPF) can be used as IGPs. These IGPs are used to globally flood topology and resource information from the link management module.

Label Switching Forwarding

This forwarding mechanism provides routers with a Layer 2-like ability to direct traffic across multiple hops of the LSP established by RSVP signaling.

Configuring MPLS-TE

MPLS-TE requires co-ordination among several global neighbor routers. RSVP, MPLS-TE and IGP are configured on all routers and interfaces in the MPLS traffic engineering network. Explicit path and TE tunnel interfaces are configured only on the head-end routers. MPLS-TE requires some basic configuration tasks explained in this section.

Building MPLS-TE Topology

Building MPLS-TE topology, sets up the environment for creating MPLS-TE tunnels. This procedure includes the basic node and interface configuration for enabling MPLS-TE. To perform constraint-based routing, you need to enable OSPF or IS-IS as IGP extension.

Before You Begin

Before you start to build the MPLS-TE topology, the following pre-requisites are required:

- Stable router ID is required at either end of the link to ensure that the link is successful. If you do not assign a router ID, the system defaults to the global router ID. Default router IDs are subject to change, which can result in an unstable link.

- Enable RSVP on the port interface.

Example

This example enables MPLS-TE on a node and then specifies the interface that is part of the MPLS-TE. Here, OSPF is used as the IGP extension protocol for information distribution.

```
RP/0/RP0/CPU0:router# configure
RP/0/RP0/CPU0:router(config)# mpls traffic-eng
RP/0/RP0/CPU0:router(config-mpls-te)# interface hundredGigE0/9/0/0
RP/0/RP0/CPU0:router(config)# router ospf area 1
RP/0/RP0/CPU0:router(config-ospf)# area 0
RP/0/RP0/CPU0:router(config-ospf-ar)# mpls traffic-eng
RP/0/RP0/CPU0:router(config-ospf-ar)# interface hundredGigE0/9/0/0
RP/0/RP0/CPU0:router(config-ospf-ar-if)# exit
RP/0/RP0/CPU0:router(config-ospf)# mpls traffic-eng router-id 192.168.70.1
RP/0/RP0/CPU0:router(config)# commit
```

Example

This example enables MPLS-TE on a node and then specifies the interface that is part of the MPLS-TE. Here, IS-IS is used as the IGP extension protocol for information distribution.

```
RP/0/RP0/CPU0:router# configure
RP/0/RP0/CPU0:router(config)# mpls traffic-eng
RP/0/RP0/CPU0:router(config-mpls-te)# interface hundredGigE0/9/0/0
RP/0/RP0/CPU0:router(config)# router isis 1
RP/0/RP0/CPU0:router(config-isis)# net 47.0001.0000.0000.0002.00
RP/0/RP0/CPU0:router(config-isis)# address-family ipv4 unicast
RP/0/RP0/CPU0:router(config-isis-af)# metric-style wide
RP/0/RP0/CPU0:router(config-isis-af)# mpls traffic-eng level 1
RP/0/RP0/CPU0:router(config-isis-af)# exit
RP/0/RP0/CPU0:router(config-isis)# interface hundredGigE0/9/0/0
RP/0/RP0/CPU0:router(config-isis-if)# exit
RP/0/RP0/CPU0:router(config)# commit
```

Related Topics

- [How MPLS-TE Works, on page 35](#)
- [Creating an MPLS-TE Tunnel, on page 37](#)

Creating an MPLS-TE Tunnel

Creating an MPLS-TE tunnel is a process of customizing the traffic engineering to fit your network topology. The MPLS-TE tunnel is created at the headend router. You need to specify the destination and path of the TE LSP.

To steer traffic through the tunnel, you can use the following ways:

- Static Routing
- Autoroute Announce
- Forwarding Adjacency

From the 7.1.1 release, IS-IS autoroute announce function is enhanced to redirect traffic from a source IP address prefix to a matching IP address assigned to an MPLS-TE tunnel destination interface.



Note Configuring Segment Routing and [Autoroute Destination](#) together is not supported. If autoroute functionality is required in an Segment Routing network, we recommend you to configure Autoroute Announce.

Before You Begin

The following prerequisites are required to create an MPLS-TE tunnel:

- You must have a router ID for the neighboring router.
- Stable router ID is required at either end of the link to ensure that the link is successful. If you do not assign a router ID to the routers, the system defaults to the global router ID. Default router IDs are subject to change, which can result in an unstable link.

Configuration Example

This example configures an MPLS-TE tunnel on the headend router with a destination IP address 192.168.92.125. The bandwidth for the tunnel, path-option, and forwarding parameters of the tunnel are also configured. You can use static routing, autoroute announce or forwarding adjacency to steer traffic through the tunnel.

```
RP/0/RP0/CPU0:router# configure
RP/0/RP0/CPU0:router(config)# interface tunnel-te 1
RP/0/RP0/CPU0:router(config-if)# destination 192.168.92.125
RP/0/RP0/CPU0:router(config-if)# ipv4 unnumbered Loopback0
RP/0/RP0/CPU0:router(config-if)# path-option 1 dynamic
RP/0/RP0/CPU0:router(config-if)# autoroute announce or forwarding adjacency
RP/0/RP0/CPU0:router(config-if)# signalled-bandwidth 100
RP/0/RP0/CPU0:router(config)# commit
```

Verification

Verify the configuration of MPLS-TE tunnel using the following command.

```
RP/0/RP0/CPU0:router# show mpls traffic-engineering tunnels brief

Signalling Summary:
  LSP Tunnels Process: running
  RSVP Process:       running
  Forwarding:         enabled
  Periodic reoptimization: every 3600 seconds, next in 2538 seconds
  Periodic FRR Promotion:  every 300 seconds, next in 38 seconds
  Auto-bw enabled tunnels: 0 (disabled)
  TUNNEL NAME           DESTINATION           STATUS  STATE
-----
  tunnel-te1           192.168.92.125       up      up
Displayed 1 up, 0 down, 0 recovering, 0 recovered heads
```

Automatic Modification Of An MPLS-TE Tunnel's Metric

If the IGP calculation on a router results in an equal cost multipath (ECMP) scenario where next-hop interfaces are a mix of MPLS-TE tunnels and physical interfaces, you may want to ensure that a TE tunnel is preferred. Consider this topology:

Figure 9: MPLS-TE Tunnel

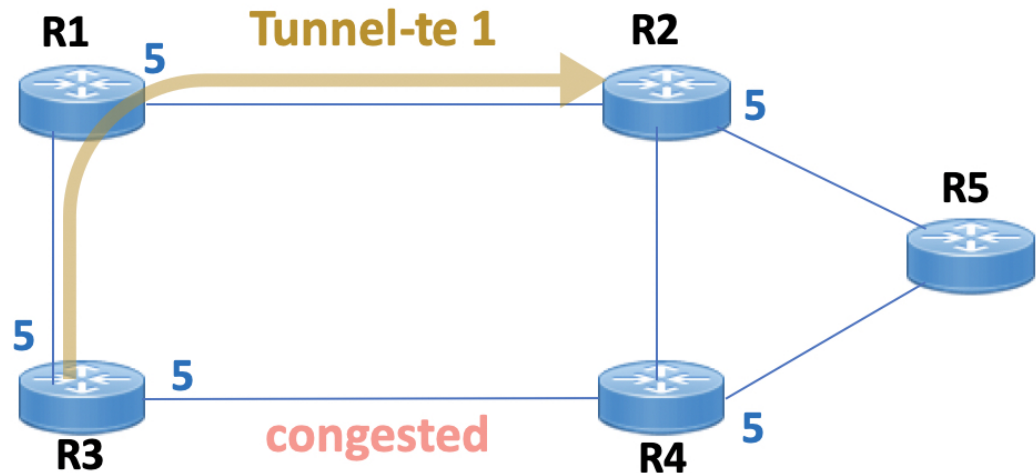

1. All links in the network have a metric of 5.
2. To offload a congested link between R3 and R4, an MPLS-TE tunnel is created from R3 to R2.
3. If the metric of the tunnel is also 5, traffic from R3 to R5 is load-balanced between the tunnel and the physical R3-R4 link.

To ensure that the MPLS-TE tunnel is preferred in such scenarios, configure the **autoroute metric** command on the tunnel interface. The modified metric is applied in the routing information base (RIB), and the tunnel is preferred over the physical path of the same metric. Sample configuration:

```
Router# configure
Router(config)# interface tunnel-te 1
Router(config-if)# autoroute metric relative -1
```

The **autoroute metric** command syntax is **autoroute metric {absolute|relative} value**

- **absolute** enables the absolute metric mode, for a metric range between 1 and 2147483647.
- **relative** enables the relative metric mode, for a metric range between -10 and 10, including zero.



Note Since the **relative** metric is not saved in the IGP database, the advertised metric of the MPLS-TE tunnel remains 5, and doesn't affect SPF calculation outcomes on other nodes.

Related Topics

- [How MPLS-TE Works, on page 35](#)
- [Building MPLS-TE Topology , on page 36](#)

Configuring Fast Reroute

Fast reroute (FRR) provides link protection to LSPs enabling the traffic carried by LSPs that encounter a failed link to be rerouted around the failure. The reroute decision is controlled locally by the router connected to the failed link. The headend router on the tunnel is notified of the link failure through IGP or through RSVP. When it is notified of a link failure, the headend router attempts to establish a new LSP that bypasses the failure. This provides a path to reestablish links that fail, providing protection to data transfer. The path of the backup tunnel can be an IP explicit path, a dynamically calculated path, or a semi-dynamic path. For detailed conceptual information on fast reroute, see [MPLS-TE Features - Details, on page 53](#)

Before You Begin

The following prerequisites are required to create an MPLS-TE tunnel:

- You must have a router ID for the neighboring router.
- Stable router ID is required at either end of the link to ensure that the link is successful. If you do not assign a router ID to the routers, the system defaults to the global router ID. Default router IDs are subject to change, which can result in an unstable link.

Configuration Example

This example configures fast reroute on an MPLS-TE tunnel. Here, tunnel-te 2 is configured as the back-up tunnel. You can use the **protected-by** command to configure path protection for an explicit path that is protected by another path.

```
RP/0/RP0/CPU0:router # configure
RP/0/RP0/CPU0:router(config)# interface tunnel-te 1
RP/0/RP0/CPU0:router(config-if)# fast-reroute
RP/0/RP0/CPU0:router(config-if)# exit
RP/0/RP0/CPU0:router(config)# mpls traffic-eng
RP/0/RP0/CPU0:router(config-mpls-te)# interface HundredGigabitEthernet0/0/1/0
RP/0/RP0/CPU0:router(config-mpls-te-if)# backup-path tunnel-te 2
RP/0/RP0/CPU0:router(config)# interface tunnel-te 2
RP/0/RP0/CPU0:router(config-if)# backup-bw global-pool 5000
RP/0/RP0/CPU0:router(config-if)# ipv4 unnumbered Loopback0
RP/0/RP0/CPU0:router(config-if)# destination 192.168.92.125
RP/0/RP0/CPU0:router(config-if)# path-option 1 explicit name backup-path protected by 10
RP/0/RP0/CPU0:router(config-if)# path-option 10 dynamic
RP/0/RP0/CPU0:router(config)# commit
```

Verification

Use the **show mpls traffic-eng fast-reroute database** command to verify the fast reroute configuration.

```
RP/0/RP0/CPU0:router# show mpls traffic-eng fast-reroute database
```

```
Tunnel head FRR information:
Tunnel      Out intf/label          FRR intf/label      Status
-----
tt4000      HundredGigabitEthernet 0/0/1/0:34          tt1000:34           Ready
tt4001      HundredGigabitEthernet 0/0/1/0:35          tt1001:35           Ready
tt4002      HundredGigabitEthernet 0/0/1/0:36          tt1001:36           Ready
```

Related Topics

- [Configuring MPLS-TE, on page 36](#)

- [Configuring Auto-Tunnel Backup, on page 41](#)
- [Configuring Next Hop Backup Tunnel, on page 42](#)
- [MPLS-TE Features - Details, on page 53](#)

Configuring Auto-Tunnel Backup

The MPLS Traffic Engineering Auto-Tunnel Backup feature enables a router to dynamically build backup tunnels on the interfaces that are configured with MPLS TE tunnels instead of building MPLS-TE tunnels statically.

The MPLS-TE Auto-Tunnel Backup feature has these benefits:

- Backup tunnels are built automatically, eliminating the need for users to pre-configure each backup tunnel and then assign the backup tunnel to the protected interface.
- Protection is expanded—FRR does not protect IP traffic that is not using the TE tunnel or Label Distribution Protocol (LDP) labels that are not using the TE tunnel.

The TE attribute-set template that specifies a set of TE tunnel attributes, is locally configured at the headend of auto-tunnels. The control plane triggers the automatic provisioning of a corresponding TE tunnel, whose characteristics are specified in the respective attribute-set.

Configuration Example

This example configures Auto-Tunnel backup on an interface and specifies the attribute-set template for the auto tunnels. In this example, unused backup tunnels are removed every 20 minutes using a timer and also the range of tunnel interface numbers are specified.

```
RP/0/RP0/CPU0:router # configure
RP/0/RP0/CPU0:router(config)# mpls traffic-eng
RP/0/RP0/CPU0:router(config-mpls-te)# interface HundredGigabitEthernet0/9/0/0
RP/0/RP0/CPU0:router(config-mpls-te-if)# auto-tunnel backup
RP/0/RP0/CPU0:router(config-mpls-te-if-auto-backup)# attribute-set ab
RP/0/RP0/CPU0:router(config-mpls-te)# auto-tunnel backup timers removal unused 20
RP/0/RP0/CPU0:router(config-mpls-te)# auto-tunnel backup tunnel-id min 6000 max 6500
RP/0/RP0/CPU0:router(config)# commit
```

Verification

This example shows a sample output for automatic backup tunnel configuration.

```
RP/0/RP0/CPU0:router# show mpls traffic-eng tunnels brief
```

| TUNNEL NAME | DESTINATION | STATUS | STATE |
|---------------------|------------------|-----------|-----------|
| tunnel-te0 | 200.0.0.3 | up | up |
| tunnel-te1 | 200.0.0.3 | up | up |
| tunnel-te2 | 200.0.0.3 | up | up |
| tunnel-te50 | 200.0.0.3 | up | up |
| *tunnel-te60 | 200.0.0.3 | up | up |
| *tunnel-te70 | 200.0.0.3 | up | up |
| *tunnel-te80 | 200.0.0.3 | up | up |

Related Topics

- [Configuring Fast Reroute , on page 40](#)

- [Configuring Next Hop Backup Tunnel, on page 42](#)
- [MPLS-TE Features - Details, on page 53](#)

Configuring Next Hop Backup Tunnel

The backup tunnels that bypass only a single link of the LSP path are referred as Next Hop (NHOP) backup tunnels because they terminate at the LSP's next hop beyond the point of failure. They protect LSPs, if a link along their path fails, by rerouting the LSP traffic to the next hop, thus bypassing the failed link.

Configuration Example

This example configures next hop backup tunnel on an interface and specifies the attribute-set template for the auto tunnels. In this example, unused backup tunnels are removed every 20 minutes using a timer and also the range of tunnel interface numbers are specified.

```
RP/0/RP0/CPU0:router # configure
RP/0/RP0/CPU0:router(config)# mpls traffic-eng
RP/0/RP0/CPU0:router(config-mpls-te)# interface HundredGigabitEthernet0/0/1/00/9/0/0
RP/0/RP0/CPU0:router(config-mpls-te-if)# auto-tunnel backup nhop-only
RP/0/RP0/CPU0:router(config-mpls-te-if-auto-backup)# attribute-set ab
RP/0/RP0/CPU0:router(config-mpls-te)# auto-tunnel backup timers removal unused 20
RP/0/RP0/CPU0:router(config-mpls-te)# auto-tunnel backup tunnel-id min 6000 max 6500
RP/0/RP0/CPU0:router(config)# commit
```

Related Topics

- [Configuring Auto-Tunnel Backup, on page 41](#)
- [Configuring Fast Reroute , on page 40](#)
- [MPLS-TE Features - Details, on page 53](#)

Configuring SRLG Node Protection

Shared Risk Link Groups (SRLG) in MPLS traffic engineering refer to situations in which links in a network share common resources. These links have a shared risk, and that is when one link fails, other links in the group might fail too.

OSPF and IS-IS flood the SRLG value information (including other TE link attributes such as bandwidth availability and affinity) using a sub-type length value (sub-TLV), so that all routers in the network have the SRLG information for each link.

MPLS-TE SRLG feature enhances backup tunnel path selection by avoiding using links that are in the same SRLG as the interfaces it is protecting while creating backup tunnels.

Configuration Example

This example creates a backup tunnel and excludes the protected node IP address from the explicit path.

```
RP/0/RP0/CPU0:router # configure
RP/0/RP0/CPU0:router(config)# mpls traffic-eng
RP/0/RP0/CPU0:router(config-mpls-te)# interface HundredGigabitEthernet0/9/0/0
RP/0/RP0/CPU0:router(config-mpls-te-if)# backup-path tunnel-te 2
RP/0/RP0/CPU0:router(config-mpls-te-if)# exit
```



```
RP/0/RP0/CPU0:router(config)# interface tunnel-te 2
RP/0/RP0/CPU0:router(config-if)# ipv4 unnumbered Loopback0
RP/0/RP0/CPU0:router(config-if)# path-option 1 explicit name backup-srlg
RP/0/RP0/CPU0:router(config-if)# destination 192.168.92.125
RP/0/RP0/CPU0:router(config-if)# exit
RP/0/RP0/CPU0:router(config)# explicit-path name backup-srlg-noddep
RP/0/RP0/CPU0:router(config-if)# index 1 exclude-address 192.168.91.1
RP/0/RP0/CPU0:router(config-if)# index 2 exclude-srlg 192.168.92.2
RP/0/RP0/CPU0:router(config)# commit
```

Related Topics

- [Configuring Fast Reroute](#) , on page 40
- [MPLS-TE Features - Details](#), on page 53

Configuring Pre-Standard DS-TE

Regular traffic engineering does not provide bandwidth guarantees to different traffic classes. A single bandwidth constraint is used in regular TE that is shared by all traffic. MPLS DS-TE enables you to configure multiple bandwidth constraints on an MPLS-enabled interface. These bandwidth constraints can be treated differently based on the requirement for the traffic class using that constraint. Cisco IOS XR software supports two DS-TE modes: Pre-standard and IETF. Pre-standard DS-TE uses the Cisco proprietary mechanisms for RSVP signaling and IGP advertisements. This DS-TE mode does not interoperate with third-party vendor equipment. Pre-standard DS-TE is enabled only after configuring the sub-pool bandwidth values on MPLS-enabled interfaces.

Pre-standard Diff-Serve TE mode supports a single bandwidth constraint model a Russian Doll Model (RDM) with two bandwidth pools: global-pool and sub-pool.

Before You Begin

The following prerequisites are required to configure a Pre-standard DS-TE tunnel.

- You must have a router ID for the neighboring router.
- Stable router ID is required at either end of the link to ensure that the link is successful. If you do not assign a router ID to the routers, the system defaults to the global router ID. Default router IDs are subject to change, which can result in an unstable link.

Configuration Example

This example configures a pre-standard DS-TE tunnel.

```
RP/0/RP0/CPU0:router # configure
RP/0/RP0/CPU0:router(config)# rsvp interface HundredGigabitEthernet 0/9/0/0
RP/0/RP0/CPU0:router(config-rsvp-if)# bandwidth 100 150 sub-pool 50
RP/0/RP0/CPU0:router(config-rsvp-if)# exit
RP/0/RP0/CPU0:router(config)# interface tunnel-te 2
RP/0/RP0/CPU0:router(config-if)# signalled bandwidth sub-pool 10
RP/0/RP0/CPU0:router(config)# commit
```

Verification

Use the **show mpls traffic-eng topology** command to verify the pre-standard DS-TE tunnel configuration.

Related Topics

- [Configuring an IETF DS-TE Tunnel Using RDM, on page 44](#)
- [Configuring an IETF DS-TE Tunnel Using MAM, on page 45](#)
- [MPLS-TE Features - Details, on page 53](#)

Configuring an IETF DS-TE Tunnel Using RDM

IETF DS-TE mode uses IETF-defined extensions for RSVP and IGP. This mode interoperates with third-party vendor equipment.

IETF mode supports multiple bandwidth constraint models, including Russian Doll Model (RDM) and Maximum Allocation Model (MAM), both with two bandwidth pools. In an IETF DS-TE network, identical bandwidth constraint models must be configured on all nodes.

Before you Begin

The following prerequisites are required to create an IETF mode DS-TE tunnel using RDM:

- You must have a router ID for the neighboring router.
- Stable router ID is required at either end of the link to ensure that the link is successful. If you do not assign a router ID to the routers, the system defaults to the global router ID. Default router IDs are subject to change, which can result in an unstable link.

Configuration Example

This example configures an IETF DS-TE tunnel using RDM.

```
RP/0/RP0/CPU0:router # configure
RP/0/RP0/CPU0:router(config)# rsvp interface HundredGigabitEthernet 0/9/0/0
RP/0/RP0/CPU0:router(config-rsvp-if)# bandwidth rdm 100 150
RP/0/RP0/CPU0:router(config-rsvp-if)# exit
RP/0/RP0/CPU0:router(config)# mpls traffic-eng
RP/0/RP0/CPU0:router(config-mpls-te)# ds-te mode ietf
RP/0/RP0/CPU0:router(config-mpls-te)# exit
RP/0/RP0/CPU0:router(config)# interface tunnel-te 2
RP/0/RP0/CPU0:router(config-if)# signalled bandwidth sub-pool 10
RP/0/RP0/CPU0:router(config)# commit
```

Verification

Use the **show mpls traffic-eng topology** command to verify the IETF DS-TE tunnel using RDM configuration.

Related Topics

- [Configuring Pre-Standard DS-TE, on page 43](#)
- [Configuring an IETF DS-TE Tunnel Using MAM, on page 45](#)

- [MPLS-TE Features - Details, on page 53](#)

Configuring an IETF DS-TE Tunnel Using MAM

IETF DS-TE mode uses IETF-defined extensions for RSVP and IGP. This mode interoperates with third-party vendor equipment. IETF mode supports multiple bandwidth constraint models, including Russian Doll Model (RDM) and Maximum Allocation Model (MAM), both with two bandwidth pools.

Configuration Example

This example configures an IETF DS-TE tunnel using MAM.

```
RP/0/RP0/CPU0:router # configure
RP/0/RP0/CPU0:router(config)# rsvp interface HundredGigabitEthernet 0/9/0/0
RP/0/RP0/CPU0:router(config-rsvp-if)# bandwidth mam max-reservable-bw 1000 bc0 600 bc1 400
RP/0/RP0/CPU0:router(config-rsvp-if)# exit
RP/0/RP0/CPU0:router(config)# mpls traffic-eng
RP/0/RP0/CPU0:router(config-mpls-te)# ds-te mode ietf
RP/0/RP0/CPU0:router(config-mpls-te)# ds-te bc-model mam
RP/0/RP0/CPU0:router(config-mpls-te)# exit
RP/0/RP0/CPU0:router(config)# interface tunnel-te 2
RP/0/RP0/CPU0:router(config-if)# signalled bandwidth sub-pool 10
RP/0/RP0/CPU0:router(config)# commit
```

Verification

Use the **show mpls traffic-eng topology** command to verify the IETF DS-TE tunnel using MAM configuration.

Related Topics

- [Configuring an IETF DS-TE Tunnel Using RDM, on page 44](#)
- [Configuring Pre-Standard DS-TE, on page 43](#)
- [MPLS-TE Features - Details, on page 53](#)

Configuring Flexible Name-Based Tunnel Constraints

MPLS-TE Flexible Name-based Tunnel Constraints provides a simplified and more flexible means of configuring link attributes and path affinities to compute paths for the MPLS-TE tunnels.

In traditional TE, links are configured with attribute-flags that are flooded with TE link-state parameters using Interior Gateway Protocols (IGPs), such as Open Shortest Path First (OSPF).

MPLS-TE Flexible Name-based Tunnel Constraints lets you assign, or map, up to 32 color names for affinity and attribute-flag attributes instead of 32-bit hexadecimal numbers. After mappings are defined, the attributes can be referred to by the corresponding color name.

Configuration Example

This example shows assigning a how to associate a tunnel with affinity constraints.

```
RP/0/RP0/CPU0:router# configure
RP/0/RP0/CPU0:router(config)# mpls traffic-eng
```

```

RP/0/RP0/CPU0:router(config-mpls-te)# affinity-map red 1
RP/0/RP0/CPU0:router(config-mpls-te)# interface HundredGigabitEthernet0/9/0/0
RP/0/RP0/CPU0:router(config-mpls-te-if)# attribute-names red
RP/0/RP0/CPU0:router(config)# interface tunnel-te 2
RP/0/RP0/CPU0:router(config-if)# affinity include red
RP/0/RP0/CPU0:router(config)# commit

```

Configuring Automatic Bandwidth

Automatic bandwidth allows you to dynamically adjust bandwidth reservation based on measured traffic. MPLS-TE automatic bandwidth monitors the traffic rate on a tunnel interface and resizes the bandwidth on the tunnel interface to align it closely with the traffic in the tunnel. MPLS-TE automatic bandwidth is configured on individual Label Switched Paths (LSPs) at every headend router.

The following table specifies the parameters that can be configured as part of automatic bandwidth configuration.

Table 1: Automatic Bandwidth Parameters

| Bandwidth Parameters | Description |
|--------------------------------|---|
| Application frequency | Configures how often the tunnel bandwidths changed for each tunnel. The default value is 24 hours. |
| Bandwidth limit | Configures the minimum and maximum automatic bandwidth to set on a tunnel. |
| Bandwidth collection frequency | Enables bandwidth collection without adjusting the automatic bandwidth. The default value is 5 minutes. |
| Overflow threshold | Configures tunnel overflow detection. |
| Adjustment threshold | Configures the tunnel-bandwidth change threshold to trigger an adjustment. |

Configuration Example

This example enables automatic bandwidth on MPLS-TE tunnel interface and configure the following automatic bandwidth variables.

- Application frequency
- Bandwidth limit
- Adjustment threshold
- Overflow detection

```

RP/0/RP0/CPU0:router# configure
RP/0/RP0/CPU0:router(config)# interface tunnel-te 1
RP/0/RP0/CPU0:router(config-if)# auto-bw
RP/0/RP0/CPU0:router(config-if-tunte-autobw)# application 1000
RP/0/RP0/CPU0:router(config-if-tunte-autobw)# bw-limit min 30 max 1000
RP/0/RP0/CPU0:router(config-if-tunte-autobw)# adjustment-threshold 50 min 800
RP/0/RP0/CPU0:router(config-if-tunte-autobw)# overflow threshold 100 limit 1
RP/0/RP0/CPU0:router(config)# commit

```

Verification

Verify the automatic bandwidth configuration using the **show mpls traffic-eng tunnels auto-bw brief** command.

```
RP/0/RP0/CPU0:router# show mpls traffic-eng tunnels auto-bw brief
```

| Tunnel Name | LSP ID | Last appl BW (kbps) | Requested BW (kbps) | Signalled BW (kbps) | Highest BW (kbps) | Application Time Left |
|-------------|--------|---------------------|---------------------|---------------------|-------------------|-----------------------|
| tunnel-te1 | | 5 | 500 | 300 | 420 | 1h 10m |

Related Topics

- [MPLS-TE Features - Details, on page 53](#)

Configuring Auto-Tunnel Mesh

The MPLS-TE auto-tunnel mesh (auto-mesh) feature allows you to set up full mesh of TE Point-to-Point (P2P) tunnels automatically with a minimal set of MPLS traffic engineering configurations. You can configure one or more mesh-groups and each mesh-group requires a destination-list (IPv4 prefix-list) listing destinations, which are used as destinations for creating tunnels for that mesh-group.

You can configure MPLS-TE auto-mesh type attribute-sets (templates) and associate them to mesh-groups. Label Switching Routers (LSRs) can create tunnels using the tunnel properties defined in this attribute-set.

Auto-Tunnel mesh configuration minimizes the initial configuration of the network. You can configure tunnel properties template and mesh-groups or destination-lists on TE LSRs that further creates full mesh of TE tunnels between those LSRs. It eliminates the need to reconfigure each existing TE LSR in order to establish a full mesh of TE tunnels whenever a new TE LSR is added in the network.

Configuration Example

This example configures an auto-tunnel mesh group and specifies the attributes for the tunnels in the mesh-group.

```
RP/0/RP0/CPU0:router # configure
RP/0/RP0/CPU0:router(config)# mpls traffic-eng
RP/0/RP0/CPU0:router(config-mpls-te)# auto-tunnel mesh
RP/0/RP0/CPU0:router(config-mpls-te-auto-mesh)# tunnel-id min 1000 max 2000
RP/0/RP0/CPU0:router(config-mpls-te-auto-mesh)# group 10
RP/0/RP0/CPU0:router(config-mpls-te-auto-mesh-group)# attribute-set 10
RP/0/RP0/CPU0:router(config-mpls-te-auto-mesh-group)# destination-list dl-65
RP/0/RP0/CPU0:router(config-mpls-te)# attribute-set auto-mesh 10
RP/0/RP0/CPU0:router(config-mpls-te-attribute-set)# autoroute announce
RP/0/RP0/CPU0:router(config-mpls-te-attribute-set)# auto-bw collect-bw-only
RP/0/RP0/CPU0:router(config)# commit
```

Verification

Verify the auto-tunnel mesh configuration using the **show mpls traffic-eng auto-tunnel mesh** command.

```
RP/0/RP0/CPU0:router# show mpls traffic-eng auto-tunnel mesh
```

```
Auto-tunnel Mesh Global Configuration:
  Unused removal timeout: 1h 0m 0s
  Configured tunnel number range: 1000-2000
```

```

Auto-tunnel Mesh Groups Summary:
  Mesh Groups count: 1
  Mesh Groups Destinations count: 3
  Mesh Groups Tunnels count:
    3 created, 3 up, 0 down, 0 FRR enabled

Mesh Group: 10 (3 Destinations)
  Status: Enabled
  Attribute-set: 10
  Destination-list: dl-65 (Not a prefix-list)
  Recreate timer: Not running
  -----
  Destination      Tunnel ID      State      Unused timer
  -----
  192.168.0.2      1000          up        Not running
  192.168.0.3      1001          up        Not running
  192.168.0.4      1002          up        Not running
  Displayed 3 tunnels, 3 up, 0 down, 0 FRR enabled

Auto-mesh Cumulative Counters:
  Last cleared: Wed Oct  3 12:56:37 2015 (02:39:07 ago)
  Total
  Created:          3
  Connected:        0
  Removed (unused): 0
  Removed (in use): 0
  Range exceeded:   0

```

Configuring an MPLS Traffic Engineering Interarea Tunneling

The MPLS TE Interarea Tunneling feature allows you to establish MPLS TE tunnels that span multiple Interior Gateway Protocol (IGP) areas and levels. This feature removes the restriction that required the tunnel headend and tailend routers both to be in the same area. The IGP can be either Intermediate System-to-Intermediate System (IS-IS) or Open Shortest Path First (OSPF). To configure an inter-area tunnel, you specify on the headend router a loosely routed explicit path for the tunnel label switched path (LSP) that identifies each area border router (ABR) the LSP should traverse using the next-address loose command. The headend router and the ABRs along the specified explicit path expand the loose hops, each computing the path segment to the next ABR or tunnel destination.

Configuration Example

This example configures an IPv4 explicit path with ABR configured as loose address on the headend router.

```

Router# configure
Router(config)# explicit-path name interareal
Router(config-expl-path)# index 1 next-address loose ipv4 unicast 172.16.255.129
Router(config-expl-path)# index 2 next-address loose ipv4 unicast 172.16.255.131
Router(config)# interface tunnel-tel
Router(config-if)# ipv4 unnumbered Loopback0
Router(config-if)# destination 172.16.255.2
Router(config-if)# path-option 10 explicit name interareal
Router(config)# commit

```

Configure Policy-Based Tunnel Selection

Configuring PBTS is a process of directing incoming traffic into specific TE tunnels based on a classification criteria (DSCP). The traffic forwarding decisions are made based on the categorized traffic classes and the

destination network addresses. The following section lists the steps to configure PBTS on a MPLS-TE Tunnel network:

1. Define a class-map based on a classification criteria.
2. Define a policy-map by creating rules for the classified traffic.
3. Associate a forward-class to each type of ingress traffic.
4. Enable PBTS on the ingress interface, by applying this service-policy.
5. Create one or more egress MPLS-TE Tunnels (to carry packets based on priority) to the destination.
6. Associate the egress MPLS-TE Tunnel to a forward-class.

For more information on PBTS, see [Policy-Based Tunnel Selection](#), on page 56 in the *Implementing MPLS Traffic Engineering* chapter.

Configuration Example

The following section illustrates PBTS implementation:

```
RP/0/RP0/CPU0:router#configure
/* Class-map; classification using DSCP */
RP/0/RP0/CPU0:router(config)# class-map match-any AF41-Class
RP/0/RP0/CPU0:router(config-cmap)# match dscp AF41
RP/0/RP0/CPU0:router(config-cmap)# exit

/* Policy-map */
RP/0/RP0/CPU0:router(config)# policy-map INGRESS-POLICY
RP/0/RP0/CPU0:router(config-pmap)# class AF41-Class
/* Associating forward class */
RP/0/RP0/CPU0:router(config-pmap-c)# set forward-class 1
RP/0/RP0/CPU0:router(config-pmap-c)# exit
RP/0/RP0/CPU0:router(config-pmap)# exit

RP/0/RP0/CPU0:router(config)# interface GigabitEthernet0/9/0/0
/* Applying service-policy to ingress interface */
RP/0/RP0/CPU0:router(config-if)# service-policy input INGRESS-POLICY
RP/0/RP0/CPU0:router(config-if)# ipv4 address 10.1.1.1 255.255.255.0
RP/0/RP0/CPU0:router(config-if)# exit

/* Creating TE-tunnels to carry traffic based on priority */
RP/0/RP0/CPU0:router(config)# interface tunnel-te61
RP/0/RP0/CPU0:router(config-if)# ipv4 unnumbered Loopback0
RP/0/RP0/CPU0:router(config-if)# signalled-bandwidth 1000
RP/0/RP0/CPU0:router(config-if)# autoroute announce
RP/0/RP0/CPU0:router(config-if)# destination 10.20.20.1
RP/0/RP0/CPU0:router(config-if)# record route

/* Associating egress TE tunnels to forward class */
RP/0/RP0/CPU0:router(config-if)# forward-class 1
RP/0/RP0/CPU0:router(config-if)# path-option 1 explicit identifier 61
RP/0/RP0/CPU0:router(config-if)# exit
```

Verification

Use `show mpls forwarding tunnels` command to verify the PBTS configuration:

```
RP/0/RP0/CPU0:ios# show mpls forwarding tunnels 10 detail
Tue May 16 01:18:19.681 UTC
```

```

Tunnel      Outgoing      Outgoing      Next Hop      Bytes
Name        Label          Interface     Next Hop      Switched
-----
tt10        Exp-Null-v4   Te0/0/0/16   20.20.17.21   0
Updated: May 11 19:31:54.716
Version: 483, Priority: 2
Label Stack (Top -> Bottom): { 0 }
NHID: 0x0, Encap-ID: N/A, Path idx: 0, Backup path idx: 0, Weight: 0
MAC/Encaps: 14/18, MTU: 1500
Packets Switched: 0

Interface:
Name: tunnel-te10 (ifhandle 0x0800005c)
Local Label: 64016, Forwarding Class: 1, Weight: 0

Packets/Bytes Switched: 0/0

```

Configuring LDP over MPLS-TE

LDP and RSVP-TE are signaling protocols used for establishing LSPs in MPLS networks. While LDP is easy to configure and reliable, it lacks the traffic engineering capabilities of RSVP that helps to avoid traffic congestions. LDP over MPLS-TE feature combines the benefits of both LDP and RSVP. In LDP over MPLS-TE, an LDP signalled label-switched path (LSP) runs through a TE tunnel established using RSVP-TE.

The following diagram explains a use case for LDP over MPLS-TE. In this diagram, LDP is used as the signalling protocol between provider edge (PE) router and provider (P) router. RSVP-TE is used as the signalling protocol between the P routers to establish an LSP. LDP is tunneled over the RSVP-TE LSP.

Figure 10: LDP over MPLS-TE

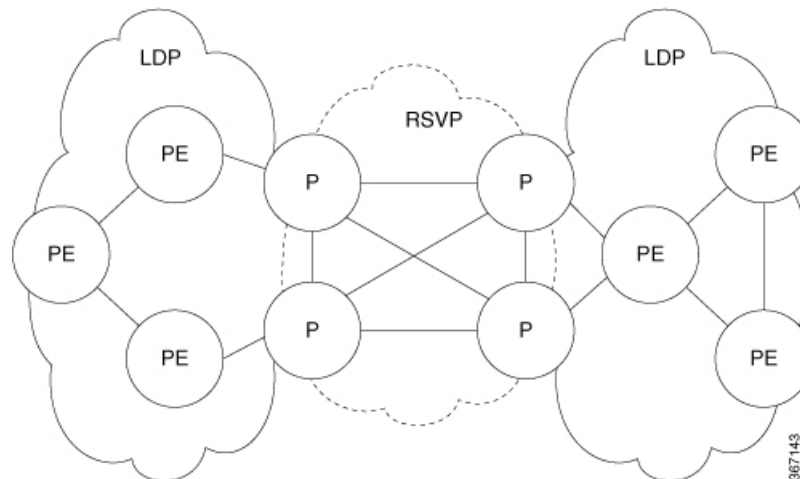

Restrictions and Guidelines for LDP over MPLS-TE

The following restrictions and guidelines apply for this feature in Cisco IOS-XR release 6.3.2:

- MPLS services over LDP over MPLS-TE are supported when BGP neighbours are on the head or tail node of the TE tunnel.
- MPLS services over LDP over MPLS-TE are supported when the TE headend router is acting as transit point for that service.

- If MPLS services are originating from the TE headend, but the TE tunnel is ending before the BGP peer, LDP over MPLS-TE feature is not supported.
- If LDP optimization is enabled using the **hw-module fib mpls ldp lsr-optimized** command, the following restrictions apply:
 - EVPN is not supported.
 - For any prefix or label all outgoing paths has to be LDP enabled.
- Do not use the **hw-module fib mpls ldp lsr-optimized** command on a Provider Edge (PE) router because already configured features such as EVPN, MPLS-VPN, and L2VPN might not work properly.

Configuration Example:

This example shows how to configure an MPLS-TE tunnel from provider router P1 to P2 and then enable LDP over MPLS-TE. In this example, the destination of the tunnel from P1 is configured as the loop back for P2.

```
RP/0/RP0/CPU0:router # configure
RP/0/RP0/CPU0:router(config)# interface tunnel-te 1
RP/0/RP0/CPU0:router(config-if)# ipv4 unnumbered Loopback0
RP/0/RP0/CPU0:router(config-if)# autoroute announce
RP/0/RP0/CPU0:router(config-if)# destination 4.4.4.4
RP/0/RP0/CPU0:router(config-if)# path-option 1 dynamic
RP/0/RP0/CPU0:router(config-if)# exit
RP/0/RP0/CPU0:Router(config)# mpls ldp
RP/0/RP0/CPU0:Router(config-ldp)# router-id 192.168.1.1
RP/0/RP0/CPU0:Router(config-ldp)# interface TenGigE 0/0/0/0
RP/0/RP0/CPU0:Router(config-ldp-if)# interface tunnel-te 1
RP/0/RP0/CPU0:Router(config-ldp-if)# exit
```

Configuring MPLS-TE Path Protection

Path protection provides an end-to-end failure recovery mechanism for MPLS-TE tunnels. A secondary Label Switched Path (LSP) is established, in advance, to provide failure protection for the protected LSP that is carrying a tunnel's TE traffic. When there is a failure on the protected LSP, the source router immediately enables the secondary LSP to temporarily carry the tunnel's traffic. Failover is triggered by a RSVP error message sent to the LSP head end. Once the head end received this error message, it switches over to the secondary tunnel. If there is a failure on the secondary LSP, the tunnel no longer has path protection until the failure along the secondary path is cleared. Path protection can be used within a single area (OSPF or IS-IS), external BGP [eBGP], and static routes. Both the explicit and dynamic path-options are supported for the MPLS-TE path protection feature. You should make sure that the same attributes or bandwidth requirements are configured on the protected option.

Before You Begin

The following prerequisites are required for enabling path protection.

- You should ensure that your network supports MPLS-TE, Cisco Express Forwarding, and Intermediate System-to-Intermediate System (IS-IS) or Open Shortest Path First (OSPF).
- You should configure MPLS-TE on the routers.

Configuration Example

This example configures how to configure path protection for a mpls-te tunnel. The primary path-option should be present to configure path protection. In this configuration, R1 is the headend router and R3 is the tailend router for the tunnel while R2 and R4 are mid-point routers. In this example, 6 explicit paths and 1 dynamic path is created for path protection. You can have upto 8 path protection options for a primary path.

```
RP/0/RP0/CPU0:router # configure
RP/0/RP0/CPU0:router(config)# interface tunnel-te 0
RP/0/RP0/CPU0:router(config-if)# destination 192.168.3.3
RP/0/RP0/CPU0:router(config-if)# ipv4 unnumbered Loopback0
RP/0/RP0/CPU0:router(config-if)# autoroute announce
RP/0/RP0/CPU0:router(config-if)# path-protection
RP/0/RP0/CPU0:router(config-if)# path-option 1 explicit name r1-r2-r3-00 protected-by 2
RP/0/RP0/CPU0:router(config-if)# path-option 2 explicit name r1-r2-r3-01 protected-by 3
RP/0/RP0/CPU0:router(config-if)# path-option 3 explicit name r1-r4-r3-01 protected-by 4
RP/0/RP0/CPU0:router(config-if)# path-option 4 explicit name r1-r3-00 protected-by 5
RP/0/RP0/CPU0:router(config-if)# path-option 5 explicit name r1-r2-r4-r3-00 protected-by 6
RP/0/RP0/CPU0:router(config-if)# path-option 6 explicit name r1-r4-r2-r3-00 protected-by 7
RP/0/RP0/CPU0:router(config-if)# path-option 7 dynamic
RP/0/RP0/CPU0:router(config-if)# exit
RP/0/RP0/CPU0:router(config)# commit
```

Verification

Use the **show mpls traffic-eng tunnels** command to verify the MPLS-TE path protection configuration.

```
RP/0/RP0/CPU0:router# show mpls traffic-eng tunnels 0
Fri Oct 13 16:24:39.379 UTC
Name: tunnel-te0 Destination: 192.168.92.125 Ifhandle:0x8007d34
Signalled-Name: router
Status:
  Admin:    up Oper:    up Path:    valid Signalling: connected
  path option 1, type explicit r1-r2-r3-00 (Basis for Setup, path weight 2)
    Protected-by PO index: 2
  path option 2, type explicit r1-r2-r3-01 (Basis for Standby, path weight 2)
    Protected-by PO index: 3
  path option 3, type explicit r1-r4-r3-01
    Protected-by PO index: 4
  path option 4, type explicit r1-r3-00
    Protected-by PO index: 5
  path option 5, type explicit r1-r2-r4-r3-00
    Protected-by PO index: 6
  path option 6, type explicit r1-r4-r2-r3-00
    Protected-by PO index: 7
  path option 7, type dynamic
G-PID: 0x0800 (derived from egress interface properties)
Bandwidth Requested: 0 kbps CT0
Creation Time: Fri Oct 13 15:05:28 2017 (01:19:11 ago)
Config Parameters:
  Bandwidth:    0 kbps (CT0) Priority:  7 7 Affinity: 0x0/0xffff
  Metric Type: TE (global)
  Path Selection:
    Tiebreaker: Min-fill (default)
  Hop-limit: disabled
  Cost-limit: disabled
  Delay-limit: disabled
  Path-invalidation timeout: 10000 msec (default), Action: Tear (default)
  AutoRoute: enabled LockDown: disabled Policy class: not set
  Forward class: 0 (not enabled)
  Forwarding-Adjacency: disabled
  Autoroute Destinations: 0
  Loadshare:    0 equal loadshares
```

```

Auto-bw: disabled
Fast Reroute: Disabled, Protection Desired: None
Path Protection: Enabled
BFD Fast Detection: Disabled
Reoptimization after affinity failure: Enabled
Soft Preemption: Disabled
History:
Tunnel has been up for: 01:14:13 (since Fri Oct 13 15:10:26 UTC 2017)
Current LSP:
  Uptime: 01:14:13 (since Fri Oct 13 15:10:26 UTC 2017)
Reopt. LSP:
  Last Failure:
    LSP not signalled, identical to the [CURRENT] LSP
    Date/Time: Fri Oct 13 15:08:41 UTC 2017 [01:15:58 ago]
Standby Reopt LSP:
  Last Failure:
    LSP not signalled, identical to the [STANDBY] LSP
    Date/Time: Fri Oct 13 15:08:41 UTC 2017 [01:15:58 ago]
    First Destination Failed: 192.3.3.3
Prior LSP:
  ID: 8 Path Option: 1
  Removal Trigger: path protection switchover
Standby LSP:
  Uptime: 01:13:56 (since Fri Oct 13 15:10:43 UTC 2017)
Path info (OSPF 1 area 0):
Node hop count: 2
Hop0: 192.168.1.2
Hop1: 192.168.3.1
Hop2: 192.168.3.2
Hop3: 192.168.3.3
Standby LSP Path info (OSPF 1 area 0), Oper State: Up :
Node hop count: 2
Hop0: 192.168.2.2
Hop1: 192.168.3.1
Hop2: 192.168.3.2
Hop3: 192.168.3.3
Displayed 1 (of 4001) heads, 0 (of 0) midpoints, 0 (of 0) tails
Displayed 1 up, 0 down, 0 recovering, 0 recovered heads

```

MPLS-TE Features - Details

MPLS TE Fast Reroute Link and Node Protection

Fast Reroute (FRR) is a mechanism for protecting MPLS TE LSPs from link and node failures by locally repairing the LSPs at the point of failure, allowing data to continue to flow on them while their headend routers try to establish new end-to-end LSPs to replace them. FRR locally repairs the protected LSPs by rerouting them over backup tunnels that bypass failed links or node.



Note If FRR is greater than 50ms, it might lead to a loss of traffic.

Backup tunnels that bypass only a single link of the LSP's path provide link protection. They protect LSPs if a link along their path fails by rerouting the LSP's traffic to the next hop (bypassing the failed link). These tunnels are referred to as next-hop (NHOP) backup tunnels because they terminate at the LSP's next hop beyond the point of failure.

The following figure illustrates link protection.

Figure 11: Link Protection

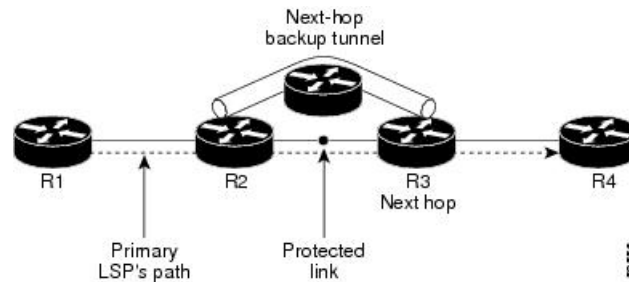

FRR provides node protection for LSPs. Backup tunnels that bypass next-hop nodes along LSP paths are called next-next-hop (NNHOP) backup tunnels because they terminate at the node following the next-hop node of the LSP paths, bypassing the next-hop node. They protect LSPs if a node along their path fails by enabling the node upstream of the failure to reroute the LSPs and their traffic around the failed node to the next-next hop. NNHOP backup tunnels also provide protection from link failures, because they bypass the failed link and the node.

The following figure illustrates node protection.

Figure 12: Node Protection

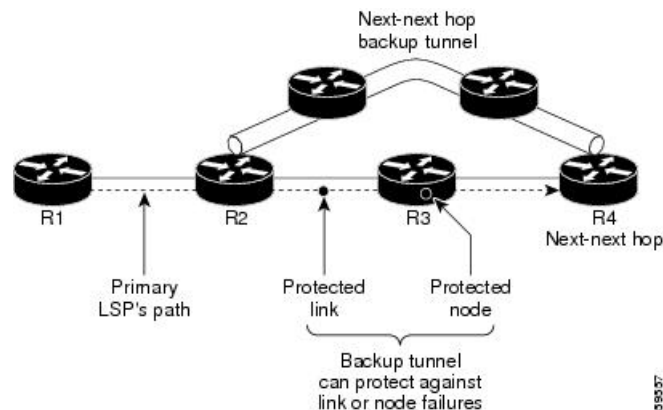

MPLS-TE Forwarding Adjacency

MPLS TE forwarding adjacency allows you to handle a TE label-switched path (LSP) tunnel as a link in an Interior Gateway Protocol (IGP) network that is based on the Shortest Path First (SPF) algorithm. Both Intermediate System-to-Intermediate System (IS-IS) and Open Shortest Path First (OSPF) are supported as the IGP. A forwarding adjacency can be created between routers regardless of their location in the network. The routers can be located multiple hops from each other.

As a result, a TE tunnel is advertised as a link in an IGP network with the tunnel's cost associated with it. Routers outside of the TE domain see the TE tunnel and use it to compute the shortest path for routing traffic throughout the network. TE tunnel interfaces are advertised in the IGP network just like any other links. Routers can then use these advertisements in their IGPs to compute the SPF even if they are not the headend of any TE tunnels.

Automatic Bandwidth

Automatic bandwidth allows you to dynamically adjust bandwidth reservation based on measured traffic. MPLS-TE automatic bandwidth is configured on individual Label Switched Paths (LSPs) at every headend router. MPLS-TE automatic bandwidth monitors the traffic rate on a tunnel interface and resizes the bandwidth on the tunnel interface to align it closely with the traffic in the tunnel.

MPLS-TE automatic bandwidth can perform these functions:

- Monitors periodic polling of the tunnel output rate
- Resizes the tunnel bandwidth by adjusting the highest rate observed during a given period.

For every traffic-engineered tunnel that is configured for an automatic bandwidth, the average output rate is sampled, based on various configurable parameters. Then, the tunnel bandwidth is readjusted automatically based on either the largest average output rate that was noticed during a certain interval, or a configured maximum bandwidth value.

While re-optimizing the LSP with the new bandwidth, a new path request is generated. If the new bandwidth is not available, the last good LSP remains used. This way, the network experiences no traffic interruptions. If minimum or maximum bandwidth values are configured for a tunnel, the bandwidth, which the automatic bandwidth signals, stays within these values.

The output rate on a tunnel is collected at regular intervals that are configured by using the **application** command in MPLS-TE auto bandwidth interface configuration mode. When the application period timer expires, and when the difference between the measured and the current bandwidth exceeds the adjustment threshold, the tunnel is re-optimized. Then, the bandwidth samples are cleared to record the new largest output rate at the next interval. If a tunnel is shut down, and is later brought again, the adjusted bandwidth is lost, and the tunnel is brought back with the initially configured bandwidth. When the tunnel is brought back, the application period is reset.

MPLS Traffic Engineering Interarea Tunneling

The MPLS-TE interarea tunneling feature allows you to establish TE tunnels spanning multiple Interior Gateway Protocol (IGP) areas and levels, thus eliminating the requirement that headend and tailend routers reside in a single area.

Interarea support allows the configuration of a TE LSP that spans multiple areas, where its headend and tailend label switched routers (LSRs) reside in different IGP areas. Customers running multiple IGP area backbones (primarily for scalability reasons) requires Multiarea and Interarea TE . This lets you limit the amount of flooded information, reduces the SPF duration, and lessens the impact of a link or node failure within an area, particularly with large WAN backbones split in multiple areas.

The following figure shows a typical interarea TE network using OSPF.

Figure 13: Interarea (OSPF) TE Network Diagram

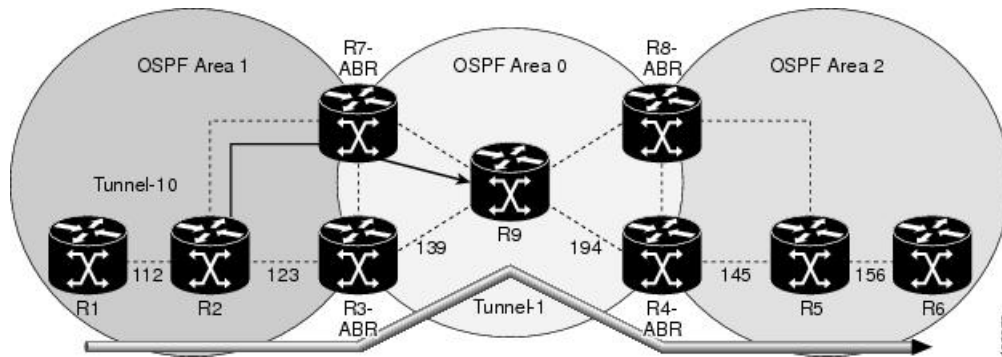

The following figure shows a typical interlevel (IS-IS) TE Network.

Figure 14: Interlevel (IS-IS) TE Network Diagram

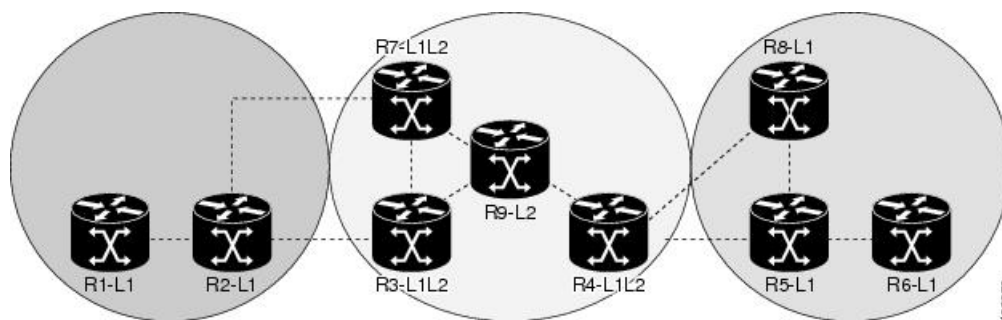

As shown in the [Figure 14: Interlevel \(IS-IS\) TE Network Diagram, on page 56](#), R2, R3, R7, and R4 maintain two databases for routing and TE information. For example, R3 has TE topology information related to R2, flooded through Level-1 IS-IS LSPs plus the TE topology information related to R4, R9, and R7, flooded as Level 2 IS-IS Link State PDUs (LSPs) (plus, its own IS-IS LSP).

Loose hop optimization allows the re-optimization of tunnels spanning multiple areas and solves the problem which occurs when an MPLS-TE LSP traverses hops that are not in the LSP's headend's OSPF area and IS-IS level. Interarea MPLS-TE allows you to configure an interarea traffic engineering (TE) label switched path (LSP) by specifying a loose source route of ABRs along the path. Then it is the responsibility of the ABR (having a complete view of both areas) to find a path obeying the TE LSP constraints within the next area to reach the next hop ABR (as specified on the headend router). The same operation is performed by the last ABR connected to the tailend area to reach the tailend LSR.

You must be aware of these considerations when using loose hop optimization:

- You must specify the router ID of the ABR node (as opposed to a link address on the ABR).
- When multiarea is deployed in a network that contains subareas, you must enable MPLS-TE in the subarea for TE to find a path when loose hop is specified.
- You must specify the reachable explicit path for the interarea tunnel.

Policy-Based Tunnel Selection

Policy-Based Tunnel Selection (PBTS) is a mechanism that lets you direct traffic into specific TE tunnels based on different classification criteria. PBTS will benefit Internet service providers (ISPs) that carry voice

and data traffic through their MPLS and MPLS/VPN networks and would have to route this traffic to provide optimized voice service.

PBTS works by selecting tunnels based on the classification criteria of the incoming packets, which are based on the IP precedence or differentiated services code point (DSCP), or the Type of Service (ToS) fields in the packets. The traffic forwarding decisions are made based on the traffic classes AND the destination network addresses instead of only considering the destination network.

Default-class configured for paths is always zero (0). If there is no TE for a given forward-class, then the default-class (0) will be tried. If there is no default-class, then the packet is tried against the lowest configured forward-class tunnels. PBTS supports up to seven (exp 1 - 7) EXP values associated with a single TE-tunnel.

The following figure illustrates PBTS Network Topology:

Figure 15: Policy-Based Tunnel Selection Implementation

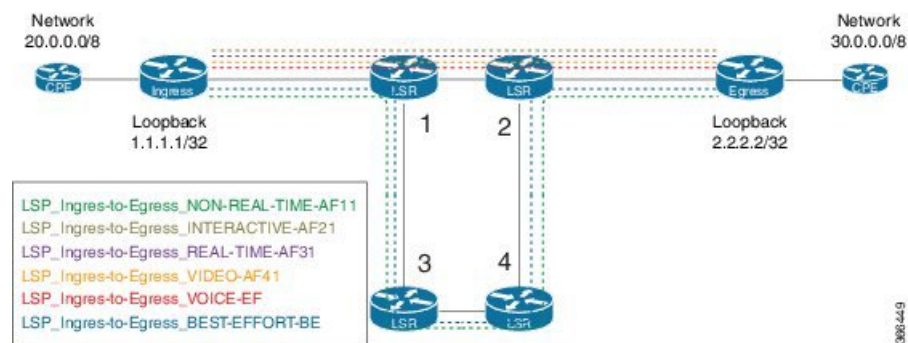

- Tunnels are created between Ingress and Egress nodes through LSR 1-2 and LSR 1-3-4-2 paths.
- High priority traffic takes the path: Ingress->LSR1->LSR2->Egress.
- Low priority traffic takes the path: Ingress->LSR1->LSR3->LSR4->LSR2->Egress

PBTS Function Details

The following PBTS functions are supported on the router:

- Classify the Ingress traffic into different classes by creating rules using PBR configuration.
- Classify packets using DSCP/IP precedence for both IPv4 and IPv6 traffic.
- After classification, set the desired forward-class to each type of Ingress traffic.
- Define one or many MPLS-TE tunnels in the destination using Tunnel configuration.
- Associate the MPLS-TE tunnels to a specific forward-class under Tunnel configuration.
- Enable PBTS on the Ingress interface by applying the service policy that uses the configured classification rules.

The following list gives PBTS support information:

- PBTS is supported only on Ipv4/Ipv6 incoming traffic only.
- A maximum of eight forward-classes per destination prefix is supported.
- A maximum of 64 TE-tunnels within each forward class is supported.

- A maximum of 64 TE-tunnels can be configured on a given destination.
- Incoming labeled traffic is not supported.
- PBTS with L2VPN/L3VPN traffic is not supported.

PBTS Forward Class

A class-map is defined for various types of packets and these class-maps are associated with a forward-class. A class-map defines the matching criteria for classifying a particular type of traffic and a forward-class defines the forwarding path these packets should take.

After a class-map is associated with a forwarding-class in the policy map, all the packets that match the class-map are forwarded as defined in the policy-map. The egress traffic engineering (TE) tunnel interfaces that the packets should take for each forwarding-class is specified by associating the TE interface explicitly (or implicitly in case of default value) with the forward-group.

When the TE interfaces are associated with the forward-class, they can be exported to the routing protocol module using the **auto-route** command. This will then associate the route in the FIB database with these tunnels. If the TE interface is not explicitly associated with a forward-class, it gets associated with a default-class (0). All non-TE interfaces will be routed to the forwarding plane (with forward-class set to default-class) by the routing protocol.

UCMP Over MPLS-TE

In Equal Cost Multi Path (ECMP), you can load-balance routed traffic over multiple paths of the same cost. With Unequal-Cost Multipath (UCMP), you can load-balance traffic over multiple paths of varying costs.

Consider three forwarding links, with two 10 Gigabit Ethernet links and a 100 Gigabit Ethernet link, as shown in the image.

In such a scenario, the incoming traffic load is not equally distributed using ECMP. On the other hand, UCMP applies a weight to a path, and adds more forwarding instances to a path that has a higher weight (larger bandwidth). This results in an equal load distribution over paths of varying bandwidths (and costs).

Configuration Example

UCMP Configuration:

```
R1# configure
R1(config)# mpls traffic-eng
R1(config-mpls-te)# load-share unequal
R1(config-mpls-te)# commit
```

Tunnels Configuration:

```
R1(config)# interface tunnel-te 1
R1(config-if)# ipv4 unnumbered loopback 1
R1(config-if)# load-share 5
R1(config-if)# autoroute announce
R1(config-if-tunte-aa)# commit
R1(config-if-tunte-aa)# exit
R1(config-if)# destination 172.16.0.1
R1(config-if)# path-option 1 dynamic

R1(config)# interface tunnel-te 2
```



```
R1(config-if)# ipv4 address 192.168.0.1 255.255.255.0
R1(config-if)# load-share 6
R1(config-if)# autoroute announce
R1(config-if-tunte-aa)# commit
R1(config-if-tunte-aa)# exit
R1(config-if)# destination 172.16.0.1
R1(config-if)# path-option 1 dynamic
```

Associated Commands

- [load-share](#)
- [load-share unequal](#)
- [show cef](#)

Verification

Verify UCMP Configuration:

```
R1# show cef 172.16.0.1 detail

172.16.0.1/32, version 16, internal 0x1000001 0x0 (ptr 0x97dela58) [1], 0x0 (0x97fa3728),
0xa20 (0x98fc00a8)
  Updated Jun 17 16:07:46.325
  Prefix Len 32, traffic index 0, precedence n/a, priority 3
  gateway array (0x97e0ba08) reference count 3, flags 0x68, source lsd (5), 1 backups
    [3 type 4 flags 0x8401 (0x9849f728) ext 0x0 (0x0)]
  LW-LDI[type=1, refc=1, ptr=0x97fa3728, sh-ldi=0x9849f728]
  gateway array update type-time 1 Jun 17 16:07:46.325
  LDI Update time Jun 17 16:07:46.350
  LW-LDI-TS Jun 17 16:07:46.350
    via 172.16.0.1/32, tunnel-te1, 5 dependencies, weight 100, class 0 [flags 0x0]
      path-idx 0 NHID 0x0 [0x98e19380 0x98e192f0]
      next hop 172.16.0.1/32
      local adjacency
        local label 24001      labels imposed {ImplNull}
    via 172.16.0.1/32, tunnel-te2, 7 dependencies, weight 10, class 0 [flags 0x0]
      path-idx 1 NHID 0x0 [0x98e194a0 0x98e19410]
      next hop 172.16.0.1/32
      local adjacency
        local label 24001      labels imposed {ImplNull}

  Weight distribution:

  slot 0, weight 100, normalized_weight 10, class 0
  slot 1, weight 10, normalized_weight 1, class 0
  Load distribution: 0 0 0 0 0 0 0 0 0 0 1 (refcount 3)

  Hash  OK  Interface      Address
  0     Y   tunnel-te1     point2point
  1     Y   tunnel-te1     point2point
  2     Y   tunnel-te1     point2point
  3     Y   tunnel-te1     point2point
  4     Y   tunnel-te1     point2point
  5     Y   tunnel-te1     point2point
  6     Y   tunnel-te1     point2point
  7     Y   tunnel-te1     point2point
  8     Y   tunnel-te1     point2point
  9     Y   tunnel-te1     point2point
  10    Y   tunnel-te2     point2point
```

Some sample output:

```

Router# show run formal mpls traffic-eng

mpls traffic-eng
mpls traffic-eng interface Bundle-Ether2
mpls traffic-eng interface Bundle-Ether3
..
mpls traffic-eng load-share unequal
mpls traffic-eng reoptimize 180
mpls traffic-eng signalling advertise explicit-null
mpls traffic-eng reoptimize timers delay path-protection 60

Router# show run formal interface tunnel-te400

interface tunnel-te400
interface tunnel-te400 description TE-STI-GRTMIABR5-GRTBUEBA3-BW-0
interface tunnel-te400 ipv4 unnumbered Loopback0
interface tunnel-te400 load-interval 30
interface tunnel-te400 signalled-name TE-STI-GRTMIABR5-GRTBUEBA3-BW-0
interface tunnel-te400 load-share 80
interface tunnel-te400 autoroute destination 94.142.100.214
interface tunnel-te400 destination 94.142.100.214
interface tunnel-te400 path-protection
interface tunnel-te400 path-option 1 explicit name BR5-BA3-0 protected-by 2
interface tunnel-te400 path-option 2 explicit name BW-BR5-1-VAP3-BA3-0
interface tunnel-te400 path-option 3 explicit name BW-BR5-VAP3-BA3-0

Router# show run formal interface tunnel-te406

interface tunnel-te406
interface tunnel-te406 description TE-STI-GRTMIABR5-GRTBUEBA3-BW-20
interface tunnel-te406 ipv4 unnumbered Loopback0
interface tunnel-te406 load-interval 30
interface tunnel-te406 signalled-name TE-STI-GRTMIABR5-GRTBUEBA3-BW-20
interface tunnel-te406 load-share 10
interface tunnel-te406 autoroute destination 94.142.100.214
interface tunnel-te406 destination 94.142.100.214
interface tunnel-te406 path-protection
interface tunnel-te406 path-option 1 explicit name BR5-1-BA3-0 protected-by 2
interface tunnel-te406 path-option 2 explicit name BW-BR5-VAP4-BA3-0

Router# show cef 94.142.100.214/32 det

94.142.100.214/32, version 25708656, attached, internal 0x4004081 0x0 (ptr 0x764ff1b0) [3],
0x0 (0x7267d848), 0x440 (0x7d93b2b8)
Updated Nov 19 08:02:26.545
Prefix Len 32, traffic index 0, precedence n/a, priority 3
gateway array (0x72411528) reference count 3, flags 0xd0, source lsd (4), 1 backups
[3 type 4 flags 0x10101 (0x7300d648) ext 0x0 (0x0)]
LW-LDI[type=1, refc=1, ptr=0x7267d848, sh-ldi=0x7300d648]
via tunnel-te400, 3 dependencies, weight 80, class 0 [flags 0x8]
  path-idx 0 NHID 0x0 [0x72082a40 0x72983b58]
  local adjacency
    local label 16440      labels imposed {ImplNull}
via tunnel-te406, 3 dependencies, weight 10, class 0 [flags 0x8]
  path-idx 1 NHID 0x0 [0x7207b4ac 0x729886bc]
  local adjacency
    local label 16440      labels imposed {ImplNull}
via tunnel-te410, 3 dependencies, weight 80, class 0 [flags 0x8]
  path-idx 2 NHID 0x0 [0x72085218 0x72985ee4]
  local adjacency
    local label 16440      labels imposed {ImplNull}
via tunnel-te426, 3 dependencies, weight 10, class 0 [flags 0x8]
  path-idx 3 NHID 0x0 [0x7207d4b4 0x7297fecc]

```

```

local adjacency
  local label 16440      labels imposed {ImplNull}
via tunnel-te427, 3 dependencies, weight 25, class 0 [flags 0x8]
  path-idx 4 NHID 0x0 [0x720802cc 0x7298726c]
  local adjacency
    local label 16440      labels imposed {ImplNull}
via tunnel-te1089, 3 dependencies, weight 40, class 0 [flags 0x8]
  path-idx 5 NHID 0x0 [0x72081848 0x7298037c]
  local adjacency
    local label 16440      labels imposed {ImplNull}
via tunnel-te1090, 3 dependencies, weight 60, class 0 [flags 0x8]
  path-idx 6 NHID 0x0 [0x7207d770 0x72987780]
  local adjacency
    local label 16440      labels imposed {ImplNull}
via tunnel-te1099, 3 dependencies, weight 60, class 0 [flags 0x8]
  path-idx 7 NHID 0x0 [0x7207ed50 0x72981c7c]
  local adjacency
    local label 16440      labels imposed {ImplNull}

```

Weight distribution:

```

slot 0, weight 80, normalized_weight 7, class 0
slot 1, weight 10, normalized_weight 1, class 0
slot 2, weight 80, normalized_weight 7, class 0
slot 3, weight 10, normalized_weight 1, class 0
slot 4, weight 25, normalized_weight 1, class 0
slot 5, weight 40, normalized_weight 3, class 0
slot 6, weight 60, normalized_weight 5, class 0
slot 7, weight 60, normalized_weight 5, class 0

```

Router# show cef 94.142.100.213/32 det

```

94.142.100.213/32, version 25708617, attached, internal 0x4004081 0x0 (ptr 0x771925c8) [3],
0x0 (0x7267a594), 0x440 (0x7d93d364)
Updated Nov 19 08:02:01.029
Prefix Len 32, traffic index 0, precedence n/a, priority 3
gateway array (0x7240f638) reference count 3, flags 0xd0, source lsd (4), 1 backups
  [3 type 4 flags 0x10101 (0x73013360) ext 0x0 (0x0)]
LW-LDI[type=1, refc=1, ptr=0x7267a594, sh-ldi=0x73013360]
via tunnel-te220, 3 dependencies, weight 60, class 0 [flags 0x8]
  path-idx 0 NHID 0x0 [0x7207d838 0x72982af0]
  local adjacency
    local label 17561      labels imposed {ImplNull}
via tunnel-te230, 3 dependencies, weight 60, class 0 [flags 0x8]
  path-idx 1 NHID 0x0 [0x7207d068 0x72986e20]
  local adjacency
    local label 17561      labels imposed {ImplNull}
via tunnel-te236, 3 dependencies, weight 50, class 0 [flags 0x8]
  path-idx 2 NHID 0x0 [0x720830e4 0x7297f508]
  local adjacency
    local label 17561      labels imposed {ImplNull}
via tunnel-te246, 3 dependencies, weight 100, class 0 [flags 0x8]
  path-idx 3 NHID 0x0 [0x7207a1ec 0x7298483c]
  local adjacency
    local label 17561      labels imposed {ImplNull}
via tunnel-te221, 3 dependencies, weight 50, class 0 [flags 0x8]
  path-idx 4 NHID 0x0 [0x7207ea30 0x72982834]
  local adjacency
    local label 17561      labels imposed {ImplNull}
via tunnel-te222, 3 dependencies, weight 25, class 0 [flags 0x8]
  path-idx 5 NHID 0x0 [0x72084a48 0x72989850]
  local adjacency
    local label 17561      labels imposed {ImplNull}
via tunnel-te1091, 3 dependencies, weight 30, class 0 [flags 0x8]
  path-idx 6 NHID 0x0 [0x720851b4 0x729895f8]
  local adjacency

```

```

    local label 17561      labels imposed {ImplNull}
via tunnel-te342, 3 dependencies, weight 100, class 0 [flags 0x8]
path-idx 7 NHID 0x0 [0x72085344 0x7298b024]
local adjacency
    local label 17561      labels imposed {ImplNull}

Weight distribution:
slot 0, weight 60, normalized_weight 2, class 0
slot 1, weight 60, normalized_weight 2, class 0
slot 2, weight 50, normalized_weight 2, class 0
slot 3, weight 100, normalized_weight 4, class 0
slot 4, weight 50, normalized_weight 2, class 0
slot 5, weight 25, normalized_weight 1, class 0
slot 6, weight 30, normalized_weight 1, class 0
slot 7, weight 100, normalized_weight 4, class 0

Load distribution: 0 0 1 1 2 2 3 3 3 3 4 4 5 6 7 7 7 7 (refcount 3)

Hash OK Interface Address
0 Y tunnel-te220 point2point
1 Y tunnel-te220 point2point
2 Y tunnel-te230 point2point
3 Y tunnel-te230 point2point
4 Y tunnel-te236 point2point
5 Y tunnel-te236 point2point
6 Y tunnel-te246 point2point
7 Y tunnel-te246 point2point
8 Y tunnel-te246 point2point
9 Y tunnel-te246 point2point
10 Y tunnel-te221 point2point
11 Y tunnel-te221 point2point
12 Y tunnel-te222 point2point
13 Y tunnel-te1091 point2point
14 Y tunnel-te342 point2point
15 Y tunnel-te342 point2point
16 Y tunnel-te342 point2point
17 Y tunnel-te342 point2point

```

Configuring Performance Measurement

Network performance metrics such as packet loss, delay, delay variation, and bandwidth utilization is a critical measure for traffic engineering (TE) in service provider networks. These network performance metrics provide network operators information about the performance characteristics of their networks for performance evaluation and helps to ensure compliance with service level agreements. The service-level agreements (SLAs) of service providers depend on the ability to measure and monitor these network performance metrics. Network operators can use performance measurement (PM) feature to monitor the network metrics for links as well as end-to-end TE label switched paths (LSPs).

Path Calculation Metric Type

To configure the metric type to be used for path calculation for a given tunnel, use the **path-selection metric** command in either the MPLS-TE configuration mode or under the tunnel interface configuration mode.

The metric type specified per interface takes the highest priority, followed by the MPLS-TE global metric type.



Note If the delay metric is configured, CSPF finds a path with optimized *minimum* link delay metric. See the *Configuring Performance Measurement* chapter in the Segment Routing Configuration Guide for information on configuring interface performance delay measurement.

Configuration Example

The following example shows how to set the path-selection metric to use the IGP metric under a specific tunnel interface:

```
Router# configure
Router(config)# interface tunnel-te 1
Router(config-if)# path-selection metric igp
Router(config-if)# commit
```

The following example shows how to set the path-selection metric to use the delay metric under the MPLS-TE configuration mode:

```
Router# configure
Router(config)# mpls traffic-eng
Router(config-mpls-te)# path-selection metric delay
Router(config-mpls-te)# commit
```

Path-Selection Delay Limit

Apply the **path-selection delay-limit** configuration to set the upper limit on the path aggregate delay when computing paths for MPLS-TE LSPs. After you configure the **path-selection delay-limit** value, if the sum of minimum-delay metric from all links that are traversed by the path exceeds the specified delay-limit, CSPF will not return any path. The periodic path verification checks if the delay-limit is crossed.

The **path-selection delay-limit** value can be configured at the global MPLS-TE, per-interface tunnel, and per path-option attribute set. The path-selection delay-limit per path-option attribute set takes the highest priority, followed by per-interface, and then the MPLS-TE global path-selection delay-limit values.

The delay limit range is a value from 1 to 4294967295 microseconds.



Note See the *Configuring Performance Measurement* chapter in the Segment Routing Configuration Guide for information on configuring interface performance delay measurement.

Configuration Example

The following example shows how to set the path-selection delay limit under a specific tunnel interface:

```
Router# configure
Router(config)# interface tunnel-te2000
Router(config-if)# path-selection metric delay
Router(config-if)# path-selection delay-limit 200
Router(config-if)# commit
```

The following example shows how to set the path-selection delay limit under a path-option attribute set:

```
Router# configure
Router(config)# mpls traffic-eng
Router(config-mpls-te)# attribute-set path-option test
Router(config-te-attribute-set)# path-selection delay-limit 300
Router(config-te-attribute-set)# root
Router(config)# interface tunnel-te1000
```

```
Router(config-if)# path-option 10 dynamic attribute-set test
Router(config-if)# commit
```

The following example shows how to set the path-selection delay limit under the global MPLS-TE configuration mode:

```
Router# configure
Router(config)# mpls traffic-eng
Router(config-mpls-te)# path-selection metric delay
Router(config-mpls-te)# path-selection delay-limit 150
Router(config-mpls-te)# commit
```



CHAPTER 4

Implementing RSVP for MPLS-TE

Resource Reservation Protocol (RSVP) is a signaling protocol that enables systems to request resource reservations from the network. RSVP processes protocol messages from other systems, processes resource requests from local clients, and generates protocol messages. As a result, resources are reserved for data flows on behalf of local and remote clients. RSVP creates, maintains, and deletes these resource reservations.

MPLS Traffic Engineering (MPLS-TE) learns the topology and resources available in a network and then maps traffic flows to particular paths based on resource requirements and network resources such as bandwidth. MPLS TE builds a unidirectional tunnel from a source to a destination in the form of a label switched path (LSP), which is then used to forward traffic. MPLS-TE uses RSVP to signal LSPs.

- [Setting up MPLS LSP Using RSVP, on page 65](#)
- [Overview of RSVP for MPLS-TE Features, on page 66](#)
- [Configuring RSVP for MPLS-TE, on page 66](#)
- [RSVP for MPLS-TE Features- Details, on page 72](#)

Setting up MPLS LSP Using RSVP

The following figure shows how RSVP sets up a LSP from router R1 through router R4 that can be used for TE in an MPLS environment.

Figure 16: MPLS LSP Using RSVP

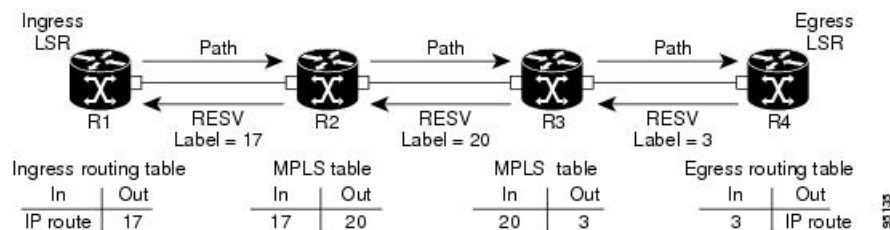

The LSP setup is initiated when the LSP head node sends path messages to the tail node. The Path messages reserve resources along the path to each node, and creates path states associated with the session on each node. When the tail node receives a path message, it sends a reservation (RESV) message with a label back to the previous node. The reservation state in each router is considered as a soft state, which means that periodic PATH and RESV messages must be sent at each hop to maintain the state.

When the reservation message arrives at the previous node, it causes the reserved resources to be locked and forwarding entries are programmed with the MPLS label sent from the tail-end node. A new MPLS label is

allocated and sent to the next node upstream. When the reservation message reaches the head node, the label is programmed and the MPLS data starts to flow along the path.

Overview of RSVP for MPLS-TE Features

This section provides an overview of the various features of RSVP for MPLS-TE.

RSVP is automatically enabled on interfaces on which MPLS-TE is configured. For MPLS-TE LSPs with bandwidth, the RSVP bandwidth has to be configured on the interfaces. There is no need to configure RSVP, if all MPLS-TE LSPs have zero bandwidth.

RSVP Graceful restart ensures high availability and allows RSVP TE enabled routers to recover RSVP state information from neighbors after a failure in the network.

RSVP requires that the path and reservation state that are set up during LSP signaling must be refreshed by periodically sending refresh messages. Refresh messages are used to synchronize the state between RSVP neighbors and to recover from lost RSVP messages. RSVP refresh reduction feature includes support for reliable messages which are transmitted rapidly when the messages are lost. Summary refresh messages contain information to refresh multiple states and reduces the number of messages required to refresh states.

RSVP messages can be authenticated to ensure that only trusted neighbors can set up reservations.

For detailed information about RSVP for MPLS-TE features, see *RSVP for MPLS-TE Features- Details*.

Configuring RSVP for MPLS-TE

RSVP requires coordination among several routers, establishing exchange of RSVP messages to set up LSPs. To configure RSVP, you need to install the following two RPMs :

- ncs540-mpls-2.0.0.0-r601.x86_64.rpm-6.0.1
- ncs540-mpls-te-rsvp-2.0.0.0-r601.x86_64.rpm-6.0.1

Depending on the requirements, RSVP requires some basic configuration described in the following topics:

Configuring RSVP Message Authentication Globally

The RSVP authentication feature permits neighbors in an RSVP network to use a secure hash algorithm to authenticate all RSVP signaling messages digitally. The authentication is accomplished on a per-RSVP-hop basis using an RSVP integrity object in the RSVP message. The integrity object includes a key ID, a sequence number for messages, and keyed message digest.

You can globally configure the values of authentication parameters including the key-chain, time interval that RSVP maintains security associations with other trusted RSVP neighbors (life time) and maximum number of RSVP authenticated messages that can be received out of sequence (window size). These defaults are inherited for each neighbor or interface.

Configuration Example

In this example, authentication parameters are configured globally on a router. The authentication parameters including authentication key-chain, lifetime, and window size are configured. A valid key-chain should be configured before performing this task.

```
RP/0/RP0/CPU0:router# configure
RP/0/RP0/CPU0:router(config)# key chain mpls-keys
RP/0/RP0/CPU0:router(config-mpls-keys)# exit
RP/0/RP0/CPU0:router(config)# rsvp authentication
RP/0/RP0/CPU0:router(config-rsvp-auth)# key-source key-chain mpls-keys
RP/0/RP0/CPU0:router(config-rsvp-auth)# life-time 2000
RP/0/RP0/CPU0:router(config-rsvp-auth)# window-size 33
```

Verification

Verify the configuration of authentication parameters using the following command.

```
RP/0/RP0/CPU0:router# show rsvp authentication detail

RSVP Authentication Information:
  Source Address:          3.0.0.1
  Destination Address:    3.0.0.2
  Neighbour Address:      3.0.0.2
  Interface:              HundredGigabitEthernet 0/0/0/3
  Direction:              Send
  LifeTime:                2000 (sec)
  LifeTime left:          1305 (sec)
  KeyType:                 Static Global KeyChain
  Key Source:              mpls-keys
  Key Status:              No error
  KeyID:                   1
  Digest:                  HMAC MD5 (16)
  window-size:            33
Challenge:                 Not supported
TX Sequence:              5023969459702858020 (0x45b8b99b00000124)
Messages successfully authenticated: 245
Messages failed authentication: 0
```

Related Topics

- [Configuring RSVP Authentication for an Interface, on page 67](#)
- [Configuring RSVP Authentication on a Neighbor, on page 68](#)
- [#unique_65](#)

Configuring RSVP Authentication for an Interface

You can individually configure the values of RSVP authentication parameters including key-chain, life time, and window size on an interface. Interface specific authentication parameters are used to secure specific interfaces between two RSVP neighbors.

Configuration Example

This example configures authentication key-chain, life time for the security association, and window size on an interface. A valid key-chain should be already configured to use it as part of this task.

```
RP/0/RP0/CPU0:router# configure
RP/0/RP0/CPU0:router(config)# rsvp interface HundredGigabitEthernet0/0/0/3
RP/0/RP0/CPU0:router(config-rsvp-if)# authentication
RP/0/RP0/CPU0:router(config-rsvp-if-auth)# key-source key-chain mpls-keys
RP/0/RP0/CPU0:router(config-rsvp-if-auth)# life-time 2000
RP/0/RP0/CPU0:router(config-rsvp-if-auth)# window-size 33
RP/0/RP0/CPU0:router(config)# commit
```

Verification

Verify the configuration of authentication parameters using the following command.

```
RP/0/RP0/CPU0:router# show rsvp authentication detail

RSVP Authentication Information:
  Source Address:      3.0.0.1
  Destination Address: 3.0.0.2
  Neighbour Address:   3.0.0.2
  Interface:           HundredGigabitEthernet 0/0/0/3
  Direction:           Send
  LifeTime:             2000 (sec)
  LifeTime left:       1305 (sec)
  KeyType:              Static Global KeyChain
  Key Source:           mpls-keys
  Key Status:           No error
  KeyID:                1
  Digest:               HMAC MD5 (16)
  window-size:         33
  Challenge:            Not supported
  TX Sequence:         5023969459702858020 (0x45b8b99b00000124)
  Messages successfully authenticated: 245
  Messages failed authentication: 0
```

Related Topics

- [Configuring RSVP Message Authentication Globally, on page 66](#)
- [Configuring RSVP Authentication on a Neighbor, on page 68](#)
- [#unique_65](#)

Configuring RSVP Authentication on a Neighbor

You can individually configure the values of RSVP authentication parameters including key-chain, life time, and window size on a neighbor.

Configuration Example

This example configures the authentication key-chain, life time for the security association, and window size on a RSVP neighbor. A valid key-chain should be already configured to use it as part of this task.

```
RP/0/RP0/CPU0:router# configure
RP/0/RP0/CPU0:router(config)# rsvp neighbor 10.0.0.1 authentication
RP/0/RP0/CPU0:router(config-rsvp-if-auth)# key-source key-chain mpls-keys
RP/0/RP0/CPU0:router(config-rsvp-if-auth)# life-time 2000
RP/0/RP0/CPU0:router(config-rsvp-if-auth)# window-size 33
RP/0/RP0/CPU0:router(config)# commit
```

Verification

Verify the configuration of authentication parameters using the following command.

```
RP/0/RP0/CPU0:router# show rsvp authentication detail

RSVP Authentication Information:
  Neighbour Address:   10.0.0.1
  Interface:           HundredGigabitEthernet 0/0/0/3
  Direction:           Send
  LifeTime:             2000 (sec)
  LifeTime left:       1205 (sec)
```

```

KeyType:           Static Global KeyChain
Key Source:        mpls-keys
Key Status:        No error
KeyID:             1
Digest:            HMAC MD5 (16)
window-size:      33
Challenge:         Not supported

```

Related Topics

- [Configuring RSVP Message Authentication Globally, on page 66](#)
- [Configuring RSVP Authentication for an Interface, on page 67](#)
- [#unique_65](#)

Configuring Graceful Restart

RSVP graceful restart provides a mechanism to ensure high availability (HA), which allows detection and recovery from failure conditions for systems running Cisco IOS XR software and ensures non-stop forwarding services. RSVP graceful restart is based on RSVP hello messages and allows RSVP TE enabled routers to recover RSVP state information from neighbors after a failure in the network. RSVP uses a Restart Cap object (RSVP RESTART) in hello messages in which restart and recovery times are specified to advertise the restart capability of a node. The neighboring node helps a restarting node by sending a Recover Label object to recover the forwarding state of the restarting node.

You can configure standard graceful restart which is based on node-id address based hello messages and also interface-based graceful restart which is interface-address based hello messages.

Configuration Example

In this example, RSVP-TE is already enabled on the router nodes on a network and graceful restart needs to be enabled on the router nodes for failure recovery. Graceful restart is configured globally to enabled node-id address based hello messages and also on a router interface to support interface-address based hello messages.

```

RP/0/RP0/CPU0:router# configure
RP/0/RP0/CPU0:router(config)# rsvp
RP/0/RP0/CPU0:router(config-rsvp)# signalling graceful-restart
RP/0/RP0/CPU0:router(config-rsvp)# interface HundredGigabitEthernet 0/0/0/3
RP/0/RP0/CPU0:router(config-rsvp-if)# signalling graceful-restart
interface-based
RP/0/RP0/CPU0:router(config)# commit

```

Verification

Use the following commands to verify that graceful restart is enabled.

```

RP/0/RP0/CPU0:router# show rsvp graceful-restart
Graceful restart: enabled Number of global neighbors: 1
Local MPLS router id: 192.168.55.55
Restart time: 60 seconds Recovery time: 120 seconds
Recovery timer: Not running
Hello interval: 5000 milliseconds Maximum Hello miss-count: 4

RP/0/RP0/CPU0:router# show rsvp graceful-restart neighbors detail

Neighbor: 192.168.77.77 Source: 192.168.55.55 (MPLS)

```

```

Hello instance for application MPLS
  Hello State: UP          (for 00:20:52)
  Number of times communications with neighbor lost: 0
  Reason: N/A
Recovery State: DONE
Number of Interface neighbors: 1
  address: 192.168.55.0
Restart time: 120 seconds Recovery time: 120 seconds
Restart timer: Not running
Recovery timer: Not running
Hello interval: 5000 milliseconds Maximum allowed missed Hello messages: 4

```

Related Topics

- [#unique_65](#)

Configuring Refresh Reduction

RSVP Refresh Reduction improves the reliability of Resource Reservation Protocol (RSVP) signaling to enhance network performance and message delivery and it is enabled by default. Refresh reduction is used with a neighbor only if the neighbor supports it. You can also disable refresh reduction on an interface if you want.

This feature ensures reliable delivery of RSVP messages when network traffic is disrupted. To ensure that its message is delivered to its neighbor, RSVP requests the neighbor to send an acknowledgment message by a given time duration. If it doesn't receive the acknowledgment, it resends the message and doubles its current wait time. After 5 attempts, RSVP stops retransmitting the message to the neighbor.

Configuration Example

The example shows how to configure the various parameters available for the refresh reduction feature.

The following parameters are configured to change their default values:

- refresh interval
- number of refresh messages a node can miss
- retransmit time
- acknowledgment hold time
- acknowledgment message size
- refresh message summary size

```

Router# configure
Router(config)# rsvp
Router(config-rsvp)# interface HundredGigabitEthernet 0/0/0/3
Router(config-rsvp-if)# signalling refresh interval 40
Router(config-rsvp-if)# signalling refresh missed 6
Router(config-rsvp-if)# signalling refresh reduction reliable retransmit-time 2000
Router(config-rsvp-if)# signalling refresh reduction reliable ack-hold-time 1000
Router(config-rsvp-if)# signalling refresh reduction reliable ack-max-size 1000
Router(config-rsvp-if)# signalling refresh reduction summary max-size 1500
Router(config)# commit

```

Configuring ACL Based Prefix Filtering

You can configure extended access lists (ACLs) to forward, drop, or perform normal processing on RSVP router-alert (RA) packets. For each incoming RSVP RA packet, RSVP inspects the IP header and attempts to match the source or destination IP addresses with a prefix configured in an extended ACL. If there is no explicit permit or explicit deny, the ACL infrastructure returns an implicit deny by default. By default, RSVP processes the packet if the ACL match yields an implicit (default) deny.

Configuration Example

This example configures ACL based prefix filtering on RSVP RA packets. When RSVP receives a RA packet from source address 10.0.0.1 it is forwarded and packets destined to the IP address 172.16.0.1 are dropped.

```
RP/0/RP0/CPU0:router# configure
RP/0/RP0/CPU0:router(config)# ipv4 access-list rsvpacl
RP/0/RP0/CPU0:router(config-ipv4-acl)# 10 permit ipv4 host 10.0.0.1 any
RP/0/RP0/CPU0:router(config-ipv4-acl)# 20 deny ipv4 any host 172.16.0.1
RP/0/RP0/CPU0:router(config)# rsvp
RP/0/RP0/CPU0:router(config-rsvp)# signalling prefix-filtering access-list rsvp-acl
RP/0/RP0/CPU0:router(config)# commit
```

Verification

Verify the configuration of ACL based prefix filtering

```
RP/0/RP0/CPU0:router# show rsvp counters prefix-filtering access-list rsvp-acl
```

| ACL:rsvp-acl | Forward | Local | Drop | Total |
|--------------|---------|-------|------|-------|
| Path | 0 | 0 | 0 | 0 |
| PathTear | 0 | 0 | 0 | 0 |
| ResvConfirm | 0 | 0 | 0 | 0 |
| Total | 0 | 0 | 0 | 0 |

Related Topics

- [Configuring RSVP Packet Dropping, on page 71](#)

Configuring RSVP Packet Dropping

You can configure extended access lists (ACLs) to forward, drop, or perform normal processing on RSVP router-alert (RA) packets. By default, RSVP processes the RA packets even if the ACL match yields an implicit deny. You can configure RSVP to drop RA packets when the ACL matches results in an implicit deny.

Configuration Example

This example configures ACL based prefix filtering on RSVP RA packets. When RSVP receives a RA packet from source address 10.0.0.1 it is forwarded and packets destined to the IP address 172.16.0.1 are dropped. RA packets are dropped if the ACL matches results in an implicit deny.

```
RP/0/RP0/CPU0:router# configure
RP/0/RP0/CPU0:router(config)# ipv4 access-list rsvpacl
RP/0/RP0/CPU0:router(config-ipv4-acl)# 10 permit ipv4 host 10.0.0.1 any
RP/0/RP0/CPU0:router(config-ipv4-acl)# 20 deny ipv4 any host 172.16.0.1
RP/0/RP0/CPU0:router(config)# rsvp
RP/0/RP0/CPU0:router(config-rsvp)# signalling prefix-filtering default-deny-action drop
RP/0/RP0/CPU0:router(config)# commit
```

Verification

Verify the configuration of RSVP packet drop using the following command.

```
RP/0/RP0/CPU0:router# show rsvp counters prefix-filtering access-list rsvpacl
```

| ACL: rsvpacl | Forward | Local | Drop | Total |
|--------------|---------|-------|------|-------|
| Path | 4 | 1 | 0 | 5 |
| PathTear | 0 | 0 | 0 | 0 |
| ResvConfirm | 0 | 0 | 0 | 0 |
| Total | 4 | 1 | 0 | 5 |

Related Documents

- [Configuring ACL Based Prefix Filtering, on page 71](#)

Enabling RSVP Traps

By implementing the RSVP MIB, you can use SNMP to access objects belonging to RSVP. You can also specify two traps (NewFlow and LostFlow) which are triggered when a new flow is created or deleted. RSVP MIBs are automatically enabled when you turn on RSVP, but you need to enable RSVP traps.

Configuration Example

This example shows how to enable RSVP MIB traps when a flow is deleted or created and also how to enable both the traps.

```
RP/0/RP0/CPU0:router# configure
RP/0/RP0/CPU0:router(config)# snmp-server traps rsvp lost-flow
RP/0/RP0/CPU0:router(config)# snmp-server traps rsvp new-flow
RP/0/RP0/CPU0:router(config)# snmp-server traps rsvp all
RP/0/RP0/CPU0:router(config)# commit
```

RSVP for MPLS-TE Features- Details

RSVP Graceful Restart Operation

RSVP graceful restart is based on RSVP hello messages. Hello messages are exchanged between the router and its neighbor nodes. Each neighbor node can autonomously issue a hello message containing a hello request object. A receiver that supports the hello extension replies with a hello message containing a hello acknowledgment (ACK) object. If the sending node supports state recovery, a Restart Cap object that indicates a node's restart capability is also carried in the hello messages. In the Restart Cap object, the restart time and the recovery time is specified. The restart time is the time after a loss in Hello messages within which RSVP hello session can be re-established. The recovery time is the time that the sender waits for the recipient to re-synchronize states after the re-establishment of hello messages.

For graceful restart, the hello messages are sent with an IP Time to Live (TTL) of 64. This is because the destination of the hello messages can be multiple hops away. If graceful restart is enabled, hello messages (containing the restart cap object) are sent to an RSVP neighbor when RSVP states are shared with that neighbor. If restart cap objects are sent to an RSVP neighbor and the neighbor replies with hello messages containing the restart cap object, the neighbor is considered to be graceful restart capable. If the neighbor does not reply with hello messages or replies with hello messages that do not contain the restart cap object, RSVP backs off sending hellos to that neighbor. If a hello Request message is received from an unknown neighbor, no hello ACK is sent back.

RSVP Authentication

Network administrators need the ability to establish a security domain to control the set of systems that initiates RSVP requests. The RSVP authentication feature permits neighbors in an RSVP network to use a secure hash to sign all RSVP signaling messages digitally, thus allowing the receiver of an RSVP message to verify the sender of the message without relying solely on the sender's IP address.

The signature is accomplished on a per-RSVP-hop basis with an RSVP integrity object in the RSVP message as defined in RFC 2747. The integrity object includes a key ID, a sequence number for messages, and keyed message digest. This method provides protection against forgery or message modification. However, the receiver must know the security key used by the sender to validate the digital signature in the received RSVP message. Network administrators manually configure a common key for each RSVP neighbor on the shared network. The sending and receiving systems maintain a security association for each authentication key that they share. For detailed information about different security association parameters, see the **Security Association Parameters** table.

You can configure global defaults for all authentication parameters including key, window size, and lifetime. These defaults are inherited when you configure authentication for each neighbor or interface. However, you can also configure these parameters individually on a neighbor or interface basis, in which case the global values (configured or default) are no longer inherited.

Interface and neighbor interface modes unless explicitly configured, inherit the parameters from global configuration mode as follows:

- Window-size is set to 1.
- Lifetime is set to 1800.
- key-source key-chain command is set to none or disabled.

The following situations explain how to choose between global, interface, or neighbor configuration modes:

- Global configuration mode is optimal when a router belongs to a single security domain (for example, part of a set of provider core routers). A single common key set is expected to be used to authenticate all RSVP messages.
- Interface, or neighbor configuration mode, is optimal when a router belongs to more than one security domain. For example, a provider router is adjacent to the provider edge (PE), or a PE is adjacent to an edge device. Different keys can be used but not shared.

A security association (SA) is a collection of information that is required to maintain secure communications with a peer. The following table lists the main parameters that defines a security association

Table 2: Security Association Parameters

| Security Association Parameters | Description |
|---------------------------------|--|
| src | IP address of the sender. |
| dst | IP address of the final destination. |
| interface | Interface of the security association. |
| direction | Send or receive type of the security association. |
| Lifetime | Expiration timer value that is used to collect unused security association data. |

| Security Association Parameters | Description |
|---------------------------------|---|
| Sequence Number | Last sequence number that was either sent or accepted (dependent of the direction type). |
| key-source | Source of keys for the configurable parameter. |
| keyID | Key number (returned from the key-source) that was last used. |
| Window Size | Specifies the maximum number of authenticated messages that can be received out of order. |
| Window | Specifies the last <i>window size</i> value sequence number that is received or accepted. |

MPLS-TE LSP OOR

The MPLS-TE LSP OOR function adds capability for the RSVP-TE control plane to track the LSP scale of transit routers, so that it can take a specific set of (pre-configured) actions when threshold limits are crossed, and inform other routers in the network. MPLS-TE keeps track of the number of transit LSPs set up through the router. The limits do not apply to ingress and egress LSP routers since they are driven by explicit configuration. In other words, the configuration determines how many egress or ingress LSPs a router has. For midpoint routers, the number is a function of the topology, the links metrics, and links' bandwidth.

State Transition Triggers - The LSP OOR state transition is triggered by checking the total transit LSP count and the unprotected count. If either count crosses the threshold, the state transition is triggered. If both counts cross the limit, the more critical state is chosen. Each limit will have a value for the *Yellow* threshold and a value for the *Red* threshold. When these thresholds are crossed, the configured MPLS-TE LSP OOR actions take effect. Similarly, the transition to *Green* state occurs when the LSP numbers drop.

LSP OOR State Dampening - The reason for LSP OOR State Dampening is that the number of accepted LSPs would be at the threshold and once an LSP is deleted, the state goes back from Red to Yellow, and a new LSP is setup and the state goes back to Red.

The solution is to introduce dampening when there is a state transition from Red to Yellow or from Yellow to Green. Whenever the transit number of LSPs crosses down a threshold, a timer is started for 10 seconds. After the timer expires, the new state is computed and moved to it. The timer is stopped if the transit number threshold is crossed (up) again. The transition from a state to a more severe state is not dampened.

Low and High Priority LSPs - When the LSP OOR is in yellow or red state, new high priority LSPs will not preempt low priority LSPs. Preemption can still occur but only for bandwidth reasons. In other words, if the router is in Red state where one of the actions is to reject any new LSP, the new high-priority LSPs are rejected even if there is an established low-priority LSP. The low-priority LSP is not removed to make room for the high-priority one.

Configuration Limit - Setting the configured limit to a value that is smaller than the current number of LSPs will trigger state transition but will not cause existing LSPs to be deleted or preempted. Setting the configured limit to a value that is larger than the current number of LSPs takes the node out of LSP OOR state. When an LSP cannot be admitted due to LSP OOR, the LSRs send Path Error messages to the LERs.

Event Logging - This is generated when the system transitions across OOR states, such as a resource change into an *yellow* or *red* state. Reporting level for *Red* is critical (1), and for yellow is warning (4). The following example shows that the count has crossed the threshold of 5000.

```
RP/0/RP1/CPU0:May 15 17:05:48 PDT: te_control[1034]: %ROUTING-MPLS_TE-4-LSP_OOR :
Transit LSP resources changed to Yellow.
Total transit: configured threshold 5000; actual count 5001;
Unprotected transit: configured threshold 4294967295; actual count 0
```

When the resource comes out of OOR, it will report as *green*.

Configuration Example

```
mpls traffic-eng
 lsp-oor
  green
  action accept reopt-lsp
  action flood available-bw 20
  recovery-duration
  action admit lsp-min-bw X -- > (in kbps, a lower limit than yellow and red state)

  yellow
  transit-all threshold 75000
  action accept reopt-lsp
  action flood available-bw 0
  action admit lsp-min-bw Y

  red
  transit-all threshold 90000
  action flood available-bw 0
  action admit lsp-min-bw Z
```

The LSP OOR threshold values are set to yellow as 75000 and red as 90000. When these thresholds are crossed, corresponding actions are applied to all the TE interfaces.



Note The default values of the above thresholds are infinite.

When the LSP OOR *yellow* state is reached, the **accept reopt-lsp** action, **flood available-bw 0** action and **admit lsp-min-bw** actions are activated. This allows headend routers to reoptimize existing LSPs through, but doesn't allow new LSPs to get established. Also, MPLS-TE advertises zero bandwidth out of all interfaces, making this transit router less preferable for new LSPs. To handle a sudden burst of new LSPs that get signaled, the **action admit lsp-min-bw** function ensures only a small number of high bandwidth LSPs get provisioned through the affected router. When the red threshold state is crossed, the **flood available-bw 0** and **admit lsp-min-bw** actions prevent any additional or reoptimized transit LSPs from getting set up through the affected router.



CHAPTER 5

Implementing MPLS OAM

MPLS Operations, Administration, and Maintenance (OAM) helps service providers to monitor label-switched paths (LSPs) and quickly isolate MPLS forwarding problems to assist with fault detection and troubleshooting in an MPLS network. This module describes MPLS LSP Ping and Traceroute features which can be used for failure detection and troubleshooting of MPLS networks.

- [MPLS LSP Ping, on page 77](#)
- [MPLS LSP Traceroute, on page 79](#)

MPLS LSP Ping

The MPLS LSP Ping feature is used to check the connectivity between Ingress LSR and egress LSRs along an LSP. MPLS LSP ping uses MPLS echo request and reply messages, similar to Internet Control Message Protocol (ICMP) echo request and reply messages, to validate an LSP. While ICMP echo request and reply messages validate IP networks, MPLS echo and reply messages validate MPLS networks. The MPLS echo request packet is sent to a target router through the use of the appropriate label stack associated with the LSP to be validated. Use of the label stack causes the packet to be forwarded over the LSP itself. The destination IP address of the MPLS echo request packet is different from the address used to select the label stack. The destination IP address is defined as a 127.x.y.z/8 address and it prevents the IP packet from being IP switched to its destination, if the LSP is broken.

An MPLS echo reply is sent in response to an MPLS echo request. The reply is sent as an IP packet and it is forwarded using IP, MPLS, or a combination of both types of switching. The source address of the MPLS echo reply packet is an address obtained from the router generating the echo reply. The destination address is the source address of the router that originated the MPLS echo request packet. The MPLS echo reply destination port is set to the echo request source port.

The following figure shows MPLS LSP ping echo request and echo reply paths.

Figure 17: MPLS LSP Ping Echo Request and Reply Paths

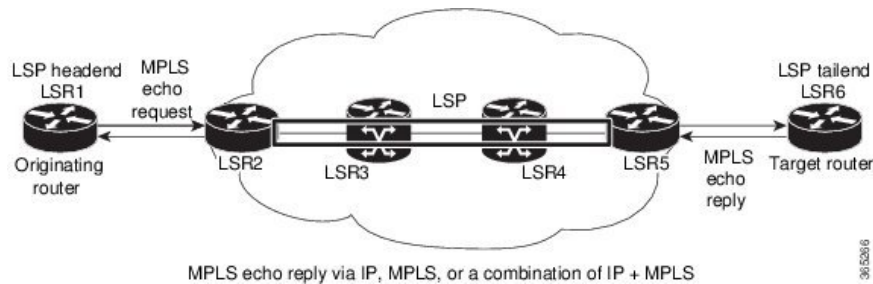

Configuration Examples

This example shows how to use MPLS LSP ping to test the connectivity of an IPv4 LDP LSP. The destination is specified as a Label Distribution Protocol (LDP) IPv4 prefix and Forwarding Equivalence Class (FEC) type is specified as generic.

```
RP/0/RP0/CPU0:router# ping mpls ipv4 10.1.1.2/32 fec-type generic
```

```
Wed Nov 25 03:36:33.143 UTC
Sending 5, 100-byte MPLS Echos to 10.1.1.2/32,
  timeout is 2 seconds, send interval is 0 msec:
```

```
Codes: '!' - success, 'Q' - request not sent, '.' - timeout,
'L' - labeled output interface, 'B' - unlabeled output interface,
'D' - DS Map mismatch, 'F' - no FEC mapping, 'f' - FEC mismatch,
'M' - malformed request, 'm' - unsupported tlvs, 'N' - no rx label,
'P' - no rx intf label prot, 'p' - premature termination of LSP,
'R' - transit router, 'I' - unknown upstream index,
'X' - unknown return code, 'x' - return code 0
```

Type escape sequence to abort.

```
!!!!
Success rate is 100 percent (5/5), round-trip min/avg/max = 2/2/3 ms
```

This example shows how to use MPLS LSP ping to test the connectivity when the destination is specified as a MPLS traffic engineering (TE) tunnel.

```
RP/0/RP0/CPU0:router# ping mpls traffic-eng tunnel-te 4003 source 10.1.1.2
```

```
Tue Nov 24 20:39:39.179 PST
Sending 5, 100-byte MPLS Echos to tunnel-te4003,
  timeout is 2 seconds, send interval is 0 msec:
```

```
Codes: '!' - success, 'Q' - request not sent, '.' - timeout,
'L' - labeled output interface, 'B' - unlabeled output interface,
'D' - DS Map mismatch, 'F' - no FEC mapping, 'f' - FEC mismatch,
'M' - malformed request, 'm' - unsupported tlvs, 'N' - no rx label,
'P' - no rx intf label prot, 'p' - premature termination of LSP,
'R' - transit router, 'I' - unknown upstream index,
'X' - unknown return code, 'x' - return code 0
```

Type escape sequence to abort.

```
!!!!
Success rate is 100 percent (5/5), round-trip min/avg/max = 3/3/4 ms
```

This example shows how to use the **show mpls oam** command to display the MPLS OAM information

```
RP/0/RP0/CPU0:router# show mpls oam counters packet

Wed Nov 25 03:38:07.397 UTC Global Packet Statistics:

                Pkt                Bytes
                -----                -----
Receive Counts:
  Good Requests:                0                0
  Good Replies:                10               760
  Unknown Pkt Types:            0                0
  IP header error:              0                0
  UDP header error:            0                0
  Runts:                        0                0
  Dropped (Q full):            0                0
  General error:                0                0
  Error, no IF:                0                0
  Error, no memory:            0                0

Transmit Counts:
  Good:                        10               960
  Dropped:                      0                0
```

MPLS LSP Traceroute

The MPLS LSP Traceroute feature is used to isolate the failure point of an LSP. It is used for hop-by-hop fault localization and path tracing. The MPLS LSP Traceroute feature relies on the expiration of the Time to Live (TTL) value of the packet that carries the echo request. When the MPLS echo request message hits a transit node, it checks the TTL value and if it is expired, the packet is passed to the control plane, else the message is forwarded. If the echo message is passed to the control plane, a reply message is generated based on the contents of the request message.

The following figure shows an MPLS LSP traceroute example with an LSP from LSR1 to LSR4.

Figure 18: MPLS LSP Traceroute

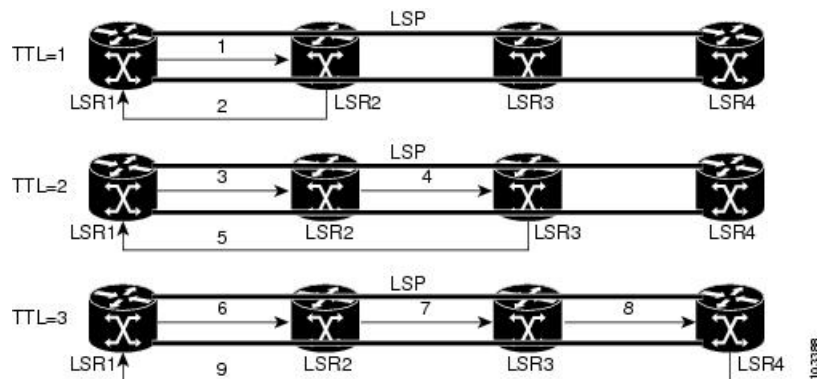

Configuration Examples

This example shows how to use the **traceroute** command to trace to a destination with Forwarding Equivalence Class (FEC) type specified as generic.

```
RP/0/RP0/CPU0:router# traceroute mpls ipv4 192.168.0.1/32 fec-type generic
Mon Nov 30 17:48:45.585 UTC
```

```
Tracing MPLS Label Switched Path to 192.168.0.1/32, timeout is 2 seconds
```

```
Codes: '!' - success, 'Q' - request not sent, '.' - timeout,  
'L' - labeled output interface, 'B' - unlabeled output interface,  
'D' - DS Map mismatch, 'F' - no FEC mapping, 'f' - FEC mismatch,  
'M' - malformed request, 'm' - unsupported tlvs, 'N' - no rx label,  
'P' - no rx intf label prot, 'p' - premature termination of LSP,  
'R' - transit router, 'I' - unknown upstream index,  
'X' - unknown return code, 'x' - return code 0
```

```
Type escape sequence to abort.
```

```
  0 10.1.1.57 MRU 1500 [Labels: implicit-null Exp: 0]  
! 1 10.1.1.58 7 ms23:19
```



CHAPTER 6

Configuring Global Weighted SRLG Protection

A shared risk link group (SRLG) is a set of links sharing a common resource and thus shares the same risk of failure. The existing loop-free alternate (LFA) implementations in interior gateway protocols (IGPs) support SRLG protection. However, the existing implementation considers only the directly connected links while computing the backup path. Hence, SRLG protection may fail if a link that is not directly connected but shares the same SRLG is included while computing the backup path. Global weighted SRLG protection feature provides better path selection for the SRLG by associating a weight with the SRLG value and using the weights of the SRLG values while computing the backup path.

To support global weighted SRLG protection, you need information about SRLGs on all links in the area topology. You can flood SRLGs for remote links using ISIS or manually configuring SRLGS on remote links.

Configuration Examples: Global Weighted SRLG Protection

There are three types of configurations that are supported for the global weighted SRLG protection feature.

- local SRLG with global weighted SRLG protection
- remote SRLG flooding
- remote SRLG static provisioning

This example shows how to configure the local SRLG with global weighted SRLG protection feature.

```
RP/0/RP0/CPU0:router(config)# srlg
RP/0/RP0/CPU0:router(config-srlg)# interface TenGigE0/0/0/0
RP/0/RP0/CPU0:router(config-srlg-if)# name group1
RP/0/RP0/CPU0:router(config-srlg-if)# exit
RP/0/RP0/CPU0:router(config-srlg)# interface TenGigE0/0/0/1
RP/0/RP0/CPU0:router(config-srlg-if)# name group1
RP/0/RP0/CPU0:router(config-srlg)# name group value 100
RP/0/RP0/CPU0:router(config)# router isis 1
RP/0/RP0/CPU0:router(config-isis)# address-family ipv4 unicast
RP/0/RP0/CPU0:router(config-isis-if-af)# fast-reroute per-prefix srlg-protection
weighted-global
RP/0/RP0/CPU0:router(config-isis-if-af)# fast-reroute per-prefix tiebreaker srlg-disjoint
index 1
RP/0/RP0/CPU0:router(config-isis)# interface TenGigE0/0/0/0
RP/0/RP0/CPU0:router(config-isis-if)# point-to-point
RP/0/RP0/CPU0:router(config-isis-if)# address-family ipv4 unicast
RP/0/RP0/CPU0:router(config-isis-if-af)# fast-reroute per-prefix
RP/0/RP0/CPU0:router(config-isis-if-af)# fast-reroute per-prefix ti-lfa
RP/0/RP0/CPU0:router(config-isis)# srlg
```

```
RP/0/RP0/CPU0:router(config-isis-srlg)# name group1
RP/0/RP0/CPU0:router(config-isis-srlg-name)# admin-weight 5000
```

This example shows how to configure the global weighted SRLG protection feature with remote SRLG flooding. The configuration includes local and remote router configuration. On the local router, the global weighted SRLG protection is enabled by using the **fast-reroute per-prefix srlg-protection weighted-global** command. In the remote router configuration, you can control the SRLG value flooding by using the **advertise application lfa link-attributes srlg** command. You should also globally configure SRLG on the remote router.

The local router configuration for global weighted SRLG protection with remote SRLG flooding is as follows:

```
RP/0/RP0/CPU0:router(config)# router isis 1
RP/0/RP0/CPU0:router(config-isis)# address-family ipv4 unicast
RP/0/RP0/CPU0:router(config-isis-if-af)# fast-reroute per-prefix srlg-protection
weighted-global
RP/0/RP0/CPU0:router(config-isis-if-af)# fast-reroute per-prefix tiebreaker srlg-disjoint
index 1
RP/0/RP0/CPU0:router(config-isis-if-af)# exit
RP/0/RP0/CPU0:router(config-isis)# interface TenGigE0/0/0/0
RP/0/RP0/CPU0:router(config-isis-if)# point-to-point
RP/0/RP0/CPU0:router(config-isis-if)# address-family ipv4 unicast
RP/0/RP0/CPU0:router(config-isis-if-af)# fast-reroute per-prefix
RP/0/RP0/CPU0:router(config-isis-if-af)# fast-reroute per-prefix ti-lfa
RP/0/RP0/CPU0:router(config-isis-if-af)# exit
RP/0/RP0/CPU0:router(config-isis)# srlg
RP/0/RP0/CPU0:router(config-isis-srlg)# name group1
RP/0/RP0/CPU0:router(config-isis-srlg-name)# admin-weight 5000
```

The remote router configuration for global weighted SRLG protection with remote SRLG flooding is as follows:

```
RP/0/RP0/CPU0:router(config)# srlg
RP/0/RP0/CPU0:router(config-srlg)# interface TenGigE0/0/0/0
RP/0/RP0/CPU0:router(config-srlg-if)# name group1
RP/0/RP0/CPU0:router(config-srlg-if)# exit
RP/0/RP0/CPU0:router(config-srlg)# interface TenGigE0/0/0/1
RP/0/RP0/CPU0:router(config-srlg-if)# name group1
RP/0/RP0/CPU0:router(config-srlg)# name group value 100
RP/0/RP0/CPU0:router(config-srlg)# exit
RP/0/RP0/CPU0:router(config)# router isis 1
RP/0/RP0/CPU0:(config-isis)# address-family ipv4 unicast
RP/0/RP0/CPU0:router(config-isis-af)# advertise application lfa link-attributes srlg
```

This example shows configuring the global weighted SRLG protection feature with static provisioning of SRLG values for remote links. You should perform these configurations on the local router.

```
RP/0/RP0/CPU0:router(config)# srlg
RP/0/RP0/CPU0:router(config-srlg)# interface TenGigE0/0/0/0
RP/0/RP0/CPU0:router(config-srlg-if)# name group1
RP/0/RP0/CPU0:router(config-srlg-if)# exit
RP/0/RP0/CPU0:router(config-srlg)# interface TenGigE0/0/0/1
RP/0/RP0/CPU0:router(config-srlg-if)# name group1
RP/0/RP0/CPU0:router(config-srlg)# name group value 100
RP/0/RP0/CPU0:router(config-srlg)# exit
RP/0/RP0/CPU0:router(config)# router isis 1
RP/0/RP0/CPU0:router(config-isis)# address-family ipv4 unicast
RP/0/RP0/CPU0:router(config-isis-if-af)# fast-reroute per-prefix srlg-protection
weighted-global
RP/0/RP0/CPU0:router(config-isis-if-af)# fast-reroute per-prefix tiebreaker srlg-disjoint
index 1
```



```
RP/0/RP0/CPU0:router(config-isis)# interface TenGigE0/0/0/0
RP/0/RP0/CPU0:router(config-isis-if)# point-to-point
RP/0/RP0/CPU0:router(config-isis-if)# address-family ipv4 unicast
RP/0/RP0/CPU0:router(config-isis-if-af)# fast-reroute per-prefix
RP/0/RP0/CPU0:router(config-isis-if-af)# fast-reroute per-prefix ti-lfa
RP/0/RP0/CPU0:router(config-isis)# srlg
RP/0/RP0/CPU0:router(config-isis-srlg)# name group1
RP/0/RP0/CPU0:router(config-isis-srlg-name)# admin-weight 5000
RP/0/RP0/CPU0:router(config-isis-srlg-name)# static ipv4 address 10.0.4.1 next-hop ipv4
address 10.0.4.2
RP/0/RP0/CPU0:router(config-isis-srlg-name)# static ipv4 address 10.0.4.2 next-hop ipv4
address 10.0.4.1
```



CHAPTER 7

Configuring Auto-bandwidth Bundle TE++

MPLS-TE tunnels are used to set up labeled connectivity and to provide dynamic bandwidth capacity between endpoints. The auto-bandwidth feature addresses the dynamic bandwidth capacity demands by dynamically resizing the MPLS-TE tunnels based on the measured traffic loads. However, many customers require multiple auto-bandwidth tunnels between endpoints for load balancing and redundancy. When the aggregate bandwidth demand increases between two endpoints, you can either configure auto-bandwidth feature to resize the tunnels or create new tunnels and load balance the overall demand over all the tunnels between two endpoints. Similarly, when the aggregate bandwidth demand decreases between two endpoints you can either configure the auto-bandwidth feature to decrease the sizes of the tunnel or delete the new tunnels and load balance the traffic over the remaining tunnels between the endpoints. The autobandwidth bundle TE++ feature is an extension of the auto-bandwidth feature and allows you to automatically increase or decrease the number of MPLS-TE tunnels to a destination based on real time traffic needs.

Tunnels that are automatically created as a response to the increasing bandwidth demands are called clones. The cloned tunnels inherit properties of the main configured tunnel. However, user configured load interval cannot be inherited. The original tunnel and its clones are collectively called a set. You can specify an upper limit and lower limit on the number of clones that can be created for the original tunnel.

Splitting is the process of cloning a new tunnel when there is a demand for bandwidth increase. When the size of any of the tunnels in the set crosses a configured split bandwidth, then splitting is initiated and clone tunnels are created.

The following figure explains creating clone tunnels when the split bandwidth is exceeded.

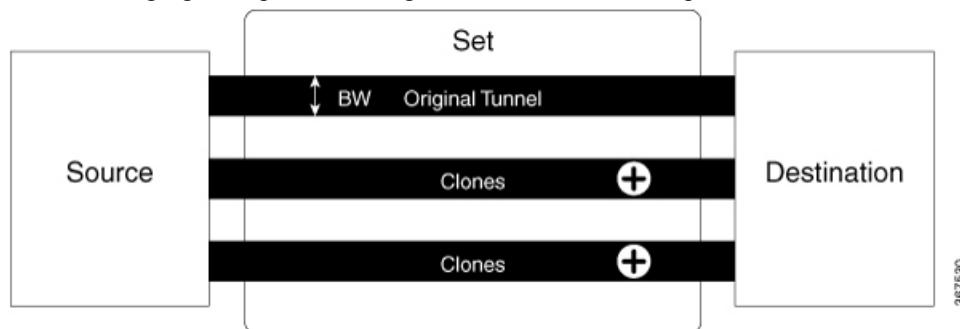

Merging is the process of removing a clone tunnel when the bandwidth demand decreases. If the bandwidth goes below the configured merge bandwidth in any one of the tunnels in the set, clone tunnels are removed.

The following figure explains removing clone tunnels to merge with the original tunnel when the bandwidth falls below the merge bandwidth.

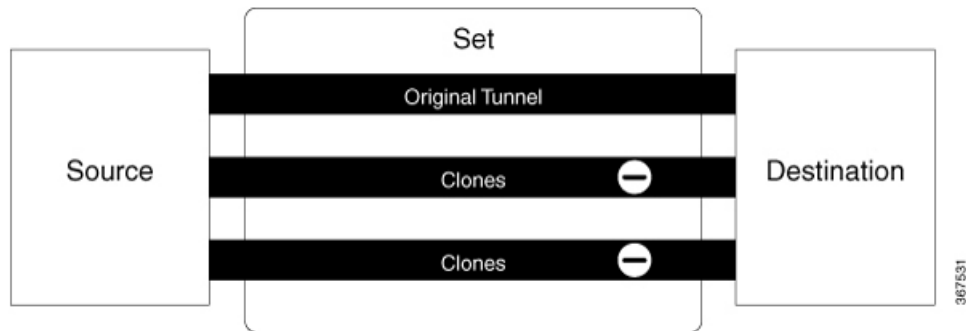

There are multiple ways to equally load-share the aggregate bandwidth demand among the tunnels in the set. This means that an algorithm is needed to choose the pair which satisfies the aggregate bandwidth requirements. You can configure a nominal bandwidth to guide the algorithm to determine the average bandwidths of the tunnels. If nominal bandwidth is not configured, TE uses the average of split and merge bandwidth as nominal bandwidth.

Restrictions and Usage Guidelines

The following usage guidelines apply for the auto-bandwidth bundle TE++ feature.

- This feature is only supported for the named tunnels and not supported on tunnel-te interfaces.
- The range for the lower limit on the number of clones is 0 to 63 and the default value for the lower limit on the number of clones is 0.
- The range for the upper limit on the number of clones is 1 to 63 and the default value for the upper limit on the number of clones is 63.

Configuration Example

This example shows how to configure the autobandwidth bundle TE++ feature for a named MPLS-TE traffic tunnel. You should configure the following values for this feature to work:

- `min-clones`: Specifies the minimum number of clone tunnels that the original tunnel can create.
- `max-clones`: Specifies the maximum number of clone tunnels that the original tunnel can create.
- `nominal-bandwidth`: Specifies the average bandwidth for computing the number of tunnels to satisfy the overall demand.
- `split-bandwidth`: Specifies the bandwidth value for splitting the original tunnel. If the tunnel bandwidth exceeds the configured split bandwidth, clone tunnels are created.
- `merge-bandwidth`: Specifies the bandwidth for merging clones with the original tunnel. If the bandwidth goes below the configured merge bandwidth, clone tunnels are removed.

In this example, the lower limit on the number of clones is configured as two and the upper limit on the number of clones is configured as four. The bandwidth size for splitting and merging is configured as 200 and 100 kbps.

```
RP/0/RP0/CPU0:router(config)# mpls traffic-eng
RP/0/RP0/CPU0:router(config-mpls-te)# named-tunnels
```

```
RP/0/RP0/CPU0:router(config-te-named-tunnels)# tunnel-te xyz
RP/0/RP0/CPU0:router(config-te-tun-name)# auto-bw
RP/0/RP0/CPU0:router(config-mpls-te-tun-autobw)# auto-capacity
RP/0/RP0/CPU0:router(config-te-tun-autocapacity)# min-clones 2
RP/0/RP0/CPU0:router(config-te-tun-autocapacity)# max-clones 4
RP/0/RP0/CPU0:router(config-te-tun-autocapacity)# nominal-bandwidth 150
RP/0/RP0/CPU0:router(config-te-tun-autocapacity)# split-bandwidth 200
RP/0/RP0/CPU0:router(config-te-tun-autocapacity)# merge-bandwidth 100
```



CHAPTER 8

Configuring Point to Multipoint Traffic Engineering

To carry multicast traffic in service provider networks, a multicast protocol like PIM needs to be deployed to set up forwarding paths in the service provider core. However for an MPLS backbone network, service providers can use label encapsulation instead of IP tunneling. This approach helps to reduce the control traffic overhead on the service provider core and also leverages the MPLS traffic engineering and protection features.

The label encapsulation could be either point-to-multipoint (P2MP) label switched paths (LSPs) or multipoint-to-multipoint (MP2MP) LSPs. For creating multicast LSPs, RSVP-TE protocol extensions can be used. The RSVP-TE protocol is extended to signal P2MP LSPs across the MPLS networks. P2MP-TE feature enables transporting multicast traffic through a PIM free service provider core using P2MP-TE tunnels.

The following figure explains the topology that is used in this feature.

Figure 19: PIM Free LSP Core

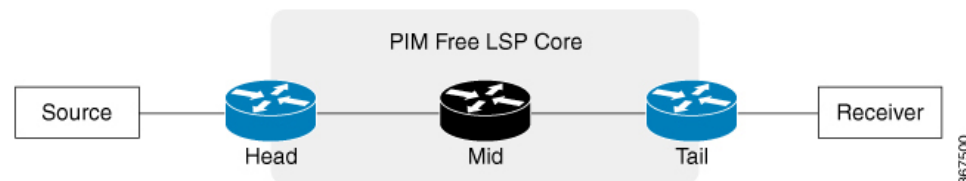

In this figure, the following terminologies are used:

- Head—A router on which a TE tunnel is configured.
- Tail—The router on which the TE tunnel terminates.
- Mid—A router through which the TE tunnel passes.

A Multicast VPN (mVPN) profile is configured for the global context or per VRF. Different mVPN profiles can be applied depending on where the multicast streams need to be transported.

The following mVPN profiles are supported for the P2MP-TE feature:

- mVPN profile 8 for global context
- mVPN profile 10 for L3VPN context

Restrictions and Usage Guidelines

The following restrictions and guidelines apply for this feature:

- Only Source-Specific Multicast (SSM) traffic is supported.
- For profile 8, both IPv4 and IPv6 are supported.
- For profile 10, only IPv4 is supported.
- Fast Reroute (FRR) for P2MP-TE tunnel is not supported.
- BVI interface is not supported.

Configuration Example: P2MP-TE Profile 8

This example shows the P2MP-TE configuration for profile 8. You need to configure the head, mid, and tail routers in the P2MP tunnel.

The head router configuration is given as follows. This configuration includes IGP, MPLS-TE tunnel, and multicast configurations. You should also configure LDP and RSVP while configuring this feature.

```
RP/0/RP0/CPU0:router(config)# router ospf 1
RP/0/RP0/CPU0:router(config-router)# area 0
RP/0/RP0/CPU0:router(config-ospf-ar)# mpls traffic-eng
RP/0/RP0/CPU0:router(config-ospf-ar-mpls-te)# exit
RP/0/RP0/CPU0:router(config-ospf-ar)# interface Loopback0
RP/0/RP0/CPU0:router(config-ospf-ar-if)# exit
RP/0/RP0/CPU0:router(config-ospf-ar)# interface TenGigE0/0/0/0
RP/0/RP0/CPU0:router(config-ospf-ar-if)# cost 1
RP/0/RP0/CPU0:router(config-ospf-ar-if)# network point-to-point
RP/0/RP0/CPU0:router(config-ospf-ar-if)# exit
RP/0/RP0/CPU0:router(config-ospf-ar)# interface TenGigE0/0/0/2
RP/0/RP0/CPU0:router(config-ospf-ar-if)# cost 1
RP/0/RP0/CPU0:router(config-ospf-ar-if)# network point-to-point
RP/0/RP0/CPU0:router(config-ospf-ar-if)# exit
RP/0/RP0/CPU0:router(config-ospf-ar)# exit
RP/0/RP0/CPU0:router(config-ospf)# mpls traffic-eng router-id loopback 0
RP/0/RP0/CPU0:router(config)# interface tunnel-mte 2
RP/0/RP0/CPU0:router(config-if)# ipv4 unnumbered Loopback0
RP/0/RP0/CPU0:router(config-if)# destination 10.2.2.2
RP/0/RP0/CPU0:router(config-if-p2mp-dest)# path-option 1 dynamic
RP/0/RP0/CPU0:router(config-if-p2mp-dest)# exit
RP/0/RP0/CPU0:router(config)# multicast-routing
RP/0/RP0/CPU0:router(config-mcast)# address-family ipv4
RP/0/RP0/CPU0:router(config-mcast-default-ipv4)# interface Loopback0
RP/0/RP0/CPU0:router(config-mcast-default-ipv4-if)# enable
RP/0/RP0/CPU0:router(config-mcast-default-ipv4-if)# exit
RP/0/RP0/CPU0:router(config-mcast-default-ipv4)# interface tunnel-mte 2
RP/0/RP0/CPU0:router(config-mcast-default-ipv4-if)# enable
RP/0/RP0/CPU0:router(config-mcast-default-ipv4-if)# exit
RP/0/RP0/CPU0:router(config-mcast-default-ipv4)# mdt source Loopback0
RP/0/RP0/CPU0:router(config-mcast-default-ipv4)# interface all enable
RP/0/RP0/CPU0:router(config-mcast-default-ipv4)# accounting per-prefix
RP/0/RP0/CPU0:router(config)# router igmp
RP/0/RP0/CPU0:router(config-igmp)# interface tunnel-mte 2
RP/0/RP0/CPU0:router(config-igmp-if)# static-group 232.0.0.2 10.0.0.100
RP/0/RP0/CPU0:router(config-igmp)# interface TenGigE0/0/0/0
RP/0/RP0/CPU0:router(config-igmp-if)# version 3
RP/0/RP0/CPU0:router(config)# router pim
RP/0/RP0/CPU0:router(config-pim)# address-family ipv4
RP/0/RP0/CPU0:router(config-pim-default-ipv4)# interface tunnel-mte 2
```



```
RP/0/RP0/CPU0:router(config-pim-default-ipv4-if)# enable
RP/0/RP0/CPU0:router(config-pim-default-ipv4-if)# exit
```

The running configuration for the head router is given as follows.

```
interface Loopback0
  ipv4 address 10.1.1.1 255.255.255.255
!
interface TenGigE0/0/0/0
  ipv4 address 10.0.0.1 255.255.255.0
!
interface TenGigE0/0/0/2
  ipv4 address 10.2.0.1 255.255.255.0
!
router ospf 1
  area 0
    mpls traffic-eng
    !
    interface Loopback0
    interface TenGigE0/0/0/0
      cost 1
      network point-to-point
    interface TenGigE0/0/0/2
      cost 1
      network point-to-point
    !
  mpls traffic-eng router-id Loopback0
!
rsvp
  interface TenGigE0/0/0/2
    bandwidth percentage 100
  !
!
mpls traffic-eng
  interface TenGigE0/0/0/2
  !
mpls ldp
  discovery
    targeted-hello interval 10
  !
  router-id 10.1.1.1
  address-family ipv4
    discovery targeted-hello accept
  !
  interface TenGigE0/0/0/2
  !
!
!
interface tunnel-mte2
  ipv4 unnumbered Loopback0
  destination 10.2.2.2
  path-option 1 dynamic
!
!
!
multicast-routing
  address-family ipv4
    interface Loopback0
      enable
    !
    interface tunnel-mte2
      enable
    !
  mdt source Loopback0
```

```

interface all enable
accounting per-prefix
!
!
!
router igmp
interface tunnel-mte2
static-group 232.0.0.2 10.0.0.100
!
interface TenGigE0/0/0/0
version 3
!
!
router pim
address-family ipv4
interface tunnel-mte2
enable
!
!
!

```

The mid router only requires MPLS-TE, RSVP and an IGP like OSPF configurations. The running configuration for the mid router is given as follows:

```

interface Loopback0
ipv4 address 10.5.5.5 255.255.255.255
interface TenGigE0/0/0/2
ipv4 address 10.10.0.5 255.255.255.0
interface TenGigE0/0/0/3
ipv4 address 10.13.0.5 255.255.255.0
router ospf 1
area 0
mpls traffic-eng
interface Loopback0
interface TenGigE0/0/0/2
cost 1
network point-to-point
interface TenGigE0/0/0/3
cost 1
network point-to-point
mpls traffic-eng router-id Loopback0
rsvp
interface TenGigE0/0/0/2
bandwidth percentage 100
interface TenGigE0/0/0/3
bandwidth percentage 100
mpls traffic-eng
interface TenGigE0/0/0/2
interface TenGigE0/0/0/3
mpls ldp
discovery
targeted-hello interval 10
router-id 10.5.5.5
address-family ipv4
discovery targeted-hello accept
interface TenGigE0/0/0/2
interface TenGigE0/0/0/3
!
!

```

The tail router configuration is given as follows. This configuration includes IGP, MPLS-TE tunnel and multicast configurations. Similar to head router, you should also configure RSVP and LDP while configuring this feature.

```

RP/0/RP0/CPU0:router(config)# router ospf 1
RP/0/RP0/CPU0:router(config-router)# area 0
RP/0/RP0/CPU0:router(config-ospf-ar)# mpls traffic-eng
RP/0/RP0/CPU0:router(config-ospf-ar-mpls-te)# exit
RP/0/RP0/CPU0:router(config-ospf-ar)# interface Loopback0
RP/0/RP0/CPU0:router(config-ospf-ar-if)# exit
RP/0/RP0/CPU0:router(config-ospf-ar)# interface TenGigE0/0/0/3
RP/0/RP0/CPU0:router(config-ospf-ar-if)# cost 1
RP/0/RP0/CPU0:router(config-ospf-ar-if)# network point-to-point
RP/0/RP0/CPU0:router(config-ospf-ar-if)# exit
RP/0/RP0/CPU0:router(config-ospf-ar)# exit
RP/0/RP0/CPU0:router(config-ospf)# mpls traffic-eng router-id loopback 0
RP/0/RP0/CPU0:router(config)# interface tunnel-mte 2
RP/0/RP0/CPU0:router(config-if)# ipv4 unnumbered Loopback0
RP/0/RP0/CPU0:router(config-if)# destination 10.2.2.2
RP/0/RP0/CPU0:router(config-if-p2mp-dest)# path-option 1 dynamic
RP/0/RP0/CPU0:router(config-if-p2mp-dest)# exit
RP/0/RP0/CPU0:router(config)# multicast-routing
RP/0/RP0/CPU0:router(config-mcast)# address-family ipv4
RP/0/RP0/CPU0:router(config-mcast-default-ipv4)# interface Loopback0
RP/0/RP0/CPU0:router(config-mcast-default-ipv4-if)# enable
RP/0/RP0/CPU0:router(config-mcast-default-ipv4-if)# exit
RP/0/RP0/CPU0:router(config-mcast-default-ipv4)# mdt source Loopback0
RP/0/RP0/CPU0:router(config-mcast-default-ipv4)# core-tree-protocol rsvp-te
RP/0/RP0/CPU0:router(config-mcast-default-ipv4)# static-rpf 10.0.0.100 32 mpls 1.1.1.1
RP/0/RP0/CPU0:router(config-mcast-default-ipv4)# rate-per-route
RP/0/RP0/CPU0:router(config-mcast-default-ipv4)# interface all enable
RP/0/RP0/CPU0:router(config-mcast-default-ipv4)# accounting per-prefix
RP/0/RP0/CPU0:router(config)# router igmp
RP/0/RP0/CPU0:router(config-igmp)# interface TenGigE0/0/0/3
RP/0/RP0/CPU0:router(config-igmp-if)# version 3
RP/0/RP0/CPU0:router(config)# router pim
RP/0/RP0/CPU0:router(config-pim)# address-family ipv4
RP/0/RP0/CPU0:router(config-pim-default-ipv4)# interface TenGigE0/0/0/3
RP/0/RP0/CPU0:router(config-pim-default-ipv4-if)# enable
RP/0/RP0/CPU0:router(config-pim-default-ipv4-if)# exit

```

The running configuration for the tail router is given as follows:

```

!
interface Loopback0
  ipv4 address 10.2.2.2 255.255.255.255
!
interface TenGigE0/0/0/3
  ipv4 address 10.3.0.2 255.255.255.0
!
interface TenGigE0/0/0/6
  ipv4 address 10.6.0.2 255.255.255.0
!
router ospf 1
  area 0
    mpls traffic-eng
    interface Loopback0
    !
    interface TenGigE0/0/0/3
      cost 1
      network point-to-point
    !
!
mpls traffic-eng router-id Loopback0
!
rsvp
  interface TenGigE0/0/0/3

```

```

    bandwidth percentage 100
    !
    !
mpls traffic-eng
    interface TenGigE0/0/0/3
    !
mpls ldp
    discovery
        targeted-hello interval 10
    !
    router-id 10.2.2.2
    address-family ipv4
        discovery targeted-hello accept
    !
    interface TenGigE0/0/0/3
    !
    !
multicast-routing
    address-family ipv4
interface Loopback0
    enable
    !
    mdt source Loopback0
    core-tree-protocol rsvp-te
    static-rpf 10.0.0.100 32 mpls 10.1.1.1
    rate-per-route
    interface all enable
    accounting per-prefix
    !
    !
    !
router igmp
    !
    interface TenGigE0/0/0/6
        version 3
    !
    !
router pim
    !
    address-family ipv4
        interface TenGigE0/0/0/6
            enable
        !
    !
    !

```

Configuration Example: P2MP-TE Profile 10

This example shows the P2MP-TE configuration for profile 10. You need to configure the head, mid, and tail routers.

The head router configuration is given as follows. This configuration includes IGP, L3VPN, and multicast configurations. You should also configure MPLS-TE, LDP, and RSVP while configuring this feature.

```

RP/0/RP0/CPU0:router(config)# router ospf 1
RP/0/RP0/CPU0:router(config-router)# area 0
RP/0/RP0/CPU0:router(config-ospf-ar)# mpls traffic-eng
RP/0/RP0/CPU0:router(config-ospf-ar-mpls-te)# exit
RP/0/RP0/CPU0:router(config-ospf-ar)# interface Loopback0
RP/0/RP0/CPU0:router(config-ospf-ar-if)# exit
RP/0/RP0/CPU0:router(config-ospf-ar)# interface TenGigE0/0/0/2
RP/0/RP0/CPU0:router(config-ospf-ar-if)# cost 1
RP/0/RP0/CPU0:router(config-ospf-ar-if)# network point-to-point

```

```

RP/0/RP0/CPU0:router(config-ospf-ar-if)# exit
RP/0/RP0/CPU0:router(config-ospf-ar)# exit
RP/0/RP0/CPU0:router(config-ospf)# mpls traffic-eng router-id loopback 0
RP/0/RP0/CPU0:router(config-ospf)# exit
RP/0/RP0/CPU0:router(config)# vrf vpn_2
RP/0/RP0/CPU0:router(config-vrf)# address-family ipv4 unicast
RP/0/RP0/CPU0:router(config-vrf-af)# import route-target 100:2
RP/0/RP0/CPU0:router(config-vrf-af)# export route-target 120:2
RP/0/RP0/CPU0:router(config)# interface TengigE0/0/0/0
RP/0/RP0/CPU0:router(config-if)# vrf vpn_2
RP/0/RP0/CPU0:router(config-if-vrf)# ipv4 address 10.0.0.1 255.255.255.0
RP/0/RP0/CPU0:router(config)# route-policy pass-all
RP/0/RP0/CPU0:router(config)# pass
RP/0/RP0/CPU0:router(config)#router bgp 1
RP/0/RP0/CPU0:router(config-bgp)# bgp router-id 10.1.1.1
RP/0/RP0/CPU0:router(config-bgp)# address-family ipv4 unicast
RP/0/RP0/CPU0:router(config-bgp-af)# address-family vpnv4 unicast
RP/0/RP0/CPU0:router(config-bgp-af)# address-family ipv4 mvpn
RP/0/RP0/CPU0:router(config-bgp)# neighbor 10.2.2.2
RP/0/RP0/CPU0:router(config-bgp-nbr)# remote-as 1
RP/0/RP0/CPU0:router(config-bgp-nbr)# update-source Loopback0
RP/0/RP0/CPU0:router(config-bgp-nbr)# address-family ipv4 unicast
RP/0/RP0/CPU0:router(config-bgp-nbr-af)# route-policy pass-all in
RP/0/RP0/CPU0:router(config-bgp-nbr-af)# route-policy pass-all out
RP/0/RP0/CPU0:router(config-bgp-nbr)# address-family vpnv4 unicast
RP/0/RP0/CPU0:router(config-bgp-nbr-af)# route-policy pass-all in
RP/0/RP0/CPU0:router(config-bgp-nbr-af)# route-policy pass-all out
RP/0/RP0/CPU0:router(config-bgp-nbr)# address-family ipv4 mvpn
RP/0/RP0/CPU0:router(config-bgp)# vrf vpn_2
RP/0/RP0/CPU0:router(config-bgp-vrf)#rd 100:2
RP/0/RP0/CPU0:router(config-bgp-vrf)#address-family ipv4 unicast
RP/0/RP0/CPU0:router(config-bgp-vrf-af)#label mode per-prefix
RP/0/RP0/CPU0:router(config-bgp-vrf-af)#redistribute connected
RP/0/RP0/CPU0:router(config-bgp-vrf-af)#exit
RP/0/RP0/CPU0:router(config-bgp-vrf)# address-family ipv4 mvpn
RP/0/RP0/CPU0:router(config)# multicast-routing
RP/0/RP0/CPU0:router(config-mcast)# address-family ipv4
RP/0/RP0/CPU0:router(config-mcast-default-ipv4)# interface Loopback0
RP/0/RP0/CPU0:router(config-mcast-default-ipv4-if)# enable
RP/0/RP0/CPU0:router(config-mcast-default-ipv4-if)# exit
RP/0/RP0/CPU0:router(config-mcast-default-ipv4)# mdt source Loopback0
RP/0/RP0/CPU0:router(config-mcast)# vrf vpn_2
RP/0/RP0/CPU0:router(config-mcast-vpn_2)# address-family ipv4
RP/0/RP0/CPU0:router(config-mcast-vpn_2-ipv4)# mdt source loopback0
RP/0/RP0/CPU0:router(config-mcast-vpn_2-ipv4)# rate-per-route
RP/0/RP0/CPU0:router(config-mcast-vpn_2-ipv4)# interface all enable
RP/0/RP0/CPU0:router(config-mcast-vpn_2-ipv4)# bgp auto-discovery p2mp-te
RP/0/RP0/CPU0:router(config-mcast-vpn_2-ipv4-bgp-ad)# mdt static p2mp-te tunnel-mte2
RP/0/RP0/CPU0:router(config)# router igmp
RP/0/RP0/CPU0:router(config-igmp)# vrf vpn_2
RP/0/RP0/CPU0:router(config-igmp-vpn_2)# interface tunnel-mte2
RP/0/RP0/CPU0:router(config-igmp-vpn_2-if)# static-group 239.0.0.1 100.0.0.100
RP/0/RP0/CPU0:router(config-igmp-vpn_2-if)# exit
RP/0/RP0/CPU0:router(config-igmp-vpn_2)# interface TenGigE0/0/0/0
RP/0/RP0/CPU0:router(config-igmp-vpn_2-if)# version 3
RP/0/RP0/CPU0:router(config-igmp-vpn_2-if)# exit
RP/0/RP0/CPU0:router(config-igmp-vpn_2)#
RP/0/RP0/CPU0:router(config)# router pim
RP/0/RP0/CPU0:router(config-pim)# vrf vpn_2
RP/0/RP0/CPU0:router(config-pim-vpn_2)# address-family ipv4
RP/0/RP0/CPU0:router(config-pim-vpn_2-ipv4)# interface tunnel-mte2
RP/0/RP0/CPU0:router(config-pim-vpn_2-ipv4-if)# enable
RP/0/RP0/CPU0:router(config-pim-vpn_2-ipv4-if)# exit

```

```
RP/0/RP0/CPU0:router(config-pim-vpn_2-ipv4)# interface TenGigE0/0/0/0
RP/0/RP0/CPU0:router(config-pim-vpn_2-ipv4-if)# enable
```

The running configuration for the head router is given as follows.

```
!
interface Loopback0
  ipv4 address 10.1.1.1 255.255.255.255
!
interface TenGigE0/0/0/2
  ipv4 address 10.2.0.1 255.255.255.0
!
router ospf 1
  area 0
    mpls traffic-eng
    !
    interface Loopback0
    !
    interface TenGigE0/0/0/2
      cost 1
      network point-to-point
    !
  mpls traffic-eng router-id Loopback0
!
rsvp
  interface TenGigE0/0/0/2
    bandwidth percentage 100
!
!
mpls traffic-eng
  interface TenGigE0/0/0/2
!
mpls ldp
  discovery
    targeted-hello interval 10
!
  router-id 10.1.1.1
  address-family ipv4
    discovery targeted-hello accept
!
  interface TenGigE0/0/0/2
!
!
vrf vpn_2
  address-family ipv4 unicast
    import route-target
      100:2
    export route-target
      100:2

interface TenGigE0/0/0/0
  vrf vpn_2
  ipv4 address 10.0.0.1 255.255.255.0

route-policy pass-all
  pass
end-policy

router bgp 1
  bgp router-id 10.1.1.1
  address-family ipv4 unicast
  address-family vpv4 unicast
  address-family ipv4 mvpn
  neighbor 10.2.2.2
```

```

remote-as 1
update-source Loopback0
address-family ipv4 unicast
  route-policy pass-all in
  route-policy pass-all out
address-family vpnv4 unicast
  route-policy pass-all in
  route-policy pass-all out
address-family ipv4 mvpn
vrf vpn_2
  rd 100:2
  address-family ipv4 unicast
    label mode per-prefix
    redistribute connected
  address-family ipv4 mvpn
hostname head
!
multicast-routing
address-family ipv4
interface Loopback0
  enable
!
mdt source Loopback0
!
vrf vpn_2
  address-family ipv4
    mdt source Loopback0
    rate-per-route
    interface all enable
    bgp auto-discovery p2mp-te
    !
    mdt static p2mp-te tunnel-mte2
    !
!
!
router igmp
vrf vpn_2
  interface tunnel-mte2
    static-group 239.0.0.1 100.0.0.100
  !
  interface TenGigE0/0/0/0
    version 3
  !
!
router pim
vrf vpn_2
  address-family ipv4
    interface tunnel-mte2
      enable
    !
    interface TenGigE0/0/0/0
      enable
    !
  !
!
!

```

The mid router only requires MPLS-TE, RSVP, and IGP configuration. The running configuration for the mid router is given as follows:

```

interface Loopback0
  ipv4 address 10.5.5.5 255.255.255.255

interface TenGigE0/0/0/2
  ipv4 address 10.0.0.5 255.255.255.0

```

```

interface TenGigE0/0/0/3
  ipv4 address 10.3.0.5 255.255.255.0

router ospf 1
  area 0
  mpls traffic-eng
  interface Loopback0
  interface TenGigE0/0/0/2
    cost 1
    network point-to-point
  interface TenGigE0/0/0/3
    cost 1
    network point-to-point
mpls traffic-eng router-id Loopback0

rsvp
  interface TenGigE0/0/0/2
    bandwidth percentage 100
  interface TenGigE0/0/0/3
    bandwidth percentage 100

mpls traffic-eng
  interface TenGigE0/0/0/2
  interface TenGigE0/0/0/3

mpls ldp
  discovery
  targeted-hello interval 10
  router-id 10.5.5.5
  address-family ipv4
  discovery targeted-hello accept
  interface TenGigE0/0/0/2
  interface TenGigE0/0/0/3
  !
  !

```

The tail router configuration is given as follows. This configuration includes L3VPN, multicast, and IGP configurations. Similar to the head router, you should also configure MPLS-TE and RSVP before configuring this feature.

```

RP/0/RP0/CPU0:router# configure
RP/0/RP0/CPU0:router(config)# router ospf 1
RP/0/RP0/CPU0:router(config-router)# area 0
RP/0/RP0/CPU0:router(config-ospf-ar)# mpls traffic-eng
RP/0/RP0/CPU0:router(config-ospf-ar-mpls-te)# exit
RP/0/RP0/CPU0:router(config-ospf-ar)# interface Loopback0
RP/0/RP0/CPU0:router(config-ospf-ar-if)# exit
RP/0/RP0/CPU0:router(config-ospf-ar)# interface TenGigE0/0/0/3
RP/0/RP0/CPU0:router(config-ospf-ar-if)# cost 1
RP/0/RP0/CPU0:router(config-ospf-ar-if)# network point-to-point
RP/0/RP0/CPU0:router(config-ospf-ar-if)# exit
RP/0/RP0/CPU0:router(config-ospf-ar)# exit
RP/0/RP0/CPU0:router(config-ospf)# mpls traffic-eng router-id loopback 0
RP/0/RP0/CPU0:router(config-ospf)# exit
RP/0/RP0/CPU0:router(config)# vrf vpn_2
RP/0/RP0/CPU0:router(config-vrf)# address-family ipv4 unicast
RP/0/RP0/CPU0:router(config-vrf-af)# import route-target 100:2
RP/0/RP0/CPU0:router(config-vrf-af)# export route-target 120:2
RP/0/RP0/CPU0:router(config)# interface TengigE0/0/0/6
RP/0/RP0/CPU0:router(config-if)# vrf vpn_2
RP/0/RP0/CPU0:router(config-if-vrf)# ipv4 address 10.0.0.1 255.255.255.0
RP/0/RP0/CPU0:router(config)# route-policy pass-all

```



```

RP/0/RP0/CPU0:router(config)# pass
RP/0/RP0/CPU0:router(config)# end-policy
RP/0/RP0/CPU0:router(config)# router bgp 1
RP/0/RP0/CPU0:router(config-bgp)# bgp router-id 10.2.2.2
RP/0/RP0/CPU0:router(config-bgp)# address-family ipv4 unicast
RP/0/RP0/CPU0:router(config-bgp-af)# address-family vpnv4 unicast
RP/0/RP0/CPU0:router(config-bgp-af)# address-family ipv4 mvpn
RP/0/RP0/CPU0:router(config-bgp)# neighbor 10.1.1.1
RP/0/RP0/CPU0:router(config-bgp-nbr)# remote-as 1
RP/0/RP0/CPU0:router(config-bgp-nbr)# address-family ipv4 unicast
RP/0/RP0/CPU0:router(config-bgp-nbr-af)# route-policy pass-all in
RP/0/RP0/CPU0:router(config-bgp-nbr-af)# route-policy pass-all out
RP/0/RP0/CPU0:router(config-bgp-nbr)# address-family vpnv4 unicast
RP/0/RP0/CPU0:router(config-bgp-nbr-af)# route-policy pass-all in
RP/0/RP0/CPU0:router(config-bgp-nbr-af)# route-policy pass-all out
RP/0/RP0/CPU0:router(config-bgp-nbr)# address-family ipv4 mvpn
RP/0/RP0/CPU0:router(config)# multicast-routing
RP/0/RP0/CPU0:router(config-mcast)# address-family ipv4
RP/0/RP0/CPU0:router(config-mcast-default-ipv4)# interface Loopback0
RP/0/RP0/CPU0:router(config-mcast-default-ipv4-if)# enable
RP/0/RP0/CPU0:router(config-mcast-default-ipv4-if)# exit
RP/0/RP0/CPU0:router(config-mcast-default-ipv4)# mdt source Loopback0
RP/0/RP0/CPU0:router(config-mcast)# vrf vpn_2
RP/0/RP0/CPU0:router(config-mcast-vpn_2)# address-family ipv4
RP/0/RP0/CPU0:router(config-mcast-vpn_2-ipv4)# mdt source loopback0
RP/0/RP0/CPU0:router(config-mcast-vpn_2-ipv4)# core-tree-protocol rsvp-te
RP/0/RP0/CPU0:router(config-mcast-vpn_2-ipv4)# rate-per-route
RP/0/RP0/CPU0:router(config-mcast-vpn_2-ipv4)# interface all enable
RP/0/RP0/CPU0:router(config-mcast-vpn_2-ipv4)# bgp auto-discovery p2mp-te
RP/0/RP0/CPU0:router(config)# router igmp
RP/0/RP0/CPU0:router(config-igmp)# vrf vpn_2
RP/0/RP0/CPU0:router(config-igmp-vpn_2)# interface TenGigE0/0/0/6
RP/0/RP0/CPU0:router(config-igmp-vpn_2-if)# version 3
RP/0/RP0/CPU0:router(config-igmp-vpn_2-if)# exit
RP/0/RP0/CPU0:router(config)# router pim
RP/0/RP0/CPU0:router(config-pim)# vrf vpn_2
RP/0/RP0/CPU0:router(config-pim-vpn_2)# address-family ipv4
RP/0/RP0/CPU0:router(config-pim-vpn_2-ipv4)# interface TenGigE0/0/0/6
RP/0/RP0/CPU0:router(config-pim-vpn_2-ipv4-if)# enable
RP/0/RP0/CPU0:router(config)#router bgp 1
RP/0/RP0/CPU0:router(config-bgp)# bgp router-id 192.168.1.2
RP/0/RP0/CPU0:router(config-bgp)# address-family ipv4 unicast
RP/0/RP0/CPU0:router(config-bgp-af)# address-family vpnv4 unicast
RP/0/RP0/CPU0:router(config-bgp-af)# address-family ipv4 mvpn
RP/0/RP0/CPU0:router(config-bgp)# neighbor 192.168.1.1
RP/0/RP0/CPU0:router(config-bgp-nbr)# remote-as 2002
RP/0/RP0/CPU0:router(config-bgp-nbr)# address-family ipv4 unicast
RP/0/RP0/CPU0:router(config-bgp-nbr-af)# route-policy pass-all in
RP/0/RP0/CPU0:router(config-bgp-nbr-af)# route-policy pass-all out
RP/0/RP0/CPU0:router(config-bgp-nbr)# address-family vpnv4 unicast
RP/0/RP0/CPU0:router(config-bgp-nbr-af)# route-policy pass-all in
RP/0/RP0/CPU0:router(config-bgp-nbr-af)# route-policy pass-all out
RP/0/RP0/CPU0:router(config-bgp-nbr)# address-family ipv4 mvpn
RP/0/RP0/CPU0:router(config-bgp)# vrf vpn_2
RP/0/RP0/CPU0:router(config-bgp-vrf)#rd 100:2
RP/0/RP0/CPU0:router(config-bgp-vrf)#address-family ipv4 unicast
RP/0/RP0/CPU0:router(config-bgp-vrf-af)#label mode per-prefix
RP/0/RP0/CPU0:router(config-bgp-vrf-af)#redistribute connected
RP/0/RP0/CPU0:router(config-bgp-vrf-af)#exit
RP/0/RP0/CPU0:router(config-bgp-vrf)# address-family ipv4 mvpn

```

Running configuration for the tail router is given as follows:

```
interface Loopback0
```

```

    ipv4 address 10.2.2.2 255.255.255.255
    !
interface TenGigE0/0/0/3
    ipv4 address 10.3.0.2 255.255.255.0
    !
router ospf 1
    area 0
        mpls traffic-eng
        interface Loopback0
        !
        interface TenGigE0/0/0/3
            cost 1
            network point-to-point
        !
    !
mpls traffic-eng router-id Loopback0
!
rsvp
    interface TenGigE0/0/0/3
        bandwidth percentage 100
    !
!
mpls traffic-eng
    interface TenGigE0/0/0/3
    !
mpls ldp
    discovery
        targeted-hello interval 10
    !
    router-id 10.2.2.2
    address-family ipv4
        discovery targeted-hello accept
    !
    interface TenGigE0/0/0/3
    !
! vrf vpn_2
    address-family ipv4 unicast
        import route-target
            100:2
        export route-target
            100:2

interface TenGigE0/0/0/6
    vrf vpn_2
    ipv4 address 10.6.0.2 255.255.255.0

route-policy pass-all
    pass
end-policy

router bgp 1
    bgp router-id 10.2.2.2
    address-family ipv4 unicast
    address-family vpnv4 unicast
    address-family ipv4 mvpn
    neighbor 10.1.1.1
        remote-as 1
    update-source Loopback0
    address-family ipv4 unicast
        route-policy pass-all in
        route-policy pass-all out
    address-family vpnv4 unicast
        route-policy pass-all in
        route-policy pass-all out

```

```

address-family ipv4 mvpn
vrf vpn_2
rd 100:2
address-family ipv4 unicast
label mode per-prefix
redistribute connected
address-family ipv4 mvpn
!
multicast-routing
address-family ipv4
interface Loopback0
enable
!
mdt source Loopback0
!
vrf vpn_2
address-family ipv4
mdt source Loopback0
core-tree-protocol rsvp-te
rate-per-route
interface all enable
bgp auto-discovery p2mp-te
!
!
router igmp
vrf vpn_2
interface TenGigE0/0/0/6
version 3
!
!
router pim
vrf vpn_2
address-family ipv4
interface TenGigE0/0/0/6
enable
!
!
!

```

Verification: P2MP-TE

This example shows how to verify if the multicast control state is correct on the head router using the **show mrib vrf vpn_2 route** command.

```

RP/0/RP0/CPU0:router# show mrib vrf vpn_2 route

(10.0.0.100,232.0.0.1) RPF nbr: 10.0.0.100 Flags: RPF
Up: 00:00:38
Incoming Interface List
TenGigE0/0/0/0 Flags: A, Up: 00:00:38
Outgoing Interface List
Tunnel-mte2 Flags: F NS LI LVIF, Up: 00:00:38

```

You can also verify the multicast control state on the tail router.

```

RP/0/RP0/CPU0:router# show mrib vrf vpn_2 route

(10.0.0.100,232.0.0.1) RPF nbr: 10.1.1.1 Flags: RPF
Up: 00:03:55
Outgoing Interface List
TenGigE0/0/0/6 Flags: F NS LI, Up: 00:03:55

```

This example shows how to check if the TE tunnel is established on the head router by using the **show mpls traffic-eng tunnels p2mp** command.

```
RP/0/RP0/CPU0:router# show mpls traffic-eng tunnels p2mp 2
```

```
Name: tunnel-mte2
Signalled-Name: head_mt2
Status:
  Admin: up Oper: up (Up for 00:09:37)
  Config Parameters:
    Bandwidth: 0 kbps (CT0) Priority: 7 7 Affinity: 0x0/0xffff
    Interface Bandwidth: 0 kbps
    Metric Type: TE (global)
    Fast Reroute: Not Enabled, Protection Desired: None
    Record Route: Not Enabled
    Reoptimization after affinity failure: Enabled
    Destination summary: (1 up, 0 down, 0 disabled) Affinity: 0x0/0xffff
    Auto-bw: disabled
    Destination: 10.2.2.2
      State: Up for 00:09:37
      Path options:
        path-option 1 dynamic [active]
  Current LSP:
    lsp-id: 10002 p2mp-id: 2 tun-id: 2 src: 10.1.1.1 extid: 10.1.1.1
    LSP up for: 00:09:37 (since Fri May 25 22:32:03 UTC 2018)
    Reroute Pending: No
    Inuse Bandwidth: 0 kbps (CT0)
    Number of S2Ls: 1 connected, 0 signaling proceeding, 0 down S2L Sub LSP:
Destination 2.2.2.2 Signaling Status: connected
    S2L up for: 00:09:37 (since Fri May 25 22:32:03 UTC 2018)
    Sub Group ID: 1 Sub Group Originator ID: 10.1.1.1
    Path option path-option 1 dynamic (path weight 2)
    Path info (OSPF 1 area 0)
      10.0.0.5
      10.0.0.2
      10.2.2.2
    Reoptimized LSP (Install Timer Remaining 0 Seconds):
      None
    Cleaned LSP (Cleanup Timer Remaining 0 Seconds):
      None
  Displayed 1 (of 101) heads, 0 (of 0) midpoints, 0 (of 0) tails
  Displayed 1 up, 0 down, 0 recovering, 0 recovered heads
```

This example shows how to verify the label assignment on the head router using the **show mpls forwarding p2mp** command.

```
RP/0/RP0/CPU0:router# show mpls forwarding p2mp
```

| Local Label | Outgoing Label | Prefix or ID | Outgoing Interface | Next Hop | Bytes Switched |
|-------------|----------------|--------------|--------------------|----------|----------------|
| 64106 | 64008 | P2MP TE: 2 | TenGigE0/0/0/2 | 10.0.0.5 | 0 |