



## **Cisco N540-Front Haul Hardware Installation Guide**

**First Published:** 2020-12-21

### **Americas Headquarters**

Cisco Systems, Inc.  
170 West Tasman Drive  
San Jose, CA 95134-1706  
USA  
<http://www.cisco.com>  
Tel: 408 526-4000  
800 553-NETS (6387)  
Fax: 408 527-0883

THE SPECIFICATIONS AND INFORMATION REGARDING THE PRODUCTS IN THIS MANUAL ARE SUBJECT TO CHANGE WITHOUT NOTICE. ALL STATEMENTS, INFORMATION, AND RECOMMENDATIONS IN THIS MANUAL ARE BELIEVED TO BE ACCURATE BUT ARE PRESENTED WITHOUT WARRANTY OF ANY KIND, EXPRESS OR IMPLIED. USERS MUST TAKE FULL RESPONSIBILITY FOR THEIR APPLICATION OF ANY PRODUCTS.

THE SOFTWARE LICENSE AND LIMITED WARRANTY FOR THE ACCOMPANYING PRODUCT ARE SET FORTH IN THE INFORMATION PACKET THAT SHIPPED WITH THE PRODUCT AND ARE INCORPORATED HEREIN BY THIS REFERENCE. IF YOU ARE UNABLE TO LOCATE THE SOFTWARE LICENSE OR LIMITED WARRANTY, CONTACT YOUR CISCO REPRESENTATIVE FOR A COPY.

The Cisco implementation of TCP header compression is an adaptation of a program developed by the University of California, Berkeley (UCB) as part of UCB's public domain version of the UNIX operating system. All rights reserved. Copyright © 1981, Regents of the University of California.

NOTWITHSTANDING ANY OTHER WARRANTY HEREIN, ALL DOCUMENT FILES AND SOFTWARE OF THESE SUPPLIERS ARE PROVIDED "AS IS" WITH ALL FAULTS. CISCO AND THE ABOVE-NAMED SUPPLIERS DISCLAIM ALL WARRANTIES, EXPRESSED OR IMPLIED, INCLUDING, WITHOUT LIMITATION, THOSE OF MERCHANTABILITY, FITNESS FOR A PARTICULAR PURPOSE AND NON-INFRINGEMENT OR ARISING FROM A COURSE OF DEALING, USAGE, OR TRADE PRACTICE.

IN NO EVENT SHALL CISCO OR ITS SUPPLIERS BE LIABLE FOR ANY INDIRECT, SPECIAL, CONSEQUENTIAL, OR INCIDENTAL DAMAGES, INCLUDING, WITHOUT LIMITATION, LOST PROFITS OR LOSS OR DAMAGE TO DATA ARISING OUT OF THE USE OR INABILITY TO USE THIS MANUAL, EVEN IF CISCO OR ITS SUPPLIERS HAVE BEEN ADVISED OF THE POSSIBILITY OF SUCH DAMAGES.

Any Internet Protocol (IP) addresses and phone numbers used in this document are not intended to be actual addresses and phone numbers. Any examples, command display output, network topology diagrams, and other figures included in the document are shown for illustrative purposes only. Any use of actual IP addresses or phone numbers in illustrative content is unintentional and coincidental.

All printed copies and duplicate soft copies of this document are considered uncontrolled. See the current online version for the latest version.

Cisco has more than 200 offices worldwide. Addresses and phone numbers are listed on the Cisco website at [www.cisco.com/go/offices](http://www.cisco.com/go/offices).

Cisco and the Cisco logo are trademarks or registered trademarks of Cisco and/or its affiliates in the U.S. and other countries. To view a list of Cisco trademarks, go to this URL: <https://www.cisco.com/c/en/us/about/legal/trademarks.html>. Third-party trademarks mentioned are the property of their respective owners. The use of the word partner does not imply a partnership relationship between Cisco and any other company. (1721R)

© 2019–2020 Cisco Systems, Inc. All rights reserved.



## CONTENTS

---

### CHAPTER 1

#### **Safety Warnings 1**

- Standard Warning Statements 1
- Safety Guidelines for Personal Safety and Equipment Protection 2
- Safety with Electricity 2
- Cautions and Regulatory Compliance Statements for NEBS 4
- Power Supply Considerations 5
  - Power Connection Guidelines 5
    - Guidelines for DC-Powered Systems 5
    - Guidelines for AC-Powered Systems 5
  - Preventing ESD Damage 6

---

### CHAPTER 2

#### **Cisco N540-Front-Haul Router Overview 7**

- Features 7
- Specification 8
- Interface Naming 8
- Network Timing Interfaces 9
- GNSS Receiver 10
  - GNSS Module RF Input Requirements 10
- External Alarm Inputs 11
- Console 11
  - USB Port 11
  - USB Console 11
- Online Insertion and Removal 11
- Supported Transceiver Modules 12

---

### CHAPTER 3

#### **Prepare for Installation 13**

General Precautions	13
Site Planning Checklist	14
Environmental Requirements	14
Airflow for Site Planning	15
Airflow Guidelines	15
Site Power Guidelines	18
Electrical Circuit Requirements	19
Site Cabling Guidelines	19
Asynchronous Terminal Connections	20
Interference Considerations	20
Electromagnetic Interference	20
Radio Frequency Interference	20
Lightning and AC Power Fault Interference	21
Tools and Equipment	21
Prepare Your Location	21
Prepare Yourself	22
Prepare Rack for Router Installation	23
Cabinet Selection Guidelines	23
Unpack the Cisco NCS 540-Front-Haul Router	24

---

**CHAPTER 4**

<b>Install the Device</b>	<b>29</b>
Install N540-FH-CSR-SYS	29
Rack Compatibility	29
Rack Types	29
Set up Device on Rack	31
Rack Mount	31
Ground the Device	36
Install the AC Power Cables	37
Activate an AC Power Supply Module	38
Install the DC Power Cables	39
Activate a DC Power Supply Module	40
Port Connection Guidelines	40
Connect to the Console Port	41
Connect to the Management Ethernet Port	42

Connecting Timing Cables	43
Connecting Cables to a GPS Interface	44
Connecting a Cable to the Input 10MHz or 1PPS Interface	44
Connecting a Cable to the Output 10MHz or 1PPS Interface	44
Connecting a Cable to the GNSS Antenna Interface	44
Install and Remove Transceiver Module	45
Safety Precautions for Module Installation and Removal	45
Install and Remove SFP Modules	46
Bale Clasp SFP or SFP+ Module	47
Install a Bale Clasp SFP or SFP+ Module	48
Remove a Bale Clasp SFP or SFP+ Module	49
Connect Interface Ports	50
Connect a Fiber-Optic Port to the Network	50
Disconnect Optical Ports from the Network	51
Maintain Transceivers and Optical Cables	51
Install Cisco N540-FH-AGG-SYS	51
Rack Compatibility	51
Rack Types	52
Set up Device on Rack	53
Rack Mount	53
Ground the Device	57
Install the AC Power Cables	58
Activate an AC Power Supply Module	59
Install the DC Power Cables	60
Activate a DC Power Supply Module	61
Port Connection Guidelines	61
Connect to the Console Port	62
Connect to the Management Ethernet Port	63
Connecting Timing Cables	64
Connecting Cables to a GPS Interface	64
Connecting a Cable to the Input 10-MHz or 1-PPS Interface	65
Connecting a Cable to the Output 10MHz or 1PPS Interface	65
Connecting a Cable to the GNSS Antenna Interface	65
Install and Remove Transceiver Module	66

Safety Precautions for Module Installation and Removal 66  
 Install and Remove Transceiver Module 66  
 Connect Interface Ports 70  
 Maintain Transceivers and Optical Cables 70

---

**CHAPTER 5**      **Configure the Device 71**  
                     Create the Initial Router Configuration 71  
                     Verify Device Installation 73

---

**CHAPTER 6**      **Replace Power Supply 75**  
                     Remove the DC Power Supply Module 76  
                     Install the DC Power Supply Module 76  
                     Remove the AC Power Supply Module 78  
                     Install the AC Power Supply Module 79

---

**CHAPTER 7**      **Replace Fan Module 81**

---

**CHAPTER 8**      **Appendix 83**  
                     LEDs 83  
                         Router LEDs 83  
                         Power Supply LEDs 84  
                         Port LED 84  
                     System Specifications 84  
                         Weight and Power Consumption 84  
                         Environmental Specifications 84  
                         Transceiver and Cable Specifications 85  
                         RJ-45 Connectors 85  
                         GPS Port Pinouts 85  
                         Time-of-Day Port Pinouts 86  
                         BITS Interface 86  
                         Management Ethernet Port Pinouts 87  
                         USB Port Pinouts 87  
                         Alarm Port Pinouts 87  
                         Console Port Pinouts 88

AC Power Cord Specifications 88







# CHAPTER 1

## Safety Warnings

---

This handout lists the safety warnings necessary for handling this chassis. Before you install or service the chassis, review these safety warnings to avoid injuring yourself or damaging the equipment.

For a complete list of translated safety warnings, see the [Regulatory Compliance and Safety Information — Cisco NCS 500 Series Routers document](#).

The safety warnings are grouped under the following sections:

- [Standard Warning Statements, on page 1](#)
- [Safety Guidelines for Personal Safety and Equipment Protection, on page 2](#)
- [Safety with Electricity, on page 2](#)
- [Cautions and Regulatory Compliance Statements for NEBS, on page 4](#)
- [Power Supply Considerations, on page 5](#)
- [Preventing ESD Damage, on page 6](#)

## Standard Warning Statements



---

**Warning** IMPORTANT SAFETY INSTRUCTIONS

This warning symbol means danger. You are in a situation that could cause bodily injury. Before you work on any equipment, be aware of the hazards involved with electrical circuitry and be familiar with standard practices for preventing accidents. Use the statement number provided at the end of each warning to locate its translation in the translated safety warnings that accompanied this device. Statement 1071

SAVE THESE INSTRUCTIONS

---



---

**Warning** This unit is intended for installation in restricted access areas. A restricted access area can be accessed only by using a special tool, lock and key, or other means of security. Statement 1017

---



---

**Warning** Ultimate disposal of this product must be handled according to all national laws and regulations. Statement 1040

---



---

**Warning** To prevent the system from overheating, do not operate it in an area that exceeds the maximum recommended ambient temperature of: -40 to 158°F (-40 to 65°C) for N540-FH-CSR-SYS and 32 to 131°F (0 to 55°C) for N540-FH-AGG-SYS. Statement 1047

---



---

**Warning** Mount the device on a rack that is permanently affixed to the building. Statement 1049

---



---

**Warning** This device is a Class A Device and is registered for EMC requirements for industrial use. You must be aware. If sold or purchased by mistake, do replace with a residential-use type. Statement 294

---



---

**Warning** Only trained and qualified personnel should be allowed to install, replace, or service this equipment. Statement 1030

---

## Safety Guidelines for Personal Safety and Equipment Protection

The following guidelines ensure your safety and protect the equipment. This list does not include all the potentially hazardous situations. Therefore, you must be alert.

- Before moving the system, always disconnect all power cords and interface cables.
- Never assume that power is disconnected from a circuit; always check.
- Before and after installation, keep the chassis area clean and dust free.
- Keep tools and assembly components away from walk areas where you or others can trip over them.
- Do not work alone if potentially hazardous conditions exist.
- Do not perform any action that creates a potential hazard to people or makes the equipment unsafe.
- Do not wear loose clothing that may get caught in the chassis.
- When working under conditions that may be hazardous to your eyes, wear safety glasses.

## Safety with Electricity



---

**Warning** Before working on a chassis or with power supplies, unplug the power cord on AC units. Disconnect the power at the circuit breaker on DC units. Statement 12

---



---

**Warning** Before working on equipment that is connected to power lines, remove jewelry (including rings, necklaces, and watches). Metal objects heat up when connected to power and ground and can cause serious burns or weld the metal object to the terminals. Statement 43

---



---

**Warning** Read the installation instructions before connecting the system to the power source. Statement 1004

---



---

**Warning** The plug-socket combination must be accessible always, because it serves as the main disconnecting device. Statement 1019

---



---

**Warning** This unit may have more than one power supply connection. All connections must be removed to de-energize the unit. Statement 1028

---



---

**Warning** When installing or replacing the unit, ensure the ground connection first and disconnected last. Statement 1046

---



---

**Warning** This equipment is intended to be grounded to comply with emission and immunity requirements. Ensure that the switch functional ground lug is connected to earth ground during normal use. Statement 1064

---



---

**Warning** Installation of the equipment must comply with local and national electrical codes. Statement 1074

---

When working on equipment that is powered by electricity, follow these guidelines:

- Locate the room's emergency power-off switch. If an electrical accident occurs, you know where to quickly turn off the power.
- Before starting work on the system, turn off the DC main circuit breaker and disconnect the power terminal block cable.
- Disconnect all power when:
  - Working on or near power supplies
  - Installing or removing a device chassis or network processor module
  - Performing most hardware upgrades
- Never install equipment that appears damaged.
- Carefully examine your work area for possible hazards, such as moist floors, ungrounded power extension cables, and missing safety grounds.

- Never assume that power is disconnected from a circuit; always check.
- Never perform any action that creates a potential hazard to people or makes the equipment unsafe.
- If an electrical accident occurs and you are uninjured:
  - Use caution to avoid injuring yourself.
  - Turn off power to the device.
  - Seek medical attention, if necessary.

Use the following guidelines when working with any equipment that is disconnected from a power source, but connected to telephone wiring or network cabling:

- When installing or modifying telephone lines, use caution.
- Never install telephone jacks in wet locations unless the jack is designed to handle such locations.
- Never install telephone wiring during a lightning storm.

## Cautions and Regulatory Compliance Statements for NEBS

The NEBS-GR-1089-CORE regulatory compliance statements and requirements are discussed in this section.




---

**Warning** The intrabuilding port(s) of the equipment or subassembly, which is the management Ethernet port, must use shielded intrabuilding cabling/wiring that is grounded at both ends. Statement 7003

---




---

**Warning** The intrabuilding port(s) of the equipment or subassembly, which is the management Ethernet port, must not be metallically connected to interfaces that connect to the OSP or its wiring. These interfaces are designed for use as intrabuilding interfaces only (Type 2 or Type 4 ports as described in GR-1089-CORE) and require isolation from the exposed OSP cabling. The addition of Primary Protectors is not sufficient protection in order to connect these interfaces metallically to OSP wiring. Statement 7005

---




---

**Warning** This equipment shall be connected to AC mains provided with a surge protective device (SPD) at the service equipment complying with NFPA 70, the National Electrical Code (NEC). Statement 7012

---




---

**Warning** This equipment is suitable for installations utilizing the Common Bonding Network (CBN). Statement 7013

---




---

**Warning** The battery return conductor of this equipment shall be treated as (DC-I). Statement 7016

---



---

**Warning** This equipment is suitable for installation in Network Telecommunications Facilities. Statement 8015

---



---

**Warning** This equipment is suitable for installation in locations where the NEC applies. Statement 8016

---

## Power Supply Considerations

Check the power at your site to ensure that you are receiving clean power (free of spikes and noise). If necessary, install a power conditioner.

## Power Connection Guidelines

This section provides guidelines for connecting the device power supplies to the site power source.



---

**Warning** This equipment must be grounded. To reduce the risk of electric shock, never defeat the ground conductor or operate the equipment in the absence of a suitably installed ground conductor. Contact the appropriate electrical inspection authority or an electrician if you are uncertain that suitable grounding is available.

---

## Guidelines for DC-Powered Systems

Basic guidelines for DC-powered systems include the following:

- Each chassis power supply has its own dedicated input power source. The source must comply with the safety extra-low voltage (SELV) requirements in the UL 60950, CSA 60950, EN 60950, and IEC 60950 standards.
- Protect the circuit by a dedicated two-pole circuit breaker. Ensure that the circuit breaker is sized according to the power supply input rating and local or national code requirements.
- The circuit breaker is considered as the disconnect device and is easily accessible.
- The system ground is the power supply and chassis ground.
- Use the grounding lug to attach a wrist strap for ESD protection during servicing.
- Do not connect the DC return wire to the system frame or to the system-grounding equipment.
- Ensure that the DC return is grounded at the source side.
- Ensure that each power feed of the equipment is connected to different sources.

## Guidelines for AC-Powered Systems

Basic guidelines for AC-powered systems include the following:

- Each chassis power supply has its own dedicated branch circuit.

- Ensure that the circuit breaker is sized according to the power supply input rating and local or national code requirements.
- The AC power receptacles that are used to plug in the chassis must be the grounding type. The grounding conductors that connect to the receptacles must connect to protective earth ground at the service equipment.

## Preventing ESD Damage

Electrostatic Discharge (ESD) can damage equipment and impair electrical circuitry. ESD may occur when electronic printed circuit cards are improperly handled and can cause complete or intermittent failures. When removing and replacing modules, always follow these ESD prevention procedures:

- Ensure that the device chassis is electrically connected to earth ground.
- Wear an ESD-preventive wrist strap, ensuring that it makes good skin contact. To channel unwanted ESD voltages safely to ground, connect the clip to an unpainted surface of the chassis frame. To guard against ESD damage and shocks, the wrist strap and cord must operate effectively.
- If no wrist strap is available, ground yourself by touching a metal part of the chassis.
- When installing a component, use any available ejector levers or captive installation screws to properly seat the bus connectors in the backplane or midplane. These devices prevent accidental removal, provide proper grounding for the system, and help to ensure that bus connectors are properly seated.
- When removing a component, use available ejector levers or captive installation screws, if any, to release the bus connectors from the backplane or midplane.
- Handle components by only their handles or edges; do not touch the printed circuit boards or connectors.
- Place a removed component board side up on an antistatic surface or in a static-shielding container. If you plan to return the component to the factory, immediately place it in a static-shielding container.
- Avoid contact between the printed circuit boards and clothing. The wrist strap only protects components from ESD voltages on the body; ESD voltages on clothing can still cause damage.
- Never attempt to remove the printed circuit board from the metal carrier.

For the safety of your equipment, periodically check the resistance value of the antistatic wrist strap. Maintain the value between 1 and 10 Mohm.



## CHAPTER 2

# Cisco N540-Front-Haul Router Overview

---

The Cisco N540-Front-Haul 1RU router complements Cisco's offerings of IP RAN solutions for the GSM, UMTS, LTE, and CDMA.

For more information about its features and benefits, see the [Cisco Network Convergence System 540 Router Data Sheet](#).

- [Features, on page 7](#)
- [Specification, on page 8](#)
- [Interface Naming, on page 8](#)
- [Network Timing Interfaces, on page 9](#)
- [GNSS Receiver, on page 10](#)
- [External Alarm Inputs, on page 11](#)
- [Console, on page 11](#)
- [Online Insertion and Removal, on page 11](#)
- [Supported Transceiver Modules, on page 12](#)

## Features

The Cisco N540-FH-CSR-SYS router has the following hardware features:

- 8 Common Public Radio Interface (CPRI) Ports
- 2 x 10G/25G TSN ports
- 8 x 1G/10G ports
- 4 x 1G/10G/25G SFP+ ports
- 2 x 100G QSFP ports
- 4 x CPRI/1G/10G ports

The Cisco N540-FH-AGG-SYS router has the following hardware features:

- 24 x TSN or CPRI or 25G/10G/1G ports
- 4x100G QSFP ports

Figure 1: Cisco N540-FH-CSR-SYS



Figure 2: Cisco N540-FH-AGG-SYS



## Specification

For information on physical specification, temperature, Route Processor, and other details for all variants, see *Cisco NCS 540 chassis specification* in the [Cisco Network Convergence System 540 Router Data Sheet](#).

## Interface Naming

The following table shows the interface naming of the Cisco N540-FH-CSR-SYS variant:



### Caution

On port numbers 12 and 13 after initial bring up, if you perform multiple **port shutdown** and **no shutdown** configurations, it may result in a bad state of corrupting the packets (for example it affects, Ethernet, CPRI, or any protocol packets). It also affects any other protocols using these ports as the forwarding path.

Consider using the port numbers 14 to 25, for 25G core functionality, instead of port numbers 12 and 13.

Table 1: Port Numbering

CPRI ports		CPRI/1G/10G ports		10/25G TSN	1G/10G ports			1G/10G/25G ports		100G ports
1	to 7	9	11	13	15	to 21	9	11	27	
0	6	8	10	12	14	20	8	10	26	

The following table shows the interface naming of the Cisco N540-FH-AGG-SYS variant:

Table 2: Port Numbering

CPRI/1G/10G/25G TSN Ports	100G Ports
0 to 23	24 to 27



The *interface-path-id* is *rack/slot/module/port*. The slashes between values are required as part of the notation.



**Note** Dual-Rate functionality is supported only with the supported SFP.

**Table 3: Maximum Number of Interfaces for Cisco N540-FH-CSR-SYS variant**

Category	Maximum Port Number Interface	Port Number
1GE	16	0/8-0/11,0/14-0/25
10GE	18	0/8-0/25
25GE	6	0/12-0/13, 0/22-0/25
100GE	2	0/26-0/27
CPRI	12	0/0-0/11

**Table 4: Maximum Number of Interfaces for Cisco N540-FH-AGG-SYS variant**

Category	Maximum Port Number Interface	Port Number
1GE	24	0-23
10GE	24	0-23
25GE	24	0-23
100GE	4	24-27
CPRI	24	0-23

## Network Timing Interfaces

- BITS input or output—The BITS interfaces support clock recovery from either a T1 at 1.544MHz or an E1 at 2.048MHz, configurable by software. BITS interface is provided through a standard RJ-48 connector on the front panel.
- 1PPS input or output and ToD input or output—This shielded RJ-45 interface is used for input or output of time-of-day (ToD) and 1PPS pulses. ToD format includes both NTP and IEEE 1588-2008 time formats.

The same RS422 pins for 1PPS and TOD are shared between input and output directions. The direction for each can be independently configurable through software.

Use an SMB connector on the front panel for the following:

- GPS 10Mhz input and output—10MHz input for GPS synchronization.

- GPS 1 PPS input and output—1 PPS input for GPS synchronization.

## GNSS Receiver

The chassis has in-built GNSS receiver with ports present at the front panel.

### GNSS Module RF Input Requirements

- For optimal performance, the GNSS module requires an active GPS/GNSS antenna with built-in Low-Noise Amplifier (LNA). The antenna LNA amplifies the received satellite signals for two purposes:
  - Compensation of losses on the cable
  - Lifting the signal amplitude to the suitable range for the receiver frontend

The Amplification required is 22dB gain + cable/connector loss + Splitter signal loss.

The recommended range of LNA gain (minus all cable and connector losses) at the connector of the receiver module is 22dB to 30dB with a minimum of 20dB and a maximum of 35dB.

- GNSS module provides 5V to the active antenna through the same RF input.
- Surge requirement:
  - GNSS modules have built-in ESD protections on all pins, including the RF-input pin. However, additional surge protection may be required if rooftop antennas are to be connected, to meet the regulations and standards for lightning protection of countries where the end-product is installed.
  - A lightning protection must be mounted at the place where the antenna cable enters the building. The primary lightning protection must be capable of conducting all potentially dangerous electrical energy to PE.
  - Surge arrestors should support DC-pass and suitable for the GPS frequency range (1.575GHz) with low attenuation.
- Antenna Sky visibility:
  - GPS signals can only be received on a direct line of sight between antenna and satellite. The antenna must have a clear view of the sky. For proper timing, minimum of four satellites should be locked.




---

**Note** The antenna terminal should be earthed at the building entrance in accordance with the ANSI/NFPA 70, the National Electrical Code (NEC), in particular Section 820.93, Grounding of Outer Conductive Shield of a Coaxial Cable.

---

- Use a passive splitter if more than one GNSS modules are fed from a single antenna.



---

**Note** The splitter should have all the RF ports capable of DC-pass, if the antenna needs to feed power from GNSS module.

---

For information on pinout, see *GPS Port Pinouts*.

## External Alarm Inputs

The router supports four dry contact alarm inputs through an RJ-45 jack at the rear panel.

- Normally Open—indicates that no current flows through the alarm circuit and the alarm is generated when the current is flowing.

Each alarm input can be provisioned as critical, major, or minor.

## Console

The RS232 console port provides transmission (Tx), reception (Rx), and ground (Gnd).

## USB Port

USB Type-A Receptacle

USB port is used for connecting USB devices and can be used to boot from the USB devices. It can be used to transfer files, logs, and so on between the router and the USB device.

## USB Console

A single USB 2.0 Type-A receptacle on the front panel of the router provides console access to ROMMON, Cisco IOS-XR, and diagnostics. While it uses the Type-A connector, it operates as a USB peripheral only for connection to an external host computer. This interface requires the use of a Type-A to Type-A connector instead of a standard USB cable.



---

**Note** Use of the USB console is mutually exclusive of the RS232 console port. This interface requires the use of a Type-A to Type-A USB cable.

---

## Online Insertion and Removal

The router supports the following Online Insertion and Removal (OIR) operations:

- When an SFP is removed, there is no effect on traffic flowing on other ports.

- When an SFP is installed, the system initializes that port for operation based on the current configuration. If the inserted SFP is incompatible with the current configuration of that port, the port does not become operational until the configuration is updated.
- When both power supplies are installed and active, the load may be shared between them or a single PSU supports the whole load. When a power supply is not working or the input cable is removed, the remaining power supply takes the entire load without disruption.
- N540-FH-AGG-SYS supports OIR of six fan trays from rear side. The system supports single fan failure and during single fan failure all other fans run at full speed.

## Supported Transceiver Modules

For more information on the supported transceiver modules, see [Transceiver Module Group \(TMG\) Compatibility Matrix](#). In the **Begin your Search** search box, enter the keyword and click **Enter**.



## CHAPTER 3

# Prepare for Installation

---

Before you install the Cisco N540-Front Haul routers, you must prepare your site for installation.

Preparing your site involves these tasks:

- [General Precautions, on page 13](#)
- [Site Planning Checklist, on page 14](#)
- [Environmental Requirements, on page 14](#)
- [Airflow for Site Planning, on page 15](#)
- [Airflow Guidelines, on page 15](#)
- [Site Power Guidelines, on page 18](#)
- [Site Cabling Guidelines, on page 19](#)
- [Tools and Equipment, on page 21](#)
- [Prepare Your Location , on page 21](#)
- [Prepare Yourself , on page 22](#)
- [Prepare Rack for Router Installation, on page 23](#)
- [Cabinet Selection Guidelines, on page 23](#)
- [Unpack the Cisco NCS 540-Front-Haul Router, on page 24](#)

## General Precautions

Observe the following general precautions when using and working with your router:

- Keep your system components away from radiators and heat sources, and do not block cooling vents.
- Do not spill food or liquids on your system components, and never operate the product in a wet environment.
- Do not push any objects into the openings of your system components. Doing so can cause fire or electric shock by shorting out interior components.
- Position system cables and power supply cable carefully. Route system cables, the power supply cable, and plug so that they are not stepped on or tripped over. Be sure that nothing else rests on your system component cables or power cable.
- Do not modify power cables or plugs. Consult a licensed electrician or your power company for site modifications. Always follow your local and national wiring rules.

- If you turn off your system, wait at least 30 seconds before turning it on again to avoid damage to the system components.

## Site Planning Checklist

Use the following checklist to perform and account for all the site planning tasks described in this chapter:

- The site meets the environmental requirements.
- The site's air conditioning system can compensate for the heat dissipation of the router.
- The floor space that the router occupies can support the weight of the system.
- Electrical service to the site complies with the requirements.
- The electrical circuit servicing the router complies with the requirements.
- Consideration has been given to the console port wiring and limitations of the cabling involved, according to TIA/EIA-232F.
- The router Ethernet cabling distances are within the prescribed limitations.
- The equipment rack in which you plan to install the router complies with prescribed requirements.
- The following factors have been carefully considered when selecting the location of the rack: safety, ease of maintenance, and proper airflow.

## Environmental Requirements

For outside plant installation (cell site cabinet, hut, and so on), you must protect the router against airborne contaminants, dust, moisture, insects, pests, corrosive gases, polluted air, or other reactive elements. Sealed equipment chamber with air-conditioning or a heat exchanger is recommended for OSP deployments. The equipment chamber must comply with the temperature and clearance requirements. Examples of such cabinets include IP66 cabinets with heat exchanger complying with Telcordia GR487. Temperature must be maintained within  $-40^{\circ}\text{C}$  to  $65^{\circ}\text{C}$ .

The equipment shall be placed inside an enclosure (that is protected from direct outside weather and environmental stresses by the enclosure), and where the operating climate, as defined by Class 2 of GR-3108-CORE, is between:

- $-40$  to  $158^{\circ}\text{F}$  ( $-40$  to  $65^{\circ}\text{C}$ )
- 5% and 85% RH

N540-FH-AGG-SYS is designed to be used in central office application only, as defined by Class 1 of GR-3108-CORE:

- $-32$  to  $131^{\circ}\text{F}$  ( $0$  to  $55^{\circ}\text{C}$ )
- 5% to 85% RH

For more information on Environmental properties and Regulatory standards, see the [Cisco Network Convergence System 540 Router Data Sheet](#).

# Airflow for Site Planning

For site planning, the Maximum System Airflow at maximum system temperature is 90.0CFM for N540-FH-CSR-SYS and 125.0CFM for N540-FH-AGG-SYS.

## Airflow Guidelines

Cool air is circulated through the router by fans that are located along the rear side of the router. The internal fans maintain acceptable operating temperatures for the internal components by drawing in cool air through the vents, and circulating the air through the router.

To ensure adequate airflow, we recommended that you always maintain this minimum clearance distance for N540-FH-CSR-SYS:

- Front clearance—5 inches (12.7 centimeters)
- Rear clearance—2 inches (5.08 centimeters)

To ensure adequate airflow, we recommended that you always maintain this minimum clearance distance for N540-FH-AGG-SYS:

- Front clearance—5 inches (12.7 centimeters)
- Rear clearance—6.0 inches (15.24 centimeters)

Figure 3: Airflow Top View Clearance or N540-FH-CSR-SYS

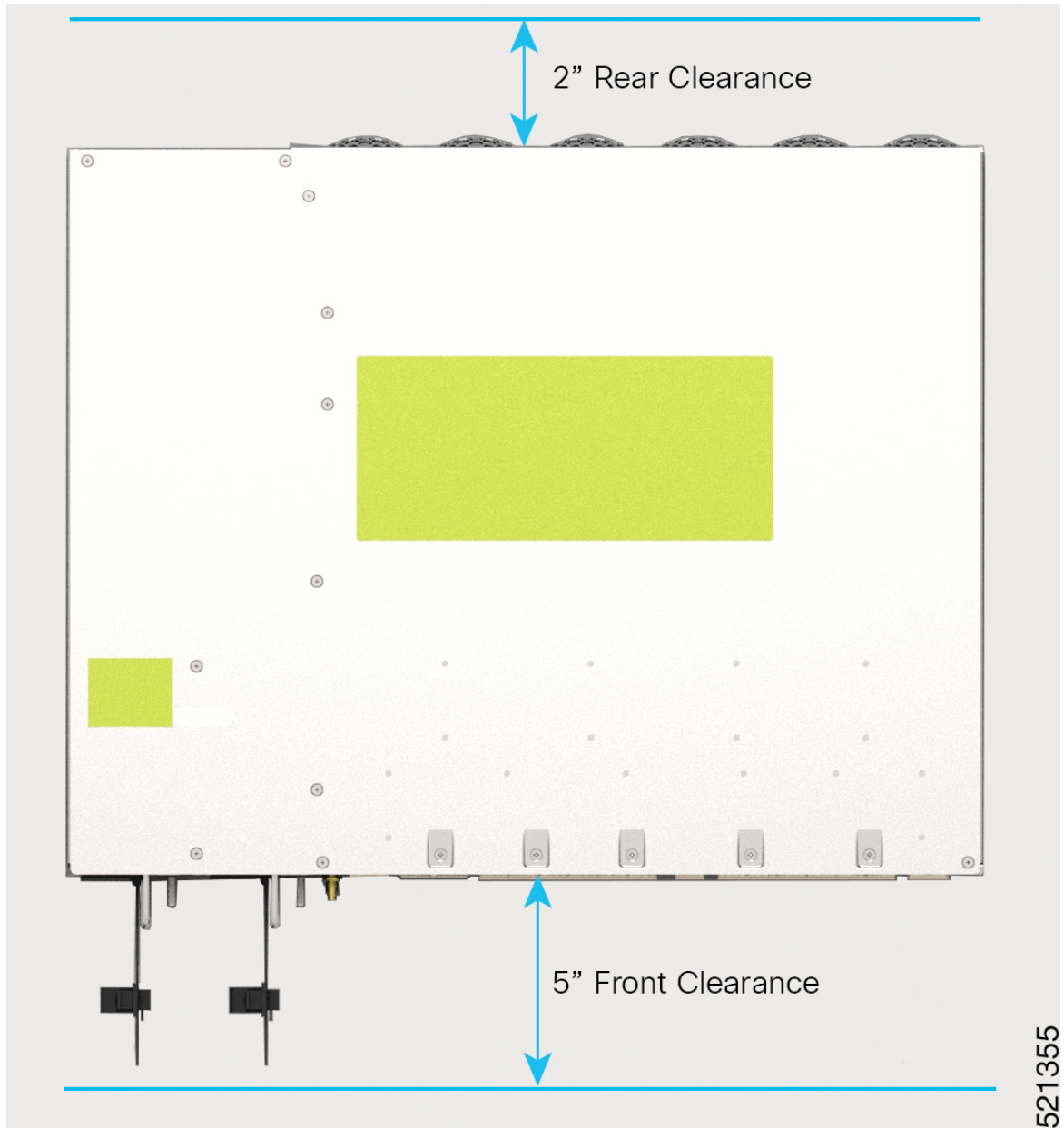




Figure 4: Airflow Side View for N540-FH-CSR-SYS



521354

Figure 5: Airflow Side View for N540-FH-AGG-SYS



521665

Note the following points:

- When installing the router in a back-to-back position with another device, ensure that there is a minimum of 3.9 inches (10 centimeters) airflow clearance between the two devices.

- If airflow through the equipment rack and the routers that occupy it is blocked or restricted, or if the ambient air being drawn into the rack is too warm, an overtemperature condition may occur within the rack and the routers that occupy it.
- The site must be as dust-free as possible. Dust tends to clog the router fans, reducing the flow of cooling air through the equipment rack and the routers that occupy it, thereby increasing the risk of an overtemperature condition.
- Enclosed racks must have adequate ventilation. Ensure that the rack is not congested because each router generates heat. An enclosed rack must have louvered sides and a fan to provide cooling air. The equipment generates heat near the bottom of the rack, which can be drawn upward into the intake ports of the equipment above.
- When mounting a router in an open rack, ensure that the rack frame does not block the exhaust fans.
- When rack-installed equipment fails, especially equipment in an enclosed rack, try operating the equipment by itself, if possible. Power off all the other equipment in the rack (and in adjacent racks) to give the router maximum cooling air and clean power.
- Avoid installing the router in a location in which the router air intake vents may draw in the exhaust air from adjacent equipment. Consider how the air flows through the router; the airflow direction is front to back, with ambient air drawn in from the vents located on the front panel of the router.

## Site Power Guidelines

The chassis has specific power and electrical wiring requirements. Adhering to these requirements ensures the reliable operation of the system. Follow these precautions and recommendations when planning your site power for the chassis:

- The redundant power option provides a second, identical power supply to ensure uninterrupted power supply.
- Connect each power supply to a separate input power source. Otherwise, it results in a total power failure to the system due to a fault in the external wiring or a tripped circuit breaker.
- To prevent loss of input power, ensure that the maximum load on each circuit is within the current ratings of the wiring and the breakers.
- Check the power at your site before installation, and periodically after installation, to ensure that you are receiving clean power. If necessary, install a power conditioner.
- Provide proper grounding to avoid personal injury and damage to the equipment due to power surges or lightning striking power lines. The chassis ground must be attached to a central office or other interior ground system.



---

**Warning**

This product requires short-circuit (overcurrent) protection to be provided as part of the building installation. Install only in accordance with national and local wiring regulations. Statement 1045

---

**Caution**

This product requires external surge protection device for both AC and DC power feeds to the equipment. For DC power feed, the surge protective device (SPD) must handle common mode and differential mode surge as per the local standards.

**Note**

The chassis installation must comply with all the applicable codes, and is approved for use with only copper conductors. The ground bond-fastening hardware must be compatible and preclude loosening, deterioration, and electrochemical corrosion of hardware and joined material. Attachment of the chassis ground to a central office or other interior ground system must be made with a 6-AWG gauge wire copper ground conductor.

**Note**

The AC PSU requires external surge protection devices for installations where electrical surges higher than 2KV common mode and 2KV differential mode are expected. Failure to do so can result in permanent damage to the product.

The DC PSU requires external surge protection devices for installations where electrical surges higher than 2KV common mode and 1KV differential mode are expected. Failure to do so can result in permanent damage to the product.

## Electrical Circuit Requirements

Each router requires a dedicated electrical circuit. If you equip the router with dual-power feeds, provide a separate circuit for each power supply to avoid compromising the power redundancy feature.

The routers can be powered by a DC source. Ensure that equipment grounding is present and observe the power-strip ratings. Make sure that the total ampere rating of all the products plugged into the power strip does not exceed 80% of the rating.

## Site Cabling Guidelines

This section contains guidelines for wiring and cabling at your site. When preparing your site for network connections to the router, consider the type of cable required for each component, and the cable limitations. Consider the distance limitations for signaling, ElectroMagnetic Interference (EMI), and connector compatibility. Possible cable types are fiber, thick or thin coaxial, foil twisted-pair, or unshielded twisted-pair cabling.

Also consider any additional interface equipment you need, such as transceivers, hubs, switches, modems, Channel Service Units (CSU), or Data Service Units (DSU).

Before you install the router, have all the additional external equipment and cables on hand. For information about ordering, contact a Cisco customer service representative.

The extent of your network and the distances between the network interface connections depend, in part, on the following factors:

- Signal type

- Signal speed
- Transmission medium

The distance and rate limits referenced in the following sections are the IEEE-recommended maximum speeds and distances for signaling purposes. Use this information as a guideline when planning your network connections *prior to* installing the router.

If wires exceed the recommended distances, or if wires pass between buildings, give special consideration to the effect of a lightning strike in your vicinity. The electromagnetic pulse caused by lightning or other high-energy phenomena can easily couple enough energy into unshielded conductors to destroy electronic devices. If you have had problems of this sort in the past, you may want to consult experts in electrical surge suppression and shielding.

## Asynchronous Terminal Connections

The router provides a console port to connect a terminal or computer for local console access. The router supports RS-232 asynchronous data with distance recommendations specified in the IEEE RS-232 standard.

## Interference Considerations

When wires are run for any significant distance, there is a risk that stray signals will be induced on the wires as interference. If interference signals are strong, they may cause data errors or damage to the equipment.

The following sections describe the sources of interference and how to minimize their effects on the router system.

### Electromagnetic Interference

All the equipment powered by AC current can propagate electrical energy that can cause EMI and possibly affect the operation of other equipment. The typical sources of EMI are equipment power cords and power service cables from electric utility companies.

Strong EMI can destroy the signal drivers and receivers in the router and even create an electrical hazard by causing power surges through the power lines into installed equipment. These problems are rare, but could be catastrophic.

To resolve these problems, you need specialized knowledge and equipment that could consume substantial time and money. However, you can ensure that you have a properly grounded and shielded electrical environment, paying special attention to the need for electrical surge suppression.

### Radio Frequency Interference

When electromagnetic fields act over a long distance, Radio Frequency Interference (RFI) may be propagated. Building wiring can often act as an antenna, receiving the RFI signals and creating more EMI on the wiring.

If you use twisted-pair cable in your plant wiring with a good distribution of grounding conductors, the plant wiring is unlikely to emit radio interference. If you exceed the recommended distances, use a high-quality twisted-pair cable with one ground conductor for each data signal.

## Lightning and AC Power Fault Interference

If signal wires exceed the recommended cabling distances, or if signal wires pass between buildings, you should consider the effect that a lightning strike in your vicinity might have on the router.

The Electromagnetic Pulse (EMP) generated by lightning or other high-energy phenomena can couple enough energy into unshielded conductors to damage or destroy electronic equipment. If you have previously experienced such problems, you should consult with RFI and EMI experts to ensure that you have adequate electrical surge suppression and shielding of signal cables in your router operating environment.

## Tools and Equipment

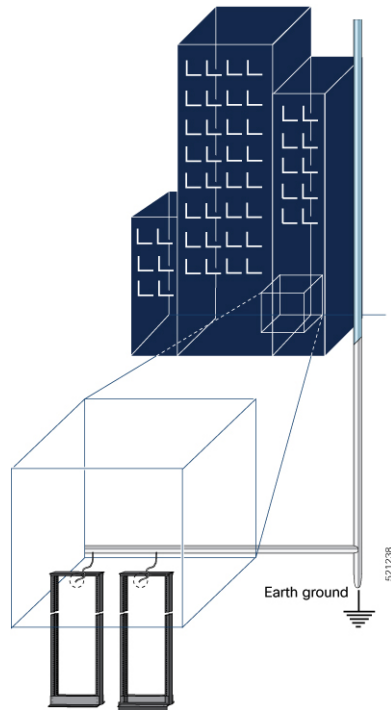
You need the following tools and equipment to install and upgrade the router and its components:

- ESD-preventive cord and wrist strap
- Antistatic mat or antistatic foam
- Number 1 and Number 2 Phillips-head screwdrivers
- #12-24 pan-head screws to secure the router to the equipment rack
- Cables for connecting to the network ports (depending on the configuration)
- Ethernet hub, switch, or PC with a network interface card for connecting to the Ethernet ports
- Console terminal (an ASCII terminal or a PC running terminal emulation software) that is configured for 115200 baud, 8 data bits, no parity, no flow control, and 1stop bit
- Console cable for connecting to the console port
- Ratcheting torque screwdriver with a Phillips head that exerts up to 30-pound force per square inch (in-lb) or 0.02-kilograms force per square millimeter (kgf/mm<sup>2</sup>) of pressure
- Crimping tool as specified by the ground lug manufacturer
- Wire-stripping tools for stripping both 6-AWG and 14-AWG wires
- Tape measure and level

## Prepare Your Location

This section illustrates how the building that houses the chassis must be properly grounded to the earth ground.

*Figure 6: Building with Rack Room Connected to Earth Ground*

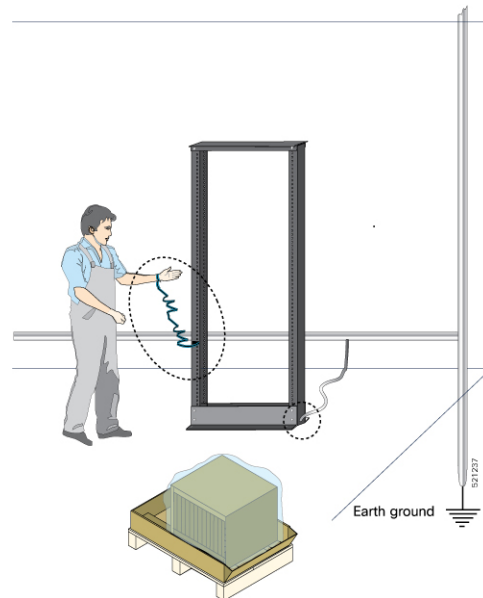


## Prepare Yourself

This section illustrates how to prepare yourself before removing the chassis from the sealed antistatic bag. The figures show how to wear the ESD strap around the wrist and how to connect the other end of the strap to the ground. ESD wrist straps are the primary means of controlling static charge on personnel.

Note: These images are for only representation purposes. The chassis' actual appearance and size would vary.

Figure 7: Wearing the ESD Strap



## Prepare Rack for Router Installation

Install the chassis into a two-post standard rack with standard horizontal mounting rails. Before you mount the chassis into the rack, we recommend that you do the following:

---

**Step 1** Place the rack where you plan to install the chassis. Ensure that the rack is grounded to earth.

**Step 2** Secure the rack to the floor.

To bolt the rack to the floor, a floor bolt kit (also called an anchor embedment kit) is required. For information on bolting the rack to the floor, consult a company that specializes in floor mounting kits (such as Hilti; see [Hilti.com](https://www.hilti.com) for details). Make sure that floor mounting bolts are accessible, especially if an annual retorquing of bolts is required.

---

## Cabinet Selection Guidelines

Equipment that is intended for installation in controlled environmental space has average yearly levels of contamination. Ventilated cabinets or racks can be used if pollutant levels are maintained within allowable limits.

Equipment intended for installation in outside plant (OSP) areas must have sealed cabinets with heat exchanger that meet the NEMA -4 or IP66 protection and low average yearly levels of concentration of contaminants inside the cabinet.



**Note** Ventilated cabinets and racks are not recommended for OSP applications.

**Table 5: Cabinet Type for Indoor and Outdoor Installation**

Cabinet Type	Suitable for Indoor Installation?	Suitable for Outdoor Installation?
Open rack with no front and rear doors	Yes	No
Ventilated cabinets with normal air filter at intake and fans	Yes	No
Sealed cabinets with heat exchanger that meet NEMA -4 or IP66 protection	Yes	Yes
Sealed cabinets with air-conditioners that meet NEMA -4 or IP66/IP65 protection	Yes	Yes

#### Allowable limits for Environmental Pollutants

Concentration of pollutant levels in outdoor and indoor environment must be less than pollutant levels mentioned in Table 2.3 and Table 2.4 of *NEBS GR-63-CORE Issue 5 Dec 2017*, respectively. High concentrations of pollutants have a negative impact on the equipment life time.

#### Allowable Temperature and Humidity

Maximum allowable temperature and humidity levels must be within the values that are mentioned in the data sheets. Do not install in places where condensation may occur, or where equipment is exposed to high humidity for long time, such as near the sea, rivers, and large water bodies.

#### Installations in Highly-corrosive Environment

Installation in highly corrosive area is not recommended. Examples of highly corrosive areas are seashore, less than 10 meters from high traffics roadway, and areas having high industrial pollutants.

#### Periodic Measurement of Environmental Pollutants

We recommend that you check concentration of pollutants periodically. Necessary protection should be provided to ensure the equipment is not exposed to high concentration level of pollutants.

## Unpack the Cisco NCS 540-Front-Haul Router

Ensure that there is sufficient room around the chassis pallet for unpacking.

1. Remove the accessory tray and the packing material.
2. Carefully set the packing material aside.





---

**Tip** Be sure to save the packaging in case you need to return any of the components products.

---

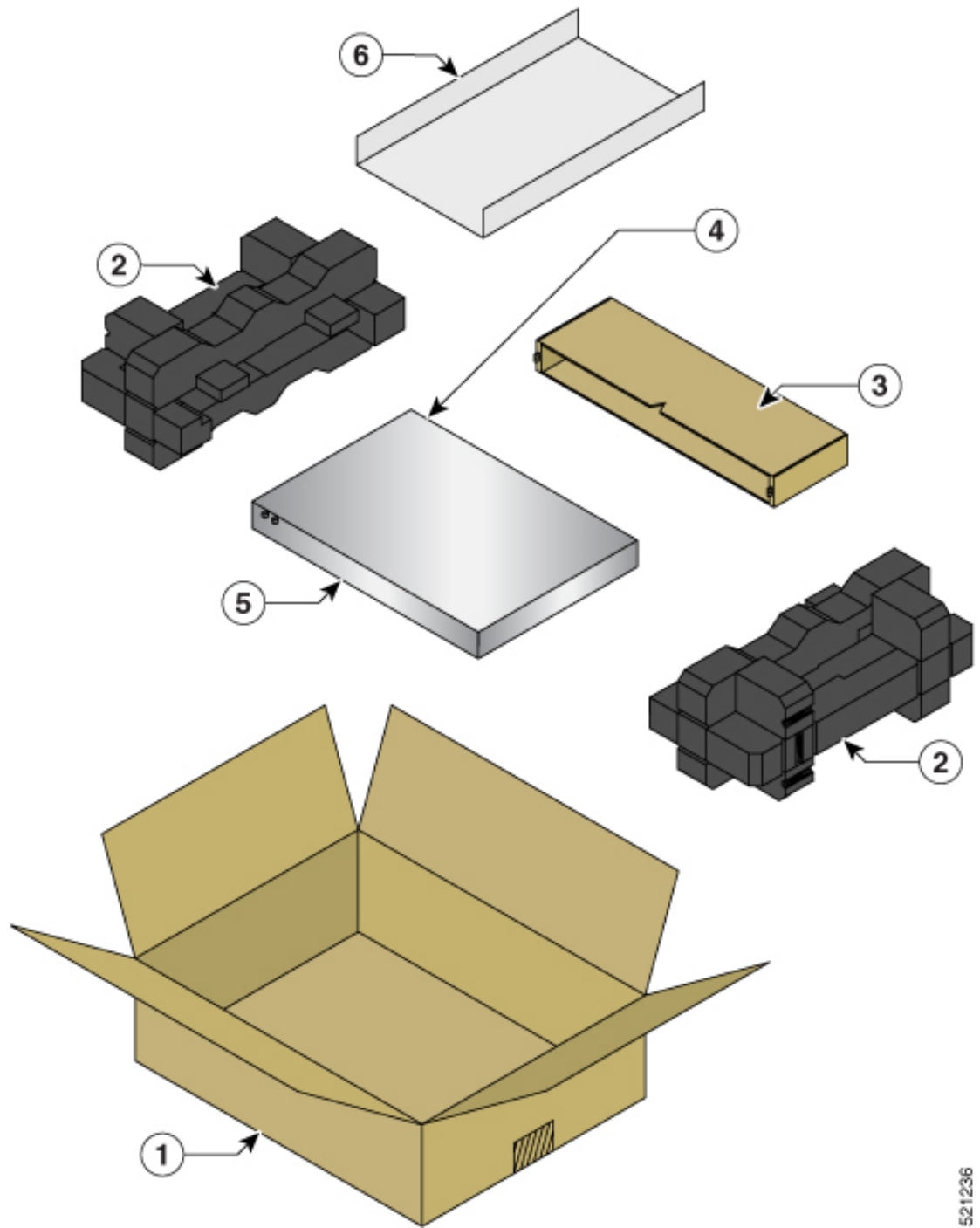


---

**Note** These images are for only representation purposes. The chassis' actual appearance and size would vary.

---

Figure 8: Unpacking the Device



1	Regular Slotted Container (shipping box)	2	Foam end caps
3	Front corrugated cap	4	Front end of the product
5	Back end of the product	6	Accessory tray

521236

Table 6: Accessories Kit for N540-FH-CSR-SYS

19- inch Rack Mount Brackets	23- inch Rack Mount Brackets	ETSI Rack Mount Brackets	Wall Mount Brackets	Desktop Brackets	Cable Management Brackets
N540-RKM-19-FHC	N540-RKM-23-FHC	N540-RKM-ETSI-FHC	NA	NA	N540-CBL-BRKT-FHC

Table 7: Accessories Kit for N540-FH-AGG-SYS

19- inch Rack Mount Brackets	23- inch Rack Mount Brackets	ETSI Rack Mount Brackets	4 Post Support, ETSI, and 23-inch Adapters	PSU Blank	Cable Management Brackets
N540-RKM-19-FHA	N540-RKM-23-FHA	N540-RKM-ETSI-FHA	N540-RKM-4PST-FHA	N540-PSU-BLNK-FHA	N540-CBL-BRKT-FHA



**Note** Most Cisco documentation is available online. The chassis Pointer Card that is shipped with your Cisco NCS 500 Series Services Routers contains links and information to other online documentation.



**Note** If the product is not in use, store the device in the initial packaged condition or in an ESD PE sealed bag with silica gel.





# CHAPTER 4

## Install the Device

Before you begin this task, ensure that you have read and understood the safety warnings in the *Standard Warning Statements* section of the *Safety Warnings* handout.

- [Install N540-FH-CSR-SYS, on page 29](#)
- [Install Cisco N540-FH-AGG-SYS, on page 51](#)

## Install N540-FH-CSR-SYS

Installing the Cisco N540-FH-CSR-SYS involves these tasks:

### Rack Compatibility

We recommend that you follow these rack specifications.

### Rack Types

**Figure 9: Rack specification EIA (19 inches and 23 inches)**

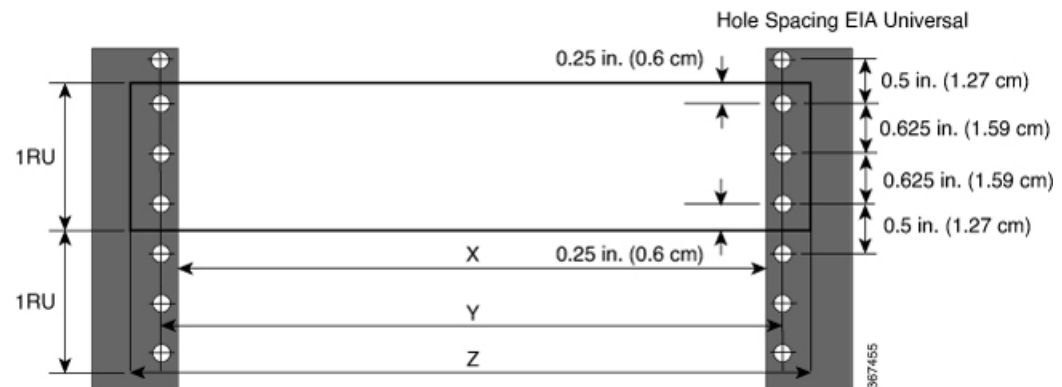
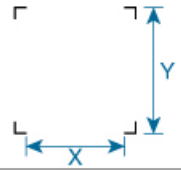
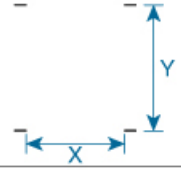
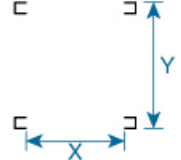


Table 8: Rack specification EIA (19 inches and 23 inches)

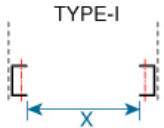
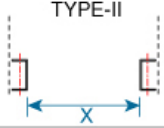

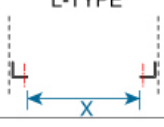
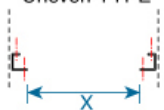
Post Type	Rack Type	Rack Front Opening (X)	Rack Mounting Hole Centre-Centre (Y)	Mounting Flange Dimension (Z)
4 Post	19 inches (48.3 centimeters)	17.75 inches (45 centimeters)	18.31 inches (46.5 centimeters)	19 inches (48.2 centimeters)
2 Post				
4 Post	23 inches (58.4 centimeters)	21.75 inches (55.24 centimeters)	22.31 inches (56.6 centimeters)	23 inches (58.4 centimeters)
2 Post				

Figure 10: Four Post Rack Type

4 – Post Type (Hole EIA Universal)		Width Available (X)	Compatibility
All 23" Type rack		552.45mm (21.75")	Yes
All ETSI rack (21" rack)		500.0mm (19.68")	Yes
19" Type rack L-Type Post		17.75" (450.8 mm)	Yes
		17.50" (444.5 mm)	No
19" Type Racks Flat-Post		17.75" (450.8 mm)	Yes
		17.50" (444.5 mm)	No
19" Type racks C- Type Post		17.75" (450.8 mm)	Yes
		17.50" (444.5 mm)	No

367456

Figure 11: Two Post Rack Type

2 – Post Type (Hole EIA Universal)	X – 19" Rack	Compatibility	X-23" Rack	Compatibility
 <p>TYPE-I</p>	17.75" (450.8 mm)	Yes	21.75" (552.45mm)	Yes
	17.50" (444.5 mm)	No	21.75" (552.45mm)	Yes
 <p>TYPE-II</p>	17.75" (450.8 mm)	Yes	21.75" (552.45mm)	Yes
	17.50" (444.5 mm)	No	21.75" (552.45mm)	Yes
 <p>TYPE-III</p>	17.75" (450.8 mm)	Yes	21.75" (552.45mm)	Yes
	17.50" (444.5 mm)	No	21.75" (552.45mm)	Yes
 <p>L-TYPE</p>	17.75" (450.8 mm)	Yes	21.75" (552.45mm)	Yes
	17.50" (444.5 mm)	No	21.75" (552.45mm)	Yes
 <p>Uneven-TYPE</p>	17.75" (450.8 mm)	Yes	21.75" (552.45mm)	Yes
	17.50" (444.5 mm)	No	21.75" (552.45mm)	Yes

367457

## Set up Device on Rack

You can set up the Cisco N540-FH-CSR-SYS on a rack.

### Rack Mount

The device is shipped with rack mounting brackets that are to be secured on the sides of the device.



**Caution** If the rack is on wheels, ensure that the brakes are engaged or the rack is otherwise stabilized.

Table 9: Cisco N540-FH-CSR-SYS Router Rack-Mount Kit

Quantity	Part Description
2	Front Rear brackets
16	M4 x 0.7 x 7-mm Phillips flat-head screws
4	12-24 x 0.49 inches L, Philips pan head screws

1. Attach the rack-mount brackets and the cable guides to the router as follows:

- a. The router has port-side intake modules, position the router so that its ports are facing the cold aisle.
- b. Position the bracket ears facing front or middle rack-mount, on the side of the chassis so that the holes are aligned.
- c. Use four M4 screws to attach the brackets to the chassis.
- d. Repeat Steps 1b and 1c with the other rack-mount bracket on the other side of the router.

**Figure 12: Installing Rack-Mount Brackets**



**Figure 13: Installing Cable Management and 19 inch Rack-Mount Brackets in the Front**





**Figure 14: Installing Cable Management and 19 inch Rack-Mount Brackets in the Middle**



**Figure 15: Installing Cable Management and 19 inch Rack-Mount Brackets in the Rear**

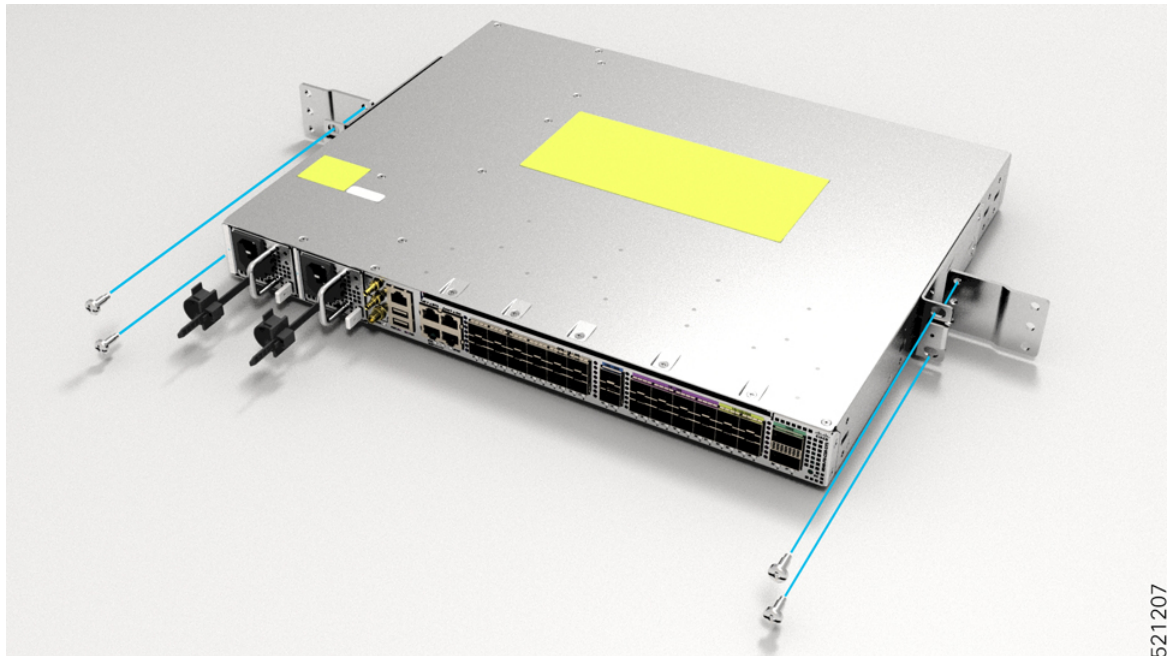


**Figure 16: Installing Cable Management and 23 inch Rack-Mount Brackets in the Front**



521206

**Figure 17: Installing Cable Management and 23 inch Rack-Mount Brackets in the Middle**



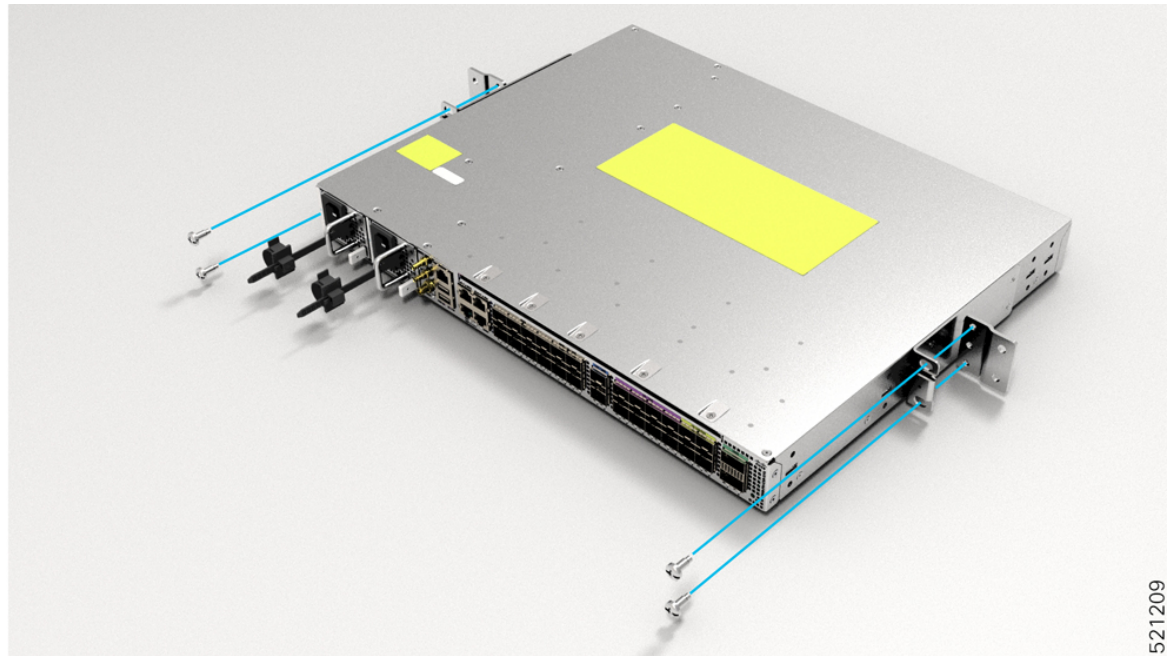
521207

Figure 18: Installing Cable Management and ETSI Rack-Mount Brackets in the Front



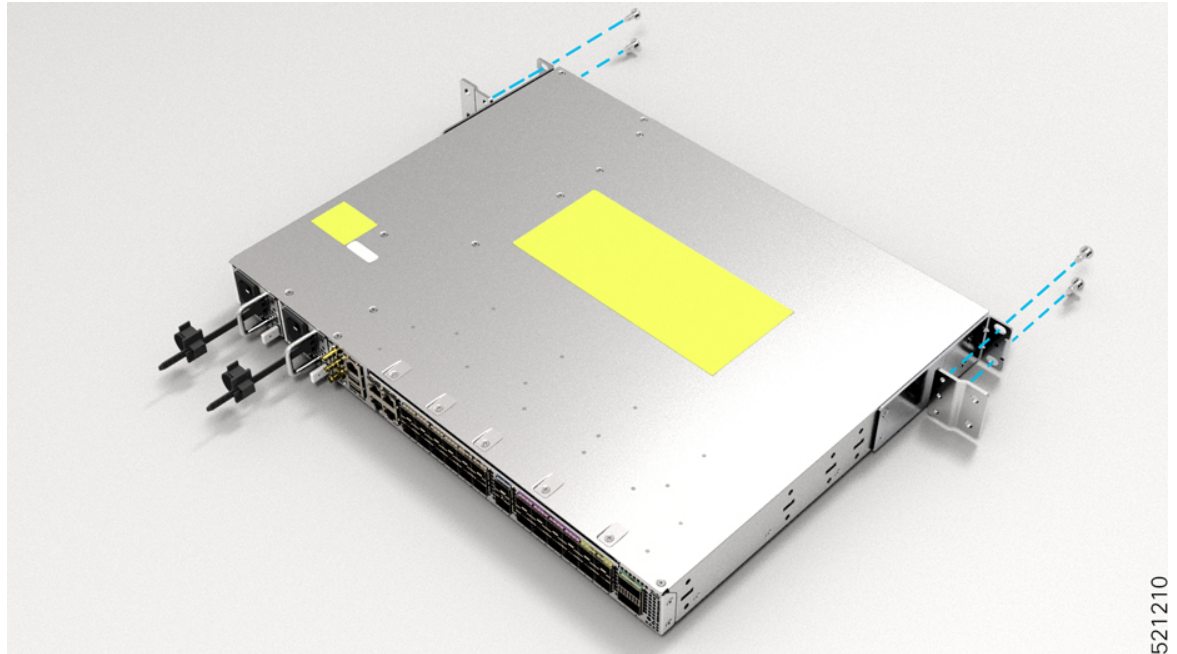
521208

Figure 19: Installing Cable Management and ETSI Rack-Mount Brackets in the Middle



521209

**Figure 20: Installing Cable Management and ETSI Rack-Mount Brackets in the Rear**



521210

## Ground the Device

Before you begin this task, ensure that you have read and understood the safety warnings in the Preventing ESD Damage section of the *Safety Warnings* handout.

Before you connect the power or turn on the power to the device, you must provide an adequate device ground (earth) connection to your device.

This section describes how to ground the device. The grounding lug location is on the back panel of the device.

1. Verify that the ground cable is connected to the top of the rack and according to local site practice.

**Figure 21: Ground Lug**

2. Attach one end of the shelf ground cable (#6 AWG cable) to the ground point on the rear of the chassis using the specified dual-hole lug connector.
  - Use a wire-stripping tool to remove approximately 0.75 inches (19 mm) of the covering from the end of the grounding cable.
  - Insert the stripped end of the grounding cable into the open end of the grounding lug.
  - Use the crimping tool to secure the grounding cable in the grounding lug.
  - Remove the adhesive label from the grounding pad on the chassis.
  - Place the grounding lug against the grounding pad so that there is solid metal-to-metal contact, and insert the two M4 screws with washers through the holes in the grounding lug and into the grounding pad.
  - Ensure that the lug and cable do not interfere with other equipment.
  - Prepare the other end of the grounding cable and connect it to an appropriate grounding point in your site to ensure adequate earth ground.

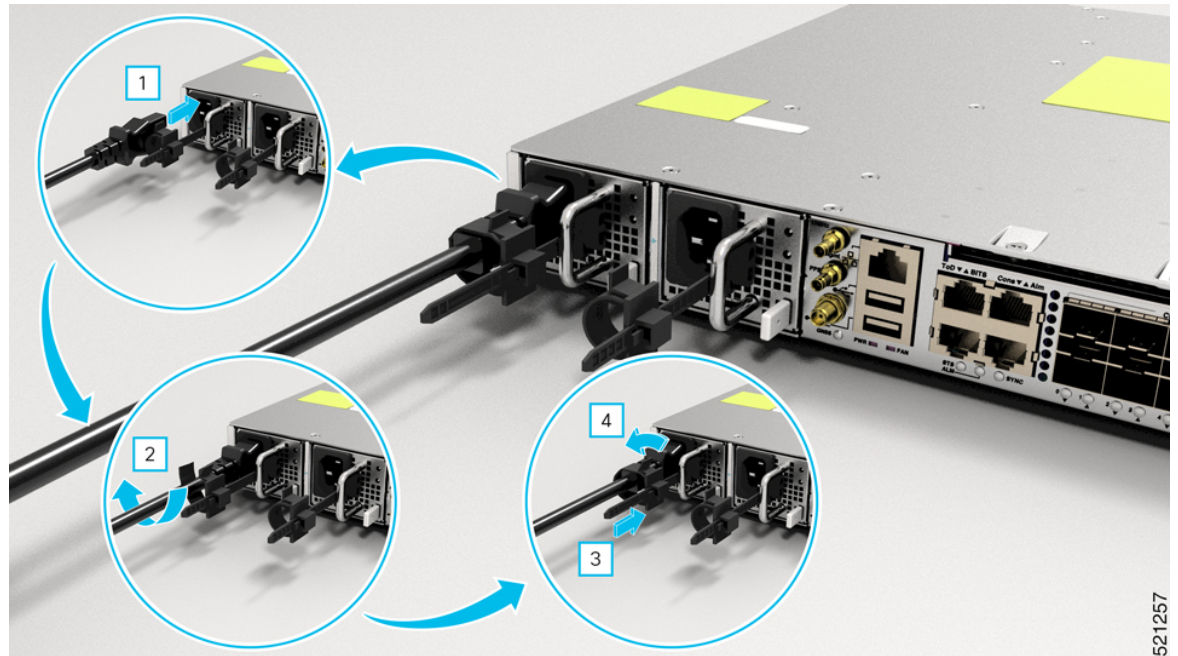
## Install the AC Power Cables

Refer *Chapter 6: Replace Power Supply* for more information about AC power cables installation.

To install the AC power cables in the power supply slots:

1. Plug the power supply cord in the power supply module.
2. Insert the power supply cord into the tie [1, 3] and tighten the tie around the power supply cord as shown in [2, 4] in the figure below.

Figure 22: Attach the AC Power Tie-and-Clip Cord



**Note** These images are for only representation purposes. Certain variants of Cisco NCS 540 do not include a tie for the power supply cord.

## Activate an AC Power Supply Module

Perform the following procedure to activate an AC power supply:

- 
- Step 1** Plug the power cord into the power supply.
  - Step 2** Connect the other end of the power cord to an AC-input power source.
  - Step 3** Verify power supply operation by checking if the respective power supply front panel LED (PS0 or PS1) is green.
  - Step 4** If the LEDs indicate a power problem, see *Troubleshooting* for troubleshooting information.
  - Step 5** If you are also connecting a redundant AC power supply, repeat these steps for the second power source.

**Note** If you are connecting a redundant AC power supply, ensure that each power supply is connected to a separate power source in order to prevent power loss in the event of a power failure.

---

## Install the DC Power Cables



**Note** When installing DC power supply, use 12AWG, 90°C temperature rated cable. The recommended cable length is three meters maximum from source. For lengths up to five meters, use 10AWG, and for lengths up to three meters, use 12AWG, 90°C temperature rated cable. For other lengths, contact Cisco.



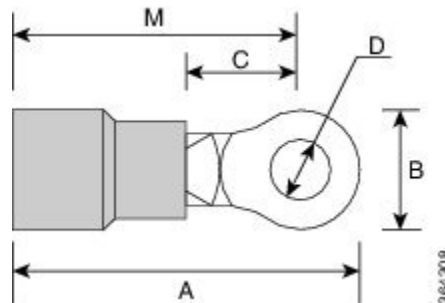
**Note**

- Always ensure that the building's installation for short-circuit (overcurrent) protection does not exceed 15A.
- We recommend using a circuit breaker or a fast acting fuse with a maximum DC rating of 10A for over current protection.



**Note** The DC connector or terminal block has an in-built screw and cage nut to which a torque of 1.3 to 1.8 N-m may be applied.

**Figure 23: DC Connector with In built Screw**

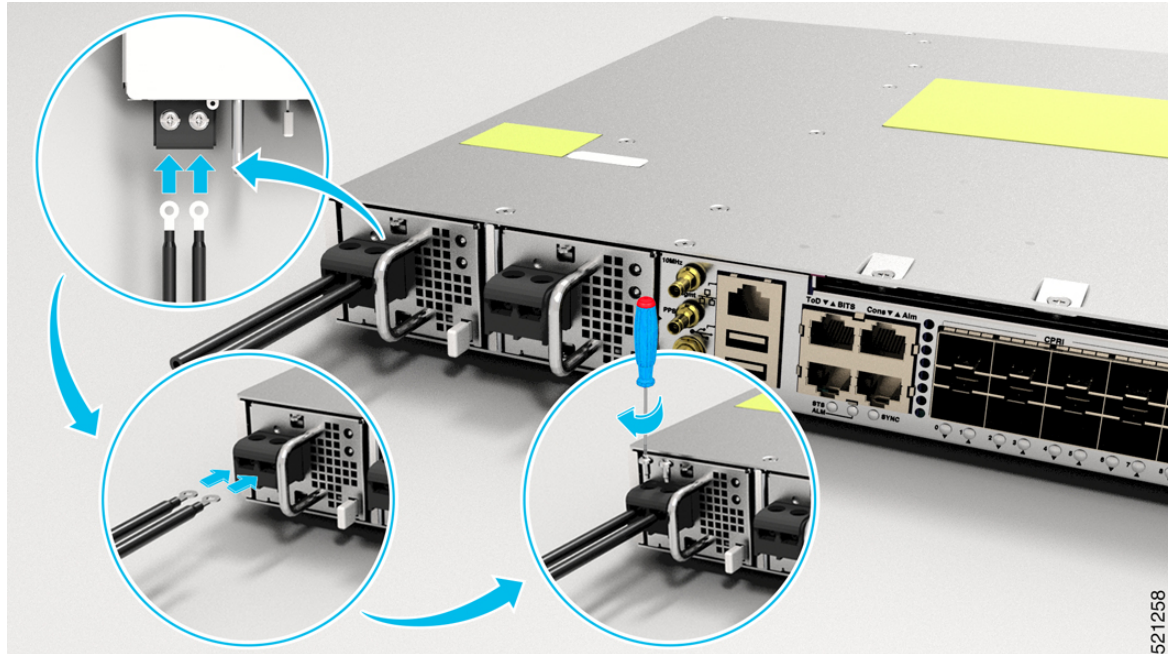


A	0.97 in. (2.4 cm)	C	0.27 in. (0.68 cm)
B	0.31 in. (0.78 cm)	D	0.17 in. (0.43 cm)
M	0.81 in. (2 cm)		

To attach the DC power supplies:

1. Locate the terminal block plug.
2. Insert the DC-input power source wires into the terminal block plug.
3. Attach the DC supply wires using the designated screws.
4. Use a ratcheting torque screwdriver to torque the terminal block plug captive screw. (See the following figure)

Figure 24: Attach the DC Power Supply Wires



## Activate a DC Power Supply Module

Perform the following procedure to activate a DC power supply:

- 
- Step 1** Remove the tape from the circuit-breaker router handle, and restore power by moving the circuit-breaker router handle to the On (I) position.
- Step 2** Verify the power supply operation by checking whether the respective power supply front panel LED (PS0 or PS1) is green.
- Step 3** If the LEDs indicate any issues with power problem, see *Troubleshooting*.
- Step 4** If you are also connecting a redundant DC power supply, repeat these steps for the second power source.
- Note** If you are connecting a redundant DC power supply, ensure that each power supply is connected to a separate power source in order to prevent power loss in the event of a power failure.
- 

## Port Connection Guidelines

Depending on the chassis, you can use Quad Small Form-Factor Pluggable Plus (QSFP+), QSFP28, SFP, SFP+, and RJ45 connectors to connect the ports on the line cards to other network devices.

To prevent damage to the fiber-optic cables, we recommend that you keep the transceivers disconnected from their fiber-optic cables when installing the transceiver in the line card. Before removing a transceiver from the router, remove the cable from the transceiver.

To maximize the effectiveness and life of your transceivers and optical cables, do the following:



- Wear an ESD-preventative wrist strap that is connected to an earth ground whenever handling transceivers. The router is typically grounded during installation and provides an ESD port to which you can connect your wrist strap.
- Do not remove and insert a transceiver more often than is necessary. Repeated removals and insertions can shorten its useful life.
- Keep the transceivers and fiber-optic cables clean and dust free to maintain high signal accuracy and to prevent damage to the connectors. Attenuation (loss of light) is increased by contamination and should be kept below 0.35 dB.
  - Clean these parts before installation to prevent dust from scratching the fiber-optic cable ends.
  - Clean the connectors regularly; the required frequency for cleaning depends upon the environment. In addition, clean connectors when they are exposed to dust or accidentally touched. Both wet and dry cleaning techniques can be effective; refer to your site's fiber-optic connection cleaning procedures.
  - Do not touch the ends of connectors. Touching the ends can leave fingerprints and cause other contamination.
- Inspect routinely for dust and damage. If you suspect damage, clean and then inspect fiber ends under a microscope to determine if damage has occurred.

## Connect to the Console Port

- The router must be fully installed in its rack, connected to a power source, and grounded.
- The necessary cabling for the console, management, and network connections must be available.
  - An RJ-45 rollover cable and DB9F/RJ-45 adapter are provided in the router accessory kit.
  - Network cabling should already be routed to the location of the installed router.

Before you create a network management connection for the router or connect the router to the network, you must create a local management connection through a console terminal and configure an IP address for the router. You also can use the console to perform the following functions (each of which can be performed through the management interface after you make that connection):

- Configure the router using the command-line interface (CLI).
- Monitor network statistics and errors.
- Configure Simple Network Management Protocol (SNMP) agent parameters.
- Download software updates.

The system console port is an RJ-45 receptacle for connecting a data terminal to perform the initial configuration of the router. The console cable is shipped with the hardware.

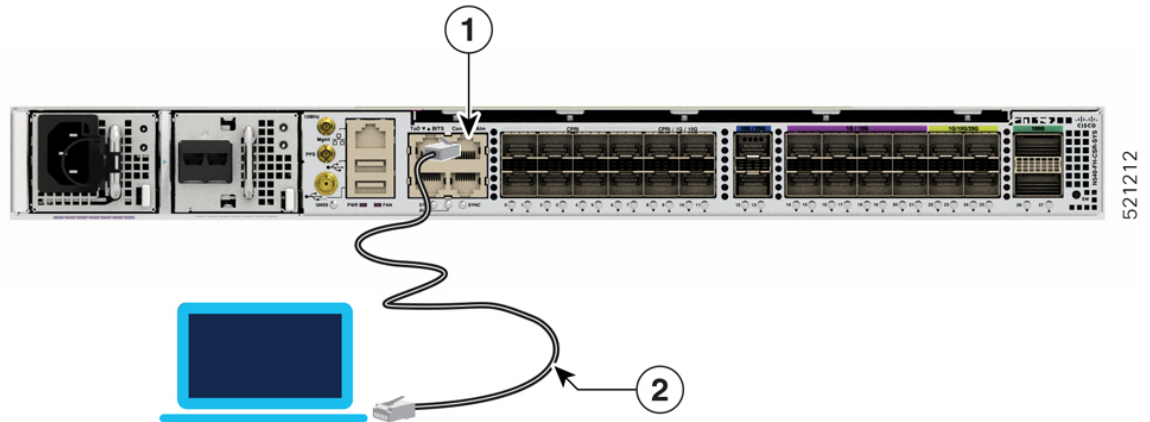


---

**Note** Only RJ45 to DB-9 adapter cable is provided in the package.

---

Figure 25: Connecting the USB Console Cable to the Chassis



521212

1	RJ45 Port	2	Console cable
---	-----------	---	---------------

Follow this procedure to connect a data terminal to the console port:

1. Set your terminal to these operational values: 115200 bps, 8 data bits, no parity, and two stop bits.
2. Attach the terminal end of the cable to the interface port on the data terminal.
3. Attach the other end of the cable to the console port.

Table 10: RJ-45 Straight-through Cable Pin-outs

RJ-45 Pin	Signal
1	—
2	—
3	Tx
4	Ground (GND)
5	GND
6	Rx
7	—
8	—

## Connect to the Management Ethernet Port

You must complete the initial router configuration.

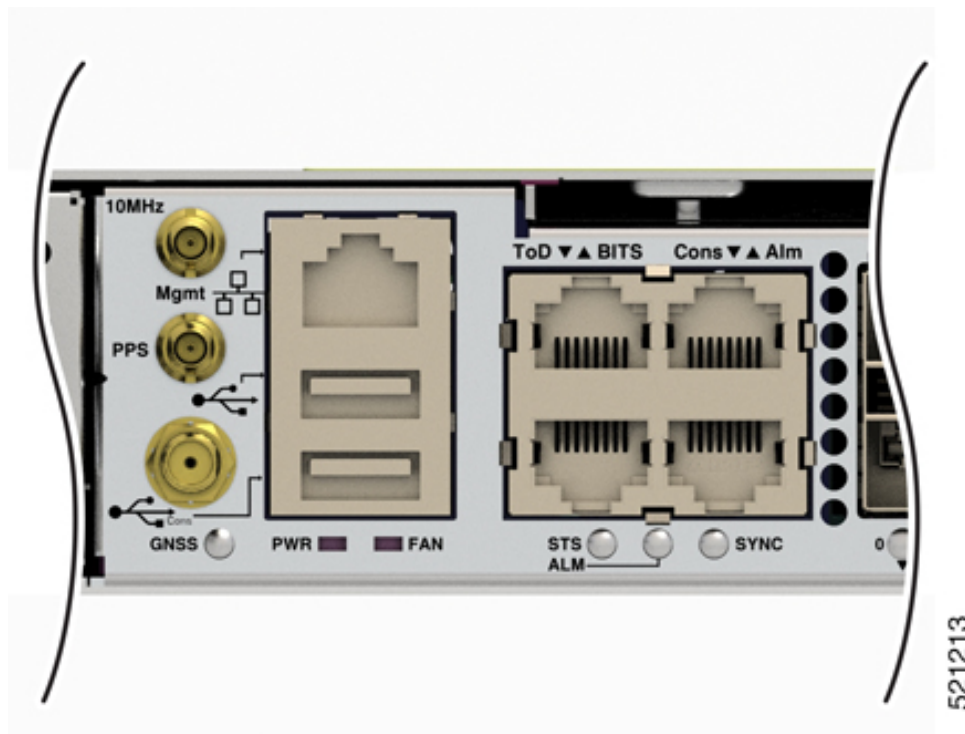
The management Ethernet port provides out-of-band management, which enables you to use the Command Line Interface (CLI) to manage the router by its IP address. This port uses a 10/100/1000 Ethernet connection with an RJ-45 interface.



**Note** To prevent an IP address conflict, do not connect the management Ethernet port until the initial configuration is complete.

To connect cables to the system management port, attach Category 5 cables directly to the RJ-45 receptacle on the management Ethernet port.

**Figure 26: Console Port**



**Note** To comply with GR-1089-CORE, the intra-building port(s) of the equipment must use shielded intra-building cabling or wiring that is grounded at both ends.

1. Plug the cable directly into the RJ-45 receptacle.
2. Connect the network end of your RJ-45 cable to a switch, hub, repeater, or other external equipment.

## Connecting Timing Cables

The following sections describe how to connect timing cables.

## Connecting Cables to a GPS Interface

The following sections describe how to connect cables from the router to a GPS unit for input or output timing of frequency:

### Connecting a Cable to the Input 10MHz or 1PPS Interface

---

- Step 1** Connect one end of a mini-coax cable to the GPS unit.
- Step 2** Connect the other end of the mini-coax cable to the 10MHz or 1PPS port on the RSP of the router.
- 

### Connecting a Cable to the Output 10MHz or 1PPS Interface

---

- Step 1** Connect one end of a mini-coax cable to the Slave unit.
- Step 2** Connect the other end of the mini-coax cable to the 10MHz or 1PPS port of the router.
- 

## Connecting a Cable to the GNSS Antenna Interface

1. Connect one end of a shielded coaxial cable to the GNSS RF IN port.
2. Connect the other end of the shielded coaxial cable to the GNSS antenna after the primary protector.



---

**Note** The GNSS RF In port should have a primary protector installed to meet the Local Safety guidelines.

---

The GNSS RF In coaxial cable shield must be connected to the Facility Equipment Ground through the chassis. The chassis must have the ground wire connected to the Facility Equipment Ground.

Figure 27: Installing the GNSS Module in the RSP



## Install and Remove Transceiver Module

This section shows how to install and remove transceiver module.

### Safety Precautions for Module Installation and Removal

Be sure to observe the following safety precautions when you work on the chassis.



**Warning** To prevent bodily injury when mounting or servicing this unit in a rack, you must take special precautions to ensure that the system remains stable. The following guidelines are provided to ensure your safety:

- This unit should be mounted at the bottom of the rack if it is the only unit in the rack.
- When mounting this unit in a partially filled rack, load the rack from the bottom to the top with the heaviest component at the bottom of the rack.
- If the rack is provided with stabilizing devices, install the stabilizers before mounting or servicing the unit in the rack.



**Warning** This product is a Class 1 laser product.



**Warning** An instructed person is someone who has been instructed and trained by a skilled person and takes the necessary precautions when working with equipment.

A skilled person or qualified personnel is someone who has training or experience in the equipment technology and understands potential hazards when working with equipment.

There are no serviceable parts inside. To avoid risk of electric shock, do not open.



**Warning** Only a skilled person should be allowed to install, replace, or service this equipment. See statement 1089 for the definition of a skilled person.

There are no serviceable parts inside. To avoid risk of electric shock, do not open.

## Install and Remove SFP Modules

Before you remove or install an SFP or SFP+ module, read the installation information in this section.



**Caution** Protect all the unused ports by inserting clean dust covers or dust caps into them.



**Warning** Invisible laser radiation is present. Do not expose to users of telescopic optics. This applies to Class 1/1M laser products.





**Warning** Invisible laser radiation may be emitted from the end of the unterminated fiber cable or connector. Do not view directly with optical instruments. Viewing the laser output with certain optical instruments, for example, eye loupes, magnifiers, and microscopes, within a distance of 100 mm, may pose an eye hazard.



**Caution** Protect the line card by inserting a clean SFP/SFP+ module cage cover (shown in the following figure) into the optical module cage when there is no SFP or SFP+ module installed. The SFP/SFP+ module cage cover is not a standard part of the accessories kit.

*Figure 28: SFP/SFP+ Module Cage Cover*



**Caution** Protect the SFP or SFP+ modules by inserting clean dust covers into them after the cables are removed. Be sure to clean the optic surfaces of the fiber cables before you plug them back into the optical ports of another module. Avoid getting dust and other contaminants into the optical ports of your SFP or SFP+ modules, because the optics do not work correctly when obstructed by dust.



**Caution** We strongly recommend that you do not install or remove the SFP or SFP+ module with fiber-optic cables attached to it because of the potential of damaging the cable, the cable connector, or the optical interfaces in the module. Disconnect all cables before removing or installing an SFP or SFP+ module. Removing and inserting a module can shorten its useful life; so you should not remove and insert modules more than it is absolutely necessary.

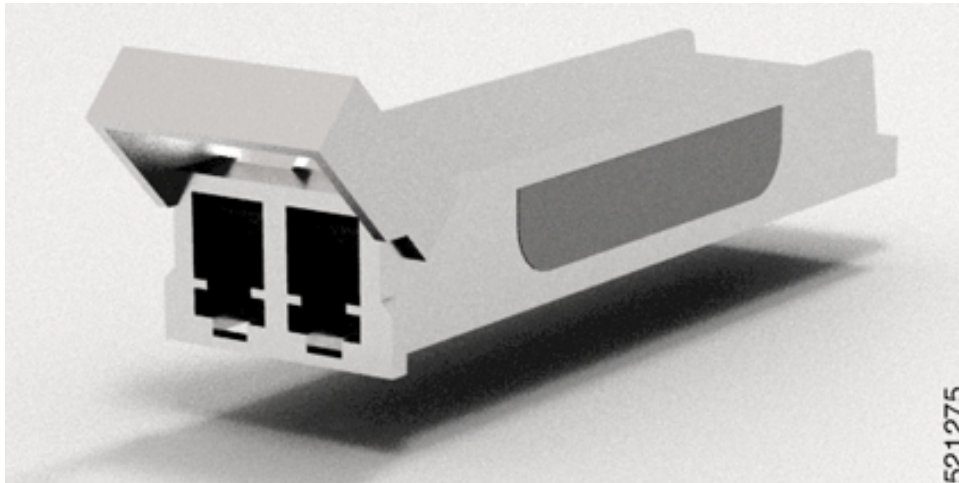


**Note** When installing an SFP or SFP+ module, you would hear a click as the triangular pin on the bottom of the module snaps into position into the hole in the receptacle. The click indicates that the module is correctly seated and secured in the receptacle. Verify that the modules are completely seated and secured in their assigned receptacles on the line card by firmly pushing on each SFP or SFP+ module.

## Bale Clasp SFP or SFP+ Module

The bale clasp SFP or SFP+ module has a clasp that you use to remove or install the module. (See the figure below.)

Figure 29: Bale Clasp SFP or SFP+ Module

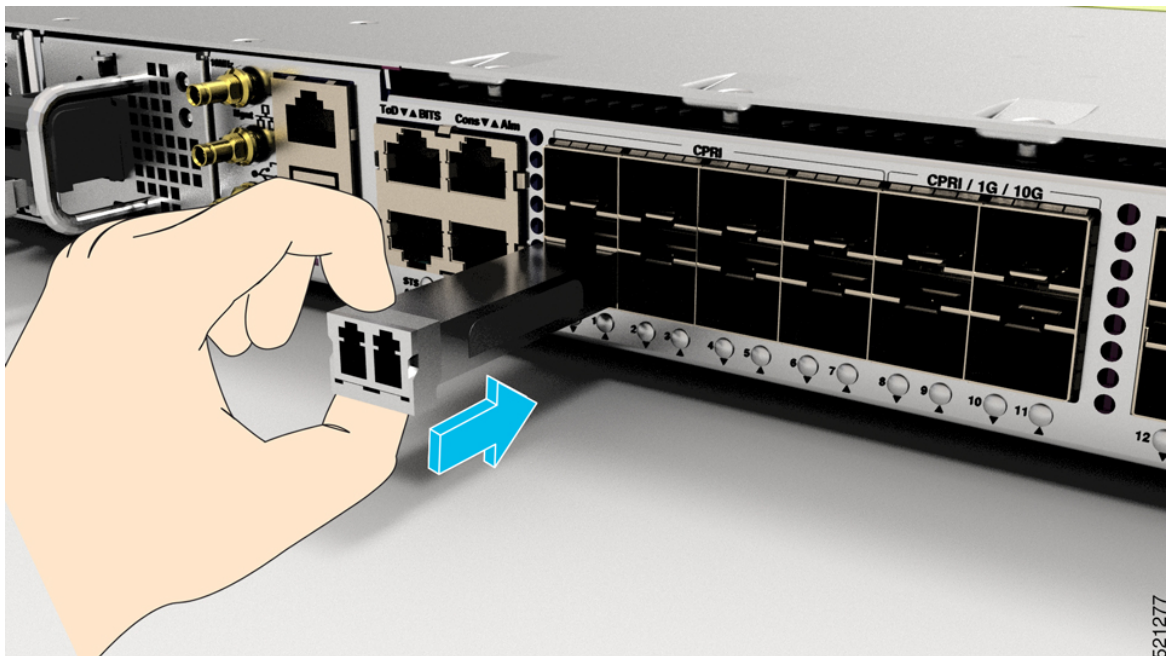


## Install a Bale Clasp SFP or SFP+ Module

To install this type of SFP or SFP+ module:

1. Attach an ESD-preventive wrist or ankle strap and follow its instructions for use.
2. Close the bale clasp before inserting the SFP module.
3. Line up the SFP module with the port and slide it into the port. (See the figure below.)

Figure 30: Installing a Bale Clasp SFP Module into a Port







---

**Note** When installing an SFP or SFP+ module, you should hear a click as the triangular pin on the bottom of the SFP module snaps into the hole in the receptacle. This click indicates that the module is correctly seated and secured in the receptacle. Verify that the SFP modules are completely seated and secured in their assigned receptacles on the line card by firmly pushing on each SFP module.

---

## Remove a Bale Clasp SFP or SFP+ Module

To remove this type of SFP or SFP+ module:

1. Attach an ESD-preventive wrist or ankle strap and follow its instructions for use.
2. Disconnect and remove all interface cables from the ports; note the current connections of the cables to the ports on the line card.
3. Open the bale clasp on the SFP module with your index finger, as shown in the figure below. If the bale clasp is obstructed and if you cannot open it, use your index finger, use a small flat-blade screwdriver or other long, narrow instrument to open the bale clasp.
4. Grasp the SFP module between your thumb and index finger and carefully remove it from the port, as shown in the figure below.

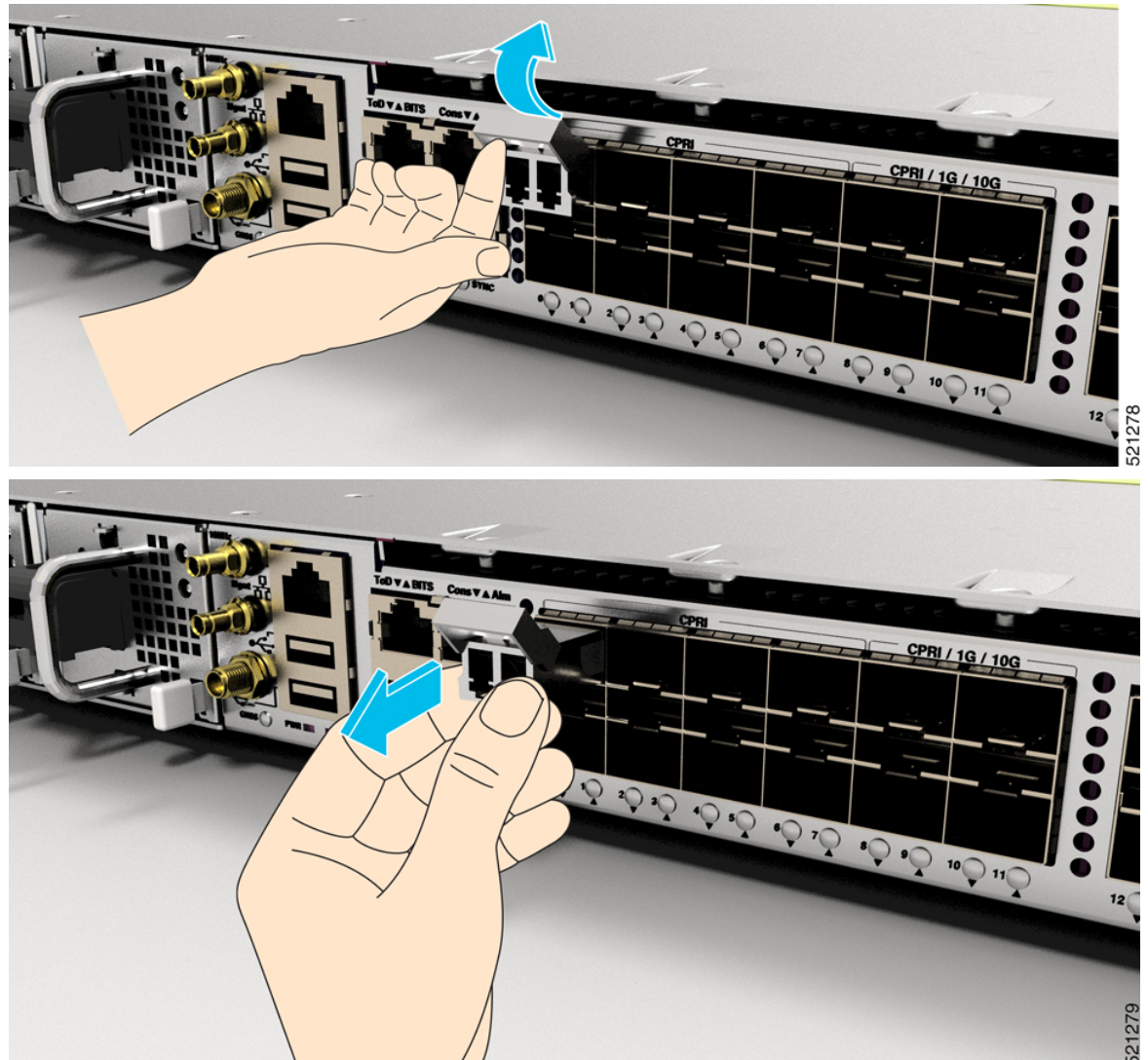


---

**Note** This action must be performed during your first instance. After all ports are populated, this may not be possible.

---

Figure 31: Removing a Bale Clasp SFP or SFP+ Module



5. Place the SFP module that you removed on an antistatic mat, or immediately place it in a static shielding bag if you plan to return it to the factory.
6. Protect your line card by inserting a clean SFP module cage covers into the optical module cage when there is no SFP module installed.

## Connect Interface Ports

You can connect optical interface ports on line cards with other devices for network connectivity.

### Connect a Fiber-Optic Port to the Network

Depending on the line card model that you are using, you can use either QSFP+ or QSFP28 transceivers. Some transceivers work with fiber-optic cables that you attach to the transceivers and other transceivers work

with pre-attached copper cables. When installing fiber-optic cables for a port, you must install SFP transceivers for 1-Gigabit optical ports or install SFP+ transceivers for 10-Gigabit optical ports or QSFP+ transceivers for 100-Gigabit ports before installing the fiber-optic cable in the transceivers.



---

**Caution** Removing and installing a transceiver can shorten its useful life. Do not remove and insert transceivers more than it is absolutely necessary. We recommend that you disconnect cables before installing or removing transceivers to prevent damage to the cable or transceiver.

---

## Disconnect Optical Ports from the Network

When you need to remove fiber-optic transceivers, you must first remove the fiber-optic cables from the transceiver before you remove the transceiver from the port.

## Maintain Transceivers and Optical Cables

To maintain high signal accuracy and to prevent damage to the connectors, transceivers and fiber-optic cables must be kept clean and free of dust. Attenuation (loss of light) is increased by contamination and should be below 0.35 dB.

Consider the following maintenance guidelines:

- Transceivers are static sensitive. To prevent ESD damage, wear an ESD-preventative wrist strap that is connected to the grounded chassis.
- Do not remove and insert a transceiver more than it is necessary. Repeated removals and insertions can shorten its useful life.
- Keep all optical connections covered when not in use. Clean them before use to prevent dust from scratching the fiber-optic cable ends.
- Do not touch the ends of connectors. Touching the ends would leave fingerprints and cause other contamination.
- Clean the connectors regularly; the required frequency of cleaning depends upon the environment. In addition, clean connectors if they are exposed to dust or have been accidentally touched. Both wet and dry cleaning techniques can be effective; refer to your site's fiber-optic connection cleaning procedures.
- Inspect routinely for dust and damage. Clean and then inspect fiber ends under a microscope to determine whether any damage has occurred.

## Install Cisco N540-FH-AGG-SYS

Installing the Cisco N540-FH-AGG-SYS involves these tasks:

### Rack Compatibility

We recommend that you follow these rack specifications.

## Rack Types

Figure 32: Rack specification EIA (19 inches and 23 inches)

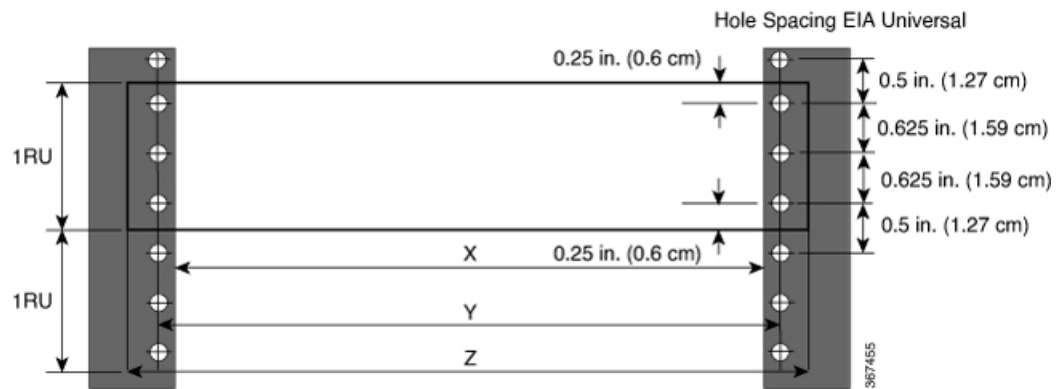


Table 11: Rack specification EIA (19 inches and 23 inches)

Post Type	Rack Type	Rack Front Opening (X)	Rack Mounting Hole Centre-Centre (Y)	Mounting Flange Dimension (Z)
4 Post	19 inches (48.3 centimeters)	450.8mm (17.75")	465mm (18.312")	482.6mm (19")
4 Post	23 inches (58.4 centimeters)	552.45mm (21.75")	566.7mm (22.312")	584.2mm (23")

Figure 33: Four Post Rack Type

4 – Post Type (Hole EIA Universal)	Width Available (X)	Depth Compatible (Y)	Compatibility
All 23" Type rack	552.45mm (21.75")	732.5 mm (28.84") to 910.3 mm (35.84")	Yes
All ETSI rack (21" rack)	500.0mm (19.68")	732.5 mm (28.84") to 910.3 mm (35.84")	Yes
19" Type rack	17.75" (450.8 mm)	732.5 mm (28.84") to 910.3 mm (35.84")	Yes
L-Type Post	17.50" (444.5 mm)	---	No
19" Type Racks	17.75" (450.8 mm)	732.5 mm (28.84") to 910.3 mm (35.84")	Yes
Flat-Post	17.50" (444.5 mm)	---	No
19" Type racks	17.75" (450.8 mm)	732.5 mm (28.84") to 910.3 mm (35.84")	Yes
C- Type Post	17.50" (444.5 mm)	---	No

5320296

## Set up Device on Rack

You can set up the Cisco N540-FH-AGG-SYS on a rack.

### Rack Mount

The device is shipped with rack mounting brackets that are to be secured on the sides of the device.



**Caution** If the rack is on wheels, ensure that the brakes are engaged or the rack is otherwise stabilized.

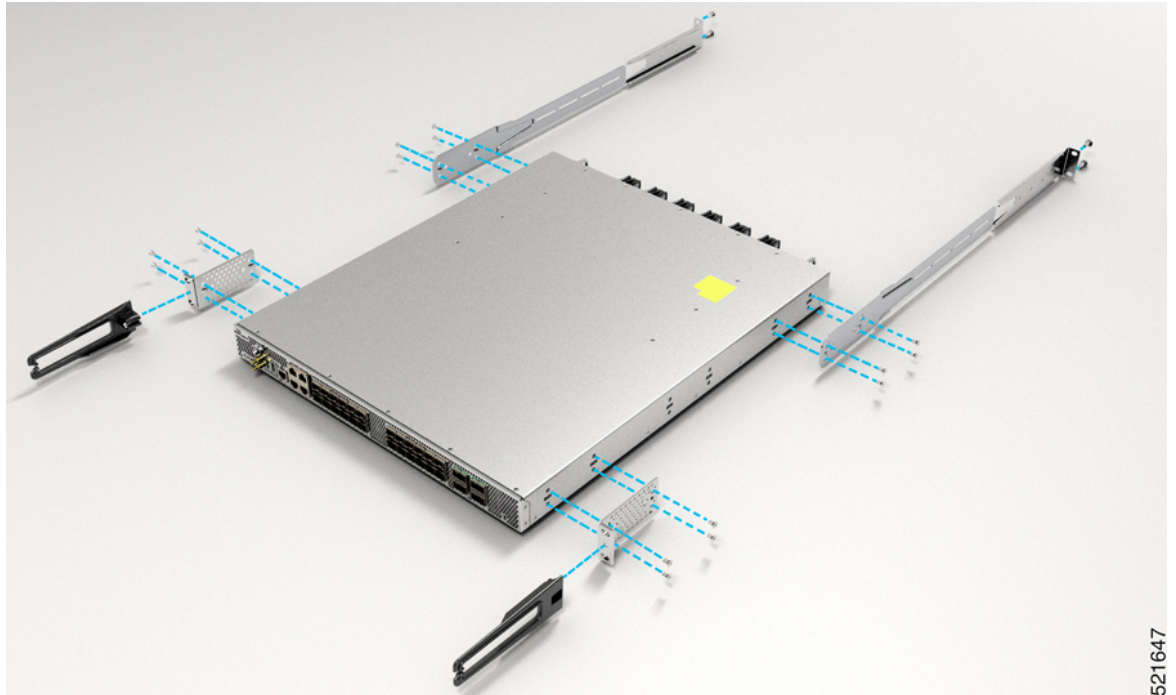
Table 12: Cisco N540-FH-CSR-SYS Router Rack-Mount Kit

Quantity	Part Description
2	Rack-mount brackets
8	M4 x 0.7 x 7-mm Phillips flat-head screws
4	12-24 x 0.49 inches L, Philips pan head screws

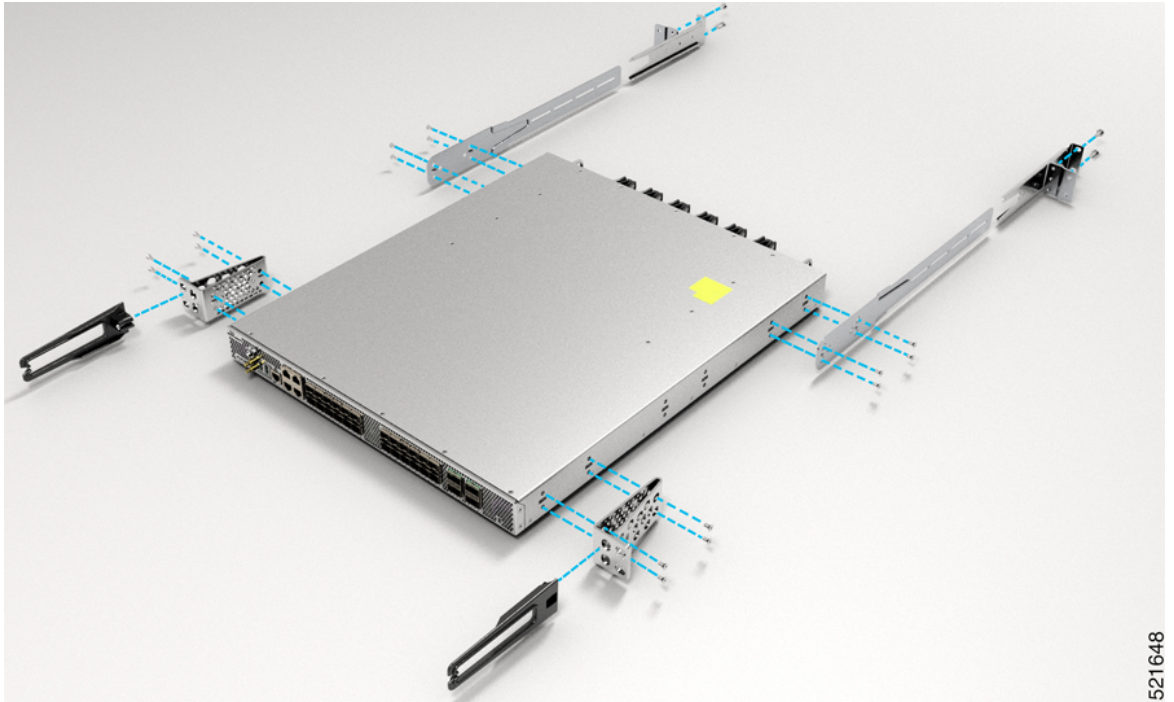
1. Attach the rack-mount brackets and the cable guides to the router as follows:
  - a. The router has port-side intake modules, position the router so that its ports are facing the cold aisle.

- b. Position the bracket ears facing front or middle rack-mount, on the side of the chassis so that the holes are aligned.
- c. Position the bracket extension facing rear side so that the holes are aligned properly.
- d. Use 8 M4 screws to attach both the brackets to the chassis.
- e. Repeat steps 1b to 1d with the other rack mount bracket on the other side of the router.

**Figure 34: Installing Cable Management and 19 inch Rack-Mount Brackets**

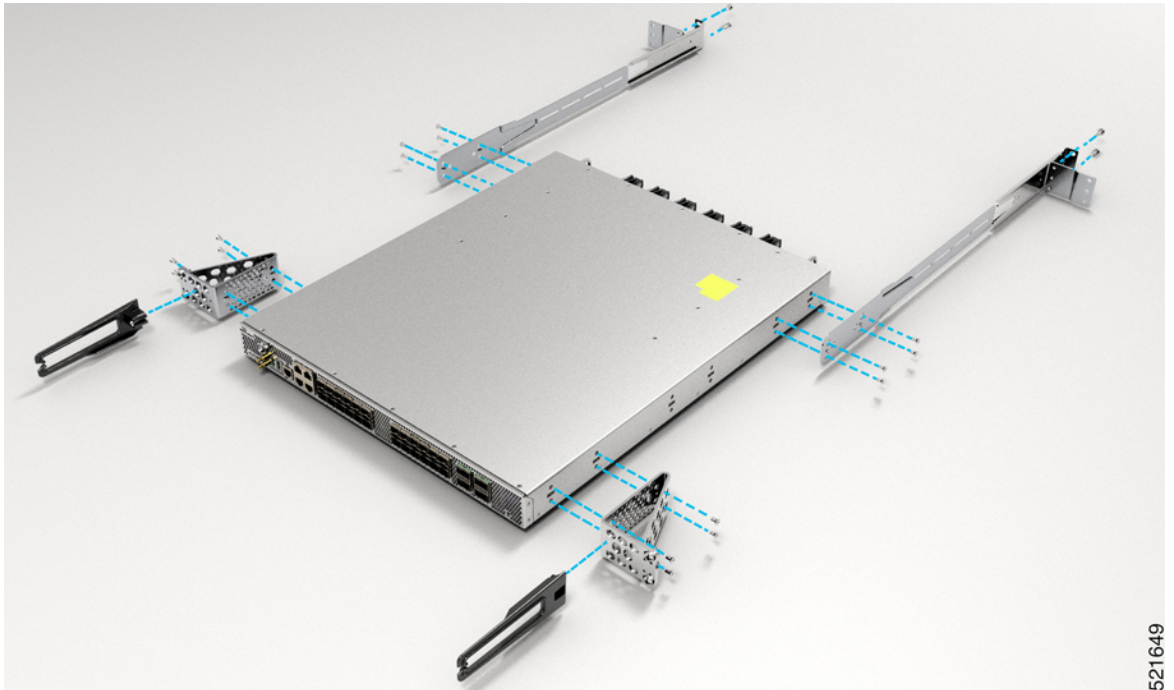


**Figure 35: Installing Cable Management and 21 inch Rack-Mount Brackets**



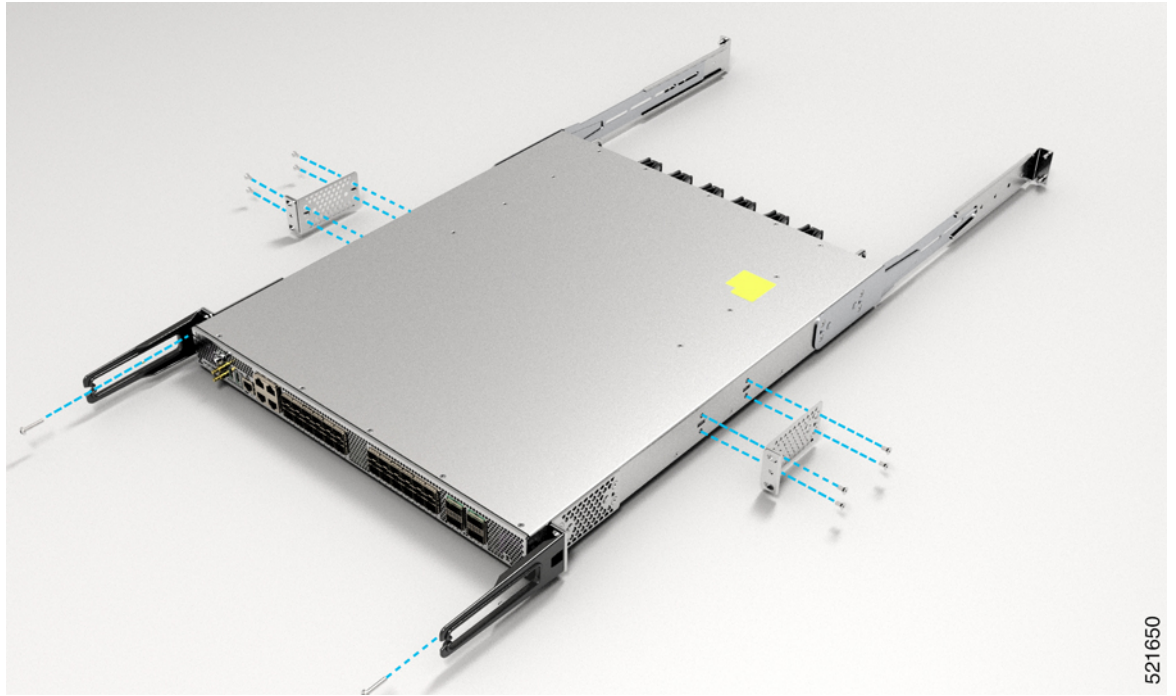
521648

**Figure 36: Installing Cable Management and 23 inch Rack-Mount Brackets**



521649

**Figure 37: Installing 19 inch Rack-Mount Brackets in the Middle with Cable Management Attached in Front Position Bracket**



**Figure 38: Installing 21 inch Rack-Mount Brackets in the Middle with Cable Management Attached in Front Position Bracket**

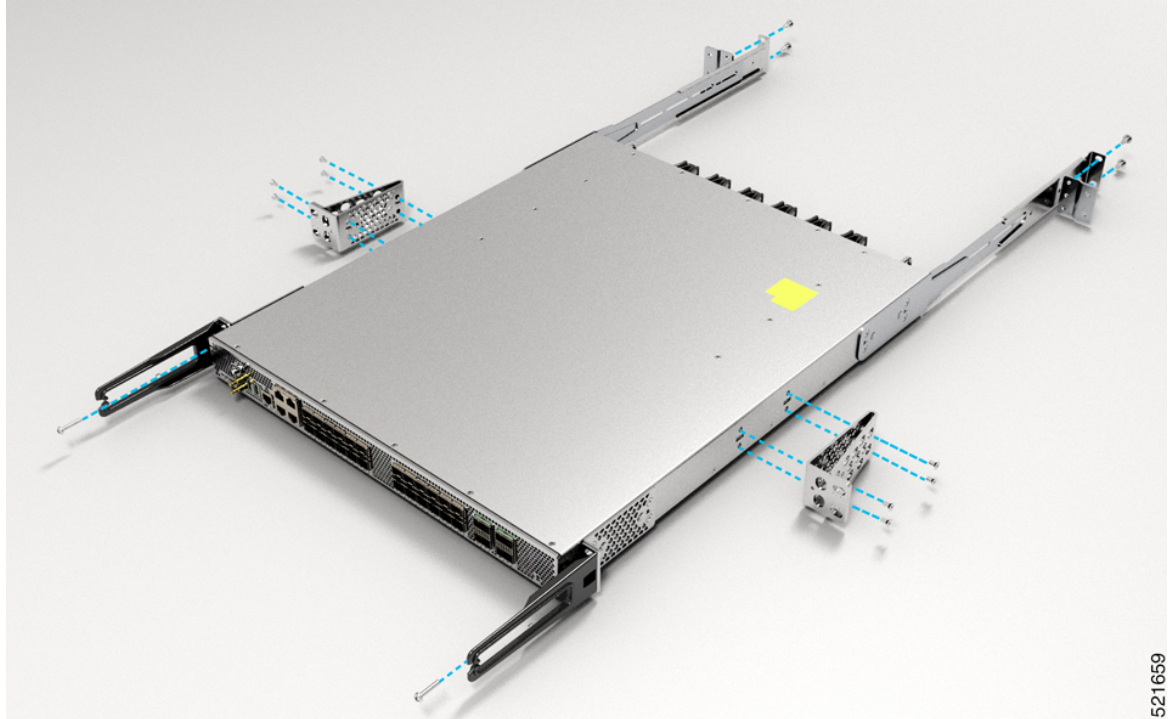
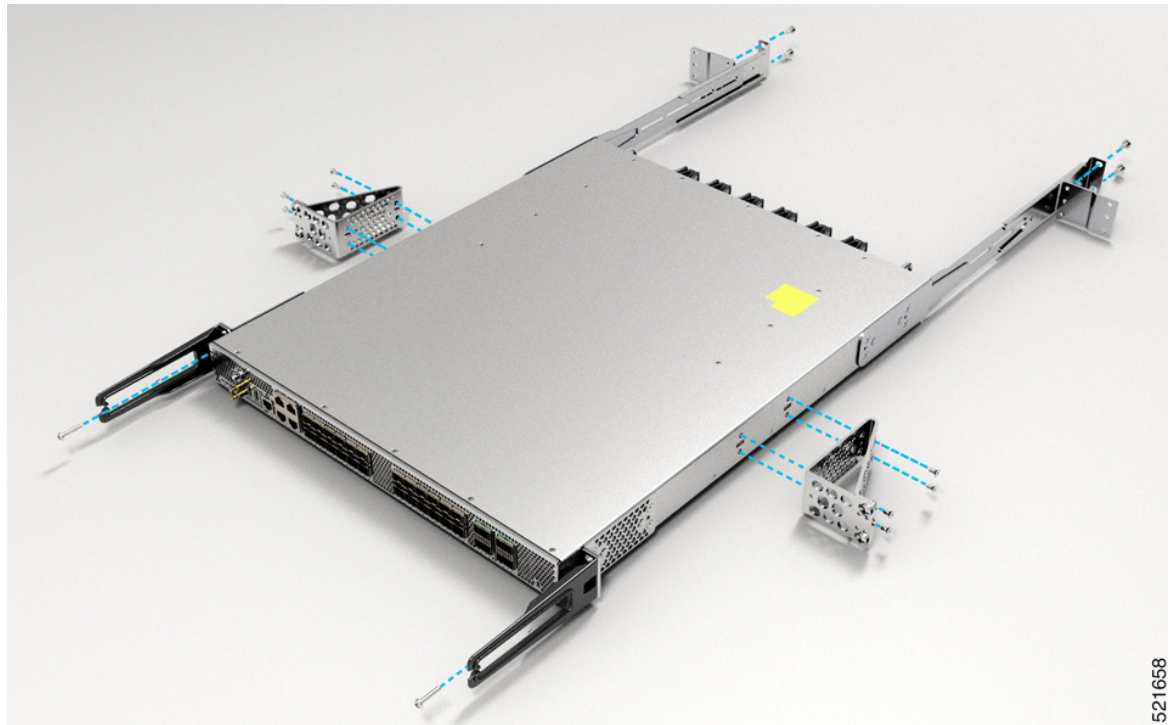




Figure 39: Installing 23 inch Rack-Mount Brackets in the Middle with Cable Management Attached in Front Position Bracket



521658

## Ground the Device

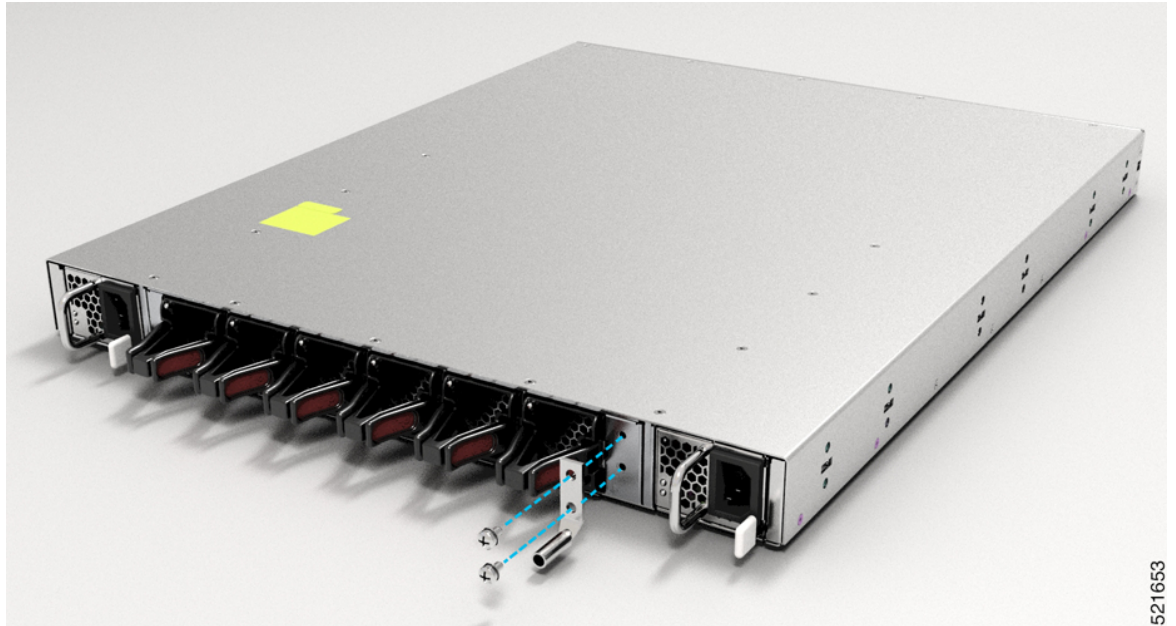
Before you begin this task, ensure that you have read and understood the safety warnings in the Preventing ESD Damage section of the *Safety Warnings* handout.

Before you connect the power or turn on the power to the device, you must provide an adequate device ground (earth) connection to your device.

This section describes how to ground the device. The grounding lug location is on the back panel of the device.

1. Verify that the ground cable is connected to the top of the rack and according to local site practice.

Figure 40: Ground Lug



521653

2. Attach one end of the shelf ground cable (#6 AWG cable) to the ground point on the rear of the chassis using the specified dual-hole lug connector.
  - Use a wire-stripping tool to remove approximately 0.75 inches (19 mm) of the covering from the end of the grounding cable.
  - Insert the stripped end of the grounding cable into the open end of the grounding lug.
  - Use the crimping tool to secure the grounding cable in the grounding lug.
  - Remove the adhesive label from the grounding pad on the chassis.
  - Place the grounding lug against the grounding pad so that there is solid metal-to-metal contact, and insert the two M4 screws with washers through the holes in the grounding lug and into the grounding pad.
  - Ensure that the lug and cable do not interfere with other equipment.
  - Prepare the other end of the grounding cable and connect it to an appropriate grounding point in your site to ensure adequate earth ground.

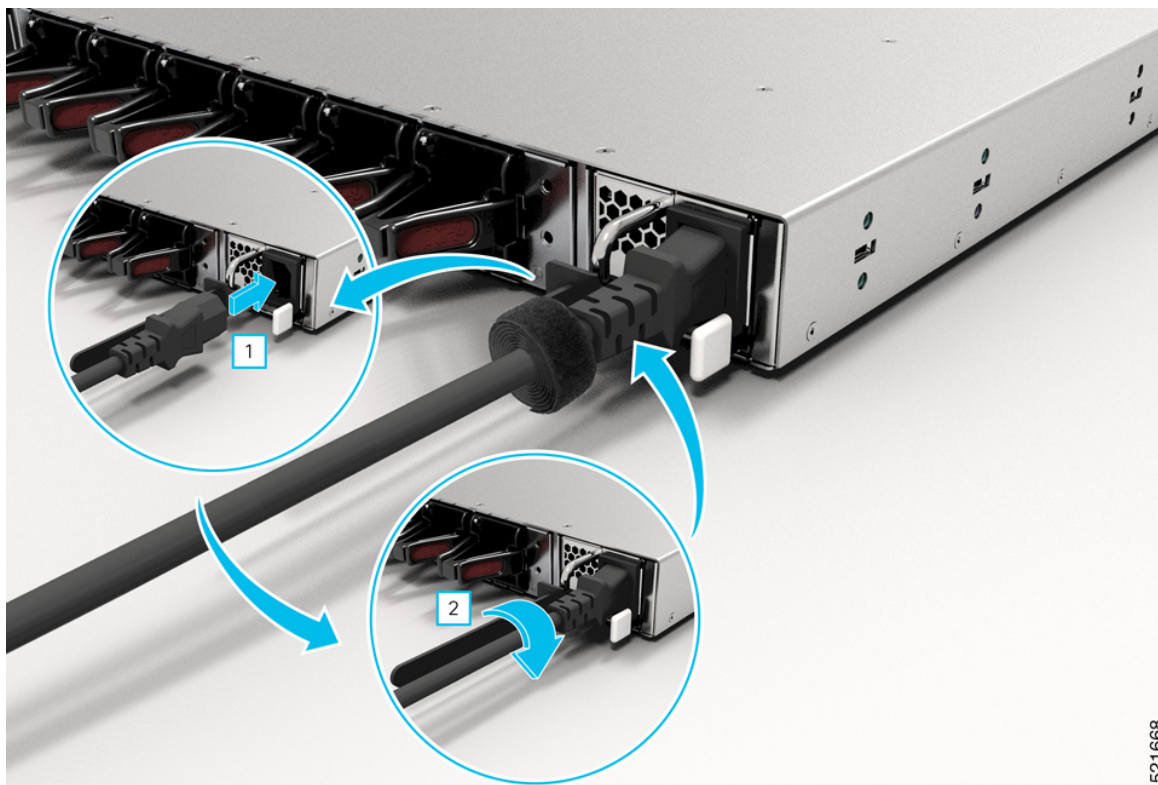
## Install the AC Power Cables

Refer *Chapter 6: Replace Power Supply* for more information about AC power cables installation.

To install the AC power cables in the power supply slots:

1. Plug the power supply cord in the power supply module.
2. Insert the power supply cord into the tie [1, 3] and tighten the tie around the power supply cord as shown in [2, 4] in the figure below.

Figure 41: Attach the AC Power Tie-and-Clip Cord



521668



**Note** These images are for only representation purposes. Certain variants of Cisco NCS 540 do not include a tie for the power supply cord.

## Activate an AC Power Supply Module

Perform the following procedure to activate an AC power supply:

- Step 1** Plug the power cord into the power supply.
- Step 2** Connect the other end of the power cord to an AC-input power source.
- Step 3** Verify power supply operation by checking if the respective power supply front panel LED (PS0 or PS1) is green.
- Step 4** If the LEDs indicate a power problem, see *Troubleshooting* for troubleshooting information.
- Step 5** If you are also connecting a redundant AC power supply, repeat these steps for the second power source.

**Note** If you are connecting a redundant AC power supply, ensure that each power supply is connected to a separate power source in order to prevent power loss in the event of a power failure.

## Install the DC Power Cables



**Note** When installing DC power supply, use 12AWG, 90°C temperature rated cable. The recommended cable length is three meters maximum from source. For lengths up to five meters, use 10AWG, and for lengths up to three meters, use 12AWG, 90°C temperature rated cable. For other lengths, contact Cisco.



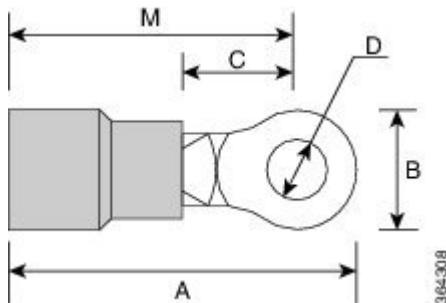
**Note**

- Always ensure that the building's installation for short-circuit (overcurrent) protection does not exceed 20A.
- We recommend using a circuit breaker or a fast acting fuse with a maximum DC rating of 20A for over current protection.



**Note** The DC connector or terminal block has an in-built screw and cage nut to which a torque of 1.3 to 1.8 N-m may be applied.

**Figure 42: DC Connector with In built Screw**

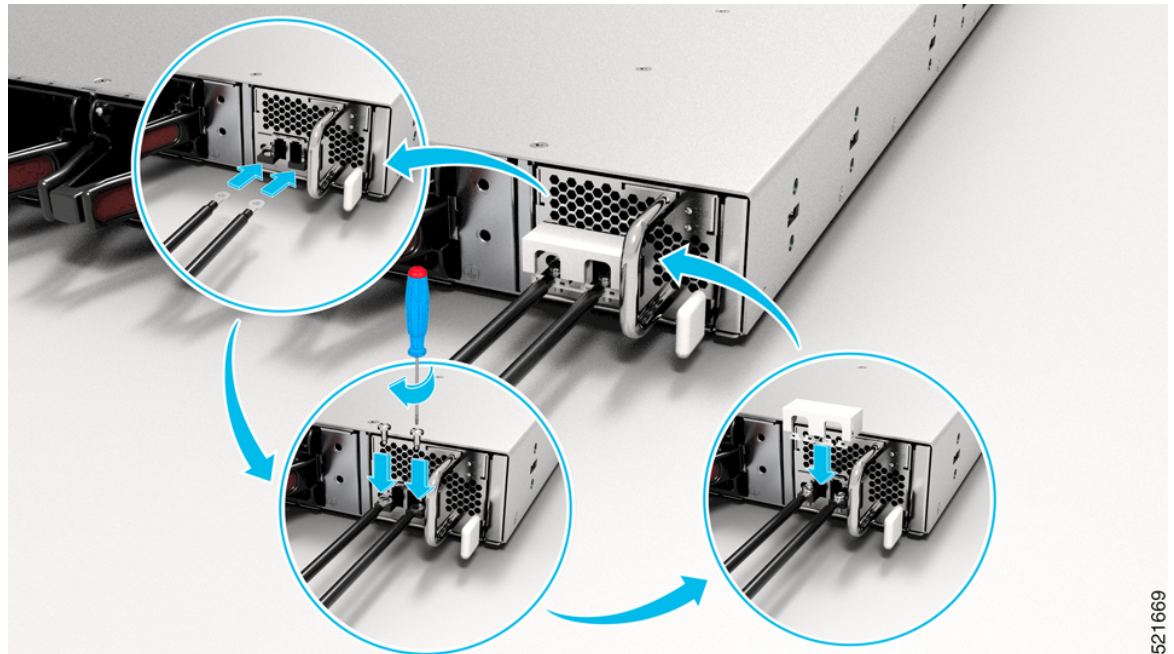


A	0.97 in. (2.4 cm)	C	0.27 in. (0.68 cm)
B	0.31 in. (0.78 cm)	D	0.17 in. (0.43 cm)
M	0.81 in. (2 cm)		

To attach the DC power supplies:

1. Locate the terminal block plug.
2. Insert the DC-input power source wires into the terminal block plug.
3. Attach the DC supply wires using the designated screws.
4. Use a ratcheting torque screwdriver to torque the terminal block plug captive screw. (See the following figure)

Figure 43: Attach the DC Power Supply Wires



521669

## Activate a DC Power Supply Module

Perform the following procedure to activate a DC power supply:

- 
- Step 1** Remove the tape from the circuit-breaker router handle, and restore power by moving the circuit-breaker router handle to the On (I) position.
- Step 2** Verify the power supply operation by checking whether the respective power supply front panel LED (PS0 or PS1) is green.
- Step 3** If the LEDs indicate any issues with power problem, see *Troubleshooting*.
- Step 4** If you are also connecting a redundant DC power supply, repeat these steps for the second power source.
- Note** If you are connecting a redundant DC power supply, ensure that each power supply is connected to a separate power source in order to prevent power loss in the event of a power failure.
- 

## Port Connection Guidelines

Depending on the chassis, you can use Quad Small Form-Factor Pluggable Plus (QSFP+), QSFP28, SFP, SFP+, and RJ45 connectors to connect the ports on the line cards to other network devices.

To prevent damage to the fiber-optic cables, we recommend that you keep the transceivers disconnected from their fiber-optic cables when installing the transceiver in the line card. Before removing a transceiver from the router, remove the cable from the transceiver.

To maximize the effectiveness and life of your transceivers and optical cables, do the following:

- Wear an ESD-preventative wrist strap that is connected to an earth ground whenever handling transceivers. The router is typically grounded during installation and provides an ESD port to which you can connect your wrist strap.
- Do not remove and insert a transceiver more often than is necessary. Repeated removals and insertions can shorten its useful life.
- Keep the transceivers and fiber-optic cables clean and dust free to maintain high signal accuracy and to prevent damage to the connectors. Attenuation (loss of light) is increased by contamination and should be kept below 0.35 dB.
  - Clean these parts before installation to prevent dust from scratching the fiber-optic cable ends.
  - Clean the connectors regularly; the required frequency for cleaning depends upon the environment. In addition, clean connectors when they are exposed to dust or accidentally touched. Both wet and dry cleaning techniques can be effective; refer to your site's fiber-optic connection cleaning procedures.
  - Do not touch the ends of connectors. Touching the ends can leave fingerprints and cause other contamination.
- Inspect routinely for dust and damage. If you suspect damage, clean and then inspect fiber ends under a microscope to determine if damage has occurred.

## Connect to the Console Port

- The router must be fully installed in its rack, connected to a power source, and grounded.
- The necessary cabling for the console, management, and network connections must be available.
  - An RJ-45 rollover cable and DB9F/RJ-45 adapter are provided in the router accessory kit.
  - Network cabling should already be routed to the location of the installed router.

Before you create a network management connection for the router or connect the router to the network, you must create a local management connection through a console terminal and configure an IP address for the router. You also can use the console to perform the following functions (each of which can be performed through the management interface after you make that connection):

- Configure the router using the command-line interface (CLI).
- Monitor network statistics and errors.
- Configure Simple Network Management Protocol (SNMP) agent parameters.
- Download software updates.

The system console port is an RJ-45 receptacle for connecting a data terminal to perform the initial configuration of Cisco NCS 540 fixed-port chassis. The console cable is shipped with the hardware.

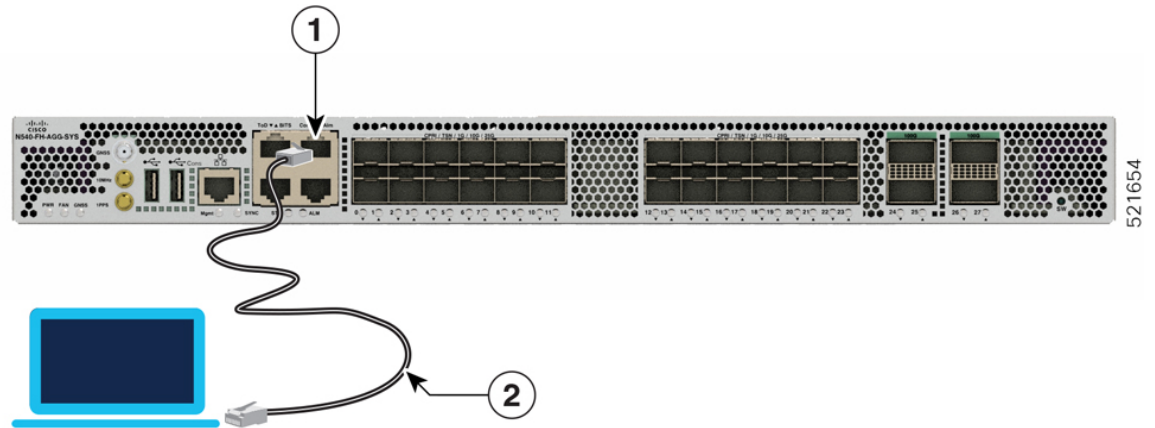


---

**Note** Only RJ45 to DB-9 adapter cable is provided in the package.

---

Figure 44: Connecting the USB Console Cable to the Chassis



1	RJ45 Port	2	Console cable
---	-----------	---	---------------

Follow this procedure to connect a data terminal to the console port:

1. Set your terminal to these operational values: 115200 bps, 8 data bits, no parity, and two stop bits.
2. Attach the terminal end of the cable to the interface port on the data terminal.
3. Attach the other end of the cable to the console port.

Table 13: RJ-45 Straight-through Cable Pin-outs

RJ-45 Pin	Signal
1	—
2	—
3	Tx
4	Ground (GND)
5	GND
6	Rx
7	—
8	—

## Connect to the Management Ethernet Port

You must complete the initial router configuration.

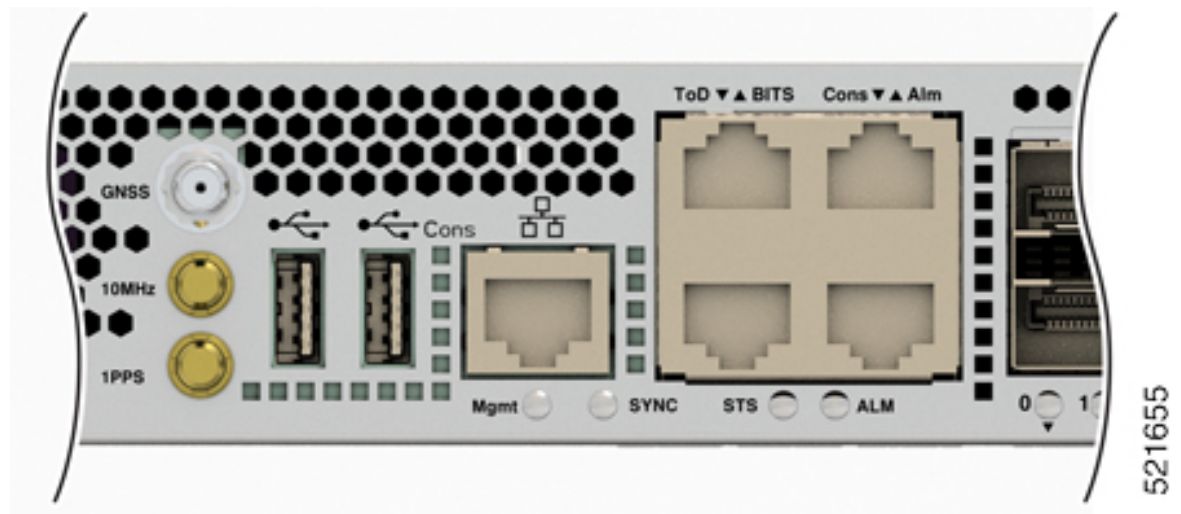
The management Ethernet port provides out-of-band management, which enables you to use the Command Line Interface (CLI) to manage the router by its IP address. This port uses a 10/100/1000 Ethernet connection with an RJ-45 interface.



**Note** To prevent an IP address conflict, do not connect the management Ethernet port until the initial configuration is complete.

To connect cables to the system management port, attach Category 5 cables directly to the RJ-45 receptacle on the management Ethernet port.

*Figure 45: Console Port*



**Note** To comply with GR-1089-CORE, the intra-building port(s) of the equipment must use shielded intra-building cabling or wiring that is grounded at both ends.

1. Plug the cable directly into the RJ-45 receptacle.
2. Connect the network end of your RJ-45 cable to a switch, hub, repeater, or other external equipment.

## Connecting Timing Cables

The following sections describe how to connect timing cables.

## Connecting Cables to a GPS Interface

The following sections describe how to connect cables from the router to a GPS unit for input or output timing of frequency:



## Connecting a Cable to the Input 10-MHz or 1-PPS Interface

Connect one end of a mini-coax cable to the GPS unit.

## Connecting a Cable to the Output 10MHz or 1PPS Interface

**Step 1** Connect one end of a mini-coax cable to the Slave unit.

**Step 2** Connect the other end of the mini-coax cable to the 10MHz or 1PPS port of the router.

## Connecting a Cable to the GNSS Antenna Interface

1. Connect one end of a shielded coaxial cable to the GNSS RF IN port.
2. Connect the other end of the shielded coaxial cable to the GNSS antenna after the primary protector.



**Note** The GNSS RF In port should have a primary protector installed to meet the Local Safety guidelines.

The GNSS RF In coaxial cable shield must be connected to the Facility Equipment Ground through the chassis. The chassis must have the ground wire connected to the Facility Equipment Ground.

*Figure 46: Installing the GNSS Module in the RSP*



## Install and Remove Transceiver Module

This section shows how to install and remove transceiver module.

### Safety Precautions for Module Installation and Removal

Be sure to observe the following safety precautions when you work on the chassis.




---

**Warning** To prevent bodily injury when mounting or servicing this unit in a rack, you must take special precautions to ensure that the system remains stable. The following guidelines are provided to ensure your safety:

- This unit should be mounted at the bottom of the rack if it is the only unit in the rack.
  - When mounting this unit in a partially filled rack, load the rack from the bottom to the top with the heaviest component at the bottom of the rack.
  - If the rack is provided with stabilizing devices, install the stabilizers before mounting or servicing the unit in the rack.
- 




---

**Warning** This product is a Class 1 laser product.

---




---

**Warning** An instructed person is someone who has been instructed and trained by a skilled person and takes the necessary precautions when working with equipment.

A skilled person or qualified personnel is someone who has training or experience in the equipment technology and understands potential hazards when working with equipment.

There are no serviceable parts inside. To avoid risk of electric shock, do not open.

---




---

**Warning** Only a skilled person should be allowed to install, replace, or service this equipment. See statement 1089 for the definition of a skilled person.

There are no serviceable parts inside. To avoid risk of electric shock, do not open.

---

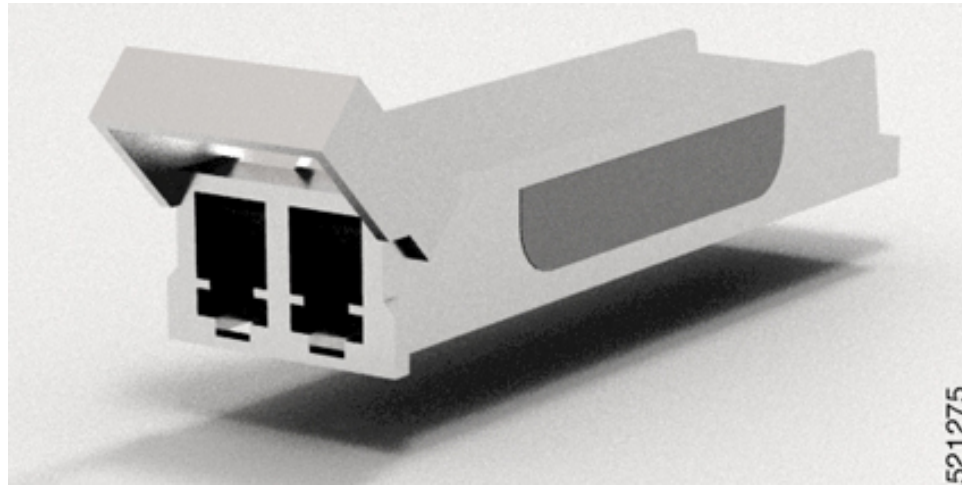
## Install and Remove Transceiver Module

This section shows how to install and remove transceiver module.

### Bale Clasp SFP or SFP+ Module

The bale clasp SFP or SFP+ module has a clasp that you use to remove or install the module. (See the figure below.)

*Figure 47: Bale Clasp SFP or SFP+ Module*

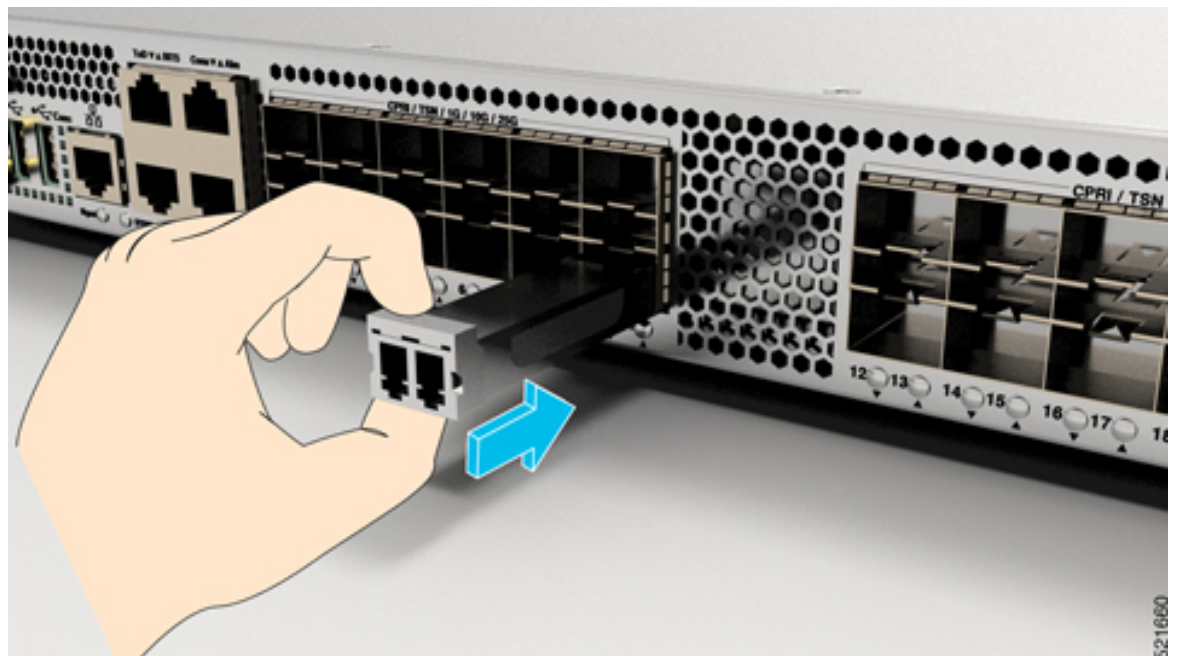


### Install a Bale Clasp SFP or SFP+ Module

To install this type of SFP or SFP+ module:

1. Attach an ESD-preventive wrist or ankle strap and follow its instructions for use.
2. Close the bale clasp before inserting the SFP module.
3. Line up the SFP module with the port and slide it into the port. (See the figure below.)

*Figure 48: Installing a Bale Clasp SFP Module into a Port*





---

**Note** When installing an SFP or SFP+ module, you should hear a click as the triangular pin on the bottom of the SFP module snaps into the hole in the receptacle. This click indicates that the module is correctly seated and secured in the receptacle. Verify that the SFP modules are completely seated and secured in their assigned receptacles on the line card by firmly pushing on each SFP module.

---

### Remove a Bale Clasp SFP or SFP+ Module

To remove this type of SFP or SFP+ module:

1. Attach an ESD-preventive wrist or ankle strap and follow its instructions for use.
2. Disconnect and remove all interface cables from the ports; note the current connections of the cables to the ports on the line card.
3. Open the bale clasp on the SFP module with your index finger, as shown in the figure below. If the bale clasp is obstructed and if you cannot open it, use your index finger, use a small flat-blade screwdriver or other long, narrow instrument to open the bale clasp.
4. Grasp the SFP module between your thumb and index finger and carefully remove it from the port, as shown in the figure below.

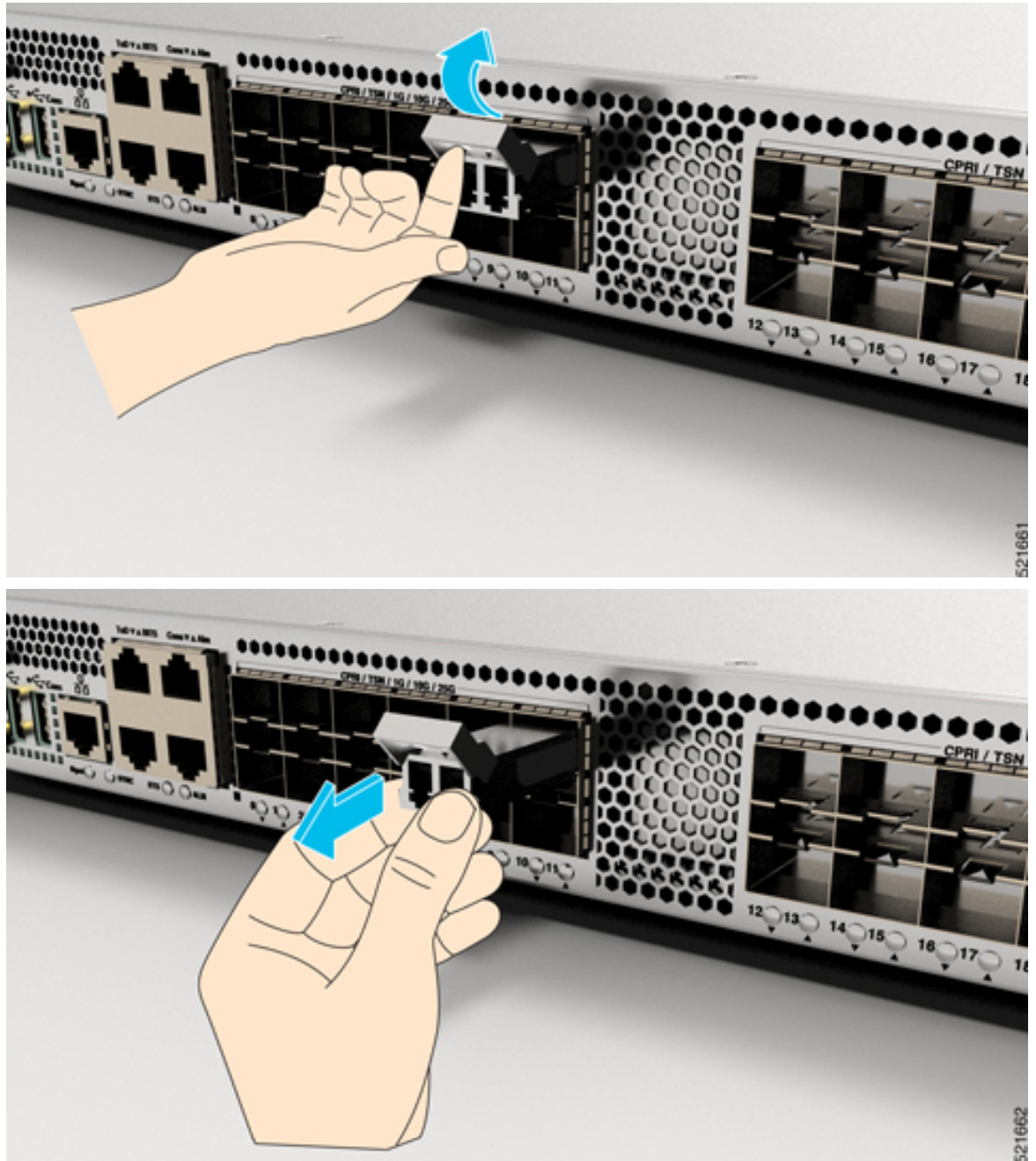


---

**Note** This action must be performed during your first instance. After all ports are populated, this may not be possible.

---

Figure 49: Removing a Bale Clasp SFP or SFP+ Module



5. Place the SFP module that you removed on an antistatic mat, or immediately place it in a static shielding bag if you plan to return it to the factory.
6. Protect your line card by inserting a clean SFP module cage covers into the optical module cage when there is no SFP module installed.

## Connect Interface Ports

You can connect optical interface ports on line cards with other devices for network connectivity.

### Connect a Fiber-Optic Port to the Network

Depending on the line card model that you are using, you can use either QSFP+ or QSFP28 transceivers. Some transceivers work with fiber-optic cables that you attach to the transceivers and other transceivers work with pre-attached copper cables. When installing fiber-optic cables for a port, you must install SFP transceivers for 1-Gigabit optical ports or install SFP+ transceivers for 10-Gigabit optical ports or QSFP+ transceivers for 100-Gigabit ports before installing the fiber-optic cable in the transceivers.



---

**Caution** Removing and installing a transceiver can shorten its useful life. Do not remove and insert transceivers more than it is absolutely necessary. We recommended that you disconnect cables before installing or removing transceivers to prevent damage to the cable or transceiver.

---

### Disconnect Optical Ports from the Network

When you need to remove fiber-optic transceivers, you must first remove the fiber-optic cables from the transceiver before you remove the transceiver from the port.

## Maintain Transceivers and Optical Cables

To maintain high signal accuracy and to prevent damage to the connectors, transceivers and fiber-optic cables must be kept clean and free of dust. Attenuation (loss of light) is increased by contamination and should be below 0.35 dB.

Consider the following maintenance guidelines:

- Transceivers are static sensitive. To prevent ESD damage, wear an ESD-preventative wrist strap that is connected to the grounded chassis.
- Do not remove and insert a transceiver more than it is necessary. Repeated removals and insertions can shorten its useful life.
- Keep all optical connections covered when not in use. Clean them before use to prevent dust from scratching the fiber-optic cable ends.
- Do not touch the ends of connectors. Touching the ends would leave fingerprints and cause other contamination.
- Clean the connectors regularly; the required frequency of cleaning depends upon the environment. In addition, clean connectors if they are exposed to dust or have been accidentally touched. Both wet and dry cleaning techniques can be effective; refer to your site's fiber-optic connection cleaning procedures.
- Inspect routinely for dust and damage. Clean and then inspect fiber ends under a microscope to determine whether any damage has occurred.



## CHAPTER 5

# Configure the Device

Before you begin this task, ensure that you have read and understood the safety warnings in the *Safety with Electricity* section of the Safety Warnings handout.



---

**Note** This equipment is designed to boot up in less than 30 minutes, depending on its neighbouring devices that must be fully up and running.

---



---

**Note** You can experience CPRI and MPLS traffic failure with load and unload configurations once in 40 power cycles.

---

Configuring the Cisco router involves these tasks:

- [Create the Initial Router Configuration, on page 71](#)
- [Verify Device Installation, on page 73](#)

## Create the Initial Router Configuration

You must assign an IP address to the router management interface so that you can then connect the router to the network.

When you initially power up the router, it boots up and asks a series of questions to help configure the router. To enable you to connect the router to the network, you can use the default choices for each configuration except for the IP address, which you must provide.



---

**Note** These routers are designed to boot up in less than 30 minutes, provided the neighboring devices are in full operational state.

---



---

**Note** Be aware of the router's unique name to identify it among the other devices in the network.

---

**Before you begin**

- A console device must be connected with the router.
- The router must be connected to a power source.
- Determine the IP address and netmask needed for the Management interfaces: `MgmtEth0/RP0/CPU0/0` and `MgmtEth0/RP1/CPU0/0`.

**Step 1** Power up the router.

The LEDs on each power supply light up (green) when the power supply units are sending power to the router, and the software asks you to specify a password to use with the router.

**Step 2** When the system is booted up for the first time, a new username and a password is to be created. The following prompt appears:

```
!!!!!!!!!!!!!!!!!!!!!! NO root-system username is configured. Need to configure root-system username.
!!!!!!!!!!!!!!!!!!!!!!

--- Administrative User Dialog ---

Enter root-system username:
% Entry must not be null.

Enter root-system username: root
Enter secret:
Use the 'configure' command to modify this configuration.
User Access Verification

Username: root
Password:

RP/0/RP0/CPU0:ios#
```

**Step 3** Enter a new password to use for this router.

The software checks the security strength of it and rejects your password if it is not considered to be a strong password. To increase the security strength of your password, make sure that it adheres to the following guidelines:

- At least eight characters
- Minimizes or avoids the use of consecutive characters (such as "abcd")
- Minimizes or avoids repeating characters (such as "aaa")
- Does not contain recognizable words from the dictionary
- Does not contain proper names
- Contains both uppercase and lowercase characters
- Contains both numbers and letters

**Note** Clear text passwords cannot include the dollar sign (\$) special character.



**Tip** If a password is trivial (such as a short, easy-to-decipher password), the software rejects the password configuration. Be sure to configure a strong password as described by the guidelines in this step. Passwords are case sensitive.

If you enter a strong password, the software asks you to confirm the password.

**Step 4** Reenter the password.

When you enter the same password, the software accepts the password .

**Step 5** Enter the IP address for the management interface.

**Step 6** Enter a network mask for the management interface.

**Step 7** The software asks whether you want to edit the configuration. Enter **no** to not edit the configuration.

**Step 8** The software asks whether you want to save the configuration. Enter **yes** to save the configuration.

---

## Verify Device Installation

After installing the Cisco router, you use the **show** commands to verify the installation and configuration. If any issue is detected, take corrective action before continuing with further configurations.

### 1. **show inventory**

Displays information about the field replaceable units (FRUs), including product IDs, serial numbers, and version IDs.

Example:

```
#show inventory
```

### 2. **admin show environment**

Displays all environment-related router information.

Example:

```
#admin show environment
```

### 3. **show environment temperature**

Displays temperature readings for on-board temperature sensors and for PSU. Each temperature sensor has three thresholds:

- Minor temperature threshold: When a minor threshold is exceeded, a minor alarm occurs and the following actions occur for all sensors:
  - System messages are displayed
  - SNMP notifications (if configured) are sent
  - Log environmental alarm event is triggered (Run the **show alarm** command to review this.)
- Major temperature threshold: When a major threshold is exceeded, a major alarm occurs and the following actions occur for all sensors:
  - System messages are displayed
  - SNMP notifications (if configured) are sent

- Log environmental alarm event is triggered (Run the **show alarm** command to review this.)
- Critical temperature threshold: When a critical threshold is exceeded, a critical alarm occurs and the following actions occurs:
  - For all the main board sensors the system is shut down.
  - For the PSU sensor, the particular PSU is turned off .

#### 4. **show environment power**

Displays the power usage information for the entire router.

Example:

```
#show environment power
```

#### 5. **show environment voltage**

Displays the voltage for the entire router.

Example:

```
#show environment voltage
```

#### 6. **show environment current**

Displays current for different voltage rails of the router.

Example:

```
#show environment current
```

#### 7. **show environment fan**

Displays the speed of all the fans including the fan in PSU.

Example:

```
#show environment fan
```



## CHAPTER 6

# Replace Power Supply

The router provides a choice of two different power supplies:

- DC power—The DC power supply uses two-position terminal block-style connector with positive latching or securing, and labeled connections for +24/48V, GRD, -24/48V. The terminal block connector is of suitable size to carry the appropriate AWG wire size to handle the input current of the power supply. No ON/OFF switch is provided.
- AC power—The AC power supply has an IEC 320-type power receptacle and a 15 Amp service connector. You can use standard right angle power cords with the AC power supply. The power supply includes a power cord retainer. No ON/OFF switch is provided.

You can install dual power supplies for redundancy.



---

**Note** Products that have an AC power connection are required to have an external SPD provided as part of the building installation to comply with the Telcordia GR-1089 NEBS standard for electromagnetic compatibility and safety.

---



---

**Caution** Do not use interface module and power supply ejector handles to lift the chassis; using the handles to lift the chassis can deform or damage the handles.

---

### PSU Redundancy Lost Alarm:

PSU redundancy lost alarms are generated when there is no proper input feed applied on any one of Power Modules (PMs) (PM0 or PM1). The alarms are also generated when the output for PM0 or PM1 is not proper.

The following alarms are raised for PSU redundancy lost event with a faulty PM0:

- Power Module Generic Fault
- Power Module Error
- Power Group Redundancy Lost

This is applicable to the following routers with modular PSUs:

- Cisco N540-FH-CSR-SYS
- Cisco N540-FH-AGG-SYS

- [Remove the DC Power Supply Module, on page 76](#)
- [Install the DC Power Supply Module, on page 76](#)
- [Remove the AC Power Supply Module, on page 78](#)
- [Install the AC Power Supply Module, on page 79](#)

## Remove the DC Power Supply Module

This section provides information about removing and replacing the DC power supply.



---

**Warning** Before performing any of the following procedures, ensure that power is removed from the DC circuit. Statement 1003

---



---

**Warning** Only trained and qualified personnel should be allowed to install, replace, or service this equipment. Statement 1030

---

Follow these steps to remove and replace the DC power supply:

1. Before servicing the power supply, switch off the circuit breaker in your equipment area. As an additional precaution, tape the circuit-breaker switch in the Off position.
2. Slip on the ESD-preventive wrist strap that is included in the accessory kit.
3. Switch the power supply circuit-breaker switch to the Off (O) position.
4. Pull the terminal block plug cover out of the terminal block head in the power supply. (See the following figure.)
5. Unscrew the terminal block screws and remove the cables.
6. Grasp the power supply handle. Press the power supply lock towards the left and simultaneously pull the power supply out from the chassis while supporting it with the other hand.

## Install the DC Power Supply Module

This equipment is suitable for installation in network telecommunications facilities and locations where the NEC applies.

This equipment is suitable for installations utilizing the Common Bonding Network (CBN).

The grounding architecture of this product is DC-Isolated (DC-I) for DC-powered products. DC-powered products have a nominal operating DC voltage of 48 VDC.

Perform the following procedure to install the power supply module:

1. Ensure that the system (earth) ground connection is made. (See the following figure.)
2. If necessary, remove the blank power supply filler plate from the chassis power supply bay opening by loosening the captive installation screws.

3. Verify that power to the DC circuit connected to the power supply you are installing is turned off. To ensure that power has been removed from the DC circuits, locate the circuit breakers for the DC circuits, switch the circuit breakers to the OFF position, and tape the circuit-breaker switches in the OFF position.
4. Grasp the power supply handle with one hand. Place your other hand underneath the power supply. Slide the power supply into the power supply bay. Make sure that the power supply is fully seated in the bay.

**Figure 50: Install DC Power Supply Module for N540-FH-CSR-SYS**



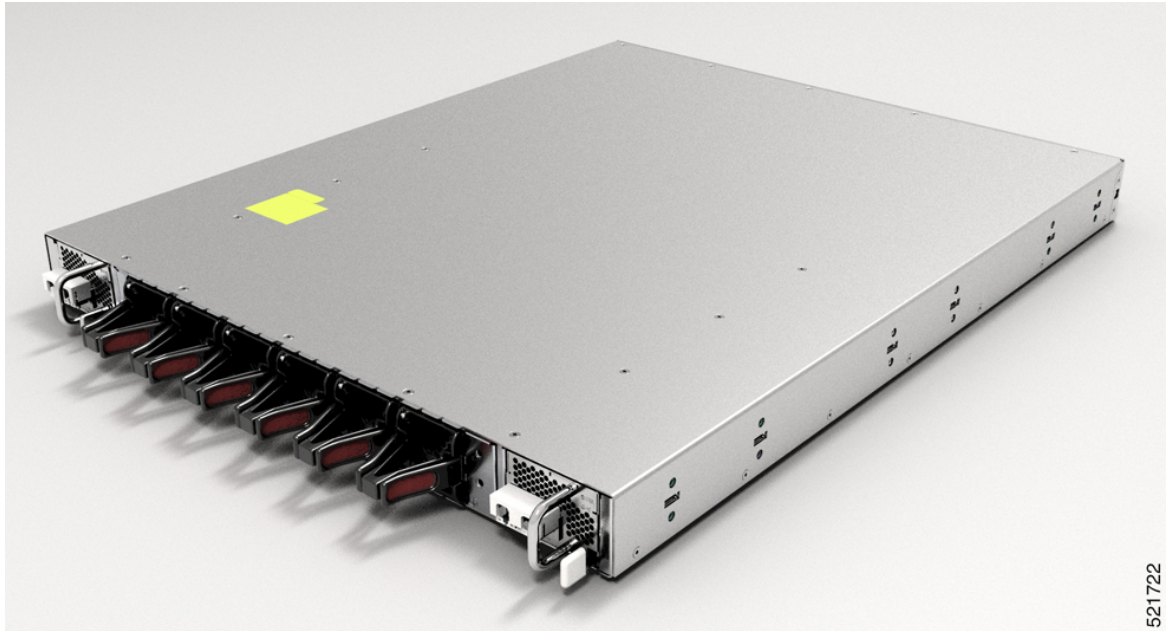
521222

**Figure 51: Install DC Power Supply Module for N540-FH-AGG-SYS**



521721

Figure 52: Assembled DC Power Supply Module with N540-FH-AGG-SYS Chassis



521722

## Remove the AC Power Supply Module

This section describes how to remove and replace the AC power supply.



**Warning** When you install the unit, the ground connection must always be made first and disconnected last. Statement 1046



**Warning** Only trained and qualified personnel should be allowed to install, replace, or service this equipment. Statement 1030



**Warning** Installation of the equipment must comply with local and national electrical codes. Statement 1074

Follow these steps to remove and replace the AC power supply:

- Step 1** Disconnect the power cord from the power source. Do not touch any metal on the power cord when it is still connected to the power supply.
- Step 2** Loosen the tie and remove the power cord from the tie-and holder.
- Step 3** Remove the power cord from the power connection on the power supply. Do not touch the metal prongs embedded in the power supply.

- Step 4** Grasp the power supply handle. Press the power supply lock towards the left and simultaneously pull the power supply out from the chassis while supporting it with the other hand.
- 

## Install the AC Power Supply Module

Follow these steps to install the AC power supply module:

1. Ensure that the system (earth) ground connection is made.
2. If necessary, remove the blank power supply filler plate from the chassis power supply bay opening by loosening the captive installation screws.
3. Grasp the power supply handle with one hand. Place your other hand underneath the power supply. Slide the power supply into the power supply bay. Make sure that the power supply is fully seated in the bay. (See the following figure.)

**Figure 53: Install AC Power Supply Module for N540-FH-CSR-SYS**



521215

*Figure 54: Install AC Power Supply Module for N540-FH-AGG-SYS*



521657

*Figure 55: AC Power Supply Module Assembled with N540-FH-AGG-SYS Chassis*



521652

4. Slide the AC power supply cord inside the tie of the tie-and-holder and tighten the tie around the power supply cord.
5. Plug the power supply cord into the AC power supply. For N540-FH-AGG-SYS, the PSU installation is from rear side of the chassis.





## CHAPTER 7

# Replace Fan Module

Before you begin this task, ensure that you have read and understood the safety warnings in the Safety with Electricity section of the Safety Warnings handout topic.



---

**Note** This chapter is *only* applicable to N540-FH-AGG-SYS.

---



---

**Caution** If you cannot replace a fan tray within three minutes, we recommend that you leave it in the chassis until you are prepared to replace it within that specified time limit.

---



---

**Note** If you remove more than one fan tray at a time during operations, the router allows up to 2 minutes of operations before shutting down, unless you replace extra missing fan trays within that time. If the router senses an over temperature condition when multiple fan trays are removed, the shutdown can occur in less than 2 minutes.

---

1. Press the two tabs on both sides of the fan tray handle.

**Figure 56: Install and Remove Fan Module from the Chassis**



521723

2. Pull the fan tray to remove the fan tray to be replaced.
3. Hold the fan module with the light pipe at the top and connector at the bottom.
4. Align the fan module to the open fan tray slot in the chassis and press the module all the way into the slot until the left and right latches click and lock on the chassis.
5. If the chassis is powered on, listen for the fans. You should immediately hear them in operation. If you do not hear them, ensure that the fan module is inserted completely in the chassis.
6. Verify that the fan module LED is green. If the LED is not green, one or more fans are faulty.



## CHAPTER 8

# Appendix

Certain troubleshooting aids of the Cisco N540-FH-CSR-SYS and Cisco N540-FH-AGG-SYS enable you to perform these tasks that assist the troubleshooting process:

- [LEDs, on page 83](#)
- [System Specifications, on page 84](#)

## LEDs

The Cisco N540-FH-CSR-SYS Router LEDs are similar for most of the variants, and any differences between the routers are specifically called out.

## Router LEDs

All the data port LEDs in the Cisco N540-FH-CSR-SYS Router are at the front panel. There are five LEDs that reflect the different statuses of the system.

**Table 14: Router LED Descriptions**

LED	Color	Status
Alarm	Red	Critical alarm - system-scope (including RP0).
	Amber	Major alarm - system-scope (including RP0).
	Flashing Amber	Minor alarm - system-scope (including RP0).
	Off	No alarm.
Status	Green	The module is operational but has no active major or critical alarms.
	Amber	Host kernel booted and XR is booting.
	Flashing Red	Not Applicable.

## Power Supply LEDs



**Note** The following table is applicable only for Cisco N540-FH-CSR-SYS variants.

**Table 15: Power Supply LED Descriptions**

LED	Color	Status
STATUS	Green	Power Supply ON and operating normally.
	Off	Not receiving power or PSU-12V fail or 3V3 STDBY failure.
	Red	Power failure with one of the input power feeds failed or one of the on-board voltage rails has failed.
	Amber	STDBY FPGA upgrade is in progress due to post Reload/Power cycle after HW FPD upgrade All. <b>Note</b> Upgrade of the STDBY FPGA takes three to five minutes.

## Port LED

**Table 16: Port LED**

Port LED Color	Status
Off	Port is shut down or admin is down
Amber	Link is down
Green	Link is up

## System Specifications

Certain troubleshooting aids of the Cisco N540-FH-CSR-SYS and Cisco N540-FH-AGG-SYS enable you to perform tasks that assist the troubleshooting process:

## Weight and Power Consumption

For information on physical specifications and power consumption, see table *Cisco NCS 540 chassis specification* on the [Cisco Network Convergence System 540 Router Data Sheet](#).

## Environmental Specifications

For information on environmental specifications, see table *Environmental properties for NCS 540 fixed systems* on the [Cisco Network Convergence System 540 Router Data Sheet](#).

## Transceiver and Cable Specifications

To determine which transceivers and cables are supported by this router, see [Cisco Transceiver Modules Compatibility Information](#).

To see the transceiver specifications and installation information, see [Cisco Transceiver Modules Install and Upgrade Guides](#).

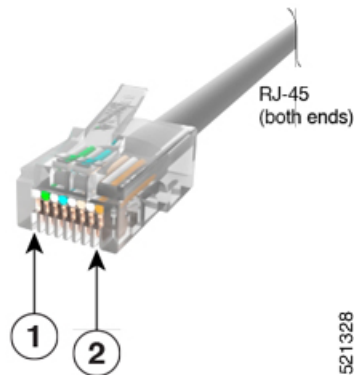
## RJ-45 Connectors

The RJ-45 connector connects Category 3, Category 5, Category 5e, Category 6, or Category 6A foil twisted-pair or unshielded twisted-pair cable from the external network to the following module interface connectors:

- Router chassis
  - CONSOLE port
  - MGMT ETH port

The following figure shows the RJ-45 connector.

**Figure 57: RJ-45 Connector**



## GPS Port Pinouts

The platform is capable of receiving or sourcing GPS signals of 1 PPS & 10 MHz. Same 2 mini-coax 50-ohm connectors are used for output and input.

This table below summarizes the GPS port pinouts:

**Table 17: GPS Port Pinouts**

	10 MHz (Input and Output)	1PPS (Input and Output)
Waveform	Input—Sine wave Output—Square wave	Input—Rectangular pulse Output—Rectangular pulse
Amplitude	Input— > 1.7 volt p-p(+8 to +10 dBm) Output— > 2.4 volts TTL compatible	Input— > 2.4 volts TTL compatible Output— > 2.4 volts TTL compatible

	10 MHz (Input and Output)	1PPS (Input and Output)
Impedance	50 ohms	50 ohms
Pulse Width	50% duty cycle	50% duty cycle
Rise Time	Input—AC coupled Output—5 nanoseconds	40 nanoseconds

## Time-of-Day Port Pinouts

This table summarizes the ToD/1-PPS port pinouts:

**Table 18: RJ-45 ToD/1-PPS Port Pinouts**

Pin	Signal Name	Direction	Description
1	—	—	—
2	—	—	—
3	1PPS_N	Output or Input	1PPS RS422 signal
4	GND	—	—
5	GND	—	—
6	1PPS_P	Output or Input	1PPS RS422 signal
7	TOD_N	Output or Input	Time-of-Day character
8	TOD_P	Output or Input	Time-of-Day character

## BITS Interface

This table summarizes the BITS interface RJ48 port pinouts:

**Table 19: BITS Interface RJ48 Port Pinouts**

Pin	Signal Name	Direction	Description
1	RX Ring	Input	Receive Ring
2	RX TIP	Input	Receive TIP (T1/E1)
3, 6, 7, 8	—	NC	—
4	TX Ring	Output	Transmit Ring

Pin	Signal Name	Direction	Description
5	TX TIP	Output	Transmit TIP (T1/E1)

## Management Ethernet Port Pinouts

The following table summarizes the Management Ethernet port pinouts:

**Table 20: Management Ethernet Port Pinouts**

Pin	Signal Name
1	TRP0+
2	TRP0-
3	TRP1+
4	TRP2+
5	TRP2-
6	TRP1-
7	TRP3+
8	TRP3-

## USB Port Pinouts

The following table summarizes the USB port pinouts:

**Table 21: USB Port Pinouts**

Pin	Signal Name	Description
A1	Vcc	+5 VDC
A2	D-	Data -
A3	D+	Data +
A4	Gnd	Ground

## Alarm Port Pinouts

The following table summarizes the external alarm input pinouts:

Table 22: External Alarm Input Pinouts

Pin	Signal Name	Description
1	ALARM0_IN	Alarm input 0
2	ALARM1_IN	Alarm input 1
3	—	—
4	ALARM2_IN	Alarm input 2
5	ALARM3_IN	Alarm input 3
6	—	—
7	—	—
8	ALARM_IN_COMMON	Alarm Input Common

## Console Port Pinouts

This following table summarizes the Console port pinouts:

Table 23: Console Port Pinouts

Pin	Signal Name	Direction	Description
1	ACONS-TX	Output	Aux Consoles transmit output, RS232
2	NC	NA	NA
3	CONS-TX	Output	Console RS232 transmit
4	Gnd	NA	Ground
5	Gnd	NA	Ground
6	CONS-RX	Input	Console RS232 receive
7	ACONS-RTX	Input	Aux Consoles receive input, RS232
8	NC	NA	NA

## AC Power Cord Specifications

For more information on the supported power cables, see *Ordering information for power cables supported on NCS 540* on the [Cisco Network Convergence System 540 Small Density Router Data Sheet](#).