



System Setup and Software Installation Guide for Cisco NCS 540 Series Routers, IOS XR Release 7.10.x

First Published: 2023-08-16

Americas Headquarters

Cisco Systems, Inc.
170 West Tasman Drive
San Jose, CA 95134-1706
USA
<http://www.cisco.com>
Tel: 408 526-4000
800 553-NETS (6387)
Fax: 408 527-0883

THE SPECIFICATIONS AND INFORMATION REGARDING THE PRODUCTS IN THIS MANUAL ARE SUBJECT TO CHANGE WITHOUT NOTICE. ALL STATEMENTS, INFORMATION, AND RECOMMENDATIONS IN THIS MANUAL ARE BELIEVED TO BE ACCURATE BUT ARE PRESENTED WITHOUT WARRANTY OF ANY KIND, EXPRESS OR IMPLIED. USERS MUST TAKE FULL RESPONSIBILITY FOR THEIR APPLICATION OF ANY PRODUCTS.

THE SOFTWARE LICENSE AND LIMITED WARRANTY FOR THE ACCOMPANYING PRODUCT ARE SET FORTH IN THE INFORMATION PACKET THAT SHIPPED WITH THE PRODUCT AND ARE INCORPORATED HEREIN BY THIS REFERENCE. IF YOU ARE UNABLE TO LOCATE THE SOFTWARE LICENSE OR LIMITED WARRANTY, CONTACT YOUR CISCO REPRESENTATIVE FOR A COPY.

The Cisco implementation of TCP header compression is an adaptation of a program developed by the University of California, Berkeley (UCB) as part of UCB's public domain version of the UNIX operating system. All rights reserved. Copyright © 1981, Regents of the University of California.

NOTWITHSTANDING ANY OTHER WARRANTY HEREIN, ALL DOCUMENT FILES AND SOFTWARE OF THESE SUPPLIERS ARE PROVIDED "AS IS" WITH ALL FAULTS. CISCO AND THE ABOVE-NAMED SUPPLIERS DISCLAIM ALL WARRANTIES, EXPRESSED OR IMPLIED, INCLUDING, WITHOUT LIMITATION, THOSE OF MERCHANTABILITY, FITNESS FOR A PARTICULAR PURPOSE AND NON-INFRINGEMENT OR ARISING FROM A COURSE OF DEALING, USAGE, OR TRADE PRACTICE.

IN NO EVENT SHALL CISCO OR ITS SUPPLIERS BE LIABLE FOR ANY INDIRECT, SPECIAL, CONSEQUENTIAL, OR INCIDENTAL DAMAGES, INCLUDING, WITHOUT LIMITATION, LOST PROFITS OR LOSS OR DAMAGE TO DATA ARISING OUT OF THE USE OR INABILITY TO USE THIS MANUAL, EVEN IF CISCO OR ITS SUPPLIERS HAVE BEEN ADVISED OF THE POSSIBILITY OF SUCH DAMAGES.

Any Internet Protocol (IP) addresses and phone numbers used in this document are not intended to be actual addresses and phone numbers. Any examples, command display output, network topology diagrams, and other figures included in the document are shown for illustrative purposes only. Any use of actual IP addresses or phone numbers in illustrative content is unintentional and coincidental.

All printed copies and duplicate soft copies of this document are considered uncontrolled. See the current online version for the latest version.

Cisco has more than 200 offices worldwide. Addresses and phone numbers are listed on the Cisco website at www.cisco.com/go/offices.

Cisco and the Cisco logo are trademarks or registered trademarks of Cisco and/or its affiliates in the U.S. and other countries. To view a list of Cisco trademarks, go to this URL: <https://www.cisco.com/c/en/us/about/legal/trademarks.html>. Third-party trademarks mentioned are the property of their respective owners. The use of the word partner does not imply a partnership relationship between Cisco and any other company. (1721R)

© 2023 Cisco Systems, Inc. All rights reserved.



CONTENTS

PART I

Setup System and Install IOS XR Software 9

CHAPTER 1

Overview of the Router 1

Command Modes 2

CHAPTER 2

Bring-up the Router 5

Boot the Router 5

Setup Root User Credentials 6

Access the System Admin Console 8

Configure the Management Port 8

Perform Clock Synchronization with NTP Server 10

CHAPTER 3

Provision Network Devices using Zero Touch Provisioning 13

Learn about Zero Touch Provisioning 13

Zero Touch Provisioning on a Fresh Boot of a Router 15

Fresh Boot Using Removable Storage Device 15

Fresh Boot Using DHCP 16

Build your Configuration File 17

Create User Script 18

ZTP Shell Utilities 18

ZTP Helper Python Library 20

Set Up DHCP Server 24

Authentication on Data Ports 27

Invoke ZTP Manually 28

Configure ZTP BootScript 29

Customize ZTP Initialization File 30

CHAPTER 4	Deploy Router Using Secure ZTP	33
	On board Devices Using Three-Step Validation	33
	Secure ZTP Components	34
	Initial Set Up for Secure ZTP	41
	How Does Secure ZTP Work?	43
	Upgrade Image Using Secure ZTP	47

CHAPTER 5	ZTP over Layer 2	51
	Prerequisites	54
	Customizing the ztp.ini File	54
	Prerequisites	55
	Customizing the ztp.ini File	55

CHAPTER 6	Perform Preliminary Checks	57
	Verify Status of Hardware Modules	57
	Verify Node Status	59
	Verify Software Version	60
	Verify Firmware Version	61
	Verify Interface Status	62
	Verify SDR Information	63

CHAPTER 7	Create User Profiles and Assign Privileges	65
	Create a User Profile in System Admin VM	67
	Create a User Group in System Admin VM	69
	Create Command Rules	70
	Create Data Rules	73
	Change Disaster-recovery Username and Password	75

CHAPTER 8	Perform System Upgrade and Install Feature Packages	77
	Upgrading the System	77
	View Supported Software Upgrade or Downgrade Versions	79
	Upgrading Features	82

Workflow for Install Process 84

Install Packages 84

Install Prepared Packages 89

Uninstall Packages 92

CHAPTER 9**Upgrading Field-Programmable Device 95**

Prerequisites for FPD Image Upgrades 95

Overview of FPD Image Upgrade Support 95

FPD upgrade service 95

 Determining Upgrade Requirement 96

 Manual FPD upgrade 96

 How to Upgrade FPD Images 97

 Configuration Examples for FPD Image Upgrade 98

 Auto FPD Upgrade 99

 Limitations and Usage Guidelines 99

 Configuring Auto FPD During System Upgrade 100

 Automatic FPD Upgrade for PSU 101

 Upgrade Failure 102

CHAPTER 10**Manage Automatic Dependency 103**

Update RPMs and SMUs 104

Upgrade Base Software Version 104

CHAPTER 11**Customize Installation using Golden ISO 107**

 Limitations 107

 Customize Installation using Golden ISO 108

 Limitations 108

 Golden ISO Workflow 109

 Build Golden ISO Using Script 110

 Install Golden ISO 112

 Install Replace with Golden ISO 114

CHAPTER 12**Disaster Recovery 119**

 Boot using USB Drive 119

- Create a Bootable USB Drive Using Compressed Boot File 119
- Boot the Router Using the Bootable USB Drive 120
- Boot the Router Using iPXE 121
 - Zero Touch Provisioning 122
 - Setup DHCP Server 122
 - Invoke ZTP 124
 - Boot the Router Using iPXE 126
 - Disaster Recovery Using Manual iPXE Boot 127

PART II

Setup System and Install IOS XR7 Software 129

CHAPTER 13

Setup Cisco NCS 540 Series Routers with XR7 OS 131

- Bring-up the Cisco NCS 540 Series Router 132
 - Boot the Cisco NCS 540 Series Router Using Manual iPXE 132
 - Boot the Cisco NCS 540 Series Router Using USB Drive 133
 - Configure the Management Port on the Cisco NCS 540 Series Router 136
 - Synchronize Router Clock with NTP Server 138
- Perform Preliminary Checks with Cisco NCS 540 Series Router 139
 - Verify Software Version on Cisco NCS 540 Series Router 139
 - Verify Status of Hardware Modules on Cisco NCS 540 Series Router 140
 - Verify Interface Status on the Cisco NCS 540 Series Router 142
 - Verify Node Status on Cisco NCS 540 Series Router 143
- Create Users and Assign Privileges on the Cisco NCS 540 Series Router 145
 - Create a User Profile 145
 - Create a User Group 146

CHAPTER 14

Install Cisco IOS XR7 on NCS 540 Series Routers 149

- Supported Packages 151
 - Software Deliverables and Terminologies 152
- Workflow for Installing Cisco IOS XR7 Software 154
 - Obtain Data Models for Install Operation 154
 - Create Repository to Access Files for Installing IOS XR Software 156
 - Upgrade the Current Active Version of Cisco IOS XR Software 159
 - Install Optional Packages to Provide Additional Functionality 165

Delete Optional Packages	167
Installing the Image Over the Network	168
Additional Install Operations	169
View the Version of Installed Packages	169
Build a Golden ISO	171
Upgrade the System Using the IOS XR Configuration File in GISO	174
Upgrade the System to Obtain Bug Fixes	178
Downgrade to a Previously Installed Package	183
Roll Back Software to a Previously Saved Installation Point	184
Telemetry Support for Install Operations	187
Caveats	188



PART I

Setup System and Install IOS XR Software

- [Overview of the Router, on page 1](#)
- [Bring-up the Router, on page 5](#)
- [Provision Network Devices using Zero Touch Provisioning, on page 13](#)
- [Deploy Router Using Secure ZTP, on page 33](#)
- [ZTP over Layer 2, on page 51](#)
- [Perform Preliminary Checks, on page 57](#)
- [Create User Profiles and Assign Privileges, on page 65](#)
- [Perform System Upgrade and Install Feature Packages, on page 77](#)
- [Upgrading Field-Programmable Device, on page 95](#)
- [Manage Automatic Dependency, on page 103](#)
- [Customize Installation using Golden ISO, on page 107](#)
- [Disaster Recovery, on page 119](#)



CHAPTER 1

Overview of the Router

The Cisco NCS 540 system is a high fault-resilient platform, which provides next generation data-center switching environment with high bandwidth and low latency.

Cisco NCS 540 system provides:

- High performance (300 Gbps full-duplex switching)
- Flexible network interface (10GbE, 25GbE, 40GbE, 50GbE, and 100GbE interfaces as well as ILKN interfaces)
- Traffic manager and in-band management
- Flexible and microcode-programmable packet processor
- Label Switched Router (LSR) and possible Light Label switched Edge Router (LER) features and functionality with limited hardware scale and software functionality.



Note Cisco IOS XR Software Release 7.0.1 specific updates are not applicable for the following variants of Cisco NCS 540 Series Routers:

- N540-28Z4C-SYS-A
- N540-28Z4C-SYS-D
- N540X-16Z4G8Q2C-A
- N540X-16Z4G8Q2C-D
- N540-12Z20G-SYS-A
- N540-12Z20G-SYS-D
- N540X-12Z16G-SYS-A
- N540X-12Z16G-SYS-D

These variants of the NCS 540 Series Routers run on the Cisco IOS XR7 operating system. For information about setting up the routers, see [Setup Cisco NCS 540 Series Routers with XR7 OS, on page 131](#). For information about installing the XR7 OS on NCS 540 series routers, see [Install Cisco IOS XR7 on NCS 540 Series Routers, on page 149](#).

Effective Cisco IOS XR Release 7.3.1, the following variants are introduced in the Cisco NCS 540 family. These variants fall under the small density routers:

- N540X-6Z18G-SYS-A
- N540X-6Z18G-SYS-D
- N540X-8Z16G-SYS-A
- N540X-8Z16G-SYS-D

These variants of the NCS 540 Series Routers also run on the Cisco IOS XR7 operating system.

For more information on these routers, see the [Cisco Network Convergence System 540 Small-Density Routers Hardware Installation Guide](#) and the [Cisco Network Convergence System 540 Small-Density Router Data Sheet](#).

- [Command Modes, on page 2](#)

Command Modes

The router runs on virtualized Cisco IOS XR software. Therefore, the CLI commands must be executed on virtual machines, namely the XR LXC and the System Admin LXC.

The command modes are applicable for the Cisco NCS540 Series Routers. This table lists the command modes for the LXCs.

Command Mode	Description
XR EXEC mode (XR LXC execution mode)	Run commands on the XR LXC to display the operational state of the router. Example: <pre>RP/0/RP0/CPU0:router#</pre>
XR Config mode (XR LXC configuration mode)	Perform security, routing, and other XR feature configurations on the XR LXC. Example: <pre>RP/0/RP0/CPU0:router#configure RP/0/RP0/CPU0:router(config)#</pre>
System Admin EXEC mode (System Admin LXC execution mode) Note Only the following NCS 540 variants support this mode: <ul style="list-style-type: none"> • N540-ACC-SYS • N540X-ACC-SYS • N540-24Z8Q2C-SYS 	Run commands on the System Admin LXC to display and monitor the operational state of the router hardware. The chassis or individual hardware modules can be reloaded from this mode. Example: <pre>RP/0/RP0/CPU0:router#admin sysadmin-vm:0_RP0#</pre>

Command Mode	Description
<p>System Admin Config mode (System Admin LXCconfiguration mode)</p> <p>Note Only the following NCS 540 variants support this mode:</p> <ul style="list-style-type: none">• N540-ACC-SYS• N540X-ACC-SYS• N540-24Z8Q2C-SYS	<p>Run configuration commands on the System Admin LXC to manage and operate the hardware modules of the entire chassis.</p> <p>Example:</p> <pre>RP/0/RP0/CPU0:router#admin sysadmin-vm:0_RP0#config sysadmin-vm:0_RP0(config)#</pre>



CHAPTER 2

Bring-up the Router

After installing the hardware, boot the router. Connect to the XR console port and power on the router. The router completes the boot process using the pre-installed operating system (OS) image. If no image is available within the router, the router can be booted using PXE boot or an external bootable USB drive.

After booting is complete, create the root username and password, and then use it to log on to the XR console and get the router prompt. The first user created in XR console is synchronized to the System Admin console. From the XR console, access the System Admin console to configure system administration settings.

In a large-scale environment, to provision routers remotely without any manually intervention, we recommend you to use Zero Touch Provisioning (ZTP) mechanism. ZTP offers the following implementation choices worth considering in advance:

- You can use Classic Zero Touch Provisioning, when you want to provision the devices within a secured network. See the *Provision Network Devices using Zero Touch Provisioning* chapter. .
- You can use Secure ZTP when you must securely provision remote network devices, transverse through public internet for provisioning, or when the devices are from third-party manufacturers. See [Deploy Router Using Secure ZTP, on page 33](#).
- [Boot the Router, on page 5](#)
- [Setup Root User Credentials, on page 6](#)
- [Access the System Admin Console, on page 8](#)
- [Configure the Management Port, on page 8](#)
- [Perform Clock Synchronization with NTP Server, on page 10](#)

Boot the Router

Use the console port on the Route Processor (RP) to connect to a new router. The console port connect to the XR console by default. If necessary, subsequent connections can be established through the management port, after it is configured.

Procedure

Step 1 Connect a terminal to the console port of the RP

Step 2 Start the terminal emulation program on your workstation.

In the **COM1 Properties** window, select the **Port Settings** tab, and enter the following settings:

The console settings are:

- For modular chassis RP, the console settings are baud rate 9600 bps, no parity, 1 stop bits and 8 data bits
- For fixed chassis, the console settings are baud rate 115200 bps, no parity, 1 stop bits and 8 data bits.

The baud rate is set by default and cannot be changed.

Step 3 Power on the router.

Connect the power cord to Power Module. Turn on the router by switching the power switch to the "ON" position. The power switch is usually located near the power module. The router boots up. The boot process details are displayed on the console screen of the terminal emulation program.

Step 4 Press **Enter**.

The boot process is complete when the system prompts to enter the root-system username. If the prompt does not appear, wait for a while to give the router more time to complete the initial boot procedure, then press **Enter**.

Important If the boot process fails, it may be because the preinstalled image on the router is corrupt. In this case, the router can be booted using an external bootable USB drive.

Note We recommended that you check the `md5sum` of the image after copying from source location to the server from where router boots up with new version. This ensures that if `md5sum` mismatch is observed, you can remove the corrupted file and ensure that a working copy of the image file is available for setup to begin.

What to do next

Specify the root username and password. For more information, see [Setup Root User Credentials, on page 6](#).

Setup Root User Credentials

When you boot the router for the first time, the system prompts you to configure root credentials (username and password). These credentials have been set up for the root user on the XR console (root-lr), the System Admin VM (root-system), and for disaster recovery purposes.

Procedure

Step 1 Enter root-system username: *username*

Enter the username of the root user. The character limit is 1023. In this example, the name of the root user is "root".

Important The specified username is mapped to the "root-lr" group on the XR console. It is also mapped as the "root-system" user on the System Admin console.

When starting the router for the first time, or after resetting the router's operating system to its default state, the router does not have any user configuration. In such cases, the router prompts you to specify the "root-system username". However, if the router has been configured previously, the router prompts you to enter the "username", as described in Step 4.

Step 2 **Enter secret:** *password*

Enter the password for the root user. The character range of the password is from 6 through 253 characters. The password that you type is not displayed on the CLI for security reasons.

The root-system username and password must be safeguarded as they have superuser privileges. They are used to access the complete router configuration.

Step 3 **Enter secret again:** *password*

Reenter the password for the root-system user. The password that you type is not displayed on the CLI for security reasons.

Step 4 **Username:** *username*

Enter the root-system username to login to the XR VM console.

Step 5 **Password:** *password*

Enter the password of the root-system user. The correct password displays the router prompt. You are now logged into the XR VM console.

Step 6 (Optional) **show run username**

Displays user details.

```
username root
 group root-lr
 group cisco-support
 secret 5 $1$NBg7$fHs1inKPZVvzqxMv775UE/
!
```

Example

```
Enter root-system username: admin
Enter secret:
Enter secret again:
Use the 'configure' command to modify this configuration.
User Access Verification
```

```
Username: admin
Password:
```

```
RP/0/RP0/CPU0:ios# show run username
Sun May 30 14:20:42.311 UTC
username admin
 group root-lr
 group cisco-support
 secret 10
$6$RS5knlr/ww.DDn1.$eDFxhqTEYa6hqTs3MODQt11mBp4cMgdQqt.syC/J831QI11yJT9vd2W8zEHfBKz4.z4FyLmRdzvvtqAMuyBA0
!
```

Access the System Admin Console



Note Only the following Cisco NCS 540 router variants support the System Admin mode:

- N540-ACC-SYS
- N540X-ACC-SYS
- N540-24Z8Q2C-SYS

You must log in to the System Admin console through the XR console to perform all system administration and hardware management setup.

Procedure

Step 1 Log in to the XR console as the root user.

Step 2 `admin`

Example:

The login banner is enabled by default. The following example shows the command output with the login banner enabled:

```
RP/0/RP0/CPU0:router#admin
Mon May 22 06:57:29.350 UTC

root connected from 127.0.0.1 using console on host
sysadmin-vm:0_RP0# exit
Mon May 22 06:57:32.360 UTC
```

The following example shows the command output with the login banner disabled:

```
RP/0/RP0/CPU0:router#admin
Thu Mar 01:07:14.509 UTC
sysadmin-vm:0_RP0# exit
```

Step 3 (Optional) `exit`

Return to the XR mode from the System Admin mode.

Configure the Management Port

To use the Management port for system management and remote communication, you must configure an IP address and a subnet mask for the management ethernet interface. To communicate with devices on other networks (such as remote management stations or TFTP servers), you need to configure a default (static) route for the router.

Before you begin

- Consult your network administrator or system planner to procure IP addresses and a subnet mask for the management interface.
- Physical port Ethernet 0 and Ethernet 1 on RP are the management ports. Ensure that the port is connected to management network.



Note The Physical port MgmtEth0/RP0/CPU0/1 on XR must be shut down while configuring manageability applications.

Procedure**Step 1** **configure****Example:**

```
RP/0/RP0/CPU0:router# configure
```

Enters mode.

Step 2 **interface MgmtEth** *rack/slot/port***Example:**

```
RP/0/RP0/CPU0:router(config)#interface mgmtEth 0/RP0/CPU0/0
```

Enters interface configuration mode for the management interface of the primary RP.

Step 3 **ipv4 address** *ipv4-address subnet-mask***Example:**

```
RP/0/RP0/CPU0:router(config-if)#ipv4 address 10.1.1.1/8
```

Assigns an IP address and a subnet mask to the interface.

Step 4 **ipv4 address** *ipv4 virtual address subnet-mask***Example:**

```
RP/0/RP0/CPU0:router(config-if)#ipv4 address 1.70.31.160 255.255.0.0
```

Assigns a virtual IP address and a subnet mask to the interface.

Step 5 **no shutdown****Example:**

```
RP/0/RP0/CPU0:router(config-if)#no shutdown
```

Places the interface in an "up" state.

Step 6 **exit****Example:**

```
RP/0/RP0/CPU0:router(config-if)#exit
```

Exits the Management interface configuration mode.

Step 7 `router static address-family ipv4 unicast 0.0.0.0/0 default-gateway`

Example:

```
RP/0/RP0/CPU0:router(config)#router static address-family ipv4 unicast 0.0.0.0/0 12.25.0.1
```

Specifies the IP address of the default-gateway to configure a static route; this is to be used for communications with devices on other networks.

Step 8 Use the `commit` or `end` command.

commit —Saves the configuration changes and remains within the configuration session.

end —Prompts user to take one of these actions:

- **Yes** — Saves configuration changes and exits the configuration session.
- **No** —Exits the configuration session without committing the configuration changes.
- **Cancel** —Remains in the configuration session, without committing the configuration changes.

What to do next

Connect to the management port to the ethernet network. With a terminal emulation program, establish a SSH or telnet connection to the management interface port using its IP address. Before establishing a telnet session, use the `telnet ipv4|ipv6 server max-servers` command in the XR Config mode, to set number of allowable telnet sessions to the router.

Perform Clock Synchronization with NTP Server

There are independent system clocks for the XR console and the System Admin console. To ensure that these clocks do not deviate from true time, they need to be synchronized with the clock of a NTP server. In this task you will configure a NTP server for the XR console. After the XR console clock is synchronized, the System Admin console clock will automatically synchronize with the XR console clock.

Before you begin

Configure and connect to the management port.

Procedure

Step 1 `configure`

Example:

```
RP/0/RP0/CPU0:router# configure
```

Enters mode.

Step 2 `ntp server server_address`

Example:

```
RP/0/RP0/CPU0:router(config)#ntp server 64.90.182.55
```

The XR console clock is configured to be synchronized with the specified sever.

The following is a sample configuration:

```
RP/0/RP0/CPU0:Router(config)# interface mgmtEth 0/RP0/CPU0/0
RP/0/RP0/CPU0:Router(config-if)#vrf mgmt
RP/0/RP0/CPU0:Router(config-if)#ipv4 address 10.197.240.71 255.255.254.0
RP/0/RP0/CPU0:Router(config-if)#commit
router static
vrf mgmt
address-family ipv4 unicast
0.0.0.0/0 MgmtEth0/RP0/CPU0/0 10.197.240.1
!
!
!
RP/0/RP0/CPU0:Router#configure terminal
Thu May 27 14:19:09.281 UTC
RP/0/RP0/CPU0:Router(config)#ntp server 3.2.1.4
RP/0/RP0/CPU0:Router(config)#commit
```



CHAPTER 3

Provision Network Devices using Zero Touch Provisioning

Manually deploying network devices in a large-scale environment requires skilled workers and is time consuming.

With Zero Touch Provisioning (ZTP), you can seamlessly provision thousands of network devices accurately within minutes and without any manual intervention. This can be easily defined using a configuration file or script using shell or python.

Table 1: Feature History Table

Feature Name	Release Information	Feature Description
Zero Touch Provisioning	Release 7.3.1	With this release, you can use a removable storage device, (such as a USB drive) containing the raw boot image file thereby enabling the removable storage device to be a self-sufficient bootstrapping solution.

- [Learn about Zero Touch Provisioning, on page 13](#)
- [Zero Touch Provisioning on a Fresh Boot of a Router, on page 15](#)
- [Build your Configuration File, on page 17](#)
- [Set Up DHCP Server, on page 24](#)
- [Invoke ZTP Manually, on page 28](#)
- [Configure ZTP BootScript, on page 29](#)
- [Customize ZTP Initialization File, on page 30](#)

Learn about Zero Touch Provisioning

ZTP allows you to provision the network device with day 0 configurations and supports both management ports and data ports.



Note Currently, ZTP only supports single name-server. When the DHCP server has more than one server address configured, ZTP fails to apply the server configuration.

ZTP provides multiple options, such as:

- Automatically apply specific configuration in a large-scale environment.
- Download and install specific IOS XR image.
- Install specific application package or third party applications automatically.
- Deploy containers without manual intervention.
- Upgrade or downgrade software versions effortlessly on thousands of network devices at a time

Benefits of Using ZTP

ZTP helps you manage large-scale service providers infrastructures effortlessly. Following are the added benefits of using ZTP:

- ZTP helps you to remotely provision a router anywhere in the network. Thus eliminates the need to send an expert to deploy network devices and reduces IT cost.
- Automated provisioning using ZTP can remove delay and increase accuracy and thus is cost-effective and provides better customer experience.

By automating repeated tasks, ZTP allows network administrators to concentrate on more important stuff.

- ZTP process helps you to quickly restore service. Rather than troubleshooting an issue by hand, you can reset a system to well-known working status.

Use Cases

The following are some of the useful use cases for ZTP:

- Using ZTP to install Chef
- Using ZTP to integrate IOS-XR with NSO
- Using ZTP to install Puppet

You can initiate ZTP in one of the following ways:

- **Fresh Boot:** Use this method for devices that has no pre-loaded configuration. See [Getting Started with ZTP on a Fresh Boot of a Router](#). See [Zero Touch Provisioning on a Fresh Boot of a Router](#), on page 15
- **Manual Invocation:** Use this method when you want to forcefully initiate ZTP on a fully configured device. See [Invoke ZTP Manually](#), on page 28.

Zero Touch Provisioning on a Fresh Boot of a Router

When you boot the device, the ZTP process initiates automatically if the device does not have a prior configuration.

During the process, the router verifies the list of sources and receives the information of the configuration file accordingly. The following are the sources that can provide the configuration file information.

- Removable storage: A directly attached removable storage device, for example, USB flash drive.
- DHCP server

Fresh Boot Using Removable Storage Device

You can automatically provision a network device using ZTP from a removable storage device such as a USB flash drive. The following are the configuration types available in a removable storage device:

- Device-specific configuration: The device-specific configuration is available in the folder that has a name matching the chassis serial number of the device. The sample path for the device-specific configuration is `/USB-path/xr-config/serial-number/router-cfg`. For example, `/USB-path/xr-config/FOC2102R1D0/router-cfg` `FOC2102R1D0` is the chassis serial number.
- Generic configuration: The generic configuration is available in the `xr-config` folder. The sample path for the generic configuration is `/USB-path/xr-config/router-cfg`

Here is the high-level work flow of the ZTP process using a USB flash drive:

1. When you boot the device, the device verifies if the USB is enabled in the `ztp.ini` file. By default, the USB fetcher is enabled and assigned the highest priority.

Fetcher defines which port ZTP should use to get the provisioning details. By default, each port has a fetcher priority defined in the `ztp.ini` file.

2. ZTP checks for a USB flash drive on the device. If the USB drive isn't available, the ZTP process moves to the next fetcher as defined in the fetcher priority of the `ZTP.ini` file.
3. If a USB flash drive is available, the device scans for the `xr-config` file in the root of the USB mount in the following sequence:
 - a. The ZTP process first scans for the `router-cfg` file in the folder that is matching the chassis serial number of the device within the `xr-config` folder and applies the device-specific configuration.
For example, `/USB-path/xr-config/FOC2102R1D0/router-cfg`
 - b. If the device-specific configuration with a serial number isn't available, the ZTP process scans for the `router-cfg` file in the `xr-config` folder and applies a generic configuration.
 - c. If the `xr-config` folder isn't available, the ZTP process moves to the next fetcher as defined in the fetcher priority of the `ZTP.ini` file.
4. The device applies the configuration.
5. The network device is now up and running.

Configure ZTP using USB

Follow these steps to configure ZTP using a USB flash drive:

1. Create the configuration file. See [Build your Configuration File, on page 17](#).



Note When you use a USB flash drive as a source for ZTP, you can't use the script file for provisioning. The script file isn't supported for USB fetcher.

2. Copy the bootstrapping data to the USB flash drive and mount it on the device.

Fresh Boot Using DHCP

When you boot the device, the ZTP process initiates automatically if the device does not have a prior configuration. During the process, the router receives the details of the configuration file from the DHCP server.

This image depicts the high-level work flow of the ZTP process:

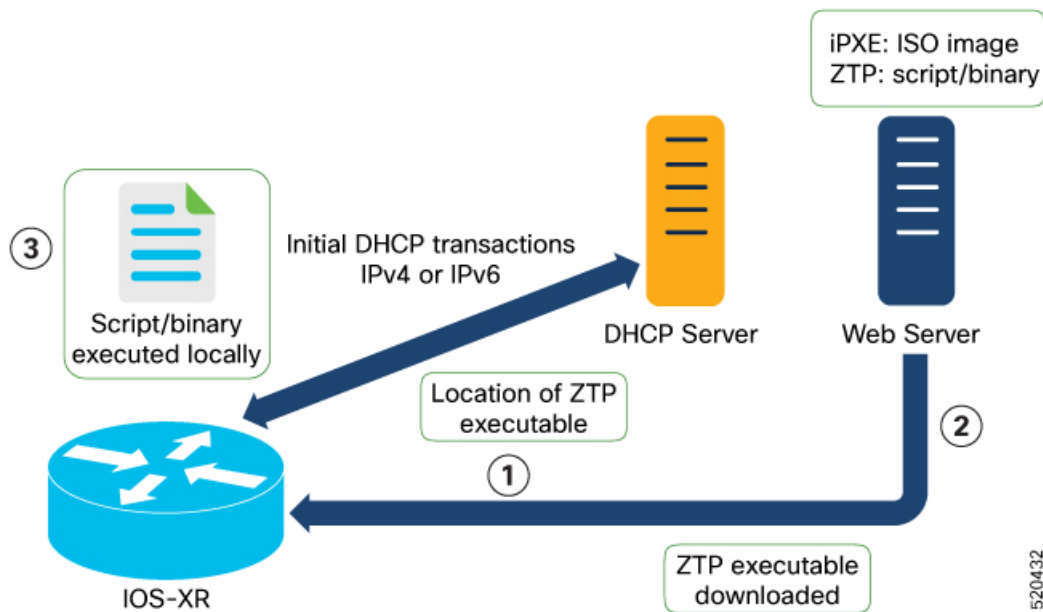

The ZTP process initiates when you boot the network-device with an IOS-XR image. The process starts only on the device that doesn't have a prior configuration.

Here is the high-level work flow of the ZTP process for the Fresh boot:

1. ZTP sends DHCP request to fetch the ZTP configuration file or user script. To help the Bootstrap server uniquely identify the device, ZTP sends below DHCP option
 - DHCP(v4/v6) client-id=Serial Number
 - DHCPv4 option 124: Vendor, Platform, Serial-Number
 - DHCPv6 option 16: Vendor, Platform, Serial-Number

The following is the default sequential flow of the ZTP process:

- ZTP sends IPv4 DHCP request first on all the management port. In case there is a failure, then ZTP sends IPv6 DHCP request on all the management port.
- ZTP sends IPv4 DHCP request first on all the data port. In case there is a failure, then ZTP sends IPv6 DHCP request on all the data port.

The default sequential flow is defined in configuration file and you can modify the sequence using the configuration file.

2. DHCP server identifies the device and responds with DHCP response using one of the following options:
DHCP server should be configured to respond with the DHCP options.
 - DHCPv4 using BOOTP filename to supply script/config location.
 - DHCPv4 using Option 67 (bootfile-name) to supply script/config location.
 - DHCPv6 using Option 59 (OPT_BOOTFILE_URL) to supply script/config location
3. The network device downloads the file from the web server using the URI location that is provided in the DHCP response.
4. The device receives a configuration file or script file from the HTTP server.



Note

- If the downloaded file content starts with `!! IOS XR` it is considered as a configuration file.
 - If the downloaded file content starts with `#!/bin/bash`, `#!/bin/sh` or `#!/usr/bin/python` it is considered as a script file.
-

5. The device applies the configuration file or executes the script or binary in the default bash shell.
6. The Network device is now up and running.

Build your Configuration File

Based on the business need, you can use a configuration or script file to initiate the ZTP process.



Note

When you use a USB flash drive as a source for ZTP, you cannot use the script file for provisioning. The script file is not supported in the USB fetcher. Fetcher defines which port the ZTP process should use to get the provisioning details as defined in the `ztp.ini` file.

The configuration file content starts with `!! IOS XR` and the script file content starts with `#!/bin/bash`, `#!/bin/sh` or `#!/usr/bin/python`.

Once you create the configuration file, apply it to the device using the `ztp_helper` function `xrapply`.

The following is the sample configuration file:

```

!! IOS XR
username root
group root-lr
password 0 lablab
!

hostname ios
alias exec al show alarms brief system active

interface HundredGigE 0/0/0/24
ipv4 address 10.10.10.55 255.255.255.0
no shutdown
!

```

Create User Script

This script or binary is executed in the IOS-XR Bash shell and can be used to interact with IOS-XR CLI to configure, verify the configured state and even run exec commands based on the workflow that the operator chooses.

Build your ZTP script with either shell and python. ZTP includes a set of CLI commands and a set of shell utilities that can be used within the user script.



Note We recommend that you do not execute the APIs on a router that is already provisioned. ZTP Utility APIs are designed to be executed from the ZTP script when you boot the router for the first time. The APIs perform additional operations to run the requested actions during the boot process and bring changes in the existing configuration before executing any action.

ZTP utility APIs have prerequisites that are executed in the ZTP workflow before running the ZTP utility APIs. These prerequisites help with running specific actions during the boot process and in making necessary configuration changes.

We recommend that you do not use ZTP utilities outside the scope of ZTP script. The APIs in this script use username as `ztp` or `ztp-user` in every action. The ZTP utility executed outside the scope of the ZTP script may fail as it is not executed from the ZTP workflow. This may modify the configurations on the device and affect other related operations. If the ZTP utility is executed outside the scope ZTP script, the logs display that the script is executed using username `ztp` or `ztp-user`, misleading that the script is executed from the workflow.

ZTP Shell Utilities

ZTP includes a set of shell utilities that can be sourced within the user script. `ztp_helper.sh` is a shell script that can be sourced by the user script. `ztp_helper.sh` provides simple utilities to access some XR functionalities. You can invoke the following bash functions:

- **xrcmd**—Used to run a single XR exec command: `xrcmd "show running"`
- **xrapply**—Applies the block of configuration, specified in a file:

```

cat >/tmp/config <<%%
!! XR config example
hostname nodel-mgmt-via-xrapply

```

```
%%
xrapply /tmp/config
```

- **xrapply_with_reason**—Used to apply a block of XR configuration along with a reason for logging purpose:

```
cat >/tmp/config <<%%
!! XR config example
hostname nodel-mgmt-via-xrapply
%%
xrapply_with_reason "this is a system upgrade" /tmp/config
```

- **xrapply_string**—Used to apply a block of XR configuration in one line:

```
xrapply_string "hostname foo\ninterface HundredGigE0/0/0/24\nipv4 address 1.2.3.44\n255.255.255.0\n"
```

- **xrapply_string_with_reason**—Used to apply a block of XR configuration in one line along with a reason for logging purposes:

```
xrapply_string_with_reason "system renamed again" "hostname venus\n interface\nHundredGigE0/0/0/24\n\nipv4 address 172.30.0.144/24\n"
```

- **xrreplace**—Used to apply XR configuration replace in XR namespace via a file.

```
cat rtr.cfg <<%%
!! XR config example
hostname nodel-mgmt-via-xrreplace
%%
xrreplace rtr.cfg
```

- **xrapply_with_extra_auth**—Used to apply XR configuration that requires authentication in XR namespace via a file. The **xrapply_with_extra_auth** API is used when configurations that require additional authentication to be applied such as alias, flex groups. This api internally performs authentication and authorization to gain additional privilege.

```
cat >/tmp/config <<%%
!! XR config example
alias exec alarms show alarms brief system active
alias exec version run cat /etc/show_version.txt
%%
xrapply_with_extra_auth >/tmp/config
```

- **xrreplace_with_extra_auth**—Used to apply XR configuration replace in XR namespace via a file. The **xrreplace_with_extra_auth** API is used when configurations that require additional authentication to be applied such as alias, flex groups. This api internally performs authentication and authorization to gain additional privilege.

```
cat >/tmp/config <<%%
!! XR config example
alias exec alarms show alarms brief system active
alias exec version run cat /etc/show_version.txt
%%
xrreplace_with_extra_auth >/tmp/config
```

API Implementation Behavior



Note The `xrcmd`, `xrapply`, and `xrreplace` APIs or utilities carry out a series of internal operations to execute specific actions. These operations, which are performed sequentially, include:

- User Creation—This operation involves generating a `ztp-user` (temporary user) before the execution of any other operations.
- Command Execution or Configuration Application—This operation encompasses executing a command, applying configurations using parser utilities, or applying the configuration through `cfg-mgr`.
- User Removal—This operation involves removing the `ztp-user` (temporary user) from the XR configuration.

In addition to these internal operations, the `xrapply_with_extra_auth` and `xrreplace_with_extra_auth` APIs performs an authentication process before applying configurations.

ZTP Helper Python Library

The ZTP python library defines a single Python class called `ZtpHelpers`. The helper script is located at `/pkg/bin/ztp_helper.sh`

ZtpHelpers Class Methods

Following are utility methods of the `ZtpHelpers` class:

- `init(self, syslog_server=None, syslog_port=None, syslog_file=None):`

```
__init__ constructor
:param syslog_server: IP address of reachable Syslog Server
:param syslog_port: Port for the reachable syslog server
:param syslog_file: Alternative or addon file for syslog
:type syslog_server: str
:type syslog_port: int
:type syslog_file: str
```

All parameters are optional. When nothing is specified during object creation, then all logs are sent to a log rotated file `/tmp/ztp_python.log` (max size of 1MB).

- `setns(cls, fd, nstype):`

```
Class Method for setting the network namespace
:param cls: Reference to the class ZtpHelpers
:param fd: incoming file descriptor
:param nstype: namespace type for the sentns call
:type nstype: int
0 Allow any type of namespace to be joined.
CLONE_NEWNET = 0x40000000 (since Linux 3.0)
fd must refer to a network namespace
```

- `get_netns_path(cls, nspath=None, nsname=None, nspid=None):`

```
Class Method to fetch the network namespace filepath
associated with a PID or name
:param cls: Reference to the class ZtpHelpers
:param nspath: optional network namespace associated name
:param nspid: optional network namespace associate PID
```

```

        :type nspath: str
        :type nspid: int
        :return: Return the complete file path
        :rtype: str

    • toggle_debug(self, enable):
        Enable/disable debug logging
        :param enable: Enable/Disable flag
        :type enable: int

    • set_vrf(self, vrfname=None):
        Set the VRF (network namespace)
        :param vrfname: Network namespace name
                        corresponding to XR VRF

    • download_file(self, file_url, destination_folder):
        Download a file from the specified URL
        :param file_url: Complete URL to download file
        :param destination_folder: Folder to store the
                                downloaded file

        :type file_url: str
        :type destination_folder: str
        :return: Dictionary specifying download success/failure
                Failure => { 'status' : 'error' }
                Success => { 'status' : 'success',
                            'filename' : 'Name of downloaded file',
                            'folder' : 'Directory location of downloaded file'}

        :rtype: dict

    • setup_syslog(self):
        Method to Correctly set sysloghandler in the correct VRF (network namespace) and point to a remote
        syslog Server or local file or default log-rotated log file.

    • xrcmd(self, cmd=None):
        Issue an IOS-XR exec command and obtain the output
        :param cmd: Dictionary representing the XR exec cmd
                    and response to potential prompts
                    { 'exec_cmd': '', 'prompt_response': '' }
        :type cmd: dict
        :return: Return a dictionary with status and output
                { 'status': 'error/success', 'output': '' }
        :rtype: dict

    • xrapply(self, filename=None, reason=None):
        Apply Configuration to XR using a file
        :param file: Filepath for a config file
                    with the following structure:
                    !
                    XR config command
                    !
                    end

        :param reason: Reason for the config commit.
                        Will show up in the output of:
                        "show configuration commit list detail"
        :type filename: str
        :type reason: str
        :return: Dictionary specifying the effect of the config change
                { 'status' : 'error/success', 'output': 'exec command based on
status'}

```

```

        In case of Error: 'output' = 'show configuration failed'
        In case of Success: 'output' = 'show configuration commit changes
last 1'
        :rtype: dict

• xrapply_string(self, cmd=None, reason=None):
Apply Configuration to XR using a single line string
:param cmd: Single line string representing an XR config command
:param reason: Reason for the config commit.
            Will show up in the output of:
            "show configuration commit list detail"
:type cmd: str
:type reason: str
:return: Dictionary specifying the effect of the config change
        { 'status' : 'error/success', 'output': 'exec command based on
status'}
        In case of Error: 'output' = 'show configuration failed'
        In case of Success: 'output' = 'show configuration commit changes
last 1'
        :rtype: dict

• xrreplace(self, filename=None):
Replace XR Configuration using a file

:param file: Filepath for a config file
            with the following structure:

            !
            XR config commands
            !
            end
:type filename: str
:return: Dictionary specifying the effect of the config change
        { 'status' : 'error/success', 'output': 'exec command based on
status'}
        In case of Error: 'output' = 'show configuration failed'
        In case of Success: 'output' = 'show configuration commit changes
last 1'
        :rtype: dict

```

API Implementation Behavior



Note The `xrcmd`, `xrapply`, and `xrreplace` APIs or utilities carry out a series of internal operations to execute specific actions. These operations, which are performed sequentially, include:

- User Creation—This operation involves generating a `ztp-user` (temporary user) before the execution of any other operations.
- Command Execution or Configuration Application—This operation encompasses executing a command, applying configurations using parser utilities, or applying the configuration through `cfg-mgr`.
- User Removal—This operation involves removing the `ztp-user` (temporary user) from the XR configuration.

Example

The following shows the sample script in python

```
[apple2:~]$ python sample_ztp_script.py

##### Debugs enabled #####

##### Change context to user specified VRF #####

##### Using Child class method, setting the root user #####
2016-12-17 04:23:24,091 - DebugZTPLogger - DEBUG - Config File content to be applied !
    username netops
    group root-lr
    group cisco-support
    secret 5 $1$7kTu$zjrgqbgW08vEXsYzUycXw1
    !
    end
2016-12-17 04:23:28,546 - DebugZTPLogger - DEBUG - Received exec command request: "show
configuration commit changes last 1"
2016-12-17 04:23:28,546 - DebugZTPLogger - DEBUG - Response to any expected prompt ""
Building configuration...
2016-12-17 04:23:29,329 - DebugZTPLogger - DEBUG - Exec command output is [!!! IOS XR
Configuration version = 6.2.1.21I', 'username netops', 'group root-lr', 'group cisco-support',
'secret 5 $1$7kTu$zjrgqbgW08vEXsYzUycXw1', '!', 'end']
2016-12-17 04:23:29,330 - DebugZTPLogger - DEBUG - Config apply through file successful,
last change = [!!! IOS XR Configuration version = 6.2.1.21I', 'username netops', 'group
root-lr', 'group cisco-support', 'secret 5 $1$7kTu$zjrgqbgW08vEXsYzUycXw1', '!', 'end']

##### Debugs Disabled #####

##### Executing a show command #####

Building configuration...
{'output': [!!! IOS XR Configuration version = 6.2.1.21I',
'!!! Last configuration change at Sat Dec 17 04:23:25 2016 by UNKNOWN',
'!!!',
'hostname customer2',
'username root',
'group root-lr',
'group cisco-support',
'secret 5 $1$7kTu$zjrgqbgW08vEXsYzUycXw1',
'!!!',
'username noc',
'group root-lr',
'group cisco-support',
'secret 5 $1$7kTu$zjrgqbgW08vEXsYzUycXw1',
'!!!',
'username netops',
'group root-lr',
'group cisco-support',
'secret 5 $1$7kTu$zjrgqbgW08vEXsYzUycXw1',
'!!!',
'username netops2',
'group root-lr',
'group cisco-support',
'secret 5 $1$7kTu$zjrgqbgW08vEXsYzUycXw1',
'!!!',
'username netops3',
'group root-lr',
```

```

        'group cisco-support',
        'secret 5 $1$7kTu$zjrgqbgW08vEXsYzUycXw1',
        '!',
        'cdp',
        'service cli interactive disable',
        'interface MgmtEth0/RP0/CPU0/0',
        'ipv4 address 11.11.11.59 255.255.255.0',
        '!',
        'interface TenGigE0/0/0/0/24',
        'shutdown',
        '!',
        'interface TenGigE0/0/0/0/25',
        'shutdown',
        '!',

        'router static',
        'address-family ipv4 unicast',
        '0.0.0.0/0 11.11.11.2',
        '!',
        '!',
        'end'],
    'status': 'success'}

##### Apply valid configuration using a file #####

Building configuration...
{'status': 'success', 'output': ['!! IOS XR Configuration version = 6.2.1.21I', 'hostname
customer', 'cdp', 'end']}

##### Apply valid configuration using a string #####

Building configuration...
{'output': ['!! IOS XR Configuration version = 6.2.1.21I',
            'hostname customer2',
            'end'],
 'status': 'success'}

##### Apply invalid configuration using a string #####

{'output': ['!! SYNTAX/AUTHORIZATION ERRORS: This configuration failed due to',
            '!! one or more of the following reasons:',
            '!! - the entered commands do not exist,',
            '!! - the entered commands have errors in their syntax,',
            '!! - the software packages containing the commands are not active,']}

```

For information on helper APIs, see <https://github.com/ios-xr/iosxr-ztp-python#iosxr-ztp-python>.

Set Up DHCP Server

For ZTP to operate a valid IPv4 or IPv6 address is required and the DHCP server must send a pointer to the configuration script.

The DHCP request from the router has the following DHCP options to identify itself:

- **Option 60:** “vendor-class-identifier” : Used to Identify the following four elements:
 - The type of client: For example, PXEClient
 - The architecture of The system (Arch): For example: 00009 Identify an EFI system using a x86-64 CPU

- The Universal Network Driver Interface (UNDI):

For example 003010 (first 3 octets identify the major version and last 3 octets identify the minor version)

- The Product Identifier (PID):
- **Option 61**: “dhcp-client-identifier” : Used to identify the Serial Number of the device.
- **Option 66** : Used to request the TFTP server name.
- **Option 67**: Used request the TFTP filename.
- **Option 97**: “uuid” : Used to identify the Universally Unique Identifier a 128-bit value (not usable at this time)

Example

The following DHCP request sample provides a fixed IP address and a configuration file with the mac address of the management interface.

```
host cisco-rp0 {
  hardware ethernet e4:c7:22:be:10:ba;
  fixed-address 172.30.12.54;
  filename "http://172.30.0.22/configs/cisco-1.config";
}
```

The following DHCP request sample provides a fixed IP address and a configuration file with the mac address of the management interface along with capability to re-image the system using iPXE ("xr-config" option):

```
host cisco-rp0 {
  hardware ethernet e4:c7:22:be:10:ba;
  fixed-address 172.30.12.54;
  if exists user-class and option user-class = "iPXE" {
    filename = "http://172.30.0.22/boot.ipxe";
  } elsif exists user-class and option user-class = "xr-config" {
    filename = "http://172.30.0.22/scripts/cisco-rp0_ztp.sh";
  }
}
```

DHCP server identifies the device and responds with either an IOS-XR configuration file or a ZTP script as the filename option.

The DHCP server responds with the following DHCP options:

- DHCPv4 using BOOTP filename to supply script/config location.
- DHCPv4 using Option 67 (bootfile-name) to supply script/config location.
- DHCPv6 using Option 15: If you have configured this option for the server to identify ztp requests, ensure that you update the server configuration, for Linux or ISC servers. Sample server-side configuration required to check user-class for ZTP is shown in the following example:

```
if exists dhcp6.user-class and (substring(option dhcp6.user-class, 0, 9) = "xr-config"
or substring(option dhcp6.user-class, 2, 9) = "xr-config"){
  #
}
```

- DHCPv6 using Option 59 (OPT_BOOTFILE_URL) to supply script/config location

The following sample shows the DHCP response with bootfile-name (option 67):

```

option space cisco-vendor-id-vendor-class code width 1 length width 1;
option vendor-class.cisco-vendor-id-vendor-class code 9 = {string};

##### Network 11.11.11.0/24 #####
shared-network 11-11-11-0 {

##### Pools #####
  subnet 11.11.11.0 netmask 255.255.255.0 {
    option subnet-mask 255.255.255.0;
    option broadcast-address 11.11.11.255;
    option routers 11.11.11.2;
    option domain-name-servers 11.11.11.2;
    option domain-name "cisco.local";
    # DDNS statements
    ddns-domainname "cisco.local.";
    # use this domain name to update A RR (forward map)
    ddns-rev-domainname "in-addr.arpa.";
    # use this domain name to update PTR RR (reverse map)

  }

##### Matching Classes #####

  class "cisco" {
    match if (substring(option dhcp-client-identifier,0,11) = "FGE194714QS");
  }

  pool {
    allow members of "cisco";
    range 11.11.11.47 11.11.11.50;
    next-server 11.11.11.2;

    if exists user-class and option user-class = "iPXE" {
      filename="http://11.11.11.2:9090/cisco-mini-x-6.2.25.10I.iso";
    }

    if exists user-class and option user-class = "xr-config"
    {
      if (substring(option vendor-class.cisco-vendor-id-vendor-class,19,99)="cisco")
      {
        option bootfile-name "http://11.11.11.2:9090/scripts/exhaustive_ztp_script.py";
      }
    }

    ddns-hostname "cisco-local";
    option routers 11.11.11.2;
  }
}

```



Important In Cisco IOS XR Release 7.3.1 and earlier, the system accepts the device sending **user-class = "exr-config"**; however starting Cisco IOS XR Release 7.3.2 and later, you must use only **user-class = "xr-config"**.

In Cisco IOS XR Release 7.3.2 and later, use:

```
host cisco-rp0 {
  hardware ethernet e4:c7:22:be:10:ba;
  fixed-address 172.30.12.54;
  if exists user-class and option user-class = "iPXE" {
    filename = "http://172.30.0.22/boot.ipxe";
  } elseif exists user-class and option user-class = "xr-config" {
    filename = "http://172.30.0.22/scripts/cisco-rp0_ztp.sh";
  }
}
```

Also, when upgrading from any release that is Cisco IOS XR Release 7.3.1 or earlier to Cisco IOS XR Release 7.3.2 or later release, use the following:

```
host cisco-rp0 {
  hardware ethernet e4:c7:22:be:10:ba;
  fixed-address 172.30.12.54;
  if exists user-class and option user-class = "iPXE" {
    filename = "http://172.30.0.22/boot.ipxe";
  } elseif exists user-class and option user-class = "exr-config" {
    filename = "http://172.30.0.22/scripts/cisco-rp0_ztp.sh";
  }
}
```

Authentication on Data Ports

On fresh boot, ZTP process is initiated from management ports and may switch to data ports. To validate the connection with DHCP server, authentication is performed on data ports through DHCP option 43 for IPv4 and option 17 for IPv6. These DHCP options are defined in option space and are included within **dhcpd.conf** and **dhcpd6.conf** configuration files. You must provide following parameters for authentication while defining option space:

- Authentication code—The authentication code is either 0 or 1; where 0 indicates that authentication is not required, and 1 indicates that MD5 checksum is required.



Note If the option 43 for IPv4, and option 17 for IPv6 is disabled, the authentication fails.

- Client identifier—The client identifier must be 'xr-config'.
- MD5 checksum—This is chassis serial number. It can be obtained using **echo -n \$SERIALNUMBER | md5sum | awk '{print \$1}'**.

Here is the sample **dhcpd.conf** configuration. In the example below, the option space called **VendorInfo** is defined with three parameters for authentication:

```
class "vendor-classes" {
  match option vendor-class-identifier;
}
```

```

option space VendorInfo;
option VendorInfo.clientId code 1 = string;
option VendorInfo.authCode code 2 = unsigned integer 8;
option VendorInfo.md5sum code 3 = string;
option vendor-specific code 43 = encapsulate VendorInfo;
subnet 10.65.2.0 netmask 255.255.255.0 {
  option subnet-mask 255.255.255.0;
  option routers 10.65.2.1;
  range 10.65.2.1 10.65.2.200;
}
host cisco-mgmt {
  hardware ethernet 00:50:60:45:67:01;
  fixed-address 10.65.2.39;
  vendor-option-space VendorInfo;
  option VendorInfo.clientId "xr-config";
  option VendorInfo.authCode 1;
  option VendorInfo.md5sum "aedf5c457c36390c664f5942ac1ae3829";
  option bootfile-name "http://10.65.2.1:8800/admin-cmd.sh";
}

```

Invoke ZTP Manually

You can invoke Zero Touch Provisioning (ZTP) manually through the Command Line Interface. This method is ideal for verifying the ZTP configuration without a reboot. This manual approach helps you to provision the router in stages. To invoke ZTP on an interface (data ports or management port), you don't have to bring up and configure the interface first.

Even when the interface is down, you can run the `ztp initiate` command, and the ZTP script will bring it up and invoke `dhclient`. Hence, ZTP can run on all interfaces irrespective of their availability.

Use the following commands to manually invoke the ZTP commands and to force ZTP to run on all interfaces:

- **ztp initiate** — Invokes a new ZTP DHCP session. Logs can be found in `/disk0:/ztp/ztp.log`.

Configuration Example:

```

Router#ztp initiate debug verbose interface HundredGigE 0/0/0/24
Invoke ZTP? (this may change your configuration) [confirm] [y/n] :

```

- **ztp terminate** — Terminates any ZTP session in progress.

Configuration Example:

```

Router #ztp terminate verbose
Mon Oct 10 16:52:38.507 UTC
Terminate ZTP? (this may leave your system in a partially configured state) [confirm]
[y/n] :y
ZTP terminated

```

- **ztp enable** — Enables the ZTP at boot.

Configuration Example:

```

Router#ztp enable
Fri Jul 12 16:09:02.154 UTC
Enable ZTP? [confirm] [y/n] :y
ZTP Enabled.

```

- **ztp disable** — Disables the ZTP at boot.

Configuration Example:

```
Router#ztp disable
Fri Jul 12 16:07:18.491 UTC
Disable ZTP? [confirm] [y/n] :y
ZTP Disabled.
Run ZTP enable to run ZTP again.
```

- **ztp clean** —Removes only the ZTP state files.

Configuration Example:

```
Router#ztp clean verbose
Mon Oct 10 17:03:43.581 UTC
Remove all ZTP temporary files and logs? [confirm] [y/n] :y
All ZTP files have been removed.
If you now wish ZTP to run again from boot, do 'conf t/commit replace' followed by
reload.
```

The log file `ztp.log` is saved in `/var/log` folder, and a copy of log file is available at `/disk0:/ztp/ztp.log` location using a soft link. However, executing **ztp clean** clears files saved on disk and not on `/var/log` folder where current ZTP logs are saved. In order to have a log from current ZTP run, you must manually clear the ZTP log file from `/var/log/` folder.

Configuration

This task shows the most common use case of manual ZTP invocation: invoke ZTP.

1. Invoke DHCP sessions on all data ports which are up or could be brought up. ZTP runs in the background. Use `show logging` or look at `/disk0:/ztp/ztp.log` to check progress.

Configuration Example:

```
Router# ztp initiate dataport
```

Configure ZTP BootScript

If you want to hard code a script to be executed every boot, configure the following.

```
Router#configure
Router(config)#ztp bootscript /disk0:/myscript
Router(config)#commit
```

The above configuration will wait for the first data-plane interface to be configured and then wait an additional minute for the management interface to be configured with an IP address, to ensure that we have connectivity in the third party namespace for applications to use. If the delay is not desired, use:

```
Router#configure
Router(config)#ztp bootscript preip /disk0:/myscript
Router(config)#commit
```



Note When the above command is first configured, you will be prompted if you wish to invoke it now. The prompt helps with testing.

This is the example content of `/disk0:/myscript`:

```
#!/bin/bash
exec &> /dev/console # send logs to console
source /pkg/bin/ztp_helper.sh

# If we want to only run one time:
xrcmd "show running" | grep -q myhostname
if [[ $? -eq 0 ]]; then
    echo Already configured
fi

# Set the hostname
cat >/tmp/config <<%%
!! XR config example
hostname myhostname
%%
xrapplly /tmp/config

#
# Force an invoke of ZTP again. If there was a username normally it would not run. This
forces it.
# Kill off ztp if it is running already and suppress errors to the console when ztp runs
below and
# cleans up xrcmd that invokes it. ztp will continue to run however.
#
xrcmd "ztp terminate noprompt" 2>/dev/null
xrcmd "ztp initiate noprompt" 2>/dev/null
```

Customize ZTP Initialization File

You can customize the following ZTP configurable options in the *ztp.ini* file:

- **ZTP:** You can enable or disable ZTP at boot using CLI or by editing the *ztp.ini* file.
- **Retry:** Set the ZTP DHCP retry mechanism: The available values are infinite and once.
- **Fetcher Priority:** Fetcher defines which port ZTP should use to get the provisioning details. By default, each port has a fetcher priority defined in the *ztp.ini* file. You can modify the default priority of the fetcher. Allowed range is 0–10.



Note Lower the number higher the priority. The value 0 has the highest priority and 10 has the lowest priority.

By default, the USB port has the higher priority.

In the following example, the Mgmt4 port has the highest priority:

```
[Fetcher Priority]
Mgmt4: 0
Mgmt6: 1
DPort4: 2
DPort6: 3
```

- **progress_bar:** Enable progress bar on the console. By default, the progress bar is disabled. To enable the progress bar, add the following entry in the *ztp.ini* file.

```
[Options]
progress_bar: True
```

By default, the `ztp.ini` file is located in the `/pkg/etc/` location. To modify the ZTP configurable options, make a copy of the file in the `/disk0:/ztp/` directory and then edit the `ztp.ini` file.

To reset to the default options, delete the `ztp.ini` file in the `/disk0:/ztp/` directory.



Note Do not edit or delete the `ztp.ini` file in the `/pkg/etc/` location to avoid issues during installation.

The following example shows the sample of the `ztp.ini` file:

```
[Startup]
start: True
retry_forever: True

[Fetcher Priority]
USB: 0

Mgmt4: 1
Mgmt6: 2
DPort4: 3
DPort6: 4
```

Enable ZTP Using CLI

If you want to enable ZTP using CLI, use the `ztp enable` command.

Configuration example

```
Router#ztp enable
Fri Jul 12 16:09:02.154 UTC
Enable ZTP? [confirm] [y/n] :y
ZTP Enabled.
```

Disable ZTP Using CLI

If you want to disable ZTP using CLI, use the `ztp disable` command.

Configuration example

```
Router#ztp disable
Fri Jul 12 16:07:18.491 UTC
Disable ZTP? [confirm] [y/n] :y
ZTP Disabled.
Run ZTP enable to run ZTP again.
```



CHAPTER 4

Deploy Router Using Secure ZTP

With Secure Zero Touch Provisioning, you can securely and seamlessly provision thousands of network devices accurately within minutes and without any manual intervention.

Table 2: Feature History Table

In a secured network such as datacenter, the zero-touch provisioning mechanism helps you provision hundreds of remote devices without your intervention. But, the access devices are typically in an insecure network. There is a high risk of malicious actions on the device, such as adding an unauthorized or infected device. Security is a critical aspect while remotely provisioning the network devices.

Secure ZTP combines seamless automation with security. Network devices can securely establish a connection with the ZTP server and authenticate the onboarding information that it receives. The process eliminates any security risks or malicious actions during the provisioning of remote devices.

- ZTP helps you remotely provision a router securely anywhere in the network. Thus, eliminate the risk of malicious attacks or unauthorized ownership claims.
- Secure ZTP authenticates not only the onboarding network device but also validates the server authenticity and provisioning information that it is receiving from the ZTP server.

The following are the topics covered in this chapter:

- [On board Devices Using Three-Step Validation, on page 33](#)
- [Initial Set Up for Secure ZTP, on page 41](#)
- [How Does Secure ZTP Work? , on page 43](#)
- [Upgrade Image Using Secure ZTP, on page 47](#)

On board Devices Using Three-Step Validation

The Cisco IOS XR software implements the secure zero touch provisioning capabilities as described in RFC 8572. Secure ZTP uses a three-step validation process to on board the remote devices securely:

- 1. Router Validation:** The ZTP server authenticates the router before providing bootstrapping data using the Trust Anchor Certificate (SUDI certificate). Ensure that you have preinstalled the CA certificate chain for Cisco, as this is a prerequisite for the Cisco CA on ZTP server to verify the client/router SUDI certificates. The required certificates are:
 - subject=O = Cisco, CN = ACT2 SUDI CA
 - subject=O = Cisco Systems, CN = Cisco Root CA 2048

- subject=CN = High Assurance SUDI CA, O = Cisco
 - subject=O = Cisco, CN = Cisco Root CA 2099
2. **Server Validation:** The router device in turn validates the ZTP server to make sure that the on board happens to the correct network. Upon completion, the ZTP server sends the bootstrapping data (for example, a YANG data model) or artifact to the router. See [Secure ZTP Components](#) , on page 34.
 3. **Artifact Validation:** The configuration validates the bootstrapping data or artifact that is received from the ZTP server.

Secure ZTP Components

Let's first understand the components required for secure ZTP.

Table 3: Components used in Secure ZTP

Components	Description
Onboarding Device (Router)	The router is a Cisco device that you want to provision and connect to your network. Secure ZTP is supported only on platforms that have Hardware TAM support. Routers with HW TAM have the SUDI embedded in TAM.
DHCP Server	The secure ZTP process relies on the DHCP server to provide the URL to access the bootstrapping information.

Components	Description
ZTP Server	<p>A ZTP server is any server used as a source of secure ZTP bootstrapping data and can be a RESTCONF or HTTPs server.</p> <p>Note Currently, ZTP only supports single name-server. When the DHCP server has more than one server address configured, ZTP fails to apply the server configuration.</p> <p>The ZTP server contains the following artifacts:</p> <ul style="list-style-type: none"> • Cisco IOS XR software images: You can download Cisco images, SMU, and patches using the Cisco Support & Downloads page. • ZTP scripts: Contains the following libraries and you can build a script to initiate the ZTP process. See the <i>Build your Configuration File</i> section. <ul style="list-style-type: none"> • Python library: Includes IOS XR CLI (show commands and configuration commands) and YANG-XML (ncclient, native Netconf client). • BASH library: Includes IOS XR CLI show commands, configuration commands • Bootstrapping Data

Components	Description
Bootstrapping Data	

Components	Description
	<p>Bootstrapping data is the collection of data that the router obtains from the ZTP server during the secure ZTP process. You must create and upload the bootstrapping data in the ZTP server. For more information, refer RFC 8572.</p> <ul style="list-style-type: none"> The bootstrapping data mainly has three artifacts: <ul style="list-style-type: none"> Conveyed Information: Conveyed Information contains the required bootstrapping data for the device. It contains either the redirect information or onboarding information to provision the device. <p>For example:</p> <pre> module: ietf-sztp-conveyed-info yang-data conveyed-information: +-- (information-type) +--: (redirect-information) +-- redirect-information +-- bootstrap-server* [address] +-- address inet:host +-- port? inet:port-number +-- trust-anchor? cms +--: (onboarding-information) +-- onboarding-information +-- boot-image +-- os-name? string +-- os-version? string +-- download-uri* inet:uri +-- image-verification* [hash-algorithm] +-- hash-algorithm identityref +-- hash-value yang:hex-string +-- configuration-handling? enumeration +-- pre-configuration-script? script +-- configuration? binary +-- post-configuration-script? script </pre>

Components	Description
	<p>• Redirect Information: Redirect information is used to redirect a device to another bootstrap server. The redirect information contains a list of bootstrap servers along with a hostname, an optional port, and an optional trust anchor certificate that the device uses to authenticate the bootstrap server.</p> <p>For Example:</p> <pre> { "ietf-sztp-conveyed-info:redirect-information" : { "bootstrap-server" : [{ "address" : "szt1.example.com", "port" : 8443, "trust-anchor" : "base64encodedvalue==" }, { "address" : "szt2.example.com", "port" : 8443, "trust-anchor" : "base64encodedvalue==" }, { "address" : "szt3.example.com", "port" : 8443, "trust-anchor" : "base64encodedvalue==" }] } } </pre>

Components	Description
	<p>• Onboarding Information: Onboarding information provides data necessary for a device to bootstrap itself and establish secure connections with other systems. It specifies details about the boot image, an initial configuration the device must commit, and scripts that the device must execute.</p> <p>For Example:</p> <pre> { "ietf-sztp-conveyed-info:onboarding-information" : { "boot-image" : { "os-name" : "VendorOS", "os-version" : "17.2R1.6", "download-uri" : ["https://example.com/path/to/image/file"], "image-verification" : [{ "hash-algorithm" : "ietf-sztp-conveyed-info:sha-256", "hash-value" : "ba:ec:cf:a5:67:82:b4:10:77:c6:67:a6:22:ab:\ 7d:50:04:a7:8b:8f:0e:db:02:8b:f4:75:55:fb:cl:13:d2:33" }] }, "configuration-handling" : "merge", "pre-configuration-script" : "base64encodedvalue==", "configuration" : "base64encodedvalue==", "post-configuration-script" : "base64encodedvalue==" } } </pre>

Components	Description
	<ul style="list-style-type: none">• Owner Certificate: The owner certificate is installed on the router with the public key of your organization. The router uses the owner certificate to verify the signature in the conveyed information artifact using the public key that is available in the owner certificate.• Ownership Voucher: Ownership Voucher is used to identify the owner of the device by verifying the owner certificate that is stored in the device. Cisco supplies Ownership Voucher in response to your request. You must submit the Pinned Domain Certificate and device serial numbers with the request. Cisco generates and provides the Ownership Voucher to you.

Components	Description
Report Progress	<p>When the device obtains the onboarding information from a ZTP server, the router reports the bootstrapping progress to the ZTP server using the API calls.</p> <p>See RFC 8572 for the detailed report-progress messages that can be sent to the ZTP server.</p> <p>The following is the structure of the <code>report-progress</code> sent the progress message to a ZTP server.</p> <pre> +---x report-progress {onboarding-server}? +---w input +---w progress-type enumeration +---w message? string +---w ssh-host-keys +---w ssh-host-key* [] +---w algorithm string +---w key-data binary +---w trust-anchor-certs +---w trust-anchor-cert* cms </pre> <p>The following example illustrates a device using the Yang module to post a progress report to a ZTP server with a <code>bootstrap complete</code> message:</p> <pre> { 'progress-type': 'bootstrap-complete', 'message': 'example message', 'trust-anchor-certs': [{ 'trust-anchor-cert': 'base64encodedvalue==' 'ssh-host-keys': [{ 'key-data': 'base64encodedvalue==', 'algorithm': 'ssh-rsa' }, { 'key-data': 'base64encodedvalue==', 'algorithm': 'rsa-sha2-256' }] } </pre> <p>RESPONSE from the ZTP server</p> <pre> HTTP/1.1 204 No Content Date: Sat, 31 Oct 2015 17:02:40 GMT Server: example-server </pre>

Initial Set Up for Secure ZTP

The network administrator performs the following tasks as part of the initial setup for secure ZTP:

1. Contact Cisco Support to obtain a voucher. Provide the following details to request for ownership voucher certificate:

- Pinned Domain Certificate: A trusted digital certificate issued by the Certificate Authority (CA) and pinned by the operator.
- Order details with the Serial numbers of the routers
- For example,

```
{
  "expires-on": "2016-10-21T19:31:42Z",
  "assertion": "verified",
  "serial-number": "JADA123456789",
  "idevid-issuer": "base64encodedvalue==",
  "pinned-domain-cert": "base64endvalue==",
  "last-renewal-date": "2017-10-07T19:31:42Z"
}
```

2. Upload the following bootstrapping data to the ZTP server. Steps to upload may vary depending on the server that you're using, refer to the documentation provided by your vendor.
 - Cisco IOS XR software images: You can download Cisco images, SMU, and patches using the [Cisco Support & Downloads](#) page.
 - ZTP scripts that include IOS XR configurations, pre, and post configuration scripts. Build a script to initiate the ZTP process. See the *Build your Configuration File* section.
 - Python library: Includes IOS XR CLI (show commands and configuration commands) and YANG-XML (ncclient, native Netconf client).
 - BASH library: Includes IOS XR CLI show commands, configuration commands
 - Serial numbers of the routers you plan to onboard using ZTP
 - Owner certificates
 - Pinned Domain Certificate (PDC)
 - Ownership vouchers

3. Set up the DHCP server to provide the redirect URL to the router:

Before triggering the secure ZTP process, configure the DHCP server to provide the location of the IOS-XR image to the router. For information on how to configure the DHCP server, see your DHCP server documentation.

Configure the following parameters in the DHCP server:

- `option-code`: The DHCP SZTP redirect Option has the following parameters:
 - `OPTION_V4_SZTP_REDIRECT` (143): Use this DHCP v4 code for IPV4.
 - `OPTION_V6_SZTP_REDIRECT` (136): Use this DHCP v4 code for IPV6.

For example, `option dhcp6.bootstrap-servers code 136 = text;`

- `option-length`: The option length in octets
- `bootstrap-servers`: A list of servers for the onboarding device to contact the servers for the bootstrapping data.

- `bootfile-url` : The URI of the SZTP bootstrap server should use the HTTPS URI scheme and it should be in the following format:

```
"https://<ip-address-or-hostname>[:<port>]"
```

4. Power on the router.
5. Enable the secure ZTP option on the onboarding device. Execute the following command on your router to enable secure ZTP:

```
Router# ztp secure-mode enable
```

How Does Secure ZTP Work?

Before you begin, ensure that you configure the network with the DHCP and ZTP server. See [Initial Set Up for Secure ZTP, on page 41](#).

1. When you boot the device with an IOS-XR image, the secure ZTP process verifies if the secure ZTP mode (`secure-ztp mode`) is enabled. If not enabled, the device boots normally.



Note When `secure-ztp mode` is enabled, the ZTP process accepts only the `secure-redirect-URL` and ignores the presence of boot file name option from the DHCP response.

2. DHCP discovery:

- a. The router initiates a DHCP request to the DHCP server.
- b. The DHCP server responds with a DHCPv4 143 address option (for IPv4 addressing) or a DHCPv6 136 option (for IPv6 addressing). In addition, URLs to access bootstrap servers for further configuration is also listed.

Figure 1: DHCP discovery

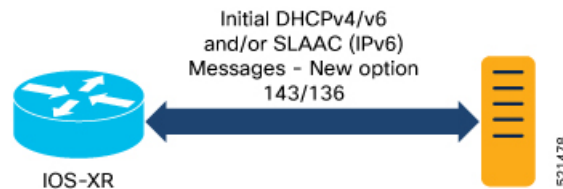

3. Router validation:

- a. After receiving the URL from the DHCP server, the router sends an HTTPS request to the RESTCONF or HTTPS server using the specified URL. Along with the HTTPS request, the device sends the client certificate that is provided by the manufacturer (also called SUDI certificate). This certificate identifies and authenticates itself to the ZTP server.

Figure 2: Router Validation

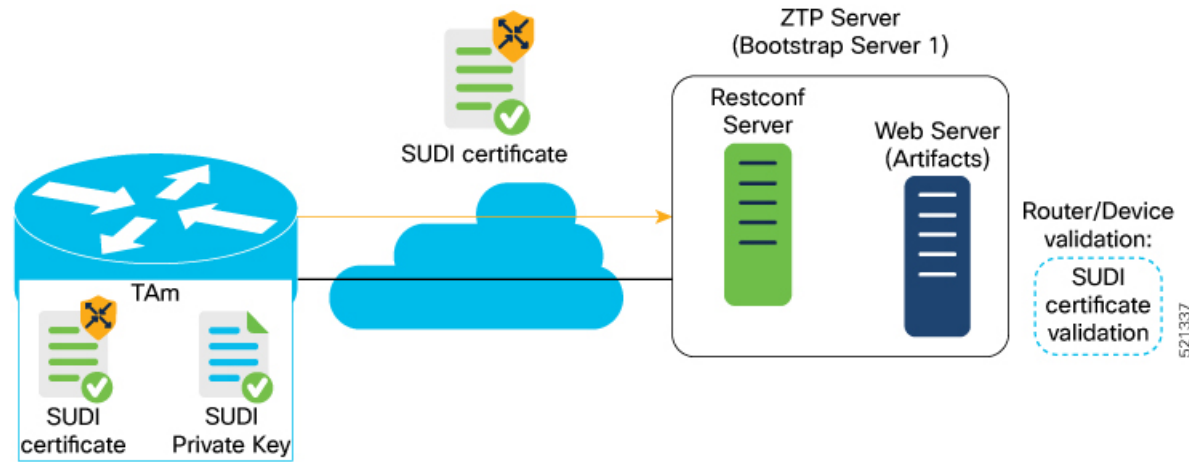

- b. The RESTCONF or HTTPs server verifies the received SUDI certificate with the public certificate that it contains. Cisco issues the public certificate to ensure that the onboarding device is an authorized Cisco device.
- c. After the onboarding device is authenticated, the web server sends the required artifacts along with the secure ZTP yang model to the onboarding device.

4. Server validation :

The router receives the yang model that contains Owner Certificate, Ownership Voucher, and Conveyed Information artifact. The router verifies the ownership voucher by validating its signature to one of its preconfigured trusts anchors and downloads the image. When the router obtains the onboarding information, it reports the bootstrapping progress to the ZTP server. See [RFC 8572](#) for the progress information.

Figure 3: Server Validation

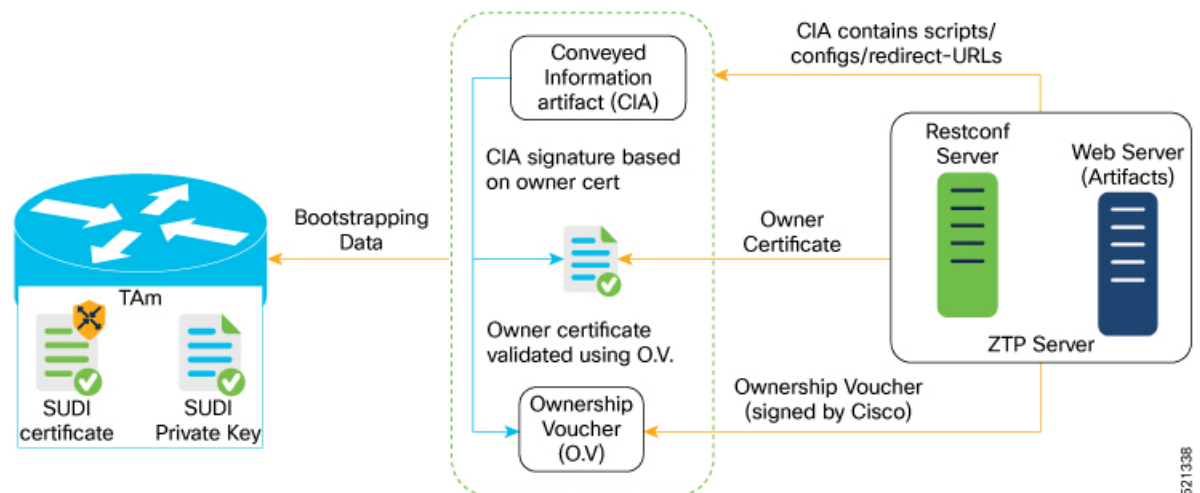

5. Artifact Validation:

The router validates the artifact received from the ZTP server.

- a. The device extracts the `pinned-domain-cert` node, an X.509 certificate from the ownership voucher to verify the owner certificate.
- b. The device authenticates the owner certificate by performing the X.509 certificate path verification process on the trusted certificate.
- c. Finally, the device verifies whether the conveyed information artifact is signed by the validated owner certificate.

6. Provision the device:

- a. The device first processes the boot image information.
- b. Executes the pre-configuration script and then commits the initial configuration
- c. Execute the post configuration script.

7. After the onboarding process is completed, the network device is operational.

The following figure illustrates the end-to-end sequence of the Secure ZTP process:

Figure 4: End-to-end sequence of the Secure ZTP process

Upgrade Image Using Secure ZTP

You can upgrade the system image using one of the following methods:

- Default installation method
- Preconfiguration script

Even though there are multiple ways of upgrading the software image using the default installation method, each router platform has a different installation behaviour. The default installation method uses a combination of `install add <>` and `install activate reload id <>` commands, which aren't optimized for all platforms. There's no single command in Cisco IOS XR that works on all platforms across all scenarios. Therefore, the recommended method is to use the preconfiguration script, which allows the use of any installation command. Also, this method allows you to modify traffic or rate-related configuration for download.

Here is a sample preconfiguration script:

```
[xr-vm_nodehost_CPU0:/misc/scratch]$ cat /disk0\:/ztp/customer/pre_config.candidate
#!/bin/bash

# !!!!!!!!!!!!!!!!!!!!!!!!!!!!!!! WARNING !!!!!!!!!!!!!!!!!!!!!!!!!!!!!!!
# For this script to work on Cisco IOSXR OS use Unix style
# EOL character - LF, not Windows style - CRLF

exec &> /dev/console # send logs to console
source /pkg/bin/ztp_helper.sh
export LOGFILE=/disk0:/ztp/user-script.log

#Set to 1 for GISO image upgrade
GISO_UPGRADE=0

# Crosswork parameters
HOST_IP="5.10.18.112"
PORT="5002"

# Software upgrade parameters
TARGET_SOFTWARE_VERSION="7.9.1.33I"
IMAGE_FILENAME="ncs5500-mini-x.iso"
IMAGE_MD5_CHECKSUM="20d020d9912eb01ce4b242532544cc0e"
#IMAGE_PACKAGE="ncs5500-mini-x-7.9.1.33I"
IMAGE_URL="http://${HOST_IP}:${PORT}/images/ncs7/${IMAGE_FILENAME}"

function ztp_log(){
    echo "$(date +"%b %d %H:%M:%S") "$1 >> $LOGFILE"
}

function check_version(){
    # returns 0 is version matches, 1 otherwise
    local current_ver=`xrcmd "show version" | grep Version | grep Cisco | cut -d " " -f 6`;

    ztp_log "### ZTP version check current=$current_ver, target=$TARGET_SOFTWARE_VERSION
###";
    if [[ "$current_ver" = "$TARGET_SOFTWARE_VERSION" ]]; then
        ztp_log "### ZTP software version check result: match ###";
        return 0
    else
        ztp_log "### ZTP software version check result: mismatch ###";
        return 1
    fi
}
```

```

}

function download_image(){
    # Download image to harddisk:
    ztp_log "### IOS-XR INSTALL - downloading image $IMAGE_FILENAME from $IMAGE_URL ###"
    /usr/bin/wget ${IMAGE_URL} -O /harddisk:$IMAGE_FILENAME 2>&1 >> $LOGFILE
    if [[ "$?" != 0 ]]; then
        ztp_log "### IOS-XR INSTALL - error downloading $IMAGE_FILENAME, check
/var/log/ztp_user_script.log for details ###"
        exit 1
    else
        ztp_log "### IOS-XR INSTALL - $IMAGE_FILENAME download completed ###";
    fi

    # check MD5 hash checksum
    ztp_log "### IOS-XR INSTALL - verifying image md5 checksum ###"
    local checksum=`xrcmd "show md5 file /harddisk:$IMAGE_FILENAME"`;
    if [[ "$checksum" != *"$IMAGE_MD5_CHECKSUM"* ]]; then
        ztp_log "### IOS-XR INSTALL - error, image checksum $checksum does not match
$IMAGE_MD5_CHECKSUM, exiting ###"
        exit 1
    else
        ztp_log "### IOS-XR INSTALL - md5 checksum verification successful ###"
    fi
}

#optional
function install_commit_packages(){
    local output

    ztp_log "### IOS-XR INSTALL - Commit packages ###"
    output=$(xrcmd "install commit")
    ztp_log "$output"
}

#optional
function remove_inactive_packages(){
    local output

    # remove inactive packages if any
    ztp_log "### IOS-XR INSTALL - removing inactive packages ###"
    output=$(xrcmd "install remove inactive all synchronous")
    ztp_log "$output"
}

function install_giso_target_image(){
    local output
    touch /disk0\:/ztp/state/state_is_install_started
    # do GISO image install
    ztp_log "### IOS-XR INSTALL - doing GISO install replace ###"
    output=$(xrcmd "install replace /harddisk:$IMAGE_FILENAME noprompt commit")
    ztp_log "$output"
    if [[ "$output" != *"aborted"* ]]; then
        ztp_log "### IOS-XR INSTALL - GISO install replace completed ###"
        ztp_log "### Upgraded IOS-XR to $TARGET_SOFTWARE_VERSION, device should reboot ###";
    else
        ztp_log "### IOS-XR INSTALL - error, GISO install replace failed, check 'show install
log' ###"
        return 1
    fi
}

function install_add_image(){

```

```

local output

# do image install add
ztp_log "### IOS-XR INSTALL - doing install add ###"
output=$(xrcmd "install add source /misc/disk1/ $IMAGE_FILENAME")
ztp_log "$output"
install_add_id=$(echo $output | awk '{print $5}')
if [[ "$output" != *"aborted"* ]]; then
    ztp_log "### IOS-XR INSTALL - install add completed ###"
else
    ztp_log "### IOS-XR INSTALL - error, install add failed, check 'show install log'
###"
    return 1
fi
}

function install_target_image(){
    local output
    touch /disk0\:/ztp/state/state_is_install_started
    # do image install
    ztp_log "### IOS-XR INSTALL - doing install activate ###"
    output=$(xrcmd "install activate id $install_add_id noprompt synchronous")
    ztp_log "$output"
    if [[ "$output" != *"aborted"* ]]; then
        ztp_log "### IOS-XR INSTALL - install activate completed ###"
        ztp_log "### Upgraded IOS-XR to $TARGET_SOFTWARE_VERSION, device should reboot ###";

    else
        ztp_log "### IOS-XR INSTALL - error, install activate failed, check 'show install
log' ###"
        return 1
    fi
}

# ==== Script entry point ==== #
# run version check and decide if need to download target image
check_version;
if [[ "$?" = 1 ]]; then
    ztp_log "### Software Version mismatch, downloading IOS-XR $TARGET_SOFTWARE_VERSION
###";
    download_image;
    NEED_UPGRADE=1
    ztp_log "### Downloaded IOS-XR $TARGET_SOFTWARE_VERSION image ###";
else
    NEED_UPGRADE=0
    ztp_log "### Image Download: Software Version match $TARGET_SOFTWARE_VERSION, nothing
to do ###";
fi

# do software upgrade
if [[ $NEED_UPGRADE = 1 ]]; then
    ztp_log "### Software Version mismatch, upgrading IOS-XR to $TARGET_SOFTWARE_VERSION
###";
    install_commit_packages;
    remove_inactive_packages;
    if [[ $GISO_UPGRADE = 1 ]]; then
        install_giso_target_image;
    else
        install_add_image;
        install_target_image;
    fi
else
    ztp_log "### Upgrade: Software Version match $TARGET_SOFTWARE_VERSION, nothing to do
###";

```

```
fi  
ztp_log "### ZTP DONE ###";
```



CHAPTER 5

ZTP over Layer 2

Table 4: Feature History Table

Feature Name	Release Information	Feature Description
ZTP over Layer 2 on Cisco NCS 540 variants	Release 7.7.1	<p>ZTP over Layer 2 is now supported on the following NCS 540 router variants:</p> <ul style="list-style-type: none">• N540-ACC-SYS• N540X-ACC-SYS• N540-24Z8Q2C-SYS• N540-28Z4C-SYS-A/D• N540X-16Z4G8Q2C-A/D• N540-12Z20G-SYS-A/D• N540X-12Z16G-SYS-A/D• N540X-6Z18G-SYS-A/D• N540X-8Z16G-SYS-A/D• N540X-4Z14G2Q-A/D• N540-FH-CSR-SYS• N540-FH-AGG-SYS• N540-24Q8L2DD-SYS• N540-6Z14S-SYS-D

Feature Name	Release Information	Feature Description
ZTP over Layer 2 on Cisco N540X-16Z4G8Q2C-A/D routers	Release 7.3.2	<p>Previously available over Layer 3, this feature is now available to auto-provision your routers and DHCP devices on Layer 2 networks.</p> <p>This functionality is essential because many network topologies have services configured for various Layer 2 VLAN tags, requiring cost-effective and reliable provisioning.</p> <p>In this release this feature is supported on the Cisco N540X-16Z4G8Q2C-A/D routers.</p>

When a device boots up without any configuration, it is not possible to configure the VLAN to tag the DHCP request packets. Because ZTP is the first active process that runs before any router configuration is present or before any manual intervention, ZTP can either:

- Monitor a set of control packets to receive the VLAN IDs, or
- Be preconfigured with a set of VLAN IDs

Consider the following sample network:

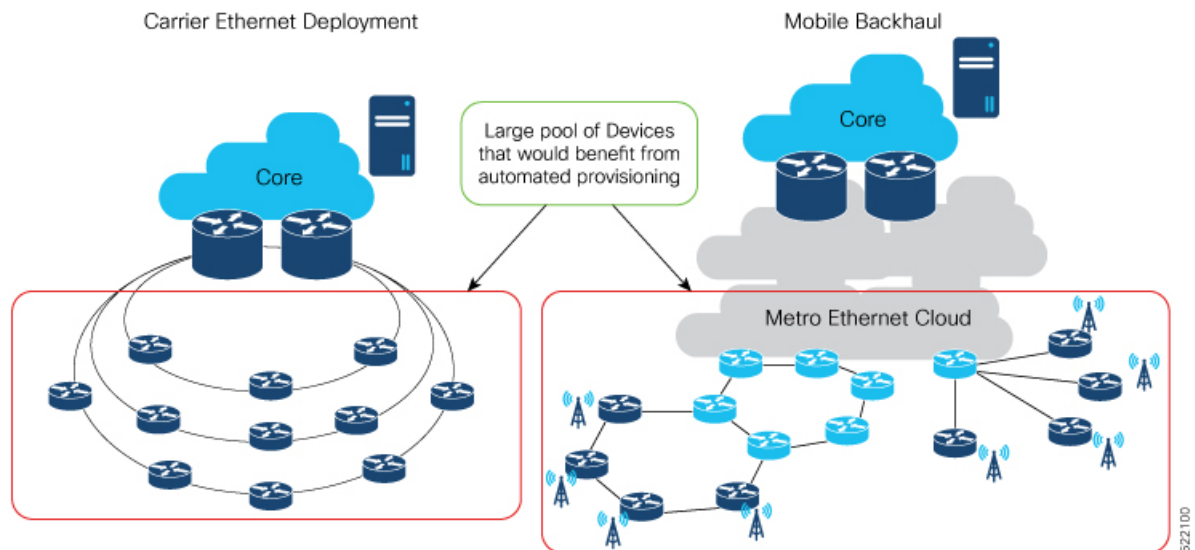

ZTP obtains VLAN details in one of the following ways:

1. Statically, by reading the options mentioned in ztp.ini file

Figure 5: Getting VLAN Details From ztp.ini File

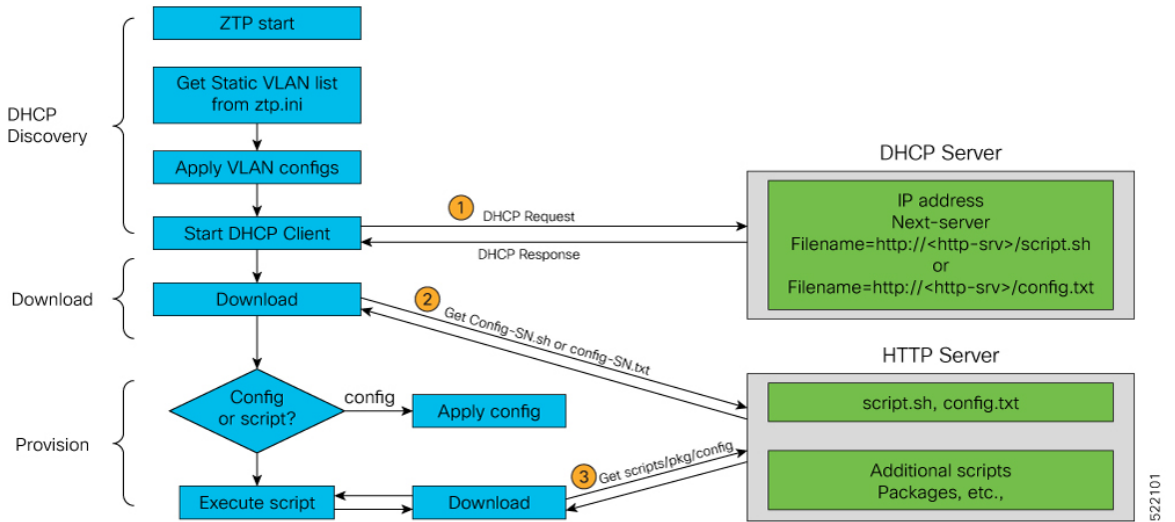

2. Dynamically, by snooping the packets in the network

Figure 6: Getting VLAN Details by Packet Snooping

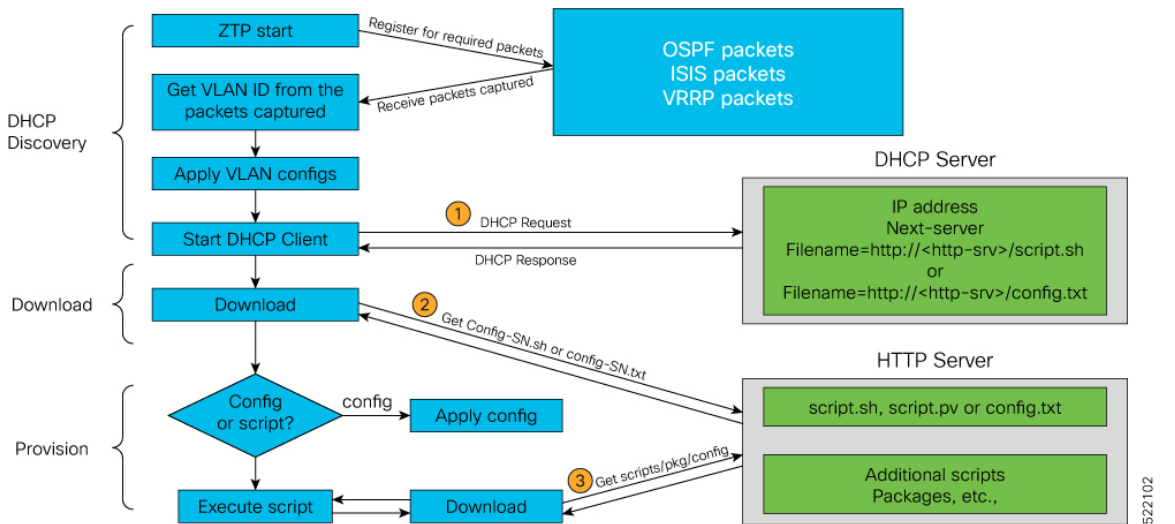

Note Dynamic VLAN workflow with snooping is supported only on a fresh boot or reload of the router.

- Prerequisites, on page 54
- Customizing the ztp.ini File, on page 54
- Prerequisites, on page 55
- Customizing the ztp.ini File, on page 55

Prerequisites

1. Only the following Layer 2 encapsulation protocols are supported:
 - a. DOT1Q
 1. Either inner VLAN ID
 2. Or only an outer VLAN ID
2. ZTP processes packets only from the following protocols to detect the VLAN IDs:
 - a. OSPF
 - b. ISIS
 - c. VRRP

Customizing the ztp.ini File

The ZTP configuration file is called the `ztp.ini`. This file defines a default sequential flow for ZTP.

To modify the ZTP configurable options, create a copy of the `ztp.ini` file in any location, for example, `/disk0:/ztp/` directory.



Note To reset to the default options, delete the `ztp.ini` file in the `/disk0:/ztp/` directory.

To include VLAN in the `ztp.ini` file, customize the `Fetcher Priority` attribute.

`Fetcher Priority` defines which port ZTP should use to get the provisioning details. By default, each port has a `fetcher priority` defined in the `ztp.ini` file. You can modify the default priority of the fetcher. Allowed range is from 0 to 9.



Note The lower the number, the higher the priority. The value 0 has the highest priority and 9 has the lowest priority. By default, the USB port has the higher priority.

In this example, ZTP first sends IPv4 DHCP request on all the management ports. If there is a failure, then ZTP sends IPv6 DHCP request on all the management ports. Similarly, the same order is followed on all the data ports as well as for VLAN ports.

```
# Copyright (c) 2018-2020 by cisco Systems, Inc.
# All rights reserved.
```

```
[Startup]
start:          True
retry_forever: False
```

```
[Fetcher Priority]
usb:           0
Mgmt4:        1
Mgmt6:        2
```



```

DPort4: 3
DPort6: 4
Vlan4: 6
Vlan6: 7

[Vlan Options]          <--Vlan options can be set only if the vlan fetcher priority is
set.
snoop_packets: False   <-- a 'False' value sets up static VLAN; a 'True' value sets up
dynamic OSPF, ISIS, or VRRP packet snooping in the network.
vlan_type: dot1q
vlan_ids: 650

```

The other configurable options are:

- ZTP: Enable or disable ZTP at boot using CLI or by editing the *ztp.ini* file.
- Retry: Set the ZTP DHCP retry mechanism: The available values are infinite and once.
- progress_bar: Enable progress bar on the console. By default, the progress bar is disabled. To enable the progress bar, add the following entry in the *ztp.ini* file.

```

[Options]
progress_bar: True

```

Prerequisites

1. Only the following Layer 2 encapsulation protocols are supported:
 - a. DOT1Q
 1. Either inner VLAN ID
 2. Or only an outer VLAN ID
2. ZTP processes packets only from the following protocols to detect the VLAN IDs:
 - a. OSPF
 - b. ISIS
 - c. VRRP

Customizing the ztp.ini File

The ZTP configuration file is called the *ztp.ini*. This file defines a default sequential flow for ZTP.

To modify the ZTP configurable options, create a copy of the *ztp.ini* file in any location, for example, */disk0:/ztp/* directory.



Note To reset to the default options, delete the *ztp.ini* file in the */disk0:/ztp/* directory.

To include VLAN in the *ztp.ini* file, customize the `Fetcher Priority` attribute.

`Fetcher Priority` defines which port ZTP should use to get the provisioning details. By default, each port has a fetcher priority defined in the `ztp.ini` file. You can modify the default priority of the fetcher. Allowed range is from 0 to 9.



Note The lower the number, the higher the priority. The value 0 has the highest priority and 9 has the lowest priority. By default, the USB port has the higher priority.

In this example, ZTP first sends IPv4 DHCP request on all the management ports. If there is a failure, then ZTP sends IPv6 DHCP request on all the management ports. Similarly, the same order is followed on all the data ports as well as for VLAN ports.

```
# Copyright (c) 2018-2020 by cisco Systems, Inc.
# All rights reserved.
```

```
[Startup]
start:          True
retry_forever: False
```

```
[Fetcher Priority]
usb:           0
Mgmt4:        1
Mgmt6:        2
DPort4:       3
DPort6:       4
Vlan4:        6
Vlan6:        7
```

```
[Vlan Options]          <--Vlan options can be set only if the vlan fetcher priority is
set.
snoop_packets: False   <-- a 'False' value sets up static VLAN; a 'True' value sets up
dynamic OSPF, ISIS, or VRRP packet snooping in the network.
vlan_type: dot1q
vlan_ids: 650
```

The other configurable options are:

- `ZTP`: Enable or disable ZTP at boot using CLI or by editing the `ztp.ini` file.
- `Retry`: Set the ZTP DHCP retry mechanism: The available values are infinite and once.
- `progress_bar`: Enable progress bar on the console. By default, the progress bar is disabled. To enable the progress bar, add the following entry in the `ztp.ini` file.

```
[Options]
progress_bar: True
```



CHAPTER 6

Perform Preliminary Checks

After successfully logging into the console, you must perform some preliminary checks to verify the default setup. If any setup issue is detected when these checks are performed, take corrective action before making further configurations. These preliminary checks are:

- [Verify Status of Hardware Modules, on page 57](#)
- [Verify Node Status, on page 59](#)
- [Verify Software Version, on page 60](#)
- [Verify Firmware Version, on page 61](#)
- [Verify Interface Status, on page 62](#)
- [Verify SDR Information, on page 63](#)

Verify Status of Hardware Modules

Hardware modules include RPs, LCs, fan trays, and so on. On the router, multiple hardware modules are installed. Perform this task to verify that all hardware modules are installed correctly and are operational.

Before you begin

Ensure that all required hardware modules have been installed on the router.

Procedure

Step 1 admin

Example:

```
RP/0/RP0/CPU0:router# admin
```

Enters System Admin EXEC mode.

Note Only the following Cisco NCS 540 router variants support this mode:

- N540-ACC-SYS
- N540X-ACC-SYS
- N540-24Z8Q2C-SYS

Step 2 **show platform****Example:**

```
sysadmin-vm:0_RP0#show platform
```

Note Only the following Cisco NCS 540 router variants support this mode:

- N540-ACC-SYS
- N540X-ACC-SYS
- N540-24Z8Q2C-SYS

Displays the list of hardware modules detected on the router.

Location	Card Type	HW State	SW State	Config State
0/RP0	N540-24Z8Q2C-M	OPERATIONAL	OPERATIONAL	NSHUT
0/FT0	N540-FAN	OPERATIONAL	N/A	NSHUT
0/FT1	N540-FAN	OPERATIONAL	N/A	NSHUT
0/FT2	N540-FAN	OPERATIONAL	N/A	NSHUT
0/FT3	N540-FAN	OPERATIONAL	N/A	NSHUT

From the result, verify that all the hardware modules installed on the chassis are listed. If a module is not listed, it indicates either that module is malfunctioning, or it is not properly installed. Remove and reinstall the hardware module.

Step 3 **show hw-module fpd****Example:**

```
RP/0/RP0/CPU0:router# show hw-module fpd
```

Displays the list of hardware modules detected on the router.

```
RP/0/RP0/CPU0:Router#show hw-module fpd
```

```
FPD Versions
```

```
=====
```

Location	Card type	HWver	FPD device	ATR	Status	Running	Programd
0/RP0	N540-24Z8Q2C-M	0.5	MB-MIFPGA		CURRENT	0.04	0.04
0/RP0	N540-24Z8Q2C-M	0.5	Bootloader		CURRENT	1.07	1.07
0/RP0	N540-24Z8Q2C-M	0.5	CPU-IOFPGA		CURRENT	0.03	0.03
0/RP0	N540-24Z8Q2C-M	0.5	MB-IOFPGA		CURRENT	0.16	0.16

```
RP/0/RP0/CPU0:ios#
```

```
RP/0/RP0/CPU0:Router#show hw-module fpd
```

```
Fri May 28 13:53:23.325 UTC
```

```
Auto-upgrade:Disabled
```

```
Attribute codes: B golden, P protect, S secure
```

```
FPD Versions
```

```
=====
```

Location	Card type	HWver	FPD device	ATR	Status	Running	Programd	Reload	Loc
0/RP0/CPU0	N540X-6Z18G-SYS-A	0.2	IoFpga		CURRENT	0.13	0.13		0/RP0
0/RP0/CPU0	N540X-6Z18G-SYS-A	0.2	IoFpgaGolden	B	NEED UPGD	0.00			0/RP0
0/RP0/CPU0	N540X-6Z18G-SYS-A	0.2	Prim-BootLoader		CURRENT	10.07	10.07		0/RP0
0/RP0/CPU0	N540X-6Z18G-SYS-A	0.2	Stdbypfpga	S	CURRENT	0.28	0.28		0/RP0
0/RP0/CPU0	N540X-6Z18G-SYS-A	0.2	StdbypfpgaGolden	BS	NEED UPGD	0.25			0/RP0

```
0/RP0/CPU0 N540X-6Z18G-SYS-A 0.2 TamFw S CURRENT 6.05 6.05 0/RP0
0/RP0/CPU0 N540X-6Z18G-SYS-A 0.2 TamFwGolden BS CURRENT 6.05 0/RP0
```

Verify Node Status

Each card on the router represents a node. The operational status of the node is verified using the **show platform** command. This command is to be executed independently from both XR and System Admin mode CLIs.



Note Only the following Cisco NCS 540 router variants support the System Admin mode:

- N540-ACC-SYS
- N540X-ACC-SYS
- N540-24Z8Q2C-SYS

Procedure

Step 1 show platform

Example:

```
RP/0/RP0/CPU0:router#show platform
```

The **show platform** command when executed from the XR EXEC mode displays the status of XR console running on various RPs and LCs.

```
RP/0/RP0/CPU0:<router>#show platform
Node   Type   State   Config state
```

```
-----
0/RP0/CPU0 N540-X-24Z8Q2C-M(Active) IOS XR RUN NSHUT
0/RP0/NPU0 Slice UP
0/FT0 N540-FAN OPERATIONAL NSHUT
0/FT1 N540-FAN OPERATIONAL NSHUT
0/FT2 N540-FAN OPERATIONAL NSHUT
0/FT3 N540-FAN OPERATIONAL NSHUT
```

```
RP/0/RP0/CPU0:Router#show platform
```

```
Fri May 28 13:52:46.172 UTC
```

```
Node           Type                               State           Config state
-----
0/RP0/CPU0     N540X-6Z18G-SYS-A(Active)         IOS XR RUN      NSHUT
0/PM0          N540L-PSU-FIXED-A                 OPERATIONAL     NSHUT
0/PM1          N540L-PSU-FIXED-A                 OPERATIONAL     NSHUT
0/FT0          N540L-FAN                          OPERATIONAL     NSHUT
```

Verify that all RPs are listed and their state is OPERATIONAL. This indicates that the XR console is operational on the cards.

Step 2 admin

Example:

```
RP/0/RP0/CPU0:router# admin
```

Enters mode.

Step 3 **show platform**

Example:

```
#show platform
```

The **show platform** command when executed from the System Admin EXEC mode displays the status of all hardware units like cards (RPs, IMs and FCs,) and hardware modules (fan trays) on the router.

This is an example for single-chassis system:

```
RP/0/RP0/CPU0:<router>#sh platform
Thu Mar 29 06:50:06.788 UTC
Location  Card Type  HW State  SW State  Config State
-----
0/RP0    N540-X-24Z8Q2C-M OPERATIONAL OPERATIONAL NSHUT
0/FT0    N540-FAN    OPERATIONAL N/A      NSHUT
0/FT1    N540-FAN    OPERATIONAL N/A      NSHUT
0/FT2    N540-FAN    OPERATIONAL N/A      NSHUT
0/FT3    N540-FAN    OPERATIONAL N/A      NSHUT
```

Verify that all cards installed on the router are displayed in the result. The software state of LCs/IMs and RPs and the hardware state of FC and FTs should be "OPERATIONAL". Various hardware and software states are listed here.

Hardware states:

- OPERATIONAL—Card is operating normally and is fully functional
- POWERED_ON—Power is on and the card is booting up
- FAILED—Card is powered on but has experienced some internal failure
- PRESENT—Card is in the shutdown state
- OFFLINE—User has changed the card state to OFFLINE. The card is accessible for diagnostics

Software states:

- OPERATIONAL—Software is operating normally and is fully functional
- SW_INACTIVE—Software is not completely operational
- FAILED—Software is operational but the card has experienced some internal failure

Verify Software Version

The router is shipped with the Cisco IOS XR software pre-installed. Verify that the latest version of the software is installed. If a newer version is available, perform a system upgrade. This will install the newer version of the software and provide the latest feature set on the router.

Perform this task to verify the version of Cisco IOS XR software running on the router.

Procedure

show version

Example:

```
RP/0/RP0/CPU0:router# show version
```

Displays the version of the various software components installed on the router. The result includes the version of Cisco IOS XR software and its various components.

Example

```
Cisco IOS XR Software, Version <release-version>  
Copyright (c) 2013-2017 by Cisco Systems, Inc.
```

```
Build Information:  
Built By : <user>  
Built On : <date and time stamp>  
Build Host : iox-lnx-030  
Workspace : /x.x.x/ncs540/ws  
Version : <release-version>  
Location : /opt/cisco/XR/packages/
```

```
cisco NCS-540 () processor  
System uptime is 1 day, 16 hours, 18 minutes
```

What to do next

Verify the result to ascertain whether a system upgrade or additional package installation is required. If that is required, refer to the tasks in the chapter [Perform System Upgrade and Install Feature Packages](#).

Verify Firmware Version

The firmware on various hardware components of the router must be compatible with the Cisco IOS XR image installed. Incompatibility might cause the router to malfunction. Complete this task to verify the firmware version.

Procedure

show hw-module fpd

Example:

Displays the list of hardware modules detected on the router.

Note This command can be run from both XR VM and System Admin VM modes.

Note Only the following Cisco NCS 540 router variants support the System Admin mode:

- N540-ACC-SYS
- N540X-ACC-SYS
- N540-24Z8Q2C-SYS

In the above output, some of the significant fields are:

- FPD Device- Name of the hardware component such as FPD, CFP, and so on.
 - ATR-Attribute of the hardware component. Some of the attributes are:
 - B- Backup Image
 - S-Secure Image
 - P-Protected Image
 - Status- Upgrade status of the firmware. The different states are:
 - CURRENT-The firmware version is the latest version.
 - READY-The firmware of the FPD is ready for an upgrade.
 - NOT READY-The firmware of the FPD is not ready for an upgrade.
 - NEED UPGD-A newer firmware version is available in the installed image. It is recommended that an upgrade be performed.
 - RLOAD REQ-The upgrade has been completed, and the ISO image requires a reload.
 - UPGD DONE-The firmware upgrade is successful.
 - UPGD FAIL- The firmware upgrade has failed.
 - BACK IMG-The firmware is corrupted. Reinstall the firmware.
 - UPGD SKIP-The upgrade has been skipped because the installed firmware version is higher than the one available in the image.
 - Running- Current version of the firmware running on the FPD.
-

Verify Interface Status

After the router has booted, all available interfaces must be discovered by the system. If interfaces are not discovered, it might indicate a malfunction in the unit. Complete this task to view the number of discovered interfaces.

Procedure

show ipv4 interface summary

Example:

```
RP/0/RP0/CPU0:router#show ipv4 interface summary
```

When a router is turned on for the first time, all interfaces are in the 'unassigned' state. Verify that the total number of interfaces displayed in the result matches with the actual number of interfaces present on the router.

In the above result:

- Assigned— An IP address is assigned to the interface.
- Unnumbered— Interface which has borrowed an IP address already configured on one of the other interfaces of the router.
- Unassigned—No IP address is assigned to the interface.

You can also use the **show interfaces brief** and **show interfaces summary** commands in the XR EXEC mode to verify the interface status.

Verify SDR Information

Secure domain routers (SDRs) divide a single physical system into multiple logically-separated routers. SDRs are also known as logical routers (LRs). On the router, only one SDR is supported. This SDR is termed the default-sdr. Every router is shipped with the default-sdr, which owns all RPs installed in the routing system. An instance of this SDR runs on line cards and route processors. Complete this task to verify the details of the SDR instances.



Note Only the following Cisco NCS 540 router variants support the System Admin mode:

- N540-ACC-SYS
 - N540X-ACC-SYS
 - N540-24Z8Q2C-SYS
-

Procedure

Step 1 admin

Example:

```
RP/0/RP0/CPU0:router# admin
```

Enters mode.

Step 2 **show sdr****Example:**

```
sysadmin-vm:0_RP0# show sdr
```

Displays the SDR information for every node.

```
RP/0/RP0/CPU0:router#show sdr
Type                NodeName           NodeState          RedState           PartnerName
-----
LC                  0/0/CPU0          IOS XR RUN         N/A                N/A
RP                  0/RP0/CPU0        IOS XR RUN         ACTIVE             NONE
Slice               0/RP0/NPU0        UP                 N/A                N/A
N540-X-24Z8Q2C-M   0/RP0              OPERATIONAL        N/A                N/A
N540-FAN            0/FT0              OPERATIONAL        N/A                N/A
N540-FAN            0/FT1              OPERATIONAL        N/A                N/A
N540-FAN            0/FT2              OPERATIONAL        N/A                N/A
N540-FAN            0/FT3              OPERATIONAL        N/A                N/A
```

For a functional SDR, the VM State is "RUNNING". If the SDR is not running on a node, no output is shown in the result, for that location.

What to do next

If you find SDR is not running on a node, try reloading the node. To do that, use the **hw-module location node-id reload** command in the System Admin EXEC mode.



CHAPTER 7

Create User Profiles and Assign Privileges

To provide controlled access to the XR and System Admin configurations on the router, user profiles are created with assigned privileges. The privileges are specified using command rules and data rules.



Note Only the following Cisco NCS 540 router variants support the System Admin mode:

- N540-ACC-SYS
- N540X-ACC-SYS
- N540-24Z8Q2C-SYS

For information on how to create user profiles and assign privileges on other Cisco NCS 540 router variants, see the *Create Users and Assign Privileges on Cisco NCS 540 Series Router* section in the *Setup Cisco NCS 540 Series Routers with XR7 OS* chapter.

The authentication, authorization, and accounting (aaa) commands are used for the creation of users, groups, command rules, and data rules. The `aaa` commands are also used for changing the disaster-recovery password.



Note You cannot configure the external AAA server and services from the System Admin VM. It can be configured only from the XR VM.

Configure AAA authorization to restrict users from uncontrolled access. If AAA authorization is not configured, the command and data rules associated to the groups that are assigned to the user are bypassed. An IOS-XR user can have full read-write access to the IOS-XR configuration through Network Configuration Protocol (NETCONF), google-defined Remote Procedure Calls (gRPC) or any YANG-based agents. In order to avoid granting uncontrolled access, enable AAA authorization before setting up any configuration.



- Note** If any user on XR is deleted, the local database checks whether there is a first user on System Admin VM.
- If there is a first user, no syncing occurs.
 - If there is no first user, then the first user on XR (based on the order of creation) is synced to System Admin VM.
 - When a user is added in XR, if there is no user on System Admin mode, then the user is synced to sysadmin-vm. After the synchronization, any changes to the user on XR VM does not synchronize on the System Admin VM.
 - A user added on the System Admin VM does not synchronize with XR VM.
 - Only the first user or disaster-recovery user created on System Admin VM synchronizes with the host VM.
 - Changes to credentials of first user or disaster-recovery user on System Admin VM synchronizes with the host VM.
 - The first user or disaster-recovery user deleted on System Admin VM does not synchronize with the host VM. The host VM retains the user.

Users are authenticated using username and password. Authenticated users are entitled to execute commands and access data elements based on the command rules and data rules that are created and applied to user groups. All users who are part of a user group have such access privileges to the system as defined in the command rules and data rules for that user group.

The workflow for creating user profile is represented in this flow chart:

Figure 7: Workflow for Creating User Profiles

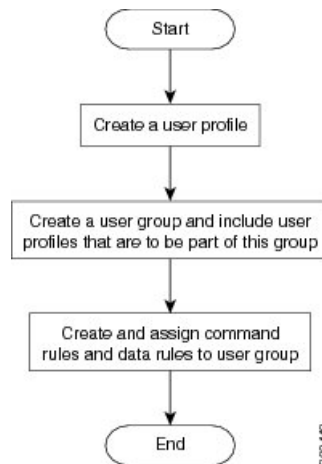

- Note** The root-1r user, created for the XR VM during initial router start-up, is mapped to the root-system user for the System Admin VM. The root-system user has superuser permissions for the System Admin VM and therefore has no access restrictions.

Use the **show run aaa** command in the Config mode to view existing aaa configurations.

The topics covered in this chapter are:

- [Create a User Profile in System Admin VM, on page 67](#)
- [Create a User Group in System Admin VM, on page 69](#)
- [Create Command Rules, on page 70](#)
- [Create Data Rules, on page 73](#)
- [Change Disaster-recovery Username and Password, on page 75](#)

Create a User Profile in System Admin VM



Note Only the following Cisco NCS 540 router variants support the System Admin mode:

- N540-ACC-SYS
- N540X-ACC-SYS
- N540-24Z8Q2C-SYS

For information on how to create user profiles and assign privileges on other Cisco NCS 540 router variants, see the *Create Users and Assign Privileges on Cisco NCS 540 Series Router* section in the *Setup Cisco NCS 540 Series Routers with XR7 OS* chapter.

Create new users for the System Admin VM. Users are included in a user group and assigned certain privileges. The users have restricted access to the commands and configurations in the System Admin VM console, based on assigned privileges.

The router supports a maximum of 1024 user profiles.

The root-Ir user of XR VM can access the System Admin VM by entering **Admin** command in the XR EXEC mode. The router does not prompt you to enter any username and password. The XR VM root-Ir user is provided full access to the System Admin VM.

Procedure

Step 1 **admin**

Example:

```
RP/0/RP0/CPU0:router# admin
```

Enters mode.

Step 2 **config**

Example:

```
sysadmin-vm:0_RP0#config
```

Enters System Admin Config mode.

Step 3 **aaa authentication users user** *user_name*

Example:

```
sysadmin-vm:0_RP0(config)#aaa authentication users user us1
```

Creates a new user and enters user configuration mode. In the example, the user "us1" is created.

Step 4 **password** *password***Example:**

```
sysadmin-vm:0_RP0(config-user-us1)#password pwd1
```

Enter the password that will be used for user authentication at the time of login into System Admin VM.

Step 5 **uid** *user_id_value***Example:**

```
sysadmin-vm:0_RP0(config-user-us1)#uid 100
```

Specify a numeric value. You can enter any 32 bit integer.

Step 6 **gid** *group_id_value***Example:**

```
sysadmin-vm:0_RP0(config-user-us1)#gid 50
```

Specify a numeric value. You can enter any 32 bit integer.

Step 7 **ssh_keydir** *ssh_keydir***Example:**

```
sysadmin-vm:0_RP0(config-user-us1)#ssh_keydir dir1
```

Specify any alphanumeric value.

Step 8 **homedir** *homedir***Example:**

```
sysadmin-vm:0_RP0(config-user-us1)#homedir dir2
```

Specify any alphanumeric value.

Step 9 Use the **commit** or **end** command.

commit —Saves the configuration changes and remains within the configuration session.

end —Prompts user to take one of these actions:

- **Yes** — Saves configuration changes and exits the configuration session.
- **No** —Exits the configuration session without committing the configuration changes.
- **Cancel** —Remains in the configuration session, without committing the configuration changes.

Create a User Group in System Admin VM



Note Only the following Cisco NCS 540 router variants support the System Admin mode:

- N540-ACC-SYS
- N540X-ACC-SYS
- N540-24Z8Q2C-SYS

For information on how to create user profiles and assign privileges on other Cisco NCS 540 router variants, see the *Create a User Group* section in the *Setup Cisco NCS 540 Series Routers with XR7 OS* chapter.

Create a user group for the System Admin VM.

The router supports a maximum of 32 user groups.

Before you begin

Create a user profile. See the *Create User* section.

Procedure

Step 1 admin

Example:

```
RP/0/RP0/CPU0:router# admin
```

Enters mode.

Step 2 config

Example:

```
sysadmin-vm:0_RP0#config
```

Enters System Admin Config mode.

Step 3 aaa authentication groups group *group_name*

Example:

```
sysadmin-vm:0_RP0(config)#aaa authentication groups group gr1
```

Creates a new user group (if it is not already present) and enters the group configuration mode. In this example, the user group "gr1" is created.

Note By default, the user group "root-system" is created by the system at the time of root user creation. The root user is part of this user group. Users added to this group will get root user permissions.

Step 4 users *user_name*

Example:

```
sysadmin-vm:0_RP0(config-group-gr1)#users us1
```

Specify the name of the user that should be part of the user group.

You can specify multiple user names enclosed withing double quotes. For example, **users** "user1 user2 ...".

Step 5 `gid group_id_value`

Example:

```
sysadmin-vm:0_RP0(config-group-gr1)#gid 50
```

Specify a numeric value. You can enter any 32 bit integer.

Step 6 Use the **commit** or **end** command.

commit —Saves the configuration changes and remains within the configuration session.

end —Prompts user to take one of these actions:

- **Yes** — Saves configuration changes and exits the configuration session.
- **No** —Exits the configuration session without committing the configuration changes.
- **Cancel** —Remains in the configuration session, without committing the configuration changes.

What to do next

- Create command rules.
- Create data rules.

Create Command Rules



Note Only the following Cisco NCS 540 router variants support the System Admin mode:

- N540-ACC-SYS
- N540X-ACC-SYS
- N540-24Z8Q2C-SYS

For information on how to create user profiles and assign privileges on other Cisco NCS 540 router variants, see the *Setup Cisco NCS 540 Series Routers with XR7 OS* chapter.

Command rules are rules based on which users of a user group are either permitted or denied the use of certain commands. Command rules are associated to a user group and get applied to all users who are part of the user group.

A command rule is created by specifying whether an operation is permitted, or denied, on a command. This table lists possible operation and permission combinations:

Operation	Accept Permission	Reject Permission
-----------	-------------------	-------------------

Read (R)	Command is displayed on the CLI when "?" is used.	Command is not displayed on the CLI when "?" is used.
Execute (X)	Command can be executed from the CLI.	Command cannot be executed from the CLI.
Read and execute (RX)	Command is visible on the CLI and can be executed.	Command is neither visible nor executable from the CLI.

By default, all permissions are set to **Reject**.

Each command rule is identified by a number associated with it. When multiple command rules are applied to a user group, the command rule with a lower number takes precedence. For example, cmdrule 5 permits read access, while cmdrule10 rejects read access. When both these command rules are applied to the same user group, the user in this group gets read access because cmdrule 5 takes precedence.

As an example, in this task, the command rule is created to deny read and execute permissions for the "show platform" command.

Before you begin

Create an user group. See [Create a User Group in System Admin VM, on page 69](#).

Procedure

Step 1 admin

Example:

```
RP/0/RP0/CPU0:router# admin
```

Enters mode.

Step 2 config

Example:

```
sysadmin-vm:0_RP0#config
```

Enters System Admin Config mode.

Step 3 aaa authorization cmdrules cmdrule *command_rule_number*

Example:

```
sysadmin-vm:0_RP0(config)#aaa authorization cmdrules cmdrule 1100
```

Specify a numeric value as the command rule number. You can enter a 32 bit integer.

Important Do not use numbers between 1 to 1000 because they are reserved by Cisco.

This command creates a new command rule (if it is not already present) and enters the command rule configuration mode. In the example, command rule "1100" is created.

Note By default "cmdrule 1" is created by the system when the root-system user is created. This command rule provides "accept" permission to "read" and "execute" operations for all commands. Therefore, the root user has no restrictions imposed on it, unless "cmdrule 1" is modified.

Step 4 command *command_name*

Example:

```
sysadmin-vm:0_RP0(config-cmdrule-1100)#command "show platform"
```

Specify the command for which permission is to be controlled.

If you enter an asterisk '*' for **command**, it indicates that the command rule is applicable to all commands.

Step 5 **ops {r | x | rx}****Example:**

```
sysadmin-vm:0_RP0(config-cmdrule-1100)#ops rx
```

Specify the operation for which permission has to be specified:

- **r** — Read
- **x** — Execute
- **rx** — Read and execute

Step 6 **action {accept | accept_log | reject}****Example:**

```
sysadmin-vm:0_RP0(config-cmdrule-1100)#action reject
```

Specify whether users are permitted or denied the use of the operation.

- **accept** — users are permitted to perform the operation
- **accept_log**— users are permitted to perform the operation and every access attempt is logged.
- **reject**— users are restricted from performing the operation.

Step 7 **group *user_group_name*****Example:**

```
sysadmin-vm:0_RP0(config-cmdrule-1100)#group gr1
```

Specify the user group on which the command rule is applied.

Step 8 **context *connection_type*****Example:**

```
sysadmin-vm:0_RP0(config-cmdrule-1100)#context *
```

Specify the type of connection to which this rule applies. The connection type can be *netconf* (Network Configuration Protocol), *cli* (Command Line Interface), or *xml* (Extensible Markup Language). It is recommended that you enter an asterisk '*'; this indicates that the command rule applies to all connection types.

Step 9 Use the **commit** or **end** command.

commit —Saves the configuration changes and remains within the configuration session.

end —Prompts user to take one of these actions:

- **Yes** — Saves configuration changes and exits the configuration session.
- **No** —Exits the configuration session without committing the configuration changes.

- **Cancel** —Remains in the configuration session, without committing the configuration changes.

What to do next

Create data rules. See [Create Data Rules, on page 73](#).

Create Data Rules



Note Only the following Cisco NCS 540 router variants support the System Admin mode:

- N540-ACC-SYS
- N540X-ACC-SYS
- N540-24Z8Q2C-SYS

For information on user profiles and user groups on other Cisco NCS 540 router variants, see the *Setup Cisco NCS 540 Series Routers with XR7 OS* chapter.

Data rules are rules based on which users of the user group are either permitted, or denied, accessing and modifying configuration data elements. The data rules are associated to a user group. The data rules get applied to all users who are part of the user group.

Each data rule is identified by a number associated to it. When multiple data rules are applied to a user group, the data rule with a lower number takes precedence.

Before you begin

Create an user group. See [Create a User Group in System Admin VM, on page 69](#).

Procedure

Step 1

admin

Example:

```
RP/0/RP0/CPU0:router# admin
```

Enters mode.

Step 2

config

Example:

```
sysadmin-vm:0_RP0#config
```

Enters System Admin Config mode.

Step 3

aaa authorization datarules datarule *data_rule_number*

Example:

```
sysadmin-vm:0_RP0(config)#aaa authorization datarules datarule 1100
```

Specify a numeric value as the data rule number. You can enter a 32 bit integer.

Important Do not use numbers between 1 to 1000 because they are reserved by Cisco.

This command creates a new data rule (if it is not already present) and enters the data rule configuration mode. In the example, data rule "1100" is created.

Note By default "datarule 1" is created by the system when the root-system user is created. This data rule provides "accept" permission to "read", "write", and "execute" operations for all configuration data. Therefore, the root user has no restrictions imposed on it, unless "datarule 1" is modified.

Step 4 **keypath** *keypath***Example:**

```
sysadmin-vm:0_RP0(config-datarule-1100)#keypath /aaa/disaster-recovery
```

Specify the keypath of the data element. The keypath is an expression defining the location of the data element. If you enter an asterisk '*' for **keypath**, it indicates that the command rule is applicable to all configuration data.

Step 5 **ops** *operation***Example:**

```
sysadmin-vm:0_RP0(config-datarule-1100)#ops rw
```

Specify the operation for which permission has to be specified. Various operations are identified by these letters:

- c—Create
- d—Delete
- u—Update
- w— Write (a combination of create, update, and delete)
- r—Read
- x—Execute

Step 6 **action** { **accept** | **accept_log** | **reject** }**Example:**

```
sysadmin-vm:0_RP0(config-datarule-1100)#action reject
```

Specify whether users are permitted or denied the operation.

- **accept** — users are permitted to perform the operation
- **accept_log**— users are permitted to perform the operation and every access attempt is logged
- **reject**— users are restricted from performing the operation

Step 7 **group** *user_group_name***Example:**

```
sysadmin-vm:0_RP0(config-datarule-1100)#group gr1
```

Specify the user group on which the data rule is applied. Multiple group names can also be specified.

Step 8 **context** *connection type*

Example:

```
sysadmin-vm:0_RP0(config-datarule-1100)#context *
```

Specify the type of connection to which this rule applies. The connection type can be *netconf* (Network Configuration Protocol), *cli* (Command Line Interface), or *xml* (Extensible Markup Language). It is recommended that you enter an asterisk '*', which indicates that the command applies to all connection types.

Step 9 **namespace** *namespace*

Example:

```
sysadmin-vm:0_RP0(config-datarule-1100)#namespace *
```

Enter asterisk '*' to indicate that the data rule is applicable for all namespace values.

Step 10 Use the **commit** or **end** command.

commit —Saves the configuration changes and remains within the configuration session.

end —Prompts user to take one of these actions:

- **Yes** — Saves configuration changes and exits the configuration session.
- **No** —Exits the configuration session without committing the configuration changes.
- **Cancel** —Remains in the configuration session, without committing the configuration changes.

Change Disaster-recovery Username and Password



Note Only the following Cisco NCS 540 router variants support the System Admin mode:

- N540-ACC-SYS
- N540X-ACC-SYS
- N540-24Z8Q2C-SYS

For information on user profiles and user groups on other Cisco NCS 540 router variants, see the *Setup Cisco NCS 540 Series Routers with XR7 OS* chapter.

When you define the root-system username and password initially after starting the router, the same username and password gets mapped as the disaster-recovery username and password for the System Admin console. However, it can be changed.

The disaster-recovery username and password is useful in these scenarios:

- Access the system when the AAA database, which is the default source for authentication in System Admin console is corrupted.

- Access the system through the management port, when, for some reason, the System Admin console is not working.
- Create new users by accessing the System Admin console using the disaster-recovery username and password, when the regular username and password is forgotten.



Note On the router, you can configure only one disaster-recovery username and password at a time.

Procedure

Step 1 admin

Example:

```
RP/0/RP0/CPU0:router# admin
```

Enters mode.

Step 2 config

Example:

```
sysadmin-vm:0_RP0#config
```

Enters System Admin Config mode.

Step 3 **aaa disaster-recovery username *username* password *password***

Example:

```
sysadmin-vm:0_RP0(config)#aaa disaster-recovery username us1 password pwd1
```

Specify the disaster-recovery username and the password. You have to select an existing user as the disaster-recovery user. In the example, 'us1' is selected as the disaster-recovery user and assigned the password as 'pwd1'. The password can be entered as a plain text or md5 digest string.

When you need to make use of the disaster recovery username, you need to enter it as *username@localhost*.

Step 4 Use the **commit** or **end** command.

commit —Saves the configuration changes and remains within the configuration session.

end —Prompts user to take one of these actions:

- **Yes** — Saves configuration changes and exits the configuration session.
 - **No** —Exits the configuration session without committing the configuration changes.
 - **Cancel** —Remains in the configuration session, without committing the configuration changes.
-



CHAPTER 8

Perform System Upgrade and Install Feature Packages

The system upgrade and package installation processes are executed using **install** commands on the router. The processes involve adding and activating the iso images (*.iso*) and feature packages on the router. These files are accessed from a network server and then activated on the router. If the installed package or SMU causes any issue on the router, it can be uninstalled.

The topics covered in this chapter are:

- [Upgrading the System, on page 77](#)
- [View Supported Software Upgrade or Downgrade Versions, on page 79](#)
- [Upgrading Features, on page 82](#)
- [Workflow for Install Process, on page 84](#)
- [Install Packages, on page 84](#)
- [Install Prepared Packages, on page 89](#)
- [Uninstall Packages, on page 92](#)

Upgrading the System

Upgrading the system is the process of installing a new version of the Cisco IOS XR operating system on the router. The router comes preinstalled with the Cisco IOS XR image. However, you can install the new version in order to keep router features up to date. The system upgrade operation is performed from the XR VM. However, during system upgrade, the software that runs on both the XR VM and the System Admin VM get upgraded.



Note If an interface on a router doesn't have a configuration and is brought up by performing no-shut operation, then upon router reload, the interface state changes to **admin-shutdown** automatically.



-
- Note**
- Ensure that you have adequate disk space.
 - Run the **fsck** command to check the status of the file system, for a successful IOS XR upgrade. You must run the **fsck** command in the System Admin EXEC mode to install a System Admin package, and in the XR EXEC mode to install the XR package.
 - All install commands are applicable in both the System Admin EXEC mode and in XR EXEC mode. System Admin install operations are done from XR EXEC mode.
-

Perform a system upgrade by installing a base package—Cisco IOS XR Unicast Routing Core Bundle. To install this bundle, run the **install** command. The filename for the Cisco IOS XR Unicast Routing Core Bundle bundle is *ncs540-mini-x.iso*.



-
- Caution** Do not perform any install operations when the router is reloading.
Do not reload the router during an upgrade operation.
-



-
- Note** To enable hardware programming after upgrading the chassis from an older software version to IOS XR Release 7.6.x or later through ISSU, initiate a chassis reload. The chassis reload is mandatory, if you must enable a maximum transmission unit (MTU) value of 9646 on applicable interfaces.
-

Cisco IOS XR supports RPM signing and signature verification for Cisco IOS XR RPM packages in the ISO and upgrade images. All RPM packages in the Cisco IOS XR ISO and upgrade images are signed to ensure cryptographic integrity and authenticity. This guarantees that the RPM packages haven't been tampered with and the RPM packages are from Cisco IOS XR. The private key, which is used for signing the RPM packages, is created and securely maintained by Cisco.

View Supported Software Upgrade or Downgrade Versions

Table 5: Feature History Table

Feature Name	Release Information	Description
Supported Software Upgrade or Downgrade IOS XR Versions	Release 7.5.1	<p>You can determine whether a software version can be upgraded or downgraded to another version using this functionality. Before an actual upgrade or downgrade process, you can also view the hardware or software limitations that could cause the upgrade or downgrade to fail. This feature helps you plan successful software upgrades or downgrades.</p> <p>This feature introduces the show install upgrade-matrix command.</p>

Your Cisco router comes preinstalled with IOS XR software. You either upgrade the software release to use new features and software fixes, or you downgrade the software. To leverage new features that are added or software fixes that are provided, it is important that you upgrade your router to a current version.

To help you select a Cisco IOS XR software release that aligns with Cisco-certified upgrade and downgrade paths, this feature provides answers to the following questions:

- What upgrade or downgrade releases are supported for the current release?
- I plan to upgrade from Release X to Release Y. Does my router support upgrade to Release Y?
- Are there any bridging SMUs that must be installed before I upgrade the software?

This feature provides a mechanism to determine whether the current release supports an upgrade to a target release. This task is run at the start of a software upgrade or downgrade through the **install replace** command. If the validation fails, the software upgrade is blocked, and the system notifies the reason for the failure. This feature allows you to proactively examine whether you can upgrade or downgrade to a certain release, saving time and effort involved in planning and upgrading the software.

The feature provides the following information to help you understand the prerequisites or limitations related to the specific software upgrade or downgrade:

- Required bridging SMU RPMs
- Blocking SMU RPMs
- Unsupported hardware
- Caveats or restrictions

You can overwrite the automatic validation using the **force** keyword in the **install replace** command. With this option, the system displays warning messages when the upgrade fails but does not block the software

upgrade. Use the **force ?** keyword to understand any other impact to system functionalities apart from the disabling of this process that determines the supported releases for software upgrade or downgrade.

You can view the support information using the following **show** commands or through the operational data.

Command	Description
show install upgrade-matrix running	Displays all supported software upgrades from the current version according to the support data installed on the running system
show install upgrade-matrix iso <i>path-to-ISO</i>	Displays details about the software upgrade from the current version to the version of the target ISO according to the support data in both the running system and the ISO image
show install upgrade-matrix iso <i>path-to-ISO</i> all	Displays all supported software upgrades from any version according to the support data in the target ISO image
show install upgrade-matrix iso <i>path-to-ISO</i> from-running	Displays details about the software upgrade from the current version to the version of ISO according to the support matrices in both the running system and the target ISO image

View All Supported Software Upgrade from Running Version

The following example shows all supported releases for upgrade from the current version 7.5.1 on the router:

```
Router#show install upgrade-matrix running
Fri Jul 29 10:29:53.769 IST
This may take a while ...
```

The current software [7.5.1] can be upgraded from and downgraded to the following releases:

```
=====
From      To        Bridge SMUs Required    Caveats
=====
7.5.1     7.4.1     None                    None
-----
7.5.1     7.1.2     None                    None
-----
7.5.1     7.2.1     None                    None
-----
7.5.1     7.2.2     None                    None
-----
7.4.1     7.5.1     None                    None
-----
7.1.2     7.5.1     None                    None
-----
7.2.1     7.5.1     None                    None
-----
7.2.2     7.5.1     None                    None
-----
=====
From      To        Bridge SMUs Required    Caveats
```

```
=====
7.5.1    7.4.1    None          None
-----
7.5.1    7.1.2    None          None
-----
7.5.1    7.2.1    None          None
-----
7.5.1    7.2.2    None          None
-----
7.4.1    7.5.1    None          None
-----
7.1.2    7.5.1    None          None
-----
7.2.1    7.5.1    None          None
-----
7.2.2    7.5.1    None          None
=====
```

View Supported Releases to Upgrade Software From Current Version to Target Version

This example shows the supported release to upgrade software from the current version to a target version.

```
Router#show install upgrade-matrix iso /harddisk:/ncs540-goldenk9-x-7.5.2-rev1.iso
Fri Jul 29 10:30:15.776 IST
This may take a while ...
Upgrade from the current software [7.5.1] to 7.5.2 is supported
```

```
=====
From      To        Bridge SMUs Required  Caveats
=====
7.5.1     7.5.2     None                  None
=====
```

The current image has the upgrade matrix that specifies only its supported upgrade or downgrade versions up to a certain version. If you want to determine the upgrade path of a newer version of ISO that is higher than the version in the current matrix, the upgrade matrix from the new ISO provides the supported upgrade or downgrade paths.

View Supported Releases from Current Version to an ISO Version

The following example shows the software upgrade paths, downgrade paths, and restrictions to an upgrade from the current version to the target ISO version:

```
Router#show install upgrade-matrix iso /harddisk:/ncs540-goldenk9-x-7.5.2-rev1.iso all
Fri Jul 29 10:30:18.772 IST
This may take a while ...
```

7.5.2 can be upgraded from and downgraded to the following releases:

```
=====
From      To        Bridge SMUs Required  Caveats
=====
7.5.1     7.5.2     None                  None
-----
7.4.2     7.5.2     None                  None
-----
7.4.1     7.5.2     None                  None
-----
7.5.2     7.5.1     None                  None
=====
```

7.5.2	7.4.2	None	None
7.5.2	7.6.1	None	None
7.5.2	7.4.1	None	None
7.5.2	7.1.2	None	None
7.5.2	7.2.1	None	None
7.5.2	7.2.2	None	None
7.5.2	7.3.1	None	None
7.5.2	7.3.2	None	None
7.1.2	7.5.2	None	None
7.2.1	7.5.2	None	None
7.2.2	7.5.2	None	None
7.6.1	7.5.2	None	None
7.3.1	7.5.2	None	None
7.3.2	7.5.2	None	None

View Supported Releases from Running Version to an ISO Version

The following example displays details about the software upgrade from the current version to the version of ISO according to the support matrices in both the running system and the target ISO image:

```
Router#show install upgrade-matrix iso /harddisk:/ncs540-goldenk9-x-7.5.2-rev1.iso
from-running
Fri Jul 29 10:30:24.389 IST
This may take a while ...
Upgrade from the current software [7.5.1] to 7.5.2 is supported
```

From	To	Bridge SMUs Required	Caveats
7.5.1	7.5.2	None	None

Upgrading Features

Upgrading features is the process of deploying new features and software patches on the router. Perform a feature upgrade by installing packages. Perform a software patch installation by installing Software Maintenance Upgrade (SMU) files.

Installing a package on the router installs specific features that are part of that package. Cisco IOS XR Software is divided into various software packages; this enables you to select the features to run on your router. Each package contains components that perform a specific set of router functions, such as routing, security, and so on.

For example, the components of the routing package are split into individual RPMs such as BGP and OSPF. BGP is a part of the base software version and is a mandatory RPM, and hence can't be removed. However, you can add and remove optional RPMs such as OSPF as required.

The naming convention of the package is <platform>-<pkg>-<pkg version>-<release version>.<architecture>.rpm.

- ncs540-isis-1.0.0.0-r701.x86_64.rpm
- ncs540-k9sec-1.1.0.0-r701.x86_64.rpm
- ncs540-li-1.0.0.0-r701.x86_64.rpm
- ncs540-mcast-1.0.0.0-r701.x86_64.rpm
- ncs540-mgbl-1.0.0.0-r701.x86_64.rpm
- ncs540-mini-x-7.0.1.iso
- ncs540-mpls-1.0.0.0-r701.x86_64.rpm
- ncs540-mpls-te-rsvp-1.0.0.0-r701.x86_64.rpm
- ncs540-ospf-1.0.0.0-r701.x86_64.rpm

Use the **install** commands to install packages and SMUs. For more information about the install process, see [Install Packages, on page 84](#).



Note

- Ensure that you have adequate disk space.
 - Run the **fsck** command to check the status of the file system, for a successful IOS XR upgrade. You must run the **fsck** command in the System Admin EXEC mode to install a System Admin package, and in the XR EXEC mode to install the XR package.
 - All install commands are applicable in both the System Admin EXEC mode and in XR EXEC mode. System Admin install operations are done from XR EXEC mode.
-

There are separate packages and SMUs for the XR VM and the System Admin VM. They can be identified by their filenames.

The XR and System Admin packages and SMUs can be activated from XR and System Admin VMs.

You can alternatively perform a cross VM operation, by activating or deactivating the System Admin packages and SMUs from XR.



Note Only the following Cisco NCS 540 router variants support the System Admin mode:

- N540-ACC-SYS
 - N540X-ACC-SYS
 - N540-24Z8Q2C-SYS
-

Third-Party SMUs

Consider these points while activating and deactivating third-party SMUs:

- To activate a third-party SMU, you should have a corresponding base package.
- When you activate a third-party SMU, the corresponding third-party base package state is inactive, this is an expected behavior.
- To deactivate a third-party SMU, ensure that you activate the corresponding third-party base package. Third-party SMUs deactivated explicitly might lead to triages to the install team.



Note All SMUs are bundled together with the base package in a TAR file



Note All Cisco RPMs have the platform name in the filename. For example, **ncs540-sysadmin**.

Workflow for Install Process

The workflow for installation and uninstallation processes is depicted in this flowchart.

For installing a package, see [Install Packages, on page 84](#). For uninstalling a package, see [Uninstall Packages, on page 92](#).

Install Packages

Complete this task to upgrade the system or install a patch. The system upgrade is done using an ISO image file, while the patch installation is done using packages and SMUs. You can also include SMUs in an upgrade operation along with mini ISO.

This task is also used to install *.rpm* files. The *.rpm* file contains multiple packages and SMUs that are merged into a single file. The packaging format defines one RPM per component, without dependency on the card type.



-
- Note**
- Ensure that you have adequate disk space.
 - Run the **fsck** command to check the status of the file system, for a successful IOS XR upgrade. You must run the **fsck** command in the System Admin EXEC mode to install a System Admin package, and in the XR EXEC mode to install the XR package.
 - All install commands are applicable in both the System Admin EXEC mode and in XR EXEC mode. System Admin install operations are done from XR EXEC mode.
-

**Note**

- The system upgrade is supported only from XR EXEC mode.
- While the System Admin package can be executed using **install** commands in the System Admin EXEC mode and XR EXEC mode, the XR package can only be executed using the install commands in XR EXEC mode. All **install** commands are applicable in both these modes.
- While the System Admin SMUs can be installed in System Admin EXEC mode and XR EXEC mode, the XR SMUs can only be installed through the XR EXEC mode.
- Install operation over IPv6 is not supported.

**Note**

Only the following Cisco NCS 540 router variants support the System Admin mode:

- N540-ACC-SYS
- N540X-ACC-SYS
- N540-24Z8Q2C-SYS

For information on installing packages on other Cisco NCS 540 router variants, see the *Install XR7 OS on NCS 540 Series Routers* chapter.

The workflow for installing a package is shown in this flowchart.

Figure 8: Installing Packages Workflow

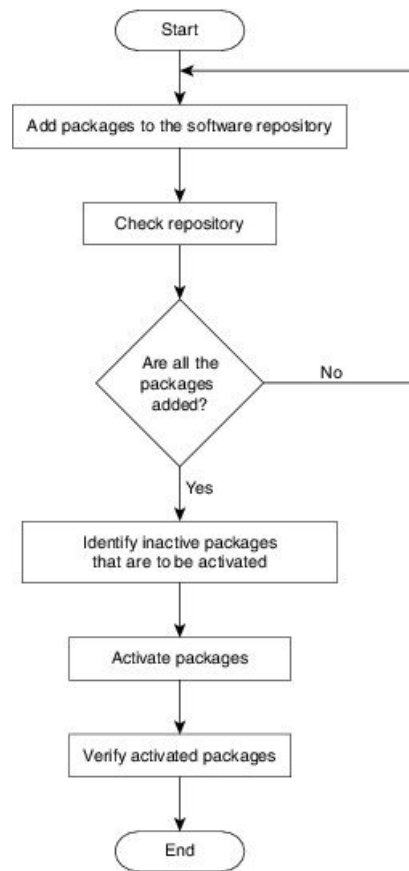

Before you begin

- You can add a package to the repository from a local disk in the router, from an inserted USB disk, or from a remote repository accessible through the management port or any data port.

If the installable file is located on a USB in the router's USB port, use the **show media** or **show filesystem** commands. The installable file is labeled as either **usb:** or **disk2:** in the command outputs.

If the installable file is located in a remote location that can be accessed through the management port, you must configure and bring up the management port to ensure reachability to the remote location. For more information, see the *Configure the Management Port* section in the *Bring-up the Router* chapter.

Procedure

Step 1

Execute one of these:

- install add source** *<http or shttp transfer protocol>/package_path/ filename1 filename2 ...*
- install add source** *<tftp transfer protocol>/package_path/ filename1 filename2 ...*
- install add source** *<ftp or sftp transfer protocol>/user@server:/package_path/ filename1 filename2 ...*
- install add source** *disk2: filename1 filename2 ...*

Example:

```
RP/0/RP0/CPU0:router#install add source /harddisk:/ ncs540-mpls-te-rsvp-1.0.0.0-731.x86_64.rpm
ncs540-mpls-te-rsvp-1.0.0.0-732.x86_64.rpm
```

or

```
RP/0/RP0/CPU0:router#install add source sftp://root@8.33.5.15:/auto/ncs/package/
ncs540-mcast-1.0.0.0-731.x86_64.rpm ncs540-iosxr-mpls-1.0.0.0-732.x86_64.rpm
```

or

```
RP/0/RP0/CPU0:router#install add source /harddisk:/
ncs540-mpls-te-rsvp-1.0.0.0-<release-number>.x86_64.rpm
ncs540-mpls-te-rsvp-1.0.0.0-<release-number>.x86_64.rpm
```

or

```
RP/0/RP0/CPU0:router#install add source sftp://root@8.33.5.15:/auto/ncs/package/
ncs540-mcast-1.0.0.0-<release-number>.x86_64.rpm
ncs540-iosxr-mpls-1.0.0.0-<release-number>.x86_64.rpm
```

Note A space must be provided between the *package_path* and *filename*.

The software files are unpacked from the package, validated, and then added to the software repository. This operation might take time depending on the size of the files being added. The operation is performed in asynchronous mode. The **install add** command runs in the background, and the EXEC prompt is returned when all files are unpacked.

Note The repositories for the XR VM and the System Admin VM are different. The system automatically adds a routing package to the XR VM repository and a system administration package to the System Admin VM repository.

Step 2 **show install request****Example:**

```
RP/0/RP0/CPU0:router#show install request
```

(Optional) Displays the operation ID of the add operation and its status. The operation ID can be later used to execute the **activate** command.

```
Install operation 8 is still in progress
```

Step 3 **show install repository****Example:**

```
RP/0/RP0/CPU0:router#show install repository
```

Displays packages that are added to the repository. Packages are displayed only after the `install add` operation is complete.

Step 4 **show install inactive****Example:**

```
RP/0/RP0/CPU0:router#show install inactive
```

Displays inactive packages that are present in the repository. Only inactive packages can be activated.

Step 5 Execute one of these:

- **install activate** *package_name*
- **install activate id** *operation_id*

Example:

```
RP/0/RP0/CPU0:router#install activate ncs540-mcast-1.0.0.0-<release-number>.x86_64.rpm
ncs540-mps-1.0.0.0-<release-number>.x86_64.rpm
```

The *operation_id* is that of the **install add** operation, see [Install Packages, on page 84](#) [Step Step 2, on page 87](#). This command can also be run from the Sys Admin mode. The package configurations are made active on the router. As a result, new features and software fixes take effect. This operation is performed in asynchronous mode, as this is the default. The **install activate** command runs in the background, and the EXEC prompt is returned.

You can run the activate operation either through the synchronous mode or by selecting the `sync` option from the CLI.

If you use the operation ID, all packages that were added in the specified operation are activated together. For example, if 5 packages are added in operation ID 8, by executing **install activate id 8**, all 5 packages are activated together. You do not have to activate the packages individually.

Activation does not happen instantaneously, but takes some time. When activation completes, the system reloads automatically. For restart SMU activation, the SMU takes effect once the processes impacted by the SMU are restarted.

If the SMU has dependency on both XR VM and System Admin VM, perform the reload after activating the SMU in both VMs so that they take effect simultaneously. To reload the router, use the **hw-module location all reload** command from the System Admin EXEC mode.

Step 6 **show install active****Example:**

```
RP/0/RP0/CPU0:router#show install active
```

Displays packages that are active.

From the result, verify that the same image and package versions are active on all RPs and LCs.

Table 6: Example: Installing Packages: Related Commands

Related Commands	Purpose
show install log	Displays the log information for the install process; this can be used for troubleshooting in case of install failure.
show install package	Displays the details of the packages that have been added to the repository. Use this command to identify individual components of a package.
install prepare	Makes pre-activation checks on an inactive package, to prepare it for activation.
show install prepare	Displays the list of package that have been prepared and are ready for activation.

Step 7 **install commit****Example:**

```
RP/0/RP0/CPU0:router#install commit
```

Commits the Host, XR, and System Admin newly active software.

Note On Multi-SDR mode, you can use the **install commit sdr** to commit just the sdr from where the CLI is being triggered. For more information, see [Secure Domain Router Commands](#).

What to do next

- After performing a system upgrade, upgrade FPD by using the **upgrade hw-module location all fpd all** command from the System Admin EXEC mode. The progress of FPD upgrade process can be monitored using the **show hw-module fpd** command in the System Admin EXEC mode. Reload the router after the FPD upgrade is completed.
- Verify the installation using the **install verify packages** command.
- Uninstall the packages or SMUs if their installation causes any issues on the router. See [Uninstall Packages, on page 92](#).

Install Prepared Packages

A system upgrade or feature upgrade is performed by activating the ISO image file, packages, and SMUs. It is possible to prepare these installable files before activation. During the prepare phase, preactivation checks are made and the components of the installable files are loaded on to the router setup. The prepare process runs in the background and the router is fully usable during this time. When the prepare phase is over, all the prepared files can be activated instantaneously. The advantages of preparing before activation are:

- If the installable file is corrupted, the prepare process fails. This provides an early warning of the problem. If the corrupted file was activated directly, it might cause router malfunction.
- Directly activating an ISO image for system upgrade takes considerable time during which the router is not usable. However, if the image is prepared before activation, not only does the prepare process run asynchronously, but when the prepared image is subsequently activated, the activation process too takes less time. As a result, the router downtime is considerably reduced.
- It performs a disk-space check that is required for a successful operation. This quantifies the disk-space deficit, and provides you possible alternatives to free up space in the filesystem.
- It performs a package compatibility check. This ensures that all the required installation packages are available. For any package compatibility check error, details of the package and version are logged.



Note Only the following Cisco NCS 540 router variants support the System Admin mode:

- N540-ACC-SYS
- N540X-ACC-SYS
- N540-24Z8Q2C-SYS

For information on installing prepared packages on other Cisco NCS 540 router variants, see the *Install XR7 OS on NCS 540 Series Routers* chapter.

Complete this task to upgrade the system and install packages by making use of the prepare operation.



Note Depending on whether you are installing a System Admin package or a XR package, execute the **install** commands in the System Admin EXEC mode or XR EXEC mode respectively. All **install** commands are applicable in both these modes. System Admin install operations can be done from XR mode.

Procedure

Step 1 Add the required ISO image and packages to the repository.

For details, see [Install Packages, on page 84](#).

Step 2 **show install repository**

Example:

```
RP/0/RP0/CPU0:router#show install repository
```

Perform this step to verify that the required installable files are available in the repository. Packages are displayed only after the "install add" operation is complete.

Step 3 **show install request**

Example:

```
RP/0/RP0/CPU0:router#show install request
```

(Optional) Displays the operation ID of the add operation and its status. The operation ID can be later used to execute the **activate** command.

```
Install operation 8 is still in progress
```

Step 4 Execute one of these:

- **install prepare** *package_name*
- **install prepare id** *operation_id*

Example:

The prepare process takes place. This operation is performed in asynchronous mode. The **install prepare** command runs in the background, and the EXEC prompt is returned as soon as possible.

If you use the operation ID, all packages that were added in the specified operation are prepared together. For example, if 5 packages are added in operation 8, by executing **install prepare id 8**, all 5 packages are prepared together. You do not have to prepare the packages individually.

Step 5 **show install prepare**

Example:

```
RP/0/RP0/CPU0:router#show install prepare
```

Displays packages that are prepared. From the result, verify that all the required packages have been prepared.

Step 6 **install activate**

Example:

```
RP/0/RP0/CPU0:router#install activate
```

All the packages that have been prepared are activated together to make the package configurations active on the router.

Note You should not specify any package name or operation ID in the CLI.

Activations of some SMUs require manual reload of the router. When such SMUs are activated, a warning message is displayed to perform reload. The components of the SMU get activated only after the reload is complete. Perform router reload immediately after the execution of the **install activate** command is completed.

Step 7 **show install active**

Example:

```
RP/0/RP0/CPU0:router#show install active
```

Displays packages that are active.

From the result, verify that on all RPs and LCs, the same image and package versions are active.

Step 8 **install commit**

Example:

```
RP/0/RP0/CPU0:router#install commit
```

Installing Packages: Related Commands

Related Commands	Purpose
show install log	Displays the log information for the install process; this can be used for troubleshooting in case of install failure.
show install package	Displays the details of the packages that have been added to the repository. Use this command to identify individual components of a package.
install prepare clean	Clears the prepare operation and removes all the packages from the prepared state.

What to do next

- After performing a system upgrade, upgrade FPD by using the **upgrade hw-module location all fpd all** command from the System Admin EXEC mode. The progress of FPD upgrade process can be monitored using the **show hw-module fpd** command in the System Admin EXEC mode. Reload the router after the FPD upgrade is completed.
- Verify the installation using the **install verify packages** command.
- Uninstall the packages or SMUs if their installation causes any issues on the router. See [Uninstall Packages](#).



Note ISO images cannot be uninstalled. However, you can perform a system downgrade by installing an older ISO version.

Uninstall Packages



Note Only the following Cisco NCS 540 router variants support the System Admin mode:

- N540-ACC-SYS
- N540X-ACC-SYS
- N540-24Z8Q2C-SYS

For information on deleting packages on other Cisco NCS 540 router variants, see the *Delete Optional Packages* section in the *Install XR7 OS on NCS 540 Series Routers* chapter.

Complete this task to uninstall a package. All router functionalities that are part of the uninstalled package are deactivated. Packages that are added in the XR VM cannot be uninstalled from the System Admin VM. However, the cross VM operation allows System Admin packages to be deactivated from XR as well.



Note Installed ISO images cannot be uninstalled. Also, kernel SMUs that install third party SMU on host, XR VM and System Admin VM, cannot be uninstalled. However, subsequent installation of ISO image or kernel SMU overwrites the existing installation.

The workflow for uninstalling a package is shown in this flowchart.

Figure 9: Uninstalling Packages Workflow

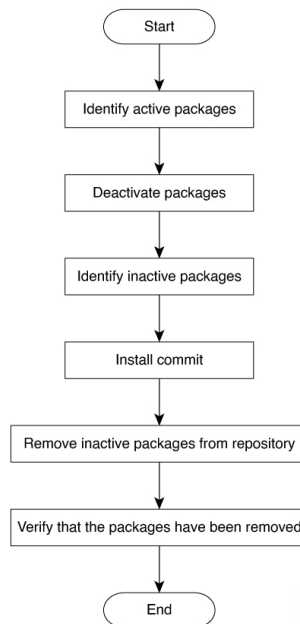

This task uninstalls XR VM packages. If you need to uninstall System Admin packages, run the same commands from the System Admin EXEC mode.

Procedure

Step 1 **show install active**

Example:

```
RP/0/RP0/CPU0:router#show install active
```

Displays active packages. Only active packages can be deactivated.

Step 2 Execute one of these:

- **install deactivate** *package_name*
- **install deactivate id** *operation_id*

Example:

The *operation_id* is the ID from **install add** operation. All features and software patches associated with the package are deactivated. You can specify multiple package names and deactivate them simultaneously.

If you use the operation ID, all packages that were added in the specified operation are deactivated together. You do not have to deactivate the packages individually. If System admin packages were added as a part of the **install add** operation (of the ID used in deactivate) then those packages will also be deactivated.

Step 3 **show install inactive**

Example:

```
RP/0/RP0/CPU0:router#show install inactive
```

The deactivated packages are now listed as inactive packages. Only inactive packages can be removed from the repository.

Step 4 **install commit**

Step 5 **install remove** *package_name*

Example:

The inactive packages are removed from the repository.

Use the **install remove** command with the **id** *operation-id* keyword and argument to remove all packages that were added for the specified operation ID.

You can also use the **install remove inactive all** to remove all inactive packages from XR and System Admin.

Step 6 **show install repository**

Example:

```
RP/0/RP0/CPU0:router#show install repository
```

Displays packages available in the repository. The package that are removed are no longer displayed in the result.

What to do next

Install required packages. .



CHAPTER 9

Upgrading Field-Programmable Device

An FPD is a field programmable logic device which contains non-volatile, re-programmable memory to define its internal wiring and functionality. The contents of this non-volatile memory are called the FPD image or FPD firmware. Over the lifespan of an FPD, FPD firmware images may need upgrades for bug fixes or functionality improvements. These upgrades are performed in the field with minimum system impact.

- [Prerequisites for FPD Image Upgrades, on page 95](#)
- [Overview of FPD Image Upgrade Support, on page 95](#)
- [FPD upgrade service, on page 95](#)

Prerequisites for FPD Image Upgrades

You must install the FPD pie before you install the SMUs or Service Packs. If you install the SMU or Service Packs before the FPD pie, the FPDs on the line card may not upgrade. In such cases, you must remove the SMUs and Service Packs and reload the router.

Overview of FPD Image Upgrade Support

An FPD image is used to upgrade the software on an FPD.

FPD versions must be compatible with the Cisco IOS XR software that is running on the router; if an incompatibility exists between an FPD version and the Cisco IOS XR software, the device with the FPGA may not operate properly until the incompatibility is resolved.



Note

- It is mandatory to upgrade all the required FPDs before doing a reload when you are upgrading FPDs on line cards. This is because, partial FPD component upgrades might result in booting errors (in some cases).
- You must not reload any line card or the router before all FPD image upgrades are completed successfully.

FPD upgrade service

The main tasks of the FPD upgrade service are:

- Check FPD image version to decide if a specific firmware image needs an upgrade or not.
- Automatic FPD Image Upgrade (if enabled).
- Manual FPD Image Upgrade using the **upgrade hw-module fpd** command.
- Invoke the appropriate device driver with a name of the new image to load.

An FPD image package is used to upgrade FPD images. The **install activate** command is used to place the FPD binary files into the expected location on the boot devices.

Supported Upgrade Methods

Method	Remarks
Manual Upgrade	Upgrade using CLI, force upgrade supported.
Auto Upgrade	Upgrade using install SMU activation or during image upgrade. User can enable/disable auto upgrade feature.

Determining Upgrade Requirement

Use the **show hw-module fpd** command to determine if an FPD upgrade is required. Check for NEED UPGD in the Status column.

Example

```
Router: #show hw - module fpd
```

```
Wed Dec 14 07:08:08.424 UTC
```

```
Auto-upgrade:Disabled
```

Location	Card type	HWver	FPD device	ATR Status	FPD Versions	
					Running	Programd
0/0	NC55-18H18F	1.0	MIFPGA	NEED UPGD	7.01	7.01
0/0	NC55-18H18F	1.0	Bootloader	CURRENT	1.14	1.14
0/0	NC55-18H18F	1.0	IOFPGA	CURRENT	0.07	0.07
0/0	NC55-18H18F	1.0	SATA-M600-MCT	CURRENT	0.23	0.23

Use the **show fpd package** command to find out which FPGAs are supported with your current software release and minimum hardware requirements for each module.

Manual FPD upgrade

Manual FPD upgrade is performed using the **upgrade hw-module fpd** command. All cards or all FPGA in a card can be upgraded. If reload is required to activate FPD, the upgrade should be complete. Line-cards, fabric cards and RP cards cannot be reloaded during the process of the FPD upgrade.

FPD upgrade is transaction-based:

- Each fpd upgrade CLI execution is one transaction.
- Only one transaction is allowed at any given time.

- One transaction may include one or many FPD upgrades

The **force** option can be used to forcibly upgrade the FPD (regardless of whether it is required or not). It triggers all FPDs to be upgraded or downgraded. The **force** option can also be used to downgrade or upgrade the FPGAs even after the version check.

Note

- Sometimes, FPDs can have primary and backup images.
- Force FPD upgrade with **upgrade hw-module location all fpd all force** command affects forwarding over BVI interface. You must reload involved locations to recover.
- The use of the **force** option when performing an FPD upgrade is not recommended except under explicit direction from Cisco engineering or TAC for a one-time purpose only.
- FPD upgrade should be performed in Admin mode only.
- A new FPD upgrade should be issued only when previous FPD upgrades have been completed on the same FPD with the following syslog message:

```
RP/0/RP0/CPU0:May 10 10:11:44.414 UTC: fpd-serv[205]: %INFRA-FPD_Manager-1-UPGRADE_ALERT
: FPD Upgrade Completed (use "show hw-module fpd" to check upgrade status)
```

Note

On the Cisco N540-FH-CSR-SYS and Cisco N540-FH-AGG-SYS routers, when upgrading or downgrading from Cisco IOS XR Releases 7.3.2, 7.4.x, or 7.5.1 to Release 7.4.1, data path FPGA (DPFPGA) ports do not come up due to the 'layer 1 port creation' failure. For the DPFPGA ports to come up successfully, you must manually upgrade the DPFPGA after the software upgrade or downgrade to Cisco IOS XR Release 7.4.1.

DPFPGA ports:

- On N540-FH-CSR-SYS: Ports 0-13
- On N540-FH-AGG-SYS: Ports 0-23

How to Upgrade FPD Images

You must determine if an FPD image upgrade is needed using the **show hw-module fpd** command and perform the upgrade, if needed, under the following circumstances:

- Migrate the software to a later Cisco IOS XR software release.

In the event of an FPD incompatibility with your card, you might receive the following error message:

```
LC/0/0/CPU0:Jul 5 03:00:18.929 UTC: optics_driver[220]: %L2-OPTICS-3-BAD_FPGA_IMAGE :
Detected bad MI FPGA image programmed in MI FPGA SPI flash in 0/0/CPU0 location: Failed to
validate meta data CRC
LC/0/0/CPU0:Jul 5 03:00:19.019 UTC: optics_driver[220]: %L2-OPTICS-3-BACKUP_FPGA_LOADED :
Detected Backup FPGA image running on 0/0/CPU0 - primary image corrupted (@0x8c = 0x44)
RP/0/RP0/CPU0:Jul 5 03:00:48.987 UTC: fpd-serv[301]: %PKT_INFRA-FM-3-FAULT_MAJOR : ALARM_MAJOR
: FPD-NEED-UPGRADE :DECLARE :0/0:
```

Upgrades to the Cisco IOS XR software might result in an FPD incompatibility. Ensure that you perform the FPD upgrade procedure and resolve all incompatibilities, for the cards to function properly.



Note The use of the **force** option when performing a FPD upgrade is not recommended except under explicit direction from Cisco engineering or TAC for a one-time purpose only.

Before you begin

- The FPD upgrade procedure is performed while the card is online. At the end of the procedure the card must be reloaded before the FPD upgrade is complete. To reload the card, you can use the **hw-module location <location> reload** command in Admin mode, during the next maintenance window. The upgrade procedure is not complete until the card is reloaded.
- During the FPD upgrade, you *must not* do the following:
 - Reload, perform an online insertion and removal (OIR) of a line card (LC), or power down the chassis. Doing so may cause the node to enter an unusable state.
 - Press **Ctrl-C** if the console appears to hang without any output. Doing so may abort the upgrade.
- If you are not sure whether a card requires an FPD upgrade, you can install the card and use the **show hw-module fpd** command to determine if the FPD image on the card is compatible with the currently running Cisco IOS XR software release.

Configuration Examples for FPD Image Upgrade

The following examples indicates the use of commands associated with the FPD image upgrade procedure.

show fpd package Command Output: Example

Use the **show fpd package** command in System Admin EXEC mode to find out which line cards are supported with your current Cisco IOS XR software release, which FPD image package you need for each line card, and what the minimum hardware requirements are for each module. If multiple FPD images are available for your card, they are listed as Subtype fpga2, fpga3, and so on.



Note The FPD name used in the FPD Description column of the output of the `show fpd package` command includes the last ten characters of DCO-PID. Depending on the slot and port numbers, the FPD name is appended with DCO_0, DCO_1, or DCO_2. For example, the FPD names for CFP2-WDM-D-1HL in port 0 and port 1 are -WDM-D-1HL_DCO_0 and WDM-D-1HL_DCO_1 respectively.

upgrade hw-module fpd Command Output: Example

Use the **upgrade hw-module fpd** command to upgrade the FPD image. The upgrade can be executed for all FPDs or for specific FPDs that need an upgrade. To upgrade all FPDs, use **upgrade hw-module fpd all location all** command. To upgrade a specific FPD image type, use the FPD subtype value in the **upgrade hw-module fpd** command.

show platform Command Output: Example

Use the **show platform** command to verify that the line card is up and running.

Auto FPD Upgrade

Table 7: Feature History Table

Feature Name	Release Information	Feature Description
Auto FPD Upgrade	Release 7.3.2	This functionality enables automatic upgrade and reload for field-programmable devices (FPDs) whenever the Cisco IOS XR image has a newer FPD version. This functionality upgrades all route processors and line card FPDs simultaneously while displaying upgrade triggers on the console.

Effective Cisco IOS XR Release 7.3.2, you can enable automatic upgrade of FPD by using the “`fpd auto-upgrade enable`” command.

To automatically upgrade all FPDs, use:

```
RP/0/RP0/CPU0:IOS(config)#fpd auto-upgrade enable
```

To reload the interface modules following the `fpd auto-upgrade`, use:

```
RP/0/RP0/CPU0:IOS(config)#fpd auto-reload enable
```

Limitations and Usage Guidelines

Limitations

- FPD auto-upgrade should be enabled only in the XR VM and *not* in the System Admin VM.
- With auto-upgrade enabled, if any card is in RELOAD REQUIRED state, auto-upgrade is re-triggered during any SSO or FPD-serv process restart.
- When an interface module (IM) or route processor (RP) is in RELOAD REQUIRED state and auto-upgrade is enabled, FPD upgrades are triggered again.
- With auto-upgrade enabled, if line card is inserted, an auto-upgrade is triggered. During this phase optics alarms are generated. If auto-reload is not enabled, you must reload the line cards manually to clear these alarms.
- SATA allows you to upgrade or downgrade when an FPD version change is available. Therefore, when auto-upgrade is enabled, the system automatically downgrades if lower versions are available. This behavior is specific only to SATA FPDs.
- FPD auto-reload is applicable for line cards only. Line cards are automatically reloaded after the `fpd auto-upgrade` process is completed.
- You must disable auto-upgrade during XR ISSU; otherwise, the router goes into a state where redundancy cannot be achieved. In this case, standby RP must be reloaded to achieve redundancy.
-
- TimingICs do not support **auto fpd upgrade** on NCS5500 Series Routers as the TimingIC requires a card reload immediately after upgrade. For the same reason, the TimingICs are not upgraded if the user specifies **location all** in the **auto fpd upgrade** command. To upgrade a TimingIC FPD, specify the FPD

name along with the card location. For example, **upgrade hw-module fpd TimngIC-A location 0/RP0/cpu0**.

Usage Guidelines—Online Insertion of Line Cards

When a line card with a lower FPD version is inserted, one of the following scenarios apply:

- If fpd auto-upgrade and auto-reload are enabled, and a new line card is inserted, the system upgrades the line card FPDs automatically with the latest FPDs and reloads the line cards.
- If fpd auto-upgrade and auto-reload are both disabled, no action is required.
- If fpd auto-upgrade is enabled and auto-reload is disabled, the following alarms are displayed on the console:

```
RP/0/RP1/CPU0:Jun 1 10:05:46.095 UTC: optics_driver[231]: %PKT_INFRA-FM-3-FAULT_MAJOR
: ALARM_MAJOR :OPTICS SUPPORTED_ERROR :DECLARE : Optics0/5/0/6: Optics0/5/0/6
RP/0/RP1/CPU0:Jun 1 10:05:46.096 UTC: optics_driver[231]: %PKT_INFRA-FM-2-FAULT_CRITICAL
: ALARM_CRITICAL :OPTICS NOT SUPPORTED :DECLARE : Optics0/5/0/6: Optics0/5/0/6
```

You must reload the line cards manually to clear these alarms

Usage Guidelines—Online Insertion of RPs

When fpd auto-upgrade is enabled and a new RP is inserted, the system upgrades the RP FPDs automatically with the latest FPDs.



Note RPs are not reloaded automatically. You must manually reload the RP or chassis for the latest FPD version to reflect.



Note Reload of active RPs and line cards impacts the network traffic.

Table 8: Action Required on FPDs After Auto Upgrade

FPD	Action Required
IOFPGA	Manual reload required
ADM	Upgraded version available immediately
PRIMARY-BIOS	Manual reload required
SATA	Upgraded version available immediately
PSOC	Upgraded version available immediately
IMFPGA	Manual reload required, if auto-reload is not configured

Configuring Auto FPD During System Upgrade

In case of Software upgrade (without ISSU), configure the **fpd auto-upgrade enable** command. All the FPDs are automatically upgraded in the currently installed image (V1). After the upgrade, the router automatically

reloads and comes up with the new image (V2) with the upgraded FPDs already running. No additional reloads are required.



Note System reloads are part of the SU process, therefore you can disable the FPD auto reload functionality by using the **fpd auto-reload disable** command.

1. Enable FPD auto-upgrade

```
RP/0/RP0/CPU0:IOS#conf
RP/0/RP0/CPU0:IOS(config)#fpd auto-upgrade enable
RP/0/RP0/CPU0:IOS#commit
```

2. Check for FPD Versions

3. Check that Auto Upgrades are Triggered for FPDs with Newer Versions Available



Note At this step, all RSP, IMs, and fan FPD upgrades are initiated and completed. All cards are upgraded *before* the router reloads.

4. Check the RP FPD Versions and FPD Status

When the router is operational after the reload, all the RP, IMs, and fan FPDs are upgraded to the latest FPD versions.

Automatic FPD Upgrade for PSU

During the Power Supply Unit (PSU) insertion and installation process, the routers can now automatically upgrade the Field-Programmable Devices (FPD) associated with the PSUs.

Starting with Cisco IOS-XR Release 7.5.2, the automatic FPD upgrade includes the FPDs associated with the PSUs by default. This means that when automatic FPD upgrade is enabled, the FPDs associated with the PSUs will also be upgraded. The upgrades for the PSUs will occur sequentially, so the FPD upgrades for the PSUs will take longer than for other components.

You can choose to exclude PSUs from the automatic upgrade process to reduce the time taken for FPD automatic upgrade by preventing them from being upgraded upon insertion or during a system upgrade using the **fpd auto-upgrade exclude pm** command.

Configuration example for excluding PSUs from automatic FPD upgrade:

Configuration

```
Router# config
Router(config)# fpd auto-upgrade enable
Router(config)# fpd auto-upgrade exclude pm
Router(config)# commit
```

Show Running Configuration

```
Router# show running-config fpd auto-upgrade
fpd auto-upgrade enable
fpd auto-upgrade include pm
```

Upgrade Failure

On failure of an FPD upgrade, you get a warning with the following syslog message:

```
LC/0/5/CPU0:Jun 27 05:02:25.742 UTC: optics_driver[216]: %INFRA-FPD_Driver-1-UPGRADE_ALERT
: FPD MIFPGA@0/5 image programming completed with UPGD FAIL state Info: [Image verification
failed at offset 0x5c8, flash value = 0x0, image value = 0x40, image size = 4194304]
LC/0/5/CPU0:Jun 27 05:02:26.570 UTC: optics_driver[216]: %INFRA-FPD_Driver-1-UPGRADE_ALERT
: FPD MIFPGA@0/5 image programming completed with UPGD FAIL state Info: [Image verification
failed at offset 0x1e, flash value = 0x56, image value = 0xff, image size = 4194304]
```

When you use the **show hw-module fpd** command, the status column displays **UPGD FAIL** to indicate failure of the FPD upgrade.



Note

- Do not reload the line card with a failed FPD upgrade image.
 - Upgrade failed FPDs will be fixed with a manual upgrade.
 - Contact Cisco TAC or your account representative if the FPD upgrade failure is not repaired.
-



CHAPTER 10

Manage Automatic Dependency



Note This document is applicable only for the following Cisco NCS 540 router variants:

- N540-ACC-SYS
- N540X-ACC-SYS
- N540-24Z8Q2C-SYS

Flexible packaging supports automatic dependency management. While you update an RPM, the system automatically identifies all relevant dependent packages and updates them.

Figure 10: Flow for Installation (base software, RPMs and SMUs)

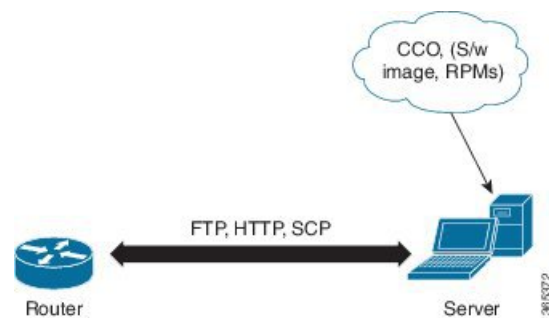

Until this release, you download the software image and required RPMs from CCO on a network server (the repository), and used the **install add** and the **install activate** commands to add and activate the downloaded files on the . Then, you manually identified relevant dependent RPMs, to add and activate them.

With automatic dependency management, you need not identify dependent RPMs to individually add and activate them. You can execute new install commands to identify and install dependent RPMs automatically.

The new commands are **install update** **install source** and **install upgrade**. The **install update** **install source** command identifies and updates dependent packages. The command does not update the base package. The **install upgrade** command upgrades the base package.



- Note**
- 1.
 - 2.

The rest of this chapter contains these sections:

- [Update RPMs and SMUs, on page 104](#)
- [Upgrade Base Software Version, on page 104](#)

Update RPMs and SMUs

An RPM may contain a fix for a specific defect, and you may need to update the system with that fix. To update RPMs and SMUs to a newer version, use the **install update install source** command. When the **install update install source** command is issued for a particular RPM, the router communicates with the repository, and downloads and activates that RPM. If the repository contains a dependent RPM, the router identifies that dependent RPM and installs that too.

The syntax of the **install update install source** command is:

```
install update source install source repository [rpm]
```

Four scenarios in which you can use the **install update install source** command are:

- **When a package name is not specified**

When no package is specified, the command updates the latest SMUs of all installed packages.

```
install update source install source [repository]
```

- **When a package name is specified**

If the package name is specified, the command installs that package, updates the latest SMUs of that package, along with its dependencies. If the package is already installed, only the SMUs of that package are installed. (SMUs that are already installed are skipped.)

- **When a package name and version number are specified**

If a particular version of package needs to be installed, the complete package name must be specified; that package is installed along with the latest SMUs of that package present in the repository.

- **When an SMU is specified**

If an SMU is specified, that SMU is downloaded and installed, along with its dependent SMUs.

Upgrade Base Software Version

You may choose to upgrade to a newer version of the base software when it becomes available. To upgrade to the latest base software version, use the **install upgrade** command. With the upgrade of the base version, RPMs that are currently available on the router are also upgraded.



Note SMUs are not upgraded as part of this process.

The syntax of the **install upgrade** command is:

install upgrade source *repository* **version** *version*[rpm]



Note VRF and TPA on dataport is not supported. If the server is reachable only through non-default VRF interface, the file must already be retrieved using ftp, sftp, scp, http or https protocols.

You can use the **install upgrade** command when:

- **The version number is specified**

The base software (.mini) is upgraded to the specified version; all installed RPMs are upgraded to the same release version.

install upgrade source[repository] **version** <release-number>



CHAPTER 11

Customize Installation using Golden ISO

Golden ISO (GISO) is a customized ISO that a user can build to suit the installation requirement. The user can customize the installable image to include the standard base image with the basic functional components, and add additional RPMs, SMUs and configuration files based on requirement.

The ease of installation and the time taken to seamlessly install or upgrade a system plays a vital role in a cloud-scale network. An installation process that is time-consuming and complex affects the resiliency and scale of the network. The GISO simplifies the installation process, automates the installation workflow, and manages the dependencies in RPMs and SMUs automatically.

GISO is built using a build script `gisobuild.py` available on the github location [Github](#) location.

When a system boots with GISO, additional SMUs and RPMs in GISO are installed automatically, and the router is pre-configured with the XR configuration in GISO. For more information about downloading and installing GISO, see [Install Golden ISO, on page 112](#).

The capabilities of GISO can be used in the following scenarios:

- Initial deployment of the router
- Software disaster recovery
- System upgrade from one base version to another
- System upgrade from same base version but with additional SMUs
- Install update to identify and update dependant packages
- [Limitations, on page 108](#)
- [Customize Installation using Golden ISO, on page 108](#)
- [Golden ISO Workflow, on page 109](#)
- [Build Golden ISO Using Script, on page 110](#)
- [Install Golden ISO, on page 112](#)
- [Install Replace with Golden ISO, on page 114](#)

Limitations

The following are the known problems and limitations with the customized ISO:

- Building and booting GISO for asynchronous package (a package of different release than the ISO) is not supported.

- Verifying the XR configuration is not supported in the GISO build script `gisobuild.py`.
- Renaming a GISO build and then installing from the renamed GISO build is not supported.
- Install operation over IPv6 is not supported.

Customize Installation using Golden ISO

Golden ISO (GISO) is a customized ISO that a user can build to suit the installation requirement. The user can customize the installable image to include the standard base image with the basic functional components, and add additional RPMs, SMUs and configuration files based on requirement.

The ease of installation and the time taken to seamlessly install or upgrade a system plays a vital role in a cloud-scale network. An installation process that is time-consuming and complex affects the resiliency and scale of the network. The GISO simplifies the installation process, automates the installation workflow, and manages the dependencies in RPMs and SMUs automatically.

GISO is built using a build script `gisobuild.py` available on the github location [Github](#) location.

When a system boots with GISO, additional SMUs and RPMs in GISO are installed automatically, and the router is pre-configured with the XR configuration in GISO. For more information about downloading and installing GISO, see [Install Golden ISO, on page 112](#).

The capabilities of GISO can be used in the following scenarios:

- Initial deployment of the router
- Software disaster recovery
- System upgrade from one base version to another
- System upgrade from same base version but with additional SMUs
- Install update to identify and update dependant packages

Limitations

The following are the known problems and limitations with the customized ISO:

- Building and booting GISO for asynchronous package (a package of different release than the ISO) is not supported.
- Verifying the XR configuration is not supported in the GISO build script `gisobuild.py`.
- Renaming a GISO build and then installing from the renamed GISO build is not supported.
- Install operation over IPv6 is not supported.

Golden ISO Workflow



Note This document is applicable only for the following Cisco NCS 540 router variants:

- N540-ACC-SYS
- N540X-ACC-SYS
- N540-24Z8Q2C-SYS

For all other Cisco NCS 540 router variants, see the *Build a Golden ISO* section in the *Install XR7 OS on NCS 540 Series Routers* chapter.

The following image shows the workflow for building and installing golden ISO.

Figure 11: Golden ISO Workflow

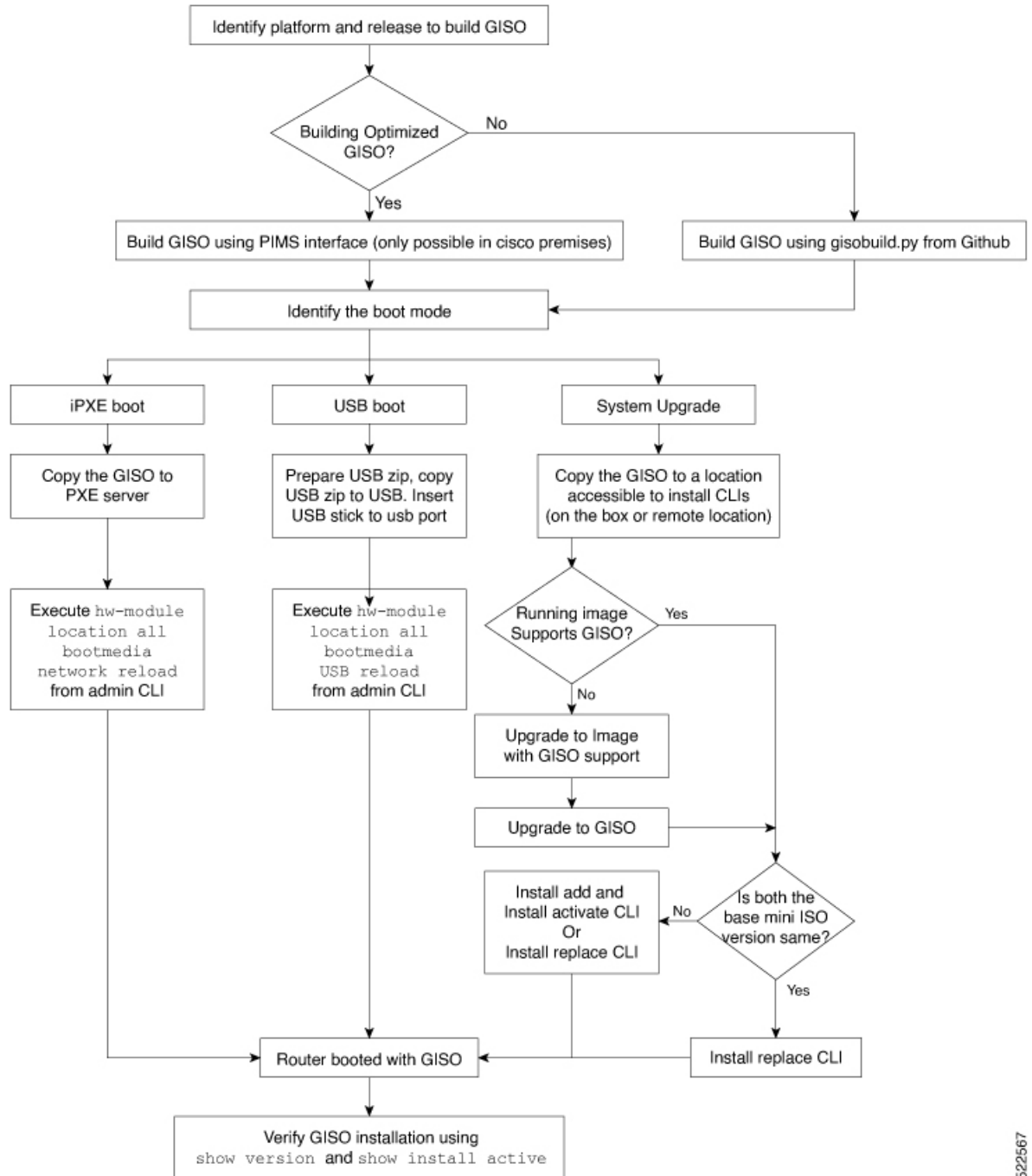

522567

Build Golden ISO Using Script

To build GISO, provide the following input parameters to the script:

- Base mini-x.iso (mandatory)

- XR configuration file (optional)
- one or more Cisco-specific SMUs for host, XR and System admin (optional)



Note We recommend including only the host and XR SMUs as parameters in the script used to build the GISO image. After the router boots up, you must install the System Admin SMU separately to avoid boot failure. Including System Admin SMUs as part of the GISO image results in the system failing to boot. This is applicable for:

- Cisco IOS XR Release 7.10.x and earlier.
 - USB and PXE boot modes.
-

- one or more third-party SMUs for host, XR and System admin (optional)
- Label for golden ISO (optional)
- Optional RPMs



Note To successfully add k9sec RPM to GISO, change the permission of the file to 644 using the **chmod** command.

```
chmod 644 [k9 sec rpm]
```

To build GISO, perform the following steps:

Before you begin

- To upgrade from a release that did not support GISO to a release supporting GISO version, it is mandatory to first upgrade to mini ISO with GISO support.
- The system where GISO is built must meet the following requirements:
 - System must have Python version 3.6 and later.
 - System must have free disk space of minimum 12 GB.
 - Verify that the Linux utilities `mount`, `rm`, `cp`, `umount`, `zcat`, `chroot`, `mkisofs` are present in the system. These utilities will be used by the script. Ensure privileges are available to execute all of these Linux commands.
 - Kernel version of the system must be later than 3.16 or later than the version of kernel of Cisco ISO.
 - Verify that a `libyaml` rpm supported by the Linux kernel is available to successfully `import yaml` in the tool.
 - User should have proper permission for security rpm(k9sec-rpm) in rpm repository, else security rpm would be ignored for Golden ISO creation.
- The system from where the `gisobuild.py` script is executed must have root credentials.

Procedure

- Step 1** Copy the script `gisobuild.py` from the [Github](#) location to an offline system or external server where the GISO will be built. Ensure that this system meets the pre-requisites described above in the *Before You Begin* section.
- Step 2** Run the script `gisobuild.py` and provide parameters to build the golden ISO off the router.

Example:

```
[directory-path]$ gisobuild.py [-h] [-i <mini-x.iso>] [-r <rpm repository>]
[-c <config-file>] [-l <giso label>] [-m] [-v]
```

Note The `-i` option is mandatory, and either or both `-r` or `-c` options must be provided.

The corresponding GISO and build logs are available under the specified `out_directory` path. The default directory is `/output_gisobuild`.

where:

- `-i` is the path to `mini-x.iso`
- `-r` is the path to RPM repository
- `-c` is the path to XR config file
- `-l` is the golden ISO label
- `-h` shows the help message
- `-v` is the version of the build tool `gisobuild.py`
- `-m` is to build the migration tar to migrate from IOS XR to IOS XR 64 bit

Note It is recommended to build GISOs with a label name.

The corresponding GISO and build logs are available under the specified directory in `out_directory`. If a directory is not specified, the files are placed in `/output_gisobuild` directory.



Note The GISO script does not support verification of XR configuration.

What to do next

Install the GISO image on the router.

Install Golden ISO

Golden ISO (GISO) automatically performs the following actions:

- Installs host and system admin RPMs.
- Partitions repository and TFTP boot on RP.

- Creates software profile in system admin and XR modes.
- Installs XR RPMs. Use **show install active** command to see the list of RPMs.
- Applies XR configuration. Use **show running-config** command in XR mode to verify.

Procedure

Step 1 Download GISO image to the router using one of the following options:

- **PXE boot:** when the router is booted, the boot mode is identified. After detecting PXE as boot mode, all available ethernet interfaces are brought up, and DHCPClient is run on each interface. DHCPClient script parses HTTP or TFTP protocol, and GISO is downloaded to the box.

When you bring up a router using the PXE boot mode, existing configurations are removed. To recover smart licensing configurations like Permanent License Reservation (PLR), enable these configurations after the router comes up.

```
Router#configure
Router(config)#license smart reservation
Router(config)#commit
```

- **System Upgrade:** when the system is upgraded, GISO can be installed using **install add**, **install activate**, or using **install replace** commands.

Important To replace the current version and packages on the router with the version from GISO, note the change in command and format.

- In versions prior to Cisco IOS XR Release 6.3.3, 6.4.x and 6.5.1, use the **install update** command:

```
install update source <source path> <Golden-ISO-name> replace
```

- In Cisco IOS XR Release 6.5.2 and later, use the **install replace** command.

```
install replace <absolute-path-of-Golden-ISO>
```

Note To create a Bootable External USB Disk, do the following:

- Ensure that the USB Boot Disk has a minimum storage of 8GB, and that you have root/admin or appropriate permission to create bootable disk on linux machine.
- a. Copy and execute usb-install script on the Linux machine to create a bootable external USB.
- b. Reset the RSP/RP and plug in bootable USB to RSP/RP's front panel. The USB will get detected in ROMMON. Note that when the system is in ROMMON, and if you add a front panel external USB, the USB will not be detected until the RSP/RP is reset.

The options to upgrade the system are as follows:

- **system upgrade from a non-GISO (image that does not support GISO) to GISO image:** If a system is running a version1 with an image that does not support GISO, the system cannot be upgraded directly to version2 of an image that supports GISO. Instead, the version1 must be upgraded to version2 mini ISO, and then to version2 GISO.

- **system upgrade in a release from version1 GISO to version2 GISO:** If both the GISO images have the same base version but different labels, **install add** and **install activate** commands does not support same version of two images. Instead, using **install source** command installs only the delta RPMs. System reload is based on restart type of the delta RPMs.

Using **install replace** command performs a system reload, irrespective of the difference between ISO and the existing version.

- **system upgrade across releases from version1 GISO to version2 GISO:** Both the GISO images have different base versions. Use **install add** and **install activate** commands, or **install replace** command to perform the system upgrade. The router reloads after the upgrade with the version2 GISO image.

Step 2 Run the **show install repository all** command in System Admin mode to view the RPMs and base ISO for host, system admin and XR.

Step 3 Run the **show install package <golden-iso>** command to display the list of RPMs, and packages built in GISO.

Note To list RPMs in the GISO, the GISO must be present in the install repository.

The ISO, SMUs and packages in GISO are installed on the router.

Install Replace with Golden ISO

Table 9: Feature History Table

Feature Name	Release Information	Description
Check Integrity of Golden ISO (GISO) Files	Release 7.5.1	This feature enables an automated check during operations to ensure that the files in GISO has not been corrupted. It does so by calculating the md5sum of the files and comparing it against md5sum value that is contained within the GISO that was calculated when the image was built.
Automatic Bridging of Bug Fix RPMs	Release 7.5.2	This release enables an easy, one-step, no-prompt upgrade or downgrade based on GISO. This removes the dependency on manually installing RPMs that bridge bug fixes across release versions.

Golden ISO (GISO) upgrades the router to a version that has a predefined list of software maintenance update (SMUs) with a single operation. However, to update to the same version with a different set of SMUs requires a two-step process.

To avoid this two-step process, use the **install replace** command to replace the currently active version with the full package including the image and SMUs in the newly added GISO.

The process involves upgrading the GISO to add the delta SMUs, and manually deactivating the SMUs that are not in use. In addition, this is the only method to upgrade to GISO containing different optional RPMs, which is a subset of the running set of optional RPMs. For example, consider V1 of GISO is the running version with V1 mini and optional RPMs V1 mpls, V1 mpls-te, V1 mgbl, and V1 k9sec. If V2 of GISO does not contain V2 k9sec, then use **install replace** to upgrade to the optional RPMs in V2.

From Cisco IOS XR Release 7.5.x, you can now add bridging bug fixes through the GISO, and this helps you to automatically install the bridging bug fix RPMs that are prerequisite for a system upgrade or a downgrade. The GISO can include bridging SMUs for multiple source releases, and installs only the specific bridging SMUs required for the target release.

The bridging bug fix RPMs can be used in the following scenarios:

- To resolve a bug that might stop upgrade.
- The latest version has new prerequisite requirements that are not met by the earlier version.

The **install replace** command adds and applies the highest version of any bridging bugfix RPMs for the currently active XR version.



Important To replace the current version and packages on the router with the version from GISO, note the change in command and format.

- In versions prior to Cisco IOS XR Release 6.3.3, 6.4.x and 6.5.1, use the **install update** command:

```
install update source <source path> <Golden-ISO-name> replace
```
- In Cisco IOS XR Release 6.5.2 and later, use the **install replace** command.

```
install replace <absolute-path-of-Golden-ISO>
```



Note The command is supported only with GISO, but not with .mini and .rpm packages directly.

Procedure

Step 1 `install replace <GISO-location> [commit | noprompt]`

Example:

```
Router#install replace harddisk:/<giso-image>.iso
+++++
Install operation 11 started by root:
exec-timeout is suspended.
No install operation in progress at this moment
Label = More_Pkgs
ISO <giso-iso-image>.iso in input package list. Going to upgrade the system to
version <new-giso-image>.
System is in committed state
Current full-label: <giso-image>_R_Commit
```

```

Current only-label: R_Commit
Current label: R_Commit
Updating contents of golden ISO
Scheme : localdisk
Hostname : localhost
Username : None
SourceDir : /ws
Collecting software state..
Getting platform
Getting supported architecture
Getting active packages from XR
Getting inactive packages from XR
Getting list of RPMs in local repo
Getting list of provides of all active packages
Getting provides of each rpm in repo
Getting requires of each rpm in repo
Fetching .... <giso-image>.iso
Label within GISO: More_Pkgs
Skipping <platform>-mgbl-3.0.0.0-<release>.x86_64.rpm from GISO as it's active
Adding packages
    <platform>-golden-x-<release>-<Label>.iso
RP/0/RP0/CPU0:Jun 20 14:43:59.349 UTC: sdr_instmgr[1164]: %INSTALL-INSTMGR-2-OPERATION_SUCCESS
:

Install operation 12 finished successfully
Install add operation successful
Activating <platform>-golden-x-<release>-<Label>
Jun 20 14:44:05 Install operation 13 started by root:
    install activate pkg <platform>-golden-x-<release>-<Label> replace noprompt
Jun 20 14:44:05 Package list:
Jun 20 14:44:05     <platform>-golden-x-<release>-<Label>.iso
Jun 20 14:44:29 Install operation will continue in the background
exec-timeout is resumed.
Router# Install operation 13 finished successfully
Router: sdr_instmgr[1164]: %INSTALL-INSTMGR-2-OPERATION_SUCCESS :

Install operation 13 finished successfully

Router#install replace <path-to-image> <platform-name-golden-x-<version>-<label>.iso
Tue Mar 17 08:07:15.176 UTC
+++++
Mar 17 08:07:24 Install operation 46 started by root:
Mar 17 08:07:24   install replace source <path-to-image>
<platform-name-golden-x-<version>-<label>.iso
Mar 17 08:07:24 No install operation in progress at this moment
Mar 17 08:07:24 Checking system is ready for install operation
Mar 17 08:07:24 'install replace' in progress
Mar 17 08:07:24 Label = GISO_IMAGE_XRV9K_<version>
Mar 17 08:07:24 ISO xrv9k-goldenk9-x-<version>-<label>.iso in input package list. Going to
upgrade the system to version <new-version>
Mar 17 08:07:25 Scheme : http
Mar 17 08:07:25 Hostname : 10.x.x.x
Mar 17 08:07:25 Collecting software state..
Mar 17 08:07:25 Getting platform
Mar 17 08:07:25 Getting supported architecture
Mar 17 08:07:25 Getting active packages from XR
Mar 17 08:07:25 Getting inactive packages from XR
Mar 17 08:07:28 Getting list of RPMs in local repo
Mar 17 08:07:28 Getting list of provides of all active packages
Mar 17 08:07:28 Getting provides of each rpm in repo
Mar 17 08:07:28 Getting requires of each rpm in repo
Mar 17 08:07:36 Fetching .... xrv9k-goldenk9-x-<version>-<label>.iso
Mar 17 08:08:02 Adding packages
    xrv9k-goldenk9-x-<version>-<label>.iso

```

```

Router:Mar 17 08:09:03.487 UTC: sdr_instmgr[1281]: %INSTALL-INSTMGR-2-OPERATION_SUCCESS :
Install operation 47 finished successfully
Mar 17 08:09:03 Install add operation successful
Mar 17 08:09:08 Activating xrv9k-goldenk9-x-<version>-<label>
Mar 17 08:09:10 Install operation 46 started by root:
  install activate pkg xrv9k-goldenk9-x-<version>-<label> replace
Mar 17 08:09:10 Package list:
Mar 17 08:09:10      xrv9k-goldenk9-x-<version>-<label>
This install operation will reload the system, continue?
[yes/no]:[yes] yes
Mar 17 08:10:30 Install operation will continue in the background
Mar 17 08:10:30 Activate operation ID is: 46 for 'install source' ID:46

Router# Install operation 46 finished successfully
%INSTALL-INSTMGR-2-OPERATION_SUCCESS : Install operation 46 finished successfully
sdr_instmgr[1150]: %INSTALL-INSTMGR-2-SYSTEM_RELOAD_INFO : The whole system will be reloaded
to complete install operation 46

```

Note The md5sum of the GISO files is checked automatically during this operation to ensure that the image has not been corrupted. A mismatch in md5sum value indicates that the file is manipulated, and the operation fails.

For Cisco IOS XR Release 7.1.1, use the command `install replace harddisk:/<dir>/<giso-image>.iso`.

Important For versions earlier than Cisco IOS XR Release 6.5.2, use the following command:

For example,

```
Router#install update source harddisk:/ <giso-image>.iso replace
```

The version and label of the newly added GISO is compared with the version and label of the currently active version. If a mismatch is identified, a new partition is created and the full package is installed. After installation, the system reloads with the image and packages from the newly added GISO.

Note Activating or deactivating on a system that has a valid label invalidates the label. This action is irreversible. For example, running **show version** command on the system displays the label 6.3.3_633rev1005. If any SMU is activated or deactivated on the system, the label 633rev1005 is invalidated, and the `show version` command displays only 6.3.3 as the label.

Step 2 **show version**

Example:

```

Router#show version
Wed Jun 20 15:06:37.915 UTC
Cisco IOS XR Software, Version <new-giso-image>
Copyright (c) 2013-2018 by Cisco Systems, Inc.

Build Information:
Built By      : <user>
Built On     : <date>
Build Host   : <host-name>
Workspace    : <workspace-name>
Version      : <version>
Location     : <path>
Label       : <label-name>

cisco <platform> () processor
System uptime is 3 hours 51 minutes

```

The system loads with the image and packages from the newly added GISO.



CHAPTER 12

Disaster Recovery



Note This document is applicable only for the following variants of the Cisco NCS 540 router variants:

- N540-ACC-SYS
- N540X-ACC-SYS
- N540-24Z8Q2C-SYS

For information on booting the other Cisco NCS 540 router variants using iPXE or USB drive, see the *Setup Cisco NCS 540 Series Routers with XR7 OS* chapter.

The topics covered in this chapter are:

- [Boot using USB Drive, on page 119](#)
- [Boot the Router Using iPXE, on page 121](#)

Boot using USB Drive

The bootable USB drive is used to re-image the router for the purpose of system upgrade or boot the router in case of boot failure. The bootable USB drive can be created using a compressed boot file.

Create a Bootable USB Drive Using Compressed Boot File

A bootable USB drive is created by copying a compressed boot file into a USB drive. The USB drive becomes bootable after the contents of the compressed file are extracted.



Note In case of failure to read or boot from USB drive, ensure that the drive is inserted correctly. If the drive is inserted correctly and still fails to read from USB drive, check the contents of the USB on another system.

This task can be completed using Windows, Linux, or MAC operating systems available on your local machine. The exact operation to be performed for each generic step outlined here depends on the operating system in use.

Before you begin

- You have access to a USB drive with a storage capacity that is between 8GB (min) and 64GB (max). USB 2.0 and USB 3.0 are supported.



Caution We recommend that you do not use Kingston USB 3.0 memory cards with 64GB storage capacity as this might cause a hardware error.

- Copy the compressed boot file from the software download page at cisco.com to your local machine. The file name for the compressed boot file is in the format `ncs540-usb-boot-<release_number_zip>`.

Procedure

-
- Step 1** Connect the USB drive to your local machine and format it with FAT32 or MS-DOS file system using the Windows Operating System or Apple MAC Disk Utility.
- Step 2** Copy the compressed boot file to the USB drive.
- Step 3** Verify that the copy operation is successful. To verify, compare the file size at source and destination. Additionally, verify the MD5 checksum value.
- Step 4** Extract the content of the compressed boot file by unzipping it inside the USB drive. This converts the USB drive to a bootable drive.
- Note** The content of the zipped file ("EFI" and "boot" directories) should be extracted directly into root of the USB drive. If the unzipping application places the extracted files in a new folder, move the "EFI" and "boot" directories to root of the USB drive.
- Step 5** Eject the USB drive from your local machine.
-

What to do next

Use the bootable USB drive to boot the router or upgrade its image.

Boot the Router Using the Bootable USB Drive

Before you begin

The router can be booted using an external bootable USB drive. This might be required when the router is unable to boot from the installed image. A boot failure may happen when the image gets corrupted. During the USB boot process, the router gets reimaged with the version available on the USB drive.

Create a bootable USB drive. See [Create a Bootable USB Drive Using Compressed Boot File](#).

Procedure

-
- Step 1** Plug in the bootable USB drive with the required image to an Active RP USB port on the router.
- Step 2** Use one of the two methods to boot the router from the USB:

- Method 1

Perform the following steps when you are unable to access the router console:

- As the router reloads, you must press the ESC key to enter the **Boot Manager** window. A message, **Esc is pressed. Go to boot options.** is displayed.
- In the next screen, select **Boot Manager**.
- In the **Boot Manager** screen, select the USB drive from the list of boot devices and press **Enter**.

```
Cisco BIOS Setup Utility - Copyright (C) 2019 Cisco Systems, Inc
```

```
Boot Override
UEFI: Micron_M600_MTFDDAT064MBF, Partition 4
UEFI: Built-in iPXE
UEFI: Built-in Shell
UEFI: Built-in Grub
EFI USB Device (Sandisk)
UEFI: IPv4 0 Intel® I210 Gigabit Network Con
UEFI: IPv4 0 Intel® Ethernet Connection x552
UEFI: IPv4 1 Intel® Ethernet Connection x552
UEFI: IPv4 2 Intel® Ethernet Connection x552
UEFI: IPv4 3 Intel® Ethernet Connection x552
```

The router boots the image from the USB drive, and installs the image onto the hard disk. The router boots from the hard disk after the installation is successful.

- Method 2

USB based image boot can also be used when the router needs to be clean booted with a new image version.

- At the **Sysadmin VM** prompt, execute the **hw-module location all bootmedia usb reload** command.

The router boots the image from the USB drive, and installs the image onto the hard disk. After image installation is successful, the router automatically boots from this newly installed image on the hard disk.

Note Clean boot results in previous logs, image, and config being removed. No user intervention is required for selecting the USB boot device during the boot to initiate the USB based recovery.

Step 3 After the booting is completed, specify the root-system **username** and **password**.

Boot the Router Using iPXE

iPXE is a pre-boot execution environment that is included in the network card of the management interfaces and works at the system firmware (UEFI) level of the router. iPXE is used to re-image the system, and boot the router in case of boot failure or in the absence of a valid bootable partition. iPXE downloads the ISO image, proceeds with the installation of the image, and finally bootstraps inside the new installation.

iPXE acts as a boot loader and provides the flexibility to choose the image that the system will boot based on the Platform Identifier (PID), the Serial Number, or the management mac-address. iPXE must be defined in the DHCP server configuration file.

Zero Touch Provisioning

Zero Touch Provisioning (ZTP) helps in auto provisioning after the software installation of the router using iPXE.

ZTP auto provisioning involves:

- **Configuration:** Downloads and executes the configuration file. The first line of the file must contain `!! IOS XR` for ZTP to process the file as a configuration.
- **Script:** Downloads and executes the script files. The script files include a programmatic approach to complete a task. For example, scripts created using IOS XR commands to perform patch upgrades. The first line of the file must contain `#!/bin/bash` or `#!/bin/sh` for ZTP to process the file as a script.

Setup DHCP Server

A DHCP server must be configured for IPv4, IPv6 or both communication protocols. The following example shows ISC-DHCP server running on Linux system.

Before you begin

- Consult your network administrator or system planner to procure IP addresses and a subnet mask for the management interface.
- Physical port Ethernet 0 on RP is the management port. Ensure that the port is connected to management network.
- Enable firewall to allow the server to process DHCP packets.
- For DHCPv6, a Routing advertisement (RA) message must be sent to all nodes in the network that indicates which method to use to obtain the IPv6 address. Configure Router-advertise-daemon (radvd, install using `yum install radvd`) to allow the client to send DHCP request. For example:

```
interface eth3
{
    AdvSendAdvert on;
    MinRtrAdvInterval 60;
    MaxRtrAdvInterval 180;
    AdvManagedFlag on;
    AdvOtherConfigFlag on;
    prefix 2001:1851:c622:1::/64
    {
        AdvOnLink on;
        AdvAutonomous on;
        AdvRouterAddr off;
    };
};
```

- The HTTP server can be in the same server as that of the DHCP server, or can be on a different server. After the IP address is assigned from DHCP server, the router must connect to the HTTP server to download the image.

Procedure

Step 1 Create the `dhcpd.conf` file (for IPv4, IPv6 or both communication protocols), `dhcpv6.conf` file (for IPv6) or both in the `/etc/` or `/etc/dhcp` directory. This configuration file stores the network information such as the path to the script, location of the ISO install file, location of the provisioning configuration file, serial number, MAC address of the router.

Step 2 Test the server once the DHCP server is running. For example, for IPv4:

- Use MAC address of the router:

Note Using the `host` statement provides a fixed address that is used for DNS, however, verify that option 77 is set to iPXE in the request. This option is used to provide the bootfile to the system when required.

Ensure that the above configuration is successful.

- Use serial number of the router: The serial number of the router is derived from the BIOS and is used as an identifier.

Step 3 Restart DHCP.

```
killall dhcpd
/usr/sbin/dhcpd -f -q -4 -pf /run/dhcp-server/dhcpd.pid
-cf /etc/dhcp/dhcpd.conf ztp-mgmt &
```

Example

The example shows a sample `dhcpd.conf` file:

```
allow bootp;
allow booting;
ddns-update-style interim;
option domain-name "cisco.com";
option time-offset -8;
ignore client-updates;
default-lease-time 21600;
max-lease-time 43200;
option domain-name-servers <ip-address-server1>, <ip-address-server2>;
log-facility local0;
:
subnet <subnet> netmask <netmask> {
    option routers <ip-address>;
    option subnet-mask <subnet-mask>;
    next-server <server-addr>;
}
:
host <hostname> {
    hardware ethernet e4:c7:22:be:10:ba;
    fixed-address <address>;
    filename "http://<address>/<path>/<image.bin>";
}
```

The example shows a sample `dhcpd6.conf` file:

```
option dhcp6.name-servers <ip-address-server>;
option dhcp6.domain-search "cisco.com";
```

```

dhcpv6-lease-file-name "/var/db/dhcpd6.leases";
option dhcp6.info-refresh-time 21600;
option dhcp6.bootfile-url code 59 = string;
subnet6 <subnet> netmask <netmask> {
    range6 2001:1851:c622:1::2 2001:1851:c622:1::9;
    option dhcp6.bootfile-url "http://<address>/<path>/<image.bin>";
}

```

What to do next

Invoke ZTP.

Invoke ZTP

ZTP runs within the XR namespace, and within the global VPN routing/forwarding (VRF) namespace for management interfaces and line card interfaces.

Before you begin

Ensure that a DHCP server is setup. For more information, see [Setup DHCP Server, on page 122](#).

Procedure

Edit the dhcpd.conf file to utilize the capabilities of ZTP.

The following example shows a sample DHCP server configuration including iPXE and ZTP:

```

host <host-name>
{
hardware ethernet <router-serial-number or mac-id>;
fixed-address <ip-address>;
    if exists user-class and option user-class = "iPXE" {
        # Image request, so provide ISO image
        filename "http://<ip-address>/<directory>/" ;
    } else
    {
        # Auto-provision request, so provide ZTP script or configuration
        filename "http://<ip-address>/<script-directory-path>/" ;
        #filename "http://<ip-address>/<script-directory-path>/
    }
}

```

Note Either the ZTP .script file or the .cfg file can be provided at a time for auto-provisioning.

With this configuration, the system boots using during installation, and then download and execute when XR VM is up.

Invoke ZTP Manually

ZTP can also be invoked manually with the modified one touch provisioning approach. The process involves:

Before you begin

A configuration file can be used to specify a list of interfaces that will be brought up in XR and DHCP will be invoked on. /pkg/etc/ztp.config is a platform specific file that allows the platform to specify which if any additional interfaces will be used.

```
#
# List all the interfaces that ZTP will consider running on. ZTP will attempt
# to bring these interfaces. At which point dhclient will be able to use them.
#
# Platforms may add dynamically to this list.
#
#ZTP_DHCLIENT_INTERFACES=" \
#   Gi0_0_0_0 \
#"
...
```

Procedure

- Step 1** Boot the router.
- Step 2** Login manually.
- Step 3** Enable interfaces.
- Step 4** Invoke a new ZTP DHCP session manually using the **ztp initiate** command.

```
Router#ztp initiate
```

For example, to send DHCP requests on the GigabitEthernet interface 0/0/0/0, run the command:

```
Router#ztp initiate debug verbose interface GigabitEthernet0/0/0/0
```

ZTP will run on the management port by default unless the platform has configured otherwise. The logs will be logged in /disk0:/ztp/ztp/log location.

Note To configure a 40G interface into 4 separate 10G interfaces, use the **ztp breakout nosignal-stay-in-breakout-mode** command.

Note To enable dataport breakouts and invoke DHCP sessions on all dataport and line card interfaces that are detected, use the **ztp breakout** command.

```
Router#ztp breakout debug verbose
Router#ztp initiate dataport debug verbose
Invoke ZTP?(this may change your configuration) [confirm] [y/n]:
```

To override the prompt:

```
Router#ztp initiate noprompt
Invoke ZTP?(this may change your configuration) [confirm] [y/n]:
```

ZTP will now run in the background.
Please use "show logging" or look at /disk0:/ztp/ztp/log to check progress.

ZTP runs on the management interfaces that are UP by default.

Step 5 To terminate the ZTP session, use the **ztp terminate** command.

What to do next

Boot the router using iPXE.

Boot the Router Using iPXE

Before you use the iPXE boot, ensure that:

- DHCP server is set and is running.
- You have logged in to the System Admin console using the **admin** command.

Run the following command to invoke the iPXE boot process to reimage the router:

```
hw-module location all bootmedia network reload
```



Note For the following variants of Cisco NCS 540 series routers, use the **reload bootmedia network location all noprompt** command for iPXE boot process:

- N540-28Z4C-SYS-A/D
- N540X-16Z4G8Q2C-A/D
- N540-12Z20G-SYS-A/D
- N540X-12Z16G-SYS-A/D
- N540X-6Z18G-SYS-A/D
- N540X-8Z16G-SYS-A/D
- N540-FH-CSR-SY

Example:

```
sysadmin-vm:0_RP0# hw-module location all bootmedia network reload
Wed Dec 23 15:29:57.376 UTC
Reload hardware module ? [no,yes]
```



Note The following variants of Cisco NCS 540 series routers do not support the `sysadmin-vm:0_RP0` prompt:

- N540-28Z4C-SYS-A/D
- N540X-16Z4G8Q2C-A/D
- N540-12Z20G-SYS-A/D
- N540X-12Z16G-SYS-A/D
- N540X-6Z18G-SYS-A/D
- N540X-8Z16G-SYS-A/D
- N540-FH-CSR-SY

The following example shows the output of the command:

```
iPXE 1.0.0+ (3e573) -- Open Source Network Boot Firmware -- http://ipxe.org
Features: DNS HTTP TFTP VLAN EFI ISO9660 NBI Menu
Trying net0...
net0: c4:72:95:a6:14:e1 using dh8900cc on PCI01:00.1 (open)
[Link:up, TX:0 TXE:0 RX:0 RXE:0]
Configuring (net0 c4:72:95:a6:14:e1)..... Ok << Talking to DHCP/PXE server to
  obtain network information
net0: 10.37.1.101/255.255.0.0 gw 10.37.1.0
net0: fe80::c672:95ff:fea6:14e1/64
net0: 2001:1800:5000:1:c672:95ff:fea6:14e1/64 gw fe80::20c:29ff:fefb:b9fe
net1: fe80::c672:95ff:fea6:14e3/64 (inaccessible)
Next server: 10.37.1.235
Filename: http://10.37.1.235/

http://10.37.1.235/ ... 58% << Downloading file as indicated by DHCP/PXE server to boot
install image
```

Disaster Recovery Using Manual iPXE Boot

Manually booting the system using iPXE can be used to reinstall a clean system in case of a corrupt install or recover lost password. However, all the disks will be wiped out and the configuration will be removed.

Procedure

-
- Step 1** Use the arrow keys (up, down) to select **UEFI: Built-in EFI IPXE** to enable iPXE boot. The iPXE boot launches the auto boot.
- To manually boot using iPXE, press **Ctrl-B** keys to reach the iPXE command line.
- Step 2** Identify the management interface. If the management interface is connected properly and is UP, it displays `Link:up` in the following output:

Example:

Choose the net interface that shows `Link:up`. If there are multiple interfaces that show the status as UP, identify the management interface with MAC address.

iPXE also supports HTTP, TFTP and FTP. For more information, see <https://ipxe.org/cmd>.

After installing the mini ISO image, the system reboots. After successful reboot, specify the root username and password. Once you get back to the XR prompt, you can load the configuration and install remaining packages.



PART II

Setup System and Install IOS XR7 Software

- [Setup Cisco NCS 540 Series Routers with XR7 OS, on page 131](#)
- [Install Cisco IOS XR7 on NCS 540 Series Routers, on page 149](#)



CHAPTER 13

Setup Cisco NCS 540 Series Routers with XR7 OS

The following variants of Cisco NCS 540 series routers run on XR7 OS:

- N540X-16Z4G8Q2C-A/D
- N540-12Z20G-SYS-A/D
- N540X-12Z16G-SYS-A/D
- N540X-6Z18G-SYS-A/D
- N540X-8Z16G-SYS- A/D
- N540X-4Z14G2Q -A/D
- N540-24Q8L2DD-SYS
- N540-6Z14S-SYS-D
- N540X-16Z8Q2C-D
- N540-28Z4C-SYS-A/D
- N540-FH-CSR-SYS
- N540-FH-AGG-SYS

XR7 OS provides significant architectural enhancements to Cisco IOS XR in these areas:

- **Modularity:** Decoupled hardware and software; disintegrated software with the flexibility to consume software packages based on requirement
- **Programmability:** Cloud scale enhancement with model-driven APIs at all layers
- **Manageability:** Simplified software management and installation that is based on Linux tools

For more information about installing the router, see *Cisco NCS 540 Series Hardware Installation Guide*.

This document helps you set up the Cisco NCS 540 series router. You will bring-up the router, run a health check of the system, create user profiles, and assign privileges.

- [Bring-up the Cisco NCS 540 Series Router, on page 132](#)
- [Perform Preliminary Checks with Cisco NCS 540 Series Router, on page 139](#)
- [Create Users and Assign Privileges on the Cisco NCS 540 Series Router, on page 145](#)

Bring-up the Cisco NCS 540 Series Router

Connect to the console port on a Route Processor (RP) of the router, and power ON the router. By default, this console port connects to the XR console. If necessary, after configuration, establish subsequent connections through the management port.

The following table shows the console settings:

Table 10: Console Settings

Baud rate (in bps)	Parity	Stop bits	Data bits
115200	None	2	8

The baud rate is set by default and cannot be changed.

The router can be accessed using remote management protocols, such as SSH, Telnet, SCP and FTP. SSH is included in the software image by default, but telnet is not part of the software image. You must manually install the telnet optional package to use it.

After booting is complete, you must create a username and password. This credential is used to log on to the XR console, and get to the router prompt.

You can start or stop the console by using the following keyboard shortcuts:

- To start the console, press Ctrl + q.
- To stop the console, press Ctrl + s.

Note that by using Ctrl + s, the console output will be locked and you will need to initiate a Ctrl + q sequence to restore the console prompt.

The router completes the boot process using the pre-installed operating system (OS) image. If no image is available within the router, the router can be booted using iPXE boot or an external bootable USB drive.

Boot the Cisco NCS 540 Series Router Using Manual iPXE

Manually boot the router using iPXE if the router fails to boot when powered ON. An alternate method is to [Boot the Cisco NCS 540 Series Router Using USB Drive](#).

iPXE is a pre-boot execution environment in the network card of the management interfaces. It works at the system firmware (UEFI) level of the router. iPXE boot re-images the system, boots the router in case of a boot failure, or in the absence of a valid bootable partition. iPXE downloads the ISO image, installs the image, and finally bootstraps inside the new installation.

You need a server running HTTPS, HTTP, or TFTP. Bring-up the PXE prompt using the following steps:

Procedure

-
- Step 1** Power ON the router.
- Step 2** Press Esc or Del keys continuously (quick and repeated press and release) to pause the boot process, and get to the BIOS menu.

- Step 3** Select `Boot Manager`, and then select `Built-in iPXE` option.
- Step 4** When PXE boot starts reaching for a PXE server, press **Ctrl+B** keys to break into the PXE prompt.
- Step 5** Add the following configuration for the router. This is required for the router to connect with the external server to download, and install the image. You can use HTTP, HTTPS or TFTP server.

Example:

```
iPXE> ifopen net0 #Open the interface connecting outside world
iPXE> set net0/ip 10.0.0.2 #Configure the ip address of your router

iPXE> set net0/gateway 10.0.0.1 #configure the GW
iPXE> set net0/netmask 255.0.0.0 #Configure the Netmask
iPXE> ping 10.0.0.1 #Check you can reach GW
iPXE> ping 192.0.2.0 #check you can reach to your server running tftp or
http or https
iPXE> boot http://192.0.2.0/<directory-path>5401-x64.iso #Copy the image on the
http/https/tftp server in any path and then point to download the image from there.
```

Note To rectify errors while typing the command, use **Ctrl+H** keys to delete a character.

If a PXE server is configured to run a DHCP server, it assigns an IP address to the Ethernet Management interface of the router. This provides a channel to download the image that is required to re-image a router in case of a boot failure.

```
Router#reload bootmedia network location all
Proceed with reload? [confirm]
```

Note Use the **force** option to perform an ungraceful reload of the specified location or hardware module. When **force** option is used along with the **all** location, the chassis undergoes an ungraceful reload. Use the **noprompt** option to avoid the prompt to confirm the operation. The **force** option is not recommended, and should not be used during regular operations.

Boot the Cisco NCS 540 Series Router Using USB Drive

Boot the router using USB drive if the router fails to boot when powered ON. An alternate method is to [Boot the Cisco NCS 540 Series Router Using Manual iPXE](#).

Before you begin

Have access to a USB drive with a storage capacity that is between 8GB (min) and 32 GB (max). USB 2.0 and USB 3.0 are supported.



Caution We recommend that you do not use Kingston USB 3.0 memory cards with 64GB storage capacity as this might cause a hardware error.



Caution Booting your router using USB drive deletes all the configuration from the hard disk. Ensure that you take a backup of your current router configuration before proceeding with the USB boot.



Note Use this procedure only on the active RP; the standby RP must either be powered OFF or removed from the chassis. After the active RP is installed with images from the USB drive, insert or power ON the standby RP as appropriate.

Procedure

Step 1 Copy the bootable file to a USB disk.

A bootable USB drive is created by copying a compressed boot file into a USB drive. The USB drive becomes bootable after the contents of the compressed file are extracted.

Note If you are unable to boot from a USB drive, remove and insert the drive again. If the drive is inserted correctly, and still fails to read from the USB drive, check the contents of the USB on another system.

This task can be completed using Windows, Linux, or MAC operating systems available on your local machine.

- a) Connect the USB drive to your local machine and format it with FAT32 or MS-DOS file system using the Windows Operating System or Apple MAC Disk Utility. To check if the disk is formatted as FAT32, right click on the USB disk, and view the properties.
- b) Copy the compressed boot file in .zip format from the image file to the USB drive. This .zip file can be downloaded from the Cisco Software Download center.
- c) Verify that the copy operation is successful. To verify, compare the file size at source and destination. Additionally, verify the MD5 checksum value.
- d) Extract the contents of the compressed boot file by unzipping it inside the USB drive. This converts the USB drive to a bootable drive.

Note Extract the contents of the zipped file ("EFI" and "boot" directories) directly into the root folder of the USB drive. If the unzipping application places the extracted files in a new folder, move the "EFI" and "boot" directories to the root folder of the USB drive.

- e) Eject the USB drive from your local machine.

Step 2 Use the bootable USB drive to boot the router or upgrade its image using one of the following methods:

Note Insert the USB drive in the USB port of the ACTIVE RP.

- **Boot menu**

Figure 12: Connecting the USB Console Cable to the Route Processor

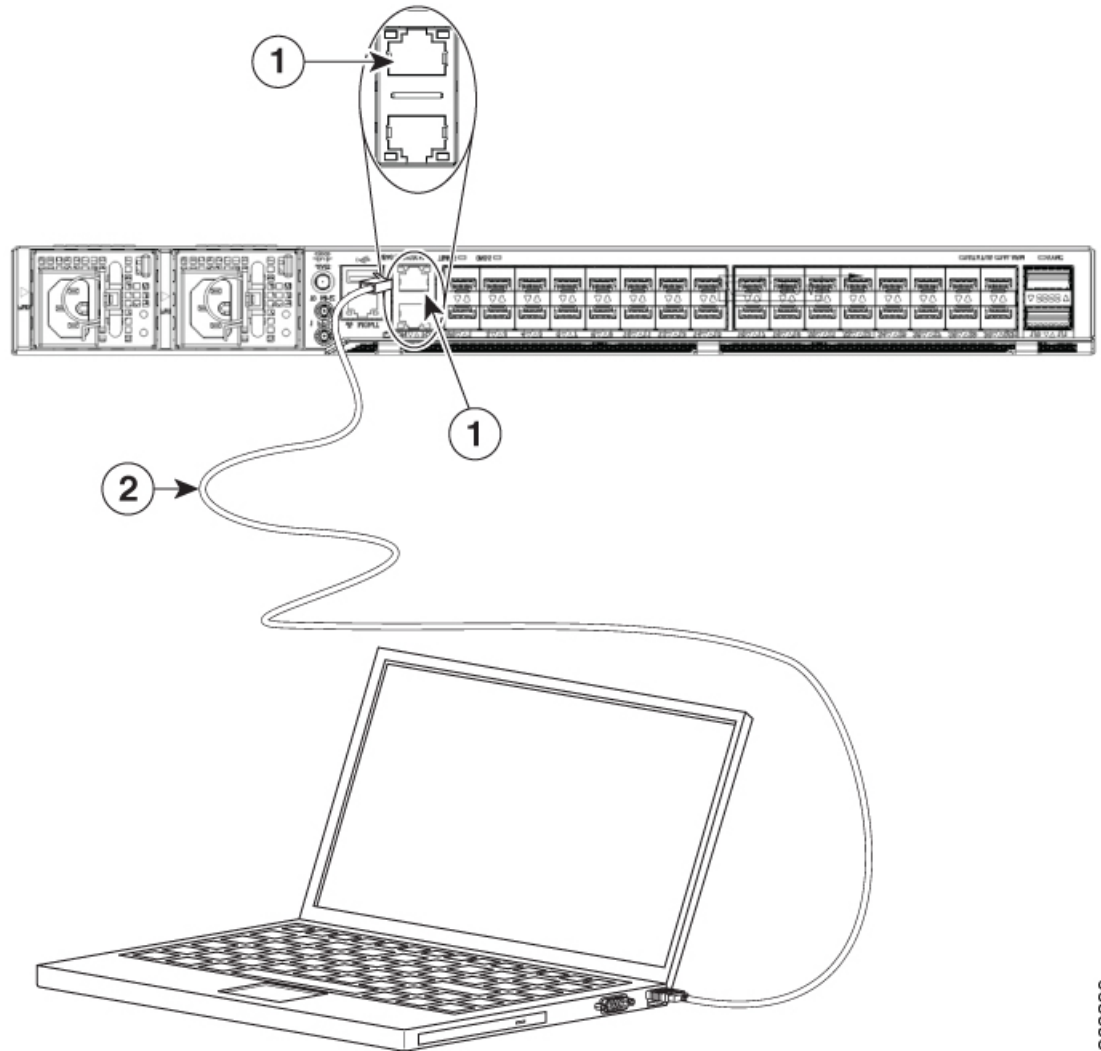

1	RJ45 Port	2	USB Type-A console cable
---	-----------	---	--------------------------

- a. Insert the USB drive, and connect to the console.
- b. Power ON the router.
- c. Press Esc or Del to pause the boot process, and get the RP to the BIOS menu.
- d. Select `Boot Manager`, and then select the `USB` option from the boot menu.

```
Cisco BIOS Setup Utility - Copyright (C) 2019 Cisco Systems, Inc
```

```
Boot Override
UEFI: Micron_M600_MTFDDAT064MBF, Partition 4
UEFI: Built-in iPXE
UEFI: Built-in Shell
UEFI: Built-in Grub
UEFI: USB Flash Memory1.00, Partition 1
```

368290

The system boots the image from the USB drive, and installs the image onto the hard disk. The router boots from the hard disk after installation.

• XR CLI

Use this method if you can access the XR prompt.

- a. Insert the USB device in the active RP.
- b. Access the XR prompt and run the command:

```
Router#reload bootmedia usb noprompt

Welcome to GRUB!!
Verifying (hd0,msdos1)/EFI/BOOT/grub.cfg...
(hd0,msdos1)/EFI/BOOT/grub.cfg verified using Pkcs7 signature.
Loading Kernel..
Verifying (loop)/boot/bzImage...
(loop)/boot/bzImage verified using attached signature.
Loading initrd..
Verifying (loop)/boot/initrd.img
```

Use the **force** option to perform an ungraceful reload of the specified location or hardware module. When **force** option is used along with the **all** location, the chassis undergoes an ungraceful reload. Use the **noprompt** option to avoid the prompt to confirm the operation. The **force** option is not recommended, and should not be used during regular operations.

The system boots the image from the USB and installs the image onto the hard disk. The router boots from the hard disk after installation.

Note Execute the `install commit` command before proceeding to the next install iteration, while performing cyclic upgrade and downgrade tests.

Configure the Management Port on the Cisco NCS 540 Series Router

To use the management port for system management and remote communication, you must configure an IP address and a subnet mask for the Management Ethernet interface.



Note We recommend that you use a Virtual Private Network (VPN) routing and the forwarding (VRF) on the Management Ethernet interface.

Before you begin

- Consult your network administrator or system planner to procure IP addresses and a subnet mask for the management interface.
- Physical port Ethernet 0 on RP is the management port. Ensure that the port is connected to the management network.

Procedure

- Step 1** Configure a VRF.
- Example:**
- ```
Router#conf t
Router(config)#vrf <vrf-name>
Router(config-vrf)#exit
```
- Step 2** Enter interface configuration mode for the management interface of the RP.
- Example:**
- ```
Router(config)#interface mgmtEth 0/RP0/CPU0/0
```
- Step 3** Assign an IP address and a subnet mask to the interface.
- Example:**
- ```
Router(config-if)#ipv4 address 10.10.10.1/8
```
- Step 4** Configure the Management Ethernet interface under the VRF.
- Example:**
- ```
Router(config-if)#vrf <vrf-name>
```
- Step 5** Exit the management interface configuration mode.
- Example:**
- ```
Router(config-if)#exit
```
- Step 6** Assign a virtual IP address and a subnet mask to the interface. The virtual address is primarily used for out-of-band management over the Management Ethernet interface.
- Example:**
- ```
Router(config)#ipv4 virtual address vrf <vrf-name> 10.10.10.1/8
```
- Step 7** Place the interface in UP state.
- Example:**
- ```
Router(config)#no shutdown
```
- Step 8** Specify the IP address of the default-gateway to configure a static route; this is used for communications with devices on other networks.
- Example:**
- ```
Router(config)#router static vrf <vrf-name> address-family ipv4 unicast 0.0.0.0/0 10.10.10.1
```
- Step 9** Commit the configuration.
- Example:**
- ```
Router(config)#commit
```
- Step 10** Connect to the management port to the ethernet network. With a terminal emulation program, establish a SSH or telnet connection to the management interface port using its IP address.
-

## Synchronize Router Clock with NTP Server

Synchronize the XR clock with that of an NTP server to avoid a deviation from true time.

NTP uses the concept of a `stratum` to describe how many NTP hops away a machine is from an authoritative time source. A `stratum 1` time server typically has an authoritative time source (such as a radio or atomic clock, or a GPS time source) directly attached to the server. A `stratum 2` time server receives its time through NTP from a `stratum 1` time server, and so on.



---

**Note** The Cisco implementation of NTP does not support `stratum 1` service.

---

### Before you begin

Configure and connect to the management port.

### Procedure

---

**Step 1** Enter the XR configuration mode.

**Example:**

```
Router#configure
```

**Step 2** Synchronize the console clock with the specified sever.

**Example:**

```
Router(config)#ntp server <NTP-source-IP-address>
```

The NTP source IP address can either be an IPv4 or an IPv6 address. For example:

IPv4:

```
Router(config)#ntp server 192.0.2.0
```

IPv6:

```
Router(config)#ntp server 2001:DB8::1
```

**Note** The NTP server can also be reachable through a VRF if the Management Ethernet interface is in a VRF.

**Step 3** Commit the configuration.

**Example:**

```
Router(config-ntp)#commit
```

**Step 4** Verify that the clock is synchronised with the NTP server.

**Example:**

```
Router#show ntp status
```

```
Clock is synchronized, stratum 3, reference is 192.0.2.0
nominal freq is 1000000000.0000 Hz, actual freq is 1000000000.0000 Hz, precision is 2**24
reference time is E12B1B02.8BB13A2F (08:42:42.545 UTC Tue Sep 17 2019)
clock offset is -3.194 msec, root delay is 4.949 msec
root dispersion is 105.85 msec, peer dispersion is 2.84 msec
loopfilter state is 'FREQ' (Drift being measured), drift is 0.000000000 s/s
```

```
system poll interval is 64, last update was 124 sec ago
authenticate is disabled
```

---

## Perform Preliminary Checks with Cisco NCS 540 Series Router

After successfully logging into the console, you must perform some preliminary checks to verify the correctness of the default setup. Correct any issues that arise before proceeding with further configurations.

### Verify Software Version on Cisco NCS 540 Series Router

The router is shipped with the Cisco IOS XR software pre-installed. Verify that the latest version of the software is installed. If a newer version is available, perform a system upgrade. Installing the newer version of the software provides the latest feature set on the router.

You can view the overview of the running software. This includes the following information:

- Image name and version
- User who built the image
- Time the image was built
- Build workspace
- Build host
- ISO label



---

**Note** If any modifications are made to the running software on the booted ISO, only the IOS XR version is displayed in the label field and not the label included in the ISO.

---

- Copyright information
- Hardware information

Display the version of the Cisco IOS XR software, and its various software components that are installed on the router.

```
Router#show version
Cisco IOS XR Software, Version 7.0.1 LNT
Copyright (c) 2013-2019 by Cisco Systems, Inc.
```

```
Build Information:
Built By : xyz
Built On : Sat Jun 29 22:45:27 2019
Build Host : iox-lnx-064
Workspace : ../7.0.1/NCS540L/ws/
Version : 7.0.1
Label : 7.0.1
```

```
cisco NCS540L
System uptime is 41 minutes
```

## Verify Status of Hardware Modules on Cisco NCS 540 Series Router

Hardware modules such as RPs, LCs, fan trays, and power modules are installed on the router. The firmware on various hardware components of the router must be compatible with the Cisco IOS XR image installed. Incompatibility may cause the router to malfunction. Verify that all hardware and firmware modules are installed correctly and are operational.

### Before you begin

Ensure that all required hardware modules are installed on the router.

### Procedure

**Step 1** View the status of the system.

#### Example:

```
Router#show platform
Node Type State Config state

0/RP0/CPU0 N540X-16Z4G8Q2C-A (Active) IOS XR RUN NSHUT
0/FT0 N540-X-BB-FAN OPERATIONAL NSHUT
```

**Step 2** View the list of hardware and firmware modules detected on the router.

#### Example:

```
Router#show hw-module fpd
 FPD Versions
 =====
Location Card type HWver FPD device ATR Status Running Programd

0/RP0/CPU0 N540-28Z4C-SYS-A 0.1 IoFpga CURRENT 1.29 1.29
0/RP0/CPU0 N540-28Z4C-SYS-A 0.1 IoFpgaGolden B CURRENT 1.29 1.29
0/RP0/CPU0 N540-28Z4C-SYS-A 0.1 Primary-BIOS S CURRENT 1.09 1.09
0/RP0/CPU0 N540-28Z4C-SYS-A 0.1 StdbyFpga S CURRENT 0.29 0.29
0/RP0/CPU0 N540-28Z4C-SYS-A 0.1 StdbyFpgaGolden BS NEED UPGD 0.00
0/RP0/CPU0 N540-28Z4C-SYS-A 0.1 TamFw S NEED UPGD 4.09 2.04
0/RP0/CPU0 N540-28Z4C-SYS-A 0.1 TamFwGolden BS NEED UPGD 0.00

Router#show hw-module fpd
Fri May 28 13:53:23.325 UTC
Auto-upgrade:Disabled
Attribute codes: B golden, P protect, S secure
 FPD Versions
 =====
Location Card type HWver FPD device ATR Status Running Programd Reload Loc

0/RP0/CPU0 N540X-6Z18G-SYS-A 0.2 IoFpga CURRENT 0.13 0.13 0/RP0
0/RP0/CPU0 N540X-6Z18G-SYS-A 0.2 IoFpgaGolden B NEED UPGD 0.00 0/RP0
0/RP0/CPU0 N540X-6Z18G-SYS-A 0.2 Prim-BootLoader CURRENT 10.07 10.07 0/RP0
0/RP0/CPU0 N540X-6Z18G-SYS-A 0.2 StdbyFpga S CURRENT 0.28 0.28 0/RP0
0/RP0/CPU0 N540X-6Z18G-SYS-A 0.2 StdbyFpgaGolden BS NEED UPGD 0.25 0/RP0
0/RP0/CPU0 N540X-6Z18G-SYS-A 0.2 TamFw S CURRENT 6.05 6.05 0/RP0
0/RP0/CPU0 N540X-6Z18G-SYS-A 0.2 TamFwGolden BS CURRENT 6.05 6.05 0/RP0
```

From the result, verify that all hardware modules that are installed on the chassis are listed. If a module is not listed, it indicates that the module is malfunctioning, or is not installed properly. Remove and reinstall that hardware module.

In the preceding output, some of the significant fields are:

- FPD Device—Name of the hardware component, such as IO FPGA, IM FPGA, or BIOS

**Note** Golden FPDs are not field upgradable.

- Status—Upgrade status of the firmware. The different states are:

| Status    | Description                                                                                                                        |
|-----------|------------------------------------------------------------------------------------------------------------------------------------|
| CURRENT   | The firmware version is the latest version.                                                                                        |
| READY     | The firmware of the FPD is ready for an upgrade.                                                                                   |
| NOT READY | The firmware of the FPD is not ready for an upgrade.                                                                               |
| NEED UPGD | A newer firmware version is available in the installed image. We recommend that you to perform an upgrade of the firmware version. |
| RLOAD REQ | The upgrade is complete, and the ISO image requires a reload.                                                                      |
| UPGD DONE | The firmware upgrade is successful.                                                                                                |
| UPGD FAIL | The firmware upgrade has failed.                                                                                                   |
| UPGD PREP | The FPD firmware is preparing for upgrade.                                                                                         |
| BACK IMG  | The firmware is corrupt. Reinstall the firmware.                                                                                   |
| UPGD SKIP | The upgrade is skipped because the installed firmware version is higher than the one available in the image.                       |

- Running—Current version of the firmware running on the FPD
- Programd—Version of the FPD programmed on the module

**Step 3** If necessary, upgrade the required firmware.

**Example:**

```
Router#upgrade hw-module location all fpd all
```

Alarms are created showing all modules that needs to be upgraded.

```
Active Alarms
```

| Location | Severity | Group     | Set Time                | Description                                           |
|----------|----------|-----------|-------------------------|-------------------------------------------------------|
| 0/6/CPU0 | Major    | FPD_Infra | 09/16/2019 12:34:59 UTC | One Or More FPDs Need Upgrade Or Not In Current State |

## Verify Interface Status on the Cisco NCS 540 Series Router

```

0/10/CPU0 Major FPD_Infra 09/16/2019 12:34:59 UTC One Or More FPDs Need
Upgrade Or Not In Current State
0/RP0/CPU0 Major FPD_Infra 09/16/2019 12:34:59 UTC One Or More FPDs Need
Upgrade Or Not In Current State
0/RP1/CPU0 Major FPD_Infra 09/16/2019 12:34:59 UTC One Or More FPDs Need
Upgrade Or Not In Current State
0/FC0 Major FPD_Infra 09/16/2019 12:34:59 UTC One Or More FPDs Need
Upgrade Or Not In Current State
0/FC1 Major FPD_Infra 09/16/2019 12:34:59 UTC One Or More FPDs Need
Upgrade Or Not In Current State

```

**Note** BIOS and IOFPGA upgrades require a power cycle of the router for the new version to take effect.

**Step 4** After the modules are upgraded verify the status of the modules.

**Example:**

```
Router#show hw-module fpd
```

```

 FPD Versions
 =====
Location Card type HWver FPD device ATR Status Running Programd

0/RP0/CPU0 N540-28Z4C-SYS-A 0.1 IoFpga CURRENT 1.29 1.29
0/RP0/CPU0 N540-28Z4C-SYS-A 0.1 IoFpgaGolden B CURRENT 1.29 1.29
0/RP0/CPU0 N540-28Z4C-SYS-A 0.1 Primary-BIOS S CURRENT 1.09 1.09
0/RP0/CPU0 N540-28Z4C-SYS-A 0.1 StdbyFpga S CURRENT 0.29 0.29
0/RP0/CPU0 N540-28Z4C-SYS-A 0.1 StdbyFpgaGolden BS RLOAD REQ 2.04 0.01
0/RP0/CPU0 N540-28Z4C-SYS-A 0.1 TamFw S RLOAD REQ 2.04 2.05
0/RP0/CPU0 N540-28Z4C-SYS-A 0.1 TamFwGolden BS RLOAD REQ 2.04 0.01

```

The status of the upgraded nodes show that a reload is required.

**Step 5** Reload the individual nodes that required an upgrade.

**Example:**

```
Router#reload location <node-location>
```

**Step 6** Verify that all nodes that required an upgrade show an updated status of `CURRENT` with an updated FPD version.

**Example:**

```
Router#show hw-module fpd
```

```

 FPD Versions
 =====
Location Card type HWver FPD device ATR Status Running Programd

0/RP0/CPU0 N540-28Z4C-SYS-A 0.1 IoFpga CURRENT 1.29 1.29
0/RP0/CPU0 N540-28Z4C-SYS-A 0.1 IoFpgaGolden B CURRENT 1.29 1.29
0/RP0/CPU0 N540-28Z4C-SYS-A 0.1 Primary-BIOS S CURRENT 1.09 1.09
0/RP0/CPU0 N540-28Z4C-SYS-A 0.1 StdbyFpga S CURRENT 0.29 0.29
0/RP0/CPU0 N540-28Z4C-SYS-A 0.1 StdbyFpgaGolden BS CURRENT 2.05 0.01
0/RP0/CPU0 N540-28Z4C-SYS-A 0.1 TamFw S CURRENT 2.05 2.05
0/RP0/CPU0 N540-28Z4C-SYS-A 0.1 TamFwGolden BS CURRENT 2.05 0.01

```

## Verify Interface Status on the Cisco NCS 540 Series Router

After the router has booted, all available interfaces must be discovered by the system. If interfaces are not discovered, it might indicate a malfunction in the unit.



## Procedure

View the interfaces discovered by the system.

### Example:

```
Router#show ipv4 interfaces brief
Interface IP-Address Status Protocol Vrf-Name

unassigned Shutdown Down default -----HundredGigE0/0/0/0
HundredGigE0/0/0/1 unassigned Shutdown Down default
HundredGigE0/0/0/2 unassigned Shutdown Down default
HundredGigE0/0/0/3 unassigned Shutdown Down default
HundredGigE0/0/0/4 unassigned Shutdown Down default
HundredGigE0/0/0/5 unassigned Shutdown Down default
HundredGigE0/0/0/6 unassigned Shutdown Down default
HundredGigE0/0/0/7 unassigned Shutdown Down default

<snip> -----TenGigE0/0/0/18/0
unassigned Up Up default
TenGigE0/0/0/18/1 unassigned Up Up default
TenGigE0/0/0/18/2 unassigned Up Up default
TenGigE0/0/0/18/3 unassigned Up Up default
MgmtEth0/RP0/CPU0/0 10.10.10.1 Up Up default
```

When a router is turned ON for the first time, all interfaces are in the `unassigned` state. Verify that the total number of interfaces displayed in the result matches with the actual number of interfaces present on the router, and that the interfaces are created according to the type of interface modules displayed in `show platform` command.

## Verify Node Status on Cisco NCS 540 Series Router

Each card on the router represents a node.

### Procedure

Verify the operational status of the node.

### Example:

```
Router#show platform
Node Type State Config state

0/RP0/CPU0 N540X-16Z4G8Q2C-A (Active) IOS XR RUN NSHUT
0/FT0 N540-X-BB-FAN OPERATIONAL NSHUT
```

Displays the status of nodes present in the chassis.

Verify that the software state of all RPs, LCs, and the hardware state of FCs, FTs, and power modules are listed, and their state is `OPERATIONAL`. This indicates that the XR console is operational on the cards.

The platform states are described in the following table:

| Card Type            | State                     | Description                                                                              |
|----------------------|---------------------------|------------------------------------------------------------------------------------------|
| All                  | UNKNOWN                   | Error – Internal card record is not available                                            |
| All                  | IDLE                      | Error – Card state is not initialized                                                    |
| All                  | DISCOVERED                | Card is detected                                                                         |
| All                  | POWERED_ON                | Card is powered on                                                                       |
| RP, LC               | BIOS_READY                | Card BIOS is up                                                                          |
| RP, LC               | IMAGE_INSTALLING          | Image is being downloaded or installed                                                   |
| RP, LC               | BOOTING                   | Image is installed and the software is booting up                                        |
| RP, LC               | IOS_XR_RUN                | Software is operating normally and is functional                                         |
| RP, LC               | IOS_XR_INITIALIZING       | Software is initializing                                                                 |
| FC, FT, PT, PM       | OPERATIONAL               | Card is operating normally and is functional                                             |
| RP, LC, FC           | RESET                     | Card is undergoing reset                                                                 |
| RP, LC               | REIMAGE                   | Card is pending reimage                                                                  |
| RP, LC, FC           | SHUTTING_DOWN             | Card is shutting down as a result of a fault condition, user action or configuration     |
| RP, LC, FC           | SHUT_DOWN                 | Card is shutdown due to a fault condition, user action or configuration                  |
| FC                   | ONLINE                    | RP is able to access this remote card                                                    |
| LC                   | DATA_PATH_POWERED_ON      | Forwarding complex is powered ON                                                         |
| RP (Active)          | SHUTTING_REMOTE_CARDS     | Active RP card is in the process of shutting down other cards as part of a chassis reset |
| RP (Standby), LC, FC | WAITING_FOR_CHASSIS_RESET | Card is shutdown and is waiting for the chassis to be reset                              |
| RP, LC               | WDOG_STAGE1_TIMEOUT       | Card CPU failed to reset the hardware watchdog                                           |

| Card Type  | State               | Description                                                              |
|------------|---------------------|--------------------------------------------------------------------------|
| RP, LC     | WDOG_STAGE2_TIMEOUT | Hardware watchdog has timed out waiting for the card CPU to reset itself |
| RP, LC, FC | FPD_UPGRADE         | One or more FPD upgrades are in progress                                 |
| FC         | CARD_ACCESS_DOWN    | RP is unable to access this remote card                                  |

## Create Users and Assign Privileges on the Cisco NCS 540 Series Router

Users are authenticated using a username and a password. The authentication, authorization, and accounting (AAA) commands help with these services:

- create users, groups, command rules, or data rules
- change the disaster-recovery password

XR has its AAA separate from Linux. XR AAA is the primary AAA system. A user created through XR can log in directly to the EXEC prompt when connected to the router. A user created through Linux can connect to the router, but arrive at the bash prompt. The user must log in to XR explicitly in order to access the XR EXEC prompt.

Configure AAA authorization to restrict users from uncontrolled access. If AAA authorization is not configured, the command and data rules associated to the groups that are assigned to the user are bypassed. A user can have full read-write access to IOS XR configuration through Network Configuration Protocol (NETCONF), google-defined Remote Procedure Calls (gRPC), or any YANG-based agents. In order to avoid granting uncontrolled access, enable AAA authorization before setting up any configuration. To gain an understanding about AAA, and to explore the AAA services, see the *Configuring AAA Services* chapter in the *System Security Configuration Guide for Cisco NCS 540 Series Routers*.

### Create a User Profile

Create new users and include the user in a user group with certain privileges. The router supports a maximum of 1024 user profiles.

In this task, you create a user, `user1`, password for this user, `pw123`, and assign the user to a group `root-lr`.

#### Procedure

**Step 1** Enter the XR configuration mode.

**Example:**

```
Router#config
```

**Step 2** Create a new user.

**Example:**

```
Router(config)#username user1
```

**Step 3** Create a password for the new user.

**Example:**

```
Router(config-un)#password pw123
```

**Step 4** Assign the user to group `root-lr`.

**Example:**

```
Router(config-un)#group root-lr
```

All users have `read` privileges. However, users can be assigned to `root-lr` usergroup. These users inherit the `write` privileges where users can create configurations, create new users, and so on.

**Step 5** Commit the configuration.

**Example:**

```
Router(config-un)#commit
```

---

**What to do next**

With the router set up, you can manage your system, install software packages, and configure your network.

## Create a User Group

Create a new user group to associate command rules and data rules with it. The command rules and data rules are enforced on all users that are part of the user group.

The router supports a maximum of 32 user groups.

In this task, you create a group name, `group1`, and assign a user, `user1` to this group.

**Before you begin**

Create a user profile. See [Create a User Profile, on page 145](#).

**Procedure**

---

**Step 1** Enter the XR configuration mode.

**Example:**

```
Router#config
```

**Step 2** Create a new user group, `group1`.

**Example:**

```
Router#(config)#group group1
```

**Step 3** Specify the name of the user, `user1` to assign to this user group.

**Example:**

```
Router#(config-GRP)#username user1
```

You can specify multiple user names enclosed withing double quotes. For example, users "`user1 user2 ...`".

**Step 4** Commit the configuration.

**Example:**

```
Router#commit
```

---

**What to do next**

With the router set up, you can manage your system, install software packages, and configure your network.





## CHAPTER 14

# Install Cisco IOS XR7 on NCS 540 Series Routers

This section describes the concepts and procedures for upgrading or downgrading your system, installing optional packages, and obtaining bug fixes for the Cisco NCS 540 series routers.

Cisco NCS 540 series routers use the Cisco IOS XR7 framework. This framework refers to a set of architectural enhancements to the Cisco IOS XR software around the capabilities of modularity, simplified platform infrastructure, and programmability at various software layers.

The Cisco IOS XR software is composed of a base image (ISO) that provides the XR infrastructure, and a TAR file. The TAR file is made up of a set of packages (also called RPMs). These packages comprise mandatory and optional RPMs that can be deployed based on specific requirements. This software modularity approach provides a flexible consumption model that allows you to install a subset of IOS XR packages on devices based on your individual requirements. All critical components are modularized as packages so that you can select the features that you want to run on your router. For example, components like CDP and Telnet are modularized as packages and separated from the base image. These packages can be individually installed, upgraded or removed based on your requirements.

Cisco IOS XR7 install is Dandified Yum- or DNF-based software package manager that is used to install, update, and remove packages on the RPM-based Linux distributions. The package manager is used to automatically compute dependencies and determine the actions required to install packages.



---

**Note** For information on how to download the system upgrade procedures document, see the *About Cisco IOS XR Software Upgrade and Downgrade Guide*.

---

The Cisco NCS 540 router variants that support XR7 in Cisco IOS XR Release 7.0.1 are:

- N540-28Z4C-SYS-A
- N540-28Z4C-SYS-D
- N540X-16Z4G8Q2C-A
- N540X-16Z4G8Q2C-D
- N540-12Z20G-SYS-A
- N540-12Z20G-SYS-D
- N540X-12Z16G-SYS-A
- N540X-12Z16G-SYS-D

The Cisco NCS 540 router variants that support XR7 in Cisco IOS XR Release 7.3.1 are:

- N540X-6Z18G-SYS-A
- N540X-6Z18G-SYS-D
- N540X-8Z16G-SYS - A
- N540X-8Z16G-SYS - D

The Cisco NCS 540 router variants that support XR7 in Cisco IOS XR Release 7.4.1 are:

- N540X-4Z14G2Q-SYS-A
- N540X-4Z14G2Q-SYS-D
- N540-24Q8L2DD-SYS

The following Cisco NCS 540 Series Routers support XR7 in Cisco IOS XR Release 7.10.1:

**Table 11: Cisco NCS 540 Series Router and PIDs**

| Cisco NCS 540 Router Type                                  | Product Identifier                                                                                                                                                                                                                                                                                          |
|------------------------------------------------------------|-------------------------------------------------------------------------------------------------------------------------------------------------------------------------------------------------------------------------------------------------------------------------------------------------------------|
| Small Density Routers                                      | <ul style="list-style-type: none"> <li>• N540X-6Z18G-SYS-A</li> <li>• N540X-6Z18G-SYS-D</li> <li>• N540X-8Z16G-SYS-A</li> <li>• N540X-8Z16G-SYS-D</li> <li>• N540X-4Z14G2Q-A</li> <li>• N540X-4Z14G2Q-D</li> <li>• N540-6Z18G-SYS-A</li> <li>• N540-6Z18G-SYS-D</li> <li>• N540-6Z14S-SYS-D</li> </ul>      |
| Medium Density Routers Supporting the XR7 Operating System | <ul style="list-style-type: none"> <li>• N540-28Z4C-SYS-A</li> <li>• N540-28Z4C-SYS-D</li> <li>• N540X-16Z4G8Q2C-A</li> <li>• N540X-16Z4G8Q2C-D</li> <li>• N540X-16Z8Q2C-D</li> <li>• N540-12Z20G-SYS-A</li> <li>• N540-12Z20G-SYS-D</li> <li>• N540X-12Z16G-SYS-A</li> <li>• N540X-12Z16G-SYS-D</li> </ul> |



| Cisco NCS 540 Router Type | Product Identifier                                                                             |
|---------------------------|------------------------------------------------------------------------------------------------|
| Large Density Routers     | N540-24Q8L2DD-SYS                                                                              |
| Fronthaul Routers         | <ul style="list-style-type: none"> <li>• N540-FH-CSR-SYS</li> <li>• N540-FH-AGG-SYS</li> </ul> |

For release specific caveats see [Caveats, on page 188](#).

- [Supported Packages, on page 151](#)
- [Workflow for Installing Cisco IOS XR7 Software, on page 154](#)
- [Additional Install Operations, on page 169](#)
- [Caveats, on page 188](#)

## Supported Packages

The base ISO image is contained within a `.tar` file. Additional optional packages (RPMs) are provided as modular software deliverables to align with diverse use cases and their deployments across the network.



**Note** You can create a golden ISO (GISO) with optional packages and bug fixes based on your requirement. Contact Cisco Support to build a GISO.

The software deliverables include:

- ISO image containing the base install image - `ncs540l-x64-7.0.1.iso`
- Tar file containing optional RPMs - `NCS540l-iosxr-7.0.1.tar`
- ZIP file for USB boot - `ncs540l-usb_boot-7.0.1.zip`

The software deliverables can be downloaded from [Cisco Software Download](#) center.

| Optional Package | Included in ISO by Default |
|------------------|----------------------------|
| ncs540l-netflow  | Yes                        |
| ncs540l-mcast    | Yes                        |
| BGP              | Yes                        |
| CDP              | No                         |
| EIGRP            | No                         |
| IPSLA            | Yes                        |
| IS-IS            | Yes                        |
| LLDP             | Yes                        |
| MCAST            | Yes                        |

| Optional Package | Included in ISO by Default |
|------------------|----------------------------|
| MPLS-OAM         | Yes                        |
| Netflow          | Yes                        |
| OSPF             | Yes                        |
| Perfmgmt         | Yes                        |
| RIP              | No                         |
| Telnet           | No                         |
| Track            | Yes                        |



**Note** The telnet package is not part of the ISO image. You must manually install the telnet optional package to use telnet for client or server. This applies to all packages that are not part of the ISO image.

SSH is part of the ISO image.

Install operation over IPv6 is not supported.

### Supported Packages for NCS 540 Small-Density Routers

Effective Cisco IOS XR Release 7.3.1, the following variants of the Cisco NCS 540 routers form the small-density routers:

- N540X-6Z18G-SYS-A
- N540X-6Z18G-SYS-D
- N540X-8Z16G-SYS-A
- N540X-8Z16G-SYS-D

The software deliverables include:

- ISO image containing the base install image—`ncs5401-aarch64-7.3.1.iso`
- Tar file containing optional RPMs—`NCS5401-iosxr-7.3.1.tar`
- ZIP file for USB boot—`ncs5401-usb_boot-7.3.1.zip`

## Software Deliverables and Terminologies

This section provides an understanding of the terms that are associated with installing the software.

- **Package:** The primary mechanism for changing the install image on a system. A package, also known as an RPM, contains the software and metadata. A package is in `.rpm` format. A package can be mandatory or optional. Mandatory packages are part of the install image and cannot be removed. Optional packages are not required for the software to work, but can be installed to provide additional functionalities, and can be installed or removed based on requirement.

- **ISO image:** A bootable image that contains the installable files of the base operating system (OS). The image contains the IOS XR (XR7) infrastructure for fixed and distributed platforms in the form of base ISO image, mandatory RPMs. An ISO image is in `.iso` format.
- **Golden ISO (GISO):** A customizable ISO image that is built to contain preferable packages to suit diverse installation requirements. GISO can be customized to include a standard base image with the basic functional components, additional RPMs, bug fixes, and configuration files based on your requirement. GISO can also include a custom image version. From IOS XR Release 7.5.x and later, you can build your GISO image without support from Cisco by using the [Build a Golden ISO](#) feature.
- **Source:** A location where packages can be installed from. The source can be a repository, local directory or a local tar file.
- **Repository:** A directory of RPMs and their metadata that a package manager uses to query the packages.
- **Active package:** A package whose software is currently running on the system.
- **Committed package:** A package that is committed and remains active following a system reload.
- **Atomic Change:** Every packaging operation is contained within an atomic change. Atomic changes may contain multiple packaging operations. During an atomic change, any changes to install IOS XR software will not be visible to the system. To make the changes visible to the system, the atomic change must be applied.
- **Top-level package:** Each block of software has a top-level package and various partition-level packages. The top-level package can be installed or upgraded directly, whereas the partition-level packages cannot be changed directly. The partition-level packages are installed or upgraded automatically as dependencies of the top-level package. The top-level package has the name format `xr-<feature>-<release>.x86_64.rpm`, whereas the dependent partition-level packages have the longer name format containing information about the partition. You can also use the standard RPM commands to check the summary or description metadata of the package, which will identify whether it is a top-level or a partition-level package.
- **Package manager:** An entity that handles the semantics to resolve dependencies in packaging operations.
- **Packaging operations:** The actions performed to change the packages that are installed on the system. The semantics are inherited from the underlying package manager. Examples of packaging operations are upgrade, downgrade, replace, add, or remove packages.
- **Synchronous action:** Synchronous action requests are supported for install actions using CLI command. Specify `synchronous` keyword in the install commands, and the prompt will only be returned when either the request has completed, `Ctrl + C` keys are pressed or a reload occurs. Pressing `Ctrl + C` keys during a synchronous action request will return the prompt to the user but will not halt the install operation. During the synchronous action request, the user is updated with the status of the request whenever it changes.
- **Transaction:** All atomic changes occur within a transaction. If the system reloads during an install transaction, the running software will be reverted to its previous state before the transaction was started. To maintain the software changes carried out during a transaction, you must commit the transaction.
- A complete install operation to modify the system's software requires three phases:
  - Packaging operation
  - **Apply:** This is required to complete an atomic change and make the software change visible to the system.

- **Commit:** This is required to end a transaction and ensure that all software changes will still be present on router reload.



---

**Note** If you perform a manual or automatic system reload without completing the transaction with the **install commit** command, the action will revert the system to the point before the install transaction commenced, including any configuration changes. Only the log is preserved for debugging.

This action clears all configuration rollback points available. You will not be able to rollback to, or view, any commits made until the install rollback event. Any new commits made after the install rollback event will start from commit ID '1000000001'.

---



---

**Note** In a multinode system, any node reloads that occur during a transaction that are not initiated as part of the install 'apply by reload' phase can result in the reloaded node being in BOOT HOLD state. The node continues to be in the BOOT HOLD state until the transaction is either committed or cancelled.

---

## Workflow for Installing Cisco IOS XR7 Software

The router is shipped with a pre-installed version of the Cisco IOS XR (XR7) software. When the router is powered ON for the first time, the pre-installed software starts functioning automatically. You configure the router for network capabilities. When a new version of the software is available, you can upgrade the system using these tasks:



---

**Note** For instructions to upgrade image-specific software, navigate to the [CCO Software Download](#) portal, select the product and refer to the `ncs540-x64-<version>.docs.tar` file for the release.

---

## Obtain Data Models for Install Operation

You can use YANG data models to install and upgrade XR7 software. The data models are packaged with the release image in the `/pkg/yang` directory.

The models are in the `.yang` format. Each data model can be identified as one of the following functionalities:

- `-oper` in the model name indicates an operational model. For example, `Cisco-IOS-XR-install-oper.yang` and `Cisco-IOS-XR-install-augmented-oper.yang` are operational models for the install operation.
- `-cfg` indicates a configuration model. For example, `Cisco-IOS-XR-install-cfg.yang` is a configuration model for the install operation.
- `-act` indicates an action model. For example, `Cisco-IOS-XR-install-augmented-act.yang` and `Cisco-IOS-XR-install-act.yang` are action models for the install operation.

## Procedure

**Step 1** View the install-related data models on the router. You can also access the supported data models to install Cisco IOS XR software from the [Github](#) repository.

### Example:

```
node0_RP0_CPU0:/pkg/yang]$ls -ltr *install*
-rw-r--r--. 1 root root 8646 Jul 2 01:59 Cisco-IOS-XR-install-act.yang
-rw-r--r--. 1 root root 7267 Jul 2 01:59 Cisco-IOS-XR-install-search-act.yang
-rw-r--r--. 1 root root 10664 Jul 2 01:59 Cisco-IOS-XR-install-augmented-act.yang
-rw-r--r--. 1 root root 2511 Jul 2 02:00 Cisco-IOS-XR-um-install-cfg.yang
-rw-r--r--. 1 root root 2270 Jul 2 02:04 Cisco-IOS-XR-install-cfg.yang
-rw-r--r--. 1 root root 6222 Jul 2 02:04 Cisco-IOS-XR-install-oper.yang
-rw-r--r--. 1 root root 14009 Jul 2 02:04 Cisco-IOS-XR-install-augmented-oper.yang
-rw-r--r--. 1 root root 13726 Jul 2 02:04 Cisco-IOS-XR-install-oper-sub1.yang
-rw-r--r--. 1 root root 2440 Jul 2 02:04 Cisco-IOS-XR-install-augmented-oper-sub2.yang
-rw-r--r--. 1 root root 59866 Jul 2 02:04 Cisco-IOS-XR-install-augmented-oper-sub1.yang
```

The following table describes the function of the install-related data models:

| Data Model                          | Description                                                                                                                                                        |
|-------------------------------------|--------------------------------------------------------------------------------------------------------------------------------------------------------------------|
| Cisco-IOS-XR-um-install-cfg model   | Unified data model that contains a collection of YANG definitions for Cisco IOS XR install package configuration, and augments the modules with configuration data |
| Cisco-IOS-XR-install-oper           | Operational data model to view details that are related to basic package information, active and committed packages, and fixes                                     |
| Cisco-IOS-XR-install-cfg            | Configuration data model to specify the location of the install source                                                                                             |
| Cisco-IOS-XR-install-act            | Action model to perform basic install operations and software upgrade                                                                                              |
| Cisco-IOS-XR-install-search-act     | Action model that contains a collection of YANG definitions for install actions related to searching for package information                                       |
| Cisco-IOS-XR-install-augmented-oper | Augmented operational model that displays information about packaging, atomic changes, and history of the install operation on the router                          |
| Cisco-IOS-XR-install-augmented-act  | Action model to perform flexible install operations, including controlling the exact timing of system reloads and rolling back to a previous commit                |
| Cisco-IOS-XR-shellutil-copy-act     | Action model to copy files on the router from a source location                                                                                                    |

**Step 2** Use a manageability agent like NETCONF or gRPC to connect and communicate with the router. You can send Remote Procedure Calls (RPC) requests to configure or retrieve operational data from the router. The

router processes the request and responds to the request through an RPC response. You use the RPCs to send requests to install the software by populating the relevant container and leaf in the data model.

For more information about understanding the data model structure and using data models, see the *Programmability Configuration Guide for Cisco NCS 540 Series Routers*.

## Create Repository to Access Files for Installing IOS XR Software



**Note** If only Golden ISO (GISO) is used, you do not need to create a repository.

To install packages (RPM), code upgrades, and updates in XR7, you need a repository of RPMs for the router to download the RPMs for installation. The repository can be local to the router, or accessed remotely through FTP, HTTP, or HTTPS.



**Important** The repository must be created specific to each platform and release. Do not create repositories with a mix of platforms and releases.

When the repository is accessed remotely, you must provide a repository URL from where the install files are fetched. The URL contains:

- IP address of the server
- Port number of the server
- (Optional) Virtual Routing and Forwarding (VRF) name

The repository can be configured to be reachable using a non-default VRF table. If the repository is reachable through an address in a VRF, specify the name of the VRF.

The format of the repository URL is one of the following:

- FTP: `ftp://<server>[:<vrf>]/<path-to-repository>`
- HTTP: `http://<server>[:<vrf>]/<path-to-repository>`
- HTTPS: `https://<server>[:<vrf>]/<path-to-repository>`
- Local: `file:///<path-to-repository>`. The path to the repository must be under `/harddisk:/` location.

For example, the URL for HTTP server is `http://172.16.0.0:3333/`.



**Note** Username and password are not supported for HTTP and FTP repositories.

## Create and Configure a Local Repository

The router can serve as repository to host the RPMs. You must be a `root-lr` user with access to the router shell. Remote repository is the recommended method to access the RPMs. However, if remote repository is not your preferred option, then you can use the router as a repository to host the RPMs.

Using a local repository removes the need to setup an external server for software installation. In this method, the image files are copied directly to the router, and used to create a repository locally. However, on the downside, the files for future updates must be copied to each router individually.

This section provides the procedure for setting up a local RPM repository on the router.

### Procedure

**Step 1** Create a directory locally on the router's `/harddisk:.` Copy the required RPMs and ISO files (using `copy` or `scp` command) from the server to the local directory on the router.

**Step 2** Access the shell of the router using `run` command and untar the RPMs.

#### Example:

```
Router#run
[node:~]$cd <directory-with-rpms>
[node:~]$tar -xvzf <rpm-name>.tgz
```

**Step 3** Exit from the shell.

**Step 4** Configure the local repository.

#### Example:

```
Router#config
Router(config)#install repository local-repo url file:///harddisk:/<directory-with-rpms>
Router(config)#commit
<data and time stamp> UTC: config[67543]: Configuration committed by user.
Router(config)#end
```

where, `local-repo` is the repository name, `file:///harddisk:/<directory-with-rpms>` is the local repository URL.

**Step 5** Check the contents of the repository.

#### Example:

```
Router#show install available
Trying to access repositories...
Package Architecture Version Repository

xr-ncs5401-core x86_64 7.0.1v1.0.1-1 local-repo
xr-core x86_64 7.0.1v1.0.1-1 local-repo
```

**Note** Only the top-level packages are displayed. The contents of the repository is displayed only when the configured repository is valid and the RPMs are present in the repository. It displays only the packages that are available in the repository and not part of active system.

## Create and Configure an External Repository

To create an external repository, use a server that can be reached over HTTP, HTTPS or FTP. The following instructions are applicable to Linux distribution systems.

Using an external repository provides a central common repository to be used across devices. This eliminates the need to copy files for future updates to each router individually. It also serves as a single source when new RPMs (bug fixes, packages, updates) are made available. This is the recommended method to setup a repository.



---

**Note** For release 7.0.1, 7.0.2, and 7.1.x, the external repository is available only through the Management Ethernet interface.

---

### Before you begin

Ensure that you have completed the following tasks:

- Set up your HTTP, HTTPS or FTP server. Ensure that the server is reachable as specified in the note above.
- Install `createrepo` utility on the Linux distribution system (if not installed already).

### Procedure

---

**Step 1** Create a directory on the server and copy all the RPMs to a directory. This directory hosts the repository and must be accessible to the HTTP, HTTPS or FTP server that the router will use to access the repository. For example, `/var/www/html`, is the directory where the repository will be created.

If the RPM files are archived (.tar format) or compressed (.tgz or .gz format), extract the files. The files hierarchically arrange in sub directories under the main directory that is used as a repository.

**Step 2** Convert the directory to a repository using `createrepo` utility on the Linux server. This creates a directory named `repodata` with the metadata of all the RPMs.

#### Example:

```
[node]$ createrepo --database /var/www/html/
Saving Primary metadata
Saving file lists metadata
Saving other metadata
Generating sqlite DBs
Sqlite DBs complete
```

```
[node]$ cd /var/www/html/
[node]$ ls
repodata
```

If you add new packages to the repository, change or remove packages from the repository, you must run `createrepo` command again to update the metadata. This ensures that the package manager chooses the correct packages.

**Step 3** Configure the external repository.

#### Example:



```
Router#config
Router(config)#install repository remote-repo url http://10.194.88.104/<directory-with-rpms>

Router(config)#commit
<data and time stamp> UTC: config[67542]: Configuration committed by user 'cisco'.
Router(config)#end
```

For FTP, the repository is configured as follows:

```
Router#config
Router(config)#install repository remote-repo url ftp://10.194.88.104/<directory-with-rpms>
Router(config)#commit
<data and time stamp> UTC: config[67543]: Configuration committed by user 'cisco'.
Router(config)#end
```

where, `remote-repo` is the repository name, `http://10.194.88.104/<directory-with-rpms>` is the HTTP repository URL, and `ftp://10.194.88.104/<directory-with-rpms>` is the FTP repository URL.

**Step 4** Verify connectivity to the server, and check the contents of the repository.

**Example:**

```
Router#show install available
Trying to access repositories...
Package Architecture Version Repository

xr-ncs5401-core x86_64 7.0.1v1.0.1-1 remote-repo
xr-core x86_64 7.0.1v1.0.1-1 remote-repo
```

**Note** Only the top-level packages are displayed. The contents of the repository are displayed only when the configured repository is valid and the RPMs with the updated metadata are present in the repository. It displays only the packages that are available in the repository and not part of active system.

## Upgrade the Current Active Version of Cisco IOS XR Software

This section shows replacing the current software version with `.iso` image. The instructions in this section also apply to system downgrade.

### Upgrade the Current Active Version

In this scenario, you replace the current software with image, apply the changes, and commit the install operation. Committing the changes indicates the end of the current transaction. The updated software is used after the changes are applied, before the install transaction is committed.

A reboot is not always necessary. Bug fixes can be applied using a GISO that contains the current running software and the additional bugfix. These fixes may not require a reboot. Reboots are required for a system version change, if too many processes need restarting, there is configuration in the GISO to apply or if the bugfix is marked as requiring a reload.

From Cisco IOS XR Release 7.5.1, you can use the Automatic Install of Bridging Bug Fix RPMs feature to install any bridging bug fix RPMs that are prerequisite for a system upgrade or a downgrade.

You need to add the required Bridging Bug Fix RPMs into the customized ISO built using Cisco Golden ISO (GISO) build script `gisobuild.py`, by going through the steps in [Build a Golden ISO, on page 171](#). Ensure that you add the required bridging bug fix RPMs into your Golden ISO. The GISO can include bridging Bug Fix

RPMs for multiple releases, and installs only the specific bridging Bug Fix RPMs required for the target release. The bridging bug fix RPMs can be used in the following scenarios:

- To resolve a bug that might stop upgrade.
- The latest version has new prerequisite requirements that are not met by the earlier version.

The **install replace** command adds and applies the highest version of any bridging bugfix RPMs for the currently active XR version.

Cisco IOS XR Software Release 7.5.1 introduces **iso-config [ignore | replace]** keywords to the **install replace** and **install package replace** commands. Before this release, the configuration file in GISO is ignored by default. If the GISO has a configuration file and it is not ignored using the **iso-config ignore** option, then the configuration in the file is applied, and the install operation requires a reboot. With the **iso-config** keyword, the default value is set to **replace** to replace the running configuration with the configuration in the file.

You can extract the configuration file from GISO using `image.py` script that is embedded in the ISO. This script interprets the GISO, and serves as an API to the ISO content at the filesystem level. The extracted configuration file replaces the running configuration after the router reloads.

**Table 12: Configuration File in GISO**

| Scenario                             | iso-config replace                                                                                                                                                                                                                             | iso-config ignore                                                                                                                                                     | Nothing Specified                                                                                                                                                                  |
|--------------------------------------|------------------------------------------------------------------------------------------------------------------------------------------------------------------------------------------------------------------------------------------------|-----------------------------------------------------------------------------------------------------------------------------------------------------------------------|------------------------------------------------------------------------------------------------------------------------------------------------------------------------------------|
| Configuration is present in GISO     | Extracts the configuration and replaces the running configuration after the changes are applied via router reload. The output of the <b>show install log</b> command displays <code>ISO config replace requested (ISO config present)</code> . | Does not extract or apply the configuration. The output of the <b>show install log</b> command does not display any information that is related to the configuration. | Extracts the configuration and replaces the running configuration after the changes are applied via router reload. The behavior is similar to <b>iso-config replace</b> operation. |
| Configuration is not present in GISO | Attempts to extract the configuration, and the operation continues as if configuration is not requested. The output of the <b>show install log</b> command displays <code>ISO config replace requested (ISO config not present)</code> .       | Does not extract or apply the configuration. The output of the <b>show install log</b> command does not display any information that is related to the configuration. | Attempts to extract the configuration, and the operation continues as if configuration is not requested. The behavior is similar to <b>iso-config replace</b> operation.           |

| Scenario                                                             | iso-config replace                                                                                                                                                                                                                | iso-config ignore                                                                                                                                                     | Nothing Specified                                                                                                                                                        |
|----------------------------------------------------------------------|-----------------------------------------------------------------------------------------------------------------------------------------------------------------------------------------------------------------------------------|-----------------------------------------------------------------------------------------------------------------------------------------------------------------------|--------------------------------------------------------------------------------------------------------------------------------------------------------------------------|
| Configuration extraction is not supported in target GISO (downgrade) | Attempts to extract the configuration, and the operation continues as if configuration is not requested. The output of the <b>show install log</b> command does not display any information that is related to the configuration. | Does not extract or apply the configuration. The output of the <b>show install log</b> command does not display any information that is related to the configuration. | Attempts to extract the configuration, and the operation continues as if configuration is not requested. The behavior is similar to <b>iso-config replace</b> operation. |
| Configuration is supported but the extraction fails                  | Attempts to extract the configuration. But the operation fails with error<br>Failed to extract the gISO config file from the ISO: <path to ISO>.                                                                                  | Does not extract or apply the configuration. The output of the <b>show install log</b> command does not display any information related to the configuration.         | The behavior is similar to <b>iso-config replace</b> operation.                                                                                                          |

## Procedure

**Step 1** Copy the ISO (or GISO) image to the `/harddisk:` location on the router.

**Step 2** Upgrade the system to replace the current software with the `.iso` image.

### Example:

```
Router#install package replace /harddisk:/ncs5401-x64-x.x.x.iso
```

**Step 3** Activate the new `.iso` image on the router by applying the changes.

### Example:

```
Router#install apply {reload | restart} [noprompt]
```

If you are using a configuration file in GISO, use the **install apply reload** command for the configuration to take effect.

**Note** You can use a single command to perform both the packaging operation and activating the applying the changes using **install replace /harddisk:/ncs5401-x64-x.x.x.iso noprompt** command.

To identify whether a reload is required or only process restart is needed, use either **show install history last transaction verbose** command or **show install request** command.

Include the keyword `noprompt` in the command to enable the system to bypass your permission to reload the router.

Applying the change gives you the flexibility to test the operation of the new software before committing the changes. If you reload the router, the router reverts the software to its previous software state.

All operations that automatically apply the new software are prohibited when an atomic change is already in progress. You must address the current atomic-change before performing this operation. To address the change, apply the current atomic-change, or cancel it with the **install package abort all-since-apply** command.

**Step 4** View the install log.

**Example:**

```
Router#show install log detail
Fri Nov 12 09:43:49.702 UTC
2021-11-12 09:33:47 UTC Transaction 1 started
2021-11-12 09:33:47 UTC Atomic change 1.1 started
2021-11-12 09:33:47 UTC Packaging operation 1.1.1 started
2021-11-12 09:33:47 UTC Replace

2021-11-12 09:35:58 UTC Packaging operation 1.1.1 success
2021-11-12 09:36:04 UTC Apply by reload started
2021-11-12 09:38:48 UTC Atomic change 1.1 successfully applied by reload
```

If configuration file is present in GISO, the output shows that the replace operation for ISO configuration is requested.

**Step 5** Verify that the image is activated successfully.

**Example:**

```
Router#show install request
```

**Step 6** Commit the transaction.

**Example:**

```
Router#install commit
```

**Note** Any action requests may be run synchronously from the CLI. During this request, you are updated with the status of the request whenever it changes. The following example shows the output from a synchronous action request:

```
Router#install commit synchronous
Starting:
 install commit
Transaction 1
The install operation will continue in the background
Press Ctrl-C to return to the exec prompt. This will not cancel the install operation

Current activity: Initializing
Current activity: Commit transaction

Transaction 4: 'install commit' completed without error
```

---

## Upgrade the System and Install RPMs

In this scenario, you replace the current software with the `.iso` image and have the possibility to install or remove optional RPMs before applying the changes. You can perform this operation while an atomic-change is already in progress. However, all packaging operations before this command are discarded. The installed software is an exact copy of the software in the ISO after this packaging operation is complete. You can perform all additional packaging operations after this operation and before applying and committing the changes.

## Procedure

**Step 1** Copy the ISO (or GISO) image to the `/harddisk:` directory on the router.

**Step 2** Upgrade the system to replace the current software with the `.iso` image.

**Example:**

```
Router#install package replace /harddisk:/ncs5401-x64-x-x-x.iso
```

**Step 3** Install other RPMs (packages) after the system upgrade operation.

- a) Configure a repository on the router. For instructions to create a local or a remote repository, see [Create Repository to Access Files for Installing IOS XR Software, on page 156](#).
- b) Check the available packages in the repository.

**Example:**

```
Router#show install available
```

- c) Install the RPMs.

**Example:**

```
Router#install package add <pkg1> <pkg2> <pkgn>
```

**Step 4** Check the status of install operation.

**Example:**

```
Router#show install request
```

```
User request: install package add xr-bgp
```

```
State: In progress since <date and timestamp>
```

```
Current activity: Package add or other package operation
```

```
Next activity: Await user input
```

```
Time started: <date and timestamp>
```

```
Timeout in: 35m 8s
```

```
Locations responded: 0/1
```

| Location   | Packaging operation stage | Notification Phase | Clients responded |
|------------|---------------------------|--------------------|-------------------|
| 0/RP0/CPU0 | Package operations        | None in progress   | N/A               |

**Note** The operation ID is a unique ID for each user request. This ID is constructed from the transaction ID, atomic change ID and packaging operation ID that was already used in the commands. For example, if the request is `install commit`, the operation ID is the transaction ID. If the request includes applying an atomic change but not committing the transaction (for example, `install replace /harddisk:/ncs540_x64.iso`), the operation ID is the atomic change ID. An operation ID of 4.2 indicates a second atomic change in the fourth transaction.

This operation ID is also returned in the action RPC. If an error occurs while the request is initiated, an empty string is returned instead of an operation ID.

When the `State` changes to `Success`, activate the new image.

```
Router#show install request
```

```
Wed Sep 14 02:53:21.525 PDT
```

```
User request: install package abort latest
```

```
Operation ID: 2.1.2
```

```
State: Failure since 2022-09-14 02:48:15 UTC-07:00
Disk space check failed on nodes: 0/0/CPU0. Query 'show install history id 2.1.2 errors'
for more details and next steps
```

```
Current activity: Await user input
Time started: 2022-09-14 02:48:20 UTC-07:00
```

```
The following actions are available:
install package add
install package remove
install package upgrade
install package downgrade
install package abort latest
install package abort all-since-apply
install apply restart
install apply reload
install reimage
```

**Note** The **install apply restart** method has the least impact.

**Step 5** Activate the new .iso image or RPM on the router by applying the changes.

**Example:**

```
Router#install apply {reload | restart} [noprompt]
```

To identify whether a reload is required or only process restart is needed, use either **show install history last transaction verbose** command or **show install request** command.

Include the keyword `noprompt` in the command to enable the system to bypass your permission to reload the router.

**Step 6** Verify the image and packages that are activated as part of `install package add` operation is activated successfully.

**Example:**

```
Router#show install request
```

**Step 7** Commit the transaction.

**Example:**

```
Router#install commit
```

To perform the same step using data models, use the `install-package-replace` RPC on the [Cisco-IOS-XR-install-augmented-act](#) data model.

```
<install-replace>
 <file>iso-name</file>
 <source-type>local</source-type>
 <source>directory-containing-iso</source>
 <commit>>true</commit>
</install-replace>
```

## Upgrade QDD Optical Modules Through CLI

The QDD optics firmware file needs to be copied to the router manually. Contact Cisco Support to check the QDD firmware version, IOS XR release compatibility, and to obtain the QDD optics firmware file.

**Limitation:** When ports share a common management interface, IOS XR serializes the firmware upgrade. Serializing and deserializing may delay the upgrade process.

## Procedure

**Step 1** From the router, copy the QDD firmware file to the hard disk using the following command:

Example: `scp user@10.1.1.1:/home/user/filename harddisk:/`

- When you are using VRF, use the following sample command:

```
scp user@10.1.1.1:/home/user/cl1.bin vrf MGMT harddisk:/
```

```
Tue Jan 25 02:57:22.762 UTC
```

```
Connecting to 10.1.1.1...
```

```
Password:
```

```
Transferred 1484800 Bytes
```

```
1484800 bytes copied in 0 sec (22161194)bytes/sec
```

```
RP/0/RP0/CPU0:8808#dir harddisk:/cl1.bin
```

```
Tue Jan 25 03:00:47.835 UTC
```

```
Directory of harddisk:/cl1.bin
```

```
35 -rw-r--r--. 1 1484800 Jan 25 02:57 dp04qsdd_dp04sfp8_161_10_01.ackit
```

```
53461500 kbytes total (42983204 kbytes free)
```

- When you are not using VRF, remove the `vrf MGMT` command:

```
scp user@10.1.1.1:/home/user/cl1.bin harddisk:/
```

**Step 2** Run the following commands to upgrade the FPD for QDD optical modules:

Multiport upgrade: `upgrade optics port 0,1,2,3,4 filename /harddisk:/cl1.bin location 0/1/CPU0`

Single port upgrade: `upgrade optics port 0 filename /harddisk:/cl1.bin location 0/1/CPU0`

You can check the firmware upgrade progress using the following command: `show optics firmware upgrade port 0,1,1,2,3,4 location 0/1/CPU0`

## Install Optional Packages to Provide Additional Functionality

You can install one or more packages (RPM) that are not already present on the system. The packages are not mandatory for the software to function, but provide additional functionality. Based on your requirement, you can install or remove these optional packages. The source file can be a repository name, repository url, local filepath, or path to a tar file.

You must specify only the top-level package name that you want to install. The associated dependencies of this package, in the form of card and partition-specific packages, are included automatically. By default, the latest available version of each package is installed. You can also explicitly install a specific version of a package.



**Note** All Cisco IOS XR images are signed to ensure the authenticity of the software.

This example shows the options to install the optional package `xr-telnet-7.0.1v1.0.1-1.x86_64.rpm`.

**Before you begin**

If you are installing the packages from a local directory, ensure that the TAR file `ncs5401-iosxr-7.0.1.tar` is copied to the `harddisk:/` on the router. If you are installing the packages from an RPM repository, ensure you have configured the repository. For more information, see [Create Repository to Access Files for Installing IOS XR Software, on page 156](#).

**Procedure**

**Step 1** Install one or more optional packages using one of the following options:

- **Option 1:** Install the package from the local directory:

```
Router# install source /harddisk:/files xr-telnet-7.0.1
v1.0.1-1.x86_64.rpm
```

**Note** The `install source` command automatically applies the changes. Use this command to install optional packages. To upgrade existing packages, see [Upgrade the System to Obtain Bug Fixes, on page 178](#).

- **Option 2:** Install the package from a configured remote repository:

```
Router#install source install-repo xr-telnet
```

Here, `install-repo` is the name of the repository. For repository configuration, see [Create Repository to Access Files for Installing IOS XR Software, on page 156](#).

- **Option 3:** Install the package from a repository URL:

```
Router#install source http://72.16.0.0:3333/remote-repo xr-telnet
```

- **Option 4:** Add the package and apply the change. The package must be available in the repository.

```
Router#install package add xr-telnet-7.0.1v1.0.1-1.x86_64.rpm
Router#install apply {restart | reload}
```

More than one package can be installed using a single packaging operation. Use the following command:

```
Router#install source <path-to-source> <package 1> <package 2> ... <package n>
```

For example,

```
Router#install source /harddisk:/files xr-telnet-7.0.1v1.0.0-1.x86_64.rpm
xr-mcast-7.0.1v1.0.0-1.x86_64.rpm
```

To perform this task using data models, use the `install` RPC on the [Cisco-IOS-XR-install-act](#) data model. Here is an example with an HTTP repository:

```
<install>
 <packages>
 <packagename>pkg1</packagename>
 <packagename>pkg2</packagename>
 ...
 <packagename>pkgn</packagename>
 </packages>
 <source-type>http</source-type>
 <source><path-to-source></source>
</install>
```

**Step 2** Commit the operation.



**Example:**

```
Router#install commit
```

**Step 3** Check the status of install operation.

**Example:**

---

## Delete Optional Packages

You can remove optional packages that you no longer require. An optional package is not mandatory for the operating system to function, and based on your requirement, it can be installed or removed.

**Procedure**

---

**Step 1** Remove the optional package.

**Example:**

```
Router#install package remove <optional-package-name>
```

**Step 2** Apply the changes to make the change active.

**Example:**

```
Router#install apply [reload | restart]
```

**Attention** To identify whether to reload or restart the system after applying the changes, use either **show install history last transaction verbose** command or **show install request** command.

**Step 3** Commit the changes to make the change persistent after a reload operation.

**Example:**

```
Router#install commit
```

---

## Installing the Image Over the Network

Table 13: Feature History Table

Feature Name	Release Information	Feature Description
Support for loading an image over the network	Release 7.4.1	<p>There is no longer a need to copy an ISO image on the router to install XR7.</p> <p>Starting with this release, you can fetch an ISO or tar file of RPMs over the network as part of Install operation. You can also directly install the image from an FTP or HTTP server that hosts the image. The install source can also be a URL to a tar file (a file with extensions, .tar, .tgz, or .tar.gz).</p> <p>This feature modifies the following commands:</p> <ul style="list-style-type: none"> <li>• <b>install replace</b></li> <li>• <b>install package replace</b></li> <li>• <b>install source</b></li> <li>• <b>install package add source</b></li> </ul>

The following commands include the **ftp** and **http** keywords to enable you to install an ISO image stored at the specified FTP or HTTP server.

- The **install replace** command is used to install an ISO image and apply this new installation.



**Note** This command requires a manual reload of the system.

```
RP/0/RP0/CPU0:ios#install replace ?
WORD Full local path to ISO - must be located in or under /var/xr/disk1/, /harddisk:/,
 or /misc/disk1/
ftp: Remote ISO ftp://<server>[;<vrf>]/<remote_path>
http: Remote ISO http://<server>[;<vrf>]/<remote_path>
```

- The **install package replace** command is used to install an ISO image; however, it does not automatically apply the software change.

```
RP/0/RP0/CPU0:ios#install package replace ?
WORD Full local path to ISO - must be located in or under /var/xr/disk1/, /harddisk:/,
 or /misc/disk1/
ftp: Remote ISO ftp://<server>[;<vrf>]/<remote_path>
http: Remote ISO http://<server>[;<vrf>]/<remote_path>
```

- The **install source** command is used to install and apply packages from a specified source. Effective Cisco IOS XR Release 7.4.1, you can use this command to install packages from a tarball located on a remote FTP or HTTP server.

```
RP/0/RP0/CPU0:ios#install source ?
WORD Configured DNF repository name to use as the source
WORD Full path to a local directory to use as the source - must be a
subdirectory of /var/xr/disk1/, /harddisk:/, or /misc/disk1/
WORD Full path to a local tar file to use as the source - must be located
in or under /var/xr/disk1/, /harddisk:/, or /misc/disk1/
any-configured Use any configured repository to obtain packages
ftp: Remote repo or tar file ftp://<server>[;<vrf>]/<remote_path>
http: Remote repo or tar file http://<server>[;<vrf>]/<remote_path>
```

- The **install package add source** command is used to install packages; however, it does not automatically apply them. Effective Cisco IOS XR Release 7.4.1, you can use this command to install packages from a tarball located on a remote FTP or HTTP server.

## Additional Install Operations

After you upgrade your system, based on your requirement, you can perform additional install operations:

### View the Version of Installed Packages

The router is shipped with a pre-installed operating system. You can view the version of the installed software and the active packages. If you have upgraded your system, installed additional packages or bug fixes, you can view the version of the committed packages.

Review the software version information:

- Package name and version
- User who built the package
- Time the package was built
- Build workspace
- Build host
- ISO label:
  - Label is present if GISO boots using PXE boot
  - Label is present if GISO is installed using the `install replace` method
  - Label reverts to default (only release version) if there is any change since the time the image with the label was installed.
  - Label is nullified and reverts to default if an RPM is added or removed on top of an existing GISO.
  - Label is repopulated if an RPM from the GISO is added or removed and a rollback operation is performed.
- Copyright information

- Hardware information

## Procedure

**Step 1** View the version of the Cisco IOS XR software, and its various software components that are installed on the router.

### Example:

The following example shows the version information for a non-GISO image:

```
Router#show version
Cisco IOS XR Software, Version 7.0.1 LNT
Copyright (c) 2013-2019 by Cisco Systems, Inc.

Build Information:
 Built By : xyz
 Built On : Sat Jun 29 22:45:27 2019
 Build Host : iox-lnx-064
 Workspace : ../7.0.1
 7.3.1/
 NCS540L/ws/
 Version : 7.0.1
 Label : 7.0.1
```

```
cisco NCS540L
System uptime is 41 minutes
```

The following example shows the version information for a GISO image. The customer label is appended to the `Label` field in the GISO image:

```
Router#show version
Cisco IOS XR Software, Version 7.0.1 LNT
Copyright (c) 2013-2019 by Cisco Systems, Inc.

Build Information:
 Built By : xyz
 Built On : Sat Jun 29 22:45:27 2019
 Build Host : iox-lnx-064
 Workspace : ../7.0.1
 /NCS540L/ws/
 Version : 7.0.1
 Label : 7.0.1-CUSTOMER_LABEL
```

```
cisco NCS540L
System uptime is 41 minutes
```

You can also use the `get` RPC on the `install.version` data model.

**Step 2** View the active packages.

### Example:

```
Router#show install active [summary]
Active Packages: XR: 112 All: 1088
Label: 7.0.1

Optional Packages Version

xr-ncs540l-mcast 7.0.1v1.0.0-1
xr-ncs540l-netflow 7.0.1v1.0.0-1
xr-bgp 7.0.1v1.0.0-1
```

```

xr-ipsla 7.0.1v1.0.0-1
xr-is-is 7.0.1v1.0.0-1
xr-lldp 7.0.1v1.0.0-1
xr-mcast 7.0.1v1.0.0-1
xr-mppls-oam 7.0.1v1.0.0-1
xr-netflow 7.0.1v1.0.0-1
xr-ospf 7.0.1v1.0.0-1
xr-perfmgmt 7.0.1v1.0.0-1
xr-track 7.0.1v1.0.0-1

```

You can also use the `get RPC` on the `install.packages.active.node` and the `install.packages.active.node.summary` data models.

To understand the data model structure and its arguments, see the [Obtain Data Models for Install Operation, on page 154](#) topic.

## Build a Golden ISO

**Table 14: Feature History Table**

Feature Name	Release Information	Description
Build Golden ISO (GISO) Using <code>gisobuild.py</code> Tool	Release 7.6.1	This feature allows you to build your GISO image without support from Cisco. You can now select the install files, add your RPMs, repack them as a custom image, and install the image.  In previous releases, you had to contact Cisco to get your GISO built.

Golden ISO (ISO) upgrades the router to a version that has a predefined set of RPMs with a single operation. For example, you can create a customized ISO with the base OS package and specific optional RPMs based on your network requirements.

GISO supports automatic dependency management, and provides these functionalities:

- Builds RPM database of all the packages present in package repository.
- Skips and removes Cisco RPMs that do not match the base ISO version.
- Skips and removes third-party RPMs that are not part of already existing third-party base package in the base ISO.



**Note** Install operation over IPv6 is not supported.

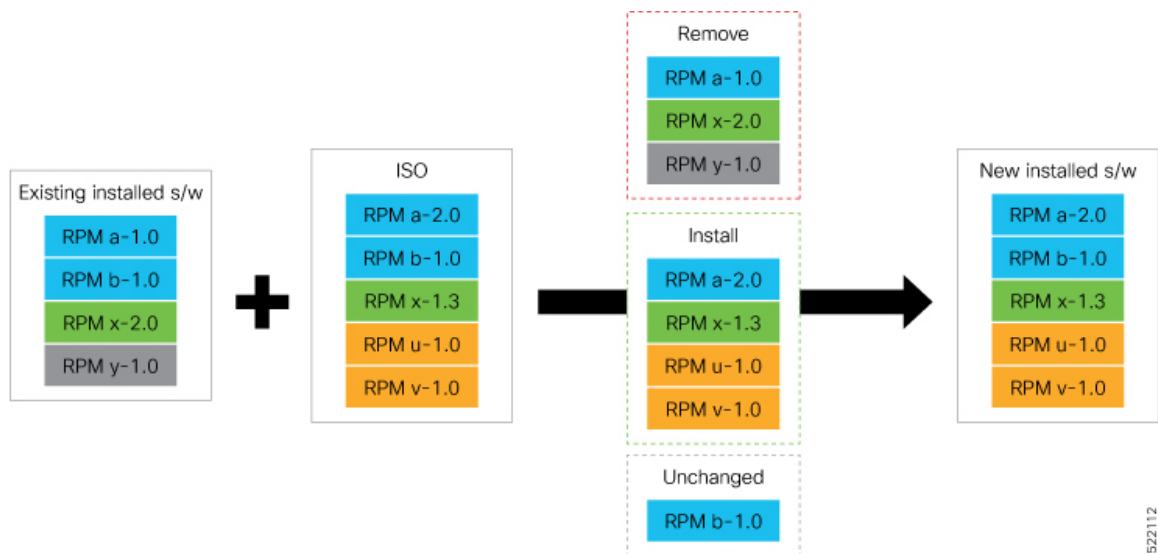

522112

## Procedure

**Step 1** Contact Cisco Support to build the GISO image with the set of packages based on your requirement.

**Step 2** Build GISO image using `gisobuild.py` tool.

To build GISO, provide the following input parameters to the script:

- Base mini-x.iso (mandatory)
- Set of packages to install (Cisco signed packages)
- XR configuration file (optional)
- Label for golden ISO (optional)
- ZTP initialization `ztp.ini` file (optional)

**Note** GISO build tool verifies the RPM dependencies and RPM signatures. GISO build fails if the RPM is unsigned or incorrectly signed.

- Copy the repository from the [Github](#) location to an offline system or external server where the GISO will be built.
- Run the script `gisobuild.py` and provide parameters to build the GISO image. Ensure that all RPMs and SMUs are present in the same directory or on a repository.

### Example:

```
$./giso/src/gisobuild.py --iso <input iso> --repo <rpm_repo1 rpm_repo2> --pkglist <pkg1
pkg2 pkg3>
 --xrconfig <config.cfg> --ztp-ini <ztp.ini> --label <label>
 --out-directory <out_directory> --clean
```

The following parameters can be provided as input to the GISO build tool:

- `--iso`: ISO path to mini.iso or full.iso file
- `--xrconfig`: XR configuration file

- `--label`: GISO label
- `--repo`: Path to repositories containing RPMs and tarballs
- `--pkglist`: Optional RPMs or SMUs to package
- `--ztp-ini`: Path to the ZTP initialization file
- `--remove-packages`: Remove RPMs from the GISO. To remove multiple RPMs, separate the RPM names using comma. For example, `--remove-packages xr-bgp,xr-mcast` command removes the `xr-bgp` and `xr-mast` packages from GISO
- `--out-directory`: Output directory to store output of the operations performed on the file
- `--clean`: Delete contents of the output directory
- `--skip-dep-check`: Skip dependency checking between files
- `--version`: Print version of the tool
- `--pkglist`: Optional RPM or SMU to package
- `--yamlfile`: Provide CLI arguments via YAML markup file
- `--docker`: Load and run pre-built docker image

The tool uses the input parameters to build the GISO image.

**Step 3** Copy the GISO image to the `/harddisk`: location on the router.

**Step 4** Upgrade the system to replace the current software with the `<platform-architecture>.iso` image, and install the RPMs.

**Example:**

```
Router#install replace <source location> <giso name.iso>
```

If you are using a configuration file in GISO, use the following command to extract and replace the configuration.

```
Router# install replace <source location> <GISO-with-cfg>-<platform>.iso
```

**Note** The default option is to replace the existing configuration. The install operation applies the configuration from a GISO, the router reboots to activate the configuration.

**Step 5** View the version information for the GISO image. You can include a label to indicate the runing software version on the router. For example, create a label `v1` for the current GISO version. When you rebuild GISO with additional RPMs, you can create a label `v2` to distinguish the builds.

**Example:**

```
Router#show version
Cisco IOS XR Software, Version 7.0.1 LNT
Copyright (c) 2013-2019 by Cisco Systems, Inc.
```

```
Build Information:
 Built By : xyz
 Built On : Sat Jun 29 22:45:27 2019
 Build Host : iox-lnx-064
 Workspace : ../7.0.1
 /NCS540L/ws/
 Version : 7.0.1
```

```

Label : 7.0.1-CUSTOMER_LABEL

cisco NCS540L
System uptime is 41 minutes

```

## Upgrade the System Using the IOS XR Configuration File in GISO

**Table 15: Feature History Table**

Feature Name	Release Information	Description
Upgrade the system using the IOS XR configuration file in GISO	Release 7.5.2	<p>This feature identifies and extracts the required IOS XR configuration file in GISO, and automates the updation of IOS XR configuration files when the router is reloaded with the new GISO.</p> <p>This feature introduces <b>iso-config [ignore   replace]</b> keywords to the <b>install replace</b> and <b>install package replace</b> commands.</p>

You can upgrade the system when a newer version is available. A system upgrade replaces the existing version of the software with a newer version. By keeping the software up to date, you can ensure that the device works with the latest features and bug fixes.

You can replace the currently active software on your system with the software from a specified ISO image or GISO image. Only a minimal set of changes is performed to upgrade to the new software. Packages are not removed and reinstalled if they have the same name and version. For example, an upgrade that differs by only one package, removes and install only that one modified package.



**Note** Even if the configuration file is bundled in a GISO, the file is not used during an upgrade of the system to Cisco IOS XR Software Release 7.5.2. When first moving the system to release 7.5.2, the configuration file is only used when the system is completely reimaged in case of disaster recovery. Upgrades from release 7.5.2 to a GISO based off release 7.5.2 (or a higher version) uses the configuration file if it is present in the GISO.



**Note** The instructions in this section also apply to system downgrade.

This section shows replacing the current software version with `.iso` image.

In this scenario, you replace the current software with image, apply the changes, and commit the install operation. Committing the changes indicates the end of the current transaction. The updated software is used after the changes are applied, before the install transaction is committed.

A reboot is not always necessary. Bugfixes can be applied using a GISO that contains the current running software and the additional bugfix. These fixes may not require a reboot. Reboots are required for a system version change, if too many processes need restarting, there is configuration in the GISO to apply or if the bugfix is marked as requiring a reload.





**Note** The `ztp.ini` is an initialization file for ZTP that is provided when building a golden ISO (GISO). This file defines the GISO ZTP configuration. If the `.ini` file is used, the next time ZTP starts, this custom `.ini` file that was used is picked up. For example, if the install starts a reload operation or when ZTP is initiated manually, the ZTP runs with the custom `ini`. This file is carried over during install replace and install rollback, as long as both the `from-version` and the `to-version` are Cisco IOS XR, Release 7.3.1 or higher.

If you start an **install replace** or **install package replace** operation with a GISO that has a `ztp.ini` file, the GISO ZTP configuration is updated on both RPs when the operation is applied. To undo this install operation and also the change in GISO ZTP configuration, use **install package abort** command. If you replace the image using an ISO without a `ztp.ini` file, the GISO ZTP configuration is removed from both RPs, if it exists, when the operation is applied.

Cisco IOS XR Software Release 7.5.2 introduces **iso-config [ignore | replace]** keywords to the **install replace** and **install package replace** commands. Before this release, the configuration file in GISO is ignored by default. If the GISO has a configuration file and it is not ignored using the **iso-config ignore** option, then the configuration in the file is applied, and the install operation requires a reboot. With the **iso-config** keyword, the default value is set to **replace** to replace the running configuration with the configuration in the file.

You can extract the configuration file from GISO using `image.py` script that is embedded in the ISO. This script interprets the GISO, and serves as an API to the ISO content at the filesystem level. The extracted configuration file replaces the running configuration after the router reloads.

**Table 16: Configuration File in GISO**

Scenario	iso-config replace	iso-config ignore	Nothing Specified
Configuration is present in GISO	Extracts the configuration and replaces the running configuration after the changes are applied via router reload. The output of the <b>show install log</b> command displays <code>ISO config replace requested (ISO config present)</code> .	Does not extract or apply the configuration. The output of the <b>show install log</b> command does not display any information related to the configuration.	Extracts the configuration and replaces the running configuration after the changes are applied via router reload. The behavior is similar to <b>iso-config replace</b> operation.
Configuration is not present in GISO	Attempts to extract the configuration, and the operation continues as if configuration is not requested. The output of the <b>show install log</b> command displays <code>ISO config replace requested (ISO config not present)</code> .	Does not extract or apply the configuration. The output of the <b>show install log</b> command does not display any information related to the configuration.	Attempts to extract the configuration, and the operation continues as if configuration is not requested. The behavior is similar to <b>iso-config replace</b> operation.

Scenario	iso-config replace	iso-config ignore	Nothing Specified
Configuration extraction is not supported in target GISO (downgrade)	Attempts to extract the configuration, and the operation continues as if configuration is not requested. The output of the <b>show install log</b> command does not display any information related to the configuration.	Does not extract or apply the configuration. The output of the <b>show install log</b> command does not display any information related to the configuration.	Attempts to extract the configuration, and the operation continues as if configuration is not requested. The behavior is similar to <b>iso-config replace</b> operation.
Configuration is supported but the extraction fails	Attempts to extract the configuration. But the operation fails with error Failed to extract the gISO config file from the ISO: <path to ISO>.	Does not extract or apply the configuration. The output of the <b>show install log</b> command does not display any information related to the configuration.	The behavior is similar to <b>iso-config replace</b> operation.

## Procedure

**Step 1** Copy the ISO (or GISO) image to the `/harddisk:` location on the router.

**Step 2** Upgrade the system to replace the current software with the `.iso` image.

### Example:

```
Router#install package replace /harddisk:/ncs540.iso
```

**Step 3** Activate the new `.iso` image on the router by applying the changes.

### Example:

```
Router#install apply {reload | restart} [noprompt]
```

If you are using a configuration file in GISO, use the **install apply reload** command for the configuration to take effect.

**Note** You can use a single command to perform both the packaging operation and activating the applying the changes using **install replace /harddisk:/540.iso noprompt** command.

To identify whether a reload is required or only process restart is needed, use either **show install history last transaction verbose** command or **show install request** command.

Include the keyword `noprompt` in the command to enable the system to bypass your permission to reload the router.

Applying the change gives you the flexibility to test the operation of the new software before committing the changes. If you reload the router, the router reverts the software to its previous software state.

All operations that automatically apply the new software are prohibited when an atomic change is already in progress. You must address the current atomic-change before performing this operation. To address the change, apply the current atomic-change, or cancel it with the **install package abort all-since-apply** command.

**Step 4** View the install log.

**Example:**

```
Router#show install log detail
Fri Nov 12 09:43:49.702 UTC
2021-11-12 09:33:47 UTC Transaction 1 started
2021-11-12 09:33:47 UTC Atomic change 1.1 started
2021-11-12 09:33:47 UTC Packaging operation 1.1.1 started
2021-11-12 09:33:47 UTC Replace

2021-11-12 09:35:58 UTC Packaging operation 1.1.1 success
2021-11-12 09:36:04 UTC Apply by reload started
2021-11-12 09:38:48 UTC Atomic change 1.1 successfully applied by reload
```

If configuration file is present in GISO, the output shows that the replace operation for ISO configuration is requested.

**Step 5** Verify that the image is activated successfully.

**Example:**

```
Router#show install request
```

**Step 6** Commit the transaction.

**Example:**

```
Router#install commit
```

**Note** Any action requests may be run synchronously from the CLI. During this request, you are updated with the status of the request whenever it changes. The following example shows the output from a synchronous action request:

```
Router#install commit synchronous
Starting:
 install commit
Transaction 1
The install operation will continue in the background
Press Ctrl-C to return to the exec prompt. This will not cancel the install operation

Current activity: Initializing
Current activity: Commit transaction

Transaction 4: 'install commit' completed without error
```

## Upgrade the System to Obtain Bug Fixes

Table 17: Feature History Table

Feature Name	Release Information	Description
Install Cisco RPM Directly from TAR File	Release 7.3.1	Cisco RPMs can be installed from one of these sources - repository name, repository URL or a local file path. Previously, to install RPMs from a TAR file, you had to manually extract the TAR file and specify the path to the locally extracted file to install the RPM. This feature extends support to install the RPM directly from the TAR file. Bug fix RPMs are available as TAR files on the <a href="#">Software Download</a> page. The RPMs can be installed from the TAR file using CLI or Yang data model.

You can upgrade the system to obtain all available bug fixes or choose specific bug fix using bug ID.

Bug fixes are available as optional RPMs. The bug fixes replace packages in the base ISO without adding up to the image size. For example, even if you add 20 RPMs to the GISO, the GISO file size will remain the same as the initial ISO.

You can download the bug fix RPMs from the [Cisco Software Download](#) portal .

From this page, download the latest bug fix RPMs as tarballs to the install repository. Untar the tarball into RPMs.

The `README` file provides the relevant information about the bug fix and also identifies the dependencies, if any, where other bug fix RPMs may be required for a complete fix.

The following image shows the options to install the bug fix RPMs.

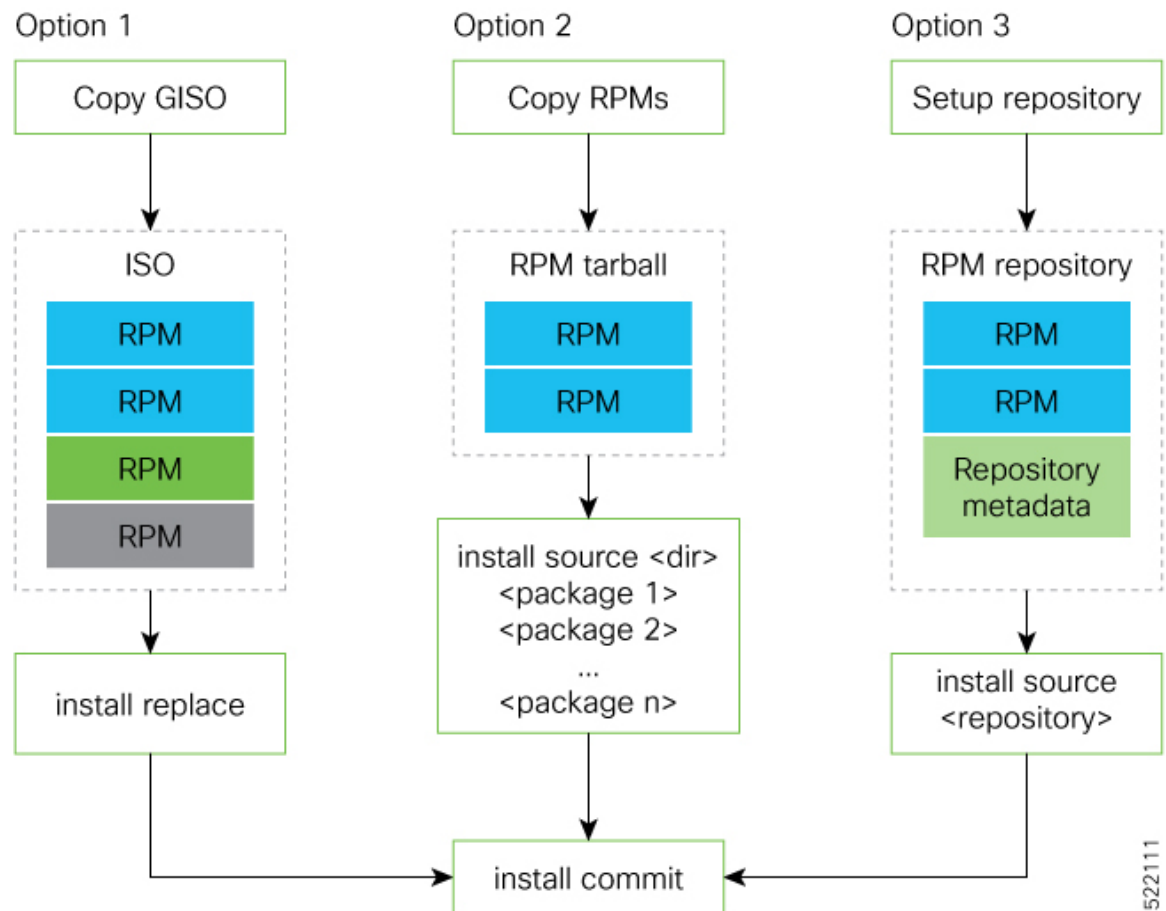

The software is split into modular blocks and the package manager infrastructure computes the dependencies between the blocks. Each block of software has a top-level package and various partition-level packages. Bug fixes that span multiple blocks may lead to creating multiple dependent packages that are built as part of earlier bug fixes.



**Note** We recommend that you leverage the GISO workflow. Contact Cisco Support to build a new GISO with the required bug fixes. The RPMs are present in the `initrd`, which is the initial RAM disk for the boot loader, and this requires that the package is signed by Cisco. You can install GISO using a single `install replace` operation. For more information about GISO, see the *Build a Golden GISO* section.

However, if you do not prefer using the GISO, here are a few alternative ways to install bug fixes:

- Create a bug fix tarball to contain all the dependent packages. The tarball may be reasonably large for bug fixes that span multiple blocks, but you can use this single tarball file directly to install the bug fixes without the need to check the individual packages within the file. You can also create a tarball containing all the dependent packages manually, but this method does not scale well.
- Create tarballs to install one or more bug fixes. For example, if you are installing bug fixes CSCxx1111, CSCyy2222 and CSCzz3333, you can use the individual tarball files and create a single tarball file.

- Use a Dandified Yum- or DNF repository to install, update, or remove relevant bug fixes. See, [Create Repository to Access Files for Installing IOS XR Software, on page 156](#).



**Note** The RPMs can be installed from the TAR file using CLI or Yang data model.

- CLI—
  - Packaging operation: `install package add source /harddisk:/ncs540-<version>.tgz synchronous`
  - Packaging operation and atomic change: `install source /harddisk:/ncs540-<version>.tgz synchronous`

- Yang Data Model—

```
<rpc xmlns="urn:ietf:params:xml:ns:netconf:
base:1.0" message-id="101">
<install-package-add xmlns=
"http://cisco.com/ns/yang/Cisco-IOS-XR-install-augmented-act">
<source-type>tar</source-type>
<source>/misc/disk1/ncs540-<version>.tgz</source>
</install-package-add>
</rpc>
```



**Note** Use the RPM repository to harvest the benefits of package manager. The package manager queries the available packages, and downloads only those packages and their dependencies that are needed for installation.

## Procedure

**Step 1** View the list of available bug fixes.

### Example:

```
Router#show install fixes available
Bug Id Packages

CSCxx12345 xr-5401-core-7.0.1v1.0.1-1
 xr-core-7.0.1v1.0.1-1
 <repository-name>
```

**Step 2** Install the bug fix or package using one of the following options:

- Install the package where the bug fix is applied.

```
Router#install package upgrade xr-5401-core-7.0.1v1.0.1-1 xr-core-7.0.1v1.0.1-1
Packaging operation 1.1.1 started - xr-5401-core-7.0.1v1.0.1-1 xr-core-7.0.1v1.0.1-1
```

This task can also be accomplished using [Cisco-IOS-XR-install-augmented-oper](#) data model.

Apply the changes.

```
Router#install apply [reload | restart]
```

**Note** To identify if you must reload or restart the system while applying the changes, use one of these two methods:

- History of last transaction

```
Router#show install history last transaction verbose
2019-09-11 17:01:46 UTC Transaction 3 started
2019-09-11 17:01:46 UTC Atomic change 3.1 started
2019-09-11 17:01:46 UTC Packaging operation 3.1.1 started
2019-09-11 17:16:46 UTC Transaction 3 complete
```

Least impactful apply method: process restart

The command also displays the information about the changes to files and processes because of the install operation, and the package operations carried out on each node.

- Show install request

Here, both `install apply restart` and `install apply reload` options are available. In this case, use `install apply restart` command because the impact on the system is the least. But when only an `install apply reload` option is available, then `reload` is the only option to apply the change.

- Install the optional package. Changes are applied automatically.

**Attention** Automatic change may trigger a reload of the router depending on the package that is installed.

```
Router#install source /harddisk:/files xr-5401-core-7.0.1v1.0.1-1.x86_64.rpm
```

**Note** Packages can also be installed using the package name.

```
Router#install source /harddisk:/files xr-5401-core
```

- This task can also be performed using YANG data models. Use `install RPC` on the [Cisco-IOS-XR-install-act](#) data model. Here is an example usage with an HTTP repository:

```
<install>
 <packages>
 <packagename>pkg1</packagename>
 </packages>
 <source-type>http</source-type>
 <source><path-to-source></source>
</install>
```

**Step 3** View the state of the packaging operation.

**Example:**

```
Router#show install request
User request: install package upgrade xr-<platform>-core-<version> xr-core-<version>
Operation ID: 2.1.2
State: In progress since
```

```
Current activity: Initiate operation
Next activity: Begin transaction
Time started: 2019-06-25 07:41:06
```

No per-location information.

**Step 4** View the log to ensure that the installation is successful.

**Example:**

```
Router#show install log
2019-06-25 07:41:06 UTC Transaction 1 started
2019-06-25 07:45:08 UTC Upgrade (Success)
2019-06-25 07:45:08 UTC xr-<platform>-core-<version>
2019-06-25 07:45:08 UTC xr-core-<version>
2019-06-25 07:57:02 UTC Atomic change 1.1 successfully applied by reload
```

**Step 5** View the history of the install operation.

**Example:**

```
Router#show install history table
Transaction Atomic Change Packaging Operations

Id Status Id Method Status Id Operation Inputs Status

1 In progress 1 Reload Success 1 Upgrade 1 Success
```

The command can also be used to view more details if there is a failed operation.

Use **show install history id <operation-id>** command to filter the history of install information by ID. IDs are of the form <transaction id>.<atomic id>.<packaging id>.

```
Router#show install history id ?
WORD Specify an operation ID (e.g. 1, 1.2, 1.2.3)
```

Use **show install history last** command to view the last packaging operation, atomic change, or transaction.

```
Router#show install history last ?
atomic-change Show the last atomic change
package Show the last packaging operation
transaction Show the last transaction
```

**Step 6** After the operation is complete, verify that the packages `xr-5401-core-7.0.1v1.0.1-1` and `xr-core-7.0.1v1.0.1-1` are installed and active.

**Example:**

```
Router#show install active summary
xr-ncs5401-bfd 7.0.1v1.0.0-1
xr-ncs5401-bmc 7.0.1v1.0.0-1
xr-ncs5401-bundles 7.0.1v1.0.0-1
xr-ncs5401-card-support 7.0.1v1.0.0-1
xr-ncs5401-core 7.0.1v1.0.1-1
xr-ncs5401-x64-core 7.0.1v1.0.1-1
xr-core 7.0.1v1.0.1-1
xr-core-calv 7.0.1v1.0.0-1
xr-host-core 7.0.1v1.0.0-1
xr-ip-core 7.0.1v1.0.0-1
xr-spi-core 7.0.1v1.0.0-1
```

**Example:**

**Example:**

```
Router#show install active summary
```

The version has changed. The version `1.0.1-1` indicates that the bug fix is installed.

This task can also be accomplished using data models. Use the `get` RPC for `install.fixes.active` operation using [Cisco-IOS-XR-install-augmented-oper](#) data model.

**Step 7** Commit the changes for the changes to persist after a reload operation.

**Example:**

```
Router#install commit
```



**Step 8** View the list of bug IDs for which fixes are committed.

**Example:**

```
Router#show install fixes committed
```

This task can also be accomplished using data models. Use the `get` RPC for `install.fixes.committed` operation using [Cisco-IOS-XR-install-augmented-oper](#) data model.

**Step 9** View the list of active bug fix RPMs.

**Example:**

```
Router#show install fixes active
```

This task can also be accomplished using data models. Use the `get` RPC for `install.fixes.active` operation using [Cisco-IOS-XR-install-augmented-oper](#) data model.

---

## Downgrade to a Previously Installed Package

You can downgrade a package to a previously installed version. By default, the subsequent previous version (version previous to the current version) is installed. Also, you can downgrade the software to a specific version of interest. To remove a bug fix RPM from the installed packages, downgrade the package to a version where the fix was not applied.



---

**Note** While downgrading, you can choose any previous version, including the base version of the RPM. However, when downgrading a bug fix RPMs, ensure that you also consider all dependencies of the current version.

Bug fix RPM is an upgrade to the existing package. The action of removing a bug fix RPM either removes the entire feature, or fails if the package is mandatory.

---

### Before you begin

Ensure you have access to the previously installed package and its source.

### Procedure

---

**Step 1** Downgrade the package using one of the following options:

- Downgrade the package where the fix was applied. When multiple older versions of the package are present in the configured repositories, the immediate previous version of the package is installed. Use caution when using this command as the current version of the package is removed completely.

```
Router#install package downgrade xr-telnet
```

Apply the changes.

```
Router#install apply [reload | restart]
```

**Attention** To identify whether to reload the router or restart the affected processes as part of the apply operation, use either **show install history last transaction verbose** command or **show install request** command.

- Install a specific earlier version of the optional package. The changes are applied automatically.

**Attention** An automatic change may trigger a reload of the router depending on the package being downgraded.

```
Router#install source <path-to-source> xr-telnet-7.0.1v1.0.0
```

- Use `install` RPC on the [Cisco-IOS-XR-install-act](#) data model. Here is an example usage with a local repository:

```
<install>
 <packages>
 <packagename>xr-telnet-7.0.1v1.0.0

 </packagename>
 </packages>
 <source>file://<path-to-source></source>
</install>
```

The package version `xr-telnet-7.0.1v1.0.1` is downgraded to `xr-telnet-7.0.1v1.0.0`.

**Step 2** Commit the operation.

**Example:**

```
Router#install commit
```

## Roll Back Software to a Previously Saved Installation Point



**Note** This section does not apply to the following variants of the Cisco NCS 540 routers:

- N540X-6Z18G-SYS-A
- N540X-6Z18G-SYS-D
- N540X-8Z16G-SYS-A
- N540X-8Z16G-SYS-D
- N540X-4Z14G2Q-SYS-A
- N540X-4Z14G2Q-SYS-D
- N540-24Q8L2DD-SYS

Table 18: Feature History Table

Feature Name	Release Information	Feature Description
Roll back to a previously-saved installation point	Release 7.4.1	<p>A maximum of 900MB of disk space is used to store all rollback points.</p> <p>You can delete older rollback points to make space for newer or smaller rollback points such as, SMUs.</p> <p>The following NCS 540 variants allow up to 900MB of disk space for rollback points:</p> <ul style="list-style-type: none"> <li>• N540-28Z4C-SYS-A/D</li> <li>• N540X-16Z4G8Q2C-A/D</li> <li>• N540-12Z20G-SYS-A/D</li> <li>• N540X-12Z16G-SYS-A/D</li> </ul> <p>This feature introduces the following commands:</p> <ul style="list-style-type: none"> <li>• <b>install commit description</b>—sets the description for a transaction ID</li> <li>• <b>install label id id description description</b>—adds a new description or overwrites the description of the specified transaction ID.</li> </ul> <p>The following command is updated to include the keyword, <b>oldest n</b>:</p> <ul style="list-style-type: none"> <li>• <b>clear install rollback oldest n</b>—deletes the specified number of rollback points</li> </ul>

You can roll your system software back to a previous version. This could be used to discard an ongoing install operation, or to undo an install operation that has already been committed. After each commit operation, the system saves a record of the committed software packages. Each record is a restoration point, and is assigned a unique ID. This ID is known as a transaction ID. You can use the transaction ID to roll back the software to a restoration point associated with this ID. Up to 900MB of space is allowed for rollback points, instead of a specific number of rollback points.



- Note**
- Use transaction ID 0 to roll back to the software that was present after the system booted for the first time.
  - If you commit an install transaction using **install commit** command, the GISO ZTP configuration is saved along with the rest of the software changes. This means that if you use the **install rollback** or **install package rollback** command to revert the software to the state of a previous transaction, the GISO ZTP configuration is also reverted to its previous state. To undo this install operation, as well as the change in GISO ZTP configuration, use **install package abort** command. If there is no GISO ZTP configuration saved at the end of the install transaction, the existing GISO ZTP configuration is reverted to the previous state when the rollback operation of that transaction is applied.

## Procedure

**Step 1** View the list of available transaction IDs.

**Example:**

```
Router# show install rollback list-ids
```

**Step 2** Explore the main packages that can be installed if you roll the software back to the specific transaction ID.

**Example:**

```
Router# show install rollback id <id>
```

**Step 3** View the relative changes that are made to the currently installed software if it is rolled back to a transaction ID.

**Example:**

```
Router# show install rollback id <id> changes
```

To perform these tasks using data models, use the `get` RPC on the Cisco-IOS-XR-install-augmented-oper data model.

```
<rpc>
 <get>
 <filter type="subtree">
 <install xmlns="http://cisco.com/ns/yang/Cisco-IOS-XR-install-augmented-oper">
 <rollback/>
 </install>
 </filter>
 </get>
</rpc>
```

**Step 4** Roll back to the software associated with the specific transaction ID.

**Example:**

```
Router# install rollback <id> [commit]
```

If you want to apply the change and roll back to the associated transaction ID, commit the change. You can also include the keyword `noprompt` in the command to enable the system to bypass your permission to reload the router.

**Attention** This roll back operation installs the previous software and also applies the change automatically. This may reload the router depending on the package that is rolled back.

Alternatively, use the **install package rollback** command to only roll back the package but not apply the changes. You can check whether the router will reload or restart if you apply the change using the **show install history last transaction verbose** command or **show install request** command. Based on the command output, you can take the appropriate action using **install apply reload | restart** command to either reload or restart the system. Use the **install commit** command to commit the transaction.

To perform this task using data models, use the `install-rollback` RPC on the Cisco-IOS-XR-install-augmented-oper data model.

```
<rpc>
 <install-rollback xmlns="http://cisco.com/ns/yang/Cisco-IOS-XR-install-augmented-act">
 <commit>true</commit>
 <transaction-id>0</transaction-id>
 </install-rollback>
</rpc>
```

To understand the data model structure and its arguments, see the Access the Install-Related Data Model.

**Step 5** Commit the operation.

**Example:**

```
Router#install commit
```

## Telemetry Support for Install Operations

*Table 19: Feature History Table*

Feature Name	Release Information	Description
Stream Telemetry Data about Install Operations	Release 7.5.2	You can stream telemetry data for install-related details such as active and committed packages, view the progress of install operations, retrieve the image version, and view the error messages with recovery information when an operation fails.

To stream telemetry data that is related to software installation, you must create subscriptions to the sensor paths in the YANG data models. See *Obtain Data Models for Install Operation* for the list of supported data models. For information about establishing a telemetry session and creating subscriptions, see the *Telemetry Configuration Guide for Cisco NCS 540 Series Routers*.

Stream Telemetry Data About	Description	YANG Path
Summary of active packages	Data is streamed after a successful <b>apply</b> operation. An active package is the software currently running on the system.	Cisco-IOS-XR-install-oper: install/packages/active/summary
Summary of committed packages	Data is streamed after a successful <b>commit</b> operation. A package that is committed remains active following a system reload.	Cisco-IOS-XR-install-oper: install/packages/committed/summary
Status of the last request operation	Data is streamed when starting a new request and also when entering an <b>idle</b> state. If the operation has failed, this includes error messages along with recovery state.	Cisco-IOS-XR-install-oper: install/request
Image version and GISO label	Data is streamed after a successful <b>apply</b> operation.	Cisco-IOS-XR-install-oper: install/version
Packaging information	Data is streamed at the start and end of a packaging operation.	Cisco-IOS-XR-install-augmented-oper: install/history/latest-packaging-operation
Atomic information	Data is streamed at the start and end of <b>apply</b> operation.	Cisco-IOS-XR-install-augmented-oper: install/history/latest-atomic-change
Transaction information	Data is streamed at the start, in progress, and end of a <b>commit</b> operation.  <b>Note</b> After a transactional rollback, some of the data such as summary of active packages, image version can change. However, telemetry events are not sent after the reload operation.	Cisco-IOS-XR-install-augmented-oper: install/history/latest-transaction

## Caveats

### Release 7.10.1

The following upgrade caveats are applicable for Cisco NCS 540 Series Routers listed in the *Cisco NCS 540 Series Router and PIDs* table for Release 7.10.1 and later.

**Table 20: Upgrade Caveats for Cisco NCS 540 Series Routers**

From	To	Bridge SMUs Required (CSCwd71524)	Caveats
7.3.2	7.10.1 and later	Yes	1*,2*,3*
7.5.2	7.10.1 and later	Yes	1*,2*,4*
7.6.1	7.10.1 and later	Yes	1*,2*,4*
7.6.2	7.10.1 and later	None	1*
7.7.1	7.10.1 and later	None	1*
7.7.2	7.10.1 and later	None	1*
7.8.1	7.10.1 and later	None	1*
7.8.2	7.10.1 and later	None	1*
7.9.1	7.10.1 and later	None	1*
7.9.2	7.10.1 and later	None	1*

1\*: You can't roll back using the **install rollback** command.

2\*: Ensure that a reload bridging SMU (CSCwd71524) is installed.

3\*: Ensure that you install the bridge SMU (CSCwd71524) manually because even if it's available inside the GISO that's replacing the existing GISO, this SMU doesn't get installed automatically.

4\*: It's applicable to the Small Density Routers listed in the *Cisco NCS 540 Series Router and PIDs* table. Before replacing GISO, ensure that you install the bridge SMU (CSCwd71524) manually.



**Note** CSCwd71524:

- When you upgrade from earlier than Release 7.10.1 to Release 7.10.1, system supports the installation process seamlessly.
- When you downgrade from Release 7.10.1, system preserves the present configuration and the install history from last transaction.

The following downgrade caveats are applicable for Cisco NCS 540 Series Routers listed in the *Cisco NCS 540 Series Router and PIDs* table for Release 7.10.1 and later.

**Table 21: Downgrade Caveats for Cisco NCS 540 Series Routers**

From	To	Target SMUs Required (CSCwd71524)	Caveats
7.10.1 and later	7.3.2	Yes	C*
7.10.1 and later	7.5.2	Yes	***, A*, B*, D*

From	To	Target SMUs Required (CSCwd71524)	Caveats
7.10.1 and later	7.6.1	Yes	***, A*, B*, D*
7.10.1 and later	7.6.2	Yes	***, A*, B*, D*
7.10.1 and later	7.7.1	Yes	***, A*, B*, D*
7.10.1 and later	7.7.2	Yes	***, A*, B*, D*
7.10.1 and later	7.8.1	Yes	***, A*, B*, D*
7.10.1 and later	7.8.2	Yes	***, A*, B*, D*
7.10.1 and later	7.9.1	Yes	***, D*
7.10.1 and later	7.9.2	Yes	***, D*

\*\*\*

- You don't need to run the **install commit** command after a downgrade operation because the operation is automatically committed.
- You can't roll back after a downgrade. To revert to the previous IOS XR previous version, replace or reimage to the relevant ISO.
- IOS XR configuration history is lost after a downgrade, but the router preserves the latest configuration.
- Install history from the last transaction is preserved after a downgrade operation.
- Downtime takes a longer time as the operation is performed through reimage.
- You can't downgrade using the **install package replace** command. Instead, use the **install replace** command to downgrade.
- Ensure that you reinstall third-party application once you complete the downgrade.
- Ensure that you disable reimage-protection feature before performing downgrade because the downgrade occurs through a reimage. You can disable the reimage-protection using the **platform security reimage-protection disable** command.



---

**Note** The reimage-protection feature applies to the Cisco NCS 540 Series Routers listed in the *Cisco NCS 540 Series Router and PIDs* table.

---

- PXE recovery is required if the image downgrading isn't bootable.
- You must re-install the *Type 6 masterkey* and reapply the configuration encrypted by it because they are lost after the downgrade.
- You must regenerate crypto keys and certificates after a downgrade.

A\*: You can't downgrade to the base ISO. You can downgrade to a GISO containing the bridge SMU (CSCwd71524).



B\* : You must recover the router through PXE if a power cycle occurs during the downgrade.

C\* : One-step downgrade isn't supported. You must use either PXE/USB to downgrade or perform a two-step downgrade through Release 7.9.1 or Release 7.5.4. The first-hop downgrade to Release 7.9.1 or Release 7.5.4 still carries the same caveats.

D\* : FPD upgrade may cause your router to reload an extra time during boot-up.

E\* : Traffic is impacted.

Use the **show install upgrade-matrix running** command to view the caveats.

