



## **Network Synchronization Configuration Guide for Cisco NCS 540 Series Routers, IOS XR Release 7.11.x**

**First Published:** 2023-12-01

### **Americas Headquarters**

Cisco Systems, Inc.  
170 West Tasman Drive  
San Jose, CA 95134-1706  
USA  
<http://www.cisco.com>  
Tel: 408 526-4000  
800 553-NETS (6387)  
Fax: 408 527-0883

THE SPECIFICATIONS AND INFORMATION REGARDING THE PRODUCTS IN THIS MANUAL ARE SUBJECT TO CHANGE WITHOUT NOTICE. ALL STATEMENTS, INFORMATION, AND RECOMMENDATIONS IN THIS MANUAL ARE BELIEVED TO BE ACCURATE BUT ARE PRESENTED WITHOUT WARRANTY OF ANY KIND, EXPRESS OR IMPLIED. USERS MUST TAKE FULL RESPONSIBILITY FOR THEIR APPLICATION OF ANY PRODUCTS.

THE SOFTWARE LICENSE AND LIMITED WARRANTY FOR THE ACCOMPANYING PRODUCT ARE SET FORTH IN THE INFORMATION PACKET THAT SHIPPED WITH THE PRODUCT AND ARE INCORPORATED HEREIN BY THIS REFERENCE. IF YOU ARE UNABLE TO LOCATE THE SOFTWARE LICENSE OR LIMITED WARRANTY, CONTACT YOUR CISCO REPRESENTATIVE FOR A COPY.

The Cisco implementation of TCP header compression is an adaptation of a program developed by the University of California, Berkeley (UCB) as part of UCB's public domain version of the UNIX operating system. All rights reserved. Copyright © 1981, Regents of the University of California.

NOTWITHSTANDING ANY OTHER WARRANTY HEREIN, ALL DOCUMENT FILES AND SOFTWARE OF THESE SUPPLIERS ARE PROVIDED "AS IS" WITH ALL FAULTS. CISCO AND THE ABOVE-NAMED SUPPLIERS DISCLAIM ALL WARRANTIES, EXPRESSED OR IMPLIED, INCLUDING, WITHOUT LIMITATION, THOSE OF MERCHANTABILITY, FITNESS FOR A PARTICULAR PURPOSE AND NON-INFRINGEMENT OR ARISING FROM A COURSE OF DEALING, USAGE, OR TRADE PRACTICE.

IN NO EVENT SHALL CISCO OR ITS SUPPLIERS BE LIABLE FOR ANY INDIRECT, SPECIAL, CONSEQUENTIAL, OR INCIDENTAL DAMAGES, INCLUDING, WITHOUT LIMITATION, LOST PROFITS OR LOSS OR DAMAGE TO DATA ARISING OUT OF THE USE OR INABILITY TO USE THIS MANUAL, EVEN IF CISCO OR ITS SUPPLIERS HAVE BEEN ADVISED OF THE POSSIBILITY OF SUCH DAMAGES.

Any Internet Protocol (IP) addresses and phone numbers used in this document are not intended to be actual addresses and phone numbers. Any examples, command display output, network topology diagrams, and other figures included in the document are shown for illustrative purposes only. Any use of actual IP addresses or phone numbers in illustrative content is unintentional and coincidental.

All printed copies and duplicate soft copies of this document are considered uncontrolled. See the current online version for the latest version.

Cisco has more than 200 offices worldwide. Addresses and phone numbers are listed on the Cisco website at [www.cisco.com/go/offices](http://www.cisco.com/go/offices).

Cisco and the Cisco logo are trademarks or registered trademarks of Cisco and/or its affiliates in the U.S. and other countries. To view a list of Cisco trademarks, go to this URL: <https://www.cisco.com/c/en/us/about/legal/trademarks.html>. Third-party trademarks mentioned are the property of their respective owners. The use of the word partner does not imply a partnership relationship between Cisco and any other company. (1721R)

© 2023 Cisco Systems, Inc. All rights reserved.



## CONTENTS

---

<b>CHAPTER 1</b>	<b>Using YANG Data Models</b>	<b>1</b>
------------------	-------------------------------	----------

---

<b>CHAPTER 2</b>	<b>Synchronous Ethernet ESMC and SSM</b>	<b>3</b>
	Frequency Synchronization Timing Concepts	7
	Sources	7
	Selection Points	7
	Restrictions	8
	Configuring Frequency Synchronization	8
	Enabling Frequency Synchronization on the Router	8
	Configuring Frequency Synchronization on an Interface	8
	Configuring Frequency Synchronization on a Clock Interface	9
	Verifying the Frequency Synchronization Configuration	9
	Verifying the ESMC Configuration	12
	Verifying Synchronous Ethernet LEDs	13

---

<b>CHAPTER 3</b>	<b>Transparent PDH over Packet (TPoP) and Channelized SDH over Packet (CSoP)</b>	<b>15</b>
	Configuring TPoP and CSoP	15
	VPWS with Smart SFP	18
	Multi Router Automatic Protection Switching	18
	Field-Pluggable Device (FPD) Version Upgrade for Smart SFP	19
	Restrictions for Smart SFP	21

---

<b>CHAPTER 4</b>	<b>TSoP Smart SFP for SDH and SONET Encapsulation</b>	<b>25</b>
	Prerequisites for TSoP	26
	Restrictions for TSoP	26
	Guidelines for TSoP Smart SFP	27

De-jitter Buffer	27
Configuration for TSoP	28

---

**CHAPTER 5**

<b>Understanding PTP</b>	<b>35</b>
Why PTP?	36
Routers and Delays	37
Message-Based Synchronization	37
PTP Event Message Sequences	38
Synchronizing with Boundary Clocks	38
Synchronizing the Local Clock	39
PTP Clocks	39
Restrictions for PTP	40
PTP Profiles	40
ITU-T Telecom Profiles for PTP	41
G.8265.1	41
G.8275.1	42
G.8275.2	43
PTP Virtual Port	45
Configuring the G.8265.1 Profile	47
Configuring the G.8275.1 Profile	47
Configuring the G.8275.2 Profile	48
Example: Configuring G.8275.2 in Hybrid Mode	50
Example: Configuring G.8275.2 in Non-Hybrid Mode	53
Configuring Virtual Port	55
Configuring APTS	56
PTP Over Bundled Virtual Interface	56
Limitations	57
Configuring PTP Over BVI	57
Verifying PTP Over BVI	59
Slow Tracking	59
PTP Holdover Traceability Suppression	60
IEEE Default Profile	61
Example: Hybrid Default Profile	61
PTP Hybrid Mode	61

Configuring PTP Hybrid Mode	62
Verifying the PTP Hybrid Mode Configurations	63
PTP Profile Interoperation	64
Verifying PTP Interoperation	66

**CHAPTER 6****External Timing Source 69**

GPS	69
Configuring GPS Settings for the Grandmaster Clock	70
Verifying the GPS Input	70
Building Integrated Timing Supply (BITS)	71
Prerequisite for BITS	71
Configuring BITS-IN	71
Configuring BITS-OUT	72
Verifying BITS-IN Configuration	72
Verifying BITS-OUT Configuration	73
Verify Quality Level Received and Clock Interfaces	73

**CHAPTER 7****Implementing NTP 75**

Information About Implementing NTP	75
Configuring NTP	76
Configuring Poll-Based Associations	76
Configuring Broadcast-Based Associations	76
Configuring NTP Access Groups	77
Configuring NTP Authentication	77
Disabling NTP on an Interface	78
Configuring the System as an Authoritative NTP Server	78
Updating the Hardware Clock	78
Configuring NTP Server Inside VRF Interface	79

**CHAPTER 8****Workflow and Use Case 81****CHAPTER 9****Configure the Global Navigation Satellite System 85**

Overview of GNSS	85
Operation of GNSS Module	86

Prerequisites for GNSS 88

Restrictions for GNSS 88

Configure GNSS 88

---

**CHAPTER 10****Network Synchronization Design Best Practices 91**

Network Synchronization Decision Tree 91

General Guidelines for Successful Synchronization Deployments 92

Guidelines for Phase Synchronization Deployments 93

PTP over IP Network Design 94

Selecting the Correct Profile For Network Synchronization 95

Reducing Asymmetry 96

Reducing Packet Delay Variation 96

Remediating Transport Asymmetry 96

Synchronizing Across Networks 97



## CHAPTER 1

# Using YANG Data Models

---

Cisco IOS XR supports a programmatic way of configuring and collecting operational data of a network device using YANG data models. Although configurations using CLIs are easier and human-readable, automating the configuration using model-driven programmability results in scalability.

The data models are available in the release image, and are also published in the [Github](#) repository. Navigate to the release folder of interest to view the list of supported data models and their definitions. Each data model defines a complete and cohesive model, or augments an existing data model with additional XPath. To view a comprehensive list of the data models supported in a release, navigate to the **Available-Content.md** file in the repository. The unsupported sensor paths are documented as deviations. For example, `openconfig-acl.yang` provides details about the supported sensor paths, whereas `cisco-xr-openconfig-acl-deviations.yang` shows the unsupported sensor paths for `openconfig-acl.yang` model on Cisco IOS XR routers.

You can also view the data model definitions using the [YANG Data Models Navigator](#) tool. This GUI-based and easy-to-use tool helps you explore the nuances of the data model and view the dependencies between various containers in the model. You can view the list of models supported across Cisco IOS XR releases and platforms, locate a specific model, view the containers and their respective lists, leaves, and leaf lists presented visually in a tree structure. This visual tree form helps you get insights into nodes that can help you automate your network.

To get started with using the data models, see the Programmability Configuration Guide for Cisco NCS 540 Series Routers.







## CHAPTER 2

# Synchronous Ethernet ESMC and SSM

*Table 1: Feature History Table*

Feature Name	Release Information	Description
Enhanced SyncE and extended ESMC	Release 7.11.1	<p>ITU-T G.8262.1 recommendation defines the requirements for timing devices used in synchronizing network equipment. For example, bandwidth, frequency accuracy, holdover, and noise generation.</p> <p>With Enhanced SyncE (eSyncE) and Extended Ethernet Synchronization Message Channel (eESMC) support, the NCS 540 Series Routers are capable of handling the following SyncE clocks on the network:</p> <ul style="list-style-type: none"> <li>• Enhanced primary reference clock (ePRC)</li> <li>• Enhanced primary reference timing clock (ePRTC)</li> </ul> <p>In this release, eSyncE and eESMC are supported on the following Cisco NCS 540 router variants:</p> <ul style="list-style-type: none"> <li>• N540-6Z14S-SYS-D</li> <li>• N540-6Z18G-SYS-A/D</li> <li>• N540X-4Z14G2Q-A/D</li> <li>• N540X-8Z16G-SYS-A/D</li> <li>• N540X-6Z18G-SYS-A/D</li> <li>• N540X-16Z4G8Q2C-A/D</li> <li>• N540-24Q8L2DD-SYS</li> </ul>

Feature Name	Release Information	Description
Synchronous Ethernet ESMC and SSM on N540X-16Z4G8Q2C-A/D	Release 7.7.1	<p>Synchronous Ethernet ESMC and SSM are now supported on the following Cisco NCS 540 router variant:</p> <ul style="list-style-type: none"> <li>• N540X-16Z4G8Q2C-A/D</li> </ul> <p>For 1G ports, clock recovery is supported only on ports 4 to 19.</p>
Synchronous Ethernet ESMC and SSM on N540-6Z14S-SYS-D	Release 7.5.2	<p>SyncE provides synchronization signals transmitted over the Ethernet physical layer to downstream devices, while the Synchronization Status Message (SSM) indicates the quality level of the transmitting clock to the neighboring nodes, informing the nodes about the level of the network's reliability. Ethernet Synchronization Message Channel (ESMC) is the logical channel that uses an Ethernet PDU (protocol data unit) to exchange SSM information over the SyncE link.</p> <p>Synchronous Ethernet ESMC and SSM are now supported on the following Cisco NCS 540 router variants:</p> <ul style="list-style-type: none"> <li>• N540-6Z14S-SYS-D</li> </ul>

Feature Name	Release Information	Description
Synchronous Ethernet ESMC and SSM, and ITU-T G.8262.1	Release 7.6.1	<p>Ethernet Synchronization Message Channel (ESMC) allows you to transmit Synchronization Status Message (SSM) information by using the ESMC protocol data units (PDUs).</p> <p>In this release, Synchronous Ethernet ESMC and SSM are supported on the following Cisco NCS 540 router variants:</p> <ul style="list-style-type: none"> <li>• N540-ACC-SYS</li> <li>• N540X-ACC-SYS</li> <li>• N540-24Z8Q2C-SYS</li> <li>• N540-FH-CSR-SYS</li> <li>• N540-FH-AGG-SYS</li> </ul> <p>ITU-T G.8262.1 defines the Timing characteristics of a synchronous equipment slave clock.</p> <p>In this release, ITU-T G.8262.1 is supported on the following Cisco NCS 540 router variants:</p> <ul style="list-style-type: none"> <li>• N540-28Z4C-SYS-A/D</li> <li>• N540X-16Z4G8Q2C-A/D</li> <li>• N540-12Z20G-SYS-A/D</li> <li>• 540X-12Z16G-SYS-A/D</li> <li>• N540-ACC-SYS</li> <li>• N540X-ACC-SYS</li> <li>• N540-24Z8Q2C-SYS</li> <li>• N540-FH-CSR-SYS</li> <li>• N540-FH-AGG-SYS</li> </ul>

Feature Name	Release Information	Description
Frequency Synchronization on the N540X-4Z14G2Q-SYS-A/D routers.	Release 7.4.1	Based on the ITU-T G.8262 recommendations, precision frequency is enabled on timing devices to deliver frequency synchronization for bandwidth, frequency accuracy, holdover, and noise generation. This support allows for correct network operations when synchronous equipment is timed from either another synchronous equipment clock or a higher-quality clock.



---

**Note** On 1G ports of Cisco N540X-16Z4G8Q2C-A/D, clock recovery is supported only on ports 4 to 19.

---



---

**Note** On Cisco N540X-4Z14G2Q-SYS-A/D routers, the Synchronous Ethernet (SyncE) feature is not supported on ports 14 and 15.

---

Synchronous Ethernet is an extension of Ethernet designed to provide the reliability found in traditional SONET/SDH and T1/E1 networks to Ethernet packet networks by incorporating clock synchronization features. It supports the Synchronization Status Message (SSM) and Ethernet Synchronization Message Channel (ESMC) for synchronous Ethernet clock synchronization.

Synchronous Ethernet incorporates the Synchronization Status Message (SSM) used in Synchronous Optical Networking (SONET) and Synchronous Digital Hierarchy (SDH) networks. While SONET and SDH transmit the SSM in a fixed location within the frame, Ethernet Synchronization Message Channel (ESMC) transmits the SSM using a protocol: the IEEE 802.3 Organization-Specific Slow Protocol (OSSP) standard.

The ESMC carries a Quality Level (QL) value identifying the clock quality of a given synchronous Ethernet timing source. Clock quality values help a synchronous Ethernet node derive timing from the most reliable source and prevent timing loops.

When configured to use synchronous Ethernet, the router synchronizes to the best available clock source. If no better clock sources are available, the router remains synchronized to the current clock source.

The router supports QL-enabled mode.

- [Frequency Synchronization Timing Concepts, on page 7](#)
- [Configuring Frequency Synchronization, on page 8](#)
- [Verifying the Frequency Synchronization Configuration, on page 9](#)
- [Verifying the ESMC Configuration, on page 12](#)
- [Verifying Synchronous Ethernet LEDs, on page 13](#)

# Frequency Synchronization Timing Concepts

The Cisco IOS XR frequency synchronization infrastructure is used to select between different frequency sources to set the router backplane frequency and time-of-day. There are two important concepts that must be understood with respect to the frequency synchronization implementation.

## Sources

A source is a piece of hardware that inputs frequency signals into the system or transmits them out of the system. There are four types of sources:

- Line interfaces: This includes SyncE interfaces.
- Clock interfaces: These are external connectors for connecting other timing signals, such as, GPS, BITS.
- PTP clock: If IEEE 1588 version 2 is configured on the router, a PTP clock may be available to frequency synchronization as a source of the time-of-day and frequency.
- Internal oscillator: This is a free-running internal oscillator chip.

Each timing source has a Quality Level (QL) associated with it which gives the accuracy of the clock. This QL information is transmitted across the network via SSMs over the Ethernet Synchronization Messaging Channel (ESMC) or SSMs contained in the SONET/SDH frames so that devices know the best available source to synchronize to. In order to define a preferred network synchronization flow, and to help prevent timing loops, you can assign priority values to particular timing sources on each router. The combination of QL information and user-assigned priority levels allows each router to choose a timing source to use to clock its SyncE and SONET/SDH interfaces, as described in the ITU standard G.781.

### Priority Levels

You can specify the priority of the frequency source on a controller or an interface. Values can range from 1 (highest priority) to 254 (lowest priority). The default value is 100. The priority is used in the clock-selection algorithm to choose between two sources that have the same quality level (QL). Lower priority values are preferred. For example, you can set the priority value for a GNSS clock source by using this command:

```
Router(config-gnss-freqsync)# priority 5
```

The router first considers the QL advertised by different timing sources. If two sources have the same QL, the router selects the source with a lower priority value for network synchronization.

## Selection Points

A selection point is any point where a choice is made between several frequency signals, and possibly one or more of them are selected. Selection points form a graph representing the flow of timing signals between the different cards in a router running Cisco IOS XR software. For example, one or multiple selection points select between the different Synchronous Ethernet inputs available on a single line card, and the result of these selection points is forwarded to a selection point on the RSP to select between the selected source from each card.

The input signals to the selection points can be:

- Received directly from a source.
- The output from another selection point on the same card.

- The output from a selection point on a different card.

The output of a selection point can be used in a number of ways:

- Used to drive the signals sent out of a set of sources.
- As input into another selection point on the card.
- As input into a selection point on another card.

Use the show frequency synchronization selection command to see a detailed view of the different selection points within the system.

## Restrictions

- SyncE isn't supported on Gigabit Ethernet 0/0/0/20 to 0/0/0/27 ports of N540X-16Z4G8Q2C-A and N540X-16Z4G8Q2C-D variants.



---

**Note** The following restrictions are applicable only for N540-24Z8Q2C-SYS, N540X-ACC-SYS, N540-ACC-SYS, and N540-28Z4C-SYS variants.

---

- SyncE isn't supported on Gigabit Ethernet 0/0/0/24 to 0/0/0/31 ports.

# Configuring Frequency Synchronization

## Enabling Frequency Synchronization on the Router

This task describes the router-level configuration required to enable frequency synchronization.

```
RP/0/RP0/CPU0:Router# configure
RP/0/RP0/CPU0:Router(config)# frequency synchronization
RP/0/RP0/CPU0:Router(config-freqsync)# clock-interface timing-mode system
RP/0/RP0/CPU0:Router(config-freqsync)# quality itu-t option 1 generation 1
RP/0/RP0/CPU0:Router(config-freqsync)# log selection changes
RP/0/RP0/CPU0:Router(config-freqsync)# commit
```

## Configuring Frequency Synchronization on an Interface

By default, there is no frequency synchronization on line interfaces. Use this task to configure an interface to participate in frequency synchronization.

### Before You Begin

You must enable frequency synchronization globally on the router.

```
RP/0/RP0/CPU0:R1#config terminal
RP/0/RP0/CPU0:R1(config)#interface TenGigabitEthernet 0/0/0/0
RP/0/RP0/CPU0:R1(config-if)#frequency synchronization
RP/0/RP0/CPU0:R1(config-if-freqsync)#selection input
RP/0/RP0/CPU0:R1(config-if-freqsync)#wait-to-restore 10
```

```

RP/0/RP0/CPU0:R1(config-if-freqsync)#priority 5
RP/0/RP0/CPU0:R1(config-if-freqsync)#quality transmit exact itu-t option 1 PRC
RP/0/RP0/CPU0:R1(config-if-freqsync)#quality receive exact itu-t option 1 PRC
RP/0/RP0/CPU0:R1(config-if-freqsync)#commit
or
RP/0/RP0/CPU0:router(config-freqsync)# commit

```

## Configuring Frequency Synchronization on a Clock Interface

To enable a clock interface to be used as frequency input or output, you must configure the port parameters and frequency synchronization, as described in this task.

```

RP/0/RP0/CPU0:R1#configure
RP/0/RP0/CPU0:R1(config)# clock-interface sync 2 location 0/RP0/CPU0
RP/0/RP0/CPU0:R1(config-clock-if)# port-parameters
RP/0/RP0/CPU0:R1(config-clk-parms)# gps-input tod-format cisco pps-input ttl
RP/0/RP0/CPU0:R1(config-clk-parms)# exit
RP/0/RP0/CPU0:R1(config-clock-if)# frequency synchronization
RP/0/RP0/CPU0:R1(config-clk-freqsync)# selection input
RP/0/RP0/CPU0:R1(config-clk-freqsync)# wait-to-restore 1
RP/0/RP0/CPU0:R1(config-clk-freqsync)# quality receive exact itu-t option 1 PRC

```

## Verifying the Frequency Synchronization Configuration

After performing the frequency synchronization configuration tasks, use this task to check for configuration errors and verify the configuration.

### 1. show frequency synchronization selection

```

RP/0/RP0/CPU0:R5# show frequency synchronization selection
Fri Apr 24 12:49:32.833 UTC
Node 0/RP1/CPU0:
=====
Selection point: T0-SEL-B (3 inputs, 1 selected)
Last programmed 3d04h ago, and selection made 3d04h ago
Next selection points
  SPA scoped      : None
  Node scoped     : CHASSIS-TOD-SEL
  Chassis scoped: LC_TX_SELECT
  Router scoped  : None
Uses frequency selection
Used for local line interface output
S  Input                Last Selection Point          QL  Pri  Status
== =====
4  HundredGigE0/7/0/0    0/RP1/CPU0 ETH_RXMUX 4          PRC  10  Locked
   PTP [0/RP1/CPU0]      n/a                            PRC  254 Available
   Internal0 [0/RP1/CPU0] n/a                            SEC  255 Available

Selection point: 1588-SEL (2 inputs, 1 selected)
Last programmed 3d04h ago, and selection made 3d04h ago
Next selection points
  SPA scoped      : None
  Node scoped     : None
  Chassis scoped: None
  Router scoped  : None
Uses frequency selection
S  Input                Last Selection Point          QL  Pri  Status
== =====
4  HundredGigE0/7/0/0    0/RP1/CPU0 ETH_RXMUX 4          PRC  10  Locked
   Internal0 [0/RP1/CPU0] n/a                            SEC  255 Available

```

```

Selection point: CHASSIS-TOD-SEL (2 inputs, 1 selected)
Last programmed 3d04h ago, and selection made 3d04h ago
Next selection points
  SPA scoped      : None
  Node scoped     : None
  Chassis scoped  : None
  Router scoped   : None
Uses time-of-day selection
S  Input                Last Selection Point      Pri  Time  Status
== =====
1  PTP [0/RP1/CPU0]     n/a                        100  Yes   Available
   HundredGigE0/7/0/0  0/RP1/CPU0 T0-SEL-B 4    100  No    Available

Selection point: ETH_RXMUX (1 inputs, 1 selected)
Last programmed 3d04h ago, and selection made 3d04h ago
Next selection points
  SPA scoped      : None
  Node scoped     : T0-SEL-B 1588-SEL
  Chassis scoped  : None
  Router scoped   : None
Uses frequency selection
S  Input                Last Selection Point      QL  Pri  Status
== =====
4  HundredGigE0/7/0/0  n/a                        PRC  10  Available

```

## 2. show frequency synchronization configuration-errors

```

RP/0/RP0/CPU0:router# show frequency synchronization configuration-errors
Node 0/2/CPU0:
=====
interface GigabitEthernet0/2/0/0 frequency synchronization
 * Frequency synchronization is enabled on this interface, but isn't enabled globally.
interface GigabitEthernet0/2/0/0 frequency synchronization quality transmit exact itu-t
option 2 generation 1 PRS
 * The QL that is configured is from a different QL option set than is configured
globally.

```

Displays any errors that are caused by inconsistencies between shared-plane (global) and local-plane (interface) configurations. There are two possible errors that can be displayed:

- Frequency Synchronization is configured on an interface (line interface or clock-interface), but is not configured globally.
- The QL option configured on some interface does not match the global QL option. Under an interface (line interface or clock interface), the QL option is specified using the quality transmit and quality receive commands. The value specified must match the value configured in the global quality itu-t option command, or match the default (option 1) if the global quality itu-t option command is not configured.

Once all the errors have been resolved, meaning there is no output from the command, continue to the next step.

## 3. show frequency synchronization interfaces brief

```

RP/0/RP0/CPU0:R5# show frequency synchronization interfaces brief
Thu Feb 1 06:30:02.945 UTC
Flags: > - Up
        d - SSM Disabled
        s - Output squelched
Fl  Interface
D - Down          S - Assigned for selection

```



```

x - Peer timed out    i - Init state
Last Selection Point
Pri Time
Status
=====
>S TenGigE0/0/0/0      PRC   PRC    1  DNU   TenGigE0/0/0/0
>x TenGigE0/0/0/1     Fail  n/a   100 PRC   TenGigE0/0/0/0
>x TwentyFiveGigE0/0/0/30 Fail  n/a   100 PRC   TenGigE0/0/0/0
=====
RP/0/RP0/CPU0:R5#

```

Verifies the configuration. Note the following points:

- All line interface that have frequency synchronization configured are displayed.
- All clock interfaces and internal oscillators are displayed.
- Sources that have been nominated as inputs (in other words, have selection input configured) have 'S' in the Flags column; sources that have not been nominated as inputs do not have 'S' displayed.



---

**Note** Internal oscillators are always eligible as inputs.

---

- '>' or 'D' is displayed in the flags field as appropriate.

If any of these items are not true, continue to the next step.

#### 4. show processes fsyncmgr location node-id

This command verifies that the fsyncmgr process is running on the appropriate nodes.

```

RP/0/RP0/CPU0:R5# show processes fsyncmgr location 0/0/cPU0
Thu Feb 1 06:26:32.979 UTC
Job Id: 181
PID: HYPERLINK "tel:3411"3411
Process name: fsyncmgr
Executable path:
/opt/cisco/XR/packages/ncs540-iosxr-fwding-1.0.0.0-r63226I/all/bin/fsyncmgr Instance #:
1
Version ID: 00.00.0000
Respawn: ON
Respawn count: 1
Last started: Tue Jan 23 04:26:57 HYPERLINK "tel:2018"2018
Process state: Run
Package state: Normal
core: MAINMEM
Max. core: 0
Level: 100
Placement: None
startup_path:
/opt/cisco/XR/packages/ncs540-iosxr-fwding-1.0.0.0-r63226I/all/startup/fsyncmgr.startup
Ready: 2.063s
Process cpu time: 168.480 user, 129.980 kernel, 298.460 total
JID TID Stack pri state NAME rt_pri
181 HYPERLINK "tel:3411"3411 OK 20 Sleeping fsyncmgr 0
181 HYPERLINK "tel:3572"3572 OK 20 Sleeping lwm_debug_threa 0
181 HYPERLINK "tel:3573"3573 OK 20 Sleeping fsyncmgr 0
181 HYPERLINK "tel:3574"3574 OK 20 Sleeping lwm_service_thr 0
181 HYPERLINK "tel:3575"3575 OK 20 Sleeping qsm_service_thr 0
181 HYPERLINK "tel:3622"3622 OK 20 Sleeping fsyncmgr 0

```

```
181 HYPERLINK "tel:3781"3781 OK 20 Sleeping fsyncmgr 0
181 HYPERLINK "tel:3789"3789 OK 20 Sleeping fsyncmgr 0
```

## Verifying the ESMC Configuration

### show frequency synchronization interfaces

```
RP/0/RP0/CPU0:R5# show frequency synchronization interfaces
Thu Feb 1 06:33:26.575 UTC
Interface TenGigE0/0/0/0 (up)
Assigned as input for selection
Wait-to-restore time 0 minutes
SSM Enabled
Peer Up for 2d01h, last SSM received 0.320s ago
Peer has come up 1 times and timed out 0 times
ESMC SSMs Total Information Event DNU/DUS
Sent: HYPERLINK "tel:178479"178479 HYPERLINK "tel:178477"178477 2 HYPERLINK "tel:178463"178463
Received: HYPERLINK "tel:178499"178499 HYPERLINK "tel:178499"178499 0

Input:
Up
Last received QL: Opt-I/PRC
Effective QL: Opt-I/PRC, Priority: 1, Time-of-day Priority 100
Supports frequency
Output:
Selected source: TenGigE0/0/0/0
Selected source QL: Opt-I/PRC
Effective QL: DNU
Next selection points: ETH_RXMUX
Interface TenGigE0/0/0/1 (up)
Wait-to-restore time 5 minutes
SSM Enabled
Peer Timed Out for 2d01h, last SSM received never
Peer has come up 0 times and timed out 1 times
ESMC SSMs Total Information Event DNU/DUS
Sent: HYPERLINK "tel:178479"178479 HYPERLINK "tel:178477"178477 2 0
Received: 0 0 0 0
Input:
Down - not assigned for selection
Supports frequency
Output:
Selected source: TenGigE0/0/0/0
Selected source QL: Opt-I/PRC
Effective QL: Opt-I/PRC
Next selection points: ETH_RXMUX
Interface TwentyFiveGigE0/0/0/30 (up)
Wait-to-restore time 5 minutes
SSM Enabled
Peer Timed Out for 01:50:24, last SSM received 01:50:30 ago
Peer has come up 1 times and timed out 1 times
ESMC SSMs Total Information Event DNU/DUS
Sent: HYPERLINK "tel:75086"75086 HYPERLINK "tel:75085"75085 1 0
Received: HYPERLINK "tel:68457"68457 HYPERLINK "tel:68455"68455 2 HYPERLINK "tel:68443"68443
Input:
Down - not assigned for selection
Supports frequency
Output:
Selected source: TenGigE0/0/0/0
Selected source QL: Opt-I/PRC
```

```
Effective QL: Opt-I/PRC
Next selection points: ETH_RXMUX
```

## Verifying Synchronous Ethernet LEDs

```
RP/0/RP0/CPU0:ios# show led
Mon Nov 2 09:29:34.637 UTC
=====
Location LED Name Mode Color
=====
0/FT0
Status OPERATIONAL GREEN
0/RP0/CPU0
Alarm OPERATIONAL AMBER
Status OPERATIONAL GREEN
Sync OPERATIONAL AMBER
```





## CHAPTER 3

# Transparent PDH over Packet (TPoP) and Channelized SDH over Packet (CSoP)

Transparent PDH over Packet (TPoP) Smart SFP converts E1 traffic to a packet stream using TDM over packet pseudo-wire technology. TPoP Smart SFP can be used on selected SFP slots in a router to transport PDH traffic across a packet network. TPoP Smart SFP is a plug-and-play device which can be used without any provisioning and simplifies configuration and service turn-up of E1 connections across a packet network. The integration of TPoP into an SFP greatly reduces system and network complexity, offers lower carbon footprint, and results in savings.

Channelized SDH over Packet (CSoP) Smart SFP converts a fully channelized SDH signal to a packet stream using TDM over packet pseudo-wire technology. CSoP Smart SFP can replace an existing SFP in a router or a switch and transport E1 traffic across a packet network. CSoP Smart SFP aggregates single E1 and enables each E1 channel to be processed individually to provide a high-density gateway between an SDH network and a TDM over packet ethernet or IP or MPLS network.

Following are the supported E1 and STM1 optical SFPs, for more information on the supported router variants based on the release versions, see [Cisco Optics-to-Device Compatibility Matrix](#).

- Framed STM1-ch E1 type: SFP-CH-OC3STM1-I
- Framed PDH E1 type: SFP-E1F-SATOP-I
- Clear channel STM1 type: SFP-TS-OC3STM1-I
- [Configuring TPoP and CSoP, on page 15](#)
- [VPWS with Smart SFP, on page 18](#)
- [Multi Router Automatic Protection Switching, on page 18](#)
- [Field-Pluggable Device \(FPD\) Version Upgrade for Smart SFP, on page 19](#)
- [Restrictions for Smart SFP, on page 21](#)

## Configuring TPoP and CSoP

Consider a deployment scenario with the TDM circuits from a base transceiver station is connected to an access router and must be transported to the base station controller through an aggregation router over an MPLS network through pseudowire.

During aggregation from transceiver to controller, the TDM circuits protect the data by using smart SFPs. For the E1 lines coming from transceiver, you must use TPoP SFPs and for the STM-1 lines coming from transceiver or controller, you must use CSoP SFPs.

You can monitor the alarms and performances on TPoP and CSoP smart SFPs.

**Table 2: Support on E1 Transmission**

Feature	E1 Framed
SATOP	Supported
Clock configuration	ACR, DCR, internal, Line
BERT - System/Line	Supported (Inverted-PRBS15)
PM -E1	SELS, LES, UAS, LCV, PCV Far End counters are NOT SUPPORTED
Alarms	LOS, AIS, LOF, RDI
Loopback - (local / line)	Supported
CEM counters	Supported

**Table 3: Support on OC3-STM1 Transmission**

Feature	OC3-STM1
E1 SATOP	STM-1 Channelized E1
Clock Configuration on Channelised-E1	ACR, DCR, internal, Line
E1 Channel BERT - System/Line channel prbs	Supported (Inverted-PRBS15)
PM-STM1 RS/MS	ES, SES, UAS Far End counters are NOT SUPPORTED
Threshold and its alerts	Supported
Alarms STM1	LOS, LOF, RS-TIM, MS-AIS, MS-RAI

Also consider a case, with Automatic Protection Switching (APS) protection being enabled on the controller, then the protect link coming from a single node or from multiple nodes with standby pseudowire is supported in the MPLS core.

### Configuring Controller for PDH E1

To configure PDH E1 on a controller, ensure the Gigabit Ethernet port is up and enter the following commands:

```
enable
configure terminal
  controller e1 0/0/0/7
  vlan 100 ecid 1
end
```

You must mention a unique VLAN ID which is specific to that port and ecid number to identify E1.

### Verifying Controller for PDH E1

Use the **show controller e1 x/y/z** command to verify the controller configuration on E1 for TPoP smart SFP.

```
Router# show controller e1 0/0/0/7
Controller State: Up
Transport Admin State: In Service
Framing: Unframed
Linecoding: High Density Bipolar Order 3
Loopback: None
Clock: Adaptive Clock Recovery (ACR)
Clock State: Locked
VLAN ID: 100
ecid:1
```

### Configuring Controller for STM1

To configure STM1 on a controller, ensure the Gigabit Ethernet port is up and enter the following commands:

```
controller STM1 0/0/0/18
  aug-mapping au4 au-4 1
  mode tug3
    tug-3 1
    mode tug2
      tug-2 1 payload vc12
      vc12 1 mapping e1

/*Configure STM1-ch E1 */
```

### Verifying Controller for STM1

Use the **show controller stm1 x/y/z** command to verify the controller configuration on STM1 for CSoP smart SFP.

```
Router# show controller STM1 0/0/0/18
Port STM 10/0/0/18

Status:
Primary State: Up
Configured Sec admin State: Normal
Inherited Sec admin State: Normal
Derived State: In Service
performance_monitoring_enabled
Loopback: None
```

### Configuring Controller for STM1-ch E1

To configure each E1 on STM1 port, enter the following commands:

```
Config terminal
  controller E1 0/0/0/18/1/1/1/1
  vlan 200 ecid 1
```

You can configure the same VLAN ID for all the E1 under the same STM1 port or a different VLAN ID for each E1 under that STM1 port.

### Verifying Controller for STM1-ch E1

Use the **show controller e1 x/y/z** command to verify the controller configuration on STM1.

```

Router# show controller e1 0/0/0/18/1/1/1/1
Controller State: Up
Transport Admin State: In Service
Framing: Unframed
Linecoding: None
Loopback: None
Clock: Internal

VLAN ID: 200
ecid:1

```

## VPWS with Smart SFP

The TDM circuits flows through the VPWS with smart SFP packetizing the incoming TDM frames. Packetizing happens with the following process:

- All frames from the TDM lines are channelized until E1 and then packetized.
- The packetization is done by adding:
  - RTP header – For DCR clocking support
  - VLAN header – For uniquely identifying the E1 channel
  - ENET header – The Ethernet DMAC and SMAC
  - CW – control word for communicating the sequence number, faults in the access side
  - Payload – the incoming TDM frames are chopped into 193Bytes frames and added into the payload.
  - The packets mentioned previously sent to the NPU.
- The E1 channel is mapped into a sub-interface (with specific VLAN).
- The packets received into the NPU with that specific VLAN number go through the VPWS logic and gets pseudowired (xconnected) with the configuration in a specific sub-interface.
- QOS configured under the sub-interface gets applied to this PW.

## Multi Router Automatic Protection Switching

The Multi Router Automatic Protection Switching (MR-APS) integration with hot standby pseudowire (HSPW) feature is a protection mechanism for SDH to switch to another circuit during failure.

Consider a deployment scenario with the MR-APS circuits from a base transceiver station is connected to access router and must be transported to the base station controller through an aggregation router over an MPLS network through pseudowire. When the pseudowire reaches the router with MR-APS, data is depacketized on the smart SFP and the raw TDM frames are sent towards the base station controller. The controller is connected to routers via two links, one as working link from router-A and other as protect link towards the router-B.

### Configuring Xconnect on Sub-Interface

To configure E1 port based on the VLAN ID, create sub-interface Gigabit Ethernet port.





**Note** The **propagate-tdm-alarm** command enables the forwarding of port level alarms to Gigabit Ethernet port in which Smart SFP resides.

```

Config terminal
controller STM1 0/0/0/0
    propagate-tdm-alarm
!
interface GigabitEthernet0/0/0/18.200 l2transport
    encapsulation dot1q 200
!

interface GigabitEthernet0/0/0/7.100 l2transport
    encapsulation dot1q 100

l2vpn
pw-class tdm_pw
    encapsulation mpls
!
!
xconnect group tdm_csop
p2p pw200
    interface GigabitEthernet0/0/0/18.200
    neighbor ipv4 2.2.2.2 pw-id 200
    pw-class tdm_pw
!
!
!
xconnect group tdm_tpop
p2p pw100
    interface GigabitEthernet0/0/0/7.100
    neighbor ipv4 2.2.2.2 pw-id 100
    pw-class tdm_pw
!
!
!

```

For more information on the standby pseudowire, see *Configure Pseudowire Redundancy* in chapter *Configure Point-to-Point Layer 2 Services* of the *L2VPN and Ethernet Services Configuration Guide*.

## Field-Pluggable Device (FPD) Version Upgrade for Smart SFP



**Note** The following steps are applicable to Channelized SDH over Packet (CSoP) STM-1 SFPs and E1 Transparent PDH over Packet (TPoP) SFPs only.

### Before you begin

To upgrade the FPD version on the Cisco NCS 540 Series Routers, perform the following steps:

1. To check the existing version of the FPD, run the **show hw-module fpd** command.

Sample output for checking the current FPD version:

```
RP/0/RP0/CPU0:router# show hw-module fpd

Wed Dec 14 07:08:08.424 UTC

Auto-upgrade:Disabled

                                FPD Versions
                                =====
Location   Card type           HWver FPD device   ATR Status   Running   Programd
-----
0/RP0      N540-ACC-SYS        0.5  MB-MIFPGA         CURRENT     0.05      0.05
0/RP0      N540-ACC-SYS        1.0  SSFP_E1F_12       NEED UPGD  7.01    7.01
0/RP0      N540-ACC-SYS        1.0  SSFP_E1F_4        CURRENT     13.01     13.01
0/RP0      N540-ACC-SYS        1.0  SSFP_STM1_TSOP_1  CURRENT     13.00     13.00
0/RP0      N540-ACC-SYS        0.5  Bootloader        NEED UPGD   1.14      1.14
0/RP0      N540-ACC-SYS        0.5  CPU-IOFPGA        NEED UPGD   0.07      0.07
0/RP0      N540-ACC-SYS        0.5  MB-IOFPGA         NEED UPGD   0.23      0.23
0/RP0      N540-ACC-SYS        0.5  SATA-M500IT-MU-B  CURRENT     4.00      4.00
```

- To upgrade the hardware, run the **upgrade hw-module location 0/RP0 fpd <> force** command.

To check the status of upgrade, run the **show hw-module fpd** command until the upgrade progress reaches 100 percent. The following are sample outputs for checking the status of the upgrade:

```
RP/0/RP0/CPU0:router# show hw-module fpd

Wed Dec 14 07:08:08.424 UTC

Auto-upgrade:Disabled

                                FPD Versions
                                =====
Location   Card type           HWver FPD device   ATR Status   Running   Programd
-----
0/RP0      N540-ACC-SYS        0.5  MB-MIFPGA         CURRENT     0.05      0.05
0/RP0      N540-ACC-SYS        1.0  SSFP_E1F_12       30% UPGD  13.01
0/RP0      N540-ACC-SYS        1.0  SSFP_E1F_4        CURRENT     13.01     13.01
0/RP0      N540-ACC-SYS        1.0  SSFP_STM1_TSOP_1  CURRENT     13.00     13.00
0/RP0      N540-ACC-SYS        0.5  Bootloader        NEED UPGD   1.14      1.14
0/RP0      N540-ACC-SYS        0.5  CPU-IOFPGA        NEED UPGD   0.07      0.07
0/RP0      N540-ACC-SYS        0.5  MB-IOFPGA         NEED UPGD   0.23      0.23
0/RP0      N540-ACC-SYS        0.5  SATA-M500IT-MU-B  CURRENT     4.00      4.00
```

```
RP/0/RP0/CPU0:router# show hw-module fpd

Wed Dec 14 07:08:08.424 UTC

Auto-upgrade:Disabled

                                FPD Versions
                                =====
Location   Card type           HWver FPD device   ATR Status   Running   Programd
```

0/RP0	N540-ACC-SYS	0.5	MB-MIFPGA	CURRENT	0.05	0.05
0/RP0	N540-ACC-SYS	1.0	SSFP_E1F_12	<b>75% UPGD</b>	<b>13.01</b>	
0/RP0	N540-ACC-SYS	1.0	SSFP_E1F_4	CURRENT	13.01	13.01
0/RP0	N540-ACC-SYS	1.0	SSFP_STM1_TSOP_1	CURRENT	13.00	13.00
0/RP0	N540-ACC-SYS	0.5	Bootloader	NEED UPGD	1.14	1.14
0/RP0	N540-ACC-SYS	0.5	CPU-IOFPGA	NEED UPGD	0.07	0.07
0/RP0	N540-ACC-SYS	0.5	MB-IOFPGA	NEED UPGD	0.23	0.23
0/RP0	N540-ACC-SYS	0.5	SATA-M500IT-MU-B	CURRENT	4.00	4.00

## Procedure

- Step 1** After the Smart SFP FPD upgrade completes 100 percent or after receiving the upgrade success message, wait for 15 seconds.
- Step 2** Perform an online insertion and removal (OIR) of the Smart SFP:
- Remove the Smart SFP and wait for two minutes for the clean-up to complete.
  - Insert the Smart SFP on the same port.
- This step recreates the controller with all its configurations.
- Step 3** To verify the Smart SFP version, run the **show hw-module fpd** command.

Sample command output for checking the FPD version of the Smart SFP:

```
RP/0/RP0/CPU0:router# show hw-module fpd
```

```
Wed Dec 14 07:08:08.424 UTC
```

```
Auto-upgrade:Disabled
```

Location	Card type	HWver	FPD device	ATR Status	FPD Versions	
					Running	Programd
0/RP0	N540-ACC-SYS	0.5	MB-MIFPGA	CURRENT	0.05	0.05
0/RP0	N540-ACC-SYS	1.0	SSFP_E1F_12	<b>CURRENT</b>	<b>13.01</b>	<b>13.01</b>
0/RP0	N540-ACC-SYS	1.0	SSFP_E1F_4	CURRENT	13.01	13.01
0/RP0	N540-ACC-SYS	1.0	SSFP_STM1_TSOP_1	CURRENT	13.00	13.00
0/RP0	N540-ACC-SYS	0.5	Bootloader	NEED UPGD	1.14	1.14
0/RP0	N540-ACC-SYS	0.5	CPU-IOFPGA	NEED UPGD	0.07	0.07
0/RP0	N540-ACC-SYS	0.5	MB-IOFPGA	NEED UPGD	0.23	0.23
0/RP0	N540-ACC-SYS	0.5	SATA-M500IT-MU-B	CURRENT	4.00	4.00

## Restrictions for Smart SFP



### Warning

If MR-APS is configured on the SFP, then remove MR-APS configuration before you remove the SFP from the port.

- CEM interface configuration isn't supported.
- The following default attributes are available only under CEM interface configuration. But you can't configure these attributes, as the configuration CLIs aren't supported.
  - dummy mode
  - dummy pattern
  - idle pattern
- E1 emulation is supported only on Ethernet pseudowire (VPWS).
- CSoP doesn't support E1-AIS alarm.
- No support to Single Router–Automatic Protection Switching (SR-APS)
- CLI configuration for the E1 controller on a VLAN needs to be mapped to an Ethernet sub-interface (by configuring same VLAN dot1q under the sub-interface). Any xconnect, also must be configured with this ethernet sub-interface.
- Multi Router-Automatic Protection Switching (MR-APS) is supported only by using the VLAN PW.
- Ensure that you have more than one MPLS paths, in core to convergence during core failure scenario.
- Only 8 smart SFPs are supported per router.
- ACR clocking is not supported in TPoP and CSoP unframed SFPs. Only framed to framed connection is supported, so not supported on framed to unframed connections.
- STM1 CSoP:
  - E1 Level shutdown is not supported.
  - Controller shutdown won't inject AIS but injects only LOS towards CE.
  - Bit error rate test (BERT) can be run only on one E1 channelized controller.
- CSoP and TPoP:
  - 25G ports are not supported.
  - Bit error rate is not supported.
- SF or SD threshold is not supported.
- Only 16-byte J0 is supported.
- BERT is not supported in unframed SFP.
- Loopback is supported only on, one of the 63 channels of CSoP SFP.
- Configuration with same ECID for CSoP E1s is not supported. ECID must be unique for each E1 under CSoP.
- The **show alarm conditions** command is not supported in Release 7.5.1.
- High convergence of 100ms is observed for MR-APS for LOS based switchover (for CSoP E1s).

- With smart SFP, high convergence of 4-6 minutes is observed in MR-APS for router reload based switchover.
- CSoP loopback on framed STM1-ch E1 doesn't work over **reload warm** command with smart SFP. Applicable only in Release 7.5.1.
- FPD upgrade for smart SFP is supported only from Release 7.8.1.
- LCV counter updates are not supported for smart SFP.





## CHAPTER 4

# TSoP Smart SFP for SDH and SONET Encapsulation

*Table 4: Feature History Table*

Feature Name	Release	Description
TSoP Smart SFP for SDH and SONET Encapsulation	Release 7.11.1	<p>This release introduces support for the Clear Channel Synchronous Transport Module Level-1 (STM1) Smart SFP (SFP-TS-OC3STM1-I) for the Transparent SONET or SDH over Packet (TSoP) protocol. This allows you to leverage your existing packet-switched network to transport traditional time-division multiplexing (TDM) traffic. TSoP Smart SFPs offer the following advantages:</p> <ul style="list-style-type: none"><li>• Encapsulation of SDH or SONET bit streams into packet-switched network format</li><li>• Improved suitability for pseudowire transport over an Ethernet network</li></ul>

The TSoP Smart SFP (SFP-TS-OC3STM1-I) is a special type of optical transceiver that allows for the transparent encapsulation of SDH or SONET bit streams into a packet format. This format is suitable for transporting pseudowires over an Ethernet network. The TSoP pseudowires can be manually configured or set up using the PWE3 control protocol [RFC4447].

TSoP provides packetization, de-packetization, and clock recovery. It translates the TDM bit stream into fixed-size data blocks (810 octets) and vice versa.

TSoP follows the SAToP method described in [RFC4553] for transporting E1/DS1 pseudowires over a packet-switched network. With TSoP, the entire OC-3 or STM-1 is encapsulated in a single circuit emulating pseudowire traffic. This traffic is then transported to a single destination across the Ethernet network.



- Note** The TSoP Smart SFP is used on any of the front panel ports of the 8-port Gigabit Ethernet SFP Interface Module (8x1GE).
- The Smart SFP transceivers are compatible with the Small Form Factor Pluggable 20-pin Multi-Source Agreement (MSA).
  - TSoP Smart SFP (SFP-TS-OC3STM1-I) transports up to 155 Mbps on a L1.1 (40km) optical data link.

- [Prerequisites for TSoP, on page 26](#)
- [Restrictions for TSoP, on page 26](#)
- [Guidelines for TSoP Smart SFP, on page 27](#)
- [De-jitter Buffer, on page 27](#)
- [Configuration for TSoP, on page 28](#)

## Prerequisites for TSoP

This section provides information about the prerequisites that apply to TSoP.

- Single mode optical fiber must be used to connect TSoP Smart SFP with the OC-3 port.
- The TSoP smart SFP pseudowire endpoints must use the same configuration parameters.

## Restrictions for TSoP

This section provides information about the restrictions that apply to TSoP.

- TSoP is not supported on the 25GE ports, but it's supported only on 1GE and 10GE ports.
- The RTP clock source value is Ethernet, by default. The **Clock source internal/line** under the **controller STM1 r/s/i/p**, is not applicable.
- Ensure that there is at least 2 minutes time-delay between the swaps, during a quick OIR of TSoP smart SFP with other SFPs on the same port.
- Before you insert TSoP, always ensure that the Ethernet interface is in a **shutdown** state. If TSoP doesn't come up when the Ethernet interface is accidentally present in **no shut**, then remove TSoP and insert Gigabit Ethernet SFP to move it to the shutdown state, and then reinsert TSoP as a workaround.
- TSoP only supports Differential Clock Recovery (DCR) by default and doesn't support any other clock configuration.
- Both sides of PE only support TSoP. Currently, interoperability with other devices is not supported.



## Guidelines for TSoP Smart SFP

The TSoP is compatible with the following SFPs supported on the OC-3 interface module. We recommend using the specified attenuator:

- ONS-SI-155-I1 - For a cable length of 15km, use a 2 dB attenuator. Use an 8 dB attenuator for short distances to avoid receiver overload.
- ONS-SI-155-L1 - For a cable length of 40km, no attenuator is needed. Use a 10 dB attenuator for short distances to avoid receiver overload.
- ONS-SI-155-L2 - For a cable length of 40km, use a 2 dB attenuator. Use a 10 dB attenuator for short distances to avoid receiver overload.



---

**Note** Multimode SFP is not supported with TSoP.

---

## De-jitter Buffer

A de-jitter buffer is a component in a packet-based network that helps mitigate the effects of jitter. Jitter refers to the variation in the arrival time of packets, which can lead to inconsistent delays and packet loss in real-time applications like voice or video.

The de-jitter buffer works by temporarily storing incoming packets and then releasing them at a regulated pace. It smooths out the variations in packet arrival times and ensures a more consistent and reliable stream of packets for playback.

The primary purpose of the de-jitter buffer is to ensure a steady and continuous playback of real-time data, such as voice packets in a voice-over-IP (VoIP) call. By absorbing and compensating for the variable delay, it helps maintain a stable voice quality without noticeable gaps or interruptions in the audio stream.

The size of the de-jitter buffer is a critical parameter to consider in network design. It should be large enough to handle the maximum expected delay variation (jitter) while still providing an acceptable level of delay. However, the buffer cannot be too large, as excessive buffering can introduce additional delay and affect the real-time nature of the application.

The de-jitter buffer for the TSoP can be configured to the following values:

- 292
- 627
- 810
- 1296
- 2633

### Example configuration

This example shows how to configure De-jitter buffer.

```

sh controll cem 0/0/0/10 payload-dejitter-mapping
Thu Jan 19 12:40:16.206 UTC
Client type : STM1
Client rate (in kbps) : 155000
Client default payload (in bytes) : 810
Client default dejitter (in usec) : 1296

Payload (in bytes) Possible dejitter values (in microseconds)
-----
810 2633, 1296, 627, 292

For configuring out of range, we will get the below error:
Int CEM <>
cem payload 810 dejitter 696
!
```

## Configuration for TSoP

Here is a sample configuration for TSoP:

**Figure 1: TSoP in Packet Switched Network**

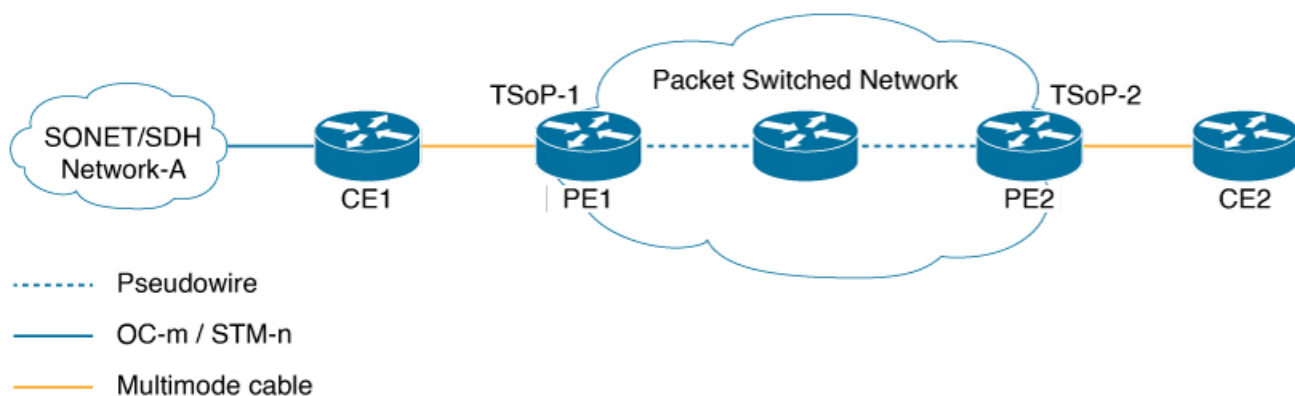

### Pre-requisites

These are the prerequisites for configuring PE routers and CE (SONET or SDH) routers for TSoP:

- The following are the pre-requisites on CE routers ASR 903:
  - The CE side routers must be ASR 903 operating on RSP4 or RSP3
  - SFP-OC3-SR must be plugged into ASR 903 for transmitting SONET or SDH packets
  - Supported Interface modules are:
    - NCS4200-1T8S-20CS
    - A900-IMA3G-1MSG
- The PE side routers must be NCS 5500 or NCS 540.
- PE and CE routers must be connected using multimode cable
- Only static L2VPN tunnel configuration is supported

- Sync-E should be operational



**Note** Traffic switch over is not supported even when multiple links are available. Traffic flow occurs as per the adjacent labels or hops defined by the user during static L2VPN tunnel configuration

### Configuration for

1. This example shows how to configure clock synchronization on the PE routers.

- Configuring Smart SFP in PE1

```
Router(config)# frequency synchronization quality itu-t option 1
Router(config)# interface GigabitEthernet0/0/0/5
Router(config)# no shut
Router(config)# frequency synchronization
Router(config)# quality transmit exact itu-t option 1 PRC
```

- Configuring Smart SFP in PE2

```
Router(config)# frequency synchronization quality itu-t option 1
Router(config)# interface GigabitEthernet0/0/0/18
Router(config)# frequency synchronization
Router(config)# selection input
Router(config)# priority 1
Router(config)# wait-to-restore 0
```

2. This example shows how to configure PE and CE interfaces.

- Configuration at CE1

```
Router(config)# interface CEM0/0/0/10
Router(config)# l2transport
```

- Configuration at PE1

```
Router(config)# interface GigabitEthernet0/0/0/5
Router(config)# ipv4 address 10.1.1.1 255.255.255.0
Router(config)# no shut
```

- Configuration at CE2

```
Router(config)# interface CEM0/0/0/17
Router(config)# l2transport
```

- Configuration at PE2

```
Router(config)# interface GigabitEthernet0/0/0/18
Router(config)# ipv4 address 10.1.1.2 255.255.255.0
Router(config)# no shut
```

3. This example shows how to configure loopback interface.

- Configuration at PE1

```
Router(config)# interface Loopback0
Router(config)# ipv4 address 1.1.1.1 255.255.255.255
```

- Configuration at PE2

```
Router(config)# interface Loopback0
Router(config)# ipv4 address 1.1.1.4 255.255.255.255
```

4. This example shows how to configure the ISIS IGP and advertise loopback and core interfaces.

- Configuration at PE1

```
Router(config)# router isis core
Router(config)# is-type level-2-only
Router(config)# net 49.0000.0000.0000.0001.00
Router(config)# nsr
Router(config)# nsf cisco
Router(config)# log adjacency changes
Router(config)# address-family ipv4 unicast
Router(config)# metric-style wide
Router(config)# segment-routing mpls sr-prefer
Router(config)# segment-routing bundle-member-adj-sid
Router(config)# address-family ipv6 unicast
Router(config)# metric-style wide
Router(config)# segment-routing mpls sr-prefer
Router(config)# segment-routing bundle-member-adj-sid
Router(config)# interface Loopback0
Router(config)# point-to-point
Router(config)# address-family ipv4 unicast
Router(config)# prefix-sid index 1
Router(config)# address-family ipv6 unicast
Router(config)# interface GigabitEthernet0/0/0/5
Router(config)# point-to-point
Router(config)# address-family ipv4 unicast
Router(config)# adjacency-sid absolute 28121
Router(config)# address-family ipv6 unicast
```

- Configuration at PE2

```
Router(config)# router isis core
Router(config)# is-type level-2-only
Router(config)# net 49.0000.0000.0000.0004.00
Router(config)# nsr
Router(config)# nsf cisco
Router(config)# log adjacency changes
Router(config)# address-family ipv4 unicast
Router(config)# metric-style wide
Router(config)# segment-routing mpls sr-prefer
Router(config)# segment-routing bundle-member-adj-sid
Router(config)# address-family ipv6 unicast
Router(config)# metric-style wide
Router(config)# segment-routing mpls sr-prefer
Router(config)# segment-routing bundle-member-adj-sid
Router(config)# interface Loopback0
Router(config)# point-to-point
Router(config)# address-family ipv4 unicast
Router(config)# prefix-sid index 4
Router(config)# address-family ipv6 unicast
Router(config)# interface GigabitEthernet0/0/0/18
Router(config)# point-to-point
Router(config)# address-family ipv4 unicast
Router(config)# adjacency-sid absolute 28211
Router(config)# address-family ipv6 unicast
```

5. This example shows how to configure Circuit-styled Segment routing traffic engineering tunnels.

- Configuration at PE1

```

Router(config)#segment-routing
Router(config)#global-block 80000 111999
Router(config)#local-block 25000 28999
Router(config)#traffic-eng
Router(config)#segment-list pe1-pe2-forward-path
Router(config)#index 1 mpls label 28121
Router(config)#segment-list pe1-pe2-reverse-path
Router(config)#index 1 mpls label 28211
Router(config)#policy pe1-pe2-circuit-styled-srte
Router(config)#color 10 end-point ipv4 1.1.1.4
Router(config)#path-protection
Router(config)#candidate-paths
Router(config)#preference 10
Router(config)#explicit segment-list pe1-pe2-forward-path
Router(config)#reverse-path segment-list pe1-pe2-reverse-path

```

- Configuration at PE2

```

Router(config)#segment-routing
Router(config)#global-block 80000 111999
Router(config)#local-block 25000 28999
Router(config)#traffic-eng
Router(config)#segment-list pe1-pe2-forward-path
Router(config)#index 1 mpls label 28121
Router(config)#segment-list pe1-pe2-reverse-path
Router(config)#index 1 mpls label 28211
Router(config)#policy pe1-pe2-circuit-styled-srte
Router(config)#color 10 end-point ipv4 1.1.1.4
Router(config)#path-protection
Router(config)#candidate-paths
Router(config)#preference 10
Router(config)#explicit segment-list pe1-pe2-forward-path
Router(config)#reverse-path segment-list pe1-pe2-reverse-path

```

## 6. This example shows how to configure BGP EVPN neighbor session.

- Configuration at PE1

```

Router(config)#router bgp 100
Router(config)#bgp router-id 1.1.1.1
Router(config)#bgp graceful-restart
Router(config)#address-family ipv4 unicast
Router(config)#address-family l2vpn evpn
Router(config)#neighbor 1.1.1.4
Router(config)#remote-as 100
Router(config)#update-source Loopback0
Router(config)#graceful-restart
Router(config)#address-family l2vpn evpn

```

- Configuration at PE2

```

Router(config)#bgp router-id 1.1.1.4
Router(config)#bgp graceful-restart
Router(config)#address-family ipv4 unicast
Router(config)#address-family l2vpn evpn
Router(config)#neighbor 1.1.1.1
Router(config)#remote-as 100
Router(config)#update-source Loopback0
Router(config)#graceful-restart
Router(config)#address-family l2vpn evpn

```

## 7. This example shows how to configure EVPN xconnect.

- Configuration at PE1

```
Router(config)#l2vpn
Router(config)#pw-class pw-cs-srte
Router(config)#encapsulation mpls
Router(config)#preferred-path sr-te policy pel-pe2-circuit-styled-srte
Router(config)#xconnect group evpn_vpws
Router(config)#p2p pl
Router(config)#interface CEM0/0/0/10
Router(config)#neighbor evpn evi 10 target 1 source 2
Router(config)#pw-class pw-cs-srte
```

- Configuration at PE2

```
Router(config)#l2vpn
Router(config)#pw-class pw-cs-srte
Router(config)#encapsulation mpls
Router(config)#preferred-path sr-te policy pel-pe2-circuit-styled-srte
Router(config)#xconnect group evpn_vpws
Router(config)#p2p pl
Router(config)#interface CEM0/0/0/17
Router(config)#neighbor evpn evi 10 target 2 source 1
Router(config)#pw-class pw-cs-srte
```

## 8. This example shows how to configure Dejitteer.

- Configuration at PE1

```
Router(config)#int cem0/0/0/10
Router(config)#cem payload 810 dejitter 696
```

- Configuration at PE2

```
Router(config)#int cem0/0/0/17
Router(config)#cem payload 810 dejitter 696
```

## Verification

Use the **show inventory** command to display all TSoP Smart SFPs installed on the router.

```
Router#show inventory
NAME: "GigabitEthernet0/0/0/17", DESCR: "Cisco SFP TSOP STM1 Pluggable Optics Module"
PID: SFP-TS-OC3STM1-I , VID: V01, SN: OEA2536001J
```

Use the **show hw-module fpd** command to display TSoP Smart SFPs FPD version.

```
Router#show hw-module fpd
Auto-upgrade:Disabled
FPD Versions
=====
Location Card type HWver FPD device ATR Status Running Programd
-----
0/RP0 NCS-55A2-MOD-SE-S 1.0 MB-MIFPGA CURRENT 0.21 0.21
0/RP0 NCS-55A2-MOD-SE-S 1.0 SSFP_OC3_STM1_6 CURRENT 12.01 12.01
0/RP0 NCS-55A2-MOD-SE-S 1.0 SSFP_STM1_TSOP_17 CURRENT 13.00 13.00 <<<<
0/RP0 NCS-55A2-MOD-SE-S 1.0 Bootloader CURRENT 1.18 1.18
0/RP0 NCS-55A2-MOD-SE-S 1.0 CPU-IOFPGA CURRENT 1.27 1.27
0/RP0 NCS-55A2-MOD-SE-S 1.0 MB-IOFPGA NEED UPGD 0.18 0.18
0/RP0 NCS-55A2-MOD-SE-S 1.0 SATA-INTEL_240G NEED UPGD 1120.00 1120.00
0/PM0 NC55-1200W-ACFW 1.0 LIT-PrimCU-ACFW CURRENT 2.09 2.09
```

```
0/PM1 NC55-1200W-ACFW LIT-PrimCU-ACFW NOT READY
RP/0/RP0/CPU0:ios#
```

Use the **show ipv4 interface brief** command to display the interface status.

```
Router#show ipv4 interface brief
Interface IP-Address Status Protocol Vrf-Name
MgmtEth0/RP0/CPU0/0 unassigned Shutdown Down default
TenGigE0/0/0/0 unassigned Shutdown Down default
GigabitEthernet0/0/0/1 unassigned Shutdown Down default
GigabitEthernet0/0/0/2 unassigned Shutdown Down default
TenGigE0/0/0/3 unassigned Shutdown Down default
TenGigE0/0/0/4 unassigned Shutdown Down default
GigabitEthernet0/0/0/5 unassigned Shutdown Down default
GigabitEthernet0/0/0/6 unassigned Up Up default
GigabitEthernet0/0/0/7 unassigned Shutdown Down default
GigabitEthernet0/0/0/8 unassigned Shutdown Down default
GigabitEthernet0/0/0/9 unassigned Shutdown Down default
GigabitEthernet0/0/0/10 unassigned Shutdown Down default
TenGigE0/0/0/11 unassigned Shutdown Down default
TenGigE0/0/0/12 unassigned Shutdown Down default
TenGigE0/0/0/13 unassigned Shutdown Down default
TenGigE0/0/0/14 unassigned Shutdown Down default
TenGigE0/0/0/15 unassigned Shutdown Down default
GigabitEthernet0/0/0/16 unassigned Up Up default
CEM0/0/0/17 unassigned Up Up default <<<
GigabitEthernet0/0/0/18 unassigned Shutdown Down default
TenGigE0/0/0/19 unassigned Shutdown Down default
```

Use the **show controller cem** verifying TSoP smart SFP stats and Dejitte configuration.

```
Router#show controller cem 0/0/0/17
Interface : CEM0/0/0/17
Admin state : Up
Oper state : Up
Port bandwidth : 155000 kbps
Dejitte buffer (oper/in-use) : 1296/180064 usec <<<<<<
Payload size (oper) : 810 bytes
PDV (min/max/avg) : 51589/142643/97116 usec
Dummy mode : last-frame
Dummy pattern : 0x0
Idle pattern : 0x0
Signalling : No CAS
RTP : Not Enabled
Clock type : Differential
Detected Alarms : None

Statistics Info
-----
Ingress packets : 0, Ingress packets drop : 0
Egress packets : 0, Egress packets drop : 0
Total error : 1145472000
Missing packets : 572736000, Malformed packets : 0
Jitter buffer underrun : 572736000, Jitter buffer overrun : 0
Misorder drops : 0
Reordered packets : 0, Frames fragmented : 0
Error seconds : 0, Severely error seconds : 0
Unavailable seconds : 0, Failure counts : 0

Generated L bits : 0, Received L bits : 0
Generated R bits : 0, Received R bits : 0

Endpoint Info
-----
Passthrough : No
```

```
//Run the same command on CEM interface of PE1 router.
```

```
Router#show controll CEM0/0/0/10
Sat Mar 25 10:49:19.471 UTC
Interface                : CEM0/0/0/6
Admin state              : Up
Oper state               : Up
Port bandwidth           : 155000 kbps
Dejitter buffer (oper/in-use) : 1296/180645 usec
Payload size (oper)      : 810 bytes
PDV (min/max/avg)       : 51589/142643/97116 usec
Dummy mode               : last-frame
Dummy pattern            : 0xab
Idle pattern             : 0xff
Signalling               : No CAS
RTP                      : Enabled
Clock type               : Differential
Detected Alarms          : None
```

```
Statistics Info
```

```
-----
Ingress packets          : 0, Ingress packets drop      : 0
Egress packets           : 0, Egress packets drop      : 0
Total error              : 385536000
    Missing packets      : 192768000, Malformed packets  : 0
    Jitter buffer underrun : 192768000, Jitter buffer overrun  : 0
    Misorder drops       : 0
Reordered packets        : 0, Frames fragmented       : 0
Error seconds            : 0, Severely error seconds    : 0
Unavailable seconds      : 0, Failure counts           : 0

Generated L bits         : 0, Received L bits          : 0
Generated R bits         : 0, Received R bits          : 0
```

```
Endpoint Info
```

```
-----
Passthrough             : No
RP/0/RP0/CPU0:Router#
```





## CHAPTER 5

# Understanding PTP

The Precision Time Protocol (PTP), as defined in the IEEE 1588 standard, synchronizes withnanosecond accuracy the real-time clocks of the devices in a network. The clocks in are organized into a server-client hierarchy. PTP identifies the port that is connected to a device with the most precise clock. This clock is referred to as the server clock. All the other devices on the network synchronize their clocks with the server clock and are referred to as members. Constantly-exchanged timing messages ensure continued synchronization.

Precision Time Protocol (PTP) is defined in IEEE 1588 as Precision Clock Synchronization for Networked Measurements and Control Systems, and was developed to synchronize the clocks in packet-based networks that include distributed device clocks of varying precision and stability. PTP is designed specifically for industrial, networked measurement and control systems, and is optimal for use in distributed systems because it requires minimal bandwidth and little processing overhead.

**Table 5: Nodes within a PTP Network**

Network Element	Description
Grandmaster (GM)	A network device physically attached to the primary time source. All clocks are synchronized to the grandmaster clock.
Ordinary Clock (OC)	An ordinary clock is a 1588 clock with a single PTP port that can operate in one of the following modes: <ul style="list-style-type: none"><li>• Server mode—Distributes timing information over the network to one or more client clocks, thus allowing the client to synchronize its clock to the server clock.</li><li>• Client mode—Synchronizes its clock to a server clock. You can enable the client mode on up to two interfaces simultaneously in order to connect to two different server clocks.</li></ul>

Network Element	Description
Boundary Clock (BC)	<p>The device participates in selecting the best server clock and can act as the server clock if no better clocks are detected.</p> <p>Boundary clock starts its own PTP session with a number of downstream clients. The boundary clock mitigates the number of network hops and results in packet delay variations in the packet network between the Grandmaster and client.</p>
Transparent Clock (TC)	A transparent clock is a device or a switch that calculates the time it requires to forward traffic and updates the PTP time correction field to account for the delay, making the device transparent in terms of time calculations.



**Note** In Cisco IOS XR Release 7.3.2, PTP is enabled by default on all Ethernet ports of the following variants of the Cisco NCS 540 router. This support facilitates interoperability with FPGA ports.

- N540-FH-CSR-SYS
- N540-FH-AGG-SYS

- [Why PTP?, on page 36](#)
- [Routers and Delays, on page 37](#)
- [Message-Based Synchronization, on page 37](#)
- [PTP Event Message Sequences, on page 38](#)
- [PTP Clocks, on page 39](#)
- [Restrictions for PTP, on page 40](#)
- [PTP Profiles, on page 40](#)
- [PTP Over Bundled Virtual Interface, on page 56](#)
- [Slow Tracking, on page 59](#)
- [PTP Holdover Traceability Suppression, on page 60](#)
- [IEEE Default Profile, on page 61](#)
- [PTP Hybrid Mode, on page 61](#)
- [Verifying the PTP Hybrid Mode Configurations, on page 63](#)
- [PTP Profile Interoperation, on page 64](#)

## Why PTP?

Smart grid power automation applications, such as peak-hour billing, virtual power generators, and outage monitoring and management, require extremely precise time accuracy and stability. Timing precision improves network monitoring accuracy and troubleshooting ability.

In addition to providing time accuracy and synchronization, the PTP message-based protocol can be implemented on packet-based networks, such as Ethernet networks. The benefits of using PTP in an Ethernet network include:

- Low cost and easy setup in existing Ethernet networks
- Limited bandwidth requirement for PTP data packets

## Routers and Delays

In an IP network, routers provide a full-duplex communication path between network devices. Routers send data packets to packet destinations using IP address information contained in the packets. When the router attempts to send multiple packets simultaneously, the router buffers some packets so that they are not lost before they are sent. When the buffer is full, the router delays sending packets. This delay can cause device clocks on the network to lose synchronization with one another.

Additional delays can occur when packets entering a router are stored in its local memory while the router searches the address table to verify packet fields. This process causes variations in packet forwarding time latency, and these variations can result in asymmetrical packet delay times.

Adding PTP to a network can compensate for these latency and delay problems by correctly adjusting device clocks so that they stay synchronized with one another. PTP enables network routers to function as PTP devices, including boundary clocks (BCs) and transparent clocks (TCs).

For more information about PTP clock devices and their role in a PTP network, see the *PTP Clocks* section.

## Message-Based Synchronization

To ensure clock synchronization, PTP requires an accurate measurement of the communication path delay between the time source (server) and the receiver (client). PTP sends messages between the server and client device to determine the delay measurement. Then, PTP measures the exact message transmit and receive times and uses these times to calculate the communication path delay.

PTP then adjusts current time information contained in network data for the calculated delay, resulting in more accurate time information.

This delay measurement principle determines path delay between devices on the network. The local clocks are adjusted for this delay using a series of messages sent between servers and clients. The one-way delay time is calculated by averaging the path delay of the transmit and receive messages. This calculation assumes a symmetrical communication path; however, routed networks do not necessarily have symmetrical communication paths, due to the various asymmetries in the network.

Using transparent clocks, PTP provides a method to measure and account for the delay in a time-interval field in network timing packets. This makes the routers temporarily transparent to the server and client nodes on the network. An end-to-end transparent clock forwards all messages on the network in the same way that a router does.

To read a detailed description of synchronization messages, see the *PTP Event Message Sequences* section. To learn more about how transparent clocks calculate network delays, refer to [Transparent Clock, on page 7](#).

# PTP Event Message Sequences

This section describes the PTP event message sequences that occur during synchronization.

## Synchronizing with Boundary Clocks

The ordinary and boundary clocks configured for the delay request-response mechanism use the following event messages to generate and communicate timing information:

- Sync
- Delay\_Req
- Follow\_Up
- Delay\_Resp

These messages are sent in the following sequence:

- The server sends a Sync message to the client and notes the time (t1) at which it was sent.
- The client receives the Sync message and notes the time of reception (t2).
- The server conveys to the client the timestamp t1 by embedding the timestamp t1 in a Follow\_Up message.
- The client sends a Delay\_Req message to the server and notes the time (t3) at which it was sent.
- The server receives the Delay\_Req message and notes the time of reception (t4).
- The server conveys to the client the timestamp t4 by embedding it in a Delay\_Resp message.

After this sequence, the client possesses all four timestamps. These timestamps can be used to compute the offset of the client clock relative to the server, and the mean propagation time of messages between the two clocks.

The offset calculation is based on the assumption that the time for the message to propagate from server to client is the same as the time required from client to server. This assumption is not always valid on an Ethernet/IP network due to asymmetrical packet delay times.

Figure 2: Detailed Steps—Boundary Clock Synchronization

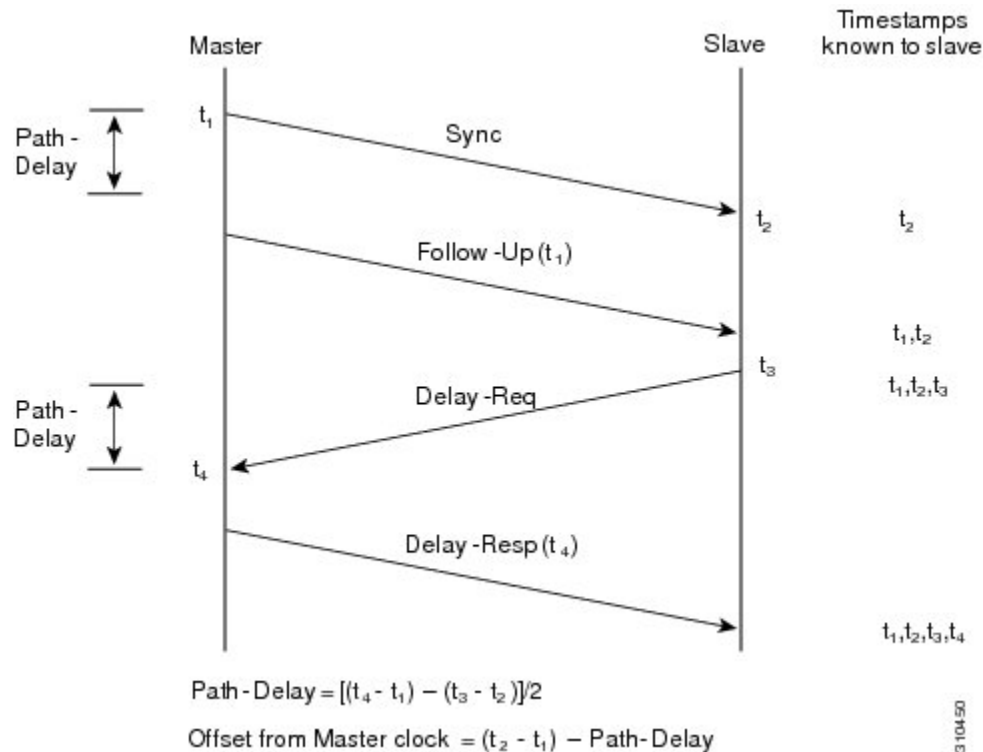

## Synchronizing the Local Clock

In an ideal PTP network, the server and client clock operate at the same frequency. However, drift can occur on the network. Drift is the frequency difference between the server and client clock. You can compensate for drift by using the time stamp information in the device hardware and follow-up messages (intercepted by the router) to adjust the frequency of the local clock to match the frequency of the server clock.

## PTP Clocks

A PTP network is made up of PTP-enabled devices and devices that are not using PTP. The PTP-enabled devices typically consist of the following clock types.

### Grandmaster Clock

Within a PTP domain, the grandmaster clock is the primary source of time for clock synchronization using PTP. The grandmaster clock usually has a very precise time source, such as a GPS or atomic clock. When the network does not require any external time reference and only needs to be synchronized internally, the grandmaster clock can free run.

### Ordinary Clock

An ordinary clock is a PTP clock with a single PTP port. It functions as a node in a PTP network and can be selected by the BMCA as a server or client within a subdomain. Ordinary clocks are the most common clock type on a PTP network because they are used as end nodes on a network that is connected to devices requiring synchronization. Ordinary clocks have various interfaces to external devices.

### Boundary Clock

A boundary clock in a PTP network operates in place of a standard network router. Boundary clocks have more than one PTP port, and each port provides access to a separate PTP communication path. Boundary clocks provide an interface between PTP domains. They intercept and process all PTP messages, and pass all other network traffic. The boundary clock uses the BMCA to select the best clock seen by any port. The selected port is then set as a client. The server port synchronizes the clocks connected downstream, while the client port synchronizes with the upstream server clock.

### Transparent Clock

The role of transparent clocks in a PTP network is to update the time-interval field that is part of the PTP event message. This update compensates for switch delay and has an accuracy of within one picosecond.

## Restrictions for PTP

PTP over MPLS is not supported.

## PTP Profiles

*Table 6: Feature History Table*

Feature Name	Release Information	Description
PTP and SyncE support on breakout ports for N540-24Q8L2DD-SYS and N540X-16Z4G8Q2C-A/D Routers	Release 7.11.1	With this release, timing support for PTP and SyncE is extended to 4x10G and 4x25G breakout ports of N540-24Q8L2DD-SYS and N540X-16Z4G8Q2C-A/D Routers.  Class B and Class C performances are supported on 4x10G and 4x25G breakout ports in N540-24Q8L2DD-SYS and N540X-16Z4G8Q2C-A/D Routers.
PTP Profiles Support for N540-6Z14S-SYS-D	Release 7.5.2	PTP Profiles are now supported on the following Cisco NCS 540 router variant: <ul style="list-style-type: none"> <li>• N540-6Z14S-SYS-D</li> </ul>

Feature Name	Release Information	Description
PTP Profiles Support for N540-24Q8L2DD-SYS	Release 7.4.1	<p>PTP Profiles are specific selections of PTP configurations that allow organizations to achieve a performance that meets the requirement of a particular application. You can configure different PTP profiles for different applications, such as audio and media. PTP profiles ensure the application components stay in sync across multiple devices.</p> <p>PTP Profiles are now supported on the following Cisco NCS 540 router variant:</p> <ul style="list-style-type: none"> <li>• N540-24Q8L2DD-SYS</li> </ul>
PTP Profiles Support for N540X-16Z4G8Q2C-A/D	Release 7.0.1	<p>PTP Profiles are now supported on the following Cisco NCS 540 router variant:</p> <ul style="list-style-type: none"> <li>• N540X-16Z4G8Q2C-A/D</li> </ul>

## ITU-T Telecom Profiles for PTP

Cisco IOS XR software supports ITU-T Telecom Profiles for PTP as defined in the ITU-T recommendation. A profile consists of PTP configuration options applicable only to a specific application.

Separate profiles can be defined to incorporate PTP in different scenarios based on the IEEE 1588-2008 standard. A telecom profile differs in several ways from the default behavior defined in the IEEE 1588-2008 standard and the key differences are mentioned in the subsequent sections.

The following sections describe the ITU-T Telecom Profiles that are supported for PTP.

### G.8265.1

G.8265.1 profile fulfills specific frequency-distribution requirements in telecom networks. Features of G.8265.1 profile are:

- Clock advertisement: G.8265.1 profile specifies changes to values used in Announce messages for advertising PTP clocks. The clock class value is used to advertise the quality level of the clock, while the other values are not used.
- Clock Selection: G.8265.1 profile also defines an alternate BMCA to select port states and clocks is defined for the profile. This profile also requires to receive Sync messages (and optionally, Delay-Response messages) to qualify a clock for selection.
- Port State Decision: The ports are statically configured to be Server or Client instead of using FSM to dynamically set port states.

- Packet Rates: The packet rates higher than rates specified in the IEEE 1588-2008 standard are used. They are:
  - Sync/Follow-Up Packets: Rates from 128 packets-per-second to 16 seconds-per-packet.
  - Delay-Request/Delay-Response Packets: Rates from 128 packets-per-second to 16 seconds-per-packet.
  - Announce Packets: Rates from 8 packets-per-second to 64 packets-per-second.
- Transport Mechanism: G.8265.1 profile only supports IPv4 PTP transport mechanism.
- Mode: G.8265.1 profile supports transport of data packets only in unicast mode.
- Clock Type: G.8265.1 profile only supports Ordinary Clock-type (a clock with only one PTP port).
- Domain Numbers: The domain numbers that can be used in a G.8265.1 profile network ranges from 4 to 23. The default domain number is 4.
- Port Numbers: Multiple ports can be configured; however, all ports must be of the same type, either Server or Client.

## G.8275.1

G.8275.1 profile fulfills the time-of-day and phase synchronization requirements in telecom networks with all network devices participating in the PTP protocol. G.8275.1 profile with SyncE provides better frequency stability for the time-of-day and phase synchronization.

Features of G.8275.1 profile are:

- Synchronization Model: G.8275.1 profile adopts hop-by-hop synchronization model. Each network device in the path from Server to Client clock synchronizes its local clock to upstream devices and provides synchronization to downstream devices.
- Clock Selection: G.8275.1 profile also defines an alternate BMCA that selects a clock for synchronization and port state for the local ports of all devices in the network is defined for the profile. The parameters defined as a part of the BMCA are:
  - Clock Class
  - Clock Accuracy
  - Offset Scaled Log Variance
  - Priority 2
  - Clock Identity
  - Steps Removed
  - Port Identity
  - notSlave flag
  - Local Priority
- Port State Decision: The port states are selected based on the alternate BMCA algorithm. A port is configured to a server-only port state to enforce the port to be a server for multicast transport mode.



- **Packet Rates:** The nominal packet rate for Announce packets is 8 packets-per-second and 16 packets-per-second for Sync/Follow-Up and Delay-Request/Delay-Response packets.
- **Transport Mechanism:** G.8275.1 profile only supports Ethernet PTP transport mechanism.
- **Mode:** G.8275.1 profile supports transport of data packets only in multicast mode. The forwarding is done based on forwardable or non-forwardable multicast MAC address.
- **Clock Type:** G.8275.1 profile supports the following clock types:
  - Telecom Grandmaster (T-GM)
  - Telecom Time subordinate/client Clock (T-TSC)
  - Telecom Boundary Clock (T-BC)
- **Domain Numbers:** The domain numbers that can be used in a G.8275.1 profile network ranges from 24 to 43. The default domain number is 24.

The G.8275.1 supports the following:

- **T-GM:** The telecom grandmaster (T-GM) provides timing to all other devices on the network. It does not synchronize its local clock with any other network element other than the Primary Reference Time Clock (PRTC).
- **T-BC:** The telecom boundary clock (T-BC) synchronizes its local clock to a T-GM or an upstream T-BC, and provides timing information to downstream T-BCs or T-TSCs. If at a given point in time there are no higher-quality clocks available, T-BC continues to provide its own timing information to its peers, although derived clock is not as accurate as the T-GM.
- **T-TSC:** The telecom time subordinate/client clock (T-TSC) synchronizes its local clock to another PTP clock (in most cases, the T-BC), and does not provide synchronization through PTP to any other device.

### Performance Requirements

The router is compliant with Class B performance requirements for T-TSC and T-BC as documented in G.8273.2.

## G.8275.2

The G.8275.2 is a PTP profile for use in telecom networks where phase or time-of-day synchronization is required. It differs from G.8275.1 in that it is not required that each device in the network participates in the PTP protocol. Also, G.8275.2 uses PTP over IPv4 in unicast mode.

The G.8275.2 profile is based on the partial timing support from the network. Hence nodes using G.8275.2 are not required to be directly connected.

The G.8275.2 profile is used in mobile cellular systems that require accurate synchronization of time and phase. For example, the fourth generation (4G) of mobile telecommunications technology.

Table 7: Feature History Table

Feature Name	Release Information	Description
ITU-T G.8275.2 and Default PTP profiles over IPv6	Release 7.7.1	<p>For ITU-T G.8275.2 and the IEEE 1588 default PTP profiles, the encapsulation type for PTP packet transport is now extended to IPv6.</p> <p>The <b>transport</b> command now accepts the keyword <b>ipv6</b>.</p> <p>In this release, this feature is supported on the following Cisco NCS 540 router variants:</p> <ul style="list-style-type: none"> <li>• N540-ACC-SYS</li> <li>• N540X-ACC-SYS</li> <li>• N540-24Z8Q2C-SYS</li> <li>• N540-28Z4C-SYS-A/D</li> <li>• N540X-16Z4G8Q2C-A/D</li> <li>• N540-12Z20G-SYS-A/D</li> <li>• N540X-12Z16G-SYS-A/D</li> </ul>

Features of G.8275.2 profile are:

- Clock Selection: G.8275.2 profile also defines an alternate BMCA that selects a clock for synchronization and port state for the local ports of all devices in the network is defined for the profile. The parameters defined as a part of the BMCA are:
  - Clock Class
  - Clock Accuracy
  - Offset Scaled Log Variance
  - Priority 2
  - Clock Identity
  - Steps Removed
  - Port Identity
  - notSlave flag
  - Local Priority



---

**Note** See ITU-T G.8275.2 document to determine the valid values for Clock Class parameter.

---

- Port State Decision: The port states are selected based on the alternate BMCA algorithm. A port can be configured as "server-only", "client-only", or "any" mode.
- Packet Rates:
  - Synchronization/Follow-Up—minimum is one packet-per-second and maximum of 128 packets-per-second.
  - Packet rate for Announce packets—minimum of one packet-per-second and maximum of eight packets-per-second.
  - Delay-Request/Delay-Response packets—minimum is one packet-per-second and maximum of 128 packets-per-second.
- Transport Mechanism: G.8275.2 profile supports only IPv4 PTP transport mechanism.
- Mode: G.8275.2 profile supports transport of data packets only in unicast mode.
- Clock Type: G.8275.2 profile supports the following clock types:
  - Telecom Grandmaster (T-GM): Provides timing for other network devices and does not synchronize its local clock to other network devices. However, T-GM can be connected to a GPS or GNSS for deriving better clock information.
  - Telecom Time Subordinate/Client Clock (T-TSC) and Partial-Support Telecom Time Subordinate/Client Clocks (T-TSC-P): A client clock synchronizes its local clock to another PTP clock, but does not provide PTP synchronization to any other network devices.
  - Telecom Boundary Clock (T-BC) and Partial-Support Telecom Boundary Clocks (T-BC-P): Synchronizes its local clock to a T-GM or an upstream T-BC clock and provides timing information to downstream T-BC or T-TSC clocks.
- Domain Numbers: The domain numbers that can be used in a G.8275.2 profile network ranges from 44 to 63. The default domain number is 44.

## PTP Virtual Port

Feature Name	Release Information	Feature Description
PTP Virtual Port Support for N540X-12Z16G-SYS-A/D and N540-24Q8L2DD-SYS	Release 7.7.1	PTP Virtual Port is now supported on the following Cisco NCS 540 router variants: <ul style="list-style-type: none"> <li>• N540X-12Z16G-SYS-A/D</li> <li>• N540-24Q8L2DD-SYS</li> </ul>

Feature Name	Release Information	Feature Description
PTP Virtual Port Support for Cisco NCS 540 routers	Release 7.4.1	<p>You can now select the best available timing source for your routers by using the PTP Virtual Port feature.</p> <p>This feature allows you to compare, select, and advertise the best clock source between a PTP server and other local timing sources connected to the routers.</p> <p>Virtual Port is an external frequency, phase, and time input interface on a Telecom Boundary Clock (T-BC), and thus participates in the timing source selection.</p>

G.8275.1 introduces the concept of a virtual port on the T-BC. A virtual port is an external frequency, phase, and time input interface on a T-BC, which can participate in the source selection.

#### Limitations

- Assisted Partial Timing Support (APTS) is supported only for the G8275.2 non hybrid mode.
- Virtual port is supported for G8275.1 and G8275.2 in hybrid and non-hybrid modes.
- Virtual port configuration is not allowed under Ordinary Clocks.
- Virtual port cannot be configured if the time of day (ToD) priority is not set under the global PTP configuration mode. Use the **time-of-day priority** command to set the ToD.

## Assisted Partial Timing Support

*Table 8: Feature History Table*

Feature Name	Release Information	Description
Assisted Partial Timing Support	Release 7.7.1	<p>Assisted Partial Timing Support (APTS) enables you to select timing and synchronization for mobile backhaul networks.</p> <p>APTS is now available on the following routers:</p> <ul style="list-style-type: none"> <li>• N540X-12Z16G-SYS-A/D</li> <li>• N540-24Q8L2DD-SYS</li> </ul> <p>APTS allows for proper distribution of phase and time synchronization in the network.</p>

In a network having GNSS or GPS reference, all nodes (or secondary clocks) at the edge of the network follow the GNSS primary clock that runs at the core. When GNSS or GPS reference fails at the core, the secondary clocks running at the edge no longer receive accurate time stamps from the primary clock.

With the use of APTS, the nodes at the edge of the network identify GNSS or GPS as primary clock source, and PTP as the secondary source. So even if the GNSS reference is lost, the nodes fall back to the backup PTP session running between the primary clock at core and the nodes at the edge, and are thereby able to maintain an accurate time stamp.

## Configuring the G.8265.1 Profile

### Configuring the Client Global Configuration: Example

#### Master Node

```
ptp
 clock
 domain 4
 profile g.8265.1 clock-type master
 profile master
 transport ipv4
 sync frequency 16
 announce interval 1
 delay-request frequency 16
 interface gi 0/1/0/0
 ptp
 profile master
 transport ipv4
 port state master-only
 ipv4 address 18.1.1.1/24
```

#### Slave Node

```
ptp
 clock
 domain 4
 profile g.8265.1 clock-type slave

 profile slave
 transport ipv4
 sync frequency 16
 announce interval 1
 delay-request frequency 16
 interface gi 0/1/0/0
 ptp
 profile slave
 transport ipv4
 Master ipv4 18.1.1.1
 port state slave-only
 ipv4 address 18.1.1.2/24
```

## Configuring the G.8275.1 Profile

### Configuring the Global Settings: Example

```
ptp
 clock
 domain 24
 profile g.8275.1 clock-type [T-BC | TGM | TTSC]
 !
 profile profile1
```

```

transport ethernet
sync frequency 16
announce frequency 8
delay-request frequency 16
!
profile profile2
transport ethernet
sync frequency 16
announce frequency 8
delay-request frequency 16
!
!
    physical-layer-frequency
!

```

### Configuring Client Port: Example

```

interface GigabitEthernet0/0/0/3
 ptp
  profile profile1
  multicast target-address ethernet 01-1B-19-00-00-00
  transport ethernet
  port state slave-only
  local-priority 10
!
  frequency synchronization
  selection input
  priority 1
  wait-to-restore 0
!
!

```

### Configuring Server Port: Example

```

interface GigabitEthernet0/0/0/1
 ptp
  profile profile2
  multicast target-address ethernet 01-1B-19-00-00-00
  port state master-only
  transport ethernet
  sync frequency 16
  announce frequency 8
  delay-request frequency 16
!
  frequency synchronization
!
!

```

## Configuring the G.8275.2 Profile

Global configuration for the telecom profile for Server clock:

```

ptp
clock
  domain 44
  profile g.8275.2 clock-type T-GM
!
profile master
transport ipv4
sync frequency 64
announce frequency 8
unicast-grant invalid-request deny
delay-request frequency 64
!

```

```

!
interface GigabitEthernet0/0/0/11
 ptp
  profile master
!
 ipv4 address 11.11.11.1 255.255.255.0
!

```

Global configuration for the telecom profile for Client clock:

Effective Cisco IOS XR Software Release 7.7.1, the encapsulation type for PTP packet transport is now extended to IPv6; you can now use the **transport ipv6** to set this encapsulation type.

```

ptp
 clock
  domain 44
  profile g.8275.2 clock-type T-TSC
!
 profile slave
  transport ipv4
  port state slave-only
  sync frequency 64
  announce frequency 8
  delay-request frequency 64
!
 log
  servo events
  best-master-clock changes
!
!
interface GigabitEthernet0/0/0/12
 ptp
  profile slave
  master ipv4 10.10.10.1
!
!
 ipv4 address 10.10.10.2 255.255.255.0
!

```

Global configuration with clock type as T-Boundary Clock (T-BC) for the telecom profile:

Effective Cisco IOS XR Software Release 7.7.1, the encapsulation type for PTP packet transport is now extended to IPv6; you can use the **transport ipv6** to set this encapsulation type.

```

ptp
 clock
  domain 44
  profile g.8275.2 clock-type T-BC
!
 profile slave
  transport ipv4
  port state slave-only
  sync frequency 64
  announce frequency 8
  unicast-grant invalid-request deny
  delay-request frequency 64
!
 profile master
  transport ipv4
  sync frequency 64
  announce frequency 8
  unicast-grant invalid-request deny
  delay-request frequency 64

```

```

!
log
  servo events
  best-master-clock changes
!
!

interface GigabitEthernet0/0/0/11
  ptp
  profile master
  !
  ipv4 address 10.10.10.2 255.255.255.0
  !

interface GigabitEthernet0/0/0/12
  ptp
  profile slave
  master ipv4 10.10.10.1
  !
  !
  ipv4 address 10.10.10.3 255.255.255.0
  !

```

## Example: Configuring G.8275.2 in Hybrid Mode

### 1. Configuring Sync2

```

clock-interface sync 2 location 0/RP0/CPU0
port-parameters
gps-input tod-format cisco pps-input ttl <depending on the tod format incoming :
cisco/ntp4>
!
frequency synchronization
selection input
priority 1
wait-to-restore 0
quality receive exact itu-t option 1 PRC

```

### 2. Configuring the T-GM with GNSS as source



---

**Note** If the server clock receives front panel inputs, skip to step b.

---

#### a. Enabling GNSS

```

gnss-receiver 0 location 0/RP1/CPU0
no shut
constellation auto
frequency synchronization
selection input
wait-to-restore 0
quality receive exact itu-t option 1 PRC

```



---

**Note** In Cisco IOS XR Release 7.0.1, GNSS is *not* supported on N540-28Z4C-SYS-A/D and N540-12Z20G-SYS-A/D variants.

---





**Note** In Cisco IOS XR Release 7.4.1, GNSS is *not* supported on the N540X-4Z14G2Q-SYS-A/D variants.

**b. Configuring global PTP**

```
ptp
    clock
    domain 44
    profile g.8275.2 clock-type T-GM
    !
    profile 8275.2
    transport ipv4
    port state any
    sync frequency 64
    announce frequency 8
    delay-request frequency 64
    !
    physical-layer-frequency
    !
```

**c. Configuring global frequency**

```
frequency synchronization
    quality itu-t option 1
    clock-interface timing-mode system
    !
```

**d. Enabling GPS for phase and frequency input**

```
clock-interface sync 2 location 0/RP0/CPU0
    port-parameters
    gps-input tod-format ntp4 pps-input ttl baud-rate 9600
    !
    frequency synchronization
    selection input
    priority 1
    wait-to-restore 0
    quality receive exact itu-t option 1 PRC
    !
    !
```

**e. Configuring PTP and SyncE output on port for T-GM**

```
interface HundredGigE0/0/0/1
    ptp
    profile 8275.2
    !
    frequency synchronization
    !
```

**3. Configuring G.8275.2 on T-BC**

**a. Configuring global SyncE**

```
frequency synchronization
    quality itu-t option 1
    clock-interface timing-mode system
    !
```

**b. Configuring global PTP**

```
ptp
clock
```

```

domain 44
profile g.8275.2 clock-type T-BC
!
profile 8275.2
  transport ipv4
  port state any
  sync frequency 64
  announce frequency 8
  delay-request frequency 64
!
physical-layer-frequency <-- This is a mandatory command -->
!

```

#### c. Configuring Client port on Hybrid BC

```

interface HundredGigE0/0/0/0
 ptp
 profile 8275.2
 !
 frequency synchronization
 selection input
 priority 1
 wait-to-restore 0
 !
 !

```

#### d. Configuring Server port on Hybrid BC

```

interface HundredGigE0/0/0/1
 ptp
 profile 8275.2
 !
 frequency synchronization
 !
 !

```

### 4. Configuring G8275.2 on T-TSC

#### a. Configuring global SyncE

```

frequency synchronization
  quality itu-t option 1
  clock-interface timing-mode system
!

```

#### b. Configuring global PTP

```

ptp
clock
domain 44
profile g.8275.2 clock-type T-TSC
!
profile 8275.2
  transport ipv4
  port state any
  sync frequency 64
  announce frequency 8
  delay-request frequency 64
!
physical-layer-frequency <-- This is a mandatory command -->
!

```

#### c. Configuring Client port on Hybrid BC

```

interface HundredGigE0/0/0/0
 ptp
 profile 8275.2
 !
 frequency synchronization
 selection input
 priority 1
 wait-to-restore 0
 !
 !

```

## Example: Configuring G.8275.2 in Non-Hybrid Mode

### 1. Configuring Sync2

```

clock-interface sync 2 location 0/RP0/CPU0
port-parameters
gps-input tod-format cisco pps-input ttl <depending on the tod format incoming :
cisco/ntp4>
!
frequency synchronization
selection input
priority 1
wait-to-restore 0
quality receive exact itu-t option 1 PRC

```

### 2. Configuring the T-GM with GNSS as source



---

**Note** If the server clock receives front panel inputs, skip to step b.

---

#### a. Enabling GNSS

```

gnss-receiver 0 location 0/RP1/CPU0
frequency synchronization
selection input
wait-to-restore 0
quality receive exact itu-t option 1 PRC

```



---

**Note** In Cisco IOS XR Release 7.0.1, GNSS is *not* supported on N540-28Z4C-SYS-A/D and N540-12Z20G-SYS-A/D variants.

---



---

**Note** In Cisco IOS XR Release 7.4.1, GNSS is *not* supported on the N540X-4Z14G2Q-SYS-A/D variants.

---

#### b. Configuring global PTP

```

ptp
    clock
    domain 44
    profile g.8275.2 clock-type T-GM
    !
    profile 8275.2
    transport ipv4

```

```

port state any
sync frequency 64
announce frequency 8
delay-request frequency 64
!
!
```

### c. Enabling GPS for phase and frequency input

```

clock-interface sync 2 location 0/RP0/CPU0
port-parameters
gps-input tod-format ntp4 pps-input ttl baud-rate 9600
!

selection input
priority 1
wait-to-restore 0
quality receive exact itu-t option 1 PRC
!
!
```

### d. Configuring PTP and SyncE output on port for T-GM

```

interface HundredGigE0/0/0/1
ptp
profile 8275.2
!
!
```

## 3. Configuring G.8275.2 on T-BC

### a. Configuring global PTP

```

ptp
clock
domain 44
profile g.8275.2 clock-type T-BC
!
profile 8275.2
transport ipv4
port state any
sync frequency 64
announce frequency 8
delay-request frequency 64
!
```

### b. Configuring Client port on Hybrid BC

```

interface HundredGigE0/0/0/0
ptp
profile 8275.2
!
selection input
priority 1
wait-to-restore 0
!
!
```

### c. Configuring Server port on Hybrid BC

```

interface HundredGigE0/0/0/1
ptp
profile 8275.2
!
!
```

#### 4. Configuring G8275.2 on T-TSC

##### a. Configuring global PTP

```
ptp
clock
domain 44
profile g.8275.2 clock-type T-TSC
!
profile 8275.2
  transport ipv4
  port state any
  sync frequency 64
  announce frequency 8
  delay-request frequency 64
!
```

##### b. Configuring Client port on Hybrid BC

```
interface HundredGigE0/0/0/0
ptp
profile 8275.2
!
selection input
priority 1
wait-to-restore 0
!
!
```

## Configuring Virtual Port

Effective Cisco IOS XR Release 7.4.1, you can configure virtual port on the G8275.1 and G8275.2 profiles in hybrid and non-hybrid modes.

For virtual port configuration to work, GNSS or Sync2 must be configured.

```
ptp
clock
domain 44
profile g.8275.2 clock-type T-BC
!
profile profile1
  transport ipv4
  sync frequency 64
  clock operation one-step
  announce frequency 8
  delay-request frequency 64
!
virtual-port
  offset-scaled-log-variance 20061
  priority2 128
  clock-class 6
  clock-accuracy 33
  local-priority 127
!
frequency priority 254
time-of-day priority 90    <!--time-of-day priority is a required parameter if you want
to configure virtual port-->>
log
```

## Configuring APTS

Effective Cisco IOS XR Release 7.4.1, you can configure APTS on the G8275.2 profile in non-hybrid mode.

```

ptp
  apts
  clock
  domain 44
  profile g.8275.2 clock-type T-BC
  !
  profile profile1
  transport ipv4
  sync frequency 64
  clock operation one-step
  announce frequency 8
  delay-request frequency 64
  !
  virtual-port
    offset-scaled-log-variance 20061
    priority2 128
    clock-class 6
    clock-accuracy 33
    local-priority 127
    !
    frequency priority 254
    time-of-day priority 90
  log

```

## PTP Over Bundled Virtual Interface

*Table 9: Feature History*

Feature Name	Release Information	Description
PTP over BVI Support on Cisco NCS 540 Small Density Routers	Release 7.10.1	<p>You can now configure PTP over BVI on the following variants:</p> <ul style="list-style-type: none"> <li>• N540-6Z14S-SYS-D</li> <li>• N540X-6Z18G-SYS-A, N540X-6Z18G-SYS-D, N540X-8Z16G-SYS-A, N540X-8Z16G-SYS-D, N540X-4Z14G2Q-A, N540X-4Z14G2Q-D</li> </ul>

Feature Name	Release Information	Description
PTP over BVI	Release 7.2.2	<p>This feature allows PTP traffic to flow over a bridged virtual interface.</p> <p>You can now configure PTP over BVI on the following variants:</p> <ul style="list-style-type: none"> <li>• N540-24Z8Q2C-SYS</li> <li>• N540X-ACC-SYS</li> <li>• N540-ACC-SYS</li> <li>• N540-28Z4C-SYS</li> <li>• N540-28Z4C-SYS-A</li> <li>• N540-28Z4C-SYS-D</li> <li>• N540X-16Z4G8Q2C-A</li> <li>• N540X-16Z4G8Q2C-D</li> <li>• N540X-16Z8Q2C-D</li> <li>• N540-12Z20G-SYS-A</li> <li>• N540-12Z20G-SYS-D</li> <li>• N540X-12Z16G-SYS-A</li> <li>• N540X-12Z16G-SYS-D</li> </ul>

## Limitations

- PTP over BVI is supported only for PTP IPv4 sessions on BVI.
- PTP over BVI is supported only on the server interfaces of T-GM and T-BC.
- For PTP over BVI to work seamlessly, SyncE must be configured on a physical interface.
- PTP over BVI is not supported on subinterfaces.
- PTP over BVI will not work when Two-Pass Forwarding over BVI is configured. For more information on [Two-Pass Forwarding over BVI](#) refer to *Interface and Hardware Component Configuration Guide for Cisco NCS 540 Series Routers*.
- Bundle support is available as BVI bridge member.

## Configuring PTP Over BVI

Consider the following topology:

Router BV11 acts as PTP server or a BC node. Hosts A and B act as clients. Bridge group *BG\_test* and bridge-domain *BD\_1* are part of a Layer 2 cloud.

Figure 3:

Figure 4: Sample Topology for Configuring PTP Over BVI

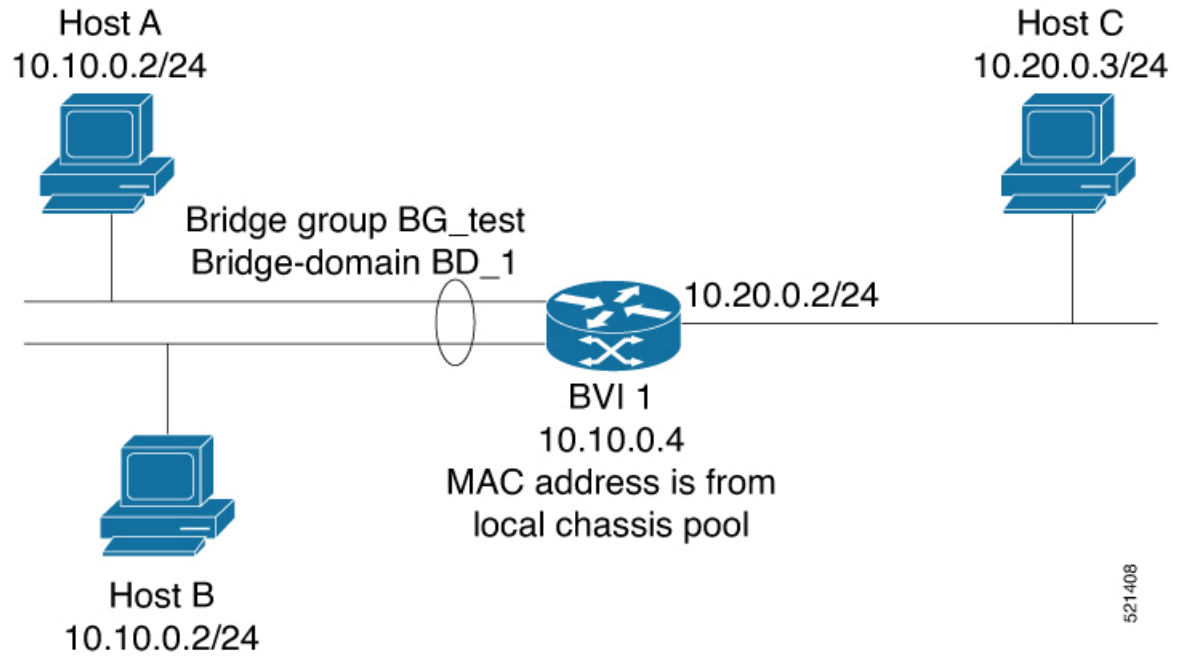

521408

On the PTP Server, BV11, configure the following:

```

ptp
!
interface GigabitEthernet0/0/0/1
l2transport
!
Interface Bundle-Ether 100
L2transport
!
interface BVI1
ptp
  profile master
!
ipv4 address 10.10.0.4 255.255.255.0
!
l2vpn
bridge group foo
  bridge-domain bar
    interface GigabitEthernet0/0/0/0
    !
    interface GigabitEthernet0/0/0/1
    !
    Interface Bundle-Ether 100
    !
    routed interface BVI1
    !
  !
!
!
!

```





---

**Note** Host routers A and B have the standard PTP client configuration.

---

## Verifying PTP Over BVI

To check for the packet counters at BVI interface on the server, use the **show ptp packet-counters bvi *bvi-name*** command.

To check the state of PTP on the BVI interface on the server, use the **show ptp interface brief** command.

## Slow Tracking

Under normal configured conditions, any change in offset triggers an immediate reaction in the servo. With the Slow Tracking feature enabled, the servo corrects the phase offset based on the configured value. If the phase offset exceeds the acceptable range, servo goes into Holdover state. In such a condition, the Slow Tracking feature becomes inactive and the servo corrects itself to the latest offset and goes into Phase locked state. Slow Tracking becomes active again.



- 
- Note**
- The supported slow tracking rate range is from 8-894 nanoseconds per second and must be in multiples of 8.
  - This feature is active only when servo is in Phase locked mode.
- 

```
Router:# config
ptp
clock
domain 24
profile g.8275.1 clock-type T-BC
!
profile profile1
multicast target-address ethernet 01-1B-19-00-00-00
transport ethernet
sync frequency 16
clock operation one-step
announce frequency 8
delay-request frequency 16
!
physical-layer-frequency
servo-slow-tracking 16
!
```

# PTP Holdover Traceability Suppression

Table 10: Feature History Table

Feature Name	Release Information	Feature Description
PTP Holdover Traceability Suppression	Release 7.4.1	When a device which is configured as a Boundary clock (T-BC) loses synchronization with a quality Primary clock, to ensure that the downstream nodes continue to receive the configured clock class for a specified duration, and it's traceable you can configure this feature.
PTP Holdover Traceability Suppression for T-GM and T-GM with VP/APTS modes	Release 7.8.1	This feature extends the PTP holdover traceability suppression functionality to the devices which are in T-GM or T-GM with VP/APTS modes.

When the device loses synchronization with a quality Primary clock, to ensure that the downstream nodes continue to receive the configured clock class, and it's traceable you can configure this feature.

This feature enables the device which is configured as a boundary clock (T-BC) with PTP Profiles G.8275.1 or G.8275.2 to send out the configured clock-class as holdover clock-class and the time traceability flag to be set as TRUE for the specified duration. This is to ensure the down-stream nodes do not have an impact as this is a deviation from prescribed G.8275.1 ITU-T standards.

The Cisco IOS XR Software Release 7.8.1 introduces the holdover traceability suppression functionality to the devices which are in T-GM or T-GM with VP/APTS modes. Prior to this release, this feature was supported on T-BC mode only.



- Note**
- There are PTP flaps during switchovers or ISSU as the PTP holdover timer is running on the active RSP.
  - Once the configured holdover override duration has lapsed and the device is unable to receive a quality Primary clock within this duration, the device sends the prescribed default clock class of 165, and the traceability flag will be set as FALSE to advertise loss of clock to downstream nodes.

## Configuring PTP Holdover traceability suppression

This section describes how to configure the PTP holdover traceability suppression feature:

```
Router# config
Router(config)# ptp
Router(config-ptp)# holdover-spec-duration 1000
Router(config-ptp)# holdover-spec-clock-class 135
Router(config-ptp)# uncalibrated-traceable-override
Router(config-ptp)# holdover-spec-traceable-override
```

## IEEE Default Profile

The IEEE 1588 standard defines one profile, the default profile. A telecom profile defines:

- Restrictions on network technology
- Required PTP options
- Allowed PTP options
- Forbidden PTP options

The IEEE 1588 Default Profile can be configured only over IP and MPLS networks.

The Default Profile requires the following PTP options:

- The standard BMCA, with both priority fields set to 128.
- All management messages implemented
- Domain number zero

## Example: Hybrid Default Profile

Global PTP Configuration:

```
ptp
 clock
  domain 0
 exit
 profile slave
  transport ipv4
  sync frequency 32
  announce frequency 2
  delay-request frequency 32
 exit
 profile master
  transport ipv4
 exit
 uncalibrated-clock-class 255 unless-from-holdover
 freerun-clock-class 255
 startup-clock-class 255
 physical-layer-frequency <-- This is a mandatory command -->
 exit
```

## PTP Hybrid Mode

Your router allows the ability to select separate sources for frequency and time-of-day (ToD). Frequency selection can be between any source of frequency available to the router, such as: GPS, SyncE or IEEE 1588 PTP. The ToD selection is between the source selected for frequency and PTP, if available (ToD selection is from GPS or PTP). This is known as hybrid mode, where a physical frequency source (SyncE) is used to provide frequency synchronization, while PTP is used to provide ToD synchronization.

Frequency selection uses the algorithm described in ITU-T recommendation G.781, and is described in the Configuring Frequency Synchronization module in this document. The ToD selection is controlled using the time-of-day priority configuration. This configuration is found under the source interface frequency synchronization configuration mode and under the global PTP configuration mode. It controls the order for which sources are selected for ToD. Values in the range of 1 to 254 are allowed, with lower numbers.

## Configuring PTP Hybrid Mode



**Note** You must configure the PTP hybrid mode when using the G.8275.1 PTP profile.

Configure hybrid mode by selecting PTP for the time-of-day (ToD) and another source for the frequency. This task summarizes the hybrid configuration. See the other PTP configuration modules for more detailed information regarding the PTP configurations. For more information on SyncE configurations, see the *Configuring Ethernet Interfaces* section in the *Interface and Hardware Component Configuration Guide for Cisco NCS 540 Series Routers*.

To configure PTP Hybrid mode:

### 1. Configure Global Frequency Synchronization

```
RP/0/RP0/CPU0:router(config)# frequency synchronization
RP/0/RP0/CPU0:router(config)# commit
RP/0/RP0/CPU0:router(config)# quality itu-t option [1 | 2]
```

### 2. Configure Frequency Synchronization in Interface.

```
RP/0/RP0/CPU0:router(config)# interface GigabitEthernet 0/0/0/0
RP/0/RP0/CPU0:router(config-if)# frequency synchronization
RP/0/RP0/CPU0:router(config-if-freqsync)# selection input
RP/0/RP0/CPU0:router(config-if-freqsync)# time-of-day-priority 100
RP/0/RP0/CPU0:router(config-if-freqsync)# commit
```

### 3. Configure Global PTP

```
RP/0/RP0/CPU0:router(config)# ptp
RP/0/RP0/CPU0:router(config-ptp)# time-of-day priority 1
RP/0/RP0/CPU0:router(config)# commit
```

### 4. Configure Client Port

```
RP/0/RP0/CPU0:router(config)# interface GigabitEthernet0/0/0/2
RP/0/RP0/CPU0:router(config-if)# ptp
RP/0/RP0/CPU0:router(config-if)# profile slave
RP/0/RP0/CPU0:router(config-if)# multicast target-address ethernet 01-1B-19-00-00-00
RP/0/RP0/CPU0:router(config-if)# transport ethernet sync frequency 16
RP/0/RP0/CPU0:router(config-if)# announce frequency 8
RP/0/RP0/CPU0:router(config-if)# delay-request frequency 16
RP/0/RP0/CPU0:router(config-if)# frequency synchronization
RP/0/RP0/CPU0:router(config-if-freqsync)# selection input
RP/0/RP0/CPU0:router(config-if-freqsync)# priority 1
RP/0/RP0/CPU0:router(config-if-freqsync)# wait-to-restore 0
```

### 5. Configure Server Port

```
RP/0/RP0/CPU0:router(config)# interface GigabitEthernet0/0/0/3
RP/0/RP0/CPU0:router(config)# ptp
RP/0/RP0/CPU0:router(config)# profile master
RP/0/RP0/CPU0:router(config)# multicast target-address ethernet 01-1B-19-00-00-00
RP/0/RP0/CPU0:router(config)# port state master-only
```

```
RP/0/RP0/CPU0:router(config)# transport ethernet
RP/0/RP0/CPU0:router(config)# sync frequency 16
RP/0/RP0/CPU0:router(config)# announce frequency 8
RP/0/RP0/CPU0:router(config)# delay-request frequency 16
RP/0/RP0/CPU0:router(config)# frequency synchronization
RP/0/RP0/CPU0:router(config-if-freqsync)# exit
```

## Verifying the PTP Hybrid Mode Configurations

Use the following show commands to verify the configurations:

- **show ptp platform servo**

```
RP/0/RP0/CPU0:ios# show ptp platform servo
Tue Mar  5 07:08:00.134 UTC
Servo status: Running
Servo stat_index: 2
Device status: PHASE_LOCKED
Servo Mode: Hybrid
Servo log level: 0
Phase Alignment Accuracy: 0 ns
Sync timestamp updated: 8631
Sync timestamp discarded: 0
Delay timestamp updated: 8631
Delay timestamp discarded: 0
Previous Received Timestamp T1: 22521.011765183 T2: 22521.011766745 T3: 22521.018061685
T4: 22521.018063247
Last Received Timestamp T1: 22521.073747183 T2: 22521.073748745 T3: 22521.080054957
T4: 22521.080056515
Offset from master:  0 secs, 2 nsecs
Mean path delay   :  0 secs, 1560 nsecs
setTime():1  stepTime():1  adjustFreq():0
Last setTime: 21984.000000000 flag:0  Last stepTime:-276573300 Last adjustFreq:0
RP/0/RP1/CPU0:ios#
```

- **show running-config ptp**

```
RP/0/RP0/CPU0:router# show running-config ptp
ptp
clock
domain 24
profile g.8275.1 clock-type T-BC
!
profile slave
transport ethernet
sync frequency 16
announce frequency 8
delay-request frequency 16
!
profile master
transport ethernet
sync frequency 16
announce frequency 8
delay-request frequency 16
!
!
physical-layer frequency
!
```

- **show running-config frequency synchronization**

```
RP/0/RP0/CPU0:router# show running-config frequency synchronization
Tue Feb 6 06:36:26.472 UTC
frequency synchronization
quality itu-t option 1
clock-interface timing-mode system
!
```

• **show frequency synchronization interface brief**

```
RP/0/RP0/CPU0:P3# show frequency synchronization interface brief
```

```
Tue Feb 6 06:37:49.234 UTC
Flags: > - Up D - Down S - Assigned for selection
d - SSM Disabled x - Peer timed out i - Init state
s - Output squelched
Fl Interface QLrcv QLuse Pri QLsnd Output driven by
=====
>S GigabitEthernet0/0/0/2 PRC PRC 1 DNU GigabitEthernet0/0/0/2
>x GigabitEthernet0/0/0/3 Fail n/a 100 PRC GigabitEthernet0/0/0/2
>x GigabitEthernet0/0/0/4 Fail n/a 100 PRC GigabitEthernet0/0/0/2
RP/0/RP0/CPU0:P3#
```

## PTP Profile Interoperation

*Table 11: Feature History Table*

Feature Name	Release Information	Description
PTP Profile Interoperation	Release 7.2.1	PTP profile interoperation enables users to deploy newer profiles in a network containing older devices that do not support these profiles. This support allows for a gradual upgrade path.  For this release, interoperation is supported only between the G.8275.1 and G.8275.2 profiles.
PTP Profile Interoperation	Release 7.5.1	Support for this feature is now extended on the following Cisco NCS 540 router variants: <ul style="list-style-type: none"> <li>• N540-FH-CSR-SYS</li> <li>• N540-FH-AGG-SYS</li> <li>• N540X-6Z18G-SYS-A/D</li> <li>• N540X-8Z16G-SYS-A/D</li> <li>• N540X-4Z14G2Q-A/D</li> </ul> For this release, interoperation is extended between default, G.8275.1, and G.8275.2 profiles.

PTP profile interoperation occurs when a device that is running a particular profile is also configured to interoperate with one or more peer clocks that are running different profiles. To enable this behavior, use the `ptp interop profile profile` command to configure the interfaces that are connected to such peer clocks to interoperate.

For each such interface, the following configuration are available:

- Profile of the peer clock. If the profile is not specified, the profile of the local clock is used.
- Domain Number of the peer clock. If not specified, the domain number of the local clock is used. Incoming PTP messages with a different domain number are dropped.
- The Ingress-Conversion behavior. This behavior allows you to specify how to convert the clock properties received in incoming Announce messages.
  - The Priority1 and Priority2 values. If not specified, the default mapping is applied.
  - The ClockAccuracy value. If not specified, the default mapping is applied.
  - The OffsetScaledLogVariance value. If not specified, the default mapping is applied.
  - Any number of Clock-Class-Mappings. These mappings override the default mappings whenever present.
  - The Clock-Class-Default value. If present, this value is used for all clock class values for which a more specific mapping is not configured.
- The Egress-Conversion behavior: This behavior allows you to specify how to convert the clock properties sent in outgoing Announce messages. The options are the same as for Ingress-Conversion.

Consider the following example:

**Figure 5: Simple Illustration of PTP Profile Interoperation**

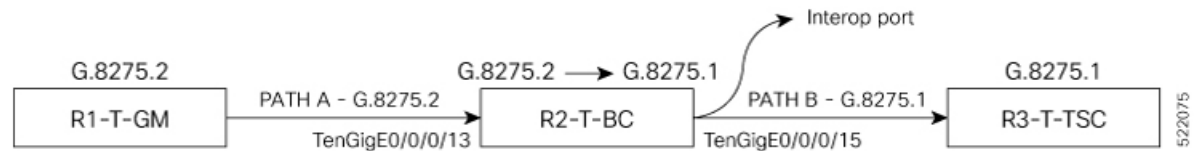

Router R1 (acting as grandmaster clock) is running the profile G.8275.2 through Path A towards router R2. R2 acts as a boundary clock and is running profile G.8275.1. The egress interface of R2 is an interop port that converts profile G.8275.2 to G.8275.1.

The profile G.8275.1 is carried over Path B toward the ordinary clock or router R3.

Configure the following on the interop port of Boundary Clock 'B':

```
interface TenGigE0/0/0/15
 ptp
  interop
  profile g.8275.1
  domain 24
 !
 multicast target-address ethernet 01-1B-19-00-00-00
 transport ethernet
 port state master-only
 sync frequency 64
 clock operation one-step
 announce interval 1
```

```

delay-request frequency 32
!
frequency synchronization

```

## Verifying PTP Interoperation

Run the following show commands on the interop port of R2 (see the figure above):

```

RP/0/RP0/CPU0:R2# show ptp platform servo
Sat Jul  3 17:28:50.107 UTC
Servo status: Running
Servo stat_index: 2
Device status: PHASE_LOCKED
Servo Mode: Hybrid
Servo log level: 0
Phase Alignment Accuracy: 1 ns
Sync timestamp updated: 24668
Sync timestamp discarded: 0
Delay timestamp updated: 24668
Delay timestamp discarded: 0
Previous Received Timestamp T1: 1625246930.271485001  T2: 1625246930.271485039  T3:
1625246930.280721326  T4: 1625246930.280
Last Received Timestamp T1: 1625246930.333474633  T2: 1625246930.333474671  T3:
1625246930.344744853  T4: 1625246930.3447448
Offset from master: -0 secs, 1 nsecs
Mean path delay   : 0 secs, 25 nsecs
setTime():1  stepTime():2  adjustFreq():12246
Last setTime: 1625245327.000000000 flag:0  Last stepTime:141500000  Last adjustFreq:5

```

```

RP/0/RP0/CPU0:JAGUAR# show ptp interop
Sat Jul  3 17:28:53.477 UTC
Interface TenGigE0/0/0/15

```

Egress Conversions:

```

Profile:                G.8275.2 -> G.8275.1
Domain:                    44 -> 24
Priority1:                  128 -> 128
Priority2:                  128 -> 128
ClockClass:            6 -> 6
ClockAccuracy:             0x21 -> 0x21
OffsetScaledLogVariance:  0x4e5d -> 0x4e5d

```

Ingress Conversions:

This port is not receiving Announce messages

```

RP/0/RP0/CPU0:R2# show ptp interfaces brief

```

```

Sat Jul  3 17:37:09.018 UTC

```

Intf Name	Port Number	Port State	Encap	Line State	Mechanism
Te0/0/0/13	1	Slave	IPv4	up	1-step DRRM
Te0/0/0/15	2	Master	Ethernet	up	1-step DRRM

```

RP/0/RP0/CPU0:R2# show ptp advertised-clock

```

```

Sat Jul  3 17:48:28.691 UTC
Clock ID: 8a96ffffef6a0d8
Clock properties:
  Domain: 44, Priority1: 128, Priority2: 128, Class: 6
  Accuracy: 0x21, Offset scaled log variance: 0x4e5d
  Time Source: GPS
  Timescale: PTP

```



```
Frequency-traceable, Time-traceable  
Current UTC offset: 37 seconds (valid)
```





## CHAPTER 6

# External Timing Source

---

Clock interfaces are external connectors for connecting other timing signals, such as, GPS, BITS.

- [GPS, on page 69](#)
- [Building Integrated Timing Supply \(BITS\), on page 71](#)

## GPS

The router can receive 1PPS, 10 MHz, and ToD signals from an external clocking and timing source. The three inputs are combined as a Sync-2 interface to form the external timing source or the GPS input.

The GPS front panel connector details are:

- ToD—RS422 format as input
- 1PPS—1.0/2.3 DIN connector as input
- 10MHz—1.0/2.3 DIN connector as input

GPS input starts only when all the three signals – 1PPS, 10MHz, and ToD are UP.



---

**Note** Unlike the Ethernet interface, the Sync-2 interface cannot receive or transmit QL. Ensure that you assign a QL value to the Sync-2 interface.

---

By default, 1PPS and 10MHz are in output mode. ToD output mode is not configurable.

For these variants - N540-24Z8Q2C-SYS, N540X-ACC-SYS, N540-ACC-SYS, N540-28Z4C-SYS, 10MHZ and 1PPS can operate in output mode only when PTP Client or BC mode are configured.

Figure 6: 1PPS, 10MHz, and the ToD ports on the Router's Front Panel

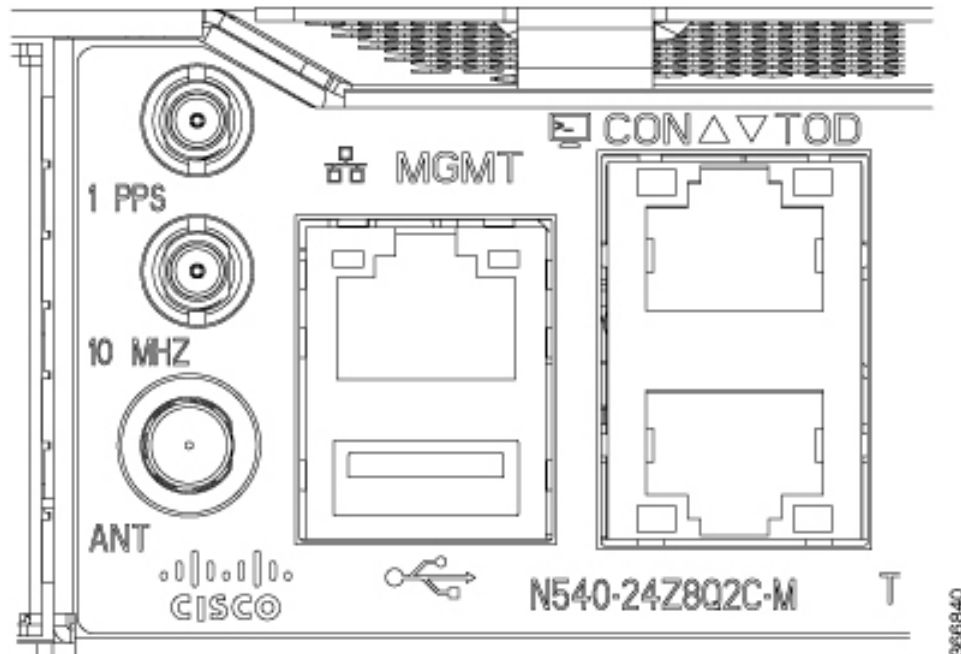

## Configuring GPS Settings for the Grandmaster Clock

```
RP/0/RP0/CPU0:router# configure
RP/0/RP0/CPU0:router(config)# clock-interface sync 2 location 0/RP0/CPU0
RP/0/RP0/CPU0:router(config-clock-if)# port-parameters
RP/0/RP0/CPU0:router(config-clk-parms)# gps-input tod-format cisco pps-input ttl
RP/0/RP0/CPU0:router(config-clk-parms)# exit
RP/0/RP0/CPU0:router(config-clock-if)# frequency synchronization
RP/0/RP0/CPU0:router(config-clk-freqsync)# selection input
RP/0/RP0/CPU0:router(config-clk-freqsync)# wait-to-restore 0
RP/0/RP0/CPU0:router(config-clk-freqsync)# quality receive exact itu-t option 1 PRC
RP/0/RP0/CPU0:router(config-clk-freqsync)# exit
RP/0/RP0/CPU0:router(config-clock-if)# frequency synchronization
RP/0/RP0/CPU0:router(config-clk-freqsync)# quality itu-t option 1
RP/0/RP0/CPU0:router(config-clk-freqsync)# clock-interface timing-mode system
RP/0/RP0/CPU0:router(config-clk-freqsync)# end
or
RP/0/RP0/CPU0:router(config-clk-freqsync)# commit
```

## Verifying the GPS Input

```
RP/0/RP0/CPU0:R1# show controllers timing controller clock

SYNCC Clock-Setting: -1 -1 6 -1
  Port 0  Port 1  Port 2  Port 3
Config :      No      No      Yes      No
Mode : -      -      GPS      -
Submode1 : -      -      CISCO   -
Submode2 : -      -      UTC     -
Submode3 : 0      0      0       0
Shutdown : 0      0      0       0
Direction : RX/TX  RX/TX  RX      RX/TX
```

```
Baud-Rate : - - 9600 -
QL Option : 01 01 - -
RX_ssm(raw) : - - - -
TX_ssm : - - - -
If_state : DOWN DOWN UP DOWN << Port 2 is UP when GPS input is
valid.
```

```
RP/0/RP0/CPU0:R1#
```

When the front panel timing LED is Green, it indicates that the GPS is configured and 1PPS, ToD, and 10M inputs are valid.

Timing LED Behavior:

- Timing LED is off: Indicates that no GPS is configured or the GPS port is down.
- Timing LED is green: Indicates that the GPS port is up.

SYNC LED Behavior:

- SYNC LED is applicable: Only when the timing configuration is applied.
- SYNC LED is green: Indicates that SyncE is locked.
- SYNC LED is amber: Indicates a holdover or free-running state.
- SYNC LED is off: Indicates that the configuration is removed.

## Building Integrated Timing Supply (BITS)

Router supports receiving (Rx) and transmitting (Tx) of frequency via BITS interface. To receive and transmit BITS signals, configuration is done under the clock-interface sync 0 on the route processor (RP).

### Prerequisite for BITS

Frequency synchronization must be configured with the required quality level option at the global level.

```
RP/0/RP0/CPU0:ios#show running-config frequency synchronization
Wed Aug 21 12:37:32.524 UTC
frequency synchronization
quality itu-t option 1
!
```



---

**Note** BITS-In and BITS-Out on the peer nodes must be configured with the same mode and format.

---

### Configuring BITS-IN

```
RP/0/RP0/CPU0:ios#configure
Wed Aug 21 12:29:59.162 UTC
RP/0/RP0/CPU0:ios(config)#clock-interface sync 0 location 0/RP0/CPU0
RP/0/RP0/CPU0:ios(config-clock-if)#port-parameters
RP/0/RP0/CPU0:ios(config-clk-parms)#bits-input e1 crc-4 sa4 ami
RP/0/RP0/CPU0:ios(config-clk-parms)#exit
```

```

RP/0/RP0/CPU0:ios(config-clock-if)#frequency synchronization
RP/0/RP0/CPU0:ios(config-clk-freqsync)#selection input
RP/0/RP0/CPU0:ios(config-clk-freqsync)#wait-to-restore 0
RP/0/RP0/CPU0:ios(config-clk-freqsync)#priority 1
RP/0/RP0/CPU0:ios(config-clk-freqsync)#commit
Wed Aug 21 12:30:53.296 UTC

RP/0/RP0/CPU0:ios#show running-config clock-interface sync 0 location 0/RP0/CPU0
Wed Aug 21 12:31:43.350 UTC
clock-interface sync 0 location 0/RP0/CPU0
  port-parameters
    bits-input e1 crc-4 sa4 ami
  !
  frequency synchronization
  selection input
  priority 1
  wait-to-restore 0
  !
  !

```

## Configuring BITS-OUT

```

RP/0/RP0/CPU0:ios#configure
Wed Aug 21 12:53:24.189 UTC
RP/0/RP0/CPU0:ios(config)#clock-interface sync 0 location 0/RP0/CPU0
RP/0/RP0/CPU0:ios(config-clock-if)#port-parameters
RP/0/RP0/CPU0:ios(config-clk-parms)#bits-output e1 crc-4 sa4 ami
RP/0/RP0/CPU0:ios(config-clk-parms)#commit
Wed Aug 21 12:53:39.411 UTC

RP/0/RP0/CPU0:ios#show running-config clock-interface sync 0 location 0/RP0/CPU0
Wed Aug 21 12:54:02.853 UTC
clock-interface sync 0 location 0/RP0/CPU0
  port-parameters
    bits-output e1 crc-4 sa4 ami
  !
  !

```



---

**Note** Based on the quality level chosen in global configuration, E1/T1 modes can be changed as required. But in all the cases, both TX and RX side modes and submodes must be the same.

For non-CRC-4/D4 modes, SSM is not present in BITS and manual receive quality level must be configured.

---

## Verifying BITS-IN Configuration

```

RP/0/RP0/CPU0:ios#show controllers timing controller clock
Wed Aug 21 12:38:20.394 UTC

SYNCC Clock-Setting: 1 -1 -1 -1

          Port 0          Port 1          Port 2          Port 3
Config    : Yes          No          No          No
Mode      : E1          -          -          -
Submode1  : CRC-4      -          -          -
Submode2  : AMI        -          -          -
Submode3  : 0          0          0          0
Shutdown  : 0          0          0          0
Direction : RX          RX/TX       RX/TX       RX/TX

```

```

Baud-Rate : -           -           -           -
QL Option  : 01         01         -           -
RX_ssm(raw): 99        -           -           -
TX_ssm     : -         -           -           -
If_state   : UP         DOWN        DOWN        DOWN

```

## Verifying BITS-OUT Configuration

```

RP/0/RP0/CPU0:ios#show controllers timing controller clock
Wed Aug 21 12:49:32.923 UTC
SYNCC Clock-Setting: 1 -1 -1 -1

```

	Port 0	Port 1	Port 2	Port 3
Config	: Yes	No	No	No
Mode	: E1	-	-	-
Submode1	: CRC-4	-	-	-
Submode2	: AMI	-	-	-
Submode3	: 0	0	0	0
Shutdown	: 0	0	0	0
Direction	: TX	RX/TX	RX/TX	RX/TX
Baud-Rate	: -	-	-	-
QL Option	: 01	01	-	-
RX_ssm(raw)	: -	-	-	-
TX_ssm	: 22	-	-	-
If_state	: UP	DOWN	DOWN	DOWN

## Verify Quality Level Received and Clock Interfaces

```

RP/0/RP0/CPU0:ios#show frequency synchronization clock-interfaces brief
Sat Mar 16 07:35:08.351 UTC
Flags: > - Up           D - Down           S - Assigned for selection
        d - SSM Disabled s - Output squelched L - Looped back
Node 0/RP0/CPU0:

```

```

=====
Fl   Clock Interface   QLrcv  QLuse  Pri  QLsnd  Output driven by
=====
>S   Sync0             PRS    PRS    5   n/a    n/a
D    Sync1             n/a    n/a    n/a  n/a    n/a
D    Sync2             n/a    n/a    n/a  n/a    n/a
>S   Internal0        n/a    ST3   255  n/a    n/a

```







## CHAPTER 7

# Implementing NTP

Network Time Protocol (NTP) is a protocol designed to time-synchronize devices within a network. Cisco IOS XR software implements NTPv4. NTPv4 retains backwards compatibility with the older versions of NTP, including NTPv3 and NTPv2 but excluding NTPv1, which has been discontinued due to security vulnerabilities.

- [Information About Implementing NTP, on page 75](#)
- [Configuring NTP, on page 76](#)

## Information About Implementing NTP

NTP synchronizes timekeeping among a set of distributed time servers and clients. This synchronization allows events to be correlated when system logs are created and other time-specific events occur.

NTP uses the User Datagram Protocol (UDP) as its transport protocol. All NTP communication uses Coordinated Universal Time (UTC). An NTP network usually receives its time from an authoritative time source, such as a radio clock or an atomic clock attached to a time server. NTP distributes this time across the network. NTP is efficient; no more than one packet per minute is necessary to synchronize two machines to within a millisecond of each other.

NTP uses the concept of a “stratum” to describe how many NTP “hops” away a machine is from an authoritative time source. A “stratum 1” time server typically has an authoritative time source (such as a radio or atomic clock, or a GPS time source) directly attached, a “stratum 2” time server receives its time via NTP from a “stratum 1” time server, and so on.

NTP avoids synchronizing to a machine whose time may not be accurate, in two ways. First, NTP never synchronizes to a machine that is not synchronized itself. Second, NTP compares the time reported by several machines and does not synchronize to a machine whose time is significantly different than the others, even if its stratum is lower. This strategy effectively builds a self-organizing tree of NTP servers.

The Cisco implementation of NTP does not support stratum 1 service; in other words, it is not possible to connect to a radio or atomic clock (for some specific platforms, however, you can connect a GPS time-source device). We recommend that time service for your network be derived from the public NTP servers available in the IP Internet.

If the network is isolated from the Internet, the Cisco implementation of NTP allows a machine to be configured so that it acts as though it is synchronized via NTP, when in fact it has determined the time using other means. Other machines can then synchronize to that machine via NTP.

Several manufacturers include NTP software for their host systems, and a publicly available version for systems running UNIX and its various derivatives is also available. This software also allows UNIX-derivative

servers to acquire the time directly from an atomic clock, which would subsequently propagate time information along to Cisco routers.

The communications between machines running NTP (known as associations) are usually statically configured; each machine is given the IP address of all machines with which it should form associations. Accurate timekeeping is made possible by exchanging NTP messages between each pair of machines with an association.

The Cisco implementation of NTP supports two ways that a networking device can obtain NTP time information on a network:

- By polling host servers
- By listening to NTP broadcasts

In a LAN environment, NTP can be configured to use IP broadcast messages. As compared to polling, IP broadcast messages reduce configuration complexity, because each machine can simply be configured to send or receive broadcast or multicast messages. However, the accuracy of timekeeping is marginally reduced because the information flow is one-way only.

An NTP broadcast client listens for broadcast messages sent by an NTP broadcast server at a designated IPv4 address. The client synchronizes the local clock using the first received broadcast message.

The time kept on a machine is a critical resource, so we strongly recommend that you use the security features of NTP to avoid the accidental or malicious setting of incorrect time. Two mechanisms are available: an access list-based restriction scheme and an encrypted authentication mechanism.

When multiple sources of time (VINES, hardware clock, manual configuration) are available, NTP is always considered to be more authoritative. NTP time overrides the time set by any other method.



---

**Note** NTP-PTP interworking is not supported on Cisco NCS 540 Series routers till IOS XR Software Release 24.1.1.

---

## Configuring NTP

### Configuring Poll-Based Associations

The following example shows an NTP configuration in which the router's system clock is configured to form a peer association with the time server host at IP address 192.168.22.33, and to allow the system clock to be synchronized by time server hosts at IP address 10.0.2.1 and 172.19.69.1:

```
ntp
 server 10.0.2.1 minpoll 5 maxpoll 7
 peer 192.168.22.33
 server 172.19.69.1
```

### Configuring Broadcast-Based Associations

The following example shows an NTP client configuration in which interface 0/2/0/0 is configured to receive NTP broadcast packets, and the estimated round-trip delay between an NTP client and an NTP broadcast server is set to 2 microseconds:

```
ntp
 interface tengige 0/2/0/0
   broadcast client
 exit
broadcastdelay 2
```

The following example shows an NTP server configuration where interface 0/2/0/2 is configured to be a broadcast server:

```
ntp
 interface tengige 0/2/0/0
 broadcast
```

## Configuring NTP Access Groups

The following example shows a NTP access group configuration where the following access group restrictions are applied:

Peer restrictions are applied to IP addresses that pass the criteria of the access list named peer-acl. Serve restrictions are applied to IP addresses that pass the criteria of access list named serve-acl.

Serve-only restrictions are applied to IP addresses that pass the criteria of the access list named serve-only-acl.

Query-only restrictions are applied to IP addresses that pass the criteria of the access list named query-only-acl.

```
ntp
 peer 10.1.1.1
 peer 10.1.1.1
 peer 10.2.2.2
 peer 10.3.3.3
 peer 10.4.4.4
 peer 10.5.5.5
 peer 10.6.6.6
 peer 10.7.7.7
 peer 10.8.8.8
 access-group peer peer-acl
 access-group serve serve-acl
 access-group serve-only serve-only-acl
 access-group query-only query-only-acl
 exit
ipv4 access-list peer-acl
 10 permit ip host 10.1.1.1 any
 20 permit ip host 10.8.8.8 any
 exit
ipv4 access-list serve-acl
 10 permit ip host 10.4.4.4 any
 20 permit ip host 10.5.5.5 any
 exit
ipv4 access-list query-only-acl
 10 permit ip host 10.2.2.2 any
 20 permit ip host 10.3.3.3 any
 exit
ipv4 access-list serve-only-acl
 10 permit ip host 10.6.6.6 any
 20 permit ip host 10.7.7.7 any
 exit
```

## Configuring NTP Authentication

The following example shows an NTP authentication configuration. In this example, the following is configured:

NTP authentication is enabled.

Two authentication keys are configured (key 2 and key 3).

The router is configured to allow its software clock to be synchronized with the clock of the peer (or vice versa) at IP address 10.3.32.154 using authentication key 2.

The router is configured to allow its software clock to be synchronized with the clock by the device at IP address 10.32.154.145 using authentication key 3.

The router is configured to synchronize only to systems providing authentication key 3 in their NTP packets.

```
ntp
  authenticate
  authentication-key 2 md5 encrypted 06120A2D40031D1008124
  authentication-key 3 md5 encrypted 1311121E074110232621
  trusted-key 3
  server 10.3.32.154 key 3
  peer 10.32.154.145 key 2
```

## Disabling NTP on an Interface

The following example shows an NTP configuration in which 0/2/0/0 interface is disabled:

```
ntp
  interface tengige 0/2/0/0
  disable
  exit
  authentication-key 2 md5 encrypted 06120A2D40031D1008124
  authentication-key 3 md5 encrypted 1311121E074110232621
  authenticate
  trusted-key 3
  server 10.3.32.154 key 3
  peer 10.32.154.145 key 2
```

## Configuring the System as an Authoritative NTP Server

The following example shows a NTP configuration in which the router is configured to use its own NTP server clock to synchronize with peers when an external NTP source becomes unavailable:

```
ntp
  master 6
```

## Updating the Hardware Clock

The following example shows an NTP configuration in which the router is configured to update its hardware clock from the software clock at periodic intervals:

```
ntp
  server 10.3.32.154
  update-calendar
```

## Configuring NTP Server Inside VRF Interface



**Note** No specific command enables NTP; the first NTP configuration command that you issue enables NTP.

```
RP/0/RP0/CPU0:router# configure
RP/0/RP0/CPU0:router(config)# ntp
RP/0/RP0/CPU0:router(config)# ntp vrf Customer_A
RP/0/RP0/CPU0:router(config)# ntp vrf Customer_A source bvi 70
RP/0/RP0/CPU0:router(config-ntp)# end
or
RP/0/RP0/CPU0:router(config-ntp)# commit
```





# CHAPTER 8

## Workflow and Use Case

Consider the following topology for configuring the G.8275.1:

**Figure 7: Sample G.8275.1 Topology**

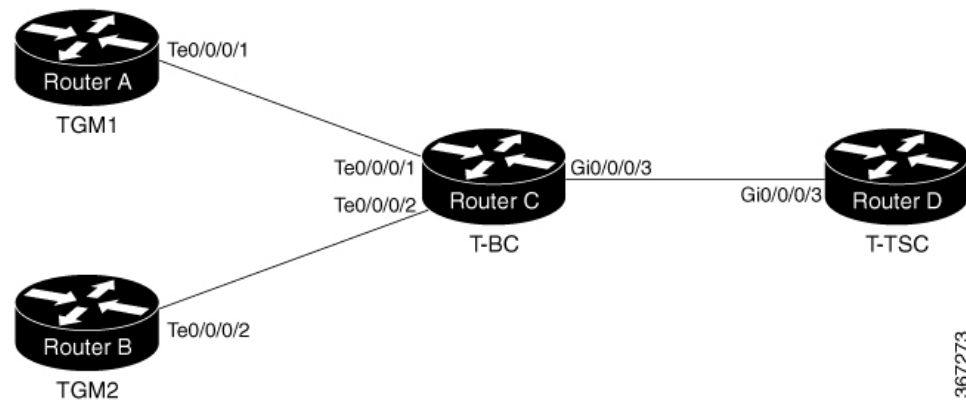

367273

### Configuration on TGM1

```

frequency synchronization
quality itu-t option 1
clock-interface timing-mode system
!
clock-interface sync 2 location 0/RP0/CPU0
port-parameters
  gps-input tod-format cisco pps-input ttl
!
frequency synchronization
  selection input
  wait-to-restore 0
  quality receive exact itu-t option 1 PRC
!
ptp clock
domain 24
  profile g.8275.1 clock-type T-GM
!
profile master
  transport ethernet
  sync frequency 16
  announce frequency 8
  delay-request frequency 16
!
interface GigabitEthernet0/0/0/1
  
```

```

ptp
  profile master
  multicast target-address ethernet 01-1B-19-00-00-00
  port state master-only
  transport ethernet
  sync frequency 16
  announce frequency 8
  delay-request frequency 16
!
frequency synchronization
!

```

### Configuration on TGM2

```

frequency synchronization
  quality itu-t option 1
  clock-interface timing-mode system
!
clock-interface sync 2 location 0/RP0/CPU0
  port-parameters
    gps-input tod-format cisco pps-input ttl
  !
  frequency synchronization
    selection input
    wait-to-restore 0
    quality receive exact itu-t option 1 PRC
!
ptp clock
domain 24
  profile g.8275.1 clock-type T-BC
!
  profile master
  transport ethernet
  sync frequency 16
  announce frequency 8
  delay-request frequency 16
!
interface GigabitEthernet0/0/0/2
  ptp
  profile master
  multicast target-address ethernet 01-1B-19-00-00-00
  port state master-only
  transport ethernet
  sync frequency 16
  announce frequency 8
  delay-request frequency 16
!
  frequency synchronization
!

```

### Configuration on T-BC

```

frequency synchronization
  quality itu-t option 1
  clock-interface timing-mode system
!
ptp clock
domain 24
  profile g.8275.1 clock-type T-BC
!
  profile slave
  transport ethernet
  sync frequency 16
  announce frequency 8
  delay-request frequency 16

```



```

!
physical-layer frequency
!

profile master
  transport ethernet
  sync frequency 16
  announce frequency 8
  delay-request frequency 16
! !
interface TenGigE0/0/0/1
  ptp
  profile slave
  multicast target-address ethernet 01-1B-19-00-00-00
  transport ethernet
  sync frequency 16
  local-priority 10
  announce frequency 8
  delay-request frequency 16
!
frequency synchronization
  selection input
  priority 1
  wait-to-restore 0
! !
interface TenGigE0/0/0/2
  ptp
  profile slave
  multicast target-address ethernet 01-1B-19-00-00-00
  transport ethernet
  port state any
  sync frequency 16
  local-priority 20
  announce frequency 8
  delay-request frequency 16
!
frequency synchronization
  selection input
  priority 1
  wait-to-restore 0
! !
interface GigabitEthernet0/0/0/3
  ptp
  profile master
  multicast target-address ethernet 01-1B-19-00-00-00
  transport ethernet
  port state any
  sync frequency 16
  announce frequency 8
  delay-request frequency 16
!
frequency synchronization
! !

```

### Configuration on T-TSC

```

frequency synchronization
  quality itu-t option 1
  clock-interface timing-mode system
! ptp
clock
  domain 24
  profile g.8275.1 clock-type T-TSC
!
profile slave

```

```
    transport ethernet
    sync frequency 16
    announce frequency 8
    delay-request frequency 16
  !
physical-layer frequency
!
!
interface GigabitEthernet0/0/0/3
  ptp
  profile slave
  multicast target-address ethernet 01-1B-19-00-00-00
  transport ethernet
  port state slave-only
  local-priority 10
!
frequency synchronization
  selection input
  priority 1
  wait-to-restore 0
!
```



## CHAPTER 9

# Configure the Global Navigation Satellite System

Effective Cisco IOS XR Release 7.5.1, GNSS is supported on the following router variants:

- N540-FH-CSR-SYS
- N540-FH-AGG-SYS

This chapter describes the Global Navigation Satellite System (GNSS) and how to configure it.

In typical telecom networks, network synchronization works in a hierarchical manner where the core network is connected to a stratum-1 clock. The timing from the stratum-1 clock is then distributed along the network in a tree-like structure. However, with a GNSS receiver, clocking is changed to a flat architecture, where access networks can directly take clock from the satellites by using an on-board GPS chip.

Router now uses a satellite receiver, also called the Global Navigation Satellite System (GNSS), as the new timing interface.

This capability simplifies network synchronization planning and provides flexibility and resilience in resolving network synchronization issues in the hierarchical network.

- [Overview of GNSS, on page 85](#)
- [Operation of GNSS Module , on page 86](#)
- [Prerequisites for GNSS, on page 88](#)
- [Restrictions for GNSS, on page 88](#)
- [Configure GNSS, on page 88](#)

## Overview of GNSS

Effective Cisco IOS XR Release 7.1.1, the following Cisco NCS 540 variants support GNSS receiver:

- N540X-16Z4G8Q2C-A
- N540X-16Z4G8Q2C-D
- N540X-12Z16G-SYS-A
- N540X-12Z16G-SYS-D
- N540-24Z8Q2C-SYS
- N540-28Z4C-SYS

- N540-ACC-SYS
- N540X-ACC-SYS

Effective Cisco IOS XR Release 7.4.1, the following Cisco NCS 540 variant supports GNSS receiver:

- N540-24Q8L2DD-SYS

No license is required to enable the GNSS module. The GNSS LED on the front panel indicates the status of the module. The following table describes the different status of GNSS LED:

LED Status	Description
Green	GNSS NormalState.Selfsurvey is complete.
Amber	GNSS not shut and not locked
OFF	If GNSS is not configured or is shut.

When connected to an external antenna, the module can acquire satellite signals and track up to 32 GNSS satellites, and compute location, speed, heading, and time. GNSS provides an accurate one pulse-per-second (PPS), a stable 10 MHz frequency output to synchronize broadband wireless, aggregation and pre-aggregation routers, and an accurate time-of-day (ToD).



**Note** NCS540X can also receive 1PPS, 10 MHz, and ToD signals from an external clocking and timing source. However, the timing signals from the GNSS module (when enabled) take precedence over those of the external source.



**Note** We do not recommend that you configure both the front panel (10M, 1PPS and ToD) input configuration and the GNSS input configuration.

By default, anti-jamming is enabled on the GNSS module.

## Operation of GNSS Module

### Operation of GNSS Module on the N540-24Z8Q2C-SYS, N540-28Z4C-SYS, N540-ACC-SYS, and N540X-ACC-SYS Routers

The GNSS module has the following stages of acquiring and providing timing signals to the Cisco router:

- Self-survey mode - When the router is reset, the GNSS module comes up in self-survey mode. It tries to lock on to a minimum of four different satellites and computes approximately 2000 different positions of the satellites to obtain a 3-D location (Latitude, Longitude, and Height) of its current position. This operation takes about 35 to 40 minutes. During this stage, the module is also able to generate accurate timing signals and achieve a Normal or Phase-locked state.

When GNSS moves into Normal state, you can start using the 1PPS, 10 MHz, and ToD inputs from GNSS. The quality of the signal in self-survey mode with Normal state is considered good enough to lock to GNSS.

- Over determined clock mode - The router switches to over determined (OD) mode when the self-survey mode is complete, and the position information is stored in non-volatile memory on the router. In this mode, the module only processes the timing information based on satellite positions captured in self-survey mode.

The router saves the tracking data, which is retained even when the router is reloaded.

The GNSS module stays in OD mode until one of the following conditions occur:

- A position relocation of the antenna of more than 100 meters is detected. This detection causes an automatic restart of the self-survey mode.
- A manual restart of the self-survey mode or when the stored reference position is deleted.
- A worst-case recovery option after a jamming-detection condition that cannot be resolved with other methods.

You can configure the GNSS module to automatically track any satellite or configure it to explicitly use a specific constellation. However, the module uses configured satellites in only the OD mode.



---

**Note** GLONASS and BeiDou satellites cannot be enabled simultaneously.

---

When the router is reloaded, it always comes up in OD mode unless:

- the router is reloaded when the self-survey mode is in progress.
- the physical location of the router is changed to more than 100 meters from its pre-reloaded condition.

When the system restarts the GNSS self-survey by using the default gns slot R0/R1 command in config mode, the 10MHz, 1PPS, and ToD signals are not changed and remain up.

#### **Operation of GNSS Module on the N540X-16Z4G8Q2C-A, N540X-16Z4G8Q2C-D, N540X-12Z16G-SYS-A, and N540X-12Z16G-SYS-D Routers**

The GNSS module has the following stages of acquiring and providing timing signals to the Cisco router:

- Self-survey mode - Self-survey is the procedure that is performed prior to using time mode. It determines the position of a stationary receiver by building a weighted mean of all valid 3D position solutions.

To stop self-survey mode, the following two requirements must be met:

- The minimum observation time defines a minimum amount of observation time regardless of the actual number of valid fixes that are used for position calculation. Reasonable values range from one day for high accuracy position calculation to a few minutes for coarse position determination.
- The required 3D position standard deviation defines a limit on the spread of positions that contribute to the calculated mean. As the position error translates into a time error when using time mode, you should carefully evaluate the time accuracy requirements and choose an appropriate value.

Self-survey ends when both requirements are met. After self-survey is completed successfully, the receiver automatically enters time-fix mode.

**Recommendations**

- Self-survey must run for at least twenty-four hours because it is important to cover a full constellation run and a day-night cycle.
- CNO or signal strength for achieving time-fix during self-survey is 35dB.
- Time-fix mode - In order to use the time-fix mode, the exact position of the receiver must be known. The exact position of the receiver is determined by using self-survey. Errors in the fixed position translate into time errors depending on the satellite constellation.

There is no minimum and maximum value (Time) in the self-survey process and the receiver makes the best effort to achieve the time-fix mode.

For achieving the time-fix mode, a minimum of four satellites are required and it may take several days to get into the time-fix mode.

If the position is already known, the module can achieve time-fix mode even if there is only one satellite received.

You can configure the GNSS module to automatically track any satellite or configure it to explicitly use a specific constellation.

When the router is reloaded, it always comes up in the time-fix mode unless the router is reloaded when the self-survey mode is in progress.

## Prerequisites for GNSS

To use GNSS, the antenna must see as much as possible from the sky. For proper timing, a minimum of four satellites must be locked. For more information, see the *Cisco NCS 540 Series Router Hardware Installation Guide*.

## Restrictions for GNSS

- The GNSS module is not supported through SNMP; all configurations are performed through commands.
- The GNSS holdover performance is one microsecond in two hours of holdover after twelve hours of GNSS lock time.
- GNSS module is not supported in default profile mode.

## Configure GNSS

**Configuration Example**

This section describes how you can configure GNSS for a router.

```
/* Enable the GNSS receiver and enter the gnss-receiver submode */

Router(config)# gnss-receiver 0 location 0/RP0/CPU0
Router(config-gnss)# no shutdown
```

```
Router(config-gnss)# frequency synchronization
Router(config-gnss-freqsync)# selection input
Router(config-gnss-freqsync)# commit
```

### Optional Configuration Example

```
Router(config)# gnss-receiver 0 location 0/RP0/CPU0
Router(config-gnss)# anti-jam disable
Router(config-gnss)# constellation GPS
Router(config-gnss)# snr threshold 10
Router(config-gnss)# frequency synchronization
Router(config-gnss-freqsync)# selection input
Router(config-gnss-freqsync)# priority 5 >>>Values can range from 1 (highest priority) to
254 (lowest priority). The default value is 100.
Router(config-gnss-freqsync)# wait-to-restore 0
```

### Running Configuration

```
gnss-receiver 0 location 0/RP0/CPU0
frequency synchronization
  selection input
  priority 1
  wait-to-restore 0
  quality receive exact itu-t option 1 PRC
!
```

### Verification

The following is the output of the **show gnss-receiver** command on the router models.

The following is the output of the **show gnss-receiver** command on the router models - N540-24Z8Q2C-SYS, N540-28Z4C-SYS, N540-ACC-SYS, and N540X-ACC-SYS.

```
RP/0/RP0/CPU0:R6# show gnss-receiver
Fri Jan 17 07:27:34.804 UTC
GNSS-receiver 0 location 0/RP0/CPU0
Status: Available, Up
Position: 12:56.18 N 77:41.77 E 0.823km
Time: 2020:01:17 07:31:41 (UTC offset: 0s)
Locked at: 2020:01:15 17:15:28
Firmware version: TIM 1.10
Lock Status: Phase Locked, Receiver Mode: Time fix only
Survey Progress: 100, Holdover Duration: Unknown
Major Alarms: Unknown
Minor Alarms: Unknown
Anti-jam: Enabled, Cable-delay compensation: 0
1PPS polarity: Positive
PDOP: 99.990, HDOP: 99.990, VDOP: 99.990, TDOP: 0.240
Constellation: GPS, Satellite Count: 17
Satellite Thresholds:
  SNR - 0 dB-Hz, Elevation - 0 degrees, PDOP - 0, TRAIM - 0 us
Satellite Info:
  CHN: Channel, AQUN: Aquisition, EPH: Ephemeris
  PRN  CHN  AQUN  EPH  SV          Signal
  No.  No.  Flag  Flag  Type        Strength  Elevat'n  Azimuth
  ---  ---  ---  ---  ---        -
  1    n/a  On    On    GPS         44.000    19.000    220.000
  3    n/a  On    On    GPS         48.000    62.000    299.000
  4    n/a  On    On    GPS         46.000    30.000    338.000
  7    n/a  On    On    GPS         47.000     9.000    261.000
```

8	n/a	On	On	GPS	41.000	17.000	172.000
9	n/a	On	On	GPS	44.000	7.000	317.000
11	n/a	On	On	GPS	42.000	10.000	202.000
14	n/a	On	On	GPS	42.000	22.000	90.000
16	n/a	On	On	GPS	46.000	66.000	59.000
22	n/a	On	On	GPS	47.000	71.000	238.000
23	n/a	On	On	GPS	46.000	27.000	332.000
26	n/a	On	On	GPS	48.000	40.000	40.000

The following is the output of the **show gnss-receiver** command on the router models - N540X-16Z4G8Q2C-A, N540X-16Z4G8Q2C-D, N540X-12Z16G-SYS-A, N540X-12Z16G-SYS-D.

```
RP/0/RP0/CPU0:ios#show gnss-receiver
Sun Sep 29 09:25:29.477 UTC
GNSS-receiver 0 location 0/RP0/CPU0
Status: Available, Up
Position: 12:56.18 N 77:41.77 E 0.823km
Time: 2019:10:24 11:32:21 (UTC offset: 0s)
Locked at: 2019:09:29 09:19:20
Firmware version: TIM 1.10
Lock Status: Phase Locked, Receiver Mode: Time fix only
Survey Progress: 100, Holdover Duration: Unknown
Major Alarms: Unknown
Minor Alarms: Unknown
Anti-jam: Enabled, Cable-delay compensation: 0
1PPS polarity: Positive
PDOP: 99.990, HDOP: 99.990, VDOP: 99.990, TDOP: 0.450
Constellation: Auto, Satellite Count: 5
Satellite Thresholds:
  SNR - 0 dB-Hz, Elevation - 0 degrees, PDOP - 0, TRAIM - 0 us
Satellite Info:
CHN: Channel, AQUN: Aquisition, EPH: Ephemeris
PRN  CHN  AQUN  EPH  SV      Signal
No.  No.   Flag  Flag  Type    Strength  Elevat'n  Azimuth
---  ---  ----  ----  -----  -
  1  n/a  On    On    GLONASS  28.000    19.000    342.000
  7  n/a  On    On    GLONASS  25.000    30.000    91.000
  8  n/a  On    On    GLONASS  25.000    42.000    28.000
 10  n/a  On    On    GLONASS  33.000    54.000    211.000
 11  n/a  On    On    GLONASS  33.000    78.000    217.000
```





## CHAPTER 10

# Network Synchronization Design Best Practices

---

The synchronization of a network is essential for ensuring that all devices in a network run on the same clock time. It also ensures that the applications in the network function correctly. To design your network synchronization accurately, you must have a clear understanding of your network requirements, timing budget, application requirements, and the desired level of synchronization accuracy. This section describes some best practices to follow when designing your network synchronization.

- [Network Synchronization Decision Tree, on page 91](#)
- [General Guidelines for Successful Synchronization Deployments, on page 92](#)
- [Guidelines for Phase Synchronization Deployments, on page 93](#)
- [PTP over IP Network Design, on page 94](#)
- [Selecting the Correct Profile For Network Synchronization, on page 95](#)
- [Reducing Asymmetry, on page 96](#)
- [Reducing Packet Delay Variation, on page 96](#)
- [Remediating Transport Asymmetry, on page 96](#)
- [Synchronizing Across Networks, on page 97](#)

## Network Synchronization Decision Tree

Use the network synchronization decision tree for determining the appropriate synchronization solution for your network deployment. Network synchronization helps in ensuring that the network operates with accurate and synchronized time.

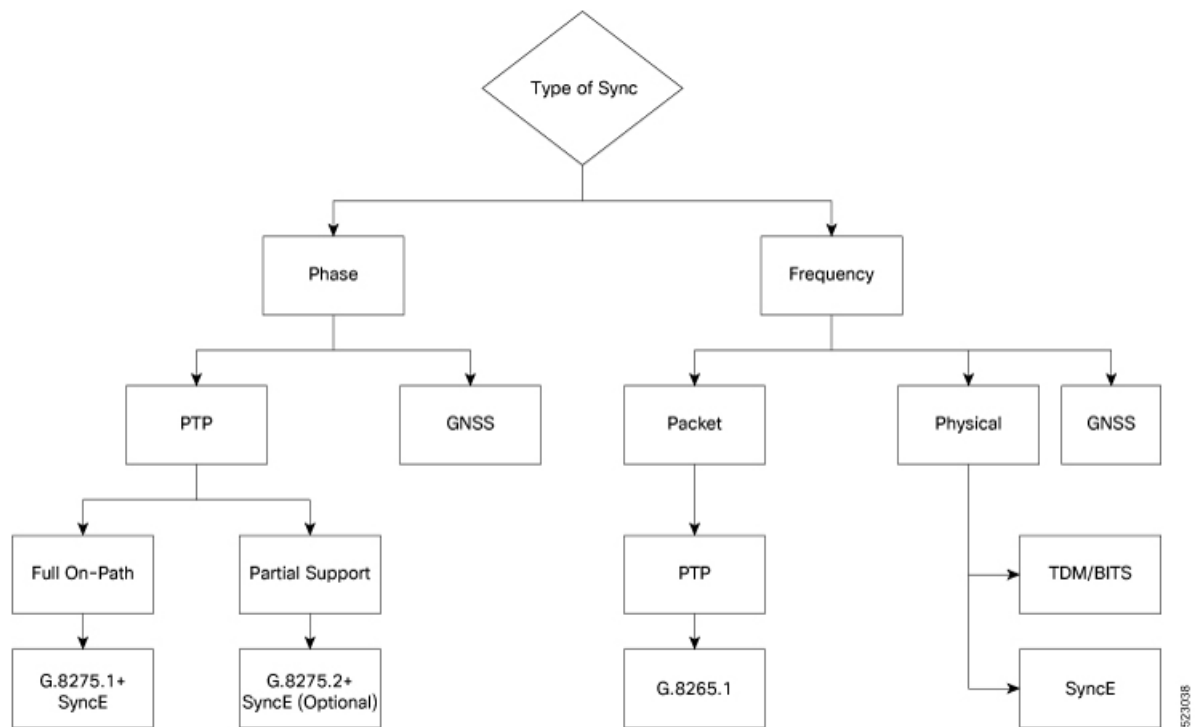

## General Guidelines for Successful Synchronization Deployments

Network synchronization is crucial for maintaining reliable and efficient network operations, ensuring data integrity, complying with regulations, and facilitating troubleshooting and management tasks. The following guidelines help in deploying successful network synchronization for your network:

- Ensure that you use a standards-based solution designed for your need. For example, use the correct profile.
- Configure the appropriate clock source for your network. It can be Global Navigation Satellite System (GNSS) based such as a Global Positioning System (GPS) clock, or a Precision Time Protocol (PTP) grandmaster clock.
  - Frequency synchronization requires Building Integrated Timing Supply (BITS) or synchronous Ethernet, and Phase synchronization requires PTP and/or GNSS.
  - Use a combination of GNSS over the air and/or PTP or synchronous Ethernet over transport.

For more information on [Frequency Synchronization Timing Concepts](#) and [Understanding PTP](#), refer to *Network Synchronization Configuration Guide for Cisco NCS 540 Series Routers*.

- Set up the synchronization protocols that are required, which includes PTP, Network Time Protocol (NTP), or synchronous Ethernet.
  - NTP uses the system clock for logging events in the system, or to show clock output, whereas PTP and GNSS work on the IEEE 1588 hardware clock in the system.
  - The NTP clock of a node can't be used to synchronize the downstream network using PTP. However, a node can synchronize its NTP clock with the available PTP or GNSS clock.



**Note** Most NTP implementations are software-based. Software-based time synchronization is less accurate than hardware-based synchronization, but it's still useful for applications where low levels of accuracy, such as 10's or 100's of milliseconds, are acceptable.

- Use PTP for phase synchronization in the absence of a GNSS.
- Synchronous Ethernet (SyncE) is a recommendation from ITU Telecommunication Standardization Sector (ITU-T) on how to deliver a frequency in a network. If you require a frequency-only synchronization solution, use SyncE instead of PTP.
- Configure the appropriate synchronization profiles and preferences for your network. It might include the accuracy, priority, and other parameters that determine how your network handles synchronization events.
- Design your network for phase synchronization with optimal time error budgets.
  - Use boundary clocks to reduce time error and to reset Packet Delay Variation (PDV).
  - Ensure that PTP awareness is implemented consistently throughout, including the transport system, and that boundary clocks accurately transmit time to minimize accumulated time error.

- For phase synchronization, use a hybrid clock that incorporates both SyncE and PTP.

For more information on [Frequency Synchronization Timing Concepts](#), refer to *Network Synchronization Configuration Guide for Cisco NCS 540 Series Routers*.

- Reduce the number of hops:
  - Distribute sources of time to meet the budget. If you have too many hops, install a GNSS receiver further out into the network.
  - Don't centralize two Primary Reference Time Clocks (PRTC) and Telecom Grandmasters (T-GM) in two different locations and try to run a synchronization signal accurately across the whole network.
- Minimize Packet Delay Variation (PDV) and jitter. Ensure that microwaves, Gigabit-capable Passive Optical Networks (GPON), Digital Subscriber Line (DSL), and Dense Wavelength Division Multiplexing (DWDM) are PTP aware.
- Monitor your synchronization deployment to ensure that it's functioning correctly and meeting your desired level of accuracy.

For more information, refer to [Understanding PTP](#) in the *Network Synchronization Configuration Guide for Cisco NCS 540 Series Routers*.

- Be aware of any relevant industry standards and practices when deploying synchronization.

## Guidelines for Phase Synchronization Deployments

Follow these guidelines for phase synchronization deployments.

- Set up the necessary network infrastructure to support phase synchronization. It includes installing timing devices such as GPS receivers, synchronous Ethernet interfaces, and timing servers.
- Configure the phase synchronization protocols such as setting up PTP as appropriate.
- As best practice, use the G.8275.1 telecommunication profile standard with complete on-path support, including Layer-2 multicast in combination with SyncE.
- Minimize phase time error by performing the following tasks:
  - Remove asymmetric routing issues.
  - Reduce the number of hops, unless telecommunication grandmaster (T-GM) clocks are deployed in the preaggregation network.
  - Decrease PDV or packet jitter.
- If you use IP protocols for PTP, you can run into issues with rerouting, asymmetric routing, Equal Cost Multi-Path (ECMP), bundles, and so on.
- If you need tight timing budgets over many hops, ensure that your hardware supports the highest levels of clock accuracy.
- For GNSS deployments:
  - Meet all the requirements for cable and antenna installations.
  - Consult with a professional if you don't have experience with GNSS installation and calibration.
- Make sure that your deployment is working as intended. Monitor it regularly to identify any potential issues.
- Consult with Cisco technical support if you encounter any issues or have questions.



---

**Note** When PTP is used with MACsec, achieving high accuracy can be challenging. PTP requires exact timestamping to maintain tight network synchronization. MACsec affixes and detaches a header that is between 24–32 bytes in size. This process can lead to significant inconsistencies in the time delays between where the link is connected and the location where the egress timestamps are applied.

---

## PTP over IP Network Design

When using networks to carry frequency over Precision Time Protocol over Internet Protocol (PTPoIP), the goal is to minimize Packet Delay Variation (PDV) by reducing the number of hops. Use the following guidelines:

- The placement of the telecom grandmaster (T-GM) clock plays an important role in ensuring that the network operates within your timing budget. For example, place a pair of T-GM clocks in a centralized location only if the network has a small number of hops. In larger networks with multiple hops, it may be necessary to distribute T-GM clocks throughout the network to ensure proper timing management at each hop.

- Use a dedicated frequency synchronization protocol such as synchronous Ethernet or 1588v2, which is designed specifically to maintain precise frequency synchronization between devices.
- Use the G.8265.1 standard. Frequency synchronization using the G.8265.1 standard is a way to make sure multiple devices on a network are operating at the same frequency, allowing for more accurate and reliable communication.
- Configure Quality of Service (QoS) policies to prioritize network traffic and reduce delays. This can be done by using traffic shaping, traffic policing, and queue management.

## Selecting the Correct Profile For Network Synchronization

### G.8275.1 PTPoE

G.8275.1 is a technical specification standard for Precision Time Protocol over Ethernet (PTPoE). It defines how you can use the Precision Time Protocol (PTP) to synchronize clocks over Ethernet networks with layer 2 multicast. PTPoE is an extension of PTP that allows it to be used over Ethernet networks. It's used in applications where precise time synchronization is required.

For more information, refer to [Understanding PTP](#) in the *Network Synchronization Configuration Guide for Cisco NCS 540 Series Routers*.

### G.8275.2 PTPoIP

G.8275.2 is a technical specification standard for Precision Time Protocol over Internet Protocol (PTPoIP). It defines the use of the Precision Time Protocol (PTP) over packet-based networks such as Internet Protocol (IP) networks, to provide precise time synchronization of network devices.

For more information, refer to [Understanding PTP](#) in the *Network Synchronization Configuration Guide for Cisco NCS 540 Series Routers*.

### Feature Adaptability on Each Profile

The following table lists the adaptability of features on each profile:

Feature	G.8275.1 PTPoE	G.8275.2 PTPoIP
Network Model	Full on-path support	Partial on-path support
IP Routing	Not applicable	Can cause issues in rings and asymmetry from a number of causes
Transit Traffic	Not allowed	Can result in jitter and asymmetry
Performance	Optimal	Variable
Configuration Model	Physical port	L3 device
PTP over Bundles	No issues	Work in progress for Telecom Boundary Clocks (T-BC)

Feature	G.8275.1 PTPoE	G.8275.2 PTPoIP
Asymmetry	Reduced due to T-BC on every node	Optimal when deployed as a Partial Support Telecom Boundary Clock (T-BC-P)
PDV/Jitter	Reduced due to T-BC on every node	Optimal when deployed as a T-BC-P

## Reducing Asymmetry

Asymmetry occurs in a PTP unaware network for the following scenarios:

- When routing large networks, complex topologies, rings, and Equal-cost multi-path (ECMP)
- When using PTP unaware transit nodes, especially with varying traffic patterns
- In the transport layer such as Passive Optical Network (PON), cable, DWDM, and complex optics



---

**Note** Every 2 seconds of asymmetry results in 1 microsecond of time error.

---

To reduce asymmetry in a PTP unaware network:

- Use QoS: QoS can help reduce asymmetry in an unaware network.
- Implement Telecom Boundary Clocks (T-BC): T-BCs can handle asymmetry in the nodes when implemented correctly.

## Reducing Packet Delay Variation

To reduce the effects of Packet Delay Variation (PDV) on PTP clock recovery, you must have a steady layer of packets that arrive in minimum time.

- Implement Telecom Boundary Clocks (T-BC) in the PTP unaware node. T-BC introduces a time reference to the PTP unaware node, which then synchronizes its clock with the T-BC.
- Use a high-quality network connection between the T-BC and the PTP unaware node. A high-quality network connection, such as a dedicated fiber link, can help reduce PDV due to network impairments.

## Remediating Transport Asymmetry

Transport asymmetry occurs when data is transported at varying rates in different directions over a communication link, leading to an imbalance in transport. To correct this issue:

- Ensure that your transport layer is PTP aware.

In optical devices, use a wavelength division multiplexing (WDM) technology such as Optical Service Channel (OSC) for managing your fiber optic infrastructure effectively.

## Synchronizing Across Networks

To avoid synchronization issues when connecting to other mobile networks:

- Make sure to align all mobile networks to a common source of time. For example, align mobile networks to the Coordinated Universal Time (UTC) from a Global Navigation Satellite System (GNSS) such as Global Positioning System (GPS).
- Monitor your clocks at the interconnect points.



---

**Note** In 5G networks, using standalone GNSS receivers at every radio site may not provide the sub-100 nanosecond accuracy required for the timing requirements of Fronthaul radio systems.

---

