



## **Cisco Container Platform 5.0.0 Installation Guide**

**First Published:** 2019-10-18

### **Americas Headquarters**

Cisco Systems, Inc.  
170 West Tasman Drive  
San Jose, CA 95134-1706  
USA  
<http://www.cisco.com>  
Tel: 408 526-4000  
800 553-NETS (6387)  
Fax: 408 527-0883





## CONTENTS

---

### CHAPTER 1

#### **Cisco Container Platform 1**

- Cisco Container Platform Architecture Overview 1
- Components of Cisco Container Platform 2
- Sample Deployment Topology 2
- Container Network Interface Plugins 4
- ACI 4

---

### CHAPTER 2

#### **System Requirements 7**

- Supported Version Matrix 7
- Software Requirements 8
- Hardware Requirements 8
- Resource Management Requirements 8
- Enabling DRS and HA on Clusters 8
- Enabling NTP Services 9
- Network Requirements 9
- Provisioning a Port Group for Cisco Container Platform VM Deployment 10
- Configuring vSphere Standard Switch 10
- Configuring Distributed Virtual Switch 10
- Configuring DHCP Server 11
- Reserving IP Addresses for Static Allocation 11
- Static and DHCP IP Address Requirements 11
- Calico 11
- Contiv 12
- HyperFlex Integration Requirements 12
- Configuring Shared Datastore 13
- Configuring Link-local Network for HyperFlex iSCSI Communication 13

- For HyperFlex 3.5+ 13
- For HyperFlex 3.0.x 13
- ACI Integration Requirements 14
  - APIC Controller Requirements 15
  - HyperFlex FI Requirements 16
  - Tenant Cluster with ACI Deployment 16
- GPU Integration Requirements 17

---

**CHAPTER 3 Getting Cisco Container Platform Software 19**

- Downloading the Software 19
- Unpacking the Software 19
- Verifying the Software 20

---

**CHAPTER 4 Installing Cisco Container Platform 21**

- Importing Cisco Container Platform Tenant Base VM 21
- Deploying Installer VM 23
- Deploying Cisco Container Platform 26

---

**CHAPTER 5 Upgrading Cisco Container Platform 35**

- Upgrading Cisco Container Platform Tenant Base VM 35
- Deploying Upgrade VM 36
- Upgrading Cisco Container Platform Control Plane 36

---

**CHAPTER 6 Uninstalling Cisco Container Platform 39**

- Uninstalling Cisco Container Platform 39

---

**CHAPTER 7 Backing Up and Restoring Cisco Container Platform 41**

- Backing Up Cisco Container Platform 41
  - Backing Up Cisco Container Platform with IP Pool Management v3.0.x+ 41
- Restoring Cisco Container Platform 42
- Backing Up Harbor Database 43
- Restoring Harbor Database 44

---

<b>APPENDIX A</b>	<b>Troubleshooting Cisco Container Platform</b>	<b>45</b>
	Installation of Cisco Container Platform Fails	45
	Unable to Upgrade Cisco Container Platform due to Network Misconfiguration	46
	Unable to Deploy NGINX Ingress Controller Using Helm	46
	Unable to Start NGINX Ingress Controller Pod	46
	Unable to Power on Worker VMs after a Shutdown	47
	Application Pods Crash When Using Contiv CNI in Tenant Clusters	47
	Example of Allocating HugePages for Applications	47
	How to Create Sosreports	49
	Troubleshoot vSphere Operator in Cisco Container Platform	50
	Troubleshoot Net Tinker in Cisco Container Platform	50

---

<b>APPENDIX B</b>	<b>Version Mapping Table</b>	<b>53</b>
	Version Mapping Table	53





# CHAPTER 1

## Cisco Container Platform

Cisco Container Platform is a turnkey, production grade, extensible platform to deploy and manage multiple Kubernetes clusters. It runs on 100% upstream Kubernetes. Cisco Container Platform offers seamless container networking, enterprise-grade persistent storage, built-in production-grade security, integrated logging, monitoring and load balancing.

This chapter contains the following topics:

- [Cisco Container Platform Architecture Overview, on page 1](#)
- [Sample Deployment Topology, on page 2](#)
- [Container Network Interface Plugins, on page 4](#)

## Cisco Container Platform Architecture Overview

The following figure shows the architecture of Cisco Container Platform deployment with [HyperFlex](#) and [ACI integration](#).

**Figure 1: Cisco Container Platform Architecture Overview**

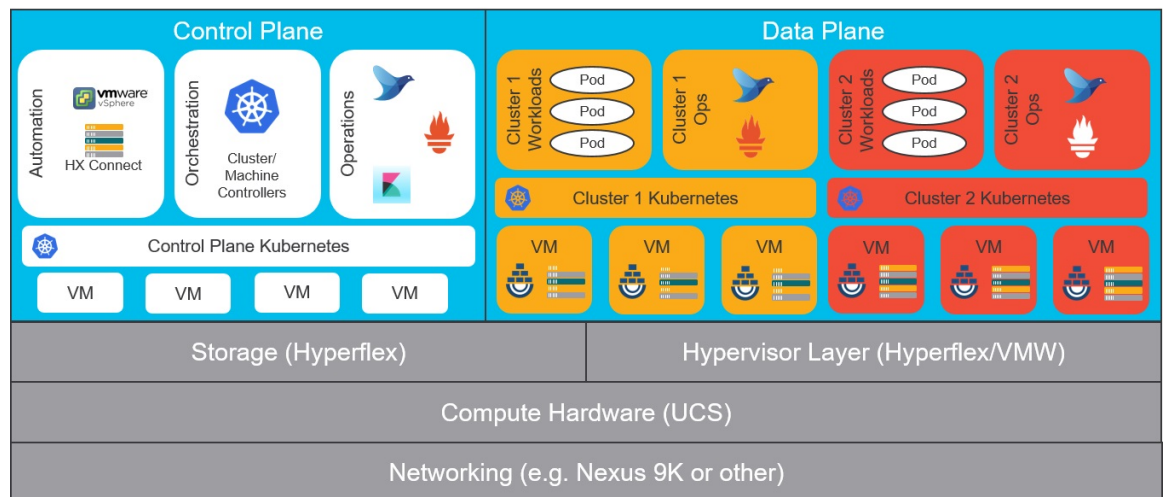



**Note** Cisco Container Platform can run on top of an ACI networking fabric as well as on a non-ACI networking fabric that performs standard L3 switching.

At the bottom of the stack, there is an ACI fabric that consists of Nexus switches, Application Policy Infrastructure Controllers (APICs) and Fabric Interconnects (FIs). The next layer up is the UCS servers running the HyperFlex software. HyperFlex provides virtualized compute resources through VMware, and distributed storage resources through the HyperFlex converged data platform.

The next layer up is the Cisco Container Platform Control Plane and Data Plane. In the preceding figure, Cisco Container Platform Control Plane runs on the four VMs on the left.

Kubernetes tenant clusters are preconfigured to support Persistent Volumes using vSphere Cloud Provider and Container Storage Interface (CSI) plugin. Both implementations use the underlying replicated, highly available HyperFlex data platform for storage.

## Components of Cisco Container Platform

The following table describes the components of Cisco Container Platform.

Function	Component
Container Runtime	Docker CE
Operating System	Ubuntu
Orchestration	Kubernetes
IaaS	vSphere
Infrastructure	HyperFlex
Container Network Interface (CNI)	ACI, Contiv, Calico
SDN	ACI
Container Storage	HyperFlex Container Storage Interface (CSI) plugin
Load Balancing	NGINX, Envoy
Service Mesh	Istio, Envoy
Monitoring	Prometheus, Grafana
Logging	Elasticsearch, Fluentd, and Kibana (EFK) stack

## Sample Deployment Topology

This section describes a sample deployment topology of the Cisco Container Platform and illustrates the network topology requirements at a conceptual level. Future sections of the document such as [System](#)



[Requirements, on page 7](#) and [Installing Cisco Container Platform, on page 21](#) provide additional configuration details based on these concepts.



**Note** In this example, the deployment target is a VMware vSphere virtualization platform, and Cisco Container Platform is using a non-ACI CNI such as Calico or Contiv. Other deployment environments are conceptually similar but with some slight differences appropriate to those environments.

In this case, it is expected that the vSphere based cluster is set up, provisioned and fully functional for virtualization and Virtual Machine functionality before any installation of Cisco Container Platform. You can refer to the standard VMware documentation for details on vSphere installation.

The following figure illustrates an example vSphere cluster on which Cisco Container Platform is to be deployed.

**Figure 2: Example vSphere Cluster**

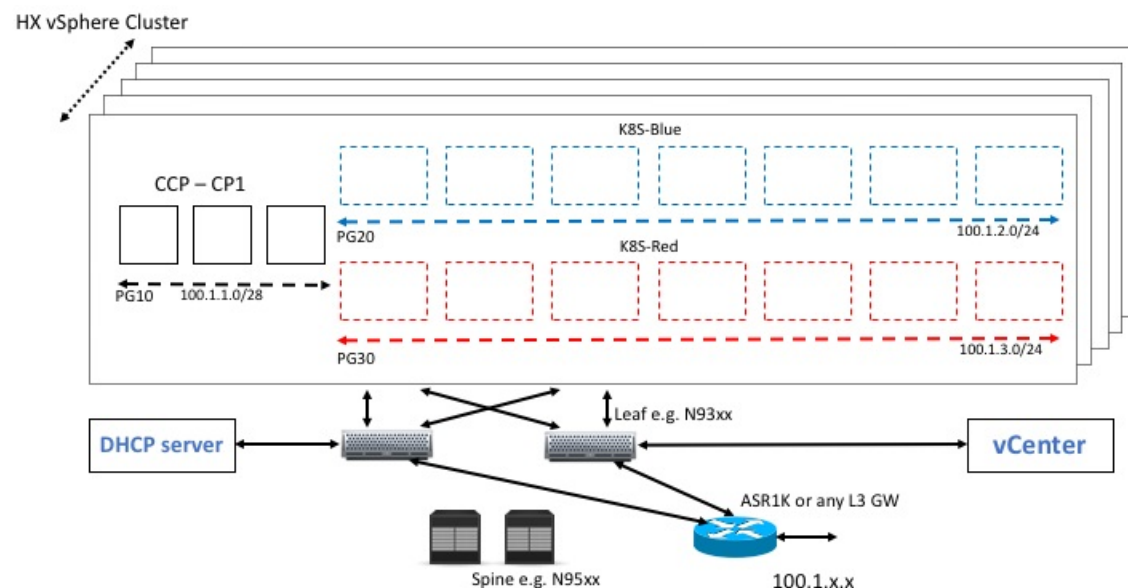

Once the vSphere cluster is ready to provision VMs, the admin then provisions one or more VMWare port groups (for example PG10, PG20 and PG30 in the figure) on which virtual machines will subsequently be provisioned as container cluster nodes. Basic L2 switching using VMWare vswitch functionality can be used to implement these port groups. IP subnets should be set aside for use on these port groups and the VLANs used to implement these port groups should be terminated on an external L3 gateway (such as the ASR1K shown in the figure). The control plane cluster and tenant plane Kubernetes clusters of Cisco Container Platform can then be provisioned on these port groups.

All provisioned Kubernetes clusters may choose to use a single shared port group or separate port groups may be provisioned (1 per Kubernetes cluster) depending on the isolation needs of the deployment. Layer 3 network isolation may be used between these different port groups as long as the following conditions are met:

- There is L3 IP address connectivity among the port group that is used for the Control Plane cluster and the tenant cluster port groups

- The IP address of the vCenter server is accessible from the Control Plane cluster
- A DHCP server is provisioned for assigning IP addresses to the installer and upgrade VMs, and it must be accessible from the Control Plane port group cluster of the cluster

The simplest functional topology would be to use a single shared port group for all clusters with a single IP subnet to be used to assign IP addresses for all container cluster VMs. This IP subnet can be used to assign one IP per cluster VM and up to four virtual IP addresses per Kubernetes cluster, but would not be used to assign individual Kubernetes pod IP addresses. Hence a reasonable capacity planning estimate for the size of this IP subnet is as follows:

(The expected total number of container cluster VMs across all clusters) + 3 x (The total number of expected Kubernetes clusters)

## Container Network Interface Plugins

Cisco Container Platform supports multiple Kubernetes CNI plugins such as:

- ACI is the recommended plugin for use with an ACI fabric. It is optimized for use with an ACI fabric. ACI is fully supported by Cisco.
- Calico is recommended when an ACI fabric is not used.
- [Contiv](#) is a user space switch that is optimized for high performance and scale.

Operationally, all the CNI plugins offer the same experience to the customer. The container network connectivity is seamless and network policies are applied using [Kubernetes NetworkPolicies](#). Under-the-hood, both ACI and Contiv offer advanced feature support. ACI allows you to map CNI NetworkPolicies to an ACI fabric and supports richer underlay policies such as common policies for containers/virtual machines/physical servers and inter-Kubernetes cluster policies. Additionally, ACI supports Kubernetes Type LoadBalancer using PBR policies in the ACI fabric.

## ACI

ACI is tightly integrated with the ACI fabric. It supports underlay integration with the ACI fabric and hardware accelerated load balancing.

The following figure shows the architecture of ACI.

Figure 3: Architecture of ACI

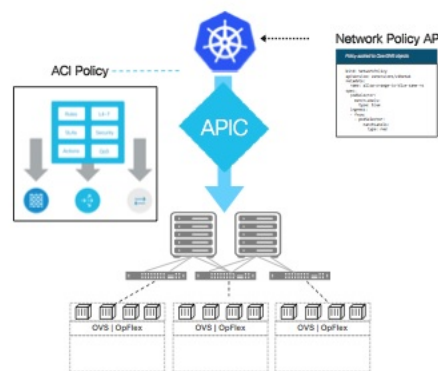

- Network policies supported using standard upstream format and enforced through OpFlex / OVS using APIC Host Protection Profiles.
- Apps can be moved without modification to/from ACI and non-ACI environments.
- Embedded fabric and virtual switch load balancing:
  - PBR in fabric for external service load balancing
  - OVS used for internal service load balancing
- Virtual Networking Domain for Kubernetes:
  - Stats per namespace, deployment, service, pod
  - Physical to container correlation





## CHAPTER 2

# System Requirements

This section describes the requirements that are necessary to deploy Cisco Container Platform.



### Note

Cisco Container Platform does not support installing virtual machines in nested datacenter, vCenter cluster or virtual machine folders. Cisco Container Platform does not support moving the virtual machines or changing their configuration from vCenter directly.

It contains the following topics:

- [Supported Version Matrix, on page 7](#)
- [Software Requirements, on page 8](#)
- [Hardware Requirements, on page 8](#)
- [Resource Management Requirements, on page 8](#)
- [Network Requirements, on page 9](#)
- [HyperFlex Integration Requirements, on page 12](#)
- [ACI Integration Requirements, on page 14](#)
- [GPU Integration Requirements, on page 17](#)

## Supported Version Matrix

Cisco Container Platform uses various software and hardware components. The following table provides information on the validated versions of each component.

Component	Validated Version
Kubernetes	1.12 1.13
vSphere	vSphere 6.5
HyperFlex software	4.0.1
ACI	4.1(1)

# Software Requirements

Ensure that the following software applications are installed in your deployment environment:

- VMware vCenter server 6.5
- VMware client integration plugin
- vSphere Flash client

# Hardware Requirements

- In the Cisco Container Platform Control Plane VM, each master and worker node requires 2 vCPUs, 8 GB memory, and 40 GB HDD.
- In the Cisco Container Platform Tenant Cluster VM, each master and worker node requires 2 vCPUs, 16 GB memory, and 40 GB HDD. You can modify the vCPU and memory configurations when you deploy a new tenant cluster.

# Resource Management Requirements

The following topics provide information on the necessary resource management requirements:

## Enabling DRS and HA on Clusters



---

**Note** You must use the Enterprise Plus license to set up VMware clusters with HA and DRS enabled. For more information on the supported versions of VMware, see [Supported Version Matrix, on page 7](#).

---

It is required that you enable DRS and HA on vCenter for the following reasons:

- DRS continuously monitors resource utilization across vSphere servers and intelligently balances VMs on the servers.
- HA provides easy to use, cost-effective high availability for applications running on virtual machines.

- 
- Step 1** In the vSphere Web Client, navigate to the host or cluster on which you want to deploy Cisco Container Platform.
  - Step 2** Click the **Configure** tab.
  - Step 3** Under **Services**, click **vSphere DRS**, and then click **Edit**.
  - Step 4** In the right pane of the **Edit Cluster Settings** window, check the **Turn ON vSphere DRS** check box, and then click **OK**.
  - Step 5** Under **Services**, click **vSphere Availability**, and then click **Edit**.

**Step 6** In the right pane of the **Edit Cluster Settings** window, check the **Turn ON vSphere HA** check box, and then click **OK**.

## Enabling NTP Services

You need to enable the Time Synchronization services on each host within your vSphere environment. If you do not enable this service, errors due to timing differences between hosts may cause installation of the Cisco Container Platform to fail.

**Step 1** In the vSphere Web Client, navigate to the host or cluster on which you want to deploy Cisco Container Platform.

**Step 2** Click the **Configure** tab.

**Step 3** From the left pane, expand **System**, and then click **Time Configuration**.

*Figure 4: Time Configuration pane*

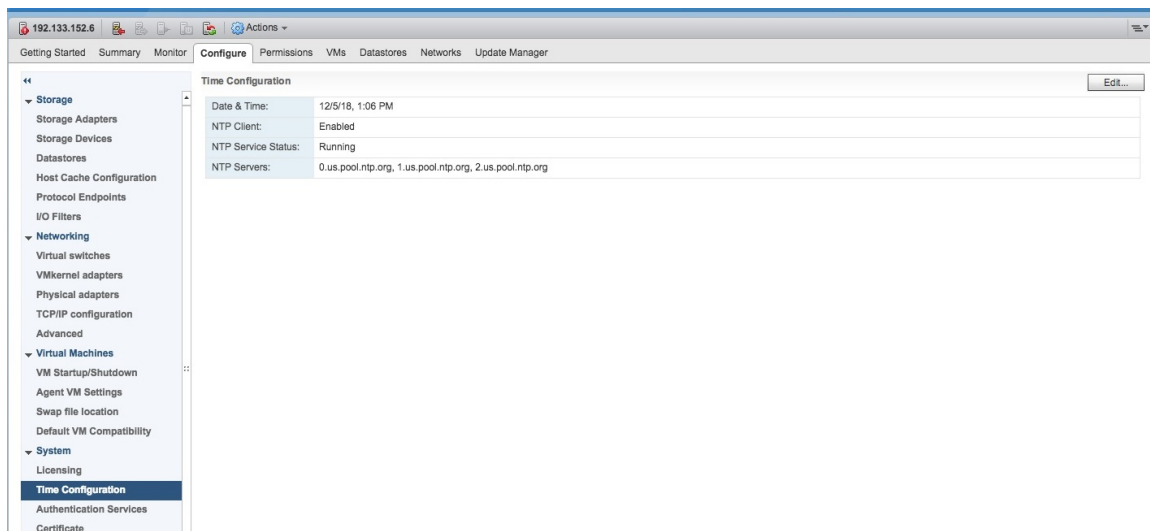

**Step 4** In the right pane, click **Edit**.

**Step 5** In the **Edit Time Configuration** window, check the **Turn ON vSphere DRS** check box, and then click **OK**.

**Note** You must ensure that each host has DNS access to enable NTP services.

## Network Requirements

The following topics provide information on the necessary network requirements:

If you have chosen Contiv as the CNI, the pod-to-pod traffic across nodes is tunneled by the VXLAN protocol.

## Provisioning a Port Group for Cisco Container Platform VM Deployment

Cisco Container Platform creates VMs that are attached to a Port Group on either a vSphere Standard Switch (VSS) or a Distributed Virtual Switch (DVS). The HyperFlex installer creates VSS switches in vSphere for the networks that are defined during installation. You need to create either VSS or DVS Switches for managing the VM traffic.

The following topics provide information on configuring a VSS or a DVS.

### Configuring vSphere Standard Switch

---

- Step 1** In the vSphere Web Client, navigate to the host or cluster on which you want to deploy Cisco Container Platform.
  - Step 2** Click the **Configure** tab.
  - Step 3** Expand **Networking**, and then select **Virtual switches**.
  - Step 4** Click **Add host networking**.
  - Step 5** Choose **Virtual Machine Port Group for a Standard Switch** as the connection type for which you want to use the new standard switch and click **Next**.
  - Step 6** Select **New standard switch** and click **Next**.
  - Step 7** Add physical network adapters to the new standard switch.
  - Step 8** Under **Assigned adapters**, click **Add adapters**.
  - Step 9** Select one or more physical network adapters from the list.
  - Step 10** From the **Failover order group** drop-down list, choose from the Active or Standby failover lists.
  - Step 11** For higher throughput and to provide redundancy, configure at least two physical network adapters in the Active list.
  - Step 12** Click **OK**.
  - Step 13** Enter connection settings for the adapter or the port group as follows:
    - a) Enter a network Label or the port group, or accept the generated label.
    - b) Set the VLAN ID to configure VLAN handling in the port group.
  - Step 14** On the **Ready to Complete** screen, click **OK**.
- 

### Configuring Distributed Virtual Switch

---

- Step 1** In the **Navigation** pane, click the DVS switch.
- Step 2** In the right pane, click the **Hosts** tab.
- Step 3** Click the **Actions** icon and click the **Add and Manage Hosts** radio button. The **Add and Manage Hosts** wizard appears.
- Step 4** In the **Select tasks** screen, click the **Add Hosts** radio button, and then click **Next**.
- Step 5** In the **Select hosts** screen, click the **Add Hosts** icon.
- Step 6** In the **Select new hosts** screen, check the check box next to the hosts that you want to add, and then click **OK**.
- Step 7** Click **Next** in the **Select network adapter tasks** screen.
- Step 8** In the **Manage physical network adapters** screen, click the network switch that you want to configure, and then click the **Assign uplink**.



- Step 9** Repeat Step 8 for all the networks, and click **Next**.
- Step 10** In the **Manage VMKernel network adapters** screen, click **Next**.
- Step 11** In the **Analyze impact** screen, click **Next**.
- Step 12** In the **Ready to complete** screen, click **Finish**.

## Configuring DHCP Server

Cisco Container Platform requires a DHCP server to be present. The Cisco Container Platform installer VM and upgrade VM get their primary interface IP addresses from the DHCP server. You must ensure that you have configured a DHCP server.

If the DHCP server does not provide the location of the NTP service, enter the NTP address in the Installer UI, under **Control Plane Settings > Advanced Settings**.

## Reserving IP Addresses for Static Allocation

Cisco Container Platform uses static IP addresses for all cluster nodes and the **CCP Control Plane master node VIP**, which provides worker nodes with a consistent IP address. Additionally, a load balancer VIP is used as an external IP address for NGINX Ingress in each Kubernetes cluster. These VIPs are configured using IP pools. The static IP addresses are assigned from the same subnet as the load balancer VIP addresses, and you must ensure that the static IP address pools for the subnet do not overlap with a DHCP pool.

## Static and DHCP IP Address Requirements

You must ensure that the following conditions are met:

- The subnet is routable to and from the VMware vCenter server.
- The client install machine is routable to the network during the Cisco Container Platform control plane install.
- The network allows communication between Cisco Container Platform VM instances. You must not use a private LAN.

The following sections summarize the static and DHCP IP address requirements for the Cisco Container Platform components:

### Calico

Component	Static IP	DHCP IP
Installer VM	0	1
Tenant clusters	3 + Number of load balancer VIPs desired for applications + Number of workers	0

Component	Static IP	DHCP IP
Control Plane and Cisco Container Platform web interface	6  <b>Note</b> 1 for the Kubernetes master VIP, 1 for the Ingress LoadBalancer, and 1 each for the master and worker nodes.	0

By default, the Cisco Container Platform Control Plane pod network uses the 192.168.0.0/16 subnet for Calico. If you have routed IP addresses in that space, you must assign another RFC1918 range for your VXLAN network. It does not need to be a full /16 subnet, a /22 subnet is adequate for the Cisco Container Platform Control Plane.

## Contiv

Component	Static IP	DHCP IP
Installer VM	0	1
Tenant clusters	4 + Number of load balancer VIPs desired for applications + (2 x Number of workers)	0
Control Plane and Cisco Container Platform web interface	10  <b>Note</b> 1 for the Kubernetes master VIP, 1 for the Ingress LoadBalancer VIP, 2 IP for the master node, and 6 for the worker nodes.	0

Contiv requires a /14 or larger subnet for pods. The Cisco Container Platform web interface default of 192.168.0.0/16 is not large enough for Contiv. You must find an RFC1918 /14 subnet that is not routed within your organization, such as one from 172.16.0.0/12 or 10.0.0.0/8.

## HyperFlex Integration Requirements



**Note** This section is applicable only if you want to use HyperFlex environment. It is not required for running VMware on UCS.

Cisco Container Platform is supported on all hardware configurations that are supported by the required HyperFlex software versions. For more information on HyperFlex hardware configurations, refer to the UCS HyperFlex product documentation.

The following topics provide information on the necessary HyperFlex integration requirements:

## Configuring Shared Datastore

After HyperFlex is installed, you need to configure a shared datastore. The datastore must be accessible to hosts such as NFS or iSCSI or FC in the cluster.

The datastore is required for the following purposes:

- Provisioning persistent volume storage
- Deploying the Cisco Container Platform tenant base VM

- 
- Step 1** Log in to the **HX Connect UI** using the VMware vCenter SSO administrator credentials.  
For more information on installing HyperFlex and accessing the HyperFlex Connect UI, refer to the [latest HperFlex documentation](#).
- Step 2** In the left pane, click **Manage > Datastores**.
- Step 3** Perform these steps to create a datastore for provisioning the Kubernetes persistent volume storage and deploying the Cisco Container Platform tenant base VM:
- a) In the right pane, click **Create Datastore**.
  - b) In the **Name** field, enter **ds1**, and then enter a size and block size for the datastore.  
**Note** We recommend that you use **1TB** size and **8K** block size.
  - c) Click **Create Datastore**.
- The newly created datastore is available on vCenter.
- 

## Configuring Link-local Network for HyperFlex iSCSI Communication

The FlexVolume plug-in requires a host-only link between each VM that runs Kubernetes and the Internet Small Computer System Interface (iSCSI) target on the ESX host.

### For HyperFlex 3.5+

- 
- Step 1** Log in to the **HX Connect UI**.
- Step 2** Choose **Settings > Integrations > Kubernetes**.
- Step 3** Click **Enable All Node** and wait until the **KUBERNETES STORAGE PROVISIONING** option is enabled.  
The HyperFlex infrastructure is configured and ready to use for Cisco Container Platform with Kubernetes persistent volume support.
- 

### For HyperFlex 3.0.x

- 
- Step 1** Open an SSH session to the HyperFlex 3.0 Platform Installer VM or one of the HyperFlex Controller VMs and log in as a root user.
- Step 2** Perform these steps to get the vCenter details that you need to enter when you run the `add_vswitch.py` script.

- a) Run the following command to get the vCenter datacenter name and vCenter cluster name.

```
stcli cluster info | grep -i vcenter
```

- b) Run the following command to validate the reachability of vCenter IP address.

```
ping <vcenter URL>
```

- Step 3** Navigate to the following location:

```
/usr/share/springpath/storfs-misc/hx-scripts/
```

- Step 4** Run the `add_vswitch.py` script.

```
python add_vswitch.py --vcenter-ip <vCenter IP address>
```

When prompted, specify the vCenter credentials, datacenter name, and cluster name that you got from the output of Step 2.

The HyperFlex infrastructure is configured and ready to use for Cisco Container Platform with Kubernetes persistent volume support.

---

## ACI Integration Requirements

Cisco ACI enables you to group your application into End Point Groups (EPGs), define policies for the EPGs, and then deploy network policies on the ACI fabric. The policy enforcement is implemented using the spine and leaf architecture of the ACI fabric.

The following figure shows the components of a Cisco Container Platform ACI integrated network topology.

**Figure 5: Cisco Container Platform ACI Integrated Network Topology**

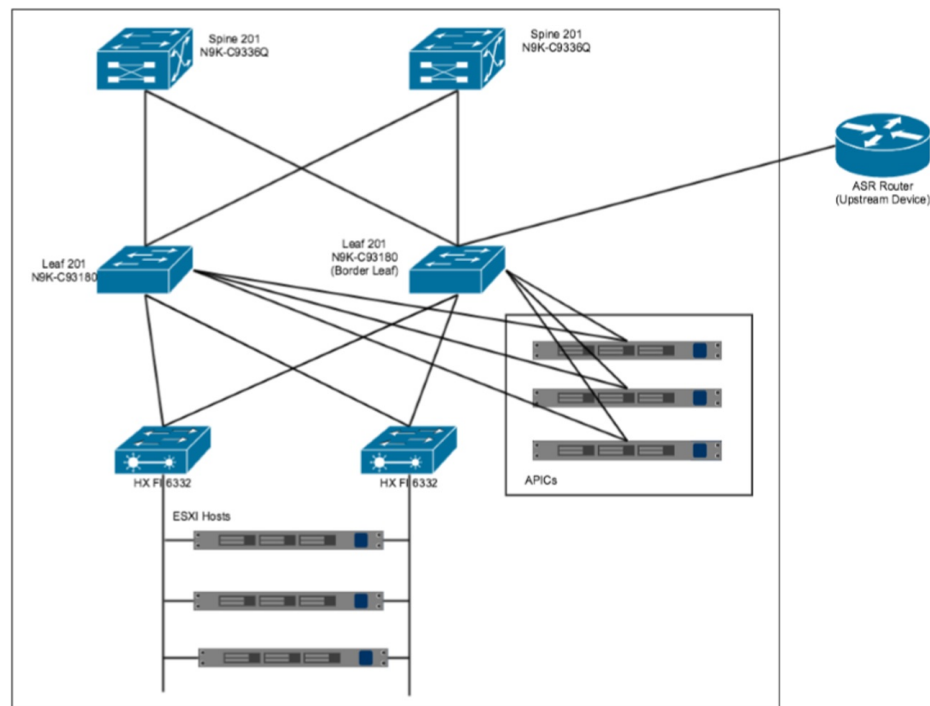

The main components of the network topology are as follows:

- **ACI Fabric** includes two spine nodes, two leaf nodes, and three APIC controllers. You can choose the number of the spine and leaf nodes and APIC controllers as per your network requirement.
- **HyperFlex Fabric Interconnect (FI)** includes two fabric interconnect switches connected between the ESXi hosts and the ACI leaf switches.
- **ESXi Hosts** includes a UCS server such as UCS C220 M4.
- **ASR router** is connected to an ACI border leaf for external internet access.

## APIC Controller Requirements

If you are using ACI, ensure that you have configured the following settings on the APIC controller:

- Assign a port number other than 4094 for Infra VLAN as 4094 is reserved for provisioning HyperFlex fabric interconnect
- Create a common tenant
- Create a Virtual Route Forwarder (VRF) in the common tenant
- Create at least one L3OUT
- Create an Access Entity Profile (AEP) for the ACI tenant physical domain

- Create an AEP for L3OUT
- Create a Virtual Machine Manager (VMM) domain which connects to vSphere

For more information on configuring an APIC controller, refer to the [latest ACI documentation](#).

## HyperFlex FI Requirements

Ensure that you have configured the following settings on HyperFlex FI:

- Configure QoS
  1. From the left pane, click **LAN**.
  2. From the right pane, click the **QoS** tab, and then configure QoS.



**Note** Using the **MTU** configuration, you must set the priority that is associated with the QoS policy of the vNIC template.

**Figure 6: QoS Tab**

Priority	Enabled	CoS	Packet Drop	Weight	Weight (%)	MTU	Multicast Optimized
Platinum	<input checked="" type="checkbox"/>	5	<input type="checkbox"/>	4	25	9216	<input type="checkbox"/>
Gold	<input checked="" type="checkbox"/>	4	<input checked="" type="checkbox"/>	4	25	9216	<input type="checkbox"/>
Silver	<input checked="" type="checkbox"/>	2	<input checked="" type="checkbox"/>	best-effort	6	normal	<input checked="" type="checkbox"/>
Bronze	<input checked="" type="checkbox"/>	1	<input checked="" type="checkbox"/>	best-effort	6	9216	<input type="checkbox"/>
Best Effort	<input checked="" type="checkbox"/>	Any	<input checked="" type="checkbox"/>	best-effort	6	9216	<input type="checkbox"/>
Fibre Channel	<input checked="" type="checkbox"/>	3	<input type="checkbox"/>	5	32	to	N/A

- Ensure that the tenant VLAN is allowed

Once Cisco Container Platform Control Plane and management node networking are configured, you can access the HyperFlex cluster on vSphere and install Cisco Container Platform. Each time you create a tenant cluster, the ACI constructs such as L3OUT, VRF, and AEP stored in the common tenant cluster are reused.

## Tenant Cluster with ACI Deployment

With an ACI deployment, each tenant cluster is required to have its own routable subnet. The node VLAN, pod subnet, and multicast subnet range should not overlap between clusters. Cisco Container Platform ensures that the VLAN and subnet do not overlap.

Unlike other CNI, an ACI tenant cluster requires two VLAN subinterfaces, one for the Node VLAN, and another for the Infra VLAN. As shown in the following figure, Cisco Container Platform assigns unique Node VLAN IDs. You need to assign a unique Infra VLAN ID for clusters during cluster creation.

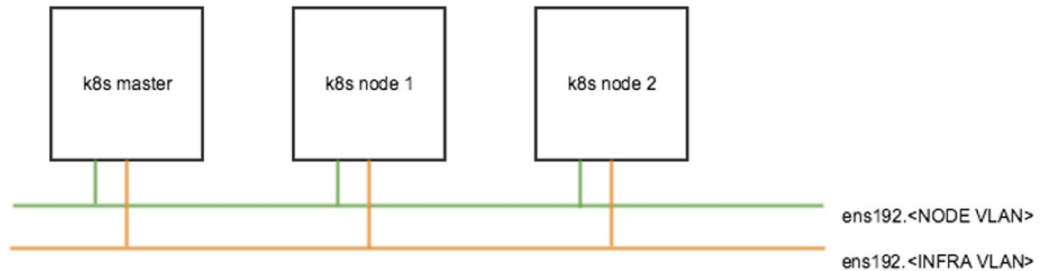

For more information on creating tenant clusters, refer to the *Creating Kubernetes Clusters* section of the *Cisco Container Platform User Guide*.

For more information on the ACI and CNI plugin, refer to the [latest documentation on Cisco ACI and Kubernetes Integration](#).

## GPU Integration Requirements

Cisco Container Platform supports GPU devices in passthrough mode to enable AI/ML workloads.

This section describes the requirements on the ESXi and vCenter hosts to integrate the GPU devices with Cisco Container Platform.

- 
- Step 1** Follow these steps to enable GPU Passthrough for the devices that you want to use:
- Access the ESXi host by typing its IP address in a web browser.
  - From the left pane, click **Manage**.
  - In the right pane, click **Hardware > PCI Devices**.  
The list of available passthrough devices is displayed.
  - Select the device, and then click **Toggle Passthrough**.
- Step 2** Follow these steps to enable shared direct passthrough for the GPU device:
- Access the vCenter server by typing its IP address in a web browser.
  - From the right pane, click **Configure > Graphics > Graphics Devices**.
  - Select the device for which you want to enable shared direct passthrough.
  - In the **Edit Graphics Device Settings** dialog box, click the **Shared Direct** radio button.
  - Click **Ok**.
- Step 3** Follow these steps to allow VM access to the GPU device:
- From the right pane, click **Configure > PCI Devices**.
  - Click the **Edit** icon.  
The **Edit PCI Device Availability** dialog box appears.
  - Select the device and check the checkbox next to the device.

d) Click **OK**.

---





## CHAPTER 3

# Getting Cisco Container Platform Software

---

This chapter contains the following topics:

- [Downloading the Software, on page 19](#)
- [Unpacking the Software, on page 19](#)
- [Verifying the Software, on page 20](#)

## Downloading the Software

Before you begin the installation, you need to download the required software assets.

- 
- Step 1** Go to the [Product Support Page](#) of Cisco Container Platform.
- Step 2** Under **Support Documentation And Software**, click **Download Software**.  
The **Software Download** page appears displaying the latest release assets.
- Step 3** Log in using your Cisco username and password that is associated with a valid service contract.
- Step 4** Download the Installer and Tenant images.
- 

## Unpacking the Software

- 
- Step 1** Browse to the directory where you have downloaded the software.
- Step 2** Open the Shell command prompt and extract each `tar.gz` file.

### Example

```
$ tar -zxvf kcp-vm-$VERSION.tar.gz
kcp-vm-$VERSION/
kcp-vm-$VERSION/ee.pem
kcp-vm-$VERSION/ccp_image_signing_release_v1_pubkey.der
kcp-vm-$VERSION/root_ca.pem
kcp-vm-$VERSION/kcp-vm-$VERSION.ova.signature
kcp-vm-$VERSION/kcp-vm-$VERSION.ova
kcp-vm-$VERSION/verify
kcp-vm-$VERSION/sub_ca.pem
kcp-vm-$VERSION/README
```

The `.ova` file contains the Cisco Container Platform image.

---

## Verifying the Software

### Before you begin

Ensure that your system has python 3.5.2 or later and OpenSSL installed.

---

**Step 1** Browse to the directory where you have unpacked the software.

**Step 2** Open the Shell command prompt and run the script to verify the software.

**Note** You must run the verification steps for each release image.

### Example

```
$ ./verify --type release --signature kcp-vm-$VERSION.ova.signature --image kcp-vm-$VERSION.ova
Verifying sha512 hash of ./root_ca.pem
Successfully verified sha512 hash of ./root_ca.pem
Verifying sha512 hash of ./sub_ca.pem
Successfully verified sha512 hash of ./sub_ca.pem
Verifying root(./root_ca.pem) and subca(./sub_ca.pem)
Successfully verified root and subca.
Verifying cert(./ee.pem) against root(./root_ca.pem) and subca(./sub_ca.pem)
Successfully verified end entity cert.
Extracting pubkey(kcp-vm-$VERSION/ee.pubkey) from ./ee.pem
Successfully extrated public key to kcp-vm-$VERSION/ee.pubkey.
Verifying signature(kcp-vm-$VERSION.ova.signature) of kcp-vm-$VERSION.ova using
kcp-vm-$VERSION/ee.pubkey
Successfully verified signature.
```

---



## CHAPTER 4

# Installing Cisco Container Platform

---

Installing Cisco Container Platform is a three-step process:

- [Importing Cisco Container Platform Tenant Base VM](#)

The Cisco Container Platform tenant base VM contains the container image and the files that are necessary to create the tenant Kubernetes clusters that are used for configuring monitoring, logging, container network interfaces (CNI), and persistent volumes.

- [Deploying Installer VM, on page 23](#)

The Installer VM contains the VM image and the files for installing other components such as Kubernetes and the Cisco Container Platform application.

- [Deploying Cisco Container Platform, on page 26](#)

The Cisco Container Platform Control Plane is set up using an installer UI. After the installer VM is switched on, the URL of the installer appears on the vCenter **Web console**.

- [Importing Cisco Container Platform Tenant Base VM, on page 21](#)
- [Deploying Installer VM, on page 23](#)
- [Deploying Cisco Container Platform, on page 26](#)

## Importing Cisco Container Platform Tenant Base VM

### Before you begin

- Ensure that you have configured the storage and networking requirements. For more information, see [HyperFlex Integration Requirements, on page 12](#) and [Network Requirements, on page 9](#).
- Ensure that vSphere has an Enterprise Plus license, which supports DRS and vSphere HA.
- Recommend to use the *vSphere Web Client (Flash)* version of the vSphere Web Client.

---

**Step 1** Log in to the VMware vSphere **Web Client** as an administrator.

**Step 2** In the **Navigation** pane, right-click the cluster on which you want to deploy Cisco Container Platform, and then choose **Deploy OVF Template**.  
The **Deploy OVF Template** wizard appears.

**Step 3** In the **Select template** screen, perform these steps:

- Click the **URL** radio button, and enter the URL of the Cisco Container Platform Tenant OVA.  
Alternatively, click the **Local file** radio button, and browse to the location where the Cisco Container Platform tenant OVA is saved on your computer.

**Note** The format of the Tenant OVA filename is as follows:

```
ccp-tenant-image-x.y.z-ubuntuXX-a.b.c.ova
```

Where *x.y.z* corresponds to the version of Kubernetes and *a.b.c* corresponds to the version of Cisco Container Platform.

The [Version Mapping Table, on page 53](#) provides the Cisco Container Platform version, Kubernetes version and image names mapping for each release.

- Click **Next**.

**Step 4** In the **Select name and location** screen, perform these steps:

- In the **Name** field, enter a name for the Cisco Container Platform tenant base VM.

**Note** You need to note down the Cisco Container Platform tenant base VM name as you will need to specify it while creating a cluster.

- In the **Browse** tab, choose the data center where you want to deploy Cisco Container Platform.
- Click **Next**.

**Step 5** In the **Select a resource** screen, choose a cluster where you want to run the Cisco Container Platform tenant base VM, and then click **Next**.

**Step 6** In the **Review details** screen, verify the Cisco Container Platform tenant base VM details, and then click **Next**. The **Select storage** screen appears.

**Figure 7: Select Storage Screen**

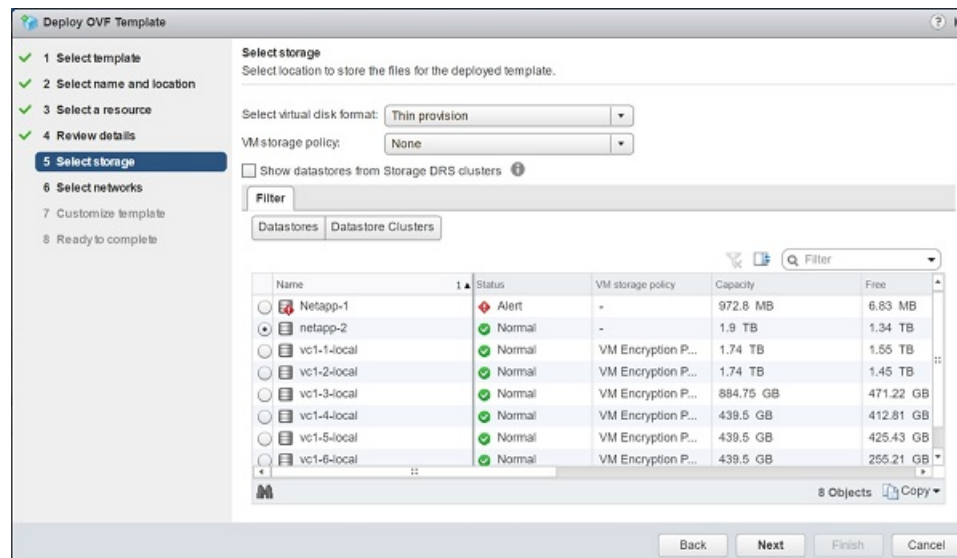

**Step 7** In the **Select storage** screen, perform these steps:

- From the **Select virtual disk format** drop-down list, choose **Thin Provision** to allocate storage on demand.
- In the **Filters** tab, choose a destination datastore for the Cisco Container Platform tenant base VM.

c) Click **Next**.

The **Select networks** screen appears.

**Figure 8: Select Networks Screen**

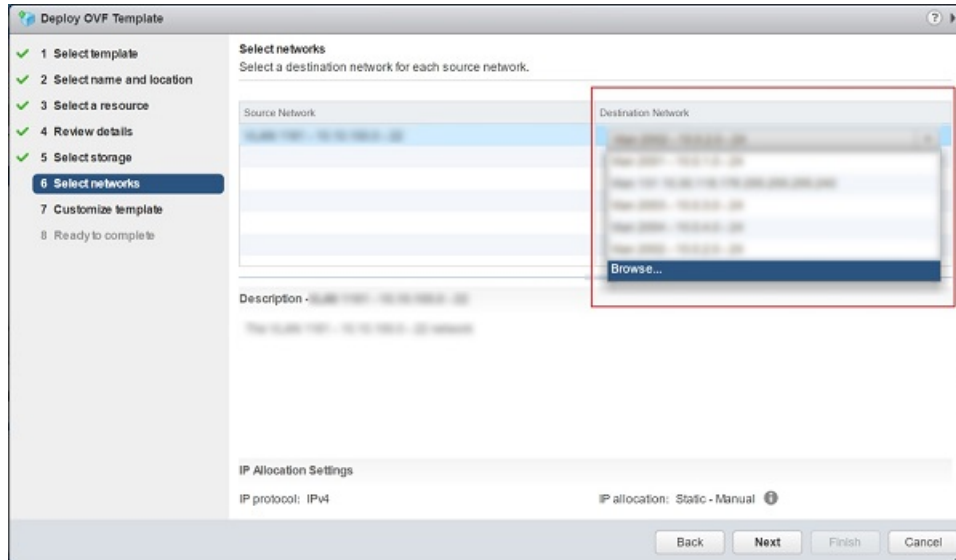

**Step 8** In the **Select networks** screen, perform these steps:

- From the **Destination Network** column, choose a network for each source network that is available in the Cisco Container Platform tenant base VM.
- Click **Next**.

**Step 9** In the **Customize template** screen, click **Next**.

**Step 10** In the **Ready to complete** screen, verify the Cisco Container Platform tenant base VM settings, and then click **Finish**. The Cisco Container Platform tenant base VM import takes few minutes to complete.

**Note** You can leave the tenant base VM powered off and continue to [Deploying Installer VM](#).

## Deploying Installer VM

### Before you begin



**Note** This deployment is for new installations of Cisco Container Platform. For upgrades, see [Upgrading Cisco Container Platform, on page 35](#).

Ensure that you have imported the [Version Mapping Table](#) during the [Importing Cisco Container Platform Tenant Base VM](#).

- 
- Step 1** Log in to the **VMware vSphere Web Client** as an administrator.
- Step 2** In the **Navigation** pane, right-click the cluster on which you want to deploy Cisco Container Platform, and then choose **Deploy OVF Template**.  
The **Deploy OVF Template** wizard appears.
- Step 3** In the **Select template** screen, perform these steps:
- Click the **URL** radio button, and enter the URL of the Installer OVA.  
Alternatively, click the **Local file** radio button, and browse to the location where the Installer OVA is saved on your computer.
- Note** The format of the Installer OVA filename is as follows:
- ```
kcp-vm-x.y.z.ova
```
- Where *x*, *y*, *z* corresponds to the major, minor, and patch release of Cisco Container Platform.
- Click **Next**.
- Step 4** In the **Select name and location** screen, perform these steps:
- In the **Name** field, enter a name for the installer VM.
  - In the **Browse** tab, choose the data center where you want to deploy Cisco Container Platform.
  - Click **Next**.
- Step 5** In the **Select a resource** screen, choose the cluster where you want to run the installer VM, and then click **Next**.
- Step 6** In the **Review details** screen, verify the template details, and then click **Next**.
- Step 7** In the **Select storage** screen, perform these steps:
- From the **Select virtual disk format** drop-down list, choose **Thin Provision** to allocate storage on demand.
  - In the **Filters** tab, choose a destination datastore to store the installer VM.
  - Click **Next**.
- Step 8** In the **Select networks** screen, perform these steps:
- From the **Destination Network** column, choose a network for each source network that is available in the installer VM.
- Note** The selected network must have access to vCenter and the tenant VM networks.
- Click **Next**.
- The **Customize template** screen appears.

Figure 9: Customize Template Screen

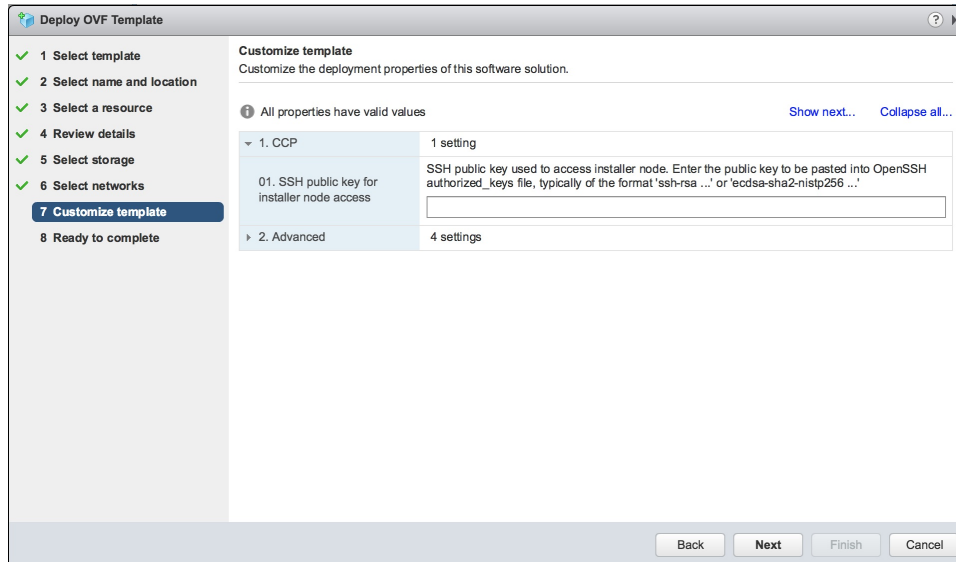
**Step 9**

In the **Customize template** screen, enter the following optional parameters to customize the deployment properties:

- a) Expand **CCP**, in the **SSH public key for installer node access** field, enter an ssh public key. You can use this key to ssh to the installer VM.

**Note**

- Ensure that you enter the public key in a single line.
- If you do not have an SSH key pair, you can generate it using the **ssh-keygen** command.
- Ensure that you use the Ed25519 or ECDSA format for the public key.

**Note:** As RSA and DSA are less secure formats, Cisco prevents the use of these formats.

- b) Expand **Advance** and enter the optional fields as necessary.

In the **CIDR for Kubernetes pod network** field, `192.168.0.0/24` is displayed as the default pod network CIDR of the Kubernetes cluster for the installer. If the CIDR IP addresses conflict with the tenant cluster VM network or the vCenter network, you need to set a different value for the CIDR.

This CIDR is the single large CIDR from which smaller CIDRs are automatically allocated to each node for allocating IP addresses to the pods in the Kubernetes cluster. For more information, refer to <https://kubernetes.io/docs/setup/scratch/#network-connectivity>.

- c) Click **Next**.

**Step 10**

In the **Ready to complete** screen, verify the installer VM deployment settings, and then click **Finish**.

**Step 11**

Click the **Power on** button to switch on the VM.

Figure 10: Switching on Installer VM

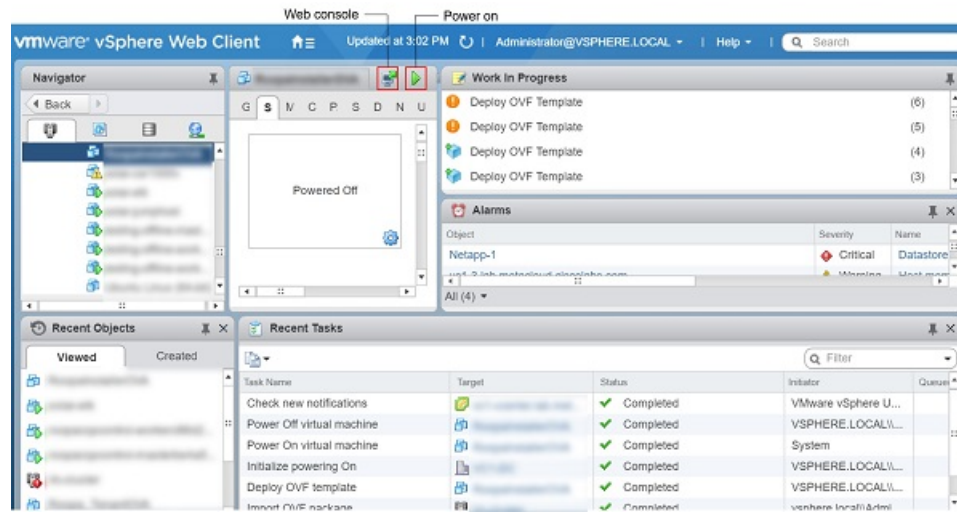

Once the installer VM is switched on, the installer UI takes a few minutes to become ready. You can view the status of the Installer UI using the **Web console** of vCenter. When the installer UI is ready, you can access it using the URL from the **Web console**.

You can use the ssh private key to access the Installer, control plane VMs, or the tenant cluster VMs. However, logging into these VMs using a username and password is not supported.

**Caution** After [Deploying Cisco Container Platform](#), do not change the location of the Control Plane VMs by modifying the datacenter or folder location **in vSphere**. Changing these settings will adversely impact the management of clusters.

## Deploying Cisco Container Platform

The Cisco Container Platform Control Plane is set up using an installer UI. After the installer VM is switched on, the URL of the installer appears on the vCenter **Web console**.

**Step 1** Obtain the URL from the vCenter **Web console** and use a browser to open the installer UI. The **Welcome** screen appears.



Figure 11: Welcome Screen

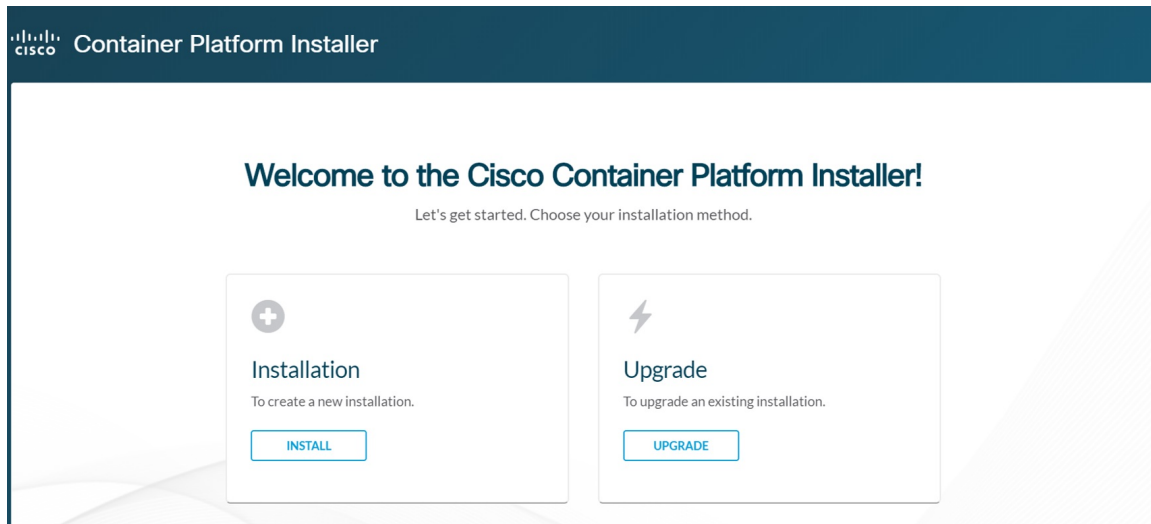

**Step 2** Click **Install**.

The **Connect your Cloud** screen appears.

Figure 12: Connect your Cloud Screen

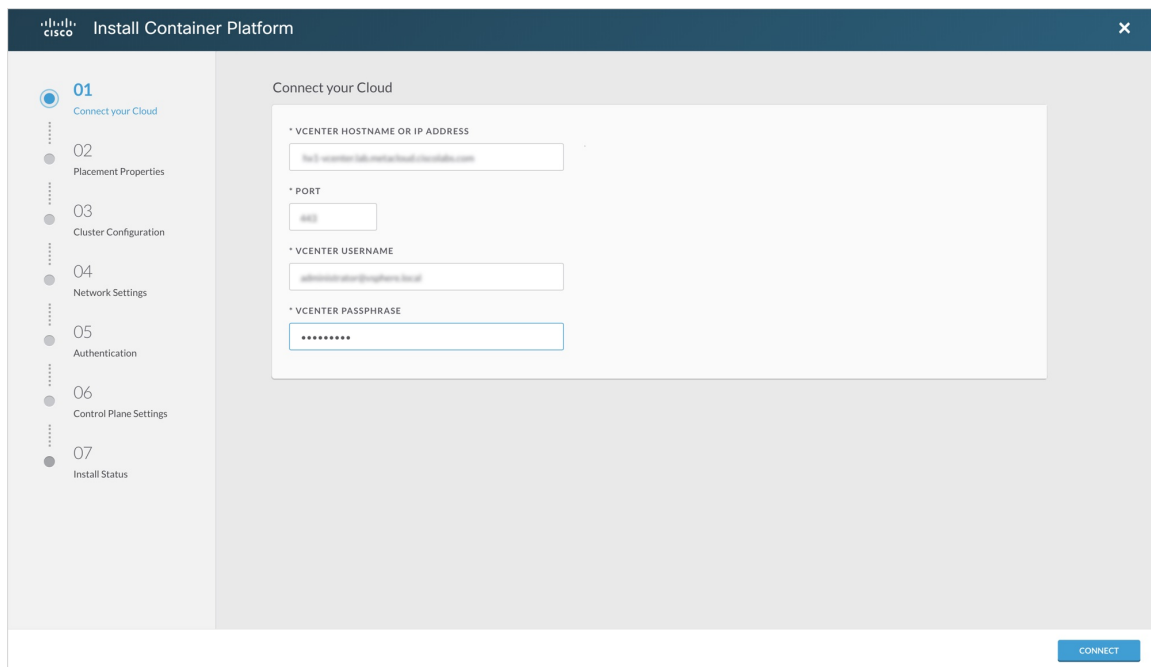

**Step 3** In the **Connect your Cloud** screen, enter the following information:

- In the **VCENTER HOSTNAME OR IP ADDRESS** field, enter the IP address of the vCenter instance that you want to use.
- In the **PORT** field, enter the port number that your vCenter server uses.

**Note** The default port for vCenter is 443.

- c) In the **VCENTER USERNAME** field, enter the username of the user with administrator access to the vCenter instance.
- d) In the **VCENTER PASSPHRASE** field, enter the passphrase of the vCenter user.
- e) Click **CONNECT**.

The **Placement Properties** screen appears.

**Figure 13: Placement Properties Screen**

**Step 4** In the **Placement Properties** screen, enter the following information:

- a) From the **VSPHERE DATACENTER** drop-down list, choose the datacenter.
- b) From the **VSPHERE CLUSTER** drop-down list, choose the cluster.
- c) From the **VSPHERE DATASTORE** drop-down list, choose the datastore.

**Caution** Do not use a datastore located in a nested folder or a Storage DRS (SDRS).

- d) From the **VSPHERE NETWORK** drop-down list, choose the network.
- e) In the **BASE VM IMAGE** field, enter the Cisco Container Platform tenant base VM name from Step 5 of the [Importing Cisco Container Platform Tenant Base VM](#) task.

**Caution** Do not select a VM name that is located in nested folder.

- f) Click **NEXT**.

The **Cluster Configuration** screen appears.

Figure 14: Cluster Configuration Screen

**Step 5**

In the **Cluster Configuration** screen, enter the following information:

- a) From the **NETWORK PLUGIN FOR TENANT KUBERNETES CLUSTERS** drop-down list, choose one of the following options for network connectivity:
  - ACI-CNI
  - Calico
  - Contiv (Tech Preview)

**Note** For more information on the network plugins, see [Container Network Interface Plugins, on page 4](#).

- b) In the **CIDR FOR CONTROLLER KUBERNETES POD NETWORK** field, **192.168.0.0/16** is displayed as the default pod network CIDR of the Kubernetes cluster for the installer. If the CIDR IP addresses conflict with the tenant cluster VM network or the vCenter network, you need to set a different value for the CIDR.

**Note** This CIDR is the single large CIDR from which smaller CIDRs are automatically allocated to each node for allocating IP addresses to the pods in the Kubernetes cluster. For more information, refer to <https://kubernetes.io/docs/setup/scratch/#network-connectivity>.

- c) In the **USERNAME FOR NODE ACCESS** field, enter the username of the user who can ssh into the Cisco Container Platform Control Plane nodes.
- d) In the **SSH PUBLIC KEY FOR NODE ACCESS** field, enter an ssh public key.  
You can use this key to ssh to the Control Plane nodes.

**Note:**

- Ensure that you enter the public key in a single line.
- If you do not have an SSH key pair, you can generate it using the **ssh-keygen** command.

- Ensure that you use the Ed25519 or ECDSA format for the public key.

**Note:** As RSA and DSA are less secure formats, Cisco prevents the use of these formats.

e) Click **NEXT**.

The **Network Settings** screen appears.

**Figure 15: Network Settings Screen**

The screenshot shows the 'Install Container Platform' window with the 'Network Settings' screen. On the left, a progress bar indicates the following steps: 01 Connect your Cloud, 02 Placement Properties, 03 Cluster Configuration, 04 Network Settings (selected), 05 Authentication, 06 Control Plane Settings, and 07 Install Status. The main content area is titled 'Network Settings' and contains the following fields and sections:

- \* NETWORK NAME:** A text input field containing 'default-network'.
- \* SUBNET CIDR:** A text input field containing '10.0.0.0/24'.
- GATEWAY IP:** A text input field containing '10.0.0.1'.
- A gateway IP will allow a cluster to access other networks**
- \* NAMESERVERS:** A table with columns 'Address' and 'Actions'. It contains one entry: '10.0.0.1' with a trash icon. Below the table is a '+ NAMESERVER' link.
- \* POOLS:** A table with columns 'First IP', 'Last IP', and 'Actions'. It contains one entry: '10.0.0.2' to '10.0.0.254' with a trash icon. Below the table is a '+ POOL' link.

At the bottom right of the window, there are 'BACK' and 'SAVE' buttons.

**Step 6** In the **Network Settings** screen, enter the following information:

**Note** These network settings will be used to configure the Cisco Container Platform web interface.

- In the **NETWORK NAME** field, enter the name of the network that you want to use.
- In the **SUBNET CIDR** field, enter a CIDR for your subnet.
- In the **GATEWAY IP** field, enter the gateway IP address that you want to use.
- Under **NAMESERVER**, enter the IP address of the necessary DNS nameserver.  
You can click **+NAMESERVER** to enter IP addresses of additional nameservers.
- Under **POOLS**, enter a range for the VIP network pool by specifying the **First IP** and **Last IP** that are within the Subnet CIDR specified above. The VIP network pool range enables us to prevent provisioning of tenant clusters with IP address ranges from overlapping subnets.

The IP address for the Control Plane is also allocated from this network pool range.

You can click **+POOL** to enter multiple pools in the subnet.

**Note** You must ensure that these IP addresses are not part of a DHCP pool.

f) Click **SAVE**.

The **Authentication** screen appears.

Figure 16: Authentication Screen

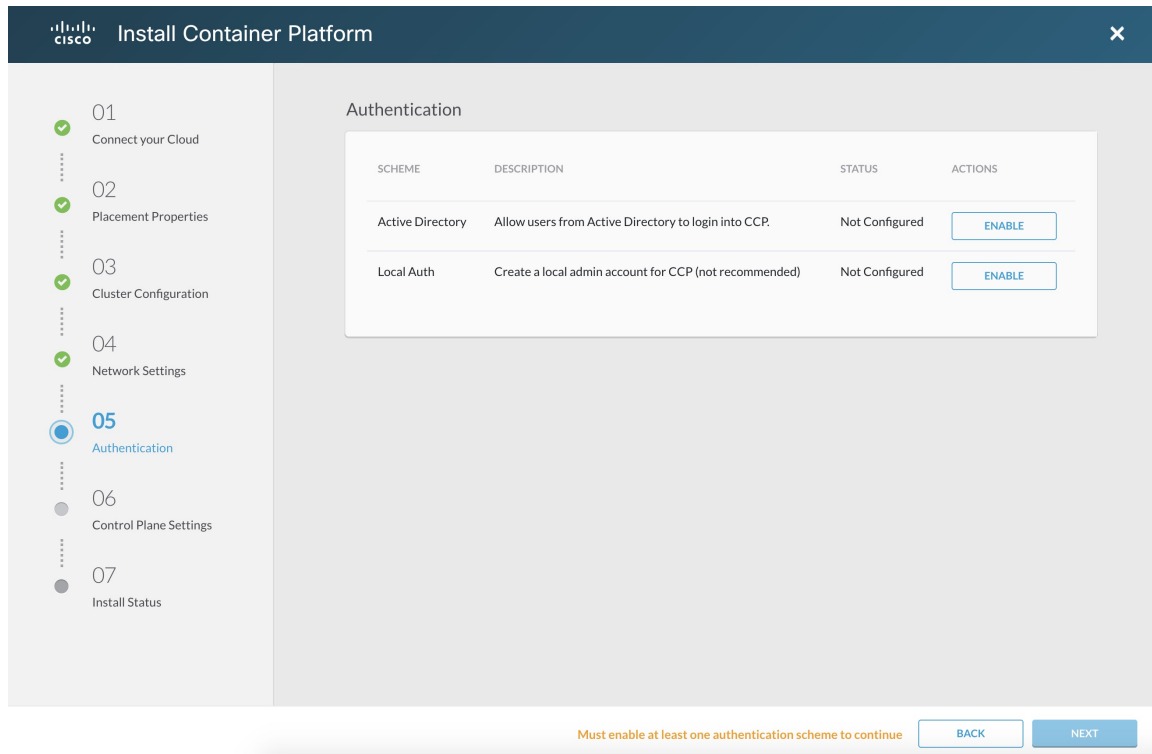
**Step 7**

In the **Authentication** screen, click the **Enable** button next to the type of authentication that you want to configure.

**Caution** Use of local authentication is not recommended and is considered less secure for production data.

a) If you have enabled **Active Directory**, specify the following information in the **Active Directory** screen:

1. Use the toggle button to enable or disable validation of Active Directory settings.
2. In the **SERVER IP ADDRESS** field, enter the IP address of the AD server.
3. In the **PORT** field, enter the port number for the AD server.
4. To establish a secure connection using SSL/TLS, enable **STARTTLS**.
5. To ensure security of your data, disable **SKIP CERTIFICATE VERIFICATION**.

**Caution** If you enable **SKIP CERTIFICATE VERIFICATION**, TLS will accept any certificate presented by the AD server. In this mode, TLS is susceptible to data loss.

6. In the **BASE DN** field, specify the domain name of the AD server.

**Note** Base DN is the Distinguished Name for the base entity. All searches for users and groups will be scoped to this distinguished name.

7. In the **ADMIN GROUP QUERY** field, enter the AD group that is associated with the Administrator role.
8. In the **SERVICE ACCOUNT DN** field, enter the service account domain name that is used for accessing the LDAP server.
9. In the **SERVICE ACCOUNT PASSPHRASE** field, enter the passphrase of the AD account.

10. Click **SAVE**.
- b) If you have enabled **Local** (not recommended), specify the following information in the **LOCAL AUTHENTICATION** screen:
1. In the **LOCAL ADMIN USERNAME** field, enter the admin username.
  2. In the **LOCAL ADMIN PASSPHRASE** field, enter a passphrase.
  3. In the **CONFIRM LOCAL ADMIN PASSPHRASE** re-enter the admin passphrase.
  4. Click **SAVE**.

The **Control Plane Settings** screen appears.

**Figure 17: Control Plane Settings Screen**

**Step 8** In the **Control Plane Settings** screen, enter the following information:

- a) In the **CONTROL PLANE NAME** field, enter the name of the Cisco Container Platform cluster.

**Note**

- The cluster name must start with an alphanumeric character (a-z, A-Z, 0-9). It can contain a combination of hyphen (-) symbols and alphanumeric characters (a-z, A-Z, 0-9). The maximum length of the cluster name is 46 characters.
- Deployment of the installer VM fails if another Control Plane cluster with the same name already exists on the same datastore. You must ensure that you specify a unique name for the Control Plane cluster.

- b) In the **CCP VERSION** field, enter the version of the Cisco Container Platform cluster.
- c) From the **CCP LICENSE ENTITLEMENT** drop-down list, choose an entitlement option that indicates the type of Smart Licensing that you want to use.

**Note** The **Partner** option will only be used in conjunction with a **Not for Retail (NFR)** or **Trial** license.

- d) Expand **Advanced Settings**, in the **NTP SERVERS** field, enter the list of any NTP servers in your environment. This field is optional.
- e) Click **DEPLOY** and then monitor the installation progress through the vCenter **Web console**.

**Caution** After deploying Cisco Container Platform, do not change the location of the Control Plane VMs by modifying the datacenter or folder location **in vSphere**. Changing these settings will adversely impact the management of clusters.

---







## CHAPTER 5

# Upgrading Cisco Container Platform

Upgrading Cisco Container Platform and upgrading tenant clusters are independent operations. You must upgrade the Cisco Container Platform to allow tenant clusters to upgrade. Specifically, tenant clusters cannot be upgraded to a higher version than the Control Plane. For example, if the Control Plane is at version 1.10, the tenant cluster cannot be upgraded to the 1.11 version.

Upgrading Cisco Container Platform is a three-step process:



---

**Note** Taking a snapshot of the VMs managed by Cisco Container Platform is currently unsupported and results in failures during upgrades.

---

You can update the size of a single IP address pool during an upgrade. However, we recommend that you plan ahead for the free IP address requirement by ensuring that the free IP addresses are available in the Control Plane cluster prior to the upgrade.

If you are upgrading from a Cisco Container Platform version:

- 3.1.x or earlier, you must ensure that at least five IP addresses are available.
- 3.2 or later, you must ensure that at least three IP addresses are available.
- [Upgrading Cisco Container Platform Tenant Base VM, on page 35](#)
- [Deploying Upgrade VM, on page 36](#)
- [Upgrading Cisco Container Platform Control Plane, on page 36](#)

## Upgrading Cisco Container Platform Tenant Base VM

You can follow the instructions in the [Installing Cisco Container Platform, on page 21](#) > [Importing Cisco Container Platform Tenant Base VM](#) section.



---

**Note** The older tenant images are no longer required, you can delete them from your vCenter instance.

---

## Deploying Upgrade VM

Follow the instructions in the [Installing Cisco Container Platform, on page 21 > Deploying Installer VM](#) section to deploy the latest VM.

It may take a few minutes for the deployment of the VM to complete. You can view the status of the upgrade task using the Web console of vCenter.



---

**Note** Depending on CNI usage, the port used to access Cisco Container Platform may change as part of the upgrade.

---

## Upgrading Cisco Container Platform Control Plane

The Cisco Container Platform Control Plane is upgraded using an installer UI. After the installer VM is switched on, the URL of the installer appears on the vCenter **Web console**.

- 
- Step 1** Obtain the URL from the vCenter **Web console** and use a browser to open the installer UI.
- Step 2** Click **Upgrade**.
- Step 3** In the **Connect your Cloud** screen, enter the following information:
- In the **VCENTER HOSTNAME OR IP ADDRESS** field, enter the IP address of the vCenter instance that you want to use.
  - In the **PORT** field, enter the port of the vCenter instance that you want to use.
  - In the **VCENTER USERNAME** field, enter the username of the user with administrator access to the vCenter instance.
  - In the **VCENTER PASSPHRASE** field, enter the passphrase of the vCenter user.
  - Click **CONNECT**.
- Step 4** In the **Authenticate CCP** screen, enter the following information:
- In the **EXISTING CISCO CONTAINER PLATFORM (CCP) URL** field, for accessing Cisco Container Platform in the following format:  
`https://<CCP_IP_Address>:<Port>`
  - To establish a secure connection, enable **VERIFY SSL**.
  - In the **ADMIN USERNAME** field, enter the username for the **Administrator** user of the Cisco Container Platform Control Plane.
  - In the **ADMIN PASSPHRASE** field, enter the current passphrase for an **Administrator** user of the Cisco Container Platform Control Plane.
  - Click **CONNECT**.
- Step 5** In the **Cluster Configuration** screen, enter the following information:
- In the **USERNAME FOR NODE ACCESS** field, enter the username of the user who can ssh into the Cisco Container Platform Control Plane nodes.
  - In the **SSH PUBLIC KEY FOR INSTALLER NODE ACCESS** field, enter an ssh public key.  
 You can use this key to ssh to the Control Plane nodes.

- Note**
- Ensure that you enter the public key in a single line.
  - You can use the private key to securely connect to the Cisco Container Platform Control Plane VMs through SSH, after installation.
  - If you do not have an SSH key pair, you can generate it using the **ssh-keygen** command.
  - Ensure that you use the Ed25519 or ECDSA format for the public key.
- Note** As RSA and DSA are less secure formats, Cisco prevents the use of these formats.

c) Click **NEXT**.

### Step 6

In the **Verify Network** screen, enter the following information:

a) In the **SUBNET CIDR** field, enter the actual CIDR of the VM network.

- Note**
- This network will be used for VM network configuration. You must ensure that the CIDR matches VM network configured on the vsphere.
  - When the **SUBNET CIDR** is updated, the **GATEWAY IP** and **IP ADDRESS RANGE** are also updated accordingly.

b) In the **GATEWAY IP** field, enter the gateway IP address of the VM network.

- Note** Ensure that you enter the correct gateway IP address for the VM network. An incorrect gateway IP address causes failures during Control Plane upgrading.

c) Under **Nameservers** enter at least on DNS server addressess.

- Note** This nameserver(s) will be used in the DNS configuration of the Control Plane. You must ensure that Cisco Container Platform has access to this DNS server.

d) Under **POOLS**, enter the available IP address ranges that can be used for the Control Panel..

- Note** Do not adjust the address range if there are enough free IP addresses across the pools in the Control Plane's subnet to support the Control Plane upgrade.
- You can extend the pool range as long as it does not overlap with any other pools in the subnet.

e) Click **NEXT**.

### Step 7

In the **Control Plane Settings** screen, enter the following information:

a) In the **CONTROL PLANE NAME** field, enter the name of the Cisco Container Platform cluster.

- Note** You need to enter the same cluster name that you used during installation.

b) From the **VSPHERE DATACENTER** drop-down list, choose the datacenter.

c) From the **BASE VM IMAGE** drop-down list, choose the Cisco Container Platform tenant base VM name.

d) In the **CCP VERSION** field, enter the version of the Cisco Container Platform cluster.

e) From the **CCP LICENSE ENTITLEMENT** drop-down list, choose an entitlement option that indicates the type of Smart Licensing that you want to use.

- Note** The **Partner** option will only be used in conjunction with a **Not for Retail (NFR)** or **Trial** license.

f) Click **UPGRADE**.

The **Upgrade Status** screen appears.

After the upgrade is complete, click **LAUNCH** to access the upgraded Cisco Container Platform web interface.

---



## CHAPTER 6

# Uninstalling Cisco Container Platform

---

This chapter contains the following sections:

- [Uninstalling Cisco Container Platform, on page 39](#)

## Uninstalling Cisco Container Platform

Uninstalling Cisco Container Platform removes all containers and services associated with it. You will no longer be able to create or manage tenant clusters on this Cisco Container Platform instance.

- 
- Step 1** Open the Cisco Container Platform web interface, log in to the Control Plane cluster using its VIP address, and then delete all the Kubernetes tenant clusters that belong to the Cisco Container Platform instance.  
For more information on deleting Kubernetes clusters, refer to the *Cisco Container Platform User Guide*.
- Step 2** Follow these steps to delete the Control Plane and installer node VMs:
- In the vSphere web client, right-click the VM, choose **Power > Power off**, and then click **Yes** in the confirmation dialog box.
  - Right-click each VM and choose **Delete from Disk**.
- Step 3** Follow these steps to delete the Control Plane cluster data disks:
- In the vSphere web client, choose **Home > Storage**.
  - From the left pane, choose the datastore that is used to install the Control Plane VMs. This is the same as the datastore to which the installer VM is imported to unless you have changed it in the installer UI.
  - If you have installed the Control Plane using the default name, right-click the folder name with the prefix **ccpcontrol** or if you have provided a different name to the Control Plane in the installer UI, right-click the folder with that name.
  - Choose **Delete File**.
-





## CHAPTER 7

# Backing Up and Restoring Cisco Container Platform

---

This chapter contains the following topics:

- [Backing Up Cisco Container Platform, on page 41](#)
- [Restoring Cisco Container Platform, on page 42](#)
- [Backing Up Harbor Database, on page 43](#)
- [Restoring Harbor Database, on page 44](#)

## Backing Up Cisco Container Platform

You can back up the Cisco Container Platform application data that pertains to the following components:

- Application users
- Virtualization providers
- Tenant clusters



---

**Note** The logging or monitoring data from Prometheus, Grafana, and the EFK stack is not included in the backup archive.

---

You must ensure that you use an up-to-date backup archive for a restore operation. Tasks such as creating, deleting, upgrading, or scaling tenant clusters or altering the number of Load Balancer Virtual IP addresses will create changes in the data that will not be present in the backup. If you perform such tasks after a backup and use an outdated backup archive to restore your Cisco Container Platform environment, unexpected IP address conflicts, unmanageable tenant clusters, or an unsuccessful restore may occur.

## Backing Up Cisco Container Platform with IP Pool Management v3.0.x+

### Before you begin

Ensure that at least 6 consecutive IP addresses are available in the same pool where the Cisco Container Platform Control Plane is deployed.

When the target for a restore is a new cluster, you must ensure that additional free IP addresses are available to avoid conflicts with the IP addresses that are currently in use.

For more information on the requirement for additional free IP addresses, refer to the *Managing Networks* section of the *Cisco Container Platform User Guide*.

---

**Step 1** Log in to the console of the master node of the Cisco Container Platform Control Plane.

**Step 2** Run the following command.

```
/ccp_related_files/percona_backup.sh ./backup.tar
```

The backup script displays the following information on the console:

- The valid IP pool ranges with enough free IP addresses to create a replacement Cisco Container Platform Control Plane

You must save the IP ranges for future use while specifying the **IP Address Range** on the **Network Settings** screen during an install, see [Deploying Cisco Container Platform, on page 26](#).

- The encryption key that is needed to decrypt the backup data encryption key that is stored on your disk.

You must save the encryption key for future use while restoring the database to a new Cisco Container Platform Control Plane. For more information, see [Restoring Cisco Container Platform, on page 42](#).

**Caution** Losing the encryption key will prevent restoration of the Cisco Container Platform Control Plane cluster.

**Step 3** Copy the `backup.tar` backup archive to a secure location.

**Note** You must ensure that the backup archive is maintained securely as anyone with access to it has administrative capabilities on all tenant clusters.

---

## Restoring Cisco Container Platform

You can restore a valid backup in one of the following ways:

- To the same cluster, in case of database corruption.
- To a new Cisco Container Platform Control Plane instance of the same version that has control over all the existing Cisco Container Platform settings and tenant clusters.

When restoring a backup archive to a new Control Plane, the Ingress, kube-apiserver, and node IP addresses will not be restored, they will remain the same as when the new Control Plane was created.

### Before you begin

For versions 3.2 and later, you must have the Encryption key provided during the [Backing Up Cisco Container Platform with IP Pool Management v3.0.x+](#).

---

**Step 1** Power off the VMs that belong to the previous Control Plane instance.

**Step 2** Install a new Cisco Container Platform Control Plane with the same version as the previous Control Plane with the same subnet configuration used for the previous Control Plane instance, but the IP pool range needs to be one of the smaller



ranges specified during the backup output. All tenant network settings and IP pool ranges from the previous Control Plane instance will be restored as part of the restoration process.

For the 3.1 version, the IP addresses required for the new Control Plane must be from the original IP address pool range of the Control Plane that was created during installation. If this is not possible, you must open a support case for assistance in creating a complete backup. You are allowed to expand the original IP address pool range by modifying the start and end of the range if required.

**Step 3** Copy the backup from the secure location to Control Plane master.

```
scp ./backup.tar <control_plane_master>:/tmp/backup.tar
```

**Step 4** Log in to the console of the master node of Cisco Container Platform Control Plane.

**Step 5** Follow these steps for Cisco Container Platform **version 3.1 only**:

a) Update the **CCP\_BACKUP** environment variable to match the filename of the backup file that was created during the [Backing Up Cisco Container Platform with IP Pool Management v3.0.x+](#):

```
CCP_BACKUP="backup.tar"
```

b) Decrypt the database encryption key and store it in an environment variable. When prompted, enter the decryption key from the [Backing Up Cisco Container Platform with IP Pool Management v3.0.x+](#).

```
AES_KEY="$(read -s -p "Encryption Key: " && echo -n $REPLY | openssl enc -d -aes-256-cbc \ -in  
<(tar -f "$CCP_BACKUP" -O -x tmp/backup/aes_key.enc) \ -pass file:/dev/stdin)"
```

c) Update the database decryption key in the new Control Plane:

```
kubectl get secret cx-aes-key --export -o json \ | jq ".data[\"aes-key\"] |= \"$(echo -n \"$AES_KEY\"  
| base64 | tr -d '\n')\"" | kubectl apply -f -
```

**Step 6** Run the following command.

```
/ccp_related_files/percona-restore.sh /tmp/backup.tar
```

If prompted to continue the backup, enter the encryption Key from the [Backing Up Cisco Container Platform with IP Pool Management v3.0.x+](#).

## Backing Up Harbor Database

The database on Harbor tenant contains information such as user data and audit logs. This information can be backed up as a safety precaution before attempting a tenant upgrade on a Harbor tenant as the upgrade process may perform a database migration.



**Note** This backup process does not include docker images hosted on the Harbor registry.

**Step 1** Log in to the console of the master node of Harbor tenant.

**Step 2** Run the following command.

```
/opt/ccp/charts/harbor-db-backup.sh ./harbor_db_backup.sql default ccp-harbor
```

**Step 3** Copy the `harbor_db_backup.sql` backup file to a secure location.

---

## Restoring Harbor Database

You can restore a valid Harbor database on a new or an existing Harbor tenant.

---

**Step 1** Copy the backup from the secure location to Harbor tenant master.

```
scp ./harbor_db_backup.sql <harbor_tenant_master>:/tmp/harbor_db_backup.sql
```

**Step 2** Log in to the console of the master node of Harbor tenant.

**Step 3** Run the following command.

```
/opt/ccp/charts/harbor-db-restore.sh /tmp/harbor_db_backup.sql default ccp-harbor
```

---



## APPENDIX **A**

# Troubleshooting Cisco Container Platform

This appendix describes the problems that may occur during the installation and operation of Cisco Container Platform and the possible ways of resolving these problems.

It contains the following topics:

- [Installation of Cisco Container Platform Fails](#) , on page 45
- [Unable to Upgrade Cisco Container Platform due to Network Misconfiguration](#) , on page 46
- [Unable to Deploy NGINX Ingress Controller Using Helm](#), on page 46
- [Unable to Start NGINX Ingress Controller Pod](#), on page 46
- [Unable to Power on Worker VMs after a Shutdown](#), on page 47
- [Application Pods Crash When Using Contiv CNI in Tenant Clusters](#), on page 47
- [How to Create Sosreports](#), on page 49
- [Troubleshoot vSphere Operator in Cisco Container Platform](#), on page 50
- [Troubleshoot Net Tinker in Cisco Container Platform](#), on page 50

## Installation of Cisco Container Platform Fails

If installation of Cisco Container Platform fails, you can reattempt the installation.

### Recommended Solution

Reboot the installer VM and then access the installer UI again.

In case you want to update an OVA parameter on the installer node, for example, update the **CIDR for Kubernetes pod network** parameter, you can follow these steps:

1. From the right pane of the vSphere Web Client, navigate to the installer VM.
2. Right-click the installer VM and choose **Power off**.  
The installer VM is turned off.
3. Right-click the installer VM and choose **Edit Settings**.  
The **Edit Settings** dialog box appears.
4. Click the **vApp Options** tab, and then open and update the required property value.
5. Click **OK**.
6. From the right pane, right-click the installer VM and choose **Power on**.

The installer VM is turned on. After the installer VM is turned on, the URL of the installer appears on the vCenter **Web console**.

7. Obtain the URL from the vCenter **Web console** and use a browser to access the installer UI to continue with the installation.

## Unable to Upgrade Cisco Container Platform due to Network Misconfiguration

When you enter a wrong IP address range for the Control Plane in the **Verify Network** screen of the **Upgrade** wizard, the following error message is appears:

```
Cannot patch address pool <uuid> with data: <some-data>
```

### Recommended Solution

You must go back to the **Verify Network** screen of the **Upgrade** wizard and configure the IP address range for the Control Plane again.

For more information, see [Upgrading Cisco Container Platform Control Plane, on page 36](#).

## Unable to Deploy NGINX Ingress Controller Using Helm

When deploying the NGINX Ingress controller using Helm fails as RBAC is not configured in Helm, the following error message appears:

```
It seems the cluster it is running with Authorization enabled (like RBAC) and there is no permissions for the ingress controller. Please check the configuration
```

### Recommended Solution

As Cisco Container Platform uses RBAC for authentication, Helm also needs to be configured to use RBAC.

Enable the RBAC parameter in Helm using the following command:

```
--set rbac.create=true
```

## Unable to Start NGINX Ingress Controller Pod

When kube-proxy is used, setting both the `controller.service.externalIPs` and `controller.hostNetwork` variables to `true` for the NGINX-Ingress chart results in an invalid configuration.

Both kube-proxy and NGINX uses port 80 for communication, causing a port conflict, and the NGINX Ingress controller pod is set to the `CrashLoopBackOff` state.

The following error message appears:

```
Port 80 is already in use. Please check the flag --http-port
```

### Recommended Solution

Ensure that both the `controller.service.externalIPs` and `controller.hostNetwork` variables are not set to `true` at the same time.

## Unable to Power on Worker VMs after a Shutdown

Worker VMs may fail to power on after a shutdown and the following error message appears:

```
File system specific implementation of LookupAndOpen[file] failed.
```

### Recommended Solution

Follow these steps to resolve the problem:

1. From the left pane, click the VM that you want to power on.
2. From the right pane, from the **Actions** drop-down list, choose **Edit Settings**.  
The **Edit Settings** window displays the multiple hard disks of the VM.
3. Except for the primary hard disk (Hard disk 1), click each hard disk, and then click the **Remove** icon.  
Ensure that the **Delete files from datastore** check box is not checked.
4. Click **OK**.

## Application Pods Crash When Using Contiv CNI in Tenant Clusters

When you use Contiv as the CNI for a tenant cluster, you need to ensure that the application pods that need HugePages must have the following section in the pod manifest. Otherwise, the pods may crash.

```
resources:
  limits:
    hugepages-2Mi: 512Mi
    memory: 512Mi
```

The preceding section in the pod manifest limits 512 MB in memory for HugePages for the pod. It allocates 256 HugePages, with each HugePage having 2MB size.

HugePages are allocated to the pods only if you have enabled HugePages on the host. Otherwise, the HugePage allocation in the pod manifest is ignored by Kubernetes. The following table shows the Cisco Container Platform CNIs that use HugePages.

| Cisco Container Platform CNI | Use HugePages |
|------------------------------|---------------|
| Contiv                       | Yes           |
| ACI                          | No            |
| Calico                       | No            |

## Example of Allocating HugePages for Applications

- 
- Step 1** Check the total and free HugePages on the worker nodes. Each HugePage is 2048 KB in size.

```
$ grep -i huge /proc/meminfo
AnonHugePages: 0 kB
ShmemHugePages: 0 kB
HugePages_Total: 1024
HugePages_Free: 972
HugePages_Rsvd: 0
HugePages_Surp: 0
Hugepagesize: 2048 kB

$ sudo sysctl -a | grep -i huge
vm.hugepages_treat_as_movable = 0
vm.hugetlb_shm_group = 0
vm.nr_hugepages = 1024
vm.nr_hugepages_mempolicy = 1024
vm.nr_overcommit_hugepages = 0
```

**Step 2** If the host has less HugePages, increase the HugePages allocation.

```
sudo su
echo 2048 > /proc/sys/vm/nr_hugepages

# Check the increased number of HugePages
cat /proc/sys/vm/nr_hugepages
grep -i huge /proc/meminfo
sudo sysctl -a | grep -i huge
```

**Note** You need to perform these steps on all the hosts.

**Step 3** Create the `bookinfo.yaml` file that allocates HugePages to the `reviews-v1` pod.

```
apiVersion: extensions/v1beta1
kind: Deployment
metadata:
  name: reviews-v1
spec:
  template:
    metadata:
      labels:
        app: reviews
        version: v1
    spec:
      containers:
      - name: reviews
        image: istio/examples-bookinfo-reviews-v1:1.5.0
        imagePullPolicy: IfNotPresent
        resources:
          limits:
            hugepages-2Mi: 512Mi
            memory: 512Mi
        ports:
        - containerPort: 9080
```

**Step 4** Deploy `bookinfo.yaml` and check usage of HugePages.

```
$ kubectl create -f istio- $\$$ ISTIO_VERSION/samples/bookinfo/kube/bookinfo.yaml
deployment.extensions "reviews-v1" created

$ kubectl get pods | grep reviews
reviews-v1-6f56455f68-t6phs          1/1          Running    0          3m

# Check usage of HugePages by the pods
$ kubectl describe pod reviews-v1-6f56455f68-t6phs | grep -i '^Name: \|Image: \|huge \|mem'
Name:          reviews-v1-6f56455f68-t6phs
Image:         istio/examples-bookinfo-reviews-v1:1.5.0
hugepages-2Mi: 512Mi
```

```

memory:          512Mi
hugepages-2Mi:  512Mi
memory:          512Mi

# Check usage of HugePages on each host
$ grep -i huge /proc/meminfo
AnonHugePages:      0 kB
ShmemHugePages:    0 kB
HugePages_Total:   1024
HugePages_Free:    972
HugePages_Rsvd:    0
HugePages_Surp:    0
Hugepagesize:     2048 kB

$ sudo sysctl -a | grep -i huge
vm.hugepages_treat_as_movable = 0
vm.hugetlb_shm_group = 0
vm.nr_hugepages = 1024
vm.nr_hugepages_mempolicy = 1024
vm.nr_overcommit_hugepages = 0

```

**Step 5** Check the decrease of the `HugePages_Free` field in the output when the `reviews-v1` pod is using HugePages.

```
grep -i huge /proc/meminfo
```

## How to Create Sosreports

Sosreports are used by support engineers for troubleshooting customer support issues. They contain system log files, configuration details, and system information from your Cisco Container Platform environment.



**Note**

- For Control Plane issues, you need to run the sosreport from the Control Plane master VM, if available.
- For tenant cluster issues, you need to run the sosreport from the Control Plane master VM and the tenant plane master VM.
- For network issues impacting pods on a particular worker, you need to run the sosreport from the impacted tenant worker node.

Follow these steps to create an sosreport:

**Step 1** ssh to the VM.

**Step 2** Run sosreport on the node of your choice.

```
sudo sosreport
```

The sosreport is created and saved in the following location:

```
/tmp/sosreport-xxxxxxx.tar.xz
```

**Step 3** Validate the sosreport file using the following checksum:

```
xxxxxxxxxx
```

- Step 4** Securely transfer the sosreport file to your customer representative. The file transfer method can vary depending on your deployment environment. For example, you can use Secure Copy (SCP) for Portable Operating System Interface systems (POSIX) and Windows Secure Copy (WinSCP) for windows clients. For more information, refer to [Uploading Files to Cisco Technical Assistance Center \(TAC\)](#).

## Troubleshoot vSphere Operator in Cisco Container Platform

Follow these steps to troubleshoot the vSphere operator in Cisco Container Platform:

- Step 1** Check the status of the pod, logs, and CRD of the vSphere operator.

```
$ kubectl get pods --all-namespaces | grep 'NAME\\|vsphere-operator'
```

| NAMESPACE | NAME                                       | READY | STATUS  | RESTARTS | AGE  |
|-----------|--------------------------------------------|-------|---------|----------|------|
| default   | kaas-ccp-vsphere-operator-788487bc68-h47dh | 1/1   | Running | 2        | 156m |

```
kubectl logs kaas-ccp-vsphere-operator-788487bc68-h47dh --all-containers=true

$ kubectl get crds | grep vsphereclusters
vsphereclusters.vsphere.ccp.cisco.com      2019-07-15T18:16:45Z

$ kubectl get vsphereclusters
NAME          AGE
vhosakot-vs  2h
```

- Step 2** Generate sosreport on the master node of the cluster running vSphere operator. See also, [How to Create Sosreports, on page 49](#).

```
cd <sosreport directory>/sos_commands/kubernetes/
cat vsphereclusters.vsphere.ccp.cisco.com
```

- Step 3** Check the status of VsphereCluster CR in the sosreport.

## Troubleshoot Net Tinker in Cisco Container Platform

Follow these steps to troubleshoot the Net Tinker operator in Cisco Container Platform:

- Step 1** Check the status of the pod, logs, and CRDs of the net tinker.

```
$ kubectl get pods --all-namespaces | grep 'NAME\\|tinker'
```

| NAMESPACE | NAME                                | READY | STATUS  | RESTARTS | AGE  |
|-----------|-------------------------------------|-------|---------|----------|------|
| default   | ccp-tinker-manager-85cf7fffd5-mnc24 | 2/2   | Running | 0        | 158m |

```
kubectl logs ccp-tinker-manager-85cf7fffd5-mnc24 --all-containers=true

$ kubectl get crds | grep net.ccp.cisco.com
clusternetworks.net.ccp.cisco.com      2019-07-15T18:17:15Z
cnis.net.ccp.cisco.com                 2019-07-15T18:17:15Z
ipaddresses.net.ccp.cisco.com          2019-07-15T18:17:15Z
ipallocators.net.ccp.cisco.com        2019-07-15T18:17:15Z
metallbs.net.ccp.cisco.com            2019-07-15T18:17:15Z
```



```
netconfigs.net.ccp.cisco.com          2019-07-15T18:17:15Z
nginxingresses.net.ccp.cisco.com      2019-07-15T18:17:15Z
```

```
kubectl get clusternetworks,cnis,ipaddresses,ipallocators,metallbs,netconfigs,nginxingresses
```

**Step 2** Generate sosreport on the master node of the cluster running net tinker.

See also, [How to Create Sosreports, on page 49](#).

```
cd <sosreport directory>/sos_commands/kubernetes/

# find . | grep
'clusternetworks\|cnis\|ipaddresses\|ipallocators\|metallbs\|netconfigs\|nginxingresses'
./cnis.net.ccp.cisco.com
./clusternetworks.net.ccp.cisco.com
./netconfigs.net.ccp.cisco.com
./ipaddresses.net.ccp.cisco.com
./ipallocators.net.ccp.cisco.com
./nginxingresses.net.ccp.cisco.com
./metallbs.net.ccp.cisco.com

find . | grep 'clusternetworks\|cnis\|ipaddresses\|ipallocators\|metallbs\|netconfigs\|nginxingresses'
| xargs cat
```

**Step 3** Check status of CRs of the net tinker in the sosreport.

---





# APPENDIX **B**

## Version Mapping Table

This chapter contains the following topic:

- [Version Mapping Table, on page 53](#)

### Version Mapping Table

| Cisco Container Platform Version | Kubernetes Version | Image Names                                                                                                                                                                                                    |
|----------------------------------|--------------------|----------------------------------------------------------------------------------------------------------------------------------------------------------------------------------------------------------------|
| 1.0.0                            | 1.10               | Control Plane Installer – kcp-vm-1.0.0.ova<br>Tenant Image – ccp-tenant-image-1.10.1-1.0.0.ova                                                                                                                 |
| 1.0.1                            | 1.10               | Control Plane Installer – kcp-vm-1.0.1.ova<br>Tenant Image – ccp-tenant-image-1.10.1-1.0.1.ova                                                                                                                 |
| 1.1.0                            | 1.10               | Control Plane Installer – kcp-vm-1.1.0.ova<br>Tenant Image – ccp-tenant-image-1.10.1-1.1.0.ova                                                                                                                 |
| 1.4.0                            | 1.10               | Control Plane Installer – kcp-vm-1.4.0.ova<br>Tenant Image – ccp-tenant-image-1.10.1-1.4.0.ova                                                                                                                 |
| 1.5.0                            | 1.10               | Control Plane Installer – kcp-vm-1.5.0.ova<br>Tenant Image –<br>ccp-tenant-image-1.10.1-ubuntu16-1.5.0.ova                                                                                                     |
| 2.0.1                            | 1.10<br>1.11       | Control Plane Installer – kcp-vm-2.0.1.ova<br>Tenant Image (Kubernetes 1.10) –<br>ccp-tenant-image-1.10.1-ubuntu16-2.0.0.ova<br>Tenant Image (Kubernetes 1.11) –<br>ccp-tenant-image-1.11.3-ubuntu18-2.0.0.ova |

| Cisco Container Platform Version | Kubernetes Version | Image Names                                                                                                                                                                                               |
|----------------------------------|--------------------|-----------------------------------------------------------------------------------------------------------------------------------------------------------------------------------------------------------|
| 2.1.0                            | 1.10<br>1.11       | Control Plane Installer – kcp-vm-2.1.0.ova<br>Tenant Image (Kubernetes 1.10) – ccp-tenant-image-1.10.1-ubuntu16-2.1.0.ova<br>Tenant Image (Kubernetes 1.11) – ccp-tenant-image-1.11.3-ubuntu18-2.1.0.ova  |
| 2.2.2                            | 1.10<br>1.11       | Control Plane Installer – kcp-vm-2.2.2.ova<br>Tenant Image (Kubernetes 1.10) – ccp-tenant-image-1.10.11-ubuntu16-2.2.2.ova<br>Tenant Image (Kubernetes 1.11) – ccp-tenant-image-1.11.5-ubuntu18-2.2.2.ova |
| 3.0.0                            | 1.11<br>1.12       | Control Plane Installer – kcp-vm-3.0.0.ova<br>Tenant Image (Kubernetes 1.11) – ccp-tenant-image-1.11.5-ubuntu18-3.0.0.ova<br>Tenant Image (Kubernetes 1.12) – ccp-tenant-image-1.12.3-ubuntu18-3.0.0.ova  |
| 3.1.0                            | 1.11<br>1.12       | Control Plane Installer – kcp-vm-3.1.0.ova<br>Tenant Image (Kubernetes 1.11) – ccp-tenant-image-1.11.5-ubuntu18-3.1.0.ova<br>Tenant Image (Kubernetes 1.12) – ccp-tenant-image-1.12.3-ubuntu18-3.1.0.ova  |
| 3.2.0                            | 1.11<br>1.12       | Control Plane Installer – kcp-vm-3.2.0.ova<br>Tenant Image (Kubernetes 1.11) – ccp-tenant-image-1.11.5-ubuntu18-3.2.0.ova<br>Tenant Image (Kubernetes 1.12) – ccp-tenant-image-1.12.3-ubuntu18-3.2.0.ova  |
| 4.0.0                            | 1.12<br>1.13       | Control Plane Installer – kcp-vm-4.0.0.ova<br>Tenant Image (Kubernetes 1.12) – ccp-tenant-image-1.12.7-ubuntu18-4.0.0.ova<br>Tenant Image (Kubernetes 1.13) – ccp-tenant-image-1.13.5-ubuntu18-4.0.0.ova  |
| 4.1.0                            | 1.12<br>1.13       | Control Plane Installer – kcp-vm-4.1.0.ova<br>Tenant Image (Kubernetes 1.12) – ccp-tenant-image-1.12.7-ubuntu18-4.1.0.ova<br>Tenant Image (Kubernetes 1.13) – ccp-tenant-image-1.13.5-ubuntu18-4.1.0.ova  |

| Cisco Container Platform Version | Kubernetes Version | Image Names                                                                                                                                                       |
|----------------------------------|--------------------|-------------------------------------------------------------------------------------------------------------------------------------------------------------------|
| 4.2.0                            | 1.12               | Control Plane Installer – kcp-vm-4.2.0.ova                                                                                                                        |
|                                  | 1.13               | Tenant Image (Kubernetes 1.12) –<br>ccp-tenant-image-1.12.7-ubuntu18-4.2.0.ova<br>Tenant Image (Kubernetes 1.13) –<br>ccp-tenant-image-1.13.5-ubuntu18-4.2.0.ova  |
| 5.0.0                            | 1.13               | Control Plane Installer – kcp-vm-5.0.0.ova                                                                                                                        |
|                                  | 1.14               | Tenant Image (Kubernetes 1.13) –<br>ccp-tenant-image-1.13.10-ubuntu18-5.0.0.ova<br>Tenant Image (Kubernetes 1.14) –<br>ccp-tenant-image-1.14.6-ubuntu18-5.0.0.ova |



**Note** It is required that you use the latest Kubernetes version OVA for the [Installing Cisco Container Platform](#).

