



Cisco Configuration Engine Administration Guide, 2.0

Corporate Headquarters

Cisco Systems, Inc.
170 West Tasman Drive
San Jose, CA 95134-1706
USA
<http://www.cisco.com>
Tel: 408 526-4000
800 553-NETS (6387)
Fax: 408 526-4100

Text Part Number: OL-6749-02



THE SPECIFICATIONS AND INFORMATION REGARDING THE PRODUCTS IN THIS MANUAL ARE SUBJECT TO CHANGE WITHOUT NOTICE. ALL STATEMENTS, INFORMATION, AND RECOMMENDATIONS IN THIS MANUAL ARE BELIEVED TO BE ACCURATE BUT ARE PRESENTED WITHOUT WARRANTY OF ANY KIND, EXPRESS OR IMPLIED. USERS MUST TAKE FULL RESPONSIBILITY FOR THEIR APPLICATION OF ANY PRODUCTS.

THE SOFTWARE LICENSE AND LIMITED WARRANTY FOR THE ACCOMPANYING PRODUCT ARE SET FORTH IN THE INFORMATION PACKET THAT SHIPPED WITH THE PRODUCT AND ARE INCORPORATED HEREIN BY THIS REFERENCE. IF YOU ARE UNABLE TO LOCATE THE SOFTWARE LICENSE OR LIMITED WARRANTY, CONTACT YOUR CISCO REPRESENTATIVE FOR A COPY.

The following information is for FCC compliance of Class A devices: This equipment has been tested and found to comply with the limits for a Class A digital device, pursuant to part 15 of the FCC rules. These limits are designed to provide reasonable protection against harmful interference when the equipment is operated in a commercial environment. This equipment generates, uses, and can radiate radio-frequency energy and, if not installed and used in accordance with the instruction manual, may cause harmful interference to radio communications. Operation of this equipment in a residential area is likely to cause harmful interference, in which case users will be required to correct the interference at their own expense.

The following information is for FCC compliance of Class B devices: The equipment described in this manual generates and may radiate radio-frequency energy. If it is not installed in accordance with Cisco's installation instructions, it may cause interference with radio and television reception. This equipment has been tested and found to comply with the limits for a Class B digital device in accordance with the specifications in part 15 of the FCC rules. These specifications are designed to provide reasonable protection against such interference in a residential installation. However, there is no guarantee that interference will not occur in a particular installation.

Modifying the equipment without Cisco's written authorization may result in the equipment no longer complying with FCC requirements for Class A or Class B digital devices. In that event, your right to use the equipment may be limited by FCC regulations, and you may be required to correct any interference to radio or television communications at your own expense.

You can determine whether your equipment is causing interference by turning it off. If the interference stops, it was probably caused by the Cisco equipment or one of its peripheral devices. If the equipment causes interference to radio or television reception, try to correct the interference by using one or more of the following measures:

- Turn the television or radio antenna until the interference stops.
- Move the equipment to one side or the other of the television or radio.
- Move the equipment farther away from the television or radio.
- Plug the equipment into an outlet that is on a different circuit from the television or radio. (That is, make certain the equipment and the television or radio are on circuits controlled by different circuit breakers or fuses.)

Modifications to this product not authorized by Cisco Systems, Inc. could void the FCC approval and negate your authority to operate the product.

The Cisco implementation of TCP header compression is an adaptation of a program developed by the University of California, Berkeley (UCB) as part of UCB's public domain version of the UNIX operating system. All rights reserved. Copyright © 1981, Regents of the University of California.

NOTWITHSTANDING ANY OTHER WARRANTY HEREIN, ALL DOCUMENT FILES AND SOFTWARE OF THESE SUPPLIERS ARE PROVIDED "AS IS" WITH ALL FAULTS. CISCO AND THE ABOVE-NAMED SUPPLIERS DISCLAIM ALL WARRANTIES, EXPRESSED OR IMPLIED, INCLUDING, WITHOUT LIMITATION, THOSE OF MERCHANTABILITY, FITNESS FOR A PARTICULAR PURPOSE AND NONINFRINGEMENT OR ARISING FROM A COURSE OF DEALING, USAGE, OR TRADE PRACTICE.

IN NO EVENT SHALL CISCO OR ITS SUPPLIERS BE LIABLE FOR ANY INDIRECT, SPECIAL, CONSEQUENTIAL, OR INCIDENTAL DAMAGES, INCLUDING, WITHOUT LIMITATION, LOST PROFITS OR LOSS OR DAMAGE TO DATA ARISING OUT OF THE USE OR INABILITY TO USE THIS MANUAL, EVEN IF CISCO OR ITS SUPPLIERS HAVE BEEN ADVISED OF THE POSSIBILITY OF SUCH DAMAGES.

CCSP, the Cisco Square Bridge logo, Follow Me Browsing, and StackWise are trademarks of Cisco Systems, Inc.; Changing the Way We Work, Live, Play, and Learn, and iQuick Study are service marks of Cisco Systems, Inc.; and Access Registrar, Aironet, ASIST, BPX, Catalyst, CCDA, CCDP, CCIE, CCIP, CCNA, CCNP, Cisco, the Cisco Certified Internetwork Expert logo, Cisco IOS, Cisco Press, Cisco Systems, Cisco Systems Capital, the Cisco Systems logo, Cisco Unity, Empowering the Internet Generation, Enterprise/Solver, EtherChannel, EtherFast, EtherSwitch, Fast Step, FormShare, GigaDrive, GigaStack, HomeLink, Internet Quotient, IOS, IP/TV, iQ Expertise, the iQ logo, iQ Net Readiness Scorecard, LightStream, Linksys, MeetingPlace, MGX, the Networkers logo, Networking Academy, Network Registrar, Packet, PIX, Post-Routing, Pre-Routing, ProConnect, RateMUX, ScriptShare, SlideCast, SMARTnet, StrataView Plus, SwitchProbe, TeleRouter, The Fastest Way to Increase Your Internet Quotient, TransPath, and VCO are registered trademarks of Cisco Systems, Inc. and/or its affiliates in the United States and certain other countries.

All other trademarks mentioned in this document or Website are the property of their respective owners. The use of the word partner does not imply a partnership relationship between Cisco and any other company. (0501R)



Audience	11
Conventions	11
Related Documentation	12
Obtaining Documentation and Submitting a Service Request	12

CHAPTER 1

Product Overview	1
Supported Interfaces	3
Cisco IOS Dependencies	3
Third-party Software	3
Modes of Operation	4
Directory	5
Configuration Service	5
Event Service	5
NameSpace Mapper	6
Event Gateway	6
Dynamic Template and Object	7
Data Structures	7
Image Service	7
imageInventoryResponse Message	7
Image Update Criteria	8
Distribution Decision Keys	8
PIX Firewall Support	10
Intelligent Modular Gateway	11
Restrictions	11
IMGW Device Module Toolkit	12
Modular Router Support	12
Encryption	13
Device Authentication	13
Bootstrap Password	13
Resynchronize cns_password	14
How the Cisco Configuration Engine Works	14
Load Initial Configuration	15
Load Partial Configuration	16

- EventIDs and ConfigIDs 17
- Dynamic ConfigID and EventID Change Synchronization 17
- Common Log File Location 17
 - Sample Logrotate Config File 18
 - Dynamic Log level Update 18
- Monitoring Service 18
 - Software Architecture 19
 - Daemon Start/Stop script 19
 - Logging 19
 - When HTTP is Down 19
 - End User Interface 20
 - Usage 20

CHAPTER 2

Graphical User Interface 1

- Logging In 1
- Logging Out 3
- Levels of Access 3
 - Operator-Level Operations 4
 - Administrator-Level Operations 4
- Feature Operations 4

CHAPTER 3

Device and Subdevice Manager 1

- Viewing Device Configuration 1
 - Using Advanced Search Feature 3
- Adding Devices 3
 - Adding Non-agent Enabled Devices 4
 - Hop Tables 8
 - Adding Agent Enabled Devices 12
 - Adding PIX Firewall Devices 16
- Discovering Devices 18
- Editing Devices 20
 - Editing Non-agent Enabled Device Information 22
 - Editing Agent Enabled Device Information 23
 - Editing PIX Device Information 24
 - Editing Device Templates 25
 - Editing Device Parameters 26
 - Editing Contact Information 26
 - Editing Subdevices 27

Editing Image Association Information	27
Resynchronizing Devices	27
Cloning Devices	28
Deleting Devices	30
Updating Device Configurations and Images	30
Updating Device Configurations	30
Updating Device Images	32
Customize Job Template	35
Configuration Control Template	36
Working with Subdevices	37
Viewing Subdevices	37
Adding Subdevices	37
Editing Subdevices	39
Editing Subdevice Information	40
Editing Subdevice Template	40
Editing Subdevice Parameters	41
Editing Contact Information	41
Cloning Subdevices	41
Deleting Subdevices	43
Querying Device Inventory	44
Delete Files on Device	46
Dynamic Operations	48

CHAPTER 4

User Account Manager	1
Adding User Account	1
Editing User Account	3
Deleting User Account	5
Changing User Password	5
Changing Account Privilege Level	6

CHAPTER 5

Configuration and Image Update Jobs Manager	1
Querying Jobs	1
Canceling or Stopping Jobs	2
Restarting Jobs	2
Deleting Completed Jobs	3

CHAPTER 6

Groups 1

- Viewing Groups 1
- Creating Groups 2
- Editing Groups 3
- Cloning Groups 3
- Moving Groups 4
- Deleting Groups 4
- Creating Groups Using Search 4

CHAPTER 7

Namespace Manager 1

- Viewing Events 1
- Adding Events 2
- Editing Events 4
- Deleting Events 5

CHAPTER 8

Query Manager 1

- Viewing Queries 1
- Creating Queries 2
- Editing Queries 3
- Deleting Queries 4

CHAPTER 9

Data Manager 1

- Scheduling Data Backup 1
- Updating Product List 3
- Managing Disk Space 4

CHAPTER 10

Directory Manager 1

- Editing Schema 1
- Importing Schema 2

CHAPTER 11

Parameter Manager 1

- Parameter Validations 1
- Edit Fetch Process 2
- Edit Save Process 3
- Import Script File 3

CHAPTER 12**Templates 1**

- Sample Template 1
- Configuration Control Templates 3
- Dynamic Flow Control Template 3
 - Inventory Operations 3
 - Other Operations 6
 - Notes 6
 - Sample1 7
 - Sample 2 7
 - Sample 3 7
- Templates for Modular Routers 7
 - Sample Templates for Modular Router 9
 - Main Device Template 9
 - FastEthernet Template 10
 - Voice-port Template 10
 - Modular Router Events 11
- Dynamic Templates 11
- Control Structures 12
- Managing Templates 13
 - Adding a Template 14
 - Editing a Template 15
 - Deleting a Template 16
 - Importing a Template 17

CHAPTER 13**Security Manager 1**

- Changing Bootstrap Password 1

CHAPTER 14**Log Manager 1**

- Viewing Log Files 1
- Clearing Logs 3
- Exporting Logs 4
- Changing Log Level 5

CHAPTER 15**Service Manager 1**

- Editing Service Properties 1
- Editing IMGW Device and Hop Types 3

CHAPTER 16

Bulk Data Manager 1

- XML DTD 1
- Uploading Bulk Data 3
 - Command-Line Upload of Bulk Data 4
 - Using Data Converter Utility 4
- Creating Sample Data 4
 - NSM Data Sample 5
- NSM Data Sample With Image Information 7
 - Image Sample Data 8

CHAPTER 17

Email Manager 1

- Editing Email SMTP Host 1

CHAPTER 18

Image Service 1

- Working with Images 1
 - Viewing an Image 1
 - Adding an Image 2
 - Editing an Image 5
 - Deleting an Image 7
 - Associating Images with Devices 7
- Search Parameters 9
 - Viewing Search Parameters 9
 - Creating Search Parameters 10
 - Editing Search Parameters 11
 - Deleting Search Parameters 11

CHAPTER 19

Upgrade or Downgrade Cisco IOS Image 1

- Things to Know 1
 - 12.0 -> 12.2 1
 - Procedure 2
 - 12.0 -> 12.3(3) or later 3
 - 12.2 -> 12.3(3) or later 3
 - Procedure 3
 - 12.3(3) or later -> 12.3(3) or later 4
 - Procedure 4
 - 12.3(3) or later -> 12.2 4
 - 12.3(3) or later -> 12.0 5

CHAPTER 20**Backup and Restore 1**

- Backup Procedure 1
- Data Restore Procedure 3
- Definitions 4

CHAPTER 21**PIX Firewall Device Support 1**

- PIX Device Polls for Updates 2
- Configuration Processing 2
- Image Processing 2
- Error Processing 3
- Processing a DeviceDetails Request from PIX Device 3
- PIX DeviceID 4
- Security Considerations 4
- PIX Device Polling Setup 4
- Configuration and Restrictions 5

CHAPTER 22**IMGW Device Module Development Toolkit 1**

- User Types 1
- Toolkit Usage 1
 - Plug Device Module Into Cisco Configuration Engine 2
 - Update Device Module on Cisco Configuration Engine 2
 - Unplug Device Module from Cisco Configuration Engine 2
- IMGW Southbound Interface 2
 - User Designed Device Module Specifications 3
 - Config Event 3
 - Exec Event 3
 - Hop Test 3
 - Parameter Descriptions 3
 - Exit Codes 5
- How to Develop Plug-in Device Module 6
 - Development Guidelines 6
 - Device Configuration Update 6
 - Command Execution 7
 - Hop Test 7
- Installing Plug-in Device Module 7
- Registering Plug-in Device Module 8
- End User Interface 8
- Configuration and Restrictions 8

Device Module Restrictions 8
 Registration Utility Restriction 8

APPENDIX A

Troubleshooting 1

Contacting Cisco TAC 1
 Cannot Log Into the System 1
 System Cannot Connect to the Network 2
 Cannot Connect to the System Using a Web Browser 3
 Cannot Connect to System with SSH or SSH Interaction is Slow 4
 Cannot Connect to System Using Telnet 4
 Backup and Restore not Working Properly 4
 No Crontab Set for Backup Job when /var is 100% Full. 5
 How to Use the showversion Command 5
 Using the cns-send and cns-listen Commands 5
 cns-send 5
 cns-listen 6

APPENDIX B

Software Licenses and Acknowledgements 1

Active TCL License Agreement 1
 Active Perl License Agreement 2
 OpenLDAP Public License 3
 Berkeley DB Software License Agreement 4
 Notices 6
 OpenSSL/Open SSL Project 6
 License Issues 6
 Apache and Tomcat 8
 ssldump 8
 Mozilla Public License 9
 GNU General Public License 9
 GNU Lesser General Public License 10

INDEX



Preface

This document describes how to conduct administrative tasks as they relate to the Cisco Configuration Engine, 2.0. It also contains information about how to administer the various network management features available with this product.



Note

This product contains cryptographic features and is subject to US and local laws governing import, export, transfer, and use.

Audience

This guide is intended primarily for:

- System administrators familiar with installing high-end networking equipment
- System administrators responsible for installing and configuring internetworking equipment who are familiar with Cisco IOS software

Conventions

This guide uses basic conventions to represent text and table information.

- Commands that you enter are in **boldface** font.
- Variables for which you supply values are in *italic* font.
- Terminal sessions and information the system displays are printed in `screen` font.
- Information you enter is in **boldface screen** font. Variables you enter are printed in *italic screen* font.
- Button names are in **boldface** font.



Note

Means *reader take note*. Notes contain helpful suggestions or references to materials not contained in the manual.



Caution

Means *reader be careful*. You are capable of doing something that might result in equipment damage or loss of data.

Related Documentation

Other documentation related to this product include:

- *Cisco Configuration Engine Linux Installation & Configuration Guide, 2.0*
- *Cisco Configuration Engine Solaris Installation & Configuration Guide, 2.0*
- *Release Notes for Cisco Configuration Engine, 2.0*
- *Cisco Configuration Engine Software Development Kit API Reference and Programmer Guide, 2.0*
- *Cisco Configuration Engine SDK Cookbook*

Obtaining Documentation and Submitting a Service Request

For information on obtaining documentation, submitting a service request, and gathering additional information, see the monthly *What's New in Cisco Product Documentation*, which also lists all new and revised Cisco technical documentation, at:

<http://www.cisco.com/en/US/docs/general/whatsnew/whatsnew.html>

Subscribe to the *What's New in Cisco Product Documentation* as a Really Simple Syndication (RSS) feed and set content to be delivered directly to your desktop using a reader application. The RSS feeds are a free service and Cisco currently supports RSS version 2.0.



Product Overview

This chapter provides a high-level overview of the Cisco Configuration Engine. It is organized as follows:

- [Cisco IOS Dependencies](#)
- [Modes of Operation](#)
- [Configuration Service](#)
- [Event Service](#)
- [Dynamic Template and Object](#)
- [Image Service](#)
- [PIX Firewall Support](#)
- [Intelligent Modular Gateway](#)
- [IMGW Device Module Toolkit](#)
- [Modular Router Support](#)
- [Encryption](#)
- [How the Cisco Configuration Engine Works](#)
- [Dynamic ConfigID and EventID Change Synchronization](#)
- [Common Log File Location](#)

The Cisco Configuration Engine is a network management application that acts as a configuration service for automating the deployment and management of network devices and services (see [Figure 1-1](#)).

The Cisco Configuration Engine runs on Linux and Solaris hardware platforms. See either *Cisco Configuration Engine Linux Installation & Configuration Guide, 2.0* or *Cisco Configuration Engine Solaris Installation & Configuration Guide, 2.0*.

Figure 1-1 Cisco Configuration Engine Architectural Overview

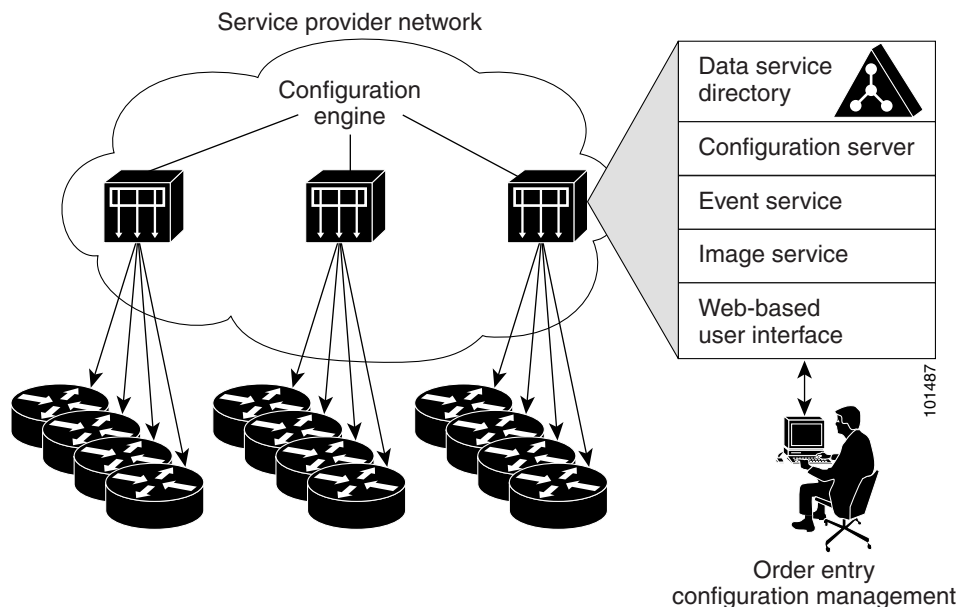

Each Cisco Configuration Engine manages a group of Cisco devices and services they deliver, storing their configurations and delivering them as needed. The Cisco Configuration Engine automates initial configurations and configuration updates by generating device-specific configuration changes, sends them to the device, executes the configuration change, and logs the results.

**Note**

If you are running devices that use an earlier version of Cisco IOS, or a different operating system, such as Catalyst, you should invoke the Intelligent Modular Gateway for communicating with the device. For more information about Intelligent Modular Gateway, see [“Intelligent Modular Gateway” section on page 1-11](#).

The Cisco Configuration Engine utilizes the following popular industry standards and technologies:

- eXtensible Markup Language (XML)
- Java naming directory interface (JNDI)
- Hypertext Transport Protocol (HTTP)
- Java servlets
- Lightweight Directory Access Protocol (LDAP)

The Cisco Configuration Engine supports two modes of operation (Internal Directory and External Directory) and it includes the following Cisco Configuration Engine, 2.0 components:

- Configuration service (web server, file manager, and namespace mapping server)
- Image Service (Cisco IOS images)
- Event service (event gateway)
- Data service directory (data models and schema)
- Intelligent Modular Gateway (IMGW)

The Cisco Configuration Engine can be used as the runtime component for deployment of customer-developed applications. These applications can be developed using the Cisco Configuration Engine Software Development Kit API Reference and Programmer Guide, 2.0.

Supported Interfaces

The software external interfaces for Cisco Configuration Engine, 2.0 include:

- Unix login
- Telnet
- SSH

Cisco IOS Dependencies

Table 1-1 shows Cisco IOS versions with corresponding versions of Cisco Configuration Engine including feature limitations associated with each version.

Table 1-1 Cisco Configuration Engine 2.0 and Cisco IOS Dependencies

Cisco IOS	Cisco Configuration Engine	Limitations
12.3	1.3.2 or later	
12.2(11)T	1.2 or later	
12.2(2)T	1.2 or later with no authentication.	Applications will be unable to use exec commands or point-to-point messaging.

Third-party Software

Table 1-2 Third-party Software

Component	Version
Linux	2.0.46
Solaris	1.3.26
Tibco	7.2
Apache	2.0.46
Velocity	1.4 patch
Log4j	1.2.7
Jakarta-tomcat	4.1.30
Jakarta-regexp	1.2
HTTPClient	2.0
Digester	1.5
Regular Express	1.1.4

Table 1-2 *Third-party Software (continued)*

Component	Version
Strut	1.1.plus
Displaytag	1.0
XERCES	2.5.0
Freemarker	2.2.5
IBM Java	1.4.2
Java JDK	1.4.1
ACE	5.4.1
PERL	5.8
TCL	8.3
Openssl	0.9.6b
Axis	1.1
JavaMail	1.3
Junit	3.8.1
Wutka (Jox)	1.16
XSLT LotusXSL	2.3.2
OpenLDAP	2.2.26
unixODBC	2.2.11
Berkeley DB	4.3
jakarta-commons-beanutils	1.6.1
jakarta-commons-cli	1.0
jakarta-commons-collections	3.1
jakarta-commons-lang	2.0
jakarta-commons-logging	1.0.4
jakarta-commons-net	1.0.0
jce	1.2.1
jfreechart	0.9.20
jsse	1.0.3.01
pja	2.5
rhino	1.5.3
rss4j	0.92

Modes of Operation

There are two modes of system operation for the Cisco Configuration Engine:

- Internal Directory Mode
- External Directory Mode

Directory

Cisco Configuration Engine, 2.0 uses OpenLDAP for Directory services.

OpenLDAP can be configured to use internal or external database as data repository for the Directory. When configured to use internal database (Internal Directory Mode), OpenLDAP stores data in plain files using Berkeley DB library. When configured to use external database (External Directory Mode), OpenLDAP stores data in relational tables using ODBC library

OpenLDAP can also be configured to act as a proxy to forward incoming LDAP requests to another external LDAP server, which provides another possibility for string data in external LDAP server, e.g., iPlanet.

**Note**

GUI access to User Manager and Directory Manager is not available when operating in External Directory mode.

Configuration Service

The Configuration Service is the core component of the Cisco Configuration Engine. It consists of a configuration server that works in conjunction with configuration agents located at each router. The Configuration Service delivers device and service configurations to Cisco IOS devices for initial configuration and mass reconfiguration by logical groups. Routers receive their initial configuration from the Configuration Service when they start up on the network the first time.

The Configuration Service uses Event Service to send events required to apply configuration changes and receive success and failure notifications.

The configuration server consists of a web server that uses configuration templates and the device-specific configuration information stored in the embedded (Internal Directory mode) or remote (External Directory mode) directory.

Configuration templates are text files containing static configuration information in the form of command-line interface (CLI) commands. In the templates, variables are specified using lightweight directory access protocol (LDAP) URLs that reference the device-specific configuration information stored in the directory.

The configuration template includes additional features that allow simple conditional control structures and modular sub-templates in the configuration template (see the [Chapter 12, “Templates.”](#)).

The configuration server uses Hypertext Transport Protocol (HTTP) to communicate with the Configuration Agent running on the managed Cisco IOS device. The configuration server transfers data in eXtensible Markup Language (XML) format. The configuration agent in the router uses its own XML parser to interpret the configuration data and remove the XML tags from the received configuration.

The configuration agent can also perform a syntax check on received configuration files. The configuration agent can also publish events through the event gateway to indicate the success or failure of the syntax check.

Event Service

The Cisco Configuration Engine uses the Event Service for receipt and generation of events. The Event Agent resides on Cisco IOS devices and facilitates communication between routers and the Event Gateway on the Cisco Configuration Engine.

The Event Service is a highly-scalable publish and subscribe communication method. The Event Service uses subject-based addressing to help messages reach their destination. Subject-based addressing conventions define a simple, uniform namespace for messages and their destinations.

NameSpace Mapper

The Namespace Mapping Service (NSM) allows you to address multiple network devices by a single posting of a publish or subscribe event, and it allows your network administrator to map Cisco-standardized event names to names of his or her choosing.

For example, in a network of 100 routers, there might be 10 that the administrator wants to configure as a VPN (Virtual Private Network). In order to load a configuration into each of these devices, your client application could either publish 10 *cisco.mgmt.cns.config.load.<deviceId>* events, or the administrator could associate the 10 devices with a common group name and your client application can post the event once. The associated administration steps are:

1. Using the device management interface, define all the device objects (see [Chapter 3, “Device and Subdevice Manager”](#)).
2. Using NSM administration interface, remap both the subscribe and publish map of *cisco.mgmt.cns.mgmt.config.load* subject to *application.load* (see [Chapter 7, “Namespace Manager”](#)).
3. For example, using the group management interface, group all the devices in the West Coast under a group called “westcoast” (see [Chapter 6, “Groups”](#)).
4. The client application would publish the mapped subject *application.load./config/westcoast* on the event bus and the devices in the “westcoast” group would get the event. The mapped subject is returned to the client application by the NSM's operational API when querying for the publish mapping for the event *cisco.mgmt.cns.config.load*.

Event Gateway

The Event Gateway acts as a relay between the Integration Bus and agent-enabled devices, which enables event-based communication. The Event Gateway uses NSM to map subjects.

Each Event Gateway process can support up to a maximum of 500 devices. To support more than 500 devices, you can run multiple gateway processes.

During **Setup**, you can set the number of concurrent gateway processes to start with either one or both of the following prompts, depending on how you want to setup your SSL (see [“Encryption” section on page 1-13](#)) communications:

```
Enter number of Event Gateways that will be started with crypto operation:
Enter number of Event Gateways that will be started with plaintext operation:
```

The original servlet, *com.cisco.cns.config.Config*, gets the configuration template from the attribute value of the Device Object in the configuration server data store (LDAP server), parses the template, and does string substitution on parameters inside the template. It is tightly coupled with the template that is assigned to the device and the attributes of device object.

The new servlet, **DynaConfig**, loosens the restriction so that the template can be assigned dynamically and the parameter values can be obtained from other objects in data store.

This servlet gets **PathInfo** information by means of `HttpServletRequest.getPathInfo()`, parses it, and gets the related template name and object reference. The structure of **PathInfo** is:

`/<argument name>=<argument value>`.

Dynamic Template and Object

The original servlet, `com.cisco.cns.config.Config`, gets the configuration template from the attribute value of the Device Object in the configuration server data store (LDAP server), parses the template, and does string substitution on parameters inside the template. It is tightly coupled with the template that is assigned to the device and the attributes of device object.

The new servlet, **DynaConfig**, loosens the restriction so that the template can be assigned dynamically and the parameter values can be obtained from other objects in data store.

This servlet gets **PathInfo** information by means of `HttpServletRequest.getPathInfo()`, parse it, and gets the related template name and object reference. The structure of **PathInfo** is:

`/<argument name>=<argument value>`.

Data Structures

The feature of dynamic template and object utilizes **PathInfo**, which is passed from the client side to the servlets. The structure of **PathInfo**, which the servlet can understand is in following format:

```
[/<argument name>=<value>]*
```

The argument and format for dynamic template and object is:

```
[/cfgtpl=value[/object=value]]
```

For more information about Dynamic Template and Object, see to the *Cisco Configuration Engine Software Development Kit API Reference and Programmer Guide, 2.0*.

Image Service

The Image Service is an automated, scalable, and secure mechanism designed to distribute Cisco IOS images and related software updates to Cisco IOS devices that have Cisco Intelligence Agents (CIAs).

All the image upgrading decisions are made by the image server. These decisions are based on the inventory response information returned by the image agent.

imageInventoryResponse Message

The **imageInventoryResponse** message contains an `imageInventoryReport` XML document. This report contains information about:

- The running image on the system
- The systems hardware resources
- The various file systems and files on the device.

The **imageInventoryResponse** is a response to an `imageInventoryRequest`. The resources requested by the tags in the request are sent in the **imageInventoryResponse** message. The `messageID` element from the request is included in the `messageID` element of the response message.

For the devices hardware resources, the minimum information reported is:

- Size of the system RAM available to run an image.
- Name(s) of the system (hostname and, imageID).
- Type of the device hardware
- Serial numbers of various hardware components.
- Currently running system image on the managed device provides the following information:
 - Image file name and location, for example *flash:/c2600-is-mz*.
 - MD5 hash of image file if it can be calculated.
 - Version string, for example *IOS (tm) C2600 Software (C2600-IS-M) Version 12.2(10.7)T, MAINTENANCE INTERIM SOFTWARE*.
- The date and time that the image was booted.
- In addition, for each local persistent file system on the device, the following information is reported:
 - Name of file system.
 - Type of the file system.
 - Size of file system.
 - Free space available.
 - Read/Write protect flags.
- For each file in each of the reported file systems, the following information is reported:
 - Name (both file name, and the complete fully qualified path name).
 - Size.
 - R/W permission flags.
 - Modification date.
- For each directory in the file system, the following information is reported:
 - Name (both directory name, and the complete fully qualified path name).
 - R/W permission flags.

Image Update Criteria

When Image Service is instructed to evaluate a given device for distribution and/or activation, it sends out an **ImageCheckServer** message over the Event Bus to get Inventory and analyze the inventory content to decide what attributes should be used to do the comparison.

Currently the following values are used from Inventory to determine which Comparison class to use:

- MD5
- ImageFile
- File System

Distribution Decision Keys

File System Activation decision keys:

- ImageFile
- MD5
- Version String

Image Service makes decisions in the following order:

1. If MD5 and File System exist:

a. Distribution:

- If **Destination** in Distribution object exists on File System in Inventory, it is not necessary to distribute this file if *Overwrite* flag is not set. For example, **Destination** is *slot0:pf-1.img4*, if inventory return by device has a file *pf-1.img4* on slot0, Server decides this distribution is not needed.
- If **Destination** does not exist in File System in Inventory, it starts to check if there is enough space left for this file on that location.

If **Erase** is checked, server gets total size of that file system (i.e. slot0) to see if the can file fit into this file system. For example, if slot0 has 1000 bytes free, 2000 bytes total size, and file size on distribution is 100 bytes, server does $2000 - 100$ to check if the result is >0 . If >0 , it is okay to distribute.

If **Overwrite**, server gets remaining free space size of that file system and adds the original file size on Inventory back, then it sees if the file will fit into this file system. For example, if slot0 has 1000 bytes free, the file is 100 bytes on inventory, the file size on distribution is 200 bytes and **Overwrite** is set, server does $1000 + 100 - 200$ to check if slot0 remaining free size is >0 . If >0 , it is okay to distribute.

b. Activation:

Server uses MD5 to compare between **RunningImageInfo** from Inventory and **ImageObject** on server side. If they are the same, Activation is not necessary.

2. If ImageFile and File System exists:

a. Distribution: (The same as 1a).

b. Activation:

Server compares *ImageFile* in **RunningImageInfo** from Inventory with **Destination** attribute on Distribution Object on server side. If they are the same, Activation is not necessary.

3. If Version String and File System exists:
 - a. Distribution: (The same as 1a).
 - b. Activation:

Server compares *Version String* in **RunningImageInfo** from Inventory with *Description* on Image Object from server side. If they are the same, Activation is not necessary.
4. If Only ImageFile exists:
 - a. Distribution:

Server always thinks Distribution is necessary. (Because server uses *ImageStatus* message to verify if the result of Distribution is successful.)
 - b. Activation: (The same as 2b).
5. If Only Version String exists:
 - a. Distribution: (The same as 4a).
 - b. Activation: The same as 3b).
6. If Only File System exists:
 - a. Distribution: (The same as 1a).
 - b. Activation:

Server always thinks Activation is not necessary. (Because there is no way to verify if the result of Activation is successful.)
7. If none of those attributes exists in Inventory:
 - a. Distribution:

Server always thinks Distribution is not necessary.
 - b. Activation:

Server will always think Activation is not necessary.

For more information about how to use the Image Service, see [Chapter 18, “Image Service.”](#)

For those devices that do not have a Cisco image agent, non-Cisco IOS devices, and non-Cisco devices, you can use the IMGW Toolkit to create scripts that support SSH sessions between these devices and the Cisco Configuration Engine, 2.0.

For more information about the IMGW Device Module Toolkit, see [Chapter 22, “How to Develop Plug-in Device Module.”](#)

PIX Firewall Support

Cisco Configuration Engine provides configuration management and image service to Cisco PIX firewall devices (PIX device).

For more information about PIX firewall support, see [Chapter 21, “PIX Firewall Device Support.”](#)

Intelligent Modular Gateway

Intelligent Modular Gateway (IMGW) allows you to run the Cisco Configuration Engine for automatically distributing configuration files to Cisco IOS network devices running Cisco IOS versions earlier than 12.2(2)T; as well as to Catalyst switches, CCS 11k devices, Cache Engines, and PIX firewalls.

**Note**

If you are running devices that use Cisco IOS version 12.2(2)T or later, you should use the Event Gateway.

The Intelligent Modular Gateway accomplishes this task by adding the ability to use alternate access methods (Telnet and SSH) to connect to devices that do not have Cisco Configuration Engine agents in their software.

The interface to the Intelligent Modular Gateway is the same as that of the Event Gateway. It responds to the same events. The NameSpace Mapper operates in the same way. Therefore, after some initial setup work is done, applications need not know the difference between communicating with agent-enabled devices by way of the Event Gateway and non-agent devices by way of the Intelligent Modular Gateway.

Restrictions

Using the Intelligent Modular Gateway with an SSH transport creates some restrictions in terms of how the Cisco Configuration Engine architecture is used.

- When using SSH as a transport, no syntax checking can be done on the configurations before they are applied.

Syntax checking in the Cisco Configuration Engine architecture is accomplished by an intelligent agent in the device that has access to internal parser functions. An SSH interface does not provide any means to access this functionality. Therefore, any syntax checking attributes are ignored. Errors are only detected when the configuration is actually applied and applications must deal with the fact that configuration lines prior to the error were executed.

- Because all logic is external to the device, there is no way to watch for configuration changes that are done outside the scope of the network management software.

For example, if a network administrator uses a standard SSH client to directly access a network element and changes the configuration, that element would not be synchronized with the network management infrastructure, and depending on the change, might become unmanageable. This is especially true if the login mechanisms (usernames and passwords) are changed. Login mechanism changes should be handled during a maintenance window, during which event-based configuration is not occurring, so that race conditions do not occur. Any such changes must be reflected on the provisioning system's device information screen so that the Device Information Database is properly updated before any new partial configurations are sent.

- The scope of error checking upon configuration load is limited to syntax checking.

Semantic errors cannot be detected. The output is returned in a buffer that applications should log. In a case where something is not operating properly, a network administrator can manually look at the log of what the device was reporting and determine if a semantic error occurred.

- The initial configuration mechanism as defined in the Cisco Configuration Engine architecture is not supported.

This mechanism allows a router to be preconfigured with the **ens config initial** command, causing it to contact the configuration server to retrieve its initial configuration. However, because the legacy devices do not have the agent code in them, they can never contact the configuration server (they do not understand the configuration command). Therefore, this mechanism does not make sense when using SSH as a transport. If an initial configuration needs to be delivered by the Cisco Configuration Engine, it has to be done through the partial configuration mechanism.

- Aside from the device information database, the gateway is stateless.

There is no read back of configurations to make sure they were applied, nor is there automatic rollback of configurations if a failure occurs.

- If a device is not directly connected to the management network, it must be attached through a Cisco communication servers.

The API allows you to set up an arbitrary network topology to reach the device. However, this release only supports two possible topologies: direct connection to one of the device network interfaces, or console access by way of a Cisco access server, such as a 2511.

- Device failures are only detected within a user-specified polling interval.

This is because while the standard Event Gateway requires that routers maintain a connection to the Event Gateway (so any breakage of that connection would signal a problem), the SSH interface is implemented through a transient connection. Therefore, the gateway must poll all devices at some user-specified interval to make sure they are responding, so failure detection is not immediate.

- When both agent-enabled and legacy devices are present on the same network, it is recommended that both gateways be run at the same time.

The standard Event Gateway talks to the agent-enabled devices and the Intelligent Modular Gateway talks to the legacy devices.



Note Do not put an entry in the Device Information Database for a router that is already agent-enabled because both gateways will try to control the router and unpredictable results might occur.

IMGW Device Module Toolkit

The Intelligent Modular Gateway (IMGW) Device Module Toolkit allows you to develop your own device modules, plug them into Cisco Configuration Engine, then use them to configure devices.

For more information about the IMGW Device Module Toolkit, see [Chapter 22, “IMGW Device Module Development Toolkit.”](#)

Modular Router Support

Cisco Configuration Engine supports modular routers. A modular router chassis includes slots in which you can install line and network interface cards.

For a modular router, a subdevice configuration object and configuration template is defined for every network module whose interfaces need to be configured and for which the interface number can be variable; based on the slot. Then, a device configuration object and a template is defined for the main device. Fixed interface numbers can be configured in the main device template.

Modular router events are published to the event bus and are accessible to applications connected to the bus. The Cisco IOS device publishes the system hardware configuration in the *cisco.mgmt.cns.inventory.device-details* event after hardware discovery. The Cisco Configuration Engine is configured to listen for this event, retrieve it and extract the hardware configuration of the device.

Encryption

Secure Socket Layer (SSL) method has been adopted as the encryption mechanism for HTTP sessions between the configuration agent and the configuration server, and the TCP session between the Event Gateway and the event agent.

To use encryption, the Cisco IOS devices must be running a crypto image and version 12.2(11)T of the Cisco IOS.

Device Authentication

The configuration server and Event Gateway are supplied with a X.509 certificate generated by a certificate authority (CA) server. It is the responsibility of the network administrator to have a CA server and to control certificate generation and revocation.

To be configured, the Cisco IOS device must be recognized by the CA. There is no client-side certificate in the Cisco IOS device.

For the configuration server, after the Cisco IOS device has validated the certificate, it sends a password over the encrypted pipe. The device uses the password to be authenticated by the Cisco Configuration Engine.



Note

Authentication is also done when the links are in clear text.

A server configured for secure connections is also able to enact non-secure (clear-text) sessions. The password check is done regardless of whether encryption is used or not.

After the server is secured, it is no longer be able to process requests that do not have a password. It cannot tell the difference between a clear text request from a device in a secure environment or from a device in a non-secure environment.

For the Event Gateway, after the Cisco IOS device has validated the certificate, it sends a DeviceID control message over the encrypted pipe that has the Cisco Configuration Engine password of the device. The **event_id:cns_password** is validated using the authentication API. If it is not matched, the SSL session is terminated and an entry is made to the security log. This ensures only authorized customer premises equipment (CPE) devices connect to the Event Gateway and are able to use the Integration Bus.

Bootstrap Password

Cisco Configuration Engine provides a bootstrap password for use where multiple devices are deployed in a batch. In this case, all devices in a particular batch are given the same (bootstrap) password to use when they each start up on the network for the first time.

The bootstrap password can be changed for different batches of devices by using the **BootStrap** function under Security Manager in the user interface (see [Chapter 13, “Security Manager”](#)).

Resynchronize cns_password

If the password of a device becomes corrupted so that there is a mismatch between the device and the corresponding password information held in the Cisco Configuration Engine directory, you can resynchronize the device with the Cisco Configuration Engine by using the **Resync Device** function in the user interface (see “Resynchronizing Devices” section on page 3-27).

How the Cisco Configuration Engine Works

The Cisco Configuration Engine dynamically generates Cisco IOS configuration files (documents), packages these file in XML format, and distributes them by means of Web/HTTP (see Figure 1-2 on page 1-14). This takes place in response to a *pull* (get) operation.

Figure 1-2 Configuration Engine Functional Diagram

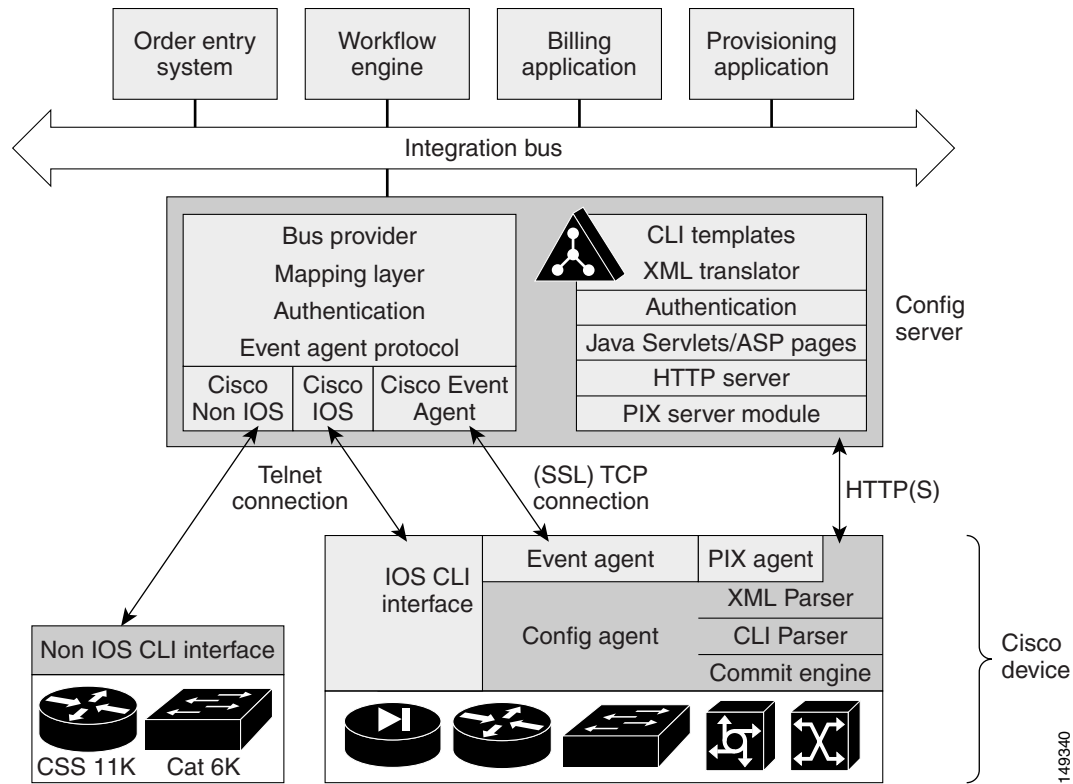

A Cisco IOS device initiates a get operation when it first appears on the network (**cns config init...**) or when notified (by subscribed event) of a configuration update (**cns config partial...**).

Note

For more information about these and other related CLI commands, see the Cisco IOS configuration guide and command reference publications.

When a Cisco IOS device issues a request for a device configuration file, the request includes a unique identifier (configID = hostname) used to help locate the relevant configuration file parameters for this device on the directory server. Figure 1-3 shows the process flow for a configuration load operation.

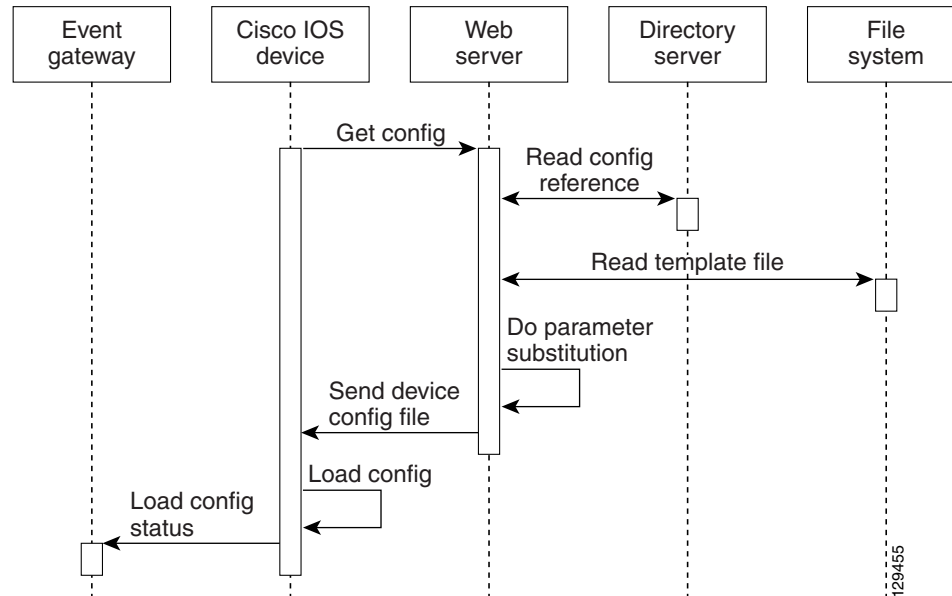
Figure 1-3 Configuration Load Process Flow

When the web server receives a request for a configuration file, it invokes the Java Servlet and executes the embedded code. This directs the web server to access the directory server and file system to read the configuration reference for this device and template. The configuration server prepares an instantiated configuration file by substituting all the parameter values specified in the template with valid values for this device. The configuration server forwards the configuration file to the web server for transmission to the Cisco IOS device.

The configuration agent at the router accepts the configuration file from the web server, performs XML parsing, syntax checking (optional), and loads the configuration file. The router reports the status of the configuration load as an event that can be subscribed to by a network monitoring or workflow application.

Load Initial Configuration

1. The Cisco Configuration Engine reads the template files.
2. The Cisco Configuration Engine does the parameter substitution.
3. The Cisco Configuration Engine sends the device configuration to the Cisco IOS device.
4. The Cisco IOS device tries to load the initial configuration.
5. The Cisco IOS device publishes the load configuration status event to the event gateway.

Modular Router

1. The modular router posts an HTTP request containing the hardware configuration to the Cisco Configuration Engine for the initial configuration.
2. The Cisco Configuration Engine reads the hardware configuration of the device from the HTTP request and updates the directory server with the latest configuration.
3. The Cisco Configuration Engine reads the template files.
4. The Cisco Configuration Engine does the parameter substitution.

5. The Cisco Configuration Engine sends the device configuration to the Cisco IOS device.
6. The modular router tries to load the initial configuration.
7. The modular router publishes the load configuration status event to the event gateway.

Load Partial Configuration

1. The user modifies a template in the Cisco Configuration Engine user interface.
2. The template contents are passed to the Cisco Configuration Engine.
3. The Cisco Configuration Engine stores the template in the file system.
4. The user clicks the update device button in the user interface.
5. The Cisco Configuration Engine publishes a *cisco.mgmt.cns.config.load* event.
6. The Cisco IOS device receives the *cisco.mgmt.cns.config.load* event and in response to this event requests its configuration by contacting the server.
7. The Cisco Configuration Engine reads the template files.
8. The Cisco Configuration Engine sends the device configuration to the Cisco IOS device.
9. The Cisco IOS device tries to load the partial configuration.
10. The Cisco IOS device publishes the load configuration status event to the event gateway.

Modular Router

1. The user modifies a template in the Cisco Configuration Engine user interface.
2. The template contents are passed to the Cisco Configuration Engine.
3. The Cisco Configuration Engine stores the template in the file system.
4. The user clicks the update device button in the user interface.
5. The Cisco Configuration Engine publishes a *cisco.mgmt.cns.config.load* event.
6. The modular router retrieves the *cisco.mgmt.cns.config.load* event and in response to this event requests its configuration by contacting the server.
7. The Cisco IOS device posts a HTTP request containing the hardware configuration to the Cisco Configuration Engine for the partial configuration.
8. The Cisco Configuration Engine reads the hardware configuration of the device from the HTTP request and updates the directory server with the latest configuration. The Cisco Configuration Engine does the parameter substitution.
9. The Cisco Configuration Engine reads the template files.
10. The Cisco Configuration Engine does the parameter substitution.
11. The Cisco Configuration Engine sends the device configuration to the modular router.
12. The modular router tries to load the partial configuration.
13. The modular router publishes the load configuration status event to the event gateway.

EventIDs and ConfigIDs

The Cisco Configuration Engine intersects two name space domains:

- Configuration Domain
- Event Domain

The Cisco Configuration Engine, 2.0 uses the Configuration Domain when a device communicates with the configuration server. It uses the Event Domain when a device communicates with the Cisco Configuration Engine using the publish and subscribe mechanism of the Integration Bus.

The device must be uniquely identified in these namespaces. The ConfigID uniquely identifies the device in the Configuration Domain. The EventID uniquely identifies the device in the Event Domain.

Because the Cisco Configuration Engine uses both the Integration Bus (event bus) and the configuration server to provide configurations to devices, both EventID and ConfigID must be defined for each configured Cisco IOS device.

The values for EventID and ConfigID for each device can be identical, or you can make them different when you add or edit device information using the user interface (see [“Editing Devices” section on page 3-20](#)).

Dynamic ConfigID and EventID Change Synchronization

The Cisco IOS, version 12.2.(11)T, was enhanced with new CLI ID commands that can modify the EventID and ConfigID, then reconnect the device to the Cisco Configuration Engine with the new IDs.

Common Log File Location

In Cisco Configuration Engine, 2.0, all log files go into `/var/log/CNSCE/<modulename>`. For all Cisco Configuration Engine logs, this feature also includes custom logrotate scripts, located in the `/etc/logrotate.d/cnsce` directory.

Logrotate is a system utility that can rotate specified log files according to the conditions specified in a config file. There is a config file defined for each module (see [“Sample Logrotate Config File” section on page 1-18](#)). An Administrator-level user can make use of these config files to rotate logs of any module at any time.

For example, the command `logrotate -f /etc/logrotate.d/cnsce/imgw` rotates all IMGW logs and backs up all existing logs in the `/var/log/CNSCE_ROTATED_LOGS` directory. This is a common backup directory where all the rotated logs for all the modules are dumped.

Having a common directory allows you to set aside separate partition, or space, for backup logs.

Sample Logrotate Config File

```
#-----
# Copyright (c) 2002, 2003, 2004 by Cisco Systems, Inc.
# All rights reserved.
#-----
/var/log/CNSCE/imgw/* {
daily
missingok
copytruncate
compress
olddir /var/log/CNSCE_ROTATED_LOGS
}
```

Dynamic Log level Update

With this release, you can now change the log level programmatically using Web Services. A new API has been defined in Admin Web Service: *setLogLevel(int level, Token token)*.

```
/**
 * Changes the logging level of CE components.
 *
 * @param level, the logging level. Allowed values debug, info, warn, error
 * , fatal
 * @param token a Token object.
 * @return int, the new Log level.
 * @throws AdminServiceException if there is an error setting the log level.
 * @throws RemoteException if there is an error communicating with the service.
 */
int setLogLevel(int level, Token token)
throws AdminServiceException, RemoteException ;
For debug, set level =1.
For info, set level =2.
For warn, set level =3.
For error, set level =4.
For fatal, set level =5.
```

Monitoring Service

A wrapper monitoring service has been provided in this release to monitor various Cisco Configuration Engine services. If any of the Configuration Engine processes die, the monitoring service exits.

Other applications can monitor this single Configuration Engine process, rather than all dependent Configuration Engine services. In the case of failure, they can take appropriate action, such as invoking the restart script.

Other applications can check for the existence of this wrapper monitoring process to make sure that all Configuration Engine services are up. If the process is not running, it will signify that one or more of Configuration Engine services are down.

This service report the health of the various Configuration Engine processes in a log file. If there is a failure, the service reports the error and exits. A time stamp is appended to each report.

There is a provision to start, stop, or check the status of this service. The following Configuration Engine processes are monitored:

- HTTP/Tomcat

- Event Gateway
- IMGW
- Web Services
- Tibco Rendezvous Daemon

Software Architecture

The monitoring service is a single process running as a daemon on the Configuration Engine host system. This daemon checks the state of various Configuration Engine processes at regular interval of time. This time interval is configurable. If any of the process in Configuration Engine dies, the daemon exits. A shell script is provided to start, stop, or check the status of this daemon. Applications can check the Configuration Engine health using this shell script.

Daemon Start/Stop script

The **MonitorCE** shell script starts and stops the daemon. This script also provides the status of the daemon script. Integrating applications use this shell script to monitor the state of Configuration Engine services.

This script is registered as a start up script on the local OS using the **chkconfig** utility. In this way, the script is started automatically after the host system is restarted. The script is located in the */etc/rc.d/init.d* directory.

Logging

The daemon checks for the health of each Configuration Engine process and reports it in a log file. The log files are located in */var/log/CNSCE/ce_health/ce_monitor.log*. A time stamp is appended with each report.

Here is an example of the log file:

```
07/14/2005-06:53 HTTP/Tomcat is UP in plain-text mode.
07/14/2005-06:53 HTTP/Tomcat is UP in ssl mode.
07/14/2005-06:53 Event Gateway (plaintext operation) at port 11011 is UP.
07/14/2005-06:53 Event Gateway (plaintext operation) at port 11013 is UP.
07/14/2005-06:53 Event Gateway (plaintext operation) at port 11015 is UP.
07/14/2005-06:53 Event Gateway (plaintext operation) at port 11017 is UP.
07/14/2005-06:53 Event Gateway (crypto operation) at port 11012 is UP.
07/14/2005-06:53 Event Gateway (crypto operation) at port 11014 is UP.
07/14/2005-06:53 Event Gateway (crypto operation) at port 11016 is UP.
07/14/2005-06:53 IMGW is UP.
07/14/2005-06:53 Cisco-CE Event Bus is UP.
07/14/2005-06:53 CEAdminService web service is UP in plain-text mode.
07/14/2005-06:53 CEConfigService web service is UP in plain-text mode.
07/14/2005-06:53 CEImageService web service is UP in plain-text mode.
07/14/2005-06:53 CEExecService web service is UP in plain-text mode.
```

When HTTP is Down

Here is an example when HTTP is down:

```
07/14/2005-06:53 HTTP/Tomcat is DOWN in plain-text mode.
HTTP GET failed on URL http://infystorm5:80/cns/Config
```

```

Connection refused

07/14/2005-06:53 HTTP/Tomcat is DOWN in ssl mode.
HTTP GET failed on URL https://infystorm5:444/cns/Config
Connection refused

07/14/2005-06:53 Event Gateway (plaintext operation) at port 11011 is UP.
07/14/2005-06:53 Event Gateway (plaintext operation) at port 11013 is UP.
07/14/2005-06:53 Event Gateway (plaintext operation) at port 11015 is UP.
07/14/2005-06:53 Event Gateway (plaintext operation) at port 11017 is UP.
07/14/2005-06:53 Event Gateway (crypto operation) at port 11012 is UP.
07/14/2005-06:53 Event Gateway (crypto operation) at port 11014 is UP.
07/14/2005-06:53 Event Gateway (crypto operation) at port 11016 is UP.
07/14/2005-06:53 IMGW is UP.
07/14/2005-06:53 Cisco-CE Event Bus is UP.
07/14/2005-06:53 CEAdminService web service is DOWN in plain-text mode.
HTTP GET failed on URL http://infystorm5:80/cns/services/CEAdminService?wsdl
Connection refused

07/14/2005-06:53 CEConfigService web service is DOWN in plain-text mode.
HTTP GET failed on URL http://infystorm5:80/cns/services/CEConfigService?wsdl
Connection refused

07/14/2005-06:53 CEImageService web service is DOWN in plain-text mode.
HTTP GET failed on URL http://infystorm5:80/cns/services/CEImageService?wsdl
Connection refused

07/14/2005-06:53 CEExecService web service is DOWN in plain-text mode.
HTTP GET failed on URL http://infystorm5:80/cns/services/CEExecService?wsdl
Connection refused

07/14/2005-06:54 Exiting the CE-Health Beep Daemon.

```

Also, a configuration file (*/etc/logrotate.d/cnsce/ce_health*) is provided to rotate the above log file.

End User Interface

You can start, stop, and check the status of the daemon using the script called **MonitorCE**. This script is located in */etc/rc.d/init.d*. To know the status of Configuration Engine services, integrating applications have to issue the command:

```
/etc/rc.d/init.d/MonitorCE status
```

Usage

MonitorCE {start|stop|restart|reload|status}

- **start** – starts MonitorCE service. If MonitorCE service is already started, it does nothing.
- **stop** – stops MonitorCE service.
- **status** – tells if the service is up or not.
- **reload** – first stops the service, and then starts it again.

restart – first stops the service, and then starts it again.



Graphical User Interface

This chapter provides general information about the graphical user interface (GUI).

Logging In

Step 1 Launch your web browser.

This user interface supports:

- Netscape 5.0 and above.
- Internet Explorer 6.0 and above.
- FireFox 1.0 and above.

Step 2 Go to the Cisco Configuration Engine URL.

For example: **http://<ip_address>**



Note If encryption is set during Setup (see [“Encryption” section on page 1-13](#)), use **https://<ip_address>**.

The login window appears (see [Figure 2-1](#)).

Figure 2-1 Logging Into the Configuration Engine



Step 3 Enter your **User ID**.

This is the value for the Configuration Engine login parameter that you entered during setup.

Step 4 Enter your password.

Step 5 Click **LOGIN**.

For an Administrator, the full-function Cisco Configuration Engine Home page appears (see [Figure 2-2](#)).

For an Operator, a limited-function Cisco Configuration Engine Home page appears without access to user-related tasks.

Figure 2-2 Administrator-level Home Page

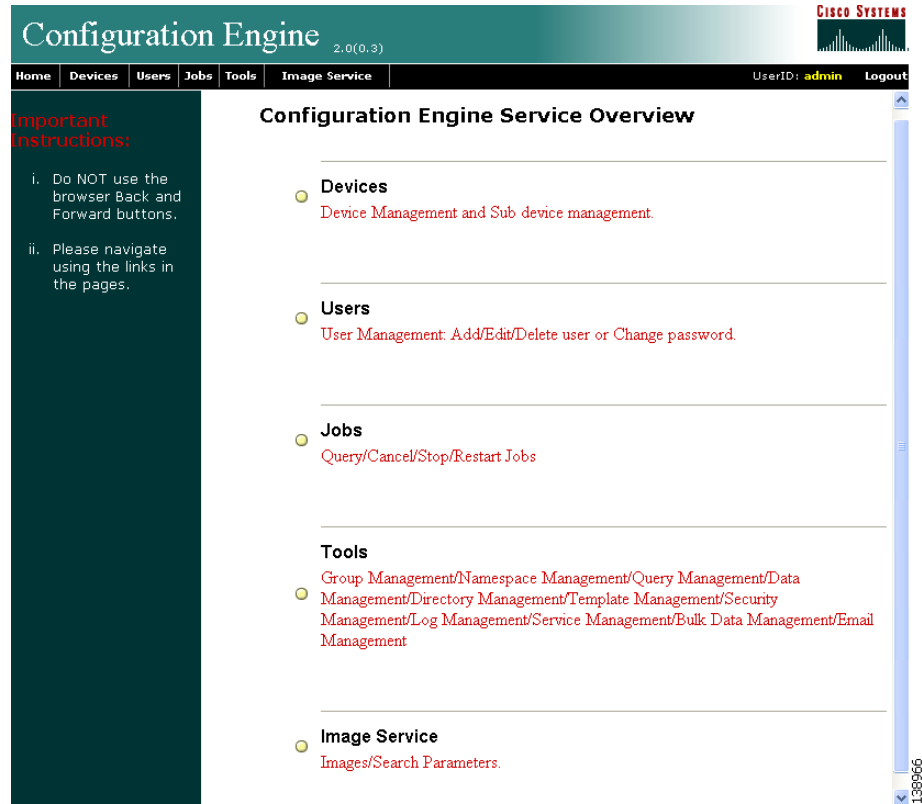

Logging Out

To log out of the system, click the **Logout** button.

Levels of Access

In Internal Directory mode, there are two categories of users who have access to device information:

- Administrator
- Operator

An Administrator has full access to system administration tasks. An Operator has access to only limited set of tasks (see “[Operator-Level Operations](#)” section on page 2-4).

Operator-Level Operations

After logging into the Cisco Configuration Engine, an Operator has access to the following functions:

- Device
 - Add
 - Edit
 - Subdevices
 - Update Device
 - Query Device Inventory
- Tools
 - Change Password
 - View Event Log
 - View Image Server Log
- Jobs
 - Query Job
 - Cancel/Stop Job
 - Restart Job
- Image Service
 - View Image

Administrator-Level Operations

An Administrator can access all of the functions provided by the Cisco Configuration Engine user interface in both Internal Directory mode and External Directory mode.

Feature Operations

The Cisco Configuration Engine GUI (see [Figure 2-2](#)) provides the following feature operations:

- Devices – Click this tab to conduct operations on Devices and Subdevices (see [Chapter 3, “Device and Subdevice Manager”](#)).
- Users – Click this tab to operate on user accounts (see [Chapter 4, “User Account Manager”](#)).
- Jobs – Click this tab to access background update tasks that have been assigned a Job IDs (see [Chapter 5, “Configuration and Image Update Jobs Manager”](#)).
- Tools – Click this tab to access the following features:
 - Group Manager (see [Chapter 6, “Groups”](#)).
 - Namespace Manager (see [Chapter 7, “Namespace Manager”](#)).
 - Query Manager (see [Chapter 8, “Query Manager”](#)).
 - Data Manager (see [Chapter 9, “Data Manager”](#)).
 - Directory Manager (see [Chapter 10, “Directory Manager”](#)).

- Parameter Manager (see [Chapter 11, “Parameter Manager”](#)).
- Template Manager (see [Chapter 12, “Templates”](#)).
- Security Manager (see [Chapter 13, “Security Manager”](#)).
- Log Manager (see [Chapter 14, “Log Manager”](#)).
- Service Manager (see [Chapter 15, “Service Manager”](#)).
- Bulk Data Manager (see [Chapter 16, “Bulk Data Manager”](#)).
- Email Manager (see [Chapter 17, “Email Manager”](#)).
- Image Service – Click this tab to work with Images and Search Parameters (see [Chapter 18, “Image Service”](#)).



Device and Subdevice Manager

To access Device tasks, log into the system (see [“Logging In” section on page 2-1](#)). Then, from the Home page, click the **Devices** tab.

The Device Functional Overview page appears showing:

- View Device
- Add Device
- Discover Device
- Edit Device
- Resynchronize Device
- Clone Device
- Delete Device
- Update Device
- Subdevices
- Query Device Inventory
- Delete Files on Device
- Dynamic Operations

Viewing Device Configuration

Step 1 From the Devices Functional Overview page, click **View Device**.

The Groups list appears.

Step 2 From the Groups list, select the group that holds the device you want to view.



Note You can also use the Advance Search feature on many GUI pages to locate devices based on user-define search parameters (see [“Using Advanced Search Feature” section on page 3-3](#)).

Step 3 The View Device list page appears (see [Figure 3-1](#)).

Figure 3-1 View Device List

View Device

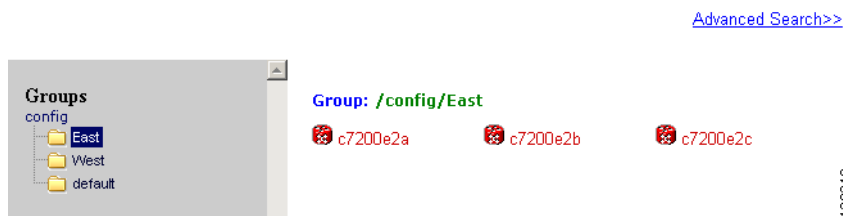

- Step 4** Click on the icon for the device you want to view.
The Configuration for that device appears (see Figure 3-2).

Figure 3-2 Device Configuration

Device: Device1

```

1 version 12.0
2 service timestamps debug uptime
3 service timestamps log uptime
4 no service password-encryption
5 service udp-small-servers
6 service tcp-small-servers
7 hostname DemoRouter
8 boot system flash c7200-is-mz
9 enable secret 5 $1$cMdl$.e37TH540MWB2GW5gMOn3/
10 enable password cisco
11 ip subnet-zero
12 interface FastEthernet0/0
13 no ip address
14 no ip directed-broadcast
15 no ip route-cache
16 no ip mroute-cache
17 shutdown
18 half-duplex
19 interface Ethernet1/0
20 ip address 10.10.1.1 255.255.255.240
21 no ip directed-broadcast
22 no ip route-cache
23 no ip mroute-cache
24 interface Ethernet1/1
25 no ip address
26 no ip directed-broadcast
27 no ip route-cache
28 no ip mroute-cache
29 shutdown
30 interface Ethernet1/2
31 no ip address
32 no ip directed-broadcast
33 no ip route-cache

```



Note The device configuration displayed is the configuration as it appears at the configuration server. It might not be the configuration running on the device.

- Step 5** To view subdevices (if applicable), in the left navigation pane, click **View Subdevices**.

- Step 6** To view Images associated with this device (if applicable), in the left navigation pane, click **View Images**.





Using Advanced Search Feature

- Step 1** From the Hierarchal View of groups (for example, see [Figure 3-1](#)), click **Advanced Search**.
- Step 2** Use the drop-down arrow to select: **Config ID**, **Event ID**, or **Device Name** for the desired device.
- Step 3** Then enter a value that corresponds to the first part of the argument, then click **Go**.
The results of the search are listed (see [Figure 3-3](#)).

Figure 3-3 Advanced Search Page

View Device [Hierarchal View>>](#)

Search Device

Devices	Associated Groups
 c7200e1	/config/default
 c7200e4	/config/default /config/East
 c7200e6	/config/East
 c7200w3	/config/West /config/West/pao-1
 c7200w7	/config/West /config/West/sjc-1 /config/West/pao-1

129607

Adding Devices

There are three variations to the Add Device procedures based on **Device Type**:

- Non-Agent Enabled Device (see below).
- Agent Enabled Device (see [“Adding Agent Enabled Devices”](#) section on page 3-12).
- PIX Firewall Device (see [“Adding PIX Firewall Devices”](#) section on page 3-16).

Adding Non-agent Enabled Devices

- Step 1** From the Devices Functional Overview page, click **Add Device**.
The Device Information page appears (see [Figure 3-4](#)).

Figure 3-4 Device Information Page

Create Device

Enter device information

Device Name: <small>(required)</small>	<input type="text" value="c7200e6"/>
Unique ID: <small>(required)</small>	<input type="text" value="c7200e6"/>
Device Type: <small>(required)</small>	Non-Agent Enabled Device
Template File Name:	<input checked="" type="radio"/> Select file: <input type="text" value="DemoRouter.cfgtpl"/> <input type="radio"/> Enter URL: <input type="text"/> <input type="button" value="Test URL"/>
<input type="button" value="Back"/> <input type="button" value="Next"/> <input type="button" value="Finish"/> <input type="button" value="Cancel"/>	

129449

- Step 2** Enter a valid value (no spaces) in the **Device Name** field.
[Table 3-1](#) shows valid values for these attributes.

Table 3-1 Valid Values for Add Device

Attribute	Description	Valid Values
Device Name	The name used as cn (common name) of the device.	a-z A-Z 0-9 -(hyphen) _(under-score) .(period)
Unique ID	Unique ID of the device.	Default or a-z A-Z 0-9 -(hyphen)
Device Type	Type of device	From drop-down list
Template File Name	Name of the configuration template to associate with the device.	From drop-down list, or user-defined

- Step 3** In the **Unique ID** field, accept the default value that appears or enter another valid value (no spaces).
Step 4 For Device Type, from the drop-down list, select **Non-Agent Enabled Device**.
Step 5 Select the Template file name, then click **Next**.
The Group Membership page appears (see [Figure 3-5](#)).

Figure 3-5 Group Membership

Create Device

Select group membership

DEVICE TYPE: Agent Enabled Device



Tip

Use the Group Manager to set up groups before you add a device (see “Creating Groups” section on page 6-2).

Step 6 Check to select the group(s) of which you want this device to become a member, then click **Next**.

The non-agent information (IMGW) page appears (see Figure 3-6).

Figure 3-6 Non-agent (IMGW) Information Page

Create Device

Enter non-agent device information

DEVICE TYPE: Non-Agent Enabled Device

Gateway Id
(required)

Device Type
(required)

Agent Type

Hop Information

Hop Type	IP Address	Port	Username	Password
Select a Hop Type	<input type="text"/>	<input type="text"/>	<input type="text"/>	<input type="text"/>

Add Another Hop

Back Next Finish Cancel

Step 7 Enter the name of the device in the **Device Name** field.

Table 3-2 lists valid values for these fields.

Table 3-2 Valid Values for Add IMGW Device

Attribute	Description	Valid Values
Device Name	The name used as cn (common name) of the IMGW device.	Non-empty string excluding the special characters: !, “, #, \$, %, &, ', (,), *, /, <, >, ?, @, \, ^, ` , ~
Gateway ID	Gateway identifier for this device. This value is established during Setup . See <i>Cisco Configuration Engine Installation & Configuration Guides</i> .	Non-empty string excluding the special characters: !, “, #, \$, %, &, ', (,), *, /, <, >, ?, @, \, ^, ` , ~
Device Type	Type of IMGW device.	From drop-down list
Agent Type	Type of agent you want IMGW to simulate.	From drop-down list

Step 8 Enter the gateway ID in the **Gateway Id** field.



Note This value is established during **Setup**. See *Cisco Configuration Engine Installation & Configuration Guides*.

Step 9 Enter the appropriate Device and Hop information.



Tip Before you enter Hop information, see [“Hop Tables” section on page 3-8](#).

Table 3-3 shows valid values for these fields.

Table 3-3 Valid Values for IMGW Device Hop Information

Attribute	Description	Valid Values
Hop Type	Type of IMGW hop.	From drop-down list
IP Address	IP address of the connecting node in the hop	Valid IP address of the following format: 10.1.14.216
Port	Port number of the node.	Integer values
Username	Username to login to the hop node.	String excluding the special characters: !, “, #, \$, %, &, ', (,), *, /, <, >, ?, @, \, ^, ` , ~
Password	Password to login to the hop node.	Non-null string

Step 10 To add another hop, click **Add Another Hop**, then enter hop information.

Step 11 To go back one page, click **Back**.

Step 12 To end this task, click **Finish**.

Step 13 To continue, click **Next**.

The Confirm IDs page appears

Figure 3-7 Confirm IDs Page

Create Device

Confirm IDs

DEVICE TYPE: Non-Agent Enabled Device

Event ID: <small>(required)</small>	<input type="text" value="c7200e6"/>
Config ID: <small>(required)</small>	<input type="text" value="c7200e6"/>
Image ID: <small>(optional, use to create a CIS Device)</small>	<input type="text" value="c7200e6"/>

Subdevices available:

Subdevices attached:

	<input type="button" value="→"/> <input type="button" value="←"/>	
--	--	--

129321

Step 14 To go back one page, click **Back**.

Step 15 To end this task, click **Finish**.

Step 16 To continue, click **Next**.

If you click **Next**, the Image Association page appears (see [Figure 3-8](#)).

Figure 3-8 Create Device > Image Association

Create Device

Step 3: Please Select Image(s) to associate with this device

	Name	Image Type	Image Locations	Over Write	Erase FileSystem	Destination
<input type="radio"/>	image1	IOS	ftp://ftp.test@10.1.7.24/ftp/c7200-is-mz.123-1.9.T	<input type="checkbox"/>	<input type="checkbox"/>	
<input type="button" value="Add Another Row"/>						

Step 4: Please select a configuration file that will be sent to the device upon activation of the new image:

Template File:	<input checked="" type="radio"/> Select file: <input type="text" value="DemoRouter.cfgtpl"/>
	<input type="radio"/> Enter URL: <input type="text"/> <input type="button" value="Test URL"/>

101503

Step 17 Select the image from the **Name** drop-down list.

The **Image Type** field and **Image Location** drop-down box are populated with corresponding information for the image.

Step 18 From the **Image Location** drop-down list, select the desired location.

Step 19 To add another row for image location, click **Add Another Row**.

You can locate multiple copies of an image on separate servers. This allows you to do load-sharing when updating a large number of devices. Each device in a large group can be associated with a copy of the image located at one of many server locations.

Step 20 In the Destination field, enter a valid URL where the image will be copied.

For example:

disk0:/c7200-mz

Step 21 To indicate which image is to be activated on the device after distribution, select the radio button in front of each row.

Step 22 Select the Configuration Control template file you want to send to this device for activation of a new image:



Tip

Use the Configuration Control template that contains the CLI commands required for image activation for this device (see [“Configuration Control Template” section on page 3-36](#)). If you do not have such a template, see [“Adding a Template” section on page 12-14](#).

- a. To select a template file from the drop-down list, click the **Select file** radio button.
- b. Use the drop-down list to choose a template file.

OR

To use an external template:

- a. Choose **Enter URL**.
- b. Enter the full URL for the server, directory, and filename where the template is stored. Currently, only **http** is supported.
- c. To test access to the external template, click **Test URL**.

If the server is unavailable or the external template cannot be accessed, an error appears. You can still save this logical device, but the template is not available until you have access to the external template.

Step 23 To clear this task, click **Cancel**.

Step 24 To go back to the previous page, click **Back**.

Step 25 To finish creating this device, click **Finish**.

Hop Tables

To access devices by means of Telnet, it is necessary to construct hop tables (see [“HopInfo Examples” section on page 3-11](#)). These are tables that indicate what network path exists to the device, and all the authentication information necessary at each stage, or hop.

What You Should Know About Device Hop Information

The Hop Information (HopInfo) structure describes one portion of the path between source and destination. HopInfo can be chained together to specify how to login to a device. Examples of uses of this structure include:

- Devices with basic authentication mode requiring IP address, username, and password

- Devices with additional authentication modes such as Cisco IOS enable mode
- Embedded-within-embedded applications such as line cards on a Catalyst switch

The latter two examples require a login, but not a hop to a different device. Therefore, they are referred to as *virtual* hops.

Table 3-4 shows the fields in the HopInfo structure:

Table 3-4 HopInfo Structure

Field	Purpose
hop_type	String indicating type of hop.
ip_address	IP address of device (string)
port	TCP port on which to access device (integer)
username	Username with which to login to device (string)
password	Password with which to login to device (string)

Currently Supported Device Types

Table 3-5 through Table 3-12 on page 3-10 provide the HopInfo list for devices that are directly accessible on the network by IMGW. For accessing devices by way of Commsserver, see Table 3-13 on page 3-10.

All the rows in these tables are mandatory. Also, the hop_type fields cannot be NULL or empty. The fields marked with **X** are mandatory in IMGW unless they are not required on the device-side.

Table 3-5 Cisco IOS Device Directly Connected

hop_type	ip_address	port	username	password
IOS_LOGIN	X		X	X
IOS_EN			X	X

Table 3-6 Cisco IOS Device Directly Connected Supporting SSH

hop_type	ip_address	port	username	password
IOS_LOGIN:SSH	X		X	X
IOS_EN			X	X

Table 3-7 Catalyst Device Directly Connected

hop_type	ip_address	port	username	password
CATALYST_LOGIN	X		X	X
CATALYST_EN			X	X

Table 3-8 Catalyst IOS MSFC Blade Directly Connected

hop_type	ip_address	port	username	password
CATALYST_LOGIN	X		X	X
IOS_CAT_BLADE		X	X	X
IOS_EN			X	X

Table 3-9 Catalyst IOS Device Directly Connected

hop_type	ip_address	port	username	password
CATIOS_LOGIN	X		X	X
CATIOS_EN			X	X

Table 3-10 CSS Device Directly Connected

hop_type	ip_address	port	username	password
CSS_LOGIN	X		X	X
CSS_EN			X	X

Table 3-11 CE Device Directly Connected

hop_type	ip_address	port	username	password
CE_LOGIN	X		X	X
CE_EN			X	X

Table 3-12 PIX Device Directly Connected

hop_type	ip_address	port	username	password
PIX_LOGIN	X		X	X
PIX_EN			X	X

When any of the above devices is accessed by way of a Commserver (such as a Cisco 2511 Access Server), the resultant HopInfo list has the following two rows prepended to the respective HopInfo list for that device:

Table 3-13 Partial HopInfo List For Commserver Access

hop_type	ip_address	port	username	password
COMMSERVER_LOGIN	X		X	X
COMMSERVER		X	////////////////	X

**Note**

Because the current release does not support port username, the username field of HopInfo structure for COMMSERVER is always ignored by IMGW. Do not set up the port username on the Commserver.

HopInfo Examples**Table 3-14 Cisco IOS Device Directly Connected**

hop_type	ip_address	port	username	password
IOS_LOGIN	172.28.6.90		Johndoe	Passnow
IOS_EN			dummy	compass

Table 3-15 Cisco IOS Device Directly Connected Supporting SSH

hop_type	ip_address	port	username	password
IOS_LOGIN:SSH	172.28.6.90		Johndoe	Passnow
IOS_EN			dummy	compass

Table 3-16 Cisco IOS Device Connected With Commserver

hop_type	ip_address	port	username	password
COMMSERVER_LOGIN	172.28.6.226		Sandra	Me1100
COMMSERVER		2005	////////////////	Lab123
IOS_LOGIN			Johndoe	Passnow
IOS_EN			dummy	compass

Table 3-17 Catalyst IOS MFSC Blade Directly Connected

hop_type	ip_address	port	username	password
CATALYST_LOGIN	172.29.132.32		Admin	Raining
IOS_CAT_BLADE		15	Admin	winding
IOS_EN			dummy	moonlight

Table 3-18 Catalyst IOS MFSC Blade Accessed With Commserver

hop_type	ip_address	port	username	password
COMMSERVER_LOGIN	172.28.22.229		Kldfg	Dsdsfg
COMMSERVER		2010	////////////////	Dadada
CATALYST_LOGIN			Admin	Raining
IOS_CAT_BLADE		15	Admin	winding
IOS_EN			dummy	moonlight

Adding Agent Enabled Devices

- Step 1** From the Devices Functional Overview page, click **Add Device**.
The Device Information page appears (see [Figure 3-9](#)).

Figure 3-9 Device Information Page

Create Device

Enter device information

Device Name: (required)	<input type="text" value="c7200e4"/>
Unique ID: (required)	<input type="text" value="c7200e4"/>
Device Type: (required)	<input type="text" value="Agent Enabled Device"/>
Template File Name:	<input checked="" type="radio"/> Select file: <input type="text" value="DemoRouter.cfgtpl"/> <input type="radio"/> Enter URL: <input type="text"/> <input type="button" value="Test URL"/>

129320

- Step 2** Enter a valid value (no spaces) in the **Device Name** field.
[Table 3-19](#) shows valid values for these attributes.

Table 3-19 Valid Values for Add Device

Attribute	Description	Valid Values
Device Name	The name used as cn (common name) of the device.	a-z A-Z 0-9 -(hyphen) _ (under-score) . (period)
Unique ID	Unique ID of the device.	Default or a-z A-Z 0-9 -(hyphen) _ (under-score) . (period)
Device Type	Type of device	From drop-down list
Template File Name	Name of the configuration template to associate with the device.	From drop-down list, or user-defined

- Step 3** In the **Unique ID** field, accept the default value that appears or enter another valid value (no spaces).
Step 4 For Device Type, from the drop-down list, select **Agent Enabled Device**.

Step 5 Select the Template file name, then click **Next**.



Note To associate an external template to this device, select **Enter URL** with the appropriate path.

The Group Membership page appears (see [Figure 3-10](#)).

Figure 3-10 Group Membership Page



Tip Use the Group Manager to set up groups before you add a device (see [“Creating Groups” section on page 6-2](#)).

Step 6 Check to select the group(s) of which you want this device to become a member, then click **Next**.

The device IDs page appears (see [Figure 3-11](#)).

Figure 3-11 Device IDs Page

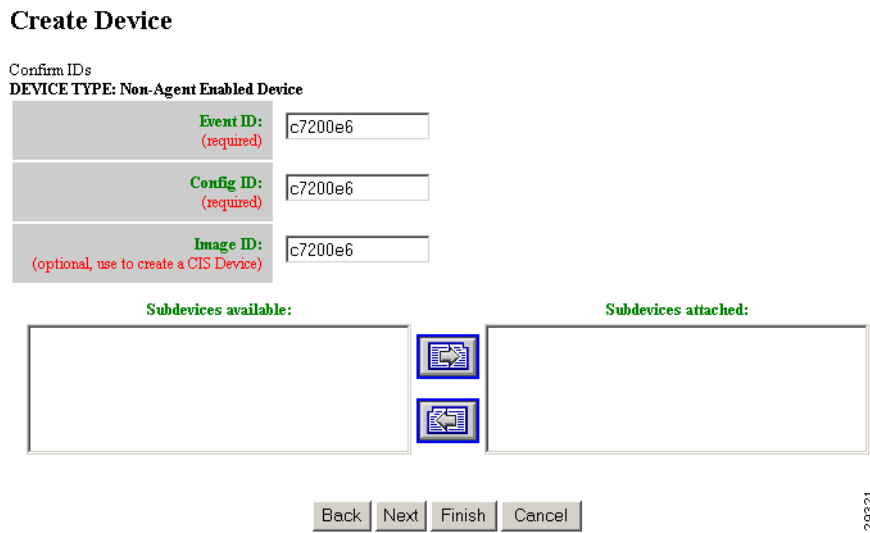

Step 7 Enter the appropriate IDs.

[Table 3-20](#) shows valid values for these attributes.

Table 3-20 Valid Values for Agent Enabled Device IDs

Attribute	Description	Valid Values
Event ID	Event ID to be associated with this device.	Default, or a-z A-Z 0-9 -(hyphen) _ (under-score) . (period)
Config ID	Configuration ID to be associated with this device.	Default, or a-z A-Z 0-9 -(hyphen) _ (under-score) . (period)
Image ID	Image ID to be associated with this device.	Default, or a-z A-Z 0-9 -(hyphen) _ (under-score) . (period)

Step 8 If applicable, select and assign subdevices to this device.

Step 9 To go back one page, click **Back**.

Step 10 To end this task, click **Finish**.

Step 11 To continue by associating this device with an image, click **Next**.

If you click **Next**, the Image Association page appears (see [Figure 3-12](#)).

Figure 3-12 Create Device > Image Association

Create Device

Step 3: Please Select Image(s) to associate with this device

	Name	Image Type	Image Locations	OverWrite	Erase FileSystem	Destination
<input type="radio"/>	image1	IOS	ftp://tp.test@10.1.7.24/http/c7200-is-mz.123-1.9.T	<input type="checkbox"/>	<input type="checkbox"/>	
<input type="button" value="Add Another Row"/>						

Step 4: Please select a configuration file that will be sent to the device upon activation of the new image:

Template File:	<input checked="" type="radio"/> Select file: DemoRouter.cfgtpl	<input type="radio"/> Enter URL: <input type="text"/>	<input type="button" value="Test URL"/>
----------------	---	---	---

101503

Step 12 Select the image from the **Name** drop-down list.

The **Image Type** field and **Image Location** drop-down box are populated with corresponding information for the image.

Step 13 From the **Image Location** drop-down list, select the desired location.

Step 14 To add another row for image location, click **Add Another Row**.

You can locate multiple copies of an image on separate servers. This allows you to do load-sharing when updating a large number of devices. Each device in a large group can be associated with a copy of the image located at one of many server locations.

Step 15 In the Destination field, enter a valid URL where the image will be copied.

For example:

disk0:/c7200-mz

Step 16 To indicate which image is to be activated on the device after distribution, select the radio button in front of each row.

Step 17 Select the Configuration Control template file you want to send to this device for activation of a new image:



Tip

Use the Configuration Control template that contains the CLI commands required for image activation for this device (see “[Configuration Control Templates](#)” section on page 12-3). If you do not have such a template, see “[Adding a Template](#)” section on page 12-14.

- a. To select a template file from the drop-down list, click the **Select file** radio button.
- b. Use the drop-down list to choose a template file.

OR

To use an external template:

- a. Choose **Enter URL**.
- b. Enter the full URL for the server, directory, and filename where the template is stored. Currently, only **http** is supported.
- c. To test access to the external template, click **Test URL**.

If the server is unavailable or the external template cannot be accessed, an error appears. You can still save this logical device, but the template is not available until you have access to the external template.

Step 18 To clear this task, click **Cancel**.

Step 19 To go back to the previous page, click **Back**.

Step 20 To finish creating this device, click **Finish**.

Adding PIX Firewall Devices

- Step 1** From the Devices Functional Overview page, click **Add Device**.
The Device Information page appears (see [Figure 3-13](#)).

Figure 3-13 Device Information Page

Create Device

Enter device information

Device Name: <small>(required)</small>	<input type="text" value="c7200e5"/>
Unique ID: <small>(required)</small>	<input type="text" value="c7200e5"/>
Device Type: <small>(required)</small>	<input type="text" value="Pix Firewall Device"/>
Template File Name:	<input checked="" type="radio"/> Select file: <input type="text" value="DemoRouter.cfgtpl"/> <input type="radio"/> Enter URL: <input type="text"/> <input type="button" value="Test URL"/>

129450

- Step 2** Enter a valid value (no spaces) in the **Device Name** field.
[Table 3-21](#) shows valid values for these attributes.

Table 3-21 Valid Values for Add Device

Attribute	Description	Valid Values
Device Name	The name used as cn (common name) of the device.	a-z A-Z 0-9 -(hyphen) _(under-score) (period)
Unique ID	Unique ID of the device.	Default or a-z A-Z 0-9 -(hyphen) _(under-score) (period)
Device Type	Type of device	From drop-down list
Template File Name	Name of the configuration template to associate with the device.	From drop-down list, or user-defined

- Step 3** In the **Unique ID** field, accept the default value that appears or enter another valid value (no spaces).
Step 4 For Device Type, from the drop-down list, select **PIX Firewall Device**.
Step 5 Select the Template file name, then click **Next**.
The Group Membership page appears (see [Figure 3-14](#)).

Figure 3-14 Group Membership Page**Create Device**

Select group membership
DEVICE TYPE: Agent Enabled Device



Tip Use the Group Manager to set up groups before you add a device (see “Creating Groups” section on page 6-2).

- Step 6** Check to select the group(s) of which you want this device to become a member, then click **Next**. The PixAuthentication Password page appears (see Figure 3-15).

Figure 3-15 PIX Authentication Password Page**Create Device**

Step 2: Enter the Authentication Password for Pix Devices

Authentication Password: (required)	<input type="password"/>
Confirm Authentication Password: (required)	<input type="password"/>

101501

- Step 7** Enter authentication password for PIX devices.
 A case-sensitive password of up to 16 alphanumeric and special characters. Any character can be used in the password except a question mark and a space.
- Step 8** To go back one page, click **Back**.
- Step 9** To end this task, click **Finish**.
- Step 10** To continue by associating this device with an image, click **Next**.
- Step 11** If you click **Next**, the Image Association page for PIX Firewall Devices appears.
- Step 12** Select the image from the **Name** drop-down list.
 The **Image Type** field and **Image Location** drop-down box are populated with corresponding information for the image.



Note Only PIX or PDM images can be associated with a PIX device.

- Step 13** From the **Image Location** drop-down list, select the desired location.
- Step 14** To add another row for image location, click **Add Another Row**.



Note For PIX devices, you can have only one PIX image and one PDM image.

- Step 15** To indicate whether the image is to be activated on the device after distribution, check the box in front of each row.
- Step 16** To cancel creating a device and return to the Devices main menu, click **Cancel**.
- Step 17** To go back to the previous page, click **Back**.
- Step 18** To finish creating this device, click **Finish**.
-

Discovering Devices

Cisco Configuration Engine can discover a device once the device (for this example: **router-3460**) is configured for CNS. For more information about this, see *CNS Image Agent* at:

http://www.cisco.com/en/US/products/ps6350/products_configuration_guide_chapter09186a008044eb_e2.html

During the execution of **setup.sh** for the Cisco Configuration Engine host, the settings configured would be:

```
...
For detail information about the parameters in this setup, refer to
"Cisco Configuration Engine 2.0 Administrator's Guide."
...

Encryption settings:
-----
Enable cryptographic (crypto) operation between Event Gateway(s)/Config server and
device(s) (y/n)? n
Each Event Gateway process serves 500 devices. Maximum number of
Event Gateways allowed is 20.
Enter number of Event Gateways that will be started with crypto operation:[1] 0
Enter number of Event Gateways that will be started with plaintext operation: [5] 2
Enter Cisco-CE Event Bus Network Parameter: [ce_host_hostname or ce_host_ip_address]
```



Note For more information about running **setup.sh**, see the *Cisco Configuration Engine Installation & Configuration Guides*.

- Step 1** Log in to **router-3460**
- Step 2** Using the Cisco IOS CLI command: **show running configuration**, verify that **router-3460** is configured with IP routing. For example:

```
hostname router-3460
...
ip cef
ip host ce_host 10.1.2.3
...
interface Ethernet0/0
ip address 10.1.2.4 255.255.255.0
...
ip default-gateway 10.1.2.1
```



```
...
ip classless
ip route 0.0.0.0 0.0.0.0 10.1.2.1
```

where:

router-3460 is the hostname identifying the device for Cisco Configuration Engine and 10.1.2.3 is the IP address of the Cisco Configuration Engine.

Step 3 Log in to **router-3640** and perform the following operations:

```
configure terminal ip host ce_host 10.1.2.3
cns trusted-server all-agents ce_host
cns id string router-3460
cns id string router-3460 event
cns event ce_host 11013
cns config notify all interval 1 old-format
cns config partial ce_host 80
cns exec 80
```



Note The above configuration will support Discover Device as well as downloading a configuration, which requires **cns config partial ce_host 80**.

Step 4 Verify IP connectivity between **ce_host** and **router-3640** by issuing the **ping** command from **ce_host** to **router-3640** and from **router-3640** to **ce_host**.

Step 5 Create a template.

For our example, name it **router-3460**.

You must insert a minimum of one line in the template. You can add a ! for this.



Note For more information about creating a template, see [Chapter 12, “Templates.”](#)

Step 6 On the Device Functional Overview page, choose **Discover Device**.

When the discovery task completes, the following information appears:

```
Discover Devices
There are 1 device(s) currently connected to the IE2100 but not yet created in the
directory.
Select the devices you want to create and click on 'Create'.
Device Name DeviceID Connected Time Template Name Group Name
router-3640 router-3640 1/19/06 9:46:03 AM
- DemoRouter.cfgtpl
- Acquire Running Config /config/default
- Acquire Startup Config
```

Step 7 Click on the check box for **router-3640**, then click on the radio button and move the cursor to **router-3640.cfgtpl**.

Step 8 Choose **Create**.

The following information appears:

```
Status of Discovered Device Creation:
Device Name Template Name Status
router-3640 router-3640.cfgtpl Success
```

Step 9 On the Device Functional Overview page, choose **View Device**.

You should see an icon for **router-3640**.

The icon color should be green indicating communication between **ce_host** and **router-3640** has been established.

Notes:

1. Before a device is discovered or created, we recommend that you configure a template for the device. When Cisco Configuration Engine discovers a device, or you create a device, you then must associate the device with a template. Although Cisco Configuration Engine has a default sample template (DemoRouter.cfgtpl) already created, it is very unlikely that your device will be configured using DemoRouter.cfgtpl. Therefore, create a new template.
2. If **Create Device** is performed after configuring a template for **router-c3460**, then Cisco Configuration Engine will not discover this router (you will not see an icon for **router-c3460** when Discover Device is selected). If you want Cisco Configuration Engine to discover the device then create only a template for the device—DO NOT use the **Create Device** operation. If you use **Create Device**, and you go to **Discover Device**, you will not see an icon for **router-c3460**. However, in either case, **View Device** should show an icon for **router-c3460**.
3. The Cisco Configuration Engine host uses odd numbered event ports for messages sent in plain text. For example, the default Cisco Configuration Engine setting is **5** event gateway ports without crypto enabled. Devices use ports 11011, 11013, 11015, 11017 or 11019 depending on what you configured on the device (for **cns event 10.1.2.3 11013** this means event gateway port 11013 is used by **router-c3640** to communicate with the Cisco Configuration Engine host, 10.1.2.3).
4. The Cisco Configuration Engine host uses even numbered event ports for message sent encrypted starting with 11012. For example, if you set the number of event gateways to **2** during setup, then ports 11012 and 11014 would be available for use by a device.

Editing Devices

Step 1 From the Devices Functional Overview page, click **Edit Device**.

The Groups list appears.

Step 2 From the Groups list, select the group that holds the device in question.

The Edit Device list appears (see [Figure 3-16](#)).

Figure 3-16 Edit Device List

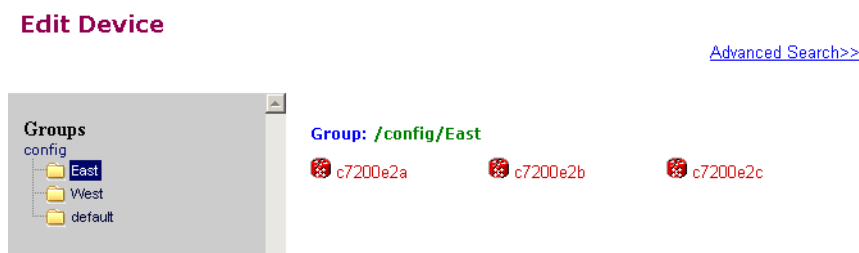

- Step 3** Click on the icon for the device you want to edit.
The device configuration appears (see [Figure 3-17](#)).

Figure 3-17 Device Configuration

Device: Device1

```

1 version 12.0
2 service timestamps debug uptime
3 service timestamps log uptime
4 no service password-encryption
5 service udp-small-servers
6 service tcp-small-servers
7 hostname DemoRouter
8 boot system flash c7200-is-mz
9 enable secret 5 $1$cMdl$.e37TH540MWB2GW5gMOn3/
10 enable password cisco
11 ip subnet-zero
12 interface FastEthernet0/0
13 no ip address
14 no ip directed-broadcast
15 no ip route-cache
16 no ip mroute-cache
17 shutdown
18 half-duplex
19 interface Ethernet1/0
20 ip address 10.10.1.1 255.255.255.240
21 no ip directed-broadcast
22 no ip route-cache
23 no ip mroute-cache
24 interface Ethernet1/1
25 no ip address
26 no ip directed-broadcast
27 no ip route-cache
28 no ip mroute-cache
29 shutdown
30 interface Ethernet1/2
31 no ip address
32 no ip directed-broadcast
33 no ip route-cache

```

- Step 4** From the left navigation pane, choose the edit function you want to use.

Editing Non-agent Enabled Device Information

- Step 1** From the Edit Device page, click **Edit Information**.
The device information editor page appears (see [Figure 3-18](#)).

Figure 3-18 Non-agent Device Information Editor



- Step 2** To modify the device name, enter a valid value (no spaces) in the **Device Name** field, then click **Next**.
Step 3 Select Group Membership, then click **Next**.
The Non-agent Edit Device Information page appears (see [Figure 3-19](#)).

Figure 3-19 Non-agent Information Page

Edit Device

Enter non-agent device information
DEVICE TYPE: Non-Agent Enabled Device

Gateway Id
(required)

Device Type
(required)

Agent Type

Hop Information

Hop Type	IP Address	Port	Username	Password	Confirm Password
Add Another Hop					

Back Next Finish Cancel

129456

- Step 4** Edit all appropriate fields, then to end this task, click **Finish**.
Step 5 To continue, click **Next**.
The device IDs page appears (see [Figure 3-20](#)).

Figure 3-20 Edit Non-agent Device IDs Page**Edit Device**

Confirm IDs
DEVICE TYPE: Non-Agent Enabled Device

Event ID: (required)	<input type="text" value="c7200e6"/>
Config ID: (required)	<input type="text" value="c7200e6"/>
Image ID: (optional, use to create a CIS Device)	<input type="text"/>

Subdevices available: **Subdevices attached:**

129457

Step 6 Modify devices IDs as required, then click **Finish**.

Editing Agent Enabled Device Information

Step 1 From the Edit Device page, click **Edit Information**.
 The device information editor page appears (see [Figure 3-21](#)).

Figure 3-21 Agent Enabled Device Information Page**Edit Device**

Enter device information

Device Name: (required)	<input type="text" value="c7200e2c"/>
Device Type: (required)	<input type="text" value="Agent Enabled Device"/>
Template File Name:	<input checked="" type="radio"/> Select file: <input type="text" value="DemoRouter.cfgtpl"/> <input type="radio"/> Enter URL: <input type="text"/> <input type="button" value="Test URL"/>

129322

Step 2 To modify the device name, enter a valid value (no spaces) in the **Device Name** field, then click **Next**.

Step 3 Select Group Membership, then click **Next**.
 The device IDs page appears (see [Figure 3-22](#)).

Figure 3-22 Agent enabled Device IDs Page**Edit Device**

Confirm IDs
DEVICE TYPE: Agent Enabled Device

Event ID: (required)	<input type="text" value="c7200e2c"/>
Config ID: (required)	<input type="text" value="c7200e2c"/>
Image ID: (optional, use to create a CIS Device)	<input type="text" value="c7200e2c"/>

Subdevices available:

Subdevices attached:

129349

Step 4 Modify device IDs as required, then click **Finish**.

Editing PIX Device Information

Step 1 From the Edit Device page, click **Edit Information**.
 The device information editor page appears (see [Figure 3-23](#)).

Figure 3-23 PIX Device Information Page**Edit Device**

Enter device information

Device Name: (required)	<input type="text" value="c7200e1"/>
Unique ID: (required)	<input type="text" value="c7200e1"/>
Device Type: (required)	<input type="text" value="Pix Firewall Device"/>
Template File Name:	<input checked="" type="radio"/> Select file: <input type="text" value="DemoRouter.cfgtpl"/> <input type="radio"/> Enter URL: <input type="text"/> <input type="button" value="Test URL"/>

129486

Step 2 To modify the device name and Image ID, if applicable, then click **Next**.

Step 3 Select Group Membership, then click **Next**.

The PIX Device Authentication Password page appears, see [Figure 3-24](#).

Figure 3-24 PIX Device Authentication Password

Edit Device

Enter the Authentication Password for Pix Devices

DEVICE TYPE: Pix Firewall Device

Authentication Password: (required)	<input type="password"/>
Confirm Authentication Password: (required)	<input type="password"/>

129823

Step 4 Modify the authentication password if required, then click **Finish**.

A case-sensitive password of up to 16 alphanumeric and special characters. Any character can be used in the password except a question mark and a space.

Editing Device Templates

Step 1 From the Edit Device page, click **Edit Template**.

The template editor appears (see Figure 3-25).

Figure 3-25 Template Editor

Template File: [DemoRouter.cfgtpl] Attributes:

```

!
version 12.0
service timestamps debug uptime
service timestamps log uptime
no service password-encryption
service udp-small-servers
service tcp-small-servers
!
hostname DemoRouter
!
boot system flash c7200-is-mz
enable secret 5 $1$cMdI$.e37TH540MWB2GW5gM0n3/
enable password cisco
!
ip subnet-zero
!
interface FastEthernet0/0
no ip address
no ip directed-broadcast
no ip route-cache
no ip mroute-cache
shutdown
half-duplex
!
interface Ethernet1/0
ip address 10.10.1.1 255.255.255.240
no ip directed-broadcast
no ip route-cache
no ip mroute-cache
!
interface Ethernet1/1
no ip address
no ip directed-broadcast

```

101506

Line 1

- Step 2** In the **Attributes** field, click the drop-down arrow.
- Step 3** Choose the attribute you want to add to the template, then click **Add**.
- Step 4** Repeat Steps 2 and 3 for all attributes you want to add to the template file.
- Step 5** Delete all unusable strings from the template file.
- Step 6** Edit strings as necessary.

The default multi-line begin and end tags are `^[` and `^]` respectively. The delimiter for these tags are: `~ ! @ ^ & * - = |`. Do not use `#` or `%`.

For example, a multi-line test banner might be:

```
banner exec ^[*
  This is a Test Banner
  1. Hi
  2. Hello
  3. Test is 1234567890*
^]
```

- Step 7** To save your edits, click **Save**.
- Step 8** To save this version as a new template, click **Save as**.
-

Editing Device Parameters

- Step 1** From the Edit Device page:
- If you have administrator-level access click **Edit Parameter-admin**.
 - To use Operator-level access click **Edit Parameter-operator**.

The parameters editor appears.

- Step 2** Edit all active lines as required.
- Step 3** To save your edits, click **Save Parameters**.
-

Editing Contact Information

- Step 1** From the Edit Device page, click **Edit ContactInfo**.
- The contact information appears.
- Step 2** Edit all active fields as required.
- Step 3** To clear your entries, click **Reset**.
- Step 4** To save your edits, click **Update**.
-

Editing Subdevices

For complete information about working with subdevices, including editing (except PIX devices), see [“Working with Subdevices” section on page 3-37](#).

Editing Image Association Information

-
- Step 1** From the Edit Device page, click **Edit Images**.
The Edit Device Image page appears.
 - Step 2** Edit image and configuration information as required.
 - Step 3** To revert to the previous state, click **Cancel**.
 - Step 4** To complete this task, click **Finish**.
-

Resynchronizing Devices

If the password of a device becomes corrupted so that there is a mismatch between the device and the corresponding password information help in the directory, you can resynchronize the device with the Cisco Configuration Engine, 2.0 by using the Resync Device function.

-
- Step 1** From the Devices Functional Overview page, click **Resync Device**.
 - Step 2** From the Resync Device page, click on the icon for the device you want to re-synchronize.



Note PIX devices will not be visible on this page.

- Step 3** In the confirmation window that appears, click **Ok**.
-

Cloning Devices

- Step 1** From the Devices Functional Overview page, click **Clone Device**.
The Groups list appears.
- Step 2** From the Groups list, select the group that holds the device you want to clone.
The Clone Device list appears (see [Figure 3-26](#)).

Figure 3-26 Clone Device List

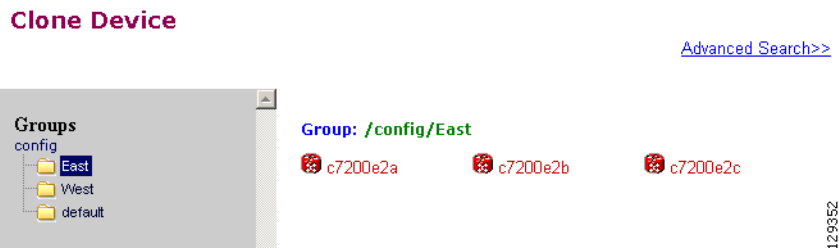

- Step 3** Select a device to clone.
The Step 1 page appears (see [Figure 3-27](#)).

Figure 3-27 Clone Device > Number of Copies

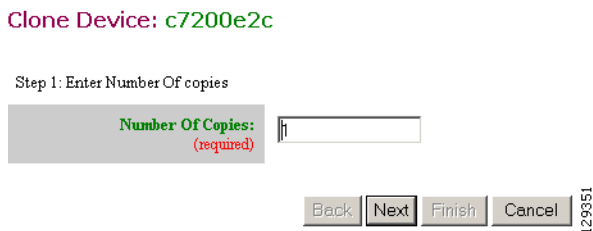

Step 4 Determine the number of copies, then click **Next**.
 The Step 2 page appears (see [Figure 3-28](#)).

Figure 3-28 Clone Device > Name and IDs

Clone Device: c7200e2c

Step 2: Create 1 copies of c7200e2c using:

	Prefix	Suffix
Device Name	copyOf	1
Event ID	copyOf	1
Config ID	copyOf	1
Image ID	copyOf	1

Also Clone:

<input checked="" type="checkbox"/>	SubDevice(s)	SubDevice Name Prefix SubDevice ID Prefix	copyOf copyOf
<input checked="" type="checkbox"/>	Image(s)		

129350

Step 5 Enter prefix and suffix for each device copy, then click **Next**.
 The Step 3 page appears (see [Figure 3-29](#)).

Figure 3-29 Clone Device > Review Parameters

Clone Device: c7200e2c

Step 3: Review parameters

The following Devices will be created:

Device Names	Event Ids	Config Ids	Image Ids
copyOfc7200e2c1	copyOfc7200e2c1	copyOfc7200e2c1	copyOfc7200e2c1

The above devices will be created with the following attributes:

ImageRefList	C7200-IS-MZ
Template	DemoRouter.cfgtpl
ActivationTemplate	DemoRouter.cfgtpl
IOSsubdevices	card2b
Group	ou=East,ou=config,ou=CNSApplications,ou=techdoc,o=cisco,c=us
AdminDevType	generic_device

129328

- Step 6** Review the parameters you set for this clone.
- Step 7** If you want to make changes, click **Back**.
- Step 8** To finish this task, click **Finish**.
-

Deleting Devices

- Step 1** From the Devices Functional Overview page, click **Delete Device**.
The Groups list appears.
- Step 2** From the Groups list, select the group that holds the device you want to delete.
The device list appears.
- Step 3** Click the check box for the device(s) you want to delete.
- Step 4** Click **Submit**.
A list of devices selected for deletion appears.
- Step 5** To continue, click **Delete**.
-

Updating Device Configurations and Images

To send an updated version of the configuration or a new image to a device, from the Devices Functional Overview page, click **Update Device**. The Update Device Functional Overview page appears showing:

- Update Configuration
- Update Image
- Customize

Updating Device Configurations

- Step 1** From the Update Devices Functional Overview page, click **Update Config**.
The Groups list appears.
- Step 2** From the Groups list, select the group that holds the device you want to update.
- Step 3** Click the check box next to the icon for the device(s) you want to update (see [Figure 3-30](#)).

Figure 3-30 Update Config Group/Device Selection Page

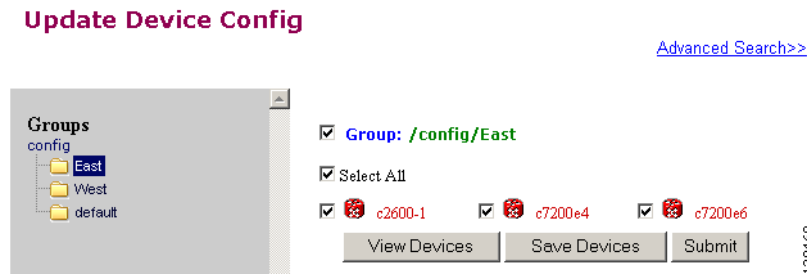

Note PIX devices will not be visible on this page.

- Step 4** Click **Submit**.
 The update notification page appears (see [Figure 3-31](#)).

Figure 3-31 Update Configuration Notification Information

Notification Information

Please mark the notification checkbox and complete the step below if a notification will be sent upon job complete.

Step 1:	<input type="checkbox"/> Send Notification
Step 2:	Send upon: <ul style="list-style-type: none"> <input type="checkbox"/> Job complete success <input type="checkbox"/> Job complete failure <input type="checkbox"/> Job is canceled
Step 3:	To: <input type="text"/> Subject: <input type="text"/> Note: <input style="width: 100%; height: 40px;" type="text"/> <div style="text-align: right; margin-top: 10px;"> <input type="button" value="Next"/> <input type="button" value="Reset"/> </div>

129367

- Step 5** If you want an email notification sent when the update job completes, fill in the information on this page, then click **Next**.



Note This page is optional. You can skip to the next page by clicking **Next**.

The update task dialog box appears (see [Figure 3-32](#))

Figure 3-32 Update Task**Update Config**

Please complete the steps below to perform an Config Update:

Step 1: Update device with pre-configured template and parameters
 Send Config:
 Select static configuration file: DemoRouter.cfgtpl

Step 2: Config Action Apply to running config
 Apply and save to NVRAM
 Overwrite NVRAM

Step 3: Syntax Check

Step 4: Immediate
 At a future time: 00 : 15 (hh:mm) on January 1 2005

Step 5: Device Batch Size: 20

Step 6: Text Description for Job:

Update Cancel

129325

Step 6 For Step 1, select the source of the configuration.

Step 7 For Step 2, choose the **Config Action** task you require.

- Apply to running config – applies the configuration to the current running configuration.
- Apply and save to NVRAM – applies the configuration without causing it to persist in NVRAM.
- Overwrite NVRAM – applies the change and causes it to persist in NVRAM.

Step 8 For Step 3, if required, check the **Syntax Check** check box.

Step 9 For Step 4, select the date and time to send the configuration update.

Step 10 For Step 5, determine the batch size.



Tip The max batch size for IMGW should be set at 25.

Step 11 For Step 6, if applicable, enter a description for this update job.

Step 12 Click **Update**.

Updating Device Images

Step 1 From the Update Device Functional Overview page, click **Update Image**.

The Groups list appears.

Step 2 From the Groups list, select the group that holds the device you want to update.

Step 3 Click the check box next to the icon for the device(s) you want to update (see [Figure 3-33](#)).

Figure 3-33 Update Image Group/Device Selection Page

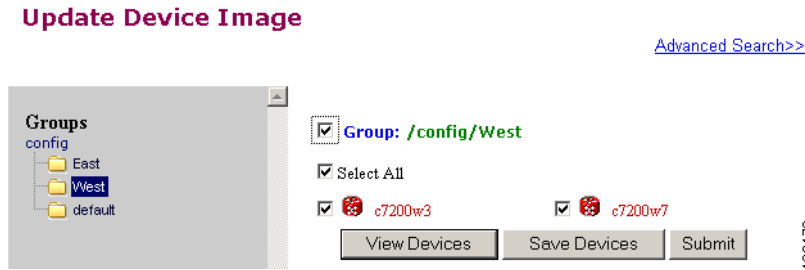

Note PIX devices will not be visible on this page.

Step 4 Click **Submit**.

The update notification page appears (see Figure 3-31).

Step 5 If you want a notification sent when the update job completes, fill in the information on this page, then click **Next**.



Note This page is optional. You can skip to the next page by clicking **Next**.

The Update Image page appears (see Figure 3-34)

Figure 3-34 Image Selection Page

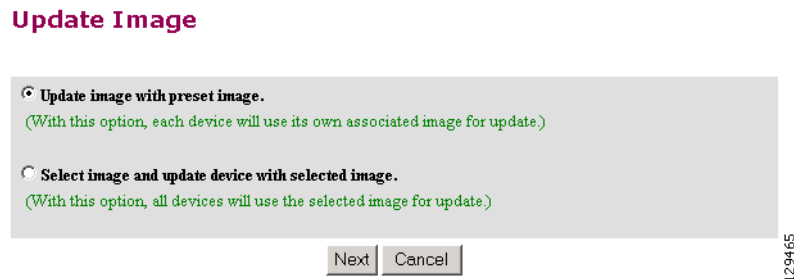

Step 6 Select the image you want to use for updates, then click **Next**.

If you select to update the device by selecting an image other than its present image, the next page gives you a list of images from which to select.

The Update Image worksheet appears (see Figure 3-35).

Figure 3-35 Update Image Worksheet

Update Image

Please complete the steps below to perform an Image Update:

Step 1: Option 1: Distribute Image
Option 2: Activate Image

Step 2: Immediate
 At a future time: : (hh:mm) on

Step 3: Device Batch Size:

Step 4: Setup Search Parameters to delete files:

Available Search Parameters:	Selected Search Parameters:
sp1a sp1b test2 End of list	End of list

Step 5: Always perform delete file operation.
 Perform delete file operation if free space is needed.

Step 6: Text Description for Job:

Step 7: Apply activation template to nvram.
 Overwrite startup-config with activation template.

Please check here if you want to perform an [Evaluation](#) and not an actual Image Update.

129326

Step 7 To distribute the image, click the check box for **Distribute Image**.

Step 8 To activate the image, click the check box for **Activate Image**.



Tip All three agents (event, partial config, and image) must be running on the device for the activation process to succeed.



Note For the image to become active on the device, you must have a Configuration Control template associated with this device that contains the CLI commands for image activation (see [“Configuration Control Templates”](#) section on page 12-3).

Step 9 To update the image immediately, click the radio button for **Immediate**.

Step 10 To update the image at a specified time in the future, click the radio button for **At a future time**:

- a. Enter a time value.
- b. Enter a date value.

Step 11 Set the **Device Batch Size**.

This is the number of concurrent image updates. This feature allows you to limit the number of concurrent requests to a server. When one batch of image update requests has been satisfied, the next batch starts.



Tip

The max batch size for IMGW should be set at 25. And for HTTP only (no event agent) mode, the batch size must be same as the number devices in the submitted job.



Note

If you are running a device image update session to a mix of IMGW and agent devices, the effective device batch size limit for IMGW devices—concurrent Telnet session limit—is equal to the value (default = 25) set for this attribute in the **Setup** program (see *Cisco Configuration Engine Installation & Configuration Guides*).

- Step 12** If applicable, enter a text description of the job.
- Step 13** To perform an evaluation rather than an actual update, click the check box at the bottom of this pane.
- Step 14** To continue, complete the steps called for, then click **Update**.

The Update Image Status page appears (see [Figure 3-36](#)). You can use this Job ID to perform job-related tasks (see [Chapter 5, “Configuration and Image Update Jobs Manager”](#)).

Figure 3-36 Job ID for Update Image

Update Image Status

Device Name	Distributed Image(s)	Activated Image(s)
Device2	image3 image2	image2

Your request has been assigned the job id: 1062710890226

10:15:09

Customize Job Template

- Step 1** From the Update Device Functional Overview page, click **Customize**.
The Groups list appears.
- Step 2** From the Groups list, select the group that holds the device you want to update.
- Step 3** Click the check box next to the icon for the device(s) you want to update (see [Figure 3-37](#)).

Figure 3-37 Custom Flow Control Device Update Selection Page

Update Device using Custom Flow Control Template

[Advanced Search>>](#)



Note PIX devices will not be visible on this page.

Step 4 Click **Submit**.

The Update Device using Customized Job Template appears (see [Figure 3-38](#)).

Figure 3-38 Customized Job Template Form

Update Device using Customized Job Template

Please complete the steps below to submit a Customized Job:

Step 1:	Customized Job Template: test1.inv ▾
Step 2:	<input checked="" type="radio"/> Immediate <input type="radio"/> At a future time: 00 : 15 (hh:mm) on January ▾ 1 ▾ 2005 ▾
Step 3:	Device Batch Size: 2
Step 4:	Text Description for Job: <input type="text"/>

Please check here if you want to perform an [Evaluation](#) and not an actual [job submission](#).

149119

Step 5 Complete the Customized Job Template form, then click **Submit**.

The next page shows the Job ID for this update task.

Step 6 To check the status of this job go to **Jobs > Query Jobs**, then click on the Job ID for this Job.

Configuration Control Template

To restart a device with a new image, you must issue the CLI commands that you would normally enter from the device console to activate a new image.

For example, if you want to restart a Cisco 3600 Series router with an image named `3600.image`, from the device console, you would issue the following CLI commands:

```
no boot system
boot system flash:3600.image
```

you must provide the device with a Configuration Control template that contains the required CLI commands for image activation.

If you do not have such a template, see [“Adding a Template” section on page 12-14](#). Also, you must associate this Configuration Control template with the particular device (see [“Adding Devices” section on page 3-3](#)).

The content of the Configuration Control template for image activation should contain the CLI commands that you would normally enter from the device console to activate a new image on the device.

Working with Subdevices

A subdevice is a configuration object for network modules in a modular router. When working with subdevices, it is very important to pick the correct type of interface card or module.

**Note**

PIX Firewall devices do not have subdevices.

To work with subdevices, from the Devices Functional Overview page, click **Subdevices**.

The Subdevices Functional Overview page appears showing:

- View Subdevice
- Add Subdevice
- Edit Subdevice
- Clone Subdevice
- Delete Subdevice

Viewing Subdevices

- Step 1** From the Subdevices Functional Overview page, select **View Subdevice**.
The list of subdevices appears (see [Figure 3-39](#)).

Figure 3-39 View Subdevice

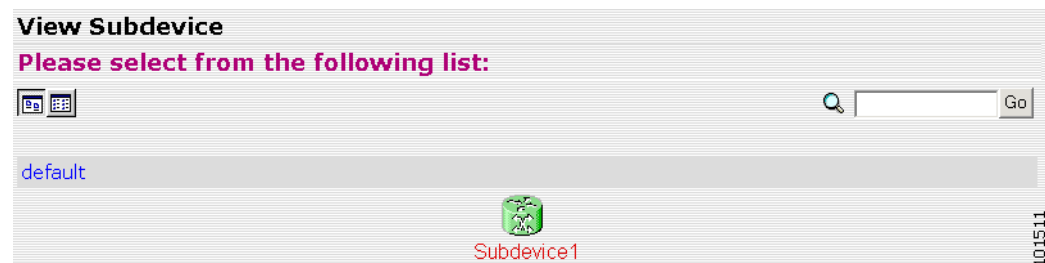

- Step 2** Click on the icon for the device configuration you want to view.
The Configuration for that device appears.

**Note**

The subdevice configuration displayed is the configuration as it appears at the configuration server. It might not be the configuration running on the subdevice.

Adding Subdevices

- Step 1** From the Subdevices Functional Overview page, click **Add Subdevice**.

The Subdevice Information page appears (see [Figure 3-40](#)).

Figure 3-40 Subdevice Information Page

Step 2 Enter a valid value (no spaces) in the **Device Name** field.

[Table 3-22](#) shows valid values for this task.

Table 3-22 Valid Values for Add Subdevice

Attribute	Description	Valid Values
Device Name	The name used as cn (common name) of the device.	a-z A-Z 0-9 -(hyphen) _ (under-score) . (period)
ConfigID	Configuration ID attribute of the device.	a-z A-Z 0-9 -(hyphen) _ (under-score) . (period)
Device Type		From drop-down list
Template File Name	Name of the configuration template to associate with the device.	From drop-down list, or user-defined

Step 3 Accept the default value that appears or enter another valid value (no spaces) in the **Config ID** field.

Step 4 From the **Device Type** drop-down list, choose the type of device to which this subdevice is associated. Device type is the name of the network module as defined in the Cisco product catalog (price list).

Step 5 Choose a template file.

To use a template on your Cisco Configuration Engine:

- a. Choose **Select file**.
- b. Use the drop-down list to choose a template.

OR

To use an external template:

- a. Choose **Enter URL**.
- b. Enter the full URL for the server, directory, and filename where the template is stored. Currently, only **http** is supported.
- c. To test access to the external template, click **Test URL**.

If the server is unavailable or the external template cannot be accessed, an error appears. You can still save this logical subdevice, but the template is not available until you have access to the external template.

Step 6 To clear your entries, click **Reset**.

Step 7 To add this device, click **Add**.

Editing Subdevices

Step 1 From the Subdevices Functional Overview page, click **Edit Subdevice**.

Step 2 From the Edit Subdevice page, click on the icon for the subdevice you want to edit.

The subdevice configuration appears with a menu of edit functions in the left navigation pane:

- Edit Information.
- Edit Template.
- Edit Parameter-Admin – Administrator-level view.
- Edit Parameter-Operator – Operator-level view; used by Administrator to verify what Operator can see after Administrator has used **Edit > AttributeInfo** under the Template Manager.
- Edit ContactInfo.

Step 3 From the left navigation pane, choose the edit function you want to use.

Editing Subdevice Information

- Step 1** From the Edit Subdevice page, click **Edit Information**.
The subdevice information editor dialog box appears (see [Figure 3-40](#)).
- Step 2** Modify all applicable fields.
For valid values, see [Table 3-22](#).
- Step 3** To clear your entries, click **Reset**.
- Step 4** To update device information, click **Modify**.
-

Editing Subdevice Template

- Step 1** From the Edit Subdevice left navigation pane, click **Edit Template**.
The template editor appears.
- Step 2** In the **Attributes** field, click the drop-down arrow.
- Step 3** Choose the attribute you want to add to the template, then click **Add**.
- Step 4** Repeat Steps 2 and 3 for all attributes you want to add to the template file.
- Step 5** Delete all unusable strings from the template file.
- Step 6** Edit strings as necessary.
The default multi-line begin and end tags are `^[` and `^]` respectively. The delimiter for these tags are: `~ ! @ ^ & * - = |`. Do not use `#` or `%`.
A multi-line test banner might be:
- ```
banner exec ^[*
 This is a Test Banner
 1. Hi
 2. Hello
 3. Test is 1234567890*
^]
```
- Step 7** To save your edits, click **Save**.
- Step 8** To save this version as a new template, click **Save as**.
-

## Editing Subdevice Parameters

- Step 1** From the Edit Subdevice left navigation pane, click **Edit Parameter-Admin**.  
The parameters editor appears.



**Note** Operator-level privileges do not include access to these parameters.

- Step 2** Modify parameters values as required.
- Step 3** To save your edits, click **Save Parameters**.

## Editing Contact Information

- Step 1** From the Edit Device left navigation pane, click **Edit ContactInfo**.  
The contact information appears.
- Step 2** Edit all active fields as required.
- Step 3** To clear your entries, click **Reset**.
- Step 4** To save your edits, click **Update**.

## Cloning Subdevices

- Step 1** From the Subdevices Functional Overview page, click **Clone Subdevice**.  
The Subdevice list appears (see [Figure 3-41](#)).

**Figure 3-41** Clone Subdevice Device List

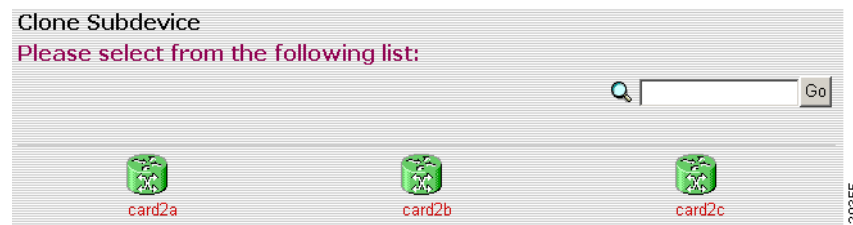

- Step 2** The Step 1 page appears (see [Figure 3-42](#)).

**Figure 3-42** Clone Subdevice > Number of Copies

Clone Subdevice: card2b

Step 1: Enter Number Of copies

|                                 |                      |
|---------------------------------|----------------------|
| Number Of Copies:<br>(required) | <input type="text"/> |
|---------------------------------|----------------------|

129356

Enter the number of copies you want to make, then click **Next**.

The Step 2 page appears (see [Figure 3-43](#)).

**Figure 3-43** Clone Subdevice > Name and IDs

Clone Subdevice: card2b

Step 2: Create 1 copies of card2b using:

|                 | Prefix                              | Suffix                         |
|-----------------|-------------------------------------|--------------------------------|
| Sub-Device Name | <input type="text" value="copyOf"/> | <input type="text" value="1"/> |
| Unique ID       | <input type="text" value="copyOf"/> | <input type="text" value="1"/> |

129331

**Step 3** Enter prefix and suffix for each device copy, click **Next**.

The Step 3 page appears (see [Figure 3-44](#)).

**Figure 3-44** Clone Subdevice > Review Parameters

Clone Subdevice: card2b

Step 3: Review parameters

The following Sub-Devices will be created:

| Sub-Device Names | Unique Ids    |
|------------------|---------------|
| copyOfcard2b1    | copyOfcard2b1 |

The above devices will be created with the following attributes:

|                 |                   |
|-----------------|-------------------|
| Template        | DemoRouter.cfgtpl |
| IOSlinecardtype | AIM-COMPR2        |
| AdminDevType    | line_card         |

129357

**Step 4** Review the parameters you set for this clone.

**Step 5** If you want to make changes, click **Back**.



**Step 6** To finish this task, click **Finish**.

## Deleting Subdevices

**Step 1** From the Subdevices Functional Overview page, click **Delete Device**.  
The Delete Subdevice page appears (see [Figure 3-45](#)).

**Figure 3-45** *Select Subdevices to Delete*



**Step 2** Check to select the subdevice(s) you want to delete.

**Step 3** To proceed, click **Next**.

A status page appears indicating that the subdevice has been selected for deletion (see [Figure 3-46](#)).

**Figure 3-46** *Delete Subdevices Confirmation*

The following sub-devices have been selected for deletion.

`cn=lineCardV1a,ou=LinecardDevices,ou=CNSDevices,ou=hikiki,ou=cisco,c=us`

Delete

129452

**Step 4** To delete this subdevice, click **Delete**.

# Querying Device Inventory

You can use the Query Device Inventory feature to get a reports from devices about:

- Running image information
- Hardware information
- File system list

**Step 1** From the Devices Functional Overview page, click **Query Device Inventory**.  
The Query Device Inventory screen appears.

**Figure 3-47 Query Device Inventory Page**

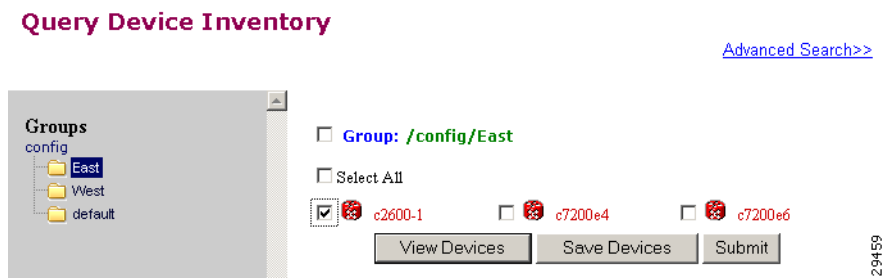

**Step 2** Check the device(s) for which you want to get an inventory report(s), then click **Submit**.  
The Query Notification Information page appears (see [Figure 3-48](#)).

**Figure 3-48 Query Notification Information Page**

## Notification Information

Please mark the notification checkbox and complete the step below if a notification will be sent upon job complete.

|                |                                                                                                                                                                                                                     |
|----------------|---------------------------------------------------------------------------------------------------------------------------------------------------------------------------------------------------------------------|
| <b>Step 1:</b> | <input type="checkbox"/> Send Notification                                                                                                                                                                          |
| <b>Step 2:</b> | Send upon: <ul style="list-style-type: none"> <li><input type="checkbox"/> Job complete success</li> <li><input type="checkbox"/> Job complete failure</li> <li><input type="checkbox"/> Job is canceled</li> </ul> |
| <b>Step 3:</b> | To: <input type="text"/><br>Subject: <input type="text"/><br>Note: <input type="text"/><br><div style="text-align: right;"> <input type="button" value="Next"/> <input type="button" value="Reset"/> </div>         |

129367

**Step 3** If you want an email notification sent when the query completes, fill in the information on this page, then click **Next**.



**Note** This page is optional. You can continue by clicking **Next**.

The Query Attributes Page appears (see [Figure 3-49](#)).

**Figure 3-49 Query Attributes Page.**

**Query Inventory**

Please complete the steps below to perform an Query Inventory:

The screenshot shows a web form with four steps:

- Step 1:** Radio buttons for "Immediate" (selected) and "At a future time: 00 : 15 (hh:mm) on January 1 2005".
- Step 2:** "Device Batch Size: 2" in a text input field.
- Step 3:** "Timeout (in Minute per Device): 0" in a text input field.
- Step 4:** "Text Description for Job:" followed by an empty text input field.

At the bottom are "Query" and "Cancel" buttons. A vertical ID "129460" is on the right.

- Step 4** Set all applicable attributes, then click **Query**.  
The query is submitted as a **Job**. A page appears indicating the job number for this query.
- Step 5** To check the status of this job, go to **Jobs > Query Job**.
- Step 6** Use the drop-down arrow to select Completed Jobs.
- Step 7** For the Inventory Job you want, click either the job number or the entry in the Status column.  
The Job Status page appears (see [Figure 3-50](#)).

**Figure 3-50 Job Status Page**

**Job Status**

|                      |                              |
|----------------------|------------------------------|
| <b>Job ID</b>        | 1110995830322                |
| <b>Description</b>   | Query c7200-ha3 Inventory    |
| <b>Schedule Time</b> | Wed Mar 16 09:57:10 PST 2005 |
| <b>Timeout</b>       | 0 minute(s)                  |
| <b>Status</b>        | Completed                    |

Total: 1 Completed: 1 Stopped: 0 [View All](#)

| Device Name | Status                         |
|-------------|--------------------------------|
| c7200-ha3   | Completed <a href="#">View</a> |

Refresh Cancel

129466

- Step 8** To view the inventory report, click **View**.  
Device inventory report appears (see [Figure 3-51](#))

Figure 3-51 Sample Device Inventory Report

ImageID:c2600-1 Reported Time: 1993-03-05T22:57:37

| Running Image Information    |                               |                  |                             |
|------------------------------|-------------------------------|------------------|-----------------------------|
| Description (Version String) | 12.2(12h)                     |                  |                             |
| Image File                   | flash:c2600-ik8o3s-mz.122-12h | Image MD5        |                             |
| Config Variable              |                               | Config Reg       | Config Reg Next Boot        |
| Boot Variable                |                               | Bootldr Variable | Return To ROM Reason reload |
| Return To ROM Time           | 2003-11-04T00:00:00           | Started At       | 2003-11-04T00:00:00         |

| Hardware Information |             |                  |          |
|----------------------|-------------|------------------|----------|
| Vendor               | cisco       | Platform Name    | 2611     |
| Processor Type       |             | Main Mem Size    | 30649288 |
| Hardware Serial #    | JAB03170532 | IO Mem Size      | 4194312  |
| Processor Rev        |             | MidPlane Version |          |
| Hardware Rework      |             |                  |          |

| File System List           |                                                                                                                                            |
|----------------------------|--------------------------------------------------------------------------------------------------------------------------------------------|
| FileSys                    | name=[nvram:], type=[nvram], size=[29688], freespace=[26473], readable=[1], writeable=[1]                                                  |
| Directory 0:               | name=[/], fullname=[nvram:/], size=[29688], readflag=[1], writeflag=[1], owner=[], modDate=[1969-12-31T00:00:00]                           |
| File 0 under Directory[/]: | name=[startup-config], fullname=[nvram:/startup-config], size=[1110], readflag=[1], writeflag=[1], owner=[], modDate=[1969-12-31T00:00:00] |

101485

## Delete Files on Device

- Step 1** From the Devices Functional Overview page, click **Delete Files on Device**. The Delete File on Device page appears (see Figure 3-52).

Figure 3-52 Delete Files on Device Page

### Delete File On Devices

[Advanced Search>>](#)



- Step 2** Check the device(s) on which you want to delete files, then click **Submit**.

The Delete Device Files Notification Information page appears (see [Figure 3-53](#)).

**Figure 3-53** Delete Device Files Notification Information Page

### Notification Information

Please mark the notification checkbox and complete the step below if a notification will be sent upon job complete.

**Step 1:**  Send Notification

**Step 2:** Send upon:  Job complete success  
 Job complete failure  
 Job is canceled

**Step 3:** To:   
 Subject:   
 Note:

Next Reset

129367

**Step 3** If you want an email notification sent when the query completes, fill in the information on this page, then click **Next**.

This page is optional. You can continue by clicking **Next**.

The Delete Files parameter page appears (see [Figure 3-54](#)).

**Figure 3-54** Delete Files Parameter Page

### Delete Files On Device

Please complete the steps below to perform the action:

**Step 1:** Select Search Parameters:

Available Search Parameters: sp1a, sp1b, test2, End of list

Selected Search Parameters: End of list

>> <<

**Step 2:** Apply to:  bootflash  nvram  Other file systems

**Step 3:**  Immediate  
 At a future time: 00 : 15 (hh:mm) on January 1 2005

**Step 4:** Text Description for Job:

Preview Submit Cancel

129462

**Step 4** Complete the steps on this page, then to preview, click **Preview**.

**Step 5** When you are satisfied with the task parameters, click **Submit**.

# Dynamic Operations

Dynamic Operations allows you to perform operations on devices that all respond to having the same attributes based on the Query used to find them.

To use this feature you must have query objects available before starting Dynamic Operations. If no Queries have been created, you will see a message stating that there are no query objects available.

To create a Query, go to the “[Creating Queries](#)” section on page 8-2.

- Step 1** From the Devices Functional Overview page, click **Dynamic Operations**.  
The Dynamic Operations page appears (see [Figure 3-55](#))

**Figure 3-55** Dynamic Operations Page

**Dynamic Operations**

Select Query (required) all\_c7200s

Add Group  
 Delete Device  
 Update Config  
 Update Image  
 Query Device Inventory  
 Delete Files on Device

Back Next Cancel List Devices

129467

- Step 2** Use the down-arrow key to select the Query you want to use.
- Step 3** Select the operation you want to perform on devices that respond to the Query, then click **List Devices**.  
The result of the Query appears (see [Figure 3-56](#)).

**Figure 3-56** Devices Responding to Query

Following devices are returned after executing the query:

| Devices   | Associated Groups |
|-----------|-------------------|
| c7200-1   | /config/default   |
| c7200-2   | /config/default   |
| c7200-ha1 | /config/default   |
| c7200-ha2 | /config/default   |
| c7200-ha3 | /config/default   |

Back Next Cancel List Devices

129468

- Step 4** To continue with the selected operation, click **Next**.



## User Account Manager

---



**Note**

User accounts can be accessed only when operating in Internal Directory mode.

---

To access User tasks, log in to the system (see [“Logging In” section on page 2-1](#)). Then, from the Home page, click the **Users** tab.

A functional overview of the user administration options appears showing:

- Add User
- Edit User
- Delete User
- Change Password

## Adding User Account

---

- Step 1** From the User Administration page, click **Add User**.  
The User Information dialog box appears (see [Figure 4-1](#)).

Figure 4-1 User Information

**User Information**

| Attribute Name   | Attribute Value      |
|------------------|----------------------|
| UserID           | <input type="text"/> |
| Password         | <input type="text"/> |
| Confirm Password | <input type="text"/> |
| Last Name        | <input type="text"/> |
| First Name       | <input type="text"/> |

| Group                                          |
|------------------------------------------------|
| <input checked="" type="radio"/> Administrator |
| <input type="radio"/> Operator                 |

53468

**Step 2** Enter a valid value (no spaces) in the **UserID** field.

Table 4-1 shows valid values for these fields.

Table 4-1 Valid Values for Add User Account

| Attribute        | Description                                          | Valid Values                                                    |
|------------------|------------------------------------------------------|-----------------------------------------------------------------|
| UserID           | ID that allows user to log in to the user interface. | a-z<br>A-Z<br>0-9<br>-(hyphen)<br>_ (under-score)<br>. (period) |
| Password         | Password                                             | Printable characters with a length of 6 – 12                    |
| Confirm Password | Password                                             | Printable characters with a length of 6 – 12                    |
| Last Name        | Last name of registered user.                        | a-z<br>A-Z<br>0-9<br>-(hyphen)<br>_ (under-score)<br>. (period) |
| First Name       | First name of registered user.                       | a-z<br>A-Z<br>0-9<br>-(hyphen)<br>_ (under-score)<br>. (period) |

**Step 3** Enter a password in the **Password** field.



- Step 4** Confirm the password by entering it again in the **Confirm Password** field.
- Step 5** Enter the user's last name in the **Last Name** field.
- Step 6** Enter the user's first name in the **First Name** field.
- Step 7** In the Group pane, click the radio button that classifies the privilege level (**Administrator, Operator**) of this user.
- Step 8** To clear your entries, click **Reset**.
- Step 9** To save your entries, click **Save**.

## Editing User Account

- Step 1** From the User Administration page, click **Edit User**.  
A shows of users appears (see [Figure 4-2](#)).

**Figure 4-2** User List

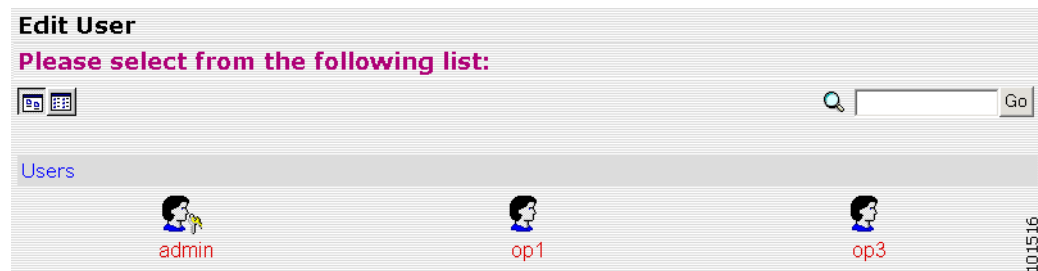

- Step 2** From the User List, click on the icon for the user account you want to edit.



**Note**

Administrator-level users are shown with a key icon associated with the figure icon.

The User Information page appears (see [Figure 4-3](#)).

**Figure 4-3** User Information**User Information**

| Attribute Name | Attribute Value |
|----------------|-----------------|
| UserID         | op3             |
| Last Name      | Begoode         |
| First Name     | Johnny          |

| Group                                     |
|-------------------------------------------|
| <input type="radio"/> Administrator       |
| <input checked="" type="radio"/> Operator |

|      |       |
|------|-------|
| Save | Reset |
|------|-------|

66136

**Step 3** To modify the user ID, enter a valid value (no spaces) in the **UserID** field.

[Table 4-2](#) shows valid values for these fields.

**Table 4-2** Valid Values for User Information

| Attribute        | Description                                          | Valid Values                                 |
|------------------|------------------------------------------------------|----------------------------------------------|
| UserID           | ID that allows user to log in to the user interface. | Information only                             |
| Password         | Password                                             | Printable characters with a length of 6 – 12 |
| Confirm Password | Password                                             | Printable characters with a length of 6 – 12 |
| Group            | Administrator or Operator level                      | Radio Button                                 |

**Step 4** To modify the user's last name, edit the **Last Name** field.

**Step 5** To modify the user's first name, edit the **First Name** field.

**Step 6** To modify the user group status, click the appropriate radio button in the **Group** pane.

**Step 7** To clear your entries, click **Reset**.

**Step 8** To save your entries, click **Save**.

User information update status appears (see [Figure 4-4](#)).

**Figure 4-4** User Information Update Status**Following parameters have been saved:**

givenName =Johnny

description =operator

sn =Begoode

cn =op3

66139

## Deleting User Account

- Step 1** From the User Administration page, click **Delete User**.
- Step 2** From the user list (see [Figure 4-2](#)), click on the icon for the user account you want to delete.

## Changing User Password

- Step 1** From the User Administration page, click **Change Password**.  
The Change Password dialog box (see [Figure 4-5](#)) appears.

**Figure 4-5** Change Password

**Change Password**

|                  |                          |
|------------------|--------------------------|
| UserID           | <input type="text"/>     |
| New password     | <input type="password"/> |
| Confirm password | <input type="password"/> |

53471

- Step 2** Enter the **UserID** for the user account password you want to change or reset.  
[Table 4-3](#) shows valid values for these fields.

**Table 4-3** Valid Values for Change Password by Administrator

| Attribute        | Description                                          | Valid Values                                                    |
|------------------|------------------------------------------------------|-----------------------------------------------------------------|
| UserID           | ID that allows user to log in to the user interface. | a-z<br>A-Z<br>0-9<br>-(hyphen)<br>_ (under-score)<br>. (period) |
| Password         | Password                                             | Printable characters with a length of 6 – 12                    |
| Confirm Password | Password                                             | Printable characters with a length of 6 – 12                    |

- Step 3** Enter the new password in the **New password** field.
- Step 4** Enter the new password again in the **Confirm password** field.
- Step 5** To clear your entries, click **Reset**.

**Step 6** To save the new password, click **Edit**.

---

## Changing Account Privilege Level

---

**Step 1** From the User Administration page, click **Edit User**.

**Step 2** Choose the user in question from the user list (see [Figure 4-2](#)).

The User Information page appears (see [Figure 4-6](#)).

**Figure 4-6** User Information

**User Information**

| Attribute Name | Attribute Value |
|----------------|-----------------|
| UserID         | cnsadmin        |
| Last Name      | Dog             |
| First Name     | Big             |

| Group                                          |
|------------------------------------------------|
| <input checked="" type="radio"/> Administrator |
| <input type="radio"/> Operator                 |

53469

**Step 3** In the Group pane, click the radio button that classifies the privilege level (Administrator, Operator) of this user.

**Step 4** To clear your entries, click **Reset**.

**Step 5** To save your entries, click **Save**.

---



## Configuration and Image Update Jobs Manager

To access tasks for managing configuration and image update Jobs, log into the system (see “[Logging In](#)” section on page 2-1). Then, from the Home page, click the **Jobs** tab.

The Jobs Functional Overview page appears showing:

- Query Job
- Cancel/Stop Job
- Restart Job
- Delete Completed Job

### Querying Jobs

**Step 1** From the Jobs Functional Overview page, click **Query Job**.

The Query Job page appears (see [Figure 5-1](#)).

**Figure 5-1** Query Job

#### Query Job

| List of       | Currently Executing | All                     |             |
|---------------|---------------------|-------------------------|-------------|
| Job ID        | Description         | Start Time              | Status      |
| 1106678875211 |                     | 2005-01-25 10:47:55 PST | In-Progress |

129337

**Step 2** Use the drop-down arrow in the left menu to select available list of jobs:

- Currently Executing
- Stopped
- Completed

**Step 3** Use the drop-down arrow in the right menu to select the type of listing:

- All
- Image Jobs
- Config Jobs
- Delete Files Jobs
- Query Inventory Jobs

## Canceling or Stopping Jobs

**Step 1** From the Jobs Functional Overview page, click **Cancel/Stop Job**.

The Cancel/Stop Job page appears (see [Figure 5-2](#)).

**Figure 5-2** *Cancel/Stop Job*

### Cancel/Stop Job

List of jobs which can be Cancelled/Stopped:

|                          | Job ID        | Start Time                   | Description | Status      |
|--------------------------|---------------|------------------------------|-------------|-------------|
| <input type="checkbox"/> | 1106678875211 | Tue Jan 25 10:47:55 PST 2005 |             | In-Progress |

129338

**Step 2** Check to select the Job you want to cancel or stop, then click **Cancel Jobs**, or **Stop Jobs**.

## Restarting Jobs

**Step 1** From the Jobs Functional Overview page, click **Restart Job**.

The Restart Job page appears (see [Figure 5-3](#)).

**Figure 5-3** *Restart Job*

### Restart Job

List of jobs which can be Restarted:

|                          | Job ID        | Start Time                   | Description | Status  |
|--------------------------|---------------|------------------------------|-------------|---------|
| <input type="checkbox"/> | 1106678875211 | Tue Jan 25 10:47:55 PST 2005 |             | Stopped |

129353

**Step 2** Check to select the Job you want to restart, then click **Restart Jobs**.

## Deleting Completed Jobs

**Step 1** From the Jobs Functional Overview page, click **Delete Completed Jobs**. The Delete Completed Jobs page appears (see [Figure 5-4](#)).

**Figure 5-4** Completed Jobs List

### Delete Completed Job

List of Completed jobs:

Select All

|                          | Job ID        | Start Time                   | Description                                    | Status    |
|--------------------------|---------------|------------------------------|------------------------------------------------|-----------|
| <input type="checkbox"/> | 1107916464334 | Tue Feb 08 18:34:24 PST 2005 |                                                | Completed |
| <input type="checkbox"/> | 1107917966260 | Tue Feb 08 18:59:26 PST 2005 |                                                | Completed |
| <input type="checkbox"/> | 1107921621739 | Tue Feb 08 20:00:21 PST 2005 |                                                | Completed |
| <input type="checkbox"/> | 1107921920495 | Tue Feb 08 17:05:19 PST 2005 | Submit through WEB SERVICE API @ 1107911119786 | Completed |
| <input type="checkbox"/> | 1107975382765 | Wed Feb 09 10:56:22 PST 2005 |                                                | Completed |

Delete Jobs Cancel

129448

**Step 2** Check to select the completed jobs you want to delete, then click **Delete Jobs**.







# Groups

To access Group management tasks, log into the system (see “[Logging In](#)” section on page 2-1). Then, from the Home page, click the **Tools** tab. The Tools page appears.

From the Tools page, click **Group Mgr.** The Group Management page appears showing:

- View Groups
- Create Group
- Edit Group
- Clone Group
- Move Group
- Delete Groups
- Create Group Using Search

## Viewing Groups

From the Group Management page click **View Groups**. The View Groups page appears (see [Figure 6-1](#)).

**Figure 6-1** View Groups Page

### View Groups



# Creating Groups

- Step 1** From the Group Management page click **Create Groups**.  
The Create Groups page appears (see [Figure 6-2](#)).

**Figure 6-2** Create Group

**Create Group**

Step 1: Group Name and Namespace information

Group Name (required) PA0

Namespace (required) config

Back Next Finish Cancel

129362

- Step 2** Enter the group name.
- Step 3** Use the drop-down arrow to select a namespace value (only **config** available), then click **Next**.  
The Select Parent Group page appears (see [Figure 6-3](#)).

**Figure 6-3** Select Parent Group Page

**Create Group**

Step 2: Select Parent Group

/  
 East  
 West  
 default

129601

- Step 4** Click the radio button(s) to select the parent group with which you want the new group to associated, then click Next.  
The Select Member Devices page appears (see [Figure 6-4](#)).

**Figure 6-4** Select Member Devices Page

**Create Group**

Step 3: Select Member Device(s)

config

Group: /config/West

Select All  
 c7200w3  c7200w7

129602

- Step 5** Check to select the devices you want to be in this group, then click **Finish**.

## Editing Groups

- 
- Step 1** From the Group Management page click **Edit Group**.  
The Group list appears.
  - Step 2** Click the radio button to select a group to edit, then click **Next**.  
The Rename Group page appears.
  - Step 3** Rename group, if applicable, then click **Finish** to complete the task, or click **Next** to continue (see [Figure 6-5](#)).

**Figure 6-5** *Edit Group Members*

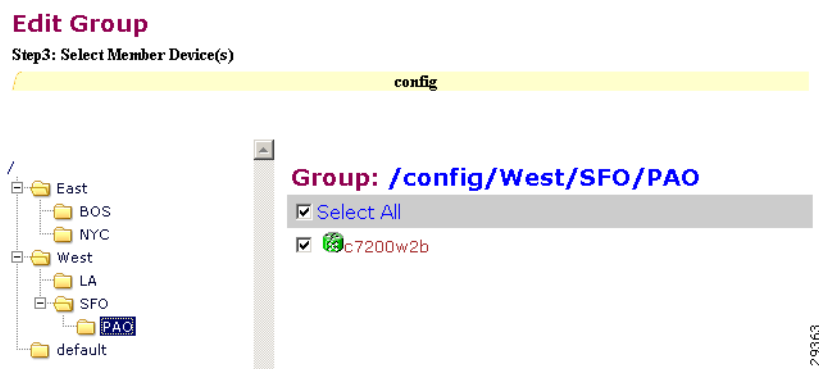

- Step 4** Click the Group you are editing to bring up its members.
  - Step 5** Modify the members in this group by using the check box next to each member, then click **Finish**.
- 

## Cloning Groups

- 
- Step 1** From the Group Management page click **Clone Group**.  
The Group list appears.
  - Step 2** Select a group to clone.
  - Step 3** Select parent group.
  - Step 4** Enter new group name.
-

## Moving Groups

- 
- Step 1** From the Group Management page click **Move Group**.  
The Group list appears.
- Step 2** Select a group to move.
- Step 3** Select parent group.
- 

## Deleting Groups

- 
- Step 1** From the Group Management page click **Delete Groups**.  
The Group list appears.
- Step 2** Check to select the group(s) you want to delete.
- 

## Creating Groups Using Search

- 
- Step 1** From the Group Management page click **Create Group Using Search**.  
The search for devices page appears (see [Figure 6-6](#)).

**Figure 6-6** Search for Devices

### Create Group Using Search

**Step 1: Search for Devices:**

[Sample Filter String: ((cn=D\*)&{IOSEventID=D\*})]

| Attribute:                                                                                                      | Operator:                           | Value:                          |                                                    |
|-----------------------------------------------------------------------------------------------------------------|-------------------------------------|---------------------------------|----------------------------------------------------|
| <input type="text" value="IOSEventID"/>                                                                         | <input "="" type="text" value="="/> | <input type="text" value="D*"/> | <input type="button" value="Add to Query String"/> |
| Query: <input type="text" value="IOSEventID=D*"/>                                                               |                                     |                                 |                                                    |
| <input type="button" value="Reset"/> <input type="button" value="Query"/> <input type="button" value="Cancel"/> |                                     |                                 |                                                    |

129364

- Step 2** Enter the appropriate arguments for the search, then click **Query**.  
Any devices found appear on the next page (see [Figure 6-7](#)).

**Figure 6-7** Select Devices to Add to Group**Create Group Using Search**

Step 2: Select Devices to be added to the Group

Select All

DemoRouter

Back Next Cancel

129365

- Step 3** Check to select the devices you want to become members of this new group, then click **Next**. The next page (see [Figure 6-8](#)) gives you the choice to add a new group, or just add the devices found to an existing group.

**Figure 6-8** Name Group and Namespace**Create Group Using Search**

Step 3: Group Name and Namespace information

Add Device(s) to existing Group

Create a new Group

Group Name (required) stage1a

Namespace (required) config

Back Next Finish Cancel

129366

- Step 4** Enter group name.
- Step 5** Use the drop-down arrow to select a namespace value, then click **Next**. The group list page appears.
- Step 6** Select group parent, then click **Finish**.





# Namespace Manager

---

The Namespace Manager provides a GUI for managing the system namespace known as “config,” which contains the set of Cisco standardized events, such as *com.cisco.cns.mgmt.config.load*, etc. By default, each event defines a mapping to itself for both the publish and subscribe mapping.

If you are using the *Cisco Configuration Engine Software Development Kit API Reference and Programmer Guide, 2.0* to develop your own application, you are free to redefine the map according to your application needs. Additional application-specific namespace values can be defined by means of the Cisco Configuration Engine SDK.



## Note

---

Cisco Configuration Engine, 2.0 supports multiple namespaces and their respective mappings by means of the Cisco Configuration Engine, 2.0 GUI.

---

The system namespace is guaranteed to return a mapping even for undefined events; in which case, the input map is returned as the output map. This is a requirement for supporting future devices which might depend on new events that are not currently defined.

To access Namespace management tasks, log into the system (see [“Logging In” section on page 2-1](#)). Then, from the Home page, click the **Tools** tab. The Tools page appears.

From the Tools page, click **Namespace Mgr**. The Namespace Management page appears showing:

- View Events
- Add Events
- Edit Events
- Delete Events















































## Viewing Events

From the Namespace Manager main page, click **View Events**. The events list for the current application (config) appears (see [Figure 7-1](#)).

Figure 7-1 Events List

## Application Details: config

## Events in the Application:

|                                                                                                                    |                                                                                                                         |                                                                                                                             |
|--------------------------------------------------------------------------------------------------------------------|-------------------------------------------------------------------------------------------------------------------------|-----------------------------------------------------------------------------------------------------------------------------|
|  cisco.mgmt.cns.config-changed    |  cisco.mgmt.cns.device.disconnect      |  cisco.mgmt.cns.device.connect           |
|  cisco.cns.config.reboot          |  cisco.mgmt.cns.event.boot             |  cisco.cns.config-changed                |
|  cisco.cns.config.load            |  cisco.mgmt.cns.inventory.get          |  cisco.mgmt.cns.config.sync-status       |
|  cisco.cns.device.connect         |  cisco.cns.exec.cmd                    |  cisco.cns.exec.reload                   |
|  cisco.mgmt.cns.image.checkServer |  cisco.mgmt.cns.exec.cmd               |  cisco.mgmt.cns.config.load              |
|  cisco.mgmt.cns.config.complete   |  cisco.cns.exec.rsp                    |  cisco.mgmt.cns.exec.reload              |
|  cisco.cns.config.id-changed      |  cisco.cns.config.complete             |  cisco.mgmt.cns.exec.rsp                 |
|  cisco.mgmt.cns.image.status      |  cisco.cns.inventory.oir               |  cisco.mgmt.cns.image.deleteRequest      |
|  cisco.mgmt.cns.config.reboot     |  cisco.mgmt.cns.reloadNotify           |  cisco.mgmt.cns.inventory.device-details |
|  cisco.mgmt.cns.config.failure    |  cisco.mgmt.cns.image.deleteResponse   |  cisco.mgmt.cns.image.upgradeRequest     |
|  cisco.cns.config.sync-status     |  cisco.mgmt.cns.config.warning         |  cisco.mgmt.cns.config-changed.lost      |
|  cisco.cns.config.failure         |  cisco.cns.inventory.get               |  cisco.cns.event.boot                    |
|  cisco.mgmt.cns.config.id-changed |  cisco.mgmt.cns.image.inventoryRequest |  cisco.cns.inventory.device-details      |
|  cisco.cns.config-changed.lost    |  cisco.cns.reloadNotify                |  cisco.cns.config.warning                |
|  cisco.cns.device.disconnect     |  cisco.mgmt.cns.event.id-changed      |  cisco.cns.event.id-changed             |
|  cisco.mgmt.cns.inventory.oir   |                                                                                                                         |                                                                                                                             |

129368

## Adding Events

The events list for the current application (config) appears (see [Figure 7-1](#)).

**Step 1** From the Namespace Manager main page, click **Add Events**.

The Event information page appears (see [Figure 7-2](#)).

Figure 7-2 Event Information Page

## Add Event to Application: config

|                                                                         |                                              |
|-------------------------------------------------------------------------|----------------------------------------------|
| <b>Event Name</b><br><small>(required)</small>                          | <input type="text"/>                         |
| <b>NSM Mode</b>                                                         | Algorithmic <input type="button" value="v"/> |
| <b>Event Mapping</b><br><small>(required)</small>                       | <input type="text"/>                         |
| <input type="button" value="Advanced"/>                                 |                                              |
| <input type="button" value="Add"/> <input type="button" value="Reset"/> |                                              |

129369



- Step 2** Enter an Event name.
- Step 3** Use the drop-down arrow to select the NSM Mode.
- Algorithmic – Mapped events qualified with group name or device name are returned from NSM. This is the preferred mode for all users. It allows you to provision the selected group(s) of device(s).
  - Non-Algorithmic – Mapped events are returned from NSM without group name or device name. You are forced to provision all device(s).
- Step 4** Enter a valid Event Mapping.  
For example: **cisco.mgmt.cns.exec.reload**
- Step 5** To define separate parameters for Subscriber Mapping and Publisher Mapping, click **Advanced**.  
The advanced event information page appears (see [Figure 7-3](#)).

**Figure 7-3** Advanced Event Information Page

**Add Event to Application: config**

|                                         |                                                                                                                                              |
|-----------------------------------------|----------------------------------------------------------------------------------------------------------------------------------------------|
| <b>Event Name</b><br>(required)         | <input type="text"/>                                                                                                                         |
| <b>Subscriber Default</b>               | Algorithmic <input type="button" value="v"/>                                                                                                 |
| <b>Publisher Default</b>                | Algorithmic <input type="button" value="v"/>                                                                                                 |
| <b>Subscriber Mapping</b><br>(required) | <input type="text"/><br><input type="button" value="Remove"/><br>New Mapping <input type="text"/> <input type="button" value="Add to list"/> |
| <b>Publisher Mapping</b><br>(required)  | <input type="text"/><br><input type="button" value="Remove"/><br>New Mapping <input type="text"/> <input type="button" value="Add to list"/> |

129453

- Step 6** Enter information in the appropriate fields, then click **Add**.

# Editing Events

- Step 1** From the Namespace Manager main page, click **Edit Events**.  
The Event information page appears (see [Figure 7-4](#)).

**Figure 7-4** Event List to Edit

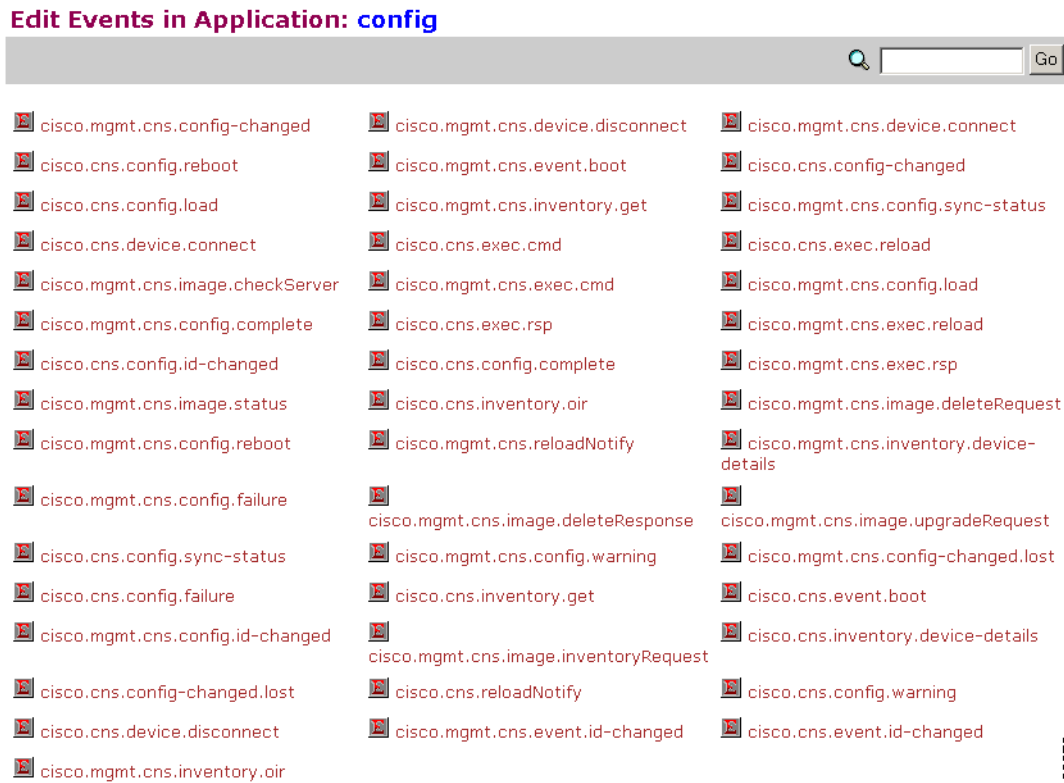

129370

- Step 2** Click on the Event you want to edit.  
The Edit Event parameters page appears (see [Figure 7-5](#)).

Figure 7-5 Edit Event Parameters

**Edit Event: cisco.cns.config.load**

|                                                        |                                                                                                                                                                                 |
|--------------------------------------------------------|---------------------------------------------------------------------------------------------------------------------------------------------------------------------------------|
| <b>Subscriber Default</b><br><small>(required)</small> | Algorithmic                                                                                                                                                                     |
| <b>Publisher Default</b><br><small>(required)</small>  | Algorithmic                                                                                                                                                                     |
| <b>Subscriber Mapping</b><br><small>(required)</small> | <input type="text" value="cisco.mgmt.cns.config.load"/><br><input type="button" value="Remove"/><br>New Mapping <input type="text"/> <input type="button" value="Add to list"/> |
| <b>Publisher Mapping</b><br><small>(required)</small>  | <input type="text" value="cisco.mgmt.cns.config.load"/><br><input type="button" value="Remove"/><br>New Mapping <input type="text"/> <input type="button" value="Add to list"/> |

129371

**Step 3** Modify all applicable fields, then click **Edit**.

## Deleting Events

**Step 1** From the Namespace Manager main page, click **Delete Events**.  
The Delete Event list page appears (see [Figure 7-6](#)).

Figure 7-6 Event List for Deleting Events

Delete Events From Application : config

Select All

|                                                           |                                                              |                                                                  |
|-----------------------------------------------------------|--------------------------------------------------------------|------------------------------------------------------------------|
| <input type="checkbox"/> cisco.mgmt.cns.config-changed    | <input type="checkbox"/> cisco.mgmt.cns.device.disconnect    | <input type="checkbox"/> cisco.mgmt.cns.device.connect           |
| <input type="checkbox"/> cisco.cns.config.reboot          | <input type="checkbox"/> cisco.mgmt.cns.event.boot           | <input type="checkbox"/> cisco.cns.config-changed                |
| <input type="checkbox"/> cisco.cns.config.load            | <input type="checkbox"/> cisco.mgmt.cns.inventory.get        | <input type="checkbox"/> cisco.mgmt.cns.config.sync-status       |
| <input type="checkbox"/> cisco.cns.device.connect         | <input type="checkbox"/> cisco.cns.exec.cmd                  | <input type="checkbox"/> cisco.cns.exec.reload                   |
| <input type="checkbox"/> cisco.mgmt.cns.image.checkServer | <input type="checkbox"/> cisco.mgmt.cns.exec.cmd             | <input type="checkbox"/> cisco.mgmt.cns.config.load              |
| <input type="checkbox"/> cisco.mgmt.cns.config.complete   | <input type="checkbox"/> cisco.cns.exec.rsp                  | <input type="checkbox"/> cisco.mgmt.cns.exec.reload              |
| <input type="checkbox"/> cisco.cns.config.id-changed      | <input type="checkbox"/> cisco.cns.config.complete           | <input type="checkbox"/> cisco.mgmt.cns.exec.rsp                 |
| <input type="checkbox"/> cisco.mgmt.cns.image.status      | <input type="checkbox"/> cisco.cns.inventory.oir             | <input type="checkbox"/> cisco.mgmt.cns.image.deleteRequest      |
| <input type="checkbox"/> cisco.mgmt.cns.config.reboot     | <input type="checkbox"/> cisco.mgmt.cns.reloadNotify         | <input type="checkbox"/> cisco.mgmt.cns.inventory.device-details |
| <input type="checkbox"/> cisco.mgmt.cns.config.failure    | <input type="checkbox"/> cisco.mgmt.cns.image.deleteResponse | <input type="checkbox"/> cisco.mgmt.cns.image.upgradeRequest     |
| <input type="checkbox"/> cisco.cns.config.sync-status     | <input type="checkbox"/> cisco.mgmt.cns.config.warning       | <input type="checkbox"/> cisco.mgmt.cns.config-changed.lost      |

129372

**Step 2** Check to select the Event(s) you want to delete, then click **Delete**.

A confirmation box appears.

**Step 3** To Delete the selected Event(s), click **OK**.



# Query Manager

To access Query management tasks, log into the system (see “Logging In” section on page 2-1). Then, from the Home page, click the **Tools** tab. The Tools page appears.

From the Tools page, click **Query Mgr**. The Query Manager Functional Overview page appears showing:

- View Query
- Create Query
- Edit Query
- Delete Query

## Viewing Queries

**Step 1** From the Query Manager Functional Overview page, click **View Query**. The View Queries page appears (see [Figure 8-1](#)).

**Figure 8-1** View Queries Page

### View Query

Q

| Query Name   | User Query String            |
|--------------|------------------------------|
| IOSdomain    | IOSdomain=cisco.com          |
| vpn_cfg_tmpl | IOSconfigtemplate=VPN.cfgtpl |

129373

**Step 2** Click on the Query Name for which you want to view details. The Query Details page appears (see [Figure 8-2](#)).

**Figure 8-2 Query Details****Query Details:**

|                   |                       |
|-------------------|-----------------------|
| Query Name        | IOSdomain             |
| User Query String | IOSdomain=cisco.com   |
| Ldap Query String | (IOSdomain=cisco.com) |

129374

## Creating Queries

- Step 1** From the Query Manager Functional Overview page, click **Create Query**.  
The Create Query page appears (see [Figure 8-3](#)).

**Figure 8-3 Create Query Page****Create Query**

Query Name (required)

=  Add to Query String

User Query String:   
 Sample User Query String: ((IOSconfigtemplate=VPN.cfgtpl) & (IOSdomain=cisco.com))

Following devices qualify the search: (AuthPassword=pista)

129454

- Step 2** Enter a Query Name.
- Step 3** Use the drop-down arrow to select Operators and Attributes with which to build a Query String, then for each successive click **Add to Query String**.  
Each time you click **Add to Query String**, that portion of the argument is added to the query string.
- Step 4** If required, enter the remainder of the argument in the User Query string field.
- Step 5** To validate this query before you create it, click **Validate**.  
The Query returns a result.
- Step 6** To create this query, click **Create**.

# Editing Queries

**Step 1** From the Query Manager Functional Overview page, click **Edit Query**.  
The Edit Query page appears (see [Figure 8-4](#)).

**Figure 8-4 Edit Query Page**

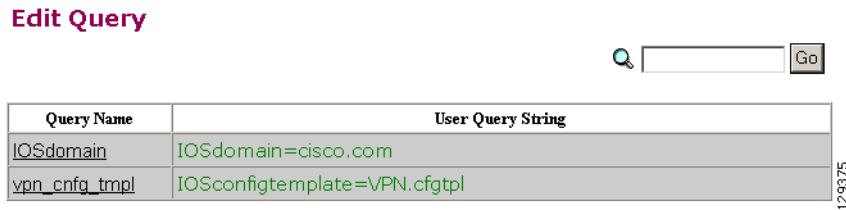

**Step 2** Click on the Query Name you want to edit.  
The Edit Query Attributes page appears (see [Figure 8-5](#)).

**Figure 8-5 Edit Query Attributes Page**

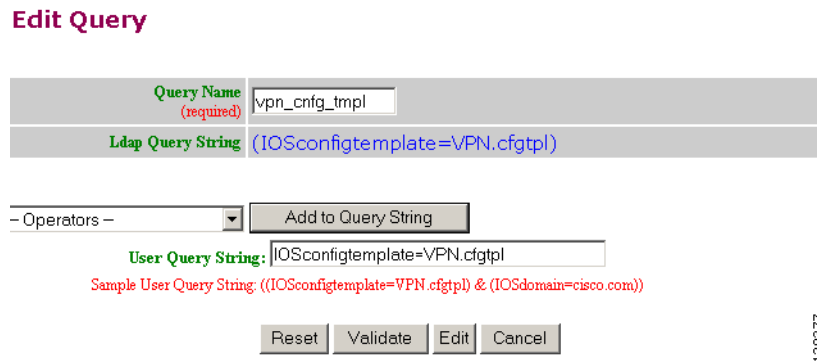

**Step 3** Modify all applicable fields:

- Use the drop-down arrow to select Operators and Attributes with which to build a Query String, then for each successive click **Add to Query String**.  
Each time you click **Add to Query String**, that portion of the argument is added to the query string.
- If required, enter the remainder of the argument in the User Query string field.
- To validate this query before you create it, click **Validate**.  
The Query returns a result.

**Step 4** To save your changes to this query, click **Edit**.

# Deleting Queries

- Step 1** From the Query Manager Functional Overview page, click **Delete Query**. The Delete Query page appears (see [Figure 8-6](#)).

**Figure 8-6** Delete Query Page

**Delete Query:**

| <input type="checkbox"/> Select All | Query Name    | User Query String            | Ldap Query String              |
|-------------------------------------|---------------|------------------------------|--------------------------------|
| <input type="checkbox"/>            | IOSdomain     | IOSdomain=cisco.com          | (IOSdomain=cisco.com)          |
| <input type="checkbox"/>            | vpn_cnfg_tmpl | IOSconfigtemplate=VPN.cfgtpl | (IOSconfigtemplate=VPN.cfgtpl) |

129378

- Step 2** Check to select the Query you want to delete, then click **Delete**.





## Data Manager

---

To access Data management tasks, log into the system (see “[Logging In](#)” section on page 2-1). Then, from the Home page, click the **Tools** tab. The Tools page appears.

From the Tools page, click **Data Manager**. The Data Manager page appears. The Data Manager functions include:

- Schedule Backup
- Update Product List
- Manage Disk Space

## Scheduling Data Backup

---

- Step 1** From the Data Manager Overview page, click **ScheduleBackup**.  
The backup information dialog box appears (see [Figure 9-1](#)).

Figure 9-1 Backup Schedule Parameters

**BACKUP SCHEDULE PARAMETERS**

|                                                                                                                              |                                                                                                                                                                                                                                                                                                                                                                                                        |
|------------------------------------------------------------------------------------------------------------------------------|--------------------------------------------------------------------------------------------------------------------------------------------------------------------------------------------------------------------------------------------------------------------------------------------------------------------------------------------------------------------------------------------------------|
| <b>Backup server name</b><br>(This is the server name, where all the backup files will be put.)                              | Ftp <input type="text"/><br><small>Warning : If you select tftp, make sure that a file with the name "backup-cnscce-(hostname).tar.gz" is already present with 777 permissions in the tftp enabled directory on the tftp server. Here (hostname) is the output of 'hostname' command on the local machine. Just a blank file will also do.<br/>For eg: backup-cnscce-myie2100.cisco.com.tar.gz</small> |
| <b>Username</b><br>(Username to login to Backup FTP server.)                                                                 | <input type="text"/>                                                                                                                                                                                                                                                                                                                                                                                   |
| <b>Password</b><br>(Password to login to Backup FTP server.)                                                                 | <input type="password"/>                                                                                                                                                                                                                                                                                                                                                                               |
| <b>Directory</b><br>(This is the subdirectory where the files will be put. Absolute path is required.)                       | <input type="text"/>                                                                                                                                                                                                                                                                                                                                                                                   |
| <b>Enable Log File Management</b><br>(When enabled, log files will be backed up on the server and deleted from the IE2100.)  | No <input type="checkbox"/>                                                                                                                                                                                                                                                                                                                                                                            |
| <b>Backup Schedule</b><br>(At the designated time (hh:mm) on a specified day, the background scripts will run as a cron job) | <input checked="" type="radio"/> Daily At <input type="text" value="00:00"/> (hh:mm)<br><input type="radio"/> Weekly every <input type="text" value="Saturday"/> At <input type="text" value="00:00"/> (hh:mm)<br><input type="radio"/> Monthly on day <input type="text" value="1"/> At <input type="text" value="00:00"/> (hh:mm)                                                                    |

129317

**Step 2** To specify where you want the backup data to be stored, enter the FTP server name in the **FTP Server Name** field.

Table 9-1 shows valid values for these fields.

Table 9-1 Valid Values for Backup Schedule Parameters

| Attribute       | Description                                           | Valid Values                                                  |
|-----------------|-------------------------------------------------------|---------------------------------------------------------------|
| FTP Server name | Server name where all backup files will be put.       | a-z<br>A-Z<br>0-9<br>-(hyphen)<br>_ (under-score)<br>(period) |
| Username        | Login username for the FTP server.                    | a-z<br>A-Z<br>0-9<br>-(hyphen)<br>_ (under-score)<br>(period) |
| Password        | Password for FTP server.                              | Printable characters with a length of 6 – 12                  |
| Directory       | Subdirectory into which all backup files will be put. | Absolute path                                                 |

**Table 9-1** Valid Values for Backup Schedule Parameters (continued)

| Attribute                  | Description                                                             | Valid Values        |
|----------------------------|-------------------------------------------------------------------------|---------------------|
| Enable Log File Management | determines whether files will be deleted from host system after backup. | From drop-down list |
| Backup Schedule            | Date and time fields.                                                   | As required         |

- Step 3** To specify the username to log into the FTP server, enter a valid username in the **Username** field.
- Step 4** To specify the password to use to log into the FTP server, enter a valid value in the **Password** field.
- Step 5** To specify the subdirectory where the data file is put, enter the absolute path in the **Directory** field.
- Step 6** Choose whether to **Enable Log File Management**.
- Step 7** To specify the backup schedule, complete the fields in the **Backup Schedule** pane.



**Note** The time base for the host system should be set to Coordinated Universal Time (UTC).

- Step 8** To cancel the backup operation, click **Cancel**.
- Step 9** To start the backup operation, click **Backup**.

## Updating Product List

The product list is a mapping between product name of the network modules as specified in the pricing list and the numeric identification number stored in EPROM. As new products are added, this list grows and hence the need for the Cisco Configuration Engine to update this list whenever new products are added. This list can be downloaded from the Cisco web site at: <http://www.cisco.com>.

- Step 1** From the Data Manager page, click **Update Product List**.  
The Update Product List dialog box appears (see [Figure 9-2](#)).

**Figure 9-2** Update Product List

### Update Product List

The dialog box titled "Update Product List" has a light blue header. Under "Select Download Option:", the "Download from Specified URL." option is selected. The "URL:" field contains "http://". The "Username:" and "Password:" fields are empty. A "Download" button is at the bottom.

129444

- Step 2** Select the appropriate download option.

Table 9-2 shows valid values for these fields.

**Table 9-2** Valid Values for Update Product List

| Attribute              | Description                | Valid Values                                                    |
|------------------------|----------------------------|-----------------------------------------------------------------|
| Select Download Option | Available download options | Radio Button                                                    |
| URL                    | Target URL                 | Valid URL as per RFC 1738.                                      |
| Username               | Your username              | a-z<br>A-Z<br>0-9<br>-(hyphen)<br>_ (under-score)<br>. (period) |
| Password               | Your password              | Printable characters with a length of 6 – 12                    |

- Step 3** Enter the target URL.
- Step 4** Enter your username and password.
- Step 5** To download the product list, click **Download**.

## Managing Disk Space

- Step 1** From the Data Manager page, click **Manage Disk Space**.  
The Setup Disk Space Notification dialog box appears (see Figure 9-3).

**Figure 9-3** Disk Space Notification

### Setup Disk Space Notification

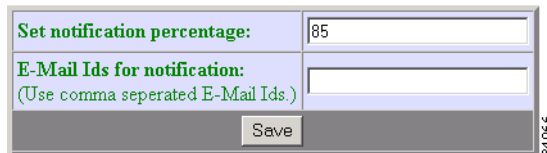

The screenshot shows a dialog box titled "Setup Disk Space Notification". It has two input fields. The first field is labeled "Set notification percentage:" and contains the number "85". The second field is labeled "E-Mail Ids for notification:" with a sub-label "(Use comma separated E-Mail Ids.)" and is currently empty. At the bottom right of the dialog box is a "Save" button. The dialog box has a grey border and a light blue header area.

- Step 2** Set the notification percentage to the value that triggers an e-mail notification.

Table 9-3 shows valid values for these fields.

**Table 9-3** Valid Values for Setup Disk Space Notification

| Attribute                    | Description                                                   | Valid Values                                                    |
|------------------------------|---------------------------------------------------------------|-----------------------------------------------------------------|
| Set notification percentage  | Notification percentage that triggers an e-mail notification. | 0 – 100                                                         |
| E-Mail Ids for notification: | E-mail address to send notification.                          | a-z<br>A-Z<br>0-9<br>-(hyphen)<br>_ (under-score)<br>. (period) |

**Step 3** Set the appropriate e-mail address for notification e-mail.

**Step 4** To save these entries, click **Save**.

---





# Directory Manager



**Note**

Directory Manager can be accessed only when operating in Internal Directory mode.

To access Directory management tasks, log into the system (see “[Logging In](#)” section on page 2-1). Then, from the Home page, click the **Tools** tab. The Tools page appears.

From the Tools page, click **Directory Mgr.**

With the directory manager you can:

- Edit the schema
- Import a schema from an XML file

## Editing Schema

**Step 1** From the Directory Manager page, click **Edit Schema**.

The schema editor appears (see [Figure 10-1](#)).

**Figure 10-1** Schema Editor

**Schema Editor**

|                                          |                           |
|------------------------------------------|---------------------------|
| Name of class to which attribute belongs | IOSConfigClass            |
| Name of the attribute                    | <input type="text"/>      |
| Unique ID for this attribute             | 1.2.840.113548.3.1.2.3001 |

149120

**Step 2** Enter the name of the new attribute.

[Table 10-1](#) shows valid values for these fields.

**Table 10-1** Valid Values for Schema Editor

| Attribute                    | Description                  | Valid Values                                                    |
|------------------------------|------------------------------|-----------------------------------------------------------------|
| Name of the attribute        | Name of the attribute        | a-z<br>A-Z<br>0-9<br>-(hyphen)<br>_ (under-score)<br>. (period) |
| Unique ID for this attribute | Unique ID for this attribute | a-z<br>A-Z<br>0-9<br>-(hyphen)<br>_ (under-score)<br>. (period) |

- Step 3** Accept or modify the **Unique ID** for this attribute.
- Step 4** To clear your entries, click **Reset**.
- Step 5** To add this attribute to the schema, click **Add Entry**.

## Importing Schema

You can import a schema accessible from your computer. However, the file must be in XML format and conform to the definitions specified in the document type definition (DTD) file shown here:

```
<?xml version="1.0" encoding="UTF-8"?>
<!-- DTD for DAML -->
<!-- Last updated: 2006-01-18 -->
<!ELEMENT attribute EMPTY>
<!ATTLIST attribute
ref CDATA #REQUIRED
required CDATA #REQUIRED
>
<!ELEMENT attribute-type (name, object-identifier, syntax)>
<!ATTLIST attribute-type
id CDATA #REQUIRED
single-value CDATA #REQUIRED
obsolete CDATA #REQUIRED
user-modification CDATA #REQUIRED
>
<!ELEMENT class (name, object-identifier, attribute)>
<!ATTLIST class
id CDATA #REQUIRED
superior CDATA #REQUIRED
type CDATA #REQUIRED
obsolete CDATA #REQUIRED
>
<!ELEMENT directory-schema (attribute-type, class)>
<!ELEMENT dsml (directory-schema)>
<!ATTLIST dsml
complete CDATA #REQUIRED
>
```



```
<!ELEMENT name (#PCDATA)>
<!ELEMENT object-identifier (#PCDATA)>
<!ELEMENT syntax (#PCDATA)>
>
```

### Example

For example, a valid schema would look like:

```
<?xml version="1.0" encoding="UTF-8"?>
<!DOCTYPE dsml SYSTEM "dsml.dtd">
<dsml complete="true">
 <directory-schema>
 <attribute-type id="IOSelipaddress" single-value="true" obsolete="false"
user-modification="true">
 <name>IOSelipaddress</name>
 <object-identifier>1.2.840.113548.3.1.2.20</object-identifier>
 <syntax>1.3.6.1.4.1.1466.115.121.1.15</syntax>
 </attribute-type>
 <class id="IOSConfigClass" superior="top" type="structural" obsolete="false">
 <name>IOSConfigClass</name>
 <object-identifier>1.2.840.113548.3.2.2.1</object-identifier>
 <attribute ref="1.2.840.113548.3.1.2.20" required="false"/>
 </class>
 </directory-schema>
</dsml>
```

**Step 1** From the Directory Manager page, click **Import Schema**.

The import schema dialog box appears (see [Figure 10-2](#)).

**Figure 10-2** Import Schema

**Step 2** Enter the filename of the schema you want to import in the **Schema Filename** field.

[Table 10-2](#) shows valid values for these fields.

**Table 10-2** Valid Values for Import Schema

Attribute	Description	Valid Values
Schema Filename	Name of schema file to import.	a-z A-Z 0-9 -(hyphen) _ (under-score) . (period)

Use the browse function to locate the file, if needed.

**Step 3** To clear your entries, click **Reset**.

**Step 4** To import the file, click **Import**.

---



## Parameter Manager

---

To access Parameter management tasks, log into the system (see [“Logging In” section on page 2-1](#)). Then, from the Home page, click the **Tools** tab. The Tools page appears.

From the Tools page, click **Parameter Mgr.**

With the directory manager you can:

- Parameter Validations
- Edit Fetch Process
- Edit Save Process
- Import Script File

## Parameter Validations

---

**Step 1** From the Parameter Manager page, click **Parameter Validations**.

The Parameter Validations page appears (see [Figure 11-1](#)).

**Figure 11-1** ParametersValidations Page

Edit Parameters Validations

Available Parameters	Validation Functions
AdminDevType	— No Validation —
IOSdomain	— No Validation —
IOShostname	— No Validation — Positive_integer_Only verify_Date_Time verify_Domain_Name
IOSipaddress	verify_Email_Address verify_IP_Address verify_URL
IOSpassword	— No Validation —
IOSprotocol	— No Validation —
IOSroutingprotocol	— No Validation —
IOSsubnetmask	— No Validation —
IOStimeout	— No Validation —
SW1InterfaceName	— No Validation —
SW2InterfaceName	— No Validation —

Update

129603

- Step 2** From drop-down list for each available parameter, select the desired validation function, then click **Update**.

A status page appears showing the updates you have made.

## Edit Fetch Process

- Step 1** From the Parameter Manager page, click **Edit Fetch Process**.

The Edit Fetch Process page appears (see [Figure 11-2](#)).

**Figure 11-2** Edit Fetch Process Page

Edit Fetch Process

**Fetch Process:**

— No Fetch Process —

— No Fetch Process —  
event\_setup.js  
event\_setup\_security.js  
fetchP.js  
fetchP\_no\_output.js  
saveP.js  
saveP\_no\_output.js

129604

- Step 2** Use the drop-down arrow to select the desired fetch process, then click **Update**.

Confirmation of this action is reported.

# Edit Save Process

- Step 1** From the Parameter Manager page, click **Edit Save Process**.  
The Edit Save Process page appears (see [Figure 11-3](#)).

**Figure 11-3** *Edit Save Process Page*

Edit Save Process

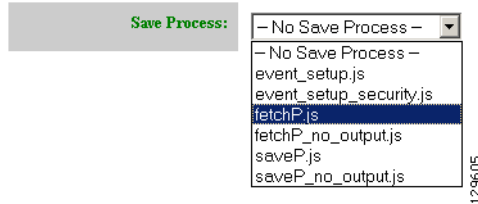

- Step 2** Use the drop-down arrow to select the desired save process, then click **Update**.  
Confirmation of this action is reported.

# Import Script File

- Step 1** From the Parameter Manager page, click **Import Script File**.  
The Import Script File page appears (see [Figure 11-4](#)).

**Figure 11-4** *Import Script File Page*

Import Script File

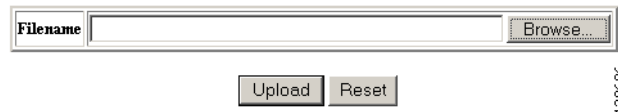

- Step 2** Enter the desired filename, or click Browse to access your file system, then click **Upload**.





## Templates

---

When creating a template, it is possible to specify variables that will be contextually substituted. Many of these variables are available in the drop-down menu in the Template Editor (see [Figure 12-4](#)). It is also possible to create these files offline without the Template Editor and still use these variables.

The basic format of a template file is simply the text of the configuration to be downloaded to your device (see “[Sample Template](#)” section on [page 12-1](#)). However, you can put variable substitutions of the following form (for example, the variable name could be *iosipaddress*):

```
Internal directory mode:
 ${LDAP://this:attrName=iosipaddress}
External directory mode:
 ${LDAP://10.1.1.2.3/cn=Device1,ou=CNSDevices,o=cisco,c=us:attrName=iosipaddress}
```

It is possible to create segments of templates that can be included in other templates. For example, you might have an Ethernet configuration that would be used by multiple devices. In each device template, you could have:

```
#include /opt/CSCOcsie/Templates/ethernet_setup.cfgtpl
```

Now, you could centralize all the administration for Ethernet configuration in one file.



**Caution**

---

Circular includes of template files are not allowed.

---

## Sample Template

The following sample is the configuration template for the DemoRouter (*DemoRouter.cfgtpl*), which is pre-loaded on your system:

```
!
version 12.0
service timestamps debug uptime
service timestamps log uptime
no service password-encryption
service udp-small-servers
service tcp-small-servers
!
hostname DemoRouter
!
boot system flash c7200-is-mz
enable secret 5 1cMdI$.e37TH540MWB2GW5gM0n3/
enable password cisco
```

```
!
ip subnet-zero
!
interface FastEthernet0/0
 no ip address
 no ip directed-broadcast
 no ip route-cache
 no ip mroute-cache
 shutdown
 half-duplex
!
interface Ethernet1/0
 ip address 10.10.1.1 255.255.255.240
 no ip directed-broadcast
 no ip route-cache
 no ip mroute-cache
!
interface Ethernet1/1
 no ip address
 no ip directed-broadcast
 no ip route-cache
 no ip mroute-cache
 shutdown
!
interface Ethernet1/2
 no ip address
 no ip directed-broadcast
 no ip route-cache
 no ip mroute-cache
 shutdown
!
interface Ethernet1/3
 no ip address
 no ip directed-broadcast
 no ip route-cache
 no ip mroute-cache
 shutdown
!
ip classless
ip route 0.0.0.0 0.0.0.0 10.10.1.1
ip http server
!
dialer-list 1 protocol ip permit
dialer-list 1 protocol ipx permit
!
line con 0
 transport input none
line aux 0
line vty 0 4
 password cisco
 login
!
end
```



# Configuration Control Templates

To restart a device with a new image, you need Configuration Control templates that contain the required CLI commands for image activation on particular devices.

For example, if you want to restart a Cisco 3600 Series router with an image named *3600.image*, from the device console, you would issue the following CLI commands:

```
no boot system
boot system flash:3600.image
```

The content of the Configuration Control template for image activation should contain the CLI commands that you would normally enter from the device console to activate a new image on the device.

## Dynamic Flow Control Template

The inventory information collected from image agents is made available for external users by means of the Dynamic Flow Control Template. This enables you to write templates that can control the flow of configuration and image distribution jobs, based on the inventory information.

## Inventory Operations

These are the operations that are exposed to you to access the inventory of the device from the Dynamic Flow Control Templates:

<b>Function</b>	<b><code>#{invObj.getDram()}</code></b>
Return Type	int (bytes).
Description	Dram = Main Mem Size + IO Mem Size. Returns the size of the DRAM.

<b>Function</b>	<b><code>#{invObj.getVersionString()}</code></b>
Return Type	String.
Description	Returns the version string of the current running image from the device inventory.

<b>Function</b>	<b><code>#{invObj.getImageFile()}</code></b>
Return Type	String.
Description	Returns the current running image file name.

<b>Function</b>	<b><code>!{invObj.getImageMD5()}</code></b>
Return Type	String.
Description	Returns the MD5 as provided in the device inventory.

<b>Function</b>	<b><code>!{invObj.getStartedAt()}</code></b>
Return Type	String.
Description	Returns the time string of when the device started.

<b>Function</b>	<b><code>!{invObj.getPlatformName()}</code></b>
Return Type	String.
Description	Returns the platform name.

<b>Function</b>	<b><code>!{invObj.getFlash()}</code></b>
Return Type	int (bytes).
Description	Returns the size of the flash.

<b>Function</b>	<b><code>!{invObj.getFileSysSize("bootflash")}</code></b>
Return Type	int (bytes).
Description	Returns the size of the bootflash.

<b>Function</b>	<b><code>!{invObj.getFileSysFreespace("bootflash")}</code></b>
Return Type	int (bytes).
Description	Returns the amount of free space in the bootflash.

<b>Function</b>	<b><code>!{invObj.getFileSysSize("nvram")}</code></b>
Return Type	int (bytes).
Description	Returns the size of the NVRAM.

<b>Function</b>	<b><code>#{invObj.getFileSysFreespace("nvram")}</code></b>
Return Type	int (bytes).
Description	Returns the amount of free space in the NVRAM.

<b>Function</b>	<b><code>#{invObj.getFileSysSize("disk0")}</code></b>
Return Type	int (bytes).
Description	Returns the size of disk0.

<b>Function</b>	<b><code>#{invObj.getFileSysFreespace("disk0")}</code></b>
Return Type	int (bytes).
Description	Returns the amount of free space in disk0.

<b>Function</b>	<b><code>#{invObj.getFileSysSize("slot0")}</code></b>
Return Type	int (bytes).
Description	Returns the size of slot0.

<b>Function</b>	<b><code>#{invObj.getFileSysFreespace("slot0")}</code></b>
Return Type	int (bytes).
Description	Returns the amount of free space in slot0.

<b>Function</b>	<b><code>#{invObj.getFileSysSize("slot1")}</code></b>
Return Type	int (bytes).
Description	Returns the size of slot1.

<b>Function</b>	<b><code>#{invObj.getFileSysFreespace("slot1")}</code></b>
Return Type	int (bytes).
Description	Returns the amount of free space in slot1.

## Other Operations

These are the operations that are exposed to you to perform an action based on the above criterion from the Dynamic Flow Control Template:

<b>Function</b>	<b><code>!{cnsceObj.distribute()}</code></b>
Parameters	None.
Description	Perform image distribution. The pre-configured image is used.

<b>Function</b>	<b><code>!{cnsceObj.activate("persist"   "nv_overwrite")}</code></b>
Parameters	Sets the config action: <ul style="list-style-type: none"> <li>• “persist” – apply and save configuration to NVRAM.</li> <li>• “nv_overwrite” – overwrite NVRAM configuration.</li> </ul>
Description	Performs image activation. The pre-configured image is used.

<b>Function</b>	<b><code>!{cnsceObj.updateConfig(true   false, "write"   "persist"   "nv_overwrite")}</code></b>
Parameters	First parameter sets the syntax check: <ul style="list-style-type: none"> <li>• true – syntax check is turned on.</li> <li>• false – syntax check is turned off.</li> </ul> Second parameter is to set the config action: <ul style="list-style-type: none"> <li>• “write” – apply to running configuration.</li> <li>• “persist” – apply and save configuration to NVRAM.</li> <li>• “nv_overwrite” – overwrite NVRAM configuration.</li> </ul>
Description	Performs configuration update. The pre-configured template is used.

## Notes

The `invObj.getDram()` operation returns the following:

Dram = Main Mem Size + IO Mem Size

### Example

```
#set($dram = !{invObj.getDram()})
##
#if ($dram > 6100)
 !{cnsceObj.distribute()}
 !{cnsceObj.activate("persist")}
#end
```

As seen in the example above, you can customize the flow of the job depending on the DRAM size.

When a custom job with the above inventory template is submitted, the device is queried for its inventory, and depending on the DRAM size, the decision is made if the image upgrade is to be performed or not. Hence when the above example inventory template is evaluated, if the DRAM size of the device is greater than 6100 bytes the image distribution and image activation will be performed.

### Sample1

```
#set($dram = ${invObj.getDRAM()})
#set($flash = ${invObj.getFlash()})
##
#if ($dram > 64000000)
 ${cnsceObj.distribute()}
 #if ($flash > 48000000)
 ${cnsceObj.activate("persist")}
 #end
#end
```

### Sample 2

```
#set($disk0free = ${invObj.getFileSysFreespace("disk0")})
##
#if $disk0free > 3500000
 ${cnsceObj.distribute()}
 ${cnsceObj.activate("persist")}
#end
```

### Sample 3

```
#set($flash = ${invObj.getFlash()})
##
#if ($flash > 65000000)
 ${cnsceObj.updateConfig(true, "persist")}
#end
```

## Templates for Modular Routers

The template mechanism for the devices has been enhanced to support modular routers. A modular router chassis includes slots in which you can install modules. You can install any module into any available slot in the chassis. Some modules like 2 Ethernet 2 WAN card slot module can in turn have sub slots to install interface cards or line cards. Device management has been extended to support subdevices representing line cards.

Additional attributes representing line card number, line card type, and subdevices have been added to the existing device object structure in the directory server in order to have the same structure to represent the main device or the subdevice.

Currently, card type is a string that maps to the product code of the network module. Since the EPROM data in the card stores part numbers only, not product codes, the part numbers are mapped to product codes. The user uses part numbers and the configuration server maps part numbers to product codes.

In the context of main device, the line card number and line card type fields make no sense and hence are set to NULL value. The subdevices field in the sub device (representing the line card) is set to NULL value.

New interface variable support has been added. These variables are included in the templates, which are parameterize with the interface numbers in the template. These are not attributes. They are special format variables that are replaced by the configuration server based on the interface information, which comes from the device. These variables only specify the relative position of the interface on the module and are replaced by the actual slot number, shelf-ID or port number. The interface variables are wrapped in percent sign (%) characters and specify the type, if any, and the relative position. The configuration server replaces these variables with the interface numbers. The interface type still has to be specified in the CLI using the following syntax:

**Interface Variable = %[InterfaceType] RelativePosition%**

For example:

**%FastEthernet 0%** for interface FastEthernet

**%Serial 0%** interface Serial

**%T1 0%** controller T1

**%E1 0%** controller E1

**%voice-port 0%** voice-port

#### Example 1:

A network module with two FastEthernet ports plugged in Slot 2 would be referred in the configuration CLI as FastEthernet 2/0 and FastEthernet 2/1 and referred in the template as FastEthernet %FastEthernet 0% and FastEthernet %FastEthernet 1%:

```
!
interface FatsEthernet 2/0
 ip address 10.10.1.1 255.255.255.0
!
interface FatsEthernet 2/1
 ip address 20.20.1.1 255.255.255.0
!
```

Templates for these CLIs would be:

```
!
interface FastEthernet %FastEthernet 0%
 ip address 10.10.1.1 255.255.255.0
!
interface FastEthernet %FastEthernet 1%
 ip address 20.20.1.1 255.255.255.0
!
```

**Example 2 (Voice card with two ports plugged in slot 3):**

```

!
voice-port 3/0/0
 description 4082224444
!
voice-port 3/0/0
 description 4082225555
!

```

Templates for these CLIs would be:

```

!
voice-port %voice-port 0%
 description 4082224444
!
voice-port %voice-port 1%
 description 4082225555
!

```

The main device template does not include links to the subdevice templates. The subdevice templates are appended to the main device template. The line card numbers are a parameter in the subdevice templates.

All the CLI commands which reference a line card interface are specified in the subdevice template for that line card. This implies that any command in the global configuration mode, or otherwise, that refers to a particular line card interface is in the template for that subdevice (line card) and not in the main device template.

Only the CLI commands in the global configuration mode, and not pertaining to the any specific interface, are specified in the main device template.

The port number and channel number are not template parameters since these are fixed for a given line card. The network administrator can configure specific channels on the interfaces by explicitly specifying the channels in the subdevice templates.

For example:

```
interface Serial %Serial 0%:0
```

## Sample Templates for Modular Router

The names of the attributes for slot, slot-unit, line card type and so forth, are used for demonstration purposes.

### Main Device Template

```

!
version 12.2
no parser cache
no service single-slot-reload-enable
service timestamps debug uptime
service timestamps log uptime
no service password-encryption
!
hostname 2600
!

```

```

logging rate-limit console 10 except errors
!
memory-size iomem 25
ip subnet-zero
!
!
!
no ip dhcp-client network-discovery
lcp max-session-starts 0
!
ip classless
no ip http server
!
call rsvp-sync
!
no mgcp timer receive-rtcp
!
mgcp profile default
!
dial-peer cor custom
!
!
!
!
line con 0
line aux 0
line vty 0 4
 login
line vty 5 15
 login
!

```

## FastEthernet Template

```

Interface FastEthernet %FastEthernet 0%

ip address 10.0.0.1 255.0.0.0
shutdown
speed auto

```

## Voice-port Template

```

voice-port %voice-port 0%
 playout-delay mode adaptive
!
voice-port %voice-port 1%
!
dial-peer voice 10 pots
 destination-pattern 200
 port %voice-port 0%
 forward-digits all

voice-port %voice-port 0%
!
dial-peer voice 20 pots
 destination-pattern 100
 port %voice-port 0%
!
voice-port %voice-port 1%

```



## Modular Router Events

Modular router events are published to the event bus and are accessible to applications connected to the bus. The IOS device publishes the system hardware configuration in the *cisco.cns.config.device-details* event after hardware discovery. The Cisco Configuration Engine is configured to listen for this event, retrieve it, and extract the hardware configuration of the device.

Following is the DTD of the *cisco.cns.config.device-details* event that the Cisco IOS device sends:

```
<!ELEMENT device-details (config-id, connect-interface?, card-info*>
<!ELEMENT config-id (#PCDATA)>
<!ELEMENT connect-interface (#PCDATA)>
<!ELEMENT card-info (card-info+)>
<!ELEMENT card-info
(card-type,card-desc?,slot,daughter?,serial-number,part-number,hw-version?,board-revision?
,ports?,controller?,rma-number?,test-history?,eeprom-version?,eeprom-data?,interface?,cont
roller?,voice-port?)>
<!ELEMENT card-type (#PCDATA)>
<!ELEMENT card-desc (#PCDATA)>
<!ELEMENT slot (#PCDATA)>
<!ELEMENT daughter (#PCDATA)>
<!ELEMENT serial-number (#PCDATA)>
<!ELEMENT part-number (#PCDATA)>
<!ELEMENT hw-version (#PCDATA)>
<!ELEMENT board-revision (#PCDATA)>
<!ELEMENT ports (#PCDATA)>
<!ELEMENT controller (#PCDATA)>
<!ELEMENT rma-number (#PCDATA)>
<!ELEMENT test-history (#PCDATA)>
<!ELEMENT eeprom-version (#PCDATA)>
<!ELEMENT eeprom-data (#PCDATA)>
<!ELEMENT interface (#PCDATA)>
<!ELEMENT controller (#PCDATA)>
<!ELEMENT voice-port (#PCDATA)>
```

## Dynamic Templates

There might be times when the actual contents of a template needs to be dynamically generated. To do this, you would use the **#call** mechanism. This executes a JavaScript program whose output becomes part of the template. The program is re-executed each time a device asks for the template.

For example, you might want to distribute the load across the various event gateway processes without permanently assigning a device to a particular event gateway. This is useful because of the limit of 500 devices per event gateway daemon instance.

Let us take the following template as an example:

```
version 12.0
service timestamps debug uptime
service timestamps log uptime
no service password-encryption
service udp-small-servers
service tcp-small-servers
!
hostname DemoRouter
#call /opt/CSCOcsie/Templates/event_setup.js
```

Here is an example of an *event\_setup.js* that one might use:

```
/*
 * An instance of Event Gateway resides on every odd port from 11011 to 11031.
```

```

* This will choose a random one in this range so that devices are spread out
* evenly among the various ports. Adjust the IP address in the println
* statement to be the address of the IE2100 itself.
*/
var port = Math.floor(Math.random() * 11) * 2 + 11011;
println("cns event 10.1.6.131 " + port.toString());

```

The result of this combination would be a template that appears as follows:

```

version 12.0
service timestamps debug uptime
service timestamps log uptime
no service password-encryption
service udp-small-servers
service tcp-small-servers
!
hostname DemoRouter
cns event 10.1.6.131 11017

```

The last line is programmatically determined and recalculated every time the template is requested by the device. So the next time a device requests this template, the last line might be:

```
cns event 10.1.6.131 11023
```

Simple modifications to *event\_setup.js* could even be used to distribute devices across multiple host devices (by dynamically generating the IP address). It could also be used to affect any part of the device configuration—be it DNS servers or routing tables. Anything that is printed out by the JavaScript program becomes a dynamic part of the template.

## Control Structures

The configuration template can include simple control structures such as *if*, *else* and *elseif*. By using these control structures, the user can include or exclude a block of CLI commands based on a parameter stored in the directory.

The syntax for these # preprocessing control structures is as follows:

### Syntax Description

**#if** <URL> = constant

cli-command(s)

**#elseif** <URL> = constant

cli-command(s)

**#else**

cli-command(s)

**#endif**

Where *constant* is an integer, boolean or a string in single quotes and the <URL> is a URL pointing to an attribute in the Directory or Database.



### Note

Nested **#if** and **#elseif** is NOT supported.

**Usage Guidelines**

The configuration template can include **#define** entries to define short names for long URLs.

The syntax for the **#define** preprocessing command is as follows:

```
#define definition-name <URL> | constant
```

where <URL> is a reference to an attribute in the directory.

The configuration template can contain another **#** preprocessing command **#include**, which allows the inclusion of other configuration templates or the results of an ASP page.

The syntax for the **#** preprocessing command is as follows:

```
#include <URL> | '<Filename>' | <Filename>
```

Whenever an **#include** directive is encountered, it is replaced by the content of the file.

The following configuration template sample includes either IP sub-template or ISDN sub-template based on the value of the parameter protocol in the directory or database.

**Examples**

```
!
version 12.0
service timestamps debug uptime
service timestamps log uptime
no service password-encryption
service udp-small-servers
service tcp-small-servers
!
hostname ${LDAP://this:attrName=IOShostname}
#if ${LDAP://this:attrName=IOSIPprotocol} = true then
 #include ${LDAP://this:attrName=IPsubTemplate}
#else
 #include ${LDAP://this:attrName=ISDNsubTemplate}
#endif
```

The parameter, `${LDAP://this:attrName=IPsubTemplate}` contains the location of the file.

## Managing Templates

To access Template management tasks, log into the system (see [“Logging In” section on page 2-1](#)). Then, from the Home page, click the **Tools** tab. The Tools page appears.

From the Tools page, click **Template Mgr**. The Template Manager page appears showing:

- Add Template
- Edit Template
- Delete Template
- Import Template

## Adding a Template

- Step 1** From the Template Manager page, click **Add Template**.  
The Template Engine page appears (see [Figure 12-1](#)).

**Figure 12-1** *Template Engine*

Add Template  
Please select a template engine for the new template:

Templae Engine Name	Suffix
<input checked="" type="radio"/> Legacy Template Engine	.cftpl
<input type="radio"/> Velocity Template Engine	.vm
<input type="radio"/> Inventory Template Engine	.inv

129329

- Select the Template Engine for the new template, then click **Next**.  
A blank template page appears (see [Figure 12-2](#)).

**Figure 12-2** *Blank Template Page*

Template File:  .cftpl      Attributes:

SW1InterfaceName  
SW2InterfaceName

- Connection -  
- Logical Slot Numbers -  
%Serial 0%  
%Serial 1%  
%ATM 0%  
%ATM 1%  
%POS 0%  
%POS 1%

Opened: new doc      Line 1

129464

- Step 2** Enter the filename for this template in the **Template File** field.  
[Table 12-1](#) shows valid values for these fields.

**Table 12-1** Valid Values for Add Template

Attribute	Description	Valid Values
Template File	Filename of template	a-z A-Z 0-9 -(hyphen) _ (under-score) . (period)
Attributes	Available attributes	From drop-down list

**Step 3** To choose the attributes you want to be included in this template, use the **Attributes** menu.

**Step 4** To save your entries, click **Save**.

## Editing a Template

**Step 1** From the Template Manager page, click **Edit Template**.

The Edit Template list appears (see [Figure 12-3](#)).

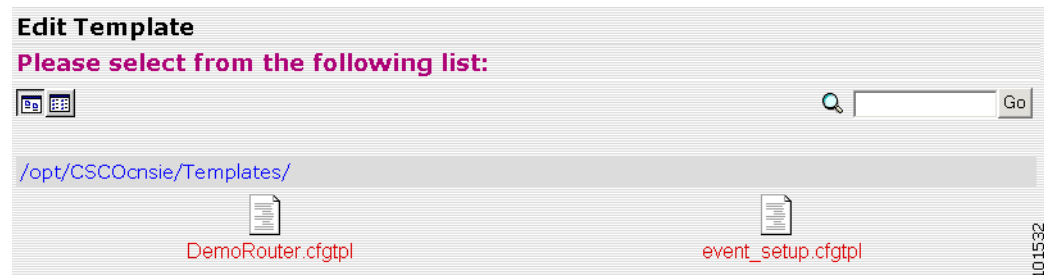
**Figure 12-3** Edit Template List

**Step 2** Click on the icon for the template file you want to edit.

The template file appears.

**Step 3** To edit parameters (attribute information):

- a. From the template file page, click **Edit AttributeInfo**.
- b. Edit the desired parameter fields.
- c. To clear your entries, click **Reset**.
- d. To save your changes, click **Save**.

**Step 4** To save and apply, **Save and Apply**.

**Step 5** To edit template content:

- a. To edit the content of a template, from the template file page, click **Edit Content**.  
The template content appears (see [Figure 12-4](#)).

Figure 12-4 Template Content

Template File: [ DemoRouter.cfgtpl ]      Attributes: [ - Device - ] Add

```

!
version 12.0
service timestamps debug uptime
service timestamps log uptime
no service password-encryption
service udp-small-servers
service tcp-small-servers
!
hostname DemoRouter
!
boot system flash c7200-is-mz
enable secret 5 1cMdl$.e37TH540MWB2GW5gM0n3/
enable password cisco
!
ip subnet-zero
!
interface FastEthernet0/0
no ip address
no ip directed-broadcast
no ip route-cache
no ip mroute-cache
shutdown
half-duplex
!
interface Ethernet1/0
ip address 10.10.1.1 255.255.255.240
no ip directed-broadcast
no ip route-cache
no ip mroute-cache
!
interface Ethernet1/1
no ip address
no ip directed-broadcast

```

Opened: DemoRouter.cfgtpl      Line 1

Save    Save as...

101533

- b. Edit the content by adding or deleting attributes.
- c. To save your edits, click **Save**.
- d. To save as a new template, click **Save as**.

## Deleting a Template

- Step 1** From the Template Manager page, click **Delete Template**.  
The template file list appears.
- Step 2** Select the template you want to delete.
- Step 3** Delete the desired template file.

## Importing a Template

---

- Step 1** From the Template Manager page, click **Import Template**.
  - Step 2** In the dialog box that appears, enter the name of the template file in the **Filename** field, if known, or browse your directory tree to choose the filename you desire.
  - Step 3** To clear the field, click **Reset**.
  - Step 4** To upload the template file, click **Upload**.
-







## Security Manager

---

With the security manager tool you can change the bootstrap password.

The bootstrap password is used to authenticate a Cisco IOS device before it connects to the Event Gateway. For additional information see [“Device Authentication” section on page 1-13](#).

To access Security management tasks, log into the system (see [“Logging In” section on page 2-1](#)). Then, from the Home page, click the **Tools** tab. The Tools page appears. From the Tools page, click **Security Mgr**.

The Security Manager page appears showing: BootStrap.

## Changing Bootstrap Password

The bootstrap password is used where multiple devices are deployed in a batch. In this case, all devices in a particular batch are given the same (bootstrap) password to use when they each start up on the network for the first time. The bootstrap password can be changed for different batches of devices by using the Security Manager.

---

**Step 1** From the Security Management page, click **BootStrap**.

The Change Bootstrap Password page appears (see [Figure 13-1](#)).

**Figure 13-1** Change Bootstrap Password**Change Bootstrap Password**

New password	<input type="text"/>
Confirm password	<input type="text"/>

Note: An empty string is considered a valid bootstrap password.

**Action for devices that have not had their initial registration.**

- Update** - Update the database's copy of the passwords that are equal to the current bootstrap password. (This will require manual intervention on all currently uninstalled devices when they do their initial registration.)
- Keep** - Do not modify the database's copy of any password that is equal to the current bootstrap password. (This allows all currently uninstalled devices to complete their initial registration without manual intervention.)

OK Reset

101535

**Step 2** In the password dialog box, enter the new password.

Table 13-1 shows valid values for these fields.

**Table 13-1** Valid Values for Change Bootstrap Password

Attribute	Description	Valid Values
New password	Bootstrap password	Printable characters with a length of 6 – 12
Confirm password	Bootstrap password	Printable characters with a length of 6 – 12
Update	Modifies the database copy of the password that is equal to the current bootstrap password. This will require manual intervention on all currently uninstalled devices when they do their initial registration.	Radio button
Keep	Does not modify the database copy of any password that is equal to the current bootstrap password. This allows all currently uninstalled devices to complete their initial registration without manual intervention.	Radio button

**Step 3** Confirm the new password.

**Step 4** Choose (**Keep**, **Update** radio buttons) the subsequent action to the database regarding any password that is equal to the bootstrap password.

**Step 5** To clear all entries, click **Reset**.

**Step 6** To save the new password, click **OK**.



## Log Manager

To access Log management tasks, log into the system (see “[Logging In](#)” section on page 2-1). Then, from the Home page, click the **Tools** tab. The Tools page appears.

From the Tools Page, click **Log Manager**. The Log Manager page appears showing:

- View Logs
- Clear Logs
- Export Logs
- Change Log Level

## Viewing Log Files

**Step 1** From the Log Manager page, click **View Logs**.

The View Log Files dialog box appears (see [Figure 14-1](#)).

**Figure 14-1** Selecting Log File to View

### View Log Files

<b>Select Log File:</b>	<input checked="" type="radio"/> Events log <input type="button" value="Advanced"/>
	<input type="radio"/> Config Server log
	<input type="radio"/> HTTP Server log
	<input type="radio"/> Access log
	<input type="radio"/> Cron Tab
	<input type="radio"/> Authentication Errors
	<input type="radio"/> PIX Log
	<input type="radio"/> Image Server log
	<input type="radio"/> IMGW Runtime log
	<input type="radio"/> IMGW Device log
<b>Number of lines:</b>	25
<b>Filter String:</b>	
<input type="button" value="View"/>	

**Step 2** Select the log file you want to view.

Table 14-1 shows valid values for these fields.

**Table 14-1** Valid Values for View Log Files

Attribute	Description	Valid Values
Select Log Files	List of available log files.	Radio button
Number of lines	Number of lines displayed.	
Filter String	Filter string	a-z A-Z 0-9 -(hyphen) _ (under-score) . (period)

**Step 3** For additional attributes related to viewing Event Logs, click **Advanced**.

The View Event Log window appears (see Figure 14-2).

**Figure 14-2** Event Log Attributes

### View Event Log

The screenshot shows a dialog box titled "View Event Log" with the following fields and controls:

- Device/Group:** A text input field.
- Status Filter:** Three checkboxes labeled "Complete", "Failure", and "Warning".
- Any other Filter:** A text input field.
- Number of lines:** A text input field containing the value "25".
- View:** A button at the bottom center.

**Step 4** Enter the attributes you want to view a specific Event Log, then click **View**.

**Step 5** In the main View Log Files window (see Figure 14-1), set the number lines you want to display.

**Step 6** To limit the report to display only specific entries, set a case-sensitive keyword filter, or leave blank.

**Step 7** Click **View**.

A report displays.

# Clearing Logs

- Step 1** From the Log Manager page, click **Clear Logs**.  
The Clear Log Files dialog box appears (see [Figure 14-1](#)).

**Figure 14-3** Clear Logs

## Clear Logs

Select Log File:

- Events Log
- Config Server Log
- HTTP Server Log
- Access Log
- Cron Tab
- Authentication Errors
- PIX Log
- Image Server Log
- IMGW Runtime Log
- IMGW Device Log

Clear Cancel

149116

- Step 2** Check the log files you want to clear.
- Step 3** To cancel this task, click **Cancel**.
- Step 4** To clear the selected log files, click **Clear**.

# Exporting Logs

- Step 1** From the Log Manager page, click **Export Logs**.  
The Export Log Files dialog box appears (see [Figure 14-4](#)).

**Figure 14-4** Export Logs

## Export Logs

Select Log File:

- Events Log
- Config Server Log
- HTTP Server Log
- Access Log
- Cron Tab
- Authentication Errors
- PIX Log
- Image Server Log
- IMGW Runtime Log
- IMGW Device Log

Clear logs after export.

Export Cancel

149117

- Step 2** Check the log files you want to export.
- Step 3** To clear logs after export, check the check box.
- Step 4** To cancel this task, click **Cancel**.
- Step 5** To export the selected log files, click **Export**.

# Changing Log Level

- Step 1** From the Log Manager page, click **Change Log Level**.  
The Change Log Level dialog box appears (see [Figure 14-5](#)):

**Figure 14-5** *Selecting Log Level*

## Change Log Level

Select Log Level:

- Debug
- Info
- Warn
- Error
- Fatal

Submit Cancel

149118

- Step 2** Select the desired log level by clicking the appropriate radio button, then click **Submit**.







## Service Manager

---

To access Service management tasks, log into the system (see “[Logging In](#)” section on page 2-1). Then, from the Home page, click the **Tools** tab. The Tools page appears.

From the Tools Page, click **Service Manager**. The Service Manager page appears showing:

- Edit Service Properties
- Edit IMGW Device and Hop Types

## Editing Service Properties

- Step 1** From the Service Manager Functional Overview page, click **Edit Service Properties**. The Edit Service Properties page appears (see [Figure 15-1](#)).

**Figure 15-1** *Edit Service Properties*

### Edit Service Properties

Select Service:	<input checked="" type="radio"/> CNS Image Service
-----------------	----------------------------------------------------

10.15.40

- Step 2** From the Edit Service Properties page, select Image Service by clicking the associated radio button. The service properties page for Image Service appears (see [Figure 15-2](#)).

Figure 15-2 Image Service Properties

## Edit Service Properties

Image Service Configurable Properties:

Name	Value
Image Types	<div style="border: 1px solid gray; padding: 5px;"> <div style="display: flex; justify-content: space-between;"> <div style="width: 45%;"> <p>Removed Image Types:</p> <div style="border: 1px solid gray; height: 40px; width: 100%;"></div> </div> <div style="width: 10%; text-align: center;"> <p>&lt;&lt;</p> <p>&gt;&gt;</p> </div> <div style="width: 45%;"> <p>Image Types:</p> <div style="border: 1px solid gray; padding: 5px;">           IOS            PDM            Fix-image            Other         </div> </div> </div> <div style="margin-top: 10px; display: flex; justify-content: flex-end;"> <input style="width: 50px;" type="text"/> <input type="button" value="Add New"/> </div> </div>
Boot Timeout	<input style="width: 50px;" type="text" value="300"/> seconds
Check Server Msg Timeout	<input style="width: 50px;" type="text" value="600"/> seconds
Check Server Msg Retry	<input style="width: 50px;" type="text" value="6"/> times

129445

- Step 3** To Edit Image Types: Click the move button (<<) to move an image type to the Removed Image Types column.
- Step 4** To Edit Boot Timeout: Enter a new value in the text box.
- Step 5** To Edit Check Server Msg Timeout: Enter a new value in the text box.
- Step 6** To Edit Check Server Msg Retry: Enter a new value in the text box.
- Step 7** To cancel this task, click **Cancel**.
- Step 8** To submit the changes, click **OK**.

# Editing IMGW Device and Hop Types

- Step 1** From the Service Manager Functional Overview page, click **Edit IMGW Device and Hop Types**. The IMGW Device and Hop Types page appears (see [Figure 15-3](#)).

**Figure 15-3** IMGW Device and Hop Types

## Add and Remove IMGW Device Types and Hop Types:

<b>Device Types</b>	<div style="border: 1px solid gray; padding: 5px;">           CATIOS            CATOS            CE            CSS         </div> <div style="margin-top: 5px;"> <input type="button" value="Remove"/> </div> <div style="margin-top: 5px;">           New DeviceType <input type="text"/> <input type="button" value="Add to list"/> </div>
<b>Hop Types</b>	<div style="border: 1px solid gray; padding: 5px;">           AP_LOGIN            CATALYST_EN            CATALYST_LOGIN            CATIOS_EN         </div> <div style="margin-top: 5px;"> <input type="button" value="Remove"/> </div> <div style="margin-top: 5px;">           New HopType <input type="text"/> <input type="button" value="Add to list"/> </div>

129600

- Step 2** To remove a Device Type or Hop Type, click the item, then click **Remove**.
- Step 3** To add a new Device Type or Hop Type, enter the item in the dialog box, then click **Add to list**.
- Step 4** When complete, so save your changes, click **Edit**.





## Bulk Data Manager

To access Bulk Data management tasks, log into the system (see [“Logging In” section on page 2-1](#)). Then, from the Home page, click the **Tools** tab. The Tools page appears.

From the Tools page, click **Bulk Data Mgr.** The Bulk Data Page appears showing:

- Upload Bulk Data
- Create Sample Data

## XML DTD

The following example shows the Document Type Definition (DTD) for the XML bulk upload:

```
<?xml version="1.0" encoding="utf-8"?>
<!ELEMENT cns-bulk-upload (cns-element-data)>
<!ATTLIST cns-bulk-upload
 stop-on-error (true | false) "false"
>
<!ELEMENT cns-element-data (NSM-DATA | IMGW-DATA | IMAGE-DATA)>
<!ELEMENT IMGW-DATA (imgw-device*)>
<!ATTLIST IMGW-DATA
 op-type (add) #REQUIRED
>
<!ELEMENT imgw-device (device-id, gateway-id?, device-type, hop-information*)>
<!ELEMENT device-id (#PCDATA)>
<!ELEMENT gateway-id (#PCDATA)>
<!ELEMENT device-type (#PCDATA)>
<!ELEMENT hop-information (hop-type, ip-address?, port?, username?, password?)>
<!ELEMENT hop-type (#PCDATA)>
<!ELEMENT ip-address (#PCDATA)>
<!ELEMENT port (#PCDATA)>
<!ELEMENT username (#PCDATA)>
<!ELEMENT password (#PCDATA)>
<!ELEMENT NSM-DATA (cns-device-container*, cns-device-info*, cns-application-info*,
cns-group-info*)>
<!ATTLIST NSM-DATA
 op-type (add) #REQUIRED
 validate-data (true | false) #REQUIRED
>
<!ELEMENT cns-device-container (device-container-name+, parent-container?)>
<!-- This tag is to add the sub containers for devices-->
<!ELEMENT device-container-name (#PCDATA)>
<!ELEMENT parent-container (#PCDATA)>
<!-- This is an optional tag that specifies which container the dev. container object is
to be added-->
```

```

<!ELEMENT cns-device-info (cns-device-name, cns-extended-attr*, device-container?,
dev-image-information?)>
<!ELEMENT device-container (#PCDATA)>
<!-- This is an optional tag that specifies which container this object is to be added-->
<!ELEMENT cns-device-name (#PCDATA)>
<!ELEMENT cns-extended-attr (#PCDATA)>
<!ELEMENT dev-image-information (image-id, activation-template?, dev-image-info+)>
<!ELEMENT image-id (#PCDATA)>
<!ELEMENT activation-template (#PCDATA)>
<!ELEMENT dev-image-info (image-name, distribution)>
<!ELEMENT image-name (#PCDATA)>
<!ELEMENT distribution (destination?, location)>
<!ATTLIST distribution
 overwrite (yes | no) "no"
 erase-flash (yes | no) "no"
 activate (true | false) "false"
>
<!ELEMENT destination (#PCDATA)>
<!ELEMENT location (#PCDATA)>
<!ELEMENT cns-application-info (cns-application-name, cns-subject-mapping*,
application-container?)>
<!ELEMENT application-container (#PCDATA)>
<!-- This is an optional tag that specifies which container this object is to be added-->
<!ELEMENT cns-application-name (#PCDATA)>
<!ELEMENT cns-subject-mapping (cns-original-subject, cns-pub-mapping*, cns-sub-mapping*,
cns-pub-default, cns-sub-default, cns-extended-attr*)>
<!ELEMENT cns-original-subject (#PCDATA)>
<!ELEMENT cns-pub-mapping (#PCDATA)>
<!ELEMENT cns-sub-mapping (#PCDATA)>
<!ELEMENT cns-pub-default (#PCDATA)>
<!ELEMENT cns-sub-default (#PCDATA)>
<!ELEMENT cns-group-info (cns-group-name, cns-group-application-name*, cns-group-member*,
cns-extended-attr*, group-container?)>
<!ELEMENT group-container (#PCDATA)>
<!-- This is an optional tag that specifies which container this object is to be added-->
<!ELEMENT cns-group-name (#PCDATA)>
<!ELEMENT cns-group-application-name (#PCDATA)>
<!ELEMENT cns-group-member (#PCDATA)>
<!ATTLIST cns-group-application-name
 application-container CDATA #IMPLIED
>
<!ATTLIST cns-group-member
 device-container CDATA #IMPLIED
>
<!ATTLIST cns-extended-attr
 name CDATA #REQUIRED
>
<!-- Here starts the definition for Image-data-->
<!ELEMENT IMAGE-DATA (image+)>
<!ATTLIST IMAGE-DATA
 op-type (add) #REQUIRED
>
<!ELEMENT image (name, image-info)>
<!ELEMENT name (#PCDATA)>
<!ELEMENT image-info (img-name, img-chksum?, hdr-chksum?, software-version?,
system-description?, file-byte-size?, platform-family-name?, img-location*)>
<!ATTLIST image-info
 image-type (IOS | pix-image | pdm | other) "IOS"
>
<!ELEMENT img-name (#PCDATA)>
<!ELEMENT img-chksum (#PCDATA)>
<!ELEMENT hdr-chksum (#PCDATA)>
<!ELEMENT file-byte-size (#PCDATA)>
<!ELEMENT system-description (#PCDATA)>

```

```
<!ELEMENT platform-family-name (#PCDATA)>
<!ELEMENT software-version (#PCDATA)>
<!ELEMENT img-location (#PCDATA)>
```

## Uploading Bulk Data

- Step 1** From the Bulk Data main menu, click **Upload Bulk Data**.  
The Upload Bulk Data parameters page appears (see [Figure 16-1](#)).

**Figure 16-1** Upload Bulk Data Parameters

**Upload Bulk Data:**

**Filename**  
(required)

**Data Format**  
(required)

Note: The maximum file size that can be uploaded is 7 MB

1209446

- Step 2** If you know the filename of the data file you want to load, enter it in the **Filename** field, otherwise use the browse function.

[Table 16-1](#) shows the valid values for this field.

**Table 16-1** Valid Values for Upload Bulk Data

Attribute	Description	Valid Values
Filename	Name of the file containing the data to be uploaded.	a-z A-Z 0-9 -(hyphen) _ (under-score) . (period)

- Step 3** Use the drop-down arrow to select the Data Format:
- XML
  - CSV
- Step 4** To clear this task, click **Reset**.
- Step 5** To upload this data file, click **Upload**.

## Command-Line Upload of Bulk Data

You can also upload the XML file to the directory using a command line utility as follows:

- 
- Step 1** FTP the bulk upload XML file to the `/opt/CSCOdatscripts/` directory on the host system.
  - Step 2** Log into the box using Telnet
  - Step 3** Go to: `/opt/CSCOdatscripts/`
  - Step 4** Run the following command to invoke the bulk upload command line utility:

```
./upload.sh <xml filename>
```

For example: `./upload.sh my_bulk_data.xml`

This uploads the data to the LDAP directory.

---

## Using Data Converter Utility

There is a data converter utility that you can use to convert bulk upload data on a system with a release prior to 2.0. This will allow you to do a bulk upload of data to Cisco Configuration Engine, 2.0.

You can find this utility in `<install base dir>/ConfigEngine/CSCOdats/XMLTransform`.

## Creating Sample Data

Even though the DTD (see “XML DTD” section on page 16-1) outlines the structure of the input XML file, it does not convey the information about what values should be given for each tag. By looking at the sample data files in this section, you can get an idea of how the data should be arranged in the Bulk Upload XML file.

- 
- Step 1** From the Bulk Data main menu, click **Add Bulk Data**.  
The Upload Bulk Data page appears (see Figure 16-2).

**Figure 16-2** Create Sample Data Page

**Create Sample Data:**

<b>Prefix</b> <small>(required)</small>	<input type="text"/>
<b>Data Format</b>	XML ▾
<b>Sample Data</b>	Without image info ▾

Note: All device/group/application names in the sample data file will start with the prefix entered above.

129447

- Step 2** Enter the prefix name for this sample in the **Prefix** field.  
[Table 16-2](#) shows valid values for these fields.



**Table 16-2** Valid Values for Create Sample Data

Attribute	Description	Valid Values
Prefix	Prefix that is used to create the device/application/group objects.	a-z A-Z 0-9 -(hyphen) _ (under-score) . (period)
Data Format	XML, CSV	From drop-down list
Sample Data Without image info	Creates application, group, device data without the image information for device.	From drop-down list
Sample Data With image info	Creates application, group, device data without the image information for device. Also creates IMAGE object data.	From drop-down list
Sample IMAGE Data only	Creates only IMAGE object data	From drop-down list

**Step 3** Select Sample Data.

**Step 4** To create this sample, click **OK**.

## NSM Data Sample

The following example shows an NSM data sample for bulk upload:

```
<?xml version="1.0" encoding="UTF-8" ?>
<!DOCTYPE cns-bulk-upload (View Source for full doctype...)>
- <cns-bulk-upload stop-on-error="false" version="1.5">
 - <cns-element-data>
 - <NSM-DATA op-type="add" validate-data="false">
 - <cns-device-info dev-type="other">
 <cns-device-name>pista1Device1</cns-device-name>
 <cns-extended-attr
 name="IOSconfigtemplate">DemoRouter.cfgtpl</cns-extended-attr>
 <cns-extended-attr name="IOSConfigID">pista1Device1</cns-extended-attr>
 <cns-extended-attr name="IOSEventID">pista1Device1</cns-extended-attr>
 </cns-device-info>
 - <cns-device-info dev-type="other">
 <cns-device-name>pista1Device2</cns-device-name>
 <cns-extended-attr
 name="IOSconfigtemplate">DemoRouter.cfgtpl</cns-extended-attr>
 <cns-extended-attr name="IOSConfigID">pista1Device2</cns-extended-attr>
 <cns-extended-attr name="IOSEventID">pista1Device2</cns-extended-attr>
 </cns-device-info>
 - <cns-device-info dev-type="other">
 <cns-device-name>pista1Device3</cns-device-name>
 <cns-extended-attr
 name="IOSconfigtemplate">DemoRouter.cfgtpl</cns-extended-attr>
 <cns-extended-attr name="IOSConfigID">pista1Device3</cns-extended-attr>
 <cns-extended-attr name="IOSEventID">pista1Device3</cns-extended-attr>
 </cns-device-info>
 - <cns-device-info dev-type="imgw">
 <cns-device-name>pista1Device4</cns-device-name>
```

```

<cns-extended-attr
 name="IOSconfigtemplate">DemoRouter.cfgtpl</cns-extended-attr>
<cns-extended-attr name="IOSConfigID">pista1Device4</cns-extended-attr>
<cns-extended-attr name="IOSEventID">pista1Device4</cns-extended-attr>
- <imgw-data>
 <gateway-id>pista1IMGWGatewayID4</gateway-id>
 <device-type>IOS</device-type>
 <simulation-agent>CONFIGAGENT</simulation-agent>
 - <hop-information>
 <hop-type>IOS_LOGIN</hop-type>
 <ip-address>0.0.0.0</ip-address>
 <port>0000</port>
 <username>pista1usr4</username>
 <password>pista1pwd4</password>
 </hop-information>
 - <hop-information>
 <hop-type>IOS_LOGIN</hop-type>
 <ip-address>0.0.0.0</ip-address>
 <port>0000</port>
 <username>pista1user4</username>
 <password>pista1passwd4</password>
 </hop-information>
</imgw-data>
</cns-device-info>
- <cns-device-info dev-type="imgw">
 <cns-device-name>pista1Device5</cns-device-name>
 <cns-extended-attr
 name="IOSconfigtemplate">DemoRouter.cfgtpl</cns-extended-attr>
 <cns-extended-attr name="IOSConfigID">pista1Device5</cns-extended-attr>
 <cns-extended-attr name="IOSEventID">pista1Device5</cns-extended-attr>
 - <imgw-data>
 <gateway-id>pista1IMGWGatewayID5</gateway-id>
 <device-type>IOS</device-type>
 <simulation-agent>IMAGEAGENT</simulation-agent>
 - <hop-information>
 <hop-type>IOS_LOGIN</hop-type>
 <ip-address>0.0.0.0</ip-address>
 <port>0000</port>
 <username>pista1usr5</username>
 <password>pista1pwd5</password>
 </hop-information>
 - <hop-information>
 <hop-type>IOS_LOGIN</hop-type>
 <ip-address>0.0.0.0</ip-address>
 <port>0000</port>
 <username>pista1user5</username>
 <password>pista1passwd5</password>
 </hop-information>
 </imgw-data>
</cns-device-info>
- <cns-application-info>
 <cns-application-name>pista1TestApp</cns-application-name>
 - <cns-subject-mapping>
 <cns-original-subject>pista1TestApp.Event1</cns-original-subject>
 <cns-pub-mapping>pista1TestApp.Event1.cns-pub-mapping</cns-pub-mapping>
 <cns-sub-mapping>pista1TestApp.Event1.cns-sub-mapping</cns-sub-mapping>
 <cns-pub-default>1</cns-pub-default>
 <cns-sub-default>1</cns-sub-default>
 </cns-subject-mapping>
 - <cns-subject-mapping>
 <cns-original-subject>pista1TestApp.Event2</cns-original-subject>
 <cns-pub-mapping>pista1TestApp.Event2.cns-pub-mapping</cns-pub-mapping>
 <cns-sub-mapping>pista1TestApp.Event2.cns-sub-mapping</cns-sub-mapping>
 <cns-pub-default>1</cns-pub-default>

```

```

 <cns-sub-default>1</cns-sub-default>
 </cns-subject-mapping>
</cns-application-info>
- <cns-group-info>
 <cns-group-name>/pista1TestApp/pista1Group1</cns-group-name>
 <cns-group-member type="DEV">pista1Device1</cns-group-member>
 <cns-group-member type="GRP">pista1SubGroup1</cns-group-member>
</cns-group-info>
- <cns-group-info>
 <cns-group-name>/pista1TestApp/pista1Group2</cns-group-name>
 <cns-group-member type="DEV">pista1Device1</cns-group-member>
 <cns-group-member type="DEV">pista1Device2</cns-group-member>
 <cns-group-member type="GRP">pista1SubGroup2</cns-group-member>
</cns-group-info>
</NSM-DATA>
</cns-element-data>
</cns-bulk-upload>

```

## NSM Data Sample With Image Information

The following example shows an NSM data sample with image information:

```

<?xml version="1.0" encoding="UTF-8" ?>
<!DOCTYPE cns-bulk-upload (View Source for full doctype...)>
- <cns-bulk-upload stop-on-error="false" version="1.5">
 - <cns-element-data>
 - <IMAGE-DATA op-type="add" validate-data="false">
 - <image>
 <name>pista2IMAGEObj1</name>
 - <image-info image-type="IOS">
 <img-name>c7200-js-mz1</img-name>
 <img-chksum>0x1256faf245</img-chksum>
 <software-version>12.2(8)T6</software-version>
 <system-description>Cisco Network Operating System</system-description>
 <file-byte-size>1040</file-byte-size>
 <platform-family-name>7200</platform-family-name>
 <img-location>tftp://test.com/c7200-js-mz1</img-location>
 </image-info>
 </image>
 - <image>
 <name>pista2IMAGEObj2</name>
 - <image-info image-type="IOS">
 <img-name>c7200-js-mz2</img-name>
 <img-chksum>0x1256faf245</img-chksum>
 <software-version>12.2(8)T6</software-version>
 <system-description>Cisco Network Operating System</system-description>
 <file-byte-size>1040</file-byte-size>
 <platform-family-name>7200</platform-family-name>
 <img-location>tftp://test.com/c7200-js-mz2</img-location>
 </image-info>
 </image>
 - <image>
 <name>pista2IMAGEObj3</name>
 - <image-info image-type="IOS">
 <img-name>c7200-js-mz3</img-name>
 <img-chksum>0x1256faf245</img-chksum>
 <software-version>12.2(8)T6</software-version>
 <system-description>Cisco Network Operating System</system-description>
 <file-byte-size>1040</file-byte-size>
 <platform-family-name>7200</platform-family-name>
 <img-location>tftp://test.com/c7200-js-mz3</img-location>
 </image-info>
 </image>
 </cns-element-data>
</cns-bulk-upload>

```

```

 </image-info>
 </image>
 - <image>
 <name>pista2IMAGEObj4</name>
 - <image-info image-type="IOS">
 <img-name>c7200-js-mz4</img-name>
 <img-chksum>0x1256faf245</img-chksum>
 <software-version>12.2(8)T6</software-version>
 <system-description>Cisco Network Operating System</system-description>
 <file-byte-size>1040</file-byte-size>
 <platform-family-name>7200</platform-family-name>
 <img-location>tftp://test.com/c7200-js-mz4</img-location>
 </image-info>
 </image>
 - <image>
 <name>pista2IMAGEObj5</name>
 - <image-info image-type="IOS">
 <img-name>c7200-js-mz5</img-name>
 <img-chksum>0x1256faf245</img-chksum>
 <software-version>12.2(8)T6</software-version>
 <system-description>Cisco Network Operating System</system-description>
 <file-byte-size>1040</file-byte-size>
 <platform-family-name>7200</platform-family-name>
 <img-location>tftp://test.com/c7200-js-mz5</img-location>
 </image-info>
 </image>
</IMAGE-DATA>
</cns-element-data>
</cns-bulk-upload>

```

## NOTES

- For Bulk Upload of NSM devices with Image Info, make sure that the image objects referenced in the **dev-image-info** element tag already exist.
- The location given should be one of the multiple image locations specified with the image object.
- If there are errors while adding the devices, please check the error file provided as a result of the Upload operation. There can be an exception given as CISException, which points to the CISDevice creation failed, which could have occurred if you had ignored the checklist. In this case, just recheck the information provided in the **dev-image-information** element tag. Correct the file and upload it again.

## Image Sample Data

The following example shows image data sample:

```

<?xml version="1.0" encoding="UTF-8" ?>
<!DOCTYPE cns-bulk-upload (View Source for full doctype...)>
- <cns-bulk-upload stop-on-error="false" version="1.5">
 - <cns-element-data>
 - <IMAGE-DATA op-type="add" validate-data="false">
 - <image>
 <name>pista3IMAGEObj1</name>
 - <image-info image-type="IOS">
 <img-name>c7200-js-mz1</img-name>
 <img-chksum>0x1256faf245</img-chksum>
 <software-version>12.2(8)T6</software-version>
 <system-description>Cisco Network Operating System</system-description>
 <file-byte-size>1040</file-byte-size>
 <platform-family-name>7200</platform-family-name>

```

```

 <img-location>tftp://test.com/c7200-js-mz1</img-location>
 </image-info>
</image>
- <image>
 <name>pista3IMAGEObj2</name>
 - <image-info image-type="IOS">
 <img-name>c7200-js-mz2</img-name>
 <img-chksum>0x1256faf245</img-chksum>
 <software-version>12.2(8)T6</software-version>
 <system-description>Cisco Network Operating System</system-description>
 <file-byte-size>1040</file-byte-size>
 <platform-family-name>7200</platform-family-name>
 <img-location>tftp://test.com/c7200-js-mz2</img-location>
 </image-info>
</image>
- <image>
 <name>pista3IMAGEObj3</name>
 - <image-info image-type="IOS">
 <img-name>c7200-js-mz3</img-name>
 <img-chksum>0x1256faf245</img-chksum>
 <software-version>12.2(8)T6</software-version>
 <system-description>Cisco Network Operating System</system-description>
 <file-byte-size>1040</file-byte-size>
 <platform-family-name>7200</platform-family-name>
 <img-location>tftp://test.com/c7200-js-mz3</img-location>
 </image-info>
</image>
- <image>
 <name>pista3IMAGEObj4</name>
 - <image-info image-type="IOS">
 <img-name>c7200-js-mz4</img-name>
 <img-chksum>0x1256faf245</img-chksum>
 <software-version>12.2(8)T6</software-version>
 <system-description>Cisco Network Operating System</system-description>
 <file-byte-size>1040</file-byte-size>
 <platform-family-name>7200</platform-family-name>
 <img-location>tftp://test.com/c7200-js-mz4</img-location>
 </image-info>
</image>
- <image>
 <name>pista3IMAGEObj5</name>
 - <image-info image-type="IOS">
 <img-name>c7200-js-mz5</img-name>
 <img-chksum>0x1256faf245</img-chksum>
 <software-version>12.2(8)T6</software-version>
 <system-description>Cisco Network Operating System</system-description>
 <file-byte-size>1040</file-byte-size>
 <platform-family-name>7200</platform-family-name>
 <img-location>tftp://test.com/c7200-js-mz5</img-location>
 </image-info>
</image>
</IMAGE-DATA>
</cns-element-data>
</cns-bulk-upload>

```





## Email Manager

---

To access Email management tasks, log into the system (see “[Logging In](#)” section on page 2-1). Then, from the Home page, click the **Tools** tab. The Tools page appears.

From the Tools page, click **Email Manager**. The Email page appears showing: Edit Email SMTP Host.

### Editing Email SMTP Host

---

**Step 1** From the Email Manager Functional Overview page, click **Edit Email SMTP Host**.

The Edit Email SMTP Host page appears:

**Figure 17-1** *Edit Email SMTP Host*

#### Edit Email SMTP Host

Set SMTP Host:	<input type="text" value="-CNS_INSTALL_DIR"/>
<input type="button" value="Submit"/> <input type="button" value="Cancel"/>	

129354

**Step 2** Enter a new host path, then click **Submit**.

---







## Image Service

---

This chapter describes Image Service management tasks for Internal Directory mode including information about.

To access the Image Service feature, click the **Image Service** tab. The Image Service Functional Overview page appears showing:

- Images
- Search Parameters

## Working with Images

From the Image Service Functional Overview page, click **Images**. The Images Functional Overview page appears showing:

- View Image
- Create Image
- Edit Image
- Delete Image
- Associate Image with Device(s)

## Viewing an Image

---

**Step 1** From the Images Functional Overview page, click **View Image**.

The list of images to view appears (see [Figure 18-1](#)).

**Figure 18-1 View Image List****View Image**

Search :

Name	Image Locations
<a href="#">image1</a>	ftp://ftp.test@10.1.7.24/tftp/c7200-is-mz.123-1.9.T
<a href="#">image2</a>	ftp://ftp.test@10.1.7.24/tftp/c3640-tea-mz_geo_20030810
<a href="#">image3</a>	ftp://ftp.test@10.1.7.24/tftp/c7200-tk8ea-mz_geo_20030721.T
<a href="#">image4</a>	ftp://ftp.test@10.1.7.24/tftp/c7200-tk8ea-mz.v123-3_20030714.T

10.1545

**Step 2** From the Name column, select the image you want to view.

The image information appears (see [Figure 18-2](#)).

**Figure 18-2 View Image Information****View Image**

image1	
<b>Image Name</b>	C7200-IS-MZ
<b>Version</b>	12.3(1.9)T,
<b>Platform Family</b>	C7200
<b>Image Checksum</b>	8fc6160c10141ed4122b6db19f01d2f0
<b>Size</b>	17723372 bytes
<b>Description</b>	Cisco Internetwork Operating System Software IOS (tm) 7200 Software (C7200-IS-MZ), Version 12.3(1.9)T, MAINTENANCE INTERIM SOFTWARE Synched to technology version 12.3(1.9) TAC Support: <a href="http://www.cisco.com/tac">http://www.cisco.com/tac</a> Copyright (c) 1986-2003 by cisco Systems, Inc. Compiled Thu 12-Jun-03 17:19 by ccai
<b>Image Type</b>	IOS
<b>Image Locations</b>	ftp://ftp.test@10.1.7.24/tftp/c7200-is-mz.123-1.9.T

10.1546

**Adding an Image**

**Step 1** From the Image Service Functional Overview page, click **Create Image**.

The Create Image page appears (see [Figure 18-3](#)).

Figure 18-3 Create Image

## Create Image

<b>Name</b> (required)	<input type="text"/>
<b>Image Name</b>	<input type="text"/>
<b>Version</b>	<input type="text"/>
<b>Platform Family</b>	<input type="text"/>
<b>Image Checksum</b>	<input type="text"/>
<b>Size</b> (required)	<input type="text"/>
<b>Description</b>	<input type="text"/>
<b>Image Type</b>	<input type="text" value="IOS"/>
<b>Image Locations</b>	<input type="text"/>
	<input type="text"/>
	<input type="button" value="Add Another Row"/>

Enter a location as <protocol>://<hostname><absolutefilepath>  
For example: ftp://username.password@ftp.server.com/directory/imagefile

Populate image attributes by acquiring values from image location

[Lookup image attributes from CCO](#)

101547

There are two methods for creating an Image Object:

**Manual data entry**

To enter image information manually, jump to [Step 2](#).

**Timesaver**

You can get image attributes for manual entry by clicking the link: **Lookup image attributes from Cisco.com**.

**Automatic data entry**

- a. In the **Image Location** field, enter a valid URL for the desired image.
- b. Click **Populate**.

**Step 2** Enter the name of the image used by Image Service to identify this image object in the **Name** field.

[Table 18-1](#) shows valid values for these attributes.

**Table 18-1** Valid Values for Create Image

Attribute	Description	Valid Values
Name	The name used by Image Services to identify this image object.	a-z A-Z 0-9 # _ (under-score) - (hyphen)
Image Name	The actual Image name.	a-z A-Z 0-9 - (hyphen)
Version	Version of the image.	a-z A-Z 0-9 . (period) ( (open braces) ) (close braces)
Platform Family	Platform family of the image.	a-z A-Z 0-9 - (hyphen)
Image Checksum	Checksum generated by MD5 hashing algorithm	128-bit hex number
Size	File size	0 – 9
Description	Description of the image.	Any text except Ctrl characters.
Image Type	(i) PDM (ii) QDM (iii) VDM (iv) Other (v) Pix-image	From drop-down list.
Image Location	- Any Valid URL: (i) http (ii) https (iii) ftp (iv) tftp - rcp	Valid URL as per RFC 1738.

- Step 3** Enter the actual image name in the **Image Name** field.
- Step 4** Enter the version of the image in the **Version** field.
- Step 5** Enter the name of the platform family in the **Platform Family** field.

- Step 6** Enter the image checksum for the image in the **Image Checksum** field.
- Step 7** Enter the size of this file in the **Size** field.
- Step 8** Enter a description of the image in the space provided.
- Step 9** Select an image type from the **Image Type** drop-down list.
- Step 10** Enter a valid URL for the image location in the **Image Location** field.  
Follow the proper syntax as described.



**Note** You can create an image without specifying a location. You can add a location later by using the **Edit Image** function.

- Step 11** To add another row for image location, click **Add Another Row**.  
You can locate multiple copies of an image on separate servers. This allows you to do load-sharing when updating a large number of devices. Each device in a large group can be associated with a copy of the image (see “[Adding Devices](#)” section on page 3-3) located at one of many server locations.
- Step 12** To cancel this task, click **Cancel**.
- Step 13** To create this image, click **Create**.

## Editing an Image

- Step 1** From the Image Service Functional Overview page, click **Edit Image**.  
The Edit Image page appears (see [Figure 18-4](#)).

**Figure 18-4** *Edit Image*

### Edit Image

Search:

Name	Image Locations
<a href="#">image1</a>	ftp://ftp:test@10.1.7.24/ftp/c7200-is-mz.123-1.9.T
<a href="#">image2</a>	ftp://ftp:test@10.1.7.24/ftp/c3640-tea-mz.geo_20030810
<a href="#">image3</a>	ftp://ftp:test@10.1.7.24/ftp/c7200-tk8ea-mz.geo_20030721.T
<a href="#">image4</a>	ftp://ftp:test@10.1.7.24/ftp/c7200-tk8ea-mz.v123-3_20030714.T

101548

- Step 2** Select the image you want to edit by clicking the Image Name.  
The Edit Image information page appears (see).

**Figure 18-5** Edit Image Information**Edit Image**

<b>Name</b>	<input type="text" value="image2"/>
<b>Image Name</b>	C3640-TEA-MZ
<b>Version</b>	12.3(20030811:051206)
<b>Platform Family</b>	C3640
<b>Image Checksum</b>	0df47cfe9c86c497e7937da132efc5dc5
<b>Size</b>	7889812 bytes
<b>Description</b>	Cisco Internetwork Operating System Software IOS (tm) 3600 Software (C3640-TEA-MZ), Experimental Version 12.3(20030811:051206) [anrichar-georgia-20030810 105] Copyright (c) 1986-2003 by cisco Systems, Inc. Compiled Sun 10-Aug-03 23:43 by anrichar
<b>Image Type</b>	IOS
<b>Image Locations</b>	<input type="text" value="ftp://ftp.test@10.1.7.24/ftp/c3640-tea-mz.geo_20030810"/>
	<input type="text"/> <input type="button" value="Add Another Row"/>
	<input type="button" value="Edit"/> <input type="button" value="Cancel"/>

101549

**Step 3** To edit the image name, enter a new value in the **Name** field.

**Table 18-2** Valid Values for Edit Image

Attribute	Description	Valid Values
Name	The name used by Image Services to identify this image object.	a-z A-Z 0-9 # _ (under-score) - (hyphen)
Image Location	- Any Valid URL: (i) http (ii) https (iii) ftp (iv) tftp - rcp	Valid URL as per RFC 1738.

**Step 4** To edit the image location, enter a valid URL in the **Image Location** field.

**Step 5** To cancel this task, click **Cancel**.

**Step 6** To make these changes, click **Edit**.

## Deleting an Image

- Step 1** From the Image Service Functional Overview page, click **Delete Image**.  
The Delete Image page appears (see [Figure 18-6](#)).

**Figure 18-6 Delete Image**

### Delete Image

Search:

Please select Image(s) from the following list:

<input type="checkbox"/>	Name	Image Name	Version	Platform
<input type="checkbox"/>	image1	C7200-IS-MZ	12.3(1.9)T,	C7200
<input type="checkbox"/>	image2	C3640-TEA-MZ	12.3(20030811:051206)	C3640
<input type="checkbox"/>	image3	C7200-TK8EA-MZ	12.3(20030722:022836)	C7200
<input type="checkbox"/>	image4	C7200-TK8EA-MZ	12.3(20030715:044015)	C7200

101550

- Step 2** Check the image(s) you want to delete.
- Step 3** To cancel this task, click **Cancel**.
- Step 4** To make these changes, click **Delete**.

## Associating Images with Devices



**Note**

To associate a device with the image, the device must have been registered for image service during device object creation by providing an ImageI. If this has not been done, before trying to associate the device, the device must be edited and an ImageID must be provided.

- Step 1** From the Image Service Functional Overview page, click **Associate Image with Device(s)**.  
The Associate Image with Device(s) page appears (see [Figure 18-7](#)).

**Figure 18-7 Associate Image with Device(s)**

### Associate Image with Device(s)

Search:

Please Select an Image:

Name	Image Type	Image Locations	Over Write	Erase File System	Destination
image1	IOS	ftp://ftp.test@10.1.7.24/ftp/c7200-is-mz.123-1.9.T	<input type="checkbox"/>	<input type="checkbox"/>	<input type="text"/>

Set this image as the image to be activated on device(s).

101551

- Step 2** Select the image from the **Name** drop-down list.  
The **Image Type** field and **Image Location** drop-down box are populated with corresponding information for the image.
- Step 3** From the **Image Location** drop-down list, select the desired location.
- Step 4** In the Destination field, enter a valid URL where the image will be copied.  
For example:  
**disk0:/c7200-mz**
- Step 5** To assign this image to be the active image after distribution, check **Set this image as the Image to be activated on device**.
- Step 6** To cancel this task, click **Cancel**.
- Step 7** To continue, click **Next**.  
The Group list page appears.
- Step 8** To associate this image with a group of devices, check the group, then click **Submit**.
- Step 9** To associate this image with specific devices, click **View**.  
The Device list page appears (see [Figure 18-8](#)).

**Figure 18-8** Device List

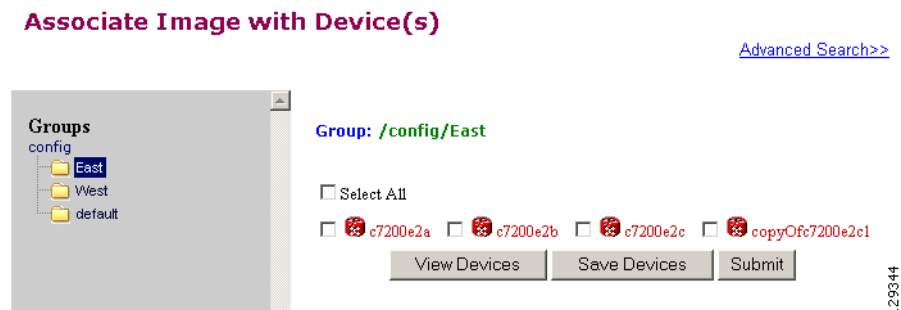

- Step 10** Check the desired device(s).
- Step 11** To cancel this task, click **Cancel**.
- Step 12** To associate this image to the selected devices, click **Submit**.  
A confirmation page appears.



# Search Parameters

Each Search Parameter can be associated with an action to be performed. In this release, Search Parameters are associated with the action to delete certain files from the file system on a device.

For example, if you want to delete all files that contain **.bin** from a device, you can create a Search Parameter that states: **FileName contains .bin** and use this Precondition from the **Devices > Delete Files**.

From the Image Service Functional Overview page, click **Search Parameters**.

The Search Parameters Functional Overview page appears showing:

- View Search Parameters
- Create Search Parameter
- Edit Search Parameter
- Delete Search Parameters

## Viewing Search Parameters

- Step 1** From the Search Parameters Functional Overview page, click **View Search Parameters**.  
The View Search Parameters page appears (see [Figure 18-9](#)).

**Figure 18-9** View Search Parameters

### View Search Parameters

Search:

Name	Description	
sp1a	File Size is greater than 80000 bytes	<input type="button" value="EDIT"/>
sp1b	File Name contains 7200	<input type="button" value="EDIT"/>
test2	File Size is greater than 11 bytes	<input type="button" value="EDIT"/>

129345

- Step 2** To edit a Precondition, click **Edit** for the desired Precondition, then go to [“Editing Search Parameters” section on page 18-11](#).

## Creating Search Parameters

- Step 1** From the Search Parameters Functional Overview page, click **Create Search Parameter**.  
The Create Search Parameter page appears (see [Figure 18-10](#)).

**Figure 18-10 Create Search Parameter**

### Create Search Parameter

1293146

- Step 2** Enter the name of this Search Parameter.
- Step 3** Use the drop-down arrow in the left Content menu to select:
- File Size**
  - File Name**
  - File Timestamp**
- a. For **File Size**, use the drop-down arrow in the center Content menu to select:
    - is greater than**
    - is less than**
    - is equal to**
  - b. For **File Name**, the only choice is **contains**.
  - c. For File Timestamp, the only choice is **before**.
- Step 4** Enter the remaining portion of the argument in the right Content field.  
For example:  
**File Size is greater than 80,000 bytes**
- Step 5** To cancel this task, click **Cancel**.
- Step 6** Click **Create**.

## Editing Search Parameters

- Step 1** From the Search Parameters Functional Overview page, click **Edit Search Parameter**.  
The Edit Search Parameter page appears.
- Step 2** Select Search Parameter you want to edit.  
The argument page for the Search Parameter appears (see [Figure 18-11](#)).

**Figure 18-11 Edit Search Parameter Argument**

### Edit Search Parameter

- Step 3** Edit the name or argument as required.
- Step 4** To cancel this task, click **Cancel**.
- Step 5** To save your changes, click **Edit**.

## Deleting Search Parameters

- Step 1** From the Search Parameters Functional Overview page, click **Delete Search Parameter**.  
The Delete Search Parameters page appears (see [Figure 18-12](#)).

**Figure 18-12 Delete Search Parameters**

### Delete Search Parameters

Search :

Please select Search Parameter(s) from the following list:

<input type="checkbox"/>	Name	Content
<input type="checkbox"/>	sp1a	File Size is greater than 80000 bytes
<input type="checkbox"/>	sp1b	File Name contains 7200
<input type="checkbox"/>	test2	File Size is greater than 11 bytes

- Step 2** Check to select the Search Parameter(s) to delete, then click **Delete**.





## Upgrade or Downgrade Cisco IOS Image

---

With the Image Service feature, you can not only update the Cisco IOS image on a device, you can revert back to an earlier version of the image. When you do this, the availability of Cisco Configuration Engine agents on the device might change. This means you might have to use IMGW to simulate agents to update configurations and images on the device.

Cisco Configuration Engine agents at the device-level are a function of the particular version of Cisco IOS running on that device:

- 12.0 or earlier – No Cisco Configuration Engine agents on the device.
- 12.2 – Configuration Agent and Event Agent but not the Image Agent.
- 12.3(3) or later – Configuration Agent, Event Agent, and Image Agent.

### Things to Know

- IMGW can simulate different agent types:
  - Configuration Agent only
  - Image Agent only
  - both Configuration Agent and Image Agent

Make sure to select the correct agent for your purpose when creating IMGW devices.

- You should always have one set of the same agents running for the same device object. The common mistake when upgrading/downgrading to a different version of an image is:
  - Upgrading: after enabling a certain agent on the device, you still have an IMGW device that is simulating the same agent on the Cisco Configuration Engine, 2.0, or the other way around.
  - Downgrading: a certain agent is not available on the device anymore, but the IMGW device is not simulating this agent. The next update will fail.

### 12.0 -> 12.2

To update an image from 12.0 to 12.2, the image needs to use IMGW to simulate both Configuration Agent and Image Agent.

## Procedure

- 
- Step 1** Create a template for configuration update. This template only applies to a device when you do a configuration update.
- Step 2** Create a template for image activation.
- The activation template should include the boot image information. For example, if you want to copy image *c837-k9o3y6-mz.122-13.ZH2.bin* to flash and run it as the active image, the following CLI commands should be in the active template:
- ```
no boot system
boot system flash:c837-k9o3y6-mz.122-13.ZH2.bin
```
- Step 3** Create the image for the device:
- Setup an FTP/TFTP server.
 - Copy the image onto the FTP/TFTP server.
 - Log into the Cisco Configuration Engine, 2.0, go to **Image Service** -> **Images** -> **Create Image**.
 - Enter image information on the page or just enter **Name** and **Image Locations** on the FTP/TFTP server, then click on **Populate** to get image information.
 - Click on **Create**.
 - To verify, go to **Image Service** -> **Images** -> **View Image**, select the image and verify the image information.
- Step 4** Create an IMGW device with device hop info. Make sure to select an agent type to simulate both Configuration Agent and Image Agent (see [“Adding Non-agent Enabled Devices”](#) section on page 3-4).
- Step 5** Update image (see [“Updating Device Images”](#) section on page 3-32).
- Step 6** To check the updating status, go to **Jobs** -> **Query Job**, click **Status** to check the job status.
- Step 7** To see more debug message on the job, go to **Log Manager** -> **View Logs** and select the log to view.
- Step 8** Now you should have the 12.2 image running on the device. If you want to enable Configuration Agent and Event Agent on the device, put the following CLI commands in device configuration template that you created in Step 1, then do **Update Config** from Cisco Configuration Engine, 2.0:
- ```
cns config partial server_ipaddress port
cns event server_ipaddress port
```
- Step 9** To verify, go to the View Device page on Cisco Configuration Engine, 2.0. You should be able to see a green indicator next to this device object.
- 



### Note

In order to use Configuration Agent and Event Agent to do configuration updates, you should delete the IMGW device object since it should never have two sets of the same agent for the device on the Cisco Configuration Engine, 2.0.

---

## 12.0 -> 12.3(3) or later

To update image from 12.0 to 12.3(3) or later image you need to use IMGW to simulate both Configuration Agent and Image Agent.

The image update procedure is the same as 12.0 -> 12.2 except in Step 9. To enable the image agent on the device, you can also add the following line to the configuration template and update the configuration to the device:

```
cns image server http://server_ipaddress/cns/HttpMsgDispatcher status
http://server_ipaddress/cns/HttpMsgDispatcher
```



### Note

In order to use Configuration Agent, Event Agent, and image agent to do configuration and image updates, you should delete the IMGW device object since it should never have two sets of the same agent for a device on the Cisco Configuration Engine, 2.0.

## 12.2 -> 12.3(3) or later

There are two ways to update the image from 12.2 to 12.3(3) or later image:

1. No agents enabled on the device and use IMGW to simulate both Configuration Agent and Image Agent. The procedure is same as update from 12.0 -> 12.2.
2. Enable Event Agent and Configuration Agent on devices to update activation template and use IMGW to simulate image agent only.

## Procedure

**Step 1** On the device, make sure to enable Configuration and Image Agents with the following commands (it can be done from router command line or from Cisco Configuration Engine, 2.0 configuration update):

```
cns event server_ipaddress port
cns config partial server_ipaddress port
```

**Step 2** Repeat the procedure in 12.0 -> 12.2 except in Step 4. When creating the IMGW device, make sure to select **Image Agent** for Agent Type.

**Step 3** To enable the image agent on the device, you can also add the following line to configuration template and update configuration to the device:

```
cns image server http://server_ipaddress:http_port/cns/HttpMsgDispatcher status
http://server_ipaddress:http_port/cns/HttpMsgDispatcher
```



### Note

In order to use Configuration Agent, Event Agent, and Image Agent to do configuration and image updates, you should delete the IMGW device object since it should never have two sets of the same agent for a device on the Cisco Configuration Engine, 2.0.

## 12.3(3) or later -> 12.3(3) or later

Image upgrading from 12.3(3) or later -> 12.3(3) later images can be done with agents enabled on device. There is no need for IMGW.

### Procedure

- 
- Step 1** On the device, make sure to enable the Configuration Agent with the following commands (it can be done from router command line or from Cisco Configuration Engine, 2.0 configuration update):
- ```
cns event server_ipaddress prot
cns config partial server_ipaddress prot
cns image server http://server_ipaddress/cns/HttpMsgDispatcher status
http://server_ipaddress/cns/HttpMsgDispatcher
```
- Step 2** Create a template for configuration updates.
- Step 3** Create a template for image activation.
- Step 4** Create an image for device:
- Setup FTP/TFTP server.
 - Copy image on FTP/TFTP server.
 - Log into the Cisco Configuration Engine, 2.0, go to **Image Service -> Images -> Create Image**.
 - Enter image information on the page or just enter **Name** and **Image Locations** on the FTP/TFTP server then click **Populate** to get image information.
 - Click on **Create**.
 - To verify, go to **Image Service -> Images -> View Image**, select the image and verify the image information.
- Step 5** Create a device object on Cisco Configuration Engine, 2.0 (see [“Adding Agent Enabled Devices” section on page 3-12](#)).
- Step 6** Associate the device object with an image object.
- Step 7** Update image see [“Updating Device Images” section on page 3-32](#).
- Step 8** To check the updating status, go to **Jobs -> Query Job**, click the **Status** to check the job status.
- Step 9** To see more debug messages on the job, go to **Log Manager -> View Logs** and select the log to view.
-

12.3(3) or later -> 12.2

This is the same as upgrading from 12.2 -> 12.3(3) or later images. There are several things that you should check before submitting the update:

- If you are using the second option in 12.2->12.3(3), which uses IMGW to simulate only the Image Agent, but not the Configuration Agent and Event Agent, make sure there is only Event Agent and Configuration Agent enabled on the device but no Image Agent; even though it is running 12.3(3) or later image that has all the agents. The IMGW on the server side will simulate the Image Agent.

- If there is already a device on the Cisco Configuration Engine, 2.0, you only need to add an IMGW device with the same device name as device object on Cisco Configuration Engine, 2.0.
- Please remove any commands in your configuration template to configuration Image Agent.

12.3(3) or later -> 12.0

Same as upgrading from 12.0 -> 12.3(3) or later image. There are several things that users should check before submit the update:

-
- Step 1** Make sure there is no agent enabled on router even it runs 12.3(3) or later image that has all the agents. The IMGW on server side will simulate both Configuration Agent and Image Agent.
- Step 2** If there is already device object on the Cisco Configuration Engine, 2.0, users only need to add IMGW device with the same device name as device object on Cisco Configuration Engine, 2.0.
- Step 3** Please remove them if you have any command in your configuration template to configure Configuration Agent, Event Agent, or Image Agent.
-





Backup and Restore

This chapter describes Backup and Restore management tasks for Internal Directory mode.

The Backup and Restore function allows you to backup directory data (configuration templates, device and user information, and so forth) to a remote location.

Backup Procedure

Step 1 Log into the Cisco Configuration Engine, 2.0 user interface.

Step 2 Go to **Tools > Data Manager > Schedule Backup**.

The backup information dialog box appears (see [Figure 20-1](#)).

Figure 20-1 Backup Schedule Parameters

BACKUP SCHEDULE PARAMETERS

| | |
|---|---|
| Backup server name
<small>(This is the server name, where all the backup files will be put.)</small> | Ftp <input type="text"/>
<small>Warning: If you select tftp, make sure that a file with the name "backup-cnsee-(hostname).tar.gz" is already present with 777 permissions in the tftp enabled directory on the tftp server. Here (hostname) is the output of 'hostname' command on the local machine. Just a blank file will also do.
For eg. backup-cnsee-myie2100.cisco.com.tar.gz</small> |
| Username
<small>(Username to login to Backup FTP server.)</small> | <input type="text"/> |
| Password
<small>(Password to login to Backup FTP server.)</small> | <input type="password"/> |
| Directory
<small>(This is the subdirectory where the files will be put. Absolute path is required.)</small> | <input type="text"/> |
| Enable Log File Management
<small>(When enabled, log files will be backed up on the server and deleted from the IE2100.)</small> | No <input type="text"/> |
| Backup Schedule
<small>(At the designated time (hh:mm) on a specified day, the background scripts will run as a cron job)</small> | <input checked="" type="radio"/> Daily At <input type="text" value="00:00"/> (hh:mm)
<input type="radio"/> Weekly every <input type="text" value="Saturday"/> At <input type="text" value="00:00"/> (hh:mm)
<input type="radio"/> Monthly on day <input type="text" value="1"/> At <input type="text" value="00:00"/> (hh:mm) |

Backup Reset

129317

Step 3 Use the drop-down arrow to select **FTP**, or **TFTP**.



Note If you select TFTP, the Username, Password, and Directory fields are disabled.

Step 4 To specify where you want the backup data to be stored, enter the FTP server name in the **FTP Server Name** field.

Table 20-1 shows valid values for these fields.

Table 20-1 Valid Values for Backup Schedule Parameters

| Attribute | Description | Valid Values |
|----------------------------|---|---|
| FTP/TFTP | Select TFP or TFTP type.

When you select TFTP server, the Userame, Password and Directory fields are disabled because the TFTP server does not require a username and password, and all the files will go into the TFTP root directory.

Read the Warning (in red) on the GUI page to learn more about setup requirements to use TFTP.

Warning : If you select TFTP, make sure that a file with the name <i>backup-cnsce-{hostname}.tar.gz</i> is already present with 777 permissions in the TFTP enabled directory on the TFTP server. Here, <i>{hostname}</i> is the output of hostname command on the local machine. Just a blank file will also do. For example:
<i>backup-cnsce-myie2100.cisco.com.tar.gz</i> | From drop-down |
| Server name | Server name where all backup files will be put. | a-z
A-Z
0-9
-(hyphen)
_ (under-score)
. (period) |
| Username | Login username for the FTP server. | a-z
A-Z
0-9
-(hyphen)
_ (under-score)
. (period) |
| Password | Password for FTP server. | |
| Directory | Subdirectory into which all backup files will be put. | Absolute path |
| Enable Log File Management | determines whether files will be deleted from host system after backup. | From drop-down list |
| Backup Schedule | Date and time fields. | As required |

- Step 5** To specify the username to log into the FTP server, enter a valid username in the **Username** field.
- Step 6** To specify the password to use to log into the FTP server, enter a valid value in the **Password** field.
- Step 7** To specify the subdirectory where the data file is put, enter the absolute path in the **Directory** field.
- Step 8** Choose whether to **Enable Log File Management**.
- Step 9** To specify the backup schedule, complete the fields in the **Backup Schedule** pane.
-  **Note** The time base for the host system should be set to Coordinated Universal Time (UTC).
- Step 10** To cancel this task, click **Cancel**.
- Step 11** To schedule the backup operation, click **Backup**.

Data Restore Procedure

- Step 1** Log in to the host system.
- Step 2** Type **datarestore** at the command line, then press **Enter**.
- Step 3** Provide inputs to following prompts:

Notes

Sample user inputs are shown in **bold** text.

FTP Server

```
root@i336s6 root]# datarestore
Entering Data Restore section
Type ctrl-c to exit

Enter Transfer Protocol (FTP[F] or TFTP[T]): F
Enter FTP server (hostname.domainname or IP address): 10.77.27.17
Enter username used for FTP server: root
Enter FTP password: *****
Re-enter FTP password: *****
Enter absolute pathname of backup file on FTP server: /backup.tar
```

TFTP Server

```
[root@i336s6 root]# datarestore
Entering Data Restore section
Type ctrl-c to exit

Enter Transfer Protocol (FTP[F] or TFTP[T]): T
Enter the TFTP server (hostname.domainname or IP address): 10.77.27.17
Enter pathname of backup file on the TFTP server(relative to tftp root dir):
backup.tar
```

DNS Server

```
[root@i336s6 root]# datarestore
Entering Data Restore section
Type ctrl-c to exit

Enter Transfer Protocol (FTP[F] or TFTP[T]): T
Enter the TFTP server (hostname.domainname or IP address): test.cisco.com
Enter DNS server IP address: 10.77.27.1
Enter pathname of backup file on the TFTP server(relative to tftp root dir):
backup.tar
```

Definitions

FTP: File transfer protocol.

FTP/TFTP Server: <hostname.domainname>, or IP address, of the FTP/TFTP server on which the backup file is located.

DNS Server: IP address of the DNS server. This appears when you enter a hostname instead of an IP address for the server prompt.

FTP Username: username used for FTP server.

FTP Password: password used to log into the FTP server.

Absolute pathname of backup file on FTP/TFTP server: fully specified path of the backup file stored on the FTP server, or TFTP server (relative to TFTP root directory).



PIX Firewall Device Support

Cisco Configuration Engine provides configuration management and image service to Cisco PIX firewall devices (PIX device). [Figure 21-1](#) shows a functional block diagram of Cisco Configuration Engine, 2.0 including the PIX device interface module.

Figure 21-1 *PIX-Compatible Configuration Engine Module Interaction*

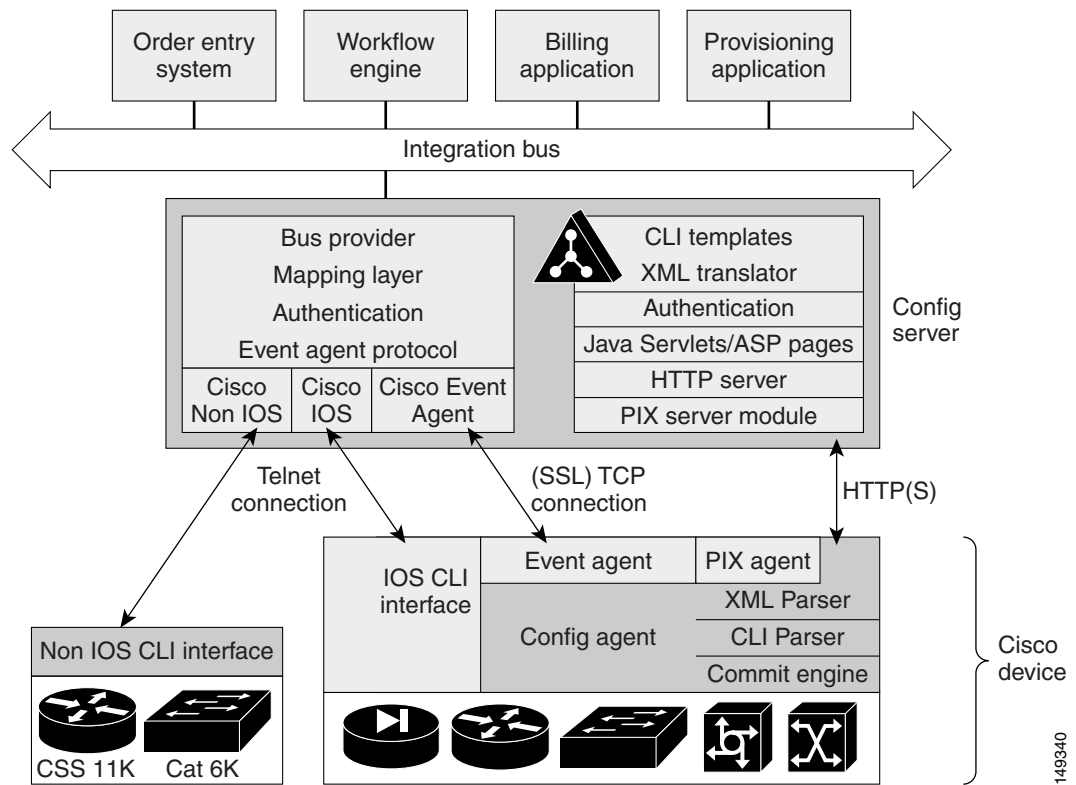

Note

Encryption must be enabled during Setup for PIX devices to be supported by Cisco Configuration Engine, 2.0.

PIX Device Polls for Updates

The PIX device contacts the PIX module in the Cisco Configuration Engine, 2.0 to report information about itself. This occurs when the PIX starts, when any of the reported information changes and whenever the PIX wants to check for updates. PIX sends the **DeviceDetails** message to the server. **DeviceDetails** gives the Cisco Configuration Engine, 2.0 an update of the versions of software the device is currently running. The information received in **DeviceDetails** is logged into the log file (*pix.log*) for reference.

The server responds with the **UpdateInfo** message. This message contains (optionally)

- Checksum and URL for the configuration file the PIX should be running
- Checksum and URL for the PIX image
- Checksum and URL for the PIX Device Manager (PDM) image
- URL for reporting any errors

The PIX compares the checksum in the message with the current checksum of the component concerned. In the case of configuration, it also calculates the cryptchecksum of the running configuration and compare that with the one calculated the last time the configuration was updated from the Cisco Configuration Engine, 2.0. An update is required if the checksum (or cryptchecksum) differs.

If a software/configuration update is required, the PIX sends requests on the respective URLs.

Configuration Processing

For any configuration update that is required, the PIX sends an HTTPS GET request to the returned URL. The configuration file is completely read into a local buffer before being applied. This is to prevent a connection error from leaving the PIX in a partially configured state. If there are no errors (or the *errors* attribute of the **config-data** message is *continue*) while applying the configuration commands, then the running configuration is copied to flash with the **write memory** command. All configuration files work in the *replace* mode.

Completion of configuration download by a PIX device results in a log file entry indicating the same in *pix.log*.

**Note**

The log entry does not mean that the configuration has been successfully applied on a PIX device. It only means that the PIX device has downloaded the configuration file.

Image Processing

The **DeviceDetails** XML sent along with the initial HTTPS POST optionally has information regarding the PIX image, its version and checksum. Cisco Configuration Engine, 2.0 returns with the UpdateInfo XML containing image URLs and checksums based on the entries in the directory. The PIX downloads and applies images one after the other (and reload itself if required). Any error is processed as mentioned below.

**Note**

There is no notification of successful image download because image distribution might be external to Cisco Configuration Engine, 2.0 and hence the PIX server cannot keep track of the same. Also, PIX device does not provide any image upgrade successful indication.

Error Processing

All errors are reported by way of HTTPS POST to the error URL using the **ErrorList** message.

Each configuration error report (type=error, warning or info) is logged by the Cisco Configuration Engine, 2.0 into *pix.log*. The log file is cyclic to limit disk space usage. The content of error-message is the error XML from the PIX device itself.

**Note**

An error occurring during configuration does not mean that the downloaded configuration has not been applied on the PIX entirely. It only means that the error mentioned in the log file has happened with respect to this particular device.

Any error or notification (type= warning, notification, informational, debugging, emergency, alert, critical and error) that occurs while retrieving the data at one of the URLs received from the Cisco Configuration Engine, 2.0 results in log file entries.

If a failure is encountered during the processing of any of the URLs in the UpdateInfo response from the server, the error is reported to the Error URL. Also, processing of all URLs received in the current call home is discontinued. Any further processing is deferred till the PIX calls home again.

After all updates are successfully completed, another **DeviceDetails** message is sent to the Cisco Configuration Engine, 2.0 by the PIX device. Cisco Configuration Engine, 2.0 again sends the **UpdateInfo** and checksum. The PIX device compares the checksums and finds that no further updates are required.

Processing a DeviceDetails Request from PIX Device

The sequence of processing a DeviceDetails request from a PIX device is as follows:

1. PIX device contacts the Cisco Configuration Engine, 2.0 with **DeviceDetails** as XML payload by means of an HTTPS post request.
2. New PIX Configuration servlet receives request, parses XML, and retrieves DeviceID.
3. The device is authenticated.
4. The template associated with this DeviceID is processed to generate a configuration file.
5. The configuration file is converted into XML format as per the PIX DTD and the file is saved (over-written in case a file is already present for this DeviceID).
6. The checksum of XML configuration file is calculated and URL noted.
7. URLs and checksums for pix image and PDM images are retrieved from image object attached with the PIX device.
8. Checksums and URLs for configuration file and various images (if the corresponding checksum differs) and the Error URL are sent to the PIX device as an HTTP response with an XML payload (UpdateInfo).
9. Device now requests for configuration/image based on the content of the UpdateInfo response.
10. If errors are encountered, information is posted to error URL.
11. The error servlet logs the errors to *pix.log*.

PIX DeviceID

The following PIX CLI decides the value of DeviceID sent by PIX in the DeviceDetails request:

```
[no] auto-update device-id hardware-serial | hostname | ipaddress [if-name] | mac-address [if-name] | string text
```

- **auto-update device-id** command specifies the device ID to send when polling the Management server.
- **no auto-update device-id** command resets the device ID to the default of hostname.
- **hardware-serial** option uses the PIX serial number.
- **hostname** option uses the PIX host name.
- **ipaddress** option uses the IP address of the interface with the name **if-name**.

If the interface name is not specified, it uses the IP address of the interface used to communicate with the remote management server.

- **mac-address** option uses the MAC address of the interface with the name *if-name*.

If the interface name is not specified, it uses the MAC address of the interface used to communicate with the remote management server.

- **string** option uses the specified *text*.

The text can not contain white space or the characters ‘, “, <, >, & and ?.



Note

Since DeviceID provided by PIX is internally mapped to ConfigID and EventID in the Cisco Configuration Engine, 2.0, it only supports hyphen (-), underscore (_), period (.) and alphanumeric characters.

Security Considerations

Since PIX devices are firewall devices and configuration information is vital, transport of this information is made secure by the use of SSL.

HTTPS has been enforced as the transport protocol between PIX devices and Cisco Configuration Engine, 2.0 under all circumstances. **DeviceDetails**, **Update Info**, **ErrorInfo** and configuration files are transported only using HTTPS. The authorization mechanism used in Configuration Service has been leveraged in the PIX server module. The URLs supplied by you towards PDM/pix-image can use HTTP or HTTPS.

PIX Device Polling Setup

PIX devices can be configured to poll the Cisco Configuration Engine, 2.0 at regular intervals for configuration or image updates. This entry has to be made by you on the PIX device itself. Details are available from PIX device documentation. CLI format for the same is as follows:

Usage: auto-update device-id hardware-serial | hostname |

ipaddress [<if_name>] | mac-address [<if_name>] | string <text>

no auto-update device-id

```
auto-update poll-period <poll-period> [<retry-count>
[<retry-period>]]
```

```
no auto-update poll-period
```

```
auto-update server <url> [verify-certificate]
```

```
no auto-update server
```

```
auto-update timeout <period>
```

```
no auto-update timeout
```

Example:

```
auto-update device-id string myPIXDevice
auto-update poll-period 120
auto-update server https://*****@cns-ie2100/cns/PIXConfig
```

The URI to be polled on the Cisco Configuration Engine, 2.0 is:

```
/cns/PIXConfig
```

The **auto-update poll-period** command specifies how often to poll the Management server for configuration or image updates. The *poll-period* parameter specifies how often (in minutes) to check for an update. The default is 720 (12 hours). The *retry-count* option specifies how many times to try re-connecting to the server if the first attempt fails. The default is 0. The *retry-period* option specifies how long to wait (in minutes) between retries. The default is 5.

The **no auto-update poll-period** command resets the poll period to the default.

Also, you must map the hostname of the server on the PIX device with its IP address. You can do this by using the *name* command as follows:

```
pixfirewall# conf t
pixfirewall(config)# name <ip_address of the server> <hostname of the server>
```

Configuration and Restrictions

PIX compatibility module is set up along with Configuration Service during the initial setup of the system. You need not do anything specifically to enable PIX compatibility.

PIX devices with **software versions of 6.2.1 and higher** are supported by Cisco Configuration Engine, 2.0 (auto-update from PIX device side was introduced in this version). All PIX hardware platforms that run software version 6.2.1 or higher will be supported.

The configuration files will be generated with options config-action= **replace** and errors=**revert**. No other options are supported.



IMGW Device Module Development Toolkit

The Intelligent Modular Gateway (IMGW) device module development toolkit clearly defines the southbound interface of IMGW and provides a registration utility to allow you to register plug-in device modules into IMGW after the device module is installed onto the Cisco Configuration Engine, 2.0.

This chapter analyzes the requirements of the IMGW device module development toolkit and describes the functionality that is offered by this toolkit.



Note

You can also implement the device module in either shell scripts or Linux/Solaris executables as long as the device module conforms to IMGW southbound interface.

User Types

This toolkit is oriented to three types of users:

- *Plug-in Developer*—responsible for developing the device module that complies with the IMGW southbound interface defined in this toolkit
- *System Administrator*—responsible for the following:
 - Plug the device module into and out of the Cisco Configuration Engine
 - Register and de-register the plug-in device module
 - Update the device module on the Cisco Configuration Engine
- *Network Operator*—configures the device through the plug-in device module

Toolkit Usage

There are three common usages of this toolkit:

- Plug a device module into Cisco Configuration Engine and configure devices using the device module.
- Update a device module on the Cisco Configuration Engine and configure devices through the modified device module.
- Unplug a device module from the Cisco Configuration Engine.

Plug Device Module Into Cisco Configuration Engine

- Step 1** The *Plug-in Developer* develops a device module conforming to the IMGW southbound interface defined in this toolkit to handle the given device type.
- For information about the device module syntax, see “[IMGW Southbound Interface](#)” section on [page 22-2](#).
- Step 2** The *System Administrator* installs the device module onto Cisco Configuration Engine.
- Step 3** The *System Administrator* runs the registration utility to register the device module into IMGW.
- Step 4** The *Network Operator* configures devices through the device module.
-

Update Device Module on Cisco Configuration Engine

- Step 1** The *Plug-in Developer* provides a new version of the device module.
- Step 2** The *System Administrator* runs the registration utility to de-register the device module from IMGW. If the device module you want to update is not registered, skip this step.
- Step 3** The *System Administrator* updates the device module with the new version on Cisco Configuration Engine.
- Step 4** The *System Administrator* runs registration utility to register the updated device module into IMGW.
- Step 5** The *Network Operator* configures devices through modified device module.
-

Unplug Device Module from Cisco Configuration Engine

- Step 1** The *System Administrator* runs the registration utility to de-register the plug-in device module from IMGW.
- Step 2** The *System Administrator* uninstalls the plug-in device module from Cisco Configuration Engine.
-

IMGW Southbound Interface

When a command execution or a configuration update event is received by IMGW runtime, it will first retrieve device type information from the device information database. If the device module corresponding to device type and operation type (`CONFIG_UPLOAD` or `CONFIG_DOWNLOAD`) is registered, IMGW runtime forks a process to execute the proper plug-in program and pass the parameter list to the plug-in program.

The initial mapping information from the `<device type, operation type>` pair to the plug-in program is read from a configuration file into memory upon start up. When IMGW is running, the system administrator can still add, remove, or update the entries of mapping information by way of the toolkit registration utility.

The *System Administrator* can modify only the entries for non-legacy device modules. This restriction is enforced by IMGW runtime.

User Designed Device Module Specifications

A user-defined device module must conform to the IMGW southbound interface as specified in this section.

Config Event

```
<plug-in program> <temp_logfile_name> <logging_level> <device_id> <action_type>
<warning_logfile_name> <error_logfile_name> <hop_information_string> <configuration_file_name>
<persistence> <operation_timeout_value> <prompt_timeout_value>.
```

Exec Event

```
<plug-in program> <temp_logfile_name> <logging_level> <device_id> <action_type>
<hop_information_string> <command_to_be_executed> <command_arguments>
<exec_response_logfile_name> <operation_timeout_value> <prompt_timeout_value>.
```

Hop Test

```
<plug-in program> <temp_logfile_name> <logging_level> <device_id> <action_type>
<hop_information_string> <operation_timeout_value> <prompt_timeout_value>.
```



Note

All files specified for the IMGW southbound interface are managed by IMGW runtime and their file names are absolute path names.

Parameter Descriptions

Plug-in Program: The plug-in program that is executed in the child process forked by IMGW runtime. The system administrator gives this information to IMGW runtime during registration.

temp_logfile_name: The full path to the device module temporary log file, which should be used by the device module to log the processing history of one instance of operation (configuration download, command execution or hop test). This file is by default located at */tmp* directory on the Cisco Configuration Engine. After the plug-in program exits, IMGW runtime puts the content of this file into a centralized log file named */opt/CSCOimgw/bin/IMGW-DEVMOD_LOG* for debugging purpose, then unlinks this file.

logging_level: It could be verbose, error, or silent. This flag can be set up by running setup command on the host system. It is recommended that the device module log information into the file *<temp_logfile_name>* based on the specified logging level.

device_id: The identification of the device that is processed by the device module. It is passed in by the *cisco.mgmt.cns.config.load* or *cisco.mgmt.cns.exec.cmd* event.

action_type: It could be **config**, **exec**, or **hoptest**. Action type **config** notifies the device module to update the device configuration. Action type **exec** notifies the device module to execute a command on the device. Action type **hoptest** notifies the device module to test if the device is reachable by way of the hop information provided in *<hop_information_string>*. The device module should do the proper operation in response to this flag.

warning_logfile_name: The full path to the file that is used by the device module to log all warning messages and its corresponding configuration commands line numbers. This parameter is supplied by IMGW runtime only when the action type is **config** because the information in this file is only used to generate the response message to the *cisco.mgmt.cns.config.load* event if the configure succeeds with warnings. In order for the IMGW runtime to generate the proper response message, each warning message should begin a new line and be prefixed with the string of **LINE** *<line number of the configuration command that causes the warning message>*: An example of the warning file is as follows:

```
LINE 3: The interface has already been removed
.
.
.
LINE 7: The interface already exists.
```

The location of this file is under */tmp* on the host system. After the plug-in program exits, IMGW runtime puts the content of this file into the response event payload, then immediately unlinks this file.

error_logfile_name: The full path to the file that is used by the device module to log the occurrences of the error messages and their corresponding configuration command line numbers. This parameter is supplied by IMGW runtime only when the action type is **config** because the information in this file is only used to generate the response message to the *cisco.mgmt.cns.config.load* event if the configure fails. In order for the IMGW runtime to generate the proper response message, each error message should begin a new line and be prefixed with the string of **LINE** *<line number of the configuration command that causes the error message>*.

An example of the error file is as follows:

```
LINE 3: % Invalid input detected at
LINE 7: % Incomplete command
.
.
.
LINE 12: % The interface already exists
```

The location of this file is under */tmp* on the host system. After the plug-in program exits, IMGW runtime puts the content of this file into the response event payload, then immediately unlinks this file.

exec_response_logfile_name: The full path to the file that is used to log the output of command execution on the device. It is supplied by IMGW runtime only when the action type is **exec** and its location is under */tmp* on the host system. After the plug-in program exits, IMGW runtime puts the content of this file into the response event payload, then immediately unlinks this file.

hop_information_string: The string used to store the access information of the device. It is the string concatenation of all individual hop information of the device in order. An example the hop information and its *<hop_information_string>* are as follows:

| Hop type | IP address | Port | Username | Password |
|-----------|---------------|------|----------|----------|
| IOS_LOGIN | 172.29.145.45 | | Admin | Cisco |
| IOS_EN | | | Lab | Lab |

The corresponding *<hop_information_string>* should be as follows:

```
"IOS_LOGIN" "172.29.145.45" " " "Admin" "Cisco" "IOS_EN" " " " " "Lab" "Lab"
```



Note

For those fields of hop information with null value, IMGW runtime automatically adds a space before passing it to the child process.

command_to_be_executed: The command to be executed on the device. It is supplied by IMGW runtime only when the action type is **exec**.

command_arguments: The arguments of the command to be executed on the device. It is supplied by IMGW runtime only when the action type is **exec**.

configuration_file_name: The full path to the configuration file which will be downloaded onto the device. It is supplied by IMGW runtime only when the action type is **config** and its location is under */tmp* on the host system. After the plug-in program exits, IMGW runtime immediately unlinks this file.

persistence: **y** or **n**. The value **y** means the configuration needs to be written into non-volatile storage. It is supplied by IMGW runtime only when the action type is **config**. This option is dependent on the device type. This means the device module can ignore it if the device type does not support it.

operation_timeout_value: The maximum time period allowed to execute a command on the device. This parameter is now used by Expect scripts in IMGW legacy device module for IOS, CatOS, CatIOS, PIX, CSS and CE devices. A user-defined device module can ignore this parameter if it does not use it.

prompt_timeout_value: The maximum time period allowed to wait for the next prompt during login session to the device. This parameter is now used by Expect scripts in IMGW legacy device module for IOS, CatOS, CatIOS, PIX, CSS and CE devices. A user-defined device module can ignore this parameter if it does not use it.

Exit Codes

When the forked process (in which the plug-in program is executed) exits, the following exit codes are expected by IMGW runtime from the forked process:

config event:

- 0 – Download succeeds
- 1 – Download fails
- 2 – Download succeeds but with warning messages

Exec Event:

- 0 – Command execution succeeds
- 1 – Command execution fails

Hop Test:

- 0 – Hop test succeeds
- 1 – Hop test fails

How to Develop Plug-in Device Module

This toolkit allows the *Plug-in Developer* to use any implementation to realize the plug-in device module as long as the device module complies with IMGW southbound interface specified in “[IMGW Southbound Interface](#)” section on page 22-2.

This toolkit also provides sample code (see [How to Develop Plug-in Device Module, page 22-6](#)) in Perl plus Expect scripts as well as inline comments to help beginners to understand the workflow of the plug-in device module.

The plug-in device module should render three basic functions:

- Device configuration update
- Command execution
- Hop test

The first two functions are in response to the *cisco.mgmt.cns.config.load* and *cisco.mgmt.cns.exec.cmd* events respectively. The last one is an internal routine operation required by IMGW runtime and is transparent to network operators.

After IMGW runtime spawns a child process to execute the plug-in program, the corresponding device module should read the action type from the parameter list. If the action type is:

- **config** – device module should do device a configuration update.
- **exec** – device module should do a command execution.
- **hoptest** – device module should do hop test.

Development Guidelines

The following subsections describe the processes associated with each function.



Note

The subject of actions in the subsections below is the plug-in device module.

Device Configuration Update

1. Access the device by way of the *<hop_information_string>*.
2. Download the configuration file named after *<configuration_file_name >* onto the device.
3. If the above download operation succeeds, the *<persistence>* is set to y and the device supports this option, then write the configuration to non-volatile storage.
4. Write all warning messages prompted by the device and their corresponding configuration commands line numbers into the file named after *<warning_logfile_name>* in the specified format (see “[Parameter Descriptions](#)” section on page 22-3). The content of this file will be part of the payload of the response event if the download succeeds but with warning messages.
5. Write all error messages prompted by the device and their corresponding configuration commands’ line numbers into the file named after *<error_logfile_name>* in the specified format (see “[Parameter Descriptions](#)” section on page 22-3). The first error message and its corresponding configuration command line number will be part of the payload of the response event if the download fails.

6. Based on the `<logging_level>`, selectively redirect the processing history into the file named after `<temp_logfile_name>` for debugging purpose during the whole procedure.
7. Exit with proper exit code to return control to IMGW runtime. See “Exit Codes” section on page 22-5 to get the definition of exit codes.

Command Execution

1. Access the device by way of the `<hop_information_string>`.
2. Execute on the device the `<command_to_be_executed>` with the `<command_arguments>`.
3. Capture all output from the command execution into the file named after `<exec_response_logfile_name>`. The content of this file will be part of the payload of the response event.
4. Based on the `<logging_level>`, selectively redirect the processing history into the file named after `<temp_logfile_name>` for debugging purpose during the whole procedure.
5. Exit with proper exit code to return control to IMGW runtime. See “Exit Codes” section on page 22-5 to get the definition of exit codes.

Hop Test

1. Access the device by way of the `<hop_information_string>`.
2. Based on the `<logging_level>`, selectively redirect the processing history into the file named after `<temp_logfile_name>` for debugging purpose during the whole procedure.
3. Exit with proper exit code to return control to IMGW runtime. See “Exit Codes” section on page 22-5 to get the definition of exit codes.

Installing Plug-in Device Module

The *System Administrator* is required to take charge of the install/uninstall. He/She should make sure the installation is successful before calling the registration utility.

The System Administrator should install all plug-in device modules into the reserved file directory of `/opt/ConfigEngine/CSCOimgw/plugin-modules` with one subdirectory per device module. For example, install the device module for MGX into `/opt/ConfigEngine/CSCOimgw/plugin-modules/MGX` while install the one for NT into `/opt/ConfigEngine/CSCOimgw/plugin-modules/NT`.

The *System Administrator* should only operate within the device module installation directory to set/remove the running environment of the module. The installation activities should not affect the running environment of other components on the Cisco Configuration Engine.

Registering Plug-in Device Module

The *System Administrator* must provide the device type and the full path to the plug-in program when registering a device module. IMGW runtime does not check the integrity of this information. It is responsibility of the *System Administrator* to make sure the information is correct.

This toolkit provides a dynamic registration utility to the system administrator, which allows the *System Administrator* to plug the device module into and out of IMGW seamlessly without tearing down IMGW runtime. Therefore, the services irrelevant to the device module that is being registered/de-registered will not be affected. However, this might not be the case for other services.

For example, at the time you issue the de-register command on device module *x*, the events related to *x* that are still queued in event bus might get failure responses from IMGW.

**Caution**

It is **HIGHLY RECOMMENDED** that the *System Administrator* notify all *Network Operators* of the upcoming registration activities so that *Network Operators* have a chance to stop beforehand any relevant operation.

End User Interface

The end user interface of IMGW device module development toolkit consists of IMGW southbound interface and the command line registration utility.

Configuration and Restrictions

This toolkit does not put a restriction on the maximum number of plug-in device modules that can be put into IMGW.

Device Module Restrictions

- The device module must be able to run on the Linux and/or Solaris platform.
- If the executable of the device module is a C++ binary file, it must utilize the glib that exists on Cisco Configuration Engine where applicable.
- If the executable of the device module is a java class, it must run in the existing JVM of Cisco Configuration Engine.
- If the device module includes Perl and/or Expect scripts, the scripts should use the Perl and/or Expect interpreters that exist on Cisco Configuration Engine.

Registration Utility Restriction

The *System Administrator* is not allowed to register/de-register IMGW legacy device module. Sometimes users might want to modify one of the legacy device modules to do upload/download operation on CatOS, CatIOS, PIX, CSS, CE or IOS devices to meet their specific needs. In this case, they can only modify their own copy of the legacy device module, associate a different device type name to the modified device module and register the device module into IMGW.



Troubleshooting

This appendix provides troubleshooting information. It contains information about:

- [Contacting Cisco TAC](#)
- [Cannot Log Into the System](#)
- [System Cannot Connect to the Network](#)
- [Cannot Connect to the System Using a Web Browser](#)
- [Cannot Connect to System with SSH or SSH Interaction is Slow](#)
- [Backup and Restore not Working Properly](#)
- [How to Use the showversion Command](#)
- [Using the cns-send and cns-listen Commands](#)

Contacting Cisco TAC

In some of the following sections, you might be advised to contact the Cisco Technical Assistance Center (TAC) for assistance. You can obtain TAC assistance online at <http://www.cisco.com/tac>.

Cannot Log Into the System

Problem: You cannot log into the system.

Probable causes:

- You did not run the setup program to create an initial system configuration.
- You lost all of the user account passwords.

Resolution:

Step 1 Did you run the setup program after starting the system for the first time?

If no, run the setup program as described in either *Cisco Configuration Engine Linux Installation & Configuration Guide, 2.0* or *Cisco Configuration Engine Solaris Installation & Configuration Guide, 2.0*.

If yes, continue.

Step 2 Do you know the password for any system user accounts?

If no, reconfigure the system to create a new user account. See [Chapter 4, “User Account Manager”](#) for more information.

If yes, continue.

Step 3 If you are certain you entered a valid username and password, contact the TAC for assistance.

System Cannot Connect to the Network

Problem: The system cannot connect to the network.

Probable causes:

- The network cable is not connected to an Ethernet port.
- The Ethernet interface is disabled or misconfigured.
- The system is configured correctly, but the network is down or misconfigured.
- The system is not configured correctly.

Resolution:

Step 1 Verify that the network cable is connected to an Ethernet port and the Link light is on.

- If the network cable is not connected, connect it.
- If the network cable is connected but the Link light is not on, these are the probable causes:
 - The network cable is faulty.
 - The network cable is the wrong type (for example, a cross-over type, rather than the required straight-through type).
 - The port on the default gateway to which the system connects is down.

If the network cable is connected and the Link light is on but the system cannot connect to the network, continue.

Step 2 Use the **ping** command to perform the following tests:

a. Try to connect to a well-known host on the network. A DNS server is a good target host.

If the ping command can reach another host, the system is connected to the network. If it cannot connect to a particular host, the problem is with the network configuration or that host. Contact your network administrator for assistance.

If the ping command cannot reach another host, continue.

b. Attempt to reach another host on the same subnet as the system.

If the ping command can reach a host on the same subnet, but cannot reach a host on a different subnet, the default gateway is probably down or misconfigured.

If the ping command cannot reach any hosts, continue.

Step 3 Use the **ifconfig** command to determine if the Ethernet interface is disabled or misconfigured.

If the Ethernet interface is disabled, enable it. If it is misconfigured, configure it correctly.

If the interface is enabled and correctly configured, continue.

Step 4 To ensure all network settings are configured correctly, run the **Setup** program again by entering the **setup** command in the shell prompt.



Note You cannot run **Setup** a second time by logging in as **setup** because that account is disabled for security reasons after it is used once successfully.

- Step 5** Contact your network administrator to verify that there are no conditions on the network that prevent the system from connecting to the network.
- If conditions prevent the system from connecting to the network, have your network administrator correct them.
- Step 6** If no conditions are preventing the system from connecting to the network, contact TAC for assistance.
-

Cannot Connect to the System Using a Web Browser

Problem: You cannot connect to the system by entering its IP address in a web browser.

Probable causes:

- The system cannot connect to the network.
- Encryption is enabled (plaintext disabled).
- The HTTP service is not running.

Resolution:

- Step 1** Make sure that the system can connect to the network by following the procedure in the [“System Cannot Connect to the Network”](#) section on page A-2.
- Step 2** When you are sure that the system is connected to the network, attempt to connect the system using a web browser.
- If encryption is enabled:
- Use **https://...** to connect.
 - Ensure the certificate is correct.
- If you still cannot connect, continue
- Step 3** To stop and start the web server only, enter the following commands:
- ```
/etc/rc.d/init.d/httpd stop
/etc/rc.d/init.d/httpd start
```
- If the LDAP directory contains thousands of devices, restart and wait 20 minutes.
- Step 4** Attempt to connect the system using a web browser.
- If you cannot connect, continue.
- Step 5** Restart the system.
- If the LDAP directory contains thousands of devices, restart and wait 20 minutes.
- Step 6** If you still cannot connect to the system using a web browser, contact the Cisco TAC for assistance.
-

## Cannot Connect to System with SSH or SSH Interaction is Slow

**Problem:** You cannot connect to the system using SSH or SSH interaction with the system is extremely slow, even though the system is connected to the network.

**Probable cause:** The system cannot get DNS services from the network. The system will not function correctly without DNS. SSH problems are the most visible symptom, but the system will have more serious problems. In most cases, it will not correctly process requests from management applications that use it.

**Resolution:** Perform the following steps. Connect to the console if you cannot connect using SSH.

- 
- Step 1** To set up the name servers properly, edit the */etc/resolv.conf* file.  
Or, you can re-execute **Setup**.
- Step 2** Verify that the system can get DNS services from the network by entering the following command:  
# **host** <dns-name>
- where <dns-name> is the DNS name of a host on the network that is registered in DNS. The command returns the IP address of the host.
- Step 3** If the system cannot resolve DNS names to IP addresses, the DNS server it is using is not working properly.  
Resolve the network DNS problem, then continue.
- Step 4** If the system can resolve DNS names to IP addresses but you still cannot connect to the system using SSH or SSH interaction with the system is extremely slow, contact the Cisco TAC.
- 

## Cannot Connect to System Using Telnet

**Problem:** You cannot connect to the system using Telnet even though the system is connected to the network.

**Probable cause:** Telnet service is disabled on the system.

**Resolution:** Connect to the system with SSH.

## Backup and Restore not Working Properly

**Problem:** Your backup and restore is not working properly.

**Probable causes:**

- The time base for the host system is not set to the UTC time zone.
- The time has changed.
- The cron job is not started.

**Resolution:** Perform the following steps:

- 
- Step 1** Connect to the console if you cannot connect using SSH.



- Step 2** Log in to the host system as root.
- Step 3** To determine if the time is correct, enter the command:
- ```
# date
```
- Step 4** To determine the state of the cron job, enter the command:
- ```
/etc/rc.d/init.d/crond restart
```

Example:

```
/etc/rc.d/init.d/crond restart
Stopping cron daemon: [OK]
Starting cron daemon: [OK]
#
```

## No Crontab Set for Backup Job when /var is 100% Full.

Certain system commands need some space in */var* to run and crontab is such a command in order to schedule the backup job for the user. Because of this, the crontab command issued by the script (called from the GUI) fails, which results in the failure of backup job.

Clean up */var* partition on the system (moved some files to */home/*), then resubmit the backup schedule from the GUI.

## How to Use the showversion Command

Use the **showversion** command to list all the current RPMs (package managers) loaded on your host system. This command is located in the */opt/CSCOcsie/bin* directory.

## Using the cns-send and cns-listen Commands

Use the **cns-send** and **cns-listen** commands to send and receive test messages to the event gateway in the Cisco Configuration Engine. These commands are located in the */opt/CSCOcsie/tools* directory.

### cns-send

The syntax for the cns-send command is:

```
cns-send -version
```

or

```
cns-send [-service <service>] [-network <network>] [-daemon <daemon>] [-file <filename>]
<subject> [<message>]
```

#### Syntax Description

<b>-version</b>	Outputs the version of cns-send.
<b>-service &lt;service&gt;</b>	(Optional) The port number (default: 7500).

<b>-network</b> <network>	(Optional) Network interface (in local machine) where messages are sent.
<b>-daemon</b> <daemon>	(Optional) Internal port of application to the rvd daemon (default: 7500).
<b>-file</b> <filename>	(Optional) Filename containing the XML-message. The filename can be sent instead of individual subject/messages.
<subject>	Subject name of the message.
<message>	(Optional) Message in the message field.

To use the `cns-send` command, follow these steps:

- 
- Step 1** Log in to the host system as root.
  - Step 2** Change directories to `/opt/CSCOcsnie/tools`.
  - Step 3** Type `./cns-send -file <filename> <subject>`
- 

**Note**

The `cns-send` command sends messages in the opaque data format.

---

## cns-listen

The syntax for the `cns-listen` command is:

**cns-listen -version**

or

**cns-listen [-service <service>] [-network <network>] [-daemon <daemon>] <subject\_list>**

---

**Syntax Description**

<b>-version</b>	Outputs the version of <code>cns-listen</code> .
<b>-service</b> <service>	(Optional) The port number (default: 7500).
<b>-network</b> <network>	(Optional) Network interface (in local machine) where messages are received.
<b>-daemon</b> <daemon>	(Optional) Internal port of application to the rvd daemon (default: 7500).
<subject_list>	Subjects listen to.

---

To use the `cns-listen` command, follow these steps:

- 
- Step 1** Log in to the host system as root.
  - Step 2** Change directories to `/opt/CSCOcsnie/tools`.
  - Step 3** Type `./cns-listen <subject_list>`
-

---

**Usage Guidelines** Use the greater than symbol (>) for a wildcard.

---

**Examples** `./cns-listen "cisco.cns.config.load"`  
`./cns-listen "cisco.cns.>"`

---





## APPENDIX **B**

# Software Licenses and Acknowledgements

---

This appendix lists licenses for private and, so called, public domain software used by this product.

## Active TCL License Agreement

ActiveState Community License

Preamble:

The intent of this document is to state the conditions under which the Package (ActiveTcl) may be copied and distributed, such that ActiveState maintains control over the development and distribution of the Package, while allowing the users of the Package to use the Package in a variety of ways.

The Package may contain software covered by other licenses:

**TCL LICENSE AGREEMENT**

This software is copyrighted by the Regents of the University of California, Sun Microsystems, Inc., Scriptics Corporation, and other parties. The following terms apply to all files associated with the software unless explicitly disclaimed in individual files.

The authors hereby grant permission to use, copy, modify, distribute, and license this software and its documentation for any purpose, provided that existing copyright notices are retained in all copies and that this notice is included verbatim in any distributions. No written agreement, license, or royalty fee is required for any of the authorized uses. Modifications to this software may be copyrighted by their authors and need not follow the licensing terms described here, provided that the new terms are clearly indicated on the first page of each file where they apply.

**IN NO EVENT SHALL THE AUTHORS OR DISTRIBUTORS BE LIABLE TO ANY PARTY FOR DIRECT, INDIRECT, SPECIAL, INCIDENTAL, OR CONSEQUENTIAL DAMAGES ARISING OUT OF THE USE OF THIS SOFTWARE, ITS DOCUMENTATION, OR ANY DERIVATIVES THEREOF, EVEN IF THE AUTHORS HAVE BEEN ADVISED OF THE POSSIBILITY OF SUCH DAMAGE.**

**THE AUTHORS AND DISTRIBUTORS SPECIFICALLY DISCLAIM ANY WARRANTIES, INCLUDING, BUT NOT LIMITED TO, THE IMPLIED WARRANTIES OF MERCHANTABILITY, FITNESS FOR A PARTICULAR PURPOSE, AND NON-INFRINGEMENT. THIS SOFTWARE IS PROVIDED ON AN "AS IS" BASIS, AND THE AUTHORS AND DISTRIBUTORS HAVE NO OBLIGATION TO PROVIDE MAINTENANCE, SUPPORT, UPDATES, ENHANCEMENTS, OR MODIFICATIONS.**

**GOVERNMENT USE:**

If you are acquiring this software on behalf of the U.S. government, the Government shall have only “Restricted Rights” in the software and related documentation as defined in the Federal Acquisition Regulations (FARs) in Clause 52.227.19 (c) (2). If you are acquiring the software on behalf of the Department of Defense, the software shall be classified as “Commercial Computer Software” and the Government shall have only “Restricted Rights” as defined in Clause 252.227-7013 (c) (1) of DFARs. Notwithstanding the foregoing, the authors grant the U.S. Government and others acting in its behalf permission to use and distribute the software in accordance with the terms specified in this license.

Definitions:

“ActiveState” refers to ActiveState Corp., the Copyright Holder of the Package.

“Package” refers to those files, including, but not limited to, source code, binary executables, images, and scripts, which are distributed by the Copyright Holder.

“You” is you, if you are thinking about copying or distributing this Package.

Terms:

1. You may use this Package for commercial or non-commercial purposes without charge.
2. You may make and give away verbatim copies of this Package for personal use, or for use within your organization, provided that you duplicate all of the original copyright notices and associated disclaimers. You may not distribute copies of this Package, or copies of packages derived from this Package, to others outside your organization without specific prior written permission from ActiveState (although you are encouraged to direct them to sources from which they may obtain it for themselves).
3. You may apply bug fixes, portability fixes, and other modifications derived from ActiveState. A Package modified in such a way shall still be covered by the terms of this license.
4. ActiveState's name and trademarks may not be used to endorse or promote packages derived from this Package without specific prior written permission from ActiveState.
5. THIS PACKAGE IS PROVIDED “AS IS” AND WITHOUT ANY EXPRESS OR IMPLIED WARRANTIES, INCLUDING, WITHOUT LIMITATION, THE IMPLIED WARRANTIES OF MERCHANTABILITY AND FITNESS FOR A PARTICULAR PURPOSE.

ActiveState Community License Copyright (C) 2001 ActiveState Corp.

All rights reserved.

## Active Perl License Agreement

ActiveState Community License

Preamble:

The intent of this document is to state the conditions under which the Package may be copied and distributed, such that ActiveState maintains control over the development and distribution of the Package, while allowing the users of the Package to use the Package in a variety of ways. The Package may contain software covered by the Artistic License. The ActiveState Community License complies with Clause 5 of the Artistic License and does not limit your rights to software covered by the Artistic License.

Authorized electronic distributors of the Package are:

- Any ActiveState.com site
- Any complete, public CPAN mirror listed at [www.perl.com](http://www.perl.com)

For more information on CPAN please see <http://www.perl.com/>.

**Definitions:**

“ActiveState” refers to ActiveState Tool Corp., the Copyright Holder of the Package.

“Package” refers to those files, including, but not limited to, source code, binary executables, images, and scripts, which are distributed by the Copyright Holder.

“You” is you, if you're thinking about copying or distributing this Package.

1. You may use this Package for commercial or non-commercial purposes without charge.
2. You may make and give away verbatim copies of this Package for personal use, or for use within your organization, provided that you duplicate all of the original copyright notices and associated disclaimers. You may not distribute copies of this Package, or copies of packages derived from this Package, to others outside your organization without specific prior written permission from ActiveState (although you are encouraged to direct them to sources from which they may obtain it for themselves).
3. You may apply bug fixes, portability fixes, and other modifications derived from ActiveState. A Package modified in such a way shall still be covered by the terms of this license.
4. ActiveState's name and trademarks may not be used to endorse or promote packages derived from this Package without specific prior written permission from ActiveState.
5. THIS PACKAGE IS PROVIDED “AS IS” AND WITHOUT ANY EXPRESS OR IMPLIED WARRANTIES, INCLUDING, WITHOUT LIMITATION, THE IMPLIED WARRANTIES OF MERCHANTABILITY AND FITNESS FOR A PARTICULAR PURPOSE.

ActiveState Community License Copyright © 2000 ActiveState Tool Corp.

All rights reserved.

## OpenLDAP Public License

Version 2.8, 17 August 2003

Redistribution and use of this software and associated documentation (“Software”), with or without modification, are permitted provided that the following conditions are met:

1. Redistributions in source form must retain copyright statements and notices,
2. Redistributions in binary form must reproduce applicable copyright statements and notices, this list of conditions, and the following disclaimer in the documentation and/or other materials provided with the distribution, and
3. Redistributions must contain a verbatim copy of this document.

The OpenLDAP Foundation may revise this license from time to time. Each revision is distinguished by a version number. You may use this Software under terms of this license revision or under the terms of any subsequent revision of the license.

THIS SOFTWARE IS PROVIDED BY THE OPENLDAP FOUNDATION AND ITS CONTRIBUTORS “AS IS” AND ANY EXPRESSED OR IMPLIED WARRANTIES, INCLUDING, BUT NOT LIMITED TO, THE IMPLIED WARRANTIES OF MERCHANTABILITY AND FITNESS FOR A PARTICULAR PURPOSE ARE DISCLAIMED. IN NO EVENT SHALL THE OPENLDAP FOUNDATION, ITS CONTRIBUTORS, OR THE AUTHOR(S) OR OWNER(S) OF THE SOFTWARE BE LIABLE FOR ANY DIRECT, INDIRECT, INCIDENTAL, SPECIAL, EXEMPLARY, OR CONSEQUENTIAL DAMAGES (INCLUDING, BUT NOT LIMITED TO, PROCUREMENT OF SUBSTITUTE GOODS OR SERVICES; LOSS OF USE, DATA, OR PROFITS; OR BUSINESS INTERRUPTION) HOWEVER CAUSED AND ON ANY THEORY OF LIABILITY, WHETHER IN CONTRACT, STRICT

LIABILITY, OR TORT (INCLUDING NEGLIGENCE OR OTHERWISE) ARISING IN ANY WAY OUT OF THE USE OF THIS SOFTWARE, EVEN IF ADVISED OF THE POSSIBILITY OF SUCH DAMAGE.

The names of the authors and copyright holders must not be used in advertising or otherwise to promote the sale, use or other dealing in this Software without specific, written prior permission. Title to copyright in this Software shall at all times remain with copyright holders.

OpenLDAP is a registered trademark of the OpenLDAP Foundation.

Copyright 1999-2003 The OpenLDAP Foundation, Redwood City, California, USA. All Rights Reserved. Permission to copy and distribute verbatim copies of this document is granted.

## Berkeley DB Software License Agreement

The following is the license that applies to this copy of the Berkeley DB software. For a license to use the Berkeley DB software under conditions other than those described here, or to purchase support for this software, please contact Sleepycat Software by email at [info@sleepycat.com](mailto:info@sleepycat.com), or on the Web at <http://www.sleepycat.com>.

Copyright (c) 1990-2004

Sleepycat Software. All rights reserved.

Redistribution and use in source and binary forms, with or without modification, are permitted provided that the following conditions are met:

1. Redistributions of source code must retain the above copyright notice, this list of conditions and the following disclaimer.
2. Redistributions in binary form must reproduce the above copyright notice, this list of conditions and the following disclaimer in the documentation and/or other materials provided with the distribution.
3. Redistributions in any form must be accompanied by information on how to obtain complete source code for the DB software and any accompanying software that uses the DB software. The source code must either be included in the distribution or be available for no more than the cost of distribution plus a nominal fee, and must be freely redistributable under reasonable conditions. For an executable file, complete source code means the source code for all modules it contains. It does not include source code for modules or files that typically accompany the major components of the operating system on which the executable file runs.

THIS SOFTWARE IS PROVIDED BY SLEEPYCAT SOFTWARE ``AS IS" AND ANY EXPRESS OR IMPLIED WARRANTIES, INCLUDING, BUT NOT LIMITED TO, THE IMPLIED WARRANTIES OF MERCHANTABILITY, FITNESS FOR A PARTICULAR PURPOSE, OR NON-INFRINGEMENT, ARE DISCLAIMED. IN NO EVENT SHALL SLEEPYCAT SOFTWARE BE LIABLE FOR ANY DIRECT, INDIRECT, INCIDENTAL, SPECIAL, EXEMPLARY, OR CONSEQUENTIAL DAMAGES (INCLUDING, BUT NOT LIMITED TO, PROCUREMENT OF SUBSTITUTE GOODS OR SERVICES; LOSS OF USE, DATA, OR PROFITS; OR BUSINESS INTERRUPTION) HOWEVER CAUSED AND ON ANY THEORY OF LIABILITY, WHETHER IN CONTRACT, STRICT LIABILITY, OR TORT (INCLUDING NEGLIGENCE OR OTHERWISE) ARISING IN ANY WAY OUT OF THE USE OF THIS SOFTWARE, EVEN IF ADVISED OF THE POSSIBILITY OF SUCH DAMAGE.

Copyright (c) 1990, 1993, 1994, 1995

The Regents of the University of California. All rights reserved.

Redistribution and use in source and binary forms, with or without modification, are permitted provided that the following conditions are met:



1. Redistributions of source code must retain the above copyright notice, this list of conditions and the following disclaimer.
2. Redistributions in binary form must reproduce the above copyright notice, this list of conditions and the following disclaimer in the documentation and/or other materials provided with the distribution.
3. Neither the name of the University nor the names of its contributors may be used to endorse or promote products derived from this software without specific prior written permission.

THIS SOFTWARE IS PROVIDED BY THE REGENTS AND CONTRIBUTORS ``AS IS" AND ANY EXPRESS OR IMPLIED WARRANTIES, INCLUDING, BUT NOT LIMITED TO, THE IMPLIED WARRANTIES OF MERCHANTABILITY AND FITNESS FOR A PARTICULAR PURPOSE ARE DISCLAIMED. IN NO EVENT SHALL THE REGENTS OR CONTRIBUTORS BE LIABLE FOR ANY DIRECT, INDIRECT, INCIDENTAL, SPECIAL, EXEMPLARY, OR CONSEQUENTIAL DAMAGES (INCLUDING, BUT NOT LIMITED TO, PROCUREMENT OF SUBSTITUTE GOODS OR SERVICES; LOSS OF USE, DATA, OR PROFITS; OR BUSINESS INTERRUPTION) HOWEVER CAUSED AND ON ANY THEORY OF LIABILITY, WHETHER IN CONTRACT, STRICT LIABILITY, OR TORT (INCLUDING NEGLIGENCE OR OTHERWISE) ARISING IN ANY WAY OUT OF THE USE OF THIS SOFTWARE, EVEN IF ADVISED OF THE POSSIBILITY OF SUCH DAMAGE.

Copyright (c) 1995, 1996

The President and Fellows of Harvard University. All rights reserved.

Redistribution and use in source and binary forms, with or without modification, are permitted provided that the following conditions are met:

1. Redistributions of source code must retain the above copyright notice, this list of conditions and the following disclaimer.
2. Redistributions in binary form must reproduce the above copyright notice, this list of conditions and the following disclaimer in the documentation and/or other materials provided with the distribution.
3. Neither the name of the University nor the names of its contributors may be used to endorse or promote products derived from this software without specific prior written permission.

THIS SOFTWARE IS PROVIDED BY HARVARD AND ITS CONTRIBUTORS ``AS IS" AND ANY EXPRESS OR IMPLIED WARRANTIES, INCLUDING, BUT NOT LIMITED TO, THE IMPLIED WARRANTIES OF MERCHANTABILITY AND FITNESS FOR A PARTICULAR PURPOSE ARE DISCLAIMED. IN NO EVENT SHALL HARVARD OR ITS CONTRIBUTORS BE LIABLE FOR ANY DIRECT, INDIRECT, INCIDENTAL, SPECIAL, EXEMPLARY, OR CONSEQUENTIAL DAMAGES (INCLUDING, BUT NOT LIMITED TO, PROCUREMENT OF SUBSTITUTE GOODS OR SERVICES; LOSS OF USE, DATA, OR PROFITS; OR BUSINESS INTERRUPTION) HOWEVER CAUSED AND ON ANY THEORY OF LIABILITY, WHETHER IN CONTRACT, STRICT LIABILITY, OR TORT (INCLUDING NEGLIGENCE OR OTHERWISE) ARISING IN ANY WAY OUT OF THE USE OF THIS SOFTWARE, EVEN IF ADVISED OF THE POSSIBILITY OF SUCH DAMAGE.

# Notices

The following notices pertain to this software license.

## OpenSSL/Open SSL Project

This product includes software developed by the OpenSSL Project for use in the OpenSSL Toolkit (<http://www.openssl.org/>).

This product includes cryptographic software written by Eric Young (eay@cryptsoft.com).

This product includes software written by Tim Hudson (tjh@cryptsoft.com).

## License Issues

The OpenSSL toolkit stays under a dual license, i.e. both the conditions of the OpenSSL License and the original SSLeay license apply to the toolkit. See below for the actual license texts. Actually both licenses are BSD-style Open Source licenses. In case of any license issues related to OpenSSL please contact [openssl-core@openssl.org](mailto:openssl-core@openssl.org).

### OpenSSL License:

Copyright © 1998-2007 The OpenSSL Project. All rights reserved.

Redistribution and use in source and binary forms, with or without modification, are permitted provided that the following conditions are met:

1. Redistributions of source code must retain the copyright notice, this list of conditions and the following disclaimer.
2. Redistributions in binary form must reproduce the above copyright notice, this list of conditions, and the following disclaimer in the documentation and/or other materials provided with the distribution.
3. All advertising materials mentioning features or use of this software must display the following acknowledgment: “This product includes software developed by the OpenSSL Project for use in the OpenSSL Toolkit (<http://www.openssl.org/>)”.
4. The names “OpenSSL Toolkit” and “OpenSSL Project” must not be used to endorse or promote products derived from this software without prior written permission. For written permission, please contact [openssl-core@openssl.org](mailto:openssl-core@openssl.org).
5. Products derived from this software may not be called “OpenSSL” nor may “OpenSSL” appear in their names without prior written permission of the OpenSSL Project.
6. Redistributions of any form whatsoever must retain the following acknowledgment:  
“This product includes software developed by the OpenSSL Project for use in the OpenSSL Toolkit (<http://www.openssl.org/>)”.

THIS SOFTWARE IS PROVIDED BY THE OpenSSL PROJECT “AS IS” AND ANY EXPRESSED OR IMPLIED WARRANTIES, INCLUDING, BUT NOT LIMITED TO, THE IMPLIED WARRANTIES OF MERCHANTABILITY AND FITNESS FOR A PARTICULAR PURPOSE ARE DISCLAIMED. IN NO EVENT SHALL THE OpenSSL PROJECT OR ITS CONTRIBUTORS BE LIABLE FOR ANY DIRECT, INDIRECT, INCIDENTAL, SPECIAL, EXEMPLARY, OR CONSEQUENTIAL DAMAGES (INCLUDING, BUT NOT LIMITED TO, PROCUREMENT OF SUBSTITUTE GOODS OR SERVICES; LOSS OF USE, DATA, OR PROFITS; OR BUSINESS INTERRUPTION) HOWEVER CAUSED AND ON ANY THEORY OF LIABILITY, WHETHER IN CONTRACT, STRICT

LIABILITY, OR TORT (INCLUDING NEGLIGENCE OR OTHERWISE) ARISING IN ANY WAY OUT OF THE USE OF THIS SOFTWARE, EVEN IF ADVISED OF THE POSSIBILITY OF SUCH DAMAGE.

This product includes cryptographic software written by Eric Young (eay@cryptsoft.com). This product includes software written by Tim Hudson (tjh@cryptsoft.com).

**Original SSLeay License:**

Copyright © 1995-1998 Eric Young (eay@cryptsoft.com). All rights reserved.

This package is an SSL implementation written by Eric Young (eay@cryptsoft.com).

The implementation was written so as to conform with Netscapes SSL.

This library is free for commercial and non-commercial use as long as the following conditions are adhered to. The following conditions apply to all code found in this distribution, be it the RC4, RSA, lhash, DES, etc., code; not just the SSL code. The SSL documentation included with this distribution is covered by the same copyright terms except that the holder is Tim Hudson (tjh@cryptsoft.com).

Copyright remains Eric Young's, and as such any Copyright notices in the code are not to be removed. If this package is used in a product, Eric Young should be given attribution as the author of the parts of the library used. This can be in the form of a textual message at program startup or in documentation (online or textual) provided with the package.

Redistribution and use in source and binary forms, with or without modification, are permitted provided that the following conditions are met:

1. Redistributions of source code must retain the copyright notice, this list of conditions and the following disclaimer.
2. Redistributions in binary form must reproduce the above copyright notice, this list of conditions and the following disclaimer in the documentation and/or other materials provided with the distribution.
3. All advertising materials mentioning features or use of this software must display the following acknowledgement:

“This product includes cryptographic software written by Eric Young (eay@cryptsoft.com)”.

The word ‘cryptographic’ can be left out if the routines from the library being used are not cryptography-related.

4. If you include any Windows specific code (or a derivative thereof) from the apps directory (application code) you must include an acknowledgement: “This product includes software written by Tim Hudson (tjh@cryptsoft.com)”.

THIS SOFTWARE IS PROVIDED BY ERIC YOUNG “AS IS” AND ANY EXPRESS OR IMPLIED WARRANTIES, INCLUDING, BUT NOT LIMITED TO, THE IMPLIED WARRANTIES OF MERCHANTABILITY AND FITNESS FOR A PARTICULAR PURPOSE ARE DISCLAIMED. IN NO EVENT SHALL THE AUTHOR OR CONTRIBUTORS BE LIABLE FOR ANY DIRECT, INDIRECT, INCIDENTAL, SPECIAL, EXEMPLARY, OR CONSEQUENTIAL DAMAGES (INCLUDING, BUT NOT LIMITED TO, PROCUREMENT OF SUBSTITUTE GOODS OR SERVICES; LOSS OF USE, DATA, OR PROFITS; OR BUSINESS INTERRUPTION) HOWEVER CAUSED AND ON ANY THEORY OF LIABILITY, WHETHER IN CONTRACT, STRICT LIABILITY, OR TORT (INCLUDING NEGLIGENCE OR OTHERWISE) ARISING IN ANY WAY OUT OF THE USE OF THIS SOFTWARE, EVEN IF ADVISED OF THE POSSIBILITY OF SUCH DAMAGE.

The license and distribution terms for any publicly available version or derivative of this code cannot be changed. i.e. this code cannot simply be copied and put under another distribution license [including the GNU Public License].

# Apache and Tomcat

The Apache Software License, Version 1.1

Copyright (c) 2000 The Apache Software Foundation. All rights reserved.

Redistribution and use in source and binary forms, with or without modification, are permitted provided that the following conditions are met:

1. Redistributions of source code must retain the above copyright notice, this list of conditions and the following disclaimer.
2. Redistributions in binary form must reproduce the above copyright notice, this list of conditions and the following disclaimer in the documentation and/or other materials provided with the distribution.
3. The end-user documentation included with the redistribution, if any, must include the following acknowledgment: “This product includes software developed by the Apache Software Foundation (<http://www.apache.org/>).” Alternately, this acknowledgment may appear in the software itself, if and wherever such third-party acknowledgments normally appear.
4. The names “Apache” and “Apache Software Foundation” must not be used to endorse or promote products derived from this software without prior written permission. For written permission, please contact [apache@apache.org](mailto:apache@apache.org).
5. Products derived from this software may not be called “Apache”, nor may “Apache” appear in their name, without prior written permission of the Apache Software Foundation.

THIS SOFTWARE IS PROVIDED “AS IS” AND ANY EXPRESSED OR IMPLIED WARRANTIES, INCLUDING, BUT NOT LIMITED TO, THE IMPLIED WARRANTIES OF MERCHANTABILITY AND FITNESS FOR A PARTICULAR PURPOSE ARE DISCLAIMED. IN NO EVENT SHALL THE APACHE SOFTWARE FOUNDATION OR ITS CONTRIBUTORS BE LIABLE FOR ANY DIRECT, INDIRECT, INCIDENTAL, SPECIAL, EXEMPLARY, OR CONSEQUENTIAL DAMAGES (INCLUDING, BUT NOT LIMITED TO, PROCUREMENT OF SUBSTITUTE GOODS OR SERVICES; LOSS OF USE, DATA, OR PROFITS; OR BUSINESS INTERRUPTION) HOWEVER CAUSED AND ON ANY THEORY OF LIABILITY, WHETHER IN CONTRACT, STRICT LIABILITY, OR TORT (INCLUDING NEGLIGENCE OR OTHERWISE) ARISING IN ANY WAY OUT OF THE USE OF THIS SOFTWARE, EVEN IF ADVISED OF THE POSSIBILITY OF SUCH DAMAGE.

This software consists of voluntary contributions made by many individuals on behalf of the Apache Software Foundation. For more information on the Apache Software Foundation, please see <http://www.apache.org/>. Portions of this software are based upon public domain software originally written at the National Center for Supercomputing Applications, University of Illinois, Urbana-Champaign.

## ssldump

Copyright (C) 1999-2000 RTFM, Inc. All Rights Reserved

This package is a SSLv3/TLS protocol analyzer written by Eric Rescorla <[ekr@rtfm.com](mailto:ekr@rtfm.com)> and licensed by RTFM, Inc.

Redistribution and use in source and binary forms, with or without modification, are permitted provided that the following conditions are met:

1. Redistributions of source code must retain the above copyright notice, this list of conditions and the following disclaimer.

2. Redistributions in binary form must reproduce the above copyright notice, this list of conditions and the following disclaimer in the documentation and/or other materials provided with the distribution.
3. All advertising materials mentioning features or use of this software must display the following acknowledgement: This product includes software developed by Eric Rescorla for RTFM, Inc.
4. Neither the name of RTFM, Inc. nor the name of Eric Rescorla may be used to endorse or promote products derived from this software without specific prior written permission.

THIS SOFTWARE IS PROVIDED BY ERIC RESCORLA AND RTFM, INC. "AS IS" AND ANY EXPRESS OR IMPLIED WARRANTIES, INCLUDING, BUT NOT LIMITED TO, THE IMPLIED WARRANTIES OF MERCHANTABILITY AND FITNESS FOR A PARTICULAR PURPOSE ARE DISCLAIMED. IN NO EVENT SHALL THE REGENTS OR CONTRIBUTORS BE LIABLE FOR ANY DIRECT, INDIRECT, INCIDENTAL, SPECIAL, EXEMPLARY, OR CONSEQUENTIAL DAMAGES (INCLUDING, BUT NOT LIMITED TO, PROCUREMENT OF SUBSTITUTE GOODS OR SERVICES; LOSS OF USE, DATA, OR PROFITS; OR BUSINESS INTERRUPTION) HOWEVER CAUSED AND ON ANY THEORY OF LIABILITY, WHETHER IN CONTRACT, STRICT LIABILITY, OR TORT (INCLUDING NEGLIGENCE OR OTHERWISE) ARISING IN ANY WAY OUT OF THE USE OF THIS SOFTWARE, EVEN IF ADVISED OF THE POSSIBILITY SUCH DAMAGE.

## Mozilla Public License

The contents of this file are subject to the Mozilla Public License Version 1.1 (the "License"); you may not use this file except in compliance with the License. You may obtain a copy of the License at <http://www.mozilla.org/MPL/>

Software distributed under the License is distributed on an "AS IS" basis, WITHOUT WARRANTY OF ANY KIND, either express or implied. See the License for the specific language governing rights and limitations under the License.

The Original Code is RHINO v 1.5.3.

## GNU General Public License

GNU GENERAL PUBLIC LICENSE

Version 2, June 1991

Copyright (C) 1989, 1991 Free Software Foundation, Inc.

59 Temple Place, Suite 330, Boston, MA 02111-1307 USA

Everyone is permitted to copy and distribute verbatim copies of this license document, but changing it is not allowed.

### Preamble

The licenses for most software are designed to take away your freedom to share and change it. By contrast, the GNU General Public License is intended to guarantee your freedom to share and change free software--to make sure the software is free for all its users. This General Public License applies to most of the Free Software Foundation's software and to any other program whose authors commit to using it. (Some other Free Software Foundation software is covered by the GNU Library General Public License instead.) You can apply it to your programs, too.

When we speak of free software, we are referring to freedom, not price. Our General Public Licenses are designed to make sure that you have the freedom to distribute copies of free software (and charge for this service if you wish), that you receive source code or can get it if you want it, that you can change the software or use pieces of it in new free programs; and that you know you can do these things.

To protect your rights, we need to make restrictions that forbid anyone to deny you these rights or to ask you to surrender the rights. These restrictions translate to certain responsibilities for you if you distribute copies of the software, or if you modify it.

For example, if you distribute copies of such a program, whether gratis or for a fee, you must give the recipients all the rights that you have. You must make sure that they, too, receive or can get the source code. And you must show them these terms so they know their rights.

We protect your rights with two steps: (1) copyright the software, and (2) offer you this license which gives you legal permission to copy, distribute and/or modify the software.

Also, for each author's protection and ours, we want to make certain that everyone understands that there is no warranty for this free software. If the software is modified by someone else and passed on, we want its recipients to know that what they have is not the original, so that any problems introduced by others will not reflect on the original authors' reputations.

Finally, any free program is threatened constantly by software patents. We wish to avoid the danger that redistributors of a free program will individually obtain patent licenses, in effect making the program proprietary. To prevent this, we have made it clear that any patent must be licensed for everyone's free use or not licensed at all. The precise terms and conditions for copying, distribution and modification follow.

## GNU Lesser General Public License

Version 2.1, February 1999

Copyright (C) 1991, 1999 Free Software Foundation, Inc. 59 Temple Place, Suite 330, Boston, MA 02111-1307 USA

Everyone is permitted to copy and distribute verbatim copies of this license document, but changing it is not allowed.

[This is the first released version of the Lesser GPL. It also counts as the successor of the GNU Library Public License, version 2, hence the version number 2.1.]

Preamble

The licenses for most software are designed to take away your freedom to share and change it. By contrast, the GNU General Public Licenses are intended to guarantee your freedom to share and change free software--to make sure the software is free for all its users.

This license, the Lesser General Public License, applies to some specially designated software packages--typically libraries--of the Free Software Foundation and other authors who decide to use it. You can use it too, but we suggest you first think carefully about whether this license or the ordinary General Public License is the better strategy to use in any particular case, based on the explanations below.

When we speak of free software, we are referring to freedom of use, not price. Our General Public Licenses are designed to make sure that you have the freedom to distribute copies of free software (and charge for this service if you wish); that you receive source code or can get it if you want it; that you can change the software and use pieces of it in new free programs; and that you are informed that you can do these things.

To protect your rights, we need to make restrictions that forbid distributors to deny you these rights or to ask you to surrender these rights. These restrictions translate to certain responsibilities for you if you distribute copies of the library or if you modify it.

For example, if you distribute copies of the library, whether gratis or for a fee, you must give the recipients all the rights that we gave you. You must make sure that they, too, receive or can get the source code. If you link other code with the library, you must provide complete object files to the recipients, so that they can relink them with the library after making changes to the library and recompiling it. And you must show them these terms so they know their rights.

We protect your rights with a two-step method: (1) we copyright the library, and (2) we offer you this license, which gives you legal permission to copy, distribute and/or modify the library.

To protect each distributor, we want to make it very clear that there is no warranty for the free library. Also, if the library is modified by someone else and passed on, the recipients should know that what they have is not the original version, so that the original author's reputation will not be affected by problems that might be introduced by others.

Finally, software patents pose a constant threat to the existence of any free program. We wish to make sure that a company cannot effectively restrict the users of a free program by obtaining a restrictive license from a patent holder. Therefore, we insist that any patent license obtained for a version of the library must be consistent with the full freedom of use specified in this license.

Most GNU software, including some libraries, is covered by the ordinary GNU General Public License. This license, the GNU Lesser General Public License, applies to certain designated libraries, and is quite different from the ordinary General Public License. We use this license for certain libraries in order to permit linking those libraries into non-free programs.

When a program is linked with a library, whether statically or using a shared library, the combination of the two is legally speaking a combined work, a derivative of the original library. The ordinary General Public License therefore permits such linking only if the entire combination fits its criteria of freedom. The Lesser General Public License permits more lax criteria for linking other code with the library.

We call this license the “Lesser” General Public License because it does Less to protect the user's freedom than the ordinary General Public License. It also provides other free software developers Less of an advantage over competing non-free programs. These disadvantages are the reason we use the ordinary General Public License for many libraries. However, the Lesser license provides advantages in certain special circumstances.

For example, on rare occasions, there may be a special need to encourage the widest possible use of a certain library, so that it becomes a de-facto standard. To achieve this, non-free programs must be allowed to use the library. A more frequent case is that a free library does the same job as widely used non-free libraries. In this case, there is little to gain by limiting the free library to free software only, so we use the Lesser General Public License.

In other cases, permission to use a particular library in non-free programs enables a greater number of people to use a large body of free software. For example, permission to use the GNU C Library in non-free programs enables many more people to use the whole GNU operating system, as well as its variant, the GNU/Linux operating system.

Although the Lesser General Public License is Less protective of the users' freedom, it does ensure that the user of a program that is linked with the Library has the freedom and the wherewithal to run that program using a modified version of the Library.

The precise terms and conditions for copying, distribution and modification follow. Pay close attention to the difference between a “work based on the library” and a “work that uses the library”. The former contains code derived from the library, whereas the latter must be combined with the library in order to run.

## GNU LESSER GENERAL PUBLIC LICENSE TERMS AND CONDITIONS FOR COPYING, DISTRIBUTION AND MODIFICATION

0. This License Agreement applies to any software library or other program which contains a notice placed by the copyright holder or other authorized party saying it may be distributed under the terms of this Lesser General Public License (also called “this License”).

Each licensee is addressed as “you”.

A “library” means a collection of software functions and/or data prepared so as to be conveniently linked with application programs (which use some of those functions and data) to form executables.

The “Library”, below, refers to any such software library or work which has been distributed under these terms. A “work based on the Library” means either the Library or any derivative work under copyright law: that is to say, a work containing the Library or a portion of it, either verbatim or with modifications and/or translated straightforwardly into another language. (Hereinafter, translation is included without limitation in the term “modification”).

“Source code” for a work means the preferred form of the work for making modifications to it. For a library, complete source code means all the source code for all modules it contains, plus any associated interface definition files, plus the scripts used to control compilation and installation of the library.

Activities other than copying, distribution and modification are not covered by this License; they are outside its scope. The act of running a program using the Library is not restricted, and output from such a program is covered only if its contents constitute a work based on the Library (independent of the use of the Library in a tool for writing it). Whether that is true depends on what the Library does and what the program that uses the Library does.

1. You may copy and distribute verbatim copies of the Library's complete source code as you receive it, in any medium, provided that you conspicuously and appropriately publish on each copy an appropriate copyright notice and disclaimer of warranty; keep intact all the notices that refer to this License and to the absence of any warranty; and distribute a copy of this License along with the Library.

You may charge a fee for the physical act of transferring a copy, and you may at your option offer warranty protection in exchange for a fee.

2. You may modify your copy or copies of the Library or any portion of it, thus forming a work based on the Library, and copy and distribute such modifications or work under the terms of Section 1 above, provided that you also meet all of these conditions:

- a) The modified work must itself be a software library.
- b) You must cause the files modified to carry prominent notices stating that you changed the files and the date of any change.
- c) You must cause the whole of the work to be licensed at no charge to all third parties under the terms of this License.
- d) If a facility in the modified Library refers to a function or a table of data to be supplied by an application program that uses the facility, other than as an argument passed when the facility is invoked, then you must make a good faith effort to ensure that, in the event an application does not supply such function or table, the facility still operates, and performs whatever part of its purpose remains meaningful.

(For example, a function in a library to compute square roots has a purpose that is entirely well-defined independent of the application. Therefore, Subsection 2d requires that any application-supplied function or table used by this function must be optional: if the application does not supply it, the square root function must still compute square roots.)

These requirements apply to the modified work as a whole. If identifiable sections of that work are not derived from the Library, and can be reasonably considered independent and separate works in themselves, then this License, and its terms, do not apply to those sections when you distribute them as



separate works. But when you distribute the same sections as part of a whole which is a work based on the Library, the distribution of the whole must be on the terms of this License, whose permissions for other licensees extend to the entire whole, and thus to each and every part regardless of who wrote it.

Thus, it is not the intent of this section to claim rights or contest your rights to work written entirely by you; rather, the intent is to exercise the right to control the distribution of derivative or collective works based on the Library.

In addition, mere aggregation of another work not based on the Library with the Library (or with a work based on the Library) on a volume of a storage or distribution medium does not bring the other work under the scope of this License.

3. You may opt to apply the terms of the ordinary GNU General Public License instead of this License to a given copy of the Library. To do this, you must alter all the notices that refer to this License, so that they refer to the ordinary GNU General Public License, version 2, instead of to this License. (If a newer version than version 2 of the ordinary GNU General Public License has appeared, then you can specify that version instead if you wish.) Do not make any other change in these notices.

Once this change is made in a given copy, it is irreversible for that copy, so the ordinary GNU General Public License applies to all subsequent copies and derivative works made from that copy.

This option is useful when you wish to copy part of the code of the Library into a program that is not a library.

4. You may copy and distribute the Library (or a portion or derivative of it, under Section 2) in object code or executable form under the terms of Sections 1 and 2 above provided that you accompany it with the complete corresponding machine-readable source code, which must be distributed under the terms of Sections 1 and 2 above on a medium customarily used for software interchange.

If distribution of object code is made by offering access to copy from a designated place, then offering equivalent access to copy the source code from the same place satisfies the requirement to distribute the source code, even though third parties are not compelled to copy the source along with the object code.

5. A program that contains no derivative of any portion of the Library, but is designed to work with the Library by being compiled or linked with it, is called a “work that uses the Library”. Such a work, in isolation, is not a derivative work of the Library, and therefore falls outside the scope of this License.

However, linking a “work that uses the Library” with the Library creates an executable that is a derivative of the Library (because it contains portions of the Library), rather than a “work that uses the library”. The executable is therefore covered by this License. Section 6 states terms for distribution of such executables.

When a “work that uses the Library” uses material from a header file that is part of the Library, the object code for the work may be a derivative work of the Library even though the source code is not. Whether this is true is especially significant if the work can be linked without the Library, or if the work is itself a library. The threshold for this to be true is not precisely defined by law.

If such an object file uses only numerical parameters, data structure layouts and accessors, and small macros and small inline functions (ten lines or less in length), then the use of the object file is unrestricted, regardless of whether it is legally a derivative work. (Executables containing this object code plus portions of the Library will still fall under Section 6.)

Otherwise, if the work is a derivative of the Library, you may distribute the object code for the work under the terms of Section 6. Any executables containing that work also fall under Section 6, whether or not they are linked directly with the Library itself.

6. As an exception to the Sections above, you may also combine or link a “work that uses the Library” with the Library to produce a work containing portions of the Library, and distribute that work under terms of your choice, provided that the terms permit modification of the work for the customer's own use and reverse engineering for debugging such modifications.

You must give prominent notice with each copy of the work that the Library is used in it and that the Library and its use are covered by this License. You must supply a copy of this License. If the work during execution displays copyright notices, you must include the copyright notice for the Library among them, as well as a reference directing the user to the copy of this License. Also, you must do one of these things:

- a) Accompany the work with the complete corresponding machine-readable source code for the Library including whatever changes were used in the work (which must be distributed under Sections 1 and 2 above); and, if the work is an executable linked with the Library, with the complete machine-readable “work that uses the Library”, as object code and/or source code, so that the user can modify the Library and then relink to produce a modified executable containing the modified Library. (It is understood that the user who changes the contents of definitions files in the Library will not necessarily be able to recompile the application to use the modified definitions.)
- b) Use a suitable shared library mechanism for linking with the Library. A suitable mechanism is one that (1) uses at run time a copy of the library already present on the user's computer system, rather than copying library functions into the executable, and (2) will operate properly with a modified version of the library, if the user installs one, as long as the modified version is interface-compatible with the version that the work was made with.
- c) Accompany the work with a written offer, valid for at least three years, to give the same user the materials specified in Subsection 6a, above, for a charge no more than the cost of performing this distribution. d) If distribution of the work is made by offering access to copy from a designated place, offer equivalent access to copy the above specified materials from the same place.
- e) Verify that the user has already received a copy of these materials or that you have already sent this user a copy.

For an executable, the required form of the “work that uses the Library” must include any data and utility programs needed for reproducing the executable from it. However, as a special exception, the materials to be distributed need not include anything that is normally distributed (in either source or binary form) with the major components (compiler, kernel, and so on) of the operating system on which the executable runs, unless that component itself accompanies the executable.

It may happen that this requirement contradicts the license restrictions of other proprietary libraries that do not normally accompany the operating system. Such a contradiction means you cannot use both them and the Library together in an executable that you distribute.

7. You may place library facilities that are a work based on the Library side-by-side in a single library together with other library facilities not covered by this License, and distribute such a combined library, provided that the separate distribution of the work based on the Library and of the other library facilities is otherwise permitted, and provided that you do these two things:

- a) Accompany the combined library with a copy of the same work based on the Library, uncombined with any other library facilities. This must be distributed under the terms of the Sections above.
- b) Give prominent notice with the combined library of the fact that part of it is a work based on the Library, and explaining where to find the accompanying uncombined form of the same work.

8. You may not copy, modify, sublicense, link with, or distribute the Library except as expressly provided under this License. Any attempt otherwise to copy, modify, sublicense, link with, or distribute the Library is void, and will automatically terminate your rights under this License. However, parties who have received copies, or rights, from you under this License will not have their licenses terminated so long as such parties remain in full compliance.

9. You are not required to accept this License, since you have not signed it. However, nothing else grants you permission to modify or distribute the Library or its derivative works. These actions are prohibited by law if you do not accept this License. Therefore, by modifying or distributing the Library (or any work based on the Library), you indicate your acceptance of this License to do so, and all its terms and conditions for copying, distributing or modifying the Library or works based on it.

10. Each time you redistribute the Library (or any work based on the Library), the recipient automatically receives a license from the original licensor to copy, distribute, link with or modify the Library subject to these terms and conditions. You may not impose any further restrictions on the recipients' exercise of the rights granted herein. You are not responsible for enforcing compliance by third parties with this License.

11. If, as a consequence of a court judgment or allegation of patent infringement or for any other reason (not limited to patent issues), conditions are imposed on you (whether by court order, agreement or otherwise) that contradict the conditions of this License, they do not excuse you from the conditions of this License. If you cannot distribute so as to satisfy simultaneously your obligations under this License and any other pertinent obligations, then as a consequence you may not distribute the Library at all. For example, if a patent license would not permit royalty-free redistribution of the Library by all those who receive copies directly or indirectly through you, then the only way you could satisfy both it and this License would be to refrain entirely from distribution of the Library.

If any portion of this section is held invalid or unenforceable under any particular circumstance, the balance of the section is intended to apply, and the section as a whole is intended to apply in other circumstances.

It is not the purpose of this section to induce you to infringe any patents or other property right claims or to contest validity of any such claims; this section has the sole purpose of protecting the integrity of the free software distribution system which is implemented by public license practices. Many people have made generous contributions to the wide range of software distributed through that system in reliance on consistent application of that system; it is up to the author/donor to decide if he or she is willing to distribute software through any other system and a licensee cannot impose that choice.

This section is intended to make thoroughly clear what is believed to be a consequence of the rest of this License.

12. If the distribution and/or use of the Library is restricted in certain countries either by patents or by copyrighted interfaces, the original copyright holder who places the Library under this License may add an explicit geographical distribution limitation excluding those countries, so that distribution is permitted only in or among countries not thus excluded. In such case, this License incorporates the limitation as if written in the body of this License.

13. The Free Software Foundation may publish revised and/or new versions of the Lesser General Public License from time to time. Such new versions will be similar in spirit to the present version, but may differ in detail to address new problems or concerns.

Each version is given a distinguishing version number. If the Library specifies a version number of this License which applies to it and “any later version”, you have the option of following the terms and conditions either of that version or of any later version published by the Free Software Foundation. If the Library does not specify a license version number, you may choose any version ever published by the Free Software Foundation.

14. If you wish to incorporate parts of the Library into other free programs whose distribution conditions are incompatible with these, write to the author to ask for permission. For software which is copyrighted by the Free Software Foundation, write to the Free Software Foundation; we sometimes make exceptions for this. Our decision will be guided by the two goals of preserving the free status of all derivatives of our free software and of promoting the sharing and reuse of software generally.

NO WARRANTY

15. BECAUSE THE LIBRARY IS LICENSED FREE OF CHARGE, THERE IS NO WARRANTY FOR THE LIBRARY, TO THE EXTENT PERMITTED BY APPLICABLE LAW. EXCEPT WHEN OTHERWISE STATED IN WRITING THE COPYRIGHT HOLDERS AND/OR OTHER PARTIES PROVIDE THE LIBRARY "AS IS" WITHOUT WARRANTY OF ANY KIND, EITHER EXPRESSED OR IMPLIED, INCLUDING, BUT NOT LIMITED TO, THE IMPLIED WARRANTIES OF MERCHANTABILITY AND FITNESS FOR A PARTICULAR PURPOSE. THE ENTIRE RISK AS TO THE QUALITY AND PERFORMANCE OF THE LIBRARY IS WITH YOU. SHOULD THE LIBRARY PROVE DEFECTIVE, YOU ASSUME THE COST OF ALL NECESSARY SERVICING, REPAIR OR CORRECTION.

16. IN NO EVENT UNLESS REQUIRED BY APPLICABLE LAW OR AGREED TO IN WRITING WILL ANY COPYRIGHT HOLDER, OR ANY OTHER PARTY WHO MAY MODIFY AND/OR REDISTRIBUTE THE LIBRARY AS PERMITTED ABOVE, BE LIABLE TO YOU FOR DAMAGES, INCLUDING ANY GENERAL, SPECIAL, INCIDENTAL OR CONSEQUENTIAL DAMAGES ARISING OUT OF THE USE OR INABILITY TO USE THE LIBRARY (INCLUDING BUT NOT LIMITED TO LOSS OF DATA OR DATA BEING RENDERED INACCURATE OR LOSSES SUSTAINED BY YOU OR THIRD PARTIES OR A FAILURE OF THE LIBRARY TO OPERATE WITH ANY OTHER SOFTWARE), EVEN IF SUCH HOLDER OR OTHER PARTY HAS BEEN ADVISED OF THE POSSIBILITY OF SUCH DAMAGES.

END OF TERMS AND CONDITIONS



---

## Symbols

#define 13  
#else 12  
#elseif 12  
#endif 12  
#if 12  
#include 13

---

## Numerics

12.0 -> 12.2 1  
12.0 -> 12.3(3) or later 3  
12.2 -> 12.3(3) or later 3  
12.3(3) or later -> 12.0 5  
12.3(3) or later -> 12.2 4  
12.3(3) or later -> 12.3(3) or later 4

---

## A

Active Perl license agreement 2  
Active TCL license agreement 1  
adding  
    events 2  
    image 2  
    template 14  
    user account 1  
adding a device 3  
adding agent enabled devices 12  
adding an account 1  
adding devices 3  
adding non-agent device 4  
adding non-agent enabled device 4

adding pix firewall devices 16  
adding subdevices 37  
administrator, levels of access 3  
administrator-level operations 4  
advanced search 3  
advanced search feature 3  
agent enabled devices  
    adding 12  
Apache  
    license 8  
associating images with devices 7  
audience for this document 11  
automatic data entry 3

---

## B

backup and restore 1  
    not working properly 4  
backup procedure 1  
banner 40  
batch size 34  
Berkeley DB Software license agreement 4  
Bootstrap Password 13  
bootstrap password  
    changing 1  
bulk data manager 1

---

## C

canceling  
    jobs 2  
cannot connect to system  
    using a web browser 3

- using Telnet 4
  - with SSH or SSH interaction is slow 4
  - cannot log in 1
  - cautions
    - significance of 11
  - changing
    - account privilege level 6
    - bootstrap password 1
    - log level 5
    - user password 5
  - chema
    - editing 1
  - Cisco IOS Dependencies 3
  - clearing
    - log files 3
  - cloning
    - devices 28
    - subdevices 41
  - cloning groups 3
  - cns-listen 6
  - cns-send 5
  - command execution 7
  - command-line upload of bulk data 4
  - commands
    - cns config init 14
    - cns config partial 14
    - cns-listen 5
    - cns-send 5
    - datastore 3
    - date 5
    - ifconfig 2
    - logrotate 17
    - showversion 5
  - Common Log File Location 17
  - config event 3
  - ConfigID 17
    - change synchronization 17
  - configuration agent 5
  - configuration and restrictions 5, 8
    - configuration control template 8, 36, 3
    - configuration control templates 3
    - configuration processing 2
    - configuration server 5
    - Configuration Service 5
    - configuration templates 5
    - contact information
      - editing 26
      - editing subdevice 41
    - contacting Cisco TAC 1
    - control structures 12
    - conventions, typographical 11
    - creating
      - groups using search 4
      - queries 2
      - sample data 4
      - search parameters 10
      - template 1
    - cron daemon
      - how to restart 4
    - currently supported device types 9
    - customize job template 35
- 
- D**
- data backup
    - scheduling 1
  - data converter utility 4
  - data manager 1
  - data restore 3
  - data restore procedure 3
  - Data Structures 7
    - date 5
  - delete files on device 46
  - deleting
    - completed jobs 3
    - devices 30
    - events 5
    - groups 4

- image 7
  - queries 4
  - search parameters 11
  - subdevices 43
  - template 16
  - user account 5
  - deleting devices 30
  - deleting groups 4
  - deleting user accounts 5
  - development guidelines 6
  - Device Authentication 13
  - device authentication 13
  - device batch size 34
  - device configuration
    - updating 30
    - viewing 1
  - device configuration update 6
  - device hop information 8
  - device inventory
    - query 44
  - device module restrictions 8
  - devices
    - adding 3
    - deleting 30
    - discovering 18
    - editing 20
    - editing parameters 26
  - Directory Manager 1
  - directory modes 4
  - directory services 5
  - discovering devices 18
  - disk space
    - managing 4
  - Distribution Decision Keys 8
  - DNS server 4
  - documentation
    - audience for this 11
    - conventions used in 11
    - related 12
  - Dynamic ConfigID and EventID Change Synchronization 17
  - dynamic flow control template 3
  - Dynamic Log level Update 18
  - dynamic operations 48
  - Dynamic Template and Object 7
  - dynamic templates 11
- 
- ## E
- 
- editing
    - contact information 41
    - device contact information 26
    - device parameters 26
    - devices 20
    - device templates 25
    - email SMTP Host 1
    - events 4
    - fetch process 2
    - groups 3
    - image 5
    - image association information 27
    - IMGW device and hop types 3
    - non-agent enabled device 22
    - non-agent enabled device information 22
    - parameters 15
    - pix device information 24
    - queries 3
    - save process 3
    - schema 1
    - search parameters 11
    - service properties 1
    - subdevice
      - information 40
      - parameters 41
      - template 40
    - subdevice contact information 41
    - subdevices 39
    - template 15

- templates 15
- user account 3
- editing agent enabled device information 23
- email manager 1
- Encryption 13
- encryption 13
- end user interface 8
- error processing 3
- Event Gateway 6
- EventID 17
- EventIDs and ConfigIDs 17
- event mapping 6
- events
  - adding 2
  - deleting 5
  - editing 4
  - viewing 1
- Event Service 5
- event subject names
  - new 6
- exec event 3
- exit codes 5
- exporting
  - log files 4
- eXtensible Markup Language 5
- External Directory Mode 5
- external directory mode 5

## F

---

- fastethernet template 10
- feature operations 4
- fetch process
  - editing 2
- FTP server 3

## G

---

- gateway id 6

- GNU general public license 9
- groups 1
  - cloning 3
  - creating 2
  - creating using search 4
  - deleting 4
  - editing 3
  - moving 4
  - viewing 1
- gui 1
  - administrator-level operations 4
  - levels of access 3
    - administrator 3
    - operator 3
  - logging in 1
  - logging out 3
  - operator-level operations 4

## H

---

- help
  - technical support
    - (see also troubleshooting)
- hopinfo examples 11
- hop tables 8
- hop test 3
- hostname 14
- How the Cisco Configuration Engine Works 14
- how the Configuration Engine works 14

## I

---

- ifconfig 2
- image activation 8,3
  - template 36
- imageInventoryResponse Message 7
- image processing 2
- image sample data 8
- Image Service 7



- image service [1](#)
  - associating images with devices [7](#)
  - data entry
    - automatic [3](#)
    - manual [3](#)
  - deleting
    - image [7](#)
  - downgrade [1](#)
  - editing
    - image [5](#)
  - upgrade [1](#)
  - viewing
    - image [1](#)
  - working with images [1](#)
- Image Update Criteria [8](#)
- IMGW
  - currently supported device types [9](#)
  - hopinfo examples [11](#)
  - restrictions [11](#)
- imgw
  - hop tables [8](#)
- IMGW device and hop types
  - editing [3](#)
- IMGW device module development toolkit [1](#)
  - plug-in device module
    - how to develop [6](#)
    - installing [7](#)
    - registering [8](#)
  - usage [1](#)
  - user designed device module specifications [3](#)
  - user types [1](#)
- IMGW Device Module Toolkit [12](#)
- IMGW southbound interface [2](#)
- import
  - script file [3](#)
- importing
  - schema [2](#)
  - template [17](#)
- initial configuration [15](#)

- installing plug-in device module [7](#)
- Intelligent Modular Gateway [11](#)
  - See also IMGW
- Internal Directory Mode [5](#)
- internal directory mode [1](#)
- inventory operations [3](#)

---

## J

- jobs
  - canceling [2](#)
  - deleting completed [3](#)
  - querying [1](#)
  - restarting [2](#)
  - stopping [2](#)

---

## L

- LDAP [5](#)
- levels of access [3](#)
- license agreements
  - Active Perl [2](#)
  - Active TCL [1](#)
  - Apache [8](#)
  - Berkeley DB Software [4](#)
  - GNU General Public License [9](#)
  - Mozilla Public License [9](#)
  - OpenLDAP [3](#)
  - ssldump [8](#)
  - Tomcat [8](#)
- lightweight directory access protocol [5](#)
- Load Initial Configuration [15](#)
- Load Partial Configuration [16](#)
- load-sharing [15,5](#)
- log files
  - clearing [3](#)
  - exporting [4](#)
  - viewing [1](#)
- logging in [1](#)

logging out [3](#)  
 log level  
   changing [5](#)  
 log manager [1](#)

## M

main device template [9](#)  
 managing  
   disk space [4](#)  
 managing templates [13](#)  
 manual data entry [3](#)  
 Modes of Operation [4](#)  
 modes of operation [2](#)  
 Modular Router [15,16](#)  
 modular router [12](#)  
   events [11](#)  
   sample templates [9](#)  
   templates [7](#)  
 modular router events [11](#)  
 modular router support [12](#)  
 moving  
   groups [4](#)  
 Mozilla public license [9](#)  
 multi-line tag delimiters [40](#)

## N

namespace [6](#)  
 namespace manager [1](#)  
 NameSpace Mapper [6](#)  
 no crontab set for backup job when /var is 100% full. [5](#)  
 non-agent enabled device  
   adding [4](#)  
   editing [22](#)  
 notes, significance of [11](#)  
 NSM  
   data sample [5](#)  
   with image information [7](#)

NSM modes [3](#)

## O

OpenLDAP [5](#)  
 OpenLDAP public license [3](#)  
 operator, levels of access [3](#)  
 operator-level operations [4](#)  
 overview [1](#)

## P

parameter  
   manager [1](#)  
   validations [1](#)  
 parameter descriptions [3](#)  
 partial configuration [16](#)  
 password  
   changing [5](#)  
 PIX firewall devices  
   configuration and restrictions [5](#)  
   configuration processing [2](#)  
   devicedetails [2](#)  
   devicedetails, request [3](#)  
   deviceID [4](#)  
   error processing [3](#)  
   image processing [2](#)  
   polling for updates [2](#)  
   polling setup [4](#)  
   processing devicedetails request [3](#)  
   security [4](#)  
   security considerations [4](#)  
 PIX Firewall Support [10](#)  
 plugging in device module [2](#)  
 plug-in device module  
   how to develop [6](#)  
 privilege level  
   changing [6](#)  
 product list

updating [3](#)  
 product overview [1](#)

## Q

---

queries  
   creating [2](#)  
   deleting [4](#)  
   editing [3](#)  
   used for dynamic operations [48](#)  
   viewing [1](#)  
 query device inventory [44](#)  
 querying device inventory [44](#)  
 querying jobs [1](#)  
 query manager [1](#)

## R

---

registering plug-in device module [8](#)  
 registration utility restriction [8](#)  
 restarting jobs [2](#)  
 Restrictions [11](#)  
 Resynchronize cns\_password [14](#)  
 resynchronizing devices [27](#)

## S

---

sample data for bulk upload  
   NSM [5](#)  
 Sample Logrotate Config File [18](#)  
 sample template [1](#)  
 sample templates  
   modular router [9](#)  
 save process  
   editing [3](#)  
 scheduling  
   data backup [1](#)  
 schema  
   importing [2](#)

script file  
   importing [3](#)  
 search parameters [9](#)  
 secure socket layer [13](#)  
 security manager [1](#)  
 service manager [1](#)  
 service properties  
   editing [1](#)  
 showversion [5](#)  
 software licenses and acknowledgements [1](#)  
 ssldump  
   license [8](#)  
 stopping  
   jobs [2](#)  
 stopping jobs [2](#)  
 subdevices [37](#)  
 subject-based addressing [6](#)  
 supported interfaces [3](#)  
 system cannot  
   connect to the network [2](#)

## T

---

template  
   configuration control [8](#)  
 template content  
   editing [15](#)  
 template file, basic format of [1](#)  
 template filename [38](#)  
 template manager [13](#)  
   adding a template [14](#)  
   deleting a template [16](#)  
   editing [15](#)  
   editing attributes [15](#)  
   editing content [15](#)  
   importing a template [17](#)  
 templates [5,1](#)  
   configuration control [36,3](#)  
   control structures [12](#)

- variable substitutions 1
- templates for modular routers 7
- TFTP server 3
- Tomcat
  - license 8
- toolkit usage 1
- troubleshooting
  - cannot connect to system with telnet or telnet interaction is slow 4
  - cannot connect to the system using a web browser 3
  - cannot log in to the system 1
  - system cannot connect to the network 2

## U

---

- unplugging
  - device module 2
- update jobs manager 1
- updating
  - device configuration 30
  - device configurations and images 30
  - device images 32
  - device module 2
  - product list 3
- uploading bulk data 3
- user accounts 1
  - changing password 5
  - deleting 5
  - editing 3
  - setting privilege level 6
- user designed device module specifications 3
- user types 1
- using advanced search feature 3
- using the cns-send and cns-listen commands 5

## V

---

- viewing
  - device configuration 1

- events 1
- groups 1
- image 1
- log files 1
- queries 1
- search parameters 9
- subdevices 37
- voice-port template 10

## W

---

- working with images 1

## X

---

- XML 5
  - bulk upload
    - dtd 1