



## Cisco Prime Provisioning 7.0 API Programmer Guide

Americas Headquarters  
Cisco Systems, Inc.  
170 West Tasman Drive  
San Jose, CA 95134-1706  
USA  
<http://www.cisco.com>  
Tel: 408 526-4000  
800 553-NETS (6387)  
Fax: 408 527-0883

Text Part Number:

THE SPECIFICATIONS AND INFORMATION REGARDING THE PRODUCTS IN THIS MANUAL ARE SUBJECT TO CHANGE WITHOUT NOTICE. ALL STATEMENTS, INFORMATION, AND RECOMMENDATIONS IN THIS MANUAL ARE BELIEVED TO BE ACCURATE BUT ARE PRESENTED WITHOUT WARRANTY OF ANY KIND, EXPRESS OR IMPLIED. USERS MUST TAKE FULL RESPONSIBILITY FOR THEIR APPLICATION OF ANY PRODUCTS.

THE SOFTWARE LICENSE AND LIMITED WARRANTY FOR THE ACCOMPANYING PRODUCT ARE SET FORTH IN THE INFORMATION PACKET THAT SHIPPED WITH THE PRODUCT AND ARE INCORPORATED HEREIN BY THIS REFERENCE. IF YOU ARE UNABLE TO LOCATE THE SOFTWARE LICENSE OR LIMITED WARRANTY, CONTACT YOUR CISCO REPRESENTATIVE FOR A COPY.

The Cisco implementation of TCP header compression is an adaptation of a program developed by the University of California, Berkeley (UCB) as part of UCB's public domain version of the UNIX operating system. All rights reserved. Copyright © 1981, Regents of the University of California.

NOTWITHSTANDING ANY OTHER WARRANTY HEREIN, ALL DOCUMENT FILES AND SOFTWARE OF THESE SUPPLIERS ARE PROVIDED "AS IS" WITH ALL FAULTS. CISCO AND THE ABOVE-NAMED SUPPLIERS DISCLAIM ALL WARRANTIES, EXPRESSED OR IMPLIED, INCLUDING, WITHOUT LIMITATION, THOSE OF MERCHANTABILITY, FITNESS FOR A PARTICULAR PURPOSE AND NONINFRINGEMENT OR ARISING FROM A COURSE OF DEALING, USAGE, OR TRADE PRACTICE.

IN NO EVENT SHALL CISCO OR ITS SUPPLIERS BE LIABLE FOR ANY INDIRECT, SPECIAL, CONSEQUENTIAL, OR INCIDENTAL DAMAGES, INCLUDING, WITHOUT LIMITATION, LOST PROFITS OR LOSS OR DAMAGE TO DATA ARISING OUT OF THE USE OR INABILITY TO USE THIS MANUAL, EVEN IF CISCO OR ITS SUPPLIERS HAVE BEEN ADVISED OF THE POSSIBILITY OF SUCH DAMAGES.

Cisco and the Cisco logo are trademarks or registered trademarks of Cisco and/or its affiliates in the U.S. and other countries. To view a list of Cisco trademarks, go to this URL: [www.cisco.com/go/trademarks](http://www.cisco.com/go/trademarks). Third-party trademarks mentioned are the property of their respective owners. The use of the word partner does not imply a partnership relationship between Cisco and any other company. (1721R)

Any Internet Protocol (IP) addresses and phone numbers used in this document are not intended to be actual addresses and phone numbers. Any examples, command display output, network topology diagrams, and other figures included in the document are shown for illustrative purposes only. Any use of actual IP addresses or phone numbers in illustrative content is unintentional and coincidental.

*Cisco Prime Provisioning 6.8 API Programmer Guide*  
© 2000-2018 Cisco Systems, Inc. All rights reserved.



**Preface** xv

---

CHAPTER 1

**Introduction to the Prime Provisioning API** 1-1

- API Components 1-1
  - Client 1-2
  - HTTP/HTTPS Server 1-3
    - HTTP Transport 1-3
    - HTTP Response 1-3
    - HTTP Authentication/Encryption 1-4
  - SOAP Plug-in 1-4
    - SOAP Messages 1-5
    - Message Validation/SOAP Faults 1-7
    - Message Security 1-8
  - API Notifications Server 1-8
  - API Server/Servlet 1-8
- Operations 1-9
- XML Schema 1-10
  - XML Examples 1-11
- Service Model 1-11
  - Service Orders/Service Requests 1-12
    - Service Order Life Cycle 1-12
    - Modifying a Service Request 1-12
    - Service Order Example 1-13
    - Names and Locator IDs 1-14
  - Service Definitions 1-14
- API Error Messages 1-14
  - Error Logs 1-16

---

CHAPTER 2

**Getting Started** 2-1

- Installation Notes 2-1
- Checking the API Status 2-1
  - Checking from the API 2-1
  - Checking from the GUI 2-2
- Logging In 2-3

- Work Flow 2-3
  - Populating the Repository 2-4
    - Creating Inventory 2-5
    - Defining the Provider and Customer Relationship 2-5
    - Assigning Route Aggregation 2-8
    - Defining Access Domains and VPNs 2-8
    - Creating Physical Topology 2-9
  - Collecting Device Configurations 2-10
  - Creating the Service Policy 2-11
  - Creating the Service Order/Service Request 2-11
    - Service Order Response 2-12
  - Performing a Configuration Audit 2-12

CHAPTER 3

- Common APIs 3-1**
  - Inventory 3-1
    - Devices 3-2
    - Resource Pools 3-3
    - Topology 3-4
    - Groupings 3-5
  - Session 3-7
    - Create Session Example 3-8
    - Delete Session Example 3-8
  - Tasks 3-9
    - Viewing a Task 3-9
    - Certificate Enrollment Audit 3-10
    - Collection 3-10
    - Service Decommission 3-11
    - Configuration Audit 3-11
    - Service Deployment 3-12
    - MPLS Functional Audit 3-12
    - SLA Collection 3-13
  - General Purpose APIs 3-14
  - Date/Time Format in API Requests 3-15

CHAPTER 4

- Using Templates 4-1**
  - Introduction to Templates in Prime Provisioning 4-1
    - Template Definition 4-2
    - Template Data 4-2
    - Dynamic Instantiation of Templates 4-3

Template Operations	4-3
Overview of Template Operations	4-4
Template Subtypes	4-4
Template Service Definitions	4-5
Template Service Orders	4-5
Examples of Template Operations	4-6
Adding New Templates	4-6
Setting Up Optional Template Attributes	4-8
Creating Negate Templates	4-8
Creating Subtemplates	4-9
Creating Templates in Policies (N-PE)	4-10
Creating Templates in Policies (U-PE)	4-10
Creating Datafile from Service Request	4-11
Provisioning Example	4-12
Prerequisites	4-12
Process Summary	4-12
Detailed Provisioning Process	4-13
Transient Templates	4-17
Templates in a Service Request	4-18
Using Template Node Objects	4-18
Link Template	4-18
SRAssociatedTemplate	4-19
Data Buffer Object	4-20
Removing Template Configurations	4-22
Using Negate Templates	4-22
Modifying a Service Request	4-23
Turning off Templates (for MPLS Service Requests)	4-23
Turning off Templates (for All Other Service Types)	4-24

## CHAPTER 5

**Monitoring APIs** 5-1

Event Notifications	5-1
Setting up the Client	5-2
Remote Authentication	5-2
Notification Responses	5-3
Reports	5-4
SQL-Based Reports	5-4
Canned Reports	5-6
Report Definitions	5-8
Output for Reports	5-10

- SLA Provisioning 5-12
  - Process for SLA Provisioning 5-12
  - SLA Probes 5-13
    - Creating and Deploying SLA Probes 5-13
    - Common Probe Parameters 5-16
    - Probe Types 5-17
  - Viewing SLA Probes 5-18
  - SLA Reports 5-19
- Device Locking 5-22
- Viewing Task Logs 5-24

CHAPTER 6

- MPLS Provisioning 6-1**
  - MPLS Service Definitions 6-2
    - Schema Diagram 6-2
    - Supported MPLS Operations 6-3
    - MPLS Policy Attributes 6-4
    - Policy Examples 6-5
  - MPLS Service Requests 6-11
    - Service Request Examples 6-12
      - Service Request Examples in the API Programmer Reference 6-52
  - End-to-End Provisioning Process 6-53
    - Process Summary 6-54
    - Detailed Process and Attributes 6-55
      - Create Inventory 6-55
      - Create Resource Pools 6-57
      - Collect Device Configurations 6-58
      - Create an MPLS Policy 6-60
      - Creating an MPLS Service Request 6-60
      - Auditing Service Requests 6-62

CHAPTER 7

- L2VPN Provisioning 7-1**
  - L2VPN Service Definitions 7-1
    - Supported Service Definitions 7-2
    - Policy Examples 7-2
      - ATM Policy 7-2
      - ERS Policy 7-5
  - L2VPN Service Requests 7-9
    - End-To-End Wires 7-9
    - Service Request Examples 7-10

ATM Service Request	7-11
ERS Service Request	7-15
Provisioning Example	7-20
Process Summary	7-20
Prerequisites	7-21
RBAC	7-21
Provisioning Process	7-22
Auditing Service Requests	7-32

## CHAPTER 8

<b>VPLS Provisioning</b>	<b>8-1</b>
VPLS Service Definitions	8-2
VPLS Autodiscovery	8-3
VPLS Autodiscovery Example	8-4
VPLS Service Requests	8-8
Provisioning Example	8-10
Process Summary	8-10
Prerequisites	8-11
RBAC	8-11
Provisioning Process	8-11
Auditing Service Requests	8-22

## CHAPTER 9

<b>EVC Provisioning</b>	<b>9-1</b>
EVC Service Definitions	9-1
Supported Service Definitions and Service Orders	9-2
Policy Types	9-2
MPLS Core Connectivity Types	9-2
Policy Examples	9-3
Creating a Local Connect Policy	9-3
Creating a Pseudowire Policy	9-4
Creating a VPLS Policy	9-4
Creating a Local Connect Policy with ATM/Ethernet internetworking	9-5
Creating a Pseudowire Policy with ATM/Ethernet Internetworking	9-10
Creating a Pseudowire Policy Setting the MTU Size	9-15
Creating a Pseudowire Head-End Policy for Access into L3VPN	9-20
Creating a Pseudowire Policy With Reserved Bandwidth	9-24
Configuring an SVI/EVC Hybrid Scenario	9-24
Creating a Policy for Specifying Service Instance Name	9-28
Creating a Multi-Segment Pseudowire Policy	9-31
Creating an EVC VPLS Policy for E-TREE	9-36

Policy Examples in the API Programmer Reference	9-40
EVC Service Requests	9-41
Overview	9-41
End-To-End Wires	9-42
Pseudowire Network Diagram	9-42
VPLS Network Diagram	9-43
Local Connect Network Diagram	9-44
Service Request Examples	9-44
Creating a Local Connect Service Request	9-45
Creating a Pseudowire Service Request	9-51
Creating a VPLS Service Request	9-55
Modifying a EVC Service Request	9-60
Creating Access Ring with two NPEs	9-67
Creating NPC	9-68
Configuring an SVI/EVC Hybrid Scenario Service Request	9-69
Specifying Service Instance Name for EVC Service Requests	9-74
Creating a Local Connect Service Request for IOS-XR using Bridge Domain	9-77
Creating a Pseudowire Service Request Setting the MTU Size	9-82
Creating a Pseudowire Service Request with P2P E-line Name	9-88
Creating a Pseudowire Service Request with Range of Values for Outer VLAN/Inner VLAN	9-93
Creating a Pseudowire Service Request with Encapsulation Type DEFAULT/UNTAGGED	9-93
Creating a Pseudowire Service Request with ANY VLAN/Tagged with Untagged VLANs	9-95
Creating an EVC Pseudowire Service Request with Reserved Bandwidth	9-95
Creating a Local Connect Service Request with ATM Ethernet	9-100
Creating a Pseudowire Service Request with ATM Ethernet	9-105
Creating a Pseudowire Service Request with Hybrid VPLS	9-111
Creating a Pseudowire Head-End Service Request for Access into L3VPN	9-116
Creating a VPLS Service Request with IOS XR	9-124
Creating a VPLS Service Request for E-TREE	9-128
Creating a Pseudowire Service Request for an L2-Access Link With EVC-syntax	9-133
Modifying an EVC Multi-Segment Pseudowire Service Request	9-136
Service Request Examples in the API Programmer Reference	9-138
End-to-End Provisioning Process	9-139
Process Summary	9-139
Prerequisites	9-139
Detailed Process	9-140
Auditing Service Requests	9-149



## CHAPTER 10

<b>Traffic Engineering Management Provisioning</b>	<b>10-1</b>
Prerequisites and Limitations	10-1
General Limitations	10-1
Feature-Specific Prerequisites and Limitations	10-2
Non-Cisco Devices and Prime Provisioning TEM	10-2
TEM Service Definitions	10-2
Supported TEM Features	10-2
Policy Examples	10-4
Create TE Policy	10-4
Delete TE Policy	10-6
View TE Policy	10-6
TE Network Discovery	10-7
TE Discovery Examples	10-7
TEM Service Requests	10-9
TE Topology Example	10-9
Service Request Examples	10-10
Create and Deploy TE Managed Primary Tunnel SR	10-10
Create and Deploy Unmanaged Primary Tunnel SR	10-17
Create and Deploy TE Backup Tunnel SR	10-18
Create and Deploy TE Traffic Admission SR	10-19
Provisioning Example	10-24
Process Summary	10-24
Provisioning Process	10-24
Using Computation ID and Locator ID	10-29
Planning Tools	10-29
Compute Backup	10-29
Auditing Service Requests	10-31

## CHAPTER 11

<b>RAN Backhaul Provisioning</b>	<b>11-1</b>
Policy Types	11-1
TDM-CEM Service Definitions	11-3
CEM Class Inventory Operations	11-3
Supported Service Definitions and Service Orders	11-4
Policy Examples	11-4
Creating a TDM-CEM (CESoPN) Policy	11-4
Creating a TDM-CEM (SAToP) Policy	11-6
Creating RAN Backhaul TDM-CEM Policy with IOS XR Support	11-8
TDM-CEM Service Requests	11-8

- Service Request Examples 11-9
  - Creating a TDM-CEM (CESoPN) Service Request Without Pseudowire Redundancy 11-9
  - Creating a TDM-CEM (CESoPN) Service Request With Pseudowire Redundancy 11-12
  - Creating a RAN Backhaul CEM Class 11-17
  - Creating a RAN Backhaul TDM Service Request 11-18
  - Creating a TDM-CEM Service Request for IOS XR 11-19
  - Creating a TDM-CEM Service Request with E1-E1 Service 11-20
  - Creating a TDM-CEM Service Request with T1-T1 Service 11-24
- TDM-CEM End-to-End Provisioning Process 11-27
  - Process Summary 11-27
  - Detailed Process 11-27
  - Auditing Service Requests 11-34
- ATM Pseudowire Service Definitions 11-34
  - Supported Service Definitions and Service Orders 11-34
  - Policy Examples 11-35
    - Create ATM Pseudowire Policy 11-35
    - Creating RAN Backhaul ATM Policy with IOS XR Support 11-36
- ATM Pseudowire Service Requests 11-37
  - Service Request Examples 11-37
    - Create ATM (VCC) Service Request Without Pseudowire Redundancy 11-37
    - Create ATM (VCC) Service Request With Pseudowire Redundancy 11-41
    - Create ATM (PVP) Service Request Without enabling Pseudowire Redundancy: 11-46
    - Create ATM (PVP) Service Request with Pseudowire Redundancy enabled: 11-49
    - Create RAN Backhaul ATM Service Request With IOS XR 11-53
- ATM Pseudowire End-to-End Provisioning Process 11-54
  - Process Summary 11-54
  - Detailed Process 11-54
  - Auditing Service Requests 11-60

CHAPTER 12

- MPLS Transport Profile Provisioning 12-1**
  - Prerequisites and Limitations 12-1
  - MPLS-TP Service Definitions 12-1
    - Supported MPLS-TP Features 12-2
    - Policy Example 12-2
  - MPLS-TP Discovery 12-5
    - MPLS-TP Discovery Example 12-6
  - MPLS-TP Service Requests 12-7
    - Typical Sequence of Calls 12-8
    - Service Request Examples 12-8

Creating an MPLS-TP Service Request With Path Protection	12-8
Modifying an MPLS-TP Service Request	12-11
Modifying an MPLS-TP Protect Path Service Request	12-15
Modifying an MPLS-TP Service Request with Include/Exclude Multiple Nodes	12-16
Provisioning Example	12-20
Process Summary	12-20
Provisioning Process	12-21
Auditing Service Requests	12-24
Config Audit	12-24
Functional Audit	12-25

---

 APPENDIX A

**GUI to API Mapping** A-1

Service Inventory Tab	A-1
Inventory and Connection Manager	A-2
Service Design Tab	A-4
Monitoring Tab	A-5
Administration Tab	A-5

---

 APPENDIX B

**Implementing a Notification Server** B-1

Event Notification Overview	B-1
Running the Example Servlet	B-3
Customizing the Example Servlet	B-5
Events for Collection	B-5

---

 APPENDIX C

**Scripts** C-1

README File	C-2
Scripts Main directory	C-2
env	C-2
changeMaxRoutes	C-2
changepasswd	C-3
changepw	C-3
Fcollect	C-4
collectConfig	C-4
deletece	C-5
deletesr	C-5
deleteSR	C-6
deleteUnusedCpes	C-6
deployallsr	C-7

- deployAISR C-7
- deploysr C-7
- downinterface C-8
- getfile C-9
- getpe C-9
- getPEs C-10
- modifyce C-10
- purgeces C-11
- purgeConfigs C-12
- purgesrs C-12
- removesr C-13
- showces C-13
- showsr C-13
- srdump C-14
- srDump C-16
- taskdump C-18
- taskDump C-18
- upinterface C-19
- VrfPing C-20
- Script Subdirectories C-20
  - util C-21
  - xml C-21
  - filters C-21
  - queries C-21

APPENDIX D

- Prime Provisioning XDE SDK D-1**
  - Introduction D-1
  - System Recommendations D-1
  - Installing and Setting Up the Prime Provisioning XDE SDK D-2
  - Process Overview D-2
  - Creating or Modifying Provisioning Logic D-3
    - Using Extension Points D-3
  - XDE SDK Functional Tests D-3

INDEX



## Preface

---

The *Cisco Prime Provisioning API Programmer Guide* describes APIs that are available to third party Operations Support System (OSS) products. The Prime Provisioning API provides a mechanism for inserting, retrieving, updating, and removing data from the Prime Provisioning servers using an eXtensible Markup Language (XML) interface.

This preface contains the following sections:

- [Who Should Use This Book, page xv](#)
- [How This Book Is Organized, page xvi](#)
- [Related Documentation, page xvi](#)
- [Additional Information, page xvii](#)
- [Obtaining Documentation and Submitting a Service Request, page xvii](#)



### Note

---

Prime Provisioning can be used as a standalone product or as part of the Prime Carrier Management Suite. When installed as part of the suite, you can launch Prime Provisioning from the Prime Central portal. For more information about Prime Central, see the documentation for [Cisco Prime Central](#).

---

## Who Should Use This Book

This guide is intended to be a technical resource for application developers who want to use the Prime Provisioning APIs to provision network services.

You should have an advanced level of understanding of Internet network design, operation, and terminology, be familiar with Cisco Internetwork Operating System (IOS) software and its commands, and have a basic understanding of the Cisco Prime Provisioning product.

Service provider developers that use the API should also have an understanding of a high-level programming language such as Java, or an equivalent language. Additionally, we recommend that you have knowledge of the following:

- Hypertext Transport Protocol (HTTP/HTTPS)
- Socket programming
- XML and XML Schema

You should be familiar with the Prime Provisioning GUI and how to use it to provision your network. In most cases, API operations correlate to GUI operations. See [Appendix A, “GUI to API Mapping,”](#) for more information.

# How This Book Is Organized

This programmer guide is organized as follows:

- These chapters describe the Prime Provisioning API fundamentals.
  - [Chapter 1, “Introduction to the Prime Provisioning API,”](#) describes the fundamental concepts for using the API XML, and includes the API model, components, and operations.
  - [Chapter 2, “Getting Started,”](#) describes the steps required to log into the API, and the basic steps for creating inventory, service requests, and service policies.
  - [Chapter 3, “Common APIs,”](#) describes the APIs for operations that are common to all Prime Provisioning services.
  - [Chapter 4, “Using Templates,”](#) describes Prime Provisioning templates and how to use them to download configurations and use them in a service request.
  - [Chapter 5, “Monitoring APIs,”](#) describes how to use the API to monitor services and create reports.
- These chapters describe the concepts for each service and provide a provisioning example, which includes the steps required to provision the services using the Prime Provisioning APIs.
  - [Chapter 6, “MPLS Provisioning”](#)
  - [Chapter 7, “L2VPN Provisioning”](#)
  - [Chapter 8, “VPLS Provisioning”](#)
  - [Chapter 9, “EVC Provisioning”](#)
  - [Chapter 10, “Traffic Engineering Management Provisioning.”](#)
  - [Chapter 11, “RAN Backhaul Provisioning”](#)
  - [Chapter 12, “MPLS Transport Profile Provisioning”](#)
- Additional information:
  - [Appendix A, “GUI to API Mapping,”](#) maps the GUI operations to the corresponding APIs.
  - [Appendix B, “Implementing a Notification Server,”](#) provides an example for implementing a servlet to receive notification events from Prime Provisioning, and lists all events that can be collected for notification.
  - [Appendix C, “Scripts,”](#) provides the list of scripts available with the Prime Provisioning software application.
  - [Appendix D, “Prime Provisioning XDE SDK,”](#) Gives an overview of the XDE SDK, how to install it, and how to use it to extend the functionality of Prime Provisioning.

## Related Documentation

See the [Cisco Prime Provisioning Documentation Overview](#) for a list of all Prime Provisioning guides.

We sometimes update the documentation after original publication. Therefore, you should also review the documentation on Cisco.com for any updates. **Other Cisco Prime Product Documentation**

If you are deploying Prime Provisioning as part of the Prime Carrier Management suite, then see also the documentation for the other suite components:

- [Cisco Prime Central 2.0](#)

- [Cisco Prime Network 5.0](#)
- [Cisco Prime Optical 10.7](#)
- [Cisco Prime Performance Manager 1.7](#)

## Additional Information

- For Tomcat web server:  
<http://jakarta.apache.org/tomcat/index.html>
- For SOAP plug-in:
  - <http://xml.apache.org/soap/>
- For XML and XML Schema
  - <http://www.w3.org/XML>
  - <http://www.w3.org/TR/xmlschema-0/>
- For events and notifications through the CIM event model  
<http://www.dmtf.org/standards/documents/CIM/DSP0107.pdf>
- For CIM Objects over HTTP, DMTF  
<http://www.dmtf.org/standards/documents/WBEM/DSP200.html>

## Obtaining Documentation and Submitting a Service Request

For information on obtaining documentation, using the Cisco Bug Search Tool (BST), submitting a service request, and gathering additional information, see [What's New in Cisco Product Documentation](#).

To receive new and revised Cisco technical content directly to your desktop, you can subscribe to the [What's New in Cisco Product Documentation RSS feed](#). The RSS feeds are a free service.







# Introduction to the Prime Provisioning API

---

The Cisco Prime Provisioning application program interface (API) allows you to use operations support system (OSS) client programs to connect to the Prime Provisioning system. The Prime Provisioning APIs provide a mechanism for inserting, retrieving, updating, and removing data from Prime Provisioning servers using an eXtensible Markup Language (XML) interface request/response system. The Prime Provisioning API optionally uses Secure Hypertext Transfer Protocol (HTTPS) for message encryption, and Cisco role-based access control (RBAC) for user authentication.

The Prime Provisioning APIs use an HTTP/HTTPS/SOAP (Simple Object Access Protocol) interface. The API requests are executed using a combination of HTTP/HTTPS and SOAP by sending the XML data to the API server. The server returns an XML response, which is also an encoded SOAP message, to indicate if the request is successful, or to return data.

The API optionally uses a notification server for database change events. An event is registered and a notification is sent any time a database object is created, modified, or deleted, or when a scheduled task begins or ends its execution. Event notifications are sent in the form of an XML response to the client, or to a specified URL.

You can use the API to perform the some of the operations that are available in the Prime Provisioning GUI. For more information, see [Appendix A, “GUI to API Mapping.”](#)

This guide describes how to use the API to perform operations that are common to all Prime Provisioning services and provides examples for provisioning MPLS, L2VPN, VPLS, EVC, and TEM services in your network.

This chapter contains the following sections:

- [API Components, page 1-1](#)
- [Operations, page 1-9](#)
- [XML Schema, page 1-10](#)
- [Service Model, page 1-11](#)
- [API Error Messages, page 1-14](#)

## API Components

The main components of the Prime Provisioning API are:

- Client—The OSS client program.
- HTTP/HTTPS Server—A standard HTTP/HTTPS Tomcat server to process the HTTP/HTTPS binding information.

- SOAP Plug-In—A standard Apache SOAP plug-in.
- API Server/Servlet—Receives SOAP messages and removes the SOAP encoding.
- API Notification Server—Used for asynchronous notifications for database change events. Prime Provisioning learns of events that occur using the Tibco Event Bus.
- Processing Servers—The servers that perform the specific processing activities.
- Database—The Prime Provisioning repository.
- XML validation schema(s) and metadata—Validation files for the XML encoded data.

Figure 1-1 shows the main components of the Prime Provisioning API and the process flow for XML messages.

Figure 1-1 API Components

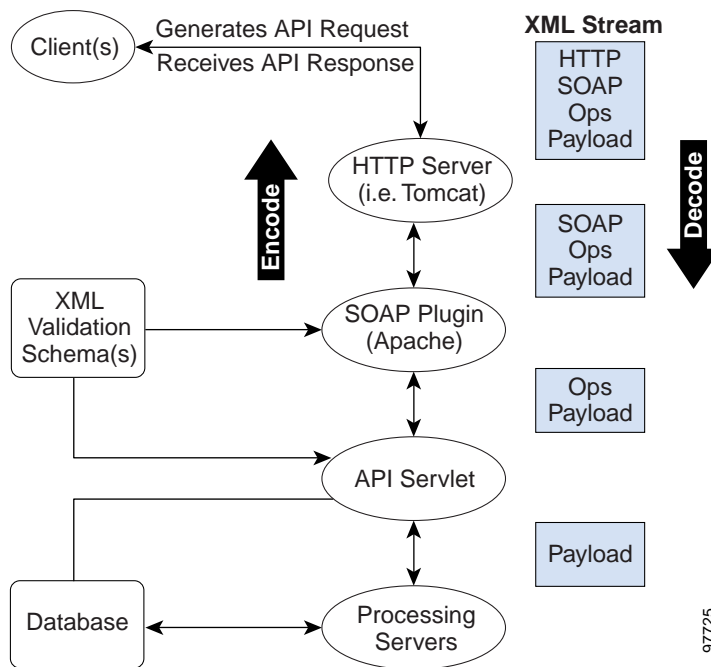

These components are described in the following sections.

## Client

The client can be any OSS client program. It formulates the XML request messages and receives the XML responses. Use any language that supports the XML format to generate the API messages.

The client interface:

- Logs in to the Prime Provisioning API system
- Generates XML requests
- Sends requests to the API server
- Receives responses from the API server
- Parses the XML response data content

**Note**

The API client should handle unrecoverable exceptions, that is `ConnectionException`, by itself to ensure a successful sequential execution.

## HTTP/HTTPS Server

Prime Provisioning uses a Tomcat server to process the HTTP/HTTPS binding information. The default ports are:

- HTTP—8030
- HTTPS—8443

You can specify a different port during the Prime Provisioning installation. See the [Cisco Prime Provisioning 6.8 Installation Guide](#) for more information.

## HTTP Transport

The API uses standard HTTP/HTTPS for message transport. The payload of an HTTP request or response is a SOAP message. Each SOAP request is sent to the web server using HTTP POST. The following are required HTTP headers:

- **POST** —The first header identifies that this particular POST is intended for the SOAP API. All HTTP requests that do not include a POST are ignored.
- **Content-type: text/xml**—The second header confirms that the data being sent is XML. If this header is not found, an HTTP 415 error is returned.
- **Content-length: <value in kilobytes>**—The third header must be a positive integer and cannot exceed 40. If the value is greater than 40 kilobytes, an HTTP 413 error is returned.
- The fourth header is the length (in bytes) of the SOAP message.

The following is an example HTTP header for an XML request:

```
POST /soap/servlet/messagerouter HTTP/1.0
Host: server1.myhost.com:80
Content-type: text/xml
Content-length: 613
```

**Note**

HTTP headers might vary. See the client software included with the Prime Provisioning installation for the latest HTTP software that shows the HTTPS strings.

## HTTP Response

If an error is detected in the HTTP protocol, the appropriate HTTP error message is returned in the HTTP response. The following are examples of HTTP return codes that can be returned for processing a SOAP request:

- **Content length exceeds 40 KB**  
HTTP/1.1 413 Request Entity Too Large
- **Content type is not "text/xml"**  
HTTP/1.1 415 Unsupported Media Type

- Request method is any method other than POST

```
HTTP/1.1 405 Method Not Allowed
```

During the processing of a SOAP request, you always receive the HTTP return code “HTTP/1.1 200 OK”, whether an error occurs or not. See the following example:

```
contacting: http://myserver.com:8030/soap/servlet/messagerouter
with: /tmp/tmp.2764
HTTP/1.1 200 OK
Content-Type: text/html
Content-Length: 597
Date: Fri, 21 Feb 2003 15:43:58 GMT
Server: Apache Tomcat/4.0.1 (HTTP/1.1 Connector)
Set-Cookie: JSESSIONID=C2337537E4C568A7A6228022A3A39521;Path=/soap
```

## HTTP Authentication/Encryption

HTTP authentication is optional and is controlled through the HTTP basic authentication scheme. You must deactivate anonymous access to enforce user authentication.

HTTPS (HTTP Secure Socket Layer (SSL)) can be used to encrypt the API message. SSL is not enabled on the server by default. To use SSL, you must install HTTPS during the Prime Provisioning installation process. When the SSL certificate is installed on the server, you can send requests using the HTTPS protocol instead of HTTP.



Note

---

The Prime Provisioning API supports remote authentication. See the [“Remote Authentication” section on page 5-2](#) for more information.

---

## SOAP Plug-in

Prime Provisioning includes a SOAP plug-in for validating that messages comply with the SOAP protocol. SOAP is an XML-based protocol that consists of:

- A set of encoding rules for expressing instances of application-defined data types.
- A convention for representing remote procedure calls and responses.
- A framework for describing what is in a message and how to process it.

SOAP provides server-side infrastructure for deploying, managing and running SOAP enabled services.



Note

---

The Prime Provisioning API supports SOAP formatting through SOAP libraries. However, SOAP libraries can be disabled if necessary for service provider clients that do not require SOAP library capabilities. Without this functionality, Prime Provisioning uses normal HTTP/HTTPS socket mechanisms to send and receive SOAP formatted messages. To disable SOAP libraries, set **nbi.Writer.SoapEncapsulation=false** (the default setting) in the Prime Provisioning properties file. The default setting allows you to run both SOAP-encapsulated and non-SOAP-encapsulated clients. You can set this attribute to **true** if you are running a pure SOAP environment.

---

## SOAP Messages

The payload of an HTTP request/response is a SOAP message. A SOAP message includes the envelope, the header, and the body.

- The **soapenv-Envelope** defines a framework for describing what is in a SOAP message and how to process it.
- The **soapenv-Header** defines session data and contains message handling information and information about the format of the payload data.
- The **soapenv-Body** element contains the child elements (operations, name/value pairs, key properties), which are the domain specific data.
  - The **soapenv-Fault** element contains error messages that are particular to SOAP. These messages are returned in the SOAP body.

### SOAP Message Envelope

The message envelope is used to declare namespaces. SOAP messages are routed using the XML namespaces associated with the first element in the message body. The first block of namespaces in the SOAP Envelope are standard for SOAP and XML encoding. See the following example:

```
<?xml version="1.0" encoding="UTF-8"?>
<soapenv:Envelope
  xmlns:soapenv="http://schemas.xmlsoap.org/soap/envelope/"
  xmlns:soapenc="http://schemas.xmlsoap.org/soap/encoding/"
  xmlns:xsd="http://www.w3.org/2001/XMLSchema"
  xmlns:xsi="http://www.w3.org/2001/XMLSchema-instance"
  xmlns:ns0="http://www.cisco.com/cim-cx/2.0"
  xmlns:ns1="http://insmbu.cisco.com/urn:CIM">
  <soapenv:Header>
    <ns0:message id="87855" timestamp="2002-12-13T14:55:38.885Z"
      sessiontoken="p36bttjwy1"/>
  </soapenv:Header>
  <soapenv:Body>
    <ns1:createInstanceResponse/>
  </soapenv:Body>
</soapenv:Envelope>
Responses
```

For the namespaces indicated in bold:

- `xmlns:ns0="http://www.cisco.com/cim-cx/2.0"` is used to indicate the message header formatting.
- `xmlns:ns1="http://insmbu.cisco.com/urn:CIM"` is used to indicate the operations performed and the data model.

### SOAP Message Header

The message header includes information about the message itself. This includes the message ID, the timestamp for the message, the session token, and wait flags. The following example shows SOAP header information:

```
<soapenv:Header>
  <ns0:message id="87855" timestamp="2002-12-13T14:55:38.885Z"
    sessiontoken="p36bttjwy1" wait="true" waitTimeout="60" />
</soapenv:Header>
<soapenv:Body>
```

Table 1-1 describes the details of a SOAP message header.

**Table 1-1 Header Definition**

Element	Description
Message ID	A correlation ID used for tracking client requests and responses. Prime Provisioning ignores this ID.
Timestamp	Time when message was sent (in Zulu time). For more information on the date/time format, see <a href="#">Date/Time Format in API Requests</a> , page 3-15.
Session Token	Session ID assigned during the login and used to access the system.
Wait Flags	Described in <a href="#">Table 1-2</a> .

Wait flags are specified in the SOAP message header and in certain view operations. [Table 1-2](#) lists the wait flags that can be returned in an XML response. Wait flags are optional request attributes.

**Table 1-2 SOAP Message Wait Flags**

Flag	Applies to	Values	Comments
level	enumerateInstance	positive integer	The object depth that is returned in a view. Suppresses lower level objects if needed.
wait	Header	true   false	Specifies whether the connection should stay open until the service request completes. Upon completion, the state of the service request is returned. <b>Default=false</b> (no wait).
waitTimeout	Header	Interval, in seconds	Maximum time to wait for a service request to complete. You can set the <b>waitTimeout</b> value in the Prime Provisioning properties file. The default is 20 minutes.  <b>Note</b> If the wait times out, the service request returns an error message indicating that the wait time has been exceeded. However, the request is still processed.

**Tip**

To use the API to lock a device so that Prime Provisioning cannot access it for provisioning, see the [“Device Locking”](#) section on page 5-22.

**SOAP Message Body**

The message body within a SOAP envelope implements a set of operations. The first line of the SOAP body is the method call, or operation, and the object for this operation is indicated by the **className**. Attributes for an object are specified in the properties (name/value pairs) for each class.

In the following XML example for creating a new site, the operation is **createInstance** and the **className** is **Site**. Properties for **Name**, **Organization**, and **SiteInfo** are included.

```
<soapenv:Body>
  <ns1:createInstance>
    <objectPath xsi:type="ns1:CIMObjectPath">
```

```

<className xsi:type="xsd:string">Site</className>
<properties xsi:type="ns1:CIMPropertyList"
  soapenc:arrayType="ns1:CIMProperty[]">
  <item xsi:type="ns1:CIMProperty">
    <name xsi:type="xsd:string">Name</name>
    <value xsi:type="xsd:string">Site1</value>
  </item>
  <item xsi:type="ns1:CIMProperty">
    <name xsi:type="xsd:string">Organization</name>
    <value xsi:type="xsd:string">Customer2</value>
  </item>
  <item xsi:type="ns1:CIMProperty">
    <name xsi:type="xsd:string">SiteInfo</name>
    <value xsi:type="xsd:string">Site comment info</value>
  </item>
</properties>
</objectPath>
</ns1:createInstance>
</soapenv:Body>

```

See the [“Operations” section on page 1-9](#) for more information on operations implemented in the SOAP body.

## Message Validation/SOAP Faults

If an XML request is not well-formed, or if there is an internal error in the SOAP server, you receive a SOAP *Fault* message. See the following example:

```

<?xml version="1.0" encoding="UTF-8"?>
<soapenv:Envelope
  xmlns:soapenv="http://schemas.xmlsoap.org/soap/envelope/"
  xmlns:soapenc="http://schemas.xmlsoap.org/soap/encoding/"
  xmlns:xsd="http://www.w3.org/2001/XMLSchema"
  xmlns:xsi="http://www.w3.org/2001/XMLSchema-instance"
  xmlns:ns0="http://www.cisco.com/cim-cx/2.0"
  xmlns:ns1="http://insmbu.cisco.com/urn:CIM">
  <soapenv:Header>
    <ns0:message id="87855" timestamp="2002-12-13T14:55:38.885Z"
      sessiontoken="p36bttjwy1"/>
  </soapenv:Header>
  <soapenv:Body>
    < soapenv:Fault>
      <faultcode>SOAP-ENV:Client</faultcode>
      <faultstring>Client Error</faultstring>
      <faultactor/>
    </soapenv:Fault>
  </soapenv:Body>

```

Additionally, if the XML request fails the validation, an error is generated.

- Exception messages are shown to the user within the <Exception> XML tags in the XML response.
- Frequently seen error messages are translated to reader-understandable text and presented within the <Message> tag of the XML response.

For Prime Provisioning error reporting, see the [“API Error Messages” section on page 1-14](#).

## Message Security

The Prime Provisioning API supports the following security methods for SOAP messages:

- For message security, the API supports encryption at the transport layer. See the [“HTTP Response” section on page 1-3](#).
- For user security, the API supports Cisco role-based access control (RBAC) to control user sessions. See the [“Tasks” section on page 3-9](#) for more information.

## API Notifications Server

This server is used for asynchronous notifications for database change events. It listens for the specified database change events and sends a notification across the client connection or to a URL.

**Note**

---

The notification URL is set in the Prime Provisioning properties file and can be specified during installation.

---

See the [“Event Notifications” section on page 5-1](#) for more information.

## API Server/Servlet

The API server (running as a servlet) receives the SOAP messages and removes the SOAP encoding. The API server also validates that the message is formatted correctly before initiating processing.

- For requests, the API delegates the request message to the appropriate processing server.
- For responses, the processing server sends the request back to the client.

The API is synchronous for operations, meaning a request is issued and then a response for each request is issued. An HTTP/HTTPS connection is established for incoming requests and another HTTP/HTTPS connection is used for receiving outgoing responses. You can disconnect and re-establish these connections as needed.

[Figure 1-2](#) shows the process flow for an XML request from the client program in the provider system to the Prime Provisioning repository, and the return path for the XML responses.



Figure 1-2 Process Flow Diagram

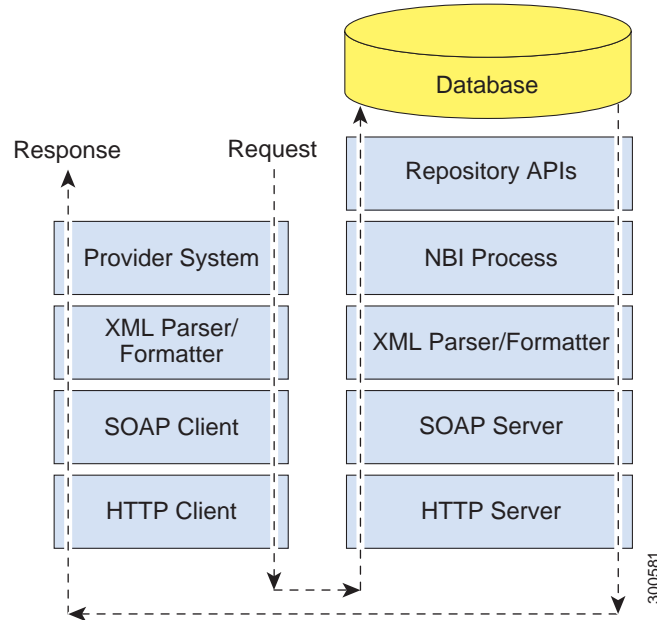

## Operations

The process servers perform the specific processing activities, or operations. These operations are executed on Prime Provisioning inventory and service objects. The API repository object model contains all object relationships, attributes, and operations.

API operations are divided into three categories: general, specialized, and response.

- General operations are executed on Prime Provisioning inventory objects.
  - createInstance—Create an object
  - deleteInstance—Remove an object
  - modifyInstance—Edit an object
  - execQuery—SQL-based queries
  - execReport—Canned reports and SLA report queries
  - execMethod—Used for device locking.
  - enumerateInstances—Get multiple objects, or view the properties of an object
- Specialized operations are used for accessing the system.
  - createSession—Login
  - deleteSession—Logout
- Each API operation has an associated response (except **deliverEvent**, which is a response itself). There are four types of responses for each of the operations:
  - Response—Response to indicate that a request was successful.
  - Data—Response for a request for information.

- Notifications (**deliverEvent**)—Response to indicate the addition, deletion, or change to a database object.
- Errors—Response to indicate that an error has occurred.

The operations that can be executed for Prime Provisioning repository objects are listed in [Figure 1-3](#).

**Figure 1-3 SOAP Envelope Body Operations**

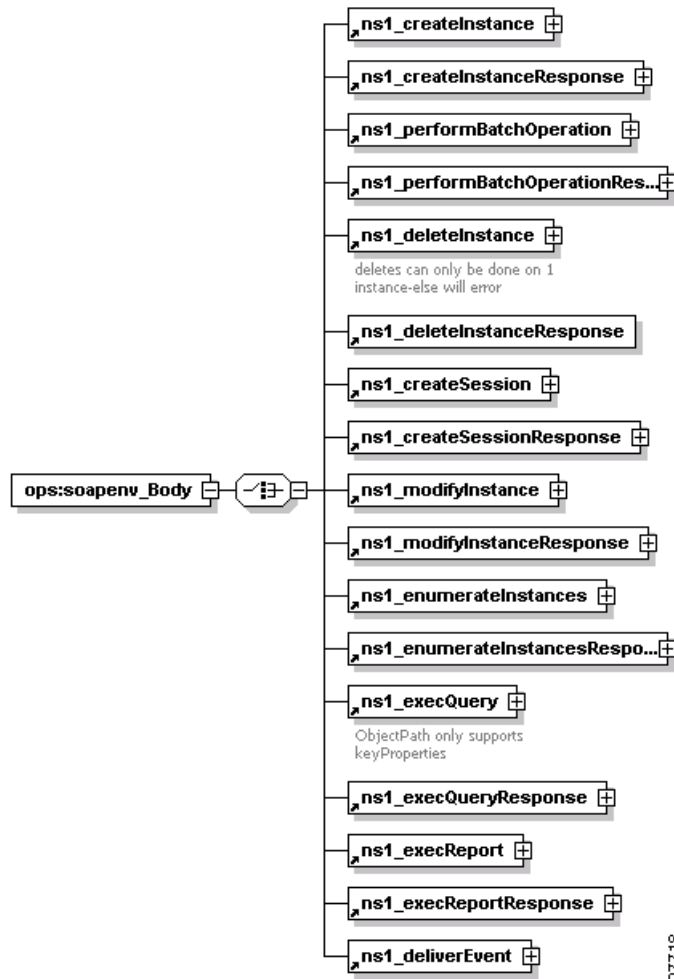

See the appropriate chapter in this guide for more information on APIs for specific operations.

## XML Schema

Prime Provisioning uses an XML schema and metadata to validate that the XML requests passed from the client are correct. The validation verifies that the **className** is valid and that the attributes listed in the XML request are recognized.

The API XML schema is defined by the World Wide Web Consortium (W3C) organization, which defines a structured way to express data structures. The schema provides constructs for defining data types and the mapping of those data types to data structures.

**Note**

The inventory of XML examples for the Prime Provisioning API is available at: [Cisco Prime Provisioning API 6.8 Programmer Reference](#).

## XML Examples

Prime Provisioning provides example XML requests and responses with the product. Use the XML examples as a reference to develop your own client code.

The inventory of XML examples for the Prime Provisioning API can be downloaded from here:

[Cisco Prime Provisioning API 6.8 Programmer Reference](#)

Table 1-3 describes the different categories for XML examples and where each is described in this guide.

**Table 1-3 XML Examples Available with Prime Provisioning**

Example XML Category	Described in
Evc	<a href="#">Chapter 9, “EVC Provisioning.”</a>
Events	<a href="#">Chapter 3, “Common APIs.”</a>
ExecQuery	<a href="#">Chapter 3, “Common APIs.”</a>
General	<a href="#">Chapter 3, “Common APIs.”</a>
Inventory	<a href="#">Chapter 3, “Common APIs.”</a>
L2VPN	<a href="#">Chapter 7, “L2VPN Provisioning.”</a>
MPLS	<a href="#">Chapter 6, “MPLS Provisioning.”</a>
Pools	<a href="#">Chapter 3, “Common APIs”</a>
Reports	<a href="#">Chapter 5, “Monitoring APIs”</a>
Session	<a href="#">Chapter 3, “Common APIs.”</a>
SLA	<a href="#">Chapter 5, “Monitoring APIs”</a>
Task	<a href="#">Chapter 3, “Common APIs.”</a>
TEM	<a href="#">Chapter 10, “Traffic Engineering Management Provisioning.”</a>
Templates	<a href="#">Chapter 4, “Using Templates.”</a>
VPLS	<a href="#">Chapter 8, “VPLS Provisioning”</a>
MPLS-TP	<a href="#">Chapter 12, “MPLS Transport Profile Provisioning”</a>
RAN Backhaul	<a href="#">Chapter 11, “RAN Backhaul Provisioning”</a>

## Service Model

The Prime Provisioning service model uses service orders, service definitions, and service requests in the provisioning process.

- Service orders allow you to schedule a provisioning process and capture the history of the provisioning process. Service orders provide a means to group together multiple service requests. This allows Prime Provisioning to download multiple configuration commands, which might be targeted to a single PE, in one step, and reduces the number of reconfigurations to a network device.

- Service requests are implemented through service orders. It is the service request that is provisioned and activated in the network. The service request defines attributes for the physical links and specifies the service policy to use. A service policy is defined in service definitions.
- Service definitions define the service policy. When you define a service policy, you can also set an additional attribute (**editable=true**) for policy properties. This allows the service request creator to override certain policy attributes. Service orders and service requests use service definitions to define common data used during the provisioning process.

## Service Orders/Service Requests

Prime Provisioning services can be defined as either end-user services or infrastructure services. An end-user service is available to an end user (individual or organization) for which a service provider generates revenue. An infrastructure service is required to be in place before an end-user service can be offered, and the infrastructure service cannot by itself be offered as an end-user service. The Prime Provisioning API supports both types of these services using service orders.

A service order allows a service provider to track the creation, modification, or deletion of all service requests implemented using Prime Provisioning.

Service orders can be created to:

- Specify one or more service requests, for batch operations.
- Modify an existing service request.
- Specify the order of implementation for service requests.
- Implement many disjoint operations. One service order can modify an MPLS service request and perform other operations at the same time.
- Perform related operations. One service order can create an organization, a service definition, and a Cisco router.

## Service Order Life Cycle

The following is the typical life cycle of a service order:

- The service order is created and the service request is specified.
- Prime Provisioning receives the service request.
- The service request is implemented based on the due date. If the service order or any service requests within the service order has a due date in the future, it is placed in the schedule queue.
- The service request is executed at the appropriate time.
- A response message is generated to indicate if the service request has successfully deployed.

## Modifying a Service Request

To make changes to a service request that has already been deployed, you must create a new service order that modifies the existing service request. The new service order becomes the *Active* service order. The previous service order becomes a historical record for the active service. Similarly, to delete a service request, you must create a new service order to decommission the existing service request.

**Note**

When you modify a service request that has templates, or before you can decommission a service request that has templates, you must first remove the template information from the service request. See the [“Removing Template Configurations”](#) section on page 4-22 for more information.

## Service Order Example

A service order XML request has a header with general information and is followed by one or more service requests and a service definition. Some of the header information can be used across multiple service requests. The service request contains service specific information, but it can also be used to override the global parameters defined in the service order header.

The following example shows a service order XML request with header information and the contained service request.

```
<?xml version="1.0" encoding="UTF-8"?>
<soapenv:Envelope
  xmlns:soapenv="http://schemas.xmlsoap.org/soap/envelope/"
  xmlns:soapenc="http://schemas.xmlsoap.org/soap/encoding/"
  xmlns:xsd="http://www.w3.org/2001/XMLSchema"
  xmlns:xsi="http://www.w3.org/2001/XMLSchema-instance"
  xmlns:ns0="http://www.cisco.com/cim-cx/2.0"
  xmlns:ns1="urn:CIM">
  <soapenv:Header>
    <!-- WaitTimeout has a default set in system properties.-->
    <ns0:message id="87855" timestamp="2002-12-13T14:55:38.885Z"
      Wait="false" WaitTimeout="60" sessiontoken="p36bttjwy1"/>
  </soapenv:Header>
  <soapenv:Body>
    <ns1:performBatchOperation>
      <actions xsi:type="ns1:CIMActionList"
        soapenc:arrayType="ns1:CIMAction[]">
        <action>
          <actionName xsi:type="xsd:string">createInstance</actionName>
          <objectPath xsi:type="ns1:CIMObjectPath">
            <className xsi:type="xsd:string">ServiceOrder</className>
            <properties xsi:type="ns1:CIMPropertyList"
              soapenc:arrayType="ns1:CIMProperty[]">
              <item xsi:type="ns1:CIMProperty">
                <name xsi:type="xsd:string">ServiceName</name>
                <value xsi:type="xsd:string">ServiceOrder-ConfigAudit</value>
              </item>
              <item xsi:type="ns1:CIMProperty">
                <name xsi:type="xsd:string">CarrierId</name>
                <value xsi:type="xsd:string">5</value>
              </item>
              <item xsi:type="ns1:CIMProperty">
                <name xsi:type="xsd:string">DesiredDueDate</name>
                <value xsi:type="xsd:dateTime">2002-12-14T14:55:38.885Z</value>
              </item>
              <item xsi:type="ns1:CIMProperty">
                <name xsi:type="xsd:string">NumberOfRequests</name>
                <value xsi:type="xsd:string">1</value>
              </item>
            </properties>
          </objectPath>
        </action>
        <action>
          <actionName xsi:type="xsd:string">createInstance</actionName>
          <objectPath xsi:type="ns1:CIMObjectPath">
```

```

<className xsi:type="xsd:string">ServiceRequest</className>
<properties xsi:type="ns1:CIMPropertyList"
  soapenc:arrayType="ns1:CIMProperty[]">
  <item xsi:type="ns1:CIMProperty">
    <name xsi:type="xsd:string">RequestName</name>
    <value xsi:type="xsd:string">CONFIG-AUDIT-TASK</value>
  </item>

```

## Names and Locator IDs

When you create a service order or a service request, you must specify a service name. Use these names to facilitate queries.

Some example service names are:

- For service orders—AcmeServiceOrder1, L2PN-ATM-SO.
- For service requests—MPLSServiceRequest, L2VPN-FrameRelaySR.

When you submit a service order XML request, Prime Provisioning returns a **LocatorId** in the XML response. This Locator ID is associated with the service order or request **Name**. The Locator ID is unique across all service request types. MPLS, or TemplateData are examples of service request types.



Tip

Make a record of the Locator ID or service name for all service orders and service requests. The Locator ID is required to view a service order, to perform a service order task (configuration audit or functional audit), and for all subsequent requests related to the service order or service request.

Responses to service orders and service requests also contain a **TaskLocatorId**, which can be used to retrieve log information for failed service requests. For more information, see the [“Viewing Task Logs” section on page 5-24](#).

## Service Definitions

A service definition defines a service policy and its characteristics. Service definitions can be specified in a service request, but they are not required. Use service definitions to create configuration parameters that can be used by multiple services.

Prime Provisioning supports service definitions for each of the service types (MPLS, L2VPN), and for templates.

See the appropriate chapter on service provisioning for more information. For more information on template service definitions, see [“Template Service Definitions” section on page 4-5](#).

## API Error Messages

The API is a request/response system. The input messages are processed for errors, and any errors are reported back to the API client as part of the XML response. Errors are formatted into a standard encoding scheme. The encoding scheme is a set of three attributes as shown by the following schema:

```

<xs:element name="error">
  <xs:complexType>
    <xs:sequence>
      <xs:element ref="code"/>
      <xs:element ref="description"/>
      <xs:element ref="detail"/>
    </xs:sequence>
  </xs:complexType>
</xs:element>

```

```

        </xs:sequence>
    </xs:complexType>
</xs:element>

```

The error defines a fundamental error that prevented a method or operation from executing normally.

- The **code** attribute contains a numerical status code indicating the nature of the error.
- The **description** attribute provides a human-readable description of the error.
- The **detail** attribute, when populated, provides additional clarifications.

An error can be caused by more than one Prime Provisioning component. For example, the code and description might refer to the API error, and the details might have information regarding an error in another component.

Prime Provisioning processes error messages according to the context (create, delete, modify) in which the error was found and the class in which the error was realized. For this reason, the API returns both the operation and classname in the XML response.

The noteworthy text in the following message is indicated in bold:

```

<?xml version="1.0" encoding="UTF-8"?>
<soapenv:Envelope xmlns:soapenv="http://schemas.xmlsoap.org/soap/envelope/"
xmlns:soapenc="http://schemas.xmls
oap.org/soap/encoding/" xmlns:xsd="http://www.w3.org/2001/XMLSchema"
xmlns:xsi="http://www.w3.org/2001/XMLSche
ma-instance" xmlns:ns0="http://www.cisco.com/cim-cx/2.0" xmlns:ns1="urn:CIM">
  <soapenv:Header>
    <ns0:message id="87855" sessiontoken="040833748184101892B5C1130544B053"
timestamp="2003-10-29T17:30:23.199
Z" />
  </soapenv:Header>
  <soapenv:Body>
    <ns1:createInstanceResponse>
      <returns xsi:type="ns1:CIMReturnList" soapenc:arrayType="ns1:CIMReturn[]">
        <objectPath xsi:type="ns1:CIMObjectPath">
          <className xsi:type="xsd:string">VPNServicesModule</className>
          <errors xsi:type="ns1:CIMErrorList" soapenc:arrayType="ns1:CIMError[]">
            <error xsi:type="ns1:CIMError">
              <code xsi:type="xsd:int">1104</code>
              <description xsi:type="xsd:string">Unable to find object (Device) with value
(CatIOS). Referenced object does not exist.</description>
              <detail xsi:type="xsd:string">For input string: "CatIOS"</detail>
            </error>
          </errors>
        </objectPath>
      </returns>
    </ns1:createInstanceResponse>
  </soapenv:Body>
</soapenv:Envelope>

```

In this example:

- The **createInstanceResponse** indicates the error is associated with a *create* operation.
- The class that the create operation is being performed on is **VPNServicesModule**.
- The error code, **1104**, is used to find the message in the error message documentation. The message is a concatenation of code and description. Hence, it is **1104- Unable to find object (Device) with value (CatIOS). Referenced object does not exist.**



Note

The block call **<errors>** are used when there is more than one **<error>** for one response.

The following sample API error message shows a **createInstanceResponse** for a **ServiceRequest**.

```
<actionName xsi:type="xsd:string">createInstanceResponse</actionName>
  <objectPath xsi:type="ns1:CIMObjectPath">
    <className xsi:type="xsd:string">ServiceRequest</className>
    <errors xsi:type="ns1:CIMErrorList" soapenc:arrayType="ns1:CIMError[]">
      <error xsi:type="ns1:CIMError">
        <detail xsi:type="xsd:string">ORA-00060: deadlock detected while waiting
for resource
</detail>
        <description xsi:type="xsd:string">22 : SQL Exception while updating
com.cisco.vpnsc.repository.mpls.RepMplsSR</description>
        <code xsi:type="xsd:int">22</code>
      </error>
    </errors>
  </objectPath>
</createInstanceResponse>
```

In this example:

- The error is a repository error as indicated by the error code **22**.
- The description shows an error within the **MPLS SR**.
- The detail shows it as an **ORACLE deadlock**.

## Error Logs

The API also provides error logs, which can be used for debugging purposes. The following example shows an NBI log in the **tmp** directory of the installation.

```
FINE: getErrorMsgByName(2029)
Oct 29, 2003 12:15:57 PM com.cisco.vpnsc.repository.common.RepVpnscLogger severe
SEVERE: [NbiException.processException:
com.sybase.jdbc2.jdbc.SybSQLException: ASA Error -196: Index 'MGMT_ADDR_CR' for table
'CISCO_ROUTER' would not be unique
  at com.sybase.jdbc2.tds.Tds.processEed(Tds.java:2538)
  at com.sybase.jdbc2.tds.Tds.nextResult(Tds.java:1922)
  at com.sybase.jdbc2.jdbc.ResultGetter.nextResult(ResultGetter.java:69)
  at com.sybase.jdbc2.jdbc.SybStatement.nextResult(SybStatement.java:201)
  at com.sybase.jdbc2.jdbc.SybStatement.nextResult(SybStatement.java:182)
  .....
```

In this example:

- In the call to **getErrorMsgByName**, with argument **2029**; 2029 is the error code.
- The **ASA Error** (from SYBASE) is shown in the detail field.

The stack trace information can be used to assist the Cisco Technical Assistance Center (TAC).





## Getting Started

---

This chapter describes how to begin service provisioning with the Cisco Prime Provisioning application program interface (API) and includes API-related installation notes, verifying the status of the API, and the typical work flow steps.

This chapter contains the following sections:

- [Installation Notes, page 2-1](#)
- [Checking the API Status, page 2-1](#)
- [Logging In, page 2-3](#)
- [Work Flow, page 2-3](#)

## Installation Notes

All components needed for the API are included with the installation of Prime Provisioning. The API servlet has no additional startup or shutdown requirements than normal Prime Provisioning, as the API servlet is embedded in the Tomcat engine. The API is a common component and is aware of blade-specific data in any given installation.

The end-user interface for the Prime Provisioning API interface is XML-encoded messages. A java client library and sample messages are shipped as part of the Prime Provisioning product.

See the [Cisco Prime Provisioning 7.0 Installation Guide](#) for more information.

## Checking the API Status

You can verify the status of the API from the API itself, or from the GUI.

The GUI and the API are both on the same port, 8030 (port=8443 for HTTPS). Both clients run from the Tomcat server. Normally, if the GUI client is started, the API client is also started.

## Checking from the API

To view the status of the API, you can:

- View the status of the watchdog client. Enter the following command:

```
prime.sh status
```

The following is an example output for the **prime.sh status** command:

```
$ prime.sh status
```

```
Status on machine : valmont.cisco.com
Name           State      Gen  Exec Time           Success  Missed
nspoller       started   1    Oct 14 09:56:32 MDT  72      0
dbpoller       started   1    Oct 14 09:56:32 MDT  73      0
httpd          started   1    Oct 14 09:56:37 MDT  71      0
rgserver       started   1    Oct 14 09:56:57 MDT  72      0
cnsserver      started   1    Oct 14 09:56:37 MDT  73      0
discovery      started   1    Oct 14 09:56:32 MDT  72      0
```

The httpd is the Tomcat server for the GUI and API. If the API is running, the httpd server status is *started*.

- Attempt to log into the API.

```
runNbi x $PRIMEF_HOME/resources/nbi/xml/examples/Session/Login.xml
```

- If the API is not running, you receive a message:  
Failed to start client, Connection Refused.
- If the API is running, you receive a session token.

## Checking from the GUI

To check the status of the API from the GUI:

- Step 1 From the Administration tab, choose **Control Center > Hosts**.
- Step 2 Choose your server.
- Step 3 Click **Servers**.
- Step 4 Check the state of the httpd server. The httpd server is the http Tomcat server for the API client. If the API is running, it is in the *Started* state.

Figure 2-1 shows the status of the httpd server.

Figure 2-1 Server Status Window in the GUI

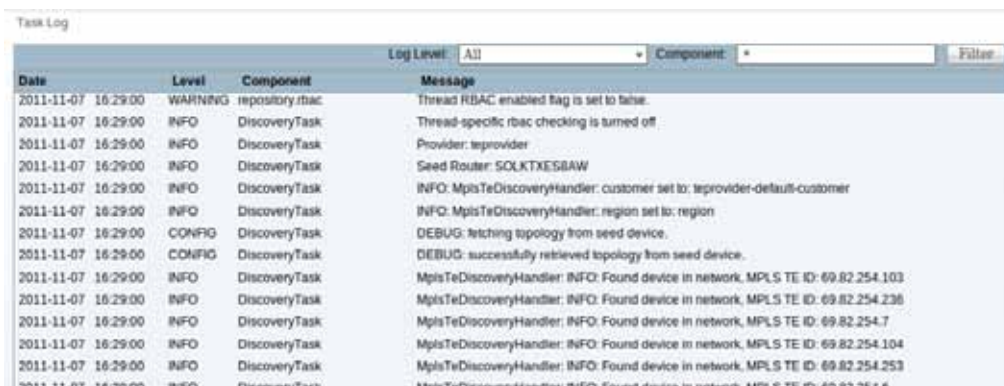

Date	Level	Component	Message
2011-11-07 16:29:00	WARNING	repository.rbac	Thread RBAC: enabled flag is set to false.
2011-11-07 16:29:00	INFO	DiscoveryTask	Thread-specific rbac checking is turned off
2011-11-07 16:29:00	INFO	DiscoveryTask	Provider: teprovider
2011-11-07 16:29:00	INFO	DiscoveryTask	Seed Router: SOLKTXE8AW
2011-11-07 16:29:00	INFO	DiscoveryTask	INFO: MplsTeDiscoveryHandler: customer set to: teprovider-default-customer
2011-11-07 16:29:00	INFO	DiscoveryTask	INFO: MplsTeDiscoveryHandler: region set to: region
2011-11-07 16:29:00	CONFIG	DiscoveryTask	DEBUG: fetching topology from seed device.
2011-11-07 16:29:00	CONFIG	DiscoveryTask	DEBUG: successfully retrieved topology from seed device.
2011-11-07 16:29:00	INFO	DiscoveryTask	MplsTeDiscoveryHandler: INFO: Found device in network, MPLS TE ID: 69.82.254.103
2011-11-07 16:29:00	INFO	DiscoveryTask	MplsTeDiscoveryHandler: INFO: Found device in network, MPLS TE ID: 69.82.254.236
2011-11-07 16:29:00	INFO	DiscoveryTask	MplsTeDiscoveryHandler: INFO: Found device in network, MPLS TE ID: 69.82.254.7
2011-11-07 16:29:00	INFO	DiscoveryTask	MplsTeDiscoveryHandler: INFO: Found device in network, MPLS TE ID: 69.82.254.104
2011-11-07 16:29:00	INFO	DiscoveryTask	MplsTeDiscoveryHandler: INFO: Found device in network, MPLS TE ID: 69.82.254.253
2011-11-07 16:29:00	INFO	DiscoveryTask	MplsTeDiscoveryHandler: INFO: Found device in network, MPLS TE ID: 69.82.254.104

- Step 5 To view more details, select the httpd server and click **Logs**.

# Logging In

Prime Provisioning uses Cisco role-based access control (RBAC) for user login and logoff. These user roles and permissions are set up using the GUI.

When a user sends a login request, the login is validated against the RBAC processor. If the validation is successful, an RBAC security token (session token) is maintained internally and also returned in the XML response as the **SessionId**. Each subsequent request requires the security token.

Prime Provisioning uses this security token to restrict access to Prime Provisioning data. The session token is generated by Prime Provisioning from the Tomcat session ID.

Figure 2-2 shows the user login sequence.

Figure 2-2 User Login Sequence

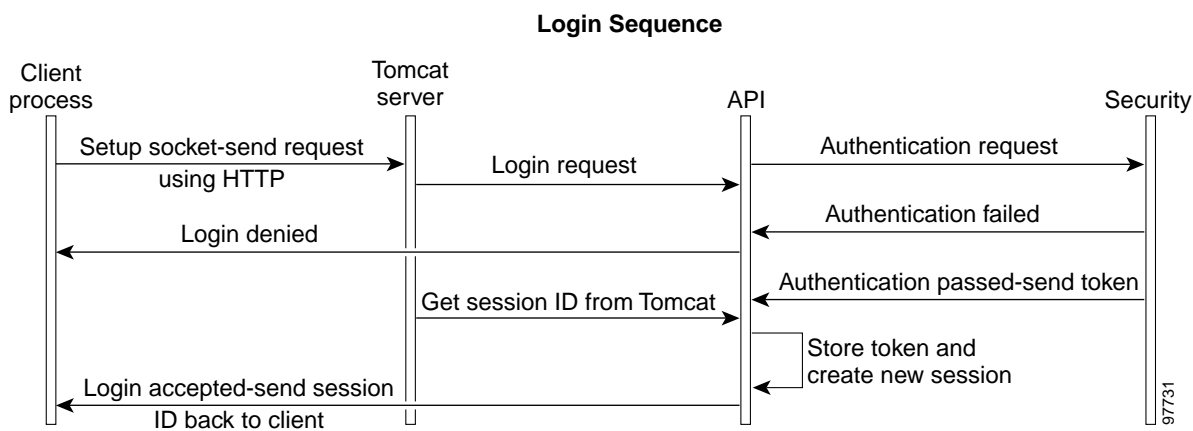

The following is an example of an XML response to a **createSession** (Login) operation. The security token is indicated in **bold**.

```

<soapenv:Body>
  <ns1:createSessionResponse>
    <returns xsi:type="ns1:CIMPropertyList" soapenc:arrayType="ns1:CIMProperty[]">
      <item xsi:type="ns1:CIMProperty">
        <name xsi:type="xsd:string">SessionId</name>
        <value xsi:type="xsd:string">F322D1A95424C095B58083C5C3A45633</value>
      </item>
    </returns>
  </ns1:createSessionResponse>
</soapenv:Body>
</soapenv:Envelope>
  
```

The security token in the XML response must be used in the header message for all subsequent requests to the server.

## Work Flow

This section describes the typical order of operations when using the API for service provisioning. The fundamental steps include:

- [Populating the Repository, page 2-4](#)

- [Collecting Device Configurations, page 2-10](#)
- [Creating the Service Policy, page 2-11](#)
- [Creating the Service Order/Service Request, page 2-11](#)
- [Performing a Configuration Audit, page 2-12](#)

Most end-to-end provisioning services require most or all of these operations.

## Populating the Repository

Every network element that Prime Provisioning manages must be defined as a device in the system. An element is any device that Prime Provisioning can collect configuration information from. Additionally, you must define device roles, groups, resource pools, and the topology of the network. Each of these items represents inventory in the Prime Provisioning database.

Prime Provisioning offers several options for populating the inventory in the repository.

- **Inventory Manager**—The Inventory Manager (IM) is a stand-alone Java Application on a client machine that allows you to import and administer network-specific data into the Prime Provisioning database. You must access the IM from the Prime Provisioning GUI. Use the IM for:
    - **Autodiscovery**—A IM feature that automatically discovers the state of the service provider's network, including physical connections, encapsulation types, and routing information.
    - **Importing configuration files**
  - **GUI**—Use the Inventory and Connection Manager in the GUI to add each object.
- For more information on IM and the Prime Provisioning GUI, see the [Cisco Prime Provisioning 7.0 User Guide](#).
- **API**—Use the API to create each object and then collect the configurations from each device or device group.



### Note

Inventory Manager and Autodiscovery do not apply to Traffic Engineering (TE) devices. A special TE Discovery tool is available for discovering TE devices in the core of the network. An example of how to use it from an API perspective is found in the TEM [Provisioning Example, page 10-24](#). More detailed information about the TE Discovery tool is found in the chapter on TE Network Discovery in the [Cisco Prime Provisioning 7.0 User Guide](#).

This section describes the basic steps to populate the Prime Provisioning repository using the API.



### Note

Use the XML example `CreateInventory.xml` for populating the database in bulk.

Populating the repository typically includes the following operations:

- Creating the inventory
- Defining provider and customer relationships
- Assigning route aggregation
- Defining access domains and VPNs
- Creating the physical topology.

## Creating Inventory

To provision most Prime Provisioning services, the following steps for creating inventory are required:

- Create devices
- Create device groups
- Create providers and regions
- Assign PE devices to access domains
- Create customers and sites, and assign CPEs to them.

See the [“Inventory” section on page 3-1](#) for a complete list of inventory items that can be created using Prime Provisioning.

## Defining the Provider and Customer Relationship

A service provider network architecture contains access routers, distributed routers, and core routers or ATM switches. Access routers terminate customer connections at the edge of the network.

Prime Provisioning provisioning is configured on the access circuit that involves the access router (provider edge devices or PEs) in the service provider network, and the customer premise equipment (CPE) in the customer network.

### Provider

The provider administrative domain is the administrative domain of an ISP with one BGP autonomous system (AS) number. The network owned by the provider administrative domain (PAD) is called the backbone network. If an ISP has two AS numbers, you must define it as two PADs.

A service provider supplies VPN services to multiple customers. [Figure 2-3](#) shows two different customers, each with a single VPN.

Figure 2-3 Provider View of the Network

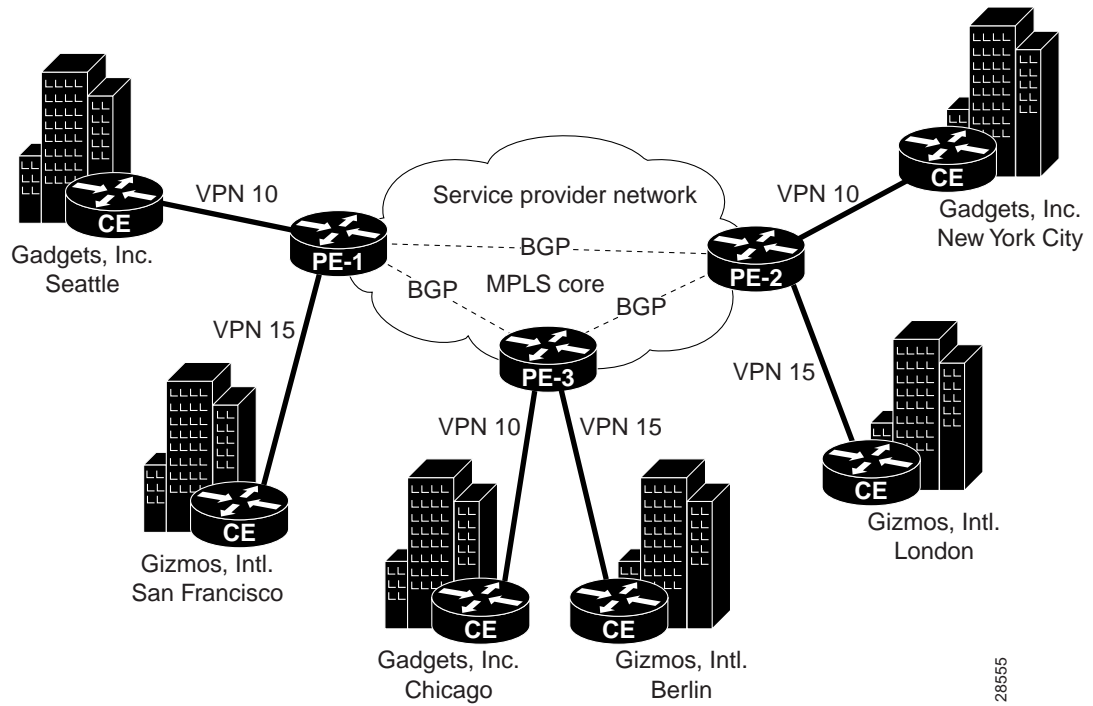

28555

To create a **Provider** object, you need:

- Provider name (**Name**)
- Autonomous system number (**AsNumber**).

## Customer

Customers have internal routers that communicate with their own customer edge devices (CEs) from one site to another through a VPN, which is managed by the service provider. See [Figure 2-4](#).

**Figure 2-4** Customer View of the Network

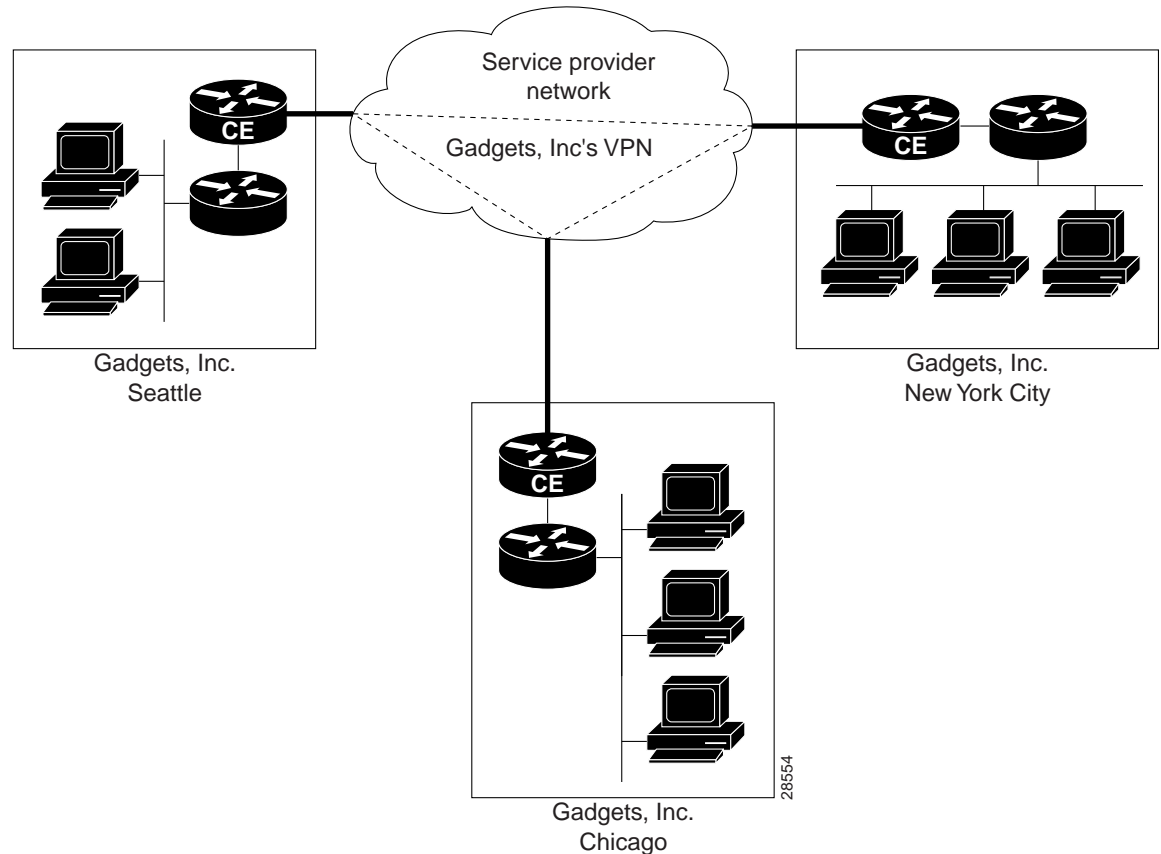

By using VPNs, the customers experience direct communication to each site as though they had their own private network, even though their traffic is traversing a public network.

To create a customer object, you need a customer (**Organization**).

## Region

A region is a group of PE devices within a single BGP AS or PAD. Each provider can contain multiple region objects.

To create a Region object, you need:

- Region name (**Name**)
- Provider domain for this region (**Provider**).

## Site

A customer site is a set of IP systems with mutual IP connectivity between them, without the use of a VPN. A customer site can belong to only one customer, and can contain one or more CPEs, for load balancing.

To create a **Site** object, you need:

- Site name (**Name**)
- Customer for this site (**Organization**).

## Assigning Route Aggregation

Resource pools are assigned per provider and are used for route aggregation within regions. Resource pools include the route distinguisher (RD), route target (RT), and address pools. See [Figure 2-5](#).

**Figure 2-5** Resource Pools

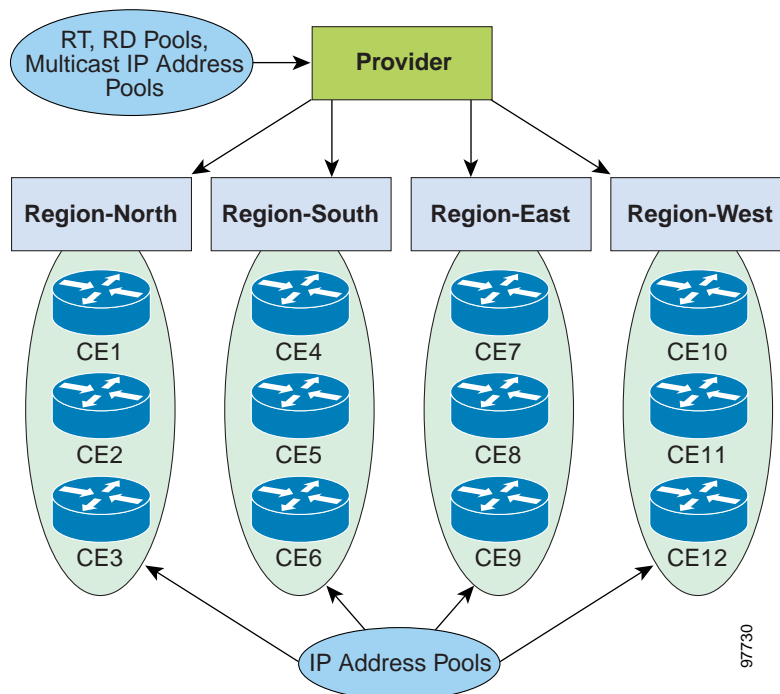

Resource pools allow you to manage various pool types, and to associate a pool with any service model object in the Prime Provisioning repository. Pools help to automate service deployment.

See the [“Resource Pools” section on page 3-3](#) for a complete list of the supported resource pools.

## Defining Access Domains and VPNs

Access domains characterize the physical relationship of the devices between the provider network and the CE devices. VPNs characterize the routing relationship between the CEs through the provider network.



## Access Domains

An access domain is the Layer 2 Ethernet switching domain that is attached to the PE. All switches attached to the PE-POP belong to the same access domain. You can associate multiple VLAN pools to a single access domain. You can assign two PEs to an access domain for redundancy.

To create an **AccessDomain** object, you need:

- Provider name (**Provider**)
- The VLAN pool reserved for this domain (**ReservedVlanPool**)—The range of the VLAN pool is specified with **Start** and **Size**.

## Virtual Private Networks

A virtual private network (VPN) is a collection of customer sites that share the same routing table. A VPN can consist of sites that are all from the same enterprise (intranet), or from different enterprises (extranet). VPNs can consist of sites that all attach to the same service provider backbone or to different service provider backbones.

The path between two sites in a VPN, and the characteristics of that path, can also be determined (in whole or in part) by the service policy (service definition). See [Figure 2-4](#) for an example of a VPN between customer sites.

To create a VPN, you need:

- VPN name (**Name**)
- Customer (**Organization**)
- CE routing community (**CERC**)—For MPLS VPNs only.

## Creating Physical Topology

If you use a manual method for populating the repository (any method except Autodiscovery), you must also create the physical network topology. Named physical circuits (NPCs) are the physical connections between network elements and their PEs. You must create a connection from each network device in an access domain. NPCs are required for L2VPN and MPLS provisioning.

[Figure 2-6](#) shows a network example with a distributed PE scenario. The CPE is connected to the PE through an access domain, which contains a layer 2 switching environment.

Figure 2-6 Sample L2VPN Network

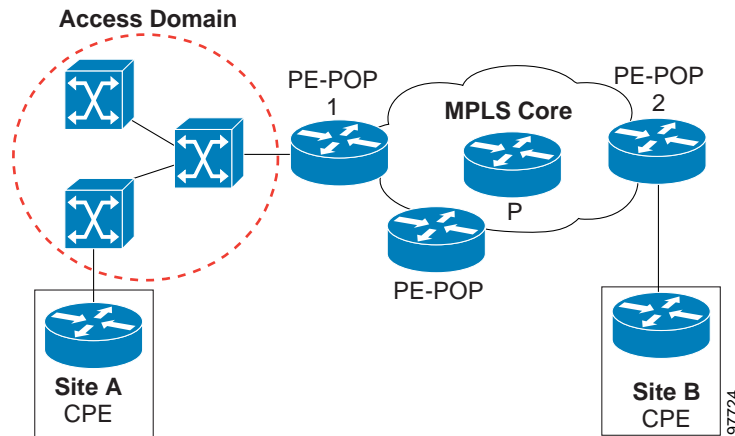

To create the NPCs for this network, first specify the link from the CPE at Site A to the PE-POP 1, and then one physical link for each intermediate switch between the CPE and PE-POP.

For each **NPC** object, you need:

- Source device (**SrcDevice**)
- Destination device (**DestDevice**)
- Source device interface name (**SrcIfName**)
- Destination device interface name (**DestIfName**).

See the “[Topology](#)” section on page 3-4 for more information on the APIs available for defining network topology.

## Collecting Device Configurations

A device configuration collection is a task. This task uploads the current configuration from the device to the Prime Provisioning database. The collection task is executed through a service request or a service order.

The following information is required for each device that you collect configurations from:

- General device information
- Login and Password information
- Device and configuration access information:
  - Device access protocol (Telnet, SSH, CNS)
  - SNMP Version
  - SNMP V1/V2/V3 information
  - Terminal Server Information.

Collection tasks can be executed immediately or they can be scheduled. See the “[Collection](#)” section on page 3-10 for more information.

## Creating the Service Policy

A service policy is defined in a service definition. The service definition defines the service policy and policy characteristics. You can set an additional attribute (**editable=true**) for policy properties in the service definition to allow the service request creator to override the policy attributes. Service orders and service requests use service definitions to define common data to be used during the provisioning process.

Use service definitions to create configuration parameters that can be used by multiple services. Prime Provisioning supports service policies for each of the service types (MPLS, L2VPN).

To create a service definition for most services, you need:

- Service definition name (**Name**)
- Service definition type (**Mpls, L2Vpn**)
- Service definition details (**ServiceDefinitionDetails**)—The service definitions details specify the policy information.

See the appropriate chapter on provisioning for more information on creating service policies for:

- [Template Service Definitions](#)
- [MPLS Service Definitions](#)
- [L2VPN Service Definitions](#).

## Creating the Service Order/Service Request

Service orders allow you to schedule a provisioning process and capture its history. Service orders are used to implement service requests. It is the service request that is provisioned and activated in the network. The service request defines attributes for the physical links and specifies the service policy (defined in a service definition) to use.

Use service orders to:

- Specify and implement one or more service requests, for batch operations
- Modify an existing service request
- Specify the order of implementation for service requests
- Initiate a task.

Service request deployment is scheduled based on the service order or service request due date. If the service order or any service requests within the service order has a due date in the future, it is placed in a schedule queue.

To schedule a service order, you need:

- Service order name (**ServiceName**)
- The number of requests (**NumberOfRequests**)
- The service request to implement (**ServiceRequest**)—The service request details specify the attribute and service policy information. You can specify one or more service requests.

## Service Order Response

The XML response to a service order contains its own **LocatorId** (required) and **ServiceName** (optional). If the service order is created to implement a service request, the service order response also contains the response to the service request, which includes the **LocatorId** (required) and the **ServiceRequestName** (optional).

If the service order is created to initiate a task (collect configurations, perform functional audits), the service order XML response also contains data. Use the Locator ID for subsequent requests relating to the service order or service request.

You can view any service order record using the **LocatorId** attribute. The response to a view request contains a **TaskLocatorId** attribute, which is used to track the status of any task created in conjunction with the service order. The **TaskLocatorId** attribute also allows you to view the task logs. See the [“Viewing Task Logs” section on page 5-24](#) for more information.

See the appropriate chapter on provisioning for more information on creating service orders.

## Performing a Configuration Audit

You can perform a configuration audit as part of a service request deployment or as a separate operation. During a configuration audit, Prime Provisioning verifies that all Cisco IOS commands are present and that they have the correct syntax. A configuration audit also verifies that there were no errors during service deployment.

A configuration audit is considered a task in the API and is executed with a service order. To schedule a configuration audit you need to specify:

- The type of audit you want to perform in the service request details (**SubType=CONFIG\_AUDIT**)
- Locator ID of the service request that was used to deploy the configuration to audit (**LocatorId**).



### Note

---

If the configuration audit is part of a service request deployment, you do not need to perform an audit as a separate operation.

---

Configuration Audits are described in the [“Tasks” section on page 3-9](#).



## Common APIs

---

This chapter describes the Cisco Prime Provisioning APIs for operations that are common to all Prime Provisioning services. These operations include; creating inventory in the Prime Provisioning repository, session login, auditing, deployment and collection tasks, database event notifications, and general purpose XML requests.

This chapter contains the following sections:

- [Inventory, page 3-1](#)
- [Devices, page 3-2](#)
- [Session, page 3-7](#)
- [Tasks, page 3-9](#)
- [General Purpose APIs, page 3-13](#)
- [Date/Time Format in API Requests, page 3-15](#)

## Inventory

You can create, modify, delete, or view any inventory object in the Prime Provisioning repository. Use the following API operations to:

- Create an object—`createInstance`
- Modify an object—`modifyInstance` (Resource pools do not support the *Modify* operation.)
- Delete an object—`deleteInstance`
- View an object—`enumerateInstances`



---

**Note** When you send a view request (**`enumerateInstances`**) for an object, the response returns the *create* and *modify* date information.

---

Inventory APIs are divided into the following categories:

- Devices—Physical devices in the network
- Resource Pools—IP address pools, VLAN pools, route target, route distinguisher
- Topology—CE routing communities (CERCs), virtual private networks (VPNs), and named physical circuits (NPCs)
- Groupings—Access domains, device groups, collection zones.



Note

XML examples for all APIs are available at: [Cisco Prime Provisioning API 7.0 Programmer Reference](#)

## Devices

The inventory APIs for devices allow you to define a physical device in the Prime Provisioning repository. Every network element that Prime Provisioning manages must be defined as a device in the system. An element is any device from which Prime Provisioning can collect configuration information.

[Table 3-1](#) shows the devices available as inventory objects.

**Table 3-1** *Inventory Objects—Devices*

className	Required Parameters	XML Examples
AAAServer	<ul style="list-style-type: none"> <li>• Number of Retries</li> <li>• Address</li> <li>• AuthServerType=               <ul style="list-style-type: none"> <li>– RADIUS</li> <li>– NTDOMAIN</li> <li>– SDI</li> <li>– TACACS+</li> </ul> </li> <li>• Role=               <ul style="list-style-type: none"> <li>– AUTHENTICATION</li> <li>– ACCOUNTING</li> <li>– BOTH</li> </ul> </li> </ul>	<ul style="list-style-type: none"> <li>• CreateAAAServer.xml</li> <li>• CreateAAAServerNTDOMAIN.xml</li> <li>• CreateAAAServerRADIUS.xml</li> <li>• CreateAAAServerSDI.xml</li> <li>• CreateAAAServerTACACS.xml</li> </ul>
CatOs (Cat OS operating system)	One or more of the following: <ul style="list-style-type: none"> <li>• ManagementIPAddress</li> <li>• HostName</li> <li>• DomainName</li> </ul>	CreateCat.xml
CatIOS (Cisco IOS operating system)	One or more of the following: <ul style="list-style-type: none"> <li>• ManagementIPAddress</li> <li>• HostName</li> <li>• DomainName</li> </ul>	CreateCatIOS.xml
CiscoRouter	One or more of the following: <ul style="list-style-type: none"> <li>• ManagementIPAddress</li> <li>• HostName</li> <li>• DomainName</li> </ul>	CreateCiscoRouter.xml
Cpe	<ul style="list-style-type: none"> <li>• Site</li> <li>• Device</li> <li>• Name</li> </ul>	CreateCpe.xml

Table 3-1 Inventory Objects—Devices (continued)

className	Required Parameters	XML Examples
PE	<ul style="list-style-type: none"> <li>• Device</li> <li>• Region</li> </ul>	CreatePE.xml
PIX	One or more of the following: <ul style="list-style-type: none"> <li>• ManagementIPAddress</li> <li>• HostName</li> <li>• DomainName</li> </ul>	CreatePIX.xml
TerminalServer	One or more of the following: <ul style="list-style-type: none"> <li>• ManagementIPAddress</li> <li>• HostName</li> <li>• DomainName</li> </ul>	CreateTerminalServer.xml
VPNServicesModule	<ul style="list-style-type: none"> <li>• Parent</li> <li>• SlotNumber</li> </ul>	CreateVPNSM.xml
IE2100	One or more of the following: <ul style="list-style-type: none"> <li>• IPAddress</li> <li>• HostName</li> <li>• DomainName</li> </ul>	CreateIE2100.xml
NonCiscoDevice	One or more of the following: <ul style="list-style-type: none"> <li>• ManagementIPAddress</li> <li>• HostName</li> <li>• DomainName</li> </ul>	CreateNonCiscoDevice.xml

## Resource Pools

Resource pools allow you to manage various pool types and to associate a pool with any service model object in the Prime Provisioning repository. Pools help to automate service deployment.

Prime Provisioning supports the following resource pools:

- IP address pools—Defined and assigned to regions.
- Multicast pools—Used for multicast MPLS VPNs.
- Route Distinguisher (RD) pool—The IP subnets advertised by the CPE devices to the PE devices are augmented with a 64-bit prefix, which is the route distinguisher.
- Route Target (RT) pool—The MPLS mechanism that informs PEs which routes to insert into the appropriate VPN routing and forwarding table (VRF). Every VPN route is tagged with one or more route targets when it is exported from a VRF and offered to other VRFs.
- Site-of-origin pool—The pool of values for the site-of-origin attribute. The site-of-origin attribute prevents routing loops when a site has multiple connections to the MPLS VPN backbone.
- VLAN ID pool—VLAN ID pools are attached to an access domain. To have Prime Provisioning automatically assign VLANs to end-to-end wire links (for L2VPN provisioning), you can specify the **AutoPickVlanId** option.

- VC ID pool—A 32-bit identifier that is shared between the two PEs. The VC ID is a globally unique value.

**Note**

The *Modify* operation is not supported with resource pools.

Table 3-2 shows the resource pools available as inventory objects.

**Table 3-2** *Inventory Objects—Resource Pools*

className	Required Parameters	XML Examples
IPAddressPool	<ul style="list-style-type: none"> <li>• IPAddressPool</li> <li>• SubnetMask</li> <li>• AssocClassType= <ul style="list-style-type: none"> <li>– Region</li> <li>– VPN</li> </ul> </li> </ul>	CreateIPAddressPool.xml
MulticastAddrPool	<ul style="list-style-type: none"> <li>• MulticastAddress</li> </ul>	CreateMulticastAddrPool.xml
RouteDistinguisher	<ul style="list-style-type: none"> <li>• Start</li> <li>• Size</li> <li>• AssocClassType=Provider</li> <li>• AssocClassId</li> </ul>	CreateRouteDistinguisher.xml
RouteTarget	<ul style="list-style-type: none"> <li>• Start</li> <li>• Size</li> <li>• AssocClassType=Provider</li> <li>• AssocClassId</li> </ul>	CreateRouteTarget.xml
SiteOfOrigin	<ul style="list-style-type: none"> <li>• Start</li> <li>• Size</li> <li>• AssocClassType=Provider</li> <li>• AssocClassId</li> </ul>	CreateSiteOfOrigin.xml
VcIdPool	<ul style="list-style-type: none"> <li>• Start</li> <li>• Size</li> </ul>	CreateVcIdPool.xml
VlanIdPool	<ul style="list-style-type: none"> <li>• Start</li> <li>• Size</li> <li>• AssocClassType=Provider</li> <li>• AssocClassId</li> </ul>	CreateVlanIdPool.xml

## Topology

In complex topologies, it is sometimes necessary to further define the connectivity between CE and PE devices into groups, such as CE routing communities (CERCs), virtual private networks (VPNs), and named physical circuits (NPCs).





Tip

Use the Topology tool in the GUI to check CERC memberships and the resulting VPNs.

Table 3-3 shows the topology elements available as Prime Provisioning inventory objects.

**Table 3-3** *Inventory Objects—Topology*

className	Required Parameters	XML Examples
CERC	<ul style="list-style-type: none"> <li>Provider</li> </ul>	<ul style="list-style-type: none"> <li>CreateCERC.xml</li> </ul> <p><b>Note</b> The CreateCERC.xml appends the route target values, if a CERC already exists with the same name. To ensure uniqueness of CERC names, use ViewCERC.xml to verify that a CERC with the same name does not exist.</p> <ul style="list-style-type: none"> <li>CreateVPN_DefaultCERC.xml</li> </ul>
VPN	<ul style="list-style-type: none"> <li>Name</li> <li>Organization</li> </ul>	<ul style="list-style-type: none"> <li>CreateVPN.xml</li> </ul>
NamedPhysicalCircuit	<ul style="list-style-type: none"> <li>PhysicalLink               <ul style="list-style-type: none"> <li>SrcDevice</li> <li>DestDevice</li> <li>SrcIfName</li> <li>DestIfName</li> </ul> </li> </ul>	<ul style="list-style-type: none"> <li>CreateNamedPhysicalCircuit.xml</li> </ul>
NamedPhysicalCircuitRing	<ul style="list-style-type: none"> <li>LocatorId</li> </ul>	<ul style="list-style-type: none"> <li>CreateNamedPhysicalCircuitRing.xml</li> <li>CreateNamedPhysicalCircuitRingExisting.xml</li> </ul>



Tip

Use **ViewVRF.xml** to view the VRF routing tables.

## Groupings

Prime Provisioning is designed to provision a large number of devices through its distributed architecture. Groupings are provided to simplify management tasks of devices for administrative or geographical reasons or for scalability.

- Access domain—The access domain object is associated with the provider access domain (PAD). Each PE-POP is assigned to an access domain.
- Device groups—Devices that are organized for collection and management purposes.
- Organization (Customer)—A requestor of VPN services from an Internet service provider (ISP).
- Site—A set of IP systems with mutual IP connectivity between them without the use of a VPN.
- Provider—An enterprise that provides internet services for customers.

- **Region**—A group of PE devices within a single border gateway protocol autonomous system (BGP AS).
- **Collection zones**—Collection servers are used to off load the work of the master server when the number of devices in the network increases. Network devices are associated with these collection servers using collection zones.

Table 3-4 shows the groupings as inventory objects.

**Table 3-4** *Inventory Objects—Groupings*

className	Required Parameters	XML Examples
AccessDomain	<ul style="list-style-type: none"> <li>• Provider</li> <li>• ReservedVlanPool               <ul style="list-style-type: none"> <li>– Start</li> <li>– Size</li> <li>– Managed</li> </ul> </li> </ul>	CreateAccessDomain.xml
DeviceGroup	<ul style="list-style-type: none"> <li>• Name</li> <li>• Devices</li> </ul>	CreateDeviceGroup.xml
Organization	<ul style="list-style-type: none"> <li>• Name</li> <li>• ContactInfo</li> <li>• SiteOfOrigin=enabled (use for multiple connections to the MPLS backbone)</li> </ul>	CreateOrganization.xml
Site	<ul style="list-style-type: none"> <li>• Name</li> <li>• Customer</li> </ul>	CreateSite.xml
Provider	<ul style="list-style-type: none"> <li>• Name</li> <li>• AsNumber</li> </ul>	CreateProvider.xml
Region	<ul style="list-style-type: none"> <li>• Name</li> <li>• Provider</li> </ul>	CreateRegion.xml

**Table 3-4** *Inventory Objects—Groupings (continued)*

className	Required Parameters	XML Examples
CollectionZone	<ul style="list-style-type: none"> <li>• Name</li> <li>• VPNSCHost</li> </ul>	CreateCollectionZone.xml
NetworkObject	<ul style="list-style-type: none"> <li>• Name</li> <li>• Type= <ul style="list-style-type: none"> <li>– STRING</li> <li>– NETWORK</li> <li>– HOST</li> </ul> </li> <li>• Values</li> <li>• ContainerId</li> <li>• FQCN (container type) <ul style="list-style-type: none"> <li>– Global</li> <li>– Customer</li> <li>– Site</li> <li>– Cpe</li> </ul> </li> </ul>	CreateNetworkObject.xml

## Session

Sessions are specialized API operations. Prime Provisioning supports the following session operations:

- createSession—Login
- deleteSession—Logout

The first XML request sent by the client is a login request. The login request generates a session ID, which is used each time you access the system. The session ID is valid for a configurable period of time. During this time, you can make an indefinite amount of calls to the server, using the session ID for authentication. Each call to the server resets the time-to-live (ttl) time back to the original period of time. The default session time is 20 minutes.

The API license is global to the installation and is checked at the start of each session. If the API license does not exist, the session is not granted. During the session, if a user attempts to provision a service that is not licensed, an error is returned.

**Table 3-5** *User Login*

className	Required Parameters	XML Examples
Session	<ul style="list-style-type: none"> <li>• LoginName</li> <li>• LoginPassword</li> </ul>	Login.xml (\$PRIMEF_HOME/resources/nbi/xml/examples/Session/Login.xml)

## Create Session Example

The following example shows the XML response to a login request. The **SessionId** is indicated in **bold**.

```
<?xml version="1.0" encoding="UTF-8"?>
<soapenv:Envelope xmlns:soapenv="http://schemas.xmlsoap.org/soap/envelope/"
xmlns:soapenc="http://schemas.xmlsoap.org/soap/encoding/"
xmlns:xsd="http://www.w3.org/2001/XMLSchema"
xmlns:xsi="http://www.w3.org/2001/XMLSchema-instance"
xmlns:ns0="http://www.cisco.com/cim-cx/2.0" xmlns:ns1="urn:CIM">
  <soapenv:Header>
    <ns0:message id="87855" timestamp="2013-10-10T19:43:16.380Z"
sessiontoken="93E0A400406693604270C6B6A07731A4" />
  </soapenv:Header>
  <soapenv:Body>
    <ns1:createSessionResponse>
      <returns xsi:type="ns1:CIMPropertyList" soapenc:arrayType="ns1:CIMProperty[]">
        <item xsi:type="ns1:CIMProperty">
          <name xsi:type="xsd:string">SessionId</name>
          <value xsi:type="xsd:string">93E0A400406693604270C6B6A07731A4</value>
        </item>
      </returns>
    </ns1:createSessionResponse>
  </soapenv:Body>
</soapenv:Envelope>
```

## Delete Session Example

The following example shows the XML response to a logout request. The **SessionId** is indicated in **bold**.

```
<?xml version="1.0" encoding="UTF-8"?>
<soapenv:Envelope
xmlns:soapenv="http://schemas.xmlsoap.org/soap/envelope/"
xmlns:soapenc="http://schemas.xmlsoap.org/soap/encoding/"
xmlns:xsd="http://www.w3.org/2001/XMLSchema"
xmlns:xsi="http://www.w3.org/2001/XMLSchema-instance"
xmlns:ns0="http://www.cisco.com/cim-cx/2.0"
xmlns:ns1="urn:CIM">
  <soapenv:Header>
    <ns0:message id="87855" timestamp="2013-12-13T14:55:38.885Z"
sessiontoken="D31B83292511721301233D3BB28F2C30" />
  </soapenv:Header>
  <soapenv:Body>
    <ns1:deleteSession>
      <objectPath xsi:type="ns1:CIMObjectPath">
        <className xsi:type="xsd:string">Session</className>
      </objectPath>
    </ns1:deleteSession>
  </soapenv:Body>
</soapenv:Envelope>
```

# Tasks

Task APIs are used for auditing, deployment, and collection activities. Tasks follow the same service order/service request structure as other Prime Provisioning services, where the service request is executed as part of a service order.

- For device-related tasks (Collection and SLA Collection), you must enter the device or device group.
- For service request-related tasks (Certificate Enrollment Audit, Configuration Audit, Service Deployment, and MPLS Functional Audits), you must enter the service request Locator ID.

Tasks are scheduled using the **DesiredDueDate** field in the service request or service order. A task with a **DesiredDueDate** that is in the past, or within 5 minutes of the current time, is executed immediately. Tasks with due dates in the future are scheduled.

Prime Provisioning uses the following guidelines for **DesiredDueDate**

- If there is no due date in the service request, the task uses the service order due date.
- If there is a date in the service request, the service request due date overrides the service order due date for that particular task.
- If there is no due date specified in the service order or the service request, the service is not deployed.

Tasks can be created, deleted, and viewed using the API. However, you can only modify the **DesiredDueDate** field in a Task.

All Tasks are deployed using a service order that specifies a service request with **Type=Task**.

## Viewing a Task

To obtain information about task service requests, run a view of the task (ViewTask.xml), using the **TaskLocatorId**.

Use this process to retrieve the **TaskLocatorId**:

- 
- |               |   |
|---------------|---|
| <b>Step 1</b> | Record the service order <b>LocatorId</b> that is returned in the XML response.<br>When you submit a service order XML request for any task, Prime Provisioning returns a <b>LocatorId</b> in the XML response. This Locator ID is associated with the service order or request <b>Name</b> . |
| <b>Step 2</b> | Run a view of the service order using ViewServiceOrder.xml, and the <b>LocatorId</b> from Step 1.   |
| <b>Step 3</b> | Record the <b>TaskLocatorId</b> that is returned in the XML response.   |
| <b>Step 4</b> | Run a view of the Task using ViewTask.xml. Specify <b>className=PersistentTask</b> and use the <b>TaskLocatorId</b> from Step 3.  |
- 

The API supports the following tasks:

- [Certificate Enrollment Audit](#)
- [Collection](#)
- [Service Decommission](#)
- [Configuration Audit](#)
- [Service Deployment](#)

- [MPLS Functional Audit](#)
- [MPLS Functional Audit](#)
- [SLA Collection](#)

## Certificate Enrollment Audit

A certificate enrollment audit is performed on devices to verify the certificates issued to them by a certificate authority (CA).

A certificate enrollment audit does the following:

- Verifies the certificates issued by the CA to a device or device groups.
- Confirms the presence of the root certificate and device certificate for the certificate chain of the specified trust point.
- Returns a summary that indicates the certificate enrollment status and expiration status on the audited devices.

**Table 3-6** Certificate Enrollment Task

className	Required Parameters	XML Examples
ServiceRequestDetails	<ul style="list-style-type: none"> <li>• SubType= CERT_ENROLLMENTAUDIT</li> <li>• Device (or DeviceGroup)</li> <li>• TrustedPort</li> <li>• IncludeRootCert</li> </ul>	CreateTaskServiceOrderCertAudit.xml

## Collection

A collection operation collects configuration information from network devices and serves the following purposes:

- It loads the current configuration information for the devices that populate many of the configuration cells.
- It verifies reachability and passwords for the devices from which it collects configuration files.

**Table 3-7** Collection Task

className	Required Parameters	XML Examples
ServiceRequestDetails	<ul style="list-style-type: none"> <li>• SubType=COLLECTION</li> <li>• Device (or DeviceGroup)</li> </ul> <p><b>Note</b> You must select at least one device or device group.</p> <ul style="list-style-type: none"> <li>• RetrieveVersion=true</li> <li>• RetrieveDeviceInterface=true</li> </ul>	Create TaskServiceOrderCollection.xml

**Tip**

Performing a device collection on your network is more accurate and efficient than manually entering individual device information.

## Service Decommission

Decommissioning a service request removes a service from all devices associated with the service request.

**Note**

To decommission a service request that includes templates, you must first negate the template information on the device. See the [“Removing Template Configurations” section on page 4-22](#) for more information.

During the decommission process, Prime Provisioning creates the necessary removal configuration to delete the service from each device and automatically audits the configuration to ensure that the service is completely removed. Once audited, the service request changes to a *Closed* state.

**Table 3-8**      *Decommission Task*

className	Required Parameters	XML Examples
ServiceRequestDetails	<ul style="list-style-type: none"> <li>SubType=DECOMMISSION</li> <li>LocatorId</li> </ul> <p><b>Note</b>    The <b>LocatorId</b> of the service request to decommission.</p>	CreateTask ServiceOrderDecommission.xml

If you do not want the configuration audit to occur, change the value for the **Audit** parameter. The **Audit** parameter supports these values:

- **Audit**—This is the default. A successfully deployed decommission service request is automatically audited unless this flag is changed.
- **NoAudit**—Do not perform a configuration audit when the decommission service request is deployed.
- **ForceAudit**—Perform a configuration audit even if the deployment of the decommission service request is not successful.

## Configuration Audit

A configuration audit is executed as part of a service request deployment. During a configuration audit, Prime Provisioning verifies that all Cisco IOS commands are present and that they have the correct syntax. A configuration audit also verifies that there were no errors during service deployment.

**Table 3-9 Configuration Audit Task**

className	Required Parameters	XML Examples
ServiceRequestDetails	<ul style="list-style-type: none"> <li>SubType=CONFIG_AUDIT</li> <li>LocatorId</li> </ul> <p><b>Note</b> The <b>LocatorId</b> of the service request used to deploy the configlets.</p>	CreateTask ServiceOrderConfigAudit.xml

## Service Deployment

A service deployment downloads the Prime Provisioning-generated configlet, created for a service order, to the device configuration file.

You can specify the following options for service deployment:

- ForceDeploy**—Takes a configlet for a service request that is already in the *Deployed* state and downloads it to the network device. Use **ForceDeploy** when a device configuration is lost or when you replace or change equipment.

**Table 3-10 Deployment Task**

className	Required Parameters	XML Examples
ServiceRequestDetails	<ul style="list-style-type: none"> <li>SubType=DEPLOYMENT</li> <li>Provision</li> <li>LocatorId</li> </ul> <p><b>Note</b> The <b>LocatorId</b> of the service request used to deploy the configlets.</p>	Create TaskServiceOrderDeployment.xml

## MPLS Functional Audit

An MPLS functional audit verifies that the links in a service request or VPN are working correctly. The audit checks the routes to remote CPE devices in the VRF route tables on the PE devices.

**Table 3-11 MPLS Functional Audit Task**

className	Required Parameters	XML Example
ServiceRequestDetails	<ul style="list-style-type: none"> <li>SubType=MPLS_FUNCTIONALAUDIT</li> <li>LocatorId</li> </ul> <p><b>Note</b> The <b>LocatorId</b> of the service request used to deploy the configlets.</p> <ul style="list-style-type: none"> <li>VPN</li> <li>MPLSMirrorPing</li> </ul>	CreateTask ServiceOrderMPLSFuncAudit.xml



## SLA Collection

Prime Provisioning uses the Cisco SA Agent MIB to monitor service level agreement (SLA) metrics. SLAs monitor the network performance by measuring response time, jitter, connect time, throughput, and packet loss. The SA Agent allows you to configure probes for performance measurements and uses a router monitor (RTRMON) MIB for access through SNMP. The MIB also supports SNMP notifications.

An SLA collection task collects all SLA data from SLA-enabled devices. Prime Provisioning collects the relevant performance data and stores it persistently in the database. To view the data, you must execute a task to aggregate the data and run the SLA Report.



### Note

To collect SLA data from a device, it must have SA Agent and SNMP enabled, and SNMP parameters must already be set.

SLA collection includes performance data on Jitter (voice jitter) and the following protocols:

- Dynamic Host Configuration Protocol (DHCP)
- Domain Name System (DNS)
- File Transfer Protocol (FTP)
- Internet Control Message Protocol Echo (ICMP Echo)
- Transmission Control Protocol Connect (TCP Connect)
- User Datagram Protocol Echo (UDP Echo)
- Hypertext Transfer Protocol (HTTP)

**Table 3-12** SLA Collection Task

className	Required Parameters	XML Example
ServiceRequestDetails	<ul style="list-style-type: none"> <li>• SubType=SLA_COLLECTION</li> <li>• Device (or DeviceGroup)</li> </ul> <p><b>Note</b> You must select at least one device or device group.</p>	CreateTask ServiceOrderSLACollection.xml

## General Purpose APIs

The following general purpose API XML examples are provided with Prime Provisioning:

- CreateConfigServiceOrderDownload—Creates a service order to download an inline configuration to a device.
- Create Inventory—Can be used to populate a database with sample inventory and is commonly used for testing or demonstration. The service order adds one type of each inventory element to the repository and enters the host name, domain name, management IP address, and the login and password for each device.
- CreateNPCInventory—Creates several physical links in a network, including the source and destination devices and relevant interfaces.
- CreateExecCommandServiceOrder—Creates a service order to execute a command on a device or device group. You can execute any command allowed by the device console.

- **CreateServiceOrderResponse**—Returns the following values for a service order:
  - **ServiceName** (for the service order)
  - **ServiceRequestName**
  - **LocatorId** (for the service request)
- **CreateSLAInventory**—Can be used to populate a database with sample inventory and is commonly used for testing. The service order adds the host name, domain name, and SLA data to devices in device groups.
- **CreateResourceLock\_Device**, **CreateResourceLock\_Device\_Batch**, **CreateResourceUnlock\_Device**, **ViewResourceLock\_Device**—See the “[Device Locking](#)” section on [page 5-22](#).
- **DeleteServiceOrder**—Deletes a service order.
- **DeleteServiceOrder\_purge**—Deletes a service request of a specified subtype (**Type = L2VPN, Mpls**), with a given Locator ID and **Force=true**.
- **ViewConfiglet**—View the Prime Provisioning generated configlet for a specified service request. Returns the **ViewConfigletResponse**.
- **ViewConfigletResponse**—Returns the following values:
  - **ConfigletClob**
  - **LocatorId**
  - **Device**
  - **ConfigletText**—Contains the configlet.
- **ViewConfiguration**—View the configuration of a specified device. Returns the **ViewConfigurationResponse**.
- **ViewConfigurationResponse**—Returns the following values:
  - **LocatorId**
  - **Device**
  - **DeviceConfig**—Contains the device configuration.
- **ViewCpe\_propList\_level**—Provides a sample of a properties list and level usage. Returns the **ViewCpe\_propList\_level\_Response**.
- **ViewCpe\_propList\_level\_Response**—Returns the following values:
  - **LocatorId**
  - **Site**
  - **Device**
- **ViewMPLSServiceRequest\_propList\_level**—Provides a sample of a properties list and level usage. Returns the **ViewMPLSServiceRequest\_propList\_level\_Response**.
- **ViewMPLSServiceRequest\_propList\_level\_Response**—Returns the following values:
  - **OpType** (operation type; ADD or DELETE)
  - **LocatorId**
  - **MplsVpnLink** (and link attributes)
  - **CERCMembership**

- **ViewServiceOrder**—View the status of any service order, with a given service order name or Locator ID. If the service order employs a task, the task locator ID is returned. The **TaskLocatorId** is required to view a task service order (**ViewTask**).

## Date/Time Format in API Requests

For all API requests where the date and time needs to be specified, the zulu format is used. Zulu is the military designation for "Greenwich Mean Time."

Use the following format: 2011-03-17T15:05:38.885Z

Local time cannot be specified. Therefore, outside the UK any time difference has to be taken into consideration.

In the current format, the desired due date has to be followed by "Z", which means that the task will be executed one hour after the specified date.

So for example, when the clock is moved back one hour in the UK in October, the Zulu time will be equal to the UK time.





## Using Templates

---

Cisco Prime Provisioning uses templates to generate device commands that are not supported by Prime Provisioning, and to download them to a Cisco device. For example, Prime Provisioning does not configure importing of root certificates. A template enables you to add this configuration to a device. A template configuration file can be either a partial or complete configuration file. The template configuration file is merged with (either appended or prepended to) the Prime Provisioning configlet. The combined configlet is downloaded to the device as part of a service request or as a transient template.

Templates are defined in service definitions and can be deployed:

- Using a service order.
- Attached to a service request for another service (see the [“Templates in a Service Request” section on page 4-18](#)).

You can use the API to generate template definitions, template data, and device configlets based on the templates.

This chapter contains the following sections:

- [Introduction to Templates in Prime Provisioning, page 4-1](#)
- [Template Operations, page 4-3](#)
- [Provisioning Example, page 4-12](#)
- [Templates in a Service Request, page 4-18](#)
- [Removing Template Configurations, page 4-22](#)

See the [Cisco Prime Provisioning 6.8 User Guide](#) for information on the GUI Template Manager.

For further information about templates from an MPLS provisioning perspective, see the template information in the MPLS part of the [Cisco Prime Provisioning 6.8 User Guide](#).

## Introduction to Templates in Prime Provisioning

Templates consist of template definitions and template data. The template definition contains the logic and variables to be populated with template data. The template data is the configuration information to be downloaded to a device. When Prime Provisioning merges the template definition’s variables with the data in the template data file, a template configuration file is created. The template configuration file is downloaded to the device.

Templates can be deployed independently of other Prime Provisioning functions or they can be attached to a service request.

The API supports the following types of template operations:

- Templates created from a template definition and a data file.
- Buffer templates—Template data is pulled from a data buffer instead of a data file and inserted directly into a service request (only for MPLS service requests).
- Templates integrated as part of a service request—The service request specifies the device to receive the configuration (the template definition and template data method).
- Transient templates—Transient template data is used only for the download and then discarded. It is not available for subsequent viewing (only for direct template download service requests).

Template definition files and template data files are stored in XML format. The template definition file, its data files, and all resulting template configuration files are mapped to a single directory. One template definition can contain many data files, but a template data file can be attached to only one template definition.



Tip

---

When you generate a template configuration file using a particular template data file, the configuration filename correlates to the data filename.

---

To view the interaction between the template and the device, use the task logs. See the [“Viewing Task Logs” section on page 5-24](#) for more information.

## Template Definition

The template definition defines the variables that are populated with template data. It defines the actions that need to be taken for any device to which the template is attached.

The template definition specifies what data is necessary to create the template configuration file, and includes how the variable names and the data are associated.



Note

---

The template definition in the API corresponds to the template in the GUI.

---

## Template Data

The template data consists of name/value pairs for each variable defined in the template definition. Each template data file can be associated with only one template definition.

Template data can be created using the GUI or the API. The data can exist in a template data file, be merged with a template definition from a data buffer, or be entered as transient data directly into a service request.

Creating a template data file is a separate operation. However, if you use transient data or data buffers, this allows you to enter template data at the same time you are creating the service definition or service request.

The data file contains data for all variables in the template definition.



Note

---

To view the configuration created using a template, without downloading the template to the device, use the ViewTemplateConfig XML request. Specify the template definition and template data, and the configuration is returned in the XML response.

---

## Dynamic Instantiation of Templates

A template using other templates is called a super template. The template being used by another template is called a subtemplate.

This section describes how super and subtemplate templates work and their limitations.

The super template instantiates all required subtemplates by passing values for the variables in the subtemplate. After instantiation, the super template puts the configlets generated for the subtemplate into the super template.

The subtemplate will have optional device attributes. These can be attached to a policy or a service request. During deployment, the super template will pick one of the subtemplates based on real-time link details. Prime Provisioning branches templates into subtemplates based on device type, line card type, port type, role type, and software versions. These optional attributes are set while creating the subtemplates. The subtemplates are selected based on the following matching criteria:

- Only exact matches are recognized for the card type and port type attributes. No wild card match is allowed for these attributes.
- Only an exact match is recognized for the device type attribute.
- For the software version attribute, the match is done for a software version equal to the current version, if available. If not, the previous highest version is matched.
- If none of the attributes are matched, then the default subtemplate is applied.
- If no default subtemplate exists, a subtemplate with all null attribute values is matched.
- If no match occurs, then no subtemplate is used. A warning message is displayed.

Furthermore, super templates and subtemplates are characterized by the following:

- Only one level of subtemplate is supported, but there are no checks for depth of subtemplates.
- No validations occur to check if super template and subtemplate structure is cyclic.
- When you try to delete a subtemplate that is referenced by a super-template, a warning message appears. You can modify a subtemplate.
- Subtemplates can be attached to multiple super templates.
- Only one subtemplate will be picked for a super template.
- Datafiles are not supported for subtemplates. If multiple datafiles are found, the first available datafile is chosen based on the alphabetic sorting during deployment.

An overview of available template operations is provided in [Overview of Template Operations, page 4-4](#).

For more information on the process of selecting subtemplates in Prime Provisioning, see the [Cisco Prime Provisioning 6.8 User Guide](#).

## Template Operations

Prime Provisioning's template features allows you to perform a number of basic operations, policy-level operations, and service-level operations. Doing this requires a variety of subtypes, service definitions, and service orders.

This section describes the following:

- [Overview of Template Operations, page 4-4](#)
- [Template Subtypes, page 4-4](#)

- [Template Service Definitions, page 4-5](#)
- [Template Service Orders, page 4-5](#)
- [Examples of Template Operations, page 4-6.](#)

## Overview of Template Operations

The following template operations are available in Prime Provisioning. Examples of a selection of these operations are provided in [Examples of Template Operations, page 4-6](#).

### Basic Template Manager Functions

- Create templates and negate templates for different configurations.
- Specify device attributes for the templates.
- Associate subtemplates to templates, if applicable
- Create data files for the subtemplates.
- Create a negate template for each subtemplate.
- Create data files for the negate templates.
- Create a super template and attach subtemplates to it.

### Policy-Level Template Functions

- Create a policy and enable template support for the policy.
- Associate templates to the policy, if desired.

### Service-Level Template Functions



---

**Note** When a policy is only associated with a template and no data file, then during creation of a service request using that policy, the selection of a data file for that template takes place, if the template has only one data file.

---

- Create a service request and associate template(s) to a link.
- Deploy the service request on a device (for example, a 7600).
- The subtemplate and corresponding data file for the 7600 are autoselected for deployment.
- A configlet is generated from the subtemplate.
- Decommission the service request.
- The negate template for the subtemplate is autoselected and deployed.

## Template Subtypes

Template definitions and template data files are specified in a service definition. The device to receive the template configuration and transient data and data buffers (if applicable) are defined in the service request as part of a service order.



The API supports these template subtypes:

- **TemplateDefinition**—The template itself, which contains the variables and logic to be populated with template data.
- **TemplateData**—The data to be merged with a template definition.
- **TemplateConfig**—The template configlet that is the result of the template definition being merged with the template data.
- **TemplateDownload**—Used to download a template configlet to a device using template data from a data file.
- **TemplateTransient**—Used to download a template configlet to a device using template data that is added directly into the XML request.
- **TemplateFolder**—Used to create or delete a template folder.

The following template operations can be executed using the API:

- For service definition subtypes:
  - **TemplateDefinition**—Create, Delete, Modify, or View
  - **TemplateData**—Create, Delete, Modify, or View.
- For service request subtypes:
  - **TemplateConfig**—Create, Modify, or View
  - **TemplateDownload**—Create, Delete, Modify, or View
  - **TemplateDataTransient**—Create or View.

## Template Service Definitions

Using service definitions to define templates enables the XML requests to be processed the same as other service policies (MPLS, and L2VPN) and allows them to be specified in service orders.

A template service definition consists of a template definition and the corresponding template data items. The template definition specifies the variable names and logic in the **BodyText** property.

Figure 4-1 shows the schema diagram for a template service definition. The *item* refers to the template definition, and the *name/value* pairs refer to the template data.

Figure 4-1 Schema Diagram for Template Service Definitions

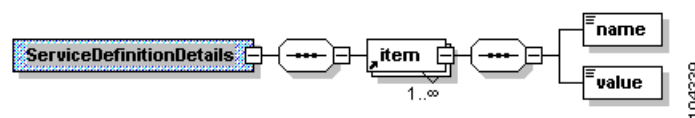

## Template Service Orders

A template is implemented using a service order. During a service request deployment, the template definition and data file are merged, and the resulting configuration is appended or prepended to the Prime Provisioning-generated configlet. The combined configuration is downloaded to the device specified in the service request.

If the template is:

- **Prepended**—The template commands take place before the service request commands.
- **Appended**—The template commands take place after the service request commands.

Service orders can specify template downloads, transient data downloads, and templates specified within a service request.

To view a template service order:

- For templates that specify a data file, only the data file name is listed in the service request. Viewing the data file is a separate operation.
- For templates that specify a data buffer, the data is displayed within the service request. Template data buffers can only be viewed by viewing the service request. Use the **enumerateInstances** operation and enter the **LocatorId** of the service request that contains the template data buffers.

## Examples of Template Operations

This section contains the following examples of template operations:

- [Adding New Templates, page 4-6](#)
- [Setting Up Optional Template Attributes, page 4-8](#)
- [Creating Negate Templates, page 4-8](#)
- [Creating Templates in Policies \(N-PE\), page 4-10](#)
- [Creating Datafile from Service Request, page 4-11.](#)

## Adding New Templates

When the original template information is disabled and removed from the device, you can add new template information using:

- A **createInstance** to create the service order to modify the service request.
- A **modifyInstance** to modify the service request and service request details.
- A **createInstance** subaction to add the new template.

You are not required to create a new service order to add new templates. In one modify service request, you can turn off templates, add negate templates, and add new templates. However, you must keep the correct order of operations (turn off, add negate, then add new). This is described in more detail in [Modifying a Service Request, page 4-23](#).

See the following example:

```
<ns1:performBatchOperation>
  <actions xsi:type="ns1:CIMActionList"
    soapenc:arrayType="ns1:CIMAction[]" >
    <action>
      <actionName xsi:type="xsd:string">createInstance</actionName>
      <objectPath xsi:type="ns1:CIMObjectPath">
      <className xsi:type="xsd:string">ServiceOrder</className>
      <properties xsi:type="ns1:CIMPropertyList"
        soapenc:arrayType="ns1:CIMProperty[]" >
        <item xsi:type="ns1:CIMProperty">
          <name xsi:type="xsd:string">ServiceName</name>
          <value xsi:type="xsd:string">Acme-Template1</value>
        </item>
```

```

<item xsi:type="ns1:CIMProperty">
  <name xsi:type="xsd:string">CarrierId</name>
  <value xsi:type="xsd:string">22</value>
</item>
<item xsi:type="ns1:CIMProperty">
  <name xsi:type="xsd:string">DesiredDueDate</name>
  <value xsi:type="xsd:dateTime">2002-12-13T14:55:38.885Z</value>
</item>
<item xsi:type="ns1:CIMProperty">
  <name xsi:type="xsd:string">Organization</name>
  <value xsi:type="xsd:dateTime">NbiCustomer</value>
</item>
<item xsi:type="ns1:CIMProperty">
  <name xsi:type="xsd:string">NumberOfRequests</name>
  <value xsi:type="xsd:string">1</value>
</item>
</properties>
</objectPath>
</action>
<action>
  <actionName xsi:type="xsd:string">modifyInstance</actionName>
  <objectPath subAction="modifyInstance" xsi:type="ns1:CIMObjectPath">
    <className xsi:type="xsd:string">ServiceRequest</className>
    <properties xsi:type="ns1:CIMPropertyList"
      soapenc:arrayType="ns1:CIMProperty[]">
      <item xsi:type="ns1:CIMProperty">
        <name xsi:type="xsd:string">RequestName</name>
        <value xsi:type="xsd:string">Templatel</value>
      </item>
      <item xsi:type="ns1:CIMProperty">
        <name xsi:type="xsd:string">Type</name>
        <value xsi:type="xsd:string">Mpls</value>
      </item>
    </properties>
    <objectPath subAction="modifyInstance" xsi:type="ns1:CIMObjectPath">
      <className xsi:type="xsd:string">ServiceRequestDetails</className>
      <keyProperties xsi:type="ns1:CIMKeyPropertyList"
        soapenc:arrayType="ns1:CIMKeyProperty[]">
        <item xsi:type="ns1:CIMProperty">
          <name xsi:type="xsd:string">LocatorId</name>
          <value xsi:type="xsd:string">36</value>
        </item>
      </keyProperties>
      <objectPath subAction="modifyInstance" xsi:type="ns1:CIMObjectPath">
        <className xsi:type="xsd:string">MplsVpnLink</className>
        <keyProperties xsi:type="ns1:CIMKeyPropertyList"
          soapenc:arrayType="ns1:CIMKeyProperty[]">
          <item xsi:type="ns1:CIMProperty">
            <name xsi:type="xsd:string">LocatorId</name>
            <value xsi:type="xsd:string">33</value>
          </item>
        </keyProperties>
        <properties xsi:type="ns1:CIMPropertyList"
          soapenc:arrayType="ns1:CIMProperty[]">
        </properties>
        <objectPath subAction="modifyInstance" xsi:type="ns1:CIMObjectPath">
          <className xsi:type="xsd:string">LinkAttrs</className>
          <keyProperties xsi:type="ns1:CIMKeyPropertyList"
            soapenc:arrayType="ns1:CIMKeyProperty[]">
          </keyProperties>
          <properties xsi:type="ns1:CIMPropertyList"
            soapenc:arrayType="ns1:CIMProperty[]">
          </properties>
        </objectPath>
      </objectPath>
    </keyProperties>
  </objectPath>
</action>

```

```

<objectPath subAction="createInstance" xsi:type="ns1:CIMObjectPath">
  <className xsi:type="xsd:string">LinkTemplate</className>
  <keyProperties xsi:type="ns1:CIMKeyPropertyList"
    soapenc:arrayType="ns1:CIMKeyProperty[]">
    <item xsi:type="ns1:CIMProperty">
      <name xsi:type="xsd:string">LogicalDevice</name>
      <value xsi:type="xsd:string">PE-POP1</value>
    </item>
    <item xsi:type="ns1:CIMProperty">
      <name xsi:type="xsd:string">DatafilePath</name>
      <value xsi:type="xsd:string">/Examples/templ4-enable</value>
    </item>
  </keyProperties>
  <properties/>
  <!-- objectPath xsi:type="ns1:CIMObjectPath">
<className xsi:type="xsd:string">DataBuffer</className>
<properties xsi:type="ns1:CIMPropertyList"
  soapenc:arrayType="ns1:CIMProperty[]">
  <item xsi:type="ns1:CIMProperty">
    <name xsi:type="xsd:string">DLCI</name>
    <value xsi:type="xsd:string">20</value>
  </item>

```

## Setting Up Optional Template Attributes

In the following example, a template is created with optional device-specific attributes.

```

<objectPath xsi:type="ns1:CIMObjectPath">
  <className xsi:type="xsd:string">TemplateAttributes</className>
  <properties xsi:type="ns1:CIMPropertyList"
    soapenc:arrayType="ns1:CIMProperty[]">

  <item xsi:type="ns1:CIMProperty">
    <name xsi:type="xsd:string">DeviceType</name>
    <value xsi:type="xsd:string">7600</value>
  </item>
  <item xsi:type="ns1:CIMProperty">
    <name xsi:type="xsd:string">CardType</name>
    <value xsi:type="xsd:string">7600-ES20-D3C</value>
  </item>
  <item xsi:type="ns1:CIMProperty">
    <name xsi:type="xsd:string">PortType</name>
    <value xsi:type="xsd:string">Gigabit12</value>
  </item>
  <item xsi:type="ns1:CIMProperty">
    <name xsi:type="xsd:string">SoftwareVersion</name>
    <value xsi:type="xsd:string">13.2.0</value>
  </item>
</properties>
</objectPath>

```

## Creating Negate Templates

In Prime Provisioning, a template is removed by way of negate templates. These have to be created one time for each template and will then be selected automatically if present. No manual intervention is required. If there are no negate templates, the template commands are not removed.

In the following example, a negate template is created.

```

<objectPath xsi:type="ns1:CIMObjectPath">
  <className xsi:type="xsd:string">NegateTemplate</className>
  <properties xsi:type="ns1:CIMPropertyList"
    soapenc:arrayType="ns1:CIMProperty[]">

    <item xsi:type="ns1:CIMProperty">
      <name xsi:type="xsd:string">Description</name>
      <value xsi:type="xsd:string">A template definition for negate template.</value>
    </item>

    <item xsi:type="ns1:CIMProperty">
      <name xsi:type="xsd:string">BodyText</name>
      <value xsi:type="xsd:string"> user $name </value>
    </item>
  </properties>
  <objectPath xsi:type="ns1:CIMObjectPath">
    <className xsi:type="xsd:string">TemplateString</className>
    <properties xsi:type="ns1:CIMPropertyList"
      soapenc:arrayType="ns1:CIMProperty[]">
      <item xsi:type="ns1:CIMProperty">
        <name xsi:type="xsd:string">Dimension</name>
        <value xsi:type="xsd:string">0</value>
      </item>
      <item xsi:type="ns1:CIMProperty">
        <name xsi:type="xsd:string">VariableName</name>
        <value xsi:type="xsd:string">name</value>
      </item>
      <item xsi:type="ns1:CIMProperty">
        <name xsi:type="xsd:string">MinLength</name>
        <value xsi:type="xsd:string">5</value>
      </item>
      <item xsi:type="ns1:CIMProperty">
        <name xsi:type="xsd:string">Required</name>
        <value xsi:type="xsd:string">true</value>
      </item>
      <item xsi:type="ns1:CIMProperty">
        <name xsi:type="xsd:string">AvailableValues</name>
        <value xsi:type="xsd:string">admin, iscadmin</value>
      </item>
    </properties>
  </objectPath>
</objectPath>

```

## Creating Subtemplates

In the following example, a subtemplate with attributes is created.

```

<objectPath xsi:type="ns1:CIMObjectPath">
  <className xsi:type="xsd:string">SubTemplate</className>
  <properties xsi:type="ns1:CIMPropertyList"
    soapenc:arrayType="ns1:CIMProperty[]">
  <item xsi:type="ns1:CIMProperty">
    <name xsi:type="xsd:string">Name</name>
    <value xsi:type="xsd:string">/test/t4</value>
  </item>
  <item xsi:type="ns1:CIMProperty">
    <name xsi:type="xsd:string">DeviceDefault</name>
    <value xsi:type="xsd:string">>false</value>
  </item>
  <item xsi:type="ns1:CIMProperty">

```

```

    <name xsi:type="xsd:string">VersionDefault</name>
    <value xsi:type="xsd:string">>false</value>
  </item>
</properties>
</objectPath>

```

## Creating Templates in Policies (N-PE)

In this example, a N-PE-based policy template is configured based on a template definition and a template data file.

```

<objectPath xsi:type="ns1:CIMObjectPath">
  <className xsi:type="xsd:string">PolicyTemplate</className>
  <properties xsi:type="ns1:CIMPropertyList"
    soapenc:arrayType="ns1:CIMProperty[]">
    <item xsi:type="ns1:CIMProperty">
      <name xsi:type="xsd:string">RoleType</name>
      <value xsi:type="xsd:string">N-PE</value>
    </item>

    <item xsi:type="ns1:CIMProperty">
      <name xsi:type="xsd:string">DatafilePath</name>
      <value xsi:type="xsd:string">Certificate/Cert-Enrollment</value>
    </item>
    <item xsi:type="ns1:CIMProperty">
      <name xsi:type="xsd:string">DatafileName</name>
      <value xsi:type="xsd:string">SampleData0</value>
    </item>

    <item xsi:type="ns1:CIMProperty">
      <name xsi:type="xsd:string">TemplateAction</name>
      <value xsi:type="xsd:string">APPEND</value>
    </item>
    <item xsi:type="ns1:CIMProperty">
      <name xsi:type="xsd:string">TemplateActive</name>
      <value xsi:type="xsd:string">>true</value>
    </item>
    <item xsi:type="ns1:CIMProperty">
      <name xsi:type="xsd:string">Editable</name>
      <value xsi:type="xsd:string">>true</value>
    </item>
  </properties>
</objectPath>

```

## Creating Templates in Policies (U-PE)

In this example, a U-PE-based policy template is configured based on a template definition and a template data file. The U-PE template is differentiated by having two policy template nodes with UNIDatafilePath/UNIDatafileName for UNI and DatafilePath/DatafileName for all others.

When you include templates in a MPLS, L2VPN, VPLS or EVC service policy, the template information is defined using the PolicyTemplate object. This policy template contains the path to the template definition and the location of the template data. For each policy type, the policy template is defined in service definition details.

This is also valid for PE-AGG alone after the U-PE.

```

<objectPath xsi:type="ns1:CIMObjectPath">
  <className xsi:type="xsd:string">PolicyTemplate</className>
  <properties xsi:type="ns1:CIMPropertyList" soapenc:arrayType="ns1:CIMProperty[]">
    <item xsi:type="ns1:CIMProperty"><name xsi:type="xsd:string">RoleType</name>
      <value xsi:type="xsd:string">U-PE</value>
    </item>
    <item xsi:type="ns1:CIMProperty">
      <name xsi:type="xsd:string">UNIDatafilePath</name>
      <value xsi:type="xsd:string">/nbi/AccessList2</value>
    </item>
    <item xsi:type="ns1:CIMProperty">
      <name xsi:type="xsd:string">UNIDatafileName</name>
      <value xsi:type="xsd:string">MyTemplate2</value>
    </item>
    <item xsi:type="ns1:CIMProperty">
      <name xsi:type="xsd:string">TemplateActive</name>
      <value xsi:type="xsd:string">>true</value>
    </item>
    <item xsi:type="ns1:CIMProperty">
      <name xsi:type="xsd:string">TemplateAction</name>
      <value xsi:type="xsd:string">APPEND</value>
    </item>
    <item xsi:type="ns1:CIMProperty">
      <name xsi:type="xsd:string">Editable</name>
      <value xsi:type="xsd:string">>true</value>
    </item>
  </properties>
</objectPath>
<objectPath xsi:type="ns1:CIMObjectPath">
  <className xsi:type="xsd:string">PolicyTemplate</className>
  <properties xsi:type="ns1:CIMPropertyList" soapenc:arrayType="ns1:CIMProperty[]">
    <item xsi:type="ns1:CIMProperty"><name xsi:type="xsd:string">RoleType</name>
      <value xsi:type="xsd:string">U-PE</value>
    </item>
    <item xsi:type="ns1:CIMProperty">
      <name xsi:type="xsd:string">DatafilePath</name>
      <value xsi:type="xsd:string">/nbi/AccessList1</value>
    </item>
    <item xsi:type="ns1:CIMProperty">
      <name xsi:type="xsd:string">DatafileName</name>
      <value xsi:type="xsd:string">MyTemplate2</value>
    </item>
    <item xsi:type="ns1:CIMProperty">
      <name xsi:type="xsd:string">TemplateActive</name>
      <value xsi:type="xsd:string">>true</value>
    </item>
    <item xsi:type="ns1:CIMProperty">
      <name xsi:type="xsd:string">TemplateAction</name>
      <value xsi:type="xsd:string">APPEND</value>
    </item>
    <item xsi:type="ns1:CIMProperty">
      <name xsi:type="xsd:string">Editable</name>
      <value xsi:type="xsd:string">>true</value>
    </item>
  </properties>
</objectPath>

```

## Creating Datafile from Service Request

In the following example, a data file is created from a service request.

```

<objectPath xsi:type="ns1:CIMObjectPath">
  <className xsi:type="xsd:string">DataFile</className>
  <properties xsi:type="ns1:CIMPropertyList" soapenc:arrayType="ns1:CIMProperty[]">
    <item xsi:type="ns1:CIMProperty">
      <name xsi:type="xsd:string">Name</name>
      <value xsi:type="xsd:string">/Examples/AccessList1/Data0</value>
    </item>
    <item xsi:type="ns1:CIMProperty">
      <name xsi:type="xsd:string">Description</name>
      <value xsi:type="xsd:string">Description for datafile</value>
    </item>
    <item xsi:type="ns1:CIMProperty">
      <name xsi:type="xsd:string">Application</name>
      <value xsi:type="xsd:string">eq smtp</value>
    </item>
    <item xsi:type="ns1:CIMProperty">
      <name xsi:type="xsd:string">protocol</name>
      <value xsi:type="xsd:string">tcp</value>
    </item>
  </properties>
</objectPath>

```

## Provisioning Example

This section describes the required steps for using templates independent of service requests. See the [“Templates in a Service Request” section on page 4-18](#) for information on deploying templates with service requests.

This section describes the following:

- [Prerequisites, page 4-12](#)
- [Process Summary, page 4-12](#)
- [Detailed Provisioning Process, page 4-13](#)
- [Transient Templates, page 4-17](#).

## Prerequisites

Prime Provisioning provides prepopulated examples to help you create a template.

- If you are using Sybase as a back-end database, you are provided with prepopulated template examples. These examples can be found on the left pane of the main Template Manager window.
- If you are using Oracle as a back-end database, you are not automatically provided with pre-populated template examples. You must either create a template definition from scratch or import a template. To import all templates, run the script **populateTemplates.sh** located in the **<install-dir>/bin** directory.

## Process Summary

In this template provisioning example, the following steps are listed:

1. Create a template definition file.



2. Create a template data file.
3. View the template data file.
4. View the template configuration.
5. Download the template configuration to a device.
6. Delete the template data file and template definition.

## Detailed Provisioning Process

This section provides an example provisioning process using XML examples. The inventory of XML examples for the Prime Provisioning API is available here:

[Cisco Prime Provisioning API 7.0 Programmer Reference](#)

To execute the [Process Summary](#) mentioned above, use the following steps:

**Step 1** Create a template definition.

**Table 4-1** Create Template Definition

Operation	className	Required Parameters
createInstance	ServiceDefinition	<ul style="list-style-type: none"> <li>• Name</li> <li>• Type=TemplateDefn</li> <li>• ServiceDefinitionDetails</li> </ul>
	ServiceDefinitionDetails	Can contain one or more of the following classes, with associated variable name/value pairs as child objects: <ul style="list-style-type: none"> <li>• TemplateInteger</li> <li>• TemplateString</li> </ul>

**XML Example:**

- CreateTemplateDefnSimple.xml

**Step 2** Create a template data file.

**Table 4-2** Create Template Data

Operation	className	Required Parameters
createInstance	ServiceDefinition	<ul style="list-style-type: none"> <li>• Name</li> <li>• Type=TemplateData</li> <li>• ServiceDefinitionDetails</li> </ul>
	ServiceDefinitionDetails	<template data> (The name/value pairs.)

The following XML examples show how to populate a template containing one-dimensional variables or two-dimensional variables. The incoming template data must match the format of the template definition. The API validates the incoming data against the variable definition. An error is returned if they do not match.

#### XML Examples:

- CreateTemplateData1Dim.xml
- CreateTemplateData2Dim.xml

#### Step 3 View the template data file.

To view the data file, provide the full pathname and filename. This is the same as the folder pathname and filename in the GUI.

**Table 4-3 View Template Data**

Operation	className	Required Parameters
enumerateInstances	ServiceDefinition	<ul style="list-style-type: none"> <li>• Name=&lt;pathname/filename to template data file&gt;</li> <li>• Type=TemplateData</li> </ul>

#### XML Example:

ViewTemplateData.xml

#### Step 4 View the configlet generated for the template.

**Table 4-4 View Configlet**

Operation	className	Required Parameters
enumerateInstances	Task	<ul style="list-style-type: none"> <li>• Type=TemplateConfig</li> <li>• TemplateDefn=&lt;pathname to template definition&gt;</li> <li>• TemplateData=&lt;template data filename&gt;</li> </ul>

#### XML Example:

ViewTemplateConfig.xml

The following example shows a response to a ViewTemplateConfig XML request.

```
<?xml version="1.0" encoding="UTF-8"?>
<soapenv:Envelope xmlns:soapenv="http://schemas.xmlsoap.org/soap/envelope/"
xmlns:soapenc="http://schemas.xmlsoap.org/soap/encoding/"
xmlns:xsd="http://www.w3.org/2001/XMLSchema"
xmlns:xsi="http://www.w3.org/2001/XMLSchema-instance"
xmlns:ns0="http://www.cisco.com/cim-cx/2.0" xmlns:ns1="urn:CIM">
  <soapenv:Header>
    <ns0:message id="87855" sessiontoken="F1856684E9A183F5E542890772B3D040"
timestamp="2003-09-25T21:38:07.645Z" />
  </soapenv:Header>
  <soapenv:Body>
```

```

<ns1:enumerateInstancesResponse>
  <returns xsi:type="ns1:CIMPropertyList" soapenc:arrayType="ns1:CIMProperty[]">
    <item xsi:type="ns1:CIMProperty">
      <name xsi:type="xsd:string">Configlet</name>
      <value xsi:type="xsd:string">
ip vrf $vrfName
maximum routes 2 75
export map To_NM_VPN
route-target import 2:103000
route-target import 2:103500
route-target import 2:103020
route-target import 2:103520
route-target import 0
route-target import 1
exit
router bgp 13979
address-family ipv4 vrf vrf1
default-information originate
maximum-paths eibgp 6
bgp suppress-inactive
neighbor 10.10.10.1 route-map set_ce_local_pref in
neighbor 10.10.10.1 maximum-prefix 21 50
neighbor 10.10.10.1 capability orf prefix-list receive
neighbor 10.10.10.1 advertisement-interval 60
exit
</value>
    </item>
  </returns>
</ns1:enumerateInstancesResponse>
</soapenv:Body>
</soapenv:Envelope>

```

**Step 5** Download the template configuration to a device.

**Table 4-5** Download Template Configuration

Operation	className	Required Parameters
performBatchOperation		
createInstance	ServiceOrder	<ul style="list-style-type: none"> <li>• ServiceName</li> <li>• NumberOfRequests This number indicates the number of devices to which the templates need to be downloaded.</li> <li>• ServiceRequest</li> </ul>

Table 4-5 Download Template Configuration

Operation	className	Required Parameters
	ServiceRequest	<ul style="list-style-type: none"> <li>• RequestName</li> <li>• Type=TemplateDownload</li> <li>• Template definition information: <ul style="list-style-type: none"> <li>– ServiceDefinition=&lt;pathname to template definition&gt;</li> <li>– ServiceDefinitionType=TemplateDefn</li> </ul> </li> <li>• Template data information: <ul style="list-style-type: none"> <li>– ServiceDefinition=&lt;pathname /filename to template data file&gt;</li> <li>– ServiceDefinitionType=TemplateData</li> </ul> </li> <li>• ServiceRequestDetails</li> </ul>
	ServiceRequestDetails	LogicalDevice=<name of device to receive the template configuration>

**XML Example:**

CreateTemplateServiceOrderDownload.xml

**Note**

For this XML, the tag <action> <actionName xsi:type="xsd:string">createInstance</actionName> </action> should be repeated for every request. For example, if the number of requests is 2, then the tag should be repeated two times in the XML with the proper inputs.

**Step 6** Delete the template data file and the template definition file. This step is optional.

Table 4-6 Delete Template Files

Operation	className	Required Parameters
deleteInstance	ServiceDefinition	<p>To delete the template data file:</p> <ul style="list-style-type: none"> <li>• Name=&lt;pathname to template definition file&gt;</li> <li>• Type=TemplateData</li> </ul> <p>To delete the template definition file:</p> <ul style="list-style-type: none"> <li>• TemplatePathname=&lt;pathname/file name to template data file&gt;</li> <li>• Type=TemplateDefn</li> </ul>

**XML Examples:**

- DeleteTemplateData.xml

- DeleteTemplateDefn.xml

## Transient Templates

For transient templates, the template data is not specified through a previously defined data file. The template data is entered directly into the XML request. Transient data is used only for the instance of the service order and is then discarded. The transient data is not available for subsequent service orders, and you cannot view transient data when you view the service order.

- To view the generated configlet, refer to [“View the configlet generated for the template.”](#) on page 14.
- To download transient template data to a device, refer to [“Download the template configuration to a device.”](#) on page 15.

For transient templates, leave out the following two properties:

- **ServiceDefinition=<pathname/filename to template data file>**
- **ServiceDefinitionType=TemplateData**

Instead, specify **SubType=TemplateDataTransient** in the **ServiceDefinition**, and enter the template data (name/value pairs) in the **ServiceDefinitionDetails**. See the following example:

```
<objectPath xsi:type="ns1:CIMObjectPath">
  <className xsi:type="xsd:string">ServiceRequest</className>
  <properties xsi:type="ns1:CIMPropertyList"
    soapenc:arrayType="ns1:CIMProperty[]">
    <item xsi:type="ns1:CIMProperty">
      <name xsi:type="xsd:string">RequestName</name>
      <value xsi:type="xsd:string">MYSR-1</value>
    </item>
    <item xsi:type="ns1:CIMProperty">
      <name xsi:type="xsd:string">Type</name>
      <value xsi:type="xsd:string">TemplateDownload</value>
    </item>
    <item xsi:type="ns1:CIMProperty">
      <name xsi:type="xsd:string">ServiceDefinition</name>
      <value xsi:type="xsd:string">/User/UsernameTemplate</value>
      <qualifier xsi:type="ns1:CIMQualifier">
        <name xsi:type="xsd:string">ServiceDefintionType</name>
        <value xsi:type="xsd:string">TemplateDefn</value>
      </qualifier>
    </item>
  </properties>
  <objectPath xsi:type="ns1:CIMObjectPath">
    <className xsi:type="xsd:string">ServiceDefinition</className>
    <properties xsi:type="ns1:CIMPropertyList"
      soapenc:arrayType="ns1:CIMProperty[]">
      <item xsi:type="ns1:CIMProperty">
        <name xsi:type="xsd:string">SubType</name>
        <value xsi:type="xsd:string">TemplateDataTransient</value>
      </item>
    </properties>
  <objectPath xsi:type="ns1:CIMObjectPath">
    <className xsi:type="xsd:string">ServiceDefinitionDetails</className>
    <properties xsi:type="ns1:CIMPropertyList"
      soapenc:arrayType="ns1:CIMProperty[]">
      <item xsi:type="ns1:CIMProperty">
        <name xsi:type="xsd:string">username</name>
        <value xsi:type="xsd:string">user1</value>
      </item>
```

```

</properties>
</objectPath>

```

#### XML Example:

CreateTemplateServiceOrderDownloadTransient.xml

## Templates in a Service Request

You can add templates to and remove templates from a service request. When the service order is deployed, the template configuration is downloaded to the device, along with the configuration from the service request.

To add templates to a service request, see [Adding New Templates, page 4-6](#).

To remove templates from a service request, see [“Removing Template Configurations” section on page 4-22](#).

## Using Template Node Objects

The template information in a service request template contains the **LinkTemplate** object, which defines the location of the template definition and data files, the device to receive the configuration download, and whether to prepend or append the template configuration.

This node object is **SRAssociatedTemplate** for EVC and **LinkTemplate** for other provisioning services as described in the following sections:

- [Link Template](#)
- [SRAssociatedTemplate](#).

### Link Template

When you include templates in a MPLS, L2VPN, or VPLS service request, the template information is defined using the **LinkTemplate** object. The **LinkTemplate** contains the path to the template definition and the location of the template data.

For each service type, the **LinkTemplate** is defined in these link objects in the service request:

- MPLS—**MplsVpnLink**
- L2VPN—**ACAAttr** (EndtoEndWire>AttachmentCircuit>ACAAttr)
- VPLS—**VPLSLink**

See the appropriate chapter on service provisioning for more information on using **LinkTemplate** in service requests.

The following is an example of using the **LinkTemplate** node:

```

<objectPath subAction="createInstance" xsi:type="ns1:CIMObjectPath">
  <className xsi:type="xsd:string">LinkTemplate</className>
  <properties xsi:type="ns1:CIMPropertyList"
    soapenc:arrayType="ns1:CIMProperty[]">
    <item xsi:type="ns1:CIMProperty">
      <name xsi:type="xsd:string">LogicalDevice</name>
      <value xsi:type="xsd:string">8</value>
    </item>
  </properties>
</objectPath>

```

```

</item>
<item xsi:type="ns1:CIMProperty">
  <name xsi:type="xsd:string">DatafilePath</name>
  <value xsi:type="xsd:string">/nbi/AccessList</value>
</item>
<item xsi:type="ns1:CIMProperty">
  <name xsi:type="xsd:string">DatafileName</name>
  <value xsi:type="xsd:string">MyTemplate1</value>
</item>
<item xsi:type="ns1:CIMProperty">
  <name xsi:type="xsd:string">TemplateActive</name>
  <value xsi:type="xsd:string">>true</value>
</item>
<item xsi:type="ns1:CIMProperty">
  <name xsi:type="xsd:string">TemplateAction</name>
  <value xsi:type="xsd:string">APPEND</value>
</item>
</properties>
</objectPath>

```

## SRAssociatedTemplate

In the case of EVC, when you include templates in an EVC service request, the template information is defined using the SRAssociatedTemplate object. As with LinkTemplate, the SRAssociatedTemplate contains the path to the template definition and the location of the template data.

For the EVC service type, the SRAssociatedTemplate is defined in the **EvcLink** link object in the service request.

See [Chapter 9, “EVC Provisioning”](#) for more information on using SRAssociatedTemplate in service requests.

The following is an example of using the SRAssociatedTemplate node:

```

<objectPath subAction="createInstance" xsi:type="ns1:CIMObjectPath">
  <className xsi:type="xsd:string">SRAssociatedTemplate</className>
  <properties xsi:type="ns1:CIMPropertyList"
    soapenc:arrayType="ns1:CIMProperty[]">
    <item xsi:type="ns1:CIMProperty">
      <name xsi:type="xsd:string">Device</name>
      <value xsi:type="xsd:string">iscind-3750-6</value>
    </item>
    <item xsi:type="ns1:CIMProperty">
      <name xsi:type="xsd:string">TemplateDefn</name>
      <value xsi:type="xsd:string">/Examples/AccessList1</value>
    </item>
    <item xsi:type="ns1:CIMProperty">
      <name xsi:type="xsd:string">TemplateData</name>
      <value xsi:type="xsd:string">Protocol-IP</value>
    </item>
    <item xsi:type="ns1:CIMProperty">
      <name xsi:type="xsd:string">TemplateActive</name>
      <value xsi:type="xsd:string">>false</value>
    </item>
    <item xsi:type="ns1:CIMProperty">
      <name xsi:type="xsd:string">TemplateActionType</name>
      <value xsi:type="xsd:string">APPEND</value>
    </item>
  </properties>
</objectPath>

```

## Data Buffer Object

If the template data is pulled from a template data file, the **LinkTemplate** object contains the path to the data file. If the template data is pulled from a data buffer (MPLS only), the **LinkTemplate** object contains the **DataBuffer** object. The **DataBuffer** can contain values for any variable defined in the template definition.

In the following example, the values for the variables **Source-IP**, **Dest-IP**, and **protocol**, are defined in the **DataBuffer** object.

```
<objectPath xsi:type="ns1:CIMObjectPath">
  <className xsi:type="xsd:string">DataBuffer</className>
  <properties xsi:type="ns1:CIMPropertyList"
    soapenc:arrayType="ns1:CIMProperty[]">
    <item xsi:type="ns1:CIMProperty">
      <name xsi:type="xsd:string">Source-IP</name>
      <value xsi:type="xsd:string">132.235.123.0</value>
    </item>
    <item xsi:type="ns1:CIMProperty">
      <name xsi:type="xsd:string">Dest-IP</name>
      <value xsi:type="xsd:string">54.103.63.0</value>
    </item>
    <item xsi:type="ns1:CIMProperty">
      <name xsi:type="xsd:string">protocol</name>
      <value xsi:type="xsd:string">udp</value>
    </item>
  </properties>
</objectPath>
```

You can also use the **DataBuffer** to specify values for variables defined elsewhere in the service request. Instead of entering the variable and value in the service request and then repeating them again in the **LinkTemplate**, you can simply call the value using the **DataBuffer**.

In the following partial example for an MPLS service request, in the **LinkAttrs** class, values are listed for **PE\_VCI**, **PE\_BGP\_AS\_ID**, and **Max\_route\_threshold**.

```
<objectPath xsi:type="ns1:CIMObjectPath">
  <className xsi:type="xsd:string">LinkAttrs</className>
  <properties xsi:type="ns1:CIMPropertyList"
    soapenc:arrayType="ns1:CIMProperty[]">
    <item xsi:type="ns1:CIMProperty">
      <name xsi:type="xsd:string">CE_Intf_Name</name>
      <value xsi:type="xsd:string">ATM1.22</value>
    </item>
    <item xsi:type="ns1:CIMProperty">
      <name xsi:type="xsd:string">PE_Intf_Name</name>
      <value xsi:type="xsd:string">Switch1.234</value>
    </item>
    <item xsi:type="ns1:CIMProperty">
      <name xsi:type="xsd:string">PE_VCI</name>
      <value xsi:type="xsd:string">234</value>
    </item>
    <item xsi:type="ns1:CIMProperty">
      <name xsi:type="xsd:string">PE_BGP_AS_ID</name>
      <value xsi:type="xsd:string">13979</value>
    </item>
    <item xsi:type="ns1:CIMProperty">
      <name xsi:type="xsd:string">Max_route_threshold</name>
      <value xsi:type="xsd:string">25</value>
    </item>
  </properties>
</objectPath>
```

The next section of this example shows these same values being called again in the **DataBuffer**.



```

<objectPath xsi:type="ns1:CIMObjectPath">
  <className xsi:type="xsd:string">DataBuffer</className>
  <properties xsi:type="ns1:CIMPropertyList"
    soapenc:arrayType="ns1:CIMProperty[]">
    <item xsi:type="ns1:CIMProperty">
      <name xsi:type="xsd:string">PE_VCI</name>
      <value xsi:type="xsd:string">${PE_VCI}</value>
    </item>
    <item xsi:type="ns1:CIMProperty">
      <name xsi:type="xsd:string">PE_BGP_AS_ID</name>
      <value xsi:type="xsd:string">${PE_BGP_AS_ID}</value>
    </item>
    <item xsi:type="ns1:CIMProperty">
      <name xsi:type="xsd:string">Max_route_threshold</name>
      <value xsi:type="xsd:string">${Max_route_threshold}</value>
    </item>
  </properties>
</objectPath>

```

**Note**

See the Repository Variable Chooser in the GUI Template Manager for a list of variables, by service blade, that can be recalled by the **DataBuffer**. (From the Service Design tab, click the Templates link. Choose the template Data file and click **Vars** on the Data File Editor window.)

In [Table 4-7](#), the required parameters listed for **ServiceRequestDetails** are only for the template portion of the service order. For more information on service requests, see the appropriate chapters on service provisioning in this guide.

**Table 4-7**      *Templates in a Service Request*

Operation	className	Required Parameters
createInstance	ServiceOrder	<ul style="list-style-type: none"> <li>• ServiceName</li> <li>• NumberOfRequests</li> <li>• ServiceRequest</li> </ul>
	ServiceRequest	<ul style="list-style-type: none"> <li>• RequestName</li> <li>• Type=&lt;choose the appropriate service type&gt;</li> <li>• ServiceRequestDetails</li> </ul>
	ServiceRequestDetails	<ul style="list-style-type: none"> <li>• MplsVpnLink (or ACAAttr)</li> </ul>

Table 4-7 Templates in a Service Request (continued)

Operation	className	Required Parameters
	MplsVpnLink (or the link object for your service)	<ul style="list-style-type: none"> <li>• LinkTemplate</li> </ul>
	LinkTemplate	<ul style="list-style-type: none"> <li>• DatafilePath=&lt;the pathname to the template definition folder&gt;</li> <li>• LogicalDevice</li> <li>• The template data information, either from a data file or a data buffer. <ul style="list-style-type: none"> <li>– DatafileName=&lt;the pathname/filename to the template data file&gt;</li> <li>– DataBuffer=&lt;template data&gt; (The name/value pairs.)</li> </ul> </li> <li>• TemplateActive=true</li> <li>• TemplateAction= <ul style="list-style-type: none"> <li>– APPEND</li> <li>– PREPEND</li> </ul> </li> </ul>

**Note**

The attributes **PE\_Template**, **PE\_Intf\_Template**, **CE\_Template**, and **CE\_Intf\_Template** allow NBI access to variables designed to hold template blobs (template blobs were used during MPLS provisioning in legacy versions of Prime Provisioning).

**XML Examples:**

- CreateMPLSTemplateServiceOrder.xml
- CreateL2VPNTemplateServiceOrder.xml

## Removing Template Configurations

To modify a service request that has templates and before decommissioning a service request that has templates, first remove the template information from the service request. This is accomplished by applying a negate template to the existing service, which is done automatically in Prime Provisioning.

## Using Negate Templates

You can assign both a positive and negative template/data file to a policy. Prime Provisioning can determine which one it should use based on the requested service request action (for example, deploying or decommissioning a service).

The negate template has the same name as the template, with the addition of the suffix **.Negate**. The negate template uses the same data file as the positive template on which it is based.

## Modifying a Service Request

To modify a template in an existing service request, the following tasks must occur in the order listed:

1. Turn off templates.

This action changes the **TemplateActive** attribute for the template from **true** to **false**.

- For MPLS service requests, the **modifyInstance** subaction automatically toggles the **TemplateActive** attribute to **false**.

See [Turning off Templates \(for MPLS Service Requests\)](#), page 4-23.

- For all other service requests, the **TemplateActive** attribute must be specifically set to **false** in the **modifyInstance** subaction.

See [Turning off Templates \(for All Other Service Types\)](#), page 4-24.

2. Add new templates.

This action adds a new template to the service request. Use the **createInstance** action to add templates.

See [Adding New Templates](#), page 4-6.



### Note

Negate templates are added automatically at the time when the template is selected. As a result, you do not need to attach a negate template to a policy or a service request.



### Note

Wait until the task has completed (you will receive a task completed message) before running the next task.

## Turning off Templates (for MPLS Service Requests)

When you create the MPLS service request with a template, Prime Provisioning sets the attribute **TemplateActive=true**. To turn off the template, the attribute needs to be changed to **TemplateActive=false**.

For templates in an MPLS service request, this is accomplished using a **modifyInstance** subaction. When you execute a **modifyInstance** subaction on a template, Prime Provisioning automatically changes the status of the attribute to **TemplateActive=false**.



### Note

This automatic change in the template attribute only occurs when you use a **modifyInstance** on a template in an MPLS service request. For other service type, see the “[Turning off Templates \(for All Other Service Types\)](#)” section on page 4-24.

Include the device that received the template configuration and the template name (**DataFilePath**) from the service request where the template was implemented. See the following example:

```
<objectPath subAction="modifyInstance" xsi:type="ns1:CIMObjectPath">
  <className xsi:type="xsd:string">LinkTemplate</className>
  <keyProperties xsi:type="ns1:CIMKeyPropertyList"
    soapenc:arrayType="ns1:CIMKeyProperty[]">
    <item xsi:type="ns1:CIMProperty">
      <name xsi:type="xsd:string">LogicalDevice</name>
      <value xsi:type="xsd:string">PE-POP1</value>
    </item>
```

```

<item xsi:type="ns1:CIMProperty">
  <name xsi:type="xsd:string">DatafilePath</name>
  <value xsi:type="xsd:string">/Examples/temp11-enable</value>
</item>

```

In this XML example, the template name /Examples/temp11-enable, for device PE-POP1, is turned off (**TemplateActive=false**) by the **modifyInstance** subaction.

## Turning off Templates (for All Other Service Types)

Unlike with MPLS, this attribute change does not happen automatically for all other service types. You must use a **modifyInstance** subaction and include the attribute **TemplateActive=false** in the XML request. See the following example:

```

<objectPath subAction="modifyInstance" xsi:type="ns1:CIMObjectPath">
  <className xsi:type="xsd:string">LinkTemplate</className>
  <keyProperties xsi:type="ns1:CIMKeyPropertyList"
    soapenc:arrayType="ns1:CIMKeyProperty[]">
    <item xsi:type="ns1:CIMProperty">
      <name xsi:type="xsd:string">LogicalDevice</name>
      <value xsi:type="xsd:string">PE-POP1</value>
    </item>
    <item xsi:type="ns1:CIMProperty">
      <name xsi:type="xsd:string">TemplateActive</name>
      <value xsi:type="xsd:string">false</value>
    </item>
    <item xsi:type="ns1:CIMProperty">
      <name xsi:type="xsd:string">DatafilePath</name>
      <value xsi:type="xsd:string">/Examples/temp11-enable</value>
    </item>
  </keyProperties>
</objectPath>

```



## Monitoring APIs

---

Cisco Prime Provisioning provides methods for monitoring services. Monitoring APIs include event notifications, canned reports and SQL queries, SLA monitoring, and task logs. Monitoring APIs provide real-time information for service providers.

This chapter contains the following sections:

- [Event Notifications, page 5-1](#)
- [Reports, page 5-4](#)
- [SLA Provisioning, page 5-12](#)
- [Device Locking, page 5-22](#)
- [Viewing Task Logs, page 5-24](#)

## Event Notifications

The API uses a notification server to deliver database change events. An event is registered and a notification is sent any time a database object is created, modified, or deleted, when a scheduled task begins or ends its execution, or when a watchdog event signals a change in execution status for any Prime Provisioning server.

The event types are:

- **InstCreation**— An object has been created.
- **InstDeletion**—An object has been deleted.
- **InstModification**—An object has been modified.
- **InstStateChange**—A change in execution status for any Prime Provisioning server.

The notification server listens to the Tibco bus for interested database change events and sends a notification to the client. When an event is recognized, the daemon processes the event and generates the appropriate indication XML response. The XML response is delivered either back across the client connection or to a specified URL.

## Setting up the Client



### Note

An example client, `EventListener`, provided with the Prime Provisioning software, is a simple servlet that listens to the notifications servlet. Use this example to create your own client for event notifications. See [Appendix B, “Implementing a Notification Server,”](#) for more information.

The client must register for events. Use the following properties to enable notifications and to indicate where notification messages should be sent.

- `notification.clientEnabled`—Used to turn notification forwarding on and off. To enable the client, set **`notification.clientEnabled=true`**.
- `notification.clientHost`—The machine running the event notification receiving program.
- `notification.clientPort`—The listener port to open on the receiving machine.
- `notification.clientMethod`—The method, or program, to contact on the receiving machine. The `clientMethod` is defined in the Tomcat `web.xml` file. The notification `web.xml` file (located in `$PRIMEF_HOME/resources/webserver/tomcat/webapps/notification/WEB-INF`) identifies two servlets. One is the `notificationServlet` and the other is the `eventListener` (`EventReceivingServlet` program) servlet.
  - The `notificationServlet` is the Prime Provisioning program responsible for collecting and forwarding events of interest.
  - The `clientHost`, `clientMethod`, and `clientPort` are used to construct a URL.
  - The `clientMethod/notification/servlet/eventListener` is mapped to the `eventListener` servlet.
- `notification.clientRegFile`—Located in `/opt/vpnc/iscadmin/resources/nbi/notification/clientReg.txt`, this file contains the events of interest to be forwarded. See [Appendix B, “Implementing a Notification Server,”](#) for a complete list of the events that can be collected.

To define the events are of interest to the client, change the **`notification.clientRegFile`** so that it points to a file that contains all interested events. For example, if you have the following lines in this file:

```
com.cisco.vpnc.repository.devices.PIX.add
com.cisco.vpnc.repository.devices.PIX.modify
com.cisco.vpnc.repository.task.PersistentTask.>
```

The first line defines events that add PIX objects. The second line defines events that modify PIX objects. The third line defines all **`PersistentTask`** related events. (The “>” symbol is a wildcard to represent any match.)



### Tip

Use **`com.cisco.vpnc.repository.>`** to represent any repository change event.

## Remote Authentication

The notification server allows Prime Provisioning events to be delivered using an HTTP interface to a remote system. If your remote system requires authentication, use these properties to set up the remote user and password information.

- `notification.remoteUsername`

- notification.remotePassword

These properties allows the Prime Provisioning notification server to respond to remote authentication requests, which is required by certain systems prior to establishing a connection. The default values for these properties is null.

## Notification Responses

Event notifications are sent in the form of XML responses. The operation for event notification is **deliverEvent**. For each event, the following information is returned in the XML response:

- IndicationTime
- IndicationType=
  - InstCreation
  - InstDeletion
  - InstModification
  - InstStateChange (for service requests)
- InstClassName
- LocatorId
- Name

If the state of a service request changes, additional information is returned under **InstIndicationDetails**:

- Previous\_SR\_State
- Current\_SR\_State
- Description

See the following example:

```
<objectPath xsi:type="ns1:CIMObjectPath">
  <className xsi:type="xsd:string">InstIndicationDetails</className>
  <properties xsi:type="ns1:CIMPropertyList"
    soapenc:arrayType="ns1:CIMProperty[]">
    <item>
      <name xsi:type="xsd:string">Previous_SR_State</name>
      <value xsi:type="xsd:string">PENDING</value>
    </item>
    <item>
      <name xsi:type="xsd:string">Current_SR_State</name>
      <value xsi:type="xsd:string">ACTIVE</value>
    </item>
    <item>
      <name xsi:type="xsd:string">Description</name>
      <value xsi:type="xsd:string">System is active</value>
    </item>
  </properties>
</objectPath>
</objectPath>
```

# Reports

The Prime Provisioning API includes a reporting feature for queries on inventory, topology, and services. Reports can be generated from SQL-based queries or from canned reports that are provided with the Prime Provisioning product.



**Note**

---

Prime Provisioning's reporting feature supports Sybase and Oracle databases.

---

The Prime Provisioning API can generate reports for:

- Inventory
  - Physical inventory
  - VLAN usage reports
  - Customer reports
  - Site reports
  - Resource usage reports
- Topology reports:
  - Device connectivity
  - L2VPN topology
  - MPLS topology
  - VPLS topology
- Service reports
  - Service request reports
  - Service order reports

Generating reports from meta-based SQL queries (**execQuery**) and from canned reports (**execReport**) are described in the following sections. SLA Reports are described in [“SLA Reports” section on page 5-19](#).

## SQL-Based Reports

The **execQuery** operation allows you to execute a direct search of the Prime Provisioning database and to specify the form of the output data. The query language is a subset of SQL and supports queries specified with parameters and objects defined in the XML schema. A response to an **execQuery** returns data records and can be sent in an XML response or saved to a file. File data can be in either XML format or comma separated value (CSV) format. See [“Output for Reports” section on page 5-10](#) for more information.



**Note**

---

You can specify a delimiter other than commas, if necessary. The Prime Provisioning API supports a single character delimiter.

---



Use the **execQuery** operation to query the main Prime Provisioning repository or the SLA repository.

- The main Prime Provisioning repository holds data for objects representing devices and VPN network elements. It also contains data collected from devices by the collection server, and task data, which is used by the scheduler.
- The SLA repository contains SLA tables populated with the data gathered by SLA probes.

The SQL search criteria for **execQuery** is defined as follows:

- *Select* property list—A comma-separated list of property names related to the individual classes specified in the *From* clause. An asterisk (\*) can be used to specify ALL of the properties of a class.
- *From* class list—A comma-separated list of class names. If more than one class name is specified, the classes must be related by an association, which is a condition in the *Where* clause.
- *Where* conditions—Specifies the criteria by which results are selected. The criteria can be simple property comparisons.
- *Orderby* clause—Specifies the criteria by which results are sorted.



#### Tip

If you are using an Oracle database, you should use aliases for your *Select* names because it has a 30 character limit.



#### Note

The **execQuery** operation does not support aggregate functions or subqueries. Use the *where* clause for joins.

The body of the XML request contains the **execQuery** operation, the **QueryLanguage**, and the SQL search criteria, specified with the **Query** attribute. See the following example:

```
<ns1:execQuery>
  <objectPath xsi:type="ns1:CIMObjectPath">
    <className xsi:type="xsd:string">execQuery</className>
    <keyProperties xsi:type="ns1:CIMKeyPropertyList"
      soapenc:arrayType="ns1:CIMKeyProperty[]">
      <item xsi:type="ns1:CIMKeyProperty">
        <name xsi:type="xsd:string">QueryLanguage</name>
        <value xsi:type="xsd:string">WQL</value>
      </item>
      <item xsi:type="ns1:CIMKeyProperty">
        <name xsi:type="xsd:string">Query</name>
        <value xsi:type="xsd:string">select Id, Name, ContactInfo from
Organization</value>
      </item>
    </keyProperties>
  </objectPath>
</ns1:execQuery>
```

In this example:

- The operation is **execQuery**
- In the **execQuery** class, the **QueryLanguage** is **WQL**
- The search criteria for the **execQuery** class is; *Select* properties, **Id**, **Name**, and **ContactInfo** *From* any record with the class name **Organization**.

An **execQuery** request with the above search criteria returns the following records in XML format:

```
<record>
  <objectPath xsi:type="ns1:CIMObjectPath">
```

```

    <className xsi:type="xsd:string">Record#1</className>
    <properties xsi:type="ns1:CIMPropertyList"
soapenc:arrayType="ns1:CIMProperty[]">
      <item xsi:type="ns1:CIMProperty">
        <name xsi:type="xsd:string">Organization.Name</name>
        <value xsi:type="xsd:string">NbiCustomer</value>
      </item>
      <item xsi:type="ns1:CIMProperty">
        <name xsi:type="xsd:string">Organization.Id</name>
        <value xsi:type="xsd:string">1</value>
      </item>
      <item xsi:type="ns1:CIMProperty">
        <name xsi:type="xsd:string">Organization.ContactInfo</name>
        <value xsi:type="xsd:string">Mrs Brown, Boulder, Colorado</value>
      </item>
    </properties>
  </objectPath>
</record>
<record>
  <objectPath xsi:type="ns1:CIMObjectPath">
    <className xsi:type="xsd:string">Record#2</className>
    <properties xsi:type="ns1:CIMPropertyList"
soapenc:arrayType="ns1:CIMProperty[]">
      <item xsi:type="ns1:CIMProperty">
        <name xsi:type="xsd:string">Organization.Name</name>
        <value xsi:type="xsd:string">cust_for_greymgmt_NbiProvider_0</value>
      </item>
      <item xsi:type="ns1:CIMProperty">
        <name xsi:type="xsd:string">Organization.Id</name>
        <value xsi:type="xsd:string">2</value>
      </item>
      <item xsi:type="ns1:CIMProperty">
        <name xsi:type="xsd:string">Organization.ContactInfo</name>
        <value xsi:type="xsd:string">Cust for GreyMgmtVpn for
Provider=NbiProvider</value>
      </item>
    </properties>
  </objectPath>
</record>

```

## Canned Reports

Prime Provisioning provides canned reports for frequently requested report data. These canned reports can be used as is, copied, modified, or extended by customers. Canned reports are located in the \$PRIMEF\_HOME/resources/nbi/reports/ISC directory. This is the default location for canned reports.

Custom reports, which are canned reports that have been modified for a particular customer, are located in the \$PRIMEF\_HOME/resources/nbi/reports/custom directory. To use custom reports, you must change the property file to so that it points to this directory. See the following example:

```
nbi.CustomerReportMetaDir=/opt/isc/resources/nbi/reports/custom
```

[Table 5-1](#) describes the types of canned reports provided with Prime Provisioning.

**Table 5-1 Canned Reports Provided with Prime Provisioning**

Report Type	Response Data
Service path information	Customer ID, service order number, Locator ID, circuit path per access leg, including the device ID, VLAN ID, Port ID, VC ID for the PE-CLE, PE-POP, and all intermediate devices.
Service class and service path information	Customer ID, service order number, Locator ID, service level or service class, committed information rate (CIR), peak information rate (PIR), and the service path information.
Detailed service configuration information	Customer ID, service order number, Locator ID, port ID, assigned VLAN ID, CIR and PIR for the PE-CLEs and PE-POPs that are the UNI endpoints.
MPLS VPN association information	Interface name, IP address, and index, VLAN and VC IDs, and physical interface name for the PE-POPs, CE ID, Customer ID, VRF and VPN information, and service request state and Locator ID.
Inventory queries	For the entire network, by access domain, or by network element.
List of assigned VLAN Ids	UNI (port ID) and VLAN IDs.
List of available VLAN Ids	VLAN IDs.
List of available PE-CLEs within an access domain	PE-POP and PE-CLE IDs.
List of available UNIs within an access domain	UNI and network element ID.
List of PE-CLEs within an access domain	PE-POP and PE-CLE IDs.
List of assigned UNIs	Customer ID, network element ID, and UNI.
List of assigned services	Customer ID and service type.
Service order status	Customer ID, service order number, Locator ID, status and due date.

Canned reports use the **execReport** operation in the XML request. The XML request provides the search criteria, and the response returns the report data.

See the following example of an XML request for the canned report; **VPNReport**:

```

</soapenv:Header>
<soapenv:Body>
  <ns1:execReport >
    <objectPath xsi:type="ns1:CIMObjectPath">
      <className xsi:type="xsd:string">VPNReport</className>
      <keyProperties xsi:type="ns1:CIMKeyPropertyList"
        soapenc:arrayType="ns1:CIMKeyProperty[]">
        <item xsi:type="ns1:CIMKeyProperty">
          <name xsi:type="xsd:string">customer.name</name>
          <value xsi:type="xsd:string">Nbi%</value>
        </item>
        <item xsi:type="ns1:CIMKeyProperty">
          <name xsi:type="xsd:string">vpn.name</name>
          <value xsi:type="xsd:string">vpnX</value>
        </item>
        <item xsi:type="ns1:CIMKeyProperty">
          <name xsi:type="xsd:string">pe_cisco_router.host_name</name>

```

```

    <value xsi:type="xsd:string">enswosr1</value>
  </item>
  <item xsi:type="ns1:CIMKeyProperty">
    <name xsi:type="xsd:string">mpls_sr.sr_state</name>
    <value xsi:type="xsd:string">FAILED_DEPLOY</value>
  </item>
</keyProperties>
<sortList xsi:type="ns1:CIMPropertyList"
  soapenc:arrayType="ns1:CIMProperty[]">
  <itemName xsi:type="xsd:string">pe_cisco_router.host_name:asc</itemName>
  <itemName xsi:type="xsd:string">vpn.name:desc</itemName>
  <itemName xsi:type="xsd:string">dev_endpoint.intf_name</itemName>
</sortList>
</objectPath>
</ns1:execReport>
</soapenv:Body>
</soapenv:Envelope>

```

## Report Definitions

The search criteria for a canned report is derived from a report definition. The search criteria in the example XML request, **vpn.name**, **pe\_cisco\_router.host\_name**, and **mpls\_sr.sr\_state**, correlate to parameters in the the report definition (meta file). Each canned report has an associated report definition file.

The report definition specifies report header information, search criteria, parameter definitions, filters, and sort order for the report output. The following sections show the different parts in a report definition.

### Header

The header in the report definition lists the report name, the label, and report title.

```

<packageDef name="MPLS">
<objectDef name="VPNReport"
  label="VPNReport"
  title="MPLS VPN Association report"
  inSchema="report"
  securityOn="true"
  sql="

```



#### Note

---

There is no RBAC record filter in the current version of Prime Provisioning.

---

### Search Criteria

The search criteria includes:

- *Select* property list—A comma-separated list of property names related to the individual classes specified in the *From* clause. An asterisk (\*) can be used to specify ALL of the properties of a class.
- *From* class list—A comma-separated list of class names. If more than one class name is specified, the classes must be related by an association, which is a condition in the *Where* clause.
- *Where* conditions—Specifies the criteria by which results are selected. The criteria can be simple property comparisons.
- The search criteria in the report definition is the same as for execQuery

```

SELECT distinct
pe_cisco_router.host_name,

```

```

pe_endpoint.ip_address,
customer.name,
mpls_sr.id,
mpls_sr.sr_state,
vpn.name,

FROM
customer,
cerc JOIN vpn
    ON cerc.vpn_id = vpn.id,
vrf_role JOIN cisco_router as pe_cisco_router
    ON vrf_role.device_id = pe_cisco_router.id,
mpls_vpn_link JOIN mpls_sr
    ON mpls_vpn_link.sr_id = mpls_sr.id,
mpls_vpn_link LEFT OUTER JOIN endpoint AS pe_endpoint
    ON mpls_vpn_link.pe_ep_id = pe_endpoint.id
WHERE mpls_sr.subsumed_by IS NULL
AND pe_cisco_router.id = pe_dev_ifc.device_id
AND vpn.customer_id = customer.id {and (filterSet1 or filterSet2)}">

```

**Note**

The filter sets in this meta definition (*filterSet1* and *filterSet2*) are defined with the filter parameters (see [Filters](#)), and referenced in the SQL search criteria. See [Named Filter Sets, page 5-10](#) for more information.

## Parameter Definitions

The parameter definitions associate objects and definitions in the Prime Provisioning meta file to use in the canned report. Parameter definitions can also define access parameters for each object and filter options. The parameters definitions used in the example XML request are indicated in bold.

```

<paramDef name="pe_cisco_router.host_name"
    objectRefName="CiscoRouter"
    objectRefParamName="HostName"
    access="create_na, modify_na, view_ro"
    label="PE Device Name" />

<paramDef name="customer.name"
    objectRefName="Customer"
    objectRefParamName="Name"
    mandatory="true"
    filterOperator="like"
    access="create_na, modify_na, view_ro"
    label="Customer Name"/>

<paramDef name="mpls_sr.id"
    objectRefName="MplsSR"
    objectRefParamName="JobId"
    access="create_na, modify_na, view_ro"
    label="SR Locator Id" />

<paramDef name="mpls_sr.sr_state"
    objectRefName="MplsSR"
    objectRefParamName="State"
    access="create_na, modify_na, view_ro"
    label="SR State"/>

<paramDef name="vpn.name"
    objectRefName="VPN"
    label="VPN Name"
    access="create_na, modify_na, view_ro" />

```

## Filters

The filter section lists the parameters that filters can be applied to in this report definition. The items in bold indicate the parameters used in the example XML request.

```
<paramSetDef name="filter">
  <paramSetItem name="pe_cisco_router.host_name" />
  <paramSetItem name="customer.name" />
  <paramSetItem name="mpls_sr.id" />
  <paramSetItem name="vpn.name" />
  <paramSetItem name="mpls_sr.sr_state" />
</paramSetDef>
```

## Named Filter Sets

There can be additional filters with special references in the meta definition, called named filter sets. Named filter sets can be used when an SQL subqueries has its own *where* clause that requires user input. You can apply operators, arguments, and attributes (such as *mandatory*), to filters sets in the meta definition.

```
<paramSetDef name="filterSet1">
<paramSetItem name="pe_cisco_router.host_name" />
</paramSetDef>

<paramSetDef name="filterSet2">
<paramSetItem name="ce_cisco_router.host_name" />
</paramSetDef>
```

## Sorting

This section of the report definition defines the default sort criteria. Use the paramDef *name* (not the label) to identify the parameters to sort. Note that the PE Device Name is sorted in ascending order (asc), and VPN Name is sorted in descending order (decs).

```
<paramSetDef name="sort">
  <paramSetItem name="pe_cisco_router.host_name:asc" />
  <paramSetItem name="vpn.name:desc" />
</paramSetDef>
</objectDef>
</packageDef>
```

## Output for Reports

The response to an **execQuery** or **execReport** request can be sent as an XML response or exported to an output file on the Prime Provisioning server. File data can be in XML format or comma separated value (CSV) format.

- Output in XML format is a typical XML response that contains data records separated by record elements. The XML format is the default for **execQuery** or **execReport** output data.
- Output in CSV format is data records separated by commas (or another specified delimiter). The first line of the output is the list of column labels. The following lines contain the records. See the following example:

```
Organization.Name, Organization.Id, Organization.ContactInfo
NbiCustomer, 1, Mrs Brown Boulder Colorado
cust_for_greymgmt_NbiProvider_0, 2, Cust for GreyMgmtVpn for Provider=NbiProvider
```

To specify CSV format for the output data, you must add the filename, format, and delimiter in the first line of the XML response. To have the output data sent to a file (XML or CSV data), you define the filename and format in the first line of the **execQuery** and **execReport** XML requests. The first line is processed during the output and not during the query operation. See the following example:

```
<ns1:execQuery filename="/users/user1/tmp/querydata.xml" format="csv" delimiter=";"
maxRecords = "100">
  <objectPath xsi:type="ns1:CIMObjectPath">
    <className xsi:type="xsd:string">execQuery</className>
    <keyProperties xsi:type="ns1:CIMKeyPropertyList"
      soapenc:arrayType="ns1:CIMKeyProperty[]">
      <item xsi:type="ns1:CIMKeyProperty">
        <name xsi:type="xsd:string">QueryLanguage</name>
        <value xsi:type="xsd:string">WQL</value>
      </item>
      <item xsi:type="ns1:CIMKeyProperty">
        <name xsi:type="xsd:string">Query</name>
        <value xsi:type="xsd:string">select a.Name, b.* from Organization a, Site b
where a.Id=b.Customer_Id order by a.Name</value>
      </item>
    </keyProperties>
  </objectPath>
</ns1:execQuery>
```

In this example:

- **filename="/users/user1/tmp/querydata"** is the location of the output file name.
- **format="csv"** specifies that the output be in CSV format
- **delimiters=";"** specifies that the output data be separated by semi-colons. This parameter is optional.
- **maxRecords="100"** specifies that the API return no more than 100 records. This parameter is optional.

Use the following guidelines when choosing the format of the output data:

- If you specify XML, or do not specify a format, the output is returned in the form of an XML response.
- If you specify CSV, and send the output to a file, the output is CSV data only, no XML tags. This data cannot be sent across an HTTP connection. CSV data can be imported into a spreadsheet, or any reporting tool that supports a one character delimiter.
- If the file already exists, the response data overwrites this existing file.
- If you specify an output file, the XML response sent across the client connection lists the name of the file and a line count of the output data.
- If you specify an output file, report data is written to a file on the Prime Provisioning server.



---

**Note** The line count equals the number of records, plus one (the line for the column labels).

---

- If the API cannot write to this file, you receive an error.
- If the maximum record limit is reached, the data is truncated at the record limit. You receive the following message, which includes the maximum records value that has been exceeded.

```
<error xsi:type="ns1:CIMError">
  <code xsi:type="xsd:int">1001</code>
  <description xsi:type="xsd:string">Max records exceeded</description>
  <detail xsi:type="xsd:string"> Max number of records = 4096</detail>
```

```
</error>
```

The report headers in the output for a canned report, include report title, creation time, and the user associated with the session. [Figure 5-1](#) shows the output for the MPLS VPN Association Report sent to a CSV file and displayed in a spreadsheet.

**Figure 5-1** Example of an MPLS VPN Association Report

	A	B	C	D	E	F	G	H	I
1	Report Title	User Name	Report Time						
2	MPLS VPN Association report	admin	Fri Feb 06 12:47:34 MST 2004						
3									
4	PE Device Name	PE I/F IP	PE I/F Name	PE I/F Index	PE VPI or VLAN	PE VCI	CE Device Name	Customer Name	SR Locato
5	PE-POP-D1	192.168.1.15/16	GigabitEthernet9/4.122	70	122	-1	mpls-cpe1	EMS-cust	
6	PE-POP-D2	191.121.0.13/30	GigabitEthernet3/15.123	5	123	-1		EMS-cust	
7	PE-POP-D2	191.121.0.13/30	GigabitEthernet3/15.123	19	123	-1		EMS-cust	
8	PE-POP-D2	192.168.21.2/16	GigabitEthernet9/4.124	72	124	-1	mpls-cpe2	EMS-cust	
9									

## SLA Provisioning

A service level agreement (SLA) defines the level of service provided to a customer by a service provider. Prime Provisioning can monitor the service-related performance criteria by provisioning, collecting, and monitoring SLAs on Cisco IOS routers that support the Service Assurance Agent (SA Agent) devices.

Prime Provisioning uses the Cisco SA Agent MIB to monitor SLA metrics. The SA Agent allows you to configure probes for performance measurements and uses a router monitor (RTRMON) MIB for access through simple network management protocol (SNMP). The MIB also supports SNMP notifications.

The SLA server monitors network performance by measuring response time, jitter, connect time, throughput, and packet loss. The API supports configuring SLA probes and creating SLA reports to retrieve the data collected by the probes.



### Note

To collect SLA data, a device must have SA Agent and SNMP enabled, and have SNMP parameters set. To use the jitter (voice jitter) protocol to collect SLA data from the edge devices in your network, enable SA Agent on each device from which you want to collect this data.



### Note

You must have IP connectivity between SA Agent devices.

## Process for SLA Provisioning

The following process summarizes the SLA provisioning process using the API.

1. Create and deploy the SLA probes. See the [“Creating and Deploying SLA Probes”](#) section on [page 5-13](#).
2. Modify the SLA probe to enable or disable traps. Use `ModifySLAProbe.xml`.
3. Run an SLA collection task to start the collection of SLA data. See the [“SLA Collection”](#) section on [page 3-13](#).



4. Gather the SLA data using the processes for [SQL-Based Reports](#) or [Canned Reports](#). Prime Provisioning collects the data from the appropriate SLA databases. See the [“SLA Reports” section on page 5-19](#).
5. Prime Provisioning returns the data across the client HTTP connection in an XML response or saves it to an output file. The output file can be in XML or CSV format. See the [“Output for Reports” section on page 5-10](#).
6. This process is optional. Set up the API to receive event notifications for SLA probe and SLA collection changes (add/delete/modify instances). See the [“Event Notifications” section on page 5-1](#).

## SLA Probes

SLA probes can be configured on Cisco IOS devices. The probes store the measurement parameters at a certain frequency (for example, every 5 minutes) in the IOS buffer. An SLA collection server retrieves the measurement data from the device buffer at hour intervals and stores it in the Prime Provisioning database. There is one database for each collection server.

Using the Prime Provisioning API, you can create, delete, or view an SLA probe. You can modify a probe, but only to change the value of the **EnableProbe** or **EnableTraps** attributes (true/false).

Prime Provisioning supports creating probes from the following devices:

- From any SA Agent device
- From MPLS CPE
- From MPLS PE or MVRF-CE

To retrieve the measurement data from the database, use an SLA report. See the [“SLA Reports” section on page 5-19](#) for more information.

## Creating and Deploying SLA Probes

To create an SLA probe from any SA Agent device, specify the common probe parameters, source devices, destination devices (where applicable), and protocol (**ProbeType**).

To create an SLA probe from an MPLS CPE, PE, or MVRF-CE, you must also specify a VPN. For MPLS PEs and MPLS MVRF-CEs, a VRF is also required.

[Table 5-2](#) shows the operation, classNames, and child attributes to specify to create and deploy an SLA probe.

*Table 5-2 Create SLA Probe*

Operation	className	Children
performBatchOperation		
createInstance	ServiceOrder	<ul style="list-style-type: none"> <li>• ServiceName</li> <li>• NumberOfRequests</li> <li>• ServiceRequest</li> </ul>

Table 5-2 Create SLA Probe

Operation	className	Children
	ServiceRequest	<ul style="list-style-type: none"> <li>• RequestName</li> <li>• Type=SLAProbe</li> <li>• ServiceRequestDetails</li> </ul>
	ServiceRequestDetails	<ul style="list-style-type: none"> <li>• <a href="#">Common Probe Parameters</a></li> <li>• SourceDevice</li> <li>• DestinationDevice (where applicable)</li> <li>• VPN (only for MPLS PE, MPLS CPE, or MPLS MVRF-CE)</li> <li>• VRF (only for MPLS PE or MPLS MVRF-CE)</li> <li>• <a href="#">Probe Types</a> (protocol)</li> </ul>

See the following example:

```
<soapenv:Body>
  <ns1:performBatchOperation>
    <actions xsi:type="ns1:CIMActionList"
      soapenc:arrayType="ns1:CIMAction[]">
      <action>
        <actionName xsi:type="xsd:string">createInstance</actionName>
        <objectPath xsi:type="ns1:CIMObjectPath">
          <className xsi:type="xsd:string">ServiceOrder</className>
          <properties xsi:type="ns1:CIMPropertyList"
            soapenc:arrayType="ns1:CIMProperty[]">
            <item xsi:type="ns1:CIMProperty">
              <name xsi:type="xsd:string">ServiceName</name>
              <value xsi:type="xsd:string">SLAProbeSR</value>
            </item>
            <item xsi:type="ns1:CIMProperty">
              <name xsi:type="xsd:string">DesiredDueDate</name>
              <value xsi:type="xsd:dateTime">2003-04-10T14:55:38.885Z</value>
            </item>
            <item xsi:type="ns1:CIMProperty">
              <name xsi:type="xsd:string">NumberOfRequests</name>
              <value xsi:type="xsd:dateTime">1</value>
            </item>
          </properties>
        </objectPath>
      </action>
      <action>
        <actionName xsi:type="xsd:string">createInstance</actionName>
        <objectPath xsi:type="ns1:CIMObjectPath">
          <className xsi:type="xsd:string">ServiceRequest</className>
          <properties xsi:type="ns1:CIMPropertyList"
            soapenc:arrayType="ns1:CIMProperty[]">
            <item xsi:type="ns1:CIMProperty">
              <name xsi:type="xsd:string">RequestName</name>
              <value xsi:type="xsd:string">SLAProbeSR</value>
            </item>
            <item xsi:type="ns1:CIMProperty">
              <name xsi:type="xsd:string">Type</name>
              <value xsi:type="xsd:string">SLAProbe</value>
            </item>
          </properties>
        </objectPath>
      </action>
    </actions>
  </ns1:performBatchOperation>
</soapenv:Body>
```

```

</properties>
<objectPath xsi:type="ns1:CIMObjectPath">
  <className xsi:type="xsd:string">ServiceRequestDetails</className>
  <properties xsi:type="ns1:CIMPropertyList"
    soapenc:arrayType="ns1:CIMProperty[]">
    <item xsi:type="ns1:CIMProperty">
      <name xsi:type="xsd:string">ProbeThreshold</name>
      <value xsi:type="xsd:string">5000</value>
    </item>
    <item xsi:type="ns1:CIMProperty">
      <name xsi:type="xsd:string">ProbeTimeout</name>
      <value xsi:type="xsd:string">5000</value>
    </item>
    <item xsi:type="ns1:CIMProperty">
      <name xsi:type="xsd:string">ProbeLife</name>
      <value xsi:type="xsd:string">-1</value>
    </item>
    <item xsi:type="ns1:CIMProperty">
      <name xsi:type="xsd:string">ProbeFrequency</name>
      <value xsi:type="xsd:string">5500</value>
    </item>
    <item xsi:type="ns1:CIMProperty">
      <name xsi:type="xsd:string">ProbeTOSType</name>
      <value xsi:type="xsd:string">PRECEDENCE</value>
    </item>
    <item xsi:type="ns1:CIMProperty">
      <name xsi:type="xsd:string">ProbeTOSValue</name>
      <value xsi:type="xsd:string">0</value>
    </item>
    <item xsi:type="ns1:CIMProperty">
      <name xsi:type="xsd:string">ProbeKeepHistoryFlag</name>
      <value xsi:type="xsd:string">>false</value>
    </item>
    <item xsi:type="ns1:CIMProperty">
      <name xsi:type="xsd:string">EnableTraps</name>
      <value xsi:type="xsd:string">>false</value>
    </item>
  </properties>
</objectPath>
<objectPath xsi:type="ns1:CIMObjectPath">
  <className xsi:type="xsd:string">SourceDevice</className>
  <properties xsi:type="ns1:CIMPropertyList"
    soapenc:arrayType="ns1:CIMProperty[]">
    <item xsi:type="ns1:CIMProperty">
      <name xsi:type="xsd:string">SrcDevice</name>
      <value xsi:type="xsd:string">slaDummyOne</value>
    </item>
    <item xsi:type="ns1:CIMProperty">
      <name xsi:type="xsd:string">Interface</name>
      <value xsi:type="xsd:string">Ethernet0/0</value>
    </item>
  </properties>
</objectPath>
<objectPath xsi:type="ns1:CIMObjectPath">
  <className xsi:type="xsd:string">DestinationDevice</className>
  <properties xsi:type="ns1:CIMPropertyList"
    soapenc:arrayType="ns1:CIMProperty[]">
    <item xsi:type="ns1:CIMProperty">
      <name xsi:type="xsd:string">DestDevice</name>
      <value xsi:type="xsd:string">slaDummyTwo</value>
    </item>
    <item xsi:type="ns1:CIMProperty">
      <name xsi:type="xsd:string">Interface</name>
      <value xsi:type="xsd:string">Ethernet1/1</value>
    </item>
  </properties>
</objectPath>

```

```

        </properties>
    </objectPath>
    <objectPath xsi:type="ns1:CIMObjectPath">
        <className xsi:type="xsd:string">EchoProbe</className>
        <properties xsi:type="ns1:CIMPropertyList"
            soapenc:arrayType="ns1:CIMProperty[]" >
            <item xsi:type="ns1:CIMProperty">
                <name xsi:type="xsd:string">RequestDataSize</name>
                <value xsi:type="xsd:string">32</value>
            </item>
        </properties>
    </objectPath>
</objectPath>
</action>
</actions>
</ns1:performBatchOperation>
</soapenv:Body>

```

## Common Probe Parameters

Table 5-3 describes the common probe parameters.

**Table 5-3** Common Probe Parameters

Parameter	Description
<b>Required Parameters</b>	
ProbeLife	The number of seconds the probe is active. A value of <b>-1</b> indicates that the probe is active indefinitely.
ProbeThreshold	Threshold limit, in milliseconds. When this value is exceeded and traps are enabled, a trap is sent. If the SA Agent operation time exceeds this limit, a violation is recorded by the SA Agent. This value must not exceed the <b>ProbeTimeout</b> value.
ProbeTimeout	The time, in milliseconds, to wait for an SA Agent operation to complete. The value must be less than or equal to the <b>ProbeFrequency</b> value and greater than or equal to the <b>ProbeThreshold</b> value.
ProbeFrequency	The duration, in seconds, between initiating each SA Agent operation. The value must be greater than or equal to the <b>ProbeTimeout</b> value. The range is 0 to 604800.
ProbeTOSType { <b>PRECEDENCE</b>   <b>DSCP</b> }	The range is: <ul style="list-style-type: none"> <li><b>PRECEDENCE</b>— 0 to 7</li> <li><b>DSCP</b>—0 to 63.</li> </ul>
ProbeTOSValue	The three most significant bits of the TOS field in an IP header.
<b>Optional Parameters</b>	
ProbeKeepHistoryFlag { <b>true</b>   <b>false</b> }	If true, Prime Provisioning keeps the recent history table on the router. This is kept in the SA Agent MIB that keeps the raw round-trip time (RTT) SLA measurement. You must also specify the <b>ProbeHistoryBuckets</b> . <p><b>Note</b> Not supported for HTTP and Jitter reports.</p>

**Table 5-3** Common Probe Parameters (continued)

Parameter	Description
ProbeHistoryBuckets	Required if <b>ProbeKeepHistoryFlag=true</b> . Indicates the number of most recent raw data entries to be kept in the raw history data. When the raw data entries value is exceeded, the oldest bucket is removed to keep the entries within the limit. The range is 1 to 60.
EnableTraps { <b>true</b>   <b>false</b> }	If true, the SLA is configured to send three types of traps. You must also specify <b>ProbeFallingThreshold</b> .
ProbeFallingThreshold	Required if <b>EnableTraps=true</b> . When traps are enabled and the delay meets this value, a trap is sent. The range is 1 to the <b>ProbeThreshold</b> value, in milliseconds.

## Probe Types

Prime Provisioning uses the **ProbeType** to specify the protocol of the traffic to monitor. The following protocols are available when you create an SLA probe from all devices *only* if destination devices are available:

- Internet Control Message Protocol Echo (ICMP Echo)
- Transmission Control Protocol Connect (TCP Connect)
- User Datagram Protocol Echo (UDP Echo)
- Jitter (voice jitter)

The following protocols are available when you create an SLA probe from all devices *except* MPLS PE:

- TCP Connect
- File Transfer Protocol (FTP)
- Domain Name System (DNS)
- Hyper text Transfer Protocol (HTTP)
- Dynamic Host Configuration Protocol (DHCP)

[Table 5-4](#) describes the required attributes for each probe type (protocol).

**Table 5-4** Attributes for Probe Types

Probe Type	Attributes
EchoProbe	<ul style="list-style-type: none"> <li>• RequestDataSize</li> </ul>
UDPEchoProbe	<ul style="list-style-type: none"> <li>• RequestDataSize</li> <li>• DestinationPortNumber</li> </ul>
DNSProbe	<ul style="list-style-type: none"> <li>• NameServerAddress</li> <li>• NameToBeResolved</li> <li>• RequestDataSize</li> </ul>
FTPProbe	<ul style="list-style-type: none"> <li>• UserName</li> <li>• Password</li> <li>• HostIPAddress</li> <li>• FilePath</li> </ul>

Table 5-4 Attributes for Probe Types

Probe Type	Attributes
DHCPProbe	<ul style="list-style-type: none"> <li>No specific attributes</li> </ul>
HTTPProbe	<ul style="list-style-type: none"> <li>HTTPVersion</li> <li>HTTPUrl</li> <li>EnableHTTPCacheFlag</li> <li>HTTPProxyServer</li> <li>NameServerAddress</li> <li>HTTPOperation               <ul style="list-style-type: none"> <li>HTTPGet</li> <li>HTTPRaw (<b>HTTPRawRequest</b> is also required)</li> </ul> </li> <li>RequestDataSize</li> </ul>
JitterProbe	<ul style="list-style-type: none"> <li>RequestDataSize</li> <li>DestinationPortNumber</li> <li>PacketCount</li> <li>Interval</li> </ul>
TCPConnectProbe	<ul style="list-style-type: none"> <li>RequestDataSize</li> <li>DestinationPortNumber</li> </ul>

## Viewing SLA Probes

To view an SLA probe, use **enumerateInstances**, specify the probe type (for example, **EchoProbe**, **JitterProbe**, **HTTPProbe**), and enter a unique identifier, such as **LocatorID**.



### Note

The **LocatorID** can also be used to retrieve, modify, and delete a specific probe.

To view probes for a specific device, use **SrcDevice** or **DestDevice** as the unique identifier. See the following example:

```
<?xml version="1.0" encoding="UTF-8"?>
<soapenv:Envelope
  xmlns:soapenv="http://schemas.xmlsoap.org/soap/envelope/"
  xmlns:soapenc="http://schemas.xmlsoap.org/soap/encoding/"
  xmlns:xsd="http://www.w3.org/2001/XMLSchema"
  xmlns:xsi="http://www.w3.org/2001/XMLSchema-instance"
  xmlns:ns0="http://www.cisco.com/cim-cx/2.0"
  xmlns:ns1="urn:CIM">
  <soapenv:Header>
    <ns0:message id="87855" timestamp="2002-12-13T14:55:38.885Z"
      sessiontoken="p36bttjwy1"/>
  </soapenv:Header>
  <soapenv:Body>
    <ns1:enumerateInstances>
      <objectPath xsi:type="ns1:CIMObjectPath">
        <className xsi:type="xsd:string">EchoProbe</className>
        <keyProperties xsi:type="ns1:CIMKeyPropertyList"
          soapenc:arrayType="ns1:CIMKeyProperty[]">
```

```

    <item xsi:type="ns1:CIMKeyProperty">
      <name xsi:type="xsd:string">SrcDevice</name>
      <value xsi:type="xsd:string">slaDummyOne</value>
    </item>
  </keyProperties>
</objectPath>
</ns1:enumerateInstances>
</soapenv:Body>
</soapenv:Envelope>

```

## SLA Reports

SLA reports gather information from the various SLA tables in the SLA database. SLA data is derived at specific intervals from the SLA repository. The information gathered in SLA reports depends on the probes that have been set for collection of information.

SLA reports can be created using **execQuery** or **execReport**.

- **execQuery** retrieves raw data from the main Prime Provisioning database or the SLA database. See the “[SQL-Based Reports](#)” section on page 5-4 for more information.
- **execReport** for SLA, generates SLA reports based solely on data from the SLA tables in the SLA database.

Prime Provisioning supports the following report types:

- **SLASummaryReport**
- **SLAHTTPReport**
- **SLAJitterReport**
- **SLASummaryCoSReport**
- **SLAHTTPCoSReport**
- **SLAJitterCoSReport**

For the Summary, HTTP, and Jitter reports, you filter the SLA probe by DSCP and or IP precedence value. For the Summary CoS, HTTP CoS, and Jitter CoS reports, you specify the TOS type for the whole report.

To define the conditions for the SLA report, use the following required attributes:

- **ValueDisplayed**—See [Table 5-5](#) for a complete list of options for each report type.
- **Timeline** and **TimeGranularity**—**All, Yearly, Monthly, or Daily, Hourly.**
- **AggregateBy**—**All, Customer, Provider, VPN, Source\_Router, or Probe.**

The following filters are also available for SLA reports:

- Organization
- Provider
- VPN
- SrcDevice
- DestDevice
- Probes
- TOS

## - DSCP

See the following example:

```
<soapenv:Body>
  <ns1:execReport>
    <objectPath xsi:type="ns1:CIMObjectPath">
      <className xsi:type="xsd:string">SLAJitterReport</className>
      <keyProperties xsi:type="ns1:CIMKeyPropertyList"
        soapenc:arrayType="ns1:CIMKeyProperty[]">
        <item xsi:type="ns1:CIMKeyProperty">
          <name xsi:type="xsd:string">ValueDisplayed</name>
          <value xsi:type="xsd:string">Avg_Forward_Jitter</value>
        </item>
        <item xsi:type="ns1:CIMKeyProperty">
          <name xsi:type="xsd:string">AggregateBy</name>
          <value xsi:type="xsd:string">VPN</value>
        </item>
        <item xsi:type="ns1:CIMKeyProperty">
          <name xsi:type="xsd:string">TimeGranularity</name>
          <value xsi:type="xsd:string">Weekly</value>
        </item>
        <item xsi:type="ns1:CIMKeyProperty">
          <name xsi:type="xsd:string">Timeline</name>
          <value xsi:type="xsd:dateTime">2004-1-30T00:55:38Z</value>
        </item>
      </keyProperties>
    </objectPath>
  </ns1:execReport>
</soapenv:Body>
```



**Table 5-5 Value Displayed Options for SLA Reports**

Report Type	Options for ValueDisplayed
SLASummaryReport and SLASummaryCoSReport	<ul style="list-style-type: none"> <li>• All</li> <li>• Connections</li> <li>• Timeouts</li> <li>• Connectivity</li> <li>• Threshold_Violations</li> <li>• Max_Delay</li> <li>• Min_Delay</li> <li>• Avg_Delay</li> </ul>
SLAHTTPReport and SLAHTTPCoSReport	<ul style="list-style-type: none"> <li>• All</li> <li>• Connectivity</li> <li>• Max_Delay</li> <li>• Threshold_Violations</li> <li>• DNS_RTT</li> <li>• DNS_Timeouts</li> <li>• DNS_Errors</li> <li>• TCP_Connection_RTT</li> <li>• TCP_Connection_Timeouts</li> <li>• Transaction_RTT</li> <li>• Transaction_Timeouts</li> <li>• Transaction_Errors</li> </ul>
SLAJitterReport and SLAJitterCoSReport	<ul style="list-style-type: none"> <li>• All</li> <li>• Avg_Forward_Jitter</li> <li>• Avg_Positive_Forward_Jitter</li> <li>• Avg_Negative_Forward_Jitter</li> <li>• Min_Forward_Jitter</li> <li>• Max_Forward_Jitter</li> <li>• Backward_Packet_Drops</li> <li>• Avg_Backward_Jitter</li> <li>• Avg_Positive_Backward_Jitter</li> <li>• Avg_Negative_Backward_Jitter</li> <li>• Min_Backward_Jitter</li> <li>• Max_Backward_Jitter</li> </ul>

The output of an SLA report can be an XML response or saved to a file. An output file can be in XML or CSV format. See the [“Output for Reports”](#) section on page 5-10 for more information.

# Device Locking

When downloading a service configuration, the Prime Provisioning provisioning engine locks the corresponding device to ensure it has dedicated access during the configuration download. By default, the back-end servers control device locking during the service provisioning process. However, you can use the API to manually lock a device to block Prime Provisioning from accessing it for provisioning.

The API also supports these device locking operations:

- Locking multiple devices in batch mode
- Unlocking devices
- Viewing the status of a device lock

To manually lock a device, use an XML request with the **execMethod** operation, the **ResourceLock** object definition (className), and these parameters:

- **Action**=<choose one of the following>
  - **Lock**
  - **Unlock**
  - **Status**
- **Type**=**Device**
- Use one of these parameters to identify the resource to lock:
  - **Device**=<Device name>
  - **Device**=<Device ID number>
  - **JobId**=<Job ID number>

The following example shows a device locking XML request for multiple devices in batch mode.

```
<soapenv:Body>
  <ns1:performBatchOperation>
    <actions xsi:type="ns1:CIMActionList" soapenc:arrayType="ns1:CIMAction[]">
      <action>
        <actionName xsi:type="xsd:string">execMethod</actionName>
        <objectPath xsi:type="ns1:CIMObjectPath">
          <className xsi:type="xsd:string">ResourceLock</className>
          <properties xsi:type="ns1:CIMPropertyList"
soapenc:arrayType="ns1:CIMProperty[]">
            <item xsi:type="ns1:CIMProperty">
              <name xsi:type="xsd:string">Action</name>
              <value xsi:type="xsd:string">Lock</value>
            </item>
            <item xsi:type="ns1:CIMProperty">
              <name xsi:type="xsd:string">Type</name>
              <value xsi:type="xsd:string">Device</value>
            </item>
            <item xsi:type="ns1:CIMProperty">
              <name xsi:type="xsd:string">Device</name>
              <value xsi:type="xsd:string">enswosr2</value>
            </item>
          </properties>
        </objectPath>
      </action>
      <action>
        <actionName xsi:type="xsd:string">execMethod</actionName>
        <objectPath xsi:type="ns1:CIMObjectPath">
          <className xsi:type="xsd:string">ResourceLock</className>
```

```

        <properties xsi:type="ns1:CIMPropertyList"
soapenc:arrayType="ns1:CIMProperty[]" ">
            <item xsi:type="ns1:CIMProperty">
                <name xsi:type="xsd:string">Action</name>
                <value xsi:type="xsd:string">Status</value>
            </item>
            <item xsi:type="ns1:CIMProperty">
                <name xsi:type="xsd:string">Type</name>
                <value xsi:type="xsd:string">Device</value>
            </item>
            <item xsi:type="ns1:CIMProperty">
                <name xsi:type="xsd:string">JobId</name>
                <value xsi:type="xsd:string">0</value>
            </item>
        </properties>
    </objectPath>
</action>
<action>
    <actionName xsi:type="xsd:string">execMethod</actionName>
    <objectPath xsi:type="ns1:CIMObjectPath">
        <className xsi:type="xsd:string">ResourceLock</className>
        <properties xsi:type="ns1:CIMPropertyList"
soapenc:arrayType="ns1:CIMProperty[]" ">
            <item xsi:type="ns1:CIMProperty">
                <name xsi:type="xsd:string">Action</name>
                <value xsi:type="xsd:string">Unlock</value>
            </item>
            <item xsi:type="ns1:CIMProperty">
                <name xsi:type="xsd:string">Type</name>
                <value xsi:type="xsd:string">Device</value>
            </item>
            <item xsi:type="ns1:CIMProperty">
                <name xsi:type="xsd:string">DeviceId</name>
                <value xsi:type="xsd:string">4</value>
            </item>
        </properties>
    </objectPath>
</action>
</actions>
</ns1:performBatchOperation>
</soapenv:Body>
</soapenv:Envelope>

```

The response to an XML request for device locking indicates the **Action**, **Status** and **JobId**.

- If the status value is **RUN**, your request is being processed.
- If the status is **SLEEP**, the device lock is in place.
- If the status is **FINISHED**, the lock has been removed.
- If there is a failure, a failure description is returned.

The following example is a response to a ViewResourceLock\_Device XML request.

```

<soapenv:Envelope xmlns:soapenv="http://schemas.xmlsoap.org/soap/envelope/"
xmlns:soapenc="http://schemas.xmlsoap.org/soap/encoding/"
xmlns:xsd="http://www.w3.org/2001/XMLSchema"
xmlns:xsi="http://www.w3.org/2001/XMLSchema-instance"
xmlns:ns0="http://www.cisco.com/cim-cx/2.0" xmlns:ns1="urn:CIM">
    <soapenv:Header>
        <ns0:message id="87855" sessiontoken="9DCB8431CB9773C285DCDBE5E1375299"
waittimeout="800000" timestamp="2004-02-27T18:42:48.051Z" wait="true" />
    </soapenv:Header>
    <soapenv:Body>

```

```

<ns1:execMethodResponse>
  <returns xsi:type="ns1:CIMPropertyList" soapenc:arrayType="ns1:CIMProperty[]">
    <item xsi:type="ns1:CIMProperty">
      <name xsi:type="xsd:string">Action</name>
      <value xsi:type="xsd:string">Status</value>
    </item>
    <item xsi:type="ns1:CIMProperty">
      <name xsi:type="xsd:string">Status</name>
      <value xsi:type="xsd:string">SLEEP</value>
    </item>
    <item xsi:type="ns1:CIMProperty">
      <name xsi:type="xsd:string">JobId</name>
      <value xsi:type="xsd:string">0</value>
    </item>
  </returns>
</ns1:execMethodResponse>
</soapenv:Body>
</soapenv:Envelope>

```

## Viewing Task Logs

The XML response to a **ViewTask** operation is an extensive list of information about the service order. This information includes:

- Information about the service order itself (**Creator**, **CreateTime**, **TaskType**, **MaxRuns**)
- The complete list of attributes in the service order
- The task log output, which includes all messages according to the level specified in the properties file

To view the logs for a specific task (for example, configuration audits, MPLS functional audits, or collection), perform the following steps:

- 
- Step 1** Record the service order **LocatorId** that is returned in the XML response.
  - Step 2** Run a view of the service order using `ViewServiceOrder.xml`, and the **LocatorId** from Step 1.
  - Step 3** Record the **TaskLocatorId** that is returned in the XML response.
  - Step 4** Run a view of the Task using `ViewTask.xml`. Specify **className=PersistentTask** and use the **TaskLocatorId** from Step 3.
- 

The following example shows the tail end of the **ViewTask** XML response, which displays the task log output.

```

<xsi:type="xsd:string">view.cisco.com//opt/vpnsc/user/tmp/TaskLogs/jobLog_1064765379277_pr
ov.provdrv.ProvDrv_20</value>
  </item>
  <item xsi:type="ns1:CIMProperty">
    <name xsi:type="xsd:string">LogContent</name>
    <value xsi:type="xsd:string">
      Date: 2003-09-28T10:09:39 Level: INFO Message: The argument to the ProvDrv are:
      IsProvision = true
      JobIdList = 3
      ipsec-rekey = false
      IsForceRedeploy = false
      targets = []
    </value>
  </item>

```

```

Date: 2003-09-28T10:09:39 Level: INFO Message: Opening repository ...
Date: 2003-09-28T10:09:39 Level: INFO Message: Open repository succeeded
Date: 2003-09-28T10:09:39 Level: INFO Message: ===== Creating ProvDrvSR for
Job#3SR#3
Date: 2003-09-28T10:09:39 Level: INFO Message: Filter to getLogicalDevices: 1
Date: 2003-09-28T10:09:39 Level: INFO Message: getServiceElements() : ACTION -
PROVISIONING
Date: 2003-09-28T10:09:39 Level: INFO Message: Number of logicalDevices got: 2
Date: 2003-09-28T10:09:39 Level: INFO Message: Processing logical device 7 with
physical id 5
Date: 2003-09-28T10:09:39 Level: INFO Message: Service blade for this device:
com.cisco.vpnsc.prov.mpls.MplsServiceBlade
Date: 2003-09-28T10:09:39 Level: INFO Message: Create blade the first time:
com.cisco.vpnsc.prov.mpls.MplsServiceBlade
Date: 2003-09-28T10:09:39 Level: INFO Message: created service blade
Date: 2003-09-28T10:09:39 Level: INFO Message: returning XML_JDOM as preference
Date: 2003-09-28T10:09:39 Level: INFO Message: Filter to generateXML: 1
Date: 2003-09-28T10:09:39 Level: INFO Message: Generate XML: xmlPref[2] Filter
[1]
Date: 2003-09-28T10:09:39 Level: INFO Message: getServiceElements() : ACTION -
PROVISIONING
Date: 2003-09-28T10:09:39 Level: INFO Message: Number Of MPLS VPN Link[ 1]
Date: 2003-09-28T10:09:40 Level: SEVERE Message: Unable to Generate input.xml
for MPLS Deployable Interface
com.cisco.vpnsc.repository.RepException: 158 : Unable to allocate IP Address from the
/32 IP Address Pool
    at
com.cisco.vpnsc.repository.servmodelaccess.MPLSServiceModelAccess.appendLink(MPLSServiceMo
delAccess.java:237)
    at
com.cisco.vpnsc.repository.servmodelaccess.MPLSServiceModelAccess.createServiceModel(MPLSS
erviceModelAccess.java:176)
    at com.cisco.vpnsc.repository.servmodelaccess.GSAM.generateXML(GSAM.java:172)
    at com.cisco.vpnsc.repository.mpls.RepMplsSR.generateXML(RepMplsSR.java:1207)
    at
com.cisco.vpnsc.prov.provdrv.ProvDrvSR.buildBladeMapAndDoBladeValidation(ProvDrvSR.java:27
2)
    at
com.cisco.vpnsc.prov.provdrv.ProvDrvSR.populateRouterLists(ProvDrvSR.java:540)
    at com.cisco.vpnsc.prov.provdrv.ProvDrv.createProvDrvSR(ProvDrv.java:2472)
    at com.cisco.vpnsc.prov.provdrv.ProvDrv.populateSRMap(ProvDrv.java:2173)
    at com.cisco.vpnsc.prov.provdrv.ProvDrv.perform(ProvDrv.java:172)
    at com.cisco.vpnsc.dist.VpnscJob.perform(VpnscJob.java:80)
    at com.cisco.vpnsc.dist.WorkerImpl.jobPerformWrapper(WorkerImpl.java:1163)
    at com.cisco.vpnsc.dist.WorkerImpl.access$000(WorkerImpl.java:31)
    at com.cisco.vpnsc.dist.WorkerImpl$JobExecutionTask.run(WorkerImpl.java:1285)
    at com.cisco.vpnsc.dist.ThreadPool$TaskThread.run(ThreadPool.java:268)

Date: 2003-09-28T10:09:40 Level: SEVERE Message: Exception caught: null
Date: 2003-09-28T10:09:40 Level: INFO Message: Cache input.xml with preferred
value: 2
Date: 2003-09-28T10:09:40 Level: WARNING Message: Input XML is null!
Date: 2003-09-28T10:09:40 Level: INFO Message: returning success for validation
Date: 2003-09-28T10:09:40 Level: INFO Message: Processing logical device 3 with
physical id 3
Date: 2003-09-28T10:09:40 Level: INFO Message: Service blade for this device:
com.cisco.vpnsc.prov.mpls.MplsServiceBlade
Date: 2003-09-28T10:09:40 Level: INFO Message: The blade
com.cisco.vpnsc.prov.mpls.MplsServiceBlade is shared by multiple types of devices.
Date: 2003-09-28T10:09:40 Level: INFO Message: Use existing blade
com.cisco.vpnsc.prov.mpls.MplsServiceBlade
Date: 2003-09-28T10:09:40 Level: INFO Message: Added Router 5 to the union map.
Date: 2003-09-28T10:09:40 Level: INFO Message: Adding logical device 7 to
Job#3SR#3 's local router list.

```

```

    Date: 2003-09-28T10:09:40 Level: INFO Message: Add logical device 7 to
Job#3SR#3 's blade com.cisco.vpnsc.prov.mpls.MplsServiceBlade's local router list.
    Date: 2003-09-28T10:09:40 Level: INFO Message: Added Router 3 to the union map.
    Date: 2003-09-28T10:09:40 Level: INFO Message: Adding logical device 3 to
Job#3SR#3 's local router list.
    Date: 2003-09-28T10:09:40 Level: INFO Message: Add logical device 3 to
Job#3SR#3 's blade com.cisco.vpnsc.prov.mpls.MplsServiceBlade's local router list.
    Date: 2003-09-28T10:09:40 Level: INFO Message:
===== Creating ProvDrvSR succeeded for Job#3SR#3
The union router map has devices:
3 5
    Date: 2003-09-28T10:09:40 Level: INFO Message: Service Request to be processed:
Job#3SR#3 .
    Date: 2003-09-28T10:09:40 Level: INFO Message: ===== Uploading configuration
    Date: 2003-09-28T10:09:40 Level: INFO Message: Creating instance of GTL
    Date: 2003-09-28T10:09:41 Level: INFO Message: ===== Upload completed.
    Date: 2003-09-28T10:09:41 Level: INFO Message: ===== Processing Service
Request Job#3SR#3
    Date: 2003-09-28T10:09:41 Level: INFO Message: Entering provision method
    Date: 2003-09-28T10:09:41 Level: SEVERE Message: invalid arguments
    Date: 2003-09-28T10:09:41 Level: INFO Message: Result.xml from
ServiceBlade[com.cisco.vpnsc.prov.mpls.MplsServiceBlade]:
null
    Date: 2003-09-28T10:09:41 Level: SEVERE Message: Service
Blade[com.cisco.vpnsc.prov.mpls.MplsServiceBlade] returned null result for Job#3SR#3
.
    Date: 2003-09-28T10:09:41 Level: SEVERE Message: Job#3SR#3 skipped template
instantiation because all service blades have failed.
    Date: 2003-09-28T10:09:41 Level: SEVERE Message: Failed for all service blades.
SR Job ID 3 transitioned from INVALID to INVALID
    Date: 2003-09-28T10:09:41 Level: INFO Message: ===== Downloading
configuration.
    Date: 2003-09-28T10:09:41 Level: INFO Message: Skipping device 3, the configlet
is empty.
    Date: 2003-09-28T10:09:41 Level: INFO Message: Skipping device 5, the configlet
is empty.
    Date: 2003-09-28T10:09:41 Level: INFO Message: ===== Download completed
    Date: 2003-09-28T10:09:41 Level: INFO Message: ===== Update Service for SR
Job#3SR#3
    Date: 2003-09-28T10:09:41 Level: INFO Message: getServiceElements() : ACTION -
PROVISIONING
    Date: 2003-09-28T10:09:41 Level: INFO Message: ProvDrv is completed.</value>
</item>

```



## MPLS Provisioning

---

The service provider's backbone is comprised of the core provider edge (PE) device and its provider routers. An MPLS VPN consists of a set of customer sites that are interconnected through an MPLS provider core network. At each site, there are one or more customer edge (CE) devices, which attach to one or more PEs.

Cisco Prime Provisioning provisioning engine for MPLS accesses the configuration files on both the CE and PE to compute the necessary changes to the configuration files to support the service on the PE to CE link (or PE to CLE, PE to MVRFCE to CE, or PE to MVRFCE to CLE).

This chapter describes MPLS VPN service concepts and the steps required to provision MPLS VPN services using the Prime Provisioning API. The provisioning example includes the process flow from creating the inventory to auditing the service deployment.

For information on MPLS provisioning using the Prime Provisioning GUI, see the [Cisco Prime Provisioning 6.8 User Guide](#).

This chapter contains the following sections:

- [MPLS Service Definitions](#), page 6-2
- [MPLS Service Requests](#), page 6-11
- [End-to-End Provisioning Process](#), page 6-53.

# MPLS Service Definitions

An MPLS service definition defines attributes for the policy type (**MPLSPolicyAttributes**), and can include the CE routing community (CERC) membership and redistributed protocol information.

CERC membership defines the CE routing community for this policy and is represented by the VPN routing and forwarding tables (VRFs), and the redistributed protocols define the metric attributes. MPLS policy attributes are described in the [MPLS Policy Attributes](#) section.

## Schema Diagram

Figure 6-1 shows the schema diagram for an MPLS service definition.

Figure 6-1 MPLS Service Definition Schema Diagram

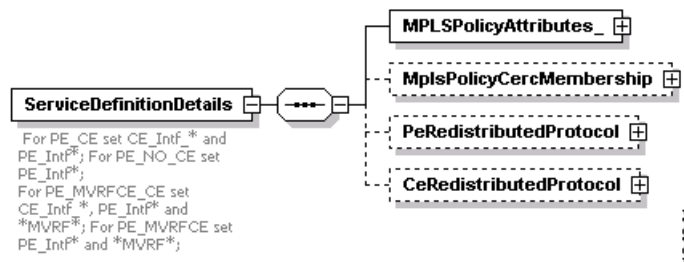

For each service definition property, you can set an additional attribute, **editable=true**, to allow the network operator to override these attributes when creating the service request. If an attribute is set to **editable=false**, these attributes cannot be changed in the service request.



### Note

When a property has the additional attribute **editable=true**, all the related and child attributes are also editable.

See the following example:

```
<objectPath xsi:type="ns1:CIMObjectPath">
  <className xsi:type="xsd:string">ServiceDefinitionDetails</className>
  <properties xsi:type="ns1:CIMPropertyList"
    soapenc:arrayType="ns1:CIMProperty[]">
    <item xsi:type="ns1:CIMProperty">
      <name xsi:type="xsd:string">SubType</name>
      <value xsi:type="xsd:string">PE_CE</value>
    </item>
    <item xsi:type="ns1:CIMProperty">
      <name xsi:type="xsd:string">PE_Intf_Type</name>
      <value xsi:type="xsd:string">GigabitEthernet</value>
      <qualifier xsi:type="ns1:CIMQualifier">
        <name xsi:type="xsd:string">editable</name>
        <value xsi:type="xsd:string">true</value>
      </qualifier>
    </item>
    <item xsi:type="ns1:CIMProperty">
      <name xsi:type="xsd:string">PE_Intf_Desc</name>
      <value xsi:type="xsd:string">Interface Description</value>
    </item>
  </properties>
</objectPath>
```



```
<qualifier xsi:type="ns1:CIMQualifier">
  <name xsi:type="xsd:string">editable</name>
  <value xsi:type="xsd:string">true</value>
</qualifier>
</item>
<item xsi:type="ns1:CIMProperty">
  <name xsi:type="xsd:string">PE_Intf_Shutdown</name>
  <value xsi:type="xsd:string">TRUE</value>
  <qualifier xsi:type="ns1:CIMQualifier">
    <name xsi:type="xsd:string">editable</name>
    <value xsi:type="xsd:string">true</value>
  </qualifier>
</item>
```

## Supported MPLS Operations

The following basic API operations are supported in this release:

### Policies

- PE\_CE
  - Create PE\_CE Policy
  - Modify PE\_CE Policy
  - Delete the PE\_CE Policy
- PE\_NOCE
  - Create PE\_NOCE Policy
  - Modify the PE\_NOCE Policy
  - Delete the PE\_NOCE Policy
- MVRF\_CE
  - Create MVRF\_CE Policy
  - Modify MVRF\_CE Policy
  - Delete MVRF\_CE Policy
- MVRF\_NO\_CE
  - Create MVRF\_NO\_CE Policy
  - Modify MVRF\_NOCE Policy
  - Delete MVRF\_NOCE Policy

### Service Requests

- PE\_CE SR
  - Create PE\_CE SR
  - Modify PE\_CE SR
  - Delete the PE\_CE SR
- PE\_NOCE SR
  - Create PE\_NOCE SR
  - Modify the PE\_NOCE SR

- Delete the PE\_NOCE SR
- MVRF\_CE SR
  - Create MVRF\_CE SR
  - Modify MVRF\_CE SR
  - Delete MVRF\_CE SR
- MVRF\_NO\_CE SR
  - Create MVRF\_NO\_CE SR
  - Modify MVRF\_NOCE SR
  - Delete MVRF\_NOCE SR

Besides the above, you can also perform the following operations:

- View MPLS Policy
- View MPLS SR Response
- View MPLS SR

The End-to-End Provisioning section of this document includes examples of inventory and resource pool operations.

## MPLS Policy Attributes

The MPLS policy attributes include; the policy subtype, device interfaces and encapsulation types, IP addressing schemes, routing protocols, and VPN membership information. These values are set based on the policy subtype.

The following MPLS policy subtypes are supported:

- PE\_CE—A standard MPLS policy for the PE\_CE link. This is the default MPLS policy for Prime Provisioning.
- PE\_NO\_CE—In this policy type, you specify only the PE interface information. The CE device at the customer location is not managed by Prime Provisioning.
- PE\_MVRFCE\_CE—A Multi-VPN routing and forwarding CE (MVRFCE) network has multiple CE devices that connect to one MVRFCE device. The MVRFCE stores the VRFs for all VPNs in the customer network and connects directly with the PE device at the edge of the provider network. Prime Provisioning manages the PE to MVRFCE to CE link.
- PE\_MVRFCE\_NO\_CE—Prime Provisioning manages the PE to MVRFCE link. The CE device at the customer site is not managed by Prime Provisioning.



### Note

For all policy subtypes with no CE present, you do not declare the CE devices to be CPEs, and you do not set policy attributes for the CE devices in the service definition.

There are numerous properties that can be set for an MPLS policy. [Figure 6-2](#) shows a partial schema diagram for the **MPLSPolicAttributes** with **SubType=PE\_CE**.

Figure 6-2 MPLS Policy Attributes Schema Diagram

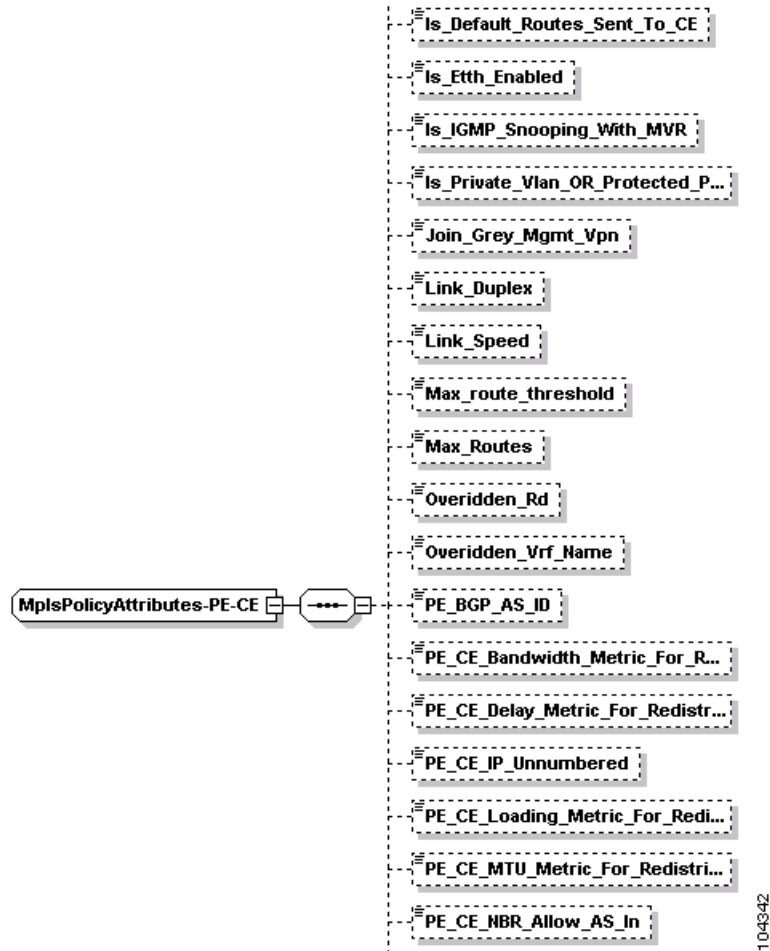

## Policy Examples

This section contains API XML examples of the following MPLS policies:

- [Creating an MPLS Pseudowire Policy, page 6-5](#)
- [Creating an MPLS VPN Topology, page 6-7](#)

### Creating an MPLS Pseudowire Policy

As an example of an MPLS pseudowire policy, the following illustrates how to create a BGP policy for a PE no CE case.

Example: CreateMPLSServiceDefn\_PE\_NO\_CE\_PW\_MPLS.xml

```
<?xml version="1.0"?>
```

```

<soapenv:Envelope xmlns:ns0="http://www.cisco.com/cim-cx/2.0" xmlns:ns1="urn:CIM"
xmlns:soapenc="http://schemas.xmlsoap.org/soap/encoding/"
xmlns:soapenv="http://schemas.xmlsoap.org/soap/envelope/"
xmlns:xsd="http://www.w3.org/2001/XMLSchema"
xmlns:xsi="http://www.w3.org/2001/XMLSchema-instance">
  <soapenv:Header>
    <ns0:message id="87855" sessiontoken="DD8EEDA45B35DF2E1AE8E07FDF72BB4A"
timestamp="2002-12-13T14:55:38.885Z"/>
  </soapenv:Header>
  <soapenv:Body>
    <ns1:createInstance>
      <objectPath xsi:type="ns1:CIMObjectPath">
        <className xsi:type="xsd:string">ServiceDefinition</className>
        <properties soapenc:arrayType="ns1:CIMProperty[]" xsi:type="ns1:CIMPropertyList">
          <item xsi:type="ns1:CIMProperty">
            <name xsi:type="xsd:string">Name</name>
            <value xsi:type="xsd:string">POLICY</value>
          </item>
          <item xsi:type="ns1:CIMProperty">
            <name xsi:type="xsd:string">Type</name>
            <value xsi:type="xsd:string">Mpls</value>
          </item>
          <item xsi:type="ns1:CIMProperty">
            <name xsi:type="xsd:string">Remarks</name>
            <value xsi:type="xsd:string">data remarks</value>
          </item>
        </properties>
        <objectPath xsi:type="ns1:CIMObjectPath">
          <className xsi:type="xsd:string">ServiceDefinitionDetails</className>
          <properties soapenc:arrayType="ns1:CIMProperty[]" xsi:type="ns1:CIMPropertyList">
            <item xsi:type="ns1:CIMProperty">
              <name xsi:type="xsd:string">SubType</name>
              <value xsi:type="xsd:string">PE_NO_CE</value>
            </item>
            <item xsi:type="ns1:CIMProperty">
              <name xsi:type="xsd:string">IsCreateVirtualInterface</name>
              <value xsi:type="xsd:string">true</value>
            </item>
            <item xsi:type="ns1:CIMProperty">
              <name xsi:type="xsd:string">PE_Intf_Desc</name>
              <value xsi:type="xsd:string">MyDesc</value>
              <qualifier xsi:type="ns1:CIMQualifier">
                <name xsi:type="xsd:string">editable</name>
                <value xsi:type="xsd:string">true</value>
              </qualifier>
            </item>
            <item xsi:type="ns1:CIMProperty">
              <name xsi:type="xsd:string">PE_Intf_Shutdown</name>
              <value xsi:type="xsd:string">>false</value>
              <qualifier xsi:type="ns1:CIMQualifier">
                <name xsi:type="xsd:string">editable</name>
                <value xsi:type="xsd:string">true</value>
              </qualifier>
            </item>
            <item xsi:type="ns1:CIMProperty">
              <name xsi:type="xsd:string">PE_Intf_Type</name>
              <value xsi:type="xsd:string">ANY</value>
              <qualifier xsi:type="ns1:CIMQualifier">
                <name xsi:type="xsd:string">editable</name>
                <value xsi:type="xsd:string">true</value>
              </qualifier>
            </item>
            <item xsi:type="ns1:CIMProperty">
              <name xsi:type="xsd:string">Autopick_Vlan_ID</name>

```

```

<value xsi:type="xsd:string">>false</value>
<qualifier xsi:type="ns1:CIMQualifier">
<name xsi:type="xsd:string">editable</name>
<value xsi:type="xsd:string">>true</value>
</qualifier>
</item>
<item xsi:type="ns1:CIMProperty">
<name xsi:type="xsd:string">PE_CE_IPV6_Routing_Protocol</name>
<value xsi:type="xsd:string">BGP</value>
<qualifier xsi:type="ns1:CIMQualifier">
<name xsi:type="xsd:string">editable</name>
<value xsi:type="xsd:string">>true</value>
</qualifier>
</item>
<item xsi:type="ns1:CIMProperty">
<name xsi:type="xsd:string">Template_Enabled</name>
<value xsi:type="xsd:string">>false</value>
<qualifier xsi:type="ns1:CIMQualifier">
<name xsi:type="xsd:string">editable</name>
<value xsi:type="xsd:string">>true</value>
</qualifier>
</item>
</properties>
<objectPath xsi:type="ns1:CIMObjectPath">
<className xsi:type="xsd:string">MplsPolicyCercMembership</className>
<properties xsi:type="ns1:CIMPropertyList"
soapenc:arrayType="ns1:CIMProperty[]">
<item xsi:type="ns1:CIMProperty">
<name xsi:type="xsd:string">CERC</name>
<value xsi:type="xsd:string">rtt</value>
</item>
<item xsi:type="ns1:CIMProperty">
<name xsi:type="xsd:string">IsHub</name>
<value xsi:type="xsd:string">true</value>
</item>
</properties>
</objectPath>
</objectPath>
</ns1:createInstance>
</soapenv:Body>
</soapenv:Envelope>

```

## Creating an MPLS VPN Topology

This example is used to set up a L3VPN topology in a service policy. To do this, the **VPN\_TOPOLOGY** attribute must be set to **true** as in the example. Also make sure to set the attribute **CERC\_RTTYPE**.

Example: CreateMPLSServiceDefn\_PE\_NO\_CE\_VPN\_TOPOLOGY.xml

```

<?xml version="1.0" ?>
- <soapenv:Envelope xmlns:ns0="http://www.cisco.com/cim-cx/2.0" xmlns:ns1="urn:CIM"
xmlns:soapenc="http://schemas.xmlsoap.org/soap/encoding/"
xmlns:soapenv="http://schemas.xmlsoap.org/soap/envelope/"
xmlns:xsd="http://www.w3.org/2001/XMLSchema"
xmlns:xsi="http://www.w3.org/2001/XMLSchema-instance">
- <soapenv:Header>
<ns0:message id="87855" sessiontoken="856A44B24C52AA43D5CA254B79DE3452"
timestamp="2002-12-13T14:55:38.885Z" />
</soapenv:Header>
- <soapenv:Body>

```

```

- <ns1:createInstance>
- <objectPath xsi:type="ns1:CIMObjectPath">
  <className xsi:type="xsd:string">ServiceDefinition</className>
- <properties soapenc:arrayType="ns1:CIMProperty[]" xsi:type="ns1:CIMPropertyList">
- <item xsi:type="ns1:CIMProperty">
  <name xsi:type="xsd:string">Name</name>
  <value xsi:type="xsd:string">VPN-Topology-Pol-1</value>
</item>
- <item xsi:type="ns1:CIMProperty">
  <name xsi:type="xsd:string">Type</name>
  <value xsi:type="xsd:string">Mpls</value>
</item>
- <item xsi:type="ns1:CIMProperty">
  <name xsi:type="xsd:string">Remarks</name>
  <value xsi:type="xsd:string">data remarks</value>
</item>
- <item xsi:type="ns1:CIMProperty">
  <name xsi:type="xsd:string">Organization</name>
  <value xsi:type="xsd:string">Customer1</value>
</item>
</properties>
- <objectPath xsi:type="ns1:CIMObjectPath">
  <className xsi:type="xsd:string">ServiceDefinitionDetails</className>
- <properties soapenc:arrayType="ns1:CIMProperty[]" xsi:type="ns1:CIMPropertyList">
- <item xsi:type="ns1:CIMProperty">
  <name xsi:type="xsd:string">SubType</name>
  <value xsi:type="xsd:string">PE_NO_CE</value>
</item>
- <item xsi:type="ns1:CIMProperty">
  <name xsi:type="xsd:string">IsCreateVirtualInterface</name>
  <value xsi:type="xsd:string">>false</value>
</item>
- <item xsi:type="ns1:CIMProperty">
  <name xsi:type="xsd:string">PE_Intf_Desc</name>
  <value xsi:type="xsd:string">MyDesc</value>
- <qualifier xsi:type="ns1:CIMQualifier">
  <name xsi:type="xsd:string">editable</name>
  <value xsi:type="xsd:string">>true</value>
</qualifier>
</item>
- <item xsi:type="ns1:CIMProperty">
  <name xsi:type="xsd:string">PE_Intf_Shutdown</name>
  <value xsi:type="xsd:string">>false</value>
- <qualifier xsi:type="ns1:CIMQualifier">
  <name xsi:type="xsd:string">editable</name>
  <value xsi:type="xsd:string">>true</value>
</qualifier>
</item>
- <item xsi:type="ns1:CIMProperty">
  <name xsi:type="xsd:string">PE_Intf_Type</name>
  <value xsi:type="xsd:string">ANY</value>
- <qualifier xsi:type="ns1:CIMQualifier">
  <name xsi:type="xsd:string">editable</name>
  <value xsi:type="xsd:string">>true</value>
</qualifier>
</item>
- <item xsi:type="ns1:CIMProperty">
  <name xsi:type="xsd:string">Autopick_Vlan_ID</name>
  <value xsi:type="xsd:string">>false</value>
- <qualifier xsi:type="ns1:CIMQualifier">
  <name xsi:type="xsd:string">editable</name>
  <value xsi:type="xsd:string">>true</value>
</qualifier>
</item>

```

```

- <item xsi:type="ns1:CIMProperty">
  <name xsi:type="xsd:string">PE_CE_Routing_Protocol</name>
  <value xsi:type="xsd:string">NONE</value>
- <qualifier xsi:type="ns1:CIMQualifier">
  <name xsi:type="xsd:string">editable</name>
  <value xsi:type="xsd:string">true</value>
</qualifier>
</item>
- <!--
<item xsi:type="ns1:CIMProperty">
<name xsi:type="xsd:string">PE_CE_IPV6_Routing_Protocol</name>
<value xsi:type="xsd:string">BGP</value>
<qualifier xsi:type="ns1:CIMQualifier">
<name xsi:type="xsd:string">editable</name>
<value xsi:type="xsd:string">true</value>
</qualifier>
</item>

-->
- <item xsi:type="ns1:CIMProperty">
  <name xsi:type="xsd:string">Template_Enabled</name>
  <value xsi:type="xsd:string">true</value>
- <qualifier xsi:type="ns1:CIMQualifier">
  <name xsi:type="xsd:string">editable</name>
  <value xsi:type="xsd:string">true</value>
</qualifier>
- <item xsi:type="ns1:CIMProperty">
  <name xsi:type="xsd:string">VPN_TOPOLOGY</name>
  <value xsi:type="xsd:string">true</value>
</item>
</item>
</properties>
- <objectPath xsi:type="ns1:CIMObjectPath">
  <className xsi:type="xsd:string">MplsPolicyCercMembership</className>
- <properties xsi:type="ns1:CIMPropertyList" soapenc:arrayType="ns1:CIMProperty[]">
- <item xsi:type="ns1:CIMProperty">
  <name xsi:type="xsd:string">CERC</name>
  <value xsi:type="xsd:string">rtt</value>
</item>
- <item xsi:type="ns1:CIMProperty">
  <name xsi:type="xsd:string">IsHub</name>
  <value xsi:type="xsd:string">true</value>
</item>
- <item xsi:type="ns1:CIMProperty">
  <name xsi:type="xsd:string">CERC_RTTYPE</name>
  <value xsi:type="xsd:string">rtt=IPv4</value>
</item>
</properties>
</objectPath>
- <!--
<objectPath xsi:type="ns1:CIMObjectPath">
  <className xsi:type="xsd:string">MplsPolicyCercMembership</className>
  <properties xsi:type="ns1:CIMPropertyList"
    soapenc:arrayType="ns1:CIMProperty[]">
    <item xsi:type="ns1:CIMProperty">
      <name xsi:type="xsd:string">CERC</name>
      <value xsi:type="xsd:string">rtt2</value>
    </item>
    <item xsi:type="ns1:CIMProperty">
      <name xsi:type="xsd:string">IsHub</name>
      <value xsi:type="xsd:string">true</value>
    </item>
    <item xsi:type="ns1:CIMProperty">
      <name xsi:type="xsd:string">CERC_RTTYPE</name>

```

```

        <value xsi:type="xsd:string">rtt2=IPv6</value>
    </item>
</properties>
</objectPath>

-->
</objectPath>
</objectPath>
</ns1:createInstance>
</soapenv:Body>
</soapenv:Envelope>

```

### Other Policy Examples

- CreateMPLSServiceDefn\_BGPMAXPREFIX\_PE\_NO\_CE\_IPV4
- CreateMPLSServiceDefn\_BGPMAXPREFIX\_PE\_NO\_CE\_IPV6
- CreateMPLSServiceDefn\_BGPMAPPREFIX\_PE\_CE\_IPV4\_IPV6
- CreateMPLSServiceDefn\_BGPMAPPREFIX\_PE\_NO\_CE\_IPV4\_IPV6
- CreateMPLSServiceDefn\_EIGRP\_KeyChain\_PE\_CE\_IPV4
- CreateMPLSServiceDefn\_EIGRP\_KeyChain\_PE\_CE\_IPV6
- CreateMPLSServiceDefn\_EIGRP\_KeyChain\_PE\_NO\_CE\_IPV4
- CreateMPLSServiceDefn\_EIGRP\_KeyChain\_PE\_NO\_CE\_IPV6
- CreateMPLSServiceDefn\_MVRF\_CE
- CreateMPLSServiceDefn\_MVRF\_NO\_CE
- CreateMPLSServiceDefn\_MVRF\_NO\_CE\_OSPFPOLICY
- CreateMPLSServiceDefn\_OSPF\_DefaultInfoOriginate\_PE\_CE\_IPV4
- CreateMPLSServiceDefn\_OSPF\_DefaultInfoOriginate\_PE\_NO\_CE\_IPV4
- CreateMPLSServiceDefn\_PE\_CE
- CreateMPLSServiceDefn\_PE\_CE\_BGP\_DEFAULT\_INFO\_ORIGINATE\_IPV4
- CreateMPLSServiceDefn\_PE\_CE\_BGP\_DEFAULT\_INFO\_ORIGINATE\_IPV6
- CreateMPLSServiceDefn\_PE\_CE\_BGP\_IPV4\_BGPROUTEMAP
- CreateMPLSServiceDefn\_PE\_CE\_BGP\_IPV4\_IPV6\_BGPROUTEMAP
- CreateMPLSServiceDefn\_PE\_CE\_BGP\_IPV4\_IPV6\_RdFormat
- CreateMPLSServiceDefn\_PE\_CE\_BGP\_IPV4\_RdFormat
- CreateMPLSServiceDefn\_PE\_CE\_CRSPRT
- CreateMPLSServiceDefn\_PE\_CE\_OSPFMATCH
- CreateMPLSServiceDefn\_PE\_CE\_OSPFPOLICY
- CreateMPLSServiceDefn\_PE\_NO\_CE
- CreateMPLSServiceDefn\_PE\_NO\_CE\_ALLOW\_DUPLICATE\_IP
- CreateMPLSServiceDefn\_PE\_NO\_CE\_BGP\_DEFAULT\_INFO\_ORIGINATE\_IPV4
- CreateMPLSServiceDefn\_PE\_NO\_CE\_BGP\_DEFAULT\_INFO\_ORIGINATE\_IPV6
- CreateMPLSServiceDefn\_PE\_NO\_CE\_BGP\_IPV4\_IPV6\_BGPROUTEMAP
- CreateMPLSServiceDefn\_PE\_NO\_CE\_BGP\_IPV4\_IPV6\_RdFormat



- CreateMPLSServiceDefn\_PE\_NO\_CE\_BGP\_IPV6
- CreateMPLSServiceDefn\_PE\_NO\_CE\_BGP\_IPV6\_RdFormat
- CreateMPLSServiceDefn\_PE\_NO\_CE\_BGP\_redis\_IPV6

## MPLS Service Requests

An MPLS service request specifies the MPLS policy (service definition) to use, the list of links, referred to as MPLS VPN links, and the link attributes. Use the link attribute settings in the service request to override any policy settings defined as editable in the service definition.



Note

You can also integrate an Prime Provisioning template with an MPLS service request and associate one or more templates to the CPE and PE devices. See [Chapter 4, “Using Templates,”](#) for more information.

Prime Provisioning supports an extensive list of properties that can be set for MPLS VPN links. [Figure 6-3](#) shows a partial schema diagram for the **MplsVpnLink** in a service request.

Figure 6-3 MPLS VPN Link Schema Diagram

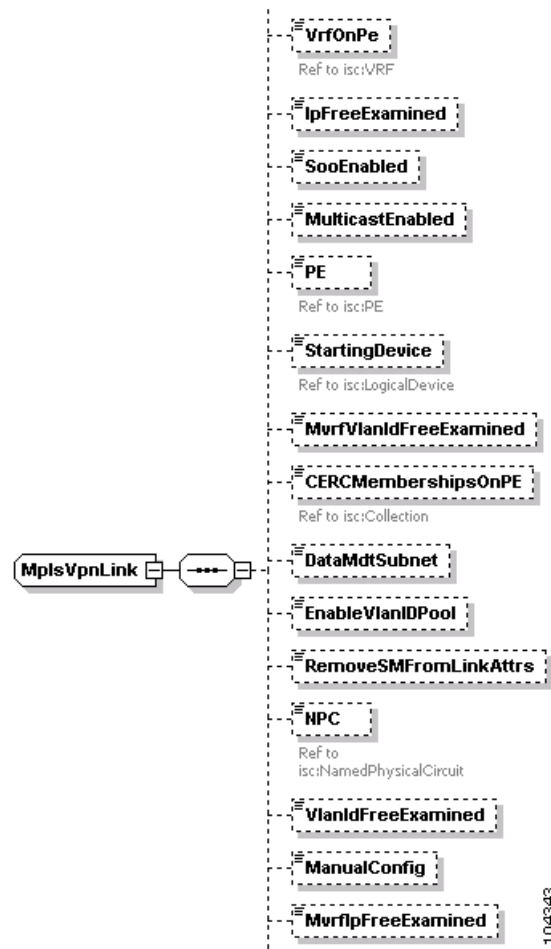

## Service Request Examples

The following XML examples illustrate how MPLS APIs can be used. They also demonstrate the kinds of properties that need to be specified for each request.

In the following examples, significant attributes are highlighted in bold.

Examples of these three features are included below:

- [Creating an Independent Route Target Service Request, page 6-12](#)
- [Creating a Static Route Configuration Service Request, page 6-18](#)
- [Creating a BGP Max Prefix Service Request with Second VLAN ID and BGP DIO, page 6-22](#)
- [Creating an EIGRP Key Chain Service Request, page 6-28](#)
- [Creating an OSPF Default Info Originate Service Request, page 6-34](#)
- [Creating an MPLS Pseudowire Service Request, page 6-38](#)
- [Creating an MPLS VPN PE No CE EVC UPE Service Request, page 6-39](#)
- [Creating an MPLS VPN Topology Service Request, page 6-44](#)
- [Creating an MPLS 6VPE Grey Management Service Request, page 6-47](#)

### Creating an Independent Route Target Service Request

In this example, a service order is created with a unique route target for IPv4 and IPv6.

The attribute relevant for the unique route target example is **CERC\_RTTYPE** (in **bold** below). The preferred values for **CERC\_RTTYPE** tag are IPv4, IPv6 and dual. If the RT Type mentioned does not match with IPv4 or IPv6 or dual, it will throw an error.

Note the following:

- The unique RT feature is supported only for IOS XR devices and only when the corresponding DCPL property is set to true.
- When a service request is created, the RT Type of the CERCs mentioned in the CERC\_MEMBERSHIP should be indicated.
- When modifying a service request, a new CERC of RT Type can be added according to the address family only. Otherwise, it will throw error.
- If the **CERC\_RTTYPE** tag is not indicated when modifying the script, the newly added CERC will take RT Type as its address family.
- When modifying a service request, the **CERC\_RTTYPE** of an existing CERC can be modified.
- When modifying a CERC of RT Type dual to IPv6, pass the CERC name with the RT Type to be modified.

Example:

cerc1=dual is the RT Type at the time the service request is created. This now needs to be changed to IPv6 and when modifying the script, pass cerc1=IPv6 in the **CERC\_RTTYPE** tag. Then the cerc1 RT configuration will be changed to IPv6.

If a CERC needs to be deleted, specify the CERC name in deleteInstance. The specified CERC will be deleted.

**Note**

When creating a service request for dual address family, the RT configuration can be IPv4 and IPv6, or dual. There should be two CERCs, one with IPv4 and another with IPv6, or one CERC with the RT configuration dual. If a service request is created for IPV4 address family, the RT configuration should be only IPv4, and if it is created for IPv6 address family, it should be only IPv6.

**Example: CreateMPLSServiceOrder\_PE\_NO\_CE\_IPV4\_IPV6\_Unique\_RT.xml**

```
<?xml version="1.0" encoding="UTF-8"?>
<soapenv:Envelope
  xmlns:soapenv="http://schemas.xmlsoap.org/soap/envelope/"
  xmlns:soapenc="http://schemas.xmlsoap.org/soap/encoding/"
  xmlns:xsd="http://www.w3.org/2001/XMLSchema"
  xmlns:xsi="http://www.w3.org/2001/XMLSchema-instance"
  xmlns:ns0="http://www.cisco.com/cim-cx/2.0"
  xmlns:ns1="urn:CIM">
  <soapenv:Header>
    <!-- WaitTimeout has a default set in system properties.-->
    <ns0:message id="87855" timestamp="2002-12-13T14:55:38.885Z"
      Wait="true" WaitTimeout="90" sessiontoken="p36bttjwy1"/>
  </soapenv:Header>
  <soapenv:Body>
    <ns1:performBatchOperation>
      <actions xsi:type="ns1:CIMActionList"
        soapenc:arrayType="ns1:CIMAction[]">
        <action>
          <actionName xsi:type="xsd:string">createInstance</actionName>
          <objectPath xsi:type="ns1:CIMObjectPath">
            <className xsi:type="xsd:string">ServiceOrder</className>
            <properties xsi:type="ns1:CIMPropertyList"
              soapenc:arrayType="ns1:CIMProperty[]">
              <item xsi:type="ns1:CIMProperty">
                <name xsi:type="xsd:string">ServiceName</name>
                <value xsi:type="xsd:string">ServiceOrder253</value>
              </item>
              <item xsi:type="ns1:CIMProperty">
                <name xsi:type="xsd:string">CarrierId</name>
                <value xsi:type="xsd:string">322</value>
              </item>
              <item xsi:type="ns1:CIMProperty">
                <name xsi:type="xsd:string">DesiredDueDate</name>
                <value xsi:type="xsd:dateTime">2002-12-13T14:55:38.000Z</value>
              </item>
              <item xsi:type="ns1:CIMProperty">
                <name xsi:type="xsd:string">NumberOfRequests</name>
                <value xsi:type="xsd:string">1</value>
              </item>
              <!--item xsi:type="ns1:CIMProperty">
                <name xsi:type="xsd:string">Organization</name>
                <value xsi:type="xsd:string">NbiCustomer</value>
              </item-->
            </properties>
          </objectPath>
        </action>
        <action>
          <actionName xsi:type="xsd:string">createInstance</actionName>
          <objectPath xsi:type="ns1:CIMObjectPath">
            <className xsi:type="xsd:string">ServiceRequest</className>
            <properties xsi:type="ns1:CIMPropertyList"
              soapenc:arrayType="ns1:CIMProperty[]">
              <item xsi:type="ns1:CIMProperty">
```

```

        <name xsi:type="xsd:string">RequestName</name>
        <value xsi:type="xsd:string">MYSR-1</value>
    </item>
    <item xsi:type="ns1:CIMProperty">
        <name xsi:type="xsd:string">Type</name>
        <value xsi:type="xsd:string">Mpls</value>
    </item>
</properties>
<objectPath xsi:type="ns1:CIMObjectPath">
    <className xsi:type="xsd:string">ServiceRequestDetails</className>
    <properties xsi:type="ns1:CIMPropertyList"
        soapenc:arrayType="ns1:CIMProperty[]">
<!-- Policy Info -->
    <item xsi:type="ns1:CIMProperty">
        <name xsi:type="xsd:string">ServiceDefinition</name>
        <value xsi:type="xsd:string">PE_NO_CE</value>
        <qualifier xsi:type="xsd:string">
            <name xsi:type="xsd:string">ServiceDefinitionType</name>
            <value xsi:type="xsd:string">Mpls</value>
        </qualifier>
    </item>
</properties>
<objectPath xsi:type="ns1:CIMObjectPath">
    <className xsi:type="xsd:string">MplsVpnLink</className>
    <properties xsi:type="ns1:CIMPropertyList"
        soapenc:arrayType="ns1:CIMProperty[]">

<!-- ManualConfig is needed when specifying PE-CE link and not using NPC -->
<!-- Device Info -->
    <item xsi:type="ns1:CIMProperty">
        <name xsi:type="xsd:string">ManualConfig</name>
        <value xsi:type="xsd:string">>true</value>
    </item>
    <item xsi:type="ns1:CIMProperty">
        <name xsi:type="xsd:string">PE</name>
        <value xsi:type="xsd:string">CRS</value>
    </item>

</properties>
<objectPath xsi:type="ns1:CIMObjectPath">
    <className xsi:type="xsd:string">LinkAttrs</className>
    <properties xsi:type="ns1:CIMPropertyList"
soapenc:arrayType="ns1:CIMProperty[]">

<!-- PE Intf Info -->
    <item xsi:type="ns1:CIMProperty">
        <name xsi:type="xsd:string">PE_Intf_Name</name>
        <value xsi:type="xsd:string">Bundle-Ether123</value>
    </item>

    <item xsi:type="ns1:CIMProperty">
        <name xsi:type="xsd:string">PE_Intf_Encap</name>
        <value xsi:type="xsd:string">DOT1Q</value>
    </item>

    <item xsi:type="ns1:CIMProperty">
        <name xsi:type="xsd:string">PE_Vlan_ID</name>
        <value xsi:type="xsd:string">1600</value>
    </item>
    <item xsi:type="ns1:CIMProperty">
        <name xsi:type="xsd:string">Autopick_Vlan_ID</name>
        <value xsi:type="xsd:string">>false</value>
    </item>

```

```

<!-- interface Addresses for IPV4 -->
    <item xsi:type="ns1:CIMProperty">
        <name xsi:type="xsd:string">PE_Intf_Address</name>
        <value xsi:type="xsd:string">12.20.19.47/24</value>
    </item>

<!-- interface Addresses for IPV6 -->
    <item xsi:type="ns1:CIMProperty">
        <name xsi:type="xsd:string">PE_Intf_Address_IPV6</name>
        <value xsi:type="xsd:string">2009::47/32</value>
    </item>

    <item xsi:type="ns1:CIMProperty">
        <name xsi:type="xsd:string">Auto_Assign_IP_Address</name>
        <value xsi:type="xsd:string">>false</value>
    </item>

<!-- IPV4 Routing Protocol -->
    <item xsi:type="ns1:CIMProperty">
        <name xsi:type="xsd:string">PE_CE_Routing_Protocol</name>
        <value xsi:type="xsd:string">STATIC</value>
    </item>

<!-- IPV6 Routing Protocol -->
    <item xsi:type="ns1:CIMProperty">
        <name xsi:type="xsd:string">PE_CE_IPV6_Routing_Protocol</name>
        <value xsi:type="xsd:string">NONE</value>
    </item>

<!-- CERC Type -->
    <item xsi:type="ns1:CIMProperty">
        <name xsi:type="xsd:string">CERC_RTTYPE</name>
        <value xsi:type="xsd:string">cerc3=IPv4,cerc5=IPv6</value>
    </item>

<!-- Enable RD Format -->
    <!--item xsi:type="ns1:CIMProperty">
        <name xsi:type="xsd:string">RD_FORMAT</name>
        <value xsi:type="xsd:string">RD_AS</value>
    </item-->

    </properties>
</objectPath>

<!-- CERC's -->
<objectPath xsi:type="ns1:CIMObjectPath">
    <className xsi:type="xsd:string">CERCMembership</className>
    <properties xsi:type="ns1:CIMPropertyList"
        soapenc:arrayType="ns1:CIMProperty[]" >
        <item xsi:type="ns1:CIMProperty">
            <name xsi:type="xsd:string">CERC</name>
            <value xsi:type="xsd:string">cerc3</value>
        </item>
        <item xsi:type="ns1:CIMProperty">
            <name xsi:type="xsd:string">IsHub</name>
            <value xsi:type="xsd:string">>true</value>
        </item>
    </properties>
</objectPath>

```

```

<objectPath xsi:type="ns1:CIMObjectPath">
  <className xsi:type="xsd:string">CERCMembership</className>
  <properties xsi:type="ns1:CIMPropertyList"
    soapenc:arrayType="ns1:CIMProperty[]">
    <item xsi:type="ns1:CIMProperty">
      <name xsi:type="xsd:string">CERC</name>
      <value xsi:type="xsd:string">cerc5</value>
    </item>
    <item xsi:type="ns1:CIMProperty">
      <name xsi:type="xsd:string">IsHub</name>
      <value xsi:type="xsd:string">>true</value>
    </item>
  </properties>
</objectPath>

<!-- LinkTemplate example using template definition and direct input of template data
(buffer method). The template data
                                is entered in the DataBuffer objectDef section -->
<!-- Template start here-->

<!-- Template Ends Here -->
  </objectPath>

  <objectPath xsi:type="ns1:CIMObjectPath">
    <className xsi:type="xsd:string">MplsVpnLink</className>
    <properties xsi:type="ns1:CIMPropertyList"
      soapenc:arrayType="ns1:CIMProperty[]">

<!-- ManualConfig is needed when specifying PE-CE link and not using NPC -->
<!-- Device Info -->
    <item xsi:type="ns1:CIMProperty">
      <name xsi:type="xsd:string">ManualConfig</name>
      <value xsi:type="xsd:string">>true</value>
    </item>
    <item xsi:type="ns1:CIMProperty">
      <name xsi:type="xsd:string">PE</name>
      <value xsi:type="xsd:string">CRS</value>
    </item>

  </properties>
  <objectPath xsi:type="ns1:CIMObjectPath">
    <className xsi:type="xsd:string">LinkAttrs</className>
    <properties xsi:type="ns1:CIMPropertyList"
soapenc:arrayType="ns1:CIMProperty[]">

<!-- PE Intf Info -->
    <item xsi:type="ns1:CIMProperty">
      <name xsi:type="xsd:string">PE_Intf_Name</name>
      <value xsi:type="xsd:string">Bundle-Ether123</value>
    </item>

    <item xsi:type="ns1:CIMProperty">
      <name xsi:type="xsd:string">PE_Intf_Encap</name>
      <value xsi:type="xsd:string">DOT1Q</value>
    </item>

    <item xsi:type="ns1:CIMProperty">
      <name xsi:type="xsd:string">PE_Vlan_ID</name>
      <value xsi:type="xsd:string">1600</value>
    </item>
    <item xsi:type="ns1:CIMProperty">
      <name xsi:type="xsd:string">Autopick_Vlan_ID</name>

```

```

        <value xsi:type="xsd:string">>false</value>
    </item>

<!-- interface Addresses for IPV4 -->

    <item xsi:type="ns1:CIMProperty">
        <name xsi:type="xsd:string">PE_Intf_Address</name>
        <value xsi:type="xsd:string">12.20.19.47/24</value>
    </item>

<!-- interface Addresses for IPV6 -->

    <item xsi:type="ns1:CIMProperty">
        <name xsi:type="xsd:string">Auto_Assign_IP_Address</name>
        <value xsi:type="xsd:string">>false</value>
    </item>

<!-- IPV4 Routing Protocol -->
    <item xsi:type="ns1:CIMProperty">
        <name xsi:type="xsd:string">PE_CE_Routing_Protocol</name>
        <value xsi:type="xsd:string">STATIC</value>
    </item>

<!-- IPV6 Routing Protocol -->
<!-- <item xsi:type="ns1:CIMProperty">
    <name xsi:type="xsd:string">PE_CE_IPV6_Routing_Protocol</name>
    <value xsi:type="xsd:string">EIGRP</value>
</item>
<item xsi:type="ns1:CIMProperty">
    <name xsi:type="xsd:string">PE_EIGRP_AS_ID</name>
    <value xsi:type="xsd:string">2369</value>
</item>
<item xsi:type="ns1:CIMProperty">
    <name xsi:type="xsd:string">CE_EIGRP_AS_ID</name>
    <value xsi:type="xsd:string">1526</value>
</item>
<item xsi:type="ns1:CIMProperty">
    <name
xsi:type="xsd:string">PE_CE_Bandwidth_Metric_For_Redistribution</name>
    <value xsi:type="xsd:string">6311</value>
</item>
<item xsi:type="ns1:CIMProperty">
    <name
xsi:type="xsd:string">PE_CE_Delay_Metric_For_Redistribution</name>
    <value xsi:type="xsd:string">5312</value>
</item>
<item xsi:type="ns1:CIMProperty">
    <name
xsi:type="xsd:string">PE_CE_Reliability_Metric_For_Redistribution</name>
    <value xsi:type="xsd:string">169</value>
</item>
<item xsi:type="ns1:CIMProperty">
    <name
xsi:type="xsd:string">PE_CE>Loading_Metric_For_Redistribution</name>
    <value xsi:type="xsd:string">147</value>
</item>
<item xsi:type="ns1:CIMProperty">
    <name xsi:type="xsd:string">PE_CE_MTU_Metric_For_Redistribution</name>
    <value xsi:type="xsd:string">864</value>
</item>

<!-- CERC Type -->

```

```

<!-- Enable Multipath Loadsharing -->

<!-- Enable RD Format -->

        </properties>
    </objectPath>

<!-- CERC's -->

    <objectPath xsi:type="ns1:CIMObjectPath">
        <className xsi:type="xsd:string">CERCMembership</className>
        <properties xsi:type="ns1:CIMPropertyList"
            soapenc:arrayType="ns1:CIMProperty[]">
            <item xsi:type="ns1:CIMProperty">
                <name xsi:type="xsd:string">CERC</name>
                <value xsi:type="xsd:string">multi-cerc3</value>
            </item>
            <item xsi:type="ns1:CIMProperty">
                <name xsi:type="xsd:string">IsHub</name>
                <value xsi:type="xsd:string">true</value>
            </item>
        </properties>
    </objectPath>

<!-- LinkTemplate example using template definition and direct input of template data
(buffer method). The template data
                                     is entered in the DataBuffer objectDef section -->
<!-- TEmplate start here-->

<!-- Template Ends Here -->
    </objectPath>

        </objectPath>
    </objectPath>
</action>
</actions>
</ns1:performBatchOperation>
</soapenv:Body>
</soapenv:Envelope>

```

## Creating a Static Route Configuration Service Request

In this example XML script, a static route configuration is created. Both the IPv4 attribute **Static\_Next\_Hop\_Option** and the IPv6 attribute **Static\_Next\_Hop\_Option\_IPV6** are given the new value **OUTGOING\_INTF\_NAME\_NEXT\_HOP\_IPADDR** when the service request is created.

The preferred values for **Static\_Next\_Hop\_Option** are **OUT\_GOING\_INTF\_NAME**, **NEXT\_HOP\_IPADDR**, and **OUTGOING\_INTF\_NAME\_NEXT\_HOP\_IPADDR**.

Other relevant attributes are the IPv4 attribute **STATIC\_NEXT\_HOP\_IP\_ADDR**, which is set to 2.22.29.28 and the IPv6 attribute **STATIC\_NEXT\_HOP\_IPV6\_ADDR**, which is set to 89::68.



### Note

In the PE\_CE case, no values have been specified for Next Hop Ip Address. For PE\_NO\_CE, the Next Hop Ip Address value should be specified when selecting **NEXT\_HOP\_IPADDR** or **OUTGOING\_INTF\_NAME\_NEXT\_HOP\_IPADDR** for **Static\_Next\_Hop\_Option**.

File: CreateMPLSServiceOrder\_StaticRoute\_PE\_NO\_CE.xml



```

<?xml version="1.0" encoding="UTF-8"?>
<soapenv:Envelope
  xmlns:soapenv="http://schemas.xmlsoap.org/soap/envelope/"
  xmlns:soapenc="http://schemas.xmlsoap.org/soap/encoding/"
  xmlns:xsd="http://www.w3.org/2001/XMLSchema"
  xmlns:xsi="http://www.w3.org/2001/XMLSchema-instance"
  xmlns:ns0="http://www.cisco.com/cim-cx/2.0"
  xmlns:ns1="urn:CIM">
  <soapenv:Header>
    <!-- WaitTimeout has a default set in system properties.-->
    <ns0:message id="87855" timestamp="2002-12-13T14:55:38.885Z"
      Wait="true" WaitTimeout="90" sessiontoken="p36bttjwy1"/>
  </soapenv:Header>
  <soapenv:Body>
    <ns1:performBatchOperation>
      <actions xsi:type="ns1:CIMActionList"
        soapenc:arrayType="ns1:CIMAction[]">
        <action>
          <actionName xsi:type="xsd:string">createInstance</actionName>
          <objectPath xsi:type="ns1:CIMObjectPath">
            <className xsi:type="xsd:string">ServiceOrder</className>
            <properties xsi:type="ns1:CIMPropertyList"
              soapenc:arrayType="ns1:CIMProperty[]">
              <item xsi:type="ns1:CIMProperty">
                <name xsi:type="xsd:string">ServiceName</name>
                <value xsi:type="xsd:string">ServiceOrder253</value>
              </item>
              <item xsi:type="ns1:CIMProperty">
                <name xsi:type="xsd:string">CarrierId</name>
                <value xsi:type="xsd:string">322</value>
              </item>
              <item xsi:type="ns1:CIMProperty">
                <name xsi:type="xsd:string">DesiredDueDate</name>
                <value xsi:type="xsd:dateTime">2002-12-13T14:55:38.000Z</value>
              </item>
              <item xsi:type="ns1:CIMProperty">
                <name xsi:type="xsd:string">NumberOfRequests</name>
                <value xsi:type="xsd:string">1</value>
              </item>
              <!--item xsi:type="ns1:CIMProperty">
                <name xsi:type="xsd:string">Organization</name>
                <value xsi:type="xsd:string">NbiCustomer</value>
              </item-->
            </properties>
          </objectPath>
        </action>
        <action>
          <actionName xsi:type="xsd:string">createInstance</actionName>
          <objectPath xsi:type="ns1:CIMObjectPath">
            <className xsi:type="xsd:string">ServiceRequest</className>
            <properties xsi:type="ns1:CIMPropertyList"
              soapenc:arrayType="ns1:CIMProperty[]">
              <item xsi:type="ns1:CIMProperty">
                <name xsi:type="xsd:string">RequestName</name>
                <value xsi:type="xsd:string">MYSR-1</value>
              </item>
              <item xsi:type="ns1:CIMProperty">
                <name xsi:type="xsd:string">Type</name>
                <value xsi:type="xsd:string">Mpls</value>
              </item>
            </properties>
          <objectPath xsi:type="ns1:CIMObjectPath">
            <className xsi:type="xsd:string">ServiceRequestDetails</className>

```

```

        <properties xsi:type="ns1:CIMPropertyList"
            soapenc:arrayType="ns1:CIMProperty[]" >
<!-- Policy Info -->
    <item xsi:type="ns1:CIMProperty">
        <name xsi:type="xsd:string">ServiceDefinition</name>
        <value xsi:type="xsd:string">PE_NO_CE</value>
        <qualifier xsi:type="xsd:string">
            <name xsi:type="xsd:string">ServiceDefinitionType</name>
            <value xsi:type="xsd:string">Mpls</value>
        </qualifier>
    </item>
</properties>
<objectPath xsi:type="ns1:CIMObjectPath">
    <className xsi:type="xsd:string">MplsVpnLink</className>
    <properties xsi:type="ns1:CIMPropertyList"
        soapenc:arrayType="ns1:CIMProperty[]" >

<!-- ManualConfig is needed when specifying PE-CE link and not using NPC -->
<!-- Device Info -->
        <item xsi:type="ns1:CIMProperty">
            <name xsi:type="xsd:string">ManualConfig</name>
            <value xsi:type="xsd:string">true</value>
        </item>
        <item xsi:type="ns1:CIMProperty">
            <name xsi:type="xsd:string">PE</name>
            <value xsi:type="xsd:string">Cisco CRS</value>
        </item>

    </properties>
    <objectPath xsi:type="ns1:CIMObjectPath">
        <className xsi:type="xsd:string">LinkAttrs</className>
        <properties xsi:type="ns1:CIMPropertyList"
            soapenc:arrayType="ns1:CIMProperty[]" >

<!-- PE Intf Info -->
        <item xsi:type="ns1:CIMProperty">
            <name xsi:type="xsd:string">PE_Intf_Name</name>
            <value xsi:type="xsd:string">TenGigE0/0/0/0</value>
        </item>
        <item xsi:type="ns1:CIMProperty">
            <name xsi:type="xsd:string">PE_Intf_Encap</name>
            <value xsi:type="xsd:string">DOT1Q</value>
        </item>

        <item xsi:type="ns1:CIMProperty">
            <name xsi:type="xsd:string">PE_Vlan_ID</name>
            <value xsi:type="xsd:string">1709</value>
        </item>
        <item xsi:type="ns1:CIMProperty">
            <name xsi:type="xsd:string">Autopick_Vlan_ID</name>
            <value xsi:type="xsd:string">>false</value>
        </item>

    </properties>

<!-- interface Addresses for IPV4 -->
        <item xsi:type="ns1:CIMProperty">
            <name xsi:type="xsd:string">PE_Intf_Address</name>
            <value xsi:type="xsd:string">78.69.19.37/24</value>
        </item>

<!-- interface Addresses for IPV6 -->
        <item xsi:type="ns1:CIMProperty">
            <name xsi:type="xsd:string">PE_Intf_Address_IPV6</name>
            <value xsi:type="xsd:string">3::32/64</value>

```

```

    </item>

    <item xsi:type="ns1:CIMProperty">
      <name xsi:type="xsd:string">Auto_Assign_IP_Address</name>
      <value xsi:type="xsd:string">>false</value>
    </item>

  <!-- IPv4 Routing Protocol -->
    <item xsi:type="ns1:CIMProperty">
      <name xsi:type="xsd:string">PE_CE_Routing_Protocol</name>
      <value xsi:type="xsd:string">STATIC</value>
    </item>
    <item xsi:type="ns1:CIMProperty">
      <name xsi:type="xsd:string">PE_CE_IPV6_Routing_Protocol</name>
      <value xsi:type="xsd:string">STATIC</value>
    </item>
    <item xsi:type="ns1:CIMProperty">
      <name xsi:type="xsd:string">Is_Default_Routes_Sent_To_CE</name>
      <value xsi:type="xsd:string">TRUE</value>
    </item>
    <item xsi:type="ns1:CIMProperty">
      <name xsi:type="xsd:string">Is_Default_Routes_Sent_To_CE_IPV6</name>
      <value xsi:type="xsd:string">TRUE</value>
    </item>
    <item xsi:type="ns1:CIMProperty">
      <name xsi:type="xsd:string">Is_Default_Info_Originate</name>
      <value xsi:type="xsd:string">TRUE</value>
    </item>
    <item xsi:type="ns1:CIMProperty">
      <name xsi:type="xsd:string">Static_Next_Hop_Option</name>
      <value
xsi:type="xsd:string">OUTGOING_INTF_NAME_NEXT_HOP_IPADDR</value>
      </item>
    <item xsi:type="ns1:CIMProperty">
      <name xsi:type="xsd:string">STATIC_NEXT_HOP_IP_ADDR</name>
      <value xsi:type="xsd:string">2.22.29.28</value>
    </item>
    <item xsi:type="ns1:CIMProperty">
      <name xsi:type="xsd:string">Static_Next_Hop_Option_IPV6</name>
      <value
xsi:type="xsd:string">OUTGOING_INTF_NAME_NEXT_HOP_IPADDR</value>
      </item>
    <item xsi:type="ns1:CIMProperty">
      <name xsi:type="xsd:string">STATIC_NEXT_HOP_IPV6_ADDR</name>
      <value xsi:type="xsd:string">89::68</value>
    </item>
  </properties>
</objectPath>
<objectPath xsi:type="ns1:CIMObjectPath">
  <className xsi:type="xsd:string">AdvertisedRoutesForCe</className>
  <properties xsi:type="ns1:CIMPropertyList"
    soapenc:arrayType="ns1:CIMProperty[]">
    <item xsi:type="ns1:CIMProperty">
      <name xsi:type="xsd:string">Advr_Routes_IP_Address</name>
      <value xsi:type="xsd:string">2.5.16.34/32</value>
    </item>
    <item xsi:type="ns1:CIMProperty">
      <name xsi:type="xsd:string">Advr_Routes_Metric</name>
      <value xsi:type="xsd:string">18</value>
    </item>
  </properties>
</objectPath>
<objectPath xsi:type="ns1:CIMObjectPath">
  <className xsi:type="xsd:string">AdvertisedRoutesForCeIPV6</className>

```

```

    <properties xsi:type="ns1:CIMPropertyList"
              soapenc:arrayType="ns1:CIMProperty[]">
      <item xsi:type="ns1:CIMProperty">
        <name xsi:type="xsd:string">Advr_Routes_IPV6_Address</name>
        <value xsi:type="xsd:string">29::24/128</value>
      </item>
      <item xsi:type="ns1:CIMProperty">
        <name xsi:type="xsd:string">Advr_Routes_Metric_IPV6</name>
        <value xsi:type="xsd:string">40</value>
      </item>
    </properties>
  </objectPath>
<!-- CERC's -->

  <objectPath xsi:type="ns1:CIMObjectPath">
    <className xsi:type="xsd:string">CERCMembership</className>
    <properties xsi:type="ns1:CIMPropertyList"
              soapenc:arrayType="ns1:CIMProperty[]">
      <item xsi:type="ns1:CIMProperty">
        <name xsi:type="xsd:string">CERC</name>
        <value xsi:type="xsd:string">cerc4</value>
      </item>
      <item xsi:type="ns1:CIMProperty">
        <name xsi:type="xsd:string">IsHub</name>
        <value xsi:type="xsd:string">>true</value>
      </item>
    </properties>
  </objectPath>
</objectPath>
</objectPath>
</objectPath>
</action>
</actions>
</ns1:performBatchOperation>
</soapenv:Body>
</soapenv:Envelope>

```

## Creating a BGP Max Prefix Service Request with Second VLAN ID and BGP DIO

This example shows how to create a service request for BGP max prefix, BGP Default Info Originate and second VLAN ID with a PE no CE case (IPv4 and IPv6).

The significant attributes for this specific example are highlighted in bold>.

Example:

CreateMPLSServiceOrder\_BGP\_MaxPrefix\_BGP\_DIO\_SecondVlanId\_PE\_NO\_CE\_IPV4\_IPV6.xml

```

<!-- Example for BPG MaxPrefix Attributes on IPv4/IPv6,BGP Default Info Originate for
IPv4/IPv6 and DOT1Q on second VLAN ID -->
<?xml version="1.0" encoding="UTF-8"?>
<soapenv:Envelope
  xmlns:soapenv="http://schemas.xmlsoap.org/soap/envelope/"
  xmlns:soapenc="http://schemas.xmlsoap.org/soap/encoding/"
  xmlns:xsd="http://www.w3.org/2001/XMLSchema"
  xmlns:xsi="http://www.w3.org/2001/XMLSchema-instance"
  xmlns:ns0="http://www.cisco.com/cim-cx/2.0"
  xmlns:ns1="urn:CIM">
  <soapenv:Header>
    <ns0:message id="87855" timestamp="2002-12-13T14:55:38.885Z" Wait="true"
WaitTimeout="90" sessiontoken="p36bttjwy1"/>
  </soapenv:Header>
  <soapenv:Body>

```

```

<ns1:performBatchOperation>
  <actions xsi:type="ns1:CIMActionList" soapenc:arrayType="ns1:CIMAction[]">
    <action>
      <actionName xsi:type="xsd:string">createInstance</actionName>
      <objectPath xsi:type="ns1:CIMObjectPath">
        <className xsi:type="xsd:string">ServiceOrder</className>
        <properties xsi:type="ns1:CIMPropertyList"
soapenc:arrayType="ns1:CIMProperty[]">
          <item xsi:type="ns1:CIMProperty">
            <name xsi:type="xsd:string">ServiceName</name>
            <value xsi:type="xsd:string">ServiceOrder253</value>
          </item>
          <item xsi:type="ns1:CIMProperty">
            <name xsi:type="xsd:string">CarrierId</name>
            <value xsi:type="xsd:string">322</value>
          </item>
          <item xsi:type="ns1:CIMProperty">
            <name xsi:type="xsd:string">DesiredDueDate</name>
            <value
xsi:type="xsd:dateTime">2002-12-13T14:55:38.000Z</value>
          </item>
          <item xsi:type="ns1:CIMProperty">
            <name xsi:type="xsd:string">NumberOfRequests</name>
            <value xsi:type="xsd:string">1</value>
          </item>
          <!--
          <item xsi:type="ns1:CIMProperty">
            <name xsi:type="xsd:string">Organization</name>
            <value xsi:type="xsd:string">NbiCustomer</value>
          </item>
          -->
        </properties>
      </objectPath>
    </action>

    <action>
      <actionName xsi:type="xsd:string">createInstance</actionName>
      <objectPath xsi:type="ns1:CIMObjectPath">
        <className xsi:type="xsd:string">ServiceRequest</className>
        <properties xsi:type="ns1:CIMPropertyList"
soapenc:arrayType="ns1:CIMProperty[]">
          <item xsi:type="ns1:CIMProperty">
            <name xsi:type="xsd:string">RequestName</name>
            <value xsi:type="xsd:string">MYSR-1</value>
          </item>
          <item xsi:type="ns1:CIMProperty">
            <name xsi:type="xsd:string">Type</name>
            <value xsi:type="xsd:string">Mpls</value>
          </item>
        </properties>
        <objectPath xsi:type="ns1:CIMObjectPath">
          <className xsi:type="xsd:string">ServiceRequestDetails</className>
          <properties xsi:type="ns1:CIMPropertyList"
soapenc:arrayType="ns1:CIMProperty[]">
            <!-- Policy Info -->
            <item xsi:type="ns1:CIMProperty">
              <name xsi:type="xsd:string">ServiceDefinition</name>
              <value
xsi:type="xsd:string">PE_NoCE_BGPMaxPrefix_Dual</value>
              <qualifier xsi:type="xsd:string">
                <name xsi:type="xsd:string">ServiceDefinitionType</name>
                <value xsi:type="xsd:string">Mpls</value>
              </qualifier>
            </item>

```

```

        </properties>

<!-- ##### ( MPLS VPN LINK Start )#####
-->
    <objectPath xsi:type="ns1:CIMObjectPath">
    <className xsi:type="xsd:string">MplsVpnLink</className>
    <properties xsi:type="ns1:CIMPropertyList"
soapenc:arrayType="ns1:CIMProperty[]">
<!-- Device Info -->
        <item xsi:type="ns1:CIMProperty">
            <name xsi:type="xsd:string">ManualConfig</name>
            <value xsi:type="xsd:string">>true</value>
        </item>
        <item xsi:type="ns1:CIMProperty">
            <name xsi:type="xsd:string">PE</name>
            <value xsi:type="xsd:string">enpe-25</value>
        </item>

    </properties>

<!-- ##### ( LINKATTRS Start )#####
-->
    <objectPath xsi:type="ns1:CIMObjectPath">
    <className xsi:type="xsd:string">LinkAttrs</className>
    <properties xsi:type="ns1:CIMPropertyList"
soapenc:arrayType="ns1:CIMProperty[]">
<!-- PE Intf info -->
        <item xsi:type="ns1:CIMProperty">
            <name xsi:type="xsd:string">PE_Intf_Name</name>
            <value
xsi:type="xsd:string">GigabitEthernet0/3/0/1</value>
        </item>

        <item xsi:type="ns1:CIMProperty">
            <name xsi:type="xsd:string">PE_Vlan_ID</name>
            <value xsi:type="xsd:string">457</value>
        </item>
        <item xsi:type="ns1:CIMProperty">
            <name xsi:type="xsd:string">Second_PE_Vlan_ID</name>
            <value xsi:type="xsd:string">63</value>
        </item>

        <item xsi:type="ns1:CIMProperty">
            <name
xsi:type="xsd:string">Autopick_Vlan_ID</name>
            <value xsi:type="xsd:string">>false</value>
        </item>

<!-- PE interface Addresses for IPV4 -->
        <item xsi:type="ns1:CIMProperty">
            <name
xsi:type="xsd:string">PE_Intf_Address</name>
            <value
xsi:type="xsd:string">29.71.2.5/24</value>
        </item>
        <item xsi:type="ns1:CIMProperty">
            <name
xsi:type="xsd:string">Auto_Assign_IP_Address</name>
            <value xsi:type="xsd:string">>false</value>
        </item>

<!-- PE interface Addresses for IPV6 -->

```

```

        <item xsi:type="ns1:CIMProperty">
            <name
xsi:type="xsd:string">PE_Intf_Address_IPV6</name>
            <value xsi:type="xsd:string">27::19/25</value>
        </item>

<!-- PE IPv4 Routing Protocol -->

        <item xsi:type="ns1:CIMProperty">
            <name xsi:type="xsd:string">PE_CE_Routing_Protocol</name>
            <value xsi:type="xsd:string">BGP</value>
        </item>
        <item xsi:type="ns1:CIMProperty">
            <name xsi:type="xsd:string">CE_BGP_AS_ID</name>
            <value xsi:type="xsd:string">100</value>
        </item>

        <item xsi:type="ns1:CIMProperty">
            <name xsi:type="xsd:string">BGP_NBR_IP_ADDR</name>
            <value xsi:type="xsd:string">1.3.4.6</value>
        </item>
        <item xsi:type="ns1:CIMProperty">
            <name xsi:type="xsd:string">PE_CE_NBR_DEFAULT_INFO_ORIGINATE</name>
            <value xsi:type="xsd:string">Enable</value>
        </item>
        <item xsi:type="ns1:CIMProperty">
            <name
xsi:type="xsd:string">PE_CE_NBR_DEFAULT_INFO_ORIGINATE_ROUTE_POLICY</name>
            <value xsi:type="xsd:string">cisco</value>
        </item>
        <item xsi:type="ns1:CIMProperty">
            <name xsi:type="xsd:string">PE_CE_BGP_ADVERTISE_INTERVAL</name>
            <value xsi:type="xsd:string">6</value>
        </item>
        <item xsi:type="ns1:CIMProperty">
            <name xsi:type="xsd:string">PE_CE_BGP_MAX_PREFIX_NUMBER</name>
            <value xsi:type="xsd:string">10</value>
        </item>
        <item xsi:type="ns1:CIMProperty">
            <name xsi:type="xsd:string">PE_CE_BGP_MAX_PREFIX_THRESHOLD</name>
            <value xsi:type="xsd:string">55</value>
        </item>
        <item xsi:type="ns1:CIMProperty">
            <name xsi:type="xsd:string">PE_CE_BGP_MAX_PREFIX_RESTART</name>
            <value xsi:type="xsd:string">451</value>
        </item>
        <item xsi:type="ns1:CIMProperty">
            <name xsi:type="xsd:string">PE_CE_BGP_MAX_PREFIX_WARNING_ONLY</name>
            <value xsi:type="xsd:string">>true</value>
        </item>

<!-- PE IPv6 Routing Protocol -->

        <item xsi:type="ns1:CIMProperty">
            <name xsi:type="xsd:string">PE_CE_IPV6_Routing_Protocol</name>
            <value xsi:type="xsd:string">BGP</value>
        </item>
        <item xsi:type="ns1:CIMProperty">
            <name xsi:type="xsd:string">CE_BGP_AS_ID_IPV6</name>
            <value xsi:type="xsd:string">100</value>
        </item>
        <item xsi:type="ns1:CIMProperty">
            <name xsi:type="xsd:string">BGP_NBR_IPV6_ADDR</name>

```

```

        <value xsi:type="xsd:string">1::32</value>
      </item>

      <item xsi:type="ns1:CIMProperty">
        <name xsi:type="xsd:string">PE_CE_NBR_DEFAULT_INFO_ORIGINATE_IPV6</name>
        <value xsi:type="xsd:string">Enable</value>
      </item>

      <item xsi:type="ns1:CIMProperty">
        <name
xsi:type="xsd:string">PE_CE_NBR_DEFAULT_INFO_ORIGINATE_ROUTE_POLICY_IPV6</name>
        <value xsi:type="xsd:string">cisco</value>
      </item>

      <item xsi:type="ns1:CIMProperty">
        <name xsi:type="xsd:string">PE_CE_BGP_ADVERTISE_INTERVAL_IPV6</name>
        <value xsi:type="xsd:string">5</value>
      </item>
      <item xsi:type="ns1:CIMProperty">
        <name xsi:type="xsd:string">PE_CE_BGP_MAX_PREFIX_NUMBER_IPV6</name>
        <value xsi:type="xsd:string">18</value>
      </item>
      <item xsi:type="ns1:CIMProperty">
        <name
xsi:type="xsd:string">PE_CE_BGP_MAX_PREFIX_THRESHOLD_IPV6</name>
        <value xsi:type="xsd:string">84</value>
      </item>
      <item xsi:type="ns1:CIMProperty">
        <name xsi:type="xsd:string">PE_CE_BGP_MAX_PREFIX_RESTART_IPV6</name>
        <value xsi:type="xsd:string">35</value>
      </item>
      <item xsi:type="ns1:CIMProperty">
        <name
xsi:type="xsd:string">PE_CE_BGP_MAX_PREFIX_WARNING_ONLY_IPV6</name>
        <value xsi:type="xsd:string">>true</value>
      </item>

<!-- CERC Type -->
                                <!--
                                <item xsi:type="ns1:CIMProperty">
                                  <name xsi:type="xsd:string">CERC_RTTYPE</name>
                                  <value
xsi:type="xsd:string">cerc005=dual,cerc006=IPv6</value>
                                </item>
                                -->

<!-- BGP Route Map In / Out -->
                                <!--
                                <item xsi:type="ns1:CIMProperty">
                                  <name
xsi:type="xsd:string">PE_CE_NBR_ROUTE_MAP_IN_NAME</name>
                                  <value xsi:type="xsd:string">verve2</value>
                                </item>
                                <item xsi:type="ns1:CIMProperty">
                                  <name
xsi:type="xsd:string">PE_CE_NBR_ROUTE_MAP_OUT_NAME</name>
                                  <value xsi:type="xsd:string">verve2</value>
                                </item>
                                -->

<!-- Enable Multipath Loadsharing -->
                                <!--
                                <item xsi:type="ns1:CIMProperty">

```



```

                                <name
xsi:type="xsd:string">Bgp_Multipath_Enabled</name>
                                <value xsi:type="xsd:string">>true</value>
                                </item>
                                -->
<!-- Enable RD Format -->
                                <!--
                                <item xsi:type="ns1:CIMProperty">
                                    <name xsi:type="xsd:string">RD_FORMAT</name>
                                    <value xsi:type="xsd:string">RD_AS</value>
                                </item>

                                <item xsi:type="ns1:CIMProperty">
                                    <name xsi:type="xsd:string">RD_FORMAT</name>
                                    <value xsi:type="xsd:string">RD_IPADDR</value>
                                </item>

                                <item xsi:type="ns1:CIMProperty">
                                    <name xsi:type="xsd:string">RD_IPADDRESS</name>
                                    <value
xsi:type="xsd:string">11.21.30.24</value>
                                </item>

                                <item xsi:type="ns1:CIMProperty">
                                    <name xsi:type="xsd:string">Enable_CSC</name>
                                    <value xsi:type="xsd:string">>false</value>
                                </item>
                                <item xsi:type="ns1:CIMProperty">
                                    <name
xsi:type="xsd:string">MulticastEnabled</name>
                                    <value xsi:type="xsd:string">>false</value>
                                </item>
                                <item xsi:type="ns1:CIMProperty">
                                    <name
xsi:type="xsd:string">Vrf_Rd_Overwrite_Enabled</name>
                                    <value xsi:type="xsd:string">>true</value>
                                </item>
                                <item xsi:type="ns1:CIMProperty">
                                    <name
xsi:type="xsd:string">Overridden_Vrf_Name</name>
                                    <value xsi:type="xsd:string">test3</value>
                                </item>
                                <item xsi:type="ns1:CIMProperty">
                                    <name xsi:type="xsd:string">Overridden_Rd</name>
                                    <value xsi:type="xsd:string">158:143</value>
                                </item>
                                -->
                                </properties>
                                </objectPath>
                                <!-- ##### ( LINKATTRS End ) ##### -->

<!-- CERC's -->

                                <objectPath xsi:type="ns1:CIMObjectPath">
                                    <className xsi:type="xsd:string">CERCMembership</className>
                                    <properties xsi:type="ns1:CIMPropertyList"
soapenc:arrayType="ns1:CIMProperty[]">
                                        <item xsi:type="ns1:CIMProperty">
                                            <name xsi:type="xsd:string">CERC</name>
                                            <value xsi:type="xsd:string">27Mycerc1</value>
                                        </item>
                                        <item xsi:type="ns1:CIMProperty">
                                            <name xsi:type="xsd:string">IsHub</name>
                                            <value xsi:type="xsd:string">>true</value>

```

```

        </item>
      </properties>
    </objectPath>

<!-- Template Info -->
  <!--
    <objectPath xsi:type="ns1:CIMObjectPath">
      <className xsi:type="xsd:string">LinkTemplate</className>
      <properties xsi:type="ns1:CIMPropertyList"
soapenc:arrayType="ns1:CIMProperty[]">
        <item xsi:type="ns1:CIMProperty">
          <name xsi:type="xsd:string">LogicalDevice</name>
          <value xsi:type="xsd:string">CRS</value>
        </item>
        <item xsi:type="ns1:CIMProperty">
          <name xsi:type="xsd:string">DatafilePath</name>
          <value xsi:type="xsd:string">/mpls/sample3</value>
        </item>
        <item xsi:type="ns1:CIMProperty">
          <name xsi:type="xsd:string">DatafileName</name>
          <value xsi:type="xsd:string">data3</value>
        </item>
        <item xsi:type="ns1:CIMProperty">
          <name xsi:type="xsd:string">TemplateActive</name>
          <value xsi:type="xsd:string">>true</value>
        </item>
        <item xsi:type="ns1:CIMProperty">
          <name xsi:type="xsd:string">TemplateAction</name>
          <value xsi:type="xsd:string">APPEND</value>
        </item>
      </properties>

    </objectPath>
  -->
  <!-- End of Template here -->

  </objectPath>
  <!-- ##### ( MPLS VPN LINK End
)##### -->

  <!-- ##### ( If you need Add one more link here
)##### -->

  </objectPath>
  </objectPath>
  </action>
</actions>
</ns1:performBatchOperation>
</soapenv:Body>
</soapenv:Envelope>

```

## Creating an EIGRP Key Chain Service Request

This example shows how to create a service request for the EIGRP key chain feature with a PE and a CE (IPv4 or IPv6).

Example: CreateMPLSServiceOrder\_EIGRP\_KeyChain\_PE\_CE\_IPV4\_IPV6.xml

```
<!-- Example for EIGRP Key Chain Feature for IPv4/IPv6 -->
```

```

<?xml version="1.0" encoding="UTF-8"?>
<soapenv:Envelope
  xmlns:soapenv="http://schemas.xmlsoap.org/soap/envelope/"
  xmlns:soapenc="http://schemas.xmlsoap.org/soap/encoding/"
  xmlns:xsd="http://www.w3.org/2001/XMLSchema"
  xmlns:xsi="http://www.w3.org/2001/XMLSchema-instance"
  xmlns:ns0="http://www.cisco.com/cim-cx/2.0"
  xmlns:ns1="urn:CIM">
  <soapenv:Header>
    <!-- WaitTimeout has a default set in system properties.-->
    <ns0:message id="87855" timestamp="2002-12-13T14:55:38.885Z"
      Wait="true" WaitTimeout="90" sessiontoken="p36bttjwy1"/>
  </soapenv:Header>
  <soapenv:Body>
    <ns1:performBatchOperation>
      <actions xsi:type="ns1:CIMActionList"
        soapenc:arrayType="ns1:CIMAction[]">
        <action>
          <actionName xsi:type="xsd:string">createInstance</actionName>
          <objectPath xsi:type="ns1:CIMObjectPath">
            <className xsi:type="xsd:string">ServiceOrder</className>
            <properties xsi:type="ns1:CIMPropertyList"
              soapenc:arrayType="ns1:CIMProperty[]">
              <item xsi:type="ns1:CIMProperty">
                <name xsi:type="xsd:string">ServiceName</name>
                <value xsi:type="xsd:string">ServiceOrder253</value>
              </item>
              <item xsi:type="ns1:CIMProperty">
                <name xsi:type="xsd:string">CarrierId</name>
                <value xsi:type="xsd:string">322</value>
              </item>
              <item xsi:type="ns1:CIMProperty">
                <name xsi:type="xsd:string">DesiredDueDate</name>
                <value xsi:type="xsd:dateTime">2002-12-13T14:55:38.000Z</value>
              </item>
              <item xsi:type="ns1:CIMProperty">
                <name xsi:type="xsd:string">NumberOfRequests</name>
                <value xsi:type="xsd:string">1</value>
              </item>
              <!--item xsi:type="ns1:CIMProperty">
                <name xsi:type="xsd:string">Organization</name>
                <value xsi:type="xsd:string">NbiCustomer</value>
              </item-->
            </properties>
          </objectPath>
        </action>
        <action>
          <actionName xsi:type="xsd:string">createInstance</actionName>
          <objectPath xsi:type="ns1:CIMObjectPath">
            <className xsi:type="xsd:string">ServiceRequest</className>
            <properties xsi:type="ns1:CIMPropertyList"
              soapenc:arrayType="ns1:CIMProperty[]">
              <item xsi:type="ns1:CIMProperty">
                <name xsi:type="xsd:string">RequestName</name>
                <value xsi:type="xsd:string">MYSR-1</value>
              </item>
              <item xsi:type="ns1:CIMProperty">
                <name xsi:type="xsd:string">Type</name>
                <value xsi:type="xsd:string">Mpls</value>
              </item>
            </properties>
          <objectPath xsi:type="ns1:CIMObjectPath">
            <className xsi:type="xsd:string">ServiceRequestDetails</className>
            <properties xsi:type="ns1:CIMPropertyList"

```

```

        soapenc:arrayType="ns1:CIMProperty[]">
<item xsi:type="ns1:CIMProperty">
  <name xsi:type="xsd:string">ServiceDefinition</name>
  <value xsi:type="xsd:string">PE_CE_IPV4_NBI</value>
  <qualifier xsi:type="xsd:string">
    <name xsi:type="xsd:string">ServiceDefinitionType</name>
    <value xsi:type="xsd:string">Mpls</value>
  </qualifier>
</item>
</properties>
<objectPath xsi:type="ns1:CIMObjectPath">
  <className xsi:type="xsd:string">MplsVpnLink</className>
  <properties xsi:type="ns1:CIMPropertyList"
    soapenc:arrayType="ns1:CIMProperty[]">

<!-- ManualConfig is needed when specifying PE-CE link and not using NPC -->

    <item xsi:type="ns1:CIMProperty">
      <name xsi:type="xsd:string">ManualConfig</name>
      <value xsi:type="xsd:string">>true</value>
    </item>
    <item xsi:type="ns1:CIMProperty">
      <name xsi:type="xsd:string">PE</name>
      <value xsi:type="xsd:string">CRS</value>
    </item>
    <item xsi:type="ns1:CIMProperty">
      <name xsi:type="xsd:string">Cpe</name>
      <value xsi:type="xsd:string">iscind-7600-2</value>
    </item>

  </properties>
  <objectPath xsi:type="ns1:CIMObjectPath">
    <className xsi:type="xsd:string">LinkAttrs</className>
    <properties xsi:type="ns1:CIMPropertyList"
      soapenc:arrayType="ns1:CIMProperty[]">

<!-- PE Intf info -->
    <item xsi:type="ns1:CIMProperty">
      <name xsi:type="xsd:string">PE_Intf_Name</name>
      <value xsi:type="xsd:string">GigabitEthernet0/15/1/4</value>
    </item>

    <!-- <item xsi:type="ns1:CIMProperty">
      <name xsi:type="xsd:string">PE_Intf_Shutdown</name>
      <value xsi:type="xsd:string">>true</value>
    </item>

    <item xsi:type="ns1:CIMProperty">
      <name xsi:type="xsd:string">PE_Intf_Encap</name>
      <value xsi:type="xsd:string">DOT1Q</value>
    </item> -->

    <item xsi:type="ns1:CIMProperty">
      <name xsi:type="xsd:string">PE_Vlan_ID</name>
      <value xsi:type="xsd:string">700</value>
    </item>

    <item xsi:type="ns1:CIMProperty">
      <name xsi:type="xsd:string">Autopick_Vlan_ID</name>
      <value xsi:type="xsd:string">>false</value>
    </item>

  </properties>
</objectPath>
</properties>
  soapenc:arrayType="ns1:CIMProperty[]">

<!-- CE Intf Info -->
  <item xsi:type="ns1:CIMProperty">

```

```

        <name xsi:type="xsd:string">CE_Intf_Name</name>
        <value xsi:type="xsd:string">FastEthernet2/9</value>
    </item>
    <!-- <item xsi:type="ns1:CIMProperty">
        <name xsi:type="xsd:string">CE_Intf_Encap</name>
        <value xsi:type="xsd:string">DOT1Q</value>
    </item> -->
    <item xsi:type="ns1:CIMProperty">
        <name xsi:type="xsd:string">CE_Vlan_ID</name>
        <value xsi:type="xsd:string">702</value>
    </item>
<!-- interface Addresses for IPV4 -->
    <item xsi:type="ns1:CIMProperty">
        <name xsi:type="xsd:string">CE_Intf_Address</name>
        <value xsi:type="xsd:string">15.16.17.2/24</value>
    </item>
    <item xsi:type="ns1:CIMProperty">
        <name xsi:type="xsd:string">PE_Intf_Address</name>
        <value xsi:type="xsd:string">15.16.17.3/24</value>
    </item>
    <item xsi:type="ns1:CIMProperty">
        <name xsi:type="xsd:string">Auto_Assign_IP_Address</name>
        <value xsi:type="xsd:string">>false</value>
    </item>
<!-- interface Addresses for IPV6 -->

    <item xsi:type="ns1:CIMProperty">
        <name xsi:type="xsd:string">PE_Intf_Address_IPV6</name>
        <value xsi:type="xsd:string">2010::16/28</value>
    </item>
    <item xsi:type="ns1:CIMProperty">
        <name xsi:type="xsd:string">CE_Intf_Address_IPV6</name>
        <value xsi:type="xsd:string">2010::17/16</value>
    </item>

<!-- IPV4 Routing Protocol -->
    <item xsi:type="ns1:CIMProperty">
        <name xsi:type="xsd:string">PE_CE_Routing_Protocol</name>
        <value xsi:type="xsd:string">EIGRP</value>
    </item>
    <item xsi:type="ns1:CIMProperty">
        <name
xsi:type="xsd:string">PE_CE_EIGRP_AUTHENTICATION_KEY_CHAIN_NAME</name>
        <value xsi:type="xsd:string">nbi-key-v4</value>
    </item>
    <item xsi:type="ns1:CIMProperty">
        <name xsi:type="xsd:string">CE_EIGRP_AS_ID</name>
        <value xsi:type="xsd:string">2136</value>
    </item>
    <item xsi:type="ns1:CIMProperty">
        <name xsi:type="xsd:string">PE_EIGRP_AS_ID</name>
        <value xsi:type="xsd:string">100</value>
    </item>
    <item xsi:type="ns1:CIMProperty">
        <name
xsi:type="xsd:string">PE_CE_Bandwidth_Metric_For_Redistribution</name>
        <value xsi:type="xsd:string">1256</value>
    </item>
    <item xsi:type="ns1:CIMProperty">
        <name
xsi:type="xsd:string">PE_CE_Delay_Metric_For_Redistribution</name>
        <value xsi:type="xsd:string">4521</value>
    </item>
    <item xsi:type="ns1:CIMProperty">

```

```

        <name
xsi:type="xsd:string">PE_CE_Reliability_Metric_For_Redistribution</name>
        <value xsi:type="xsd:string">163</value>
    </item>
    <item xsi:type="ns1:CIMProperty">
        <name
xsi:type="xsd:string">PE_CE>Loading_Metric_For_Redistribution</name>
        <value xsi:type="xsd:string">145</value>
    </item>
    <item xsi:type="ns1:CIMProperty">
        <name xsi:type="xsd:string">PE_CE_MTU_Metric_For_Redistribution</name>
        <value xsi:type="xsd:string">2136</value>
    </item>

<!-- IPv6 Routing Protocol -->

    <item xsi:type="ns1:CIMProperty">
        <name xsi:type="xsd:string">PE_CE_IPV6_Routing_Protocol</name>
        <value xsi:type="xsd:string">EIGRP</value>
    </item>
    <item xsi:type="ns1:CIMProperty">
        <name
xsi:type="xsd:string">PE_CE_EIGRP_AUTHENTICATION_KEY_CHAIN_NAME_IPV6</name>
        <value xsi:type="xsd:string">nbi-key-v6</value>
    </item>
    <item xsi:type="ns1:CIMProperty">
        <name xsi:type="xsd:string">CE_EIGRP_AS_ID_IPV6</name>
        <value xsi:type="xsd:string">2136</value>
    </item>
    <item xsi:type="ns1:CIMProperty">
        <name xsi:type="xsd:string">PE_EIGRP_AS_ID_IPV6</name>
        <value xsi:type="xsd:string">100</value>
    </item>
    <item xsi:type="ns1:CIMProperty">
        <name
xsi:type="xsd:string">PE_CE_Bandwidth_Metric_For_Redistribution_IPV6</name>
        <value xsi:type="xsd:string">1256</value>
    </item>
    <item xsi:type="ns1:CIMProperty">
        <name
xsi:type="xsd:string">PE_CE_Delay_Metric_For_Redistribution_IPV6</name>
        <value xsi:type="xsd:string">4521</value>
    </item>
    <item xsi:type="ns1:CIMProperty">
        <name
xsi:type="xsd:string">PE_CE_Reliability_Metric_For_Redistribution_IPV6</name>
        <value xsi:type="xsd:string">163</value>
    </item>
    <item xsi:type="ns1:CIMProperty">
        <name
xsi:type="xsd:string">PE_CE>Loading_Metric_For_Redistribution_IPV6</name>
        <value xsi:type="xsd:string">145</value>
    </item>
    <item xsi:type="ns1:CIMProperty">
        <name
xsi:type="xsd:string">PE_CE_MTU_Metric_For_Redistribution_IPV6</name>
        <value xsi:type="xsd:string">2136</value>
    </item>

<!-- Vrf-RD- Overridden-->

    <!-- <item xsi:type="ns1:CIMProperty">

```

```

        <name xsi:type="xsd:string">Vrf_Rd_Over_Write_Enabled</name>
        <value xsi:type="xsd:string">>true</value>
    </item>
</item>
<item xsi:type="ns1:CIMProperty">
    <name xsi:type="xsd:string">Overriden_Vrf_Name</name>
    <value xsi:type="xsd:string">vrf1</value>
</item>
<item xsi:type="ns1:CIMProperty">
    <name xsi:type="xsd:string">Overriden_Rd</name>
    <value xsi:type="xsd:string">100:45</value>
</item> -->

</properties>
</objectPath>

<!-- CERC's -->

<objectPath xsi:type="ns1:CIMObjectPath">
    <className xsi:type="xsd:string">CERCMembership</className>
    <properties xsi:type="ns1:CIMPropertyList"
        soapenc:arrayType="ns1:CIMProperty[]">
        <item xsi:type="ns1:CIMProperty">
            <name xsi:type="xsd:string">CERC</name>
            <value xsi:type="xsd:string">cerc1</value>
        </item>
        <item xsi:type="ns1:CIMProperty">
            <name xsi:type="xsd:string">IsHub</name>
            <value xsi:type="xsd:string">>true</value>
        </item>
    </properties>
</objectPath>

<!-- LinkTemplate example using template definition and direct input of template data
(buffer method). The template data
        is entered in the DataBuffer objectDef section -->
<!--
<objectPath xsi:type="ns1:CIMObjectPath">
    <className xsi:type="xsd:string">LinkTemplate</className>
    <properties xsi:type="ns1:CIMPropertyList"
soapenc:arrayType="ns1:CIMProperty[]">
    <item xsi:type="ns1:CIMProperty">
        <name xsi:type="xsd:string">LogicalDevice</name>
        <value xsi:type="xsd:string">mlpe7</value>
    </item>
    <item xsi:type="ns1:CIMProperty">
        <name xsi:type="xsd:string">DatafilePath</name>
        <value xsi:type="xsd:string">/sampl8/data23</value>
    </item>
    <item xsi:type="ns1:CIMProperty">
        <name xsi:type="xsd:string">TemplateActive</name>
        <value xsi:type="xsd:string">>true</value>
    </item>
    <item xsi:type="ns1:CIMProperty">
        <name xsi:type="xsd:string">TemplateAction</name>
        <value xsi:type="xsd:string">APPEND</value>
    </item>
</properties>
<objectPath xsi:type="ns1:CIMObjectPath">
    <className xsi:type="xsd:string">DataBuffer</className>
    <properties xsi:type="ns1:CIMPropertyList"
        soapenc:arrayType="ns1:CIMProperty[]">
        <item xsi:type="ns1:CIMProperty">

```

```

        <name xsi:type="xsd:string">protocol</name>
        <value xsi:type="xsd:string">ip</value>
    </item>
    <item xsi:type="ns1:CIMProperty">
        <name xsi:type="xsd:string">Application</name>
        <value xsi:type="xsd:string">bootps</value>
    </item>
</properties>
</objectPath>
</objectPath>
-->
</objectPath>
</objectPath>
</objectPath>
</action>
</actions>
</ns1:performBatchOperation>
</soapenv:Body>
</soapenv:Envelope>

```

## Creating an OSPF Default Info Originate Service Request

This example shows how to create a service request for generating a default route into an OSPF routing domain with a PE and no CE (IPv4 only).

Example: CreateMPLSServiceOrder\_OSPF\_DefaultInfoOriginate\_PE\_NO\_CE\_IPV4.xml

```

<?xml version="1.0" encoding="UTF-8"?>
<soapenv:Envelope
  xmlns:soapenv="http://schemas.xmlsoap.org/soap/envelope/"
  xmlns:soapenc="http://schemas.xmlsoap.org/soap/encoding/"
  xmlns:xsd="http://www.w3.org/2001/XMLSchema"
  xmlns:xsi="http://www.w3.org/2001/XMLSchema-instance"
  xmlns:ns0="http://www.cisco.com/cim-cx/2.0"
  xmlns:ns1="urn:CIM">
  <soapenv:Header>
    <!-- WaitTimeout has a default set in system properties.-->
    <ns0:message id="87855" timestamp="2002-12-13T14:55:38.885Z"
      Wait="true" WaitTimeout="90" sessiontoken="p36bttjwyl"/>
  </soapenv:Header>
  <soapenv:Body>
    <ns1:performBatchOperation>
      <actions xsi:type="ns1:CIMActionList"
        soapenc:arrayType="ns1:CIMAction[]">
        <action>
          <actionName xsi:type="xsd:string">createInstance</actionName>
          <objectPath xsi:type="ns1:CIMObjectPath">
            <className xsi:type="xsd:string">ServiceOrder</className>
            <properties xsi:type="ns1:CIMPropertyList"
              soapenc:arrayType="ns1:CIMProperty[]">
              <item xsi:type="ns1:CIMProperty">
                <name xsi:type="xsd:string">ServiceName</name>
                <value xsi:type="xsd:string">ServiceOrder253</value>
              </item>
              <item xsi:type="ns1:CIMProperty">
                <name xsi:type="xsd:string">CarrierId</name>
                <value xsi:type="xsd:string">322</value>
              </item>
              <item xsi:type="ns1:CIMProperty">
                <name xsi:type="xsd:string">DesiredDueDate</name>
                <value xsi:type="xsd:dateTime">2002-12-13T14:55:38.000Z</value>
              </item>
            </properties>
          </objectPath>
        </action>
      </actions>
    </ns1:performBatchOperation>
  </soapenv:Body>
</soapenv:Envelope>

```



```

    </item>
    <item xsi:type="ns1:CIMProperty">
      <name xsi:type="xsd:string">NumberOfRequests</name>
      <value xsi:type="xsd:string">1</value>
    </item>
    <!--item xsi:type="ns1:CIMProperty">
      <name xsi:type="xsd:string">Organization</name>
      <value xsi:type="xsd:string">NbiCustomer</value>
    </item-->
  </properties>
</objectPath>
</action>
<action>
  <actionName xsi:type="xsd:string">createInstance</actionName>
  <objectPath xsi:type="ns1:CIMObjectPath">
    <className xsi:type="xsd:string">ServiceRequest</className>
    <properties xsi:type="ns1:CIMPropertyList"
      soapenc:arrayType="ns1:CIMProperty[]">
      <item xsi:type="ns1:CIMProperty">
        <name xsi:type="xsd:string">RequestName</name>
        <value xsi:type="xsd:string">MYSR-1</value>
      </item>
      <item xsi:type="ns1:CIMProperty">
        <name xsi:type="xsd:string">Type</name>
        <value xsi:type="xsd:string">Mpls</value>
      </item>
    </properties>
    <objectPath xsi:type="ns1:CIMObjectPath">
      <className xsi:type="xsd:string">ServiceRequestDetails</className>
      <properties xsi:type="ns1:CIMPropertyList"
        soapenc:arrayType="ns1:CIMProperty[]">
        <!-- Policy Name -->
        <item xsi:type="ns1:CIMProperty">
          <name xsi:type="xsd:string">ServiceDefinition</name>
          <value xsi:type="xsd:string">PE_NO_CE</value>
          <qualifier xsi:type="xsd:string">
            <name xsi:type="xsd:string">ServiceDefinitionType</name>
            <value xsi:type="xsd:string">Mpls</value>
          </qualifier>
        </item>
        </properties>
        <objectPath xsi:type="ns1:CIMObjectPath">
          <className xsi:type="xsd:string">MplsVpnLink</className>
          <properties xsi:type="ns1:CIMPropertyList"
            soapenc:arrayType="ns1:CIMProperty[]">
            <!-- ManualConfig is needed when specifying PE-CE link and not using NPC -->
            <!--Device Info -->
            <item xsi:type="ns1:CIMProperty">
              <name xsi:type="xsd:string">ManualConfig</name>
              <value xsi:type="xsd:string">true</value>
            </item>
            <item xsi:type="ns1:CIMProperty">
              <name xsi:type="xsd:string">PE</name>
              <value xsi:type="xsd:string">Cisco CRS</value>
            </item>
          </properties>
          <objectPath xsi:type="ns1:CIMObjectPath">
            <className xsi:type="xsd:string">LinkAttrs</className>

```

```

        <properties xsi:type="ns1:CIMPropertyList"
soapenc:arrayType="ns1:CIMProperty[]">
<!-- PE Intf Info -->
    <item xsi:type="ns1:CIMProperty">
        <name xsi:type="xsd:string">PE_Intf_Name</name>
        <value xsi:type="xsd:string">TenGigE0/0/0/2</value>
    </item>
    <item xsi:type="ns1:CIMProperty">
        <name xsi:type="xsd:string">PE_Vlan_ID</name>
        <value xsi:type="xsd:string">593</value>
    </item>
    <item xsi:type="ns1:CIMProperty">
        <name xsi:type="xsd:string">Autopick_Vlan_ID</name>
        <value xsi:type="xsd:string">>false</value>
    </item>

<!-- interface Addresses for IPV4 -->

    <item xsi:type="ns1:CIMProperty">
        <name xsi:type="xsd:string">PE_Intf_Address</name>
        <value xsi:type="xsd:string">36.25.4.6/24</value>
    </item>

<!-- IPV4 Routing Protocol -->

    <item xsi:type="ns1:CIMProperty">
        <name xsi:type="xsd:string">PE_CE_Routing_Protocol</name>
        <value xsi:type="xsd:string">OSPF</value>
    </item>
    <item xsi:type="ns1:CIMProperty">
        <name xsi:type="xsd:string">PE_OSPF_PROCESS_ID</name>
        <value xsi:type="xsd:string">123</value>
    </item>
    <item xsi:type="ns1:CIMProperty">
        <name xsi:type="xsd:string">PE_CE_OSPF_DEF_INFO_ORIGINATE</name>
        <value xsi:type="xsd:string">true</value>
    </item>
    <item xsi:type="ns1:CIMProperty">
        <name
xsi:type="xsd:string">PE_CE_OSPF_DEF_INFO_ORIGINATE_ALWAYS</name>
        <value xsi:type="xsd:string">true</value>
    </item>
    <item xsi:type="ns1:CIMProperty">
        <name xsi:type="xsd:string">PE_CE_OSPF_METRIC_VALUE</name>
        <value xsi:type="xsd:string">354</value>
    </item>
    <item xsi:type="ns1:CIMProperty">
        <name xsi:type="xsd:string">PE_CE_OSPF_METRIC_TYPE</name>
        <value xsi:type="xsd:string">None</value>
    </item>
    <item xsi:type="ns1:CIMProperty">
        <name xsi:type="xsd:string">PE_CE_OSPF_ROUTE_POLICY</name>
        <value xsi:type="xsd:string">dinesh</value>
    </item>
    <item xsi:type="ns1:CIMProperty">
        <name xsi:type="xsd:string">PE_CE_Ospf_Area_Number</name>
        <value xsi:type="xsd:string">345</value>
    </item>
</properties>
</objectPath>

<!-- CERC's -->

```

```

<objectPath xsi:type="ns1:CIMObjectPath">
  <className xsi:type="xsd:string">CERCMembership</className>
  <properties xsi:type="ns1:CIMPropertyList"
    soapenc:arrayType="ns1:CIMProperty[]">
    <item xsi:type="ns1:CIMProperty">
      <name xsi:type="xsd:string">CERC</name>
      <value xsi:type="xsd:string">Cerc-1-100</value>
    </item>
    <item xsi:type="ns1:CIMProperty">
      <name xsi:type="xsd:string">IsHub</name>
      <value xsi:type="xsd:string">>true</value>
    </item>
  </properties>
</objectPath>

<!-- LinkTemplate example using template definition and direct input of template data
(buffer method). The template data
                                is entered in the DataBuffer objectDef section -->
<!-- TEmplate start here-->

  <!-- <objectPath xsi:type="ns1:CIMObjectPath">
    <className xsi:type="xsd:string">LinkTemplate</className>
    <properties xsi:type="ns1:CIMPropertyList"
soapenc:arrayType="ns1:CIMProperty[]">
    <item xsi:type="ns1:CIMProperty">
      <name xsi:type="xsd:string">LogicalDevice</name>
      <value xsi:type="xsd:string">CRS</value>
    </item>
    <item xsi:type="ns1:CIMProperty">
      <name xsi:type="xsd:string">DatafilePath</name>
      <value xsi:type="xsd:string">/mpls/sample1</value>
    </item>
    <item xsi:type="ns1:CIMProperty">
      <name xsi:type="xsd:string">DatafileName</name>
      <value xsi:type="xsd:string">d21</value>
    </item>
    <item xsi:type="ns1:CIMProperty">
      <name xsi:type="xsd:string">TemplateActive</name>
      <value xsi:type="xsd:string">>true</value>
    </item>
    <item xsi:type="ns1:CIMProperty">
      <name xsi:type="xsd:string">TemplateAction</name>
      <value xsi:type="xsd:string">APPEND</value>
    </item>
  </properties>

  </objectPath>-->

<!-- Template Ends Here -->

  </objectPath>
</objectPath>
</objectPath>
</action>
</actions>
</ns1:performBatchOperation>
</soapenv:Body>
</soapenv:Envelope>

```

## Creating an MPLS Pseudowire Service Request

As an example of an MPLS pseudowire service request, the following illustrates how to create a BGP service request for a PE no CE case.

Example: CreateMPLSServiceOrder\_PE\_NO\_CE\_PW\_MPLS.xml

```
<?xml version="1.0" ?>
- <soapenv:Envelope xmlns:ns0="http://www.cisco.com/cim-cx/2.0" xmlns:ns1="urn:CIM"
xmlns:soapenc="http://schemas.xmlsoap.org/soap/encoding/"
xmlns:soapenv="http://schemas.xmlsoap.org/soap/envelope/"
xmlns:xsd="http://www.w3.org/2001/XMLSchema"
xmlns:xsi="http://www.w3.org/2001/XMLSchema-instance">
- <soapenv:Header>
  <ns0:message id="87855" sessiontoken="DD8EEDA45B35DF2E1AE8E07FDF72BB4A"
timestamp="2002-12-13T14:55:38.885Z" />
</soapenv:Header>
- <soapenv:Body>
- <ns1:createInstance>
- <objectPath subAction="createInstance" xsi:type="ns1:CIMObjectPath">
  <className xsi:type="xsd:string">ServiceRequest</className>
- <properties soapenc:arrayType="ns1:CIMProperty[]" xsi:type="ns1:CIMPropertyList">
- <item xsi:type="ns1:CIMProperty">
  <name xsi:type="xsd:string">RequestName</name>
  <value xsi:type="xsd:string">MYSR-1</value>
</item>
- <item xsi:type="ns1:CIMProperty">
  <name xsi:type="xsd:string">Type</name>
  <value xsi:type="xsd:string">Mpls</value>
</item>
</properties>
- <objectPath subAction="createInstance" xsi:type="ns1:CIMObjectPath">
  <className xsi:type="xsd:string">ServiceRequestDetails</className>
- <properties soapenc:arrayType="ns1:CIMProperty[]" xsi:type="ns1:CIMPropertyList">
- <item xsi:type="ns1:CIMProperty">
  <name xsi:type="xsd:string">Description</name>
  <value xsi:type="xsd:string">SR1</value>
</item>
- <item xsi:type="ns1:CIMProperty">
  <name xsi:type="xsd:string">ServiceDefinition</name>
  <value xsi:type="xsd:string">POLICY</value>
- <qualifier xsi:type="ns1:CIMQualifier">
  <name xsi:type="xsd:string">ServiceDefinitionType</name>
  <value xsi:type="xsd:string">Mpls</value>
</qualifier>
</item>
</properties>
- <objectPath subAction="createInstance" xsi:type="ns1:CIMObjectPath">
  <className xsi:type="xsd:string">MplsVpnLink</className>
- <properties soapenc:arrayType="ns1:CIMProperty[]" xsi:type="ns1:CIMPropertyList">
- <item xsi:type="ns1:CIMProperty">
  <name xsi:type="xsd:string">PE</name>
  <value xsi:type="xsd:string">iscind-7609-2</value>
</item>
- <item xsi:type="ns1:CIMProperty">
  <name xsi:type="xsd:string">ManualConfig</name>
  <value xsi:type="xsd:string">>true</value>
</item>
</properties>
- <objectPath xsi:type="ns1:CIMObjectPath">
  <className xsi:type="xsd:string">LinkAttrs</className>
- <properties soapenc:arrayType="ns1:CIMProperty[]" xsi:type="ns1:CIMPropertyList">
- <item xsi:type="ns1:CIMProperty">
```

```

    <name xsi:type="xsd:string">Auto_Assign_IP_Address</name>
    <value xsi:type="xsd:string">>false</value>
  </item>
- <item xsi:type="ns1:CIMProperty">
  <name xsi:type="xsd:string">Autopick_Vlan_ID</name>
  <value xsi:type="xsd:string">>false</value>
</item>
- <item xsi:type="ns1:CIMProperty">
  <name xsi:type="xsd:string">PE_Vlan_ID</name>
  <value xsi:type="xsd:string">2911</value>
</item>
- <item xsi:type="ns1:CIMProperty">
  <name xsi:type="xsd:string">PE_Intf_Address_IPV6</name>
  <value xsi:type="xsd:string">12::89/24</value>
</item>
- <item xsi:type="ns1:CIMProperty">
  <name xsi:type="xsd:string">PE_CE_IPV6_Routing_Protocol</name>
  <value xsi:type="xsd:string">NONE</value>
</item>
</properties>
</objectPath>
- <objectPath subAction="createInstance" xsi:type="ns1:CIMObjectPath">
  <className xsi:type="xsd:string">CERCMembership</className>
  <properties soapenc:arrayType="ns1:CIMProperty[]" xsi:type="ns1:CIMPropertyList">
  <item xsi:type="ns1:CIMProperty">
    <name xsi:type="xsd:string">CERC</name>
    <value xsi:type="xsd:string">rtt</value>
  </item>
  <item xsi:type="ns1:CIMProperty">
    <name xsi:type="xsd:string">IsHub</name>
    <value xsi:type="xsd:string">>true</value>
  </item>
  </properties>
</objectPath>
</objectPath>
</objectPath>
</objectPath>
</ns1:createInstance>
</soapenv:Body>
</soapenv:Envelope>

```

## Creating an MPLS VPN PE No CE EVC UPE Service Request

This XML example creates an L3VPN service request for a PE no CE EVC UPE case. The relevant attributes to set are the child attributes for the class path `UpEVCServiceInstanceAttrs`, which have been highlighted below.

Example: `CreateMPLSServiceOrder_PE_NO_CE_EVC_UPE.xml`

```

<?xml version="1.0" encoding="UTF-8"?>
<soapenv:Envelope
  xmlns:soapenv="http://schemas.xmlsoap.org/soap/envelope/"
  xmlns:soapenc="http://schemas.xmlsoap.org/soap/encoding/"
  xmlns:xsd="http://www.w3.org/2001/XMLSchema"
  xmlns:xsi="http://www.w3.org/2001/XMLSchema-instance"
  xmlns:ns0="http://www.cisco.com/cim-cx/2.0"
  xmlns:ns1="urn:CIM">
  <soapenv:Header>
    <!-- WaitTimeout has a default set in system properties.-->
    <ns0:message id="87855" timestamp="2002-12-13T14:55:38.885Z"

```

```

        Wait="true" WaitTimeout="90"
sessiontoken="42A143790EF46489DD5A8897F9D31E4F" />
</soapenv:Header>
<soapenv:Body>
  <ns1:performBatchOperation>
    <actions xsi:type="ns1:CIMActionList"
      soapenc:arrayType="ns1:CIMAction[]" >
      <action>
        <actionName xsi:type="xsd:string">createInstance</actionName>
        <objectPath xsi:type="ns1:CIMObjectPath">
          <className xsi:type="xsd:string">ServiceOrder</className>
          <properties xsi:type="ns1:CIMPropertyList"
            soapenc:arrayType="ns1:CIMProperty[]" >
            <item xsi:type="ns1:CIMProperty">
              <name xsi:type="xsd:string">ServiceName</name>
              <value xsi:type="xsd:string">ServiceOrder253</value>
            </item>
            <item xsi:type="ns1:CIMProperty">
              <name xsi:type="xsd:string">CarrierId</name>
              <value xsi:type="xsd:string">322</value>
            </item>
            <item xsi:type="ns1:CIMProperty">
              <name xsi:type="xsd:string">DesiredDueDate</name>
              <value xsi:type="xsd:dateTime">2002-12-13T14:55:38.000Z</value>
            </item>
            <item xsi:type="ns1:CIMProperty">
              <name xsi:type="xsd:string">NumberOfRequests</name>
              <value xsi:type="xsd:string">1</value>
            </item>
            <!--item xsi:type="ns1:CIMProperty">
              <name xsi:type="xsd:string">Organization</name>
              <value xsi:type="xsd:string">NbiCustomer</value>
            </item-->
          </properties>
        </objectPath>
      </action>
      <action>
        <actionName xsi:type="xsd:string">createInstance</actionName>
        <objectPath xsi:type="ns1:CIMObjectPath">
          <className xsi:type="xsd:string">ServiceRequest</className>
          <properties xsi:type="ns1:CIMPropertyList"
            soapenc:arrayType="ns1:CIMProperty[]" >
            <item xsi:type="ns1:CIMProperty">
              <name xsi:type="xsd:string">RequestName</name>
              <value xsi:type="xsd:string">MYSR-1</value>
            </item>
            <item xsi:type="ns1:CIMProperty">
              <name xsi:type="xsd:string">Type</name>
              <value xsi:type="xsd:string">Mpls</value>
            </item>
          </properties>
        <objectPath xsi:type="ns1:CIMObjectPath">
          <className xsi:type="xsd:string">ServiceRequestDetails</className>
          <properties xsi:type="ns1:CIMPropertyList"
            soapenc:arrayType="ns1:CIMProperty[]" >
            <!-- Policy Info -->
            <item xsi:type="ns1:CIMProperty">
              <name xsi:type="xsd:string">ServiceDefinition</name>
              <value xsi:type="xsd:string">noce</value>
              <qualifier xsi:type="xsd:string">
                <name xsi:type="xsd:string">ServiceDefinitionType</name>
                <value xsi:type="xsd:string">Mpls</value>
              </qualifier>
            </item>
          </properties>
        </objectPath>
      </action>
    </actions>
  </ns1:performBatchOperation>
</soapenv:Body>
</soap:Envelope>

```

```

</properties>
<objectPath xsi:type="ns1:CIMObjectPath">
  <className xsi:type="xsd:string">MplsVpnLink</className>
  <properties xsi:type="ns1:CIMPropertyList"
    soapenc:arrayType="ns1:CIMProperty[]">

<!-- ManualConfig is needed when specifying PE-CE link and not using NPC -->
<!-- Device Info -->
  <!--<item xsi:type="ns1:CIMProperty">
    <name xsi:type="xsd:string">ManualConfig</name>
    <value xsi:type="xsd:string">true</value>
  </item>
  <item xsi:type="ns1:CIMProperty">
    <name xsi:type="xsd:string">SecNpeNpcMapId</name>
    <value xsi:type="xsd:string">25</value>
  </item-->
  <item xsi:type="ns1:CIMProperty">
    <name xsi:type="xsd:string">PE</name>
    <value xsi:type="xsd:string">iscind-7609-2</value>
  </item>
  <item xsi:type="ns1:CIMProperty">
    <name xsi:type="xsd:string">UNIDeviceInterface</name>
    <value xsi:type="xsd:string">FastEthernet1/0/14</value>
  </item>
  <item xsi:type="ns1:CIMProperty">
    <name xsi:type="xsd:string">NPC</name>
    <value xsi:type="xsd:string">2</value>
  </item>

</properties>
<objectPath xsi:type="ns1:CIMObjectPath">
  <className xsi:type="xsd:string">LinkAttrs</className>
  <properties xsi:type="ns1:CIMPropertyList"
    soapenc:arrayType="ns1:CIMProperty[]">

<!-- PE Intf Info -->
  <item xsi:type="ns1:CIMProperty">
    <name xsi:type="xsd:string">PE_Intf_Name</name>
    <value xsi:type="xsd:string">GigabitEthernet7/0/4</value>
  </item>
  <item xsi:type="ns1:CIMProperty">
    <name xsi:type="xsd:string">PE_Intf_Encap</name>
    <value xsi:type="xsd:string">DOT1Q</value>
  </item>

  <item xsi:type="ns1:CIMProperty">
    <name xsi:type="xsd:string">PE_Vlan_ID</name>
    <value xsi:type="xsd:string">1850</value>
  </item>
  <!--<item xsi:type="ns1:CIMProperty">
    <name xsi:type="xsd:string">Second_PE_Vlan_ID</name>
    <value xsi:type="xsd:string">2969</value>
  </item-->
  <item xsi:type="ns1:CIMProperty">
    <name xsi:type="xsd:string">Autopick_Vlan_ID</name>
    <value xsi:type="xsd:string">>false</value>
  </item>
  <item xsi:type="ns1:CIMProperty">
    <name xsi:type="xsd:string">IS_USE_SVI</name>
    <value xsi:type="xsd:string">>false</value>
  </item>
  <item xsi:type="ns1:CIMProperty">
    <name xsi:type="xsd:string">PE_Intf_Address</name>
    <value xsi:type="xsd:string">15.90.6.1/24</value>

```

```

        </item>
<!-- interface Addresses for IPV4 -->

        <item xsi:type="ns1:CIMProperty">
            <name xsi:type="xsd:string">USE_EVC_SERVICE</name>
            <value xsi:type="xsd:string">true</value>
        </item>

<!-- interface Addresses for IPV6 -->
        <!--<item xsi:type="ns1:CIMProperty">
            <name xsi:type="xsd:string">PE_Intf_Address_IPV6</name>
            <value xsi:type="xsd:string">29::32/64</value>
        </item> -->

        <item xsi:type="ns1:CIMProperty">
            <name xsi:type="xsd:string">Auto_Assign_IP_Address</name>
            <value xsi:type="xsd:string">>false</value>
        </item>
        <!-- <item xsi:type="ns1:CIMProperty">
<name xsi:type="xsd:string">Bgp_Multipath_Enabled</name>
<value xsi:type="xsd:string">true</value>
</item> -->
<!-- IPV4 Routing Protocol -->
        <item xsi:type="ns1:CIMProperty">
            <name xsi:type="xsd:string">PE_CE_Routing_Protocol</name>
            <value xsi:type="xsd:string">STATIC</value>
        </item>
        <!-- <item xsi:type="ns1:CIMProperty">
            <name xsi:type="xsd:string">PE_CE_IPV6_Routing_Protocol</name>
            <value xsi:type="xsd:string">STATIC</value>
        </item> -->
        <!-- <item xsi:type="ns1:CIMProperty">
            <name xsi:type="xsd:string">Is_Default_Routes_Sent_To_CE</name>
            <value xsi:type="xsd:string">TRUE</value>
        </item> -->
        <!--<item xsi:type="ns1:CIMProperty">
            <name xsi:type="xsd:string">Is_Default_Routes_Sent_To_CE_IPV6</name>
            <value xsi:type="xsd:string">TRUE</value>
        </item>-->
        <!-- <item xsi:type="ns1:CIMProperty">
            <name xsi:type="xsd:string">Is_Default_Info_Originate</name>
            <value xsi:type="xsd:string">TRUE</value>
        </item> -->
        <item xsi:type="ns1:CIMProperty">
            <name xsi:type="xsd:string">Static_Next_Hop_Option</name>
            <value
xsi:type="xsd:string">OUTGOING_INTF_NAME_NEXT_HOP_IPADDR</value>
        </item>

        <item xsi:type="ns1:CIMProperty">
            <name xsi:type="xsd:string">STATIC_NEXT_HOP_IP_ADDR</name>
            <value xsi:type="xsd:string">139.22.29.28</value>
        </item>
        <!-- <item xsi:type="ns1:CIMProperty">
            <name xsi:type="xsd:string">Static_Next_Hop_Option_IPV6</name>
            <value
xsi:type="xsd:string">OUTGOING_INTF_NAME_NEXT_HOP_IPADDR</value>
        </item>
        <item xsi:type="ns1:CIMProperty">
            <name xsi:type="xsd:string">STATIC_NEXT_HOP_IPV6_ADDR</name>
            <value xsi:type="xsd:string">18::168</value>
        </item> -->
    </properties>
</objectPath>

```



```

<!--<objectPath subAction="createInstance" xsi:type="ns1:CIMObjectPath">
  <className xsi:type="xsd:string">VRFSharedAttrs</className>
  <properties soapenc:arrayType="ns1:CIMProperty[]"
xsi:type="ns1:CIMPropertyList">
    <item xsi:type="ns1:CIMProperty">
      <name xsi:type="xsd:string">Bgp_Multipath_Type</name>
      <value xsi:type="xsd:string">eBGP+iBGP</value>
    </item>
    <item xsi:type="ns1:CIMProperty">
      <name xsi:type="xsd:string">Bgp_Multipath_Max_Path</name>
      <value xsi:type="xsd:string">7</value>
    </item>
    <item xsi:type="ns1:CIMProperty">
      <name xsi:type="xsd:string">Bgp_Multipath_Import_Path</name>
      <value xsi:type="xsd:string">5</value>
    </item>

    <item xsi:type="ns1:CIMProperty">
      <name xsi:type="xsd:string">Bgp_Multipath_Unequal_Cost</name>
      <value xsi:type="xsd:string">>true</value>
    </item>
  </properties>
</objectPath-->
<!-- CERC's --->

<objectPath xsi:type="ns1:CIMObjectPath">
  <className xsi:type="xsd:string">CERCMembership</className>
  <properties xsi:type="ns1:CIMPropertyList"
    soapenc:arrayType="ns1:CIMProperty[]">
    <item xsi:type="ns1:CIMProperty">
      <name xsi:type="xsd:string">CERC</name>
      <value xsi:type="xsd:string">rtt13</value>
    </item>
    <item xsi:type="ns1:CIMProperty">
      <name xsi:type="xsd:string">IsHub</name>
      <value xsi:type="xsd:string">>true</value>
    </item>
  </properties>
</objectPath>
<objectPath xsi:type="ns1:CIMObjectPath">
  <className xsi:type="xsd:string">UpeEVCSserviceInstanceAttrs</className>
  <properties xsi:type="ns1:CIMPropertyList"
    soapenc:arrayType="ns1:CIMProperty[]">
    <item xsi:type="ns1:CIMProperty">
      <name xsi:type="xsd:string">AUTOPICK_SERVICE_INSTANCE_ID</name>
      <value xsi:type="xsd:string">>false</value>
    </item>
    <item xsi:type="ns1:CIMProperty">
      <name xsi:type="xsd:string">SERVICE_INSTANCE_ID</name>
      <value xsi:type="xsd:string">200</value>
    </item>
    <item xsi:type="ns1:CIMProperty">
      <name xsi:type="xsd:string">AUTOPICK_SERVICE_INSTANCE_NAME</name>
      <value xsi:type="xsd:string">>false</value>
    </item>
    <item xsi:type="ns1:CIMProperty">
      <name xsi:type="xsd:string">SERVICE_INSTANCE_NAME</name>
      <value xsi:type="xsd:string">upeservice</value>
    </item>
    <item xsi:type="ns1:CIMProperty">
      <name xsi:type="xsd:string">AUTOPICK_OUTER_VLAN</name>

```

```

        <value xsi:type="xsd:string">false</value>
    </item>
    <item xsi:type="ns1:CIMProperty">
        <name xsi:type="xsd:string">OUTER_VLAN_ID</name>
        <value xsi:type="xsd:string">2222</value>
    </item>
    <item xsi:type="ns1:CIMProperty">
        <name xsi:type="xsd:string">UPE_VLAN_MATCH</name>
        <value xsi:type="xsd:string">DOT1Q</value>
    </item>
    <item xsi:type="ns1:CIMProperty">
        <name xsi:type="xsd:string">UPE_VLAN_REWRITE</name>
        <value xsi:type="xsd:string">PUSH</value>
    </item>
    <item xsi:type="ns1:CIMProperty">
        <name xsi:type="xsd:string">UPE_OUTER_VLAN</name>
        <value xsi:type="xsd:string">3521</value>
    </item>
    <item xsi:type="ns1:CIMProperty">
        <name xsi:type="xsd:string">UPE_INNER_VLAN</name>
        <value xsi:type="xsd:string">544</value>
    </item>
</properties>
</objectPath>
</objectPath>

<!-- <objectPath xsi:type="ns1:CIMObjectPath">
<className xsi:type="xsd:string">CERCMembership</className>
<properties xsi:type="ns1:CIMPropertyList"
        soapenc:arrayType="ns1:CIMProperty[]">
    <item xsi:type="ns1:CIMProperty">
        <name xsi:type="xsd:string">CERC</name>
        <value xsi:type="xsd:string">rtt</value>
    </item>
    <item xsi:type="ns1:CIMProperty">
        <name xsi:type="xsd:string">IsHub</name>
        <value xsi:type="xsd:string">true</value>
    </item>
</properties>
</objectPath -->
</objectPath>
</action>
</actions>
</ns1:performBatchOperation>
</soapenv:Body>
</soapenv:Envelope>

```

## Creating an MPLS VPN Topology Service Request

This example is used to set up a L3VPN topology service request. To do this, set the attributes of the **LinkAttrs** class and the attribute **CERC\_RTTYPE**, both highlighted below.

Example: CreateMPLSServiceOrder\_PE\_NO\_CE\_VPN\_TOPOLOGY.xml

```
<?xml version="1.0" encoding="UTF-8"?>
```

```

<soapenv:Envelope xmlns:soapenv="http://schemas.xmlsoap.org/soap/envelope/"
xmlns:soapenc="http://schemas.xmlsoap.org/soap/encoding/"
xmlns:xsd="http://www.w3.org/2001/XMLSchema"
xmlns:xsi="http://www.w3.org/2001/XMLSchema-instance"
xmlns:ns0="http://www.cisco.com/cim-cx/2.0" xmlns:ns1="urn:CIM">
  <soapenv:Header>
    <!-- WaitTimeout has a default set in system properties.-->
    <ns0:message id="87855" timestamp="2002-12-13T14:55:38.885Z" Wait="true"
WaitTimeout="90" sessiontoken="856A44B24C52AA43D5CA254B79DE3452"/>
  </soapenv:Header>
  <soapenv:Body>
    <ns1:performBatchOperation>
      <actions xsi:type="ns1:CIMActionList" soapenc:arrayType="ns1:CIMAction[]">
        <action>
          <actionName xsi:type="xsd:string">createInstance</actionName>
          <objectPath xsi:type="ns1:CIMObjectPath">
            <className xsi:type="xsd:string">ServiceOrder</className>
            <properties xsi:type="ns1:CIMPropertyList"
soapenc:arrayType="ns1:CIMProperty[]">
              <item xsi:type="ns1:CIMProperty">
                <name xsi:type="xsd:string">ServiceName</name>
                <value xsi:type="xsd:string">ServiceOrder257</value>
              </item>
              <item xsi:type="ns1:CIMProperty">
                <name xsi:type="xsd:string">CarrierId</name>
                <value xsi:type="xsd:string">322</value>
              </item>
              <item xsi:type="ns1:CIMProperty">
                <name xsi:type="xsd:string">DesiredDueDate</name>
                <value
xsi:type="xsd:dateTime">2002-12-13T14:55:38.000Z</value>
              </item>
              <item xsi:type="ns1:CIMProperty">
                <name xsi:type="xsd:string">NumberOfRequests</name>
                <value xsi:type="xsd:string">1</value>
              </item>
              <!--item xsi:type="ns1:CIMProperty">
                <name xsi:type="xsd:string">Organization</name>
                <value xsi:type="xsd:string">customer1</value>
              </item -->
            </properties>
          </objectPath>
        </action>
        <action>
          <actionName xsi:type="xsd:string">createInstance</actionName>
          <objectPath xsi:type="ns1:CIMObjectPath">
            <className xsi:type="xsd:string">ServiceRequest</className>
            <properties xsi:type="ns1:CIMPropertyList"
soapenc:arrayType="ns1:CIMProperty[]">
              <item xsi:type="ns1:CIMProperty">
                <name xsi:type="xsd:string">RequestName</name>
                <value xsi:type="xsd:string">MYSR-1</value>
              </item>
              <item xsi:type="ns1:CIMProperty">
                <name xsi:type="xsd:string">Type</name>
                <value xsi:type="xsd:string">Mpls</value>
              </item>
            </properties>
          <objectPath xsi:type="ns1:CIMObjectPath">
            <className
xsi:type="xsd:string">ServiceRequestDetails</className>
            <properties xsi:type="ns1:CIMPropertyList"
soapenc:arrayType="ns1:CIMProperty[]">
              <item xsi:type="ns1:CIMProperty">

```

```

        <name xsi:type="xsd:string">ServiceDefinition</name>
        <value xsi:type="xsd:string">VPN-Topology-Pol-1</value>
        <qualifier xsi:type="xsd:string">
            <name
xsi:type="xsd:string">ServiceDefinitionType</name>
                <value xsi:type="xsd:string">Mpls</value>
            </qualifier>
        </item>
    </properties>
    <objectPath xsi:type="ns1:CIMObjectPath">
        <className xsi:type="xsd:string">MplsVpnLink</className>
        <properties xsi:type="ns1:CIMPropertyList"
soapenc:arrayType="ns1:CIMProperty[]">
            <item xsi:type="ns1:CIMProperty">
                <name xsi:type="xsd:string">ManualConfig</name>
                <value xsi:type="xsd:string">true</value>
            </item>
            <item xsi:type="ns1:CIMProperty">
                <name xsi:type="xsd:string">PE</name>
                <value xsi:type="xsd:string">enpe-24</value>
            </item>
        </properties>
        <objectPath xsi:type="ns1:CIMObjectPath">
            <className xsi:type="xsd:string">LinkAttrs</className>
            <properties xsi:type="ns1:CIMPropertyList"
soapenc:arrayType="ns1:CIMProperty[]">
                <item xsi:type="ns1:CIMProperty">
                    <name xsi:type="xsd:string">PE_Intf_Name</name>
                    <value
xsi:type="xsd:string">GigabitEthernet0/15/1/4</value>
                </item>
                <item xsi:type="ns1:CIMProperty">
                    <name
xsi:type="xsd:string">PE_CE_Routing_Protocol</name>
                    <value xsi:type="xsd:string">NONE</value>
                </item>
                <item xsi:type="ns1:CIMProperty">
                    <name xsi:type="xsd:string">PE_Intf_Encap</name>
                    <value xsi:type="xsd:string">DOT1Q</value>
                </item>
                <item xsi:type="ns1:CIMProperty">
                    <name xsi:type="xsd:string">PE_Vlan_ID</name>
                    <value xsi:type="xsd:string">394</value>
                </item>
                <item xsi:type="ns1:CIMProperty">
                    <name
xsi:type="xsd:string">PE_Intf_Address</name>
                    <value
xsi:type="xsd:string">52.20.10.1/24</value>
                </item>
                <item xsi:type="ns1:CIMProperty">
                    <name
xsi:type="xsd:string">Autopick_Vlan_ID</name>
                    <value xsi:type="xsd:string">>false</value>
                </item>
                <item xsi:type="ns1:CIMProperty">
                    <name xsi:type="xsd:string">CERC_RTTYPE</name>
                    <value xsi:type="xsd:string">rtt=IPv4</value>
                </item>
            </properties>
        </objectPath>
    </objectPath xsi:type="ns1:CIMObjectPath">

```

```

        <className
xsi:type="xsd:string">CERCMembership</className>
        <properties xsi:type="ns1:CIMPropertyList"
soapenc:arrayType="ns1:CIMProperty[]">
            <item xsi:type="ns1:CIMProperty">
                <name xsi:type="xsd:string">CERC</name>
                <value xsi:type="xsd:string">rtt</value>
            </item>
            <item xsi:type="ns1:CIMProperty">
                <name xsi:type="xsd:string">IsHub</name>
                <value xsi:type="xsd:string">>true</value>
            </item>
        </properties>
    </objectPath>
</objectPath>
</objectPath>
</objectPath>
</action>
</actions>
</ns1:performBatchOperation>
</soapenv:Body>
</soapenv:Envelope>

```

## Creating an MPLS 6VPE Grey Management Service Request

This example is used to create an MPLS 6VPE Grey Management Service Request for IOS and IOS XR. Do this by setting the attribute **Join\_Grey\_Mgmt\_Vpn** to true and the attribute **JOIN\_GREY\_MGMT\_VPN\_OPTION** to IPv6. Both are highlighted below.

Example: CreateMPLSServiceOrder\_PE\_CE\_Grey\_Mgmt.xml

```

<?xml version="1.0" encoding="UTF-8"?>
<soapenv:Envelope
  xmlns:soapenv="http://schemas.xmlsoap.org/soap/envelope/"
  xmlns:soapenc="http://schemas.xmlsoap.org/soap/encoding/"
  xmlns:xsd="http://www.w3.org/2001/XMLSchema"
  xmlns:xsi="http://www.w3.org/2001/XMLSchema-instance"
  xmlns:ns0="http://www.cisco.com/cim-cx/2.0"
  xmlns:ns1="urn:CIM">
  <soapenv:Header>
    <ns0:message id="87855" timestamp="2002-12-13T14:55:38.885Z" Wait="true"
WaitTimeout="90" sessiontoken="F8D210F3D407FCDB4AE4249BCB06037B"/>
  </soapenv:Header>
  <soapenv:Body>
    <ns1:performBatchOperation>
      <actions xsi:type="ns1:CIMActionList" soapenc:arrayType="ns1:CIMAction[]">
        <action>
          <actionName xsi:type="xsd:string">createInstance</actionName>
          <objectPath xsi:type="ns1:CIMObjectPath">
            <className xsi:type="xsd:string">ServiceOrder</className>
            <properties xsi:type="ns1:CIMPropertyList"
soapenc:arrayType="ns1:CIMProperty[]">
              <item xsi:type="ns1:CIMProperty">
                <name xsi:type="xsd:string">ServiceName</name>
                <value xsi:type="xsd:string">ServiceOrder253</value>
              </item>
              <item xsi:type="ns1:CIMProperty">
                <name xsi:type="xsd:string">CarrierId</name>
                <value xsi:type="xsd:string">322</value>
              </item>
            </properties>
          </objectPath>
        </action>
      </actions>
    </ns1:performBatchOperation>
  </soapenv:Body>
</soapenv:Envelope>

```

```

        <item xsi:type="ns1:CIMProperty">
          <name xsi:type="xsd:string">DesiredDueDate</name>
          <value
xsi:type="xsd:dateTime">2002-12-13T14:55:38.000Z</value>
          </item>
        <item xsi:type="ns1:CIMProperty">
          <name xsi:type="xsd:string">NumberOfRequests</name>
          <value xsi:type="xsd:string">1</value>
        </item>
        <!--
        <item xsi:type="ns1:CIMProperty">
          <name xsi:type="xsd:string">Organization</name>
          <value xsi:type="xsd:string">NbiCustomer</value>
        </item>
        -->
      </properties>
    </objectPath>
  </action>

  <action>
    <actionName xsi:type="xsd:string">createInstance</actionName>
    <objectPath xsi:type="ns1:CIMObjectPath">
      <className xsi:type="xsd:string">ServiceRequest</className>
      <properties xsi:type="ns1:CIMPropertyList"
soapenc:arrayType="ns1:CIMProperty[]">
        <item xsi:type="ns1:CIMProperty">
          <name xsi:type="xsd:string">RequestName</name>
          <value xsi:type="xsd:string">MYSR-1</value>
        </item>
        <item xsi:type="ns1:CIMProperty">
          <name xsi:type="xsd:string">Type</name>
          <value xsi:type="xsd:string">Mpls</value>
        </item>
      </properties>
      <objectPath xsi:type="ns1:CIMObjectPath">
        <className xsi:type="xsd:string">ServiceRequestDetails</className>
        <properties xsi:type="ns1:CIMPropertyList"
soapenc:arrayType="ns1:CIMProperty[]">
        <!-- Policy Info -->
          <item xsi:type="ns1:CIMProperty">
            <name xsi:type="xsd:string">ServiceDefinition</name>
            <value xsi:type="xsd:string">Mpls-pe-ce</value>
            <qualifier xsi:type="xsd:string">
              <name xsi:type="xsd:string">ServiceDefinitionType</name>
              <value xsi:type="xsd:string">Mpls</value>
            </qualifier>
          </item>
        </properties>

        <!-- ##### ( MPLS VPN LINK Start ) #####
-->
        <objectPath xsi:type="ns1:CIMObjectPath">
          <className xsi:type="xsd:string">MplsVpnLink</className>
          <properties xsi:type="ns1:CIMPropertyList"
soapenc:arrayType="ns1:CIMProperty[]">
        <!-- Device Info -->
          <item xsi:type="ns1:CIMProperty">
            <name xsi:type="xsd:string">ManualConfig</name>
            <value xsi:type="xsd:string">true</value>
          </item>
          <item xsi:type="ns1:CIMProperty">
            <name xsi:type="xsd:string">PE</name>
            <value xsi:type="xsd:string">enpe-25</value>
          </item>

```

```

        <item xsi:type="ns1:CIMProperty">
          <name xsi:type="xsd:string">Cpe</name>
          <value xsi:type="xsd:string">cell10</value>
        </item>
      </properties>

      <!-- ##### ( LINKATTRS Start ) ##### -->
-->
      <objectPath xsi:type="ns1:CIMObjectPath">
        <className xsi:type="xsd:string">LinkAttrs</className>
        <properties xsi:type="ns1:CIMPropertyList"
soapenc:arrayType="ns1:CIMProperty[]">
<!-- PE Intf info -->
          <item xsi:type="ns1:CIMProperty">
            <name xsi:type="xsd:string">PE_Intf_Name</name>
            <value
xsi:type="xsd:string">GigabitEthernet0/3/0/1</value>
          </item>

          <item xsi:type="ns1:CIMProperty">
            <name
xsi:type="xsd:string">PE_Intf_Shutdown</name>
            <value xsi:type="xsd:string">>true</value>
          </item>

          <item xsi:type="ns1:CIMProperty">
            <name
xsi:type="xsd:string">PE_Intf_Encap</name>
            <value xsi:type="xsd:string">DOT1Q</value>
          </item>

          <item xsi:type="ns1:CIMProperty">
            <name xsi:type="xsd:string">PE_Vlan_ID</name>
            <value xsi:type="xsd:string">2981</value>
          </item>

          <item xsi:type="ns1:CIMProperty">
            <name
xsi:type="xsd:string">Autopick_Vlan_ID</name>
            <value xsi:type="xsd:string">>false</value>
          </item>

<!-- <item xsi:type="ns1:CIMProperty">
          <name xsi:type="xsd:string">PE_DLCI</name>
          <value xsi:type="xsd:string">120</value>
        </item> -->
<!-- CE Intf Info -->
          <item xsi:type="ns1:CIMProperty">
            <name xsi:type="xsd:string">CE_Intf_Name</name>
            <value
xsi:type="xsd:string">GigabitEthernet0/0</value>
          </item>
          <item xsi:type="ns1:CIMProperty">
            <name
xsi:type="xsd:string">CE_Intf_Encap</name>
            <value xsi:type="xsd:string">DOT1Q</value>
          </item>
          <item xsi:type="ns1:CIMProperty">
            <name xsi:type="xsd:string">CE_Vlan_ID</name>
            <value xsi:type="xsd:string">2981</value>
          </item>
          <!-- <item xsi:type="ns1:CIMProperty">
            <name xsi:type="xsd:string">CE_DLCI</name>
            <value xsi:type="xsd:string">20</value>
          </item> -->

```

```

                <item xsi:type="ns1:CIMProperty">
                    <name
xsi:type="xsd:string">CE_Intf_Address</name>
                    <value
xsi:type="xsd:string">76.56.45.33/24</value>
                </item>
                <item xsi:type="ns1:CIMProperty">
                    <name
xsi:type="xsd:string">PE_Intf_Address</name>
                    <value
xsi:type="xsd:string">76.56.45.32/24</value>
                </item>
                <item xsi:type="ns1:CIMProperty">
                    <name
xsi:type="xsd:string">Auto_Assign_IP_Address</name>
                    <value xsi:type="xsd:string">>false</value>
                </item>
                <item xsi:type="ns1:CIMProperty">
                    <name xsi:type="xsd:string">PE_Intf_Address_IPV6</name>
                    <value xsi:type="xsd:string">203::16/28</value>
                </item>
                <item xsi:type="ns1:CIMProperty">
                    <name xsi:type="xsd:string">CE_Intf_Address_IPV6</name>
                    <value xsi:type="xsd:string">203::17/16</value>
                </item>

                <!-- For EIGRP RP-->

                <item xsi:type="ns1:CIMProperty">
                    <name xsi:type="xsd:string">PE_CE_Routing_Protocol</name>
                    <value xsi:type="xsd:string">EIGRP</value>
                </item>
                <item xsi:type="ns1:CIMProperty">
                    <name xsi:type="xsd:string">CE_EIGRP_AS_ID</name>
                    <value xsi:type="xsd:string">2369</value>
                </item>
                <item xsi:type="ns1:CIMProperty">
                    <name xsi:type="xsd:string">PE_EIGRP_AS_ID</name>
                    <value xsi:type="xsd:string">2369</value>
                </item>
                <item xsi:type="ns1:CIMProperty">
                    <name
xsi:type="xsd:string">PE_CE_Bandwidth_Metric_For_Redistribution</name>
                    <value xsi:type="xsd:string">2123</value>
                </item>
                <item xsi:type="ns1:CIMProperty">
                    <name
xsi:type="xsd:string">PE_CE_Delay_Metric_For_Redistribution</name>
                    <value xsi:type="xsd:string">25243</value>
                </item>

                <item xsi:type="ns1:CIMProperty">
                    <name
xsi:type="xsd:string">PE_CE_Reliability_Metric_For_Redistribution</name>
                    <value xsi:type="xsd:string">204</value>
                </item>
                <item xsi:type="ns1:CIMProperty">
                    <name
xsi:type="xsd:string">PE_CE>Loading_Metric_For_Redistribution</name>
                    <value xsi:type="xsd:string">205</value>
                </item>
                <item xsi:type="ns1:CIMProperty">

```



```

        <name xsi:type="xsd:string">PE_CE_MTU_Metric_For_Redistribution</name>
        <value xsi:type="xsd:string">2543</value>
    </item>
<!-- IPV6 Routing Protocols -->
    <item xsi:type="ns1:CIMProperty">
        <name xsi:type="xsd:string">PE_CE_IPV6_Routing_Protocol</name>
        <value xsi:type="xsd:string">EIGRP</value>
    </item>

    <item xsi:type="ns1:CIMProperty">
        <name xsi:type="xsd:string">CE_EIGRP_AS_ID_IPV6</name>
        <value xsi:type="xsd:string">2369</value>
    </item>
    <item xsi:type="ns1:CIMProperty">
        <name xsi:type="xsd:string">PE_EIGRP_AS_ID_IPV6</name>
        <value xsi:type="xsd:string">2369</value>
    </item>
    <item xsi:type="ns1:CIMProperty">
        <name
xsi:type="xsd:string">PE_CE_Bandwidth_Metric_For_Redistribution_IPV6</name>
        <value xsi:type="xsd:string">21023</value>
    </item>
    <item xsi:type="ns1:CIMProperty">
        <name
xsi:type="xsd:string">PE_CE_Delay_Metric_For_Redistribution_IPV6</name>
        <value xsi:type="xsd:string">25143</value>
    </item>

    <item xsi:type="ns1:CIMProperty">
        <name
xsi:type="xsd:string">PE_CE_Reliability_Metric_For_Redistribution_IPV6</name>
        <value xsi:type="xsd:string">203</value>
    </item>
    <item xsi:type="ns1:CIMProperty">
        <name
xsi:type="xsd:string">PE_CE>Loading_Metric_For_Redistribution_IPV6</name>
        <value xsi:type="xsd:string">204</value>
    </item>
    <item xsi:type="ns1:CIMProperty">
        <name
xsi:type="xsd:string">PE_CE_MTU_Metric_For_Redistribution_IPV6</name>
        <value xsi:type="xsd:string">2541</value>
    </item>

<!-- JOIN GREY MANAGEMENT IPv6 or IPv4 or dual option need to specified -->

    <item xsi:type="ns1:CIMProperty">
        <name xsi:type="xsd:string">Join_Grey_Mgmt_Vpn</name>
        <value xsi:type="xsd:string">true</value>
    </item>
    <item xsi:type="ns1:CIMProperty">
        <name xsi:type="xsd:string">JOIN_GREY_MGMT_VPN_OPTION</name>
        <value xsi:type="xsd:string">IPv6</value>
    </item>

</properties>
</objectPath>

<!-- CERC's -->
    <objectPath subAction="createInstance" xsi:type="ns1:CIMObjectPath">
<className xsi:type="xsd:string">CERCMembership</className>
<properties xsi:type="ns1:CIMPropertyList"

```

```

        soapenc:arrayType="ns1:CIMProperty[]">
        <item xsi:type="ns1:CIMProperty">
            <name xsi:type="xsd:string">CERC</name>
            <value xsi:type="xsd:string">Cerc101-1</value>
        </item>
        <item xsi:type="ns1:CIMProperty">
            <name xsi:type="xsd:string">IsHub</name>
            <value xsi:type="xsd:string">>true</value>
        </item>
        </properties>
    </objectPath>

<!-- CERC's -->

    </objectPath>

    </objectPath>
</objectPath>
</action>
</actions>
</ns1:performBatchOperation>
</soapenv:Body>
</soapenv:Envelope>

```

## Service Request Examples in the API Programmer Reference

The following API XMLs are included in the *Cisco Prime Provisioning API 7.0 Programmer Reference*:

- CreateMPLSServiceOrder\_AccessRing\_PE\_NO\_CE
- CreateMPLSServiceOrder\_atm
- CreateMPLSServiceOrder\_BGP\_MaxPrefix\_BGP\_DIO\_SecondVlanId\_PE\_NO\_CE\_IPV4\_IPV6
- CreateMPLSServiceOrder\_BGP\_MaxPrefix\_PE\_CE\_IPV4
- CreateMPLSServiceOrder\_BGP\_MaxPrefix\_PE\_CE\_IPV4\_IPV6
- CreateMPLSServiceOrder\_BGP\_MaxPrefix\_PE\_NO\_CE\_IPV4\_IPV6
- CreateMPLSServiceOrder\_BGP\_MaxPrefix\_PE\_NO\_CE\_IPV6
- CreateMPLSServiceOrder\_EIGRP\_KeyChain\_PE\_CE\_IPV4
- CreateMPLSServiceOrder\_EIGRP\_KeyChain\_PE\_CE\_IPV4\_IPV6
- CreateMPLSServiceOrder\_EIGRP\_KeyChain\_PE\_CE\_IPV6
- CreateMPLSServiceOrder\_EIGRP\_KeyChain\_PE\_NO\_CE\_IPV4
- CreateMPLSServiceOrder\_EIGRP\_KeyChain\_PE\_NO\_CE\_IPV6
- CreateMPLSServiceOrder\_MVRF\_CE
- CreateMPLSServiceOrder\_MVRF\_NO\_CE
- CreateMPLSServiceOrder\_OSPF\_DefaultInfoOriginate\_PE\_CE\_IPV4
- CreateMPLSServiceOrder\_OSPF\_DefaultInfoOriginate\_PE\_NO\_CE\_IPV4

- CreateMPLSServiceOrder\_PE\_CE
- CreateMPLSServiceOrder\_PE\_CE\_BGP\_DEFAULT\_INFO\_ORIGINATE\_IPV4
- CreateMPLSServiceOrder\_PE\_CE\_BGP\_DEFAULT\_INFO\_ORIGINATE\_IPV6
- CreateMPLSServiceOrder\_PE\_CE\_BGP\_IPV4\_BGPROUTEMAP
- CreateMPLSServiceOrder\_PE\_CE\_BGP\_IPV4\_IPV6\_BGPROUTEMAP
- CreateMPLSServiceOrder\_PE\_CE\_BGP\_IPV4\_IPV6\_RdFormat
- CreateMPLSServiceOrder\_PE\_CE\_BGP\_IPV4\_RdFormat
- CreateMPLSServiceOrder\_PE\_CE\_BGP\_IPV6\_RdFormat
- CreateMPLSServiceOrder\_PE\_CE\_CRSPRT
- CreateMPLSServiceOrder\_PE\_CE\_OSPFMATCH
- CreateMPLSServiceOrder\_PE\_CE\_OSPFPOLICY
- CreateMPLSServiceOrder\_PE\_NO\_CE
- CreateMPLSServiceOrder\_PE\_NO\_CE\_ALLOW\_DUPLICATE\_IP
- CreateMPLSServiceOrder\_PE\_NO\_CE\_BGP\_DEFAULT\_INFO\_ORIGINATE\_IPV4
- CreateMPLSServiceOrder\_PE\_NO\_CE\_BGP\_IPV4\_BGPROUTEMAP
- CreateMPLSServiceOrder\_PE\_NO\_CE\_BGP\_IPV4\_IPV6\_BGPROUTEMAP
- CreateMPLSServiceOrder\_PE\_NO\_CE\_BGP\_IPV4\_IPV6\_RdFormat
- CreateMPLSServiceOrder\_PE\_NO\_CE\_BGP\_IPV4\_RdFormat
- CreateMPLSServiceOrder\_PE\_NO\_CE\_BGP\_IPV6
- CreateMPLSServiceOrder\_PE\_NO\_CE\_BGP\_IPV6\_RdFormat
- CreateMPLSServiceOrder\_PE\_NO\_CE\_DEFAULT\_INFO\_ORIGINATE\_BGP\_IPV6
- CreateMPLSServiceOrder\_PE\_NO\_CE\_EVC\_NPE
- CreateMPLSServiceOrder\_PE\_NO\_CE\_EVC\_UPE
- CreateMPLSServiceOrder\_PE\_NO\_CE\_IPV4\_IPV6\_Unique\_RT
- CreateMPLSServiceOrder\_PE\_NO\_CE\_IPV6
- CreateMPLSServiceOrder\_PE\_NO\_CE\_PW\_MPLS
- CreateMPLSServiceOrder\_PE\_NO\_CE\_SOO
- CreateMPLSServiceOrder\_PE\_NO\_CE\_VPN\_TOPOLOGY
- CreateMPLSServiceOrder\_QinQ\_PE\_CE
- CreateMPLSServiceOrder\_QinQ\_PE\_NO\_CE
- CreateMPLSServiceOrder\_StaticRoute\_PE\_NO\_CE

## End-to-End Provisioning Process

The following sections describe the required steps for using the API to provision MPLS VPNs, and include the operation, class, and required parameters for each step.

## Process Summary

MPLS provisioning using the API includes the following end-to-end operations:

- 
- Step 1** Prior to creating the inventory, you need to do the following:
- Send a login XML request to generate a session ID. This is used each time you access the system. (see [Session](#), page 3-7.)
  - View the status of the API by executing
 

```
runNbi x $PRIMEF_HOME/resources/nbi/xml/examples/Session/Login.xml
```

 If the API is running, you receive a session token. (see [Checking the API Status](#), page 2-1.)
- Step 2** Create Inventory.
- **CreateProvider.xml**—Create a provider.
  - **CreateRegion.xml**—Create a region.
  - **CreateOrganization.xml**—Create customer organization.
  - **CreateSite.xml**—Create customer site.
  - **CreateCiscoRouter.xml**—Create devices (Cisco IOS router).
  - **CreateCat.xml**—Create devices (Catalyst switch).
  - **CreatePE.xml**—Declare a device as **PE** and assign it to regions.
  - **CreateCpe.xml**—Declare a device as **CPE** and assign it to sites.
- For more information, see [Create Inventory](#), page 6-55.
- Step 3** Create Resource Pools.
- Create a **VPN** and select a **CERC**:
- **CreateRouteTarget.xml**—Inform PEs which routes should be inserted into the appropriate VRFs.
  - **CreateRouteDistinguisher.xml**—Help the CE router advertise IP subnets to the PE routers. The RD value must be a globally unique value to avoid conflict with other prefixes.
  - **CreateCERC.xml**—Create a CERC.
  - **CreateVPN.xml**—Create a VPN.
- For more information, see [Create Resource Pools](#), page 6-57.
- Step 4** Collect Device Configurations.
- **CreateTaskServiceOrderCollection.xml**—upload the current configuration from the device to the Prime Provisioning database.
- For more information, see [Collect Device Configurations](#), page 6-58.
- Step 5** Create an MPLS Policy.
- **CreateMPLSServiceDefn\_PE\_CE.xml**—Define a policy template for a PE-CE link.
  - **CreateMPLSServiceDefn\_PE\_NO\_CE.xml**—Define a policy template for a PE-no CE link.
  - **CreateMPLSServiceDefn\_MVRF\_CE.xml**—Define a policy template for a MVRF-CE link.
  - **CreateMPLSServiceDefn\_MVRF\_NO\_CE.xml**—Define a policy template for a MVRF-no CE link.
- For more information, see [Create an MPLS Policy](#), page 6-60.

**Step 6** Create an MPLS Service Request.



**Note** To modify a service request, see [Modifying a Service Request, page 1-12](#). To delete or purge a service request, you need the returned Locator ID. (See [Step 7](#).) For examples of modify and delete operations, go to `examples.tar` under the MPLS directory.

Define which service definition to use, the **MplsVpnLink**, and the link attributes:

- **CreateMPLSServiceOrder\_PE\_CE.xml**—Create service request using the PE-CE policy.
- **CreateMPLSServiceOrder\_PE\_NO\_CE.xml**—Create service request using the PE-noCE policy.
- **CreateMPLSServiceOrder\_MVFR\_CE.xml**—Create service request using the MVRF-CE policy.
- **CreateMPLSServiceOrder\_MVRF\_NO\_CE.xml**—Create service request using the MVRF-no CE policy.

For more information, see [Creating an MPLS Service Request, page 6-60](#).

**Step 7** When you submit a service order XML request, Prime Provisioning returns a **LocatorId** in the XML response.

Make a record of the Locator ID or service name for all service orders and service requests. The locator ID is required to view a service order, to perform a service order task (configuration audit or functional audit), and for all subsequent requests related to the service order or service request.

For more information, see [Service Order Response, page 2-12](#).

**Step 8** Using the LocatorId, you can view the log output for the created and deployed service request. This includes all messages according to the level specified in the properties file.

For more information, see [Viewing Task Logs, page 5-24](#).

## Detailed Process and Attributes

This MPLS provisioning example includes the following operations:

1. [Create Inventory](#)
2. [Create Resource Pools](#)
3. [Collect Device Configurations](#)
4. [Create an MPLS Policy](#)
5. [Creating an MPLS Service Request](#)
6. [Auditing Service Requests, page 6-62](#).

This section provides an example provisioning process using XML examples. The inventory of XML examples for the Prime Provisioning API is available here: [Cisco Prime Provisioning 7.0 API Programmer Guide](#).

## Create Inventory

**Step 1** Create a **Provider** and **Region**.

The provider is the administrative domain of an Internet service provider (ISP), with one border gateway protocol (BGP) autonomous system (AS) number. The network owned by the provider is called the backbone network. If an ISP has two AS numbers, you must define it as two provider administrative domains (PADs). Each provider can contain multiple regions.

**Table 6-1** Create Provider and Region

Operation	className	Required Keywords
createInstance	Provider	<ul style="list-style-type: none"> <li>Name</li> <li>AsNumber</li> </ul>
	Region	<ul style="list-style-type: none"> <li>Name</li> <li>Provider</li> </ul>

**XML Examples:**

- CreateProvider.xml
- CreateRegion.xml

**Step 2** Create a Customer (**Organization**) and **Site**.

**Table 6-2** Create Customer and Site

Operation	className	Required Keywords
createInstance	Organization	<ul style="list-style-type: none"> <li>Name</li> </ul>
	Site	<ul style="list-style-type: none"> <li>Name</li> <li>Organization</li> </ul>

**XML Examples:**

- CreateOrganization.xml
- CreateSite.xml

**Step 3** Create devices.

In most cases, devices are Cisco IOS routers and Catalyst switches.

**Table 6-3** Create Devices

Operation	className	Required Keywords
createInstance	<ul style="list-style-type: none"> <li>CiscoRouter</li> <li>CatOS</li> </ul>	One or more of the following: <ul style="list-style-type: none"> <li>ManagementIPAddress</li> <li>HostName</li> <li>DomainName</li> </ul>

**XML Examples:**

- CreateCiscoRouter.xml

- CreateCat.xml

**Step 4** Declare devices as **PEs** and assign them to regions.

**Table 6-4** Create PEs

Operation	className	Required Keywords
createInstance	PE	<ul style="list-style-type: none"> <li>• Provider</li> <li>• Region</li> <li>• Role=               <ul style="list-style-type: none"> <li>– N-PE</li> <li>– U-PE</li> <li>– P</li> <li>– PE-AGG</li> </ul> </li> <li>• Device</li> <li>• Interface</li> </ul>

**XML Example:**

- CreatePE.xml

**Step 5** Declare devices as **Cpes** and assign them to sites.

When you declare a device as a **Cpe**, you also specify a **ManagementType** and interface information.

**Table 6-5** Create CPEs

Operation	className	Required Keywords
createInstance	Cpe	<ul style="list-style-type: none"> <li>• Site</li> <li>• Device</li> <li>• ManagementType</li> </ul>

**XML Example:**

- CreateCpe.xml

## Create Resource Pools

For MPLS provisioning, you define route targets, route distinguishers, CERCs, and VPNs.

A route target informs PEs which routes should be inserted into the appropriate VRFs. Every VPN route is tagged with one or more route targets when it is exported from a VRF and offered to other VRFs.

The IP subnets advertised by the CE routers to the PE routers are augmented with route distinguishers (RDs). The RD value must be a globally unique value to avoid conflict with other prefixes.

**Table 6-6** Create Resource Pools

Operation	classNames	Required Keywords
createInstance	<ul style="list-style-type: none"> <li>RouteTarget</li> <li>RouteDistinguisher</li> </ul>	<ul style="list-style-type: none"> <li>Start</li> <li>Size</li> <li>AssocClassType</li> <li>AssocClassId</li> </ul>

Create a **VPN** and select a **CERC**.

**Table 6-7** Create VPNs and CERCs

Operation	className	Required Parameters
createInstance	<ul style="list-style-type: none"> <li>VPN</li> </ul>	<ul style="list-style-type: none"> <li>Name</li> <li>CERC</li> </ul> <p><i>or</i></p> <ul style="list-style-type: none"> <li>CreateDefaultCERC</li> </ul>
	<ul style="list-style-type: none"> <li>CERC</li> </ul>	<ul style="list-style-type: none"> <li>Name</li> <li>Provider</li> <li>SpokeRouteTarget</li> <li>HubRouteTarget</li> </ul>

A CERC can either be full mesh or hub and spoke. If you specify hub and spoke, you must specify both the **SpokeRouteTarget** and **HubRouteTarget**. For a full mesh CERC, only **SpokeRouteTarget** is required.

#### XML Examples:

- CreateRouteTarget.xml
- CreateRouteDistinguisher.xml
- CreateCERC.xml
- CreateVPN.xml.

## Collect Device Configurations

A device configuration collection is a task. This task uploads the current configuration from the device to the Prime Provisioning database. The collection task is executed through a service request, and the service request is scheduled using a service order.



**Table 6-8** Collect Device Configurations

Operation	className	Required Parameters
createInstance	ServiceOrder	<ul style="list-style-type: none"> <li>• ServiceName</li> <li>• NumberofRequests</li> <li>• ServiceRequest</li> </ul>
	ServiceRequest	<ul style="list-style-type: none"> <li>• RequestName</li> <li>• Type=Task</li> <li>• ServiceRequestDetails</li> </ul>
	ServiceRequestDetails	<ul style="list-style-type: none"> <li>• SubType=Collection</li> <li>• Device (or DeviceGroup)</li> </ul> <p><b>Note</b> You must select at least one device or device group.</p> <ul style="list-style-type: none"> <li>• RetrieveVersion=true</li> <li>• RetrieveDeviceInterfaces=true</li> </ul>

The following example is a partial XML request used to collect the configuration from device ensw4000-1:

```
<className xsi:type="xsd:string">ServiceRequestDetails</className>
  <properties xsi:type="ns1:CIMPropertyList"
    soapenc:arrayType="ns1:CIMProperty[]">
    <item xsi:type="ns1:CIMProperty">
      <name xsi:type="xsd:string">SubType</name>
      <value xsi:type="xsd:string">COLLECTION</value>
    </item>
    <item xsi:type="ns1:CIMProperty">
      <name xsi:type="xsd:string">Device</name>
      <value xsi:type="xsd:string">ensw4000-1</value>
    </item>
    <item xsi:type="ns1:CIMProperty">
      <name xsi:type="xsd:string">DeviceGroup</name>
      <value xsi:type="xsd:string">PE-Group</value>
    </item>
    <item xsi:type="ns1:CIMProperty">
      <name xsi:type="xsd:string">RetrieveDeviceAttributes</name>
      <value xsi:type="xsd:string">true</value> </item>
    <item xsi:type="ns1:CIMProperty">
      <name xsi:type="xsd:string">RetrieveDeviceInterfaces</name>
      <value xsi:type="xsd:string">true</value> </item>
  </properties>
</objectPath>
```

**XML Example:**

- CreateTaskServiceOrderCollection.xml

## Create an MPLS Policy

An MPLS service policy (defined in a service definition) is a template of the parameters needed to define a service request. Once you have defined the policy template, it can be used by all MPLS service requests that share a common set of attributes.

An MPLS service definition consists of the **MplsPolicyAttributes**. The **MplsPolicyAttributes** define the properties specific to the policy subtype.

**Table 6-9** Create an MPLS Policy

Operation	className	Required Parameters
createInstance	ServiceDefinition	<ul style="list-style-type: none"> <li>Name</li> <li>Type=Mpls</li> <li>ServiceDefinitionDetails</li> </ul>
	ServiceDefinitionDetails	<ul style="list-style-type: none"> <li>MPLSPolicyAttributes</li> <li>Provider or Organization</li> </ul> <p><b>Note</b> If you do not specify a <b>Provider</b> or <b>Organization</b>, the service policy becomes a global policy.</p>
	MPLSPolicyAttributes	<ul style="list-style-type: none"> <li>SubType= <ul style="list-style-type: none"> <li>PE_CE</li> <li>PE_NO_CE</li> <li>PE_MVRFCE_CE</li> <li>PE_MVRFCE_NO_CE</li> </ul> </li> </ul>

### XML Examples:

- CreateMPLSServiceDefn\_PE\_CE.xml
- CreateMPLSServiceDefn\_PE\_NO\_CE.xml
- CreateMPLSServiceDefn\_MVRF\_CE.xml
- CreateMPLSServiceDefn\_MVRF\_NO\_CE.xml.

## Creating an MPLS Service Request

An MPLS service request defines the service definition to use, the **MplsVpnLink** and the link attributes. The **MplsVpnLink** specifies the device interfaces involved in this service request. The link attributes contain any policy setting overrides for properties set as editable in the service definition. A service request can specify one or more MPLS VPN links.



**Note**

Use **performBatchOperation** to group the service order and service request into one XML request.



**Note**

The service request name must be unique for each NBI API.

Table 6-10 Create an MPLS Service Request

Operation	className	Required Parameters
createInstance	ServiceOrder	<ul style="list-style-type: none"> <li>• ServiceName</li> <li>• NumberOfRequests</li> <li>• ServiceRequest</li> </ul>
	ServiceRequest	<ul style="list-style-type: none"> <li>• RequestName</li> <li>• Type=Mpls</li> <li>• ServiceRequestDetails</li> </ul>
	ServiceRequestDetails	<ul style="list-style-type: none"> <li>• ServiceDefinition <ul style="list-style-type: none"> <li>– ServiceDefinitionType=Mpls</li> </ul> </li> <li>• MplsVpnLink</li> </ul>
	MplsVpnLink	<ul style="list-style-type: none"> <li>• NPC</li> <li><i>or</i></li> <li>• ManualConfig=true <ul style="list-style-type: none"> <li>– PE</li> <li>– Cpe</li> </ul> </li> </ul> <p><b>Note</b> You must specify either <b>NPC</b> or <b>ManualConfig</b> to define the interfaces for the MPLS VPN links. If you use <b>ManualConfig</b>, you must also specify the interfaces (for example, <b>CE_Intf_Name</b> and <b>PE_Intf_Name</b>).</p> <ul style="list-style-type: none"> <li>• LinkAttrs</li> <li>• LinkTemplate (optional)</li> </ul> <p><b>Note</b> See the “<a href="#">Templates in a Service Request</a>” section on page 4-18.</p>
	LinkAttrs	<ul style="list-style-type: none"> <li>• PE_Intf_Name, CE_Intf_Name</li> <li>• PE_Vlan_ID</li> <li>• PE_Intf_Address, CE_Intf_Address</li> <li>• PE_CE_Routing_Protocol</li> <li>• CERCMembership</li> </ul>

**Note**

The attributes **PE\_Template**, **PE\_Intf\_Template**, **CE\_Template**, and **CE\_Intf\_Template** allow NBI access to variables designed to hold template blobs (template blobs were used during MPLS provisioning in legacy versions of Prime Provisioning).

**XML Examples:**

- CreateMPLSServiceOrder\_PE\_CE.xml
- CreateMPLSServiceOrder\_PE\_NO\_CE.xml
- CreateMPLSServiceOrder\_MVFR\_CE.xml
- CreateMPLSServiceOrder\_MVRF\_NO\_CE.xml.

## Auditing Service Requests

A configuration audit occurs automatically each time you deploy a service request. During this configuration audit, Prime Provisioning verifies that all Cisco IOS commands are present and that they have the correct syntax. An audit also verifies that there were no errors during deployment by examining the commands configured by the service request on the target devices. If the device configuration does not match what is defined in the service request, the audit flags a warning and sets the service request to a *Failed Audit* or *Lost* state.

If you do not want the configuration audit to occur, change the value for the **Audit** parameter. The **Audit** parameter supports these values:

- **Audit**—This is the default. A successfully deployed service request is automatically audited unless this flag is changed.
- **NoAudit**—Do not perform a configuration audit when the service request is deployed.
- **ForceAudit**—Perform a configuration audit even if the service request deployment is not successful.

You can use the Audit parameter with a **Create**, **Modify**, or **Decommission** service request or a **Deployment** task. See the [“Service Decommission” section on page 3-11](#) for more information. To perform a configuration audit as a separate task, or an MPLS functional audit, see the [“Tasks” section on page 3-9](#).



## L2VPN Provisioning

---

To provision L2VPN using the Cisco Prime Provisioning API, you need an L2VPN service policy of a specific subtype and an L2VPN service request.

The service policy (defined in a service definition) specifies the attributes common to the end-to-end wires and attachment circuits (ACs).

The service request defines the device interfaces for each end-to-end wire connection (called link endpoints in the GUI), and can optionally override policy attributes in each end-to-end wire link and AC.

When you deploy an L2VPN service request using a service order, the attributes specified in the service definition are applied to the devices and interfaces listed in the service request, along with the attributes for each end-to-end wire link and AC.

This chapter describes L2VPN service concepts and the steps required to provision L2VPN services using the Prime Provisioning API. The provisioning example includes the process flow from creating the inventory to auditing the service deployment.

For more information on L2VPN provisioning using Prime Provisioning, see the [Cisco Prime Provisioning 7.0 User Guide](#).

This chapter contains the following sections:

- [L2VPN Service Definitions, page 7-1](#)
- [L2VPN Service Requests, page 7-9](#)
- [Provisioning Example, page 7-20](#)

## L2VPN Service Definitions

An L2VPN service definition specifies the policy subtype, the properties for the CPE and PE devices, and the user network interface (UNI). The properties that can be set are based on the policy subtype that is specified in the service definition.

As there are a number of L2VPN naming conventions in use today, it is recommended that you read the appendix on Prime Provisioning Layer 2 VPN Concepts in the [Cisco Prime Provisioning 7.0 User Guide](#).

## Supported Service Definitions

Prime Provisioning supports the following L2VPN service definition subtypes:

- EthernetEVCS (Ethernet Virtual Circuit Service)
- EthernetEVCS\_NO\_CE
- EthernetTLS (Transparent LAN Service)
- EthernetTLS\_NO\_CE
- ATM (Asynchronous Transfer Mode)
- ATM\_NO\_CE
- FRAME\_RELAY
- FRAME\_RELAY\_NO\_CE



### Note

---

For all service definition subtypes with NO\_CE, you do not declare the CE devices to be CPEs, and you do not set policy attributes for the CE devices in the service definition.

---

A service definition can be shared by one or more service requests that have similar requirements. L2VPN service definitions include the following information about the end-to-end wires and attachment circuits:

- Service definition subtype (examples: EthernetEVCS or ATM\_NO\_CE)
- Device interface type (example: GigabitEthernet)
- VLAN IDs
- UNI Port Security
- Protocols (examples: CDP, VTP)



### Note

---

For each service definition property, you can set an additional attribute, **editable=true**, to allow the network operator to override these attributes when creating the service request. If an attribute is set to **editable=false**, these attributes cannot be changed in the service request.

---

## Policy Examples

The following shows two L2VPN XML policy examples:

- [ATM Policy, page 7-2](#)
- [ERS Policy, page 7-5](#)

### ATM Policy

In this example, an L2VPN ATM policy is created in a NPE-CE setup with TransportMode, PWClass, ELine name, and L2vpn Group name attributes, which are configured on an IOS XR device.

XML file in [Cisco Prime Provisioning API 7.0 Programmer Reference](#):

CreateL2VPNServiceDefn\_ATM\_PortMode\_PWClass.xml

```

<?xml version="1.0" encoding="UTF-8"?>
<soapenv:Envelope
  xmlns:soapenv="http://schemas.xmlsoap.org/soap/envelope/"
  xmlns:soapenc="http://schemas.xmlsoap.org/soap/encoding/"
  xmlns:xsd="http://www.w3.org/2001/XMLSchema"
  xmlns:xsi="http://www.w3.org/2001/XMLSchema-instance"
  xmlns:ns0="http://www.cisco.com/cim-cx/2.0"
  xmlns:ns1="urn:CIM">
  <soapenv:Header>
    <ns0:message id="87855" timestamp="2002-12-13T14:55:38.885Z"
      sessiontoken="p36bttjwy1"/>
  </soapenv:Header>
  <soapenv:Body>
    <ns1:createInstance>
      <objectPath xsi:type="ns1:CIMObjectPath">
        <className xsi:type="xsd:string">ServiceDefinition</className>
        <properties xsi:type="ns1:CIMPropertyList"
          soapenc:arrayType="ns1:CIMProperty[]">
          <item xsi:type="ns1:CIMProperty">
            <name xsi:type="xsd:string">Name</name>
            <value xsi:type="xsd:string">ATM-Policy-NBI-1</value>
          </item>
          <item xsi:type="ns1:CIMProperty">
            <name xsi:type="xsd:string">Type</name>
            <value xsi:type="xsd:string">L2Vpn</value>
          </item>

          <item xsi:type="ns1:CIMProperty">
            <name xsi:type="xsd:string">Organization</name>
            <value xsi:type="xsd:string">MyCustomer1</value>
          </item>
          <!-- <item xsi:type="ns1:CIMProperty">
            <name xsi:type="xsd:string">Customer</name>
            <value xsi:type="xsd:string">1</value>
          </item> -->

          <item xsi:type="ns1:CIMProperty">
            <name xsi:type="xsd:string">Remarks</name>
            <value xsi:type="xsd:string"> data remarks</value>
          </item>
        </properties>
        <objectPath xsi:type="ns1:CIMObjectPath">
          <className xsi:type="xsd:string">ServiceDefinitionDetails</className>
          <properties xsi:type="ns1:CIMPropertyList"
            soapenc:arrayType="ns1:CIMProperty[]">
            <item xsi:type="ns1:CIMProperty">
              <name xsi:type="xsd:string">SubType</name>
              <value xsi:type="xsd:string">ATM</value>
            </item>

            <item xsi:type="ns1:CIMProperty">
              <name xsi:type="xsd:string">TransportMode</name>
              <value xsi:type="xsd:string">PORT</value>
              <qualifier xsi:type="ns1:CIMQualifier">
                <name xsi:type="xsd:string">editable</name>
                <value xsi:type="xsd:string">true</value>
              </qualifier>
            </item>

            <item xsi:type="ns1:CIMProperty">
              <name xsi:type="xsd:string">Uni_Shutdown</name>
              <value xsi:type="xsd:string">true</value>
              <qualifier xsi:type="ns1:CIMQualifier">
                <name xsi:type="xsd:string">editable</name>

```

```

        <value xsi:type="xsd:string">>false</value>
      </qualifier>
    </item>
<item xsi:type="ns1:CIMProperty">
  <name xsi:type="xsd:string">USE_PWCLASS</name>
  <value xsi:type="xsd:string">>true</value>
  <qualifier xsi:type="ns1:CIMQualifier">
    <name xsi:type="xsd:string">editable</name>
    <value xsi:type="xsd:string">>true</value>
  </qualifier>
</item>

<item xsi:type="ns1:CIMProperty">
  <name xsi:type="xsd:string">PW_CLASS_ID</name>
  <value xsi:type="xsd:string">1</value>
  <qualifier xsi:type="ns1:CIMQualifier">
    <name xsi:type="xsd:string">editable</name>
    <value xsi:type="xsd:string">>true</value>
  </qualifier>
</item>

<item xsi:type="ns1:CIMProperty">
  <name xsi:type="xsd:string">ELINE_NAME</name>
  <value xsi:type="xsd:string">ELINE_Name</value>
  <qualifier xsi:type="ns1:CIMQualifier">
    <name xsi:type="xsd:string">editable</name>
    <value xsi:type="xsd:string">>true</value>
  </qualifier>
</item>

<item xsi:type="ns1:CIMProperty">
  <name xsi:type="xsd:string">L2VPN_GROUP_NAME</name>
  <value xsi:type="xsd:string">ISC</value>
  <qualifier xsi:type="ns1:CIMQualifier">
    <name xsi:type="xsd:string">editable</name>
    <value xsi:type="xsd:string">>true</value>
  </qualifier>
</item>

<item xsi:type="ns1:CIMProperty">
  <name xsi:type="xsd:string">Template_Enabled</name>
  <value xsi:type="xsd:string">>true</value>
  <qualifier xsi:type="ns1:CIMQualifier">
    <name xsi:type="xsd:string">editable</name>
    <value xsi:type="xsd:string">>true</value>
  </qualifier>
</item>

<!-- <item xsi:type="ns1:CIMProperty">
  <name xsi:type="xsd:string">CE_Intf_Type</name>
  <value xsi:type="xsd:string">ANY</value>
  <qualifier xsi:type="ns1:CIMQualifier">
    <name xsi:type="xsd:string">editable</name>
    <value xsi:type="xsd:string">>true</value>
  </qualifier>
</item-->

<item xsi:type="ns1:CIMProperty">
  <name xsi:type="xsd:string">CE_Encap</name>
  <value xsi:type="xsd:string">AAL5MUX</value>
  <qualifier xsi:type="ns1:CIMQualifier">
    <name xsi:type="xsd:string">editable</name>
    <value xsi:type="xsd:string">>true</value>
  </qualifier>
</item>

```



```

        </qualifier>
    </item>

    </properties>

    </objectPath>
</objectPath>
</ns1:createInstance>
</soapenv:Body>
</soapenv:Envelope>

```

## ERS Policy

In this example, an L2VPN point-to-point Ethernet Relay Service (ERS) policy is created in a NPE-UPE-CE setup, where the NPE is an IOS XR device and others are IOS devices.

Here, the PWClass, ELine name, and L2vpn Group name attributes are configured on IOS XR (NPE).

In addition, the Std UNI attributes are configured on IOS (UPE).

XML file in [Cisco Prime Provisioning API 7.0 Programmer Reference](#):  
CreateL2VPNServiceDefn\_EVCS\_NBIEnhance\_PWClass.xml

```

<?xml version="1.0" encoding="UTF-8"?>
<soapenv:Envelope
  xmlns:soapenv="http://schemas.xmlsoap.org/soap/envelope/"
  xmlns:soapenc="http://schemas.xmlsoap.org/soap/encoding/"
  xmlns:xsd="http://www.w3.org/2001/XMLSchema"
  xmlns:xsi="http://www.w3.org/2001/XMLSchema-instance"
  xmlns:ns0="http://www.cisco.com/cim-cx/2.0"
  xmlns:ns1="urn:CIM">
  <soapenv:Header>
    <ns0:message id="87855" timestamp="2002-12-13T14:55:38.885Z"
      sessiontoken="p36bttjwy1"/>
  </soapenv:Header>
  <soapenv:Body>
    <ns1:createInstance>
      <objectPath xsi:type="ns1:CIMObjectPath">
        <className xsi:type="xsd:string">ServiceDefinition</className>
        <properties xsi:type="ns1:CIMPropertyList"
          soapenc:arrayType="ns1:CIMProperty[]">
          <item xsi:type="ns1:CIMProperty">
            <name xsi:type="xsd:string">Name</name>
            <value xsi:type="xsd:string">NBI-ERS-Policy-1</value>
          </item>
          <item xsi:type="ns1:CIMProperty">
            <name xsi:type="xsd:string">Type</name>
            <value xsi:type="xsd:string">L2Vpn</value>
          </item>

          <item xsi:type="ns1:CIMProperty">
            <name xsi:type="xsd:string">Organization</name>
            <value xsi:type="xsd:string">MyCustomer2</value>
          </item>
          <!-- <item xsi:type="ns1:CIMProperty">
            <name xsi:type="xsd:string">Customer</name>
            <value xsi:type="xsd:string">1</value>
          </item> -->

          <item xsi:type="ns1:CIMProperty">
            <name xsi:type="xsd:string">Remarks</name>

```

```

    <value xsi:type="xsd:string"> data remarks</value>
  </item>
</properties>
<objectPath xsi:type="ns1:CIMObjectPath">
  <className xsi:type="xsd:string">ServiceDefinitionDetails</className>
  <properties xsi:type="ns1:CIMPropertyList"
    soapenc:arrayType="ns1:CIMProperty[]">
    <item xsi:type="ns1:CIMProperty">
      <name xsi:type="xsd:string">SubType</name>
      <value xsi:type="xsd:string">EthernetEVCS</value>
    </item>

    <item xsi:type="ns1:CIMProperty">
      <name xsi:type="xsd:string">Uni_Duplex</name>
      <value xsi:type="xsd:string">Auto</value>
      <qualifier xsi:type="ns1:CIMQualifier">
        <name xsi:type="xsd:string">editable</name>
        <value xsi:type="xsd:string">true</value>
      </qualifier>
    </item>
    <item xsi:type="ns1:CIMProperty">
      <name xsi:type="xsd:string">Uni_Shutdown</name>
      <value xsi:type="xsd:string">true</value>
      <qualifier xsi:type="ns1:CIMQualifier">
        <name xsi:type="xsd:string">editable</name>
        <value xsi:type="xsd:string">true</value>
      </qualifier>
    </item>
    <item xsi:type="ns1:CIMProperty">
      <name xsi:type="xsd:string">PE_Intf_Shutdown</name>
      <value xsi:type="xsd:string">>false</value>
      <qualifier xsi:type="ns1:CIMQualifier">
        <name xsi:type="xsd:string">editable</name>
        <value xsi:type="xsd:string">true</value>
      </qualifier>
    </item>
    <item xsi:type="ns1:CIMProperty">
      <name xsi:type="xsd:string">Uni_Violation_Action</name>
      <value xsi:type="xsd:string">PROTECT</value>
      <qualifier xsi:type="ns1:CIMQualifier">
        <name xsi:type="xsd:string">editable</name>
        <value xsi:type="xsd:string">true</value>
      </qualifier>
    </item>
    <item xsi:type="ns1:CIMProperty">
      <name xsi:type="xsd:string">Uni_Aging</name>
      <value xsi:type="xsd:string">1000</value>
      <qualifier xsi:type="ns1:CIMQualifier">
        <name xsi:type="xsd:string">editable</name>
        <value xsi:type="xsd:string">true</value>
      </qualifier>
    </item>
    <item xsi:type="ns1:CIMProperty">
      <name xsi:type="xsd:string">PE_Intf_Format</name>
      <value xsi:type="xsd:string" />
      <qualifier xsi:type="ns1:CIMQualifier">
        <name xsi:type="xsd:string">editable</name>
        <value xsi:type="xsd:string">true</value>
      </qualifier>
    </item>
    <item xsi:type="ns1:CIMProperty">
      <name xsi:type="xsd:string">PE_Intf_Desc</name>
      <value xsi:type="xsd:string" />

```

```

    <qualifier xsi:type="ns1:CIMQualifier">
      <name xsi:type="xsd:string">editable</name>
      <value xsi:type="xsd:string">true</value>
    </qualifier>
  </item>

  <item xsi:type="ns1:CIMProperty">
    <name xsi:type="xsd:string">STD_UNI_PORT</name>
    <value xsi:type="xsd:string">true</value>
    <qualifier xsi:type="ns1:CIMQualifier">
      <name xsi:type="xsd:string">editable</name>
      <value xsi:type="xsd:string">true</value>
    </qualifier>
  </item>

  <item xsi:type="ns1:CIMProperty">
    <name xsi:type="xsd:string">UNI_KEEP_ALIVE</name>
    <value xsi:type="xsd:string">true</value>
    <qualifier xsi:type="ns1:CIMQualifier">
      <name xsi:type="xsd:string">editable</name>
      <value xsi:type="xsd:string">true</value>
    </qualifier>
  </item>

  <item xsi:type="ns1:CIMProperty">
    <name xsi:type="xsd:string">Uni_Port_Security</name>
    <value xsi:type="xsd:string">true</value>
    <qualifier xsi:type="ns1:CIMQualifier">
      <name xsi:type="xsd:string">editable</name>
      <value xsi:type="xsd:string">true</value>
    </qualifier>
  </item>

  <item xsi:type="ns1:CIMProperty">
    <name xsi:type="xsd:string">Uni_Unicast_Traffic</name>
    <value xsi:type="xsd:string">1</value>
    <qualifier xsi:type="ns1:CIMQualifier">
      <name xsi:type="xsd:string">editable</name>
      <value xsi:type="xsd:string">true</value>
    </qualifier>
  </item>

  <item xsi:type="ns1:CIMProperty">
    <name xsi:type="xsd:string">Uni_Broadcast_Traffic</name>
    <value xsi:type="xsd:string">50</value>
    <qualifier xsi:type="ns1:CIMQualifier">
      <name xsi:type="xsd:string">editable</name>
      <value xsi:type="xsd:string">true</value>
    </qualifier>
  </item>

  <item xsi:type="ns1:CIMProperty">
    <name xsi:type="xsd:string">Uni_Multicast_Traffic</name>
    <value xsi:type="xsd:string">99</value>
    <qualifier xsi:type="ns1:CIMQualifier">
      <name xsi:type="xsd:string">editable</name>
      <value xsi:type="xsd:string">true</value>
    </qualifier>
  </item>

  <item xsi:type="ns1:CIMProperty">
    <name xsi:type="xsd:string">USE_SVI</name>
    <value xsi:type="xsd:string">true</value>
  </item>

```

```

<qualifier xsi:type="ns1:CIMQualifier">
  <name xsi:type="xsd:string">editable</name>
  <value xsi:type="xsd:string">>true</value>
</qualifier>
</item>

<item xsi:type="ns1:CIMProperty">
  <name xsi:type="xsd:string">Autopick_Vlan_ID</name>
  <value xsi:type="xsd:string">>true</value>
  <qualifier xsi:type="ns1:CIMQualifier">
    <name xsi:type="xsd:string">editable</name>
    <value xsi:type="xsd:string">>true</value>
  </qualifier>
</item>
<item xsi:type="ns1:CIMProperty">
  <name xsi:type="xsd:string">Uni_Speed</name>
  <value xsi:type="xsd:string">1000</value>
  <qualifier xsi:type="ns1:CIMQualifier">
    <name xsi:type="xsd:string">editable</name>
    <value xsi:type="xsd:string">>true</value>
  </qualifier>
</item>

<item xsi:type="ns1:CIMProperty">
  <name xsi:type="xsd:string">Use_Native_Vlan</name>
  <value xsi:type="xsd:string">>false</value>
  <qualifier xsi:type="ns1:CIMQualifier">
    <name xsi:type="xsd:string">editable</name>
    <value xsi:type="xsd:string">>true</value>
  </qualifier>
</item>

<item xsi:type="ns1:CIMProperty">
  <name xsi:type="xsd:string">Uni_Mac_Address</name>
  <value xsi:type="xsd:string">100</value>
  <qualifier xsi:type="ns1:CIMQualifier">
    <name xsi:type="xsd:string">editable</name>
    <value xsi:type="xsd:string">>true</value>
  </qualifier>
</item>

<item xsi:type="ns1:CIMProperty">
  <name xsi:type="xsd:string">Template_Enabled</name>
  <value xsi:type="xsd:string">>true</value>
  <qualifier xsi:type="ns1:CIMQualifier">
    <name xsi:type="xsd:string">editable</name>
    <value xsi:type="xsd:string">>true</value>
  </qualifier>
</item>
<item xsi:type="ns1:CIMProperty">
  <name xsi:type="xsd:string">PE_Intf_Type</name>
  <value xsi:type="xsd:string">GigabitEthernet</value>
  <qualifier xsi:type="ns1:CIMQualifier">
    <name xsi:type="xsd:string">editable</name>
    <value xsi:type="xsd:string">>true</value>
  </qualifier>
</item>
<item xsi:type="ns1:CIMProperty">
  <name xsi:type="xsd:string">PE_Encap</name>
  <value xsi:type="xsd:string">DOT1Q</value>
  <qualifier xsi:type="ns1:CIMQualifier">
    <name xsi:type="xsd:string">editable</name>
    <value xsi:type="xsd:string">>true</value>
  </qualifier>
</item>

```

```

</item>

<item xsi:type="ns1:CIMProperty">
  <name xsi:type="xsd:string">USE_PWCLASS</name>
  <value xsi:type="xsd:string">>true</value>
  <qualifier xsi:type="ns1:CIMQualifier">
    <name xsi:type="xsd:string">editable</name>
    <value xsi:type="xsd:string">>true</value>
  </qualifier>
</item>

<item xsi:type="ns1:CIMProperty">
  <name xsi:type="xsd:string">PW_CLASS_ID</name>
  <value xsi:type="xsd:string">1</value>
  <qualifier xsi:type="ns1:CIMQualifier">
    <name xsi:type="xsd:string">editable</name>
    <value xsi:type="xsd:string">>true</value>
  </qualifier>
</item>

<item xsi:type="ns1:CIMProperty">
  <name xsi:type="xsd:string">ELINE_NAME</name>
  <value xsi:type="xsd:string">ELine_Name</value>
  <qualifier xsi:type="ns1:CIMQualifier">
    <name xsi:type="xsd:string">editable</name>
    <value xsi:type="xsd:string">>true</value>
  </qualifier>
</item>

<item xsi:type="ns1:CIMProperty">
  <name xsi:type="xsd:string">L2VPN_GROUP_NAME</name>
  <value xsi:type="xsd:string">ISC</value>
  <qualifier xsi:type="ns1:CIMQualifier">
    <name xsi:type="xsd:string">editable</name>
    <value xsi:type="xsd:string">>true</value>
  </qualifier>
</item>

</properties>

</objectPath>
</objectPath>
</ns1:createInstance>
</soapenv:Body>
</soapenv:Envelope>

```

## L2VPN Service Requests

An L2VPN service request specifies the service definition, assigns device interfaces for the end-to-end wire connections, and the attachment circuit details.

## End-To-End Wires

An end-to-end wire is the link from one endpoint through the service provider cloud to another endpoint. In most cases, these links are from CE to CE. An attachment circuit is the link from the CE to the PE. If no CE is present, the attachment circuit link is from PE-CLE to PE-CLE.

In the **EthernetEVCS** network example shown in [Figure 7-1](#), End-to-End wire 1 is shown from ence132 to ence61. The two attachment circuits are the links from ence132 to enswostr1 and from ence61 to enswostr2.

Figure 7-1 End to End Wire Network Example

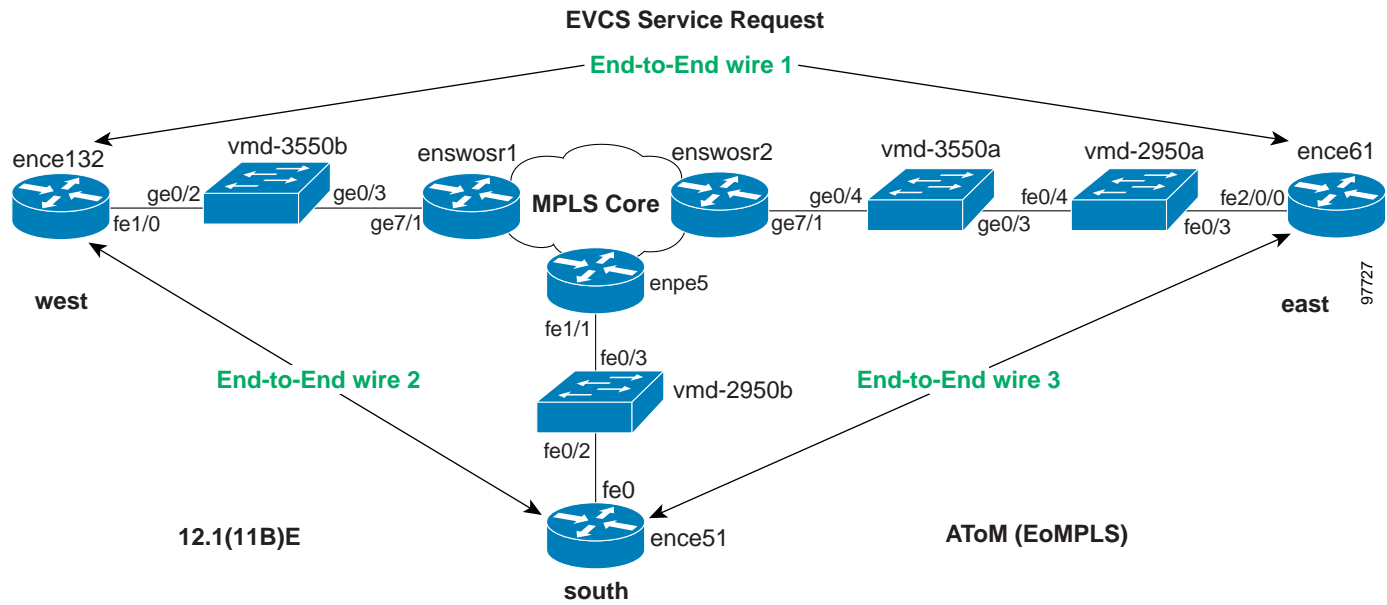

The number of end-to-end wires and attachment circuits that can be created are based on the policy subtype.

There can be one or two **AttachmentCircuits** for every **EndToEndWire** for the following policy subtypes:

- EthernetEVCS
- EthernetEVCS\_NO\_CE
- EthernetTLS
- EthernetTLS\_NO\_CE

There are 2 **AttachmentCircuits** for every **EndToEndWire** for the following policy subtypes:

- FRAME\_RELAY
- FRAME\_RELAY\_NO\_CE
- ATM
- ATM\_NO\_CE

## Service Request Examples

The following are XML examples of L2VPN service requests.

- [ATM Service Request, page 7-11](#)
- [ERS Service Request, page 7-15](#)

## ATM Service Request

In this example, an L2VPN ATM service request is created in a NPE-CE setup with TransportMode, PWClass, ELine name, and L2vpn Group name attributes, which are configured on IOS XR device.

XML file in *Cisco Prime Provisioning API 7.0 Programmer Reference*:  
CreateL2VPNServiceOrder\_ATM\_PortMode\_PWClass.xml

```
<?xml version="1.0" encoding="UTF-8"?>
<soapenv:Envelope
  xmlns:soapenv="http://schemas.xmlsoap.org/soap/envelope/"
  xmlns:soapenc="http://schemas.xmlsoap.org/soap/encoding/"
  xmlns:xsd="http://www.w3.org/2001/XMLSchema"
  xmlns:xsi="http://www.w3.org/2001/XMLSchema-instance"
  xmlns:ns0="http://www.cisco.com/cim-cx/2.0"
  xmlns:ns1="urn:CIM">
  <soapenv:Header>
    <!-- WaitTimeout has a default set in system properties.-->
    <ns0:message id="87855" timestamp="2002-12-13T14:55:38.885Z"
      Wait="true" WaitTimeout="90" sessiontoken="p36bttjwy1"/>
  </soapenv:Header>
  <soapenv:Body>
    <ns1:performBatchOperation>
      <actions xsi:type="ns1:CIMActionList"
        soapenc:arrayType="ns1:CIMAction[]">
        <action>
          <actionName xsi:type="xsd:string">createInstance</actionName>
          <objectPath xsi:type="ns1:CIMObjectPath">
            <className xsi:type="xsd:string">ServiceOrder</className>
            <properties xsi:type="ns1:CIMPropertyList"
              soapenc:arrayType="ns1:CIMProperty[]">
              <item xsi:type="ns1:CIMProperty">
                <name xsi:type="xsd:string">ServiceName</name>
                <value xsi:type="xsd:string">ServiceOrder257</value>
              </item>
              <item xsi:type="ns1:CIMProperty">
                <name xsi:type="xsd:string">CarrierId</name>
                <value xsi:type="xsd:string">322</value>
              </item>
              <item xsi:type="ns1:CIMProperty">
                <name xsi:type="xsd:string">DesiredDueDate</name>
                <value xsi:type="xsd:dateTime">2002-12-13T14:55:38.885Z</value>
              </item>
              <item xsi:type="ns1:CIMProperty">
                <name xsi:type="xsd:string">NumberOfRequests</name>
                <value xsi:type="xsd:string">1</value>
              </item>
            </properties>
          </objectPath>
        </action>
        <action>
          <actionName xsi:type="xsd:string">createInstance</actionName>
          <objectPath xsi:type="ns1:CIMObjectPath">
            <className xsi:type="xsd:string">ServiceRequest</className>
            <properties xsi:type="ns1:CIMPropertyList"
              soapenc:arrayType="ns1:CIMProperty[]">
              <item xsi:type="ns1:CIMProperty">
                <name xsi:type="xsd:string">RequestName</name>
                <value xsi:type="xsd:string">MYSR-1</value>
              </item>
              <item xsi:type="ns1:CIMProperty">
                <name xsi:type="xsd:string">Type</name>
```

```

        <value xsi:type="xsd:string">L2Vpn</value>
    </item>
</properties>
<objectPath xsi:type="ns1:CIMObjectPath">
    <className xsi:type="xsd:string">ServiceRequestDetails</className>
    <properties xsi:type="ns1:CIMPropertyList"
        soapenc:arrayType="ns1:CIMProperty[]">
        <item xsi:type="ns1:CIMProperty">
            <name xsi:type="xsd:string">ServiceDefinition</name>
            <value xsi:type="xsd:string">ATM-Policy-NBI-1</value>
            <qualifier xsi:type="xsd:string">
                <name xsi:type="xsd:string">ServiceDefinitionType</name>
                <value xsi:type="xsd:string">L2Vpn</value>
            </qualifier>
        </item>
        <item xsi:type="ns1:CIMProperty">
            <name xsi:type="xsd:string">VPN</name>
            <value xsi:type="xsd:string">l2-vpn1</value>
        </item>
        <!-- <item xsi:type="ns1:CIMProperty">
            <name xsi:type="xsd:string">topology</name>
            <value xsi:type="xsd:string">FULLMESH</value>
        </item -->
    </properties>
<objectPath xsi:type="ns1:CIMObjectPath">
    <className xsi:type="xsd:string">EndToEndWire</className>
    <objectPath xsi:type="ns1:CIMObjectPath">
        <className xsi:type="xsd:string">AttachmentCircuit</className>
        <properties xsi:type="ns1:CIMPropertyList"
            soapenc:arrayType="ns1:CIMProperty[]">

            <item xsi:type="ns1:CIMProperty">
                <name xsi:type="xsd:string">NPC</name>
                <value xsi:type="xsd:string">18</value>
            </item>

            <!-- <item xsi:type="ns1:CIMProperty">
                <name xsi:type="xsd:string">PE</name>
                <value xsi:type="xsd:string">cl-test-l2-12404-1</value>
            </item>
            <item xsi:type="ns1:CIMProperty">
                <name xsi:type="xsd:string">Cpe</name>
                <value xsi:type="xsd:string">7200_2</value>
            </item>
            <item xsi:type="ns1:CIMProperty">
                <name xsi:type="xsd:string">NPC</name>
                <value xsi:type="xsd:string">18</value>
            </item>
            <item xsi:type="ns1:CIMProperty">
                <name xsi:type="xsd:string">UNIDeviceInterface</name>
                <value xsi:type="xsd:string">ATM0/1/0/3</value>
            </item -->
        </properties>
    <objectPath xsi:type="ns1:CIMObjectPath">
        <className xsi:type="xsd:string">ACAttrs</className>
        <properties xsi:type="ns1:CIMPropertyList"
            soapenc:arrayType="ns1:CIMProperty[]">

            <item xsi:type="ns1:CIMProperty">
                <name xsi:type="xsd:string">CE_VCD</name>
                <value xsi:type="xsd:string">3000</value>
            </item>
            <item xsi:type="ns1:CIMProperty">

```



```

        <name xsi:type="xsd:string">CE_VPI</name>
        <value xsi:type="xsd:string">100</value>
    </item>
</item>
<item xsi:type="ns1:CIMProperty">
    <name xsi:type="xsd:string">CE_VCI</name>
    <value xsi:type="xsd:string">300</value>
</item>

<!-- PE info -->

    <item xsi:type="ns1:CIMProperty">
<name xsi:type="xsd:string">TransportMode</name>
<value xsi:type="xsd:string">PORT</value>
    </item>

    <item xsi:type="ns1:CIMProperty">
        <name xsi:type="xsd:string">PE_Encap</name>
        <value xsi:type="xsd:string">AAL5</value>
    </item>

    <!-- <item xsi:type="ns1:CIMProperty">
        <name xsi:type="xsd:string">Uni_Shutdown</name>
        <value xsi:type="xsd:string">>false</value>
    </item-->
    <item xsi:type="ns1:CIMProperty">
        <name xsi:type="xsd:string">USE_PWCLASS</name>
        <value xsi:type="xsd:string">>true</value>
    </item>

</item>

    <item xsi:type="ns1:CIMProperty">
<name xsi:type="xsd:string">PW_CLASS_ID</name>
<value xsi:type="xsd:string">1</value>
    </item>

    <item xsi:type="ns1:CIMProperty">
        <name xsi:type="xsd:string">ELINE_NAME</name>
        <value xsi:type="xsd:string">ELLine_Name</value>
    </item>

<item xsi:type="ns1:CIMProperty">
    <name xsi:type="xsd:string">L2VPN_GROUP_NAME</name>
    <value xsi:type="xsd:string">ISC</value>
</item>

    </properties>
</objectPath>

</objectPath>

<!-- AC2-->
<objectPath xsi:type="ns1:CIMObjectPath">
    <className xsi:type="xsd:string">AttachmentCircuit</className>
    <properties xsi:type="ns1:CIMPropertyList"
        soapenc:arrayType="ns1:CIMProperty[]">

        <item xsi:type="ns1:CIMProperty">
            <name xsi:type="xsd:string">NPC</name>
            <value xsi:type="xsd:string">19</value>
        </item>
        <!-- <item xsi:type="ns1:CIMProperty">
            <name xsi:type="xsd:string">PE</name>
            <value xsi:type="xsd:string">c1-test-12-12404-2</value>
        </item>
    </properties>
</objectPath>

```

```

        <item xsi:type="ns1:CIMProperty">
          <name xsi:type="xsd:string">Cpe</name>
          <value xsi:type="xsd:string">3640_6</value>
        </item>

        <item xsi:type="ns1:CIMProperty">
          <name xsi:type="xsd:string">UNIDeviceInterface</name>
          <value xsi:type="xsd:string">ATM0/2/0/3</value>
        </item> -->
      </properties>
    <objectPath xsi:type="ns1:CIMObjectPath">
      <className xsi:type="xsd:string">ACAttr</className>
      <properties xsi:type="ns1:CIMPropertyList"
        soapenc:arrayType="ns1:CIMProperty[]">

        <item xsi:type="ns1:CIMProperty">
          <name xsi:type="xsd:string">CE_VCD</name>
          <value xsi:type="xsd:string">3000</value>
        </item>
        <item xsi:type="ns1:CIMProperty">
          <name xsi:type="xsd:string">CE_VPI</name>
          <value xsi:type="xsd:string">100</value>
        </item>
        <item xsi:type="ns1:CIMProperty">
          <name xsi:type="xsd:string">CE_VCI</name>
          <value xsi:type="xsd:string">300</value>
        </item>

        <!-- PE info -->

        <item xsi:type="ns1:CIMProperty">
          <name xsi:type="xsd:string">TransportMode</name>
          <value xsi:type="xsd:string">PORT</value>
        </item>
        <item xsi:type="ns1:CIMProperty">
          <name xsi:type="xsd:string">PE_Encap</name>
          <value xsi:type="xsd:string">AAL5</value>
        </item>

        <!--<item xsi:type="ns1:CIMProperty">
          <name xsi:type="xsd:string">Uni_Shutdown</name>
          <value xsi:type="xsd:string">>false</value>
        </item-->

      </properties>
    </objectPath>
  </objectPath>
</objectPath>
</action>
</actions>
</ns1:performBatchOperation>
</soapenv:Body>
</soapenv:Envelope>

```

## ERS Service Request

In this example, an L2VPN point-to-point Ethernet Relay Service (ERS) service request is created in a NPE-UPE-CE setup, where the NPE is an IOS XR device and others are IOS devices.

Here, the PWClass, ELine name and L2vpn Group name attributes are configured on IOS XR (NPE).

In addition, the Std UNI attributes are configured on IOS (UPE).

XML file in [Cisco Prime Provisioning API 7.0 Programmer Reference](#):  
CreateL2VPNServiceOrder\_EVCS\_NBIEnhance\_PWClass.xml

```
<?xml version="1.0" encoding="UTF-8"?>
<soapenv:Envelope
  xmlns:soapenv="http://schemas.xmlsoap.org/soap/envelope/"
  xmlns:soapenc="http://schemas.xmlsoap.org/soap/encoding/"
  xmlns:xsd="http://www.w3.org/2001/XMLSchema"
  xmlns:xsi="http://www.w3.org/2001/XMLSchema-instance"
  xmlns:ns0="http://www.cisco.com/cim-cx/2.0"
  xmlns:ns1="urn:CIM">
  <soapenv:Header>
    <!-- WaitTimeout has a default set in system properties.-->
    <ns0:message id="87855" timestamp="2002-12-13T14:55:38.885Z"
      Wait="true" WaitTimeout="180" sessiontoken="p36bttjwy1"/>
  </soapenv:Header>
  <soapenv:Body>
    <ns1:performBatchOperation>
      <actions xsi:type="ns1:CIMActionList"
        soapenc:arrayType="ns1:CIMAction[]">
        <action>
          <actionName xsi:type="xsd:string">createInstance</actionName>
          <objectPath xsi:type="ns1:CIMObjectPath">
            <className xsi:type="xsd:string">ServiceOrder</className>
            <properties xsi:type="ns1:CIMPropertyList"
              soapenc:arrayType="ns1:CIMProperty[]">
              <item xsi:type="ns1:CIMProperty">
                <name xsi:type="xsd:string">ServiceName</name>
                <value xsi:type="xsd:string">ServiceOrder257</value>
              </item>
              <item xsi:type="ns1:CIMProperty">
                <name xsi:type="xsd:string">CarrierId</name>
                <value xsi:type="xsd:string">322</value>
              </item>
              <item xsi:type="ns1:CIMProperty">
                <name xsi:type="xsd:string">DesiredDueDate</name>
                <value xsi:type="xsd:dateTime">2002-12-13T14:55:38.885Z</value>
              </item>
              <item xsi:type="ns1:CIMProperty">
                <name xsi:type="xsd:string">NumberOfRequests</name>
                <value xsi:type="xsd:string">1</value>
              </item>
            </properties>
          </objectPath>
        </action>
        <action>
          <actionName xsi:type="xsd:string">createInstance</actionName>
          <objectPath xsi:type="ns1:CIMObjectPath">
            <className xsi:type="xsd:string">ServiceRequest</className>
            <properties xsi:type="ns1:CIMPropertyList"
              soapenc:arrayType="ns1:CIMProperty[]">
              <item xsi:type="ns1:CIMProperty">
                <name xsi:type="xsd:string">RequestName</name>
                <value xsi:type="xsd:string">new_sr</value>
              </item>
            </properties>
          </objectPath>
        </action>
      </actions>
    </ns1:performBatchOperation>
  </soapenv:Body>
</soapenv:Envelope>
```

```

    </item>
    <item xsi:type="ns1:CIMProperty">
      <name xsi:type="xsd:string">Type</name>
      <value xsi:type="xsd:string">L2Vpn</value>
    </item>
  </properties>
  <objectPath xsi:type="ns1:CIMObjectPath">
    <className xsi:type="xsd:string">ServiceRequestDetails</className>
    <properties xsi:type="ns1:CIMPropertyList"
      soapenc:arrayType="ns1:CIMProperty[]">
      <item xsi:type="ns1:CIMProperty">
        <name xsi:type="xsd:string">ServiceDefinition</name>
        <!-- Policy Edit -->
        <value xsi:type="xsd:string">NBI-ERS-Policy-1</value>

        <qualifier xsi:type="xsd:string">
          <name xsi:type="xsd:string">ServiceDefinitionType</name>
          <value xsi:type="xsd:string">L2Vpn</value>
        </qualifier>
      </item>
      <item xsi:type="ns1:CIMProperty">
        <name xsi:type="xsd:string">VPN</name>
        <value xsi:type="xsd:string">l2-vpn1</value>
      </item>
    </properties>
    <!--
      <item xsi:type="ns1:CIMProperty">
        <name xsi:type="xsd:string">topology</name>
        <value xsi:type="xsd:string">Full Mesh</value>
      </item>
    -->
  </objectPath>
  <objectPath xsi:type="ns1:CIMObjectPath">
    <className xsi:type="xsd:string">EndToEndWire</className>

    <objectPath xsi:type="ns1:CIMObjectPath">
      <!--AC1 Edit for IP Address & PW class usage -->
      <className xsi:type="xsd:string">AttachmentCircuit</className>
      <properties xsi:type="ns1:CIMPropertyList"
        soapenc:arrayType="ns1:CIMProperty[]">

        <item xsi:type="ns1:CIMProperty"> /* NPE-UPE-CE setup... NPE
is an IOS-XR device */
          <name xsi:type="xsd:string">NPC</name>
          <value xsi:type="xsd:string">4</value>
        </item>

        <!--<item xsi:type="ns1:CIMProperty">
          <name xsi:type="xsd:string">UNIDeviceInterface</name>
          <value xsi:type="xsd:string">FastEthernet1/0/17</value>
        </item-->
      </properties>

      <objectPath xsi:type="ns1:CIMObjectPath">
        <className xsi:type="xsd:string">ACAttrs</className>
        <properties xsi:type="ns1:CIMPropertyList"
          soapenc:arrayType="ns1:CIMProperty[]">

          <!-- <item xsi:type="ns1:CIMProperty">
            <name xsi:type="xsd:string">CE_Intf_Name</name>
            <value xsi:type="xsd:string">FastEthernet3/0</value>
          </item> -->

```

```

    <item xsi:type="ns1:CIMProperty">
      <name xsi:type="xsd:string">CE_Encap</name>
      <value xsi:type="xsd:string">DOT1Q</value>
    </item>

    <item xsi:type="ns1:CIMProperty">
      <name xsi:type="xsd:string">CE_Ip_Address</name>
      <value xsi:type="xsd:string">50.50.50.1/24</value>
    </item>

    <item xsi:type="ns1:CIMProperty">
<name xsi:type="xsd:string">STD_UNI_PORT</name>
<value xsi:type="xsd:string">true</value>
</item>

    <item xsi:type="ns1:CIMProperty">
      <name xsi:type="xsd:string">UNI_KEEP_ALIVE</name>
      <value xsi:type="xsd:string">true</value>
    </item>

<item xsi:type="ns1:CIMProperty">
  <name xsi:type="xsd:string">Uni_Port_Security</name>
  <value xsi:type="xsd:string">true</value>
</item>

  <item xsi:type="ns1:CIMProperty">
<name xsi:type="xsd:string">Uni_Unicast_Traffic</name>
<value xsi:type="xsd:string">2</value>
</item>

  <item xsi:type="ns1:CIMProperty">
<name xsi:type="xsd:string">Uni_Broadcast_Traffic</name>
<value xsi:type="xsd:string">2</value>
</item>

  <item xsi:type="ns1:CIMProperty">
<name xsi:type="xsd:string">Uni_Multicast_Traffic</name>
<value xsi:type="xsd:string">2</value>
</item>

<item xsi:type="ns1:CIMProperty">
  <name xsi:type="xsd:string">USE_SVI</name>
  <value xsi:type="xsd:string">true</value>
</item>

<item xsi:type="ns1:CIMProperty">
  <name xsi:type="xsd:string">Autopick_Vlan_ID</name>
  <value xsi:type="xsd:string">true</value>
</item>

  <item xsi:type="ns1:CIMProperty">
    <name xsi:type="xsd:string">USE_PWCLASS</name>
    <value xsi:type="xsd:string">true</value>
  </item>

  <item xsi:type="ns1:CIMProperty">
<name xsi:type="xsd:string">PW_CLASS_ID</name>
<value xsi:type="xsd:string">1</value>
</item>

```

```

    <item xsi:type="ns1:CIMProperty">
      <name xsi:type="xsd:string">ELINE_NAME</name>
      <value xsi:type="xsd:string">ELine_Name_AC1</value>
    </item>

    <item xsi:type="ns1:CIMProperty">
      <name xsi:type="xsd:string">L2VPN_GROUP_NAME</name>
      <value xsi:type="xsd:string">VPNSC</value>
    </item>

  </properties>
</objectPath>

</objectPath>

<!-- AC2 -->
<objectPath xsi:type="ns1:CIMObjectPath">
  <className xsi:type="xsd:string">AttachmentCircuit</className>
  <properties xsi:type="ns1:CIMPropertyList"
    soapenc:arrayType="ns1:CIMProperty[]">
    <!-- <item xsi:type="ns1:CIMProperty">
      <name xsi:type="xsd:string">PE</name>
      <value xsi:type="xsd:string">c1-test-12-7600-2</value>
    </item>
    <item xsi:type="ns1:CIMProperty">
      <name xsi:type="xsd:string">Cpe</name>
      <value xsi:type="xsd:string">c1-test-12-2821-4</value>
    </item> -->
    <item xsi:type="ns1:CIMProperty"> /* NPE-UPE-CE setup... NPE
is an IOS-XR device */
      <name xsi:type="xsd:string">NPC</name>
      <value xsi:type="xsd:string">13</value>
    </item>

    <!--<item xsi:type="ns1:CIMProperty">
      <name xsi:type="xsd:string">UNIDeviceInterface</name>
      <value xsi:type="xsd:string">FastEthernet1/0/15</value>
    </item-->

  </properties>
<objectPath xsi:type="ns1:CIMObjectPath">
  <className xsi:type="xsd:string">ACAttrs</className>
  <properties xsi:type="ns1:CIMPropertyList"
    soapenc:arrayType="ns1:CIMProperty[]">

    <!--<item xsi:type="ns1:CIMProperty">
      <name xsi:type="xsd:string">CE_Intf_Name</name>
      <value xsi:type="xsd:string">GigabitEthernet0/1</value>
    </item> -->

    <item xsi:type="ns1:CIMProperty">
      <name xsi:type="xsd:string">CE_Encap</name>
      <value xsi:type="xsd:string">DOT1Q</value>
    </item>

    <item xsi:type="ns1:CIMProperty">
      <name xsi:type="xsd:string">CE_Ip_Address</name>
      <value xsi:type="xsd:string">50.50.50.2/24</value>
    </item>

    <item xsi:type="ns1:CIMProperty">
      <name xsi:type="xsd:string">STD_UNI_PORT</name>

```

```

<value xsi:type="xsd:string">true</value>
</item>

  <item xsi:type="ns1:CIMProperty">
    <name xsi:type="xsd:string">UNI_KEEP_ALIVE</name>
    <value xsi:type="xsd:string">true</value>
  </item>

<item xsi:type="ns1:CIMProperty">
  <name xsi:type="xsd:string">Uni_Port_Security</name>
  <value xsi:type="xsd:string">true</value>
</item>

  <item xsi:type="ns1:CIMProperty">
<name xsi:type="xsd:string">Uni_Unicast_Traffic</name>
<value xsi:type="xsd:string">85</value>
  </item>

  <item xsi:type="ns1:CIMProperty">
<name xsi:type="xsd:string">Uni_Broadcast_Traffic</name>
<value xsi:type="xsd:string">90</value>
  </item>

  <item xsi:type="ns1:CIMProperty">
<name xsi:type="xsd:string">Uni_Multicast_Traffic</name>
<value xsi:type="xsd:string">99</value>
  </item>

  <item xsi:type="ns1:CIMProperty">
    <name xsi:type="xsd:string">USE_SVI</name>
    <value xsi:type="xsd:string">true</value>
  </item>

  <item xsi:type="ns1:CIMProperty">
    <name xsi:type="xsd:string">Autopick_Vlan_ID</name>
    <value xsi:type="xsd:string">true</value>
  </item>
<!--
  <item xsi:type="ns1:CIMProperty">
    <name xsi:type="xsd:string">USE_PWCLASS</name>
    <value xsi:type="xsd:string">true</value>
  </item>

  <item xsi:type="ns1:CIMProperty">
<name xsi:type="xsd:string">PW_CLASS_ID</name>
<value xsi:type="xsd:string">36</value>
  </item>
-->

    </properties>
  </objectPath>
</objectPath>
</objectPath>
</objectPath>
</action>
</actions>
</ns1:performBatchOperation>
</soapenv:Body>
</soapenv:Envelope>

```

# Provisioning Example

This section describes the required steps for using the API to provision L2VPN, and includes the operation, class, and required parameters for each step.

## Process Summary

In this L2VPN provisioning example, the following steps are listed:

1. Create device groups (optional).
2. Create devices.
3. Collect device configurations.
4. Create provider.
5. Create regions.
6. Declare devices as PEs.
7. Create access domains.
8. Create customer.
9. Create sites.
10. Declare devices as CPEs (not required for No\_CE service subtypes).
11. Create named physical circuits.
12. Create VLAN ID pool.
13. Create VC ID pool.
14. Create VPN.
15. Create PseudowireClass (optional).
16. Create the L2VPN service definition (policy).
17. Create the L2VPN service request.



---

**Note**

For clarity, this provisioning process shows each step as a separate XML request. Many of these steps can be combined using **performBatchOperations**.

---

The provisioning example in this section is based on the partial network diagram shown in [Figure 7-2](#).



Figure 7-2 L2VPN Provisioning Network Example

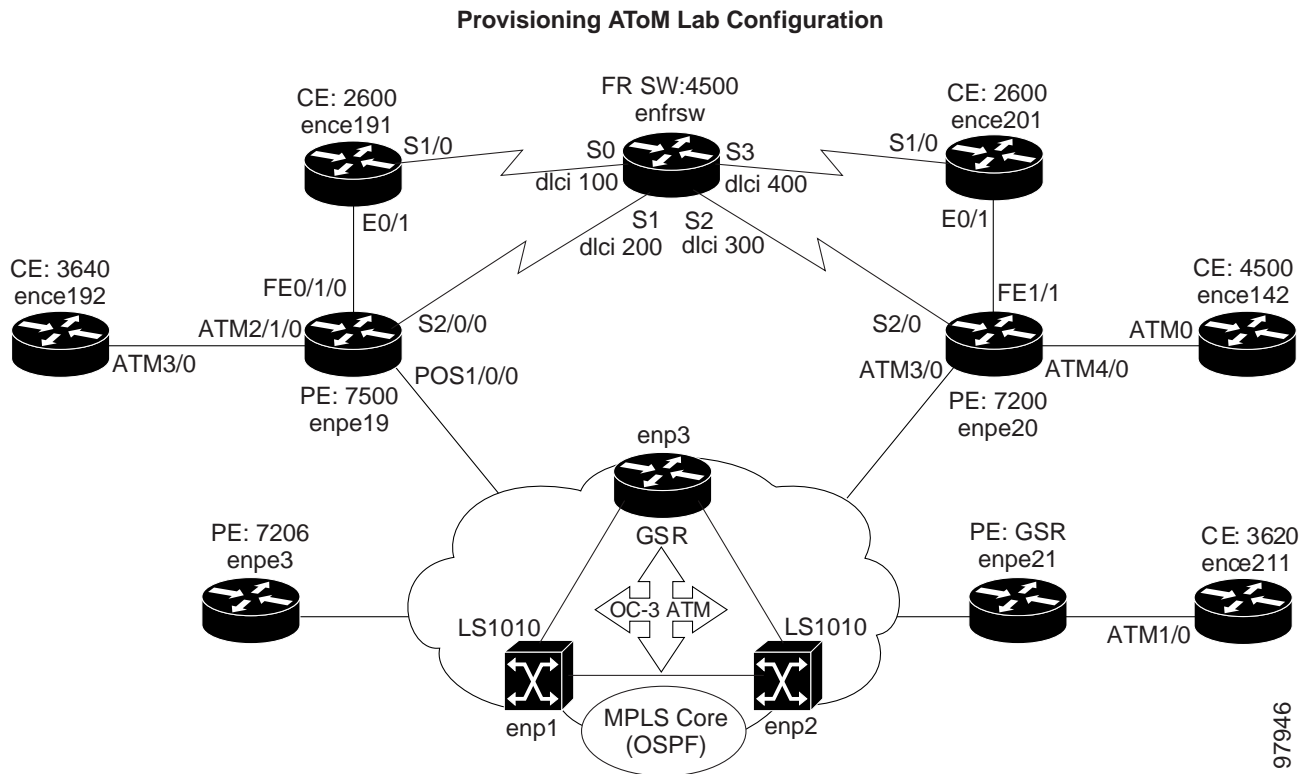

## Prerequisites

For security reasons, Prime Provisioning requires the virtual terminal protocol (VTP) to be configured in transparent mode on all switches involved in Ethernet Relay Service (ERS) or Ethernet Wire Service (EWS) before provisioning L2VPN service requests.

To set the VTP mode, enter the following Cisco IOS commands:

```
configure terminal
vtp mode transparent
```

Enter the following Cisco IOS command to verify that the VTP has changed to transparent mode:

```
Show vtp status
```

## RBAC

Prime Provisioning uses a Cisco role-based access control (RBAC) product for user login and logoff. These user roles and permissions are set up using the GUI.

When you establish an API session, you are given a session token during the login. For each API XML request, the session token is verified against the RBAC processor to ensure that the API user has permissions for that operation. If the user does not have permissions, the API returns an error.

See the [Cisco Prime Provisioning 7.0 User Guide](#) for information on setting up user roles and permissions.

## Provisioning Process

This section provides a sample provisioning process using XML examples. The inventory of XML examples for the Prime Provisioning API are available at: [Cisco Prime Provisioning API 7.0 Programmer Reference](#).

Step 1 Create device groups (optional).

**Table 7-1 Create Device Group**

Operation	className	Required Parameters
createInstance	DeviceGroup	Name

In this example, one device group is created for the customer, and one for the provider.

- CreateDeviceGroup\_ProvDev.xml
- CreateDeviceGroup\_CustDev.xml

### XML Examples:

CreateDeviceGroup.xml



#### Tip

If you plan to create device groups, create the empty device groups before you create the devices. As you create each device, add the associated device group name as a key property in the create device XML request.

In the following example, the device group (CustDev) is added as a key property when creating the device **CiscoRouter**:

```
<ns1:createInstance>
  <objectPath xsi:type="ns1:CIMObjectPath">
    <className xsi:type="xsd:string">CiscoRouter</className>
    <properties xsi:type="ns1:CIMPropertyList"
      soapenc:arrayType="ns1:CIMProperty[]">
      <item xsi:type="ns1:CIMProperty">
        <name xsi:type="xsd:string">DeviceGroup</name>
        <value xsi:type="xsd:string">CustDev</value>
      </item>
      <item xsi:type="ns1:CIMProperty">
        <name xsi:type="xsd:string">CfgUpDnldMech</name>
        <value xsi:type="xsd:string">DEFAULT</value>
      </item>
      <item xsi:type="ns1:CIMProperty">
        <name xsi:type="xsd:string">TransportMechanism</name>
        <value xsi:type="xsd:string">DEFAULT</value>
      </item>
      <item xsi:type="ns1:CIMProperty">
        <name xsi:type="xsd:string">Password</name>
        <value xsi:type="xsd:string">vpnsc</value>
      </item>
    </properties>
  </objectPath>
</ns1:createInstance>
```

**Step 2** Create devices.

Every network element that Prime Provisioning manages must be defined as a device in the system. An element is any device from which Prime Provisioning can collect information. In most cases, devices are Cisco IOS routers and Catalyst switches.

**Table 7-2** Create Devices

Operation	className	Required Parameters
createInstance	<ul style="list-style-type: none"> <li>• CiscoRouter</li> <li>• CatOS</li> </ul>	One or more of the following: <ul style="list-style-type: none"> <li>• ManagementIPAddress</li> <li>• HostName</li> <li>• DomainName</li> </ul>

In this example, an XML request is created for each device in the CPE to PE link, as shown in [Figure 7-2](#).

- CreateDevice\_enpe20.xml
- CreateDevice\_enpe21.xml
- CreateDevice\_ence142.xml
- CreateDevice\_ence211.xml

**XML Examples:**

- CreateCiscoRouter.xml
- CreateCat.xml

**Step 3** Collect device configurations.

A device configuration collection is a task. This task uploads the current configuration from the device to the Prime Provisioning database. The collection task is executed through a service request, and the service request is scheduled through a service order.

**Table 7-3** Collect Device Configurations

Operation	className	Required Parameters
createInstance	ServiceOrder	<ul style="list-style-type: none"> <li>• ServiceName</li> <li>• NumberofRequests</li> <li>• ServiceRequest</li> </ul>

**Table 7-3** *Collect Device Configurations (continued)*

Operation	className	Required Parameters
	ServiceRequest	<ul style="list-style-type: none"> <li>• RequestName</li> <li>• Type=Task</li> <li>• ServiceRequestDetails</li> </ul>
	ServiceRequestDetails	<ul style="list-style-type: none"> <li>• SubType=COLLECTION</li> <li>• Device (or DeviceGroup)</li> </ul> <p><b>Note</b> You must select at least one device or device group.</p> <ul style="list-style-type: none"> <li>• RetrieveVersion=true</li> <li>• RetrieveDeviceInterfaces=true</li> </ul>

In this example, device collection is divided into two separate tasks. One task performs a configuration collection on the devices in the customer device group, and the second task is for the provider device group. (Device groups were created in Step 1.)

- CreateTaskServiceOrderCollection1.xml
- CreateTaskServiceOrderCollection2.xml

**Note**

To perform a collection on a device group, specify the **DeviceGroup** keyword in the **ServiceRequestDetails**. (For example, **DeviceGroup=Group\_CustDev**, **DeviceGroup=Group\_ProvDev**).

**XML Example:**

- CreateTaskServiceOrderCollection.xml

**Step 4** Create Provider.

The provider is the administrative domain of an ISP, with one BGP autonomous system (AS) number. The network owned by the provider is called the backbone network. If an ISP has two AS numbers, you must define it as two provider administrative domains.

**Table 7-4** *Create Provider*

Operation	className	Required Keywords
createInstance	Provider	<ul style="list-style-type: none"> <li>• Name</li> <li>• AsNumber</li> </ul>

**XML Example:**

- CreateProvider.xml

**Step 5** Create Regions.

Each provider can contain multiple regions. In this example, an XML request is created for each region.

- CreateRegion1.xml
- CreateRegion2.xml

**Table 7-5** Create Region

Operation	className	Required Keywords
createInstance	Region	<ul style="list-style-type: none"> <li>• Name</li> <li>• Provider</li> </ul>

**XML Example:**

- CreateRegion.xml

**Step 6** Declare devices as PEs.

The XML request that assigns a PE role (PE-POP or PE-CLE) to a device is also used to:

- Assign PE devices to Regions/Provider
- Specify PE interface information

**Table 7-6** Create PEs

Operation	className	Required Keywords
createInstance	PE	<ul style="list-style-type: none"> <li>• Provider</li> <li>• Region</li> <li>• Role= <ul style="list-style-type: none"> <li>– PE_CLE</li> <li>– PE_POP</li> </ul> </li> <li>• Device</li> <li>• Interface</li> </ul>

In this example, an XML request is created for each device to be declared as a PE. Using [Figure 7-2](#) for reference, enpe21=PE1 and enpe20=PE2.

- CreatePE1.xml
- CreatePE2.xml

**XML Example:**

- CreatePE.xml

**Step 7** Create Access Domains.

Create an access domain for Ethernet-based services where Prime Provisioning automatically assigns a VLAN for the link from the VLAN pool. Select all PE-POP devices to be associated with this domain, and later in the process, when VLAN pools are created for an Access Domain, the PE-POP is automatically assigned a VLAN ID.

**Table 7-7** Create Access Domains

Operation	className	Required Keywords
createInstance	AccessDomain	<ul style="list-style-type: none"> <li>Name</li> <li>Provider</li> <li>PE (Role must be PE_POP)</li> </ul>

**XML Example:**

- CreateAccessDomain.xml

**Step 8** Create Customer.

A customer is a requestor of VPN services. Each customer can contain multiple customer sites. Each site belongs to only one customer and can contain many CPEs.

**Table 7-8** Create Customer

Operation	className	Required Keywords
createInstance	Organization	<ul style="list-style-type: none"> <li>Name</li> </ul>

**XML Examples:**

- CreateOrganization.xml

**Step 9** Create Sites.

Create sites and assign customers (**Organizations**) to them. In this example, an XML request is created for each site.

- CreateSite1.xml
- CreateSite2.xml

**Table 7-9** Create Sites

Operation	className	Required Keywords
createInstance	Site	<ul style="list-style-type: none"> <li>Name</li> <li>Organization</li> </ul>

**XML Examples:**

- CreateSite.xml

**Step 10** Declare devices as CPEs.

The XML request that assigns a CPE to a site is also used to specify:

- The management type.
- CE interface information. If no CE is present, specify the UNI (PE-CLE or PE-POP) interface information.

**Table 7-10** Create CPE Devices

Operation	className	Required Keywords
createInstance	Cpe	<ul style="list-style-type: none"> <li>• Site</li> <li>• Device</li> <li>• ManagementType</li> </ul>

In this example, an XML request is created for each device you want specified as a CPE. Using the network diagram for reference, ence142=Cpe1 and ence211=Cpe2.

- CreateCpe1.xml
- CreateCpe2.xml

**XML Example:**

- CreateCpe.xml

**Step 11** Create Named Physical Circuits.

Create an NPC for each physical link in the CPE to PE-POP end-to-end wire. If there are intermediate devices, those links must also be added to the NPC using **PhysicalLink**.

When creating an NPC, the source device of the first physical link should be the CPE or, in the case of an unmanaged CPE, the U-PE

The PE-POP or N-PE should be the destination device of the last physical link, and any intermediate devices appear twice, first as the destination device of a link, then as the source device of the next link.

**Table 7-11** Create NPCs

Operation	className	Required Parameters
createInstance	NamedPhysicalCircuit	PhysicalLink
	PhysicalLink	<ul style="list-style-type: none"> <li>• SrcDevice</li> <li>• DestDevice</li> <li>• SrcIfName</li> <li>• DestIfName</li> </ul>

**XML Examples:**

- CreateNamedPhysicalCircuit.xml
- CreateNamedPhysicalCircuitRing.xml—Use this example if there is a ring topology configuration on the PE-CLEs.

- `CreateNamedPhysicalCircuitRingExisting.xml`—Use this example to reference an NPC ring that has already been created.

**Step 12** Create VLAN ID pool.

Create a VLAN ID pool, specify a range, and associate it to an access domain to manually enter the parameters for a VLAN pool. To have Prime Provisioning automatically assign VLANs to end-to-end wire links, specify the **AutoPickVlanId** keyword in the service definition (see Step 15).

**Table 7-12** Create VLAN Pool

Operation	className	Required Keywords
createInstance	VlanIdPool	<ul style="list-style-type: none"> <li>• Start</li> <li>• Size</li> <li>• AssocClassType</li> <li>• AssocClassId</li> </ul>

**XML Example:**

- `CreateVlanIdPool.xml`

**Step 13** Create a VC ID pool.

A VC ID pool is global and not associated with a provider or organization.

**Table 7-13** Create VC ID Pool

Operation	className	Required Keywords
createInstance	VcIdPool	<ul style="list-style-type: none"> <li>• Start</li> <li>• Size</li> </ul>

**XML Example:**

- `CreateVcIdPool.xml`

**Step 14** Create a VPN.

A VPN in an L2VPN network is only a name used to group L2VPN links.

**Table 7-14** Create VPNs

Operation	className	Required Parameters
createInstance	VPN	<ul style="list-style-type: none"> <li>• Name</li> </ul>

**XML Example:**

- `CreateVPN.xml`

**Step 15** Create PseudowireClass (optional)

Configure a Pseudowire class with the required attributes. This allows Prime Provisioning to configure a Pseudowire class and preferred path on IOS XR devices.



Table 7-15 Create Pseudowire Class

Operation	className	Required Parameters
createInstance	PseudowireClass	<ul style="list-style-type: none"> <li>• Name</li> <li>• Description (optional)</li> <li>• Encapsulation</li> <li>• TransportMode</li> <li>• TunnelId (optional)</li> <li>• DisableFallback (optional)</li> </ul>

**XML Example:**

- CreatePWclass.xml

**Step 16** Create the L2VPN service definition (policy).

A service definition is a template of the parameters needed to define an L2VPN service request. Once you define the policy template, it can be used by all L2VPN service requests that share a common set of attributes.

Certain properties in the service definition can set an additional attribute, **editable=true**. This allows the service request creator to change the values on specific policy attributes. If the property is set to **editable=false**, the service request creator cannot change the policy attributes. See the following example:

```
<objectPath xsi:type="ns1:CIMObjectPath">
  <className xsi:type="xsd:string">ServiceDefinitionDetails</className>
  <properties xsi:type="ns1:CIMPropertyList"
    soapenc:arrayType="ns1:CIMProperty[]">
    <item xsi:type="ns1:CIMProperty">
      <name xsi:type="xsd:string">SubType</name>
      <value xsi:type="xsd:string">ATM</value>
    </item>
    <item xsi:type="ns1:CIMProperty">
      <name xsi:type="xsd:string">PE_Encap</name>
      <value xsi:type="xsd:string">AAL0</value>
      <qualifier xsi:type="ns1:CIMQualifier">
        <name xsi:type="xsd:string">editable</name>
        <value xsi:type="xsd:string">true</value>
      </qualifier>
    </item>
    <item xsi:type="ns1:CIMProperty">
      <name xsi:type="xsd:string">CE_Intf_Type</name>
      <value xsi:type="xsd:string">Switch</value>
      <qualifier xsi:type="ns1:CIMQualifier">
        <name xsi:type="xsd:string">editable</name>
        <value xsi:type="xsd:string">true</value>
      </qualifier>
    </item>
  </properties>
</objectPath>
```

In this example, a service definition is created, with a **SubType=ATM**, and policy attribute values for the Cpe, PE, and UNI with the **ServiceDefinitionDetails**.

- CreateL2VPNServiceDefn\_ATM.xml

Table 7-16 Create a Service Policy

Operation	className	Required Parameters
createInstance	ServiceDefinition	<ul style="list-style-type: none"> <li>Name</li> <li>Type=L2Vpn</li> <li>ServiceDefinitionDetails</li> </ul>
	ServiceDefinitionDetails	<ul style="list-style-type: none"> <li>SubType= <ul style="list-style-type: none"> <li>EthernetEVCS</li> <li>EthernetEVCS_NO_CE</li> <li>EthernetTLS</li> <li>EthernetTLS_NO_CE</li> <li>FRAME_RELAY</li> <li>FRAME_RELAY_NO_CE</li> <li>ATM</li> <li>ATM_NO_CE</li> </ul> </li> <li>Provider or Organization</li> </ul> <p><b>Note</b> If you do not specify a <b>Provider</b> or <b>Organization</b>, the service policy is global.</p>

**Note**

If you set the **AutoPickVlanId** keyword in the **ServiceDefinitionDetails**, be sure that an access domain is attached to the PE that the PE-CLE (switch) is connected to, and a VLAN pool is assigned to the access domain.

**XML Examples:**

- CreateL2VPNServiceDefn\_EVCS.xml
- CreateL2VPNServiceDefn\_EthernetEVCS\_NO\_CE.xml
- CreateL2VPNServiceDefn\_EthernetTLS.xml
- CreateL2VPNServiceDefn\_EthernetTLS\_NO\_CE.xml
- CreateL2VPNServiceDefn\_ATM.xml
- CreateL2VPNServiceDefn\_ATM\_NO\_CE.xml
- CreateL2VPNServiceDefn\_FRAME\_RELAY.xml
- CreateL2VPNServiceDefn\_FRAME\_RELAY\_NO\_CE.xml

**Step 17** Create the L2VPN service request.

An L2VPN service request consists of one or more end-to-end wires, connecting various sites in a point-to-point topology. When you create a service request, you enter several parameters, including the service definition to use, the specific interfaces on the CPE (or UNI) and PE devices, routing protocol information, and IP addressing information.

In this example, an L2VPN service request is created for an ATM network with the CE present. The service request is deployed through a service order. The **ServiceRequestDetails** specify the attributes for the end-to-end wires and attachment circuits.



**Note** The service request name must be unique for each NBI API.

**Table 7-17** Create a Service Request

Operation	className	Required Parameters
createInstance	ServiceOrder	<ul style="list-style-type: none"> <li>• ServiceName</li> <li>• NumberOfRequests</li> <li>• ServiceRequest</li> </ul>
	ServiceRequest	<ul style="list-style-type: none"> <li>• RequestName</li> <li>• Type=L2Vpn</li> <li>• ServiceRequestDetails</li> </ul>
	ServiceRequestDetails	<ul style="list-style-type: none"> <li>• ServiceDefinition               <ul style="list-style-type: none"> <li>– ServiceDefinitionType=L2Vpn</li> </ul> </li> <li>• EntoEndWire</li> <li>• VPN</li> </ul>
	EndtoEndWire	<ul style="list-style-type: none"> <li>• AttachmentCircuit</li> </ul>
	AttachmentCircuit	<ul style="list-style-type: none"> <li>• ACAttrs               <ul style="list-style-type: none"> <li>– LinkTemplate (optional)</li> </ul> </li> </ul> <p><b>Note</b> See the “<a href="#">Templates in a Service Request</a>” section on page 4-18.</p>



**Tip** Record the **LocatorId** value that is returned for the service request. The Locator ID is required to perform a configuration audit of the service request.

**XML Examples:**

- CreateL2VPNServiceOrder\_EVCS.xml
- CreateL2VPNServiceOrder\_EVCS\_NO\_CE.xml
- CreateL2VPNServiceOrder\_EthernetTLS.xml
- CreateL2VPNServiceOrder\_EthernetTLS\_NO\_CE.xml
- CreateL2VPNServiceOrder\_ATM.xml
- CreateL2VPNServiceOrder\_ATM\_NO\_CE.xml
- CreateL2VPNServiceOrder\_FRAME\_RELAY.xml
- CreateL2VPNServiceOrder\_FRAME\_RELAY\_NO\_CE.xml

## Auditing Service Requests

A configuration audit occurs automatically each time you deploy a service request. During this configuration audit, Prime Provisioning verifies that all Cisco IOS commands are present and that they have the correct syntax. An audit also verifies that there were no errors during deployment by examining the commands configured by the service request on the target devices. If the device configuration does not match what is defined in the service request, the audit flags a warning and sets the service request to a *Failed Audit* or *Lost* state.

If you do not want the configuration audit to occur, change the value for the **Audit** parameter. The **Audit** parameter supports these values:

- **Audit**—This is the default. A successfully deployed service request is automatically audited unless this flag is changed.
- **NoAudit**—Do not perform a configuration audit when the service request is deployed.
- **ForceAudit**—Perform a configuration audit even if the service request deployment is not successful.

You can use the Audit parameter with a **Create**, **Modify**, or **Decommission** service request or a **Deployment** task. See the [“Service Decommission” section on page 3-11](#) for more information. To perform a configuration audit as a separate task, see the [“Configuration Audit” section on page 3-11](#).



## VPLS Provisioning

---

Cisco Prime Provisioning supports layer 2 provisioning with layer 2 Virtual Private Network (L2VPN) services and Virtual Private LAN services (VPLS). VPLS services are multipoint (L2VPN are point-to-point) and include Ethernet services over a Multiprotocol Label Switching (MPLS) core or over an Ethernet core.

With an MPLS-based provider core, the PE devices forward customer Ethernet traffic through the core using a VPLS VPN. Multiple attachment circuits are joined together by the provider core and simulate a virtual bridge that connects all the attachment circuits together.

With an Ethernet-based provider core, the PE devices connect two or more customer devices using 802.1Q-in-Q tag-stacking technology, which encapsulates traffic from multiple VLANs from one customer with a single service provider tag. All connections within the VPLS VPN are peers and have direct communications, like a distributed switch.

For each of the core types, Prime Provisioning supports Ethernet relay service (ERS) and multipoint Ethernet wire service (EWS).

- ERS—The PE device forwards all Ethernet packets with a particular VLAN tag received from an attachment circuit (excluding bridge protocol data units (BPDUs)), to another attachment circuit.
- EWS—The PE device forwards all Ethernet packets received from an attachment circuit (including tagged (**DOT1Q**), untagged (**DEFAULT**), and BPDUs), to either another attachment circuit or to all attachment circuits.

To provision VPLS using the Prime Provisioning API, you need a VPLS service definition and a VPLS service request. The service definition specifies the core type, policy subtype, and common device properties. The service request defines the service definition to use, VPNs, attributes for each interface in the VPLS link, and template information.

In addition, you can now use autodiscovery to discover all VPLS autodiscovery-enabled devices.

This chapter describes VPLS service concepts and the steps required to provision VPLS services using the Prime Provisioning API. The provisioning example includes all steps from creating the inventory to auditing the service deployment.

For more information on VPLS provisioning using Prime Provisioning, see the [Cisco Prime Provisioning 7.0 User Guide](#).

This chapter contains the following sections:

- [VPLS Service Definitions, page 8-2](#)
- [VPLS Autodiscovery, page 8-3](#)
- [VPLS Service Requests, page 8-8](#)
- [Provisioning Example, page 8-10](#)

# VPLS Service Definitions

A VPLS service definition specifies the core type, policy subtype, device properties, and the attributes common to all attachment circuits.

Prime Provisioning supports the following:

- Policy subtypes:
  - VPLS\_EWS
  - VPLS\_EWS\_NO\_CE
  - VPLS\_ERS
  - VPLS\_ERS\_NO\_CE



---

**Note** For all service definition subtypes with NO\_CE, you do not declare the CE devices to be CPEs and you set policy attributes for the PE and the UNI (the PE-POP or PE-CLE).

---

- Core types:
  - MPLS—provider core network is MPLS-enabled
  - Ethernet—provider core network uses Ethernet switches
- Information about the attachment circuits:
  - Device interface type (example: GigabitEthernet)
  - VLAN IDs
  - UNI Port Security
  - Protocols (examples: CDP, VTP)

The properties to set for the PE and CE/UNI are based on the core type and service definition subtype. For example, if the policy subtype is:

- **VPLS\_ERS** for an Ethernet core, you specify the CE interface type, format and encapsulation type, and whether to filter BPDU.
- **VPLS\_EWS\_NO\_CE** for an MPLS core, you specify the PE/CLE interface type and format, protocol tunneling, and system MTU.



**Note**

---

For each service definition property, you can set an additional attribute, **editable=true**, to allow the network operator to override these attributes when creating the service request. If an attribute is set to **editable=false**, these attributes cannot be changed in the service request.

---

See the following example for a **VPLS\_ERS** service definition:

```
<soapenv:Body>
  <ns1:createInstance>
    <objectPath xsi:type="ns1:CIMObjectPath">
      <className xsi:type="xsd:string">ServiceDefinition</className>
      <properties xsi:type="ns1:CIMPropertyList"
        soapenc:arrayType="ns1:CIMProperty[]">
        <item xsi:type="ns1:CIMProperty">
          <name xsi:type="xsd:string">Name</name>
          <value xsi:type="xsd:string">VplsPolicyERS</value>
        </item>
        <item xsi:type="ns1:CIMProperty">
```

```

    <name xsi:type="xsd:string">Type</name>
    <value xsi:type="xsd:string">Vpls</value>
  </item>
</properties>
<objectPath xsi:type="ns1:CIMObjectPath">
  <className xsi:type="xsd:string">ServiceDefinitionDetails</className>
  <properties xsi:type="ns1:CIMPropertyList"
    soapenc:arrayType="ns1:CIMProperty[]">
    <item xsi:type="ns1:CIMProperty">
      <name xsi:type="xsd:string">SubType</name>
      <value xsi:type="xsd:string">VPLS_ERS</value>
    </item>
    <item xsi:type="ns1:CIMProperty">
      <name xsi:type="xsd:string">Core_Type</name>
      <value xsi:type="xsd:string">MPLS</value>
      <qualifier xsi:type="ns1:CIMQualifier">
        <name xsi:type="xsd:string">editable</name>
        <value xsi:type="xsd:string">true</value>
      </qualifier>
    </item>
    <item xsi:type="ns1:CIMProperty">
      <name xsi:type="xsd:string">CE_Intf_Type</name>
      <value xsi:type="xsd:string">GigabitEthernet</value>
      <qualifier xsi:type="ns1:CIMQualifier">
        <name xsi:type="xsd:string">editable</name>
        <value xsi:type="xsd:string">true</value>
      </qualifier>
    </item>
    <item xsi:type="ns1:CIMProperty">
      <name xsi:type="xsd:string">CE_Encap</name>
      <value xsi:type="xsd:string">DOT1Q</value>
      <qualifier xsi:type="ns1:CIMQualifier">
        <name xsi:type="xsd:string">editable</name>
        <value xsi:type="xsd:string">true</value>
      </qualifier>
    </item>
    <item xsi:type="ns1:CIMProperty">
      <name xsi:type="xsd:string">PE_Encap</name>
      <value xsi:type="xsd:string">DOT1Q</value>
      <qualifier xsi:type="ns1:CIMQualifier">
        <name xsi:type="xsd:string">editable</name>
        <value xsi:type="xsd:string">true</value>
      </qualifier>
    </item>
  </properties>
</objectPath>

```

## VPLS Autodiscovery

VPLS autodiscovery eliminates the need to manually configure the VPLS neighbors. It discovers PEs within the same VPLS domain and automatically detects when PEs are added or removed from the domain.

To use VPLS autodiscovery, all PE devices in the VPLS domain must be VPLS autodiscovery enabled. Mixed topologies (that is, some PEs configured with VPLS autodiscovery enabled and some without) are not supported. The VPLS discovery mode should be enabled for all service requests under the same virtual forwarding interface (VFI).

A detailed description of VPLS autodiscovery, including other prerequisites, is found in the [Cisco Prime Provisioning 7.0 User Guide](#).

The complete list of XML examples for VPLS is available here:  
[Cisco Prime Provisioning API 6.8 Programmer Reference](#)

The following example illustrates how you activate VPLS autodiscovery in Prime Provisioning via the NBI.

## VPLS Autodiscovery Example

The following is an example of how to create a VPLS autodiscovery service order.

The relevant attribute that needs to be set for this service order is **DiscoveryMode**, which is highlighted with bold in the example below. In the example, it is set to **AutoDiscovery**.

Example: CreateVPLsServiceOrder\_ERS\_NO\_CE.xml

```
<?xml version="1.0" encoding="UTF-8"?>
<soapenv:Envelope
  xmlns:soapenv="http://schemas.xmlsoap.org/soap/envelope/"
  xmlns:soapenc="http://schemas.xmlsoap.org/soap/encoding/"
  xmlns:xsd="http://www.w3.org/2001/XMLSchema"
  xmlns:xsi="http://www.w3.org/2001/XMLSchema-instance"
  xmlns:ns0="http://www.cisco.com/cim-cx/2.0"
  xmlns:ns1="urn:CIM">
  <soapenv:Header>
    <!-- WaitTimeout has a default set in system properties.-->
    <ns0:message id="87855" timestamp="2002-12-13T14:55:38.885Z"
      Wait="true" WaitTimeout="90" sessiontoken="p36bttjwy1"/>
  </soapenv:Header>
  <soapenv:Body>
    <ns1:performBatchOperation>
      <actions xsi:type="ns1:CIMActionList"
        soapenc:arrayType="ns1:CIMAction[]">
        <action>
          <actionName xsi:type="xsd:string">createInstance</actionName>
          <objectPath xsi:type="ns1:CIMObjectPath">
            <className xsi:type="xsd:string">ServiceOrder</className>
            <properties xsi:type="ns1:CIMPropertyList"
              soapenc:arrayType="ns1:CIMProperty[]">
              <item xsi:type="ns1:CIMProperty">
                <name xsi:type="xsd:string">ServiceName</name>
                <value xsi:type="xsd:string">ServiceOrder257</value>
              </item>
              <item xsi:type="ns1:CIMProperty">
                <name xsi:type="xsd:string">DesiredDueDate</name>
                <value xsi:type="xsd:dateTime">2008-12-13T14:55:38.885Z</value>
              </item>
              <item xsi:type="ns1:CIMProperty">
                <name xsi:type="xsd:string">NumberOfRequests</name>
                <value xsi:type="xsd:string">1</value>
              </item>
            </properties>
          </objectPath>
        </action>
        <action>
          <actionName xsi:type="xsd:string">createInstance</actionName>
          <objectPath xsi:type="ns1:CIMObjectPath">
            <className xsi:type="xsd:string">ServiceRequest</className>
            <properties xsi:type="ns1:CIMPropertyList"
              soapenc:arrayType="ns1:CIMProperty[]">
```



```

    <item xsi:type="ns1:CIMProperty">
      <name xsi:type="xsd:string">RequestName</name>
      <value xsi:type="xsd:string">EvcSR-7</value>
    </item>
    <item xsi:type="ns1:CIMProperty">
      <name xsi:type="xsd:string">Type</name>
      <value xsi:type="xsd:string">Evc</value>
    </item>
  </properties>
<objectPath xsi:type="ns1:CIMObjectPath">
  <className xsi:type="xsd:string">ServiceRequestDetails</className>
  <properties xsi:type="ns1:CIMPropertyList"
    soapenc:arrayType="ns1:CIMProperty[]">
    <item xsi:type="ns1:CIMProperty">
      <name xsi:type="xsd:string">ServiceDefinition</name>
      <value xsi:type="xsd:string">ETHERNET_PW_VC</value><!-- Interworking
policy -->
      <qualifier xsi:type="xsd:string">
        <name xsi:type="xsd:string">ServiceDefinitionType</name>
        <value xsi:type="xsd:string">Evc</value>
      </qualifier>
    </item>
    <item xsi:type="ns1:CIMProperty">
      <name xsi:type="xsd:string">AutopickVCID</name>
      <value xsi:type="xsd:string">>true</value>
    </item>
    <item xsi:type="ns1:CIMProperty">
      <name xsi:type="xsd:string">VPN</name>
      <value xsi:type="xsd:string">vpn1</value>
    </item>
    <item xsi:type="ns1:CIMProperty">
      <name xsi:type="xsd:string">DiscoveryMode</name>
      <value xsi:type="xsd:string">AutoDiscovery</value>
    </item>
    <item xsi:type="ns1:CIMProperty">
      <name xsi:type="xsd:string">UseSVI</name>
      <value xsi:type="xsd:string">>true</value>
    </item>
    <item xsi:type="ns1:CIMProperty">
      <name xsi:type="xsd:string">UseSplitHorizon</name>
      <value xsi:type="xsd:string">>true</value>
    </item>
  </properties>

<!-- Ethernet Link -->

<objectPath xsi:type="ns1:CIMObjectPath">
  <className xsi:type="xsd:string">EvcLink</className>
  <properties xsi:type="ns1:CIMPropertyList"
    soapenc:arrayType="ns1:CIMProperty[]">
    <item xsi:type="ns1:CIMProperty">
      <name xsi:type="xsd:string">Npe</name>
      <value xsi:type="xsd:string">iscind-7609-2</value>
    </item>
    <item xsi:type="ns1:CIMProperty">
      <name xsi:type="xsd:string">UniInftId</name>
      <value xsi:type="xsd:string">GigabitEthernet7/0/13</value>
    </item>
  </properties>

  <objectPath xsi:type="ns1:CIMObjectPath">
    <className xsi:type="xsd:string">EvcETHLinkAttrs</className>
    <properties xsi:type="ns1:CIMPropertyList"

```

```

        soapenc:arrayType="ns1:CIMProperty[]">
<item xsi:type="ns1:CIMProperty">
  <name xsi:type="xsd:string">SystemMTU</name>
  <value xsi:type="xsd:string">1563</value>
</item>
<item xsi:type="ns1:CIMProperty">
  <name xsi:type="xsd:string">AutoPickVlanId</name>
  <value xsi:type="xsd:string">>false</value>
</item>
<item xsi:type="ns1:CIMProperty">
  <name xsi:type="xsd:string">VlanID</name>
  <value xsi:type="xsd:string">18</value>
</item>
<item xsi:type="ns1:CIMProperty">
  <name xsi:type="xsd:string">UseServiceInst</name>
  <value xsi:type="xsd:string">>true</value>
</item>
<item xsi:type="ns1:CIMProperty">
  <name xsi:type="xsd:string">XconnectOnSVI</name>
  <value xsi:type="xsd:string">>true</value>
</item>
</properties>
</objectPath>
<objectPath xsi:type="ns1:CIMObjectPath">
  <className xsi:type="xsd:string">SvcServiceInstanceAttrs</className>
  <properties xsi:type="ns1:CIMPropertyList"
    soapenc:arrayType="ns1:CIMProperty[]">
    <item xsi:type="ns1:CIMProperty">
      <name xsi:type="xsd:string">AutoPickServiceInstId</name>
      <value xsi:type="xsd:string">>false</value>
    </item>
    <item xsi:type="ns1:CIMProperty">
      <name xsi:type="xsd:string">ServiceInstID</name>
      <value xsi:type="xsd:string">3488</value>
    </item>
    <item xsi:type="ns1:CIMProperty">
      <name xsi:type="xsd:string">BothTags</name>
      <value xsi:type="xsd:string">>true</value>
    </item>
    <item xsi:type="ns1:CIMProperty">
      <name xsi:type="xsd:string">OuterVlanRange</name>
      <value xsi:type="xsd:string">745</value>
    </item>
    <item xsi:type="ns1:CIMProperty">
      <name xsi:type="xsd:string">InnerVlanRange</name>
      <value xsi:type="xsd:string">746</value>
    </item>
  </properties>
</objectPath>
<objectPath xsi:type="ns1:CIMObjectPath">
  <className xsi:type="xsd:string">SvcUNIInterfaceAttrs</className>
  <properties xsi:type="ns1:CIMPropertyList"
    soapenc:arrayType="ns1:CIMProperty[]">
    <item xsi:type="ns1:CIMProperty">
      <name xsi:type="xsd:string">Shutdown</name>
      <value xsi:type="xsd:string">>true</value>
    </item>
    <item xsi:type="ns1:CIMProperty">
      <name xsi:type="xsd:string">PeIntfDesc</name>
      <value xsi:type="xsd:string">*** AC1 ***</value>
    </item>
  </properties>
</objectPath>
</objectPath>

```

```

    <objectPath xsi:type="ns1:CIMObjectPath">
    <className xsi:type="xsd:string">EvcLink</className>
    <properties xsi:type="ns1:CIMPropertyList"
      soapenc:arrayType="ns1:CIMProperty[]">
      <item xsi:type="ns1:CIMProperty">
        <name xsi:type="xsd:string">Npe</name>
        <value xsi:type="xsd:string">iscind-7609-1</value>
      </item>
      <item xsi:type="ns1:CIMProperty">
        <name xsi:type="xsd:string">UniInftId</name>
        <value xsi:type="xsd:string">GigabitEthernet7/0/13</value>
      </item>
    </properties>

    <objectPath xsi:type="ns1:CIMObjectPath">
    <className xsi:type="xsd:string">EvcETHLinkAttrs</className>
    <properties xsi:type="ns1:CIMPropertyList"
      soapenc:arrayType="ns1:CIMProperty[]">
    <item xsi:type="ns1:CIMProperty">
      <name xsi:type="xsd:string">SystemMTU</name>
      <value xsi:type="xsd:string">1563</value>
    </item>
    <item xsi:type="ns1:CIMProperty">
      <name xsi:type="xsd:string">AutoPickVlanId</name>
      <value xsi:type="xsd:string">>false</value>
    </item>
    <item xsi:type="ns1:CIMProperty">
      <name xsi:type="xsd:string">VlanID</name>
      <value xsi:type="xsd:string">18</value>
    </item>
    <item xsi:type="ns1:CIMProperty">
      <name xsi:type="xsd:string">UseServiceInst</name>
      <value xsi:type="xsd:string">>true</value>
    </item>
    <item xsi:type="ns1:CIMProperty">
      <name xsi:type="xsd:string">XconnectOnSVI</name>
      <value xsi:type="xsd:string">>true</value>
    </item>
  </properties>
</objectPath>
<objectPath xsi:type="ns1:CIMObjectPath">
<className xsi:type="xsd:string">EvcServiceInstanceAttrs</className>
<properties xsi:type="ns1:CIMPropertyList"
  soapenc:arrayType="ns1:CIMProperty[]">
  <item xsi:type="ns1:CIMProperty">
    <name xsi:type="xsd:string">AutoPickServiceInstId</name>
    <value xsi:type="xsd:string">>false</value>
  </item>
  <item xsi:type="ns1:CIMProperty">
    <name xsi:type="xsd:string">ServiceInstID</name>
    <value xsi:type="xsd:string">3439</value>
  </item>
  <item xsi:type="ns1:CIMProperty">
    <name xsi:type="xsd:string">BothTags</name>
    <value xsi:type="xsd:string">>true</value>
  </item>
  <item xsi:type="ns1:CIMProperty">
    <name xsi:type="xsd:string">OuterVlanRange</name>
    <value xsi:type="xsd:string">745</value>
  </item>
  <item xsi:type="ns1:CIMProperty">
    <name xsi:type="xsd:string">InnerVlanRange</name>
    <value xsi:type="xsd:string">746</value>
  </item>
</properties>

```

```

        </item>
      </properties>
    </objectPath>
  <objectPath xsi:type="ns1:CIMObjectPath">
    <className xsi:type="xsd:string">EvcUNIInterfaceAttrs</className>
    <properties xsi:type="ns1:CIMPropertyList"
      soapenc:arrayType="ns1:CIMProperty[]">
      <item xsi:type="ns1:CIMProperty">
        <name xsi:type="xsd:string">Shutdown</name>
        <value xsi:type="xsd:string">>true</value>
      </item>
      <item xsi:type="ns1:CIMProperty">
        <name xsi:type="xsd:string">PeIntfDesc</name>
        <value xsi:type="xsd:string">*** AC1 ***</value>
      </item>
    </properties>
  </objectPath>
</objectPath>
</objectPath>
</objectPath>
</action>
</actions>
</ns1:performBatchOperation>
</soapenv:Body>
</soapenv:Envelope>

```

#### Related APIs

- [CreateVPLsServiceOrder\\_ERS\\_NO\\_CE\\_IOSXR.xml](#)

## VPLS Service Requests

A VPLS service request defines the service definition and VPN to use, assigns interfaces and attributes for each attachment circuit (**VplsLink**), and applies template information.



#### Note

The attachment circuit, or **VplsLink**, defines the layer 2 path from the CE to the PE, including any intermediate devices. You provision attachment circuits on the PE-facing port of the CE, on all ports of intermediate devices, and on the CE-facing port on the PE.

When you deploy a VPLS service request using a service order, the attributes specified in the service definition are applied to the devices and interfaces defined in the service request, along with the link attributes for each attachment circuit.

The service request link attributes include any parameters marked as editable in the service definition and link parameters specific to each attachment circuit. The following XML example shows a partial list of the properties that can be specified for the attachment circuit **LinkAttrs**.

The complete list of XML examples for VPLS is available here:

[Cisco Prime Provisioning API 6.8 Programmer Reference](#)

```

<objectPath xsi:type="ns1:CIMObjectPath">
  <className xsi:type="xsd:string">LinkAttrs</className>
  <properties xsi:type="ns1:CIMPropertyList"
    soapenc:arrayType="ns1:CIMProperty[]">

```

```

<item xsi:type="ns1:CIMProperty">
  <name xsi:type="xsd:string">CE_Intf_Name</name>
  <value xsi:type="xsd:string">GigabitEthernet0/1</value>
</item>
<item xsi:type="ns1:CIMProperty">
  <name xsi:type="xsd:string">PE_Intf_Name</name>
  <value xsi:type="xsd:string">GigabitEthernet1/1</value>
</item>
<item xsi:type="ns1:CIMProperty">
  <name xsi:type="xsd:string">Disable_CDP</name>
  <value xsi:type="xsd:string">false</value>
</item>
<item xsi:type="ns1:CIMProperty">
  <name xsi:type="xsd:string">Uni_Duplex</name>
  <value xsi:type="xsd:string">Half</value>
</item>
<item xsi:type="ns1:CIMProperty">
  <name xsi:type="xsd:string">Uni_Shutdown</name>
  <value xsi:type="xsd:string">true</value>
</item>
<item xsi:type="ns1:CIMProperty">
  <name xsi:type="xsd:string">Uni_Speed</name>
  <value xsi:type="xsd:string">100</value>
</item>
<item xsi:type="ns1:CIMProperty">
  <name xsi:type="xsd:string">Uni_Port_Security</name>
  <value xsi:type="xsd:string">true</value>
</item>
<item xsi:type="ns1:CIMProperty">
  <name xsi:type="xsd:string">Uni_Max_Mac_Address</name>
  <value xsi:type="xsd:string">13</value>
</item>
<item xsi:type="ns1:CIMProperty">
  <name xsi:type="xsd:string">Uni_Violation_Action</name>
  <value xsi:type="xsd:string">PROTECT</value>
</item>
<item xsi:type="ns1:CIMProperty">
  <name xsi:type="xsd:string">Uni_Aging</name>
  <value xsi:type="xsd:string">234</value>
</item>
<item xsi:type="ns1:CIMProperty">
  <name xsi:type="xsd:string">Uni_Protocol_Tunnelling</name>
  <value xsi:type="xsd:string">true</value>
</item>
<item xsi:type="ns1:CIMProperty">
  <name xsi:type="xsd:string">Tunnel_Stp_Threshold</name>
  <value xsi:type="xsd:string">3001</value>
</item>
<item xsi:type="ns1:CIMProperty">
  <name xsi:type="xsd:string">Tunnel_Cdp_Threshold</name>
  <value xsi:type="xsd:string">1001</value>
</item>
<item xsi:type="ns1:CIMProperty">
  <name xsi:type="xsd:string">Tunnel_Vtp_Threshold</name>
  <value xsi:type="xsd:string">2001</value>
</item>
<item xsi:type="ns1:CIMProperty">
  <name xsi:type="xsd:string">Tunnel_Stp_Enable</name>
  <value xsi:type="xsd:string">true</value>
</item>
<item xsi:type="ns1:CIMProperty">
  <name xsi:type="xsd:string">Tunnel_Vtp_Enable</name>
  <value xsi:type="xsd:string">true</value>
</item>

```

```

<item xsi:type="ns1:CIMProperty">
  <name xsi:type="xsd:string">Tunnel_Recovery_Interval</name>
  <value xsi:type="xsd:string">4001</value>
</item>
<item xsi:type="ns1:CIMProperty">
  <name xsi:type="xsd:string">Tunnel_Cdp_Enable</name>
  <value xsi:type="xsd:string">true</value>
</item>
<item xsi:type="ns1:CIMProperty">
  <name xsi:type="xsd:string">Autopick_Vlan_ID</name>
  <value xsi:type="xsd:string">true</value>
</item>
<item xsi:type="ns1:CIMProperty">
  <name xsi:type="xsd:string">System_MTU</name>
  <value xsi:type="xsd:string">1522</value>
</item>
<item xsi:type="ns1:CIMProperty">
  <name xsi:type="xsd:string">PE_Intf_Desc</name>
  <value xsi:type="xsd:string">Pe Intf Desc</value>
</item>
</properties>
<objectPath xsi:type="ns1:CIMObjectPath">
<className xsi:type="xsd:string">LinkTemplate</className>
<properties xsi:type="ns1:CIMPropertyList"
  soapenc:arrayType="ns1:CIMProperty[]">
  <item xsi:type="ns1:CIMProperty">
    <name xsi:type="xsd:string">LogicalDevice</name>
    <value xsi:type="xsd:string">ensw3550-1</value>
  </item>
  <item xsi:type="ns1:CIMProperty">
    <name xsi:type="xsd:string">DatafilePath</name>
    <value xsi:type="xsd:string">/nbi/AccessList</value>
  </item>
  <item xsi:type="ns1:CIMProperty">
    <name xsi:type="xsd:string">TemplateActive</name>
    <value xsi:type="xsd:string">true</value>
  </item>
  <item xsi:type="ns1:CIMProperty">
    <name xsi:type="xsd:string">TemplateAction</name>
    <value xsi:type="xsd:string">APPEND</value>
  </item>
</properties>

```

## Provisioning Example

This section describes the process for using the API to provision VPLS, and includes the operation, object definition (className), and parameter definitions.

## Process Summary

This VPLS provisioning example uses the following processes:

1. Create device groups (optional).
2. Create devices.
3. Collect device configurations.
4. Create provider.

5. Create regions.
6. Declare devices as PEs.
7. Create access domains and assign PEs to them.
8. Create customer.
9. Create sites.
10. Declare devices as CPEs (not required for service types with no CE present).
11. Assign CPE devices to sites.
12. Create named physical circuits (not required if **ManualConfig=true**).
13. Create VLAN ID pool.
14. Create VC ID pool.
15. Create VPN.
16. Create VPLS service definition (policy).
17. Create VPLS service request.

## Prerequisites

For security reasons, Prime Provisioning requires the virtual terminal protocol (VTP) to be configured in transparent mode on all switches involved in Ethernet Relay Service (ERS) or Ethernet Wire Service (EWS) before provisioning VPLS service requests.

To set the VTP mode, enter the following Cisco IOS commands:

```
configure terminal
vtp mode transparent
```

Enter the following Cisco IOS command to verify that the VTP has changed to transparent mode:

```
Show vtp status
```

## RBAC

Prime Provisioning uses a Cisco role-based access control (RBAC) product for user login and logoff. These user roles and permissions are set up using the GUI.

When you establish an API session, you are given a session token during the login. For each API XML request, the session token is verified against the RBAC processor to ensure that the API user has permissions for that operation. If the user does not have permissions, the API returns an error.

See the [Cisco Prime Provisioning 7.0 User Guide](#) for information on setting up user roles and permissions.

## Provisioning Process

This section describes the process for provisioning VPLS using XML examples.

The complete list of XML examples for VPLS is available here:

[Cisco Prime Provisioning API 6.8 Programmer Reference](#)

**Note**

For clarity, this provisioning process shows each step as a separate XML request. Many of these steps can be combined using **performBatchOperations**.

**Step 1** Create device groups (optional).

**Table 8-1** Create Device Group

Operation	className	Required Parameters
createInstance	DeviceGroup	Name

**XML Examples:**

- CreateDeviceGroup.xml

**Tip**

If you plan to create device groups, create the empty device groups before you create the devices. As you create each device, add the associated device group name as a key property in the create device XML request.

In the following example, the device group (CustDev) is added as a key property when creating the device **CiscoRouter**:

```
<ns1:createInstance>
  <objectPath xsi:type="ns1:CIMObjectPath">
    <className xsi:type="xsd:string">CiscoRouter</className>
    <properties xsi:type="ns1:CIMPropertyList"
soapenc:arrayType="ns1:CIMProperty[]">
      <item xsi:type="ns1:CIMProperty">
        <name xsi:type="xsd:string">DeviceGroup</name>
        <value xsi:type="xsd:string">CustDev</value>
      </item>
      <item xsi:type="ns1:CIMProperty">
        <name xsi:type="xsd:string">CfgUpDnldMech</name>
        <value xsi:type="xsd:string">DEFAULT</value>
      </item>
      <item xsi:type="ns1:CIMProperty">
        <name xsi:type="xsd:string">TransportMechanism</name>
        <value xsi:type="xsd:string">DEFAULT</value>
      </item>
      <item xsi:type="ns1:CIMProperty">
        <name xsi:type="xsd:string">Password</name>
        <value xsi:type="xsd:string">vpnsc</value>
      </item>
    </properties>
  </objectPath>
</createInstance>
```

**Step 2** Create devices.

Every network element that Prime Provisioning manages must be defined as a device in the system. An element is any device from which Prime Provisioning can collect configuration information.



**Table 8-2** Create Devices

Operation	className	Required Parameters
createInstance	<ul style="list-style-type: none"> <li>CiscoRouter</li> <li>CatOS</li> </ul> <p><b>Note</b> If the service definition policy subtype is <b>VPLS_ERS</b>, the CE must be a <b>CiscoRouter</b>.</p>	One or more of the following: <ul style="list-style-type: none"> <li>ManagementIPAddress</li> <li>HostName</li> <li>DomainName</li> </ul>

**XML Examples:**

- CreateCiscoRouter.xml
- CreateCat.xml

**Step 3** Collect device configurations.

A device configuration collection is a task. This task uploads the current configuration from the device to the Prime Provisioning database. The collection task is executed through a service request, and the service request is scheduled through a service order.

**Note**

The service request name must be unique for each NBI API.

**Table 8-3** Collect Device Configurations

Operation	className	Required Parameters
createInstance	ServiceOrder	<ul style="list-style-type: none"> <li>ServiceName</li> <li>NumberOfRequests</li> <li>ServiceRequest</li> </ul>
	ServiceRequest	<ul style="list-style-type: none"> <li>RequestName</li> <li>Type=Task</li> <li>ServiceRequestDetails</li> </ul>
	ServiceRequestDetails	<ul style="list-style-type: none"> <li>SubType=COLLECTION</li> <li>Device (or DeviceGroup)</li> </ul> <p><b>Note</b> You must select at least one device or device group.</p> <ul style="list-style-type: none"> <li>RetrieveVersion=true</li> <li>RetrieveDeviceInterfaces=true</li> </ul>

**XML Examples:**

- CreateTaskServiceOrderCollection.xml

**Step 4** Create a provider.

The provider is the administrative domain of an ISP, with one BGP autonomous system (AS) number. The network owned by the provider is called the backbone network. If an ISP has two AS numbers, you must define it as two provider administrative domains.

**Table 8-4** Create a Provider

Operation	className	Required Parameters
createInstance	Provider	<ul style="list-style-type: none"> <li>• Name</li> <li>• AsNumber</li> </ul>

**XML Examples:**

CreateProvider.xml

**Step 5** Create regions.

Each provider can contain multiple regions.

**Table 8-5** Create Regions

Operation	className	Required Parameters
createInstance	Region	<ul style="list-style-type: none"> <li>• Name</li> <li>• Provider</li> </ul>

**XML Examples:**

CreateRegion.xml

**Step 6** Declare devices as PEs.

The XML request that assigns a PE role to a device is also used to:

- Assign PE devices to Regions/Provider
- Specify interface information

**Table 8-6** Create PE Devices

Operation	className	Required Parameters
createInstance	PE	<ul style="list-style-type: none"> <li>• Provider</li> <li>• Region</li> <li>• Role= <ul style="list-style-type: none"> <li>– PE_CLE</li> <li>– PE_POP</li> </ul> </li> <li>• Device</li> <li>• Interface</li> </ul>

**XML Examples:**

CreatePE.xml

**Step 7** Create access domains.

Prime Provisioning assigns a VLAN ID to the attachment circuit from the VLAN ID pool. Select all PE-POP devices to be associated with this domain, and later in the process, when VLAN ID pools are created, the PE-POP is automatically assigned a VLAN ID.

**Note**

If provisioning for an Ethernet provider core, all PE devices must be in the same access domain and a single VLAN ID is used for the entire VPLS VPN. If provisioning for an MPLS provider core, the PE devices can be in different access domains.

**Table 8-7** Create Access Domains

Operation	className	Required Parameters
createInstance	AccessDomain	<ul style="list-style-type: none"> <li>Name</li> <li>Provider</li> <li>PE (Role must be PE_POP)</li> </ul>

**XML Examples:**

- CreateAccessDomain.xml

**Step 8** Create a customer.

A customer is a requestor of VPN services. Each customer can contain multiple customer sites. Each site belongs to only one customer and can contain multiple CPEs.

**Table 8-8** Create Organization

Operation	className	Required Parameters
createInstance	Organization	<ul style="list-style-type: none"> <li>Name</li> </ul>

**XML Examples:**

- CreateOrganization.xml

**Step 9** Create sites and assign customers (**Organizations**) to them.**Table 8-9** Create Sites

Operation	className	Required Parameters
createInstance	Site	<ul style="list-style-type: none"> <li>Name</li> <li>Organization</li> </ul>

**XML Examples:**

- CreateSite.xml

**Step 10** Declare devices as CPEs. This step is not required for service subtypes with no CE present.

**Table 8-10** Create CPE Devices

Operation	className	Required Parameters
createInstance	Cpe	<ul style="list-style-type: none"> <li>• Site</li> <li>• Device</li> <li>• ManagementType</li> </ul>

**XML Examples:**

- CreateCpe.xml

**Step 11** Create Named Physical Circuits (NPCs). This step is not required if you plan to manually configure the physical links in the VPLS service request (Step 16).

Create an NPC for each attachment circuit (CE/UNI to PE-POP link). If there are intermediate devices, those links must also be added to the NPC using **PhysicalLink**.

**Note**

When creating an NPC, you must specify the CPE as the source device and the PE-POP as the destination device. If there are intermediate devices, such as PE-CLEs, the source and destination devices must follow the direction of the CPE to PE-POP link.

**Table 8-11** Create Named Physical Circuits

Operation	className	Required Parameters
createInstance	NamedPhysicalCircuit	PhysicalLink
	PhysicalLink	<ul style="list-style-type: none"> <li>• SrcDevice</li> <li>• DestDevice</li> <li>• SrcIfName</li> <li>• DestIfName</li> </ul>

You can create one XML request for the **NamedPhysicalCircuit** and include multiple **PhysicalLinks** as shown in the following example:

```
<ns1:createInstance>
  <objectPath xsi:type="ns1:CIMObjectPath">
    <className xsi:type="xsd:string">NamedPhysicalCircuit</className>
    <properties xsi:type="ns1:CIMPropertyList"
      soapenc:arrayType="ns1:CIMProperty[]">
    </properties>
    <objectPath xsi:type="ns1:CIMObjectPath">
      <className xsi:type="xsd:string">PhysicalLink</className>
      <properties xsi:type="ns1:CIMPropertyList"
        soapenc:arrayType="ns1:CIMProperty[]">
        <item xsi:type="ns1:CIMProperty">
```

```

<name xsi:type="xsd:string">SrcDevice</name>
<value xsi:type="xsd:string">Device1</value> </item>
<item xsi:type="ns1:CIMProperty">
<name xsi:type="xsd:string">DestDevice</name>
<value xsi:type="xsd:string">Device2</value> </item>
<item xsi:type="ns1:CIMProperty">
<name xsi:type="xsd:string">SrcIfName</name>
<value xsi:type="xsd:string">Intf1/0</value> </item>
<item xsi:type="ns1:CIMProperty">
<name xsi:type="xsd:string">DestIfName</name>
<value xsi:type="xsd:string">Intf2/1</value> </item>
</properties>
<objectPath xsi:type="ns1:CIMObjectPath">
<className xsi:type="xsd:string">PhysicalLink</className>
<properties xsi:type="ns1:CIMPropertyList"
soapenc:arrayType="ns1:CIMProperty[]">
<item xsi:type="ns1:CIMProperty">
<name xsi:type="xsd:string">SrcDevice</name>
<value xsi:type="xsd:string">Device3</value> </item>
<item xsi:type="ns1:CIMProperty">
<name xsi:type="xsd:string">DestDevice</name>
<value xsi:type="xsd:string">Device5</value> </item>
<item xsi:type="ns1:CIMProperty">
<name xsi:type="xsd:string">SrcIfName</name>
<value xsi:type="xsd:string">Intf3/0</value> </item>
<item xsi:type="ns1:CIMProperty">
<name xsi:type="xsd:string">DestIfName</name>
<value xsi:type="xsd:string">Intf5/1</value> </item>
</properties>
</objectPath>
</objectPath>
</ns1:createInstance>

```

#### XML Examples:

- CreateNamedPhysicalCircuit.xml
- CreateNamedPhysicalCircuitRing.xml—Use this example if there is a Ring topology configuration on the PE-CLEs.
- CreateNamedPhysicalCircuitRingExisting.xml—Use this example to reference an NPC ring that has already been created.

#### Step 12 Create VLAN ID pool.

Create a VLAN ID pool, specify a range, and associate it to an access domain to manually enter the parameters for a VLAN ID pool. To have Prime Provisioning automatically assign VLANs to the attachment circuits, specify the **Autopick\_Vlan\_ID** keyword in the service definition (Step 15).

When provisioning for an Ethernet core, VPLS service requests use the VLAN ID to reference the attachment circuits.

**Table 8-12** Create VLAN ID Pools

Operation	className	Required Parameters
createInstance	VlanIdPool	<ul style="list-style-type: none"> <li>• Start</li> <li>• Size</li> <li>• AssocClassType</li> <li>• AssocClassId</li> </ul>

**XML Examples:**

- CreateVlanIdPool.xml

**Step 13** Create VC ID pool.

For a VPLS VPN, all PE-POP routers use the same VC ID to establish the virtual circuit (VC) across the provider core. The VC ID is also the VPN ID and is assigned from the VC ID pool. Prime Provisioning ensures that VC IDs are unique among VPLS VPNs.

**Note**

A VC ID pool is global (not associated with a provider or organization).

**Table 8-13** Create VC ID Pool

Operation	className	Required Parameters
createInstance	VcIdPool	<ul style="list-style-type: none"> <li>• Start</li> <li>• Size</li> </ul>

**XML Examples:**

- CreateVcIdPool.xml

**Step 14** Create a VPN.

When you create a VPN to use in VPLS provisioning, you must enable it to support VPLS (**VplsVpn=true**), and define the type of service (**ERS** or **EWS**).

Prime Provisioning assigns a VPN ID (from the VC ID pool) to each VPLS VPN.

**Table 8-14** Create VPNs

Operation	className	Required Parameters
createInstance	VPN	<ul style="list-style-type: none"> <li>• Name</li> <li>• Organization or Provider</li> <li>• VplsVpn=true</li> <li>• ServiceType= <ul style="list-style-type: none"> <li>– ERS</li> <li>– EWS</li> </ul> </li> </ul>

**XML Examples:**

- CreateVPN.xml

**Step 15** Create the VPLS service definition (policy).

A VPLS service definition specifies the core type, service subtype, device properties, and the attributes common to all attachment circuits.

Table 8-15 Create a VPLS Service Definition

Operation	className	Required Parameters
createInstance	ServiceDefinition	<ul style="list-style-type: none"> <li>Name</li> <li>Type=Vpls</li> <li>Provider or Organization</li> </ul> <p><b>Note</b> If you do not specify a <b>Provider</b> or <b>Organization</b>, the service policy is global</p> <ul style="list-style-type: none"> <li>ServiceDefinitionDetails</li> </ul>
	ServiceDefinitionDetails	<ul style="list-style-type: none"> <li>SubType= <ul style="list-style-type: none"> <li>VPLS_EWS</li> <li>VPLS_EWS_NO_CE</li> <li>VPLS_ERS</li> <li>VPLS_ERS_NO_CE</li> </ul> </li> <li>Core_Type= <ul style="list-style-type: none"> <li>MPLS</li> <li>Ethernet</li> </ul> </li> <li>PE_Encap and CE_Encap= <ul style="list-style-type: none"> <li>DOT1Q</li> <li>DEFAULT</li> </ul> </li> </ul> <p><b>Note</b> If you specify <b>DEFAULT</b>, define the port type with the <b>Use_Native_Vlan</b> attribute.</p> <ul style="list-style-type: none"> <li>Use_Native_Vlan=true for Trunk with Native VLAN.</li> <li>Use_Native_Vlan=false for Access Port.</li> <li>VplsUniMacAddress <ul style="list-style-type: none"> <li>MacAddress (You can list multiple secure MAC addresses)</li> </ul> </li> <li>Autopick_Vlan_ID</li> </ul>

**Note**

If **Autopick\_Vlan\_ID=true**, be sure that an access domain is attached to the PE-POP, and a VLAN ID pool is assigned to the access domain (Step 7).

**XML Examples:**

- CreateVPLSServiceDefn\_EWS.xml
- CreateVPLSServiceDefn\_EWS\_NO\_CE.xml
- CreateVPLSServiceDefn\_ERS.xml
- CreateVPLSServiceDefn\_ERS\_NO\_CE.xml

**Step 16** Create the VPLS service request.

An VPLS service request defines the service definition and VPN, assigns interfaces and attributes for each attachment circuit (**VplsLink**), and applies any template information.

**Table 8-16** Create a VPLS Service Request

Operation	className	Required Parameters
createInstance	ServiceOrder	<ul style="list-style-type: none"> <li>• ServiceName</li> <li>• NumberOfRequests</li> <li>• Provider or Organization</li> </ul> <p><b>Note</b> If you do not specify a <b>Provider</b> or <b>Organization</b>, the service policy is global.</p> <ul style="list-style-type: none"> <li>• ServiceRequest</li> </ul>
	ServiceRequest	<ul style="list-style-type: none"> <li>• RequestName</li> <li>• Type=Vpls</li> <li>• ServiceRequestDetails</li> </ul>



Table 8-16 Create a VPLS Service Request (continued)

Operation	className	Required Parameters
	ServiceRequestDetails	<ul style="list-style-type: none"> <li>ServiceDefinition <ul style="list-style-type: none"> <li>ServiceDefinitionType=Vpls</li> </ul> </li> <li>VPN</li> <li>VplsLink</li> </ul>
	VplsLink	<ul style="list-style-type: none"> <li>NPC</li> <li>or</li> <li>ManualConfig=true <ul style="list-style-type: none"> <li>PE</li> <li>CE (not required for policy subtypes with no CE present)</li> </ul> </li> </ul> <p><b>Note</b> You can use either <b>NPC</b> or <b>ManualConfig</b> to define the VplsLink interfaces. If you use <b>ManualConfig</b>, you must also specify the interfaces (<b>CE_Intf_Name</b>, <b>UNIDeviceInterface</b> for NO_CE subtypes, and <b>PE_Intf_Name</b>).</p> <ul style="list-style-type: none"> <li>VplsUniMacAddress</li> <li>Link Template (optional)</li> </ul> <p><b>Note</b> See the “<a href="#">Templates in a Service Request</a>” section on page 4-18.</p>

**Tip**

Record the **LocatorId** value from the XML response for the service request. The Locator ID is required for subsequent service request tasks.

**XML Example:**

- CreateVPLSServiceOrder\_ERS.xml
- CreateVPLSServiceOrder\_ERS\_NO\_CE.xml
- CreateVPLSServiceOrder\_EWS.xml
- CreateVPLSServiceOrder\_EWS\_NO\_CE.xml

## Auditing Service Requests

A configuration audit occurs automatically each time you deploy a service request. During this configuration audit, Prime Provisioning verifies that all Cisco IOS commands are present and that they have the correct syntax. An audit also verifies that there were no errors during deployment by examining the commands configured by the service request on the target devices. If the device configuration does not match what is defined in the service request, the audit flags a warning and sets the service request to a *Failed Audit* or *Lost* state.

If you do not want the configuration audit to occur, change the value for the **Audit** parameter. The **Audit** parameter supports these values:

- **Audit**—This is the default. A successfully deployed service request is automatically audited unless this flag is changed.
- **NoAudit**—Do not perform a configuration audit when the service request is deployed.
- **ForceAudit**—Perform a configuration audit even if the service request deployment is not successful.

You can use the Audit parameter with a **Create**, **Modify**, or **Decommission** service request or a **Deployment** task. See the [“Service Decommission” section on page 3-11](#) for more information. To perform a configuration audit as a separate task, see the [“Configuration Audit” section on page 3-11](#).



## EVC Provisioning

---

This chapter describes the provisioning support for EVC (flexible user network interface/Ethernet Virtual Circuit) provided in Cisco Prime Provisioning.

The following EVC support is available:

- Allows the “service designers” to plan the services that are specific to the services offered through the EVC Policy. This single policy is flexible enough to cater to different service offerings using the EVC architecture.
- Allows service designers to utilize most of the EVC features in a flexible manner, closely matching the hardware/platform flexibilities.
- Allows operators to deploy services as per the created EVC policies by creating service requests.

Note that CE devices are not supported.

To provision EVC using Prime Provisioning APIs, you need an EVC service definition and an EVC service request. The service definition specifies the core type, policy subtype, and common device properties. The service request defines the service definition to use, VPNs, attributes for each interface in the EVC link, and template information.

This chapter describes EVC service concepts and the steps required to provision EVC services using the Prime Provisioning API. The provisioning example (see [End-to-End Provisioning Process, page 9-139](#)) includes all steps from creating the inventory to auditing the service deployment.

For a detailed description of supported EVC features, policy attribute definitions, GUI implementation, and other information, see the [Cisco Prime Provisioning 7.0 User Guide](#).

This chapter contains the following sections:

- [EVC Service Definitions, page 9-1](#)
- [EVC Service Requests, page 9-41](#)
- [End-to-End Provisioning Process, page 9-139](#).

## EVC Service Definitions

A EVC service definition specifies the core type, policy subtype, and the attributes common to all EVC attachment circuits.

This section lists the supported service definitions, service orders, and policies and includes corresponding examples.

To provision EVC using Prime Provisioning API, an EVC service policy and an EVC service request are required and only one subtype will be defined and of type EVC.

The EVC service policy/service definition specifies the attributes related to the end-to-end EVC links and non-EVC links. The service request defines the device interfaces for each EVC/non-EVC link connection and can optionally override policy attributes in each of the corresponding links.

When you deploy an EVC service request using a service order, the attributes specified in the service definition are applied to the devices and interfaces listed in the service request, along with the attributes for each of the EVC/non-EVC links.

## Supported Service Definitions and Service Orders

Prime Provisioning supports the following EVC features:

- Creating:
  - EVC Service Definition/Policy
  - EVC Service Order/Request
- Modifying:
  - EVC Service Definition
  - EVC Service Order/Request
- Deleting:
  - EVC Service Definition/Policy
  - EVC Service Order/Request
- Viewing:
  - EVC Service Definition
  - EVC Service Request

The above operations are supported for policies and service requests, which are created to provision a variety of network configurations.

Template-based support is available for EVC Policy and service requests.

## Policy Types

For EVC, the following policy types are supported:

- Ethernet—Ethernet to Ethernet services can be configured using this policy type.
- ATM-Ethernet interworking—ATM to Ethernet services can be configured using this policy type. This new policy type is depicted in two of the policy XML examples.

## MPLS Core Connectivity Types

There are three MPLS core connectivity types:

- PSEUDOWIRE—Allows connectivity between two N-PEs across the MPLS core.
 

This option does not limit the service to point-to-point (E-Line). This is because even with the PSEUDOWIRE option selected, multiple CEs can still be connected to a bridge domain on one or both sides of the pseudowire.
- VPLS—Allows connectivity between multiple N-PEs across the MPLS core.

There is no limit on the number of N-PEs across the MPLS core within a service request. However, many service requests can refer to the same customer-associated VPN.

- LOCAL—For local connect cases in which no connectivity is required across the MPLS core.

In the following, policy examples are given for each of these connectivity types.

## Policy Examples

The following constitute XML policy examples for the three connectivity types that are supported across the MPLS core:

- [Creating a Local Connect Policy, page 9-3](#)
- [Creating a Pseudowire Policy, page 9-4](#)
- [Creating a VPLS Policy, page 9-4](#)
- [Creating a Local Connect Policy with ATM/Ethernet internetworking, page 9-5](#)
- [Creating a Pseudowire Policy with ATM/Ethernet Internetworking, page 9-10](#)
- [Creating a Pseudowire Policy Setting the MTU Size, page 9-15](#)
- [Creating a Pseudowire Head-End Policy for Access into L3VPN, page 9-20](#)
- [Creating a Pseudowire Policy With Reserved Bandwidth, page 9-24](#)
- [Configuring an SVI/EVC Hybrid Scenario, page 9-24](#)
- [Creating a Policy for Specifying Service Instance Name, page 9-28](#)
- [Creating a Multi-Segment Pseudowire Policy, page 9-31](#)
- [Creating an EVC VPLS Policy for E-TREE, page 9-36](#)
- [Policy Examples in the API Programmer Reference, page 9-40](#)

## Creating a Local Connect Policy

In this partial example, an EVC policy is created using local connect. The **TransportType** attribute is set to **LOCAL** as shown below.

See the full example in the API Programmer Reference.

Example: CreateEVCSvcDefn\_LOCAL.xml

```
<objectPath xsi:type="ns1:CIMObjectPath">
  <className xsi:type="xsd:string">ServiceDefinitionDetails</className>
  <properties xsi:type="ns1:CIMPropertyList"
    soapenc:arrayType="ns1:CIMProperty[]">
    <item xsi:type="ns1:CIMProperty">
      <name xsi:type="xsd:string">SubType</name>
      <value xsi:type="xsd:string">Evc</value>
    </item>
    <item xsi:type="ns1:CIMProperty">
      <name xsi:type="xsd:string">AccessType</name>
      <value xsi:type="xsd:string">ETHERNET</value>
    </item>
    <item xsi:type="ns1:CIMProperty">
      <name xsi:type="xsd:string">TransportType</name>
      <value xsi:type="xsd:string">LOCAL</value>
    </item>
    <item xsi:type="ns1:CIMProperty">
```

```

    <name xsi:type="xsd:string">UniShutdown</name>
    <value xsi:type="xsd:string">true</value>
    <qualifier xsi:type="ns1:CIMQualifier">
      <name xsi:type="xsd:string">editable</name>
      <value xsi:type="xsd:string">true</value>
    </qualifier>
  </item>

```

## Creating a Pseudowire Policy

In this partial example, a EVC policy is created using pseudowire. Here, the **TransportType** attribute is set to **Pseudowire**, indicated with bold text below.

See the full example in the API Programmer Reference.

Example: CreateEVCSERVICEDEFN\_PW.XML

```

<objectPath xsi:type="ns1:CIMObjectPath">
  <className xsi:type="xsd:string">ServiceDefinitionDetails</className>
  <properties xsi:type="ns1:CIMPropertyList"
    soapenc:arrayType="ns1:CIMProperty[]">
    <item xsi:type="ns1:CIMProperty">
      <name xsi:type="xsd:string">SubType</name>
      <value xsi:type="xsd:string">Evc</value>
    </item>
    <item xsi:type="ns1:CIMProperty">
      <name xsi:type="xsd:string">AccessType</name>
      <value xsi:type="xsd:string">ETHERNET</value>
    </item>
    <item xsi:type="ns1:CIMProperty">
      <name xsi:type="xsd:string">TransportType</name>
      <value xsi:type="xsd:string">PSEUDOWIRE</value>
    </item>

    <item xsi:type="ns1:CIMProperty">
      <name xsi:type="xsd:string">StdUniPort</name>
      <value xsi:type="xsd:string">true</value>
      <qualifier xsi:type="ns1:CIMQualifier">
        <name xsi:type="xsd:string">editable</name>
        <value xsi:type="xsd:string">true</value>
      </qualifier>
    </item>
    <item xsi:type="ns1:CIMProperty">
      <name xsi:type="xsd:string">UniShutdown</name>
      <value xsi:type="xsd:string">false</value>
      <qualifier xsi:type="ns1:CIMQualifier">
        <name xsi:type="xsd:string">editable</name>
        <value xsi:type="xsd:string">true</value>
      </qualifier>
    </item>
  </properties>

```

## Creating a VPLS Policy

In this partial example, a EVC policy is created using the VPLS transport type.

See the full example in the API Programmer Reference.

Example: CreateVplsEVCPolicy.xml

```

<objectPath xsi:type="ns1:CIMObjectPath">
  <className xsi:type="xsd:string">ServiceDefinitionDetails</className>
  <properties xsi:type="ns1:CIMPropertyList"
    soapenc:arrayType="ns1:CIMProperty[]">
    <item xsi:type="ns1:CIMProperty">
      <name xsi:type="xsd:string">SubType</name>
      <value xsi:type="xsd:string">Evc</value>
    </item>
    <item xsi:type="ns1:CIMProperty">
      <name xsi:type="xsd:string">AccessType</name>
      <value xsi:type="xsd:string">ETHERNET</value>
    </item>
    <item xsi:type="ns1:CIMProperty">
      <name xsi:type="xsd:string">TransportType</name>
      <value xsi:type="xsd:string">VPLS</value>
    </item>
    <item xsi:type="ns1:CIMProperty">
      <name xsi:type="xsd:string">UniShutdown</name>
      <value xsi:type="xsd:string">>true</value>
      <qualifier xsi:type="ns1:CIMQualifier">
        <name xsi:type="xsd:string">editable</name>
        <value xsi:type="xsd:string">>true</value>
      </qualifier>
    </item>
  </properties>
</objectPath>

```

## Creating a Local Connect Policy with ATM/Ethernet internetworking

In this example, a EVC policy is created using local connect with ATM/Ethernet internetworking.

The **ATM\_ETHERNET** policy attribute is highlighted with bold in this example.

Example: ATM\_ETHERNET\_VC-Pol-LOCAL\_Create-NBI-4.xml

```

<?xml version="1.0" encoding="UTF-8"?>
<soapenv:Envelope
  xmlns:soapenv="http://schemas.xmlsoap.org/soap/envelope/"
  xmlns:soapenc="http://schemas.xmlsoap.org/soap/encoding/"
  xmlns:xsd="http://www.w3.org/2001/XMLSchema"
  xmlns:xsi="http://www.w3.org/2001/XMLSchema-instance"
  xmlns:ns0="http://www.cisco.com/cim-cx/2.0"
  xmlns:ns1="urn:CIM">
  <soapenv:Header>
    <ns0:message id="87855" timestamp="2002-12-13T14:55:38.885Z"
      sessiontoken="p36bttjwy1"/>
  </soapenv:Header>
  <soapenv:Body>
    <ns1:createInstance>
      <objectPath xsi:type="ns1:CIMObjectPath">
        <className xsi:type="xsd:string">ServiceDefinition</className>
        <properties xsi:type="ns1:CIMPropertyList"
          soapenc:arrayType="ns1:CIMProperty[]">
          <item xsi:type="ns1:CIMProperty">
            <name xsi:type="xsd:string">Name</name>
            <value xsi:type="xsd:string">ATM_ETHERNET_Local_VC</value>
          </item>
          <item xsi:type="ns1:CIMProperty">
            <name xsi:type="xsd:string">Type</name>
            <value xsi:type="xsd:string">Evc</value>
          </item>
          <item xsi:type="ns1:CIMProperty">

```

```

    <name xsi:type="xsd:string">Organization</name>
    <value xsi:type="xsd:string">Customer1</value>
  </item>
</properties>
<objectPath xsi:type="ns1:CIMObjectPath">
  <className xsi:type="xsd:string">ServiceDefinitionDetails</className>
  <properties xsi:type="ns1:CIMPropertyList"
    soapenc:arrayType="ns1:CIMProperty[]">
    <item xsi:type="ns1:CIMProperty">
      <name xsi:type="xsd:string">SubType</name>
      <value xsi:type="xsd:string">Evc</value>
    </item>
    <item xsi:type="ns1:CIMProperty">
      <name xsi:type="xsd:string">TransportType</name>
      <value xsi:type="xsd:string">LOCAL</value>
    </item>
    <item xsi:type="ns1:CIMProperty">
      <name xsi:type="xsd:string">AccessType</name>
      <!-- Access Type ATM_ETHERNET newly added for interworking -->
      <value xsi:type="xsd:string">ATM_ETHERNET</value>
    </item>
    <item xsi:type="ns1:CIMProperty">
      <name xsi:type="xsd:string">TemplateEnabled</name>
      <value xsi:type="xsd:string">>false</value>
    </item>
    <item xsi:type="ns1:CIMProperty">
      <!--AtmEncapsulationType newly added which can have values AAL0,AAL5,ALL5SNAP
-->
      <name xsi:type="xsd:string">AtmEncapsulationType</name>
      <value xsi:type="xsd:string">AAL0</value>
      <qualifier xsi:type="ns1:CIMQualifier">
        <name xsi:type="xsd:string">editable</name>
        <value xsi:type="xsd:string">>true</value>
      </qualifier>
    </item>
    <!--ATmTransportMode newly Added which can have values VP or VC -->
    <item xsi:type="ns1:CIMProperty">
      <name xsi:type="xsd:string">AtmTransportMode</name>
      <value xsi:type="xsd:string">VC</value>
      <qualifier xsi:type="ns1:CIMQualifier">
        <name xsi:type="xsd:string">editable</name>
        <value xsi:type="xsd:string">>true</value>
      </qualifier>
    </item>
    <item xsi:type="ns1:CIMProperty">
      <name xsi:type="xsd:string">UniShutdown</name>
      <value xsi:type="xsd:string">>true</value>
      <qualifier xsi:type="ns1:CIMQualifier">
        <name xsi:type="xsd:string">editable</name>
        <value xsi:type="xsd:string">>true</value>
      </qualifier>
    </item>
    <item xsi:type="ns1:CIMProperty">
      <name xsi:type="xsd:string">PortSecurity</name>
      <value xsi:type="xsd:string">>false</value>
      <qualifier xsi:type="ns1:CIMQualifier">
        <name xsi:type="xsd:string">editable</name>
        <value xsi:type="xsd:string">>true</value>
      </qualifier>
    </item>
    <item xsi:type="ns1:CIMProperty">
      <name xsi:type="xsd:string">UniProtocolTunneling</name>
      <value xsi:type="xsd:string">>false</value>

```



```

    <qualifier xsi:type="ns1:CIMQualifier">
      <name xsi:type="xsd:string">editable</name>
      <value xsi:type="xsd:string">true</value>
    </qualifier>
  </item>
</item>
<item xsi:type="ns1:CIMProperty">
  <name xsi:type="xsd:string">StdUniPort</name>
  <value xsi:type="xsd:string">>false</value>
  <qualifier xsi:type="ns1:CIMQualifier">
    <name xsi:type="xsd:string">editable</name>
    <value xsi:type="xsd:string">true</value>
  </qualifier>
</item>
<item xsi:type="ns1:CIMProperty">
  <name xsi:type="xsd:string">UniKeepAlive</name>
  <value xsi:type="xsd:string">>false</value>
  <qualifier xsi:type="ns1:CIMQualifier">
    <name xsi:type="xsd:string">editable</name>
    <value xsi:type="xsd:string">true</value>
  </qualifier>
</item>
<item xsi:type="ns1:CIMProperty">
  <name xsi:type="xsd:string">UniSpeed</name>
  <value xsi:type="xsd:string">None</value>
  <qualifier xsi:type="ns1:CIMQualifier">
    <name xsi:type="xsd:string">editable</name>
    <value xsi:type="xsd:string">true</value>
  </qualifier>
</item>
<item xsi:type="ns1:CIMProperty">
  <name xsi:type="xsd:string">UniDuplex</name>
  <value xsi:type="xsd:string">None</value>
  <qualifier xsi:type="ns1:CIMQualifier">
    <name xsi:type="xsd:string">editable</name>
    <value xsi:type="xsd:string">true</value>
  </qualifier>
</item>
<item xsi:type="ns1:CIMProperty">
  <name xsi:type="xsd:string">UseExistingACLName</name>
  <value xsi:type="xsd:string">>false</value>
  <qualifier xsi:type="ns1:CIMQualifier">
    <name xsi:type="xsd:string">editable</name>
    <value xsi:type="xsd:string">>false</value>
  </qualifier>
</item>
<item xsi:type="ns1:CIMProperty">
  <name xsi:type="xsd:string">DirectConnect</name>
  <value xsi:type="xsd:string">true</value>
  <qualifier xsi:type="ns1:CIMQualifier">
    <name xsi:type="xsd:string">editable</name>
    <value xsi:type="xsd:string">>false</value>
  </qualifier>
</item>
<item xsi:type="ns1:CIMProperty">
  <name xsi:type="xsd:string">AutoPickEsiId</name>
  <value xsi:type="xsd:string">true</value>
  <qualifier xsi:type="ns1:CIMQualifier">
    <name xsi:type="xsd:string">editable</name>
    <value xsi:type="xsd:string">true</value>
  </qualifier>
</item>
<item xsi:type="ns1:CIMProperty">
  <name xsi:type="xsd:string">AutopickVCId</name>

```

```

    <value xsi:type="xsd:string">>false</value>
    <qualifier xsi:type="ns1:CIMQualifier">
      <name xsi:type="xsd:string">editable</name>
      <value xsi:type="xsd:string">>true</value>
    </qualifier>
  </item>
  <item xsi:type="ns1:CIMProperty">
    <name xsi:type="xsd:string">EnablePWRedundancy</name>
    <value xsi:type="xsd:string">>false</value>
    <qualifier xsi:type="ns1:CIMQualifier">
      <name xsi:type="xsd:string">editable</name>
      <value xsi:type="xsd:string">>true</value>
    </qualifier>
  </item>
  <item xsi:type="ns1:CIMProperty">
    <name xsi:type="xsd:string">PwTunnelSelection</name>
    <value xsi:type="xsd:string">>false</value>
    <qualifier xsi:type="ns1:CIMQualifier">
      <name xsi:type="xsd:string">editable</name>
      <value xsi:type="xsd:string">>true</value>
    </qualifier>
  </item>
  <item xsi:type="ns1:CIMProperty">
    <name xsi:type="xsd:string">AutoPickBDVlanId</name>
    <value xsi:type="xsd:string">>false</value>
    <qualifier xsi:type="ns1:CIMQualifier">
      <name xsi:type="xsd:string">editable</name>
      <value xsi:type="xsd:string">>true</value>
    </qualifier>
  </item>
  <!-- Service Instance Name -->
  <item xsi:type="ns1:CIMProperty">
    <name xsi:type="xsd:string">AutoPickEsiName</name>
    <value xsi:type="xsd:string">>false</value>
    <qualifier xsi:type="ns1:CIMQualifier">
      <name xsi:type="xsd:string">editable</name>
      <value xsi:type="xsd:string">>true</value>
    </qualifier>
  </item >

  <item xsi:type="ns1:CIMProperty">
    <name xsi:type="xsd:string">AllowBothTags</name>
    <value xsi:type="xsd:string">>true</value>
    <qualifier xsi:type="ns1:CIMQualifier">
      <name xsi:type="xsd:string">editable</name>
      <value xsi:type="xsd:string">>true</value>
    </qualifier>
  </item>

  <item xsi:type="ns1:CIMProperty">
    <name xsi:type="xsd:string">InnerVlanRanges</name>
    <value xsi:type="xsd:string">>true</value>
    <qualifier xsi:type="ns1:CIMQualifier">
      <name xsi:type="xsd:string">editable</name>
      <value xsi:type="xsd:string">>false</value>
    </qualifier>
  </item>
  <item xsi:type="ns1:CIMProperty">
    <name xsi:type="xsd:string">PushOuter</name>
    <value xsi:type="xsd:string">>false</value>
    <qualifier xsi:type="ns1:CIMQualifier">
      <name xsi:type="xsd:string">editable</name>
      <value xsi:type="xsd:string">>true</value>
    </qualifier>
  </item>

```

```

</item>
<item xsi:type="ns1:CIMProperty">
  <name xsi:type="xsd:string">PushInner</name>
  <value xsi:type="xsd:string">>false</value>
  <qualifier xsi:type="ns1:CIMQualifier">
    <name xsi:type="xsd:string">editable</name>
    <value xsi:type="xsd:string">>true</value>
  </qualifier>
</item>
<item xsi:type="ns1:CIMProperty">
  <name xsi:type="xsd:string">PopOuter</name>
  <value xsi:type="xsd:string">>true</value>
  <qualifier xsi:type="ns1:CIMQualifier">
    <name xsi:type="xsd:string">editable</name>
    <value xsi:type="xsd:string">>true</value>
  </qualifier>
</item>
<item xsi:type="ns1:CIMProperty">
  <name xsi:type="xsd:string">PopInner</name>
  <value xsi:type="xsd:string">>true</value>
  <qualifier xsi:type="ns1:CIMQualifier">
    <name xsi:type="xsd:string">editable</name>
    <value xsi:type="xsd:string">>true</value>
  </qualifier>
</item>
<item xsi:type="ns1:CIMProperty">
  <name xsi:type="xsd:string">TranslateInner</name>
  <value xsi:type="xsd:string">>false</value>
  <qualifier xsi:type="ns1:CIMQualifier">
    <name xsi:type="xsd:string">editable</name>
    <value xsi:type="xsd:string">>true</value>
  </qualifier>
</item>
<item xsi:type="ns1:CIMProperty">
  <name xsi:type="xsd:string">TranslateOuter</name>
  <value xsi:type="xsd:string">>false</value>
  <qualifier xsi:type="ns1:CIMQualifier">
    <name xsi:type="xsd:string">editable</name>
    <value xsi:type="xsd:string">>true</value>
  </qualifier>
</item>
<item xsi:type="ns1:CIMProperty">
  <name xsi:type="xsd:string">UseEVC</name>
  <value xsi:type="xsd:string">>false</value>
  <qualifier xsi:type="ns1:CIMQualifier">
    <name xsi:type="xsd:string">editable</name>
    <value xsi:type="xsd:string">>false</value>
  </qualifier>
</item>
<item xsi:type="ns1:CIMProperty">
  <name xsi:type="xsd:string">UseBD</name>
  <value xsi:type="xsd:string">>true</value>
  <qualifier xsi:type="ns1:CIMQualifier">
    <name xsi:type="xsd:string">editable</name>
    <value xsi:type="xsd:string">>true</value>
  </qualifier>
</item>

<item xsi:type="ns1:CIMProperty">
  <name xsi:type="xsd:string">EncapsulationType</name>
  <value xsi:type="xsd:string">DOT1QTRUNK</value>
  <qualifier xsi:type="ns1:CIMQualifier">
    <name xsi:type="xsd:string">editable</name>
    <value xsi:type="xsd:string">>true</value>
  </qualifier>
</item>

```

```

        </qualifier>
    </item>
</properties>
<objectPath xsi:type="ns1:CIMObjectPath">
    <className xsi:type="xsd:string">PolicyTemplate</className>
    <properties xsi:type="ns1:CIMPropertyList"
        soapenc:arrayType="ns1:CIMProperty[]">
        <item xsi:type="ns1:CIMProperty">
            <name xsi:type="xsd:string">RoleType</name>
            <value xsi:type="xsd:string">N-PE</value>
        </item>
        <item xsi:type="ns1:CIMProperty">
            <name xsi:type="xsd:string">DatafileName</name>
            <value xsi:type="xsd:string">SampleData0</value>
        </item>
        <item xsi:type="ns1:CIMProperty">
            <name xsi:type="xsd:string">DatafilePath</name>
            <value xsi:type="xsd:string">Audit/Set-Audit-Rule</value>
        </item>
        <item xsi:type="ns1:CIMProperty">
            <name xsi:type="xsd:string">TemplateAction</name>
            <value xsi:type="xsd:string">APPEND</value>
        </item>
        <item xsi:type="ns1:CIMProperty">
            <name xsi:type="xsd:string">TemplateActive</name>
            <value xsi:type="xsd:string">true</value>
        </item>
    </properties>
</objectPath>

    </objectPath>
</objectPath>
</ns1:createInstance>
</soapenv:Body>
</soapenv:Envelope>

```

## Creating a Pseudowire Policy with ATM/Ethernet Internetworking

In this example, a EVC policy is created using pseudowire with ATM/Ethernet internetworking.

The **ATM\_ETHERNET** policy attribute is highlighted with bold in this example.

Example: ATM\_ETHERNET\_VC-Pol-PW\_Create-NBI-4.xml

```

<?xml version="1.0" encoding="UTF-8"?>
<soapenv:Envelope
    xmlns:soapenv="http://schemas.xmlsoap.org/soap/envelope/"
    xmlns:soapenc="http://schemas.xmlsoap.org/soap/encoding/"
    xmlns:xsd="http://www.w3.org/2001/XMLSchema"
    xmlns:xsi="http://www.w3.org/2001/XMLSchema-instance"
    xmlns:ns0="http://www.cisco.com/cim-cx/2.0"
    xmlns:ns1="urn:CIM">
    <soapenv:Header>
        <ns0:message id="87855" timestamp="2002-12-13T14:55:38.885Z"
            sessiontoken="p36bttjwy1"/>
    </soapenv:Header>
    <soapenv:Body>
        <ns1:createInstance>
            <objectPath xsi:type="ns1:CIMObjectPath">
                <className xsi:type="xsd:string">ServiceDefinition</className>

```

```

<properties xsi:type="ns1:CIMPropertyList"
  soapenc:arrayType="ns1:CIMProperty[]">
  <item xsi:type="ns1:CIMProperty">
    <name xsi:type="xsd:string">Name</name>
    <value xsi:type="xsd:string">ATM_ETHERNET_PW_VC</value>
  </item>
  <item xsi:type="ns1:CIMProperty">
    <name xsi:type="xsd:string">Type</name>
    <value xsi:type="xsd:string">Evc</value>
  </item>

  <item xsi:type="ns1:CIMProperty">
    <name xsi:type="xsd:string">Organization</name>
    <value xsi:type="xsd:string">Customer1</value>
  </item>
</properties>
<objectPath xsi:type="ns1:CIMObjectPath">
  <className xsi:type="xsd:string">ServiceDefinitionDetails</className>
  <properties xsi:type="ns1:CIMPropertyList"
    soapenc:arrayType="ns1:CIMProperty[]">
    <item xsi:type="ns1:CIMProperty">
      <name xsi:type="xsd:string">SubType</name>
      <value xsi:type="xsd:string">Evc</value>
    </item>
    <item xsi:type="ns1:CIMProperty">
      <name xsi:type="xsd:string">TransportType</name>
      <value xsi:type="xsd:string">PSEUDOWIRE</value>
    </item>
    <item xsi:type="ns1:CIMProperty">
      <name xsi:type="xsd:string">AccessType</name>
      <!-- Access Type ATM_ETHERNET newly added for interworking -->
      <value xsi:type="xsd:string">ATM_ETHERNET</value>
    </item>
    <item xsi:type="ns1:CIMProperty">
      <name xsi:type="xsd:string">TemplateEnabled</name>
      <value xsi:type="xsd:string">>false</value>
    </item>
    <item xsi:type="ns1:CIMProperty">
      <!--AtmEncapsulationType newly added which can have values AAL0,AAL5,ALL5SNAP
-->
      <name xsi:type="xsd:string">AtmEncapsulationType</name>
      <value xsi:type="xsd:string">AAL0</value>
      <qualifier xsi:type="ns1:CIMQualifier">
        <name xsi:type="xsd:string">editable</name>
        <value xsi:type="xsd:string">>true</value>
      </qualifier>
    </item>
    <!--AtmTransportMode newly Added which can have values VP or VC -->
    <item xsi:type="ns1:CIMProperty">
      <name xsi:type="xsd:string">AtmTransportMode</name>
      <value xsi:type="xsd:string">VC</value>
      <qualifier xsi:type="ns1:CIMQualifier">
        <name xsi:type="xsd:string">editable</name>
        <value xsi:type="xsd:string">>true</value>
      </qualifier>
    </item>
    <item xsi:type="ns1:CIMProperty">
      <name xsi:type="xsd:string">UniShutdown</name>
      <value xsi:type="xsd:string">>true</value>
      <qualifier xsi:type="ns1:CIMQualifier">
        <name xsi:type="xsd:string">editable</name>
        <value xsi:type="xsd:string">>true</value>
      </qualifier>
    </item>
  </properties>
</objectPath>

```

```

</item>
<item xsi:type="ns1:CIMProperty">
  <name xsi:type="xsd:string">PortSecurity</name>
  <value xsi:type="xsd:string">>false</value>
  <qualifier xsi:type="ns1:CIMQualifier">
    <name xsi:type="xsd:string">editable</name>
    <value xsi:type="xsd:string">>true</value>
  </qualifier>
</item>
<item xsi:type="ns1:CIMProperty">
  <name xsi:type="xsd:string">UniProtocolTunneling</name>
  <value xsi:type="xsd:string">>false</value>
  <qualifier xsi:type="ns1:CIMQualifier">
    <name xsi:type="xsd:string">editable</name>
    <value xsi:type="xsd:string">>true</value>
  </qualifier>
</item>
<item xsi:type="ns1:CIMProperty">
  <name xsi:type="xsd:string">StdUniPort</name>
  <value xsi:type="xsd:string">>false</value>
  <qualifier xsi:type="ns1:CIMQualifier">
    <name xsi:type="xsd:string">editable</name>
    <value xsi:type="xsd:string">>true</value>
  </qualifier>
</item>
<item xsi:type="ns1:CIMProperty">
  <name xsi:type="xsd:string">UniKeepAlive</name>
  <value xsi:type="xsd:string">>false</value>
  <qualifier xsi:type="ns1:CIMQualifier">
    <name xsi:type="xsd:string">editable</name>
    <value xsi:type="xsd:string">>true</value>
  </qualifier>
</item>
<item xsi:type="ns1:CIMProperty">
  <name xsi:type="xsd:string">UniSpeed</name>
  <value xsi:type="xsd:string">None</value>
  <qualifier xsi:type="ns1:CIMQualifier">
    <name xsi:type="xsd:string">editable</name>
    <value xsi:type="xsd:string">>true</value>
  </qualifier>
</item>
<item xsi:type="ns1:CIMProperty">
  <name xsi:type="xsd:string">UniDuplex</name>
  <value xsi:type="xsd:string">None</value>
  <qualifier xsi:type="ns1:CIMQualifier">
    <name xsi:type="xsd:string">editable</name>
    <value xsi:type="xsd:string">>true</value>
  </qualifier>
</item>
<item xsi:type="ns1:CIMProperty">
  <name xsi:type="xsd:string">UseExistingACLName</name>
  <value xsi:type="xsd:string">>false</value>
  <qualifier xsi:type="ns1:CIMQualifier">
    <name xsi:type="xsd:string">editable</name>
    <value xsi:type="xsd:string">>false</value>
  </qualifier>
</item>
<item xsi:type="ns1:CIMProperty">
  <name xsi:type="xsd:string">DirectConnect</name>
  <value xsi:type="xsd:string">>true</value>
  <qualifier xsi:type="ns1:CIMQualifier">
    <name xsi:type="xsd:string">editable</name>
    <value xsi:type="xsd:string">>false</value>
  </qualifier>

```

```

</item>
<item xsi:type="ns1:CIMProperty">
  <name xsi:type="xsd:string">AutoPickEsiId</name>
  <value xsi:type="xsd:string">true</value>
  <qualifier xsi:type="ns1:CIMQualifier">
    <name xsi:type="xsd:string">editable</name>
    <value xsi:type="xsd:string">true</value>
  </qualifier>
</item>

<item xsi:type="ns1:CIMProperty">
  <name xsi:type="xsd:string">AutopickVCId</name>
  <value xsi:type="xsd:string">>false</value>
  <qualifier xsi:type="ns1:CIMQualifier">
    <name xsi:type="xsd:string">editable</name>
    <value xsi:type="xsd:string">true</value>
  </qualifier>
</item>
<item xsi:type="ns1:CIMProperty">
  <name xsi:type="xsd:string">EnablePWRedundancy</name>
  <value xsi:type="xsd:string">>false</value>
  <qualifier xsi:type="ns1:CIMQualifier">
    <name xsi:type="xsd:string">editable</name>
    <value xsi:type="xsd:string">true</value>
  </qualifier>
</item>
<item xsi:type="ns1:CIMProperty">
  <name xsi:type="xsd:string">PwTunnelSelection</name>
  <value xsi:type="xsd:string">>false</value>
  <qualifier xsi:type="ns1:CIMQualifier">
    <name xsi:type="xsd:string">editable</name>
    <value xsi:type="xsd:string">true</value>
  </qualifier>
</item>
<item xsi:type="ns1:CIMProperty">
  <name xsi:type="xsd:string">AutoPickBDVlanId</name>
  <value xsi:type="xsd:string">>false</value>
  <qualifier xsi:type="ns1:CIMQualifier">
    <name xsi:type="xsd:string">editable</name>
    <value xsi:type="xsd:string">true</value>
  </qualifier>
</item>
<!-- Service Instance Name -->
<item xsi:type="ns1:CIMProperty">
  <name xsi:type="xsd:string">AutoPickEsiName</name>
  <value xsi:type="xsd:string">>false</value>
  <qualifier xsi:type="ns1:CIMQualifier">
    <name xsi:type="xsd:string">editable</name>
    <value xsi:type="xsd:string">true</value>
  </qualifier>
</item >

<item xsi:type="ns1:CIMProperty">
  <name xsi:type="xsd:string">AllowBothTags</name>
  <value xsi:type="xsd:string">true</value>
  <qualifier xsi:type="ns1:CIMQualifier">
    <name xsi:type="xsd:string">editable</name>
    <value xsi:type="xsd:string">true</value>
  </qualifier>
</item>

<item xsi:type="ns1:CIMProperty">
  <name xsi:type="xsd:string">InnerVlanRanges</name>
  <value xsi:type="xsd:string">true</value>

```

```

    <qualifier xsi:type="ns1:CIMQualifier">
      <name xsi:type="xsd:string">editable</name>
      <value xsi:type="xsd:string">>false</value>
    </qualifier>
  </item>
  <item xsi:type="ns1:CIMProperty">
    <name xsi:type="xsd:string">PushOuter</name>
    <value xsi:type="xsd:string">>false</value>
    <qualifier xsi:type="ns1:CIMQualifier">
      <name xsi:type="xsd:string">editable</name>
      <value xsi:type="xsd:string">>true</value>
    </qualifier>
  </item>
  <item xsi:type="ns1:CIMProperty">
    <name xsi:type="xsd:string">PushInner</name>
    <value xsi:type="xsd:string">>false</value>
    <qualifier xsi:type="ns1:CIMQualifier">
      <name xsi:type="xsd:string">editable</name>
      <value xsi:type="xsd:string">>true</value>
    </qualifier>
  </item>
  <item xsi:type="ns1:CIMProperty">
    <name xsi:type="xsd:string">PopOuter</name>
    <value xsi:type="xsd:string">>true</value>
    <qualifier xsi:type="ns1:CIMQualifier">
      <name xsi:type="xsd:string">editable</name>
      <value xsi:type="xsd:string">>true</value>
    </qualifier>
  </item>
  <item xsi:type="ns1:CIMProperty">
    <name xsi:type="xsd:string">PopInner</name>
    <value xsi:type="xsd:string">>true</value>
    <qualifier xsi:type="ns1:CIMQualifier">
      <name xsi:type="xsd:string">editable</name>
      <value xsi:type="xsd:string">>true</value>
    </qualifier>
  </item>
  <item xsi:type="ns1:CIMProperty">
    <name xsi:type="xsd:string">TranslateInner</name>
    <value xsi:type="xsd:string">>false</value>
    <qualifier xsi:type="ns1:CIMQualifier">
      <name xsi:type="xsd:string">editable</name>
      <value xsi:type="xsd:string">>true</value>
    </qualifier>
  </item>
  <item xsi:type="ns1:CIMProperty">
    <name xsi:type="xsd:string">TranslateOuter</name>
    <value xsi:type="xsd:string">>false</value>
    <qualifier xsi:type="ns1:CIMQualifier">
      <name xsi:type="xsd:string">editable</name>
      <value xsi:type="xsd:string">>true</value>
    </qualifier>
  </item>
  <item xsi:type="ns1:CIMProperty">
    <name xsi:type="xsd:string">UseEVC</name>
    <value xsi:type="xsd:string">>false</value>
    <qualifier xsi:type="ns1:CIMQualifier">
      <name xsi:type="xsd:string">editable</name>
      <value xsi:type="xsd:string">>false</value>
    </qualifier>
  </item>
  <item xsi:type="ns1:CIMProperty">
    <name xsi:type="xsd:string">UseBD</name>
    <value xsi:type="xsd:string">>true</value>
  </item>

```



```

        <qualifier xsi:type="ns1:CIMQualifier">
          <name xsi:type="xsd:string">editable</name>
          <value xsi:type="xsd:string">true</value>
        </qualifier>
      </item>

      <item xsi:type="ns1:CIMProperty">
        <name xsi:type="xsd:string">EncapsulationType</name>
        <value xsi:type="xsd:string">DOT1QTRUNK</value>
        <qualifier xsi:type="ns1:CIMQualifier">
          <name xsi:type="xsd:string">editable</name>
          <value xsi:type="xsd:string">true</value>
        </qualifier>
      </item>
    </properties>
  </objectPath xsi:type="ns1:CIMObjectPath">
    <className xsi:type="xsd:string">PolicyTemplate</className>
    <properties xsi:type="ns1:CIMPropertyList"
      soapenc:arrayType="ns1:CIMProperty[]">
      <item xsi:type="ns1:CIMProperty">
        <name xsi:type="xsd:string">RoleType</name>
        <value xsi:type="xsd:string">N-PE</value>
      </item>
      <item xsi:type="ns1:CIMProperty">
        <name xsi:type="xsd:string">DatafileName</name>
        <value xsi:type="xsd:string">SampleData0</value>
      </item>
      <item xsi:type="ns1:CIMProperty">
        <name xsi:type="xsd:string">DatafilePath</name>
        <value xsi:type="xsd:string">Audit/Set-Audit-Rule</value>
      </item>
      <item xsi:type="ns1:CIMProperty">
        <name xsi:type="xsd:string">TemplateAction</name>
        <value xsi:type="xsd:string">APPEND</value>
      </item>
      <item xsi:type="ns1:CIMProperty">
        <name xsi:type="xsd:string">TemplateActive</name>
        <value xsi:type="xsd:string">true</value>
      </item>
    </properties>
  </objectPath>
</ns1:createInstance>
</soapenv:Body>
</soapenv:Envelope>

```

## Creating a Pseudowire Policy Setting the MTU Size

In this example, an EVC policy is created in which an attribute is set for the MTU size for a pseudowire service. The **MTU** attribute in this example is set to **1560**. Note that the attribute **editable** for the MTU size is set to **true**.

Example: CreateEvcPolicySetMTU.xml

```

<?xml version="1.0" encoding="UTF-8"?>
<soapenv:Envelope
  xmlns:soapenv="http://schemas.xmlsoap.org/soap/envelope/"
  xmlns:soapenc="http://schemas.xmlsoap.org/soap/encoding/"

```

```

xmlns:xsd="http://www.w3.org/2001/XMLSchema"
xmlns:xsi="http://www.w3.org/2001/XMLSchema-instance"
xmlns:ns0="http://www.cisco.com/cim-cx/2.0"
xmlns:ns1="urn:CIM">
<soapenv:Header>
  <ns0:message id="87855" timestamp="2002-12-13T14:55:38.885Z"
    sessiontoken="36B0E5AD24D73FD91C3E34023A3ED367"/>
</soapenv:Header>
<soapenv:Body>
  <ns1:createInstance>
    <!-- Create Evc-pw policy: d-vc-pw -->
    <objectPath xsi:type="ns1:CIMObjectPath">
      <className xsi:type="xsd:string">ServiceDefinition</className>
      <properties xsi:type="ns1:CIMPropertyList"
        soapenc:arrayType="ns1:CIMProperty[]">
        <item xsi:type="ns1:CIMProperty">
          <name xsi:type="xsd:string">Name</name>
          <value xsi:type="xsd:string">d-nbi-1</value>
        </item>
        <item xsi:type="ns1:CIMProperty">
          <name xsi:type="xsd:string">Type</name>
          <value xsi:type="xsd:string">Evc</value>
        </item>
      </properties>
      <objectPath xsi:type="ns1:CIMObjectPath">
        <className xsi:type="xsd:string">ServiceDefinitionDetails</className>
        <properties xsi:type="ns1:CIMPropertyList"
          soapenc:arrayType="ns1:CIMProperty[]">
          <item xsi:type="ns1:CIMProperty">
            <name xsi:type="xsd:string">SubType</name>
            <value xsi:type="xsd:string">Evc</value>
          </item>
          <item xsi:type="ns1:CIMProperty">
            <name xsi:type="xsd:string">AccessType</name>
            <value xsi:type="xsd:string">ETHERNET</value>
          </item>
          <item xsi:type="ns1:CIMProperty">
            <name xsi:type="xsd:string">TransportType</name>
            <value xsi:type="xsd:string">PSEUDOWIRE</value>
          </item>
          <item xsi:type="ns1:CIMProperty">
            <name xsi:type="xsd:string">StaticPw</name>
            <value xsi:type="xsd:string">>true</value>
            <qualifier xsi:type="ns1:CIMQualifier">
              <name xsi:type="xsd:string">editable</name>
              <value xsi:type="xsd:string">>true</value>
            </qualifier>
          </item>
          <item xsi:type="ns1:CIMProperty">
            <name xsi:type="xsd:string">StdUniPort</name>
            <value xsi:type="xsd:string">>true</value>
            <qualifier xsi:type="ns1:CIMQualifier">
              <name xsi:type="xsd:string">editable</name>
              <value xsi:type="xsd:string">>true</value>
            </qualifier>
          </item>
          <item xsi:type="ns1:CIMProperty">
            <name xsi:type="xsd:string">UniShutdown</name>
            <value xsi:type="xsd:string">>false</value>
            <qualifier xsi:type="ns1:CIMQualifier">
              <name xsi:type="xsd:string">editable</name>
              <value xsi:type="xsd:string">>true</value>
            </qualifier>
          </item>
        </properties>
      </objectPath>
    </createInstance>
  </soapenv:Body>
</soapenv:Envelope>

```

```

<item xsi:type="ns1:CIMProperty">
  <name xsi:type="xsd:string">DirectConnect</name>
  <value xsi:type="xsd:string">>false</value>

</item>
<item xsi:type="ns1:CIMProperty">
  <name xsi:type="xsd:string">AutoPickEsiId</name>
  <value xsi:type="xsd:string">>true</value>
  <qualifier xsi:type="ns1:CIMQualifier">
    <name xsi:type="xsd:string">editable</name>
    <value xsi:type="xsd:string">>true</value>
  </qualifier>
</item>
<item xsi:type="ns1:CIMProperty">
  <name xsi:type="xsd:string">AutopickVCId</name>
  <value xsi:type="xsd:string">>true</value>
  <qualifier xsi:type="ns1:CIMQualifier">
    <name xsi:type="xsd:string">editable</name>
    <value xsi:type="xsd:string">>true</value>
  </qualifier>
</item>
<item xsi:type="ns1:CIMProperty">
  <name xsi:type="xsd:string">AutoPickBDVlanId</name>
  <value xsi:type="xsd:string">>true</value>
  <qualifier xsi:type="ns1:CIMQualifier">
    <name xsi:type="xsd:string">editable</name>
    <value xsi:type="xsd:string">>true</value>
  </qualifier>
</item>
<item xsi:type="ns1:CIMProperty">
  <name xsi:type="xsd:string">AllowBothTags</name>
  <value xsi:type="xsd:string">>false</value>
  <qualifier xsi:type="ns1:CIMQualifier">
    <name xsi:type="xsd:string">editable</name>
    <value xsi:type="xsd:string">>true</value>
  </qualifier>
</item><br/>
<item xsi:type="ns1:CIMProperty">
  <name xsi:type="xsd:string">MTU</name>
  <value xsi:type="xsd:string">1560</value>
  <qualifier xsi:type="ns1:CIMQualifier">
    <name xsi:type="xsd:string">editable</name>
    <value xsi:type="xsd:string">true</value>
  </qualifier>
</item>
<item xsi:type="ns1:CIMProperty">
  <name xsi:type="xsd:string">OuterVlanRanges</name>
  <value xsi:type="xsd:string">>false</value>
  <qualifier xsi:type="ns1:CIMQualifier">
    <name xsi:type="xsd:string">editable</name>
    <value xsi:type="xsd:string">>true</value>
  </qualifier>
</item>
<item xsi:type="ns1:CIMProperty">
  <name xsi:type="xsd:string">EnablePWRedundancy</name>
  <value xsi:type="xsd:string">>false</value>
  <qualifier xsi:type="ns1:CIMQualifier">
    <name xsi:type="xsd:string">editable</name>
    <value xsi:type="xsd:string">>true</value>
  </qualifier>
</item>
<item xsi:type="ns1:CIMProperty">
  <name xsi:type="xsd:string">PwTunnelSelection</name>
  <value xsi:type="xsd:string">>false</value>

```

```

    <qualifier xsi:type="ns1:CIMQualifier">
      <name xsi:type="xsd:string">editable</name>
      <value xsi:type="xsd:string">true</value>
    </qualifier>
  </item>
  <item xsi:type="ns1:CIMProperty">
    <name xsi:type="xsd:string">AutopickVCId</name>
    <value xsi:type="xsd:string">>false</value>
    <qualifier xsi:type="ns1:CIMQualifier">
      <name xsi:type="xsd:string">editable</name>
      <value xsi:type="xsd:string">true</value>
    </qualifier>
  </item>
  <item xsi:type="ns1:CIMProperty">
    <name xsi:type="xsd:string">PushOuter</name>
    <value xsi:type="xsd:string">>false</value>
    <qualifier xsi:type="ns1:CIMQualifier">
      <name xsi:type="xsd:string">editable</name>
      <value xsi:type="xsd:string">true</value>
    </qualifier>
  </item>
  <item xsi:type="ns1:CIMProperty">
    <name xsi:type="xsd:string">PushInner</name>
    <value xsi:type="xsd:string">>false</value>
    <qualifier xsi:type="ns1:CIMQualifier">
      <name xsi:type="xsd:string">editable</name>
      <value xsi:type="xsd:string">true</value>
    </qualifier>
  </item>
  <item xsi:type="ns1:CIMProperty">
    <name xsi:type="xsd:string">PopOuter</name>
    <value xsi:type="xsd:string">>false</value>
    <qualifier xsi:type="ns1:CIMQualifier">
      <name xsi:type="xsd:string">editable</name>
      <value xsi:type="xsd:string">true</value>
    </qualifier>
  </item>
  <item xsi:type="ns1:CIMProperty">
    <name xsi:type="xsd:string">PopInner</name>
    <value xsi:type="xsd:string">>false</value>
    <qualifier xsi:type="ns1:CIMQualifier">
      <name xsi:type="xsd:string">editable</name>
      <value xsi:type="xsd:string">true</value>
    </qualifier>
  </item>
  <item xsi:type="ns1:CIMProperty">
    <name xsi:type="xsd:string">TranslateInner</name>
    <value xsi:type="xsd:string">>false</value>
    <qualifier xsi:type="ns1:CIMQualifier">
      <name xsi:type="xsd:string">editable</name>
      <value xsi:type="xsd:string">true</value>
    </qualifier>
  </item>
  <item xsi:type="ns1:CIMProperty">
    <name xsi:type="xsd:string">TranslateOuter</name>
    <value xsi:type="xsd:string">>false</value>
    <qualifier xsi:type="ns1:CIMQualifier">
      <name xsi:type="xsd:string">editable</name>
      <value xsi:type="xsd:string">true</value>
    </qualifier>
  </item>
  <item xsi:type="ns1:CIMProperty">
    <name xsi:type="xsd:string">UseEVC</name>
    <value xsi:type="xsd:string">>false</value>

```

```

    </item>
  <item xsi:type="ns1:CIMProperty">
    <name xsi:type="xsd:string">UseBD</name>
    <value xsi:type="xsd:string">true</value>
    <qualifier xsi:type="ns1:CIMQualifier">
      <name xsi:type="xsd:string">editable</name>
      <value xsi:type="xsd:string">true</value>
    </qualifier>
  </item>
  <item xsi:type="ns1:CIMProperty">
    <name xsi:type="xsd:string">EncapsulationType</name>
    <value xsi:type="xsd:string">DOT1QTRUNK</value>
    <qualifier xsi:type="ns1:CIMQualifier">
      <name xsi:type="xsd:string">editable</name>
      <value xsi:type="xsd:string">true</value>
    </qualifier>
  </item>
</properties>
</objectPath>
</objectPath>
</ns1:createInstance>
<!-- <ns1:modifyInstance>
  <objectPath subAction="modifyInstance" xsi:type="ns1:CIMObjectPath">
    <className xsi:type="xsd:string">ServiceDefinition</className>
    <keyProperties xsi:type="ns1:CIMPropertyList"
      soapenc:arrayType="ns1:CIMProperty[]">
      <item xsi:type="ns1:CIMProperty">
        <name xsi:type="xsd:string">Name</name>
        <value xsi:type="xsd:string">d-evc-nbi-innerrangesEdit</value>
      </item>
      <item xsi:type="ns1:CIMProperty">
        <name xsi:type="xsd:string">Type</name>
        <value xsi:type="xsd:string">Evc</value>
      </item>
    </keyProperties>
    <objectPath subAction="modifyInstance" xsi:type="ns1:CIMObjectPath">
      <className xsi:type="xsd:string">ServiceDefinitionDetails</className>
      <properties xsi:type="ns1:CIMPropertyList"
        soapenc:arrayType="ns1:CIMProperty[]">
        <item xsi:type="ns1:CIMProperty">
          <name xsi:type="xsd:string">AllowBothTags</name>
          <value xsi:type="xsd:string">>false</value>
          <qualifier xsi:type="ns1:CIMQualifier">
            <name xsi:type="xsd:string">editable</name>
            <value xsi:type="xsd:string">true</value>
          </qualifier>
        </item>
        <item xsi:type="ns1:CIMProperty">
          <name xsi:type="xsd:string">OuterVlanRanges</name>
          <value xsi:type="xsd:string">true</value>
          <qualifier xsi:type="ns1:CIMQualifier">
            <name xsi:type="xsd:string">editable</name>
            <value xsi:type="xsd:string">true</value>
          </qualifier>
        </item>
        <item xsi:type="ns1:CIMProperty">
          <name xsi:type="xsd:string">InnerVlanRanges</name>
          <value xsi:type="xsd:string">>false</value>
          <qualifier xsi:type="ns1:CIMQualifier">
            <name xsi:type="xsd:string">editable</name>
            <value xsi:type="xsd:string">>false</value>
          </qualifier>
        </item>
      </properties>
    </objectPath>
  </ns1:modifyInstance>
-->

```

```

        </item>
      </properties>
    </objectPath>
  </objectPath>
</ns1:modifyInstance>
-->
</soapenv:Body>
</soapenv:Envelope>

```

## Creating a Pseudowire Head-End Policy for Access into L3VPN

In the following example, a pseudowire head-end policy is created for pseudowire access into L3VPN. The significant attribute is **ConfigurePseudowireHE**, which in the example is set to **true**.

Example: CreateEvcPolicy.xml

```

<?xml version="1.0" encoding="UTF-8"?>
<soapenv:Envelope
  xmlns:soapenv="http://schemas.xmlsoap.org/soap/envelope/"
  xmlns:soapenc="http://schemas.xmlsoap.org/soap/encoding/"
  xmlns:xsd="http://www.w3.org/2001/XMLSchema"
  xmlns:xsi="http://www.w3.org/2001/XMLSchema-instance"
  xmlns:ns0="http://www.cisco.com/cim-cx/2.0"
  xmlns:ns1="urn:CIM">
  <soapenv:Header>
    <ns0:message id="87855" timestamp="2002-12-13T14:55:38.885Z"
      sessiontoken="8F872554E9298441A0CAC4630D37523F"/>
  </soapenv:Header>
  <soapenv:Body>
    <ns1:createInstance>
      <!-- Create Evc-pw policy: d-vc-pw -->
      <objectPath xsi:type="ns1:CIMObjectPath">
        <className xsi:type="xsd:string">ServiceDefinition</className>
        <properties xsi:type="ns1:CIMPropertyList"
          soapenc:arrayType="ns1:CIMProperty[]">
          <item xsi:type="ns1:CIMProperty">
            <name xsi:type="xsd:string">Name</name>
            <value xsi:type="xsd:string">d-vc-nbi-pwhe</value>
          </item>
          <item xsi:type="ns1:CIMProperty">
            <name xsi:type="xsd:string">Type</name>
            <value xsi:type="xsd:string">Evc</value>
          </item>
        </properties>
        <objectPath xsi:type="ns1:CIMObjectPath">
          <className xsi:type="xsd:string">ServiceDefinitionDetails</className>
          <properties xsi:type="ns1:CIMPropertyList"
            soapenc:arrayType="ns1:CIMProperty[]">
            <item xsi:type="ns1:CIMProperty">
              <name xsi:type="xsd:string">SubType</name>
              <value xsi:type="xsd:string">Evc</value>
            </item>
            <item xsi:type="ns1:CIMProperty">
              <name xsi:type="xsd:string">AccessType</name>
              <value xsi:type="xsd:string">ETHERNET</value>
            </item>
            <item xsi:type="ns1:CIMProperty">
              <name xsi:type="xsd:string">TransportType</name>
              <value xsi:type="xsd:string">PSEUDOWIRE</value>
            </item>
            <item xsi:type="ns1:CIMProperty">

```

```

        <name xsi:type="xsd:string">StaticPw</name>
        <value xsi:type="xsd:string">>false</value>
        <qualifier xsi:type="ns1:CIMQualifier">
            <name xsi:type="xsd:string">editable</name>
            <value xsi:type="xsd:string">>true</value>
        </qualifier>
    </item>
    <item xsi:type="ns1:CIMProperty">
        <name xsi:type="xsd:string">L2VpnGrpName</name>
        <value xsi:type="xsd:string">ISC</value>
    </item>
    <item xsi:type="ns1:CIMProperty">
        <name xsi:type="xsd:string">ConfigurePseudowireHE</name>
        <value xsi:type="xsd:string">true</value>
        <qualifier xsi:type="ns1:CIMQualifier">
            <name xsi:type="xsd:string">editable</name>
            <value xsi:type="xsd:string">>true</value>
        </qualifier>
    </item>
    <item xsi:type="ns1:CIMProperty">
        <name xsi:type="xsd:string">StdUniPort</name>
        <value xsi:type="xsd:string">>true</value>
        <qualifier xsi:type="ns1:CIMQualifier">
            <name xsi:type="xsd:string">editable</name>
            <value xsi:type="xsd:string">>true</value>
        </qualifier>
    </item>
    <item xsi:type="ns1:CIMProperty">
        <name xsi:type="xsd:string">UniShutdown</name>
        <value xsi:type="xsd:string">>false</value>
        <qualifier xsi:type="ns1:CIMQualifier">
            <name xsi:type="xsd:string">editable</name>
            <value xsi:type="xsd:string">>true</value>
        </qualifier>
    </item>
    <item xsi:type="ns1:CIMProperty">
        <name xsi:type="xsd:string">DirectConnect</name>
        <value xsi:type="xsd:string">>false</value>
    </item>
    <item xsi:type="ns1:CIMProperty">
        <name xsi:type="xsd:string">AutoPickEsiId</name>
        <value xsi:type="xsd:string">>true</value>
        <qualifier xsi:type="ns1:CIMQualifier">
            <name xsi:type="xsd:string">editable</name>
            <value xsi:type="xsd:string">>true</value>
        </qualifier>
    </item>
    <item xsi:type="ns1:CIMProperty">
        <name xsi:type="xsd:string">AutopickVCId</name>
        <value xsi:type="xsd:string">>true</value>
        <qualifier xsi:type="ns1:CIMQualifier">
            <name xsi:type="xsd:string">editable</name>
            <value xsi:type="xsd:string">>true</value>
        </qualifier>
    </item>
    <item xsi:type="ns1:CIMProperty">
        <name xsi:type="xsd:string">AutoPickBDVlanId</name>
        <value xsi:type="xsd:string">>true</value>
        <qualifier xsi:type="ns1:CIMQualifier">
            <name xsi:type="xsd:string">editable</name>
            <value xsi:type="xsd:string">>true</value>
        </qualifier>
    </item>

```

```

<item xsi:type="ns1:CIMProperty">
  <name xsi:type="xsd:string">AllowBothTags</name>
  <value xsi:type="xsd:string">>false</value>
  <qualifier xsi:type="ns1:CIMQualifier">
    <name xsi:type="xsd:string">editable</name>
    <value xsi:type="xsd:string">>true</value>
  </qualifier>
</item>
<item xsi:type="ns1:CIMProperty">
  <name xsi:type="xsd:string">OuterVlanRanges</name>
  <value xsi:type="xsd:string">>false</value>
  <qualifier xsi:type="ns1:CIMQualifier">
    <name xsi:type="xsd:string">editable</name>
    <value xsi:type="xsd:string">>true</value>
  </qualifier>
</item>
<item xsi:type="ns1:CIMProperty">
  <name xsi:type="xsd:string">EnablePWRedundancy</name>
  <value xsi:type="xsd:string">>false</value>
  <qualifier xsi:type="ns1:CIMQualifier">
    <name xsi:type="xsd:string">editable</name>
    <value xsi:type="xsd:string">>true</value>
  </qualifier>
</item>
<item xsi:type="ns1:CIMProperty">
  <name xsi:type="xsd:string">PwTunnelSelection</name>
  <value xsi:type="xsd:string">>false</value>
  <qualifier xsi:type="ns1:CIMQualifier">
    <name xsi:type="xsd:string">editable</name>
    <value xsi:type="xsd:string">>true</value>
  </qualifier>
</item>
<item xsi:type="ns1:CIMProperty">
  <name xsi:type="xsd:string">AutopickVCId</name>
  <value xsi:type="xsd:string">>false</value>
  <qualifier xsi:type="ns1:CIMQualifier">
    <name xsi:type="xsd:string">editable</name>
    <value xsi:type="xsd:string">>true</value>
  </qualifier>
</item>
<item xsi:type="ns1:CIMProperty">
  <name xsi:type="xsd:string">PushOuter</name>
  <value xsi:type="xsd:string">>false</value>
  <qualifier xsi:type="ns1:CIMQualifier">
    <name xsi:type="xsd:string">editable</name>
    <value xsi:type="xsd:string">>true</value>
  </qualifier>
</item>
<item xsi:type="ns1:CIMProperty">
  <name xsi:type="xsd:string">PushInner</name>
  <value xsi:type="xsd:string">>false</value>
  <qualifier xsi:type="ns1:CIMQualifier">
    <name xsi:type="xsd:string">editable</name>
    <value xsi:type="xsd:string">>true</value>
  </qualifier>
</item>
<item xsi:type="ns1:CIMProperty">
  <name xsi:type="xsd:string">PopOuter</name>
  <value xsi:type="xsd:string">>false</value>
  <qualifier xsi:type="ns1:CIMQualifier">
    <name xsi:type="xsd:string">editable</name>
    <value xsi:type="xsd:string">>true</value>
  </qualifier>
</item>

```



```

<item xsi:type="ns1:CIMProperty">
  <name xsi:type="xsd:string">PopInner</name>
  <value xsi:type="xsd:string">>false</value>
  <qualifier xsi:type="ns1:CIMQualifier">
    <name xsi:type="xsd:string">editable</name>
    <value xsi:type="xsd:string">>true</value>
  </qualifier>
</item>
<item xsi:type="ns1:CIMProperty">
  <name xsi:type="xsd:string">TranslateInner</name>
  <value xsi:type="xsd:string">>false</value>
  <qualifier xsi:type="ns1:CIMQualifier">
    <name xsi:type="xsd:string">editable</name>
    <value xsi:type="xsd:string">>true</value>
  </qualifier>
</item>
<item xsi:type="ns1:CIMProperty">
  <name xsi:type="xsd:string">TranslateOuter</name>
  <value xsi:type="xsd:string">>false</value>
  <qualifier xsi:type="ns1:CIMQualifier">
    <name xsi:type="xsd:string">editable</name>
    <value xsi:type="xsd:string">>true</value>
  </qualifier>
</item>
<item xsi:type="ns1:CIMProperty">
  <name xsi:type="xsd:string">UseEVC</name>
  <value xsi:type="xsd:string">>false</value>
</item>
<item xsi:type="ns1:CIMProperty">
  <name xsi:type="xsd:string">UseBD</name>
  <value xsi:type="xsd:string">>true</value>
  <qualifier xsi:type="ns1:CIMQualifier">
    <name xsi:type="xsd:string">editable</name>
    <value xsi:type="xsd:string">>true</value>
  </qualifier>
</item>
<item xsi:type="ns1:CIMProperty">
  <name xsi:type="xsd:string">EncapsulationType</name>
  <value xsi:type="xsd:string">DOT1QTRUNK</value>
  <qualifier xsi:type="ns1:CIMQualifier">
    <name xsi:type="xsd:string">editable</name>
    <value xsi:type="xsd:string">>true</value>
  </qualifier>
</item>
</properties>
</objectPath>
</objectPath>
</ns1:createInstance>
<!-- ns1:modifyInstance>
<objectPath subAction="modifyInstance" xsi:type="ns1:CIMObjectPath">
  <className xsi:type="xsd:string">ServiceDefinition</className>
  <keyProperties xsi:type="ns1:CIMPropertyList"
    soapenc:arrayType="ns1:CIMProperty[]">
    <item xsi:type="ns1:CIMProperty">
      <name xsi:type="xsd:string">Name</name>
      <value xsi:type="xsd:string">d-vc-nbi-innerrangesEdit</value>
    </item>
  <item xsi:type="ns1:CIMProperty">
      <name xsi:type="xsd:string">Type</name>
      <value xsi:type="xsd:string">Evc</value>
    </item>
  </keyProperties>
  <objectPath subAction="modifyInstance" xsi:type="ns1:CIMObjectPath">

```

```

<className xsi:type="xsd:string">ServiceDefinitionDetails</className>
<properties xsi:type="ns1:CIMPropertyList"
  soapenc:arrayType="ns1:CIMProperty[]" >

  <item xsi:type="ns1:CIMProperty">
    <name xsi:type="xsd:string">AllowBothTags</name>
    <value xsi:type="xsd:string">>false</value>
    <qualifier xsi:type="ns1:CIMQualifier">
      <name xsi:type="xsd:string">editable</name>
      <value xsi:type="xsd:string">>true</value>
    </qualifier>
  </item>
  <item xsi:type="ns1:CIMProperty">
    <name xsi:type="xsd:string">OuterVlanRanges</name>
    <value xsi:type="xsd:string">>true</value>
    <qualifier xsi:type="ns1:CIMQualifier">
      <name xsi:type="xsd:string">editable</name>
      <value xsi:type="xsd:string">>true</value>
    </qualifier>
  </item>
  <item xsi:type="ns1:CIMProperty">
    <name xsi:type="xsd:string">InnerVlanRanges</name>
    <value xsi:type="xsd:string">>false</value>
    <qualifier xsi:type="ns1:CIMQualifier">
      <name xsi:type="xsd:string">editable</name>
      <value xsi:type="xsd:string">>false</value>
    </qualifier>
  </item>
</properties>
</objectPath>
</objectPath>
</ns1:modifyInstance>
-->
</soapenv:Body>
</soapenv:Envelope>

```

## Creating a Pseudowire Policy With Reserved Bandwidth

This example shows how to set a reserved bandwidth for a pseudowire policy. The significant attribute is **ConfigurePseudowireBW**, which in the example is set to **242**. The full XML example is found in the [Cisco Prime Provisioning API 6.8 Programmer Reference](#).

Example: CreateEvcPwPolicy\_ResBw.xml

```

<item xsi:type="ns1:CIMProperty">
  <name xsi:type="xsd:string">ConfigurePseudowireBW</name>
  <value xsi:type="xsd:string">242</value>
  <qualifier xsi:type="ns1:CIMQualifier">
    <name xsi:type="xsd:string">editable</name>
    <value xsi:type="xsd:string">>true</value>
  </qualifier>
</item>

```

## Configuring an SVI/EVC Hybrid Scenario

In the following example, a EVC policy is created with the EVC/SVI Hybrid scenario. The attribute relevant for the EVC/SVI Hybrid scenario is **XconnectOnSVI** (in **bold** below), which in the example is set to **true**.

## Example: CreateEVCSvcDefn\_PW\_1.xml

```

<?xml version="1.0" encoding="UTF-8"?>
<soapenv:Envelope
  xmlns:soapenv="http://schemas.xmlsoap.org/soap/envelope/"
  xmlns:soapenc="http://schemas.xmlsoap.org/soap/encoding/"
  xmlns:xsd="http://www.w3.org/2001/XMLSchema"
  xmlns:xsi="http://www.w3.org/2001/XMLSchema-instance"
  xmlns:ns0="http://www.cisco.com/cim-cx/2.0"
  xmlns:ns1="urn:CIM">
  <soapenv:Header>
    <ns0:message id="87855" timestamp="2002-12-13T14:55:38.885Z"
      sessiontoken="p36bttjwy1"/>
  </soapenv:Header>
  <soapenv:Body>
    <ns1:createInstance>
      <objectPath xsi:type="ns1:CIMObjectPath">
        <className xsi:type="xsd:string">ServiceDefinition</className>
        <properties xsi:type="ns1:CIMPropertyList"
          soapenc:arrayType="ns1:CIMProperty[]">
          <item xsi:type="ns1:CIMProperty">
            <name xsi:type="xsd:string">Name</name>
            <value xsi:type="xsd:string">doc_pw</value>
          </item>
          <item xsi:type="ns1:CIMProperty">
            <name xsi:type="xsd:string">Type</name>
            <value xsi:type="xsd:string">Evc</value>
          </item>
        </properties>
      <objectPath xsi:type="ns1:CIMObjectPath">
        <className xsi:type="xsd:string">ServiceDefinitionDetails</className>
        <properties xsi:type="ns1:CIMPropertyList"
          soapenc:arrayType="ns1:CIMProperty[]">
          <item xsi:type="ns1:CIMProperty">
            <name xsi:type="xsd:string">SubType</name>
            <value xsi:type="xsd:string">Evc</value>
          </item>
          <item xsi:type="ns1:CIMProperty">
            <name xsi:type="xsd:string">AccessType</name>
            <value xsi:type="xsd:string">ETHERNET</value>
          </item>
          <item xsi:type="ns1:CIMProperty">
            <name xsi:type="xsd:string">TransportType</name>
            <value xsi:type="xsd:string">PSEUDOWIRE</value>
          </item>
          <item xsi:type="ns1:CIMProperty">
            <name xsi:type="xsd:string">StdUniPort</name>
            <value xsi:type="xsd:string">>true</value>
            <qualifier xsi:type="ns1:CIMQualifier">
              <name xsi:type="xsd:string">editable</name>
              <value xsi:type="xsd:string">>true</value>
            </qualifier>
          </item>
          <item xsi:type="ns1:CIMProperty">
            <name xsi:type="xsd:string">UniShutdown</name>
            <value xsi:type="xsd:string">>false</value>
            <qualifier xsi:type="ns1:CIMQualifier">
              <name xsi:type="xsd:string">editable</name>
              <value xsi:type="xsd:string">>true</value>
            </qualifier>
          </item>
          <item xsi:type="ns1:CIMProperty">
            <name xsi:type="xsd:string">DirectConnect</name>

```

```

        <value xsi:type="xsd:string">false</value>
    </item>
    <item xsi:type="ns1:CIMProperty">
        <name xsi:type="xsd:string">AutoPickEsiId</name>
        <value xsi:type="xsd:string">true</value>
        <qualifier xsi:type="ns1:CIMQualifier">
            <name xsi:type="xsd:string">editable</name>
            <value xsi:type="xsd:string">true</value>
        </qualifier>
    </item>
    <item xsi:type="ns1:CIMProperty">
        <name xsi:type="xsd:string">AutopickVCId</name>
        <value xsi:type="xsd:string">true</value>
        <qualifier xsi:type="ns1:CIMQualifier">
            <name xsi:type="xsd:string">editable</name>
            <value xsi:type="xsd:string">true</value>
        </qualifier>
    </item>
    <item xsi:type="ns1:CIMProperty">
        <name xsi:type="xsd:string">AutoPickBDVlanId</name>
        <value xsi:type="xsd:string">true</value>
        <qualifier xsi:type="ns1:CIMQualifier">
            <name xsi:type="xsd:string">editable</name>
            <value xsi:type="xsd:string">true</value>
        </qualifier>
    </item>
    <item xsi:type="ns1:CIMProperty">
        <name xsi:type="xsd:string">EnablePWRedundancy</name>
        <value xsi:type="xsd:string">false</value>
        <qualifier xsi:type="ns1:CIMQualifier">
            <name xsi:type="xsd:string">editable</name>
            <value xsi:type="xsd:string">true</value>
        </qualifier>
    </item>
<!-- XConnect ON SVI-->
    <item xsi:type="ns1:CIMProperty">
        <name xsi:type="xsd:string">XconnectOnSVI</name>
        <value xsi:type="xsd:string">true</value>
        <qualifier xsi:type="ns1:CIMQualifier">
            <name xsi:type="xsd:string">editable</name>
            <value xsi:type="xsd:string">true</value>
        </qualifier>
    </item>
    <item xsi:type="ns1:CIMProperty">
        <name xsi:type="xsd:string">PwTunnelSelection</name>
        <value xsi:type="xsd:string">false</value>
        <qualifier xsi:type="ns1:CIMQualifier">
            <name xsi:type="xsd:string">editable</name>
            <value xsi:type="xsd:string">true</value>
        </qualifier>
    </item>
    <item xsi:type="ns1:CIMProperty">
        <name xsi:type="xsd:string">AutopickVCId</name>
        <value xsi:type="xsd:string">false</value>
        <qualifier xsi:type="ns1:CIMQualifier">
            <name xsi:type="xsd:string">editable</name>
            <value xsi:type="xsd:string">true</value>
        </qualifier>
    </item>
    <item xsi:type="ns1:CIMProperty">
        <name xsi:type="xsd:string">AllowBothTags</name>
        <value xsi:type="xsd:string">false</value>
        <qualifier xsi:type="ns1:CIMQualifier">
            <name xsi:type="xsd:string">editable</name>

```

```

        <value xsi:type="xsd:string">true</value>
    </qualifier>
</item>
<item xsi:type="ns1:CIMProperty">
    <name xsi:type="xsd:string">PushOuter</name>
    <value xsi:type="xsd:string">>false</value>
    <qualifier xsi:type="ns1:CIMQualifier">
        <name xsi:type="xsd:string">editable</name>
        <value xsi:type="xsd:string">true</value>
    </qualifier>
</item>
<item xsi:type="ns1:CIMProperty">
    <name xsi:type="xsd:string">PushInner</name>
    <value xsi:type="xsd:string">>false</value>
    <qualifier xsi:type="ns1:CIMQualifier">
        <name xsi:type="xsd:string">editable</name>
        <value xsi:type="xsd:string">true</value>
    </qualifier>
</item>
<item xsi:type="ns1:CIMProperty">
    <name xsi:type="xsd:string">PopOuter</name>
    <value xsi:type="xsd:string">>false</value>
    <qualifier xsi:type="ns1:CIMQualifier">
        <name xsi:type="xsd:string">editable</name>
        <value xsi:type="xsd:string">true</value>
    </qualifier>
</item>
<item xsi:type="ns1:CIMProperty">
    <name xsi:type="xsd:string">PopInner</name>
    <value xsi:type="xsd:string">>false</value>
    <qualifier xsi:type="ns1:CIMQualifier">
        <name xsi:type="xsd:string">editable</name>
        <value xsi:type="xsd:string">true</value>
    </qualifier>
</item>
<item xsi:type="ns1:CIMProperty">
    <name xsi:type="xsd:string">TranslateInner</name>
    <value xsi:type="xsd:string">>false</value>
    <qualifier xsi:type="ns1:CIMQualifier">
        <name xsi:type="xsd:string">editable</name>
        <value xsi:type="xsd:string">true</value>
    </qualifier>
</item>
<item xsi:type="ns1:CIMProperty">
    <name xsi:type="xsd:string">TranslateOuter</name>
    <value xsi:type="xsd:string">>false</value>
    <qualifier xsi:type="ns1:CIMQualifier">
        <name xsi:type="xsd:string">editable</name>
        <value xsi:type="xsd:string">true</value>
    </qualifier>
</item>
<item xsi:type="ns1:CIMProperty">
    <name xsi:type="xsd:string">UseEVC</name>
    <value xsi:type="xsd:string">>false</value>
</item>
<item xsi:type="ns1:CIMProperty">
    <name xsi:type="xsd:string">UseBD</name>
    <value xsi:type="xsd:string">true</value>
    <qualifier xsi:type="ns1:CIMQualifier">
        <name xsi:type="xsd:string">editable</name>
        <value xsi:type="xsd:string">true</value>
    </qualifier>
</item>
<item xsi:type="ns1:CIMProperty">

```

```

        <name xsi:type="xsd:string">EncapsulationType</name>
        <value xsi:type="xsd:string">DOT1QTRUNK</value>
        <qualifier xsi:type="nsl:CIMQualifier">
            <name xsi:type="xsd:string">editable</name>
            <value xsi:type="xsd:string">true</value>
        </qualifier>
    </item>
</properties>
</objectPath>
</objectPath>
</nsl:createInstance>
</soapenv:Body>
</soapenv:Envelope>

```

## Creating a Policy for Specifying Service Instance Name

The following example shows how to create a policy that specifies a service instance name for EVC service requests. The attribute used to specify a service instance name in EVC service requests is **AutoPickEsiName** (in **bold** below), which in the example is set to **true**.

Example: CreateEVCSERVICEDEFN\_PW\_2.xml

```

<?xml version="1.0" encoding="UTF-8" ?>
<soapenv:Envelope
  xmlns:soapenv="http://schemas.xmlsoap.org/soap/envelope/"
  xmlns:soapenc="http://schemas.xmlsoap.org/soap/encoding/"
  xmlns:xsd="http://www.w3.org/2001/XMLSchema"
  xmlns:xsi="http://www.w3.org/2001/XMLSchema-instance"
  xmlns:ns0="http://www.cisco.com/cim-cx/2.0"
  xmlns:ns1="urn:CIM">
  <soapenv:Header>
    <ns0:message id="87855" timestamp="2002-12-13T14:55:38.885Z"
      sessiontoken="p36bttjwy1" />
  </soapenv:Header>
  <soapenv:Body>
    <nsl:createInstance>
      <objectPath xsi:type="nsl:CIMObjectPath">
        <className xsi:type="xsd:string">ServiceDefinition</className>
        <properties xsi:type="nsl:CIMPropertyList"
          soapenc:arrayType="nsl:CIMProperty[]">
          <item xsi:type="nsl:CIMProperty">
            <name xsi:type="xsd:string">Name</name>
            <value xsi:type="xsd:string">doc_pw</value>
          </item>
          <item xsi:type="nsl:CIMProperty">
            <name xsi:type="xsd:string">Type</name>
            <value xsi:type="xsd:string">Evc</value>
          </item>
        </properties>
      <objectPath xsi:type="nsl:CIMObjectPath">
        <className xsi:type="xsd:string">ServiceDefinitionDetails</className>
        <properties xsi:type="nsl:CIMPropertyList"
          soapenc:arrayType="nsl:CIMProperty[]">
          <item xsi:type="nsl:CIMProperty">
            <name xsi:type="xsd:string">SubType</name>
            <value xsi:type="xsd:string">Evc</value>
          </item>
          <item xsi:type="nsl:CIMProperty">
            <name xsi:type="xsd:string">AccessType</name>
            <value xsi:type="xsd:string">ETHERNET</value>
          </item>
        </properties>
      </objectPath>
    </nsl:createInstance>
  </soapenv:Body>
</soapenv:Envelope>

```

```

    <item xsi:type="ns1:CIMProperty">
      <name xsi:type="xsd:string">TransportType</name>
      <value xsi:type="xsd:string">PSEUDOWIRE</value>
    </item>
  <item xsi:type="ns1:CIMProperty">
    <name xsi:type="xsd:string">StdUniPort</name>
    <value xsi:type="xsd:string">true</value>
    <qualifier xsi:type="ns1:CIMQualifier">
      <name xsi:type="xsd:string">editable</name>
      <value xsi:type="xsd:string">true</value>
    </qualifier>
  </item>
  <item xsi:type="ns1:CIMProperty">
    <name xsi:type="xsd:string">UniShutdown</name>
    <value xsi:type="xsd:string">false</value>
    <qualifier xsi:type="ns1:CIMQualifier">
      <name xsi:type="xsd:string">editable</name>
      <value xsi:type="xsd:string">true</value>
    </qualifier>
  </item>
  <item xsi:type="ns1:CIMProperty">
    <name xsi:type="xsd:string">DirectConnect</name>
    <value xsi:type="xsd:string">false</value>
  </item>
  <item xsi:type="ns1:CIMProperty">
    <name xsi:type="xsd:string">AutoPickEsiId</name>
    <value xsi:type="xsd:string">true</value>
    <qualifier xsi:type="ns1:CIMQualifier">
      <name xsi:type="xsd:string">editable</name>
      <value xsi:type="xsd:string">true</value>
    </qualifier>
  </item>
  <item xsi:type="ns1:CIMProperty">
    <name xsi:type="xsd:string">AutopickVCId</name>
    <value xsi:type="xsd:string">true</value>
    <qualifier xsi:type="ns1:CIMQualifier">
      <name xsi:type="xsd:string">editable</name>
      <value xsi:type="xsd:string">true</value>
    </qualifier>
  </item>
  <item xsi:type="ns1:CIMProperty">
    <name xsi:type="xsd:string">AutoPickBDVlanId</name>
    <value xsi:type="xsd:string">true</value>
    <qualifier xsi:type="ns1:CIMQualifier">
      <name xsi:type="xsd:string">editable</name>
      <value xsi:type="xsd:string">true</value>
    </qualifier>
  </item>
  <item xsi:type="ns1:CIMProperty">
    <name xsi:type="xsd:string">EnablePWRedundancy</name>
    <value xsi:type="xsd:string">false</value>
    <qualifier xsi:type="ns1:CIMQualifier">
      <name xsi:type="xsd:string">editable</name>
      <value xsi:type="xsd:string">true</value>
    </qualifier>
  </item>
  <item xsi:type="ns1:CIMProperty">
    <name xsi:type="xsd:string">AutoPickEsiName</name>
    <value xsi:type="xsd:string">true</value>
    <qualifier xsi:type="ns1:CIMQualifier">
      <name xsi:type="xsd:string">editable</name>
      <value xsi:type="xsd:string">true</value>
    </qualifier>
  </item >

```

```

<item xsi:type="ns1:CIMProperty">
  <name xsi:type="xsd:string">PwTunnelSelection</name>
  <value xsi:type="xsd:string">>false</value>
  <qualifier xsi:type="ns1:CIMQualifier">
    <name xsi:type="xsd:string">editable</name>
    <value xsi:type="xsd:string">>true</value>
  </qualifier>
</item>
<item xsi:type="ns1:CIMProperty">
  <name xsi:type="xsd:string">AutopickVCId</name>
  <value xsi:type="xsd:string">>false</value>
  <qualifier xsi:type="ns1:CIMQualifier">
    <name xsi:type="xsd:string">editable</name>
    <value xsi:type="xsd:string">>true</value>
  </qualifier>
</item>
<item xsi:type="ns1:CIMProperty">
  <name xsi:type="xsd:string">AllowBothTags</name>
  <value xsi:type="xsd:string">>false</value>
  <qualifier xsi:type="ns1:CIMQualifier">
    <name xsi:type="xsd:string">editable</name>
    <value xsi:type="xsd:string">>true</value>
  </qualifier>
</item>
<item xsi:type="ns1:CIMProperty">
  <name xsi:type="xsd:string">PushOuter</name>
  <value xsi:type="xsd:string">>false</value>
  <qualifier xsi:type="ns1:CIMQualifier">
    <name xsi:type="xsd:string">editable</name>
    <value xsi:type="xsd:string">>true</value>
  </qualifier>
</item>
<item xsi:type="ns1:CIMProperty">
  <name xsi:type="xsd:string">PushInner</name>
  <value xsi:type="xsd:string">>false</value>
  <qualifier xsi:type="ns1:CIMQualifier">
    <name xsi:type="xsd:string">editable</name>
    <value xsi:type="xsd:string">>true</value>
  </qualifier>
</item>
<item xsi:type="ns1:CIMProperty">
  <name xsi:type="xsd:string">PopOuter</name>
  <value xsi:type="xsd:string">>false</value>
  <qualifier xsi:type="ns1:CIMQualifier">
    <name xsi:type="xsd:string">editable</name>
    <value xsi:type="xsd:string">>true</value>
  </qualifier>
</item>
<item xsi:type="ns1:CIMProperty">
  <name xsi:type="xsd:string">PopInner</name>
  <value xsi:type="xsd:string">>false</value>
  <qualifier xsi:type="ns1:CIMQualifier">
    <name xsi:type="xsd:string">editable</name>
    <value xsi:type="xsd:string">>true</value>
  </qualifier>
</item>
<item xsi:type="ns1:CIMProperty">
  <name xsi:type="xsd:string">TranslateInner</name>
  <value xsi:type="xsd:string">>false</value>
  <qualifier xsi:type="ns1:CIMQualifier">
    <name xsi:type="xsd:string">editable</name>
    <value xsi:type="xsd:string">>true</value>
  </qualifier>
</item>

```



```

    <item xsi:type="ns1:CIMProperty">
      <name xsi:type="xsd:string">TranslateOuter</name>
      <value xsi:type="xsd:string">>false</value>
      <qualifier xsi:type="ns1:CIMQualifier">
        <name xsi:type="xsd:string">editable</name>
        <value xsi:type="xsd:string">>true</value>
      </qualifier>
    </item>
    <item xsi:type="ns1:CIMProperty">
      <name xsi:type="xsd:string">UseEVC</name>
      <value xsi:type="xsd:string">>false</value>
    </item>
    <item xsi:type="ns1:CIMProperty">
      <name xsi:type="xsd:string">UseBD</name>
      <value xsi:type="xsd:string">>true</value>
      <qualifier xsi:type="ns1:CIMQualifier">
        <name xsi:type="xsd:string">editable</name>
        <value xsi:type="xsd:string">>true</value>
      </qualifier>
    </item>
    <item xsi:type="ns1:CIMProperty">
      <name xsi:type="xsd:string">EncapsulationType</name>
      <value xsi:type="xsd:string">DOT1QTRUNK</value>
      <qualifier xsi:type="ns1:CIMQualifier">
        <name xsi:type="xsd:string">editable</name>
        <value xsi:type="xsd:string">>true</value>
      </qualifier>
    </item>
  </properties>
</objectPath>
</objectPath>
</ns1:createInstance>
</soapenv:Body>
</soapenv:Envelope>

```

## Creating a Multi-Segment Pseudowire Policy

The following example shows how to create a Multi-Segment PseudoWire (MSPW) policy.

Example: CreateEVC\_MSPW.xml

```

<?xml version="1.0" encoding="utf-8"?>
<soapenv:Envelope xmlns:soapenv="http://schemas.xmlsoap.org/soap/envelope/"
xmlns:soapenc="http://schemas.xmlsoap.org/soap/encoding/"
xmlns:xsd="http://www.w3.org/2001/XMLSchema"
xmlns:xsi="http://www.w3.org/2001/XMLSchema-instance"
xmlns:ns0="http://www.cisco.com/cim-cx/2.0" xmlns:ns1="urn:CIM">
  <soapenv:Header>
    <!-- WaitTimeout has a default set in system properties.-->
    <ns0:message id="87855" timestamp="2002-12-13T14:55:38.885Z"
Wait="true" WaitTimeout="90" sessiontoken="p36bttjwy1" />
  </soapenv:Header>
  <soapenv:Body>
    <ns1:performBatchOperation>
      <actions xsi:type="ns1:CIMActionList" soapenc:arrayType="ns1:CIMAction[]">
        <action>
          <actionName xsi:type="xsd:string">createInstance</actionName>
          <objectPath xsi:type="ns1:CIMObjectPath">
            <className xsi:type="xsd:string">ServiceOrder</className>
            <properties xsi:type="ns1:CIMPropertyList"
soapenc:arrayType="ns1:CIMProperty[]">

```

```

    <item xsi:type="ns1:CIMProperty">
      <name xsi:type="xsd:string">ServiceName</name>
      <value xsi:type="xsd:string">ServiceOrder257</value>
    </item>
    <item xsi:type="ns1:CIMProperty">
      <name xsi:type="xsd:string">DesiredDueDate</name>
      <value xsi:type="xsd:dateTime">2008-12-13T14:55:38.885Z</value>
    </item>
    <item xsi:type="ns1:CIMProperty">
      <name xsi:type="xsd:string">NumberOfRequests</name>
      <value xsi:type="xsd:string">1</value>
    </item>
  </properties>
</objectPath>
</action>
<action>
  <actionName xsi:type="xsd:string">createInstance</actionName>
  <objectPath xsi:type="ns1:CIMObjectPath">
    <className xsi:type="xsd:string">ServiceRequest</className>
    <properties xsi:type="ns1:CIMPropertyList"
soapenc:arrayType="ns1:CIMProperty[]">
      <item xsi:type="ns1:CIMProperty">
        <name xsi:type="xsd:string">RequestName</name>
        <value xsi:type="xsd:string">EvcSR-7</value>
      </item>
      <item xsi:type="ns1:CIMProperty">
        <name xsi:type="xsd:string">Type</name>
        <value xsi:type="xsd:string">Evc</value>
      </item>
    </properties>
    <objectPath subAction="createInstance" xsi:type="ns1:CIMObjectPath">
      <className xsi:type="xsd:string">ServiceRequestDetails</className>
      <properties soapenc:arrayType="ns1:CIMProperty[]"
xsi:type="ns1:CIMPropertyList">
        <item xsi:type="ns1:CIMProperty">
          <name xsi:type="xsd:string">Description</name>
          <value xsi:type="xsd:string">EVC-PW-MS-default-checking-rob</value>
        </item>
        <item xsi:type="ns1:CIMProperty">
          <name xsi:type="xsd:string">ServiceDefinition</name>
          <value xsi:type="xsd:string">EVC-PW-MS-default</value>
          <qualifier xsi:type="ns1:CIMQualifier">
            <name xsi:type="xsd:string">ServiceDefinitionType</name>
            <value xsi:type="xsd:string">Evc</value>
          </qualifier>
        </item>
        <item xsi:type="ns1:CIMProperty">
          <name xsi:type="xsd:string">VCID</name>
          <value xsi:type="xsd:string">984</value>
        </item>
        <item xsi:type="ns1:CIMProperty">
          <name xsi:type="xsd:string">UseBackupVCID</name>
          <value xsi:type="xsd:string">>false</value>
        </item>
        <item xsi:type="ns1:CIMProperty">
          <name xsi:type="xsd:string">BackupVCID</name>
          <value xsi:type="xsd:string">1234</value>
        </item>
        <item xsi:type="ns1:CIMProperty">
          <name xsi:type="xsd:string">UseSVI</name>
          <value xsi:type="xsd:string">>true</value>
        </item>
        <item xsi:type="ns1:CIMProperty">
          <name xsi:type="xsd:string">VPN</name>

```

```

        <value xsi:type="xsd:string">vpn-1</value>
    </item>
</properties>
</objectPath>
<objectPath subAction="createInstance" xsi:type="ns1:CIMObjectPath">
    <className xsi:type="xsd:string">EvcLink</className>
    <properties soapenc:arrayType="ns1:CIMProperty[]"
xsi:type="ns1:CIMPropertyList">
        <item xsi:type="ns1:CIMProperty">
            <name xsi:type="xsd:string">Npe</name>
            <value xsi:type="xsd:string">isc-cl-test-12-7600-6</value>
        </item>
        <item xsi:type="ns1:CIMProperty">
            <name xsi:type="xsd:string">UniInftId</name>
            <value xsi:type="xsd:string">GigabitEthernet4/15</value>
        </item>
    </properties>
</objectPath>
<objectPath subAction="createInstance" xsi:type="ns1:CIMObjectPath">
    <className xsi:type="xsd:string">EvcETHLinkAttrs</className>
    <properties soapenc:arrayType="ns1:CIMProperty[]"
xsi:type="ns1:CIMPropertyList">
        <item xsi:type="ns1:CIMProperty">
            <name xsi:type="xsd:string">AutoPickVlanId</name>
            <value xsi:type="xsd:string">>false</value>
        </item>
        <item xsi:type="ns1:CIMProperty">
            <name xsi:type="xsd:string">EncapsulationType</name>
            <value xsi:type="xsd:string">DOT1Q</value>
        </item>
        <item xsi:type="ns1:CIMProperty">
            <name xsi:type="xsd:string">VlanID</name>
            <value xsi:type="xsd:string">2451</value>
        </item>
        <item xsi:type="ns1:CIMProperty">
            <name xsi:type="xsd:string">UseServiceInst</name>
            <value xsi:type="xsd:string">>true</value>
        </item>
    </properties>
</objectPath>
<objectPath subAction="createInstance" xsi:type="ns1:CIMObjectPath">
    <className xsi:type="xsd:string">EvcServiceInstanceAttrs</className>
    <properties soapenc:arrayType="ns1:CIMProperty[]"
xsi:type="ns1:CIMPropertyList">
        <item xsi:type="ns1:CIMProperty">
            <name xsi:type="xsd:string">AutoPickServiceInstName</name>
            <value xsi:type="xsd:string">>false</value>
        </item>
        <item xsi:type="ns1:CIMProperty">
            <name xsi:type="xsd:string">AutoPickServiceInstId</name>
            <value xsi:type="xsd:string">>true</value>
        </item>
        <item xsi:type="ns1:CIMProperty">
            <name xsi:type="xsd:string">OuterVlanRange</name>
            <value xsi:type="xsd:string">44</value>
        </item>
        <item xsi:type="ns1:CIMProperty">
            <name xsi:type="xsd:string">RewriteActionType</name>
            <value xsi:type="xsd:string">POP</value>
        </item>
        <item xsi:type="ns1:CIMProperty">
            <name xsi:type="xsd:string">BothTags</name>
            <value xsi:type="xsd:string">>false</value>
        </item>
    </properties>
</objectPath>

```

```

</objectPath>
<objectPath subAction="createInstance" xsi:type="ns1:CIMObjectPath">
  <className xsi:type="xsd:string">EvcLink</className>
  <properties soapenc:arrayType="ns1:CIMProperty[]"
xsi:type="ns1:CIMPropertyList">
    <item xsi:type="ns1:CIMProperty">
      <name xsi:type="xsd:string">Npe</name>
      <value xsi:type="xsd:string">cl-test-12-7600-3</value>
    </item>
    <item xsi:type="ns1:CIMProperty">
      <name xsi:type="xsd:string">UniInftId</name>
      <value xsi:type="xsd:string">GigabitEthernet2/0/14</value>
    </item>
  </properties>
  <objectPath subAction="createInstance" xsi:type="ns1:CIMObjectPath">
    <className xsi:type="xsd:string">EvcETHLinkAttrs</className>
    <properties soapenc:arrayType="ns1:CIMProperty[]"
xsi:type="ns1:CIMPropertyList">
      <item xsi:type="ns1:CIMProperty">
        <name xsi:type="xsd:string">AutoPickVlanId</name>
        <value xsi:type="xsd:string">>false</value>
      </item>
      <item xsi:type="ns1:CIMProperty">
        <name xsi:type="xsd:string">EncapsulationType</name>
        <value xsi:type="xsd:string">DOT1Q</value>
      </item>
      <item xsi:type="ns1:CIMProperty">
        <name xsi:type="xsd:string">VlanID</name>
        <value xsi:type="xsd:string">1451</value>
      </item>
      <item xsi:type="ns1:CIMProperty">
        <name xsi:type="xsd:string">UseServiceInst</name>
        <value xsi:type="xsd:string">>true</value>
      </item>
    </properties>
  </objectPath>
  <objectPath subAction="createInstance" xsi:type="ns1:CIMObjectPath">
    <className xsi:type="xsd:string">EvcServiceInstanceAttrs</className>
    <properties soapenc:arrayType="ns1:CIMProperty[]"
xsi:type="ns1:CIMPropertyList">
      <item xsi:type="ns1:CIMProperty">
        <name xsi:type="xsd:string">AutoPickServiceInstName</name>
        <value xsi:type="xsd:string">>false</value>
      </item>
      <item xsi:type="ns1:CIMProperty">
        <name xsi:type="xsd:string">AutoPickServiceInstId</name>
        <value xsi:type="xsd:string">>true</value>
      </item>
      <item xsi:type="ns1:CIMProperty">
        <name xsi:type="xsd:string">OuterVlanRange</name>
        <value xsi:type="xsd:string">44</value>
      </item>
      <item xsi:type="ns1:CIMProperty">
        <name xsi:type="xsd:string">RewriteActionType</name>
        <value xsi:type="xsd:string">POP</value>
      </item>
      <item xsi:type="ns1:CIMProperty">
        <name xsi:type="xsd:string">BothTags</name>
        <value xsi:type="xsd:string">>false</value>
      </item>
    </properties>
  </objectPath>
</objectPath>
<objectPath xsi:type="ns1:CIMObjectPath">

```

```

        <className xsi:type="xsd:string">EvcPseudowireNeighborLinks</className>
        <properties xsi:type="ns1:CIMPropertyList"
soapenc:arrayType="ns1:CIMProperty[]" >
            <item xsi:type="ns1:CIMProperty">
                <name xsi:type="xsd:string">PathXml</name>
                <value xsi:type="xsd:string">
                    <![CDATA[
                        <service serviceName="MSPW" serviceType="MSPW">
                            <section name="Review Routing" required="true" useFor="SR">
                                <group cloneable="true" id="pathOptionsGroup"
position="pane01_group0">
                                    <field disabled="false" id="reqExOptionpane01_group0widget0"
name="reqExOption" position="pane01_group0widget0" required="false" title="" type="combo"
value="Required NE/Link">
                                        <valueMap>
                                            <value>Required NE/Link</value>
                                            <value>Excluded NE/Link</value>
                                        </valueMap>
                                    </field>
                                    <field name="sourceDevice" value="isc-cl-test-12-7600-6"/>
                                    <field name="destinationDevice" value="cl-test-12-7600-3"/>
                                    <field name="groupPwSelection">
                                        <pwfield name="pwSelection" segmentType ="dynamic">
                                            <field name="sourceDevice" value="isc-cl-test-12-7600-6"
pwclass ="pw-class-1"/>
                                            <field name="destinationDevice" value="cl-test-12-7600-5"
pwclass ="pw-class-1"/>
                                        </pwfield>
                                        <pwfield name="pwSelection" segmentType ="dynamic">
                                            <field name="sourceDevice" value="cl-test-12-7600-5" pwclass
="pw-class-2"/>
                                            <field name="destinationDevice" value="cl-test-12-7600-3"
pwclass ="pw-class-2"/>
                                        </pwfield>
                                    </field>
                                    <field id="reqExElementpane01_group0widget1" name="reqExElement"
position="pane01_group0widget1" required="true" resource="devicesAndTpTunnels" title=""
type="textpicker"
value="isc-cl-test-12-7600-6:Tunnel-tp7667 (7667) &lt;===&gt;cl-test-12-7600-5:Tunnel-tp7667
(7667)"/>
                                        <field id="pathypepane01_group0widget2" name="pathype"
position="pane01_group0widget2" required="false" title="" type="combo" value="Working
Path" visibility="Hidden">
                                            <valueMap>
                                                <value>Working Path</value>
                                            </valueMap>
                                        </field>
                                    </group>
                                </section>
                            </service>]]>
                    </value>
                </item>
            </properties>
        </objectPath>
    </objectPath>
</action>
</actions>
</ns1:performBatchOperation>
</soapenv:Body>
</soapenv:Envelope>

```

## Creating an EVC VPLS Policy for E-TREE

In the following example, an EVC VPLS policy is created to identify root and leaf nodes in an ETREE. The key attributes are `Etree` and `EtreeRole`, to which the following applies:

- For the **Etree** attribute, the value should be either **true** or **false**.
- If **Etree** is set to true, set the **EtreeRole** attribute. If false, this is not required.
- The **EtreeRole** attribute can be either “**ROOT**” (as in the example below) or “**LEAF**”.

Example: `CreateEVCVplsPolicy_Etree.xml`

```
<?xml version="1.0" encoding="UTF-8"?>
<soapenv:Envelope
  xmlns:soapenv="http://schemas.xmlsoap.org/soap/envelope/"
  xmlns:soapenc="http://schemas.xmlsoap.org/soap/encoding/"
  xmlns:xsd="http://www.w3.org/2001/XMLSchema"
  xmlns:xsi="http://www.w3.org/2001/XMLSchema-instance"
  xmlns:ns0="http://www.cisco.com/cim-cx/2.0"
  xmlns:ns1="urn:CIM">
  <soapenv:Header>
    <ns0:message id="87855" timestamp="2002-12-13T14:55:38.885Z"
      sessiontoken="83A0FC53D02FFC8ED19EC1A4D4635D3E"/>
  </soapenv:Header>
  <soapenv:Body>
    <ns1:createInstance>
      <objectPath xsi:type="ns1:CIMObjectPath">
        <className xsi:type="xsd:string">ServiceDefinition</className>
        <properties xsi:type="ns1:CIMPropertyList"
          soapenc:arrayType="ns1:CIMProperty[]">
          <item xsi:type="ns1:CIMProperty">
            <name xsi:type="xsd:string">Name</name>
            <value xsi:type="xsd:string">doc_vplsHEad4</value>
          </item>
          <item xsi:type="ns1:CIMProperty">
            <name xsi:type="xsd:string">Type</name>
            <value xsi:type="xsd:string">Evc</value>
          </item>
        </properties>
      <objectPath xsi:type="ns1:CIMObjectPath">
        <className xsi:type="xsd:string">ServiceDefinitionDetails</className>
        <properties xsi:type="ns1:CIMPropertyList"
          soapenc:arrayType="ns1:CIMProperty[]">
          <item xsi:type="ns1:CIMProperty">
            <name xsi:type="xsd:string">SubType</name>
            <value xsi:type="xsd:string">Evc</value>
          </item>
          <item xsi:type="ns1:CIMProperty">
            <name xsi:type="xsd:string">AccessType</name>
            <value xsi:type="xsd:string">ETHERNET</value>
          </item>
          <item xsi:type="ns1:CIMProperty">
            <name xsi:type="xsd:string">TransportType</name>
            <value xsi:type="xsd:string">VPLS</value>
          </item>
          <item xsi:type="ns1:CIMProperty">
            <name xsi:type="xsd:string">PortSecurity</name>
            <value xsi:type="xsd:string">>false</value>
            <qualifier xsi:type="ns1:CIMQualifier">
              <name xsi:type="xsd:string">editable</name>
              <value xsi:type="xsd:string">>true</value>
            </qualifier>
          </item>
        </properties>
      </objectPath>
    </ns1:createInstance>
  </soapenv:Body>
</soapenv:Envelope>
```

```

    </qualifier>
  </item>
  <item xsi:type="ns1:CIMProperty">
    <name xsi:type="xsd:string">UniProtocolTunneling</name>
    <value xsi:type="xsd:string">>false</value>
    <qualifier xsi:type="ns1:CIMQualifier">
      <name xsi:type="xsd:string">editable</name>
      <value xsi:type="xsd:string">>true</value>
    </qualifier>
  </item>
  <item xsi:type="ns1:CIMProperty">
    <name xsi:type="xsd:string">StdUniPort</name>
    <value xsi:type="xsd:string">>true</value>
    <qualifier xsi:type="ns1:CIMQualifier">
      <name xsi:type="xsd:string">editable</name>
      <value xsi:type="xsd:string">>true</value>
    </qualifier>
  </item>
  <item xsi:type="ns1:CIMProperty">
    <name xsi:type="xsd:string">UniKeepAlive</name>
    <value xsi:type="xsd:string">>false</value>
    <qualifier xsi:type="ns1:CIMQualifier">
      <name xsi:type="xsd:string">editable</name>
      <value xsi:type="xsd:string">>true</value>
    </qualifier>
  </item>
  <item xsi:type="ns1:CIMProperty">
    <name xsi:type="xsd:string">UniShutdown</name>
    <value xsi:type="xsd:string">>false</value>
    <qualifier xsi:type="ns1:CIMQualifier">
      <name xsi:type="xsd:string">editable</name>
      <value xsi:type="xsd:string">>true</value>
    </qualifier>
  </item>
  <item xsi:type="ns1:CIMProperty">
    <name xsi:type="xsd:string">UniSpeed</name>
    <value xsi:type="xsd:string">100</value>
    <qualifier xsi:type="ns1:CIMQualifier">
      <name xsi:type="xsd:string">editable</name>
      <value xsi:type="xsd:string">>true</value>
    </qualifier>
  </item>
  <item xsi:type="ns1:CIMProperty">
    <name xsi:type="xsd:string">UniDuplex</name>
    <value xsi:type="xsd:string">Half</value>
    <qualifier xsi:type="ns1:CIMQualifier">
      <name xsi:type="xsd:string">editable</name>
      <value xsi:type="xsd:string">>true</value>
    </qualifier>
  </item>
  <item xsi:type="ns1:CIMProperty">
    <name xsi:type="xsd:string">UseExistingACLName</name>
    <value xsi:type="xsd:string">>false</value>
  </item>
  <item xsi:type="ns1:CIMProperty">
    <name xsi:type="xsd:string">VlanTranslationType</name>
    <value xsi:type="xsd:string">NONE</value>
    <qualifier xsi:type="ns1:CIMQualifier">
      <name xsi:type="xsd:string">editable</name>
      <value xsi:type="xsd:string">>true</value>
    </qualifier>
  </item>
  <item xsi:type="ns1:CIMProperty">

```

```

    <name xsi:type="xsd:string">VlanTranslationNode</name>
    <value xsi:type="xsd:string">AUTO</value>
    <qualifier xsi:type="ns1:CIMQualifier">
      <name xsi:type="xsd:string">editable</name>
      <value xsi:type="xsd:string">>true</value>
    </qualifier>
  </item>
  <item xsi:type="ns1:CIMProperty">
    <name xsi:type="xsd:string">DirectConnect</name>
    <value xsi:type="xsd:string">>false</value>

  </item>
  <item xsi:type="ns1:CIMProperty">
    <name xsi:type="xsd:string">AutoPickEsiId</name>
    <value xsi:type="xsd:string">>false</value>
    <qualifier xsi:type="ns1:CIMQualifier">
      <name xsi:type="xsd:string">editable</name>
      <value xsi:type="xsd:string">>true</value>
    </qualifier>
  </item>

  <item xsi:type="ns1:CIMProperty">
    <name xsi:type="xsd:string">AutopickVCId</name>
    <value xsi:type="xsd:string">>false</value>
    <qualifier xsi:type="ns1:CIMQualifier">
      <name xsi:type="xsd:string">editable</name>
      <value xsi:type="xsd:string">>true</value>
    </qualifier>
  </item>
  <item xsi:type="ns1:CIMProperty">
    <name xsi:type="xsd:string">AutoPickBDVlanId</name>
    <value xsi:type="xsd:string">>false</value>
    <qualifier xsi:type="ns1:CIMQualifier">
      <name xsi:type="xsd:string">editable</name>
      <value xsi:type="xsd:string">>true</value>
    </qualifier>
  </item>
  <item xsi:type="ns1:CIMProperty">
    <name xsi:type="xsd:string">Etree</name>
    <value xsi:type="xsd:string">true</value>
    <qualifier xsi:type="ns1:CIMQualifier">
      <name xsi:type="xsd:string">editable</name>
      <value xsi:type="xsd:string">>false</value>
    </qualifier>
  </item>
  <item xsi:type="ns1:CIMProperty">
    <name xsi:type="xsd:string">EtreeRole</name>
    <value xsi:type="xsd:string">ROOT</value>
    <qualifier xsi:type="ns1:CIMQualifier">
      <name xsi:type="xsd:string">editable</name>
      <value xsi:type="xsd:string">>true</value>
    </qualifier>
  </item>
  <item xsi:type="ns1:CIMProperty">
    <name xsi:type="xsd:string">ConfigurePseudowireHE</name>
    <value xsi:type="xsd:string">>true</value>
    <qualifier xsi:type="ns1:CIMQualifier">
      <name xsi:type="xsd:string">editable</name>
      <value xsi:type="xsd:string">>true</value>
    </qualifier>
  </item>
  <item xsi:type="ns1:CIMProperty">
    <name xsi:type="xsd:string">AutopickVCId</name>
    <value xsi:type="xsd:string">>false</value>

```



```

    <qualifier xsi:type="ns1:CIMQualifier">
      <name xsi:type="xsd:string">editable</name>
      <value xsi:type="xsd:string">true</value>
    </qualifier>
  </item>
  <item xsi:type="ns1:CIMProperty">
    <name xsi:type="xsd:string">AllowBothTags</name>
    <value xsi:type="xsd:string">>false</value>
    <qualifier xsi:type="ns1:CIMQualifier">
      <name xsi:type="xsd:string">editable</name>
      <value xsi:type="xsd:string">true</value>
    </qualifier>
  </item>
  <item xsi:type="ns1:CIMProperty">
    <name xsi:type="xsd:string">PushOuter</name>
    <value xsi:type="xsd:string">>false</value>
    <qualifier xsi:type="ns1:CIMQualifier">
      <name xsi:type="xsd:string">editable</name>
      <value xsi:type="xsd:string">true</value>
    </qualifier>
  </item>
  <item xsi:type="ns1:CIMProperty">
    <name xsi:type="xsd:string">PushInner</name>
    <value xsi:type="xsd:string">>false</value>
    <qualifier xsi:type="ns1:CIMQualifier">
      <name xsi:type="xsd:string">editable</name>
      <value xsi:type="xsd:string">true</value>
    </qualifier>
  </item>
  <item xsi:type="ns1:CIMProperty">
    <name xsi:type="xsd:string">PopOuter</name>
    <value xsi:type="xsd:string">>false</value>
    <qualifier xsi:type="ns1:CIMQualifier">
      <name xsi:type="xsd:string">editable</name>
      <value xsi:type="xsd:string">true</value>
    </qualifier>
  </item>
  <item xsi:type="ns1:CIMProperty">
    <name xsi:type="xsd:string">PopInner</name>
    <value xsi:type="xsd:string">>false</value>
    <qualifier xsi:type="ns1:CIMQualifier">
      <name xsi:type="xsd:string">editable</name>
      <value xsi:type="xsd:string">true</value>
    </qualifier>
  </item>
  <item xsi:type="ns1:CIMProperty">
    <name xsi:type="xsd:string">TranslateInner</name>
    <value xsi:type="xsd:string">>false</value>
    <qualifier xsi:type="ns1:CIMQualifier">
      <name xsi:type="xsd:string">editable</name>
      <value xsi:type="xsd:string">true</value>
    </qualifier>
  </item>
  <item xsi:type="ns1:CIMProperty">
    <name xsi:type="xsd:string">TranslateOuter</name>
    <value xsi:type="xsd:string">>false</value>
    <qualifier xsi:type="ns1:CIMQualifier">
      <name xsi:type="xsd:string">editable</name>
      <value xsi:type="xsd:string">true</value>
    </qualifier>
  </item>
  <item xsi:type="ns1:CIMProperty">
    <name xsi:type="xsd:string">UseEVC</name>
    <value xsi:type="xsd:string">>false</value>

```

```

    </item>
    <item xsi:type="ns1:CIMProperty">
      <name xsi:type="xsd:string">UseBD</name>
      <value xsi:type="xsd:string">>true</value>
      <qualifier xsi:type="ns1:CIMQualifier">
        <name xsi:type="xsd:string">editable</name>
        <value xsi:type="xsd:string">>true</value>
      </qualifier>
    </item>
    <item xsi:type="ns1:CIMProperty">
      <name xsi:type="xsd:string">EncapsulationType</name>
      <value xsi:type="xsd:string">DOT1QTRUNK</value>
      <qualifier xsi:type="ns1:CIMQualifier">
        <name xsi:type="xsd:string">editable</name>
        <value xsi:type="xsd:string">>true</value>
      </qualifier>
    </item>
  </properties>
</objectPath>
</objectPath>
</ns1:createInstance>
</soapenv:Body>
</soapenv:Envelope>

```

## Policy Examples in the API Programmer Reference

The following policy API XMLs are included in the [Cisco Prime Provisioning API 6.8 Programmer Reference](#):

- Create\_ATM\_ETHERNET\_VC-Pol-LOCAL.xml
- Create\_ATM\_ETHERNET\_VC-Pol-PW.xml
- CreateLocalEVCPolicy.xml
- CreateVplsEVCPolicy.xml
- Create\_PW\_EVCPolicy.xml
- CreateEVCSvcDefn\_LOCAL.xml
- CreateEVCSvcDefn\_PW.xml
- CreateEVCSvcDefn\_VPLS.xml
- CreateMPLSSvcDefn\_Bundle\_PE\_CE\_IPV4\_IPV6.xml
- CreateMPLSSvcDefn\_Bundle\_PE\_NO\_CE\_IPV4\_IPV6.xml
- CreateEVCPseudoPolicy\_withTemplates.xml
- CreateEVCVplsPolicy\_wthTemplates.xml
- DeleteEVCSvcDefn.xml
- ViewEVCSvcDefn.xml
- CreateEvcPolicySetMTU.xml
- CreateEvcPolicy-pwHE.xml

# EVC Service Requests

With a EVC service request, you can configure interfaces on an N-PE to support EVC infrastructure features.

Before creating a service request, a service policy has to be defined. Use a predefined policy template as is or with modifications to create a service request, and deploy the service. For information on EVC policies, see [EVC Service Definitions, page 9-1](#).

## Overview

A EVC service request defines the service definition and VPN to use, assigns interfaces and attributes for each attachment circuit (**Evclink**), and applies template information.



### Note

The attachment circuit, or Evclink, defines the layer 2 path from the U-PE to the NPE, including any intermediate devices.

When you deploy a EVC service request using a service order, the attributes specified in the service definition are applied to the devices and interfaces defined in the service request, along with the link attributes for each attachment circuit.

The service request link attributes include any parameters marked as editable in the service definition and link parameters specific to each attachment circuit.

The following XML example shows a partial list of the properties that can be specified for the attachment circuit **Evclink**.

```
<objectPath xsi:type="ns1:CIMObjectPath">
  <className xsi:type="xsd:string">Evclink</className>
</objectPath>
<properties xsi:type="ns1:CIMPropertyList"
  soapenc:arrayType="ns1:CIMProperty[]">
  <item xsi:type="ns1:CIMProperty">
    <name xsi:type="xsd:string">Npe</name>
    <value xsi:type="xsd:string">iscind-7609-1</value>
  </item>
  <item xsi:type="ns1:CIMProperty">
    <name xsi:type="xsd:string">UniInftId</name>
    <value xsi:type="xsd:string">GigabitEthernet7/0/3</value>
  </item>
</properties>
<objectPath xsi:type="ns1:CIMObjectPath">
  <className xsi:type="xsd:string">EvclinkAttr</className>
</objectPath>
<properties xsi:type="ns1:CIMPropertyList"
  soapenc:arrayType="ns1:CIMProperty[]">
  <item xsi:type="ns1:CIMProperty">
    <name xsi:type="xsd:string">UseServiceInst</name>
    <value xsi:type="xsd:string">true</value>
  </item>
  <item xsi:type="ns1:CIMProperty">
    <name xsi:type="xsd:string">SystemMTU</name>
    <value xsi:type="xsd:string">1563</value>
  </item>
  <item xsi:type="ns1:CIMProperty">
    <name xsi:type="xsd:string">AutoPickVlanId</name>
    <value xsi:type="xsd:string">true</value>
  </item>
</properties>
```

```

</objectPath>
<objectPath xsi:type="ns1:CIMObjectPath">
  <className xsi:type="xsd:string">EvcServiceInstanceAttrs</className>
  <properties xsi:type="ns1:CIMPropertyList"
    soapenc:arrayType="ns1:CIMProperty[]">
    <item xsi:type="ns1:CIMProperty">
      <name xsi:type="xsd:string">OuterVlanRange</name>
      <value xsi:type="xsd:string">261</value>
    </item>
    <item xsi:type="ns1:CIMProperty">
      <name xsi:type="xsd:string">AutoPickServiceInstId</name>
      <value xsi:type="xsd:string">>false</value>
    </item>
    <item xsi:type="ns1:CIMProperty">
      <name xsi:type="xsd:string">ServiceInstID</name>
      <value xsi:type="xsd:string">7845</value>
    </item>
    <item xsi:type="ns1:CIMProperty">
      <name xsi:type="xsd:string">BothTags</name>
      <value xsi:type="xsd:string">>false</value>
    </item>
  </properties>
</objectPath>
</objectPath>

```

## End-To-End Wires

An end-to-end wire is the link from one endpoint through the service provider cloud to another endpoint. In most cases, these links are from CE to CE. An attachment circuit is the link from the CE to the PE. If no CE is present, the attachment circuit link is from PE-CLE to PE-CLE.

The following network diagrams depict the three types of connectivity:

- [Pseudowire Network Diagram](#)
- [VPLS Network Diagram](#)
- [Local Connect Network Diagram](#)



**Note**

---

ATM/Ethernet internetworking only supports pseudowire and local connect.

---

## Pseudowire Network Diagram

In the EVC network example shown in [Figure 9-1](#), there are two EvcLinks:

- ence132 to enswostr1
- ence61 to enswostr2.

Figure 9-1 End to End Wire Network Example - Pseudowire

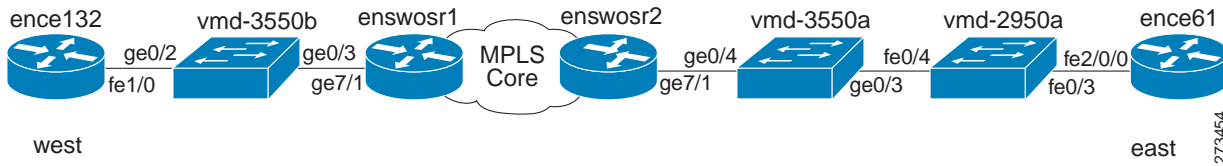

### VPLS Network Diagram

In the EthernetEVCS network example shown in Figure 9-2, there are three EvcLinks:

- ence132 to enswostr1
- ence61 to enswostr2
- ence51 to enpe5.

Figure 9-2 End to End Wire Network Example - VPLS

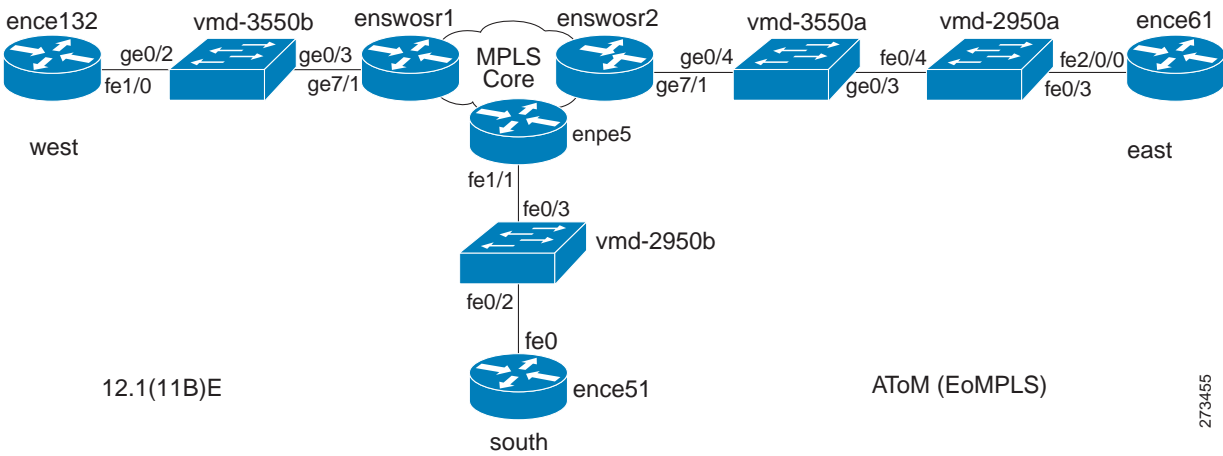

## Local Connect Network Diagram

In the EthernetEVC network example shown in [Figure 9-3](#), there are two EvcLinks:

- ence132 to enswostr1
- ence51 to enswostr1.

**Figure 9-3** End to End Wire Network Example - Local Connect

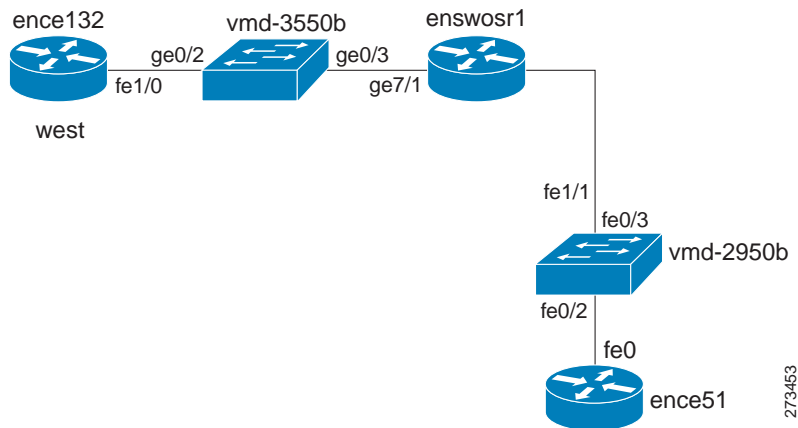

## Service Request Examples

The following XML examples illustrate how you work with service requests for EVC APIs. They also demonstrate the kinds of properties (attributes) that need to be specified for each request.

The first three are XML examples of service requests for the three supported connectivity types:

- [Creating a Local Connect Service Request, page 9-45](#)
- [Creating a Pseudowire Service Request, page 9-51](#)
- [Creating a VPLS Service Request, page 9-55](#)
- [Modifying a EVC Service Request, page 9-60](#)
- [Creating Access Ring with two NPEs, page 9-67](#)
- [Creating NPC, page 9-68](#)
- [Configuring an SVI/EVC Hybrid Scenario Service Request, page 9-69](#)
- [Specifying Service Instance Name for EVC Service Requests, page 9-74](#)
- [Creating a Local Connect Service Request for IOS-XR using Bridge Domain, page 9-77](#)
- [Creating a Pseudowire Service Request Setting the MTU Size, page 9-82](#)
- [Creating a Pseudowire Service Request with P2P E-line Name, page 9-88](#)
- [Creating a Pseudowire Service Request with Range of Values for Outer VLAN/Inner VLAN, page 9-93](#)
- [Creating a Pseudowire Service Request with Encapsulation Type DEFAULT/UNTAGGED, page 9-93](#)

- [Creating a Pseudowire Service Request with ANY VLAN/Tagged with Untagged VLANs, page 9-95](#)
- [Creating an EVC Pseudowire Service Request with Reserved Bandwidth, page 9-95](#)
- [Creating a Local Connect Service Request with ATM Ethernet, page 9-100](#)
- [Creating a Pseudowire Service Request with ATM Ethernet, page 9-105](#)
- [Creating a Pseudowire Service Request with Hybrid VPLS, page 9-111](#)
- [Creating a Pseudowire Head-End Service Request for Access into L3VPN, page 9-116](#)
- [Creating a VPLS Service Request with IOS XR, page 9-124](#)
- [Creating a VPLS Service Request for E-TREE, page 9-128](#)
- [Creating a Pseudowire Service Request for an L2-Access Link With EVC-syntax, page 9-133](#)
- [Modifying an EVC Multi-Segment Pseudowire Service Request, page 9-136](#)
- [Service Request Examples in the API Programmer Reference, page 9-138](#)

## Creating a Local Connect Service Request

In this example, a EVC service request is created using local connect. The highlighted attribute **ServiceDefinition** is set to **doc\_local** below.

Example: CreateEVCSERVICEORDER\_LOCAL.xml

```
<?xml version="1.0" encoding="UTF-8"?>
<soapenv:Envelope
  xmlns:soapenv="http://schemas.xmlsoap.org/soap/envelope/"
  xmlns:soapenc="http://schemas.xmlsoap.org/soap/encoding/"
  xmlns:xsd="http://www.w3.org/2001/XMLSchema"
  xmlns:xsi="http://www.w3.org/2001/XMLSchema-instance"
  xmlns:ns0="http://www.cisco.com/cim-cx/2.0"
  xmlns:ns1="urn:CIM">
  <soapenv:Header>
    <!-- WaitTimeout has a default set in system properties.-->
    <ns0:message id="87855" timestamp="2002-12-13T14:55:38.885Z"
      Wait="true" WaitTimeout="90" sessiontoken="p36bttjwy1"/>
  </soapenv:Header>
  <soapenv:Body>
    <ns1:performBatchOperation>
      <actions xsi:type="ns1:CIMActionList"
        soapenc:arrayType="ns1:CIMAction[]">
        <action>
          <actionName xsi:type="xsd:string">createInstance</actionName>
          <objectPath xsi:type="ns1:CIMObjectPath">
            <className xsi:type="xsd:string">ServiceOrder</className>
            <properties xsi:type="ns1:CIMPropertyList"
              soapenc:arrayType="ns1:CIMProperty[]">
              <item xsi:type="ns1:CIMProperty">
                <name xsi:type="xsd:string">ServiceName</name>
                <value xsi:type="xsd:string">ServiceOrder257</value>
              </item>
              <item xsi:type="ns1:CIMProperty">
                <name xsi:type="xsd:string">DesiredDueDate</name>
                <value xsi:type="xsd:dateTime">2008-12-13T14:55:38.885Z</value>
              </item>
              <item xsi:type="ns1:CIMProperty">
                <name xsi:type="xsd:string">NumberOfRequests</name>
                <value xsi:type="xsd:string">1</value>
              </item>
            </properties>
          </objectPath>
        </action>
      </actions>
    </ns1:performBatchOperation>
  </soapenv:Body>
</soapenv:Envelope>
```

```

        </item>
    </properties>
</objectPath>
</action>
<action>
    <actionName xsi:type="xsd:string">createInstance</actionName>
<objectPath xsi:type="ns1:CIMObjectPath">
    <className xsi:type="xsd:string">ServiceRequest</className>
    <properties xsi:type="ns1:CIMPropertyList"
        soapenc:arrayType="ns1:CIMProperty[]">
        <item xsi:type="ns1:CIMProperty">
            <name xsi:type="xsd:string">RequestName</name>
            <value xsi:type="xsd:string">EvcSR-7</value>
        </item>
        <item xsi:type="ns1:CIMProperty">
            <name xsi:type="xsd:string">Type</name>
            <value xsi:type="xsd:string">Evc</value>
        </item>
    </properties>
<objectPath xsi:type="ns1:CIMObjectPath">
    <className xsi:type="xsd:string">ServiceRequestDetails</className>
    <properties xsi:type="ns1:CIMPropertyList"
        soapenc:arrayType="ns1:CIMProperty[]">
        <item xsi:type="ns1:CIMProperty">
            <name xsi:type="xsd:string">ServiceDefinition</name>
            <value xsi:type="xsd:string">doc_local</value>
            <qualifier xsi:type="xsd:string">
                <name xsi:type="xsd:string">ServiceDefinitionType</name>
                <value xsi:type="xsd:string">Evc</value>
            </qualifier>
        </item>
        <item xsi:type="ns1:CIMProperty">
            <name xsi:type="xsd:string">VPN</name>
            <value xsi:type="xsd:string">cust3_vpn2</value>
        </item>
        <item xsi:type="ns1:CIMProperty">
            <name xsi:type="xsd:string">UseSVI</name>
            <value xsi:type="xsd:string">>true</value>
        </item>
    </properties>
<objectPath xsi:type="ns1:CIMObjectPath">
    <className xsi:type="xsd:string">EvcLink</className>
    <properties xsi:type="ns1:CIMPropertyList"
        soapenc:arrayType="ns1:CIMProperty[]">
        <item xsi:type="ns1:CIMProperty">
            <name xsi:type="xsd:string">Npe</name>
            <value xsi:type="xsd:string">iscind-7600-3</value>
        </item>
        <item xsi:type="ns1:CIMProperty">
            <name xsi:type="xsd:string">UniInftId</name>
            <value xsi:type="xsd:string">FastEthernet2/3</value>
        </item>
    </properties>
<objectPath xsi:type="ns1:CIMObjectPath">
    <className xsi:type="xsd:string">EvcETHLinkAttrs</className>
    <properties xsi:type="ns1:CIMPropertyList"
        soapenc:arrayType="ns1:CIMProperty[]">
        <item xsi:type="ns1:CIMProperty">
            <name xsi:type="xsd:string">SystemMTU</name>
            <value xsi:type="xsd:string">1563</value>
        </item>
        <item xsi:type="ns1:CIMProperty">
            <name xsi:type="xsd:string">AutoPickVlanId</name>
            <value xsi:type="xsd:string">>false</value>
        </item>
    </properties>
</objectPath>
</action>

```



```

    </item>
    <item xsi:type="ns1:CIMProperty">
      <name xsi:type="xsd:string">VlanID</name>
      <value xsi:type="xsd:string">18</value>
    </item>
  </properties>
</objectPath>
<objectPath xsi:type="ns1:CIMObjectPath">
  <className xsi:type="xsd:string">EvcServiceInstanceAttrs</className>
  <properties xsi:type="ns1:CIMPropertyList"
    soapenc:arrayType="ns1:CIMProperty[]">
    <item xsi:type="ns1:CIMProperty">
      <name xsi:type="xsd:string">AutoPickServiceInstId</name>
      <value xsi:type="xsd:string">>false</value>
    </item>
    <item xsi:type="ns1:CIMProperty">
      <name xsi:type="xsd:string">ServiceInstID</name>
      <value xsi:type="xsd:string">1947</value>
    </item>
    <item xsi:type="ns1:CIMProperty">
      <name xsi:type="xsd:string">BothTags</name>
      <value xsi:type="xsd:string">>true</value>
    </item>
    <item xsi:type="ns1:CIMProperty">
      <name xsi:type="xsd:string">OuterVlanRange</name>
      <value xsi:type="xsd:string">745</value>
    </item>
    <item xsi:type="ns1:CIMProperty">
      <name xsi:type="xsd:string">InnerVlanRange</name>
      <value xsi:type="xsd:string">746</value>
    </item>
  </properties>
</objectPath>
<objectPath xsi:type="ns1:CIMObjectPath">
  <className xsi:type="xsd:string">EvcUNIInterfaceAttrs</className>
  <properties xsi:type="ns1:CIMPropertyList"
    soapenc:arrayType="ns1:CIMProperty[]">
    <item xsi:type="ns1:CIMProperty">
      <name xsi:type="xsd:string">Shutdown</name>
      <value xsi:type="xsd:string">>true</value>
    </item>
    <item xsi:type="ns1:CIMProperty">
      <name xsi:type="xsd:string">PeIntfDesc</name>
      <value xsi:type="xsd:string">*** AC1 ***</value>
    </item>
  </properties>
</objectPath>
</objectPath>

<!-- L2Access Links -->

<objectPath xsi:type="ns1:CIMObjectPath">
  <className xsi:type="xsd:string">EvcLink</className>
  <properties xsi:type="ns1:CIMPropertyList"
    soapenc:arrayType="ns1:CIMProperty[]">
    <item xsi:type="ns1:CIMProperty">
      <name xsi:type="xsd:string">Upe</name>
      <value xsi:type="xsd:string">iscind-3750-6</value>
    </item>
    <item xsi:type="ns1:CIMProperty">

```

```

        <name xsi:type="xsd:string">UniInftId</name>
        <value xsi:type="xsd:string">FastEthernet1/0/7</value>
    </item>
    <item xsi:type="ns1:CIMProperty">
        <name xsi:type="xsd:string">NPC</name>
        <value xsi:type="xsd:string">27</value>
    </item>
</properties>
<objectPath xsi:type="ns1:CIMObjectPath">
    <className xsi:type="xsd:string">EvcETHLinkAttrs</className>
    <properties xsi:type="ns1:CIMPropertyList"
        soapenc:arrayType="ns1:CIMProperty[]">
    <item xsi:type="ns1:CIMProperty">
        <name xsi:type="xsd:string">AutopickOuterVlanId</name>
        <value xsi:type="xsd:string">>false</value>
    </item>
    <item xsi:type="ns1:CIMProperty">
        <name xsi:type="xsd:string">SystemMTU</name>
        <value xsi:type="xsd:string">1570</value>
    </item>
    <item xsi:type="ns1:CIMProperty">
        <name xsi:type="xsd:string">AutoPickVlanId</name>
        <value xsi:type="xsd:string">>true</value>
    </item>
    <item xsi:type="ns1:CIMProperty">
        <name xsi:type="xsd:string">UseServiceInst</name>
        <value xsi:type="xsd:string">>false</value>
    </item>
    </properties>
</objectPath>
<!-- <objectPath xsi:type="ns1:CIMObjectPath">
    <className xsi:type="xsd:string">EvcServiceInstanceAttrs</className>
    <properties xsi:type="ns1:CIMPropertyList"
        soapenc:arrayType="ns1:CIMProperty[]">
    <item xsi:type="ns1:CIMProperty">
        <name xsi:type="xsd:string">AutoPickServiceInstId</name>
        <value xsi:type="xsd:string">>false</value>
    </item>
    <item xsi:type="ns1:CIMProperty">
        <name xsi:type="xsd:string">ServiceInstID</name>
        <value xsi:type="xsd:string">2458</value>
    </item>
    <item xsi:type="ns1:CIMProperty">
        <name xsi:type="xsd:string">BothTags</name>
        <value xsi:type="xsd:string">>true</value>
    </item>
    <item xsi:type="ns1:CIMProperty">
        <name xsi:type="xsd:string">OuterVlanRange</name>
        <value xsi:type="xsd:string">547</value>
    </item>
    <item xsi:type="ns1:CIMProperty">
        <name xsi:type="xsd:string">InnerVlanRange</name>
        <value xsi:type="xsd:string">545</value>
    </item>
    </properties>
</objectPath> -->
<objectPath xsi:type="ns1:CIMObjectPath">
    <className xsi:type="xsd:string">EvcUNIProtocolTunnelAttrs</className>
    <properties xsi:type="ns1:CIMPropertyList"
        soapenc:arrayType="ns1:CIMProperty[]">
    <item xsi:type="ns1:CIMProperty">
        <name xsi:type="xsd:string">ProtocolTunnelling</name>
        <value xsi:type="xsd:string">>true</value>
    </item>
    </properties>
</objectPath>
-->

```

```

</item>
  <item xsi:type="ns1:CIMProperty">
    <name xsi:type="xsd:string">CdpEnable</name>
    <value xsi:type="xsd:string">>true</value>
  </item>
  <item xsi:type="ns1:CIMProperty">
    <name xsi:type="xsd:string">VtpEnable</name>
    <value xsi:type="xsd:string">>true</value>
  </item>
  <item xsi:type="ns1:CIMProperty">
    <name xsi:type="xsd:string">StpEnable</name>
    <value xsi:type="xsd:string">>true</value>
  </item>
  <item xsi:type="ns1:CIMProperty">
    <name xsi:type="xsd:string">VtpDropThreshold</name>
    <value xsi:type="xsd:string">10</value>
  </item>
  <item xsi:type="ns1:CIMProperty">
    <name xsi:type="xsd:string">CdpDropThreshold</name>
    <value xsi:type="xsd:string">20</value>
  </item>
  <item xsi:type="ns1:CIMProperty">
    <name xsi:type="xsd:string">StpDropThreshold</name>
    <value xsi:type="xsd:string">27</value>
  </item>
  <item xsi:type="ns1:CIMProperty">
    <name xsi:type="xsd:string">StpThreshold</name>
    <value xsi:type="xsd:string">27</value>
  </item>
  <item xsi:type="ns1:CIMProperty">
    <name xsi:type="xsd:string">VtpThreshold</name>
    <value xsi:type="xsd:string">2007</value>
  </item>
  <item xsi:type="ns1:CIMProperty">
    <name xsi:type="xsd:string">CdpThreshold</name>
    <value xsi:type="xsd:string">2007</value>
  </item>
  <item xsi:type="ns1:CIMProperty">
    <name xsi:type="xsd:string">RecoveryInterval</name>
    <value xsi:type="xsd:string">4789</value>
  </item>
</properties>
</objectPath>
<objectPath xsi:type="ns1:CIMObjectPath">
  <className xsi:type="xsd:string">EvcUNIInterfaceAttrs</className>
  <properties xsi:type="ns1:CIMPropertyList"
    soapenc:arrayType="ns1:CIMProperty[]">
    <item xsi:type="ns1:CIMProperty">
      <name xsi:type="xsd:string">PortSecurity</name>
      <value xsi:type="xsd:string">>true</value>
    </item>
    <item xsi:type="ns1:CIMProperty">
      <name xsi:type="xsd:string">SpeedType</name>
      <value xsi:type="xsd:string">Auto</value>
    </item>
    <item xsi:type="ns1:CIMProperty">
      <name xsi:type="xsd:string">DuplexType</name>
      <value xsi:type="xsd:string">Half</value>
    </item>
    <item xsi:type="ns1:CIMProperty">
      <name xsi:type="xsd:string">Shutdown</name>
      <value xsi:type="xsd:string">>true</value>
    </item>
    <item xsi:type="ns1:CIMProperty">

```

```

        <name xsi:type="xsd:string">ViolationActionType</name>
        <value xsi:type="xsd:string">RESTRICT</value>
    </item>
    <item xsi:type="ns1:CIMProperty">
        <name xsi:type="xsd:string">Aging</name>
        <value xsi:type="xsd:string">124</value>
    </item>
    <item xsi:type="ns1:CIMProperty">
        <name xsi:type="xsd:string">MacAddress</name>
        <value xsi:type="xsd:string">2458</value>
    </item>
    <item xsi:type="ns1:CIMProperty">
        <name xsi:type="xsd:string">BroadcastTraffic</name>
        <value xsi:type="xsd:string">24</value>
    </item>
    <item xsi:type="ns1:CIMProperty">
        <name xsi:type="xsd:string">MulticastTraffic</name>
        <value xsi:type="xsd:string">34</value>
    </item>
    <item xsi:type="ns1:CIMProperty">
        <name xsi:type="xsd:string">UnicastTraffic</name>
        <value xsi:type="xsd:string">44</value>
    </item>
    <item xsi:type="ns1:CIMProperty">
        <name xsi:type="xsd:string">StdUniPort</name>
        <value xsi:type="xsd:string">true</value>
    </item>
    <item xsi:type="ns1:CIMProperty">
        <name xsi:type="xsd:string">DisableCDP</name>
        <value xsi:type="xsd:string">true</value>
    </item>
    <item xsi:type="ns1:CIMProperty">
        <name xsi:type="xsd:string">PeIntfDesc</name>
        <value xsi:type="xsd:string">Description</value>
    </item>
    <item xsi:type="ns1:CIMProperty">
        <name xsi:type="xsd:string">PortSecurity</name>
        <value xsi:type="xsd:string">true</value>
    </item>
    <item xsi:type="ns1:CIMProperty">
        <name xsi:type="xsd:string">Shutdown</name>
        <value xsi:type="xsd:string">true</value>
    </item>
    <item xsi:type="ns1:CIMProperty">
        <name xsi:type="xsd:string">UniKeepAlive</name>
        <value xsi:type="xsd:string">true</value>
    </item>
    </properties>
</objectPath>
</objectPath>
</objectPath>
</action>
</actions>
</ns1:performBatchOperation>
</soapenv:Body>
</soapenv:Envelope>

```

## Creating a Pseudowire Service Request

In this example, a EVC service request is created using pseudowire.

Example: CreateEVCServiceOrder\_PW.xml

```
<?xml version="1.0" encoding="UTF-8"?>
<soapenv:Envelope
  xmlns:soapenv="http://schemas.xmlsoap.org/soap/envelope/"
  xmlns:soapenc="http://schemas.xmlsoap.org/soap/encoding/"
  xmlns:xsd="http://www.w3.org/2001/XMLSchema"
  xmlns:xsi="http://www.w3.org/2001/XMLSchema-instance"
  xmlns:ns0="http://www.cisco.com/cim-cx/2.0"
  xmlns:ns1="urn:CIM">
  <soapenv:Header>
    <!-- WaitTimeout has a default set in system properties.-->
    <ns0:message id="87855" timestamp="2002-12-13T14:55:38.885Z"
      Wait="true" WaitTimeout="90" sessiontoken="p36bttjwy1"/>
  </soapenv:Header>
  <soapenv:Body>
    <ns1:performBatchOperation>
      <actions xsi:type="ns1:CIMActionList"
        soapenc:arrayType="ns1:CIMAction[]">
        <action>
          <actionName xsi:type="xsd:string">createInstance</actionName>
          <objectPath xsi:type="ns1:CIMObjectPath">
            <className xsi:type="xsd:string">ServiceOrder</className>
            <properties xsi:type="ns1:CIMPropertyList"
              soapenc:arrayType="ns1:CIMProperty[]">
              <item xsi:type="ns1:CIMProperty">
                <name xsi:type="xsd:string">ServiceName</name>
                <value xsi:type="xsd:string">ServiceOrder257</value>
              </item>
              <item xsi:type="ns1:CIMProperty">
                <name xsi:type="xsd:string">CarrierId</name>
                <value xsi:type="xsd:string">322</value>
              </item>
              <item xsi:type="ns1:CIMProperty">
                <name xsi:type="xsd:string">DesiredDueDate</name>
                <value xsi:type="xsd:dateTime">2008-12-13T14:55:38.885Z</value>
              </item>
              <item xsi:type="ns1:CIMProperty">
                <name xsi:type="xsd:string">NumberOfRequests</name>
                <value xsi:type="xsd:string">1</value>
              </item>
            </properties>
          </objectPath>
        </action>
        <action>
          <actionName xsi:type="xsd:string">createInstance</actionName>
          <objectPath xsi:type="ns1:CIMObjectPath">
            <className xsi:type="xsd:string">ServiceRequest</className>
            <properties xsi:type="ns1:CIMPropertyList"
              soapenc:arrayType="ns1:CIMProperty[]">
              <item xsi:type="ns1:CIMProperty">
                <name xsi:type="xsd:string">RequestName</name>
                <value xsi:type="xsd:string">EvcSR-7</value>
              </item>
              <item xsi:type="ns1:CIMProperty">
                <name xsi:type="xsd:string">Type</name>
                <value xsi:type="xsd:string">Evc</value>
              </item>
            </properties>
          </objectPath>
        </action>
      </actions>
    </ns1:performBatchOperation>
  </soapenv:Body>
</soapenv:Envelope>
```

```

<objectPath xsi:type="ns1:CIMObjectPath">
  <className xsi:type="xsd:string">ServiceRequestDetails</className>
  <properties xsi:type="ns1:CIMPropertyList"
    soapenc:arrayType="ns1:CIMProperty[]" >
    <item xsi:type="ns1:CIMProperty">
      <name xsi:type="xsd:string">ServiceDefinition</name>
      <value xsi:type="xsd:string">doc_pw</value>
      <qualifier xsi:type="xsd:string">
        <name xsi:type="xsd:string">ServiceDefinitionType</name>
        <value xsi:type="xsd:string">Evc</value>
      </qualifier>
    </item>
    <item xsi:type="ns1:CIMProperty">
      <name xsi:type="xsd:string">VPN</name>
      <value xsi:type="xsd:string">cust1_vpn1</value>
    </item>
    <item xsi:type="ns1:CIMProperty">
      <name xsi:type="xsd:string">AutopickVCID</name>
      <value xsi:type="xsd:string">>true</value>
    </item>
    <item xsi:type="ns1:CIMProperty">
      <name xsi:type="xsd:string">UseBackupVCID</name>
      <value xsi:type="xsd:string">>true</value>
    </item>
    <item xsi:type="ns1:CIMProperty">
      <name xsi:type="xsd:string">UseSVI</name>
      <value xsi:type="xsd:string">>true</value>
    </item>
  </properties>
<objectPath xsi:type="ns1:CIMObjectPath">
  <className xsi:type="xsd:string">EvcLink</className>
  <properties xsi:type="ns1:CIMPropertyList"
    soapenc:arrayType="ns1:CIMProperty[]" >
    <item xsi:type="ns1:CIMProperty">
      <name xsi:type="xsd:string">Npe</name>
      <value xsi:type="xsd:string">iscind-7609-1</value>
    </item>
    <item xsi:type="ns1:CIMProperty">
      <name xsi:type="xsd:string">UniInftId</name>
      <value xsi:type="xsd:string">GigabitEthernet7/0/3</value>
    </item>
  </properties>
<objectPath xsi:type="ns1:CIMObjectPath">
  <className xsi:type="xsd:string">EvcETHLinkAttrs</className>
  <properties xsi:type="ns1:CIMPropertyList"
    soapenc:arrayType="ns1:CIMProperty[]" >
    <item xsi:type="ns1:CIMProperty">
      <name xsi:type="xsd:string">UseServiceInst</name>
      <value xsi:type="xsd:string">>true</value>
    </item>
    <item xsi:type="ns1:CIMProperty">
      <name xsi:type="xsd:string">SystemMTU</name>
      <value xsi:type="xsd:string">1563</value>
    </item>
    <item xsi:type="ns1:CIMProperty">
      <name xsi:type="xsd:string">AutoPickVlanId</name>
      <value xsi:type="xsd:string">>true</value>
    </item>
  </properties>
</objectPath>
<objectPath xsi:type="ns1:CIMObjectPath">
  <className xsi:type="xsd:string">EvcServiceInstanceAttrs</className>
  <properties xsi:type="ns1:CIMPropertyList"
    soapenc:arrayType="ns1:CIMProperty[]" >

```

```

    <item xsi:type="ns1:CIMProperty">
      <name xsi:type="xsd:string">OuterVlanRange</name>
      <value xsi:type="xsd:string">261</value>
    </item>
    <item xsi:type="ns1:CIMProperty">
      <name xsi:type="xsd:string">AutoPickServiceInstId</name>
      <value xsi:type="xsd:string">>false</value>
    </item>
    <item xsi:type="ns1:CIMProperty">
      <name xsi:type="xsd:string">ServiceInstID</name>
      <value xsi:type="xsd:string">7845</value>
    </item>
    <item xsi:type="ns1:CIMProperty">
      <name xsi:type="xsd:string">BothTags</name>
      <value xsi:type="xsd:string">>false</value>
    </item>
  </properties>
</objectPath>
<!-- SRAssociated Templates -->

</objectPath>

<!-- L2Access Links -->

<objectPath xsi:type="ns1:CIMObjectPath">
  <className xsi:type="xsd:string">EvcLink</className>
  <properties xsi:type="ns1:CIMPropertyList"
    soapenc:arrayType="ns1:CIMProperty[]">
    <item xsi:type="ns1:CIMProperty">
      <name xsi:type="xsd:string">Upe</name>
      <value xsi:type="xsd:string">>iscind-3750-1</value>
    </item>
    <item xsi:type="ns1:CIMProperty">
      <name xsi:type="xsd:string">UniInftId</name>
      <value xsi:type="xsd:string">FastEthernet1/0/8</value>
    </item>
    <item xsi:type="ns1:CIMProperty">
      <name xsi:type="xsd:string">NPC</name>
      <value xsi:type="xsd:string">31</value>
    </item>
  </properties>
  <objectPath xsi:type="ns1:CIMObjectPath">
    <className xsi:type="xsd:string">EvcETHLinkAttrs</className>
    <properties xsi:type="ns1:CIMPropertyList"
      soapenc:arrayType="ns1:CIMProperty[]">
      <item xsi:type="ns1:CIMProperty">
        <name xsi:type="xsd:string">UseServiceInst</name>
        <value xsi:type="xsd:string">>false</value>
      </item>
      <item xsi:type="ns1:CIMProperty">
        <name xsi:type="xsd:string">SystemMTU</name>
        <value xsi:type="xsd:string">1563</value>
      </item>
      <item xsi:type="ns1:CIMProperty">
        <name xsi:type="xsd:string">AutoPickVlanId</name>
        <value xsi:type="xsd:string">>true</value>
      </item>
    </properties>
  </objectPath>
  <objectPath xsi:type="ns1:CIMObjectPath">
    <className xsi:type="xsd:string">EvcUNIProtocolTunnelAttrs</className>
    <properties xsi:type="ns1:CIMPropertyList"
      soapenc:arrayType="ns1:CIMProperty[]">
      <item xsi:type="ns1:CIMProperty">

```

```

        <name xsi:type="xsd:string">ProtocolTunnelling</name>
        <value xsi:type="xsd:string">true</value>
    </item>
</item>
<item xsi:type="ns1:CIMProperty">
    <name xsi:type="xsd:string">VtpDropThreshold</name>
    <value xsi:type="xsd:string">10</value>
</item>
<item xsi:type="ns1:CIMProperty">
    <name xsi:type="xsd:string">CdpDropThreshold</name>
    <value xsi:type="xsd:string">20</value>
</item>
<item xsi:type="ns1:CIMProperty">
    <name xsi:type="xsd:string">StpDropThreshold</name>
    <value xsi:type="xsd:string">27</value>
</item>
<item xsi:type="ns1:CIMProperty">
    <name xsi:type="xsd:string">StpThreshold</name>
    <value xsi:type="xsd:string">27</value>
</item>
<item xsi:type="ns1:CIMProperty">
    <name xsi:type="xsd:string">VtpThreshold</name>
    <value xsi:type="xsd:string">2007</value>
</item>
<item xsi:type="ns1:CIMProperty">
    <name xsi:type="xsd:string">CdpThreshold</name>
    <value xsi:type="xsd:string">2007</value>
</item>
<item xsi:type="ns1:CIMProperty">
    <name xsi:type="xsd:string">CdpEnable</name>
    <value xsi:type="xsd:string">true</value>
</item>
<item xsi:type="ns1:CIMProperty">
    <name xsi:type="xsd:string">VtpEnable</name>
    <value xsi:type="xsd:string">true</value>
</item>
    <item xsi:type="ns1:CIMProperty">
        <name xsi:type="xsd:string">StpEnable</name>
        <value xsi:type="xsd:string">true</value>
    </item>
</properties>
</objectPath>
<objectPath xsi:type="ns1:CIMObjectPath">
    <className xsi:type="xsd:string">EvcUNIInterfaceAttrs</className>
    <properties xsi:type="ns1:CIMPropertyList"
        soapenc:arrayType="ns1:CIMProperty[]">
        <item xsi:type="ns1:CIMProperty">
            <name xsi:type="xsd:string">PortSecurity</name>
            <value xsi:type="xsd:string">true</value>
        </item>
        <item xsi:type="ns1:CIMProperty">
            <name xsi:type="xsd:string">SpeedType</name>
            <value xsi:type="xsd:string">100</value>
        </item>
        <item xsi:type="ns1:CIMProperty">
            <name xsi:type="xsd:string">DuplexType</name>
            <value xsi:type="xsd:string">Half</value>
        </item>
        <item xsi:type="ns1:CIMProperty">
            <name xsi:type="xsd:string">Shutdown</name>
            <value xsi:type="xsd:string">true</value>
        </item>
        <item xsi:type="ns1:CIMProperty">
            <name xsi:type="xsd:string">MacAddress</name>
            <value xsi:type="xsd:string">5</value>
        </item>
    </properties>
</objectPath>

```



```

        </item>
        <item xsi:type="ns1:CIMProperty">
          <name xsi:type="xsd:string">Aging</name>
          <value xsi:type="xsd:string">201</value>
        </item>
        <item xsi:type="ns1:CIMProperty">
          <name xsi:type="xsd:string">ViolationActionType</name>
          <value xsi:type="xsd:string">RESTRICT</value>
        </item>
        <item xsi:type="ns1:CIMProperty">
          <name xsi:type="xsd:string">BroadcastTraffic</name>
          <value xsi:type="xsd:string">25</value>
        </item>
        <item xsi:type="ns1:CIMProperty">
          <name xsi:type="xsd:string">MulticastTraffic</name>
          <value xsi:type="xsd:string">25</value>
        </item>
        <item xsi:type="ns1:CIMProperty">
          <name xsi:type="xsd:string">UnicastTraffic</name>
          <value xsi:type="xsd:string">25</value>
        </item>
      </properties>
    </objectPath>
  </objectPath>
</objectPath>
</action>
</actions>
</ns1:performBatchOperation>
</soapenv:Body>
</soapenv:Envelope>

```

## Creating a VPLS Service Request

In this example, a EVC service request is created using VPLS.

Example: CreateEVCSERVICEORDER\_VPLS.xml

```

<?xml version="1.0" encoding="UTF-8"?>
<soapenv:Envelope
  xmlns:soapenv="http://schemas.xmlsoap.org/soap/envelope/"
  xmlns:soapenc="http://schemas.xmlsoap.org/soap/encoding/"
  xmlns:xsd="http://www.w3.org/2001/XMLSchema"
  xmlns:xsi="http://www.w3.org/2001/XMLSchema-instance"
  xmlns:ns0="http://www.cisco.com/cim-cx/2.0"
  xmlns:ns1="urn:CIM">
  <soapenv:Header>
    <!-- WaitTimeout has a default set in system properties.-->
    <ns0:message id="87855" timestamp="2002-12-13T14:55:38.885Z"
      Wait="true" WaitTimeout="90" sessiontoken="p36bttjwy1"/>
  </soapenv:Header>
  <soapenv:Body>
    <ns1:performBatchOperation>
      <actions xsi:type="ns1:CIMActionList"
        soapenc:arrayType="ns1:CIMAction[]">
        <action>
          <actionName xsi:type="xsd:string">createInstance</actionName>
          <objectPath xsi:type="ns1:CIMObjectPath">
            <className xsi:type="xsd:string">ServiceOrder</className>
            <properties xsi:type="ns1:CIMPropertyList"
              soapenc:arrayType="ns1:CIMProperty[]">

```

```

    <item xsi:type="ns1:CIMProperty">
      <name xsi:type="xsd:string">ServiceName</name>
      <value xsi:type="xsd:string">ServiceOrder257</value>
    </item>
    <item xsi:type="ns1:CIMProperty">
      <name xsi:type="xsd:string">DesiredDueDate</name>
      <value xsi:type="xsd:dateTime">2008-12-13T14:55:38.885Z</value>
    </item>
    <item xsi:type="ns1:CIMProperty">
      <name xsi:type="xsd:string">NumberOfRequests</name>
      <value xsi:type="xsd:string">1</value>
    </item>
  </properties>
</objectPath>
</action>
<action>
  <actionName xsi:type="xsd:string">createInstance</actionName>
  <objectPath xsi:type="ns1:CIMObjectPath">
    <className xsi:type="xsd:string">ServiceRequest</className>
    <properties xsi:type="ns1:CIMPropertyList"
      soapenc:arrayType="ns1:CIMProperty[]">
      <item xsi:type="ns1:CIMProperty">
        <name xsi:type="xsd:string">RequestName</name>
        <value xsi:type="xsd:string">EvcSR-7</value>
      </item>
      <item xsi:type="ns1:CIMProperty">
        <name xsi:type="xsd:string">Type</name>
        <value xsi:type="xsd:string">Evc</value>
      </item>
    </properties>
  </objectPath xsi:type="ns1:CIMObjectPath">
    <className xsi:type="xsd:string">ServiceRequestDetails</className>
    <properties xsi:type="ns1:CIMPropertyList"
      soapenc:arrayType="ns1:CIMProperty[]">
      <item xsi:type="ns1:CIMProperty">
        <name xsi:type="xsd:string">ServiceDefinition</name>
        <value xsi:type="xsd:string">doc_vpls</value>
        <qualifier xsi:type="xsd:string">
          <name xsi:type="xsd:string">ServiceDefinitionType</name>
          <value xsi:type="xsd:string">Evc</value>
        </qualifier>
      </item>
      <item xsi:type="ns1:CIMProperty">
        <name xsi:type="xsd:string">VPN</name>
        <value xsi:type="xsd:string">cust1_vpn2</value>
      </item>
      <item xsi:type="ns1:CIMProperty">
        <name xsi:type="xsd:string">AutopickVCID</name>
        <value xsi:type="xsd:string">true</value>
      </item>
      <item xsi:type="ns1:CIMProperty">
        <name xsi:type="xsd:string">UseSVI</name>
        <value xsi:type="xsd:string">true</value>
      </item>
    </properties>
  </objectPath xsi:type="ns1:CIMObjectPath">
    <className xsi:type="xsd:string">EvcLink</className>
    <properties xsi:type="ns1:CIMPropertyList"
      soapenc:arrayType="ns1:CIMProperty[]">
      <item xsi:type="ns1:CIMProperty">
        <name xsi:type="xsd:string">Npe</name>
        <value xsi:type="xsd:string">iscind-7609-2</value>
      </item>
      <item xsi:type="ns1:CIMProperty">

```

```

        <name xsi:type="xsd:string">UniInftId</name>
        <value xsi:type="xsd:string">GigabitEthernet7/0/1</value>
    </item>
</properties>
</objectPath>
<objectPath xsi:type="ns1:CIMObjectPath">
    <className xsi:type="xsd:string">EvcETHLinkAttrs</className>
    <properties xsi:type="ns1:CIMPropertyList"
        soapenc:arrayType="ns1:CIMProperty[]">
        <item xsi:type="ns1:CIMProperty">
            <name xsi:type="xsd:string">SystemMTU</name>
            <value xsi:type="xsd:string">1544</value>
        </item>
        <item xsi:type="ns1:CIMProperty">
            <name xsi:type="xsd:string">AutoPickVlanId</name>
            <value xsi:type="xsd:string">true</value>
        </item>
        <item xsi:type="ns1:CIMProperty">
            <name xsi:type="xsd:string">UseServiceInst</name>
            <value xsi:type="xsd:string">true</value>
        </item>
    </properties>
</objectPath>
<objectPath xsi:type="ns1:CIMObjectPath">
    <className xsi:type="xsd:string">EvcServiceInstanceAttrs</className>
    <properties xsi:type="ns1:CIMPropertyList"
        soapenc:arrayType="ns1:CIMProperty[]">
        <item xsi:type="ns1:CIMProperty">
            <name xsi:type="xsd:string">BothTags</name>
            <value xsi:type="xsd:string">>false</value>
        </item>
        <item xsi:type="ns1:CIMProperty">
            <name xsi:type="xsd:string">AutoPickServiceInstId</name>
            <value xsi:type="xsd:string">true</value>
        </item>
        <item xsi:type="ns1:CIMProperty">
            <name xsi:type="xsd:string">OuterVlanRange</name>
            <value xsi:type="xsd:string">243</value>
        </item>
    </properties>
</objectPath>
<objectPath xsi:type="ns1:CIMObjectPath">
    <className xsi:type="xsd:string">EvcUNIInterfaceAttrs</className>
    <properties xsi:type="ns1:CIMPropertyList"
        soapenc:arrayType="ns1:CIMProperty[]">
        <item xsi:type="ns1:CIMProperty">
            <name xsi:type="xsd:string">Shutdown</name>
            <value xsi:type="xsd:string">true</value>
        </item>
        <item xsi:type="ns1:CIMProperty">
            <name xsi:type="xsd:string">PeIntfDesc</name>
            <value xsi:type="xsd:string">*** AC1 ***</value>
        </item>
    </properties>
</objectPath>
</objectPath>

<!-- L2Access Links -->

<objectPath xsi:type="ns1:CIMObjectPath">
    <className xsi:type="xsd:string">EvcLink</className>
    <properties xsi:type="ns1:CIMPropertyList"
        soapenc:arrayType="ns1:CIMProperty[]">
        <item xsi:type="ns1:CIMProperty">
            <name xsi:type="xsd:string">Upe</name>

```

```

        <value xsi:type="xsd:string">iscind-3750-1</value>
    </item>
    <item xsi:type="ns1:CIMProperty">
        <name xsi:type="xsd:string">UniInftId</name>
        <value xsi:type="xsd:string">FastEthernet1/0/12</value>
    </item>
    <item xsi:type="ns1:CIMProperty">
        <name xsi:type="xsd:string">NPC</name>
        <value xsi:type="xsd:string">31</value>
    </item>
</properties>
<objectPath xsi:type="ns1:CIMObjectPath">
    <className xsi:type="xsd:string">EvcETHLinkAttrs</className>
    <properties xsi:type="ns1:CIMPropertyList"
        soapenc:arrayType="ns1:CIMProperty[]">
        <item xsi:type="ns1:CIMProperty">
            <name xsi:type="xsd:string">UseServiceInst</name>
            <value xsi:type="xsd:string">>false</value>
        </item>
        <item xsi:type="ns1:CIMProperty">
            <name xsi:type="xsd:string">SystemMTU</name>
            <value xsi:type="xsd:string">1685</value>
        </item>
        <item xsi:type="ns1:CIMProperty">
            <name xsi:type="xsd:string">AutoPickVlanId</name>
            <value xsi:type="xsd:string">>true</value>
        </item>
    </properties>
</objectPath>

<objectPath xsi:type="ns1:CIMObjectPath">
    <className xsi:type="xsd:string">EvcUNIProtocolTunnelAttrs</className>
    <properties xsi:type="ns1:CIMPropertyList"
        soapenc:arrayType="ns1:CIMProperty[]">
        <item xsi:type="ns1:CIMProperty">
            <name xsi:type="xsd:string">ProtocolTunnelling</name>
            <value xsi:type="xsd:string">>true</value>
        </item>
        <item xsi:type="ns1:CIMProperty">
            <name xsi:type="xsd:string">VtpDropThreshold</name>
            <value xsi:type="xsd:string">10</value>
        </item>

        <item xsi:type="ns1:CIMProperty">
            <name xsi:type="xsd:string">CdpDropThreshold</name>
            <value xsi:type="xsd:string">20</value>
        </item>
        <item xsi:type="ns1:CIMProperty">
            <name xsi:type="xsd:string">StpDropThreshold</name>
            <value xsi:type="xsd:string">27</value>
        </item>
        <item xsi:type="ns1:CIMProperty">
            <name xsi:type="xsd:string">StpThreshold</name>
            <value xsi:type="xsd:string">27</value>
        </item>
        <item xsi:type="ns1:CIMProperty">
            <name xsi:type="xsd:string">VtpThreshold</name>
            <value xsi:type="xsd:string">2007</value>
        </item>
        <item xsi:type="ns1:CIMProperty">
            <name xsi:type="xsd:string">CdpThreshold</name>
            <value xsi:type="xsd:string">2007</value>
        </item>
        <item xsi:type="ns1:CIMProperty">

```

```

        <name xsi:type="xsd:string">CdpEnable</name>
        <value xsi:type="xsd:string">true</value>
    </item>
    <item xsi:type="ns1:CIMProperty">
        <name xsi:type="xsd:string">VtpEnable</name>
        <value xsi:type="xsd:string">true</value>
    </item>
        <item xsi:type="ns1:CIMProperty">
            <name xsi:type="xsd:string">StpEnable</name>
            <value xsi:type="xsd:string">true</value>
        </item>
    </properties>
</objectPath>
<objectPath xsi:type="ns1:CIMObjectPath">
<className xsi:type="xsd:string">EvcUNIInterfaceAttrs</className>
<properties xsi:type="ns1:CIMPropertyList"
    soapenc:arrayType="ns1:CIMProperty[]">
    <item xsi:type="ns1:CIMProperty">
        <name xsi:type="xsd:string">PortSecurity</name>
        <value xsi:type="xsd:string">true</value>
    </item>
    <item xsi:type="ns1:CIMProperty">
        <name xsi:type="xsd:string">SpeedType</name>
        <value xsi:type="xsd:string">Auto</value>
    </item>
    <item xsi:type="ns1:CIMProperty">
        <name xsi:type="xsd:string">DuplexType</name>
        <value xsi:type="xsd:string">Full</value>
    </item>
    <item xsi:type="ns1:CIMProperty">
        <name xsi:type="xsd:string">Shutdown</name>
        <value xsi:type="xsd:string">true</value>
    </item>
    <item xsi:type="ns1:CIMProperty">
        <name xsi:type="xsd:string">ViolationActionType</name>
        <value xsi:type="xsd:string">RESTRICT</value>
    </item>
    <item xsi:type="ns1:CIMProperty">
        <name xsi:type="xsd:string">Aging</name>
        <value xsi:type="xsd:string">1244</value>
    </item>
    <item xsi:type="ns1:CIMProperty">
        <name xsi:type="xsd:string">MacAddress</name>
        <value xsi:type="xsd:string">2458</value>
    </item>
    <item xsi:type="ns1:CIMProperty">
        <name xsi:type="xsd:string">BroadcastTraffic</name>
        <value xsi:type="xsd:string">54</value>
    </item>
    <item xsi:type="ns1:CIMProperty">
        <name xsi:type="xsd:string">MulticastTraffic</name>
        <value xsi:type="xsd:string">55</value>
    </item>
    <item xsi:type="ns1:CIMProperty">
        <name xsi:type="xsd:string">UnicastTraffic</name>
        <value xsi:type="xsd:string">15</value>
    </item>
    <item xsi:type="ns1:CIMProperty">
        <name xsi:type="xsd:string">StdUniPort</name>
        <value xsi:type="xsd:string">true</value>
    </item>
    <item xsi:type="ns1:CIMProperty">
        <name xsi:type="xsd:string">DisableCDP</name>
        <value xsi:type="xsd:string">true</value>
    </item>

```

```

        </item>
        <item xsi:type="ns1:CIMProperty">
          <name xsi:type="xsd:string">PeIntfDesc</name>
          <value xsi:type="xsd:string">Description</value>
        </item>
        <item xsi:type="ns1:CIMProperty">
          <name xsi:type="xsd:string">PortSecurity</name>
          <value xsi:type="xsd:string">>true</value>
        </item>
        <item xsi:type="ns1:CIMProperty">
          <name xsi:type="xsd:string">Shutdown</name>
          <value xsi:type="xsd:string">>true</value>
        </item>
        <item xsi:type="ns1:CIMProperty">
          <name xsi:type="xsd:string">UniKeepAlive</name>
          <value xsi:type="xsd:string">>true</value>
        </item>
      </properties>
    </objectPath>
  </objectPath>
</objectPath>
</action>
</actions>
</ns1:performBatchOperation>
</soapenv:Body>
</soapenv:Envelope>

```

## Modifying a EVC Service Request

In this example, a EVC service request is modified.

Example: ModifyEVCSERVICEORDER.XML

```

<?xml version="1.0" encoding="UTF-8"?>
<soapenv:Envelope
  xmlns:soapenv="http://schemas.xmlsoap.org/soap/envelope/"
  xmlns:soapenc="http://schemas.xmlsoap.org/soap/encoding/"
  xmlns:xsd="http://www.w3.org/2001/XMLSchema"
  xmlns:xsi="http://www.w3.org/2001/XMLSchema-instance"
  xmlns:ns0="http://www.cisco.com/cim-cx/2.0"
  xmlns:ns1="urn:CIM">
  <soapenv:Header>
    <!-- WaitTimeout has a default set in system properties.-->
    <ns0:message id="87855" timestamp="2008-04-15T14:55:38.885Z"
      Wait="true" WaitTimeout="90" sessiontoken="p36bttjwy1"/>
  </soapenv:Header>
  <soapenv:Body>
    <ns1:performBatchOperation>
      <actions xsi:type="ns1:CIMActionList" soapenc:arrayType="ns1:CIMAction[]">
        <action>
          <actionName xsi:type="xsd:string">createInstance</actionName>
          <objectPath xsi:type="ns1:CIMObjectPath">
            <className xsi:type="xsd:string">ServiceOrder</className>
            <properties xsi:type="ns1:CIMPropertyList"
              soapenc:arrayType="ns1:CIMProperty[]">
              <item xsi:type="ns1:CIMProperty">
                <name xsi:type="xsd:string">ServiceName</name>
                <value xsi:type="xsd:string">ServiceOrder257</value>
              </item>
            </properties>
          </objectPath>
        </action>
      </actions>
    </ns1:performBatchOperation>
  </soapenv:Body>
</soapenv:Envelope>

```

```

    <item xsi:type="ns1:CIMProperty">
      <name xsi:type="xsd:string">CarrierId</name>
      <value xsi:type="xsd:string">322</value>
    </item>
    <item xsi:type="ns1:CIMProperty">
      <name xsi:type="xsd:string">DesiredDueDate</name>
      <value xsi:type="xsd:dateTime">2009-04-15T14:55:38.885Z</value>
    </item>
    <item xsi:type="ns1:CIMProperty">
      <name xsi:type="xsd:string">NumberOfRequests</name>
      <value xsi:type="xsd:string">1</value>
    </item>
  </properties>
</objectPath>
</action>
<action>
  <actionName xsi:type="xsd:string">modifyInstance</actionName>
  <objectPath subAction="modifyInstance" xsi:type="ns1:CIMObjectPath">
    <className xsi:type="xsd:string">ServiceRequest</className>
    <properties xsi:type="ns1:CIMPropertyList"
      soapenc:arrayType="ns1:CIMProperty[]">
      <item xsi:type="ns1:CIMProperty">
        <name xsi:type="xsd:string">RequestName</name>
        <value xsi:type="xsd:string">MYSR-1-1</value>
      </item>
      <item xsi:type="ns1:CIMProperty">
        <name xsi:type="xsd:string">Type</name>
        <value xsi:type="xsd:string">Evc</value>
      </item>
    </properties>
    <objectPath subAction="modifyInstance" xsi:type="ns1:CIMObjectPath">
      <className xsi:type="xsd:string">ServiceRequestDetails</className>
      <keyProperties xsi:type="ns1:CIMKeyPropertyList"
        soapenc:arrayType="ns1:CIMKeyProperty[]">
        <item xsi:type="ns1:CIMProperty">
          <name xsi:type="xsd:string">LocatorId</name>
          <value xsi:type="xsd:string">485</value>
        </item>
      </keyProperties>
    </objectPath>

    <!-- delete instance -- >

    <objectPath subAction="deleteInstance" xsi:type="ns1:CIMObjectPath">
      <className xsi:type="xsd:string">EvcLink</className>
      <keyProperties xsi:type="ns1:CIMKeyPropertyList"
        soapenc:arrayType="ns1:CIMKeyProperty[]">
        <item xsi:type="ns1:CIMProperty">
          <name xsi:type="xsd:string">LocatorId</name>
          <value xsi:type="xsd:string">524</value>
        </item>
      </keyProperties>
    </objectPath>

    <!-- Modify Instance -->

    <objectPath subAction="modifyInstance" xsi:type="ns1:CIMObjectPath">
      <className xsi:type="xsd:string">EvcLink</className>
      <keyProperties xsi:type="ns1:CIMKeyPropertyList"
        soapenc:arrayType="ns1:CIMKeyProperty[]">
        <item xsi:type="ns1:CIMProperty">
          <name xsi:type="xsd:string">LocatorId</name>
          <value xsi:type="xsd:string">527</value>
        </item>
      </keyProperties>
    </objectPath>
  </action>
</action>

```

```

</keyProperties>
<objectPath subAction="modifyInstance" xsi:type="ns1:CIMObjectPath">
  <className xsi:type="xsd:string">EvcETHLinkAttrs</className>
  <properties xsi:type="ns1:CIMPropertyList"
    soapenc:arrayType="ns1:CIMProperty[]">
    <item xsi:type="ns1:CIMProperty">
      <name xsi:type="xsd:string">UseServiceInst</name>
      <value xsi:type="xsd:string">true</value>
    </item>
    <item xsi:type="ns1:CIMProperty">
      <name xsi:type="xsd:string">VlanTranslationNode</name>
      <value xsi:type="xsd:string">AUTO</value>
    </item>
    <item xsi:type="ns1:CIMProperty">
      <name xsi:type="xsd:string">VlanTranslationType</name>
      <value xsi:type="xsd:string">2:1</value>
    </item>
    <item xsi:type="ns1:CIMProperty">
      <name xsi:type="xsd:string">OuterVlanID</name>
      <value xsi:type="xsd:string">188</value>
    </item>
    <item xsi:type="ns1:CIMProperty">
      <name xsi:type="xsd:string">CeVlanID</name>
      <value xsi:type="xsd:string">195</value>
    </item>
  </properties>
</objectPath>

<objectPath subAction="modifyInstance" xsi:type="ns1:CIMObjectPath">
  <className xsi:type="xsd:string">EvcServiceInstanceAttrs</className>
  <properties xsi:type="ns1:CIMPropertyList"
    soapenc:arrayType="ns1:CIMProperty[]">
    <item xsi:type="ns1:CIMProperty">
      <name xsi:type="xsd:string">AutoPickServiceInstId</name>
      <value xsi:type="xsd:string">false</value>
    </item>
    <item xsi:type="ns1:CIMProperty">
      <name xsi:type="xsd:string">ServiceInstID</name>
      <value xsi:type="xsd:string">5258</value>
    </item>
    <item xsi:type="ns1:CIMProperty">
      <name xsi:type="xsd:string">OuterVlanRange</name>
      <value xsi:type="xsd:string">1928</value>
    </item>
    <item xsi:type="ns1:CIMProperty">
      <name xsi:type="xsd:string">InnerVlanRange</name>
      <value xsi:type="xsd:string">2684</value>
    </item>
    <item xsi:type="ns1:CIMProperty">
      <name xsi:type="xsd:string">BothTags</name>
      <value xsi:type="xsd:string">true</value>
    </item>
  </properties>
</objectPath>

<objectPath subAction="modifyInstance" xsi:type="ns1:CIMObjectPath">
  <className xsi:type="xsd:string">EvcUNIProtocolTunnelAttrs</className>
  <properties xsi:type="ns1:CIMPropertyList"
    soapenc:arrayType="ns1:CIMProperty[]">
    <item xsi:type="ns1:CIMProperty">
      <name xsi:type="xsd:string">ProtocolTunnelling</name>
      <value xsi:type="xsd:string">true</value>
    </item>
    <item xsi:type="ns1:CIMProperty">

```



```

        <name xsi:type="xsd:string">VtpDropThreshold</name>
        <value xsi:type="xsd:string">11</value>
    </item>
    <item xsi:type="ns1:CIMProperty">
        <name xsi:type="xsd:string">CdpDropThreshold</name>
        <value xsi:type="xsd:string">22</value>
    </item>
    <item xsi:type="ns1:CIMProperty">
        <name xsi:type="xsd:string">StpDropThreshold</name>
        <value xsi:type="xsd:string">25</value>
    </item>
    <item xsi:type="ns1:CIMProperty">
        <name xsi:type="xsd:string">StpThreshold</name>
        <value xsi:type="xsd:string">281</value>
    </item>
    <item xsi:type="ns1:CIMProperty">
        <name xsi:type="xsd:string">VtpThreshold</name>
        <value xsi:type="xsd:string">2017</value>
    </item>
    <item xsi:type="ns1:CIMProperty">
        <name xsi:type="xsd:string">CdpThreshold</name>
        <value xsi:type="xsd:string">2107</value>
    </item>
    <item xsi:type="ns1:CIMProperty">
        <name xsi:type="xsd:string">CdpEnable</name>
        <value xsi:type="xsd:string">true</value>
    </item>
    <item xsi:type="ns1:CIMProperty">
        <name xsi:type="xsd:string">VtpEnable</name>
        <value xsi:type="xsd:string">true</value>
    </item>
    <item xsi:type="ns1:CIMProperty">
        <name xsi:type="xsd:string">StpEnable</name>
        <value xsi:type="xsd:string">true</value>
    </item>
</properties>
</objectPath>

<objectPath subAction="modifyInstance" xsi:type="ns1:CIMObjectPath">
    <className xsi:type="xsd:string">EvcUNIInterfaceAttrs</className>
    <properties xsi:type="ns1:CIMPropertyList"
        soapenc:arrayType="ns1:CIMProperty[]">
        <item xsi:type="ns1:CIMProperty">
            <name xsi:type="xsd:string">PortSecurity</name>
            <value xsi:type="xsd:string">true</value>
        </item>
        <item xsi:type="ns1:CIMProperty">
            <name xsi:type="xsd:string">Shutdown</name>
            <value xsi:type="xsd:string">true</value>
        </item>
        <item xsi:type="ns1:CIMProperty">
            <name xsi:type="xsd:string">PeIntfDesc</name>
            <value xsi:type="xsd:string">*****AC2*****</value>
        </item>
        <item xsi:type="ns1:CIMProperty">
            <name xsi:type="xsd:string">MacAddress</name>
            <value xsi:type="xsd:string">568</value>
        </item>
        <!-- <item xsi:type="ns1:CIMProperty">
            <name xsi:type="xsd:string">UserDefinedACLName</name>
            <value xsi:type="xsd:string">ACL</value>
        </item> -->
        <item xsi:type="ns1:CIMProperty">
            <name xsi:type="xsd:string">BroadcastTraffic</name>

```

```

        <value xsi:type="xsd:string">55</value>
      </item>
      <item xsi:type="ns1:CIMProperty">
        <name xsi:type="xsd:string">Aging</name>
        <value xsi:type="xsd:string">1330</value>
      </item>
      <item xsi:type="ns1:CIMProperty">
        <name xsi:type="xsd:string">UniKeepAlive</name>
        <value xsi:type="xsd:string">true</value>
      </item>
      <item xsi:type="ns1:CIMProperty">
        <name xsi:type="xsd:string">StdUniPort</name>
        <value xsi:type="xsd:string">true</value>
      </item>
      <item xsi:type="ns1:CIMProperty">
        <name xsi:type="xsd:string">ViolationActionType</name>
        <value xsi:type="xsd:string">PROTECT</value>
      </item>
      <item xsi:type="ns1:CIMProperty">
        <name xsi:type="xsd:string">FilterBPDU</name>
        <value xsi:type="xsd:string">true</value>
      </item>
      <item xsi:type="ns1:CIMProperty">
        <name xsi:type="xsd:string">DuplexType</name>
        <value xsi:type="xsd:string">Half</value>
      </item>
      <item xsi:type="ns1:CIMProperty">
        <name xsi:type="xsd:string">UnicastTraffic</name>
        <value xsi:type="xsd:string">54</value>
      </item>
      <item xsi:type="ns1:CIMProperty">
        <name xsi:type="xsd:string">MulticastTraffic</name>
        <value xsi:type="xsd:string">56</value>
      </item>
      <item xsi:type="ns1:CIMProperty">
        <name xsi:type="xsd:string">SpeedType</name>
        <value xsi:type="xsd:string">1000</value>
      </item>
    </properties>
  </objectPath>

  <!-- <objectPath subAction="createInstance"
xsi:type="ns1:CIMObjectPath">
    <className xsi:type="xsd:string">EvcUNIMacACLAddresses</className>
    <properties xsi:type="ns1:CIMPropertyList"
      soapenc:arrayType="ns1:CIMProperty[]">
      <item xsi:type="ns1:CIMProperty">
        <name xsi:type="xsd:string">MacAddress</name>
        <value xsi:type="xsd:string">2222.3333.6666</value>
      </item>
      <item xsi:type="ns1:CIMProperty">
        <name xsi:type="xsd:string">Permission</name>
        <value xsi:type="xsd:string">permit</value>
      </item>
      <item xsi:type="ns1:CIMProperty">
        <name xsi:type="xsd:string">MacAclRange</name>
        <value xsi:type="xsd:string">1111.2222.4444</value>
      </item>
    </properties>
  </objectPath -->

  <objectPath subAction="createInstance" xsi:type="ns1:CIMObjectPath">

```

```

<className xsi:type="xsd:string">EvcSecureMacAddress</className>
<properties xsi:type="ns1:CIMPropertyList"
    soapenc:arrayType="ns1:CIMProperty[]">
  <item xsi:type="ns1:CIMProperty">
    <name xsi:type="xsd:string">MacAddress</name>
    <value xsi:type="xsd:string">cccc.cccc.dddd</value>
  </item>
</properties>
</objectPath>

</objectPath>

  <!-- Create Instance -->

<!-- <objectPath subAction="createInstance" xsi:type="ns1:CIMObjectPath">
  <className xsi:type="xsd:string">EvcLink</className>
  <properties xsi:type="ns1:CIMPropertyList"
    soapenc:arrayType="ns1:CIMProperty[]">
    <item xsi:type="ns1:CIMProperty">
      <name xsi:type="xsd:string">Npe</name>
      <value xsi:type="xsd:string">iscind-7609-1</value>
    </item>
    <item xsi:type="ns1:CIMProperty">
      <name xsi:type="xsd:string">UniInftId</name>
      <value xsi:type="xsd:string">GigabitEthernet7/0/9</value>
    </item>
  </properties>
  <objectPath subAction="createInstance" xsi:type="ns1:CIMObjectPath">
    <className xsi:type="xsd:string">EvcETHLinkAttrs</className>
    <properties xsi:type="ns1:CIMPropertyList"
      soapenc:arrayType="ns1:CIMProperty[]">
      <item xsi:type="ns1:CIMProperty">
        <name xsi:type="xsd:string">UseServiceInst</name>
        <value xsi:type="xsd:string">true</value>
      </item>
      <item xsi:type="ns1:CIMProperty">
        <name xsi:type="xsd:string">AutoPickVlanId</name>
        <value xsi:type="xsd:string">true</value>
      </item>
    </properties>
  </objectPath>
  <objectPath subAction="createInstance" xsi:type="ns1:CIMObjectPath">
    <className xsi:type="xsd:string">EvcServiceInstanceAttrs</className>
    <properties xsi:type="ns1:CIMPropertyList"
      soapenc:arrayType="ns1:CIMProperty[]">
      <item xsi:type="ns1:CIMProperty">
        <name xsi:type="xsd:string">AutoPickServiceInstId</name>
        <value xsi:type="xsd:string">true</value>
      </item>

      <item xsi:type="ns1:CIMProperty">
        <name xsi:type="xsd:string">OuterVlanRange</name>
        <value xsi:type="xsd:string">1584</value>
      </item>
      <item xsi:type="ns1:CIMProperty">
        <name xsi:type="xsd:string">MatchInnerVlan</name>
        <value xsi:type="xsd:string">false</value>
      </item>
    </properties>
  </objectPath>
  <objectPath subAction="createInstance" xsi:type="ns1:CIMObjectPath">
    <className xsi:type="xsd:string">EvcUNIProtocolTunnelAttrs</className>
    <properties xsi:type="ns1:CIMPropertyList"

```

```

        soapenc:arrayType="ns1:CIMProperty[]">
        <item xsi:type="ns1:CIMProperty">
            <name xsi:type="xsd:string">ProtocolTunnelling</name>
            <value xsi:type="xsd:string">>true</value>
        </item>
        <item xsi:type="ns1:CIMProperty">
            <name xsi:type="xsd:string">VtpDropThreshold</name>
            <value xsi:type="xsd:string">10</value>
        </item>
        <item xsi:type="ns1:CIMProperty">
            <name xsi:type="xsd:string">CdpDropThreshold</name>
            <value xsi:type="xsd:string">20</value>
        </item>
        <item xsi:type="ns1:CIMProperty">
            <name xsi:type="xsd:string">StpDropThreshold</name>
            <value xsi:type="xsd:string">27</value>
        </item>
        <item xsi:type="ns1:CIMProperty">
            <name xsi:type="xsd:string">StpThreshold</name>
            <value xsi:type="xsd:string">27</value>
        </item>
        <item xsi:type="ns1:CIMProperty">
            <name xsi:type="xsd:string">VtpThreshold</name>
            <value xsi:type="xsd:string">2007</value>
        </item>
        <item xsi:type="ns1:CIMProperty">
            <name xsi:type="xsd:string">CdpThreshold</name>
            <value xsi:type="xsd:string">2007</value>
        </item>
        <item xsi:type="ns1:CIMProperty">
            <name xsi:type="xsd:string">CdpEnable</name>
            <value xsi:type="xsd:string">>true</value>
        </item>
        <item xsi:type="ns1:CIMProperty">
            <name xsi:type="xsd:string">VtpEnable</name>
            <value xsi:type="xsd:string">>true</value>
        </item>
        <item xsi:type="ns1:CIMProperty">
            <name xsi:type="xsd:string">StpEnable</name>
            <value xsi:type="xsd:string">>true</value>
        </item>
    </properties>
</objectPath>
<objectPath subAction="createInstance" xsi:type="ns1:CIMObjectPath">
    <className xsi:type="xsd:string">EvcUNIInterfaceAttrs</className>
    <properties xsi:type="ns1:CIMPropertyList">
        soapenc:arrayType="ns1:CIMProperty[]">
        <item xsi:type="ns1:CIMProperty">
            <name xsi:type="xsd:string">Shutdown</name>
            <value xsi:type="xsd:string">>true</value>
        </item>
        <item xsi:type="ns1:CIMProperty">
            <name xsi:type="xsd:string">PeIntfDesc</name>
            <value xsi:type="xsd:string">**Half**</value>
        </item>
    </properties>
</objectPath>
</objectPath> -->

</objectPath>
</objectPath>
</action>
</actions>
</ns1:performBatchOperation>

```

```

    </soapenv:Body>
</soapenv:Envelope>

```

## Creating Access Ring with two NPEs

In the following three XMLs, a two calls for setting up an access ring are depicted. It is done using the following sequence:

1. Create Ring with Two NPE's - CreateRing.xml
2. Create NPC - CreateNamedPhysicalCircuitRingExisting.xml

Both examples are depicted in the following.

Example: CreateRing.xml

```

<?xml version="1.0" encoding="UTF-8"?>
<soapenv:Envelope
  xmlns:soapenv="http://schemas.xmlsoap.org/soap/envelope/"
  xmlns:soapenc="http://schemas.xmlsoap.org/soap/encoding/"
  xmlns:xsd="http://www.w3.org/2001/XMLSchema"
  xmlns:xsi="http://www.w3.org/2001/XMLSchema-instance"
  xmlns:ns0="http://www.cisco.com/cim-cx/2.0"
  xmlns:ns1="urn:CIM">
  <soapenv:Header>
    <ns0:message id="87855" timestamp="2002-12-13T14:55:38.885Z"
      sessiontoken="p36bttjwy1"/>
  </soapenv:Header>
  <soapenv:Body>
    <ns1:createInstance>
      <objectPath xsi:type="ns1:CIMObjectPath">
        <className xsi:type="xsd:string">Ring</className>
        <properties xsi:type="ns1:CIMPropertyList"
          soapenc:arrayType="ns1:CIMProperty[]">
          <objectPath xsi:type="ns1:CIMObjectPath">
            <className xsi:type="xsd:string">PhysicalLink</className>
            <properties xsi:type="ns1:CIMPropertyList"
              soapenc:arrayType="ns1:CIMProperty[]">
              <item xsi:type="ns1:CIMProperty">
                <name xsi:type="xsd:string">SrcDevice</name>
                <value xsi:type="xsd:string">iscind-3750-4</value> </item>
              <item xsi:type="ns1:CIMProperty">
                <name xsi:type="xsd:string">DestDevice</name>
                <value xsi:type="xsd:string">iscind-7600-3</value> </item>
              <item xsi:type="ns1:CIMProperty">
                <name xsi:type="xsd:string">SrcIfName</name>
                <value xsi:type="xsd:string">FastEthernet1/0/16</value> </item>
              <item xsi:type="ns1:CIMProperty">
                <name xsi:type="xsd:string">DestIfName</name>
                <value xsi:type="xsd:string">FastEthernet2/13</value> </item>
            </properties>
          </objectPath>
          <objectPath xsi:type="ns1:CIMObjectPath">
            <className xsi:type="xsd:string">PhysicalLink</className>
            <properties xsi:type="ns1:CIMPropertyList"
              soapenc:arrayType="ns1:CIMProperty[]">
              <item xsi:type="ns1:CIMProperty">
                <name xsi:type="xsd:string">SrcDevice</name>
                <value xsi:type="xsd:string">iscind-7600-3</value> </item>
              <item xsi:type="ns1:CIMProperty">
                <name xsi:type="xsd:string">DestDevice</name>
                <value xsi:type="xsd:string">iscind-7609-2</value> </item>
            </properties>
          </objectPath>
        </properties>
      </createInstance>
    </body>
  </soapenv:Envelope>

```

```

    <item xsi:type="ns1:CIMProperty">
      <name xsi:type="xsd:string">SrcIfName</name>
      <value xsi:type="xsd:string">LoopBack1000</value> </item>
    <item xsi:type="ns1:CIMProperty">
      <name xsi:type="xsd:string">DestIfName</name>
      <value xsi:type="xsd:string">LoopBack100</value> </item>
  </properties>
</objectPath>
<objectPath xsi:type="ns1:CIMObjectPath">
  <className xsi:type="xsd:string">PhysicalLink</className>
  <properties xsi:type="ns1:CIMPropertyList"
    soapenc:arrayType="ns1:CIMProperty[]">
    <item xsi:type="ns1:CIMProperty">
      <name xsi:type="xsd:string">SrcDevice</name>
      <value xsi:type="xsd:string">iscind-7609-2</value> </item>
    <item xsi:type="ns1:CIMProperty">
      <name xsi:type="xsd:string">DestDevice</name>
      <value xsi:type="xsd:string">iscind-3750-4</value> </item>
    <item xsi:type="ns1:CIMProperty">
      <name xsi:type="xsd:string">SrcIfName</name>
      <value xsi:type="xsd:string">GigabitEthernet1/0/4</value> </item>
    <item xsi:type="ns1:CIMProperty">
      <name xsi:type="xsd:string">DestIfName</name>
      <value xsi:type="xsd:string">FastEthernet1/0/18</value> </item>
  </properties>
</objectPath>
</properties>
</objectPath>
</ns1:createInstance>
</soapenv:Body>
</soapenv:Envelope>

```

## Creating NPC

In this second step, an NPC (Named Physical Circuit) is configured before the access ring service request can be created.

Example: CreateNamedPhysicalCircuitRingExisting.xml

```

<?xml version="1.0" encoding="UTF-8"?>
<soapenv:Envelope
  xmlns:soapenv="http://schemas.xmlsoap.org/soap/envelope/"
  xmlns:soapenc="http://schemas.xmlsoap.org/soap/encoding/"
  xmlns:xsd="http://www.w3.org/2001/XMLSchema"
  xmlns:xsi="http://www.w3.org/2001/XMLSchema-instance"
  xmlns:ns0="http://www.cisco.com/cim-cx/2.0"
  xmlns:ns1="urn:CIM">
  <soapenv:Header>
    <ns0:message id="87855" timestamp="2002-12-13T14:55:38.885Z"
      sessiontoken="p36bttjwy1"/>
  </soapenv:Header>
  <soapenv:Body>
    <ns1:createInstance>
      <objectPath xsi:type="ns1:CIMObjectPath">
        <className xsi:type="xsd:string">NamedPhysicalCircuit</className>
        <properties xsi:type="ns1:CIMPropertyList"
          soapenc:arrayType="ns1:CIMProperty[]">
        </properties>

      <objectPath xsi:type="ns1:CIMObjectPath">
        <className xsi:type="xsd:string">NamedPhysicalCircuitRing</className>

```

```

    <properties xsi:type="ns1:CIMPropertyList"
      soapenc:arrayType="ns1:CIMProperty[]">
      <item xsi:type="ns1:CIMProperty">
        <name xsi:type="xsd:string">LocatorId</name>
        <value xsi:type="xsd:string">1</value>
      </item>
    </properties>
  </objectPath>
<objectPath xsi:type="ns1:CIMObjectPath">
  <className xsi:type="xsd:string">PhysicalLink</className>
  <properties xsi:type="ns1:CIMPropertyList"
    soapenc:arrayType="ns1:CIMProperty[]">
    <item xsi:type="ns1:CIMProperty">
      <name xsi:type="xsd:string">SrcDevice</name>
      <value xsi:type="xsd:string">iscind-3750-4</value> </item>
    <item xsi:type="ns1:CIMProperty">
      <name xsi:type="xsd:string">DestDevice</name>
      <value xsi:type="xsd:string">iscind-7600-2</value> </item>
    <item xsi:type="ns1:CIMProperty">
      <name xsi:type="xsd:string">SrcIfName</name>
      <value xsi:type="xsd:string">FastEthernet1/1</value> </item>
    <item xsi:type="ns1:CIMProperty">
      <name xsi:type="xsd:string">DestIfName</name>
      <value xsi:type="xsd:string">FastEthernet3/1</value> </item>
    </properties>
  </objectPath>
</objectPath>
</ns1:createInstance>
</soapenv:Body>
</soapenv:Envelope>

```

## Configuring an SVI/EVC Hybrid Scenario Service Request

The following is an example of how to configure a hybrid EVC/SVI scenario in a EVC service request. If XConnectOnSVI is enabled, the forwarding commands will be configured under SVI for both flex and non-flex. If it is disabled, the forwarding commands will be configured under service instance if it is an EVC link. If the link is a non-flex link, these commands will be configured under a subinterface.

The attribute relevant for the EVC/SVI Hybrid scenario is **XconnectOnSVI** (in **bold** below), which in the example is set to **true**

Example: CreateEVCSERVICEORDER\_PW\_1.xml

```

<?xml version="1.0" encoding="UTF-8"?>
<soapenv:Envelope
  xmlns:soapenv="http://schemas.xmlsoap.org/soap/envelope/"
  xmlns:soapenc="http://schemas.xmlsoap.org/soap/encoding/"
  xmlns:xsd="http://www.w3.org/2001/XMLSchema"
  xmlns:xsi="http://www.w3.org/2001/XMLSchema-instance"
  xmlns:ns0="http://www.cisco.com/cim-cx/2.0"
  xmlns:ns1="urn:CIM">
  <soapenv:Header>
    <!-- WaitTimeout has a default set in system properties.-->
    <ns0:message id="87855" timestamp="2002-12-13T14:55:38.885Z"
      Wait="true" WaitTimeout="90" sessiontoken="p36bttjwy1"/>
  </soapenv:Header>
  <soapenv:Body>
    <ns1:performBatchOperation>
      <actions xsi:type="ns1:CIMActionList"
        soapenc:arrayType="ns1:CIMAction[]">

```

```

<action>
  <actionName xsi:type="xsd:string">createInstance</actionName>
  <objectPath xsi:type="ns1:CIMObjectPath">
    <className xsi:type="xsd:string">ServiceOrder</className>
    <properties xsi:type="ns1:CIMPropertyList"
      soapenc:arrayType="ns1:CIMProperty[]">
      <item xsi:type="ns1:CIMProperty">
        <name xsi:type="xsd:string">ServiceName</name>
        <value xsi:type="xsd:string">ServiceOrder257</value>
      </item>
      <item xsi:type="ns1:CIMProperty">
        <name xsi:type="xsd:string">CarrierId</name>
        <value xsi:type="xsd:string">322</value>
      </item>
      <item xsi:type="ns1:CIMProperty">
        <name xsi:type="xsd:string">DesiredDueDate</name>
        <value xsi:type="xsd:dateTime">2008-12-13T14:55:38.885Z</value>
      </item>
      <item xsi:type="ns1:CIMProperty">
        <name xsi:type="xsd:string">NumberOfRequests</name>
        <value xsi:type="xsd:string">1</value>
      </item>
    </properties>
  </objectPath>
</action>
<action>
  <actionName xsi:type="xsd:string">createInstance</actionName>
  <objectPath xsi:type="ns1:CIMObjectPath">
    <className xsi:type="xsd:string">ServiceRequest</className>
    <properties xsi:type="ns1:CIMPropertyList"
      soapenc:arrayType="ns1:CIMProperty[]">
      <item xsi:type="ns1:CIMProperty">
        <name xsi:type="xsd:string">RequestName</name>
        <value xsi:type="xsd:string">EvcSR-7</value>
      </item>
      <item xsi:type="ns1:CIMProperty">
        <name xsi:type="xsd:string">Type</name>
        <value xsi:type="xsd:string">Evc</value>
      </item>
    </properties>
  <objectPath xsi:type="ns1:CIMObjectPath">
    <className xsi:type="xsd:string">ServiceRequestDetails</className>
    <properties xsi:type="ns1:CIMPropertyList"
      soapenc:arrayType="ns1:CIMProperty[]">
      <item xsi:type="ns1:CIMProperty">
        <name xsi:type="xsd:string">ServiceDefinition</name>
        <value xsi:type="xsd:string">L2_NBI_1</value>
        <qualifier xsi:type="xsd:string">
          <name xsi:type="xsd:string">ServiceDefinitionType</name>
          <value xsi:type="xsd:string">Evc</value>
        </qualifier>
      </item>
      <item xsi:type="ns1:CIMProperty">
        <name xsi:type="xsd:string">VPN</name>
        <value xsi:type="xsd:string">vpn</value>
      </item>
      <item xsi:type="ns1:CIMProperty">
        <name xsi:type="xsd:string">AutopickVCID</name>
        <value xsi:type="xsd:string">true</value>
      </item>
      <item xsi:type="ns1:CIMProperty">
        <name xsi:type="xsd:string">UseBackupVCID</name>
        <value xsi:type="xsd:string">true</value>
      </item>
    </properties>
  </objectPath>
</action>

```



```

        <item xsi:type="ns1:CIMProperty">
            <name xsi:type="xsd:string">UseSVI</name>
            <value xsi:type="xsd:string">>true</value>
        </item>
    </properties>
    <objectPath xsi:type="ns1:CIMObjectPath">
        <className xsi:type="xsd:string">EvcLink</className>
        <properties xsi:type="ns1:CIMPropertyList"
            soapenc:arrayType="ns1:CIMProperty[]">
            <item xsi:type="ns1:CIMProperty">
                <name xsi:type="xsd:string">Npe</name>
                <value xsi:type="xsd:string">iscind-7609-2</value>
            </item>
            <item xsi:type="ns1:CIMProperty">
                <name xsi:type="xsd:string">UniInftId</name>
                <value xsi:type="xsd:string">GigabitEthernet7/0/8</value>
            </item>
        </properties>
    </objectPath>
    <objectPath xsi:type="ns1:CIMObjectPath">
        <className xsi:type="xsd:string">EvcETHLinkAttrs</className>
        <properties xsi:type="ns1:CIMPropertyList"
            soapenc:arrayType="ns1:CIMProperty[]">
            <item xsi:type="ns1:CIMProperty">
                <name xsi:type="xsd:string">UseServiceInst</name>
                <value xsi:type="xsd:string">>true</value>
            </item>
            <item xsi:type="ns1:CIMProperty">
                <name xsi:type="xsd:string">SystemMTU</name>
                <value xsi:type="xsd:string">1563</value>
            </item>
            <item xsi:type="ns1:CIMProperty">
                <name xsi:type="xsd:string">AutoPickVlanId</name>
                <value xsi:type="xsd:string">>true</value>
            </item>
        </properties>
    </objectPath>
    <item xsi:type="ns1:CIMProperty">
        <name xsi:type="xsd:string">XconnectOnSVI</name>
        <value xsi:type="xsd:string">>true</value>
    </item>
</properties>
</objectPath>
<objectPath xsi:type="ns1:CIMObjectPath">
    <className xsi:type="xsd:string">EvcServiceInstanceAttrs</className>
    <properties xsi:type="ns1:CIMPropertyList"
        soapenc:arrayType="ns1:CIMProperty[]">
        <item xsi:type="ns1:CIMProperty">
            <name xsi:type="xsd:string">OuterVlanRange</name>
            <value xsi:type="xsd:string">2611</value>
        </item>
        <item xsi:type="ns1:CIMProperty">
            <name xsi:type="xsd:string">AutoPickServiceInstId</name>
            <value xsi:type="xsd:string">>true</value>
        </item>
        <item xsi:type="ns1:CIMProperty">
            <name xsi:type="xsd:string">BothTags</name>
            <value xsi:type="xsd:string">>false</value>
        </item>
    </properties>
</objectPath>
</objectPath>

```

```

<!-- L2Access Links -->

<objectPath xsi:type="ns1:CIMObjectPath">
  <className xsi:type="xsd:string">EvcLink</className>
  <properties xsi:type="ns1:CIMPropertyList"
    soapenc:arrayType="ns1:CIMProperty[]">
    <item xsi:type="ns1:CIMProperty">
      <name xsi:type="xsd:string">Upe</name>
      <value xsi:type="xsd:string">iscind-3750-2</value>
    </item>
    <item xsi:type="ns1:CIMProperty">
      <name xsi:type="xsd:string">UniInftId</name>
      <value xsi:type="xsd:string">FastEthernet1/0/4</value>
    </item>
    <item xsi:type="ns1:CIMProperty">
      <name xsi:type="xsd:string">NPC</name>
      <value xsi:type="xsd:string">4</value>
    </item>
  </properties>
  <objectPath xsi:type="ns1:CIMObjectPath">
    <className xsi:type="xsd:string">EvcETHLinkAttrs</className>
    <properties xsi:type="ns1:CIMPropertyList"
      soapenc:arrayType="ns1:CIMProperty[]">
      <item xsi:type="ns1:CIMProperty">
        <name xsi:type="xsd:string">UseServiceInst</name>
        <value xsi:type="xsd:string">>false</value>
      </item>
      <item xsi:type="ns1:CIMProperty">
        <name xsi:type="xsd:string">SystemMTU</name>
        <value xsi:type="xsd:string">1563</value>
      </item>
      <item xsi:type="ns1:CIMProperty">
        <name xsi:type="xsd:string">AutoPickVlanId</name>
        <value xsi:type="xsd:string">>true</value>
      </item>
      <item xsi:type="ns1:CIMProperty">
        <name xsi:type="xsd:string">XconnectOnSVI</name>
        <value xsi:type="xsd:string">>true</value>
      </item>
    </properties>
  </objectPath>
  <objectPath xsi:type="ns1:CIMObjectPath">
    <className xsi:type="xsd:string">EvcUNIProtocolTunnelAttrs</className>
    <properties xsi:type="ns1:CIMPropertyList"
      soapenc:arrayType="ns1:CIMProperty[]">
      <item xsi:type="ns1:CIMProperty">
        <name xsi:type="xsd:string">ProtocolTunnelling</name>
        <value xsi:type="xsd:string">>true</value>
      </item>
      <item xsi:type="ns1:CIMProperty">
        <name xsi:type="xsd:string">VtpDropThreshold</name>
        <value xsi:type="xsd:string">10</value>
      </item>
      <item xsi:type="ns1:CIMProperty">
        <name xsi:type="xsd:string">CdpDropThreshold</name>
        <value xsi:type="xsd:string">20</value>
      </item>
      <item xsi:type="ns1:CIMProperty">
        <name xsi:type="xsd:string">StpDropThreshold</name>
        <value xsi:type="xsd:string">27</value>
      </item>
      <item xsi:type="ns1:CIMProperty">
        <name xsi:type="xsd:string">StpThreshold</name>

```

```

        <value xsi:type="xsd:string">27</value>
    </item>
    <item xsi:type="ns1:CIMProperty">
        <name xsi:type="xsd:string">VtpThreshold</name>
        <value xsi:type="xsd:string">2007</value>
    </item>
    <item xsi:type="ns1:CIMProperty">
        <name xsi:type="xsd:string">CdpThreshold</name>
        <value xsi:type="xsd:string">2007</value>
    </item>
    <item xsi:type="ns1:CIMProperty">
        <name xsi:type="xsd:string">CdpEnable</name>
        <value xsi:type="xsd:string">true</value>
    </item>
    <item xsi:type="ns1:CIMProperty">
        <name xsi:type="xsd:string">VtpEnable</name>
        <value xsi:type="xsd:string">true</value>
    </item>
    <item xsi:type="ns1:CIMProperty">
        <name xsi:type="xsd:string">StpEnable</name>
        <value xsi:type="xsd:string">true</value>
    </item>
</properties>
</objectPath>
<objectPath xsi:type="ns1:CIMObjectPath">
    <className xsi:type="xsd:string">EvcUNIInterfaceAttrs</className>
    <properties xsi:type="ns1:CIMPropertyList"
        soapenc:arrayType="ns1:CIMProperty[]">
        <item xsi:type="ns1:CIMProperty">
            <name xsi:type="xsd:string">PortSecurity</name>
            <value xsi:type="xsd:string">true</value>
        </item>
        <item xsi:type="ns1:CIMProperty">
            <name xsi:type="xsd:string">SpeedType</name>
            <value xsi:type="xsd:string">100</value>
        </item>
        <item xsi:type="ns1:CIMProperty">
            <name xsi:type="xsd:string">DuplexType</name>
            <value xsi:type="xsd:string">Half</value>
        </item>
        <item xsi:type="ns1:CIMProperty">
            <name xsi:type="xsd:string">Shutdown</name>
            <value xsi:type="xsd:string">true</value>
        </item>
        <item xsi:type="ns1:CIMProperty">
            <name xsi:type="xsd:string">MacAddress</name>
            <value xsi:type="xsd:string">5</value>
        </item>
        <item xsi:type="ns1:CIMProperty">
            <name xsi:type="xsd:string">Aging</name>
            <value xsi:type="xsd:string">201</value>
        </item>
        <item xsi:type="ns1:CIMProperty">
            <name xsi:type="xsd:string">ViolationActionType</name>
            <value xsi:type="xsd:string">RESTRICT</value>
        </item>
        <item xsi:type="ns1:CIMProperty">
            <name xsi:type="xsd:string">BroadcastTraffic</name>
            <value xsi:type="xsd:string">25</value>
        </item>
        <item xsi:type="ns1:CIMProperty">
            <name xsi:type="xsd:string">MulticastTraffic</name>
            <value xsi:type="xsd:string">25</value>
        </item>
    </properties>

```

```

        <item xsi:type="ns1:CIMProperty">
          <name xsi:type="xsd:string">UnicastTraffic</name>
          <value xsi:type="xsd:string">25</value>
        </item>
      </properties>
    </objectPath>
  </objectPath>
</objectPath>
</objectPath>
</action>
</actions>
</ns1:performBatchOperation>
</soapenv:Body>
</soapenv:Envelope>

```

## Specifying Service Instance Name for EVC Service Requests

The following is an example of how to specify a service instance name for EVC service requests. The attributes relevant for the Service Instance Name are **ServiceInstName** and **AutoPickServiceInstName** (both in **bold** below), which in the example are set to **manualNameNBI4** and **false** respectively.

Example: CreateEVCSERVICEORDER\_PW\_2.xml

```

<?xml version="1.0" encoding="UTF-8"?>
<soapenv:Envelope
  xmlns:soapenv="http://schemas.xmlsoap.org/soap/envelope/"
  xmlns:soapenc="http://schemas.xmlsoap.org/soap/encoding/"
  xmlns:xsd="http://www.w3.org/2001/XMLSchema"
  xmlns:xsi="http://www.w3.org/2001/XMLSchema-instance"
  xmlns:ns0="http://www.cisco.com/cim-cx/2.0"
  xmlns:ns1="urn:CIM">
  <soapenv:Header>
    <!-- WaitTimeout has a default set in system properties.-->
    <ns0:message id="87855" timestamp="2002-12-13T14:55:38.885Z"
      Wait="true" WaitTimeout="90" sessiontoken="p36bttjwy1"/>
  </soapenv:Header>
  <soapenv:Body>
    <ns1:performBatchOperation>
      <actions xsi:type="ns1:CIMActionList"
        soapenc:arrayType="ns1:CIMAction[]">
        <action>
          <actionName xsi:type="xsd:string">createInstance</actionName>
          <objectPath xsi:type="ns1:CIMObjectPath">
            <className xsi:type="xsd:string">ServiceOrder</className>
            <properties xsi:type="ns1:CIMPropertyList"
              soapenc:arrayType="ns1:CIMProperty[]">
              <item xsi:type="ns1:CIMProperty">
                <name xsi:type="xsd:string">ServiceName</name>
                <value xsi:type="xsd:string">ServiceOrder257</value>
              </item>
              <!-- item xsi:type="ns1:CIMProperty">
                <name xsi:type="xsd:string">CarrierId</name>
                <value xsi:type="xsd:string">322</value>
              </item -->
              <item xsi:type="ns1:CIMProperty">
                <name xsi:type="xsd:string">DesiredDueDate</name>
                <value xsi:type="xsd:dateTime">2008-12-13T14:55:38.885Z</value>
              </item>
              <item xsi:type="ns1:CIMProperty">
                <name xsi:type="xsd:string">NumberOfRequests</name>
                <value xsi:type="xsd:string">1</value>

```

```

        </item>
    </properties>
</objectPath>
</action>
<action>
    <actionName xsi:type="xsd:string">createInstance</actionName>
    <objectPath xsi:type="ns1:CIMObjectPath">
        <className xsi:type="xsd:string">ServiceRequest</className>
        <properties xsi:type="ns1:CIMPropertyList"
            soapenc:arrayType="ns1:CIMProperty[]">
            <item xsi:type="ns1:CIMProperty">
                <name xsi:type="xsd:string">RequestName</name>
                <value xsi:type="xsd:string">EvcSR-7</value>
            </item>
            <item xsi:type="ns1:CIMProperty">
                <name xsi:type="xsd:string">Type</name>
                <value xsi:type="xsd:string">Evc</value>
            </item>
        </properties>
    </objectPath xsi:type="ns1:CIMObjectPath">
        <className xsi:type="xsd:string">ServiceRequestDetails</className>
        <properties xsi:type="ns1:CIMPropertyList"
            soapenc:arrayType="ns1:CIMProperty[]">
            <item xsi:type="ns1:CIMProperty">
                <name xsi:type="xsd:string">ServiceDefinition</name>
                <value xsi:type="xsd:string">GUI_PW</value>
                <qualifier xsi:type="xsd:string">
                    <name xsi:type="xsd:string">ServiceDefinitionType</name>
                    <value xsi:type="xsd:string">Evc</value>
                </qualifier>
            </item>
            <item xsi:type="ns1:CIMProperty">
                <name xsi:type="xsd:string">VPN</name>
                <value xsi:type="xsd:string">vpn-core-PW</value>
            </item>
            <!-- item xsi:type="ns1:CIMProperty">
                <name xsi:type="xsd:string">AutopickVCID</name>
                <value xsi:type="xsd:string">true</value>
            </item -->
            <item xsi:type="ns1:CIMProperty">
                <name xsi:type="xsd:string">UseSVI</name>
                <value xsi:type="xsd:string">true</value>
            </item>
        </properties>

    <objectPath xsi:type="ns1:CIMObjectPath">
        <className xsi:type="xsd:string">EvcLink</className>
        <properties xsi:type="ns1:CIMPropertyList"
            soapenc:arrayType="ns1:CIMProperty[]">
            <item xsi:type="ns1:CIMProperty">
                <name xsi:type="xsd:string">Npe</name>
                <value xsi:type="xsd:string">iscind-7609-2</value>
            </item>
            <item xsi:type="ns1:CIMProperty">
                <name xsi:type="xsd:string">UniInftId</name>
                <value xsi:type="xsd:string">GigabitEthernet7/0/12</value>
            </item>
        </properties>
    <objectPath xsi:type="ns1:CIMObjectPath">
        <className xsi:type="xsd:string">EvcETHLinkAttrs</className>
        <properties xsi:type="ns1:CIMPropertyList"
            soapenc:arrayType="ns1:CIMProperty[]">

            <item xsi:type="ns1:CIMProperty">

```

```

        <name xsi:type="xsd:string">UseServiceInst</name>
        <value xsi:type="xsd:string">>true</value>
    </item>
    <item xsi:type="ns1:CIMProperty">
        <name xsi:type="xsd:string">AutoPickVlanId</name>
        <value xsi:type="xsd:string">>false</value>
    </item>
    <item xsi:type="ns1:CIMProperty">
        <name xsi:type="xsd:string">VlanID</name>
        <value xsi:type="xsd:string">100</value>
    </item>
</properties>
</objectPath>
<objectPath xsi:type="ns1:CIMObjectPath">
    <className xsi:type="xsd:string">EvcServiceInstanceAttrs</className>
    <properties xsi:type="ns1:CIMPropertyList"
        soapenc:arrayType="ns1:CIMProperty[]">
        <item xsi:type="ns1:CIMProperty">
            <name xsi:type="xsd:string">ServiceInstName</name>
            <value xsi:type="xsd:string">manualNameNBI4</value>
        </item>
        <item xsi:type="ns1:CIMProperty">
            <name xsi:type="xsd:string">AutoPickServiceInstName</name>
            <value xsi:type="xsd:string">>false</value>
        </item>
        <item xsi:type="ns1:CIMProperty">
            <name xsi:type="xsd:string">AutoPickServiceInstId</name>
            <value xsi:type="xsd:string">>true</value>
        </item>

        <item xsi:type="ns1:CIMProperty">
            <name xsi:type="xsd:string">OuterVlanRange</name>
            <value xsi:type="xsd:string">256</value>
        </item>

    </properties>
</objectPath>
</objectPath>

<objectPath xsi:type="ns1:CIMObjectPath">
    <className xsi:type="xsd:string">EvcLink</className>
    <properties xsi:type="ns1:CIMPropertyList"
        soapenc:arrayType="ns1:CIMProperty[]">
        <item xsi:type="ns1:CIMProperty">
            <name xsi:type="xsd:string">Npe</name>
            <value xsi:type="xsd:string">iscind-7609-2</value>
        </item>
        <item xsi:type="ns1:CIMProperty">
            <name xsi:type="xsd:string">UniInftId</name>
            <value xsi:type="xsd:string">GigabitEthernet7/0/13</value>
        </item>
    </properties>
    <objectPath xsi:type="ns1:CIMObjectPath">
        <className xsi:type="xsd:string">EvcETHLinkAttrs</className>
        <properties xsi:type="ns1:CIMPropertyList"
            soapenc:arrayType="ns1:CIMProperty[]">

            <item xsi:type="ns1:CIMProperty">
                <name xsi:type="xsd:string">UseServiceInst</name>
                <value xsi:type="xsd:string">>true</value>
            </item>
            <item xsi:type="ns1:CIMProperty">

```

```

        <name xsi:type="xsd:string">AutoPickVlanId</name>
        <value xsi:type="xsd:string">>false</value>
    </item>
    <item xsi:type="ns1:CIMProperty">
        <name xsi:type="xsd:string">VlanID</name>
        <value xsi:type="xsd:string">100</value>
    </item>
</properties>
</objectPath>
<objectPath xsi:type="ns1:CIMObjectPath">
    <className xsi:type="xsd:string">EvcServiceInstanceAttrs</className>
    <properties xsi:type="ns1:CIMPropertyList"
        soapenc:arrayType="ns1:CIMProperty[]" >
    <item xsi:type="ns1:CIMProperty">
        <name xsi:type="xsd:string">ServiceInstName</name>
        <value xsi:type="xsd:string">manualNameNBI4</value>
    </item>
    <item xsi:type="ns1:CIMProperty">
        <name xsi:type="xsd:string">AutoPickServiceInstName</name>
        <value xsi:type="xsd:string">>false</value>
    </item>
    <item xsi:type="ns1:CIMProperty">
        <name xsi:type="xsd:string">AutoPickServiceInstId</name>
        <value xsi:type="xsd:string">>true</value>
    </item>

    <item xsi:type="ns1:CIMProperty">
        <name xsi:type="xsd:string">OuterVlanRange</name>
        <value xsi:type="xsd:string">256</value>
    </item>

    </properties>
</objectPath>
</objectPath>
</objectPath>
</action>
</actions>
</ns1:performBatchOperation>
</soapenv:Body>
</soapenv:Envelope>

```

## Creating a Local Connect Service Request for IOS-XR using Bridge Domain

The following is an example of how to create a EVC bridge domain service request using local connect with IOS XR. The attributes relevant for the bridge domain feature are **BridgeGroupName**, **BridgeDomainName**, **UsePwClass**, and **PwClassId** (all in **bold** below).

Example: CreateEVCSR\_IOSXR\_Local\_With\_BridgeDomain.xml

```

<?xml version="1.0" encoding="UTF-8"?>
<soapenv:Envelope
    xmlns:soapenv="http://schemas.xmlsoap.org/soap/envelope/"
    xmlns:soapenc="http://schemas.xmlsoap.org/soap/encoding/"
    xmlns:xsd="http://www.w3.org/2001/XMLSchema"
    xmlns:xsi="http://www.w3.org/2001/XMLSchema-instance"
    xmlns:ns0="http://www.cisco.com/cim-cx/2.0"
    xmlns:ns1="urn:CIM">
    <soapenv:Header>
        <!-- WaitTimeout has a default set in system properties.-->

```

```

    <ns0:message id="87855" timestamp="2002-12-13T14:55:38.885Z"
      Wait="true" WaitTimeout="90" sessiontoken="p36bttjwy1"/>
  </soapenv:Header>
  <soapenv:Body>
    <ns1:performBatchOperation>
      <actions xsi:type="ns1:CIMActionList"
        soapenc:arrayType="ns1:CIMAction[]">
        <action>
          <actionName xsi:type="xsd:string">createInstance</actionName>
          <objectPath xsi:type="ns1:CIMObjectPath">
            <className xsi:type="xsd:string">ServiceOrder</className>
            <properties xsi:type="ns1:CIMPropertyList"
              soapenc:arrayType="ns1:CIMProperty[]">
              <item xsi:type="ns1:CIMProperty">
                <name xsi:type="xsd:string">ServiceName</name>
                <value xsi:type="xsd:string">ServiceOrder257</value>
              </item>
              <item xsi:type="ns1:CIMProperty">
                <name xsi:type="xsd:string">DesiredDueDate</name>
                <value xsi:type="xsd:dateTime">2008-12-13T14:55:38.885Z</value>
              </item>
              <item xsi:type="ns1:CIMProperty">
                <name xsi:type="xsd:string">NumberOfRequests</name>
                <value xsi:type="xsd:string">1</value>
              </item>
            </properties>
          </objectPath>
        </action>
        <action>
          <actionName xsi:type="xsd:string">createInstance</actionName>
          <objectPath xsi:type="ns1:CIMObjectPath">
            <className xsi:type="xsd:string">ServiceRequest</className>
            <properties xsi:type="ns1:CIMPropertyList"
              soapenc:arrayType="ns1:CIMProperty[]">
              <item xsi:type="ns1:CIMProperty">
                <name xsi:type="xsd:string">RequestName</name>
                <value xsi:type="xsd:string">EvcSR-7</value>
              </item>
              <item xsi:type="ns1:CIMProperty">
                <name xsi:type="xsd:string">Type</name>
                <value xsi:type="xsd:string">Evc</value>
              </item>
            </properties>
          <objectPath xsi:type="ns1:CIMObjectPath">
            <className xsi:type="xsd:string">ServiceRequestDetails</className>
            <properties xsi:type="ns1:CIMPropertyList"
              soapenc:arrayType="ns1:CIMProperty[]">
              <item xsi:type="ns1:CIMProperty">
                <name xsi:type="xsd:string">ServiceDefinition</name>
                <value xsi:type="xsd:string">Policy1</value>
                <qualifier xsi:type="xsd:string">
                  <name xsi:type="xsd:string">ServiceDefinitionType</name>
                  <value xsi:type="xsd:string">Evc</value>
                </qualifier>
              </item>
              <item xsi:type="ns1:CIMProperty">
                <name xsi:type="xsd:string">VPN</name>
                <value xsi:type="xsd:string">vpn1</value>
              </item>
              <item xsi:type="ns1:CIMProperty">
                <name xsi:type="xsd:string">UseSVI</name>
                <value xsi:type="xsd:string">true</value>
              </item>
            </properties>
          </objectPath>
        </action>
      </actions>
    </ns1:performBatchOperation>
  </soapenv:Body>
</ns0:message>

```



```

    </properties>
<objectPath xsi:type="ns1:CIMObjectPath">
  <className xsi:type="xsd:string">EvcLink</className>
  <properties xsi:type="ns1:CIMPropertyList"
    soapenc:arrayType="ns1:CIMProperty[]">
    <item xsi:type="ns1:CIMProperty">
      <name xsi:type="xsd:string">Npe</name>
      <value xsi:type="xsd:string">met1-asr9k-dist1</value>
    </item>
    <item xsi:type="ns1:CIMProperty">
      <name xsi:type="xsd:string">UniInftId</name>
      <value xsi:type="xsd:string">GigabitEthernet0/0/0/36</value>
    </item>
  </properties>

<objectPath xsi:type="ns1:CIMObjectPath">
  <className xsi:type="xsd:string">EvcETHLinkAttrs</className>
  <properties xsi:type="ns1:CIMPropertyList"
    soapenc:arrayType="ns1:CIMProperty[]">
    <item xsi:type="ns1:CIMProperty">
      <name xsi:type="xsd:string">SystemMTU</name>
      <value xsi:type="xsd:string">1563</value>
    </item>
    <item xsi:type="ns1:CIMProperty">
      <name xsi:type="xsd:string">AutoPickVlanId</name>
      <value xsi:type="xsd:string">>false</value>
    </item>
    <item xsi:type="ns1:CIMProperty">
      <name xsi:type="xsd:string">VlanID</name>
      <value xsi:type="xsd:string">19</value>
    </item>
    <item xsi:type="ns1:CIMProperty">
      <name xsi:type="xsd:string">UseServiceInst</name>
      <value xsi:type="xsd:string">>true</value>
    </item>
    <item xsi:type="ns1:CIMProperty">
      <name xsi:type="xsd:string">XconnectOnSVI</name>
      <value xsi:type="xsd:string">>false</value>
    </item>
    <item xsi:type="ns1:CIMProperty">
      <name xsi:type="xsd:string">BridgeGroupName</name>
      <value xsi:type="xsd:string">SampleBG1</value>
    </item>
    <item xsi:type="ns1:CIMProperty">
      <name xsi:type="xsd:string">BridgeDomainName</name>
      <value xsi:type="xsd:string">SampleBD1</value>
    </item>
    <item xsi:type="ns1:CIMProperty">
      <name xsi:type="xsd:string">UsePwClass</name>
      <value xsi:type="xsd:string">>true</value>
    </item>
    <item xsi:type="ns1:CIMProperty">
      <name xsi:type="xsd:string">PwClassId</name>
      <value xsi:type="xsd:string">1</value>
    </item>
    <!--<item xsi:type="ns1:CIMProperty">
      <name xsi:type="xsd:string">L2VpnGrpName</name>
      <value xsi:type="xsd:string">VPNSC</value>
    </item>
    <item xsi:type="ns1:CIMProperty">
      <name xsi:type="xsd:string">ElineName</name>
      <value xsi:type="xsd:string">thfda</value>
  </properties>

```

```

    </item>-->
  </properties>
</objectPath>
<objectPath xsi:type="ns1:CIMObjectPath">
  <className xsi:type="xsd:string">EvcServiceInstanceAttrs</className>
  <properties xsi:type="ns1:CIMPropertyList"
    soapenc:arrayType="ns1:CIMProperty[]">
    <!-- <item xsi:type="ns1:CIMProperty">
      <name xsi:type="xsd:string">AutoPickServiceInstId</name>
      <value xsi:type="xsd:string">>false</value>
    </item>-->
    <!-- <item xsi:type="ns1:CIMProperty">
      <name xsi:type="xsd:string">ServiceInstID</name>
      <value xsi:type="xsd:string">99</value>
    </item>-->

    <item xsi:type="ns1:CIMProperty">
      <name xsi:type="xsd:string">BothTags</name>
      <value xsi:type="xsd:string">>true</value>
    </item>
    <item xsi:type="ns1:CIMProperty">
      <name xsi:type="xsd:string">OuterVlanRange</name>
      <value xsi:type="xsd:string">1845</value>
    </item>
    <item xsi:type="ns1:CIMProperty">
      <name xsi:type="xsd:string">InnerVlanRange</name>
      <value xsi:type="xsd:string">1376</value>
    </item>
  </properties>
</objectPath>
<objectPath xsi:type="ns1:CIMObjectPath">
  <className xsi:type="xsd:string">EvcUNIInterfaceAttrs</className>
  <properties xsi:type="ns1:CIMPropertyList"
    soapenc:arrayType="ns1:CIMProperty[]">
    <item xsi:type="ns1:CIMProperty">
      <name xsi:type="xsd:string">Shutdown</name>
      <value xsi:type="xsd:string">>true</value>
    </item>
    <item xsi:type="ns1:CIMProperty">
      <name xsi:type="xsd:string">PeIntfDesc</name>
      <value xsi:type="xsd:string">*** AC1 ***</value>
    </item>
  </properties>
</objectPath>
</objectPath>
<!-- Test -->

<objectPath xsi:type="ns1:CIMObjectPath">
  <className xsi:type="xsd:string">EvcLink</className>
  <properties xsi:type="ns1:CIMPropertyList"
    soapenc:arrayType="ns1:CIMProperty[]">
    <item xsi:type="ns1:CIMProperty">
      <name xsi:type="xsd:string">Npe</name>
      <value xsi:type="xsd:string">met1-asr9k-dist1</value>
    </item>
    <item xsi:type="ns1:CIMProperty">
      <name xsi:type="xsd:string">UniInftId</name>
      <value xsi:type="xsd:string">GigabitEthernet0/0/0/34</value>
    </item>
  </properties>

  <objectPath xsi:type="ns1:CIMObjectPath">
    <className xsi:type="xsd:string">EvcETHLinkAttrs</className>
    <properties xsi:type="ns1:CIMPropertyList"

```

```

        soapenc:arrayType="ns1:CIMProperty[]">
<item xsi:type="ns1:CIMProperty">
  <name xsi:type="xsd:string">SystemMTU</name>
  <value xsi:type="xsd:string">1563</value>
</item>
<item xsi:type="ns1:CIMProperty">
  <name xsi:type="xsd:string">AutoPickVlanId</name>
  <value xsi:type="xsd:string">>false</value>
</item>
<item xsi:type="ns1:CIMProperty">
  <name xsi:type="xsd:string">VlanID</name>
  <value xsi:type="xsd:string">1009</value>
</item>
<item xsi:type="ns1:CIMProperty">
  <name xsi:type="xsd:string">UseServiceInst</name>
  <value xsi:type="xsd:string">>true</value>
</item>
<item xsi:type="ns1:CIMProperty">
  <name xsi:type="xsd:string">XconnectOnSVI</name>
  <value xsi:type="xsd:string">>false</value>
</item>
<item xsi:type="ns1:CIMProperty">
  <name xsi:type="xsd:string">BridgeGroupName</name>
  <value xsi:type="xsd:string">SampleBG1</value>
</item>
<item xsi:type="ns1:CIMProperty">
  <name xsi:type="xsd:string">BridgeDomainName</name>
  <value xsi:type="xsd:string">SampleBD1</value>
</item>

<!-- <item xsi:type="ns1:CIMProperty">
  <name xsi:type="xsd:string">L2VpnGrpName</name>
  <value xsi:type="xsd:string">VPNSC</value>
</item>
  <item xsi:type="ns1:CIMProperty">
  <name xsi:type="xsd:string">ElineName</name>
  <value xsi:type="xsd:string">gfhghf</value>
</item>-->
</properties>
</objectPath>
<objectPath xsi:type="ns1:CIMObjectPath">
  <className xsi:type="xsd:string">EvcServiceInstanceAttrs</className>
  <properties xsi:type="ns1:CIMPropertyList"
    soapenc:arrayType="ns1:CIMProperty[]">
<!--
    <item xsi:type="ns1:CIMProperty">
      <name xsi:type="xsd:string">AutoPickServiceInstId</name>
      <value xsi:type="xsd:string">>false</value>
    </item>-->
<!--
    <item xsi:type="ns1:CIMProperty">
      <name xsi:type="xsd:string">ServiceInstID</name>
      <value xsi:type="xsd:string">999</value>
    </item>-->
    <item xsi:type="ns1:CIMProperty">
      <name xsi:type="xsd:string">BothTags</name>
      <value xsi:type="xsd:string">>true</value>
    </item>
    <item xsi:type="ns1:CIMProperty">
      <name xsi:type="xsd:string">OuterVlanRange</name>
      <value xsi:type="xsd:string">1231</value>
    </item>
    <item xsi:type="ns1:CIMProperty">
      <name xsi:type="xsd:string">InnerVlanRange</name>
      <value xsi:type="xsd:string">1046</value>
    </item>
  </properties>
</objectPath>

```

```

        </properties>
    </objectPath>
    <objectPath xsi:type="ns1:CIMObjectPath">
        <className xsi:type="xsd:string">EvcUNIInterfaceAttrs</className>
        <properties xsi:type="ns1:CIMPropertyList"
            soapenc:arrayType="ns1:CIMProperty[]">
            <item xsi:type="ns1:CIMProperty">
                <name xsi:type="xsd:string">Shutdown</name>
                <value xsi:type="xsd:string">>true</value>
            </item>
            <item xsi:type="ns1:CIMProperty">
                <name xsi:type="xsd:string">PeIntfDesc</name>
                <value xsi:type="xsd:string">*** AC1 ***</value>
            </item>
        </properties>
    </objectPath>
</objectPath>
</action>
</actions>
</ns1:performBatchOperation>
</soapenv:Body>
</soapenv:Envelope>

```

## Creating a Pseudowire Service Request Setting the MTU Size

In this example, an EVC service request is created in which an attribute is set for the MTU size for a pseudowire service. The highlighted **MTU** attribute in this example is set to **1500**.

Example: CreateEvcSR-SetMTU.xml

```

<?xml version="1.0" encoding="UTF-8"?>
<soapenv:Envelope
  xmlns:soapenv="http://schemas.xmlsoap.org/soap/envelope/"
  xmlns:soapenc="http://schemas.xmlsoap.org/soap/encoding/"
  xmlns:xsd="http://www.w3.org/2001/XMLSchema"
  xmlns:xsi="http://www.w3.org/2001/XMLSchema-instance"
  xmlns:ns0="http://www.cisco.com/cim-cx/2.0"
  xmlns:ns1="urn:CIM">
  <soapenv:Header>
    <!-- WaitTimeout has a default set in system properties.-->
    <ns0:message id="87855" timestamp="2002-12-13T14:55:38.885Z"
      Wait="true" WaitTimeout="90"
      sessiontoken="971A089D9C0580746649BD5ABF06B8DD"/>
  </soapenv:Header>
  <soapenv:Body>
    <ns1:performBatchOperation>
      <actions xsi:type="ns1:CIMActionList"
        soapenc:arrayType="ns1:CIMAction[]">
        <!-- <action>
          <actionName xsi:type="xsd:string">createInstance</actionName>
          <objectPath xsi:type="ns1:CIMObjectPath">
            <className xsi:type="xsd:string">ServiceOrder</className>
            <properties xsi:type="ns1:CIMPropertyList"
              soapenc:arrayType="ns1:CIMProperty[]">
              <item xsi:type="ns1:CIMProperty">
                <name xsi:type="xsd:string">ServiceName</name>
                <value xsi:type="xsd:string">AnyName</value>

```

```

</item>
<item xsi:type="ns1:CIMProperty">
  <name xsi:type="xsd:string">DesiredDueDate</name>
  <value xsi:type="xsd:dateTime">2008-12-13T14:55:38.885Z</value>
</item>
</properties>
</objectPath>
</action-->
<action>
  <actionName xsi:type="xsd:string">createInstance</actionName>
<objectPath xsi:type="ns1:CIMObjectPath">
  <className xsi:type="xsd:string">ServiceRequest</className>
  <properties xsi:type="ns1:CIMPropertyList"
    soapenc:arrayType="ns1:CIMProperty[]">
    <item xsi:type="ns1:CIMProperty">
      <name xsi:type="xsd:string">RequestName</name>
      <value xsi:type="xsd:string">AnyName</value>
    </item>
    <item xsi:type="ns1:CIMProperty">
      <name xsi:type="xsd:string">Type</name>
      <value xsi:type="xsd:string">Evc</value>
    </item>
  </properties>
<objectPath xsi:type="ns1:CIMObjectPath">
  <className xsi:type="xsd:string">ServiceRequestDetails</className>
  <properties xsi:type="ns1:CIMPropertyList"
    soapenc:arrayType="ns1:CIMProperty[]">
    <item xsi:type="ns1:CIMProperty">
      <name xsi:type="xsd:string">ServiceDefinition</name>
      <value xsi:type="xsd:string">d-evc-pw</value>
      <qualifier xsi:type="xsd:string">
        <name xsi:type="xsd:string">ServiceDefinitionType</name>
        <value xsi:type="xsd:string">Evc</value>
      </qualifier>
    </item>
    <item xsi:type="ns1:CIMProperty">
      <name xsi:type="xsd:string">VPN</name>
      <value xsi:type="xsd:string">d-vpn-pw</value>
    </item>
    <item xsi:type="ns1:CIMProperty">
      <name xsi:type="xsd:string">VCID</name>
      <value xsi:type="xsd:string">45000</value>
    </item>
    <item xsi:type="ns1:CIMProperty">
      <name xsi:type="xsd:string">UseSVI</name>
      <value xsi:type="xsd:string">>false</value>
    </item>
    <item xsi:type="ns1:CIMProperty">
      <name xsi:type="xsd:string">MTU</name>
      <value xsi:type="xsd:string">1500</value>
    </item>
  </properties>

  <!-- Direct Link IOS 7609-1 -->
<objectPath xsi:type="ns1:CIMObjectPath">
  <className xsi:type="xsd:string">EvcLink</className>
  <properties xsi:type="ns1:CIMPropertyList"
    soapenc:arrayType="ns1:CIMProperty[]">
    <item xsi:type="ns1:CIMProperty">
      <name xsi:type="xsd:string">Npe</name>

```

```

        <value xsi:type="xsd:string">isc-me3600x</value>
    </item>
    <item xsi:type="ns1:CIMProperty">
        <name xsi:type="xsd:string">UniInftId</name>
        <value xsi:type="xsd:string">GigabitEthernet0/18</value>
    </item>
</properties>
<objectPath xsi:type="ns1:CIMObjectPath">
    <className xsi:type="xsd:string">EvcETHLinkAttrs</className>
    <properties xsi:type="ns1:CIMPropertyList"
        soapenc:arrayType="ns1:CIMProperty[]">
        <item xsi:type="ns1:CIMProperty">
            <name xsi:type="xsd:string">UseServiceInst</name>
            <value xsi:type="xsd:string">>true</value>
        </item>
        <item xsi:type="ns1:CIMProperty">
            <name xsi:type="xsd:string">SystemMTU</name>
            <value xsi:type="xsd:string">1563</value>
        </item>
        <item xsi:type="ns1:CIMProperty">
            <name xsi:type="xsd:string">EncapsulationType</name>
            <value xsi:type="xsd:string">UNTAGGED</value>
        </item>
        <item xsi:type="ns1:CIMProperty">
            <name xsi:type="xsd:string">AutoPickVlanId</name>
            <value xsi:type="xsd:string">>false</value>
        </item>
        <item xsi:type="ns1:CIMProperty">
            <name xsi:type="xsd:string">UseSplitHorizon</name>
            <value xsi:type="xsd:string">>false</value>
        </item>
        <item xsi:type="ns1:CIMProperty">
            <name xsi:type="xsd:string">VlanID</name>
            <value xsi:type="xsd:string">3800</value>
        </item>
        <item xsi:type="ns1:CIMProperty">
            <name xsi:type="xsd:string">XconnectOnSVI</name>
            <value xsi:type="xsd:string">>true</value>
        </item>
    </properties>
</objectPath>
<objectPath xsi:type="ns1:CIMObjectPath">
    <className xsi:type="xsd:string">EvcServiceInstanceAttrs</className>
    <properties xsi:type="ns1:CIMPropertyList"
        soapenc:arrayType="ns1:CIMProperty[]">

        <item xsi:type="ns1:CIMProperty">
            <name xsi:type="xsd:string">AutoPickServiceInstId</name>
            <value xsi:type="xsd:string">>false</value>
        </item>
        <item xsi:type="ns1:CIMProperty">
            <name xsi:type="xsd:string">ServiceInstID</name>
            <value xsi:type="xsd:string">7000</value>
        </item>
        <!-- <item xsi:type="ns1:CIMProperty">
            <name xsi:type="xsd:string">BothTags</name>
            <value xsi:type="xsd:string">>false</value>
        </item>
        <item xsi:type="ns1:CIMProperty">
            <name xsi:type="xsd:string">OuterVlanRange</name>
            <value xsi:type="xsd:string">3800</value>
        </item-->
        <item xsi:type="ns1:CIMProperty">
            <name xsi:type="xsd:string">RewriteActionType</name>

```

```

        <value xsi:type="xsd:string">PUSH_BOTH</value>
      </item>
    <item xsi:type="ns1:CIMProperty">
      <name xsi:type="xsd:string">TranslateOuterVlanId</name>
      <value xsi:type="xsd:string">3400</value>
    </item>
    <item xsi:type="ns1:CIMProperty">
      <name xsi:type="xsd:string">TranslateInnerVlanId</name>
      <value xsi:type="xsd:string">3400</value>
    </item>
  </properties>
</objectPath>
</objectPath>
<!-- L2Access Links -->
<!-- <objectPath xsi:type="ns1:CIMObjectPath">
  <className xsi:type="xsd:string">EvcLink</className>
  <properties xsi:type="ns1:CIMPropertyList"
    soapenc:arrayType="ns1:CIMProperty[]">
    <item xsi:type="ns1:CIMProperty">
      <name xsi:type="xsd:string">Upe</name>
      <value xsi:type="xsd:string">isc-test-7600-80</value>
    </item>
    <item xsi:type="ns1:CIMProperty">
      <name xsi:type="xsd:string">UniInftId</name>
      <value xsi:type="xsd:string">GigabitEthernet5/15</value>
    </item>
    <item xsi:type="ns1:CIMProperty">
      <name xsi:type="xsd:string">NPC</name>
      <value xsi:type="xsd:string">2</value>
    </item>
  </properties>
  <objectPath xsi:type="ns1:CIMObjectPath">
    <className xsi:type="xsd:string">EvcETHLinkAttrs</className>
    <properties xsi:type="ns1:CIMPropertyList"
      soapenc:arrayType="ns1:CIMProperty[]">
      <item xsi:type="ns1:CIMProperty">
        <name xsi:type="xsd:string">UseServiceInst</name>
        <value xsi:type="xsd:string">true</value>
      </item>
      <item xsi:type="ns1:CIMProperty">
        <name xsi:type="xsd:string">UseUpeServiceInst</name>
        <value xsi:type="xsd:string">true</value>
      </item>
      <item xsi:type="ns1:CIMProperty">
        <name xsi:type="xsd:string">SystemMTU</name>
        <value xsi:type="xsd:string">1563</value>
      </item>
      <item xsi:type="ns1:CIMProperty">
        <name xsi:type="xsd:string">AutoPickVlanId</name>
        <value xsi:type="xsd:string">>false</value>
      </item>
      <item xsi:type="ns1:CIMProperty">
        <name xsi:type="xsd:string">XconnectOnSVI</name>
        <value xsi:type="xsd:string">true</value>
      </item>
    </properties>
  </objectPath>
  <objectPath xsi:type="ns1:CIMObjectPath">
    <className
xsi:type="xsd:string">EvcUNIServiceInstanceAttrs</className>
    <properties xsi:type="ns1:CIMPropertyList"
      soapenc:arrayType="ns1:CIMProperty[]">
      <item xsi:type="ns1:CIMProperty">
        <name xsi:type="xsd:string">OuterVlanRange</name>

```

```

        <value xsi:type="xsd:string">1500</value>
    </item>
    <item xsi:type="ns1:CIMProperty">
        <name xsi:type="xsd:string">AutoPickServiceInstId</name>
        <value xsi:type="xsd:string">>false</value>
    </item>
    <item xsi:type="ns1:CIMProperty">
        <name xsi:type="xsd:string">ServiceInstID</name>
        <value xsi:type="xsd:string">2321</value>
    </item>
    <item xsi:type="ns1:CIMProperty">
        <name xsi:type="xsd:string">RewriteActionType</name>
        <value xsi:type="xsd:string">PUSH</value>
    </item>
    <item xsi:type="ns1:CIMProperty">
        <name xsi:type="xsd:string">TranslateOuterVlanId</name>
        <value xsi:type="xsd:string">3600</value>
    </item>
</properties>
</objectPath>
<objectPath xsi:type="ns1:CIMObjectPath">
    <className xsi:type="xsd:string">EvcServiceInstanceAttrs</className>
    <properties xsi:type="ns1:CIMPropertyList"
        soapenc:arrayType="ns1:CIMProperty[]">
        <item xsi:type="ns1:CIMProperty">
            <name xsi:type="xsd:string">OuterVlanRange</name>
            <value xsi:type="xsd:string">2500</value>
        </item>
        <item xsi:type="ns1:CIMProperty">
            <name xsi:type="xsd:string">AutoPickServiceInstId</name>
            <value xsi:type="xsd:string">>false</value>
        </item>
        <item xsi:type="ns1:CIMProperty">
            <name xsi:type="xsd:string">ServiceInstID</name>
            <value xsi:type="xsd:string">3700</value>
        </item>
        <item xsi:type="ns1:CIMProperty">
            <name xsi:type="xsd:string">RewriteActionType</name>
            <value xsi:type="xsd:string">PUSH</value>
        </item>
        <item xsi:type="ns1:CIMProperty">
            <name xsi:type="xsd:string">TranslateInnerVlanId</name>
            <value xsi:type="xsd:string">3700</value>
        </item>
        <item xsi:type="ns1:CIMProperty">
            <name xsi:type="xsd:string">TranslateOuterVlanId</name>
            <value xsi:type="xsd:string">3800</value>
        </item>
    </properties>
</objectPath>
<objectPath xsi:type="ns1:CIMObjectPath">
    <className xsi:type="xsd:string">EvcUNIProtocolTunnelAttrs</className>
    <properties xsi:type="ns1:CIMPropertyList"
        soapenc:arrayType="ns1:CIMProperty[]">
        <item xsi:type="ns1:CIMProperty">
            <name xsi:type="xsd:string">ProtocolTunnelling</name>
            <value xsi:type="xsd:string">>true</value>
        </item>
        <item xsi:type="ns1:CIMProperty">
            <name xsi:type="xsd:string">VtpDropThreshold</name>
            <value xsi:type="xsd:string">10</value>
        </item>
        <item xsi:type="ns1:CIMProperty">
            <name xsi:type="xsd:string">CdpDropThreshold</name>

```



```

        <value xsi:type="xsd:string">20</value>
    </item>
    <item xsi:type="ns1:CIMProperty">
        <name xsi:type="xsd:string">StpDropThreshold</name>
        <value xsi:type="xsd:string">27</value>
    </item>
    <item xsi:type="ns1:CIMProperty">
        <name xsi:type="xsd:string">StpThreshold</name>
        <value xsi:type="xsd:string">27</value>
    </item>
    <item xsi:type="ns1:CIMProperty">
        <name xsi:type="xsd:string">VtpThreshold</name>
        <value xsi:type="xsd:string">2007</value>
    </item>
    <item xsi:type="ns1:CIMProperty">
        <name xsi:type="xsd:string">CdpThreshold</name>
        <value xsi:type="xsd:string">2007</value>
    </item>
    <item xsi:type="ns1:CIMProperty">
        <name xsi:type="xsd:string">CdpEnable</name>
        <value xsi:type="xsd:string">true</value>
    </item>
    <item xsi:type="ns1:CIMProperty">
        <name xsi:type="xsd:string">VtpEnable</name>
        <value xsi:type="xsd:string">true</value>
    </item>
    <item xsi:type="ns1:CIMProperty">
        <name xsi:type="xsd:string">StpEnable</name>
        <value xsi:type="xsd:string">true</value>
    </item>
</properties>
</objectPath>
<objectPath xsi:type="ns1:CIMObjectPath">
<className xsi:type="xsd:string">EvcUNIInterfaceAttrs</className>
<properties xsi:type="ns1:CIMPropertyList"
    soapenc:arrayType="ns1:CIMProperty[]">
    <item xsi:type="ns1:CIMProperty">
        <name xsi:type="xsd:string">PortSecurity</name>
        <value xsi:type="xsd:string">true</value>
    </item>
    <item xsi:type="ns1:CIMProperty">
        <name xsi:type="xsd:string">SpeedType</name>
        <value xsi:type="xsd:string">100</value>
    </item>
    <item xsi:type="ns1:CIMProperty">
        <name xsi:type="xsd:string">DuplexType</name>
        <value xsi:type="xsd:string">Half</value>
    </item>
    <item xsi:type="ns1:CIMProperty">
        <name xsi:type="xsd:string">Shutdown</name>
        <value xsi:type="xsd:string">true</value>
    </item>
    <item xsi:type="ns1:CIMProperty">
        <name xsi:type="xsd:string">MacAddress</name>
        <value xsi:type="xsd:string">5</value>
    </item>
    <item xsi:type="ns1:CIMProperty">
        <name xsi:type="xsd:string">Aging</name>
        <value xsi:type="xsd:string">201</value>
    </item>
    <item xsi:type="ns1:CIMProperty">
        <name xsi:type="xsd:string">ViolationActionType</name>
        <value xsi:type="xsd:string">RESTRICT</value>
    </item>

```

```

        <item xsi:type="ns1:CIMProperty">
          <name xsi:type="xsd:string">BroadcastTraffic</name>
          <value xsi:type="xsd:string">25</value>
        </item>
        <item xsi:type="ns1:CIMProperty">
          <name xsi:type="xsd:string">MulticastTraffic</name>
          <value xsi:type="xsd:string">25</value>
        </item>
        <item xsi:type="ns1:CIMProperty">
          <name xsi:type="xsd:string">UnicastTraffic</name>
          <value xsi:type="xsd:string">25</value>
        </item>
      </properties>
    </objectPath>
  </objectPath> -->

</objectPath>
</objectPath>
</action>
</actions>
</ns1:performBatchOperation>
</soapenv:Body>
</soapenv:Envelope>

```

## Creating a Pseudowire Service Request with P2P E-line Name

In the following example, an EVC service request with pseudowire and p2p e-line name is created. The attributes relevant for the bridge domain feature are **L2VpnGrpName**, **ElineName**, **UsePwClass**, and **PwClassId** (all in **bold** below).

**UsePwClass** and **PwClassId** are supported only for IOS XR devices and serve to associate the PW class inventories created from the CreatePWclass.xml API.

Example: CreateEVCSR\_IOSXR\_PW\_With\_p2p\_Elinename.xml

```

<?xml version="1.0" encoding="UTF-8"?>
<soapenv:Envelope
  xmlns:soapenv="http://schemas.xmlsoap.org/soap/envelope/"
  xmlns:soapenc="http://schemas.xmlsoap.org/soap/encoding/"
  xmlns:xsd="http://www.w3.org/2001/XMLSchema"
  xmlns:xsi="http://www.w3.org/2001/XMLSchema-instance"
  xmlns:ns0="http://www.cisco.com/cim-cx/2.0"
  xmlns:ns1="urn:CIM">
  <soapenv:Header>
    <!-- WaitTimeout has a default set in system properties.-->
    <ns0:message id="87855" timestamp="2002-12-13T14:55:38.885Z"
      Wait="true" WaitTimeout="90" sessiontoken="p36bttjwy1"/>
  </soapenv:Header>
  <soapenv:Body>
    <ns1:performBatchOperation>
      <actions xsi:type="ns1:CIMActionList"
        soapenc:arrayType="ns1:CIMAction[]">
        <action>
          <actionName xsi:type="xsd:string">createInstance</actionName>
          <objectPath xsi:type="ns1:CIMObjectPath">
            <className xsi:type="xsd:string">ServiceOrder</className>
            <properties xsi:type="ns1:CIMPropertyList"
              soapenc:arrayType="ns1:CIMProperty[]">
              <item xsi:type="ns1:CIMProperty">
                <name xsi:type="xsd:string">ServiceName</name>
                <value xsi:type="xsd:string">ServiceOrder257</value>

```

```

</item>
<item xsi:type="ns1:CIMProperty">
  <name xsi:type="xsd:string">DesiredDueDate</name>
  <value xsi:type="xsd:dateTime">2008-12-13T14:55:38.885Z</value>
</item>
</properties>
</objectPath>
</action>
<action>
  <actionName xsi:type="xsd:string">createInstance</actionName>
<objectPath xsi:type="ns1:CIMObjectPath">
  <className xsi:type="xsd:string">ServiceRequest</className>
  <properties xsi:type="ns1:CIMPropertyList"
    soapenc:arrayType="ns1:CIMProperty[]">
    <item xsi:type="ns1:CIMProperty">
      <name xsi:type="xsd:string">RequestName</name>
      <value xsi:type="xsd:string">EvcSR-7</value>
    </item>
    <item xsi:type="ns1:CIMProperty">
      <name xsi:type="xsd:string">Type</name>
      <value xsi:type="xsd:string">Evc</value>
    </item>
  </properties>
<objectPath xsi:type="ns1:CIMObjectPath">
  <className xsi:type="xsd:string">ServiceRequestDetails</className>
  <properties xsi:type="ns1:CIMPropertyList"
    soapenc:arrayType="ns1:CIMProperty[]">
    <item xsi:type="ns1:CIMProperty">
      <name xsi:type="xsd:string">ServiceDefinition</name>
      <value xsi:type="xsd:string">Policy2</value>
      <qualifier xsi:type="xsd:string">
        <name xsi:type="xsd:string">ServiceDefinitionType</name>
        <value xsi:type="xsd:string">Evc</value>
      </qualifier>
    </item>
    <item xsi:type="ns1:CIMProperty">
      <name xsi:type="xsd:string">VPN</name>
      <value xsi:type="xsd:string">vpn1</value>
    </item>
    <item xsi:type="ns1:CIMProperty">
      <name xsi:type="xsd:string">UseSVI</name>
      <value xsi:type="xsd:string">>false</value>
    </item>
    <item xsi:type="ns1:CIMProperty">
      <name xsi:type="xsd:string">AutopickVCID</name>
      <value xsi:type="xsd:string">>true</value>
    </item>
  </properties>
<objectPath xsi:type="ns1:CIMObjectPath">
  <className xsi:type="xsd:string">EvcLink</className>
  <properties xsi:type="ns1:CIMPropertyList"
    soapenc:arrayType="ns1:CIMProperty[]">
    <item xsi:type="ns1:CIMProperty">
      <name xsi:type="xsd:string">Npe</name>
      <value xsi:type="xsd:string">met1-asr9k-dist1</value>
    </item>
    <item xsi:type="ns1:CIMProperty">
      <name xsi:type="xsd:string">UniInftId</name>
      <value xsi:type="xsd:string">GigabitEthernet0/0/0/36</value>

```

```

        </item>
    </properties>

    <objectPath xsi:type="ns1:CIMObjectPath">
        <className xsi:type="xsd:string">EvcETHLinkAttrs</className>
        <properties xsi:type="ns1:CIMPropertyList"
            soapenc:arrayType="ns1:CIMProperty[]">
            <item xsi:type="ns1:CIMProperty">
                <name xsi:type="xsd:string">SystemMTU</name>
                <value xsi:type="xsd:string">1563</value>
            </item>
            <item xsi:type="ns1:CIMProperty">
                <name xsi:type="xsd:string">AutoPickVlanId</name>
                <value xsi:type="xsd:string">>false</value>
            </item>
            <item xsi:type="ns1:CIMProperty">
                <name xsi:type="xsd:string">VlanID</name>
                <value xsi:type="xsd:string">19</value>
            </item>
            <item xsi:type="ns1:CIMProperty">
                <name xsi:type="xsd:string">UseServiceInst</name>
                <value xsi:type="xsd:string">>true</value>
            </item>
            <item xsi:type="ns1:CIMProperty">
                <name xsi:type="xsd:string">XconnectOnSVI</name>
                <value xsi:type="xsd:string">>false</value>
            </item>
            <item xsi:type="ns1:CIMProperty">
                <name xsi:type="xsd:string">UsePwClass</name>
                <value xsi:type="xsd:string">>true</value>
            </item>
            <item xsi:type="ns1:CIMProperty">
                <name xsi:type="xsd:string">PwClassId</name>
                <value xsi:type="xsd:string">1</value>
            </item>
            <item xsi:type="ns1:CIMProperty">
                <name xsi:type="xsd:string">L2VpnGrpName</name>
                <value xsi:type="xsd:string">VPNSC</value>
            </item>
            <item xsi:type="ns1:CIMProperty">
                <name xsi:type="xsd:string">ElineName</name>
                <value xsi:type="xsd:string">abc</value>
            </item>
        </properties>
    </objectPath>
    <objectPath xsi:type="ns1:CIMObjectPath">
        <className xsi:type="xsd:string">EvcServiceInstanceAttrs</className>
        <properties xsi:type="ns1:CIMPropertyList"
            soapenc:arrayType="ns1:CIMProperty[]">
            <!-- <item xsi:type="ns1:CIMProperty">
                <name xsi:type="xsd:string">AutoPickServiceInstId</name>
                <value xsi:type="xsd:string">>false</value>
            </item-->
            <!-- <item xsi:type="ns1:CIMProperty">
                <name xsi:type="xsd:string">ServiceInstID</name>
                <value xsi:type="xsd:string">99</value>
            </item-->

            <item xsi:type="ns1:CIMProperty">
                <name xsi:type="xsd:string">BothTags</name>
                <value xsi:type="xsd:string">>true</value>
            </item>
        </properties>
    </objectPath>

```

```

        <item xsi:type="ns1:CIMProperty">
          <name xsi:type="xsd:string">OuterVlanRange</name>
          <value xsi:type="xsd:string">1845</value>
        </item>
        <item xsi:type="ns1:CIMProperty">
          <name xsi:type="xsd:string">InnerVlanRange</name>
          <value xsi:type="xsd:string">1376</value>
        </item>
      </properties>
    </objectPath>
  </objectPath>
  <objectPath xsi:type="ns1:CIMObjectPath">
    <className xsi:type="xsd:string">EvcUNIInterfaceAttrs</className>
    <properties xsi:type="ns1:CIMPropertyList"
      soapenc:arrayType="ns1:CIMProperty[]">
      <item xsi:type="ns1:CIMProperty">
        <name xsi:type="xsd:string">Shutdown</name>
        <value xsi:type="xsd:string">>true</value>
      </item>
      <item xsi:type="ns1:CIMProperty">
        <name xsi:type="xsd:string">PeIntfDesc</name>
        <value xsi:type="xsd:string">*** AC1 ***</value>
      </item>
    </properties>
  </objectPath>
</objectPath>
<!-- Test -->

  <objectPath xsi:type="ns1:CIMObjectPath">
    <className xsi:type="xsd:string">EvcLink</className>
    <properties xsi:type="ns1:CIMPropertyList"
      soapenc:arrayType="ns1:CIMProperty[]">
      <item xsi:type="ns1:CIMProperty">
        <name xsi:type="xsd:string">Npe</name>
        <value xsi:type="xsd:string">met1-asr9k-dist2</value>
      </item>
      <item xsi:type="ns1:CIMProperty">
        <name xsi:type="xsd:string">UniInftId</name>
        <value xsi:type="xsd:string">GigabitEthernet0/1/0/34</value>
      </item>
    </properties>
  </objectPath>

  <objectPath xsi:type="ns1:CIMObjectPath">
    <className xsi:type="xsd:string">EvcETHLinkAttrs</className>
    <properties xsi:type="ns1:CIMPropertyList"
      soapenc:arrayType="ns1:CIMProperty[]">
      <item xsi:type="ns1:CIMProperty">
        <name xsi:type="xsd:string">SystemMTU</name>
        <value xsi:type="xsd:string">1563</value>
      </item>
      <item xsi:type="ns1:CIMProperty">
        <name xsi:type="xsd:string">AutoPickVlanId</name>
        <value xsi:type="xsd:string">>false</value>
      </item>
      <item xsi:type="ns1:CIMProperty">
        <name xsi:type="xsd:string">VlanID</name>
        <value xsi:type="xsd:string">1009</value>
      </item>
      <item xsi:type="ns1:CIMProperty">
        <name xsi:type="xsd:string">UseServiceInst</name>
        <value xsi:type="xsd:string">>true</value>
      </item>
      <item xsi:type="ns1:CIMProperty">
        <name xsi:type="xsd:string">XconnectOnSVI</name>
        <value xsi:type="xsd:string">>false</value>
      </item>
    </properties>
  </objectPath>

```

```

        </item>

        <item xsi:type="ns1:CIMProperty">
            <name xsi:type="xsd:string">L2VpnGrpName</name>
            <value xsi:type="xsd:string">VPNSC</value>
        </item>
        <item xsi:type="ns1:CIMProperty">
            <name xsi:type="xsd:string">ElineName</name>
            <value xsi:type="xsd:string">abc</value>
        </item>
    </properties>
</objectPath>
<objectPath xsi:type="ns1:CIMObjectPath">
    <className xsi:type="xsd:string">EvcServiceInstanceAttrs</className>
    <properties xsi:type="ns1:CIMPropertyList"
        soapenc:arrayType="ns1:CIMProperty[]">
        <!--
            <item xsi:type="ns1:CIMProperty">
                <name xsi:type="xsd:string">AutoPickServiceInstId</name>
                <value xsi:type="xsd:string">>false</value>
            </item-->
        <!--
            <item xsi:type="ns1:CIMProperty">
                <name xsi:type="xsd:string">ServiceInstID</name>
                <value xsi:type="xsd:string">999</value>
            </item-->
            <item xsi:type="ns1:CIMProperty">
                <name xsi:type="xsd:string">BothTags</name>
                <value xsi:type="xsd:string">>true</value>
            </item>
            <item xsi:type="ns1:CIMProperty">
                <name xsi:type="xsd:string">OuterVlanRange</name>
                <value xsi:type="xsd:string">1845</value>
            </item>
            <item xsi:type="ns1:CIMProperty">
                <name xsi:type="xsd:string">InnerVlanRange</name>
                <value xsi:type="xsd:string">1046</value>
            </item>
        </properties>
    </objectPath>
<objectPath xsi:type="ns1:CIMObjectPath">
    <className xsi:type="xsd:string">EvcUNIInterfaceAttrs</className>
    <properties xsi:type="ns1:CIMPropertyList"
        soapenc:arrayType="ns1:CIMProperty[]">
        <item xsi:type="ns1:CIMProperty">
            <name xsi:type="xsd:string">Shutdown</name>
            <value xsi:type="xsd:string">>true</value>
        </item>
        <item xsi:type="ns1:CIMProperty">
            <name xsi:type="xsd:string">PeIntfDesc</name>
            <value xsi:type="xsd:string">*** AC1 ***</value>
        </item>
    </properties>
</objectPath>
</objectPath>

    </objectPath>
</objectPath>
</action>
</actions>
</ns1:performBatchOperation>
</soapenv:Body>
</soapenv:Envelope>

```

## Creating a Pseudowire Service Request with Range of Values for Outer VLAN/Inner VLAN

In the following example, an EVC service request with pseudowire is created. If ranges for Outer VLAN/Inner VLAN needs to be enabled, they should be set to editable at the policy level, and in the service request the attributes **MatchOuterVlan** and **MatchInnerVlan** should be set to **TRUE/FALSE**. These attributes are highlighted in bold below. This is applicable for both IOS and ASR9K devices.



### Note

These highlighted attributes are not mandatory attributes and would be required only when a range needs to be enabled.

The following XML example shows a partial list of the properties that can be specified for the attachment circuit EvcServiceInstanceAttrs.

Example: CreateEVC\_PW\_ServiceOrder\_Ranges.xml

```
<objectPath xsi:type="ns1:CIMObjectPath">
  <className xsi:type="xsd:string">EvcServiceInstanceAttrs</className>
  <properties xsi:type="ns1:CIMPropertyList"
    soapenc:arrayType="ns1:CIMProperty[]">
    <item xsi:type="ns1:CIMProperty">
      <name xsi:type="xsd:string">MatchOuterVlan</name>
      <value xsi:type="xsd:string">>false</value>
    </item>
    <item xsi:type="ns1:CIMProperty">
      <name xsi:type="xsd:string">OuterVlanRange</name>
      <value xsi:type="xsd:string">887</value>
    </item>
    <item xsi:type="ns1:CIMProperty">
      <name xsi:type="xsd:string">BothTags</name>
      <value xsi:type="xsd:string">>true</value>
    </item>
    <item xsi:type="ns1:CIMProperty">
      <name xsi:type="xsd:string">MatchInnerVlan</name>
      <value xsi:type="xsd:string">>true</value>
    </item>
    <item xsi:type="ns1:CIMProperty">
      <name xsi:type="xsd:string">InnerVlanRange</name>
      <value xsi:type="xsd:string">887-990</value>
    </item>
  </properties>
</objectPath>
```

## Creating a Pseudowire Service Request with Encapsulation Type DEFAULT/UNTAGGED

In this example, an EVC pseudowire service request is created. In case of direct links, the encapsulation type can be set to DEFAULT or UNTAGGED. These attributes are highlighted in bold below. This is applicable for both IOS and ASR9K devices.

The table below shows the supported encapsulation types along with their respective API tag names:

Encapsulation Type	Tag Name
DOT1Q	DOT1Q*

Encapsulation Type	Tag Name
DEFAULT	DEFAULT
UNTAGGED	UNTAGGED

\* DOT1Q is an existing encapsulation type.

The following XML example shows a partial list of the properties that can be specified for the attachment circuit EvcETHLinkAttrs for Encapsulation Type **UNTAGGED**.

Example: CreateEvc\_ServiceOrder\_PW\_EncapDefaultUntag.xml

```

<objectPath xsi:type="ns1:CIMObjectPath">
  <className xsi:type="xsd:string">EvcETHLinkAttrs</className>
  <properties xsi:type="ns1:CIMPropertyList"
    soapenc:arrayType="ns1:CIMProperty[]">
    <item xsi:type="ns1:CIMProperty">
      <name xsi:type="xsd:string">UseServiceInst</name>
      <value xsi:type="xsd:string">>true</value>
    </item>
    <item xsi:type="ns1:CIMProperty">
      <name xsi:type="xsd:string">SystemMTU</name>
      <value xsi:type="xsd:string">1563</value>
    </item>
    <item xsi:type="ns1:CIMProperty">
      <name xsi:type="xsd:string">EncapsulationType</name>
      <value xsi:type="xsd:string">UNTAGGED</value>
    </item>
    <item xsi:type="ns1:CIMProperty">
      <name xsi:type="xsd:string">XconnectOnSVI</name>
      <value xsi:type="xsd:string">>true</value>
    </item>
    <item xsi:type="ns1:CIMProperty">
      <name xsi:type="xsd:string">VlanID</name>
      <value xsi:type="xsd:string">345</value>
    </item>
  </properties>
</objectPath>

```

The following XML example shows a partial list of the properties that can be specified for the attachment circuit EvcETHLinkAttrs for Encapsulation Type **DEFAULT**.

```

<objectPath xsi:type="ns1:CIMObjectPath">
  <className xsi:type="xsd:string">EvcETHLinkAttrs</className>
  <properties xsi:type="ns1:CIMPropertyList"
    soapenc:arrayType="ns1:CIMProperty[]">
    <item xsi:type="ns1:CIMProperty">
      <name xsi:type="xsd:string">UseServiceInst</name>
      <value xsi:type="xsd:string">>true</value>
    </item>
    <item xsi:type="ns1:CIMProperty">
      <name xsi:type="xsd:string">EncapsulationType</name>
      <value xsi:type="xsd:string">DEFAULT</value>
    </item>
    <item xsi:type="ns1:CIMProperty">
      <name xsi:type="xsd:string">XconnectOnSVI</name>
      <value xsi:type="xsd:string">>true</value>
    </item>
    <item xsi:type="ns1:CIMProperty">
      <name xsi:type="xsd:string">VlanID</name>

```



```

        <value xsi:type="xsd:string">345</value>
      </item>
    </properties>
  </objectPath>

```

## Creating a Pseudowire Service Request with ANY VLAN/Tagged with Untagged VLANs

In this example, an EVC pseudowire service request is created. To enable ANY VLAN or Tagged with Untagged VLANs for EVC direct connect, the attributes should be set to **TRUE/FALSE**. These attributes are highlighted in bold below. This is applicable for both IOS and ASR9K devices.



### Note

These highlighted attributes are not mandatory attributes and would be required only when ANY VLAN/Tagged with Untagged VLANs needs to be enabled.

The following XML example shows a partial list of the properties that can be specified for the attachment circuit EvcServiceInstanceAttrs.

Example: CreateEvc\_ServiceOrder\_PW\_MatchTagUntag.xml

```

<objectPath xsi:type="ns1:CIMObjectPath">
  <className xsi:type="xsd:string">EvcServiceInstanceAttrs</className>
  <properties xsi:type="ns1:CIMPropertyList"
    soapenc:arrayType="ns1:CIMProperty[]" >
    <item xsi:type="ns1:CIMProperty">
      <name xsi:type="xsd:string">BothTags</name>
      <value xsi:type="xsd:string">true</value>
    </item>
    <item xsi:type="ns1:CIMProperty">
      <name xsi:type="xsd:string">AutoPickServiceInstId</name>
      <value xsi:type="xsd:string">true</value>
    </item>
    <item xsi:type="ns1:CIMProperty">
      <name xsi:type="xsd:string">MatchAnyOuterVlan</name>
      <value xsi:type="xsd:string">>false</value>
    </item>
    <item xsi:type="ns1:CIMProperty">
      <name xsi:type="xsd:string">MatchAnyInnerVlan</name>
      <value xsi:type="xsd:string">true</value>
    </item>
    <item xsi:type="ns1:CIMProperty">
      <name xsi:type="xsd:string">MatchTaggedUntagged</name>
      <value xsi:type="xsd:string">true</value>
    </item>
    <item xsi:type="ns1:CIMProperty">
      <name xsi:type="xsd:string">OuterVlanRange</name>
      <value xsi:type="xsd:string">2524</value>
    </item>
  </properties>
</objectPath>

```

## Creating an EVC Pseudowire Service Request with Reserved Bandwidth

In the following example, an EVC pseudowire service request with reserved bandwidth is created. To set the reserved bandwidth, use the attribute **ReservedBandwidth**, which in the example is set to **542**.

## Example: CreateEvcPwSr\_ResBw.xml

```

<?xml version="1.0" encoding="UTF-8"?>
<soapenv:Envelope
  xmlns:soapenv="http://schemas.xmlsoap.org/soap/envelope/"
  xmlns:soapenc="http://schemas.xmlsoap.org/soap/encoding/"
  xmlns:xsd="http://www.w3.org/2001/XMLSchema"
  xmlns:xsi="http://www.w3.org/2001/XMLSchema-instance"
  xmlns:ns0="http://www.cisco.com/cim-cx/2.0"
  xmlns:ns1="urn:CIM">
  <soapenv:Header>
    <!-- WaitTimeout has a default set in system properties.-->
    <ns0:message id="87855" timestamp="2002-12-13T14:55:38.885Z"
      Wait="true" WaitTimeout="90" sessiontoken="p36bttjwyl"/>
  </soapenv:Header>
  <soapenv:Body>
    <ns1:performBatchOperation>
      <actions xsi:type="ns1:CIMActionList"
        soapenc:arrayType="ns1:CIMAction[]">
        <action>
          <actionName xsi:type="xsd:string">createInstance</actionName>
          <objectPath xsi:type="ns1:CIMObjectPath">
            <className xsi:type="xsd:string">ServiceOrder</className>
            <properties xsi:type="ns1:CIMPropertyList"
              soapenc:arrayType="ns1:CIMProperty[]">
              <item xsi:type="ns1:CIMProperty">
                <name xsi:type="xsd:string">ServiceName</name>
                <value xsi:type="xsd:string">ServiceOrder257</value>
              </item>
              <item xsi:type="ns1:CIMProperty">
                <name xsi:type="xsd:string">DesiredDueDate</name>
                <value xsi:type="xsd:dateTime">2008-12-13T14:55:38.885Z</value>
              </item>
              <item xsi:type="ns1:CIMProperty">
                <name xsi:type="xsd:string">NumberOfRequests</name>
                <value xsi:type="xsd:string">1</value>
              </item>
            </properties>
          </objectPath>
        </action>
        <action>
          <actionName xsi:type="xsd:string">createInstance</actionName>
          <objectPath xsi:type="ns1:CIMObjectPath">
            <className xsi:type="xsd:string">ServiceRequest</className>
            <properties xsi:type="ns1:CIMPropertyList"
              soapenc:arrayType="ns1:CIMProperty[]">
              <item xsi:type="ns1:CIMProperty">
                <name xsi:type="xsd:string">RequestName</name>
                <value xsi:type="xsd:string">EvcSR-7</value>
              </item>
              <item xsi:type="ns1:CIMProperty">
                <name xsi:type="xsd:string">Type</name>
                <value xsi:type="xsd:string">Evc</value>
              </item>
            </properties>
          <objectPath subAction="createInstance" xsi:type="ns1:CIMObjectPath">
            <className xsi:type="xsd:string">ServiceRequestDetails</className>
            <properties soapenc:arrayType="ns1:CIMProperty[]" xsi:type="ns1:CIMPropertyList">
              <item xsi:type="ns1:CIMProperty">
                <name xsi:type="xsd:string">Description</name>
                <value xsi:type="xsd:string">EVC-PW-BW</value>
              </item>
              <item xsi:type="ns1:CIMProperty">

```

```

<name xsi:type="xsd:string">ServiceDefinition</name>
<value xsi:type="xsd:string">evc-pw</value>
<qualifier xsi:type="ns1:CIMQualifier">
<name xsi:type="xsd:string">ServiceDefinitionType</name>
<value xsi:type="xsd:string">Evc</value>
</qualifier>
</item>
<item xsi:type="ns1:CIMProperty">
<name xsi:type="xsd:string">VCID</name>
<value xsi:type="xsd:string">3849</value>
</item>

<item xsi:type="ns1:CIMProperty">
<name xsi:type="xsd:string">UseBackupVCID</name>
<value xsi:type="xsd:string">>false</value>
</item>
<item xsi:type="ns1:CIMProperty">
<name xsi:type="xsd:string">BackupVCID</name>
<value xsi:type="xsd:string">1234</value>
</item>
<item xsi:type="ns1:CIMProperty">
  <name xsi:type="xsd:string">ReservedBandwidth</name>
  <value xsi:type="xsd:string">542</value>
</item>
<item xsi:type="ns1:CIMProperty">
<name xsi:type="xsd:string">UseSVI</name>
<value xsi:type="xsd:string">>true</value>
</item>
<item xsi:type="ns1:CIMProperty">
<name xsi:type="xsd:string">VPN</name>
<value xsi:type="xsd:string">cust1_vpn1</value>
</item>
</properties>
<objectPath subAction="createInstance" xsi:type="ns1:CIMObjectPath">
<className xsi:type="xsd:string">EvcLink</className>
<properties soapenc:arrayType="ns1:CIMProperty[]" xsi:type="ns1:CIMPropertyList">
<item xsi:type="ns1:CIMProperty">
<name xsi:type="xsd:string">Npe</name>
<value xsi:type="xsd:string">isc-asr903</value>
</item>
<item xsi:type="ns1:CIMProperty">
<name xsi:type="xsd:string">UniInftId</name>
<value xsi:type="xsd:string">GigabitEthernet0/0/5</value>
</item>
</properties>
<objectPath subAction="createInstance" xsi:type="ns1:CIMObjectPath">
<className xsi:type="xsd:string">EvcETHLinkAttrs</className>
<properties soapenc:arrayType="ns1:CIMProperty[]" xsi:type="ns1:CIMPropertyList">
<item xsi:type="ns1:CIMProperty">
<name xsi:type="xsd:string">AutoPickVlanId</name>
<value xsi:type="xsd:string">>false</value>
</item>

<item xsi:type="ns1:CIMProperty">
<name xsi:type="xsd:string">EncapsulationType</name>
<value xsi:type="xsd:string">DOT1Q</value>
</item>

<!-- <item xsi:type="ns1:CIMProperty">
<name xsi:type="xsd:string">PWTunnelSel</name>
<value xsi:type="xsd:string">>true</value>
</item>
<item xsi:type="ns1:CIMProperty">

```

```

<name xsi:type="xsd:string">PWTunnelId</name>
<value xsi:type="xsd:string">1000</value>
</item> -->
<item xsi:type="ns1:CIMProperty">
<name xsi:type="xsd:string">UseServiceInst</name>
<value xsi:type="xsd:string">>true</value>
</item>
</properties>
</objectPath>
<objectPath subAction="createInstance" xsi:type="ns1:CIMObjectPath">
<className xsi:type="xsd:string">EvcServiceInstanceAttrs</className>
<properties soapenc:arrayType="ns1:CIMProperty[]" xsi:type="ns1:CIMPropertyList">
<item xsi:type="ns1:CIMProperty">
<name xsi:type="xsd:string">AutoPickServiceInstName</name>
<value xsi:type="xsd:string">>false</value>
</item>
<item xsi:type="ns1:CIMProperty">
<name xsi:type="xsd:string">AutoPickServiceInstId</name>
<value xsi:type="xsd:string">>true</value>
</item>
<item xsi:type="ns1:CIMProperty">
<name xsi:type="xsd:string">OuterVlanRange</name>
<value xsi:type="xsd:string">443</value>
</item>
<item xsi:type="ns1:CIMProperty">
<name xsi:type="xsd:string">RewriteActionType</name>
<value xsi:type="xsd:string">POP</value>
</item>
<item xsi:type="ns1:CIMProperty">
<name xsi:type="xsd:string">BothTags</name>
<value xsi:type="xsd:string">>false</value>
</item>
<!-- <item xsi:type="ns1:CIMProperty">
<name xsi:type="xsd:string">EncapsulationType</name>
<value xsi:type="xsd:string">DOT1Q</value>
</item> -->
</properties>
</objectPath>
</objectPath>
<objectPath subAction="createInstance" xsi:type="ns1:CIMObjectPath">
<className xsi:type="xsd:string">EvcLink</className>
<properties soapenc:arrayType="ns1:CIMProperty[]" xsi:type="ns1:CIMPropertyList">
<item xsi:type="ns1:CIMProperty">
<name xsi:type="xsd:string">Npe</name>
<value xsi:type="xsd:string">c1-test-12-7600-5</value>
</item>
<item xsi:type="ns1:CIMProperty">
<name xsi:type="xsd:string">UniInftId</name>
<value xsi:type="xsd:string">GigabitEthernet2/3</value>
</item>
</properties>
<objectPath subAction="createInstance" xsi:type="ns1:CIMObjectPath">
<className xsi:type="xsd:string">EvcETHLinkAttrs</className>
<properties soapenc:arrayType="ns1:CIMProperty[]" xsi:type="ns1:CIMPropertyList">
<item xsi:type="ns1:CIMProperty">
<name xsi:type="xsd:string">AutoPickVlanId</name>
<value xsi:type="xsd:string">>false</value>
</item>

<item xsi:type="ns1:CIMProperty">
<name xsi:type="xsd:string">EncapsulationType</name>
<value xsi:type="xsd:string">DOT1Q</value>
</item>

```

```

<!-- <item xsi:type="ns1:CIMProperty">
<name xsi:type="xsd:string">PWTunnelSel</name>
<value xsi:type="xsd:string">>true</value>
</item>
<item xsi:type="ns1:CIMProperty">
<name xsi:type="xsd:string">PWTunnelId</name>
<value xsi:type="xsd:string">1000</value>
</item> -->
<item xsi:type="ns1:CIMProperty">
<name xsi:type="xsd:string">UseServiceInst</name>
<value xsi:type="xsd:string">>true</value>
</item>
</properties>
</objectPath>
<objectPath subAction="createInstance" xsi:type="ns1:CIMObjectPath">
<className xsi:type="xsd:string">EvcServiceInstanceAttrs</className>
<properties soapenc:arrayType="ns1:CIMProperty[]" xsi:type="ns1:CIMPropertyList">
<item xsi:type="ns1:CIMProperty">
<name xsi:type="xsd:string">AutoPickServiceInstName</name>
<value xsi:type="xsd:string">>false</value>
</item>
<item xsi:type="ns1:CIMProperty">
<name xsi:type="xsd:string">AutoPickServiceInstId</name>
<value xsi:type="xsd:string">>true</value>
</item>
<item xsi:type="ns1:CIMProperty">
<name xsi:type="xsd:string">OuterVlanRange</name>
<value xsi:type="xsd:string">447</value>
</item>
<item xsi:type="ns1:CIMProperty">
<name xsi:type="xsd:string">RewriteActionType</name>
<value xsi:type="xsd:string">POP</value>
</item>
<item xsi:type="ns1:CIMProperty">
<name xsi:type="xsd:string">BothTags</name>
<value xsi:type="xsd:string">>false</value>
</item>
<!-- <item xsi:type="ns1:CIMProperty">
<name xsi:type="xsd:string">EncapsulationType</name>
<value xsi:type="xsd:string">DOT1Q</value>
</item> -->
</properties>
</objectPath>
</objectPath>
<objectPath xsi:type="ns1:CIMObjectPath">
  <className
xsi:type="xsd:string">EvcPseudowireNeighborLinks</className>
  <properties xsi:type="ns1:CIMPropertyList"
    soapenc:arrayType="ns1:CIMProperty[]">
    <item xsi:type="ns1:CIMProperty">
      <name xsi:type="xsd:string">PathXml</name>
      <value xsi:type="xsd:string"><![CDATA[
<service serviceName="MSPW" serviceType="MSPW">

<section name="Review Routing" required="true" useFor="SR">
<group cloneable="true" id="pathOptionsGroup" position="pane01_group0">
<field disabled="false" id="reqExOptionpane01_group0widget0" name="reqExOption"
position="pane01_group0widget0" required="false" title="" type="combo" value="Required
NE/Link">
<valueMap>
<value>Required NE/Link</value>
<value>Excluded NE/Link</value>
</valueMap>

```

```

</field>
<field name="sourceDevice" value="isc-asr903"/>
<field name="destinationDevice" value="cl-test-12-7600-5"/>

<field name="groupPwSelection">

<pwfield name="pwSelection" segmentType ="dynamic">
<field name="sourceDevice" value="isc-asr903" pwclass = ""/>
<field name="destinationDevice" value="cl-test-12-7600-5" pwclass = ""/>
</pwfield>

</field>

<field id="reqExElementpane01_group0widget1" name="reqExElement"
position="pane01_group0widget1" required="true" resource="devicesAndTpTunnels" title=""
type="textpicker"
value="cl-test-12-7600-5:Tunnel-tp6 (64)&lt;===&gt;isc-asr903:Tunnel-tp682 (64)"/>
<field id="pathypepane01_group0widget2" name="pathype" position="pane01_group0widget2"
required="false" title="" type="combo" value="Working Path" visibility="Hidden">
<valueMap>
<value>Working Path</value>
</valueMap>
</field>
</group>
</section>
</service>]]> </value>
</item>
</properties>
</objectPath>
</objectPath>
</objectPath>
</action>
</actions>
</ns1:performBatchOperation>
</soapenv:Body>
</soapenv:Envelope>

```

## Creating a Local Connect Service Request with ATM Ethernet

In the following example, a EVC service request with ATM Ethernet and local connect is created. The attributes relevant for the bridge domain feature are **AtmTransportMode**, **AtmVcd**, **VirtualConnId**, and **VirtualPvtId** (all in **bold** below).

Example: CreateATM\_ETHERNET\_LOCAL\_WithBD.xml

```

<?xml version="1.0" encoding="UTF-8"?>
<soapenv:Envelope
  xmlns:soapenv="http://schemas.xmlsoap.org/soap/envelope/"
  xmlns:soapenc="http://schemas.xmlsoap.org/soap/encoding/"
  xmlns:xsd="http://www.w3.org/2001/XMLSchema"
  xmlns:xsi="http://www.w3.org/2001/XMLSchema-instance"
  xmlns:ns0="http://www.cisco.com/cim-cx/2.0"
  xmlns:ns1="urn:CIM">
  <soapenv:Header>
    <!-- WaitTimeout has a default set in system properties.-->
    <ns0:message id="87855" timestamp="2002-12-13T14:55:38.885Z"
      Wait="true" WaitTimeout="90" sessiontoken="p36bttjwy1"/>
  </soapenv:Header>
  <soapenv:Body>
    <ns1:performBatchOperation>

```

```

<actions xsi:type="ns1:CIMActionList"
  soapenc:arrayType="ns1:CIMAction[]">
  <action>
    <actionName xsi:type="xsd:string">createInstance</actionName>
    <objectPath xsi:type="ns1:CIMObjectPath">
      <className xsi:type="xsd:string">ServiceOrder</className>
      <properties xsi:type="ns1:CIMPropertyList"
        soapenc:arrayType="ns1:CIMProperty[]">
        <item xsi:type="ns1:CIMProperty">
          <name xsi:type="xsd:string">ServiceName</name>
          <value xsi:type="xsd:string">ServiceOrder257</value>
        </item>
        <item xsi:type="ns1:CIMProperty">
          <name xsi:type="xsd:string">DesiredDueDate</name>
          <value xsi:type="xsd:dateTime">2008-12-13T14:55:38.885Z</value>
        </item>
        <item xsi:type="ns1:CIMProperty">
          <name xsi:type="xsd:string">NumberOfRequests</name>
          <value xsi:type="xsd:string">1</value>
        </item>
      </properties>
    </objectPath>
  </action>
  <action>
    <actionName xsi:type="xsd:string">createInstance</actionName>
    <objectPath xsi:type="ns1:CIMObjectPath">
      <className xsi:type="xsd:string">ServiceRequest</className>
      <properties xsi:type="ns1:CIMPropertyList"
        soapenc:arrayType="ns1:CIMProperty[]">
        <item xsi:type="ns1:CIMProperty">
          <name xsi:type="xsd:string">RequestName</name>
          <value xsi:type="xsd:string">EvcSR-1</value>
        </item>
        <item xsi:type="ns1:CIMProperty">
          <name xsi:type="xsd:string">Type</name>
          <value xsi:type="xsd:string">Evc</value>
        </item>
      </properties>
    <objectPath xsi:type="ns1:CIMObjectPath">
      <className xsi:type="xsd:string">ServiceRequestDetails</className>
      <properties xsi:type="ns1:CIMPropertyList"
        soapenc:arrayType="ns1:CIMProperty[]">
        <item xsi:type="ns1:CIMProperty">
          <name xsi:type="xsd:string">ServiceDefinition</name>
          <value xsi:type="xsd:string">ATM_Local</value>
          <qualifier xsi:type="xsd:string">
            <name xsi:type="xsd:string">ServiceDefinitionType</name>
            <value xsi:type="xsd:string">Evc</value>
          </qualifier>
        </item>
        <item xsi:type="ns1:CIMProperty">
          <name xsi:type="xsd:string">VPN</name>
          <value xsi:type="xsd:string">vpn1</value>
        </item>
        <item xsi:type="ns1:CIMProperty">
          <name xsi:type="xsd:string">UseSVI</name>
          <value xsi:type="xsd:string">true</value>
        </item>
      </properties>
    <objectPath xsi:type="ns1:CIMObjectPath">
      <className xsi:type="xsd:string">EvcLink</className>
      <properties xsi:type="ns1:CIMPropertyList"
        soapenc:arrayType="ns1:CIMProperty[]">
        <item xsi:type="ns1:CIMProperty">

```

```

        <name xsi:type="xsd:string">Npe</name>
        <value xsi:type="xsd:string">iscind-7609-1</value>
    </item>
    <item xsi:type="ns1:CIMProperty">
        <name xsi:type="xsd:string">UniInftId</name>
        <value xsi:type="xsd:string">ATM6/0/0</value>
    </item>
</properties>
<!--EvcATMLinkAttrs class newly added to provide ATM Attributes values -->
<objectPath xsi:type="ns1:CIMObjectPath">
    <className xsi:type="xsd:string">EvcATMLinkAttrs</className>
    <properties xsi:type="ns1:CIMPropertyList"
        soapenc:arrayType="ns1:CIMProperty[]">
        <item xsi:type="ns1:CIMProperty">
            <name xsi:type="xsd:string">AtmInterfaceEncapType</name>
            <value
xsi:type="xsd:string">AAL5SNAP</value><!--AtmInterfaceEncapType to provide ATM
Encapsulation Types AAL0,ALL5 or AAL5SNAP -->
            </item>
            <item xsi:type="ns1:CIMProperty">
                <name xsi:type="xsd:string">AtmTransportMode</name>
                <value xsi:type="xsd:string">VC</value><!--Transport Mode VC or VP
-->
            </item>
            <item xsi:type="ns1:CIMProperty">
                <name xsi:type="xsd:string">UniShutdown</name>
                <value xsi:type="xsd:string">True</value><!--UniShutDown -->
            </item>
            <item xsi:type="ns1:CIMProperty">
                <name xsi:type="xsd:string">AtmVcd</name>
                <value xsi:type="xsd:string">2222</value><!--ATM VCD (1-2147483647)
-->
            </item>
            <item xsi:type="ns1:CIMProperty">
                <name xsi:type="xsd:string">VirtualConnId</name>
                <value xsi:type="xsd:string">111</value><!-- VPI (0-255) -->
            </item>
            <item xsi:type="ns1:CIMProperty">
                <name xsi:type="xsd:string">VirtualPvtId</name>
                <value xsi:type="xsd:string">222</value><!-- VPI (0-255) -->
            </item>
            <item xsi:type="ns1:CIMProperty">
                <name xsi:type="xsd:string">PwTunnelSelection</name>
                <value xsi:type="xsd:string">true</value><!--PW Tunnel Selction -->
            </item>
            <item xsi:type="ns1:CIMProperty">
                <name xsi:type="xsd:string">InterfaceTunnel</name>
                <value xsi:type="xsd:string">10</value><!--Tunnel ID
(0-2147483647)-->
            </item>
            <item xsi:type="ns1:CIMProperty">
                <name xsi:type="xsd:string">AutoPickVlanId</name>
                <value xsi:type="xsd:string">>false</value>
            </item>
            <item xsi:type="ns1:CIMProperty">
                <name xsi:type="xsd:string">VlanID</name>
                <value xsi:type="xsd:string">20</value>
            </item>
            <item xsi:type="ns1:CIMProperty">
                <name xsi:type="xsd:string">XconnectOnSVI</name>
                <value xsi:type="xsd:string">>false</value>
            </item>
            <item xsi:type="ns1:CIMProperty">

```



```

        <name xsi:type="xsd:string">UsePwClass</name>
        <value xsi:type="xsd:string">true</value><!--PW Tunnel Selction -->
    </item>
    <item xsi:type="ns1:CIMProperty">
        <name xsi:type="xsd:string">PwClassName</name>
        <value xsi:type="xsd:string">pw-class</value><!--Tunnel ID -->
    </item>
    </properties>
</objectPath>

</objectPath>

<!--Ethernet Link -->
<objectPath xsi:type="ns1:CIMObjectPath">
    <className xsi:type="xsd:string">EvcLink</className>
    <properties xsi:type="ns1:CIMPropertyList"
        soapenc:arrayType="ns1:CIMProperty[]">
        <item xsi:type="ns1:CIMProperty">
            <name xsi:type="xsd:string">Npe</name>
            <value xsi:type="xsd:string">iscind-7609-1</value>
        </item>
        <item xsi:type="ns1:CIMProperty">
            <name xsi:type="xsd:string">UniInftId</name>
            <value xsi:type="xsd:string">GigabitEthernet7/0/13</value>
        </item>
    </properties>

    <objectPath xsi:type="ns1:CIMObjectPath">
        <className xsi:type="xsd:string">EvcETHLinkAttrs</className>
        <properties xsi:type="ns1:CIMPropertyList"
            soapenc:arrayType="ns1:CIMProperty[]">
            <item xsi:type="ns1:CIMProperty">
                <name xsi:type="xsd:string">SystemMTU</name>
                <value xsi:type="xsd:string">1563</value>
            </item>

            <item xsi:type="ns1:CIMProperty">
                <name xsi:type="xsd:string">VlanID</name>
                <value xsi:type="xsd:string">20</value>
            </item>
            <item xsi:type="ns1:CIMProperty">
                <name xsi:type="xsd:string">UseServiceInst</name>
                <value xsi:type="xsd:string">true</value>
            </item>
        </properties>
    </objectPath>

    <objectPath xsi:type="ns1:CIMObjectPath">
        <className xsi:type="xsd:string">EvcServiceInstanceAttrs</className>
        <properties xsi:type="ns1:CIMPropertyList"
            soapenc:arrayType="ns1:CIMProperty[]">
            <item xsi:type="ns1:CIMProperty">
                <name xsi:type="xsd:string">ServiceInstID</name>
                <value xsi:type="xsd:string">1948</value>
            </item>
            <item xsi:type="ns1:CIMProperty">
                <name xsi:type="xsd:string">BothTags</name>
                <value xsi:type="xsd:string">true</value>
            </item>
            <item xsi:type="ns1:CIMProperty">
                <name xsi:type="xsd:string">OuterVlanRange</name>
                <value xsi:type="xsd:string">745</value>
            </item>
            <item xsi:type="ns1:CIMProperty">

```

```

        <name xsi:type="xsd:string">InnerVlanRange</name>
        <value xsi:type="xsd:string">746</value>
    </item>
</properties>
</objectPath>
<objectPath xsi:type="ns1:CIMObjectPath">
    <className xsi:type="xsd:string">EvcUNIInterfaceAttrs</className>
    <properties xsi:type="ns1:CIMPropertyList"
        soapenc:arrayType="ns1:CIMProperty[]">
        <item xsi:type="ns1:CIMProperty">
            <name xsi:type="xsd:string">Shutdown</name>
            <value xsi:type="xsd:string">>true</value>
        </item>
        <item xsi:type="ns1:CIMProperty">
            <name xsi:type="xsd:string">PeIntfDesc</name>
            <value xsi:type="xsd:string">*** AC1 ***</value>
        </item>
    </properties>
</objectPath>
</objectPath>

<objectPath xsi:type="ns1:CIMObjectPath">
    <className xsi:type="xsd:string">EvcLink</className>
    <properties xsi:type="ns1:CIMPropertyList"
        soapenc:arrayType="ns1:CIMProperty[]">
        <item xsi:type="ns1:CIMProperty">
            <name xsi:type="xsd:string">Npe</name>
            <value xsi:type="xsd:string">iscind-7609-1</value>
        </item>
        <item xsi:type="ns1:CIMProperty">
            <name xsi:type="xsd:string">UniInftId</name>
            <value xsi:type="xsd:string">GigabitEthernet7/0/14</value>
        </item>
    </properties>

<objectPath xsi:type="ns1:CIMObjectPath">
    <className xsi:type="xsd:string">EvcETHLinkAttrs</className>
    <properties xsi:type="ns1:CIMPropertyList"
        soapenc:arrayType="ns1:CIMProperty[]">
        <item xsi:type="ns1:CIMProperty">
            <name xsi:type="xsd:string">SystemMTU</name>
            <value xsi:type="xsd:string">1563</value>
        </item>

        <item xsi:type="ns1:CIMProperty">
            <name xsi:type="xsd:string">VlanID</name>
            <value xsi:type="xsd:string">20</value>
        </item>
        <item xsi:type="ns1:CIMProperty">
            <name xsi:type="xsd:string">UseServiceInst</name>
            <value xsi:type="xsd:string">>true</value>
        </item>
    </properties>
</objectPath>
<objectPath xsi:type="ns1:CIMObjectPath">
    <className xsi:type="xsd:string">EvcServiceInstanceAttrs</className>
    <properties xsi:type="ns1:CIMPropertyList"
        soapenc:arrayType="ns1:CIMProperty[]">
        <item xsi:type="ns1:CIMProperty">
            <name xsi:type="xsd:string">ServiceInstID</name>
            <value xsi:type="xsd:string">1948</value>
        </item>
        <item xsi:type="ns1:CIMProperty">
            <name xsi:type="xsd:string">BothTags</name>

```

```

        <value xsi:type="xsd:string">true</value>
      </item>
      <item xsi:type="ns1:CIMProperty">
        <name xsi:type="xsd:string">OuterVlanRange</name>
        <value xsi:type="xsd:string">745</value>
      </item>
      <item xsi:type="ns1:CIMProperty">
        <name xsi:type="xsd:string">InnerVlanRange</name>
        <value xsi:type="xsd:string">746</value>
      </item>
    </properties>
  </objectPath>
  <objectPath xsi:type="ns1:CIMObjectPath">
    <className xsi:type="xsd:string">EvcUNIInterfaceAttrs</className>
    <properties xsi:type="ns1:CIMPropertyList"
      soapenc:arrayType="ns1:CIMProperty[]" >
      <item xsi:type="ns1:CIMProperty">
        <name xsi:type="xsd:string">Shutdown</name>
        <value xsi:type="xsd:string">true</value>
      </item>
      <item xsi:type="ns1:CIMProperty">
        <name xsi:type="xsd:string">PeIntfDesc</name>
        <value xsi:type="xsd:string">*** AC1 ***</value>
      </item>
    </properties>
  </objectPath>
</objectPath>

</objectPath>

</action>
</actions>
</ns1:performBatchOperation>
</soapenv:Body>
</soapenv:Envelope>

```

## Creating a Pseudowire Service Request with ATM Ethernet

In the following example, a EVC service request with ATM Ethernet and pseudowire is created. The attributes for specifying the pw-class are **UseExistingPwClass** and **ExistingPwClassName** highlighted in bold.

**UseExistingPwClass** and **ExistingPwClassName** are applicable only for ATM Ethernet interworking services. They are supported only for IOS devices and require you to provide the PW class name, which should already exist in the device.

The attributes relevant for the bridge domain feature are **AtmTransportMode**, **AtmVcd**, **VirtualConnId**, and **VirtualPvtId** (all in bold below).

Example: CreateATM\_ETH\_PW\_WithBridgeDomain.xml

```

<?xml version="1.0" encoding="UTF-8"?>
<soapenv:Envelope
  xmlns:soapenv="http://schemas.xmlsoap.org/soap/envelope/"
  xmlns:soapenc="http://schemas.xmlsoap.org/soap/encoding/"
  xmlns:xsd="http://www.w3.org/2001/XMLSchema"

```

```

xmlns:xsi="http://www.w3.org/2001/XMLSchema-instance"
xmlns:ns0="http://www.cisco.com/cim-cx/2.0"
xmlns:ns1="urn:CIM">
<soapenv:Header>
  <!-- WaitTimeout has a default set in system properties.-->
  <ns0:message id="87855" timestamp="2002-12-13T14:55:48.885Z"
    Wait="true" WaitTimeout="90" sessiontoken="p36bttjwy1"/>
</soapenv:Header>
<soapenv:Body>
  <ns1:performBatchOperation>
    <actions xsi:type="ns1:CIMActionList"
      soapenc:arrayType="ns1:CIMAction[]">
      <action>
        <actionName xsi:type="xsd:string">createInstance</actionName>
        <objectPath xsi:type="ns1:CIMObjectPath">
          <className xsi:type="xsd:string">ServiceOrder</className>
          <properties xsi:type="ns1:CIMPropertyList"
            soapenc:arrayType="ns1:CIMProperty[]">
            <item xsi:type="ns1:CIMProperty">
              <name xsi:type="xsd:string">ServiceName</name>
              <value xsi:type="xsd:string">ServiceOrder257</value>
            </item>
            <item xsi:type="ns1:CIMProperty">
              <name xsi:type="xsd:string">DesiredDueDate</name>
              <value xsi:type="xsd:dateTime">2008-12-13T14:55:48.885Z</value>
            </item>
            <item xsi:type="ns1:CIMProperty">
              <name xsi:type="xsd:string">NumberOfRequests</name>
              <value xsi:type="xsd:string">1</value>
            </item>
          </properties>
        </objectPath>
      </action>
      <action>
        <actionName xsi:type="xsd:string">createInstance</actionName>
        <objectPath xsi:type="ns1:CIMObjectPath">
          <className xsi:type="xsd:string">ServiceRequest</className>
          <properties xsi:type="ns1:CIMPropertyList"
            soapenc:arrayType="ns1:CIMProperty[]">
            <item xsi:type="ns1:CIMProperty">
              <name xsi:type="xsd:string">RequestName</name>
              <value xsi:type="xsd:string">EvcSR-7</value>
            </item>
            <item xsi:type="ns1:CIMProperty">
              <name xsi:type="xsd:string">Type</name>
              <value xsi:type="xsd:string">Evc</value>
            </item>
          </properties>
        <objectPath xsi:type="ns1:CIMObjectPath">
          <className xsi:type="xsd:string">ServiceRequestDetails</className>
          <properties xsi:type="ns1:CIMPropertyList"
            soapenc:arrayType="ns1:CIMProperty[]">
            <item xsi:type="ns1:CIMProperty">
              <name xsi:type="xsd:string">ServiceDefinition</name>
              <value xsi:type="xsd:string">ATM_ETHERNET_PW_VC</value><!-- Interworking
policy -->
              <qualifier xsi:type="xsd:string">
                <name xsi:type="xsd:string">ServiceDefinitionType</name>
                <value xsi:type="xsd:string">Evc</value>
              </qualifier>
            </item>
            <item xsi:type="ns1:CIMProperty">
              <name xsi:type="xsd:string">AutopickVCID</name>
              <value xsi:type="xsd:string">true</value>
            </item>
          </properties>
        </objectPath>
      </action>
    </actions>
  </ns1:performBatchOperation>
</soapenv:Body>

```

```

</item>
<item xsi:type="ns1:CIMProperty">
  <name xsi:type="xsd:string">VPN</name>
  <value xsi:type="xsd:string">vpn1</value>
</item>
</properties>
<objectPath xsi:type="ns1:CIMObjectPath">
  <className xsi:type="xsd:string">EvcLink</className>
  <properties xsi:type="ns1:CIMPropertyList"
    soapenc:arrayType="ns1:CIMProperty[]">
    <item xsi:type="ns1:CIMProperty">
      <name xsi:type="xsd:string">Npe</name>
      <value xsi:type="xsd:string">iscind-7609-1</value>
    </item>
    <item xsi:type="ns1:CIMProperty">
      <name xsi:type="xsd:string">UniInftId</name>
      <value xsi:type="xsd:string">ATM6/0/0</value>
    </item>
  </properties>
  <!--EvcATMLinkAttrs class newly added to provide ATM Attributes values -->
  <objectPath xsi:type="ns1:CIMObjectPath">
    <className xsi:type="xsd:string">EvcATMLinkAttrs</className>
    <properties xsi:type="ns1:CIMPropertyList"
      soapenc:arrayType="ns1:CIMProperty[]">
      <item xsi:type="ns1:CIMProperty">
        <name xsi:type="xsd:string">AtmInterfaceEncapType</name>
        <value
xsi:type="xsd:string">AAL5SNAP</value><!--AtmInterfaceEncapType to provide ATM
Encapsulation Types AAL0,ALL5 or AAL5SNAP -->
        </item>
        <item xsi:type="ns1:CIMProperty">
          <name xsi:type="xsd:string">AtmTransportMode</name>
          <value xsi:type="xsd:string">VC</value><!--Transport Mode VC or VP
-->
        </item>
        <item xsi:type="ns1:CIMProperty">
          <name xsi:type="xsd:string">UniShutdown</name>
          <value xsi:type="xsd:string">True</value><!--UniShutDown -->
        </item>
        <item xsi:type="ns1:CIMProperty">
          <name xsi:type="xsd:string">AtmVcd</name>
          <value xsi:type="xsd:string">2222</value><!--ATM VCD -->
        </item>
        <item xsi:type="ns1:CIMProperty">
          <name xsi:type="xsd:string">VirtualConnId</name>
          <value xsi:type="xsd:string">111</value><!-- VCI values -->
        </item>
        <item xsi:type="ns1:CIMProperty">
          <name xsi:type="xsd:string">VirtualPvtId</name>
          <value xsi:type="xsd:string">222</value><!-- VPI values -->
        </item>
        <item xsi:type="ns1:CIMProperty">
          <name xsi:type="xsd:string">AutoPickVlanId</name>
          <value xsi:type="xsd:string">>false</value>
        </item>
        <item xsi:type="ns1:CIMProperty">
          <name xsi:type="xsd:string">VlanID</name>
          <value xsi:type="xsd:string">70</value>
        </item>

```

```

<item xsi:type="ns1:CIMProperty">
  <name xsi:type="xsd:string">XconnectOnSVI</name>
  <value xsi:type="xsd:string">>true</value>
</item>
<item xsi:type="ns1:CIMProperty">
  <name xsi:type="xsd:string">UseExistingPwClass</name>
  <value xsi:type="xsd:string">>true</value><!--PW Tunnel Selction -->
</item>
<item xsi:type="ns1:CIMProperty">
  <name xsi:type="xsd:string">ExistingPwClassName</name>
  <value xsi:type="xsd:string">pwclass1</value><!--Tunnel ID -->
</item>
</properties>
</objectPath>

</objectPath>

<!-- Ethernet Link -->

<objectPath xsi:type="ns1:CIMObjectPath">
  <className xsi:type="xsd:string">EvcLink</className>
  <properties xsi:type="ns1:CIMPropertyList"
    soapenc:arrayType="ns1:CIMProperty[]">
    <item xsi:type="ns1:CIMProperty">
      <name xsi:type="xsd:string">Npe</name>
      <value xsi:type="xsd:string">iscind-7609-2</value>
    </item>
    <item xsi:type="ns1:CIMProperty">
      <name xsi:type="xsd:string">UniInftId</name>
      <value xsi:type="xsd:string">GigabitEthernet7/0/16</value>
    </item>
  </properties>

  <objectPath xsi:type="ns1:CIMObjectPath">
    <className xsi:type="xsd:string">EvcETHLinkAttrs</className>
    <properties xsi:type="ns1:CIMPropertyList"
      soapenc:arrayType="ns1:CIMProperty[]">
      <item xsi:type="ns1:CIMProperty">
        <name xsi:type="xsd:string">SystemMTU</name>
        <value xsi:type="xsd:string">1563</value>
      </item>
      <item xsi:type="ns1:CIMProperty">
        <name xsi:type="xsd:string">AutoPickVlanId</name>
        <value xsi:type="xsd:string">>false</value>
      </item>
      <item xsi:type="ns1:CIMProperty">
        <name xsi:type="xsd:string">VlanID</name>
        <value xsi:type="xsd:string">71</value>
      </item>
      <item xsi:type="ns1:CIMProperty">
        <name xsi:type="xsd:string">UseServiceInst</name>
        <value xsi:type="xsd:string">>true</value>
      </item>
      <item xsi:type="ns1:CIMProperty">
        <name xsi:type="xsd:string">XconnectOnSVI</name>
        <value xsi:type="xsd:string">>true</value>
      </item>

      <item xsi:type="ns1:CIMProperty">
        <name xsi:type="xsd:string">UseExistingPwClass</name>
        <value xsi:type="xsd:string">>true</value><!--PW Tunnel Selction -->
      </item>
      <item xsi:type="ns1:CIMProperty">

```

```

        <name xsi:type="xsd:string">ExistingPwClassName</name>
        <value xsi:type="xsd:string">pwclass2</value><!--Tunnel ID -->
    </item>
</properties>
</objectPath>
<objectPath xsi:type="ns1:CIMObjectPath">
    <className xsi:type="xsd:string">EvcServiceInstanceAttrs</className>
    <properties xsi:type="ns1:CIMPropertyList"
        soapenc:arrayType="ns1:CIMProperty[]">
        <item xsi:type="ns1:CIMProperty">
            <name xsi:type="xsd:string">AutoPickServiceInstId</name>
            <value xsi:type="xsd:string">>false</value>
        </item>
        <item xsi:type="ns1:CIMProperty">
            <name xsi:type="xsd:string">ServiceInstID</name>
            <value xsi:type="xsd:string">3222</value>
        </item>
        <item xsi:type="ns1:CIMProperty">
            <name xsi:type="xsd:string">BothTags</name>
            <value xsi:type="xsd:string">>true</value>
        </item>
        <item xsi:type="ns1:CIMProperty">
            <name xsi:type="xsd:string">OuterVlanRange</name>
            <value xsi:type="xsd:string">745</value>
        </item>
        <item xsi:type="ns1:CIMProperty">
            <name xsi:type="xsd:string">InnerVlanRange</name>
            <value xsi:type="xsd:string">746</value>
        </item>
    </properties>
</objectPath>
<objectPath xsi:type="ns1:CIMObjectPath">
    <className xsi:type="xsd:string">EvcUNIInterfaceAttrs</className>
    <properties xsi:type="ns1:CIMPropertyList"
        soapenc:arrayType="ns1:CIMProperty[]">
        <item xsi:type="ns1:CIMProperty">
            <name xsi:type="xsd:string">Shutdown</name>
            <value xsi:type="xsd:string">>true</value>
        </item>
        <item xsi:type="ns1:CIMProperty">
            <name xsi:type="xsd:string">PeIntfDesc</name>
            <value xsi:type="xsd:string">*** AC1 ***</value>
        </item>
    </properties>
</objectPath>
</objectPath>

<!-- Ethernet Link -->
<objectPath xsi:type="ns1:CIMObjectPath">
    <className xsi:type="xsd:string">EvcLink</className>
    <properties xsi:type="ns1:CIMPropertyList"
        soapenc:arrayType="ns1:CIMProperty[]">
        <item xsi:type="ns1:CIMProperty">
            <name xsi:type="xsd:string">Npe</name>
            <value xsi:type="xsd:string">iscind-7609-2</value>
        </item>
        <item xsi:type="ns1:CIMProperty">
            <name xsi:type="xsd:string">UniInftId</name>
            <value xsi:type="xsd:string">GigabitEthernet7/0/15</value>
        </item>
    </properties>

```

```

<objectPath xsi:type="ns1:CIMObjectPath">
  <className xsi:type="xsd:string">EvcETHLinkAttrs</className>
  <properties xsi:type="ns1:CIMPropertyList"
    soapenc:arrayType="ns1:CIMProperty[]">
    <item xsi:type="ns1:CIMProperty">
      <name xsi:type="xsd:string">SystemMTU</name>
      <value xsi:type="xsd:string">1563</value>
    </item>
    <item xsi:type="ns1:CIMProperty">
      <name xsi:type="xsd:string">AutoPickVlanId</name>
      <value xsi:type="xsd:string">>false</value>
    </item>
    <item xsi:type="ns1:CIMProperty">
      <name xsi:type="xsd:string">VlanID</name>
      <value xsi:type="xsd:string">71</value>
    </item>
    <item xsi:type="ns1:CIMProperty">
      <name xsi:type="xsd:string">UseServiceInst</name>
      <value xsi:type="xsd:string">>true</value>
    </item>
    <item xsi:type="ns1:CIMProperty">
      <name xsi:type="xsd:string">XconnectOnSVI</name>
      <value xsi:type="xsd:string">>true</value>
    </item>

    <item xsi:type="ns1:CIMProperty">
      <name xsi:type="xsd:string">UseExistingPwClass</name>
      <value xsi:type="xsd:string">>true</value><!--PW Tunnel Selction -->
    </item>
    <item xsi:type="ns1:CIMProperty">
      <name xsi:type="xsd:string">ExistingPwClassName</name>
      <value xsi:type="xsd:string">pwclass2</value><!--Tunnel ID -->
    </item>
  </properties>
</objectPath>
<objectPath xsi:type="ns1:CIMObjectPath">
  <className xsi:type="xsd:string">EvcServiceInstanceAttrs</className>
  <properties xsi:type="ns1:CIMPropertyList"
    soapenc:arrayType="ns1:CIMProperty[]">
    <item xsi:type="ns1:CIMProperty">
      <name xsi:type="xsd:string">AutoPickServiceInstId</name>
      <value xsi:type="xsd:string">>false</value>
    </item>
    <item xsi:type="ns1:CIMProperty">
      <name xsi:type="xsd:string">ServiceInstID</name>
      <value xsi:type="xsd:string">3222</value>
    </item>
    <item xsi:type="ns1:CIMProperty">
      <name xsi:type="xsd:string">BothTags</name>
      <value xsi:type="xsd:string">>true</value>
    </item>
    <item xsi:type="ns1:CIMProperty">
      <name xsi:type="xsd:string">OuterVlanRange</name>
      <value xsi:type="xsd:string">745</value>
    </item>
    <item xsi:type="ns1:CIMProperty">
      <name xsi:type="xsd:string">InnerVlanRange</name>
      <value xsi:type="xsd:string">746</value>
    </item>
  </properties>
</objectPath>
<objectPath xsi:type="ns1:CIMObjectPath">
  <className xsi:type="xsd:string">EvcUNIInterfaceAttrs</className>
  <properties xsi:type="ns1:CIMPropertyList"

```



```

                soapenc:arrayType="ns1:CIMProperty[]">
                <item xsi:type="ns1:CIMProperty">
                    <name xsi:type="xsd:string">Shutdown</name>
                    <value xsi:type="xsd:string">>true</value>
                </item>
                <item xsi:type="ns1:CIMProperty">
                    <name xsi:type="xsd:string">PeIntfDesc</name>
                    <value xsi:type="xsd:string">*** AC1 ***</value>
                </item>
            </properties>
        </objectPath>
    </objectPath>
</objectPath>
</action>
</actions>
</ns1:performBatchOperation>
</soapenv:Body>
</soapenv:Envelope>

```

## Creating a Pseudowire Service Request with Hybrid VPLS

In the following example, a EVC service request with Hybrid VPLS (H-VPLS) and pseudowire is created. In the example below, the **EvcHvplsRole** attribute is set to **HUB**. This service request can be used to provision (H-)VPLS with (static) single/multi-segment pseudowire over MPLS-TP, MPLS-TE and LDP.

Example: CreateEvcSR-MS-HVPLS.xml

```

<?xml version="1.0" encoding="UTF-8"?>
<soapenv:Envelope
  xmlns:soapenv="http://schemas.xmlsoap.org/soap/envelope/"
  xmlns:soapenc="http://schemas.xmlsoap.org/soap/encoding/"
  xmlns:xsd="http://www.w3.org/2001/XMLSchema"
  xmlns:xsi="http://www.w3.org/2001/XMLSchema-instance"
  xmlns:ns0="http://www.cisco.com/cim-cx/2.0"
  xmlns:ns1="urn:CIM">
  <soapenv:Header>
    <!-- WaitTimeout has a default set in system properties.-->
    <ns0:message id="87855" timestamp="2002-12-13T14:55:38.885Z"
      Wait="true" WaitTimeout="90"
      sessiontoken="583F08B4B8B1E3B818E0CD20DFFFD2" />
  </soapenv:Header>
  <soapenv:Body>
    <ns1:performBatchOperation>
      <actions xsi:type="ns1:CIMActionList"
        soapenc:arrayType="ns1:CIMAction[]">
        <!--<action>
          <actionName xsi:type="xsd:string">createInstance</actionName>
          <objectPath xsi:type="ns1:CIMObjectPath">
            <className xsi:type="xsd:string">ServiceOrder</className>
            <properties xsi:type="ns1:CIMPropertyList"
              soapenc:arrayType="ns1:CIMProperty[]">
              <item xsi:type="ns1:CIMProperty">
                <name xsi:type="xsd:string">ServiceName</name>
                <value xsi:type="xsd:string">ServiceOrder257</value>
              </item>
              <item xsi:type="ns1:CIMProperty">
                <name xsi:type="xsd:string">DesiredDueDate</name>
                <value xsi:type="xsd:dateTime">2008-12-13T14:55:38.885Z</value>
              </item>
            </properties>
          </objectPath>
        </action>
      </actions>
    </ns1:performBatchOperation>
  </soapenv:Body>
</soapenv:Envelope>

```

```

        </item>
        <item xsi:type="ns1:CIMProperty">
            <name xsi:type="xsd:string">NumberOfRequests</name>
            <value xsi:type="xsd:string">1</value>
        </item>
    </properties>
</objectPath>
</action-->
<action>
    <actionName xsi:type="xsd:string">createInstance</actionName>
    <objectPath xsi:type="ns1:CIMObjectPath">
        <className xsi:type="xsd:string">ServiceRequest</className>
        <properties xsi:type="ns1:CIMPropertyList"
            soapenc:arrayType="ns1:CIMProperty[]">
            <item xsi:type="ns1:CIMProperty">
                <name xsi:type="xsd:string">RequestName</name>
                <value xsi:type="xsd:string">EvcSR-7</value>
            </item>
            <item xsi:type="ns1:CIMProperty">
                <name xsi:type="xsd:string">Type</name>
                <value xsi:type="xsd:string">Evc</value>
            </item>
        </properties>
    </objectPath xsi:type="ns1:CIMObjectPath">
        <className xsi:type="xsd:string">ServiceRequestDetails</className>
        <properties xsi:type="ns1:CIMPropertyList"
            soapenc:arrayType="ns1:CIMProperty[]">
            <item xsi:type="ns1:CIMProperty">
                <name xsi:type="xsd:string">ServiceDefinition</name>
                <value xsi:type="xsd:string">d-evc-msvpls</value>
                <qualifier xsi:type="xsd:string">
                    <name xsi:type="xsd:string">ServiceDefinitionType</name>
                    <value xsi:type="xsd:string">Evc</value>
                </qualifier>
            </item>
            <item xsi:type="ns1:CIMProperty">
                <name xsi:type="xsd:string">VPN</name>
                <value xsi:type="xsd:string">d-vpn-msvpls</value>
            </item>
            <!--<item xsi:type="ns1:CIMProperty">
                <name xsi:type="xsd:string">AutopickVCID</name>
                <value xsi:type="xsd:string">>true</value>
            </item-->
            <item xsi:type="ns1:CIMProperty">
                <name xsi:type="xsd:string">AutopickVfiName</name>
                <value xsi:type="xsd:string">>true</value>
            </item>
            <item xsi:type="ns1:CIMProperty">
                <name xsi:type="xsd:string">VCID</name>
                <value xsi:type="xsd:string">16543</value>
            </item>
            <!--item xsi:type="ns1:CIMProperty">
                <name xsi:type="xsd:string">VfiName</name>
                <value xsi:type="xsd:string">FAHH</value>
            </item-->
            <item xsi:type="ns1:CIMProperty">
                <name xsi:type="xsd:string">UseSVI</name>
                <value xsi:type="xsd:string">>true</value>
            </item>
            <item xsi:type="ns1:CIMProperty">
                <name xsi:type="xsd:string">DiscoveryMode</name>
                <value xsi:type="xsd:string">Manual</value>
            </item>
            <!--item xsi:type="ns1:CIMProperty">

```

```

        <name xsi:type="xsd:string">UseSplitHorizon</name>
        <value xsi:type="xsd:string">>true</value>
    </item-->
</properties>
<!-- HUB1 -->
<objectPath xsi:type="ns1:CIMObjectPath">
    <className xsi:type="xsd:string">EvcLink</className>
    <properties xsi:type="ns1:CIMPropertyList"
        soapenc:arrayType="ns1:CIMProperty[]">
        <item xsi:type="ns1:CIMProperty">
            <name xsi:type="xsd:string">Npe</name>
            <value xsi:type="xsd:string">isc-asr903</value>
        </item>
        <item xsi:type="ns1:CIMProperty">
            <name xsi:type="xsd:string">EvcHvplsRole</name>
            <value xsi:type="xsd:string">HUB</value>
        </item>

        <item xsi:type="ns1:CIMProperty">
            <name xsi:type="xsd:string">UniInftId</name>
            <value xsi:type="xsd:string">GigabitEthernet0/0/5</value>
        </item>
    </properties>
<objectPath xsi:type="ns1:CIMObjectPath">
    <className xsi:type="xsd:string">EvcETHLinkAttrs</className>
    <properties xsi:type="ns1:CIMPropertyList"
        soapenc:arrayType="ns1:CIMProperty[]">

        <item xsi:type="ns1:CIMProperty">
            <name xsi:type="xsd:string">AutoPickVlanId</name>
            <value xsi:type="xsd:string">>false</value>
        </item>
        <item xsi:type="ns1:CIMProperty">
            <name xsi:type="xsd:string">VlanID</name>
            <value xsi:type="xsd:string">3922</value>
        </item>
        <item xsi:type="ns1:CIMProperty">
            <name xsi:type="xsd:string">UseServiceInst</name>
            <value xsi:type="xsd:string">>true</value>
        </item>
    </properties>
</objectPath>
<objectPath xsi:type="ns1:CIMObjectPath">
    <className xsi:type="xsd:string">EvcServiceInstanceAttrs</className>
    <properties xsi:type="ns1:CIMPropertyList"
        soapenc:arrayType="ns1:CIMProperty[]">
        <item xsi:type="ns1:CIMProperty">
            <name xsi:type="xsd:string">BothTags</name>
            <value xsi:type="xsd:string">>false</value>
        </item>
        <item xsi:type="ns1:CIMProperty">
            <name xsi:type="xsd:string">AutoPickServiceInstId</name>
            <value xsi:type="xsd:string">>true</value>
        </item>
        <item xsi:type="ns1:CIMProperty">
            <name xsi:type="xsd:string">OuterVlanRange</name>
            <value xsi:type="xsd:string">3923</value>
        </item>
    </properties>
</objectPath>
<objectPath xsi:type="ns1:CIMObjectPath">
    <className xsi:type="xsd:string">EvcUNIInterfaceAttrs</className>
    <properties xsi:type="ns1:CIMPropertyList"

```

```

        soapenc:arrayType="ns1:CIMProperty[]">
        <item xsi:type="ns1:CIMProperty">
            <name xsi:type="xsd:string">Shutdown</name>
            <value xsi:type="xsd:string">>false</value>
        </item>
        <item xsi:type="ns1:CIMProperty">
            <name xsi:type="xsd:string">PeIntfDesc</name>
            <value xsi:type="xsd:string">*** AC1 ***</value>
        </item>
    </properties>
</objectPath>
</objectPath>

<!-- HUB2 -->
<objectPath xsi:type="ns1:CIMObjectPath">
    <className xsi:type="xsd:string">EvcLink</className>
    <properties xsi:type="ns1:CIMPropertyList"
        soapenc:arrayType="ns1:CIMProperty[]">
        <item xsi:type="ns1:CIMProperty">
            <name xsi:type="xsd:string">Npe</name>
            <value xsi:type="xsd:string">CPT</value>
        </item>
        <item xsi:type="ns1:CIMProperty">
            <name xsi:type="xsd:string">EvcHvplsRole</name>
            <value xsi:type="xsd:string">SPOKE_WITH_SPOKES</value>
        </item>
        <item xsi:type="ns1:CIMProperty">
            <name xsi:type="xsd:string">HubPe</name>
            <value xsi:type="xsd:string">isc-asr903</value>
        </item>
        <item xsi:type="ns1:CIMProperty">
            <name xsi:type="xsd:string">UniInftId</name>
            <value xsi:type="xsd:string">GigabitEthernet0/4</value>
        </item>
    </properties>
</objectPath xsi:type="ns1:CIMObjectPath">
    <className xsi:type="xsd:string">EvcETHLinkAttr</className>
    <properties xsi:type="ns1:CIMPropertyList"
        soapenc:arrayType="ns1:CIMProperty[]">

        <item xsi:type="ns1:CIMProperty">
            <name xsi:type="xsd:string">AutoPickVlanId</name>
            <value xsi:type="xsd:string">>false</value>
        </item>
        <item xsi:type="ns1:CIMProperty">
            <name xsi:type="xsd:string">VlanID</name>
            <value xsi:type="xsd:string">3922</value>
        </item>
        <item xsi:type="ns1:CIMProperty">
            <name xsi:type="xsd:string">UseServiceInst</name>
            <value xsi:type="xsd:string">>true</value>
        </item>
    </properties>
</objectPath>
<objectPath xsi:type="ns1:CIMObjectPath">
    <className xsi:type="xsd:string">EvcServiceInstanceAttr</className>
    <properties xsi:type="ns1:CIMPropertyList"
        soapenc:arrayType="ns1:CIMProperty[]">
        <item xsi:type="ns1:CIMProperty">
            <name xsi:type="xsd:string">BothTags</name>
            <value xsi:type="xsd:string">>false</value>
        </item>
        <item xsi:type="ns1:CIMProperty">

```

```

        <name xsi:type="xsd:string">AutoPickServiceInstId</name>
        <value xsi:type="xsd:string">>true</value>
    </item>
    <item xsi:type="ns1:CIMProperty">
        <name xsi:type="xsd:string">OuterVlanRange</name>
        <value xsi:type="xsd:string">3923</value>
    </item>
</properties>
</objectPath>
<objectPath xsi:type="ns1:CIMObjectPath">
    <className xsi:type="xsd:string">EvcUNIInterfaceAttrs</className>
    <properties xsi:type="ns1:CIMPropertyList"
        soapenc:arrayType="ns1:CIMProperty[]" >
        <item xsi:type="ns1:CIMProperty">
            <name xsi:type="xsd:string">Shutdown</name>
            <value xsi:type="xsd:string">>false</value>
        </item>
        <item xsi:type="ns1:CIMProperty">
            <name xsi:type="xsd:string">PeIntfDesc</name>
            <value xsi:type="xsd:string">*** AC1 ***</value>
        </item>
    </properties>
</objectPath>
</objectPath>

<objectPath xsi:type="ns1:CIMObjectPath">
    <className
xsi:type="xsd:string">EvcPseudowireNeighborLinks</className>
    <properties xsi:type="ns1:CIMPropertyList"
        soapenc:arrayType="ns1:CIMProperty[]" >
    <item xsi:type="ns1:CIMProperty">
        <name xsi:type="xsd:string">PathXml</name>
        <value xsi:type="xsd:string"><![CDATA[
<service serviceName="MSPW" serviceType="MSPW">
<section name="Review Routing" required="true" useFor="SR">
<group cloneable="true" id="pathOptionsGroup" position="pane01_group0">
<field disabled="false" id="reqExOptionpane01_group0widget0" name="reqExOption"
position="pane01_group0widget0" required="false" title="" type="combo" value="Required
NE/Link">
<valueMap>
<value>Required NE/Link</value>
<value>Excluded NE/Link</value>
</valueMap>
</field>
<field name="sourceDevice" value="isc-asr903"/>
<field name="destinationDevice" value="CPT"/>

<field name="groupPwSelection">

<pwfield name="pwSelection" segmentType ="dynamic">
<field name="sourceDevice" value="isc-asr903" pwclass = ""/>
<field name="destinationDevice" value="cl-test-12-7600-5" pwclass = ""/>
</pwfield>

<pwfield name="pwSelection" segmentType ="dynamic">
<field name="sourceDevice" value="cl-test-12-7600-5" pwclass = ""/>
<field name="destinationDevice" value="isc-cl-test-12-7600-6" pwclass = ""/>
</pwfield>

<pwfield name="pwSelection" segmentType ="dynamic">
<field name="sourceDevice" value="isc-cl-test-12-7600-6" pwclass = ""/>
<field name="destinationDevice" value="CPT" pwclass = ""/>
</pwfield>
]]></value>
    </item>
</properties>
</objectPath>

```

```

</field>

<field id="reqExElementpane01_group0widget1" name="reqExElement"
position="pane01_group0widget1" required="true" resource="devicesAndTpTunnels" title=""
type="textpicker"
value="isc-asr903:Tunnel-te6555(73)&lt;===&gt;c1-test-12-7600-5:Tunnel-te1000(73)"/>
<field id="pathypepane01_group0widget2" name="pathype" position="pane01_group0widget2"
required="false" title="" type="combo" value="Working Path" visibility="Hidden">
<valueMap>
<value>Working Path</value>
</valueMap>
</field>
</group>
<group cloneable="true" id="pathOptionsGroup" position="pane01_group0">
<field disabled="false" id="reqExOptionpane01_group0widget0" name="reqExOption"
position="pane01_group0widget0" required="false" title="" type="combo" value="Required
NE/Link">
<valueMap>
<value>Required NE/Link</value>
<value>Excluded NE/Link</value>
</valueMap>
</field>
<field id="reqExElementpane01_group0widget1" name="reqExElement"
position="pane01_group0widget1" required="true" resource="devicesAndTpTunnels" title=""
type="textpicker" value="c1-test-12-7600-5:Tunnel-tp125(42) &lt;===&gt;
isc-c1-test-12-7600-6:Tunnel-tp9808(42)"/>
<field id="pathypepane01_group0widget2" name="pathype" position="pane01_group0widget2"
required="false" title="" type="combo" value="Working Path" visibility="Hidden">
<valueMap>
<value>Working Path</value>
</valueMap>
</field>
</group>

</section>
</service>]]> </value>
                </item>

                </properties>
            </objectPath>

        </objectPath>
    </objectPath>
</action>
</actions>
</ns1:performBatchOperation>
</soapenv:Body>
</soapenv:Envelope>

```

## Creating a Pseudowire Head-End Service Request for Access into L3VPN

In the following example, a pseudowire head-end service request is created for pseudowire access into L3VPN. The significant attribute is **ConfigurePseudowireHE**, which in the example is set to **true**. This makes it possible to configure **Pw-Ether** type interfaces at the service request level in addition to existing Ethernet services

Example: CreateEvcSR-pwHE-managed.xml

```

<?xml version="1.0" encoding="UTF-8"?>
<soapenv:Envelope

```

```

xmlns:soapenv="http://schemas.xmlsoap.org/soap/envelope/"
xmlns:soapenc="http://schemas.xmlsoap.org/soap/encoding/"
xmlns:xsd="http://www.w3.org/2001/XMLSchema"
xmlns:xsi="http://www.w3.org/2001/XMLSchema-instance"
xmlns:ns0="http://www.cisco.com/cim-cx/2.0"
xmlns:ns1="urn:CIM">
<soapenv:Header>
  <!-- WaitTimeout has a default set in system properties.-->
  <ns0:message id="87855" timestamp="2002-12-13T14:55:38.885Z"
    Wait="true" WaitTimeout="90"
    sessiontoken="568C3F922C7078A0A6FE2F9182C6A4AD" />
</soapenv:Header>
<soapenv:Body>
  <ns1:performBatchOperation>
    <actions xsi:type="ns1:CIMActionList"
      soapenc:arrayType="ns1:CIMAction[]">
      <!-- <action>
        <actionName xsi:type="xsd:string">createInstance</actionName>
        <objectPath xsi:type="ns1:CIMObjectPath">
          <className xsi:type="xsd:string">ServiceOrder</className>
          <properties xsi:type="ns1:CIMPropertyList"
            soapenc:arrayType="ns1:CIMProperty[]">
            <item xsi:type="ns1:CIMProperty">
              <name xsi:type="xsd:string">ServiceName</name>
              <value xsi:type="xsd:string">AnyName</value>
            </item>
            <item xsi:type="ns1:CIMProperty">
              <name xsi:type="xsd:string">DesiredDueDate</name>
              <value xsi:type="xsd:dateTime">2008-12-13T14:55:38.885Z</value>
            </item>
            <item xsi:type="ns1:CIMProperty">
              <name xsi:type="xsd:string">NumberOfRequests</name>
              <value xsi:type="xsd:string">1</value>
            </item>
          </properties>
        </objectPath>
      </action>-->
      <action>
        <actionName xsi:type="xsd:string">createInstance</actionName>
        <objectPath xsi:type="ns1:CIMObjectPath">
          <className xsi:type="xsd:string">ServiceRequest</className>
          <properties xsi:type="ns1:CIMPropertyList"
            soapenc:arrayType="ns1:CIMProperty[]">
            <item xsi:type="ns1:CIMProperty">
              <name xsi:type="xsd:string">RequestName</name>
              <value xsi:type="xsd:string">AnyName</value>
            </item>
            <item xsi:type="ns1:CIMProperty">
              <name xsi:type="xsd:string">Type</name>
              <value xsi:type="xsd:string">Evc</value>
            </item>
          </properties>
        <objectPath xsi:type="ns1:CIMObjectPath">
          <className xsi:type="xsd:string">ServiceRequestDetails</className>
          <properties xsi:type="ns1:CIMPropertyList"
            soapenc:arrayType="ns1:CIMProperty[]">
            <item xsi:type="ns1:CIMProperty">
              <name xsi:type="xsd:string">ServiceDefinition</name>
              <value xsi:type="xsd:string">d-directEvc-pw</value>
              <qualifier xsi:type="xsd:string">
                <name xsi:type="xsd:string">ServiceDefinitionType</name>
                <value xsi:type="xsd:string">Evc</value>
              </qualifier>
            </item>
          </properties>
        </objectPath>
      </action>
    </actions>
  </ns1:performBatchOperation>
</soapenv:Body>

```

```

<item xsi:type="ns1:CIMProperty">
  <name xsi:type="xsd:string">VPN</name>
  <value xsi:type="xsd:string">d-vpn-pw</value>
</item>
<item xsi:type="ns1:CIMProperty">
  <name xsi:type="xsd:string">VCID</name>
  <value xsi:type="xsd:string">6312</value>
</item>
<item xsi:type="ns1:CIMProperty">
  <name xsi:type="xsd:string">UseSVI</name>
  <value xsi:type="xsd:string">>true</value>
</item>
</properties>

<!-- Direct Link IOS 7609-1 -->
<objectPath xsi:type="ns1:CIMObjectPath">
  <className xsi:type="xsd:string">EvcLink</className>
  <properties xsi:type="ns1:CIMPropertyList"
    soapenc:arrayType="ns1:CIMProperty[]" >
    <item xsi:type="ns1:CIMProperty">
      <name xsi:type="xsd:string">Npe</name>
      <value xsi:type="xsd:string">iscind-7609-1</value>
    </item>
    <item xsi:type="ns1:CIMProperty">
      <name xsi:type="xsd:string">UniInftId</name>
      <value xsi:type="xsd:string">GigabitEthernet7/0/15</value>
    </item>
  </properties>
</objectPath>
<objectPath xsi:type="ns1:CIMObjectPath">
  <className xsi:type="xsd:string">EvcETHLinkAttrs</className>
  <properties xsi:type="ns1:CIMPropertyList"
    soapenc:arrayType="ns1:CIMProperty[]" >
    <item xsi:type="ns1:CIMProperty">
      <name xsi:type="xsd:string">UseServiceInst</name>
      <value xsi:type="xsd:string">>true</value>
    </item>
    <!-- <item xsi:type="ns1:CIMProperty">
      <name xsi:type="xsd:string">SystemMTU</name>
      <value xsi:type="xsd:string">1563</value>
    </item> -->
    <item xsi:type="ns1:CIMProperty">
      <name xsi:type="xsd:string">EncapsulationType</name>
      <value xsi:type="xsd:string">DOT1Q</value>
    </item>
    <item xsi:type="ns1:CIMProperty">
      <name xsi:type="xsd:string">AutoPickVlanId</name>
      <value xsi:type="xsd:string">>false</value>
    </item>
    <item xsi:type="ns1:CIMProperty">
      <name xsi:type="xsd:string">UseSplitHorizon</name>
      <value xsi:type="xsd:string">>false</value>
    </item>
    <item xsi:type="ns1:CIMProperty">
      <name xsi:type="xsd:string">VlanID</name>
      <value xsi:type="xsd:string">3510</value>
    </item>
    <item xsi:type="ns1:CIMProperty">
      <name xsi:type="xsd:string">XconnectOnSVI</name>
      <value xsi:type="xsd:string">>true</value>
    </item>
  </properties>
</objectPath>
<objectPath xsi:type="ns1:CIMObjectPath">
  <className xsi:type="xsd:string">EvcServiceInstanceAttrs</className>

```



```

<properties xsi:type="ns1:CIMPropertyList"
            soapenc:arrayType="ns1:CIMProperty[]">
    <item xsi:type="ns1:CIMProperty">
        <name xsi:type="xsd:string">AutoPickServiceInstId</name>
        <value xsi:type="xsd:string">>false</value>
    </item>
    <item xsi:type="ns1:CIMProperty">
        <name xsi:type="xsd:string">ServiceInstID</name>
        <value xsi:type="xsd:string">903</value>
    </item>
    <!-- <item xsi:type="ns1:CIMProperty">
        <name xsi:type="xsd:string">BothTags</name>
        <value xsi:type="xsd:string">>false</value>
    </item> -->
    <!-- <item xsi:type="ns1:CIMProperty">
        <name xsi:type="xsd:string">AutoPickOuterVlan</name>
        <value xsi:type="xsd:string">>false</value>
    </item>
    <item xsi:type="ns1:CIMProperty">
        <name xsi:type="xsd:string">OuterVlanRange</name>
        <value xsi:type="xsd:string">300</value>
    </item>-->
    <item xsi:type="ns1:CIMProperty">
        <name xsi:type="xsd:string">InnerVlanRange</name>
        <value xsi:type="xsd:string">3900</value>
    </item>
    <!--<item xsi:type="ns1:CIMProperty">
        <name xsi:type="xsd:string">RewriteActionType</name>
        <value xsi:type="xsd:string">PUSH_BOTH</value>
    </item>
    <item xsi:type="ns1:CIMProperty">
        <name xsi:type="xsd:string">TranslateOuterVlanId</name>
        <value xsi:type="xsd:string">3402</value>
    </item>
    <item xsi:type="ns1:CIMProperty">
        <name xsi:type="xsd:string">TranslateInnerVlanId</name>
        <value xsi:type="xsd:string">3400</value>
    </item> -->
</properties>
</objectPath>
</objectPath>
<!-- L2Access Links -->
<objectPath xsi:type="ns1:CIMObjectPath">
    <className xsi:type="xsd:string">EvcLink</className>
    <properties xsi:type="ns1:CIMPropertyList"
                soapenc:arrayType="ns1:CIMProperty[]">
        <item xsi:type="ns1:CIMProperty">
            <name xsi:type="xsd:string">Npe</name>
            <value xsi:type="xsd:string">isc-tl-dev-asr9006-1</value>
        </item>
        <!--<item xsi:type="ns1:CIMProperty">
            <name xsi:type="xsd:string">UniInftId</name>
            <value xsi:type="xsd:string">GigabitEthernet0/1/0/5</value>
        </item>-->
        <item xsi:type="ns1:CIMProperty">
            <name xsi:type="xsd:string">UniInftId</name>
            <value xsi:type="xsd:string">PW-Ether550</value>
        </item>
    </properties>
    <objectPath xsi:type="ns1:CIMObjectPath">
        <className xsi:type="xsd:string">EvcETHLinkAttrs</className>
        <properties xsi:type="ns1:CIMPropertyList"
                    soapenc:arrayType="ns1:CIMProperty[]">

```

```

<item xsi:type="ns1:CIMProperty">
  <name xsi:type="xsd:string">ElineName</name>
  <value xsi:type="xsd:string">d-pwhe-asr58-550</value>
</item>
<item xsi:type="ns1:CIMProperty">
  <name xsi:type="xsd:string">UseServiceInst</name>
  <value xsi:type="xsd:string">>true</value>
</item>
<!--
<item xsi:type="ns1:CIMProperty">
  <name xsi:type="xsd:string">AutoPickVlanId</name>
  <value xsi:type="xsd:string">>false</value>
</item>
  <item xsi:type="ns1:CIMProperty">
    <name xsi:type="xsd:string">UseSplitHorizon</name>
    <value xsi:type="xsd:string">>false</value>
  </item>
<item xsi:type="ns1:CIMProperty">
  <name xsi:type="xsd:string">VlanID</name>
  <value xsi:type="xsd:string">252</value>
</item>
<item xsi:type="ns1:CIMProperty">
  <name xsi:type="xsd:string">XconnectOnSVI</name>
  <value xsi:type="xsd:string">>true</value>
</item>
  <item xsi:type="ns1:CIMProperty">
    <name xsi:type="xsd:string">PwClassName</name>
    <value xsi:type="xsd:string">>false</value>
  </item>
-->
<item xsi:type="ns1:CIMProperty">
  <name xsi:type="xsd:string">UsePwClass</name>
  <value xsi:type="xsd:string">>false</value>
</item>

  </properties>
</objectPath>
<!--<objectPath xsi:type="ns1:CIMObjectPath">
  <className xsi:type="xsd:string">EvcServiceInstanceAttrs</className>
  <properties xsi:type="ns1:CIMPropertyList"
    soapenc:arrayType="ns1:CIMProperty[]">

    <item xsi:type="ns1:CIMProperty">
      <name xsi:type="xsd:string">AutoPickServiceInstId</name>
      <value xsi:type="xsd:string">>false</value>
    </item>
    <item xsi:type="ns1:CIMProperty">
      <name xsi:type="xsd:string">ServiceInstID</name>
      <value xsi:type="xsd:string">142</value>
    </item>
    <item xsi:type="ns1:CIMProperty">
      <name xsi:type="xsd:string">EncapsulationType</name>
      <value xsi:type="xsd:string">DOT1Q</value>
    </item>
    <item xsi:type="ns1:CIMProperty">
      <name xsi:type="xsd:string">BothTags</name>
      <value xsi:type="xsd:string">>false</value>
    </item>
    <item xsi:type="ns1:CIMProperty">
      <name xsi:type="xsd:string">OuterVlanRange</name>
      <value xsi:type="xsd:string">301</value>
    </item>
  </properties>
</objectPath> -->

```

```

</objectPath>
<!-- <objectPath xsi:type="ns1:CIMObjectPath">
  <className xsi:type="xsd:string">EvcLink</className>
  <properties xsi:type="ns1:CIMPropertyList"
    soapenc:arrayType="ns1:CIMProperty[]">
    <item xsi:type="ns1:CIMProperty">
      <name xsi:type="xsd:string">Upe</name>
      <value xsi:type="xsd:string">isc-test-7600-80</value>
    </item>
    <item xsi:type="ns1:CIMProperty">
      <name xsi:type="xsd:string">UniInftId</name>
      <value xsi:type="xsd:string">GigabitEthernet5/15</value>
    </item>
    <item xsi:type="ns1:CIMProperty">
      <name xsi:type="xsd:string">NPC</name>
      <value xsi:type="xsd:string">2</value>
    </item>
  </properties>
  <objectPath xsi:type="ns1:CIMObjectPath">
    <className xsi:type="xsd:string">EvcETHLinkAttrs</className>
    <properties xsi:type="ns1:CIMPropertyList"
      soapenc:arrayType="ns1:CIMProperty[]">
      <item xsi:type="ns1:CIMProperty">
        <name xsi:type="xsd:string">UseServiceInst</name>
        <value xsi:type="xsd:string">true</value>
      </item>
      <item xsi:type="ns1:CIMProperty">
        <name xsi:type="xsd:string">UseUpeServiceInst</name>
        <value xsi:type="xsd:string">true</value>
      </item>
      <item xsi:type="ns1:CIMProperty">
        <name xsi:type="xsd:string">SystemMTU</name>
        <value xsi:type="xsd:string">1563</value>
      </item>
      <item xsi:type="ns1:CIMProperty">
        <name xsi:type="xsd:string">AutoPickVlanId</name>
        <value xsi:type="xsd:string">>false</value>
      </item>
      <item xsi:type="ns1:CIMProperty">
        <name xsi:type="xsd:string">XconnectOnSVI</name>
        <value xsi:type="xsd:string">true</value>
      </item>
    </properties>
  </objectPath>
  <objectPath xsi:type="ns1:CIMObjectPath">
    <className
xsi:type="xsd:string">EvcUNIServiceInstanceAttrs</className>
    <properties xsi:type="ns1:CIMPropertyList"
      soapenc:arrayType="ns1:CIMProperty[]">
      <item xsi:type="ns1:CIMProperty">
        <name xsi:type="xsd:string">OuterVlanRange</name>
        <value xsi:type="xsd:string">1500</value>
      </item>
      <item xsi:type="ns1:CIMProperty">
        <name xsi:type="xsd:string">AutoPickServiceInstId</name>
        <value xsi:type="xsd:string">>false</value>
      </item>
      <item xsi:type="ns1:CIMProperty">
        <name xsi:type="xsd:string">ServiceInstID</name>
        <value xsi:type="xsd:string">2321</value>
      </item>
      <item xsi:type="ns1:CIMProperty">
        <name xsi:type="xsd:string">RewriteActionType</name>
        <value xsi:type="xsd:string">PUSH</value>
      </item>
    </properties>
  </objectPath>
-->

```

```

    </item>
    <item xsi:type="ns1:CIMProperty">
      <name xsi:type="xsd:string">TranslateOuterVlanId</name>
      <value xsi:type="xsd:string">3600</value>
    </item>
  </properties>
</objectPath>
<objectPath xsi:type="ns1:CIMObjectPath">
  <className xsi:type="xsd:string">EvcServiceInstanceAttrs</className>
  <properties xsi:type="ns1:CIMPropertyList"
    soapenc:arrayType="ns1:CIMProperty[]">
    <item xsi:type="ns1:CIMProperty">
      <name xsi:type="xsd:string">OuterVlanRange</name>
      <value xsi:type="xsd:string">2500</value>
    </item>
    <item xsi:type="ns1:CIMProperty">
      <name xsi:type="xsd:string">AutoPickServiceInstId</name>
      <value xsi:type="xsd:string">>false</value>
    </item>
    <item xsi:type="ns1:CIMProperty">
      <name xsi:type="xsd:string">ServiceInstID</name>
      <value xsi:type="xsd:string">3700</value>
    </item>
    <item xsi:type="ns1:CIMProperty">
      <name xsi:type="xsd:string">RewriteActionType</name>
      <value xsi:type="xsd:string">PUSH</value>
    </item>
    <item xsi:type="ns1:CIMProperty">
      <name xsi:type="xsd:string">TranslateInnerVlanId</name>
      <value xsi:type="xsd:string">3700</value>
    </item>
    <item xsi:type="ns1:CIMProperty">
      <name xsi:type="xsd:string">TranslateOuterVlanId</name>
      <value xsi:type="xsd:string">3800</value>
    </item>
  </properties>
</objectPath>
<objectPath xsi:type="ns1:CIMObjectPath">
  <className xsi:type="xsd:string">EvcUNIProtocolTunnelAttrs</className>
  <properties xsi:type="ns1:CIMPropertyList"
    soapenc:arrayType="ns1:CIMProperty[]">
    <item xsi:type="ns1:CIMProperty">
      <name xsi:type="xsd:string">ProtocolTunnelling</name>
      <value xsi:type="xsd:string">>true</value>
    </item>
    <item xsi:type="ns1:CIMProperty">
      <name xsi:type="xsd:string">VtpDropThreshold</name>
      <value xsi:type="xsd:string">10</value>
    </item>
    <item xsi:type="ns1:CIMProperty">
      <name xsi:type="xsd:string">CdpDropThreshold</name>
      <value xsi:type="xsd:string">20</value>
    </item>
    <item xsi:type="ns1:CIMProperty">
      <name xsi:type="xsd:string">StpDropThreshold</name>
      <value xsi:type="xsd:string">27</value>
    </item>
    <item xsi:type="ns1:CIMProperty">
      <name xsi:type="xsd:string">StpThreshold</name>
      <value xsi:type="xsd:string">27</value>
    </item>
    <item xsi:type="ns1:CIMProperty">
      <name xsi:type="xsd:string">VtpThreshold</name>
      <value xsi:type="xsd:string">2007</value>
    </item>
  </properties>

```

```

</item>
<item xsi:type="ns1:CIMProperty">
  <name xsi:type="xsd:string">CdpThreshold</name>
  <value xsi:type="xsd:string">2007</value>
</item>
<item xsi:type="ns1:CIMProperty">
  <name xsi:type="xsd:string">CdpEnable</name>
  <value xsi:type="xsd:string">true</value>
</item>
<item xsi:type="ns1:CIMProperty">
  <name xsi:type="xsd:string">VtpEnable</name>
  <value xsi:type="xsd:string">true</value>
</item>
  <item xsi:type="ns1:CIMProperty">
    <name xsi:type="xsd:string">StpEnable</name>
    <value xsi:type="xsd:string">true</value>
  </item>
</properties>
</objectPath>
<objectPath xsi:type="ns1:CIMObjectPath">
  <className xsi:type="xsd:string">EvcUNIInterfaceAttrs</className>
  <properties xsi:type="ns1:CIMPropertyList"
    soapenc:arrayType="ns1:CIMProperty[]">
    <item xsi:type="ns1:CIMProperty">
      <name xsi:type="xsd:string">PortSecurity</name>
      <value xsi:type="xsd:string">true</value>
    </item>
    <item xsi:type="ns1:CIMProperty">
      <name xsi:type="xsd:string">SpeedType</name>
      <value xsi:type="xsd:string">100</value>
    </item>
    <item xsi:type="ns1:CIMProperty">
      <name xsi:type="xsd:string">DuplexType</name>
      <value xsi:type="xsd:string">Half</value>
    </item>
    <item xsi:type="ns1:CIMProperty">
      <name xsi:type="xsd:string">Shutdown</name>
      <value xsi:type="xsd:string">true</value>
    </item>
    <item xsi:type="ns1:CIMProperty">
      <name xsi:type="xsd:string">MacAddress</name>
      <value xsi:type="xsd:string">5</value>
    </item>
    <item xsi:type="ns1:CIMProperty">
      <name xsi:type="xsd:string">Aging</name>
      <value xsi:type="xsd:string">201</value>
    </item>
    <item xsi:type="ns1:CIMProperty">
      <name xsi:type="xsd:string">ViolationActionType</name>
      <value xsi:type="xsd:string">RESTRICT</value>
    </item>
    <item xsi:type="ns1:CIMProperty">
      <name xsi:type="xsd:string">BroadcastTraffic</name>
      <value xsi:type="xsd:string">25</value>
    </item>
    <item xsi:type="ns1:CIMProperty">
      <name xsi:type="xsd:string">MulticastTraffic</name>
      <value xsi:type="xsd:string">25</value>
    </item>
    <item xsi:type="ns1:CIMProperty">
      <name xsi:type="xsd:string">UnicastTraffic</name>
      <value xsi:type="xsd:string">25</value>
    </item>
  </properties>

```

```

        </objectPath>
    </objectPath> -->

    </objectPath>
</objectPath>
</action>
</actions>
</ns1:performBatchOperation>
</soapenv:Body>
</soapenv:Envelope>

```

## Creating a VPLS Service Request with IOS XR

In the following example, a VPLS EVC service request is created. The attributes for specifying the vpls class are **AutoPickBridgeGroupName**, **AutoPickBridgeDomainName**, **BridgeGroupName**, and **BridgeDomainName** highlighted in bold.

Example: CreateEVCSR\_IOSXR\_VPLS.xml

```

<?xml version="1.0" encoding="UTF-8"?>
<soapenv:Envelope
  xmlns:soapenv="http://schemas.xmlsoap.org/soap/envelope/"
  xmlns:soapenc="http://schemas.xmlsoap.org/soap/encoding/"
  xmlns:xsd="http://www.w3.org/2001/XMLSchema"
  xmlns:xsi="http://www.w3.org/2001/XMLSchema-instance"
  xmlns:ns0="http://www.cisco.com/cim-cx/2.0"
  xmlns:ns1="urn:CIM">
  <soapenv:Header>
    <!-- WaitTimeout has a default set in system properties.-->
    <ns0:message id="87855" timestamp="2002-12-13T14:55:38.885Z"
      Wait="true" WaitTimeout="90" sessiontoken="p36bttjwy1"/>
  </soapenv:Header>
  <soapenv:Body>
    <ns1:performBatchOperation>
      <actions xsi:type="ns1:CIMActionList"
        soapenc:arrayType="ns1:CIMAction[]">
        <action>
          <actionName xsi:type="xsd:string">createInstance</actionName>
          <objectPath xsi:type="ns1:CIMObjectPath">
            <className xsi:type="xsd:string">ServiceOrder</className>
            <properties xsi:type="ns1:CIMPropertyList"
              soapenc:arrayType="ns1:CIMProperty[]">
              <item xsi:type="ns1:CIMProperty">
                <name xsi:type="xsd:string">ServiceName</name>
                <value xsi:type="xsd:string">ServiceOrder257</value>
              </item>
              <item xsi:type="ns1:CIMProperty">
                <name xsi:type="xsd:string">DesiredDueDate</name>
                <value xsi:type="xsd:dateTime">2008-12-13T14:55:38.885Z</value>
              </item>
              <item xsi:type="ns1:CIMProperty">
                <name xsi:type="xsd:string">NumberOfRequests</name>
                <value xsi:type="xsd:string">1</value>
              </item>
            </properties>
          </objectPath>
        </action>
        <action>
          <actionName xsi:type="xsd:string">createInstance</actionName>
          <objectPath xsi:type="ns1:CIMObjectPath">
            <className xsi:type="xsd:string">ServiceRequest</className>

```

```

<properties xsi:type="ns1:CIMPropertyList"
  soapenc:arrayType="ns1:CIMProperty[]">
  <item xsi:type="ns1:CIMProperty">
    <name xsi:type="xsd:string">RequestName</name>
    <value xsi:type="xsd:string">EvcSR-7</value>
  </item>
  <item xsi:type="ns1:CIMProperty">
    <name xsi:type="xsd:string">Type</name>
    <value xsi:type="xsd:string">Evc</value>
  </item>
</properties>
<objectPath xsi:type="ns1:CIMObjectPath">
  <className xsi:type="xsd:string">ServiceRequestDetails</className>
  <properties xsi:type="ns1:CIMPropertyList"
    soapenc:arrayType="ns1:CIMProperty[]">
    <item xsi:type="ns1:CIMProperty">
      <name xsi:type="xsd:string">ServiceDefinition</name>
      <value xsi:type="xsd:string">VplsPolicy</value>
      <qualifier xsi:type="xsd:string">
        <name xsi:type="xsd:string">ServiceDefinitionType</name>
        <value xsi:type="xsd:string">Evc</value>
      </qualifier>
    </item>
    <item xsi:type="ns1:CIMProperty">
      <name xsi:type="xsd:string">VPN</name>
      <value xsi:type="xsd:string">vpn2</value>
    </item>
    <item xsi:type="ns1:CIMProperty">
      <name xsi:type="xsd:string">UseSVI</name>
      <value xsi:type="xsd:string">true</value>
    </item>
    <item xsi:type="ns1:CIMProperty">
      <name xsi:type="xsd:string">AutopickVCID</name>
      <value xsi:type="xsd:string">true</value>
    </item>
  </properties>
<objectPath xsi:type="ns1:CIMObjectPath">
  <className xsi:type="xsd:string">EvcLink</className>
  <properties xsi:type="ns1:CIMPropertyList"
    soapenc:arrayType="ns1:CIMProperty[]">
    <item xsi:type="ns1:CIMProperty">
      <name xsi:type="xsd:string">Npe</name>
      <value xsi:type="xsd:string">met1-asr9k-dist2</value>
    </item>
    <item xsi:type="ns1:CIMProperty">
      <name xsi:type="xsd:string">UniInftId</name>
      <value xsi:type="xsd:string">GigabitEthernet0/1/0/11</value>
    </item>
  </properties>
<objectPath xsi:type="ns1:CIMObjectPath">
  <className xsi:type="xsd:string">EvcETHLinkAttrs</className>
  <properties xsi:type="ns1:CIMPropertyList"
    soapenc:arrayType="ns1:CIMProperty[]">
    <item xsi:type="ns1:CIMProperty">
      <name xsi:type="xsd:string">SystemMTU</name>
      <value xsi:type="xsd:string">1563</value>
    </item>
    <item xsi:type="ns1:CIMProperty">
      <name xsi:type="xsd:string">AutoPickVlanId</name>
      <value xsi:type="xsd:string">false</value>
    </item>
    <item xsi:type="ns1:CIMProperty">

```

```

        <name xsi:type="xsd:string">VlanID</name>
        <value xsi:type="xsd:string">4005</value>
    </item>
    <item xsi:type="ns1:CIMProperty">
        <name xsi:type="xsd:string">UseServiceInst</name>
        <value xsi:type="xsd:string">>false</value>
    </item>
    <item xsi:type="ns1:CIMProperty">
        <name xsi:type="xsd:string">XconnectOnSVI</name>
        <value xsi:type="xsd:string">>false</value>
    </item>

    <item xsi:type="ns1:CIMProperty">
        <name xsi:type="xsd:string">AutoPickBridgeGroupName</name>
        <value xsi:type="xsd:string">>false</value>
    </item>
    <item xsi:type="ns1:CIMProperty">
        <name xsi:type="xsd:string">AutoPickBridgeDomainName</name>
        <value xsi:type="xsd:string">>false</value>
    </item>
    <item xsi:type="ns1:CIMProperty">
        <name xsi:type="xsd:string">BridgeGroupName</name>
        <value xsi:type="xsd:string">bg1</value>
    </item>
    <item xsi:type="ns1:CIMProperty">
        <name xsi:type="xsd:string">BridgeDomainName</name>
        <value xsi:type="xsd:string">bd1</value>
    </item>

    </properties>
</objectPath>

<objectPath xsi:type="ns1:CIMObjectPath">
    <className xsi:type="xsd:string">EvcUNIInterfaceAttrs</className>
    <properties xsi:type="ns1:CIMPropertyList"
        soapenc:arrayType="ns1:CIMProperty[]">
        <item xsi:type="ns1:CIMProperty">
            <name xsi:type="xsd:string">Shutdown</name>
            <value xsi:type="xsd:string">>true</value>
        </item>
        <item xsi:type="ns1:CIMProperty">
            <name xsi:type="xsd:string">PeIntfDesc</name>
            <value xsi:type="xsd:string">AC1</value>
        </item>
    </properties>
</objectPath>
</objectPath>

<objectPath xsi:type="ns1:CIMObjectPath">
    <className xsi:type="xsd:string">EvcLink</className>
    <properties xsi:type="ns1:CIMPropertyList"
        soapenc:arrayType="ns1:CIMProperty[]">
        <item xsi:type="ns1:CIMProperty">
            <name xsi:type="xsd:string">Npe</name>
            <value xsi:type="xsd:string">met1-asr9k-dist1</value>
        </item>
        <item xsi:type="ns1:CIMProperty">
            <name xsi:type="xsd:string">UniInftId</name>
            <value xsi:type="xsd:string">GigabitEthernet0/0/0/11</value>
        </item>
    </properties>

```



```

<objectPath xsi:type="ns1:CIMObjectPath">
  <className xsi:type="xsd:string">EvcETHLinkAttrs</className>
  <properties xsi:type="ns1:CIMPropertyList"
    soapenc:arrayType="ns1:CIMProperty[]">
    <item xsi:type="ns1:CIMProperty">
      <name xsi:type="xsd:string">SystemMTU</name>
      <value xsi:type="xsd:string">1563</value>
    </item>
    <item xsi:type="ns1:CIMProperty">
      <name xsi:type="xsd:string">AutoPickVlanId</name>
      <value xsi:type="xsd:string">>false</value>
    </item>
    <item xsi:type="ns1:CIMProperty">
      <name xsi:type="xsd:string">VlanID</name>
      <value xsi:type="xsd:string">4006</value>
    </item>
    <item xsi:type="ns1:CIMProperty">
      <name xsi:type="xsd:string">UseServiceInst</name>
      <value xsi:type="xsd:string">>false</value>
    </item>
    <item xsi:type="ns1:CIMProperty">
      <name xsi:type="xsd:string">XconnectOnSVI</name>
      <value xsi:type="xsd:string">>false</value>
    </item>

    <item xsi:type="ns1:CIMProperty">
      <name xsi:type="xsd:string">AutoPickBridgeGroupName</name>
      <value xsi:type="xsd:string">>false</value>
    </item>
    <item xsi:type="ns1:CIMProperty">
      <name xsi:type="xsd:string">AutoPickBridgeDomainName</name>
      <value xsi:type="xsd:string">>false</value>
    </item>
  </properties>
</objectPath>

<objectPath xsi:type="ns1:CIMObjectPath">
  <className xsi:type="xsd:string">EvcUNIInterfaceAttrs</className>
  <properties xsi:type="ns1:CIMPropertyList"
    soapenc:arrayType="ns1:CIMProperty[]">
    <item xsi:type="ns1:CIMProperty">
      <name xsi:type="xsd:string">Shutdown</name>
      <value xsi:type="xsd:string">>true</value>
    </item>
    <item xsi:type="ns1:CIMProperty">
      <name xsi:type="xsd:string">PeIntfDesc</name>
      <value xsi:type="xsd:string">AC1</value>
    </item>
  </properties>
</objectPath>
</objectPath>

```

```

        </objectPath>
    </objectPath>
</action>
</actions>
</ns1:performBatchOperation>
</soapenv:Body>
</soapenv:Envelope>

```

## Creating a VPLS Service Request for E-TREE

In the following example, an EVC VPLS service request is created to identify root and leaf nodes in an E-TREE. To do this, set the **EtreeRole** attribute to **ROOT** or **LEAF**. In the example, it is set to **LEAF**.

Example: CreateEvcVplsSr\_Etree.xml

```

<?xml version="1.0" encoding="UTF-8"?>
<soapenv:Envelope
  xmlns:soapenv="http://schemas.xmlsoap.org/soap/envelope/"
  xmlns:soapenc="http://schemas.xmlsoap.org/soap/encoding/"
  xmlns:xsd="http://www.w3.org/2001/XMLSchema"
  xmlns:xsi="http://www.w3.org/2001/XMLSchema-instance"
  xmlns:ns0="http://www.cisco.com/cim-cx/2.0"
  xmlns:ns1="urn:CIM">
  <soapenv:Header>
    <!-- WaitTimeout has a default set in system properties.-->
    <ns0:message id="87855" timestamp="2002-12-13T14:55:38.885Z"
      Wait="true" WaitTimeout="90"
      sessiontoken="A2CA3E07360764655638E548D94C888E"/>
  </soapenv:Header>
  <soapenv:Body>
    <ns1:performBatchOperation>
      <actions xsi:type="ns1:CIMActionList"
        soapenc:arrayType="ns1:CIMAction[]">
        <action>
          <actionName xsi:type="xsd:string">createInstance</actionName>
          <objectPath xsi:type="ns1:CIMObjectPath">
            <className xsi:type="xsd:string">ServiceOrder</className>
            <properties xsi:type="ns1:CIMPropertyList"
              soapenc:arrayType="ns1:CIMProperty[]">
              <item xsi:type="ns1:CIMProperty">
                <name xsi:type="xsd:string">ServiceName</name>
                <value xsi:type="xsd:string">ServiceOrder257</value>
              </item>
              <item xsi:type="ns1:CIMProperty">
                <name xsi:type="xsd:string">DesiredDueDate</name>
                <value xsi:type="xsd:dateTime">2008-12-13T14:55:38.885Z</value>
              </item>
              <item xsi:type="ns1:CIMProperty">
                <name xsi:type="xsd:string">NumberOfRequests</name>
                <value xsi:type="xsd:string">1</value>
              </item>
            </properties>
          </objectPath>
        </action>
        <action>
          <actionName xsi:type="xsd:string">createInstance</actionName>
          <objectPath xsi:type="ns1:CIMObjectPath">
            <className xsi:type="xsd:string">ServiceRequest</className>
            <properties xsi:type="ns1:CIMPropertyList"
              soapenc:arrayType="ns1:CIMProperty[]">
              <item xsi:type="ns1:CIMProperty">

```

```

        <name xsi:type="xsd:string">RequestName</name>
        <value xsi:type="xsd:string">EvcSR-7</value>
    </item>
</properties>
</CIMProperty>
<item xsi:type="ns1:CIMProperty">
    <name xsi:type="xsd:string">Type</name>
    <value xsi:type="xsd:string">Evc</value>
</item>
</properties>
</CIMObjectPath>
<objectPath xsi:type="ns1:CIMObjectPath">
    <className xsi:type="xsd:string">ServiceRequestDetails</className>
    <properties xsi:type="ns1:CIMPropertyList"
        soapenc:arrayType="ns1:CIMProperty[]">
        <item xsi:type="ns1:CIMProperty">
            <name xsi:type="xsd:string">ServiceDefinition</name>
            <value xsi:type="xsd:string">doc_vpls2</value>
            <qualifier xsi:type="xsd:string">
                <name xsi:type="xsd:string">ServiceDefinitionType</name>
                <value xsi:type="xsd:string">Evc</value>
            </qualifier>
        </item>
        <item xsi:type="ns1:CIMProperty">
            <name xsi:type="xsd:string">VPN</name>
            <value xsi:type="xsd:string">vpn5</value>
        </item>
        <item xsi:type="ns1:CIMProperty">
            <name xsi:type="xsd:string">VCID</name>
            <value xsi:type="xsd:string">100765</value>
        </item>
        <item xsi:type="ns1:CIMProperty">
            <name xsi:type="xsd:string">VfiName</name>
            <value xsi:type="xsd:string">egtgee</value>
        </item>
        <item xsi:type="ns1:CIMProperty">
            <name xsi:type="xsd:string">UseSVI</name>
            <value xsi:type="xsd:string">true</value>
        </item>
        <item xsi:type="ns1:CIMProperty">
            <name xsi:type="xsd:string">DiscoveryMode</name>
            <value xsi:type="xsd:string">Manual</value>
        </item>
    </properties>
</CIMObjectPath>
<objectPath xsi:type="ns1:CIMObjectPath">
    <className xsi:type="xsd:string">EvcLink</className>
    <properties xsi:type="ns1:CIMPropertyList"
        soapenc:arrayType="ns1:CIMProperty[]">
        <item xsi:type="ns1:CIMProperty">
            <name xsi:type="xsd:string">Npe</name>
            <value xsi:type="xsd:string">iscind-7609-1</value>
        </item>
        <item xsi:type="ns1:CIMProperty">
            <name xsi:type="xsd:string">UniInftId</name>
            <value xsi:type="xsd:string">GigabitEthernet7/0/15</value>
        </item>
    </properties>
</CIMObjectPath>
<objectPath xsi:type="ns1:CIMObjectPath">
    <className xsi:type="xsd:string">EvcETHLinkAttrs</className>
    <properties xsi:type="ns1:CIMPropertyList"
        soapenc:arrayType="ns1:CIMProperty[]">
        <item xsi:type="ns1:CIMProperty">
            <name xsi:type="xsd:string">SystemMTU</name>
            <value xsi:type="xsd:string">1544</value>
        </item>
        <item xsi:type="ns1:CIMProperty">
            <name xsi:type="xsd:string">AutoPickVlanId</name>

```

```

        <value xsi:type="xsd:string">>false</value>
    </item>
    <item xsi:type="ns1:CIMProperty">
        <name xsi:type="xsd:string">VlanID</name>
        <value xsi:type="xsd:string">1498</value>
    </item>
    <item xsi:type="ns1:CIMProperty">
        <name xsi:type="xsd:string">UseServiceInst</name>
        <value xsi:type="xsd:string">>true</value>
    </item>
    <item xsi:type="ns1:CIMProperty">
        <name xsi:type="xsd:string">EtreeRole</name>
        <value xsi:type="xsd:string">LEAF</value>
    </item>
</properties>
</objectPath>
<objectPath xsi:type="ns1:CIMObjectPath">
    <className xsi:type="xsd:string">EvcServiceInstanceAttrs</className>
    <properties xsi:type="ns1:CIMPropertyList"
        soapenc:arrayType="ns1:CIMProperty[]">
        <item xsi:type="ns1:CIMProperty">
            <name xsi:type="xsd:string">BothTags</name>
            <value xsi:type="xsd:string">>false</value>
        </item>
        <item xsi:type="ns1:CIMProperty">
            <name xsi:type="xsd:string">AutoPickServiceInstId</name>
            <value xsi:type="xsd:string">>true</value>
        </item>
        <item xsi:type="ns1:CIMProperty">
            <name xsi:type="xsd:string">OuterVlanRange</name>
            <value xsi:type="xsd:string">1248</value>
        </item>
    </properties>
</objectPath>
<objectPath xsi:type="ns1:CIMObjectPath">
    <className xsi:type="xsd:string">EvcUNIInterfaceAttrs</className>
    <properties xsi:type="ns1:CIMPropertyList"
        soapenc:arrayType="ns1:CIMProperty[]">
        <item xsi:type="ns1:CIMProperty">
            <name xsi:type="xsd:string">Shutdown</name>
            <value xsi:type="xsd:string">>true</value>
        </item>
        <item xsi:type="ns1:CIMProperty">
            <name xsi:type="xsd:string">PeIntfDesc</name>
            <value xsi:type="xsd:string">*** AC1 ***</value>
        </item>
    </properties>
</objectPath>
</objectPath>

<!-- L2Access Links -->
<!--
<objectPath xsi:type="ns1:CIMObjectPath">
    <className xsi:type="xsd:string">EvcLink</className>
    <properties xsi:type="ns1:CIMPropertyList"
        soapenc:arrayType="ns1:CIMProperty[]">
        <item xsi:type="ns1:CIMProperty">
            <name xsi:type="xsd:string">Upe</name>
            <value xsi:type="xsd:string">iscind-3750-1</value>
        </item>
        <item xsi:type="ns1:CIMProperty">
            <name xsi:type="xsd:string">UniInftId</name>
            <value xsi:type="xsd:string">FastEthernet1/0/12</value>
        </item>
    </properties>
</objectPath>

```

```

        <item xsi:type="ns1:CIMProperty">
            <name xsi:type="xsd:string">NPC</name>
            <value xsi:type="xsd:string">31</value>
        </item>
    </properties>
</objectPath>
<objectPath xsi:type="ns1:CIMObjectPath">
    <className xsi:type="xsd:string">EvcETHLinkAttrs</className>
    <properties xsi:type="ns1:CIMPropertyList"
        soapenc:arrayType="ns1:CIMProperty[]">
        <item xsi:type="ns1:CIMProperty">
            <name xsi:type="xsd:string">UseServiceInst</name>
            <value xsi:type="xsd:string">>false</value>
        </item>
        <item xsi:type="ns1:CIMProperty">
            <name xsi:type="xsd:string">SystemMTU</name>
            <value xsi:type="xsd:string">1685</value>
        </item>
        <item xsi:type="ns1:CIMProperty">
            <name xsi:type="xsd:string">AutoPickVlanId</name>
            <value xsi:type="xsd:string">>true</value>
        </item>
    </properties>
</objectPath>

<objectPath xsi:type="ns1:CIMObjectPath">
    <className xsi:type="xsd:string">EvcUNIProtocolTunnelAttrs</className>
    <properties xsi:type="ns1:CIMPropertyList"
        soapenc:arrayType="ns1:CIMProperty[]">
        <item xsi:type="ns1:CIMProperty">
            <name xsi:type="xsd:string">ProtocolTunnelling</name>
            <value xsi:type="xsd:string">>true</value>
        </item>
        <item xsi:type="ns1:CIMProperty">
            <name xsi:type="xsd:string">VtpDropThreshold</name>
            <value xsi:type="xsd:string">10</value>
        </item>

        <item xsi:type="ns1:CIMProperty">
            <name xsi:type="xsd:string">CdpDropThreshold</name>
            <value xsi:type="xsd:string">20</value>
        </item>
        <item xsi:type="ns1:CIMProperty">
            <name xsi:type="xsd:string">StpDropThreshold</name>
            <value xsi:type="xsd:string">27</value>
        </item>
        <item xsi:type="ns1:CIMProperty">
            <name xsi:type="xsd:string">StpThreshold</name>
            <value xsi:type="xsd:string">27</value>
        </item>
        <item xsi:type="ns1:CIMProperty">
            <name xsi:type="xsd:string">VtpThreshold</name>
            <value xsi:type="xsd:string">2007</value>
        </item>
        <item xsi:type="ns1:CIMProperty">
            <name xsi:type="xsd:string">CdpThreshold</name>
            <value xsi:type="xsd:string">2007</value>
        </item>
        <item xsi:type="ns1:CIMProperty">
            <name xsi:type="xsd:string">CdpEnable</name>
            <value xsi:type="xsd:string">>true</value>
        </item>
        <item xsi:type="ns1:CIMProperty">
            <name xsi:type="xsd:string">VtpEnable</name>
            <value xsi:type="xsd:string">>true</value>
        </item>
    </properties>
</objectPath>

```

```

    </item>
      <item xsi:type="ns1:CIMProperty">
        <name xsi:type="xsd:string">StpEnable</name>
        <value xsi:type="xsd:string">true</value>
      </item>
    </properties>
  </objectPath>
<objectPath xsi:type="ns1:CIMObjectPath">
  <className xsi:type="xsd:string">EvcUNIInterfaceAttrs</className>
  <properties xsi:type="ns1:CIMPropertyList"
    soapenc:arrayType="ns1:CIMProperty[]">
    <item xsi:type="ns1:CIMProperty">
      <name xsi:type="xsd:string">PortSecurity</name>
      <value xsi:type="xsd:string">true</value>
    </item>
    <item xsi:type="ns1:CIMProperty">
      <name xsi:type="xsd:string">SpeedType</name>
      <value xsi:type="xsd:string">Auto</value>
    </item>
    <item xsi:type="ns1:CIMProperty">
      <name xsi:type="xsd:string">DuplexType</name>
      <value xsi:type="xsd:string">Full</value>
    </item>
    <item xsi:type="ns1:CIMProperty">
      <name xsi:type="xsd:string">Shutdown</name>
      <value xsi:type="xsd:string">true</value>
    </item>
    <item xsi:type="ns1:CIMProperty">
      <name xsi:type="xsd:string">ViolationActionType</name>
      <value xsi:type="xsd:string">RESTRICT</value>
    </item>
    <item xsi:type="ns1:CIMProperty">
      <name xsi:type="xsd:string">Aging</name>
      <value xsi:type="xsd:string">1244</value>
    </item>
    <item xsi:type="ns1:CIMProperty">
      <name xsi:type="xsd:string">MacAddress</name>
      <value xsi:type="xsd:string">2458</value>
    </item>
    <item xsi:type="ns1:CIMProperty">
      <name xsi:type="xsd:string">BroadcastTraffic</name>
      <value xsi:type="xsd:string">54</value>
    </item>
    <item xsi:type="ns1:CIMProperty">
      <name xsi:type="xsd:string">MulticastTraffic</name>
      <value xsi:type="xsd:string">55</value>
    </item>
    <item xsi:type="ns1:CIMProperty">
      <name xsi:type="xsd:string">UnicastTraffic</name>
      <value xsi:type="xsd:string">15</value>
    </item>
    <item xsi:type="ns1:CIMProperty">
      <name xsi:type="xsd:string">StdUniPort</name>
      <value xsi:type="xsd:string">true</value>
    </item>
    <item xsi:type="ns1:CIMProperty">
      <name xsi:type="xsd:string">DisableCDP</name>
      <value xsi:type="xsd:string">true</value>
    </item>
    <item xsi:type="ns1:CIMProperty">
      <name xsi:type="xsd:string">PeIntfDesc</name>
      <value xsi:type="xsd:string">Description</value>
    </item>
    <item xsi:type="ns1:CIMProperty">

```

```

        <name xsi:type="xsd:string">PortSecurity</name>
        <value xsi:type="xsd:string">>true</value>
    </item>
    <item xsi:type="ns1:CIMProperty">
        <name xsi:type="xsd:string">Shutdown</name>
        <value xsi:type="xsd:string">>true</value>
    </item>
    <item xsi:type="ns1:CIMProperty">
        <name xsi:type="xsd:string">UniKeepAlive</name>
        <value xsi:type="xsd:string">>true</value>
    </item>
    </properties>
</objectPath>
</objectPath>
-->
</objectPath>
</objectPath>
</action>
</actions>
</ns1:performBatchOperation>
</soapenv:Body>
</soapenv:Envelope>

```

## Creating a Pseudowire Service Request for an L2-Access Link With EVC-syntax

In the following example, an EVC pseudowire service request is created. In case of L2 access links, **UseUpeServiceInst** is enabled (which is similar to the EVC UNI checkbox in the GUI). After setting the value for the attribute **UseUpeServiceInst** to **TRUE**, use the object **EvcUNIServiceInstanceAttrs** to set the then corresponding values for the EVC UNI related attributes as highlighted below. This is applicable for L2 access links only.

Example: CreateEVC\_ServiceOrder\_PW\_EVCUNI.xml

```

<?xml version="1.0" encoding="UTF-8" ?>
<soapenv:Envelope
  xmlns:soapenv="http://schemas.xmlsoap.org/soap/envelope/"
  xmlns:soapenc="http://schemas.xmlsoap.org/soap/encoding/"
  xmlns:xsd="http://www.w3.org/2001/XMLSchema"
  xmlns:xsi="http://www.w3.org/2001/XMLSchema-instance"
  xmlns:ns0="http://www.cisco.com/cim-cx/2.0"
  xmlns:ns1="urn:CIM">
  <soapenv:Header>
    <!-- WaitTimeout has a default set in system properties.-->
    <ns0:message id="87855" timestamp="2002-12-13T14:55:38.885Z"
      Wait="true" WaitTimeout="90"
      sessiontoken="F7C9020B82541A77DBFBF9A0FC6524E3" />
  </soapenv:Header>
  <soapenv:Body>
    <ns1:performBatchOperation>
      <actions xsi:type="ns1:CIMActionList"
        soapenc:arrayType="ns1:CIMAction[]">
        <action>
          <actionName xsi:type="xsd:string">createInstance</actionName>
          <objectPath xsi:type="ns1:CIMObjectPath">
            <className xsi:type="xsd:string">ServiceRequest</className>
            <properties xsi:type="ns1:CIMPropertyList"
              soapenc:arrayType="ns1:CIMProperty[]">
              <item xsi:type="ns1:CIMProperty">
                <name xsi:type="xsd:string">RequestName</name>
                <value xsi:type="xsd:string">AnyName</value>
              </item>
            </properties>
          </objectPath>
        </action>
      </actions>
    </ns1:performBatchOperation>
  </soapenv:Body>
</soapenv:Envelope>

```

```

</item>
<item xsi:type="ns1:CIMProperty">
  <name xsi:type="xsd:string">Type</name>
  <value xsi:type="xsd:string">Evc</value>
</item>
</properties>
<objectPath xsi:type="ns1:CIMObjectPath">
  <className xsi:type="xsd:string">ServiceRequestDetails</className>
  <properties xsi:type="ns1:CIMPropertyList"
    soapenc:arrayType="ns1:CIMProperty[]">
    <item xsi:type="ns1:CIMProperty">
      <name xsi:type="xsd:string">ServiceDefinition</name>
      <value xsi:type="xsd:string">d-vc-pw</value>
      <qualifier xsi:type="xsd:string">
        <name xsi:type="xsd:string">ServiceDefinitionType</name>
        <value xsi:type="xsd:string">Evc</value>
      </qualifier>
    </item>
    <item xsi:type="ns1:CIMProperty">
      <name xsi:type="xsd:string">VPN</name>
      <value xsi:type="xsd:string">d-vpn-pw</value>
    </item>
  </properties>
</objectPath>
<item xsi:type="ns1:CIMProperty">
  <name xsi:type="xsd:string">VCID</name>
  <value xsi:type="xsd:string">45000</value>
</item>
<item xsi:type="ns1:CIMProperty">
  <name xsi:type="xsd:string">UseSVI</name>
  <value xsi:type="xsd:string">>false</value>
</item>
</properties>
<!-- L2Access Links -->
<objectPath xsi:type="ns1:CIMObjectPath">
  <className xsi:type="xsd:string">EvcLink</className>
  <properties xsi:type="ns1:CIMPropertyList"
    soapenc:arrayType="ns1:CIMProperty[]">
    <item xsi:type="ns1:CIMProperty">
      <name xsi:type="xsd:string">Upe</name>
      <value xsi:type="xsd:string">isc-test-7600-80</value>
    </item>
    <item xsi:type="ns1:CIMProperty">
      <name xsi:type="xsd:string">UniInftId</name>
      <value xsi:type="xsd:string">GigabitEthernet5/15</value>
    </item>
    <item xsi:type="ns1:CIMProperty">
      <name xsi:type="xsd:string">NPC</name>
      <value xsi:type="xsd:string">2</value>
    </item>
  </properties>
</objectPath>
<objectPath xsi:type="ns1:CIMObjectPath">
  <className xsi:type="xsd:string">EvcETHLinkAttrs</className>
  <properties xsi:type="ns1:CIMPropertyList"
    soapenc:arrayType="ns1:CIMProperty[]">
    <item xsi:type="ns1:CIMProperty">
      <name xsi:type="xsd:string">UseServiceInst</name>
      <value xsi:type="xsd:string">>true</value>
    </item>
  </properties>
<item xsi:type="ns1:CIMProperty">
  <name xsi:type="xsd:string">UseUpeServiceInst</name>
  <value xsi:type="xsd:string">true</value>
</item>
<item xsi:type="ns1:CIMProperty">
  <name xsi:type="xsd:string">SystemMTU</name>
  <value xsi:type="xsd:string">1563</value>
</item>

```



```

        </item>
        <item xsi:type="ns1:CIMProperty">
            <name xsi:type="xsd:string">AutoPickVlanId</name>
            <value xsi:type="xsd:string">>false</value>
        </item>
    </properties>
</objectPath>

<objectPath xsi:type="ns1:CIMObjectPath">
    <className
xsi:type="xsd:string">EvcUNIServiceInstanceAttrs</className>
    <properties xsi:type="ns1:CIMPropertyList"
        soapenc:arrayType="ns1:CIMProperty[]" >
        <item xsi:type="ns1:CIMProperty">
            <name xsi:type="xsd:string">AutoPickServiceInstId</name>
            <value xsi:type="xsd:string">>false</value>
        </item>
        <item xsi:type="ns1:CIMProperty">
            <name xsi:type="xsd:string">ServiceInstID</name>
            <value xsi:type="xsd:string">2321</value>
        </item>
        <item xsi:type="ns1:CIMProperty">
            <name xsi:type="xsd:string">OuterVlanRange</name>
            <value xsi:type="xsd:string">1500</value>
        </item>
        <item xsi:type="ns1:CIMProperty">
            <name xsi:type="xsd:string">RewriteActionType</name>
            <value xsi:type="xsd:string">PUSH</value>
        </item>
        <item xsi:type="ns1:CIMProperty">
            <name xsi:type="xsd:string">TranslateOuterVlanId</name>
            <value xsi:type="xsd:string">3600</value>
        </item>
    </properties>
</objectPath>
<objectPath xsi:type="ns1:CIMObjectPath">
    <className xsi:type="xsd:string">EvcServiceInstanceAttrs</className>
    <properties xsi:type="ns1:CIMPropertyList"
        soapenc:arrayType="ns1:CIMProperty[]" >
        <item xsi:type="ns1:CIMProperty">
            <name xsi:type="xsd:string">OuterVlanRange</name>
            <value xsi:type="xsd:string">2500</value>
        </item>
        <item xsi:type="ns1:CIMProperty">
            <name xsi:type="xsd:string">AutoPickServiceInstId</name>
            <value xsi:type="xsd:string">>false</value>
        </item>
        <item xsi:type="ns1:CIMProperty">
            <name xsi:type="xsd:string">ServiceInstID</name>
            <value xsi:type="xsd:string">3700</value>
        </item>
        <item xsi:type="ns1:CIMProperty">
            <name xsi:type="xsd:string">RewriteActionType</name>
            <value xsi:type="xsd:string">PUSH</value>
        </item>
        <item xsi:type="ns1:CIMProperty">
            <name xsi:type="xsd:string">TranslateInnerVlanId</name>
            <value xsi:type="xsd:string">3700</value>
        </item>
        <item xsi:type="ns1:CIMProperty">

```

```

                <name xsi:type="xsd:string">TranslateOuterVlanId</name>
                <value xsi:type="xsd:string">3800</value>
            </item>
        </properties>
    </objectPath>
</objectPath>
</objectPath>
</action>
</actions>
</ns1:performBatchOperation>
</soapenv:Body>
</soapenv:Envelope>

```

## Modifying an EVC Multi-Segment Pseudowire Service Request

The following example shows how an EVC Multi Segment service request is modified. **EvcPseudowireNeighborLinks** is the XML tag used for the service request level attribute, which is highlighted below. It contains only one item **PathXml**, which has all the information about the source device, destination device, and stitching point.

Example: ModifyEVC\_MSPW.xml

```

<?xml version="1.0" encoding="utf-8"?>
<soapenv:Envelope xmlns:soapenv="http://schemas.xmlsoap.org/soap/envelope/"
xmlns:soapenc="http://schemas.xmlsoap.org/soap/encoding/"
xmlns:xsd="http://www.w3.org/2001/XMLSchema"
xmlns:xsi="http://www.w3.org/2001/XMLSchema-instance"
xmlns:ns0="http://www.cisco.com/cim-cx/2.0" xmlns:ns1="urn:CIM">
  <soapenv:Header>
    <!-- WaitTimeout has a default set in system properties.-->
    <ns0:message id="87855" timestamp="2008-04-15T14:55:38.885Z"
Wait="true" WaitTimeout="90"
sessiontoken="87FF9779CE847E2E18C5630091C3A8EB" />
  </soapenv:Header>
  <soapenv:Body>
    <ns1:performBatchOperation>
      <actions xsi:type="ns1:CIMActionList" soapenc:arrayType="ns1:CIMAction[]">
        <action>
          <actionName xsi:type="xsd:string">modifyInstance</actionName>
          <objectPath subAction="modifyInstance" xsi:type="ns1:CIMObjectPath">
            <className xsi:type="xsd:string">ServiceRequest</className>
            <properties xsi:type="ns1:CIMPropertyList"
soapenc:arrayType="ns1:CIMProperty[]">
              <item xsi:type="ns1:CIMProperty">
                <name xsi:type="xsd:string">RequestName</name>
                <value xsi:type="xsd:string">evc-test</value>
              </item>
              <item xsi:type="ns1:CIMProperty">
                <name xsi:type="xsd:string">Type</name>
                <value xsi:type="xsd:string">Evc</value>
              </item>
            </properties>
          <objectPath subAction="modifyInstance" xsi:type="ns1:CIMObjectPath">
            <className xsi:type="xsd:string">ServiceRequestDetails</className>
            <keyProperties xsi:type="ns1:CIMKeyPropertyList"
soapenc:arrayType="ns1:CIMKeyProperty[]">
              <item xsi:type="ns1:CIMProperty">
                <name xsi:type="xsd:string">LocatorId</name>
                <value xsi:type="xsd:string">3</value>
              </item>
            </keyProperties>
          </objectPath>
        </action>
      </actions>
    </ns1:performBatchOperation>
  </soapenv:Body>
</soapenv:Envelope>

```

```

</item>
<objectPath subAction="modifyInstance" xsi:type="ns1:CIMObjectPath">
  <className xsi:type="xsd:string">EvcLink</className>
  <keyProperties xsi:type="ns1:CIMKeyPropertyList"
soapenc:arrayType="ns1:CIMKeyProperty[]">
    <item xsi:type="ns1:CIMProperty">
      <name xsi:type="xsd:string">LocatorId</name>
      <value xsi:type="xsd:string">9</value>
    </item>
  </keyProperties>
</objectPath>
<objectPath subAction="modifyInstance" xsi:type="ns1:CIMObjectPath">
  <className xsi:type="xsd:string">EvcLink</className>
  <keyProperties xsi:type="ns1:CIMKeyPropertyList"
soapenc:arrayType="ns1:CIMKeyProperty[]">
    <item xsi:type="ns1:CIMProperty">
      <name xsi:type="xsd:string">LocatorId</name>
      <value xsi:type="xsd:string">10</value>
    </item>
  </keyProperties>
</objectPath>
<objectPath subAction="modifyInstance" xsi:type="ns1:CIMObjectPath">
  <className xsi:type="xsd:string">EvcPseudowireNeighborLinks</className>
  <keyProperties xsi:type="ns1:CIMKeyPropertyList"
soapenc:arrayType="ns1:CIMKeyProperty[]">
    <item xsi:type="ns1:CIMProperty">
      <name xsi:type="xsd:string">LocatorId</name>
      <value xsi:type="xsd:string">3</value>
    </item>
  </keyProperties>
<properties xsi:type="ns1:CIMPropertyList"
soapenc:arrayType="ns1:CIMProperty[]">
  <item xsi:type="ns1:CIMProperty">
    <name xsi:type="xsd:string">PathXml</name>
    <value xsi:type="xsd:string">
      <![CDATA[
        <service serviceName="MSPW" serviceType="MSPW">
          <section name="Review Routing" required="true" useFor="SR">
            <group cloneable="true" id="pathOptionsGroup"
position="pane01_group0">
              <field disabled="false" id="reqExOptionpane01_group0widget0"
name="reqExOption" position="pane01_group0widget0" required="false" title="" type="combo"
value="Required NE/Link">
                <valueMap>
                  <value>Required NE/Link</value>
                  <value>Excluded NE/Link</value>
                </valueMap>
              </field>
              <field name="sourceDevice" value="isc-cl-test-12-7600-6"/>
              <field name="destinationDevice" value="cl-test-12-7600-3"/>
              <field name="groupPwSelection">
                <pwfield name="pwSelection" segmentType ="dynamic">
                  <field name="sourceDevice" value="isc-cl-test-12-7600-6"
pwclass ="pw-class-1"/>
                  <field name="destinationDevice" value="iscind-7609-2"
pwclass ="pw-class-1"/>
                </pwfield>
                <pwfield name="pwSelection" segmentType ="dynamic">
                  <field name="sourceDevice" value="iscind-7609-2" pwclass
="pw-class-2"/>
                  <field name="destinationDevice" value="cl-test-12-7600-3"
pwclass ="pw-class-2"/>
                </pwfield>
              </field>
            </group>
          </section>
        </service>
      </value>
    </item>
  </properties>

```

```

        <field id="reqExElementpane01_group0widget1"
name="reqExElement" position="pane01_group0widget1" required="true"
resource="devicesAndTpTunnels" title="" type="textpicker"
value="isc-cl-test-12-7600-6:Tunnel-tp7667(7667)&lt;===&gt;iscind-7609-2:Tunnel-tp7667(7667)"/>
        <field id="pathtypepane01_group0widget2" name="pathtype"
position="pane01_group0widget2" required="false" title="" type="combo" value="Working
Path" visibility="Hidden">
            <valueMap>
                <value>Working Path</value>
            </valueMap>
        </field>
    </group>
</section>
</service>]]>
</value>
</item>
</properties>
</objectPath>
</keyProperties>
</objectPath>
</objectPath>
</objectPath>
</action>
</actions>
</ns1:performBatchOperation>
</soapenv:Body>
</soapenv:Envelope>

```

## Service Request Examples in the API Programmer Reference

The following API XMLs are included in the *Cisco Prime Provisioning API 6.8 Programmer Reference*:

- Create1ATM\_1ETH\_PW\_WithoutBD.xml
- CreateATM\_ATM\_Local\_VP\_SR.xml
- CreateATM\_ETH\_PW\_WithBridgeDomain.xml
- CreateATM\_ETHERNET\_LOCAL\_WithBD.xml
- CreateATM\_ETHERNET\_LOCAL\_WithoutBD.xml
- CreateEVC\_PW\_ServiceOrder\_Ranges.xml
- CreateEvc\_ServiceOrder\_PW\_EncapDefaultUntag.xml
- CreateEvc\_ServiceOrder\_PW\_MatchTagUntag.xml
- CreateEVCPseudowireOrder\_withTemplates.xml
- CreateEVCSserviceOrder\_LOCAL.xml
- CreateEVCSserviceOrder\_PW.xml
- CreateEVCSserviceOrder\_VPLS.xml
- CreateEVCSR\_IOSXR\_Local\_With\_BridgeDomain.xml
- CreateEVCSR\_IOSXR\_Local\_With\_p2p\_Elinename.xml
- CreateEVCSR\_IOSXR\_PW\_With\_BridgeDomain.xml
- CreateEVCSR\_IOSXR\_PW\_With\_p2p\_Elinename.xml
- CreateEVCSR\_IOSXR\_VPLS.xml
- ModifyEVCSserviceOrder.xml

- ViewEVCSERVICERequest.xml
- CreateEvcSR-MS-HVPLS.xml
- CreateEvcSR-pwHE-managed.xml
- CreateEvcSR-SetMTU.xml

## End-to-End Provisioning Process

This section describes the process for using the API to provision EVC, and includes the required operation, object definition (className), and parameter definitions.

### Process Summary

This EVC provisioning example uses the following processes:

1. Create device groups (optional).
2. Create devices.
3. Collect device configurations.
4. Create provider.
5. Create regions.
6. Declare devices as PEs.
7. Create access domains and assign PEs to them.
8. Create customer.
9. Create sites.
10. Create named physical circuits.
11. Create VLAN ID pool.
12. Create VC ID pool.
13. Create VPN.
14. Create EVC service definition (policy).
15. Create EVC service request.

### Prerequisites

For security reasons, Prime Provisioning requires the virtual terminal protocol (VTP) to be configured in transparent mode on all switches before provisioning EVC service requests.

To set the VTP mode, enter the following Cisco IOS commands:

```
configure terminal
vtp mode transparent
```

Enter the following Cisco IOS command to verify that the VTP has changed to transparent mode:

```
Show vtp status
```

## Detailed Process

To provision EVC using Prime Provisioning API, an EVC service policy and an EVC service request are required and only one subtype will be defined and of type Evc.

The EVC service policy/service definition specifies the attributes related to the EVC links and non-EVC links. The service request defines the device interfaces for each EVC/non-EVC link connection and can optionally override policy attributes in each of the corresponding links.

When you deploy an EVC service request using a service order, the attributes specified in the service definition are applied to the devices and interfaces listed in the service request, along with the attributes for each of the EVC/non-EVC links.

This section describes the process for provisioning EVC using XML examples.

The complete list of XML examples for EVC is available here:

[Cisco Prime Provisioning API 6.8 Programmer Reference](#)



### Note

For clarity, this provisioning process shows each step as a separate XML request. Many of these steps can be combined using **performBatchOperations**.

**Step 1** Create device groups (optional).

**Table 9-1** Create Device Group

Operation	className	Required Parameters
createInstance	DeviceGroup	Name

### XML Examples:

- CreateDeviceGroup.xml



### Tip

If you plan to create device groups, create the empty device groups before you create the devices. As you create each device, add the associated device group name as a key property in the create device XML request.

In the following example, the device group (CustDev) is added as a key property when creating the device **CiscoRouter**:

```
<ns1:createInstance>
  <objectPath xsi:type="ns1:CIMObjectPath">
    <className xsi:type="xsd:string">CiscoRouter</className>
    <properties xsi:type="ns1:CIMPropertyList"
soapenc:arrayType="ns1:CIMProperty[]">
      <item xsi:type="ns1:CIMProperty">
        <name xsi:type="xsd:string">DeviceGroup</name>
        <value xsi:type="xsd:string">CustDev</value>
      </item>
      <item xsi:type="ns1:CIMProperty">
        <name xsi:type="xsd:string">CfgUpDnldMech</name>
        <value xsi:type="xsd:string">DEFAULT</value>
      </item>
      <item xsi:type="ns1:CIMProperty">
        <name xsi:type="xsd:string">TransportMechanism</name>
        <value xsi:type="xsd:string">DEFAULT</value>
      </item>
    </properties>
  </objectPath>
</ns1:createInstance>
```

```

</item>
<item xsi:type="nsl:CIMProperty">
  <name xsi:type="xsd:string">Password</name>
  <value xsi:type="xsd:string">vpnsc</value>
</item>

```

### Step 2 Create devices.

Every network element that Prime Provisioning manages must be defined as a device in the system. An element is any device from which Prime Provisioning can collect configuration information.

**Table 9-2 Create Devices**

Operation	className	Required Parameters
createInstance	<ul style="list-style-type: none"> <li>• CiscoRouter</li> <li>• CatOS</li> </ul>	One or more of the following: <ul style="list-style-type: none"> <li>• ManagementIPAddress</li> <li>• HostName</li> <li>• DomainName</li> </ul>

#### XML Examples:

- CreateCiscoRouter.xml
- CreateCat.xml

### Step 3 Collect device configurations.

A device configuration collection is a task. This task uploads the current configuration from the device to the Prime Provisioning database. The collection task is executed through a service request, and the service request is scheduled through a service order.



**Note** The service request name must be unique for each NBI API.

**Table 9-3** *Collect Device Configurations*

Operation	className	Required Parameters
createInstance	ServiceOrder	<ul style="list-style-type: none"> <li>• ServiceName</li> <li>• NumberofRequests</li> <li>• ServiceRequest</li> </ul>
	ServiceRequest	<ul style="list-style-type: none"> <li>• RequestName</li> <li>• Type=Task</li> <li>• ServiceRequestDetails</li> </ul>
	ServiceRequestDetails	<ul style="list-style-type: none"> <li>• SubType=COLLECTION</li> <li>• Device (or DeviceGroup)</li> </ul> <p><b>Note</b> You must select at least one device or device group.</p> <ul style="list-style-type: none"> <li>• RetrieveVersion=true</li> <li>• RetrieveDeviceInterfaces=true</li> </ul>

**XML Examples:**

- CreateTaskServiceOrderCollection.xml

**Step 4** Create a provider.

The provider is the administrative domain of an ISP, with one BGP autonomous system (AS) number. The network owned by the provider is called the backbone network. If an ISP has two AS numbers, you must define it as two provider administrative domains.

**Table 9-4** *Create a Provider*

Operation	className	Required Parameters
createInstance	Provider	<ul style="list-style-type: none"> <li>• Name</li> <li>• AsNumber</li> </ul>

**XML Examples:**

CreateProvider.xml

**Step 5** Create regions.

Each provider can contain multiple regions.

**Table 9-5** *Create Regions*

Operation	className	Required Parameters
createInstance	Region	<ul style="list-style-type: none"> <li>• Name</li> <li>• Provider</li> </ul>



**XML Examples:**

CreateRegion.xml

**Step 6** Declare devices as PEs.

The XML request that assigns a PE role to a device is also used to:

- Assign PE devices to Regions/Provider
- Specify interface information

**Table 9-6** Create PE Devices

Operation	className	Required Parameters
createInstance	PE	<ul style="list-style-type: none"> <li>• Provider</li> <li>• Region</li> <li>• Role= <ul style="list-style-type: none"> <li>- PE_CLE</li> <li>- PE_POP</li> </ul> </li> <li>• Device</li> <li>• Interface</li> </ul>

**XML Examples:**

CreatePE.xml

**Step 7** Create access domains.

Prime Provisioning assigns a VLAN ID to the attachment circuit from the VLAN ID pool. Select all PE-POP devices to be associated with this domain, and later in the process, when VLAN ID pools are created, the PE-POP is automatically assigned a VLAN ID.

**Note**

If provisioning for an Ethernet provider core, all PE devices must be in the same access domain and a single VLAN ID is used for the entire VPLS VPN. If provisioning for an MPLS provider core, the PE devices can be in different access domains.

**Table 9-7** Create Access Domains

Operation	className	Required Parameters
createInstance	AccessDomain	<ul style="list-style-type: none"> <li>• Name</li> <li>• Provider</li> <li>• PE (Role must be PE_POP)</li> </ul>

**XML Examples:**

- CreateAccessDomain.xml

**Step 8** Create a customer.

A customer is a requestor of VPN services. Each customer can contain multiple customer sites. Each site belongs to only one customer and can contain multiple CPEs.

**Table 9-8** Create Organization

Operation	className	Required Parameters
createInstance	Organization	<ul style="list-style-type: none"> <li>Name</li> </ul>

**XML Examples:**

- CreateOrganization.xml

**Step 9** Create sites and assign customers (**Organizations**) to them.**Table 9-9** Create Sites

Operation	className	Required Parameters
createInstance	Site	<ul style="list-style-type: none"> <li>Name</li> <li>Organization</li> </ul>

**XML Examples:**

- CreateSite.xml

**Step 10** Create Named Physical Circuits (NPCs). This step is not required if you plan to manually configure the physical links in the VPLS service request (Step 16).

Create an NPC for each attachment circuit (CE/UNI to PE-POP link). If there are intermediate devices, those links must also be added to the NPC using **PhysicalLink**.

**Note**

When creating an NPC, you must specify the CPE as the source device and the PE-POP as the destination device. If there are intermediate devices, such as PE-CLEs, the source and destination devices must follow the direction of the CPE to PE-POP link.

**Table 9-10** Create Named Physical Circuits

Operation	className	Required Parameters
createInstance	NamedPhysicalCircuit	PhysicalLink
	PhysicalLink	<ul style="list-style-type: none"> <li>SrcDevice</li> <li>DestDevice</li> <li>SrcIfName</li> <li>DestIfName</li> </ul>

You can create one XML request for the **NamedPhysicalCircuit** and include multiple **PhysicalLinks** as shown in the following example:

```
<ns1:createInstance>
  <objectPath xsi:type="ns1:CIMObjectPath">
```

```

<className xsi:type="xsd:string">NamedPhysicalCircuit</className>
<properties xsi:type="ns1:CIMPropertyList"
  soapenc:arrayType="ns1:CIMProperty[]">
</properties>
<objectPath xsi:type="ns1:CIMObjectPath">
  <className xsi:type="xsd:string">PhysicalLink</className>
  <properties xsi:type="ns1:CIMPropertyList"
    soapenc:arrayType="ns1:CIMProperty[]">
    <item xsi:type="ns1:CIMProperty">
      <name xsi:type="xsd:string">SrcDevice</name>
      <value xsi:type="xsd:string">Device1</value> </item>
    <item xsi:type="ns1:CIMProperty">
      <name xsi:type="xsd:string">DestDevice</name>
      <value xsi:type="xsd:string">Device2</value> </item>
    <item xsi:type="ns1:CIMProperty">
      <name xsi:type="xsd:string">SrcIfName</name>
      <value xsi:type="xsd:string">Intf1/0</value> </item>
    <item xsi:type="ns1:CIMProperty">
      <name xsi:type="xsd:string">DestIfName</name>
      <value xsi:type="xsd:string">Intf2/1</value> </item>
    </properties>
  </objectPath>
  <className xsi:type="xsd:string">PhysicalLink</className>
  <properties xsi:type="ns1:CIMPropertyList"
    soapenc:arrayType="ns1:CIMProperty[]">
    <item xsi:type="ns1:CIMProperty">
      <name xsi:type="xsd:string">SrcDevice</name>
      <value xsi:type="xsd:string">Device3</value> </item>
    <item xsi:type="ns1:CIMProperty">
      <name xsi:type="xsd:string">DestDevice</name>
      <value xsi:type="xsd:string">Device5</value> </item>
    <item xsi:type="ns1:CIMProperty">
      <name xsi:type="xsd:string">SrcIfName</name>
      <value xsi:type="xsd:string">Intf3/0</value> </item>
    <item xsi:type="ns1:CIMProperty">
      <name xsi:type="xsd:string">DestIfName</name>
      <value xsi:type="xsd:string">Intf5/1</value> </item>
    </properties>
  </objectPath>
</objectPath>
</ns1:createInstance>

```

#### XML Examples:

- CreateNamedPhysicalCircuit.xml
- CreateNamedPhysicalCircuitRing.xml—Use this example if there is a Ring topology configuration on the PE-CLEs.
- CreateNamedPhysicalCircuitRingExisting.xml—Use this example to reference an NPC ring that has already been created.

#### Step 11 Create VLAN ID pool.

Create a VLAN ID pool, specify a range, and associate it to an access domain to manually enter the parameters for a VLAN ID pool. To have Prime Provisioning automatically assign VLANs to the attachment circuits, specify the **Autopick\_Vlan\_ID** keyword in the service definition (Step 15).

When provisioning for an Ethernet core, VPLS service requests use the VLAN ID to reference the attachment circuits.

**Table 9-11** Create VLAN ID Pools

Operation	className	Required Parameters
createInstance	VlanIdPool	<ul style="list-style-type: none"> <li>• Start</li> <li>• Size</li> <li>• AssocClassType</li> <li>• AssocClassId</li> </ul>

**XML Examples:**

- CreateVlanIdPool.xml

**Step 12** Create VC ID pool.

For a VPLS VPN, all PE-POP routers use the same VC ID to establish the virtual circuit (VC) across the provider core. The VC ID is also the VPN ID and is assigned from the VC ID pool. Prime Provisioning ensures that VC IDs are unique among VPLS VPNs.

**Note**

A VC ID pool is global (not associated with a provider or organization).

**Table 9-12** Create VC ID Pool

Operation	className	Required Parameters
createInstance	VcIdPool	<ul style="list-style-type: none"> <li>• Start</li> <li>• Size</li> </ul>

**XML Examples:**

- CreateVcIdPool.xml

**Step 13** Create a VPN.

When you create a VPN to use in VPLS provisioning, you must enable it to support VPLS (**VplsVpn=true**), and define the type of service (**ERS** or **EWS**).

Prime Provisioning assigns a VPN ID (from the VC ID pool) to each VPLS VPN.

**Table 9-13** Create VPNs

Operation	className	Required Parameters
createInstance	VPN	<ul style="list-style-type: none"> <li>• Name</li> <li>• Organization or Provider</li> <li>• VplsVpn=true</li> <li>• ServiceType= <ul style="list-style-type: none"> <li>– ERS</li> <li>– EWS</li> </ul> </li> </ul>

## XML Examples:

- CreateVPN.xml

**Step 14** Create EVC service definition (policy).

A EVC service definition specifies the core type, service subtype, device properties, and the attributes common to all attachment circuits.

**Table 9-14** Create a EVC Service Definition

Operation	className	Required Parameters
createInstance	ServiceDefinition	<ul style="list-style-type: none"> <li>• Name</li> <li>• Type=Evc</li> <li>• Provider or Organization</li> </ul> <p><b>Note</b> If you do not specify a <b>Provider</b> or <b>Organization</b>, the service policy is global</p> <ul style="list-style-type: none"> <li>• ServiceDefinitionDetails</li> </ul>
	ServiceDefinitionDetails	<ul style="list-style-type: none"> <li>• SubType=Evc</li> <li>• Core_Type= <ul style="list-style-type: none"> <li>– PseudoWire</li> <li>– VPLS</li> <li>– LOCAL</li> </ul> </li> <li>• N_PE_Encap and U_PE_Encap= <ul style="list-style-type: none"> <li>– DOT1Q</li> <li>– DOT1QTUNNEL</li> <li>– ACCESS</li> </ul> </li> <li>• EvcUNIMacACLAddresses <ul style="list-style-type: none"> <li>– MacAddress (You can list multiple secure MAC addresses)</li> </ul> </li> <li>• AutoPickBDVlanId</li> </ul>
	PW	<ul style="list-style-type: none"> <li>• UsePwClass= <ul style="list-style-type: none"> <li>– TRUE</li> <li>– FALSE</li> </ul> </li> <li>• PwClassId= <ul style="list-style-type: none"> <li>– 1</li> <li>– any other number</li> </ul> </li> </ul>

**Note**

If **AutoPickBDVlanId=true**, be sure that an access domain is attached to the PE-POP, and a VLAN ID pool is assigned to the access domain (Step 7).

**XML Examples:**

- CreateEVCSvcDefn\_LOCAL.xml
- CreateEVCSvcDefn\_PW.xml
- CreateEVCSvcDefn\_VPLS.xml
- Create\_PW\_EVCPolicy.xml
- CreateLocalEVCPolicy.xml
- CreateVplsEVCPolicy.xml

**Step 15** Create EVC service request.

A EVC service request defines the service definition and VPN, assigns interfaces and attributes for each attachment circuit (**EvcLink**), and applies any template information.

**Table 9-15** Create a EVC Service Request

Operation	className	Required Parameters
createInstance	ServiceOrder	<ul style="list-style-type: none"> <li>• ServiceName</li> <li>• NumberOfRequests</li> <li>• Provider or Organization</li> </ul> <p><b>Note</b> If you do not specify a <b>Provider</b> or <b>Organization</b>, the service policy is global.</p> <ul style="list-style-type: none"> <li>• ServiceRequest</li> </ul>
	ServiceRequest	<ul style="list-style-type: none"> <li>• RequestName</li> <li>• Type=Evc</li> <li>• ServiceRequestDetails</li> </ul>
	ServiceRequestDetails	<ul style="list-style-type: none"> <li>• ServiceDefinition <ul style="list-style-type: none"> <li>– ServiceDefinitionType=Evc</li> </ul> </li> <li>• VPN</li> <li>• EvcLink</li> </ul>
	EvcLink	<ul style="list-style-type: none"> <li>• NPC</li> <li>• EvcUNIMacACLAddresses</li> <li>• SRAssociatedTemplate (optional)</li> </ul> <p><b>Note</b> See the <a href="#">“Templates in a Service Request”</a> section on page 4-18.</p>

**Tip**

Record the **LocatorId** value from the XML response for the service request. The Locator ID is required for subsequent service request tasks.

**XML Example:**

- CreateEVCSERVICEORDER\_LOCAL.xml
- CreateEVCSERVICEORDER\_VPLS.xml
- CreateEVCSERVICEORDER\_PW.xml

## Auditing Service Requests

A configuration audit occurs automatically each time you deploy a service request. During this configuration audit, Prime Provisioning verifies that all Cisco IOS commands are present and that they have the correct syntax. An audit also verifies that there were no errors during deployment by examining the commands configured by the service request on the target devices. If the device configuration does not match what is defined in the service request, the audit flags a warning and sets the service request to a *Failed Audit* or *Lost* state.

If you do not want the configuration audit to occur, change the value for the **Audit** parameter. The **Audit** parameter supports these values:

- **Audit**—This is the default. A successfully deployed service request is automatically audited unless this flag is changed.
- **NoAudit**—Do not perform a configuration audit when the service request is deployed.
- **ForceAudit**—Perform a configuration audit even if the service request deployment is not successful.

You can use the Audit parameter with a **Create**, **Modify**, or **Decommission** service request or a **Deployment** task. See the “[Service Decommission](#)” section on page 3-11 for more information. To perform a configuration audit as a separate task, see the “[Configuration Audit](#)” section on page 3-11.







# Traffic Engineering Management Provisioning

---

This chapter describes the provisioning support for Traffic Engineering Management (TEM) provided in Cisco Prime Provisioning.

The TEM API solution provides bulk provisioning, updating, and deletion of traffic engineering (TE) objects.

More specifically, the chapter describes TEM service concepts and the steps required to provision TEM services using the Prime Provisioning API. The provisioning example includes all steps from creating the inventory to auditing the service deployment.

For information on TEM provisioning using the Prime Provisioning GUI, see the [Cisco Prime Provisioning 7.0 User Guide](#).

This chapter contains the following sections:

- [Prerequisites and Limitations, page 10-1](#)
- [TEM Service Definitions, page 10-2](#)
- [TE Network Discovery, page 10-7](#)
- [TEM Service Requests, page 10-9](#)
- [Provisioning Example, page 10-24.](#)

## Prerequisites and Limitations

The current release of Prime Provisioning involves certain prerequisites and limitations, which are described in this section.

See the [Cisco Prime Provisioning 7.0 Installation Guide](#) for general system recommendations and supported platforms.

## General Limitations

Let issued service requests finish deployment before issuing other service requests to avoid conflicts.

Prime Provisioning manages a single IS-IS level and multiple OSPF areas. TEM supports one user per OSPF area for managed and backup tunnels and one user per head end device for unmanaged tunnels. However, it does not support tunnels between areas. Each OSPF area is mapped to a TE provider and is discovered area by area independently.

Prime Provisioning only supports MPLS-TE topology with point-to-point links.

## Feature-Specific Prerequisites and Limitations

Some features might only be available with a particular license. In addition, the number of nodes provided by the license limits the size of the network. For more information, see the [Cisco Prime Provisioning 7.0 User Guide](#).

A number of specific requirements are associated with the **TE Discovery** task. Helpful information is available in the [Cisco Prime Provisioning 7.0 User Guide](#).

Concurrent use is supported in the Planning portion of the current implementation of Prime Provisioning.

If your repository predates the ISC 4.1 release and has been upgraded to a 4.1 or later repository, you need to run a TE Discovery task to collect software version information from the devices before deploying service requests.

## Non-Cisco Devices and Prime Provisioning TEM

Prime Provisioning does not manage non-Cisco devices and Prime Provisioning cannot be used to provision them.

Prime Provisioning will, however, discover non-Cisco devices and store them in the repository. Tunnels can be run through these devices, the bandwidth consumed can be accounted for, but the devices are not otherwise managed by Prime Provisioning. TE tunnels originating from non-Cisco devices will not be discovered.

## TEM Service Definitions

To provision TEM using the Prime Provisioning API, you need a TEM service definition and a TEM service request (SR). This section lists the supported service definitions, service orders, and policies and includes corresponding examples.

When you deploy a TEM service request using a service order, the attributes specified in the service definition are applied to the devices and interfaces listed in the service request, along with the attributes for each of the links.

## Supported TEM Features

Prime Provisioning supports the following TEM features:

- TE Provider
  - Create TE Provider
  - Delete TE Provider
  - Modify TE Provider
  - View TE Provider
- Seed Router
  - Create Seed Router
- TE Discovery Task
  - Create Discovery Task (full and incremental)

- Discovery Status.
- TE Policy
  - Create Managed and Unmanaged TE Policies
  - Create Managed TE Policy with MPLS enabled/disabled
  - Delete Policy
  - Modify Policy
  - View Policy
- TE Explicit Paths
  - Create Explicit Path
  - Delete Explicit Path
  - Modify Explicit Path
  - View Explicit Path
- TE SRLG (Shared-Risk Link Group)
  - Create SRLG
  - Delete SRLG
  - Modify SRLG
  - View SRLG
- TE Links (created during discovery)
  - Delete TE Links
  - View TE Links
- TE Traffic Admission (with Policy-Based Tunnel Selection [PBTS] or Class-Based Tunnel Selection [CBTS])
  - Create PBTS TE Traffic Admission SR
  - Modify PBTS TE Traffic Admission SR
  - Delete PBTS TE Traffic Admission SR
  - View PBTS TE Traffic Admission SR
  - Create CBTS TE Traffic Admission SR
  - Modify CBTS TE Traffic Admission SR
  - Delete CBTS TE Traffic Admission SR
  - View CBTS TE Traffic Admission SR
- TE Managed Primary Tunnels
  - Create Managed Tunnel
  - Modify Managed Tunnel
  - Delete Managed Tunnel
  - View Managed Tunnel
- TE Unmanaged Primary Tunnels
  - Create Unmanaged Tunnel
  - Modify Unmanaged Tunnel

- Delete Unmanaged Tunnel
- View Unmanaged Tunnel
- TE Backup Tunnels
  - Create Backup Tunnel
  - Delete Backup Tunnel
  - Modify Backup Tunnel
  - View TE Tunnel
- TE Routers
  - View TE Routers
- TE Protected Elements
  - Create TE Protected Element
  - View TE Protected Element
  - Create Compute Backup for TE Protected Element
  - View Compute Backup for TE Protected Element.

The above operations are supported for policies and service requests, which are created to provision a variety of network configurations.

The API XMLs for the above operations are contained in the [Cisco Prime Provisioning API 7.0 Programmer Reference](#).

## Policy Examples

The following constitute some common XML policy examples:

- [Create TE Policy, page 10-4](#)
- [Delete TE Policy, page 10-6](#)
- [View TE Policy, page 10-6.](#)

## Create TE Policy

Managed policies have setup/hold priorities of 0/0 and can have additional routing constraints such as protection level and max delay.

Unmanaged policies cannot have a setup/hold priority of zero.

Example: TeManagedPolicyCreateRequest.xml

```
<?xml version="1.0" encoding="UTF-8"?>
<soapenv:Envelope
  xmlns:soapenv="http://schemas.xmlsoap.org/soap/envelope/"
  xmlns:soapenc="http://schemas.xmlsoap.org/soap/encoding/"
  xmlns:xsd="http://www.w3.org/2001/XMLSchema"
  xmlns:xsi="http://www.w3.org/2001/XMLSchema-instance"
  xmlns:ns0="http://www.cisco.com/cim-cx/2.0"
  xmlns:ns1="urn:CIM">
  <soapenv:Header>
    <ns0:message id="87855" timestamp="2002-12-13T14:55:38.885Z"
      sessiontoken="p36btjtjwy1"/>
  </soapenv:Header>
```

```

<soapenv:Body>
  <ns1:createInstance>
    <objectPath xsi:type="ns1:CIMObjectPath">
      <className xsi:type="xsd:string">ServiceDefinition</className>
      <properties xsi:type="ns1:CIMPropertyList"
        soapenc:arrayType="ns1:CIMProperty[]">
        <item xsi:type="ns1:CIMProperty">
          <name xsi:type="xsd:string">Name</name>
          <value xsi:type="xsd:string">nbiTest</value>
        </item>
        <item xsi:type="ns1:CIMProperty">
          <name xsi:type="xsd:string">Type</name>
          <value xsi:type="xsd:string">Tunnel</value>
        </item>
        <item xsi:type="ns1:CIMProperty">
          <name xsi:type="xsd:string">Provider</name>
          <value xsi:type="xsd:string">provider1</value>
        </item>
      </properties>
    </objectPath xsi:type="ns1:CIMObjectPath">
      <className xsi:type="xsd:string">ServiceDefinitionDetails</className>
      <properties xsi:type="ns1:CIMPropertyList"
        soapenc:arrayType="ns1:CIMProperty[]">
        <item xsi:type="ns1:CIMProperty">
          <name xsi:type="xsd:string">HoldPriority</name>
          <value xsi:type="xsd:string">0</value>
        </item>
        <item xsi:type="ns1:CIMProperty">
          <name xsi:type="xsd:string">FrrProtectionLevel</name>
          <value xsi:type="xsd:string">None</value>
        </item>
        <item xsi:type="ns1:CIMProperty">
          <name xsi:type="xsd:string">LinkAffinityMask</name>
          <value xsi:type="xsd:string">0x0</value>
        </item>
        <item xsi:type="ns1:CIMProperty">
          <name xsi:type="xsd:string">SetupPriority</name>
          <value xsi:type="xsd:string">0</value>
        </item>
        <item xsi:type="ns1:CIMProperty">
          <name xsi:type="xsd:string">TeProvider</name>
          <value xsi:type="xsd:string">te_provider1</value>
        </item>
        <item xsi:type="ns1:CIMProperty">
          <name xsi:type="xsd:string">Name</name>
          <value xsi:type="xsd:string">TeMpls-10</value>
        </item>
        <item xsi:type="ns1:CIMProperty">
          <name xsi:type="xsd:string">LinkAffinity</name>
          <value xsi:type="xsd:string">0x0</value>
        </item>
        <item xsi:type="ns1:CIMProperty">
          <name xsi:type="xsd:string">BandwidthPoolType</name>
          <value xsi:type="xsd:string">GLOBAL</value>
        </item>
      </properties>
    </objectPath>
  </ns1:createInstance>
</soapenv:Body>
</soapenv:Envelope>

```

## Delete TE Policy

A policy can also be deleted based on its name.

Example: TeTunnelPolicyDeleteRequest.xml

```
<?xml version="1.0" encoding="UTF-8"?>
<soapenv:Envelope
  xmlns:soapenv="http://schemas.xmlsoap.org/soap/envelope/"
  xmlns:soapenc="http://schemas.xmlsoap.org/soap/encoding/"
  xmlns:xsd="http://www.w3.org/2001/XMLSchema"
  xmlns:xsi="http://www.w3.org/2001/XMLSchema-instance"
  xmlns:ns0="http://www.cisco.com/cim-cx/2.0"
  xmlns:ns1="urn:CIM">
  <soapenv:Header>
    <ns0:message id="87855" timestamp="2002-12-13T14:55:38.885Z"
      sessiontoken="p36bttjwy1" />
  </soapenv:Header>
  <soapenv:Body>
    <ns1:deleteInstance>
      <objectPath xsi:type="ns1:CIMObjectPath">
        <className xsi:type="xsd:string">ServiceDefinition</className>
        <keyProperties xsi:type="ns1:CIMKeyPropertyList"
          soapenc:arrayType="ns1:CIMKeyProperty[]">
          <item xsi:type="ns1:CIMKeyProperty">
            <name xsi:type="xsd:string">Name</name>
            <value xsi:type="xsd:string">TeMpls-10</value>
          </item>
          <item xsi:type="ns1:CIMKeyProperty">
            <name xsi:type="xsd:string">Type</name>
            <value xsi:type="xsd:string">Tunnel</value>
          </item>
        </keyProperties>
      </objectPath>
    </ns1:deleteInstance>
  </soapenv:Body>
</soapenv:Envelope>
```

## View TE Policy

A policy can be viewed based on its name.

Example: TeTunnelPolicyView.xml

```
<?xml version="1.0" encoding="UTF-8"?>
<soapenv:Envelope
  xmlns:soapenv="http://schemas.xmlsoap.org/soap/envelope/"
  xmlns:soapenc="http://schemas.xmlsoap.org/soap/encoding/"
  xmlns:xsd="http://www.w3.org/2001/XMLSchema"
  xmlns:xsi="http://www.w3.org/2001/XMLSchema-instance"
  xmlns:ns0="http://www.cisco.com/cim-cx/2.0"
  xmlns:ns1="urn:CIM">
  <soapenv:Header>
    <ns0:message id="87855" timestamp="2002-12-13T14:55:38.885Z"
      sessiontoken="86E195A4C6E030C1F93442D46188F361" />
  </soapenv:Header>
  <soapenv:Body>
    <ns1:enumerateInstances>
      <objectPath xsi:type="ns1:CIMObjectPath">
        <className xsi:type="xsd:string">ServiceDefinition</className>
```

```

<keyProperties xsi:type="ns1:CIMKeyPropertyList"
  soapenc:arrayType="ns1:CIMKeyProperty[]">
  <item xsi:type="ns1:CIMKeyProperty">
    <name xsi:type="xsd:string">Name</name>
    <value xsi:type="xsd:string">TeMpls-10</value>
  </item>
  <item xsi:type="ns1:CIMKeyProperty">
    <name xsi:type="xsd:string">Type</name>
    <value xsi:type="xsd:string">Tunnel</value>
  </item>
</keyProperties>
</objectPath>
</ns1:enumerateInstances>
</soapenv:Body>
</soapenv:Envelope>

```

## TE Network Discovery

After completing the preconfiguration process and creating a seed router, you can discover the TE network for a particular TE provider. This populates the repository with the network topology.

For more detailed information about TE Discovery, see the [Cisco Prime Provisioning 7.0 User Guide](#).

### TE Discovery Examples

Incremental TE Discovery includes two types of incremental discovery tasks:

- [Create Incremental TE Device Discovery, page 10-7](#)
- [Create Incremental TE Link Discovery, page 10-8](#)

#### Create Incremental TE Device Discovery

This example shows how a device that has been added to the network can be discovered. This device needs to be added in the inventory with the TE ID as management IP address. The relevant attributes are highlighted in bold below.

Example: TeIncrementalDiscoveryDevice.xml

```

<action>
  <actionName xsi:type="xsd:string">createInstance</actionName>
  <objectPath xsi:type="ns1:CIMObjectPath">
    <className xsi:type="xsd:string">ServiceRequest</className>
    <properties xsi:type="ns1:CIMPropertyList" soapenc:arrayType="ns1:CIMProperty[]">
      <item xsi:type="ns1:CIMProperty">
        <name xsi:type="xsd:string">RequestName</name>
        <value xsi:type="xsd:string">Discovery</value>
      </item>
      <item xsi:type="ns1:CIMProperty">
        <name xsi:type="xsd:string">Type</name>
        <value xsi:type="xsd:string">Task</value>
      </item>
    </properties>
    <objectPath xsi:type="ns1:CIMObjectPath">
      <className xsi:type="xsd:string">ServiceRequestDetails</className>
      <properties xsi:type="ns1:CIMPropertyList"
        soapenc:arrayType="ns1:CIMProperty[]">
        <item xsi:type="ns1:CIMProperty">

```

```

        <name xsi:type="xsd:string">SubType</name>
        <value xsi:type="xsd:string">INCREMENTAL_DISCOVERY</value> </item>
    <item xsi:type="ns1:CIMProperty">
        <name xsi:type="xsd:string">TeProvider</name>
        <value xsi:type="xsd:string">te_provider1</value> </item>
    <item xsi:type="ns1:CIMProperty">
        <name xsi:type="xsd:string">DiscoveryDevice</name>
        <value xsi:type="xsd:string"> IOU-Area0-R1 </value>
    </item>
</properties>
</objectPath>
</objectPath>
</action>

```

## Create Incremental TE Link Discovery

This example shows how a link that has been added to the network can be discovered using Link Discovery. The devices EndDeviceA and EndDeviceB must have been discovered already. The relevant attributes are highlighted in bold below.

### Example: TeIncrementalDiscoveryLink.xml

```

<action>
  <actionName xsi:type="xsd:string">createInstance</actionName>
  <objectPath xsi:type="ns1:CIMObjectPath">
  <className xsi:type="xsd:string">ServiceRequest</className>
  <properties xsi:type="ns1:CIMPropertyList"
    soapenc:arrayType="ns1:CIMProperty[]">
    <item xsi:type="ns1:CIMProperty">
      <name xsi:type="xsd:string">RequestName</name>
      <value xsi:type="xsd:string">Discovery</value>
    </item>
    <item xsi:type="ns1:CIMProperty">
      <name xsi:type="xsd:string">Type</name>
      <value xsi:type="xsd:string">Task</value>
    </item>
  </properties>
  <objectPath xsi:type="ns1:CIMObjectPath">
  <className xsi:type="xsd:string">ServiceRequestDetails</className>
  <properties xsi:type="ns1:CIMPropertyList"
    soapenc:arrayType="ns1:CIMProperty[]">
    <item xsi:type="ns1:CIMProperty">
      <name xsi:type="xsd:string">SubType</name>
      <value xsi:type="xsd:string">INCREMENTAL_DISCOVERY</value> </item>
    <item xsi:type="ns1:CIMProperty">
      <name xsi:type="xsd:string">TeProvider</name>
      <value xsi:type="xsd:string">te_provider1</value> </item>
    <item xsi:type="ns1:CIMProperty">
      <name xsi:type="xsd:string">EndDeviceA</name>
      <value xsi:type="xsd:string">c1-test-12-7600-4</value>
    </item>
    <item xsi:type="ns1:CIMProperty">
      <name xsi:type="xsd:string">InterfaceA</name>
      <value xsi:type="xsd:string">FastEthernet3/48</value>
    </item>
    <item xsi:type="ns1:CIMProperty">
      <name xsi:type="xsd:string">EndDeviceB</name>
      <value xsi:type="xsd:string">isc-cl-test-3925-1</value>
    </item>
    <item xsi:type="ns1:CIMProperty">

```



```
<name xsi:type="xsd:string">InterfaceB</name>
  <value xsi:type="xsd:string">GigabitEthernet0/2</value>
</item>
</properties>
</objectPath>
</objectPath>
</action>
```

## TEM Service Requests

Before creating a service request, a service policy has to be defined. Use a predefined policy template as is or with modifications to create a service request, and deploy the service. For information on TEM policies, see the [Cisco Prime Provisioning 7.0 User Guide](#).

A TEM service request defines the service definition to use and applies the needed policy information.

When you deploy a TEM service request using a service order, the attributes specified in the service definition are applied to the devices and interfaces defined in the service request.

This section contains the following:

- [TE Topology Example, page 10-9](#)
- [Service Request Examples, page 10-10](#).

## TE Topology Example

As an example of provisioning service requests, this section depicts a TE network in a number of OSPF areas.

A TE network is discovered by first gathering the TE topology information through a seed device. This device must be configured in Prime Provisioning TEM.

Below is a sample network topology with five IOS devices. To discover the network, isctmp1 is used as the seed router. Discovery, management, and provisioning of TE Tunnels is performed within multiple OSPF areas where each area belongs to a separate Prime Provisioning provider.

Figure 10-1 TE Discovery Through Seed Router

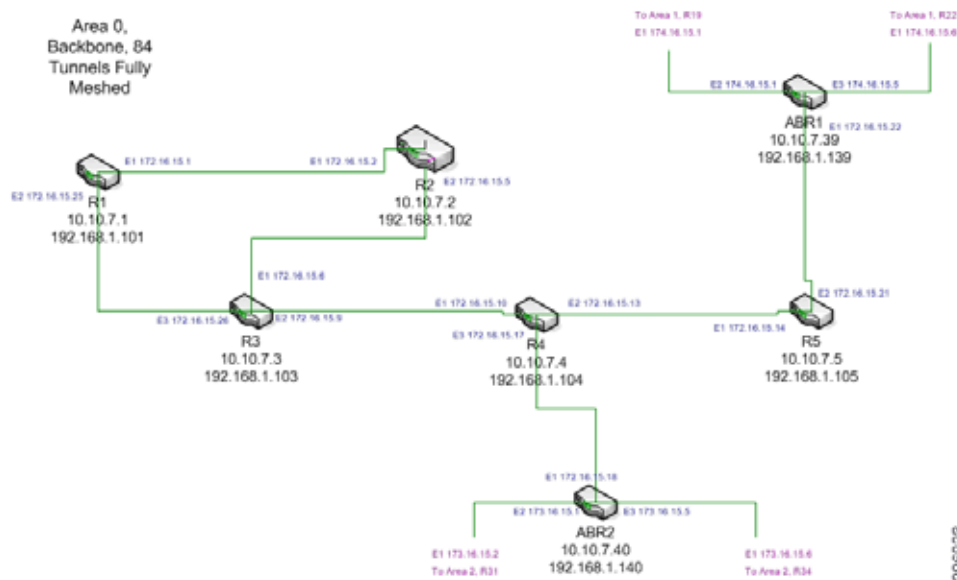

For more information about the discovery of multiple OSPF areas, see the [Cisco Prime Provisioning 7.0 User Guide](#).

## Service Request Examples

The following XML examples show a typical sequence of events from an API perspective, starting with the creation and deployment of a primary tunnel service request and followed by a short example of creating and deploying a backup tunnel service request.

They also demonstrate the kinds of properties that need to be specified for each request.

- [Create and Deploy TE Managed Primary Tunnel SR](#), page 10-10.
- [Create and Deploy Unmanaged Primary Tunnel SR](#), page 10-17.
- [Create and Deploy TE Backup Tunnel SR](#), page 10-18.
- [Create and Deploy TE Traffic Admission SR](#), page 10-19.

## Create and Deploy TE Managed Primary Tunnel SR

In this sequence of events, we go through the following steps:

1. [Create TE Managed Primary Tunnel SR](#).
2. [Create TE Managed Primary Tunnel SR Response](#).
3. [Request Performance Computation Status](#).
4. [Receive Computation Response](#).
5. [Save and Deploy Managed Primary Tunnel SR Request](#).
6. [Save and Deploy Managed Primary Tunnel SR Response](#).

## Create TE Managed Primary Tunnel SR

In this example, a managed primary tunnel is created. The request XML returns a response with a Computation ID. Using this Computation ID in the deployment XML, we can deploy the managed tunnel.

Example: CreateTeManagedTunnel.xml

```
<?xml version="1.0"?>
<soapenv:Envelope xmlns:ns0="http://www.cisco.com/cim-cx/2.0" xmlns:ns1="urn:CIM"
xmlns:soapenc="http://schemas.xmlsoap.org/soap/encoding/"
xmlns:soapenv="http://schemas.xmlsoap.org/soap/envelope/"
xmlns:xsd="http://www.w3.org/2001/XMLSchema"
xmlns:xsi="http://www.w3.org/2001/XMLSchema-instance">
  <soapenv:Header>
    <ns0:message id="87855" sessiontoken="p36bttjwy1"
timestamp="2002-12-13T14:55:38.885Z"/>
  </soapenv:Header>
  <soapenv:Body>
    <ns1:createInstance>
      <objectPath subAction="createInstance" xsi:type="ns1:CIMObjectPath">
        <className xsi:type="xsd:string">TeTunnelSr</className>
        <properties soapenc:arrayType="ns1:CIMProperty[]" xsi:type="ns1:CIMPropertyList">
          <item xsi:type="ns1:CIMProperty">
            <name xsi:type="xsd:string">RequestType</name>
            <value xsi:type="xsd:string">placement</value>
          </item>
          <item xsi:type="ns1:CIMProperty">
            <name xsi:type="xsd:string">TeProvider</name>
            <value xsi:type="xsd:string">te_provider1</value>
          </item>
        </properties>
      <objectPath subAction="createInstance" xsi:type="ns1:CIMObjectPath">
        <className xsi:type="xsd:string">TeTunnel</className>
        <properties soapenc:arrayType="ns1:CIMProperty[]"
xsi:type="ns1:CIMPropertyList">
          <item xsi:type="ns1:CIMProperty">
            <name xsi:type="xsd:string">HeadTeRouter</name>
            <value xsi:type="xsd:string">IOU-Area0-R1</value>
          </item>
          <item xsi:type="ns1:CIMProperty">
            <name xsi:type="xsd:string">TailTeRouter</name>
            <value xsi:type="xsd:string">IOU-Area0-R3</value>
          </item>
          <item xsi:type="ns1:CIMProperty">
            <name xsi:type="xsd:string">Bw</name>
            <value xsi:type="xsd:string">500</value>
          </item>
          <item xsi:type="ns1:CIMProperty">
            <name xsi:type="xsd:string">TePolicy</name>
            <value xsi:type="xsd:string">ISC-P184-IOU-ABR1:Tunnel1000</value>
          </item>
        </properties>
      <objectPath subAction="createInstance" xsi:type="ns1:CIMObjectPath">
        <className xsi:type="xsd:string">TePathOption</className>
        <properties soapenc:arrayType="ns1:CIMProperty[]"
xsi:type="ns1:CIMPropertyList">
          <item xsi:type="ns1:CIMProperty">
            <name xsi:type="xsd:string">PathOptionNumber</name>
            <value xsi:type="xsd:string">1</value>
          </item>
          <item xsi:type="ns1:CIMProperty">
            <name xsi:type="xsd:string">PathType</name>
```

```

        <value xsi:type="xsd:string">SYSTEM</value>
      </item>
    </properties>
  </objectPath>
</objectPath>
</objectPath>
</ns1:createInstance>
</soapenv:Body>
</soapenv:Envelope>

```

## Create TE Managed Primary Tunnel SR Response

The above create request generates the following XML response, which returns a Computation ID.

Example: DeployManagedTunnelComputationResponse.xml

```

<?xml version="1.0" encoding="UTF-8"?>
<soapenv:Envelope xmlns:soapenv="http://schemas.xmlsoap.org/soap/envelope/"
xmlns:soapenc="http://schemas.xmlsoap.org/soap/encoding/"
xmlns:xsd="http://www.w3.org/2001/XMLSchema"
xmlns:xsi="http://www.w3.org/2001/XMLSchema-instance"
xmlns:ns0="http://www.cisco.com/cim-cx/2.0" xmlns:ns1="urn:CIM">
  <soapenv:Header>
<ns0:message id="87855" sessiontoken="033A021898F763AF632D4914ECDB926E" />
  </soapenv:Header>
  <soapenv:Body>
    <ns1:createInstanceResponse>
      <returns xsi:type="ns1:CIMPropertyList" soapenc:arrayType="ns1:CIMProperty[]">
        <item xsi:type="ns1:CIMProperty">
          <name xsi:type="xsd:string">LocatorId</name>
          <value xsi:type="xsd:string">1</value>
        </item>
        <item xsi:type="ns1:CIMProperty">
          <name xsi:type="xsd:string">ComputationId</name>
          <value xsi:type="xsd:string">11fd0897b0d</value>
        </item>
      </returns>
    </ns1:createInstanceResponse>
  </soapenv:Body>
</soapenv:Envelope>

```

## Request Performance Computation Status

Using the Computation ID returned by the above XML response, the Computation ID can now be plugged into a request that goes to the server to check on the status of the computation.

Example: ViewTePrimaryPlanningRequest.xml

```

<?xml version="1.0" encoding="UTF-8"?>
<soapenv:Envelope xmlns:soapenv="http://schemas.xmlsoap.org/soap/envelope/"
xmlns:soapenc="http://schemas.xmlsoap.org/soap/encoding/"
xmlns:xsd="http://www.w3.org/2001/XMLSchema"
xmlns:xsi="http://www.w3.org/2001/XMLSchema-instance"
xmlns:ns0="http://www.cisco.com/cim-cx/2.0" xmlns:ns1="urn:CIM">
  <soapenv:Header>
    <ns0:message id="87855" timestamp="2002-12-13T14:55:38.885Z"
sessiontoken="p36bttjwy1" />
  </soapenv:Header>
  <soapenv:Body>
    <ns1:enumerateInstances>

```

```

    <objectPath xsi:type="ns1:CIMObjectPath">
      <className xsi:type="xsd:string">TeTunnelSr</className>
      <keyProperties xsi:type="ns1:CIMKeyPropertyList"
soapenc:arrayType="ns1:CIMKeyProperty[]">
        <item xsi:type="ns1:CIMKeyProperty">
          <name xsi:type="xsd:string">RequestType</name>
          <value xsi:type="xsd:string">viewPlanning</value>
        </item>
        <item xsi:type="ns1:CIMKeyProperty">
          <name xsi:type="xsd:string">ComputationId</name>
          <value xsi:type="xsd:string">11fd0897bod</value>
        </item>
      </keyProperties>
    </objectPath>
  </ns1:enumerateInstances>
</soapenv:Body>
</soapenv:Envelope>

```

## Receive Computation Response

Following the foregoing status request, the Prime Provisioning server will respond that it is still working on it. After the computation is finished, the server reports back whether it was a success or a failure. In this case we have a success.

Example: ViewPerformComputationResponse.xml

```

<?xml version="1.0"?>
<soapenv:Envelope xmlns:ns0="http://www.cisco.com/cim-cx/2.0" xmlns:ns1="urn:CIM"
xmlns:soapenc="http://schemas.xmlsoap.org/soap/encoding/"
xmlns:soapenv="http://schemas.xmlsoap.org/soap/envelope/"
xmlns:xsd="http://www.w3.org/2001/XMLSchema"
xmlns:xsi="http://www.w3.org/2001/XMLSchema-instance">
  <soapenv:Header>
    <ns0:message id="87855" sessiontoken="B7E5F6AFE29AA3B9FAA623CAFA3BE76E"
timestamp="2009-03-11T19:20:22.312Z"/>
  </soapenv:Header>
  <soapenv:Body>
    <ns1:enumerateInstancesResponse>
      <returns soapenc:arrayType="ns1:CIMReturn[]" xsi:type="ns1:CIMReturnList">
        <record>
          <objectPath xsi:type="ns1:CIMObjectPath">
            <className xsi:type="xsd:string">TeTunnelSr</className>
            <properties soapenc:arrayType="ns1:CIMProperty[]"
xsi:type="ns1:CIMPropertyList">
              <item xsi:type="ns1:CIMProperty">
                <name xsi:type="xsd:string">ComputationStatus</name>
                <value xsi:type="xsd:string">SUCCESS-SOLUTION_FOUND</value>
              </item>
            </properties>
          </objectPath>
          <objectPath xsi:type="ns1:CIMObjectPath">
            <className xsi:type="xsd:string">TeTunnel</className>
            <properties soapenc:arrayType="ns1:CIMProperty[]"
xsi:type="ns1:CIMPropertyList">
              <item xsi:type="ns1:CIMProperty">
                <name xsi:type="xsd:string">TailTeRouter</name>
                <value xsi:type="xsd:string">IOU-Area0-R3</value>
              </item>
              <item xsi:type="ns1:CIMProperty">
                <name xsi:type="xsd:string">OpType</name>
                <value xsi:type="xsd:string">ADD</value>
              </item>
            </properties>
          </objectPath>
        </record>
      </returns>
    </ns1:enumerateInstancesResponse>
  </soapenv:Body>
</soapenv:Envelope>

```

```

<item xsi:type="ns1:CIMProperty">
  <name xsi:type="xsd:string">HeadTeRouterId</name>
  <value xsi:type="xsd:string">5770</value>
</item>
<item xsi:type="ns1:CIMProperty">
  <name xsi:type="xsd:string">ElementStackId</name>
  <value xsi:type="xsd:string">ISC-P1</value>
</item>
<item xsi:type="ns1:CIMProperty">
  <name xsi:type="xsd:string">TailTeRouterId</name>
  <value xsi:type="xsd:string">5774</value>
</item>
<item xsi:type="ns1:CIMProperty">
  <name xsi:type="xsd:string">Conforming</name>
  <value xsi:type="xsd:string">>true</value>
</item>
<item xsi:type="ns1:CIMProperty">
  <name xsi:type="xsd:string">AdminStatus</name>
  <value xsi:type="xsd:string" />
</item>
<item xsi:type="ns1:CIMProperty">
  <name xsi:type="xsd:string">HeadTeRouter</name>
  <value xsi:type="xsd:string">IOU-Area0-R1</value>
</item>
<item xsi:type="ns1:CIMProperty">
  <name xsi:type="xsd:string">LspInUse</name>
  <value xsi:type="xsd:string" />
</item>
<item xsi:type="ns1:CIMProperty">
  <name xsi:type="xsd:string">TunnelNumber</name>
  <value xsi:type="xsd:string">1000</value>
</item>
<item xsi:type="ns1:CIMProperty">
  <name xsi:type="xsd:string">RouteServerVerified</name>
  <value xsi:type="xsd:string">1</value>
</item>
<item xsi:type="ns1:CIMProperty">
  <name xsi:type="xsd:string">RerouteEnabled</name>
  <value xsi:type="xsd:string">>true</value>
</item>
<item xsi:type="ns1:CIMProperty">
  <name xsi:type="xsd:string">State</name>
  <value xsi:type="xsd:string">REQUESTED</value>
</item>
<item xsi:type="ns1:CIMProperty">
  <name xsi:type="xsd:string">AutoBwEnabled</name>
  <value xsi:type="xsd:string">>false</value>
</item>
<item xsi:type="ns1:CIMProperty">
  <name xsi:type="xsd:string">TePolicy</name>
  <value xsi:type="xsd:string">ISC-P184-IOU-ABR1:Tunnel1000</value>
</item>
<item xsi:type="ns1:CIMProperty">
  <name xsi:type="xsd:string">Descriptor</name>
  <value xsi:type="xsd:string">ISC-P1</value>
</item>
<item xsi:type="ns1:CIMProperty">
  <name xsi:type="xsd:string">Bw</name>
  <value xsi:type="xsd:string">500</value>
</item>
<item xsi:type="ns1:CIMProperty">
  <name xsi:type="xsd:string">OperationStatus</name>
  <value xsi:type="xsd:string" />
</item>

```

```

        <item xsi:type="ns1:CIMProperty">
          <name xsi:type="xsd:string">ChangeAchieved</name>
          <value xsi:type="xsd:string">All</value>
        </item>
        <item xsi:type="ns1:CIMProperty">
          <name xsi:type="xsd:string">ChangeType</name>
          <value xsi:type="xsd:string">Tunnel Add Change</value>
        </item>
        <item xsi:type="ns1:CIMProperty">
          <name xsi:type="xsd:string">ChangeOrigin</name>
          <value xsi:type="xsd:string">Compute</value>
        </item>
      </properties>
    <objectPath xsi:type="ns1:CIMObjectPath">
      <className xsi:type="xsd:string">TePathOption</className>
      <properties soapenc:arrayType="ns1:CIMProperty[]"
xsi:type="ns1:CIMPropertyList">
        <item xsi:type="ns1:CIMProperty">
          <name xsi:type="xsd:string">LockdownEnabled</name>
          <value xsi:type="xsd:string">>false</value>
        </item>
        <item xsi:type="ns1:CIMProperty">
          <name xsi:type="xsd:string">PathOptionNumber</name>
          <value xsi:type="xsd:string">1</value>
        </item>
        <item xsi:type="ns1:CIMProperty">
          <name xsi:type="xsd:string">PathType</name>
          <value xsi:type="xsd:string">SYSTEM</value>
        </item>
      </properties>
    </objectPath>
  </objectPath>
</objectPath>
</record>
</returns>
</ns1:enumerateInstancesResponse>
</soapenv:Body>
</soapenv:Envelope>

```

## Save and Deploy Managed Primary Tunnel SR Request

Based on the successful computation in the previous example, we can now use the Computation ID to save and deploy the service request that represents the solution computed by the Prime Provisioning server. After it has run, it returns the subsequent `deployManagedComputation.xml` response.

Example: `DeployManagedTunnelComputationRequest.xml`

```

<?xml version="1.0"?>
<soapenv:Envelope xmlns:ns0="http://www.cisco.com/cim-cx/2.0" xmlns:ns1="urn:CIM"
xmlns:soapenc="http://schemas.xmlsoap.org/soap/encoding/"
xmlns:soapenv="http://schemas.xmlsoap.org/soap/envelope/"
xmlns:xsd="http://www.w3.org/2001/XMLSchema"
xmlns:xsi="http://www.w3.org/2001/XMLSchema-instance">
  <soapenv:Header>
    <ns0:message Wait="false" WaitTimeout="60" id="87855"
sessiontoken="18E1AEAA851F25B08DE5B1CA6C9E59E6" timestamp="2002-12-13T14:55:38.885Z"/>
  </soapenv:Header>
  <soapenv:Body>
    <ns1:performBatchOperation>
      <actions soapenc:arrayType="ns1:CIMAction[]" xsi:type="ns1:CIMActionList">
        <action>

```

```

    <actionName xsi:type="xsd:string">createInstance</actionName>
    <objectPath xsi:type="ns1:CIMObjectPath">
      <className xsi:type="xsd:string">ServiceOrder</className>
      <properties soapenc:arrayType="ns1:CIMProperty[]"
xsi:type="ns1:CIMPropertyList">
        <item xsi:type="ns1:CIMProperty">
          <name xsi:type="xsd:string">ServiceName</name>
          <value xsi:type="xsd:string">SAVE_AND_DEPLOY</value>
        </item>
        <item xsi:type="ns1:CIMProperty">
          <name xsi:type="xsd:string">CarrierId</name>
          <value xsi:type="xsd:string">101</value>
        </item>
        <item xsi:type="ns1:CIMProperty">
          <name xsi:type="xsd:string">DesiredDueDate</name>
          <value xsi:type="xsd:dateTime">2003-12-14T14:55:38.885Z</value>
        </item>
        <item xsi:type="ns1:CIMProperty">
          <name xsi:type="xsd:string">NumberOfRequests</name>
          <value xsi:type="xsd:string">1</value>
        </item>
      </properties>
    </objectPath>
  </action>
  <action>
    <actionName xsi:type="xsd:string">createInstance</actionName>
    <objectPath xsi:type="ns1:CIMObjectPath">
      <className xsi:type="xsd:string">ServiceRequest</className>
      <properties soapenc:arrayType="ns1:CIMProperty[]"
xsi:type="ns1:CIMPropertyList">
        <item xsi:type="ns1:CIMProperty">
          <name xsi:type="xsd:string">RequestName</name>
          <value xsi:type="xsd:string">SAVE_AND_DEPLOY</value>
        </item>
        <item xsi:type="ns1:CIMProperty">
          <name xsi:type="xsd:string">Type</name>
          <value xsi:type="xsd:string">Task</value>
        </item>
      </properties>
    <objectPath xsi:type="ns1:CIMObjectPath">
      <className xsi:type="xsd:string">ServiceRequestDetails</className>
      <properties soapenc:arrayType="ns1:CIMProperty[]"
xsi:type="ns1:CIMPropertyList">
        <item xsi:type="ns1:CIMProperty">
          <name xsi:type="xsd:string">SubType</name>
          <value xsi:type="xsd:string">SAVE_AND_DEPLOY</value>
        </item>
        <item xsi:type="ns1:CIMProperty">
          <name xsi:type="xsd:string">ComputationId</name>
          <value xsi:type="xsd:string">11fd0897bod</value>
        </item>
      </properties>
    </objectPath>
  </action>
</actions>
</ns1:performBatchOperation>
</soapenv:Body>
</soapenv:Envelope>

```



## Save and Deploy Managed Primary Tunnel SR Response

In response to the foregoing deployment request, the following example executes the deployment based on the provided Computation ID.

Example: DeployManagedTunnelComputationResponse.xml

```
<?xml version="1.0"?>
soapenv:Envelope xmlns:ns0="http://www.cisco.com/cim-cx/2.0" xmlns:ns1="urn:CIM"
xmlns:soapenc="http://schemas.xmlsoap.org/soap/encoding/"
xmlns:soapenv="http://schemas.xmlsoap.org/soap/envelope/"
xmlns:xsd="http://www.w3.org/2001/XMLSchema"
xmlns:xsi="http://www.w3.org/2001/XMLSchema-instance">
  <soapenv:Header>
    <ns0:message id="87855" sessiontoken="B7E5F6AFE29AA3B9FAA623CAFA3BE76E"
timestamp="2009-03-11T19:20:23.487Z" wait="false" waittimeout="60"/>
  </soapenv:Header>
  <soapenv:Body>
    <ns1:performBatchOperationResponse>
      <returns soapenc:arrayType="ns1:CIMActionResponse[]"
xsi:type="ns1:CIMActionResponseList">
        <actionResponse>
          <actionName xsi:type="xsd:string">createInstanceResponse</actionName>
          <objectPath xsi:type="ns1:CIMObjectPath">
            <className xsi:type="xsd:string">ServiceOrder</className>
            <properties soapenc:arrayType="ns1:CIMProperty[]"
xsi:type="ns1:CIMPropertyList">
              <item xsi:type="ns1:CIMProperty">
                <name xsi:type="xsd:string">LocatorId</name>
                <value xsi:type="xsd:string">384</value>
              </item>
              <item xsi:type="ns1:CIMProperty">
                <name xsi:type="xsd:string">ServiceName</name>
                <value xsi:type="xsd:string">SAVE_AND_DEPLOY</value>
              </item>
            </properties>
          </objectPath>
        </actionResponse>
        <actionResponse>
          <actionName xsi:type="xsd:string">createInstanceResponse</actionName>
          <objectPath xsi:type="ns1:CIMObjectPath">
            <className xsi:type="xsd:string">ServiceRequest</className>
            <properties soapenc:arrayType="ns1:CIMProperty[]"
xsi:type="ns1:CIMPropertyList">
              <item xsi:type="ns1:CIMProperty">
                <name xsi:type="xsd:string">RequestName</name>
                <value xsi:type="xsd:string">SAVE_AND_DEPLOY</value>
              </item>
            </properties>
          </objectPath>
        </actionResponse>
      </returns>
    </ns1:performBatchOperationResponse>
  </soapenv:Body>
</soapenv:Envelope>
```

## Create and Deploy Unmanaged Primary Tunnel SR

Unmanaged tunnels are provisioned in the same manner as backup tunnels. See the [Cisco Prime Provisioning API 7.0 Programmer Reference](#) for XML examples.



```

        <item xsi:type="ns1:CIMProperty">
          <name xsi:type="xsd:string">PathName</name>
          <value xsi:type="xsd:string"> IOU-Area0-R3-IOU-Area0-R5-1</value>
        </item>
        <item xsi:type="ns1:CIMProperty">
          <name xsi:type="xsd:string">PathType</name>
          <value xsi:type="xsd:string">EXPLICIT</value>
        </item>
      </properties>
    </objectPath>
  </objectPath>
</ns1:createInstance>
</soapenv:Body>
</soapenv:Envelope>

```

## Backup Tunnel SR Response

The following is an example of a response to the backup tunnel service request.

Example: DeployTeBackupTunnel.xml

```

<?xml version="1.0" encoding="UTF-8"?>
<soapenv:Envelope xmlns:soapenv="http://schemas.xmlsoap.org/soap/envelope/"
xmlns:soapenc="http://schemas.xmlsoap.org/soap/encoding/"
xmlns:xsd="http://www.w3.org/2001/XMLSchema"
xmlns:xsi="http://www.w3.org/2001/XMLSchema-instance"
xmlns:ns0="http://www.cisco.com/cim-cx/2.0" xmlns:ns1="urn:CIM">
  <soapenv:Header>
    <ns0:message id="87855" sessiontoken="3A2F67CAFDA12EBEFF773EF55573A17A" />
  </soapenv:Header>
  <soapenv:Body>
    <ns1:createInstanceResponse>
      <returns xsi:type="ns1:CIMPropertyList" soapenc:arrayType="ns1:CIMProperty[]">
        <item xsi:type="ns1:CIMProperty">
          <name xsi:type="xsd:string">LocatorId</name>
          <value xsi:type="xsd:string">19</value>
        </item>
      </returns>
    </ns1:createInstanceResponse>
  </soapenv:Body>
</soapenv:Envelope>

```

## Create and Deploy TE Traffic Admission SR

Based on the Locator ID, you can now use a TE Traffic Admission service request to enable services on the created tunnel.

This involves the following steps:

1. [Create TE Traffic Admission SR Request.](#)
2. [Create TE Traffic Admission SR Response.](#)
3. [Save and Deploy TE Traffic Admission SR Request.](#)
4. [Save and Deploy TE Traffic Admission SR Response.](#)

## Create TE Traffic Admission SR Request

In this example, a TE Traffic Admission service request is created to provision a TE Tunnel.

Example: CreateTeAdmissionSrCBTSRequest.xml

```
<?xml version="1.0" encoding="UTF-8"?>
<soapenv:Envelope
  xmlns:soapenv="http://schemas.xmlsoap.org/soap/envelope/"
  xmlns:soapenc="http://schemas.xmlsoap.org/soap/encoding/"
  xmlns:xsd="http://www.w3.org/2001/XMLSchema"
  xmlns:xsi="http://www.w3.org/2001/XMLSchema-instance"
  xmlns:ns0="http://www.cisco.com/cim-cx/2.0"
  xmlns:ns1="urn:CIM">
  <soapenv:Header>
    <ns0:message id="87855" timestamp="2002-12-13T14:55:38.885Z"
      sessiontoken="343BDF4AEB6A7A4F5D1A24FBF3EC9A50"/>
  </soapenv:Header>
  <soapenv:Body>
    <ns1:createInstance>
      <objectPath xsi:type="ns1:CIMObjectPath">
        <className xsi:type="xsd:string">TeAdmissionSr</className>
        <properties xsi:type="ns1:CIMPropertyList"
          soapenc:arrayType="ns1:CIMProperty[]">
          <item xsi:type="ns1:CIMProperty">
            <name xsi:type="xsd:string">Description</name>
            <value xsi:type="xsd:string">Provider1:nw1-r4-7206-g1:1017</value>
          </item>
          <item xsi:type="ns1:CIMProperty">
            <name xsi:type="xsd:string">TeRouterHostname</name>
            <value xsi:type="xsd:string">nw1-r4-7206-g1</value>
          </item>
          <item xsi:type="ns1:CIMProperty">
            <name xsi:type="xsd:string">TunnelNumber</name>
            <value xsi:type="xsd:string">1017</value>
          </item>
          <item xsi:type="ns1:CIMProperty">
            <name xsi:type="xsd:string">EXPMarking</name>
            <value xsi:type="xsd:string">0 2 4 6</value>
          </item>
          <item xsi:type="ns1:CIMProperty">
            <name xsi:type="xsd:string">TeProvider</name>
            <value xsi:type="xsd:string">Provider1</value>
          </item>
          <item xsi:type="ns1:CIMProperty">
            <name xsi:type="xsd:string">Metric</name>
            <value xsi:type="xsd:string">6</value>
          </item>
          <item xsi:type="ns1:CIMProperty">
            <name xsi:type="xsd:string">MetricType</name>
            <value xsi:type="xsd:string">2</value>
          </item>
          <item xsi:type="ns1:CIMProperty">
            <name xsi:type="xsd:string">AutoRouteAnnounceEnabled</name>
            <value xsi:type="xsd:string">true</value>
          </item>
        </properties>
      </objectPath>
    </ns1:createInstance>
  </soapenv:Body>
</soapenv:Envelope>
```

## Create TE Traffic Admission SR Response

If the service request is successful, the response provides a Locator ID needed for the subsequent deployment step.

Example: CreateTeAdmissionSrCBTSResponse.xml

```
<?xml version="1.0" encoding="UTF-8"?>
<soapenv:Envelope xmlns:soapenv="http://schemas.xmlsoap.org/soap/envelope/"
xmlns:soapenc="http://schemas.xmlsoap.org/soap/encoding/"
xmlns:xsd="http://www.w3.org/2001/XMLSchema"
xmlns:xsi="http://www.w3.org/2001/XMLSchema-instance"
xmlns:ns0="http://www.cisco.com/cim-cx/2.0" xmlns:ns1="urn:CIM">
  <soapenv:Header>
    <ns0:message id="87855" sessiontoken="343BDF4AEB6A7A4F5D1A24FBF3EC9A50"
timestamp="2006-10-09T17:46:42.677Z" />
  </soapenv:Header>
  <soapenv:Body>
    <ns1:createInstanceResponse>
      <returns xsi:type="ns1:CIMPropertyList" soapenc:arrayType="ns1:CIMProperty[]" >
        <item xsi:type="ns1:CIMProperty">
          <name xsi:type="xsd:string">LocatorId</name>
          <value xsi:type="xsd:string">22</value>
        </item>
      </returns>
    </ns1:createInstanceResponse>
  </soapenv:Body>
</soapenv:Envelope>
```

## Save and Deploy TE Traffic Admission SR Request

Run the following XML to save and deploy the TE Traffic Admission service request and have it provisioned on the device.

Example: DeployTeAdmissionSrRequest.xml

```
<?xml version="1.0"?>
<soapenv:Envelope xmlns:ns0="http://www.cisco.com/cim-cx/2.0" xmlns:ns1="urn:CIM"
xmlns:soapenc="http://schemas.xmlsoap.org/soap/encoding/"
xmlns:soapenv="http://schemas.xmlsoap.org/soap/envelope/"
xmlns:xsd="http://www.w3.org/2001/XMLSchema"
xmlns:xsi="http://www.w3.org/2001/XMLSchema-instance">
  <soapenv:Header>
    <ns0:message Wait="false" WaitTimeout="60" id="87855" sessiontoken="p36bttjwy1"
timestamp="2002-12-13T14:55:38.885Z" />
  </soapenv:Header>
  <soapenv:Body>
    <ns1:performBatchOperation>
      <actions soapenc:arrayType="ns1:CIMAction[]" xsi:type="ns1:CIMActionList">
        <action>
          <actionName xsi:type="xsd:string">createInstance</actionName>
          <objectPath xsi:type="ns1:CIMObjectPath">
            <className xsi:type="xsd:string">ServiceOrder</className>
            <properties soapenc:arrayType="ns1:CIMProperty[]" xsi:type="ns1:CIMPropertyList">
              <item xsi:type="ns1:CIMProperty">
                <name xsi:type="xsd:string">ServiceName</name>
                <value xsi:type="xsd:string">TEM-TRADM-CBTS-PROV-001</value>
              </item>
              <item xsi:type="ns1:CIMProperty">
                <name xsi:type="xsd:string">CarrierId</name>
                <value xsi:type="xsd:string">10</value>
              </item>
            </properties>
          </objectPath>
        </action>
      </actions>
    </ns1:performBatchOperation>
  </soapenv:Body>
</soapenv:Envelope>
```

```

</item>
<item xsi:type="ns1:CIMProperty">
  <name xsi:type="xsd:string">DesiredDueDate</name>
  <value xsi:type="xsd:dateTime">2002-12-14T14:55:38.885Z</value>
</item>
<item xsi:type="ns1:CIMProperty">
  <name xsi:type="xsd:string">NumberOfRequests</name>
  <value xsi:type="xsd:string">1</value>
</item>
</properties>
</objectPath>
</action>
<action>
  <actionName xsi:type="xsd:string">createInstance</actionName>
  <objectPath xsi:type="ns1:CIMObjectPath">
    <className xsi:type="xsd:string">ServiceRequest</className>
    <properties soapenc:arrayType="ns1:CIMProperty[]" xsi:type="ns1:CIMPropertyList">
      <item xsi:type="ns1:CIMProperty">
        <name xsi:type="xsd:string">RequestName</name>
        <value xsi:type="xsd:string">DEPLOYMENT-TASK</value>
      </item>
      <item xsi:type="ns1:CIMProperty">
        <name xsi:type="xsd:string">Type</name>
        <value xsi:type="xsd:string">Task</value>
      </item>
    </properties>
  </objectPath xsi:type="ns1:CIMObjectPath">
    <className xsi:type="xsd:string">ServiceRequestDetails</className>
    <properties soapenc:arrayType="ns1:CIMProperty[]" xsi:type="ns1:CIMPropertyList">
      <item xsi:type="ns1:CIMProperty">
        <name xsi:type="xsd:string">SubType</name>
        <value xsi:type="xsd:string">DEPLOYMENT</value>
      </item>
      <item xsi:type="ns1:CIMProperty">
        <name xsi:type="xsd:string">LocatorId</name>
        <value xsi:type="xsd:string">22</value>
      </item>
      <item xsi:type="ns1:CIMProperty">
        <name xsi:type="xsd:string">ForceDeploy</name>
        <value xsi:type="xsd:string">>false</value>
      </item>
      <item xsi:type="ns1:CIMProperty">
        <name xsi:type="xsd:string">Audit</name>
        <value xsi:type="xsd:string">ForceAudit</value>
      </item>
    </properties>
  </objectPath>
</objectPath>
</action>
</actions>
</ns1:performBatchOperation>
</soapenv:Body>
</soapenv:Envelope>

```

## Save and Deploy TE Traffic Admission SR Response

After the TE Traffic Admission service request has been processed, a response is returned.

Example: DeployTeAdmissionSrResponse.xml

```
<?xml version="1.0"?>
```

```

<soapenv:Envelope xmlns:ns0="http://www.cisco.com/cim-cx/2.0" xmlns:ns1="urn:CIM"
xmlns:soapenc="http://schemas.xmlsoap.org/soap/encoding/"
xmlns:soapenv="http://schemas.xmlsoap.org/soap/envelope/"
xmlns:xsd="http://www.w3.org/2001/XMLSchema"
xmlns:xsi="http://www.w3.org/2001/XMLSchema-instance">
  <soapenv:Header>
    <ns0:message id="87855" sessiontoken="B7E5F6AFE29AA3B9FAA623CAFA3BE76E"
timestamp="2009-03-11T21:34:48.808Z" wait="false" waittimeout="60"/>
  </soapenv:Header>
  <soapenv:Body>
    <ns1:performBatchOperationResponse>
      <returns soapenc:arrayType="ns1:CIMActionResponse[]"
xsi:type="ns1:CIMActionResponseList">
        <actionResponse>
          <actionName xsi:type="xsd:string">createInstanceResponse</actionName>
          <objectPath xsi:type="ns1:CIMObjectPath">
            <className xsi:type="xsd:string">ServiceOrder</className>
            <properties soapenc:arrayType="ns1:CIMProperty[]"
xsi:type="ns1:CIMPropertyList">
              <item xsi:type="ns1:CIMProperty">
                <name xsi:type="xsd:string">LocatorId</name>
                <value xsi:type="xsd:string">22</value>
              </item>
              <item xsi:type="ns1:CIMProperty">
                <name xsi:type="xsd:string">ServiceName</name>
                <value xsi:type="xsd:string">TEM-TRADM-CBTS-PROV-001</value>
              </item>
            </properties>
          </objectPath>
        </actionResponse>
        <actionResponse>
          <actionName xsi:type="xsd:string">createInstanceResponse</actionName>
          <objectPath xsi:type="ns1:CIMObjectPath">
            <className xsi:type="xsd:string">ServiceRequest</className>
            <properties soapenc:arrayType="ns1:CIMProperty[]"
xsi:type="ns1:CIMPropertyList">
              <item xsi:type="ns1:CIMProperty">
                <name xsi:type="xsd:string">RequestName</name>
                <value xsi:type="xsd:string">DEPLOYMENT-TASK</value>
              </item>
            </properties>
          </objectPath>
        </actionResponse>
      </returns>
    </ns1:performBatchOperationResponse>
  </soapenv:Body>
</soapenv:Envelope>

```

After this response has been received, the TE Traffic Admission service request will be in the Requested state in Prime Provisioning. It now needs to be saved and deployed to actually be provisioned on the device.



#### Note

TE Traffic Admission SR's are deleted and unprovisioned from a device by first decommissioning the TE Traffic Admission service request and then saving and deploying the same service request. By saving and deploying the service request after decommissioning it, the TE Traffic Admission configuration is removed from the device. Force Purge will only remove the TE Traffic Admission service request from Prime Provisioning's database; it will not remove the configuration from the device.

## Provisioning Example

This section describes the process for using the API to provision TEM, and includes the required operation, object definition (className), and parameter definitions.

This section contains the following:

- [Process Summary, page 10-24](#)
- [Provisioning Process, page 10-24](#)
- [Using Computation ID and Locator ID, page 10-29](#)
- [Planning Tools, page 10-29](#)
- [Auditing Service Requests, page 10-31.](#)

## Process Summary

This TEM provisioning example documents the following process:

1. Create provider.
2. Create regions.
3. Create seed device.
4. Create TE provider.
5. Create and run TE Discovery task.
6. Create service definition (policy).
7. Create explicit path.
8. Create managed primary tunnel.
9. Create service request.

## Provisioning Process

To provision TEM using Prime Provisioning APIs, a TEM service definition (policy) and a TEM service request are required.

This section describes the process for provisioning TEM using XML examples.

The complete list of XML examples for TEM is available here:

[Cisco Prime Provisioning API 7.0 Programmer Reference](#)



### Note

For clarity, this provisioning process shows each step as a separate XML request. Many of these steps can be combined using **performBatchOperations**.

### Step 1 Create a provider.

The provider is the administrative domain of an ISP, with one BGP autonomous system (AS) number. The network owned by the provider is called the backbone network. If an ISP has two AS numbers, you must define it as two provider administrative domains.

Use the TeAreaIdentifier parameter to define OSPF areas and for discovering multiple OSPF areas.



**Table 10-1** Create a Provider

Operation	className	Required Parameters
createInstance	Provider	<ul style="list-style-type: none"> <li>Name</li> <li>AsNumber</li> <li>TeAreaIdentifier (optional)</li> </ul>

**XML Examples:**

ISCPProviderCreateRequest.xml

- Step 2** Create regions.  
Each provider can contain multiple regions.

**Table 10-2** Create a Region

Operation	className	Required Parameters
createInstance	Region	<ul style="list-style-type: none"> <li>Name</li> <li>Provider</li> </ul>

**XML Examples:**

ISCDefaultRegionCreateRequest.xml

- Step 3** Create a seed device.  
This IOS or IOS XR device will be the seed router for TE Discovery. The network discovery process uses the seed router as an initial communication point to discover the MPLS TE network topology.

**Table 10-3** Create a Seed Device

Operation	className	Required Parameters
createInstance	CiscoRouter	<ul style="list-style-type: none"> <li>HostName</li> <li>Login</li> <li>Password</li> <li>EnablePassword</li> <li>SnmpRo</li> <li>SnmpRw</li> </ul>

**XML Examples:**

ISCSeedRouterCreateRequest.xml

- Step 4** Create a TE provider.

Providers can be defined as TE provider, if they are supporting MPLS TE in their network. To enable a TE network to be managed, it is necessary to create a TE provider. All TE related data associated with a given network is stored under a unique TE provider. A provider and region uniquely define a TE provider .

**Table 10-4** Create a TE Provider

Operation	className	Required Parameters
createInstance	TeProvider	<ul style="list-style-type: none"> <li>• PrimaryRgTimeout</li> <li>• Provider</li> <li>• DefaultRegion</li> <li>• BackupRgTimeout</li> <li>• MinBwLimit</li> <li>• MaxTunnelCount</li> <li>• FrrProtectionType</li> </ul>

**XML Examples:**

- ISCTEProviderCreateRequest.xml

**Step 5** Run a TE Full Discovery task.

Discover the TE network for a particular TE provider to populate the repository with a view to creating primary and backup tunnels.

**Table 10-5** Create a TE Full Discovery Task

Operation	className	Required Parameters
createInstance	Discovery	<ul style="list-style-type: none"> <li>• DesiredDueDate</li> <li>• TeProvider</li> <li>• SeedRouter</li> </ul>

**XML Examples:**

- TEDiscoveryTaskCreateRequest.xml
- incremetal\_discovery\_device
- incremetal\_discovery\_link

**Step 6** Create service definition (policy).

Service definitions or policies are used to define common tunnel attributes.

**Table 10-6** Create a TEM Service Definition (Policy)

Operation	className	Required Parameters
createInstance	ServiceDefinition	<ul style="list-style-type: none"> <li>Name</li> <li>Type</li> <li>Provider</li> </ul>
	ServiceDefinitionDetails	<ul style="list-style-type: none"> <li>TeProvider</li> <li>Name</li> <li>HoldPriority</li> <li>FrrProtectionLevel</li> <li>LinkAffinityMask</li> <li>SetupPriority</li> <li>LinkAffinity</li> <li>BandwidthPoolType</li> </ul>

**XML Examples:**

- TeManagedPolicyCreateRequest.xml
- TeUnmanagedPolicyCreateRequest.xml.

**Step 7** Create explicit path.

Paths are defined between source and destination routers, possibly with one or more hops in between. For managed tunnels, the path should not contain any non-TE enabled interfaces.

**Table 10-7** Create an Explicit Path

Operation	className	Required Parameters
createInstance	TeExplicitPath	<ul style="list-style-type: none"> <li>TeExpPathType</li> <li>PathName</li> <li>TeProvider</li> <li>HeadTeRouter</li> <li>Provisioning-Pref</li> </ul>
	TeLspHop	<ul style="list-style-type: none"> <li>TeLspHopType</li> <li>IpAddress</li> </ul>

**XML Examples:**

- TeExplicitPathExcludeCreateRequest.xml

**Step 8** Create a managed primary tunnel.

Once a TE Policy and an explicit path have been set up, a primary tunnel can be created. The process is very similar for managed and unmanaged tunnels.

**Table 10-8** Create a Managed Primary Tunnel

Operation	className	Required Parameters
createInstance	TeTunnelSr	<ul style="list-style-type: none"> <li>RequestType</li> <li>TeProvider</li> </ul>
	TeTunnel	<ul style="list-style-type: none"> <li>HeadTeRouter</li> <li>TailTeRouter</li> <li>Bw</li> <li>TePolicy</li> </ul>
	TePathOption	<ul style="list-style-type: none"> <li>PathOptionNumber</li> <li>PathType</li> </ul>

**XML Examples:**

- CreateManagedTunnel.xml

**Step 9** Create service request.

A TE service request defines the service definition and assigns interfaces and attributes.

**Table 10-9** Create a TE Service Request

Operation	className	Required Parameters
createInstance	ServiceOrder	<ul style="list-style-type: none"> <li>ServiceName</li> <li>DesiredDueDate</li> <li>NumberOfRequests</li> </ul>
	ServiceRequest	<ul style="list-style-type: none"> <li>RequestName</li> <li>Type=Task</li> <li>ServiceRequestDetails</li> </ul>
	ServiceRequestDetails	<ul style="list-style-type: none"> <li>SubType</li> <li>ComputationId</li> </ul>

**Tip**

Record the **LocatorId** value from the XML response for the service request. The Locator ID is required for subsequent service request tasks.

**XML Example:**

- SaveAndDeployPlanningRequest.xml

## Using Computation ID and Locator ID

The ComputationID is returned by TEM for certain processes and is as important as the Locator ID.

Locator ID refers to a service request object in Prime Provisioning that you are working on, whereas Computation ID refers to a server computation that must be completed satisfactorily before you can work with the service request object (Locator ID) again. The Computation ID is returned by an API request that requires server input, for example any managed tunnel operations.

Examples of how the Computation ID and Locator ID are used are found in the section [Service Request Examples, page 10-10](#).

## Planning Tools

Planning Tools, also referred to as Placement Tools, are used to perform planning functions on the existing network. They are intended for evaluating planned improvements to a traffic-engineered network based on What-If scenarios.

At the present time, most of these tools do not have API support (except [Compute Backup, page 10-29](#)) but can be activated from the GUI. See the [Cisco Prime Provisioning 7.0 User Guide](#) under Advanced Primary Tunnel Management and Protection Planning.

The planning tools include the following features:

- Primary planning tools:
  - Tunnel Audit—Audits for inconsistencies in primary placement on the existing network with or without proposed tunnel or resource changes.
  - Tunnel Placement—Usually for new tunnels. Tunnel Placement can generate a new route. It can be used for a tunnel that did not have a path before and needs to be placed.
  - Tunnel Repair—Logically performed after Tunnel Audit (if something is wrong). Tunnel Repair has rerouting capabilities and can be used to move tunnels.
  - Grooming—An optimization tool that works on the whole network. It is only available when no tunnel attributes have been changed.
- Protection planning tools:
  - Audit SR—Audits protection for manually added, modified, and deleted backup tunnels before they are deployed.
  - Compute Backup—Automatically calculates the optimal backup tunnel for selected network elements.
  - Audit Protection—Audits protection of the selected elements against the existing backup tunnels.

## Compute Backup

Compute Backup is used to let TEM automatically compute the necessary backup tunnels to protect specified network elements.

The Compute Backup examples are found in the [Cisco Prime Provisioning 7.0 User Guide](#) in the `tem\TeProtectedElements` folder.

The following example shows how Compute Backup is performed for a TE node.

Example: `CreateTeProtectedElementNode.xml`

```

<?xml version="1.0"?>
<soapenv:Envelope xmlns:ns0="http://www.cisco.com/cim-cx/2.0" xmlns:ns1="urn:CIM"
xmlns:soapenc="http://schemas.xmlsoap.org/soap/encoding/"
xmlns:soapenv="http://schemas.xmlsoap.org/soap/envelope/"
xmlns:xsd="http://www.w3.org/2001/XMLSchema"
xmlns:xsi="http://www.w3.org/2001/XMLSchema-instance">
  <soapenv:Header>
    <ns0:message Wait="false" WaitTimeout="60" id="87855" sessiontoken="p36bttjwy1"
timestamp="2002-12-13T14:55:38.885Z"/>
  </soapenv:Header>
  <soapenv:Body>
    <ns1:performBatchOperation>
      <actions soapenc:arrayType="ns1:CIMAction[]" xsi:type="ns1:CIMActionList">
        <action>
          <actionName xsi:type="xsd:string">createInstance</actionName>
          <objectPath xsi:type="ns1:CIMObjectPath">
            <className xsi:type="xsd:string">ServiceOrder</className>
            <properties soapenc:arrayType="ns1:CIMProperty[]" xsi:type="ns1:CIMPropertyList">
              <item xsi:type="ns1:CIMProperty">
                <name xsi:type="xsd:string">ServiceName</name>
                <value xsi:type="xsd:string">TEM-IOX-TRADM-VX.X-014</value>
              </item>
              <item xsi:type="ns1:CIMProperty">
                <name xsi:type="xsd:string">CarrierId</name>
                <value xsi:type="xsd:string">10</value>
              </item>
              <item xsi:type="ns1:CIMProperty">
                <name xsi:type="xsd:string">DesiredDueDate</name>
                <value xsi:type="xsd:dateTime">2002-12-14T14:55:38.885Z</value>
              </item>
              <item xsi:type="ns1:CIMProperty">
                <name xsi:type="xsd:string">NumberOfRequests</name>
                <value xsi:type="xsd:string">1</value>
              </item>
            </properties>
          </objectPath>
        </action>
        <action>
          <actionName xsi:type="xsd:string">createInstance</actionName>
          <objectPath subAction="modifyInstance" xsi:type="ns1:CIMObjectPath">
            <className xsi:type="xsd:string">TeBrTunnelSr</className>
            <keyProperties soapenc:arrayType="ns1:CIMProperty[]" xsi:type="ns1:CIMKeyPropertyList">
              <item xsi:type="ns1:CIMProperty">
                <name xsi:type="xsd:string">TeProvider</name>
                <value xsi:type="xsd:string">Provider1</value>
              </item>
            </keyProperties>
            <properties soapenc:arrayType="ns1:CIMProperty[]" xsi:type="ns1:CIMPropertyList">
              <item xsi:type="ns1:CIMProperty">
                <name xsi:type="xsd:string">RequestType</name>
                <value xsi:type="xsd:string">computeBackup</value>
              </item>
            </properties>
          <objectPath subAction="createInstance" xsi:type="ns1:CIMObjectPath">
            <className xsi:type="xsd:string">TeProtectedElement</className>
            <properties soapenc:arrayType="ns1:CIMProperty[]" xsi:type="ns1:CIMPropertyList">
              <item xsi:type="ns1:CIMProperty">
                <name xsi:type="xsd:string">Type</name>
                <value xsi:type="xsd:string">NODE</value>
              </item>
              <item xsi:type="ns1:CIMProperty">
                <name xsi:type="xsd:string">Name</name>
                <value xsi:type="xsd:string">nw1-r4-7206-g1</value>
              </item>
            </properties>
          </objectPath>
        </action>
      </actions>
    </ns1:performBatchOperation>
  </soapenv:Body>
</soapenv:Envelope>

```

```
</properties>
</objectPath>
</objectPath>
</action>
  </actions>
  </ns1:performBatchOperation>
</soapenv:Body>
</soapenv:Envelope>
```

## Auditing Service Requests

A configuration audit occurs automatically each time you deploy a service request. During this configuration audit, Prime Provisioning verifies that all Cisco IOS commands are present and that they have the correct syntax. An audit also verifies that there were no errors during deployment by examining the commands configured by the service request on the target devices. If the device configuration does not match what is defined in the service request, the audit flags a warning and sets the service request to a *Failed Audit* or *Lost* state.

If you do not want the configuration audit to occur, change the value for the **Audit** parameter. The **Audit** parameter supports these values:

- **Audit**—This is the default. A successfully deployed service request is automatically audited unless this flag is changed.
- **NoAudit**—Do not perform a configuration audit when the service request is deployed.
- **ForceAudit**—Perform a configuration audit even if the service request deployment is not successful.

You can use the **Audit** parameter with a **Create**, **Modify**, or **Decommission** service request or a **Deployment** task. See the [“Service Decommission” section on page 3-11](#) for more information. To perform a configuration audit as a separate task, see the [“Configuration Audit” section on page 3-11](#).







## RAN Backhaul Provisioning

---

RAN Backhaul APIs in Cisco Prime Provisioning includes provisioning support for creating TDM Circuit Emulation (TDM-CEM) and ATM Pseudowire services. These can be added on top of an existing Prime Provisioning EVC infrastructure.

The TDM-CEM feature supports provisioning of SAToP PW3 and CESoPSN PWE3 services whereas the ATM feature supports provisioning of ATM IMA VCC PWE3 and ATM IMA PVP PWE3 services.

This chapter describes TDM-CEM and ATM Pseudowire service concepts and the steps required to provision services using Prime Provisioning APIs. A provisioning example includes all steps from creating the inventory to auditing the service deployment.

For a detailed description of supported TDM-CEM and ATM Pseudowire features, policy attribute definitions, GUI implementation, and other information, see the [Cisco Prime Provisioning 7.0 User Guide](#).

This chapter contains the following sections:

- [Policy Types, page 11-1](#)
- [TDM-CEM Service Definitions, page 11-3](#)
- [TDM-CEM Service Requests, page 11-8](#)
- [TDM-CEM End-to-End Provisioning Process, page 11-27](#)
- [ATM Pseudowire Service Definitions, page 11-34](#)
- [ATM Pseudowire Service Requests, page 11-37](#)
- [ATM Pseudowire End-to-End Provisioning Process, page 11-54](#)

## Policy Types

The following policy types are supported for RAN Backhaul in Prime Provisioning:

- **Circuit-Emulation-TDM** – Circuit Emulation (TDM) services for RAN backhaul can be defined using this policy type.
- **ATM** – ATM services for RAN backhaul can be defined using this policy type.

For the list of RAN Backhaul Provisioning Attributes, refer to [Table 11-1](#):

**Table 11-1 RAN Backhaul Attributes**

Attributes	Description
RanServiceType	Specifies RAN backhaul service type.
ContainerType	Specifies container type.
UseCemClass	Set as True to use CEMClass.
CemClassName	Specifies CEM class name.
Terminal	Specifies pseudowire end points.
CemGroupId	CEM Group Id under the controller creates a CEM interface that has the same slot/subslot/port information as the controller. The number it can take depends on E1 or T1 line.
TimeSlot	Specifies the time slot value/range for configuring a RAN service. Range is 1-24 for T1 controllers and 1-31 for E1 Controllers.
ClockSourceType	Specifies the type of clock source. May be INTERNAL or LINE.
AugMappingType	A true value configures the administrative unit group mapping when SDH framing is used.
ChannelModeType	Specifies the channel mode type for a RAN service. If the framing type is SDH and Aug Mapping is Au-3, use c-11 as the ChannelModeType, if the framing type is SDH and Aug Mapping is Au-4, use c-12 as the ChannelModeType, and if the framing type is SONET, use sts-1 as ChannelModeType.
Tug2Number	Specifies the tug-2 number. A value from 1 to 3.
Tug3Number	Specifies the tug-3 number. A value from 1 to 7.
E1Number	Specifies the T1 Line Number. A value from 1 to 3.
MCPTTimer1	First MCPT timer value in microseconds. A number between 500 and 10000.
MCPTTimer2	Second MCPT timer value in microseconds. A number between 1000 and 10000.
MCPTTimer3	Third MCPT timer value in microseconds. A number between 1500 and 10000.
MCPTTimerToUse	Indicates which MCPT timer to use for ATM services.
AutoPickElineName	Specifies the auto-pick capability for the Eline name within the service. If the value for this attribute is set to true, then Prime Provisioning automatically created the Eline name, and if this attribute is set to false, the Eline name needs to be specified manually in the service. This is applicable only for IOS XR devices.
L2VpnGrpName	Specifies the L2VPN Group Name. Note that this would be set for IOS XR devices only.
Width	Configures the number of AU streams. This is applicable only for IOS XR devices.

# TDM-CEM Service Definitions

A TDM-CEM service definition specifies the core type, policy subtype, and the attributes common to all EVC attachment circuits. This section lists the supported service definitions, service orders, and policies and includes corresponding examples.

## CEM Class Inventory Operations

Prime Provisioning supports the creation of following CEM Class features:

- Creating
- Modifying
- Deleting
- Viewing

XML file in [Cisco Prime Provisioning API 6.8 Programmer Reference: CreateCEMClass.xml](#)

```
<?xml version="1.0" encoding="utf-8"?>
<soapenv:Envelope xmlns:soapenv="http://schemas.xmlsoap.org/soap/envelope/"
xmlns:soapenc="http://schemas.xmlsoap.org/soap/encoding/"
xmlns:xsd="http://www.w3.org/2001/XMLSchema"
xmlns:xsi="http://www.w3.org/2001/XMLSchema-instance"
xmlns:ns0="http://www.cisco.com/cim-cx/2.0" xmlns:ns1="urn:CIM">
  <soapenv:Header>
    <ns0:message id="87855" timestamp="2002-12-13T14:55:38.885Z"
sessiontoken="p36bttjwyl" />
  </soapenv:Header>
  <soapenv:Body>
    <ns1:createInstance>
      <objectPath xsi:type="ns1:CIMObjectPath">
        <className xsi:type="xsd:string">CemClass</className>
        <properties xsi:type="ns1:CIMPropertyList"
soapenc:arrayType="ns1:CIMProperty[]">
          <item xsi:type="ns1:CIMProperty">
            <name xsi:type="xsd:string">Name</name>
            <value xsi:type="xsd:string">sampleNbi_cemclass</value>
          </item>
          <item xsi:type="ns1:CIMProperty">
            <name xsi:type="xsd:string">Description</name>
            <value xsi:type="xsd:string">Sampledescription</value>
          </item>
          <item xsi:type="ns1:CIMProperty">
            <name xsi:type="xsd:string">DejitterBuffer</name>
            <value xsi:type="xsd:string">250</value>
          </item>
          <item xsi:type="ns1:CIMProperty">
            <name xsi:type="xsd:string">PayloadSize</name>
            <value xsi:type="xsd:string">400</value>
          </item>
          <item xsi:type="ns1:CIMProperty">
            <name xsi:type="xsd:string">IdlePattern</name>
            <value xsi:type="xsd:string">10</value>
          </item>
        </properties>
      </objectPath>
    </ns1:createInstance>
  </soapenv:Body>
</soapenv:Envelope>
```

## Supported Service Definitions and Service Orders

Prime Provisioning supports the following TDM-CEM features:

- Creating:
  - TDM-CEM Service Definition/Policy
  - TDM-CEM Service Order/Request
- Modifying:
  - TDM-CEM Service Definition/Policy
  - TDM-CEM Service Order/Request
- Deleting:
  - TDM-CEM Service Definition/Policy
  - TDM-CEM Service Order/Request
- Viewing:
  - TDM-CEM Service Definition/Policy
  - TDM-CEM Service Order/Request

## Policy Examples

The following constitute XML policy examples for TDM-CEM:

- [Creating a TDM-CEM \(CESoPN\) Policy, page 11-4](#)
- [Creating a TDM-CEM \(SAToP\) Policy, page 11-6](#)
- [Creating RAN Backhaul TDM-CEM Policy with IOS XR Support, page 11-8](#)

### Creating a TDM-CEM (CESoPN) Policy

In this example, a TDM-CEM (CESoPN) policy is created.

XML file in [Cisco Prime Provisioning API 6.8 Programmer Reference](#):

CreateTDM\_CEM\_CESoPN\_Policy.xml

The relevant attributes that need to be set for this policy are highlighted in bold in the example. They are **RanServiceType**, which in the example is set to **CESoPN\_TIMESLOT**, **ContainerType**, which in the example is set to **E1**, and **UseCemClass**, which in the example is set to **true**.

```
<?xml version="1.0" encoding="UTF-8" ?>
<soapenv:Envelope
  xmlns:soapenv="http://schemas.xmlsoap.org/soap/envelope/"
  xmlns:soapenc="http://schemas.xmlsoap.org/soap/encoding/"
  xmlns:xsd="http://www.w3.org/2001/XMLSchema"
  xmlns:xsi="http://www.w3.org/2001/XMLSchema-instance"
  xmlns:ns0="http://www.cisco.com/cim-cx/2.0"
  xmlns:ns1="urn:CIM">
  <soapenv:Header>
    <ns0:message id="87855" timestamp="2002-12-13T14:55:38.885Z"
```

```

        sessiontoken="p36bttjwy1"/>
    </soapenv:Header>
    <soapenv:Body>
        <ns1:createInstance>
            <objectPath xsi:type="ns1:CIMObjectPath">
                <className xsi:type="xsd:string">ServiceDefinition</className>
                <properties xsi:type="ns1:CIMPropertyList"
                    soapenc:arrayType="ns1:CIMProperty[]">
                    <item xsi:type="ns1:CIMProperty">
                        <name xsi:type="xsd:string">Name</name>
                        <value xsi:type="xsd:string">TDM_CES</value>
                    </item>
                    <item xsi:type="ns1:CIMProperty">
                        <name xsi:type="xsd:string">Type</name>
                        <value xsi:type="xsd:string">EvcIpran</value>
                    </item>
                </properties>
                <objectPath xsi:type="ns1:CIMObjectPath">
                    <className xsi:type="xsd:string">ServiceDefinitionDetails</className>
                    <properties xsi:type="ns1:CIMPropertyList"
                        soapenc:arrayType="ns1:CIMProperty[]">
                        <item xsi:type="ns1:CIMProperty">
                            <name xsi:type="xsd:string">SubType</name>
                            <value xsi:type="xsd:string">Evc</value>
                        </item>
                        <item xsi:type="ns1:CIMProperty">
                            <name xsi:type="xsd:string">AccessType</name>
                            <value xsi:type="xsd:string">TDM_CEM</value>
                        </item>
                        <item xsi:type="ns1:CIMProperty">
                            <name xsi:type="xsd:string">RanServiceType</name>
                            <value xsi:type="xsd:string">CESoPN_TIMESLOT</value>
                        </item>
                        <item>
                            <item xsi:type="ns1:CIMProperty">
                                <name xsi:type="xsd:string">AutopickVCID</name>
                                <value xsi:type="xsd:string">>true</value>
                                <qualifier xsi:type="ns1:CIMQualifier">
                                    <name xsi:type="xsd:string">editable</name>
                                    <value xsi:type="xsd:string">>true</value>
                                </qualifier>
                            </item>
                        </item>
                        <item xsi:type="ns1:CIMProperty">
                            <name xsi:type="xsd:string">EnablePWRedundancy</name>
                            <value xsi:type="xsd:string">>false</value>
                            <qualifier xsi:type="ns1:CIMQualifier">
                                <name xsi:type="xsd:string">editable</name>
                                <value xsi:type="xsd:string">>true</value>
                            </qualifier>
                        </item>
                        <item xsi:type="ns1:CIMProperty">
                            <name xsi:type="xsd:string">TransportType</name>
                            <value xsi:type="xsd:string">PSEUDOWIRE</value>
                        </item>
                        <item xsi:type="ns1:CIMProperty">
                            <name xsi:type="xsd:string">ContainerType</name>
                            <value xsi:type="xsd:string">E1</value>
                            <qualifier xsi:type="ns1:CIMQualifier">
                                <name xsi:type="xsd:string">editable</name>
                                <value xsi:type="xsd:string">>true</value>
                            </qualifier>
                        </item>
                        <item>
                            <item xsi:type="ns1:CIMProperty">
                                <name xsi:type="xsd:string">UseCemClass</name>
                                <value xsi:type="xsd:string">>true</value>
                            </item>
                        </item>
                    </properties>
                </objectPath>
            </objectPath>
        </ns1:createInstance>
    </soapenv:Body>
</soapenv:Envelope>

```

```

        <qualifier xsi:type="ns1:CIMQualifier">
          <name xsi:type="xsd:string">editable</name>
          <value xsi:type="xsd:string">>true</value>
        </qualifier>
      </item>
    </properties>
  </objectPath>
</objectPath>
</ns1:createInstance>
</soapenv:Body>
</soapenv:Envelope>

```

## Creating a TDM-CEM (SAToP) Policy

In this example, a TDM-CEM (SAToP) policy is created.

XML file in [Cisco Prime Provisioning API 6.8 Programmer Reference](#):

CreateTDM\_CEM\_SAToP\_Policy.xml

The relevant attributes that need to be set for this policy are highlighted in bold in the example. They are **RanServiceType**, which in the example is set to **SAToP\_UNFRAMED**, **ContainerType**, which in the example is set to **E1**, and **UseCemClass**, which in the example is set to **true**.

```

<?xml version="1.0" encoding="UTF-8" ?>
<soapenv:Envelope
  xmlns:soapenv="http://schemas.xmlsoap.org/soap/envelope/"
  xmlns:soapenc="http://schemas.xmlsoap.org/soap/encoding/"
  xmlns:xsd="http://www.w3.org/2001/XMLSchema"
  xmlns:xsi="http://www.w3.org/2001/XMLSchema-instance"
  xmlns:ns0="http://www.cisco.com/cim-cx/2.0"
  xmlns:ns1="urn:CIM">
  <soapenv:Header>
    <ns0:message id="87855" timestamp="2002-12-13T14:55:38.885Z"
      sessiontoken="p36bttjwy1" />
  </soapenv:Header>
  <soapenv:Body>
    <ns1:createInstance>
      <objectPath xsi:type="ns1:CIMObjectPath">
        <className xsi:type="xsd:string">ServiceDefinition</className>
        <properties xsi:type="ns1:CIMPropertyList"
          soapenc:arrayType="ns1:CIMProperty[]">
          <item xsi:type="ns1:CIMProperty">
            <name xsi:type="xsd:string">Name</name>
            <value xsi:type="xsd:string">ipran_nbi</value>
          </item>
          <item xsi:type="ns1:CIMProperty">
            <name xsi:type="xsd:string">Type</name>
            <value xsi:type="xsd:string">EvcIpran</value>
          </item>
        </properties>
      <objectPath xsi:type="ns1:CIMObjectPath">
        <className xsi:type="xsd:string">ServiceDefinitionDetails</className>
        <properties xsi:type="ns1:CIMPropertyList"
          soapenc:arrayType="ns1:CIMProperty[]">
          <item xsi:type="ns1:CIMProperty">
            <name xsi:type="xsd:string">SubType</name>
            <value xsi:type="xsd:string">Evc</value>
          </item>
          <item xsi:type="ns1:CIMProperty">
            <name xsi:type="xsd:string">AccessType</name>

```

```

        <value xsi:type="xsd:string">TDM_CEM</value>
    </item>

    <item xsi:type="ns1:CIMProperty">
        <name xsi:type="xsd:string">RanServiceType</name>
        <value xsi:type="xsd:string">SAToP_UNFRAMED</value>
    </item >

    <item xsi:type="ns1:CIMProperty">
        <name xsi:type="xsd:string">AutopickVCId</name>
        <value xsi:type="xsd:string">>true</value>
        <qualifier xsi:type="ns1:CIMQualifier">
            <name xsi:type="xsd:string">editable</name>
            <value xsi:type="xsd:string">>true</value>
        </qualifier>
    </item>
    <item xsi:type="ns1:CIMProperty">
        <name xsi:type="xsd:string">EnablePWRedundancy</name>
        <value xsi:type="xsd:string">>true</value>
        <qualifier xsi:type="ns1:CIMQualifier">
            <name xsi:type="xsd:string">editable</name>
            <value xsi:type="xsd:string">>true</value>
        </qualifier>
    </item>
    <item xsi:type="ns1:CIMProperty">
        <name xsi:type="xsd:string">TransportType</name>
        <value xsi:type="xsd:string">PSEUDOWIRE</value>
    </item>
    <item xsi:type="ns1:CIMProperty">
        <name xsi:type="xsd:string">ContainerType</name>
        <value xsi:type="xsd:string">E1</value>
        <qualifier xsi:type="ns1:CIMQualifier">
            <name xsi:type="xsd:string">editable</name>
            <value xsi:type="xsd:string">>true</value>
        </qualifier>
    </item>

        <item xsi:type="ns1:CIMProperty">
            <name xsi:type="xsd:string">UseCemClass</name>
            <value xsi:type="xsd:string">>true</value>
            <qualifier xsi:type="ns1:CIMQualifier">
                <name xsi:type="xsd:string">editable</name>
                <value xsi:type="xsd:string">>true</value>
            </qualifier>
        </item>
    <item xsi:type="ns1:CIMProperty">
        <name xsi:type="xsd:string">CemClassId</name>
        <value xsi:type="xsd:string">6</value>
        <qualifier xsi:type="ns1:CIMQualifier">
            <name xsi:type="xsd:string">editable</name>
            <value xsi:type="xsd:string">>true</value>
        </qualifier>
    </item>
</properties>
</objectPath>
</objectPath>
</ns1:createInstance>
</soapenv:Body>
</soapenv:Envelope>

```

## Creating RAN Backhaul TDM-CEM Policy with IOS XR Support

The following example shows a partial list of properties that can be specified to enable TDM-CEM support for IOS XR devices. These attributes should be added under **ServiceDefinitionDetails**. These attributes could be used for both the SAToP and the CESoPN type.

If you want to set the **AutoPickElineName** attribute to false in the request XML, add the following item manually in the service request (instead of the **AutoPickElineName** tag):

```
<item xsi:type="ns1:CIMProperty">
  <name xsi:type="xsd:string">ElineName</name>
  <value xsi:type="xsd:string">LocalSRTest1</value>
</item>
```

Example: Create\_IPRAN\_TDM\_Policy\_IOS\_XR.xml (excerpt)

```
<objectPath xsi:type="ns1:CIMObjectPath">
  <className xsi:type="xsd:string">ServiceDefinitionDetails</className>
  <properties xsi:type="ns1:CIMPropertyList"
    soapenc:arrayType="ns1:CIMProperty[]">
    <item xsi:type="ns1:CIMProperty">
      <name xsi:type="xsd:string">L2VpnGrpName</name>
      <value xsi:type="xsd:string">ISC</value>
    </item>

    <item xsi:type="ns1:CIMProperty">
      <name xsi:type="xsd:string">AutoPickElineName</name>
      <value xsi:type="xsd:string">true</value>
      <qualifier xsi:type="ns1:CIMQualifier">
        <name xsi:type="xsd:string">editable</name>
        <value xsi:type="xsd:string">true</value>
      </qualifier>
    </item>
  </properties>
</objectPath>
```

### Related APIs

- [ModifyTDM\\_CEM\\_CESoPN\\_Policy.xml](#)
- [DeleteTDM\\_CEM\\_Policy.xml](#)

## TDM-CEM Service Requests

Before creating a service request, a service policy has to be defined. For information on TDM-CEM policies, see [EVC Service Definitions, page 9-1](#).

A TDM-CEM service request defines the service definition along with the the respective attributes for a EVC-TDM link.

See the [Cisco Prime Provisioning 7.0 User Guide](#) for the illustration of RAN Backhaul Services.



## Service Request Examples

The following XML examples illustrate how you work with service requests for TDM-CEM APIs. They also demonstrate the kinds of properties (attributes) that need to be specified for each request.

This section includes the following examples:

- [Creating a TDM-CEM \(CESoPN\) Service Request Without Pseudowire Redundancy, page 11-9](#)
- [Creating a TDM-CEM \(CESoPN\) Service Request With Pseudowire Redundancy, page 11-12](#)
- [Creating a RAN Backhaul CEM Class, page 11-17](#)
- [Creating a RAN Backhaul TDM Service Request, page 11-18](#)
- [Creating a TDM-CEM Service Request for IOS XR, page 11-19](#)
- [Creating a TDM-CEM Service Request with E1-E1 Service, page 11-20](#)
- [Creating a TDM-CEM Service Request with T1-T1 Service, page 11-24](#)

### Creating a TDM-CEM (CESoPN) Service Request Without Pseudowire Redundancy

In this example, a TDM-CEM (CESoPN) service request is created without Pseudowire redundancy.

XML file in [Cisco Prime Provisioning API 6.8 Programmer Reference](#):

CreateTDM\_CEM\_CESoPN\_SR\_PW.xml

The relevant attributes that need to be set for this policy are highlighted in bold in the example. They are **CemClassName**, which in the example is set to **CEM\_1**, **ContainerType**, which in the example is set to **E1**, **UseCemClass**, which in the example is set to **true**, **Terminal**, which in the example is set to **A**, **CemGroupId**, which in the example is set to **12**, **TimeSlot**, which in the example is set to **15**, **ClockSourceType**, which in the example is set to **INTERNAL**, **TimeSlot**, which in the example is set to **12-16**, **ClockSourceType**, which in the example is set to **INTERNAL**, **AugMappingType**, which in the example is set to **au-4**, **Tug3Number**, which in the example is set to **1**, **ChannelModeType**, which in the example is set to **c-12**, **Tug2Number**, which in the example is set to **2**, and **E1Number**, which in the example is set to **1**.

```
<?xml version="1.0" encoding="utf-8"?>
<soapenv:Envelope xmlns:soapenv="http://schemas.xmlsoap.org/soap/envelope/"
xmlns:soapenc="http://schemas.xmlsoap.org/soap/encoding/"
xmlns:xsd="http://www.w3.org/2001/XMLSchema"
xmlns:xsi="http://www.w3.org/2001/XMLSchema-instance"
xmlns:ns0="http://www.cisco.com/cim-cx/2.0" xmlns:ns1="urn:CIM">
  <soapenv:Header>
    <!-- WaitTimeout has a default set in system properties.-->
    <ns0:message id="87855" timestamp="2011-11-13T14:55:38.885Z"
Wait="true" WaitTimeout="90" sessiontoken="p36bttjwy1" />
  </soapenv:Header>
  <soapenv:Body>
    <ns1:performBatchOperation>
      <actions xsi:type="ns1:CIMActionList"
soapenc:arrayType="ns1:CIMAction[]">
        <action>
          <actionName xsi:type="xsd:string">createInstance</actionName>
          <objectPath xsi:type="ns1:CIMObjectPath">
            <className xsi:type="xsd:string">ServiceOrder</className>
            <properties xsi:type="ns1:CIMPropertyList"
soapenc:arrayType="ns1:CIMProperty[]">
              <item xsi:type="ns1:CIMProperty">
                <name xsi:type="xsd:string">ServiceName</name>
                <value xsi:type="xsd:string">ServiceOrder257</value>
```

```

</item>
<item xsi:type="ns1:CIMProperty">
  <name xsi:type="xsd:string">CarrierId</name>
  <value xsi:type="xsd:string">322</value>
</item>
<item xsi:type="ns1:CIMProperty">
  <name xsi:type="xsd:string">DesiredDueDate</name>
  <value xsi:type="xsd:dateTime">2008-12-13T14:55:38.885Z</value>
</item>
<item xsi:type="ns1:CIMProperty">
  <name xsi:type="xsd:string">NumberOfRequests</name>
  <value xsi:type="xsd:string">1</value>
</item>
</properties>
</objectPath>
</action>
<action>
  <actionName xsi:type="xsd:string">createInstance</actionName>
  <objectPath xsi:type="ns1:CIMObjectPath">
    <className xsi:type="xsd:string">ServiceRequest</className>
    <properties xsi:type="ns1:CIMPropertyList"
      soapenc:arrayType="ns1:CIMProperty[]">
      <item xsi:type="ns1:CIMProperty">
        <name xsi:type="xsd:string">RequestName</name>
        <value xsi:type="xsd:string">Ipran</value>
      </item>
      <item xsi:type="ns1:CIMProperty">
        <name xsi:type="xsd:string">Type</name>
        <value xsi:type="xsd:string">EvcIpran</value>
      </item>
    </properties>
  <objectPath xsi:type="ns1:CIMObjectPath">
    <className xsi:type="xsd:string">ServiceRequestDetails</className>
    <properties xsi:type="ns1:CIMPropertyList"
      soapenc:arrayType="ns1:CIMProperty[]">
      <item xsi:type="ns1:CIMProperty">
        <name xsi:type="xsd:string">ServiceDefinition</name>
        <value xsi:type="xsd:string">TDM_CES</value>
        <qualifier xsi:type="xsd:string">
          <name xsi:type="xsd:string">ServiceDefinitionType</name>
          <value xsi:type="xsd:string">EvcIpran</value>
        </qualifier>
      </item>
      <item xsi:type="ns1:CIMProperty">
        <name xsi:type="xsd:string">AutopickVCID</name>
        <value xsi:type="xsd:string">true</value>
      </item>
      <item xsi:type="ns1:CIMProperty">
        <name xsi:type="xsd:string">ContainerType</name>
        <value xsi:type="xsd:string">E1</value>
      </item>
      <item xsi:type="ns1:CIMProperty">
        <name xsi:type="xsd:string">UseCemClass</name>
        <value xsi:type="xsd:string">true</value>
      </item>
      <item xsi:type="ns1:CIMProperty">
        <name xsi:type="xsd:string">CemClassName</name>
        <value xsi:type="xsd:string">CEM_1</value>
      </item>
    </properties>
  <objectPath xsi:type="ns1:CIMObjectPath">
    <className xsi:type="xsd:string">EvcLink</className>
    <properties xsi:type="ns1:CIMPropertyList"
      soapenc:arrayType="ns1:CIMProperty[]">

```

```

<item xsi:type="ns1:CIMProperty">
  <name xsi:type="xsd:string">Npe</name>
  <value xsi:type="xsd:string">ems2941q</value>
</item>
<item xsi:type="ns1:CIMProperty">
  <name xsi:type="xsd:string">UniInftId</name>
  <value xsi:type="xsd:string">CONTROLLER E10/3</value>
</item>
<item xsi:type="ns1:CIMProperty">
  <name xsi:type="xsd:string">Terminal</name>
  <value xsi:type="xsd:string">A</value>
</item>
</properties>
<objectPath xsi:type="ns1:CIMObjectPath">
  <className xsi:type="xsd:string">EvcTDMLinkAttrs</className>
  <properties xsi:type="ns1:CIMPropertyList"
  soapenc:arrayType="ns1:CIMProperty[]">
    <item xsi:type="ns1:CIMProperty">
      <name xsi:type="xsd:string">CemGroupId</name>
      <value xsi:type="xsd:string">12</value>
    </item>
    <!-- use Time slot for CESoPN -->
    <item xsi:type="ns1:CIMProperty">
      <name xsi:type="xsd:string">TimeSlot</name>
      <value xsi:type="xsd:string">15</value>
    </item>
    <item xsi:type="ns1:CIMProperty">
      <name xsi:type="xsd:string">ClockSourceType</name>
      <value xsi:type="xsd:string">INTERNAL</value>
    </item>
    <item xsi:type="ns1:CIMProperty">
      <name xsi:type="xsd:string">UsePwClass</name>
      <value xsi:type="xsd:string">>true</value>
    </item>
    <item xsi:type="ns1:CIMProperty">
      <name xsi:type="xsd:string">PwClassName</name>
      <value xsi:type="xsd:string">PW_1</value>
    </item>
  </properties>
</objectPath>
</objectPath>
<objectPath xsi:type="ns1:CIMObjectPath">
  <className xsi:type="xsd:string">EvcLink</className>
  <properties xsi:type="ns1:CIMPropertyList"
  soapenc:arrayType="ns1:CIMProperty[]">
    <item xsi:type="ns1:CIMProperty">
      <name xsi:type="xsd:string">Npe</name>
      <value xsi:type="xsd:string">ems7606c</value>
    </item>
    <item xsi:type="ns1:CIMProperty">
      <name xsi:type="xsd:string">UniInftId</name>
      <value xsi:type="xsd:string">CONTROLLER SONET3/2/0</value>
    </item>
    <item xsi:type="ns1:CIMProperty">
      <name xsi:type="xsd:string">Terminal</name>
      <value xsi:type="xsd:string">Z</value>
    </item>
  </properties>
<objectPath xsi:type="ns1:CIMObjectPath">
  <className xsi:type="xsd:string">EvcTDMLinkAttrs</className>
  <properties xsi:type="ns1:CIMPropertyList"
  soapenc:arrayType="ns1:CIMProperty[]">
    <item xsi:type="ns1:CIMProperty">
      <name xsi:type="xsd:string">CemGroupId</name>

```

```

        <value xsi:type="xsd:string">10</value>
    </item>
    <!-- use Time slot for CESoPN -->
    <item xsi:type="ns1:CIMProperty">
        <name xsi:type="xsd:string">Timeslot</name>
        <value xsi:type="xsd:string">12-16</value>
    </item>
    <item xsi:type="ns1:CIMProperty">
        <name xsi:type="xsd:string">ClockSourceType</name>
        <value xsi:type="xsd:string">INTERNAL</value>
    </item>
    <item xsi:type="ns1:CIMProperty">
        <name xsi:type="xsd:string">AugMappingType</name>
        <value xsi:type="xsd:string">au-4</value>
    </item>
    <item xsi:type="ns1:CIMProperty">
        <name xsi:type="xsd:string">Tug3Number</name>
        <value xsi:type="xsd:string">1</value>
    </item>
    <item xsi:type="ns1:CIMProperty">
        <name xsi:type="xsd:string">ChannelModeType</name>
        <value xsi:type="xsd:string">c-12</value>
    </item>
    <item xsi:type="ns1:CIMProperty">
        <name xsi:type="xsd:string">Tug2Number</name>
        <value xsi:type="xsd:string">2</value>
    </item>
    <item xsi:type="ns1:CIMProperty">
        <name xsi:type="xsd:string">E1Number</name>
        <value xsi:type="xsd:string">1</value>
    </item>
    <item xsi:type="ns1:CIMProperty">
        <name xsi:type="xsd:string">UsePwClass</name>
        <value xsi:type="xsd:string">>true</value>
    </item>
    <item xsi:type="ns1:CIMProperty">
        <name xsi:type="xsd:string">PwClassName</name>
        <value xsi:type="xsd:string">PW_3</value>
    </item>
</properties>
</objectPath>
</objectPath>
</objectPath>
</objectPath>
</action>
</actions>
</ns1:performBatchOperation>
</soapenv:Body>
</soapenv:Envelope>

```

## Creating a TDM-CEM (CESoPN) Service Request With Pseudowire Redundancy

In this example, a TDM-CEM (CESoPN) service request is created with Pseudowire redundancy. To enable Pseudowire redundancy, set **UseBackPwClass** and **BackPwClassName** while creating the service request.

**UseBackPwClass** and **BackPwClassName** are highlighted with bold in this below example.

XML file in [Cisco Prime Provisioning API 6.8 Programmer Reference](#):

CreateTDM\_CEM\_CESoPN\_SR\_PWRRedundancy.xml

The relevant attributes that need to be set for this policy are highlighted in bold in the example. They are **Terminal**, which in the example is set to **A**, **UseBackPwClass**, which in the example is set to **true**, **BackPwClassName**, which in the example is set to **PW\_2**.

```
<?xml version="1.0" encoding="utf-8"?>
<soapenv:Envelope xmlns:soapenv="http://schemas.xmlsoap.org/soap/envelope/"
xmlns:soapenc="http://schemas.xmlsoap.org/soap/encoding/"
xmlns:xsd="http://www.w3.org/2001/XMLSchema"
xmlns:xsi="http://www.w3.org/2001/XMLSchema-instance"
xmlns:ns0="http://www.cisco.com/cim-cx/2.0" xmlns:ns1="urn:CIM">
  <soapenv:Header>
    <!-- WaitTimeout has a default set in system properties.-->
    <ns0:message id="87855" timestamp="2011-11-13T14:55:38.885Z"
Wait="true" WaitTimeout="90" sessiontoken="p36bttjwyl" />
  </soapenv:Header>
  <soapenv:Body>
    <ns1:performBatchOperation>
      <actions xsi:type="ns1:CIMActionList"
soapenc:arrayType="ns1:CIMAction[]">
        <action>
          <actionName xsi:type="xsd:string">createInstance</actionName>
          <objectPath xsi:type="ns1:CIMObjectPath">
            <className xsi:type="xsd:string">ServiceOrder</className>
            <properties xsi:type="ns1:CIMPropertyList"
soapenc:arrayType="ns1:CIMProperty[]">
              <item xsi:type="ns1:CIMProperty">
                <name xsi:type="xsd:string">ServiceName</name>
                <value xsi:type="xsd:string">ServiceOrder257</value>
              </item>
              <item xsi:type="ns1:CIMProperty">
                <name xsi:type="xsd:string">CarrierId</name>
                <value xsi:type="xsd:string">322</value>
              </item>
              <item xsi:type="ns1:CIMProperty">
                <name xsi:type="xsd:string">DesiredDueDate</name>
                <value xsi:type="xsd:dateTime">2008-12-13T14:55:38.885Z</value>
              </item>
              <item xsi:type="ns1:CIMProperty">
                <name xsi:type="xsd:string">NumberOfRequests</name>
                <value xsi:type="xsd:string">1</value>
              </item>
            </properties>
          </objectPath>
        </action>
        <action>
          <actionName xsi:type="xsd:string">createInstance</actionName>
          <objectPath xsi:type="ns1:CIMObjectPath">
            <className xsi:type="xsd:string">ServiceRequest</className>
            <properties xsi:type="ns1:CIMPropertyList"
soapenc:arrayType="ns1:CIMProperty[]">
              <item xsi:type="ns1:CIMProperty">
                <name xsi:type="xsd:string">RequestName</name>
                <value xsi:type="xsd:string">Ipran</value>
              </item>
              <item xsi:type="ns1:CIMProperty">
                <name xsi:type="xsd:string">Type</name>
                <value xsi:type="xsd:string">EvcIpran</value>
              </item>
            </properties>
          <objectPath xsi:type="ns1:CIMObjectPath">
            <className xsi:type="xsd:string">ServiceRequestDetails</className>
            <properties xsi:type="ns1:CIMPropertyList"
soapenc:arrayType="ns1:CIMProperty[]">
```

```

<item xsi:type="ns1:CIMProperty">
  <name xsi:type="xsd:string">ServiceDefinition</name>
  <value xsi:type="xsd:string">TDM_CES</value>
  <qualifier xsi:type="xsd:string">
    <name xsi:type="xsd:string">ServiceDefinitionType</name>
    <value xsi:type="xsd:string">EvcIpran</value>
  </qualifier>
</item>
<item xsi:type="ns1:CIMProperty">
  <name xsi:type="xsd:string">AutopickVCID</name>
  <value xsi:type="xsd:string">>true</value>
</item>
<item xsi:type="ns1:CIMProperty">
  <name xsi:type="xsd:string">UseBackupVCID</name>
  <value xsi:type="xsd:string">>true</value>
</item>
<item xsi:type="ns1:CIMProperty">
  <name xsi:type="xsd:string">ContainerType</name>
  <value xsi:type="xsd:string">E1</value>
</item>
<item xsi:type="ns1:CIMProperty">
  <name xsi:type="xsd:string">UseCemClass</name>
  <value xsi:type="xsd:string">>true</value>
</item>
<item xsi:type="ns1:CIMProperty">
  <name xsi:type="xsd:string">CemClassName</name>
  <value xsi:type="xsd:string">CEM_1</value>
</item>
</properties>
<objectPath xsi:type="ns1:CIMObjectPath">
  <className xsi:type="xsd:string">EvcLink</className>
  <properties xsi:type="ns1:CIMPropertyList"
  soapenc:arrayType="ns1:CIMProperty[]">
    <item xsi:type="ns1:CIMProperty">
      <name xsi:type="xsd:string">Npe</name>
      <value xsi:type="xsd:string">ems2941q</value>
    </item>
    <item xsi:type="ns1:CIMProperty">
      <name xsi:type="xsd:string">UniInftId</name>
      <value xsi:type="xsd:string">CONTROLLER E10/2</value>
    </item>
    <item xsi:type="ns1:CIMProperty">
      <name xsi:type="xsd:string">Terminal</name>
      <value xsi:type="xsd:string">A</value>
    </item>
  </properties>
<objectPath xsi:type="ns1:CIMObjectPath">
  <className xsi:type="xsd:string">EvcTDMLinkAttrs</className>
  <properties xsi:type="ns1:CIMPropertyList"
  soapenc:arrayType="ns1:CIMProperty[]">
    <item xsi:type="ns1:CIMProperty">
      <name xsi:type="xsd:string">CemGroupId</name>
      <value xsi:type="xsd:string">4</value>
    </item>
    <!-- use Time slot for CESoPN -->
    <item xsi:type="ns1:CIMProperty">
      <name xsi:type="xsd:string">TimeSlot</name>
      <value xsi:type="xsd:string">6</value>
    </item>
    <item xsi:type="ns1:CIMProperty">
      <name xsi:type="xsd:string">ClockSourceType</name>
      <value xsi:type="xsd:string">INTERNAL</value>
    </item>
    <item xsi:type="ns1:CIMProperty">

```

```

        <name xsi:type="xsd:string">UsePwClass</name>
        <value xsi:type="xsd:string">>true</value>
    </item>
    <item xsi:type="ns1:CIMProperty">
        <name xsi:type="xsd:string">PwClassName</name>
        <value xsi:type="xsd:string">PW_1</value>
    </item>
    <item xsi:type="ns1:CIMProperty">
        <name xsi:type="xsd:string">UseBackPwClass</name>
        <value xsi:type="xsd:string">>true</value>
    </item>
    <item xsi:type="ns1:CIMProperty">
        <name xsi:type="xsd:string">BackPwClassName</name>
        <value xsi:type="xsd:string">PW_2</value>
    </item>
</properties>
</objectPath>
</objectPath>
</objectPath>
<objectPath xsi:type="ns1:CIMObjectPath">
    <className xsi:type="xsd:string">EvcLink</className>
    <properties xsi:type="ns1:CIMPropertyList"
    soapenc:arrayType="ns1:CIMProperty[]">
        <item xsi:type="ns1:CIMProperty">
            <name xsi:type="xsd:string">Npe</name>
            <value xsi:type="xsd:string">ems7609f</value>
        </item>
        <item xsi:type="ns1:CIMProperty">
            <name xsi:type="xsd:string">UniInftId</name>
            <value xsi:type="xsd:string">CONTROLLER SONET1/2/0</value>
        </item>
        <item xsi:type="ns1:CIMProperty">
            <name xsi:type="xsd:string">Terminal</name>
            <value xsi:type="xsd:string">Z</value>
        </item>
    </properties>
</objectPath xsi:type="ns1:CIMObjectPath">
    <className xsi:type="xsd:string">EvcTDMLinkAttrs</className>
    <properties xsi:type="ns1:CIMPropertyList"
    soapenc:arrayType="ns1:CIMProperty[]">
        <item xsi:type="ns1:CIMProperty">
            <name xsi:type="xsd:string">CemGroupId</name>
            <value xsi:type="xsd:string">10</value>
        </item>
        <!-- use Time slot for CESoPN -->
        <item xsi:type="ns1:CIMProperty">
            <name xsi:type="xsd:string">TimeSlot</name>
            <value xsi:type="xsd:string">25</value>
        </item>
        <item xsi:type="ns1:CIMProperty">
            <name xsi:type="xsd:string">ClockSourceType</name>
            <value xsi:type="xsd:string">INTERNAL</value>
        </item>
        <item xsi:type="ns1:CIMProperty">
            <name xsi:type="xsd:string">AugMappingType</name>
            <value xsi:type="xsd:string">au-4</value>
        </item>
        <item xsi:type="ns1:CIMProperty">
            <name xsi:type="xsd:string">Tug3Number</name>
            <value xsi:type="xsd:string">2</value>
        </item>
        <item xsi:type="ns1:CIMProperty">
            <name xsi:type="xsd:string">ChannelModeType</name>
            <value xsi:type="xsd:string">c-12</value>
        </item>
    </properties>
</objectPath>

```

```

    <item xsi:type="ns1:CIMProperty">
      <name xsi:type="xsd:string">Tug2Number</name>
      <value xsi:type="xsd:string">2</value>
    </item>
    <item xsi:type="ns1:CIMProperty">
      <name xsi:type="xsd:string">E1Number</name>
      <value xsi:type="xsd:string">1</value>
    </item>
    <item xsi:type="ns1:CIMProperty">
      <name xsi:type="xsd:string">UsePwClass</name>
      <value xsi:type="xsd:string">>true</value>
    </item>
    <item xsi:type="ns1:CIMProperty">
      <name xsi:type="xsd:string">PwClassName</name>
      <value xsi:type="xsd:string">PW_5</value>
    </item>
  </properties>
</objectPath>
</objectPath>
<objectPath xsi:type="ns1:CIMObjectPath">
  <className xsi:type="xsd:string">EvcLink</className>
  <properties xsi:type="ns1:CIMPropertyList"
  soapenc:arrayType="ns1:CIMProperty[]">
    <item xsi:type="ns1:CIMProperty">
      <name xsi:type="xsd:string">Npe</name>
      <value xsi:type="xsd:string">ems7606c</value>
    </item>
    <item xsi:type="ns1:CIMProperty">
      <name xsi:type="xsd:string">UniInftId</name>
      <value xsi:type="xsd:string">CONTROLLER SONET3/2/0</value>
    </item>
    <item xsi:type="ns1:CIMProperty">
      <name xsi:type="xsd:string">Terminal</name>
      <value xsi:type="xsd:string">Z-BackUp</value>
    </item>
  </properties>
<objectPath xsi:type="ns1:CIMObjectPath">
  <className xsi:type="xsd:string">EvcTDMLinkAttrs</className>
  <properties xsi:type="ns1:CIMPropertyList"
  soapenc:arrayType="ns1:CIMProperty[]">
    <item xsi:type="ns1:CIMProperty">
      <name xsi:type="xsd:string">CemGroupId</name>
      <value xsi:type="xsd:string">9</value>
    </item>
    <!-- use Time slot for CESoPN -->
    <item xsi:type="ns1:CIMProperty">
      <name xsi:type="xsd:string">TimeSlot</name>
      <value xsi:type="xsd:string">13</value>
    </item>
    <item xsi:type="ns1:CIMProperty">
      <name xsi:type="xsd:string">ClockSourceType</name>
      <value xsi:type="xsd:string">INTERNAL</value>
    </item>
    <item xsi:type="ns1:CIMProperty">
      <name xsi:type="xsd:string">AugMappingType</name>
      <value xsi:type="xsd:string">au-4</value>
    </item>
    <item xsi:type="ns1:CIMProperty">
      <name xsi:type="xsd:string">Tug3Number</name>
      <value xsi:type="xsd:string">2</value>
    </item>
    <item xsi:type="ns1:CIMProperty">
      <name xsi:type="xsd:string">ChannelModeType</name>
      <value xsi:type="xsd:string">c-12</value>

```



```

</item>
<item xsi:type="ns1:CIMProperty">
  <name xsi:type="xsd:string">Tug2Number</name>
  <value xsi:type="xsd:string">2</value>
</item>
<item xsi:type="ns1:CIMProperty">
  <name xsi:type="xsd:string">ElNumber</name>
  <value xsi:type="xsd:string">1</value>
</item>
<item xsi:type="ns1:CIMProperty">
  <name xsi:type="xsd:string">UsePwClass</name>
  <value xsi:type="xsd:string">true</value>
</item>
<item xsi:type="ns1:CIMProperty">
  <name xsi:type="xsd:string">PwClassName</name>
  <value xsi:type="xsd:string">PW_6</value>
</item>
</properties>
</objectPath>
</objectPath>
</objectPath>
</objectPath>
</action>
</actions>
</ns1:performBatchOperation>
</soapenv:Body>
</soapenv:Envelope>

```

## Creating a RAN Backhaul CEM Class

The following example shows a partial list of properties that can be specified to enable support for IOS XR devices. These attributes should be added under **CemClass**.

Provide a **DummyMode** attribute as either **USER DEFINED** or **LAST FRAME** as a value. If **DummyMode** is set as **UserDefined**, then a hexadecimal value has to be provided by the user for the **DummyPattern** attribute. Attributes are highlighted in bold below.



### Note

When the **DummyMode** attribute is set as **LAST FRAME**, then there is no need to set the **DummyPattern**.

```

<objectPath xsi:type="ns1:CIMObjectPath">
  <className xsi:type="xsd:string">CemClass</className>
  <properties xsi:type="ns1:CIMPropertyList"
soapenc:arrayType="ns1:CIMProperty[]">
    <item xsi:type="ns1:CIMProperty">
      <name xsi:type="xsd:string">DummyMode</name>
      <value xsi:type="xsd:string">USER DEFINED</value>
    </item>
    <item xsi:type="ns1:CIMProperty">
      <name xsi:type="xsd:string">DummyPattern</name>
      <value xsi:type="xsd:string">15</value>
    </item>
  </properties>
</objectPath>

```

## Creating a RAN Backhaul TDM Service Request

The following XML example shows a partial list of the properties that can be specified for the attachment circuit **Evclink**.

Below highlighted attributes are added to support IOS XR platform and all other attributes would be similar to what is supported for IOS.

```
<objectPath xsi:type="ns1:CIMObjectPath">
  <className xsi:type="xsd:string">Evclink</className>
  <properties xsi:type="ns1:CIMPropertyList"
  soapenc:arrayType="ns1:CIMProperty[]">
    <item xsi:type="ns1:CIMProperty">
      <name xsi:type="xsd:string">Npe</name>
      <value xsi:type="xsd:string">isc-tl-dev-asr9006-1</value>
    </item>
    <item xsi:type="ns1:CIMProperty">
      <name xsi:type="xsd:string">UniInftId</name>
      <value xsi:type="xsd:string">CONTROLLER SONET 0/2/0/0</value>
    </item>
    <item xsi:type="ns1:CIMProperty">
      <name xsi:type="xsd:string">Terminal</name>
      <value xsi:type="xsd:string">Z</value>
    </item>
  </properties>
</objectPath>
<objectPath xsi:type="ns1:CIMObjectPath">
  <className xsi:type="xsd:string">EvclinkAttrs</className>
  <properties xsi:type="ns1:CIMPropertyList"
  soapenc:arrayType="ns1:CIMProperty[]">
    <item xsi:type="ns1:CIMProperty">
      <name xsi:type="xsd:string">CemGroupId</name>
      <value xsi:type="xsd:string">12</value>
    </item>
    <!-- use Time slot for CESoPN -->
    <item xsi:type="ns1:CIMProperty">
      <name xsi:type="xsd:string">TimeSlot</name>
      <value xsi:type="xsd:string">17</value>
    </item>
    <item xsi:type="ns1:CIMProperty">
      <name xsi:type="xsd:string">AugMappingType</name>
      <value xsi:type="xsd:string">au-4</value>
    </item>
    <item xsi:type="ns1:CIMProperty">
      <name xsi:type="xsd:string">Width</name>
      <value xsi:type="xsd:string">3</value>
    </item>
    <item xsi:type="ns1:CIMProperty">
      <name xsi:type="xsd:string">Tug3Number</name>
      <value xsi:type="xsd:string">1</value>
    </item>
    <item xsi:type="ns1:CIMProperty">
      <name xsi:type="xsd:string">ChannelModeType</name>
      <value xsi:type="xsd:string">c12-e1</value>
    </item>
    <item xsi:type="ns1:CIMProperty">
      <name xsi:type="xsd:string">Tug2Number</name>
      <value xsi:type="xsd:string">2</value>
    </item>
    <item xsi:type="ns1:CIMProperty">
      <name xsi:type="xsd:string">E1Number</name>
      <value xsi:type="xsd:string">1</value>
    </item>
  </properties>
</objectPath>
```

```

<item xsi:type="ns1:CIMProperty">
  <name xsi:type="xsd:string">L2VpnGrpName</name>
  <value xsi:type="xsd:string">ISC</value>
</item>
<item xsi:type="ns1:CIMProperty">
  <name xsi:type="xsd:string">AutoPickElineName</name>
  <value xsi:type="xsd:string">>true</value>
</item>
</properties>
</objectPath>
</objectPath>

```

## Creating a TDM-CEM Service Request for IOS XR

The following XML example shows a partial list of the properties that can be specified for the attachment circuit **Evclink**.

The attributes highlighted below are added to support the IOS XR platform. All other attributes are similar to what is supported for IOS.

The relationships between the attributes **AugMappingType** and **ChannelModeType** for both IOS and IOS XR device platforms is shown in [Table 11-2](#).

**Table 11-2** TDM-CEM Attribute Relationships

Device Platform Type	AugMappingType	ChannelModeType
IOS	au-4	c12
IOS	au-3	c11
IOS XR	au-4	c12-e1
IOS XR	au-3	c11-t1

Example: CreateIPRAN\_TDM\_SR\_IOS\_XR.xml

```

<objectPath xsi:type="ns1:CIMObjectPath">
  <className xsi:type="xsd:string">Evclink</className>
  <properties xsi:type="ns1:CIMPropertyList"
  soapenc:arrayType="ns1:CIMProperty[]">
    <item xsi:type="ns1:CIMProperty">
      <name xsi:type="xsd:string">Npe</name>
      <value xsi:type="xsd:string">isc-t1-dev-asr9006-1</value>
    </item>
    <item xsi:type="ns1:CIMProperty">
      <name xsi:type="xsd:string">UniInftId</name>
      <value xsi:type="xsd:string">CONTROLLER SONET 0/2/0/0</value>
    </item>
    <item xsi:type="ns1:CIMProperty">
      <name xsi:type="xsd:string">Terminal</name>
      <value xsi:type="xsd:string">Z</value>
    </item>
  </properties>
  <objectPath xsi:type="ns1:CIMObjectPath">
    <className xsi:type="xsd:string">EvclinkAttrs</className>
    <properties xsi:type="ns1:CIMPropertyList"
    soapenc:arrayType="ns1:CIMProperty[]">
      <item xsi:type="ns1:CIMProperty">
        <name xsi:type="xsd:string">CemGroupId</name>

```

```

        <value xsi:type="xsd:string">12</value>
    </item>
    <!-- use Time slot for CESoPN -->
    <item xsi:type="ns1:CIMProperty">
        <name xsi:type="xsd:string">TimeSlot</name>
        <value xsi:type="xsd:string">17</value>
    </item>
    <item xsi:type="ns1:CIMProperty">
        <name xsi:type="xsd:string">AugMappingType</name>
        <value xsi:type="xsd:string">au-4</value>
    </item>
    <item xsi:type="ns1:CIMProperty">
        <name xsi:type="xsd:string">Width</name>
        <value xsi:type="xsd:string">3</value>
    </item>
    <item xsi:type="ns1:CIMProperty">
        <name xsi:type="xsd:string">Tug3Number</name>
        <value xsi:type="xsd:string">1</value>
    </item>
    <item xsi:type="ns1:CIMProperty">
        <name xsi:type="xsd:string">ChannelModeType</name>
        <value xsi:type="xsd:string">c12-e1</value>
    </item>
    <item xsi:type="ns1:CIMProperty">
        <name xsi:type="xsd:string">Tug2Number</name>
        <value xsi:type="xsd:string">2</value>
    </item>
    <item xsi:type="ns1:CIMProperty">
        <name xsi:type="xsd:string">E1Number</name>
        <value xsi:type="xsd:string">1</value>
    </item>
    <item xsi:type="ns1:CIMProperty">
        <name xsi:type="xsd:string">L2VpnGrpName</name>
        <value xsi:type="xsd:string">ISC</value>
    </item>
    <item xsi:type="ns1:CIMProperty">
        <name xsi:type="xsd:string">AutoPickE1LineName</name>
        <value xsi:type="xsd:string">true</value>
    </item>
</properties>
</objectPath>
</objectPath>

```

## Creating a TDM-CEM Service Request with E1-E1 Service

The following example sets up an E1-E1 service. To do so, set the attributes of the **EvcLink** and **EvcTDMLinkAttrs** classes highlighted below.

Example: Create\_TDM\_CES\_E1-E1\_SR.xml

```

<?xml version="1.0" encoding="UTF-8"?>

<soapenv:Envelope xmlns:soapenv="http://schemas.xmlsoap.org/soap/envelope/"
xmlns:soapenc="http://schemas.xmlsoap.org/soap/encoding/"
xmlns:xsd="http://www.w3.org/2001/XMLSchema"
xmlns:xsi="http://www.w3.org/2001/XMLSchema-instance"
xmlns:ns0="http://www.cisco.com/cim-cx/2.0" xmlns:ns1="urn:CIM">
  <soapenv:Header>
    <!-- WaitTimeout has a default set in system properties.-->
    <ns0:message id="87855" timestamp="2011-11-13T14:55:38.885Z" Wait="true"
WaitTimeout="90" sessiontoken="p36bttjwy1"/>

```

```

</soapenv:Header>
<soapenv:Body>
  <ns1:performBatchOperation>
    <actions xsi:type="ns1:CIMActionList" soapenc:arrayType="ns1:CIMAction[]">
      <action>
        <actionName xsi:type="xsd:string">createInstance</actionName>
        <objectPath xsi:type="ns1:CIMObjectPath">
          <className xsi:type="xsd:string">ServiceOrder</className>
          <properties xsi:type="ns1:CIMPropertyList"
soapenc:arrayType="ns1:CIMProperty[]">
            <item xsi:type="ns1:CIMProperty">
              <name xsi:type="xsd:string">ServiceName</name>
              <value xsi:type="xsd:string">ServiceOrder257</value>
            </item>
            <item xsi:type="ns1:CIMProperty">
              <name xsi:type="xsd:string">CarrierId</name>
              <value xsi:type="xsd:string">322</value>
            </item>
            <item xsi:type="ns1:CIMProperty">
              <name xsi:type="xsd:string">DesiredDueDate</name>
              <value
xsi:type="xsd:dateTime">2008-12-13T14:55:38.885Z</value>
            </item>
            <item xsi:type="ns1:CIMProperty">
              <name xsi:type="xsd:string">NumberOfRequests</name>
              <value xsi:type="xsd:string">1</value>
            </item>
          </properties>
        </objectPath>
      </action>
      <action>
        <actionName xsi:type="xsd:string">createInstance</actionName>
        <objectPath xsi:type="ns1:CIMObjectPath">
          <className xsi:type="xsd:string">ServiceRequest</className>
          <properties xsi:type="ns1:CIMPropertyList"
soapenc:arrayType="ns1:CIMProperty[]">
            <item xsi:type="ns1:CIMProperty">
              <name xsi:type="xsd:string">RequestName</name>
              <value xsi:type="xsd:string">Ipran</value>
            </item>
            <item xsi:type="ns1:CIMProperty">
              <name xsi:type="xsd:string">Type</name>
              <value xsi:type="xsd:string">EvcIpran</value>
            </item>
          </properties>
        <objectPath xsi:type="ns1:CIMObjectPath">
          <className
xsi:type="xsd:string">ServiceRequestDetails</className>
          <properties xsi:type="ns1:CIMPropertyList"
soapenc:arrayType="ns1:CIMProperty[]">
            <item xsi:type="ns1:CIMProperty">
              <name xsi:type="xsd:string">ServiceDefinition</name>
              <value xsi:type="xsd:string">TDM_CES</value>
              <qualifier xsi:type="xsd:string">
                <name
xsi:type="xsd:string">ServiceDefinitionType</name>
                <value xsi:type="xsd:string">EvcIpran</value>
              </qualifier>
            </item>
            <item xsi:type="ns1:CIMProperty">
              <name xsi:type="xsd:string">AutopickVCID</name>
              <value xsi:type="xsd:string">true</value>
            </item>
            <item xsi:type="ns1:CIMProperty">

```

```

<name xsi:type="xsd:string">VCID</name>
<value xsi:type="xsd:string">101</value>
</item>
  <item xsi:type="ns1:CIMProperty">
    <name xsi:type="xsd:string">ContainerType</name>
    <value xsi:type="xsd:string">E1</value>
  </item>
  <item xsi:type="ns1:CIMProperty">
    <name xsi:type="xsd:string">UseCemClass</name>
    <value xsi:type="xsd:string">>true</value>
  </item>
  <item xsi:type="ns1:CIMProperty">
    <name xsi:type="xsd:string">CemClassName</name>
    <value xsi:type="xsd:string">cem_e1</value>
  </item>
</properties>
<objectPath xsi:type="ns1:CIMObjectPath">
  <className xsi:type="xsd:string">EvcLink</className>
  <properties xsi:type="ns1:CIMPropertyList"
soapenc:arrayType="ns1:CIMProperty[]">
  <item xsi:type="ns1:CIMProperty">
    <name xsi:type="xsd:string">Npe</name>
    <value xsi:type="xsd:string">ems7609f</value>
  </item>
  <item xsi:type="ns1:CIMProperty">
    <name xsi:type="xsd:string">UniInftId</name>
    <value xsi:type="xsd:string">CONTROLLER E1
1/0/3</value>
  </item>

  <item xsi:type="ns1:CIMProperty">
    <name xsi:type="xsd:string">Terminal</name>
    <value xsi:type="xsd:string">A</value>
  </item>
</properties>
<objectPath xsi:type="ns1:CIMObjectPath">
  <className
xsi:type="xsd:string">EvcTDMLinkAttrs</className>
  <properties xsi:type="ns1:CIMPropertyList"
soapenc:arrayType="ns1:CIMProperty[]">
  <item xsi:type="ns1:CIMProperty">
    <name xsi:type="xsd:string">CemGroupId</name>
    <value xsi:type="xsd:string">12</value>
  </item>
  <!-- use Time slot for CESoPN -->
  <item xsi:type="ns1:CIMProperty">
    <name xsi:type="xsd:string">TimeSlot</name>
    <value xsi:type="xsd:string">15</value>
  </item>
  <item xsi:type="ns1:CIMProperty">
    <name
xsi:type="xsd:string">ClockSourceType</name>
    <value xsi:type="xsd:string">INTERNAL</value>
  </item>
  <item xsi:type="ns1:CIMProperty">
    <name xsi:type="xsd:string">UsePwClass</name>
    <value xsi:type="xsd:string">>true</value>
  </item>
  <item xsi:type="ns1:CIMProperty">
    <name xsi:type="xsd:string">PwClassName</name>
    <value
xsi:type="xsd:string">PW_Tango_40_1</value>
  </item>
</properties>

```

```

        </objectPath>
    </objectPath>
    <objectPath xsi:type="ns1:CIMObjectPath">
        <className xsi:type="xsd:string">EvcLink</className>
        <properties xsi:type="ns1:CIMPropertyList"
soapenc:arrayType="ns1:CIMProperty[]">
            <item xsi:type="ns1:CIMProperty">
                <name xsi:type="xsd:string">Npe</name>
                <value xsi:type="xsd:string">ems2941q</value>
            </item>
            <item xsi:type="ns1:CIMProperty">
                <name xsi:type="xsd:string">UniInftId</name>
                <value xsi:type="xsd:string">CONTROLLER E1
0/3</value>
            </item>
            <item xsi:type="ns1:CIMProperty">
                <name xsi:type="xsd:string">Terminal</name>
                <value xsi:type="xsd:string">Z</value>
            </item>
        </properties>
        <objectPath xsi:type="ns1:CIMObjectPath">
            <className
xsi:type="xsd:string">EvcTDMLinkAttrs</className>
            <properties xsi:type="ns1:CIMPropertyList"
soapenc:arrayType="ns1:CIMProperty[]">
                <item xsi:type="ns1:CIMProperty">
                    <name xsi:type="xsd:string">CemGroupId</name>
                    <value xsi:type="xsd:string">4</value>
                </item>
                <!-- use Time slot for CESoPN -->
                <item xsi:type="ns1:CIMProperty">
                    <name xsi:type="xsd:string">TimeSlot</name>
                    <value xsi:type="xsd:string">12-16</value>
                </item>
                <item xsi:type="ns1:CIMProperty">
                    <name
xsi:type="xsd:string">ClockSourceType</name>
                    <value xsi:type="xsd:string">INTERNAL</value>
                </item>
                <item xsi:type="ns1:CIMProperty">
                    <name xsi:type="xsd:string">UsePwClass</name>
                    <value xsi:type="xsd:string">>true</value>
                </item>
                <item xsi:type="ns1:CIMProperty">
                    <name xsi:type="xsd:string">PwClassName</name>
                    <value
xsi:type="xsd:string">PW_Tango_40_1</value>
                </item>
            </properties>
        </objectPath>
    </objectPath>
</action>
</ns1:performBatchOperation>
</soapenv:Body>
</soapenv:Envelope>

```

## Creating a TDM-CEM Service Request with T1-T1 Service

The following example sets up a T1-T1 service. To do so, set the attributes of the **Evclink** and **Evctdmlinkattrs** classes highlighted below.

Example: Create\_TDM\_SAT\_T1-T1\_SR.xml

```
<?xml version="1.0" encoding="UTF-8"?>

<soapenv:Envelope xmlns:soapenv="http://schemas.xmlsoap.org/soap/envelope/"
xmlns:soapenc="http://schemas.xmlsoap.org/soap/encoding/"
xmlns:xsd="http://www.w3.org/2001/XMLSchema"
xmlns:xsi="http://www.w3.org/2001/XMLSchema-instance"
xmlns:ns0="http://www.cisco.com/cim-cx/2.0" xmlns:ns1="urn:CIM">
  <soapenv:Header>
    <!-- WaitTimeout has a default set in system properties.-->
    <ns0:message id="87855" timestamp="2011-11-13T14:55:38.885Z" Wait="true"
WaitTimeout="90" sessiontoken="p36bttjwy1"/>
  </soapenv:Header>
  <soapenv:Body>
    <ns1:performBatchOperation>
      <actions xsi:type="ns1:CIMActionList" soapenc:arrayType="ns1:CIMAction[]">
        <action>
          <actionName xsi:type="xsd:string">createInstance</actionName>
          <objectPath xsi:type="ns1:CIMObjectPath">
            <className xsi:type="xsd:string">ServiceOrder</className>
            <properties xsi:type="ns1:CIMPropertyList"
soapenc:arrayType="ns1:CIMProperty[]">
              <item xsi:type="ns1:CIMProperty">
                <name xsi:type="xsd:string">ServiceName</name>
                <value xsi:type="xsd:string">ServiceOrder257</value>
              </item>
              <item xsi:type="ns1:CIMProperty">
                <name xsi:type="xsd:string">CarrierId</name>
                <value xsi:type="xsd:string">322</value>
              </item>
              <item xsi:type="ns1:CIMProperty">
                <name xsi:type="xsd:string">DesiredDueDate</name>
                <value
xsi:type="xsd:dateTime">2008-12-13T14:55:38.885Z</value>
              </item>
              <item xsi:type="ns1:CIMProperty">
                <name xsi:type="xsd:string">NumberOfRequests</name>
                <value xsi:type="xsd:string">1</value>
              </item>
            </properties>
          </objectPath>
        </action>
        <action>
          <actionName xsi:type="xsd:string">createInstance</actionName>
          <objectPath xsi:type="ns1:CIMObjectPath">
            <className xsi:type="xsd:string">ServiceRequest</className>
            <properties xsi:type="ns1:CIMPropertyList"
soapenc:arrayType="ns1:CIMProperty[]">
              <item xsi:type="ns1:CIMProperty">
                <name xsi:type="xsd:string">RequestName</name>
                <value xsi:type="xsd:string">Ipran</value>
              </item>
              <item xsi:type="ns1:CIMProperty">
                <name xsi:type="xsd:string">Type</name>
                <value xsi:type="xsd:string">Evclpran</value>
              </item>
            </properties>
        </action>
      </actions>
    </ns1:performBatchOperation>
  </soapenv:Body>
</soapenv:Envelope>
```



```

        <objectPath xsi:type="ns1:CIMObjectPath">
          <className
xsi:type="xsd:string">ServiceRequestDetails</className>
          <properties xsi:type="ns1:CIMPropertyList"
soapenc:arrayType="ns1:CIMProperty[]" ">
            <item xsi:type="ns1:CIMProperty">
              <name xsi:type="xsd:string">ServiceDefinition</name>
              <value xsi:type="xsd:string">TDM_SAT</value>
              <qualifier xsi:type="xsd:string">
                <name
xsi:type="xsd:string">ServiceDefinitionType</name>
                <value xsi:type="xsd:string">EvcIpran</value>
              </qualifier>
            </item>
            <item xsi:type="ns1:CIMProperty">
              <name xsi:type="xsd:string">AutopickVCID</name>
              <value xsi:type="xsd:string">true</value>
            </item>
            <item xsi:type="ns1:CIMProperty">
              <name xsi:type="xsd:string">VCID</name>
              <value xsi:type="xsd:string">101</value>
            </item>
            <item xsi:type="ns1:CIMProperty">
              <name xsi:type="xsd:string">ContainerType</name>
              <value xsi:type="xsd:string">T1</value>
            </item>
            <item xsi:type="ns1:CIMProperty">
              <name xsi:type="xsd:string">UseCemClass</name>
              <value xsi:type="xsd:string">true</value>
            </item>
            <item xsi:type="ns1:CIMProperty">
              <name xsi:type="xsd:string">CemClassName</name>
              <value xsi:type="xsd:string">CEM_Tango_40_1</value>
            </item>
          </properties>
        <objectPath xsi:type="ns1:CIMObjectPath">
          <className xsi:type="xsd:string">EvcLink</className>
          <properties xsi:type="ns1:CIMPropertyList"
soapenc:arrayType="ns1:CIMProperty[]" ">
            <item xsi:type="ns1:CIMProperty">
              <name xsi:type="xsd:string">Npe</name>
              <value xsi:type="xsd:string">ems7606c</value>
            </item>
            <item xsi:type="ns1:CIMProperty">
              <name xsi:type="xsd:string">UniInftId</name>
              <value xsi:type="xsd:string">CONTROLLER T1
3/0/4</value>
            </item>
            <item xsi:type="ns1:CIMProperty">
              <name xsi:type="xsd:string">Terminal</name>
              <value xsi:type="xsd:string">A</value>
            </item>
          </properties>
        <objectPath xsi:type="ns1:CIMObjectPath">
          <className
xsi:type="xsd:string">EvcTDMLinkAttrs</className>
          <properties xsi:type="ns1:CIMPropertyList"
soapenc:arrayType="ns1:CIMProperty[]" ">
            <item xsi:type="ns1:CIMProperty">
              <name xsi:type="xsd:string">CemGroupId</name>
              <value xsi:type="xsd:string">12</value>
            </item>
            <item xsi:type="ns1:CIMProperty">

```

```

        <name
xsi:type="xsd:string">ClockSourceType</name>
        <value xsi:type="xsd:string">LINE</value>
    </item>
    <item xsi:type="ns1:CIMProperty">
        <name xsi:type="xsd:string">UsePwClass</name>
        <value xsi:type="xsd:string">>true</value>
    </item>
    <item xsi:type="ns1:CIMProperty">
        <name xsi:type="xsd:string">PwClassName</name>
        <value
xsi:type="xsd:string">PW_Tango_40_1</value>
    </item>
</properties>
</objectPath>
</objectPath>
<objectPath xsi:type="ns1:CIMObjectPath">
    <className xsi:type="xsd:string">EvcLink</className>
    <properties xsi:type="ns1:CIMPropertyList"
soapenc:arrayType="ns1:CIMProperty[]">
        <item xsi:type="ns1:CIMProperty">
            <name xsi:type="xsd:string">Npe</name>
            <value xsi:type="xsd:string">ems2941g</value>
        </item>
        <item xsi:type="ns1:CIMProperty">
            <name xsi:type="xsd:string">UniInftId</name>
            <value xsi:type="xsd:string">CONTROLLER T1
0/7</value>
        </item>
        <item xsi:type="ns1:CIMProperty">
            <name xsi:type="xsd:string">Terminal</name>
            <value xsi:type="xsd:string">Z</value>
        </item>
    </properties>
    <objectPath xsi:type="ns1:CIMObjectPath">
        <className
xsi:type="xsd:string">EvcTDMLinkAttrs</className>
        <properties xsi:type="ns1:CIMPropertyList"
soapenc:arrayType="ns1:CIMProperty[]">
            <item xsi:type="ns1:CIMProperty">
                <name xsi:type="xsd:string">CemGroupId</name>
                <value xsi:type="xsd:string">9</value>
            </item>
            <item xsi:type="ns1:CIMProperty">
                <name
xsi:type="xsd:string">ClockSourceType</name>
                <value xsi:type="xsd:string">INTERNAL</value>
            </item>
            <item xsi:type="ns1:CIMProperty">
                <name xsi:type="xsd:string">UsePwClass</name>
                <value xsi:type="xsd:string">>true</value>
            </item>
            <item xsi:type="ns1:CIMProperty">
                <name xsi:type="xsd:string">PwClassName</name>
                <value
xsi:type="xsd:string">PW_Tango_40_1</value>
            </item>
        </properties>
    </objectPath>
</objectPath>
</objectPath>
</objectPath>
</action>
</actions>

```

```

        </ns1:performBatchOperation>
    </soapenv:Body>
</soapenv:Envelope>

```

## TDM-CEM End-to-End Provisioning Process

This section describes the process for using the API to provision TDM-CEM and includes the required operation, object definition (className), and parameter definitions.

### Process Summary

This TDM-CEM provisioning example uses the following processes:

1. Create device groups (optional).
2. Create devices.
3. Collect device configurations.
4. Create provider.
5. Create regions.
6. Declare devices as PEs.
7. Create customer.
8. Create VC ID pool.
9. Create TDM-CEM service definition (policy).
10. Create TDM-CEM service request.

### Detailed Process

This section describes the process for provisioning TDM-CEM using XML examples.

The complete list of XML examples for ATM Pseudowire is available here:

[Cisco Prime Provisioning API 6.8 Programmer Reference](#)



#### Note

For clarity, this provisioning process shows each step as a separate XML request. Many of these steps can be combined using **performBatchOperations**.

Step 1 Create device groups (optional).

**Table 11-3** Create Device Group

Operation	className	Required Parameters
createInstance	DeviceGroup	Name

XML Examples:

- CreateDeviceGroup.xml

**Tip**

If you plan to create device groups, create the empty device groups before you create the devices. As you create each device, add the associated device group name as a key property in the create device XML request.

In the following example, the device group (CustDev) is added as a key property when creating the device **CiscoRouter**:

```
<ns1:createInstance>
  <objectPath xsi:type="ns1:CIMObjectPath">
    <className xsi:type="xsd:string">CiscoRouter</className>
    <properties xsi:type="ns1:CIMPropertyList"
soapenc:arrayType="ns1:CIMProperty[]">
      <item xsi:type="ns1:CIMProperty">
        <name xsi:type="xsd:string">DeviceGroup</name>
        <value xsi:type="xsd:string">CustDev</value>
      </item>
      <item xsi:type="ns1:CIMProperty">
        <name xsi:type="xsd:string">CfgUpDnldMech</name>
        <value xsi:type="xsd:string">DEFAULT</value>
      </item>
      <item xsi:type="ns1:CIMProperty">
        <name xsi:type="xsd:string">TransportMechanism</name>
        <value xsi:type="xsd:string">DEFAULT</value>
      </item>
      <item xsi:type="ns1:CIMProperty">
        <name xsi:type="xsd:string">Password</name>
        <value xsi:type="xsd:string">vpnsc</value>
      </item>
    </properties>
  </objectPath>
</ns1:createInstance>
```

**Step 2** Create devices.

Every network element that Prime Provisioning manages must be defined as a device in the system. An element is any device from which Prime Provisioning can collect configuration information.

**Table 11-4** Create Devices

Operation	className	Required Parameters
createInstance	<ul style="list-style-type: none"> <li>• CiscoRouter</li> <li>• CatOS</li> </ul>	One or more of the following: <ul style="list-style-type: none"> <li>• ManagementIPAddress</li> <li>• HostName</li> <li>• DomainName</li> </ul>

**XML Examples:**

- CreateCiscoRouter.xml
- CreateCat.xml

**Step 3** Collect device configurations.

A device configuration collection is a task. This task uploads the current configuration from the device to the Prime Provisioning database. The collection task is executed through a service request, and the service request is scheduled through a service order.

**Note**

The service request name must be unique for each NBI API.

**Table 11-5** *Collect Device Configurations*

Operation	className	Required Parameters
createInstance	ServiceOrder	<ul style="list-style-type: none"> <li>• ServiceName</li> <li>• NumberofRequests</li> <li>• ServiceRequest</li> </ul>
	ServiceRequest	<ul style="list-style-type: none"> <li>• RequestName</li> <li>• Type=Task</li> <li>• ServiceRequestDetails</li> </ul>
	ServiceRequestDetails	<ul style="list-style-type: none"> <li>• SubType=COLLECTION</li> <li>• Device (or DeviceGroup)</li> </ul> <p><b>Note</b> You must select at least one device or device group.</p> <ul style="list-style-type: none"> <li>• RetrieveVersion=true</li> <li>• RetrieveDeviceInterfaces=true</li> </ul>

**XML Examples:**

- CreateTaskServiceOrderCollection.xml

**Step 4** Create a provider.

The provider is the administrative domain of an ISP, with one BGP autonomous system (AS) number. The network owned by the provider is called the backbone network. If an ISP has two AS numbers, you must define it as two provider administrative domains.

**Table 11-6** *Create a Provider*

Operation	className	Required Parameters
createInstance	Provider	<ul style="list-style-type: none"> <li>• Name</li> <li>• AsNumber</li> </ul>

**XML Examples:**

CreateProvider.xml

**Step 5** Create regions.

Each provider can contain multiple regions.

**Table 11-7** *Create Regions*

Operation	className	Required Parameters
createInstance	Region	<ul style="list-style-type: none"> <li>• Name</li> <li>• Provider</li> </ul>

**XML Examples:**

CreateRegion.xml

**Step 6** Declare devices as PEs.

The XML request that assigns a PE role to a device is also used to:

- Assign PE devices to Regions/Provider
- Specify interface information

**Table 11-8** Create PE Devices

Operation	className	Required Parameters
createInstance	PE	<ul style="list-style-type: none"> <li>• Provider</li> <li>• Region</li> <li>• Role= <ul style="list-style-type: none"> <li>– N-PE</li> </ul> </li> <li>• Device</li> <li>• Interface</li> </ul>

**XML Examples:**

CreatePE.xml

**Step 7** Create a customer.

A customer is a requestor of VPN services. Each customer can contain multiple customer sites. Each site belongs to only one customer and can contain multiple CPEs.

**Table 11-9** Create Organization

Operation	className	Required Parameters
createInstance	Organization	<ul style="list-style-type: none"> <li>• Name</li> </ul>

**XML Examples:**

- CreateOrganization.xml

**Step 8** Create VC ID pool.

For a VPLS VPN, all PE-POP routers use the same VC ID to establish the virtual circuit (VC) across the provider core. The VC ID is also the VPN ID and is assigned from the VC ID pool. Prime Provisioning ensures that VC IDs are unique among VPLS VPNs.

**Note**

A VC ID pool is global (not associated with a provider or organization).

**Table 11-10** Create VC ID Pool

Operation	className	Required Parameters
createInstance	VcIdPool	<ul style="list-style-type: none"> <li>• Start</li> <li>• Size</li> </ul>

**XML Examples:**

- CreateVcIdPool.xml

**Step 9** Create TDM-CEM service definition (policy).

A TDM-CEM service definition specifies the service subtype, device properties, and the attributes common to all attachment circuits.

**Table 11-11** Create a TDM-CEM Service Definition

Operation	className	Required Parameters
createInstance	ServiceDefinition	<ul style="list-style-type: none"> <li>• Name</li> <li>• Type=EvcIpran</li> <li>• Provider or Organization</li> </ul> <p><b>Note</b> If you do not specify a <b>Provider</b> or <b>Organization</b>, the service policy is global</p> <ul style="list-style-type: none"> <li>• ServiceDefinitionDetails</li> </ul>
	ServiceDefinitionDetails	<ul style="list-style-type: none"> <li>• SubType=Evc</li> <li>• Parameters: <ul style="list-style-type: none"> <li>– AccessType = TDM_CEM</li> <li>– RanServiceType = SAToP_UNFRAMED / CESoPN_TIMESLOT (depends on the policy requirement)</li> <li>– AutopickVCId</li> <li>– EnablePWRedundancy</li> <li>– TransportType = PSEUDOWIRE</li> <li>– ContainerType = E1 / T1 (depends on the requirement)</li> <li>– UseCemClass</li> </ul> </li> </ul>

**XML Examples:**

- CreateTDM\_CEM\_SAToP\_Policy.xml
- CreateTDM\_CEM\_CESoPN\_Policy.xml

**Step 10** Create TDM-CEM service request.

A TDM-CEM service request defines the service definition and assigns interfaces and attributes.

**Table 11-12** Create a TDM-CEM Service Request

Operation	className	Required Parameters
createInstance	ServiceOrder	<ul style="list-style-type: none"> <li>• ServiceName</li> <li>• NumberOfRequests</li> <li>• Provider or Organization</li> </ul> <p><b>Note</b> If you do not specify a <b>Provider</b> or <b>Organization</b>, the service policy is global.</p> <ul style="list-style-type: none"> <li>• ServiceRequest</li> </ul>



Table 11-12 Create a TDM-CEM Service Request (continued)

Operation	className	Required Parameters
	ServiceRequest	<ul style="list-style-type: none"> <li>• RequestName</li> <li>• Type=EvcIpran</li> <li>• ServiceRequestDetails</li> </ul>
	ServiceRequestDetails	<ul style="list-style-type: none"> <li>• ServiceDefinition <ul style="list-style-type: none"> <li>– ServiceDefinitionType=EvcIpran</li> </ul> </li> <li>• VCID</li> <li>• BackupVCID</li> <li>• UseCemClass</li> <li>• SonetFrameType - SDH/SONET</li> <li>• CemClassName</li> <li>• Npe</li> <li>• UniInftId</li> <li>• Terminal</li> <li>• CemGroupId</li> <li>• ClockSourceType</li> <li>• UsePwClass</li> <li>• PwClassName</li> <li>• For Z and Z-backup terminals: Following are extra parameters apart from mentioned above: <ul style="list-style-type: none"> <li>– AugMappingType</li> <li>– Tug3Number</li> <li>– ChannelModeType</li> <li>– Tug2Number</li> <li>– E1Number</li> <li>– UseBackPwClass (If PW Redundancy is selected)</li> <li>– BackPwClassName (If PW Redundancy is selected)</li> </ul> </li> </ul>

**Tip**

Record the **LocatorId** value from the XML response for the service request. The Locator ID is required for subsequent service request tasks.

**XML Example:**

- CreateTDM\_CEM\_CESoPN\_SR\_PW.xml
  - CreateTDM\_CEM\_CESoPN\_SR\_PWRedundancy.xml (use this example if there is PW Redundancy to be created)
  - CreateTDM\_CEM\_SAToP\_SR\_PW.xml
  - CreateTDM\_CEM\_SAToP\_SR\_PWRedundancy.xml (use this example if there is PW Redundancy to be created)
  - CreateIPRAN\_TDM\_SR\_IOS\_XR.xml
- 

## Auditing Service Requests

A configuration audit occurs automatically each time you deploy a service request. During this configuration audit, Prime Provisioning verifies that all Cisco IOS commands are present and that they have the correct syntax. An audit also verifies that there were no errors during deployment by examining the commands configured by the service request on the target devices. If the device configuration does not match what is defined in the service request, the audit flags a warning and sets the service request to a *Failed Audit* or *Lost* state.

If you do not want the configuration audit to occur, change the value for the **Audit** parameter. The **Audit** parameter supports these values:

- **Audit**—This is the default. A successfully deployed service request is automatically audited unless this flag is changed.
- **NoAudit**—Do not perform a configuration audit when the service request is deployed.
- **ForceAudit**—Perform a configuration audit even if the service request deployment is not successful.

You can use the Audit parameter with a **Create**, **Modify**, or **Decommission** service request or a **Deployment** task. See the [“Service Decommission” section on page 3-11](#) for more information. To perform a configuration audit as a separate task, see the [“Configuration Audit” section on page 3-11](#).

## ATM Pseudowire Service Definitions

An ATM Pseudowire service definition specifies the core type, policy subtype, and the attributes common to all EVC attachment circuits. This section lists the supported service definitions, service orders, and policies and includes corresponding examples.

## Supported Service Definitions and Service Orders

Prime Provisioning supports the following ATM Pseudowire features:

- Creating:
  - ATM Service Definition/Policy
  - ATM Service Order/Request
- Modifying:

- ATM Service Definition/Policy
- ATM Service Order/Request
- Deleting:
  - ATM Service Definition/Policy
  - ATM Service Order/Request
- Viewing:
  - ATM Service Definition/Policy
  - ATM Service Order/Request

## Policy Examples

The following constitute XML policy examples for ATM Pseudowire:

- [Create ATM Pseudowire Policy, page 11-35](#)
- [Creating RAN Backhaul ATM Policy with IOS XR Support, page 11-36](#)

XML file in *Cisco Prime Provisioning API 6.8 Programmer Reference*: CreateATM\_IMA\_Policy.xml

## Create ATM Pseudowire Policy

In this example, an ATM Pseudowire policy is created.

```
<?xml version="1.0" encoding="UTF-8"?>
<soapenv:Envelope
  xmlns:soapenv="http://schemas.xmlsoap.org/soap/envelope/"
  xmlns:soapenc="http://schemas.xmlsoap.org/soap/encoding/"
  xmlns:xsd="http://www.w3.org/2001/XMLSchema"
  xmlns:xsi="http://www.w3.org/2001/XMLSchema-instance"
  xmlns:ns0="http://www.cisco.com/cim-cx/2.0"
  xmlns:ns1="urn:CIM">
  <soapenv:Header>
    <ns0:message id="87855" timestamp="2002-12-13T14:55:38.885Z"
      sessiontoken="p36bttjwyl"/>
  </soapenv:Header>
  <soapenv:Body>
    <ns1:createInstance>
      <objectPath xsi:type="ns1:CIMObjectPath">
        <className xsi:type="xsd:string">ServiceDefinition</className>
        <properties xsi:type="ns1:CIMPropertyList"
          soapenc:arrayType="ns1:CIMProperty[]">
          <item xsi:type="ns1:CIMProperty">
            <name xsi:type="xsd:string">Name</name>
            <value xsi:type="xsd:string">ATM_VP</value>
          </item>
          <item xsi:type="ns1:CIMProperty">
            <name xsi:type="xsd:string">Type</name>
            <value xsi:type="xsd:string">EvcIpran</value>
          </item>
        </properties>
      <objectPath xsi:type="ns1:CIMObjectPath">
        <className xsi:type="xsd:string">ServiceDefinitionDetails</className>
        <properties xsi:type="ns1:CIMPropertyList"
          soapenc:arrayType="ns1:CIMProperty[]">
          <item xsi:type="ns1:CIMProperty">
            <name xsi:type="xsd:string">SubType</name>
```

```

        <value xsi:type="xsd:string">Evc</value>
    </item>
    <item xsi:type="ns1:CIMProperty">
        <name xsi:type="xsd:string">AccessType</name>
        <value xsi:type="xsd:string">ATM</value>
    </item>
    <item xsi:type="ns1:CIMProperty">
        <name xsi:type="xsd:string">TransportType</name>
        <value xsi:type="xsd:string">PSEUDOWIRE</value>
    </item>
    <item xsi:type="ns1:CIMProperty">
        <name xsi:type="xsd:string">AtmTransportMode</name>
        <value xsi:type="xsd:string">VP</value>
        <qualifier xsi:type="ns1:CIMQualifier">
            <name xsi:type="xsd:string">editable</name>
            <value xsi:type="xsd:string">true</value>
        </qualifier>
    </item>
    <item xsi:type="ns1:CIMProperty">
        <name xsi:type="xsd:string">AutopickVCID</name>
        <value xsi:type="xsd:string">true</value>
        <qualifier xsi:type="ns1:CIMQualifier">
            <name xsi:type="xsd:string">editable</name>
            <value xsi:type="xsd:string">true</value>
        </qualifier>
    </item>
    <item xsi:type="ns1:CIMProperty">
        <name xsi:type="xsd:string">EnablePWRedundancy</name>
        <value xsi:type="xsd:string">false</value>
        <qualifier xsi:type="ns1:CIMQualifier">
            <name xsi:type="xsd:string">editable</name>
            <value xsi:type="xsd:string">true</value>
        </qualifier>
    </item>
    <item xsi:type="ns1:CIMProperty">
        <name xsi:type="xsd:string">UsePwClass</name>
        <value xsi:type="xsd:string">false</value>
        <qualifier xsi:type="ns1:CIMQualifier">
            <name xsi:type="xsd:string">editable</name>
            <value xsi:type="xsd:string">true</value>
        </qualifier>
    </item>
</properties>
</objectPath>
</objectPath>
</ns1:createInstance>
</soapenv:Body>
</soapenv:Envelope>

```

## Creating RAN Backhaul ATM Policy with IOS XR Support

The following example shows a partial list of properties that can be specified to enable ATM support for IOS XR devices. These attributes should be added under **ServiceDefinitionDetails**.

```

<objectPath xsi:type="ns1:CIMObjectPath">
    <className xsi:type="xsd:string">ServiceDefinitionDetails</className>
    <properties xsi:type="ns1:CIMPropertyList"
        soapenc:arrayType="ns1:CIMProperty[]">
        <item xsi:type="ns1:CIMProperty">
            <name xsi:type="xsd:string">L2VpnGrpName</name>

```

```

    <value xsi:type="xsd:string">ISC</value>
  </item>

  <item xsi:type="ns1:CIMProperty">
    <name xsi:type="xsd:string">AutoPickELineName</name>
    <value xsi:type="xsd:string">>true</value>
    <qualifier xsi:type="ns1:CIMQualifier">
      <name xsi:type="xsd:string">editable</name>
      <value xsi:type="xsd:string">>true</value>
    </qualifier>
  </item>
</properties>
</objectPath>

```

#### Related APIs

- [ModifyATM\\_IMA\\_Policy.xml](#)
- [DeleteATM\\_IMA\\_Policy.xml](#)

## ATM Pseudowire Service Requests

Before creating a service request, a service policy has to be defined. For information on ATM Pseudowire policies, see [EVC Service Definitions, page 9-1](#).

An ATM Pseudowire service request defines the service definition along with the the respective attributes for a EVC-TDM link.

See the [Cisco Prime Provisioning 7.0 User Guide](#) for the illustration of RAN Backhaul Services.

## Service Request Examples

The following XML examples illustrate how you work with service requests for ATM Pseudowire APIs. They also demonstrate the kinds of properties (attributes) that need to be specified for each request.

This section includes the following examples:

- [Create ATM \(VCC\) Service Request Without Pseudowire Redundancy, page 11-37](#)
- [Create ATM \(VCC\) Service Request With Pseudowire Redundancy, page 11-41](#)
- [Create ATM \(PVP\) Service Request Without enabling Pseudowire Redundancy:, page 11-46](#)
- [Create ATM \(PVP\) Service Request with Pseudowire Redundancy enabled:., page 11-49](#)
- [Create RAN Backhaul ATM Service Request With IOS XR, page 11-53](#)

### Create ATM (VCC) Service Request Without Pseudowire Redundancy

In this example, a ATM Pseudowire (VCC) service request is created without Pseudowire redundancy.

XML file in [Cisco Prime Provisioning API 6.8 Programmer Reference](#):  
 CreateATM\_IMA\_VCC\_SR\_PW.xml

The relevant attributes that need to be set for this policy are highlighted in bold in the example. They are **MCPTTimer1**, which in the example is set to **1652**, **MCPTTimer2**, which in the example is set to **6245**, **MCPTTimer3**, which in the example is set to **8246**, **Terminal**, which in the example is set to **A**, **MCPTTimerToUse**, which in the example is set to **2**, and **Terminal**, which in the example is set to **Z**.

```
<?xml version="1.0" encoding="utf-8"?>
<soapenv:Envelope xmlns:soapenv="http://schemas.xmlsoap.org/soap/envelope/"
xmlns:soapenc="http://schemas.xmlsoap.org/soap/encoding/"
xmlns:xsd="http://www.w3.org/2001/XMLSchema"
xmlns:xsi="http://www.w3.org/2001/XMLSchema-instance"
xmlns:ns0="http://www.cisco.com/cim-cx/2.0" xmlns:ns1="urn:CIM">
  <soapenv:Header>
    <!-- WaitTimeout has a default set in system properties.-->
    <ns0:message id="87855" timestamp="2002-12-13T14:55:38.885Z"
      Wait="true" WaitTimeout="90" sessiontoken="p36bttjwy1" />
  </soapenv:Header>
  <soapenv:Body>
    <ns1:performBatchOperation>
      <actions xsi:type="ns1:CIMActionList"
        soapenc:arrayType="ns1:CIMAction[]">
        <action>
          <actionName xsi:type="xsd:string">createInstance</actionName>
          <objectPath xsi:type="ns1:CIMObjectPath">
            <className xsi:type="xsd:string">ServiceOrder</className>
            <properties xsi:type="ns1:CIMPropertyList"
              soapenc:arrayType="ns1:CIMProperty[]">
              <item xsi:type="ns1:CIMProperty">
                <name xsi:type="xsd:string">ServiceName</name>
                <value xsi:type="xsd:string">ATM_VC</value>
              </item>
              <item xsi:type="ns1:CIMProperty">
                <name xsi:type="xsd:string">CarrierId</name>
                <value xsi:type="xsd:string">322</value>
              </item>
              <item xsi:type="ns1:CIMProperty">
                <name xsi:type="xsd:string">DesiredDueDate</name>
                <value xsi:type="xsd:dateTime">2008-12-13T14:55:38.885Z</value>
              </item>
              <item xsi:type="ns1:CIMProperty">
                <name xsi:type="xsd:string">NumberOfRequests</name>
                <value xsi:type="xsd:string">1</value>
              </item>
            </properties>
          </objectPath>
        </action>
        <action>
          <actionName xsi:type="xsd:string">createInstance</actionName>
          <objectPath xsi:type="ns1:CIMObjectPath">
            <className xsi:type="xsd:string">ServiceRequest</className>
            <properties xsi:type="ns1:CIMPropertyList"
              soapenc:arrayType="ns1:CIMProperty[]">
              <item xsi:type="ns1:CIMProperty">
                <name xsi:type="xsd:string">RequestName</name>
                <value xsi:type="xsd:string">ATM_VC</value>
              </item>
              <item xsi:type="ns1:CIMProperty">
                <name xsi:type="xsd:string">Type</name>
                <value xsi:type="xsd:string">EvcIpran</value>
              </item>
            </properties>
          <objectPath xsi:type="ns1:CIMObjectPath">
            <className xsi:type="xsd:string">ServiceRequestDetails</className>

```

```

<properties xsi:type="ns1:CIMPropertyList"
soapenc:arrayType="ns1:CIMProperty[]">
  <item xsi:type="ns1:CIMProperty">
    <name xsi:type="xsd:string">ServiceDefinition</name>
    <value xsi:type="xsd:string">ATM_VC</value>
    <qualifier xsi:type="xsd:string">
      <name xsi:type="xsd:string">ServiceDefinitionType</name>
      <value xsi:type="xsd:string">EvcIpran</value>
    </qualifier>
  </item>
  <item xsi:type="ns1:CIMProperty">
    <name xsi:type="xsd:string">AutopickVCID</name>
    <value xsi:type="xsd:string">>true</value>
  </item>
  <item xsi:type="ns1:CIMProperty">
    <name xsi:type="xsd:string">Description</name>
    <value xsi:type="xsd:string">ATM VC SR</value>
  </item>
  <item xsi:type="ns1:CIMProperty">
    <name xsi:type="xsd:string">MCPTTimer1</name>
    <value xsi:type="xsd:string">1652</value>
  </item>
  <item xsi:type="ns1:CIMProperty">
    <name xsi:type="xsd:string">MCPTTimer2</name>
    <value xsi:type="xsd:string">6245</value>
  </item>
  <item xsi:type="ns1:CIMProperty">
    <name xsi:type="xsd:string">MCPTTimer3</name>
    <value xsi:type="xsd:string">8246</value>
  </item>
</properties>
<objectPath xsi:type="ns1:CIMObjectPath">
  <className xsi:type="xsd:string">EvcLink</className>
  <properties xsi:type="ns1:CIMPropertyList"
soapenc:arrayType="ns1:CIMProperty[]">
    <item xsi:type="ns1:CIMProperty">
      <name xsi:type="xsd:string">Npe</name>
      <value xsi:type="xsd:string">ems2941q</value>
    </item>
    <item xsi:type="ns1:CIMProperty">
      <name xsi:type="xsd:string">UniInftId</name>
      <value xsi:type="xsd:string">ATM0/IMA5</value>
    </item>
    <item xsi:type="ns1:CIMProperty">
      <name xsi:type="xsd:string">Terminal</name>
      <value xsi:type="xsd:string">A</value>
    </item>
  </properties>
<objectPath xsi:type="ns1:CIMObjectPath">
  <className xsi:type="xsd:string">EvcATMIMALinkAttrs</className>
  <properties xsi:type="ns1:CIMPropertyList"
soapenc:arrayType="ns1:CIMProperty[]">
    <item xsi:type="ns1:CIMProperty">
      <name xsi:type="xsd:string">AtmInterfaceEncapType</name>
      <value xsi:type="xsd:string">AAL0</value>
    </item>
    <item xsi:type="ns1:CIMProperty">
      <name xsi:type="xsd:string">AtmTransportMode</name>
      <value xsi:type="xsd:string">VC</value>
    </item>
    <!-- VC Attribute-->
    <item xsi:type="ns1:CIMProperty">
      <name xsi:type="xsd:string">AtmSubInterfaceNumber</name>
      <value xsi:type="xsd:string">465724</value>
    </item>
  </properties>

```

```

</item>
<item xsi:type="ns1:CIMProperty">
  <name xsi:type="xsd:string">PVPVPINumber</name>
  <value xsi:type="xsd:string">161</value>
</item>
<!-- VC Attribute-->
<item xsi:type="ns1:CIMProperty">
  <name xsi:type="xsd:string">PVPVCINumber</name>
  <value xsi:type="xsd:string">46556</value>
</item>
<item xsi:type="ns1:CIMProperty">
  <name xsi:type="xsd:string">MaxCells</name>
  <value xsi:type="xsd:string">5</value>
</item>
<item xsi:type="ns1:CIMProperty">
  <name xsi:type="xsd:string">MCPTTimerToUse</name>
  <value xsi:type="xsd:string">2</value>
</item>
<item xsi:type="ns1:CIMProperty">
  <name xsi:type="xsd:string">UsePwClass</name>
  <value xsi:type="xsd:string">true</value>
</item>
<item xsi:type="ns1:CIMProperty">
  <name xsi:type="xsd:string">PwClassName</name>
  <value xsi:type="xsd:string">PW_1</value>
</item>
</properties>
</objectPath>
</objectPath>
<!-- L2Access Links -->
<objectPath xsi:type="ns1:CIMObjectPath">
  <className xsi:type="xsd:string">EvcLink</className>
  <properties xsi:type="ns1:CIMPropertyList"
  soapenc:arrayType="ns1:CIMProperty[]">
    <item xsi:type="ns1:CIMProperty">
      <name xsi:type="xsd:string">Npe</name>
      <value xsi:type="xsd:string">ems7606c</value>
    </item>
    <item xsi:type="ns1:CIMProperty">
      <name xsi:type="xsd:string">UniInftId</name>
      <value xsi:type="xsd:string">ATM3/0/11</value>
    </item>
    <item xsi:type="ns1:CIMProperty">
      <name xsi:type="xsd:string">Terminal</name>
      <value xsi:type="xsd:string">Z</value>
    </item>
  </properties>
  <objectPath xsi:type="ns1:CIMObjectPath">
    <className xsi:type="xsd:string">EvcATMIMALinkAttrs</className>
    <properties xsi:type="ns1:CIMPropertyList"
    soapenc:arrayType="ns1:CIMProperty[]">
      <item xsi:type="ns1:CIMProperty">
        <name xsi:type="xsd:string">AtmInterfaceEncapType</name>
        <value xsi:type="xsd:string">AAL0</value>
      </item>
      <item xsi:type="ns1:CIMProperty">
        <name xsi:type="xsd:string">AtmTransportMode</name>
        <value xsi:type="xsd:string">VC</value>
      </item>
      <item xsi:type="ns1:CIMProperty">
        <name xsi:type="xsd:string">AtmSubInterfaceNumber</name>
        <value xsi:type="xsd:string">25650</value>
      </item>
      <item xsi:type="ns1:CIMProperty">

```



```

        <name xsi:type="xsd:string">PVPVPINumber</name>
        <value xsi:type="xsd:string">255</value>
    </item>
    <item xsi:type="ns1:CIMProperty">
        <name xsi:type="xsd:string">PVPVCINumber</name>
        <value xsi:type="xsd:string">18465</value>
    </item>
    <item xsi:type="ns1:CIMProperty">
        <name xsi:type="xsd:string">MaxCells</name>
        <value xsi:type="xsd:string">20</value>
    </item>
    <item xsi:type="ns1:CIMProperty">
        <name xsi:type="xsd:string">MCPTTimerToUse</name>
        <value xsi:type="xsd:string">2</value>
    </item>
    <item xsi:type="ns1:CIMProperty">
        <name xsi:type="xsd:string">UsePwClass</name>
        <value xsi:type="xsd:string">true</value>
    </item>
    <item xsi:type="ns1:CIMProperty">
        <name xsi:type="xsd:string">PwClassName</name>
        <value xsi:type="xsd:string">PW_2</value>
    </item>
    </properties>
</objectPath>
</objectPath>
</objectPath>
</objectPath>
</action>
</actions>
</ns1:performBatchOperation>
</soapenv:Body>
</soapenv:Envelope>

```

## Create ATM (VCC) Service Request With Pseudowire Redundancy

In this example, a ATM Pseudowire (VCC) service request is created with Pseudowire redundancy. To enable Pseudowire redundancy, set **UseBackPwClass** and **BackPwClassName** while creating the service request.

**UseBackPwClass** and **BackPwClassName** are highlighted with bold in this below example.

XML file in [Cisco Prime Provisioning API 6.8 Programmer Reference](#):  
CreateATM\_IMA\_VCC\_SR\_PWRedundancy.xml

```

<?xml version="1.0" encoding="UTF-8"?>
<soapenv:Envelope
  xmlns:soapenv="http://schemas.xmlsoap.org/soap/envelope/"
  xmlns:soapenc="http://schemas.xmlsoap.org/soap/encoding/"
  xmlns:xsd="http://www.w3.org/2001/XMLSchema"
  xmlns:xsi="http://www.w3.org/2001/XMLSchema-instance"
  xmlns:ns0="http://www.cisco.com/cim-cx/2.0"
  xmlns:ns1="urn:CIM">
  <soapenv:Header>
    <!-- WaitTimeout has a default set in system properties.-->
    <ns0:message id="87855" timestamp="2002-12-13T14:55:38.885Z"
      Wait="true" WaitTimeout="90" sessiontoken="p36bttjwy1"/>
  </soapenv:Header>
  <soapenv:Body>
    <ns1:performBatchOperation>
      <actions xsi:type="ns1:CIMActionList"

```

```

        soapenc:arrayType="ns1:CIMAction[]">
<action>
  <actionName xsi:type="xsd:string">createInstance</actionName>
  <objectPath xsi:type="ns1:CIMObjectPath">
    <className xsi:type="xsd:string">ServiceOrder</className>
    <properties xsi:type="ns1:CIMPropertyList"
      soapenc:arrayType="ns1:CIMProperty[]">
      <item xsi:type="ns1:CIMProperty">
        <name xsi:type="xsd:string">ServiceName</name>
        <value xsi:type="xsd:string">ATM_VC</value>
      </item>
      <item xsi:type="ns1:CIMProperty">
        <name xsi:type="xsd:string">CarrierId</name>
        <value xsi:type="xsd:string">322</value>
      </item>
      <item xsi:type="ns1:CIMProperty">
        <name xsi:type="xsd:string">DesiredDueDate</name>
        <value xsi:type="xsd:dateTime">2008-12-13T14:55:38.885Z</value>
      </item>
      <item xsi:type="ns1:CIMProperty">
        <name xsi:type="xsd:string">NumberOfRequests</name>
        <value xsi:type="xsd:string">1</value>
      </item>
    </properties>
  </objectPath>
</action>
<action>
  <actionName xsi:type="xsd:string">createInstance</actionName>
  <objectPath xsi:type="ns1:CIMObjectPath">
    <className xsi:type="xsd:string">ServiceRequest</className>
    <properties xsi:type="ns1:CIMPropertyList"
      soapenc:arrayType="ns1:CIMProperty[]">
      <item xsi:type="ns1:CIMProperty">
        <name xsi:type="xsd:string">RequestName</name>
        <value xsi:type="xsd:string">ATM_VC</value>
      </item>
      <item xsi:type="ns1:CIMProperty">
        <name xsi:type="xsd:string">Type</name>
        <value xsi:type="xsd:string">EvcIpran</value>
      </item>
    </properties>
  <objectPath xsi:type="ns1:CIMObjectPath">
    <className xsi:type="xsd:string">ServiceRequestDetails</className>
    <properties xsi:type="ns1:CIMPropertyList"
      soapenc:arrayType="ns1:CIMProperty[]">
      <item xsi:type="ns1:CIMProperty">
        <name xsi:type="xsd:string">ServiceDefinition</name>
        <value xsi:type="xsd:string">ATM_VC</value>
        <qualifier xsi:type="xsd:string">
          <name xsi:type="xsd:string">ServiceDefinitionType</name>
          <value xsi:type="xsd:string">EvcIpran</value>
        </qualifier>
      </item>
      <item xsi:type="ns1:CIMProperty">
        <name xsi:type="xsd:string">AutopickVCID</name>
        <value xsi:type="xsd:string">>true</value>
      </item>
      <item xsi:type="ns1:CIMProperty">
        <name xsi:type="xsd:string">UseBackupVCID</name>
        <value xsi:type="xsd:string">>true</value>
      </item>
      <item xsi:type="ns1:CIMProperty">
        <name xsi:type="xsd:string">Description</name>
        <value xsi:type="xsd:string">ATM VC SR</value>
      </item>
    </properties>
  </objectPath>
</action>

```

```

</item>
<item xsi:type="ns1:CIMProperty">
  <name xsi:type="xsd:string">MCPTTimer1</name>
  <value xsi:type="xsd:string">1652</value>
</item>
<item xsi:type="ns1:CIMProperty">
  <name xsi:type="xsd:string">MCPTTimer2</name>
  <value xsi:type="xsd:string">6245</value>
</item>
<item xsi:type="ns1:CIMProperty">
  <name xsi:type="xsd:string">MCPTTimer3</name>
  <value xsi:type="xsd:string">8246</value>
</item>
</properties>
<objectPath xsi:type="ns1:CIMObjectPath">
  <className xsi:type="xsd:string">EvcLink</className>
  <properties xsi:type="ns1:CIMPropertyList"
    soapenc:arrayType="ns1:CIMProperty[]">
    <item xsi:type="ns1:CIMProperty">
      <name xsi:type="xsd:string">Npe</name>
      <value xsi:type="xsd:string">ems2941g</value>
    </item>
    <item xsi:type="ns1:CIMProperty">
      <name xsi:type="xsd:string">UniInftId</name>
      <value xsi:type="xsd:string">ATM0/IMA6</value>
    </item>
    <item xsi:type="ns1:CIMProperty">
      <name xsi:type="xsd:string">Terminal</name>
      <value xsi:type="xsd:string">A</value>
    </item>
  </properties>
<objectPath xsi:type="ns1:CIMObjectPath">
  <className xsi:type="xsd:string">EvcATMIMALinkAttrs</className>
  <properties xsi:type="ns1:CIMPropertyList"
    soapenc:arrayType="ns1:CIMProperty[]">
    <item xsi:type="ns1:CIMProperty">
      <name xsi:type="xsd:string">AtmInterfaceEncapType</name>
      <value xsi:type="xsd:string">AAL0</value>
    </item>
    <item xsi:type="ns1:CIMProperty">
      <name xsi:type="xsd:string">AtmTransportMode</name>
      <value xsi:type="xsd:string">VC</value>
    </item>
    <!-- VC Attribute-->
    <item xsi:type="ns1:CIMProperty">
      <name xsi:type="xsd:string">AtmSubInterfaceNumber</name>
      <value xsi:type="xsd:string">465724</value>
    </item>
    <item xsi:type="ns1:CIMProperty">
      <name xsi:type="xsd:string">PVPVPINumber</name>
      <value xsi:type="xsd:string">161</value>
    </item>
    <!-- VC Attribute-->
    <item xsi:type="ns1:CIMProperty">
      <name xsi:type="xsd:string">PVPVCINumber</name>
      <value xsi:type="xsd:string">46556</value>
    </item>
    <item xsi:type="ns1:CIMProperty">
      <name xsi:type="xsd:string">MaxCells</name>
      <value xsi:type="xsd:string">5</value>
    </item>
    <item xsi:type="ns1:CIMProperty">
      <name xsi:type="xsd:string">MCPTTimerToUse</name>
      <value xsi:type="xsd:string">2</value>
  </properties>

```

```

    </item>
    <item xsi:type="ns1:CIMProperty">
      <name xsi:type="xsd:string">UsePwClass</name>
      <value xsi:type="xsd:string">>true</value>
    </item>
    <item xsi:type="ns1:CIMProperty">
      <name xsi:type="xsd:string">PwClassName</name>
      <value xsi:type="xsd:string">PW3</value>
    </item>
    <item xsi:type="ns1:CIMProperty">
      <name xsi:type="xsd:string">UseBackPwClass</name>
      <value xsi:type="xsd:string">>true</value>
    </item>
    <item xsi:type="ns1:CIMProperty">
      <name xsi:type="xsd:string">BackPwClassName</name>
      <value xsi:type="xsd:string">PW_2</value>
    </item>
  </properties>
</objectPath>
</objectPath>
<objectPath xsi:type="ns1:CIMObjectPath">
  <className xsi:type="xsd:string">EvcLink</className>
  <properties xsi:type="ns1:CIMPropertyList"
    soapenc:arrayType="ns1:CIMProperty[]">
    <item xsi:type="ns1:CIMProperty">
      <name xsi:type="xsd:string">Npe</name>
      <value xsi:type="xsd:string">ems7606c</value>
    </item>
    <item xsi:type="ns1:CIMProperty">
      <name xsi:type="xsd:string">UniInftId</name>
      <value xsi:type="xsd:string">ATM3/0/11</value>
    </item>
    <item xsi:type="ns1:CIMProperty">
      <name xsi:type="xsd:string">Terminal</name>
      <value xsi:type="xsd:string">Z</value>
    </item>
  </properties>
<objectPath xsi:type="ns1:CIMObjectPath">
  <className xsi:type="xsd:string">EvcATMIMALinkAttrs</className>
  <properties xsi:type="ns1:CIMPropertyList"
    soapenc:arrayType="ns1:CIMProperty[]">
    <item xsi:type="ns1:CIMProperty">
      <name xsi:type="xsd:string">AtmInterfaceEncapType</name>
      <value xsi:type="xsd:string">AAL0</value>
    </item>
    <item xsi:type="ns1:CIMProperty">
      <name xsi:type="xsd:string">AtmTransportMode</name>
      <value xsi:type="xsd:string">VC</value>
    </item>
    <item xsi:type="ns1:CIMProperty">
      <name xsi:type="xsd:string">AtmSubInterfaceNumber</name>
      <value xsi:type="xsd:string">25650</value>
    </item>
    <item xsi:type="ns1:CIMProperty">
      <name xsi:type="xsd:string">PVPVPINumber</name>
      <value xsi:type="xsd:string">255</value>
    </item>
    <item xsi:type="ns1:CIMProperty">
      <name xsi:type="xsd:string">PVPVCINumber</name>
      <value xsi:type="xsd:string">18465</value>
    </item>
    <item xsi:type="ns1:CIMProperty">
      <name xsi:type="xsd:string">MaxCells</name>
      <value xsi:type="xsd:string">20</value>
    </item>
  </properties>
</objectPath>

```

```

    </item>
    <item xsi:type="ns1:CIMProperty">
      <name xsi:type="xsd:string">MCPTTimerToUse</name>
      <value xsi:type="xsd:string">2</value>
    </item>
  </properties>
</objectPath>
</objectPath>
<objectPath xsi:type="ns1:CIMObjectPath">
  <className xsi:type="xsd:string">EvcLink</className>
  <properties xsi:type="ns1:CIMPropertyList">
    soapenc:arrayType="ns1:CIMProperty[]">
    <item xsi:type="ns1:CIMProperty">
      <name xsi:type="xsd:string">Npe</name>
      <value xsi:type="xsd:string">ems7609f</value>
    </item>
    <item xsi:type="ns1:CIMProperty">
      <name xsi:type="xsd:string">UniInftId</name>
      <value xsi:type="xsd:string">ATM3/1/2</value>
    </item>
    <item xsi:type="ns1:CIMProperty">
      <name xsi:type="xsd:string">Terminal</name>
      <value xsi:type="xsd:string">Z-BackUp</value>
    </item>
  </properties>
</objectPath xsi:type="ns1:CIMObjectPath">
  <className xsi:type="xsd:string">EvcATMIMALinkAttrs</className>
  <properties xsi:type="ns1:CIMPropertyList">
    soapenc:arrayType="ns1:CIMProperty[]">
    <item xsi:type="ns1:CIMProperty">
      <name xsi:type="xsd:string">AtmInterfaceEncapType</name>
      <value xsi:type="xsd:string">AAL0</value>
    </item>
    <item xsi:type="ns1:CIMProperty">
      <name xsi:type="xsd:string">AtmTransportMode</name>
      <value xsi:type="xsd:string">VC</value>
    </item>
    <item xsi:type="ns1:CIMProperty">
      <name xsi:type="xsd:string">AtmSubInterfaceNumber</name>
      <value xsi:type="xsd:string">25650</value>
    </item>
    <item xsi:type="ns1:CIMProperty">
      <name xsi:type="xsd:string">PVPVPINumber</name>
      <value xsi:type="xsd:string">255</value>
    </item>
    <item xsi:type="ns1:CIMProperty">
      <name xsi:type="xsd:string">PVPVCINumber</name>
      <value xsi:type="xsd:string">18465</value>
    </item>
    <item xsi:type="ns1:CIMProperty">
      <name xsi:type="xsd:string">MaxCells</name>
      <value xsi:type="xsd:string">20</value>
    </item>
    <item xsi:type="ns1:CIMProperty">
      <name xsi:type="xsd:string">MCPTTimerToUse</name>
      <value xsi:type="xsd:string">2</value>
    </item>
  </properties>
</objectPath>

```

```

        </item>
        <item xsi:type="ns1:CIMProperty">
          <name xsi:type="xsd:string">UsePwClass</name>
          <value xsi:type="xsd:string">>true</value>
        </item>
        <item xsi:type="ns1:CIMProperty">
          <name xsi:type="xsd:string">PwClassName</name>
          <value xsi:type="xsd:string">PW2</value>
        </item>
      </properties>
    </objectPath>
  </objectPath>
</objectPath>
</objectPath>
</action>
</actions>
</ns1:performBatchOperation>
</soapenv:Body>
</soapenv:Envelope>

```

## Create ATM (PVP) Service Request Without enabling Pseudowire Redundancy:

In this example, a ATM Pseudowire (PVP) service request is created without Pseudowire redundancy.

XML file in [Cisco Prime Provisioning API 6.8 Programmer Reference](#):

CreateATM\_IMA\_PVP\_SR\_PW.xml

The relevant attributes that need to be set for this policy are highlighted in bold in the example. They are **MCPTTimer1**, which in the example is set to **1505**, **MCPTTimer2**, which in the example is set to **3205**, **MCPTTimer3**, which in the example is set to **5505**, Terminal, which in the example is set to **A**, **MCPTTimerToUse**, which in the example is set to **3**, and Terminal, which in the example is set to **Z**.

```

<?xml version="1.0" encoding="utf-8"?>
<soapenv:Envelope xmlns:soapenv="http://schemas.xmlsoap.org/soap/envelope/"
xmlns:soapenc="http://schemas.xmlsoap.org/soap/encoding/"
xmlns:xsd="http://www.w3.org/2001/XMLSchema"
xmlns:xsi="http://www.w3.org/2001/XMLSchema-instance"
xmlns:ns0="http://www.cisco.com/cim-cx/2.0" xmlns:ns1="urn:CIM">
  <soapenv:Header>
    <!-- WaitTimeout has a default set in system properties.-->
    <ns0:message id="87855" timestamp="2002-12-13T14:55:38.885Z"
      Wait="true" WaitTimeout="90" sessiontoken="p36bttjwy1" />
  </soapenv:Header>
  <soapenv:Body>
    <ns1:performBatchOperation>
      <actions xsi:type="ns1:CIMActionList"
        soapenc:arrayType="ns1:CIMAction[]">
        <action>
          <actionName xsi:type="xsd:string">createInstance</actionName>
          <objectPath xsi:type="ns1:CIMObjectPath">
            <className xsi:type="xsd:string">ServiceOrder</className>
            <properties xsi:type="ns1:CIMPropertyList"
              soapenc:arrayType="ns1:CIMProperty[]">
              <item xsi:type="ns1:CIMProperty">
                <name xsi:type="xsd:string">ServiceName</name>
                <value xsi:type="xsd:string">ATM_VP</value>
              </item>
              <item xsi:type="ns1:CIMProperty">
                <name xsi:type="xsd:string">CarrierId</name>
                <value xsi:type="xsd:string">322</value>
              </item>
            </properties>
          </objectPath>
        </action>
      </actions>
    </ns1:performBatchOperation>
  </soapenv:Body>
</soapenv:Envelope>

```

```

</item>
<item xsi:type="ns1:CIMProperty">
  <name xsi:type="xsd:string">DesiredDueDate</name>
  <value xsi:type="xsd:dateTime">2008-12-13T14:55:38.885Z</value>
</item>
</properties>
</objectPath>
</action>
<action>
  <actionName xsi:type="xsd:string">createInstance</actionName>
  <objectPath xsi:type="ns1:CIMObjectPath">
    <className xsi:type="xsd:string">ServiceRequest</className>
    <properties xsi:type="ns1:CIMPropertyList"
      soapenc:arrayType="ns1:CIMProperty[]">
      <item xsi:type="ns1:CIMProperty">
        <name xsi:type="xsd:string">RequestName</name>
        <value xsi:type="xsd:string">ATM_VP</value>
      </item>
      <item xsi:type="ns1:CIMProperty">
        <name xsi:type="xsd:string">Type</name>
        <value xsi:type="xsd:string">EvcIpran</value>
      </item>
    </properties>
    <objectPath xsi:type="ns1:CIMObjectPath">
      <className xsi:type="xsd:string">ServiceRequestDetails</className>
      <properties xsi:type="ns1:CIMPropertyList"
        soapenc:arrayType="ns1:CIMProperty[]">
        <item xsi:type="ns1:CIMProperty">
          <name xsi:type="xsd:string">ServiceDefinition</name>
          <value xsi:type="xsd:string">ATM_VP</value>
          <qualifier xsi:type="xsd:string">
            <name xsi:type="xsd:string">ServiceDefinitionType</name>
            <value xsi:type="xsd:string">EvcIpran</value>
          </qualifier>
        </item>
        <item xsi:type="ns1:CIMProperty">
          <name xsi:type="xsd:string">AutopickVCID</name>
          <value xsi:type="xsd:string">true</value>
        </item>
        <item xsi:type="ns1:CIMProperty">
          <name xsi:type="xsd:string">MCPTTimer1</name>
          <value xsi:type="xsd:string">1505</value>
        </item>
        <item xsi:type="ns1:CIMProperty">
          <name xsi:type="xsd:string">MCPTTimer2</name>
          <value xsi:type="xsd:string">3205</value>
        </item>
        <item xsi:type="ns1:CIMProperty">
          <name xsi:type="xsd:string">MCPTTimer3</name>
          <value xsi:type="xsd:string">5505</value>
        </item>
      </properties>
      <objectPath xsi:type="ns1:CIMObjectPath">
        <className xsi:type="xsd:string">EvcLink</className>
        <properties xsi:type="ns1:CIMPropertyList"
          soapenc:arrayType="ns1:CIMProperty[]">
          <item xsi:type="ns1:CIMProperty">
            <name xsi:type="xsd:string">Npe</name>
            <value xsi:type="xsd:string">ems2941q</value>
          </item>
        </objectPath>
      </properties>
    </objectPath>
  </action>
</action>

```

```

<item xsi:type="ns1:CIMProperty">
  <name xsi:type="xsd:string">UniInftId</name>
  <value xsi:type="xsd:string">ATM0/IMA14</value>
</item>
<item xsi:type="ns1:CIMProperty">
  <name xsi:type="xsd:string">Terminal</name>
  <value xsi:type="xsd:string">A</value>
</item>
</properties>
<objectPath xsi:type="ns1:CIMObjectPath">
  <className xsi:type="xsd:string">EvcATMIMALinkAttrs</className>
  <properties xsi:type="ns1:CIMPropertyList"
soapenc:arrayType="ns1:CIMProperty[]">
    <item xsi:type="ns1:CIMProperty">
      <name xsi:type="xsd:string">AtmTransportMode</name>
      <value xsi:type="xsd:string">VP</value>
    </item>
    <item xsi:type="ns1:CIMProperty">
      <name xsi:type="xsd:string">PVPVPINumber</name>
      <value xsi:type="xsd:string">12</value>
    </item>
    <item xsi:type="ns1:CIMProperty">
      <name xsi:type="xsd:string">MaxCells</name>
      <value xsi:type="xsd:string">6</value>
    </item>
    <item xsi:type="ns1:CIMProperty">
      <name xsi:type="xsd:string">MCPTimerToUse</name>
      <value xsi:type="xsd:string">3</value>
    </item>
    <item xsi:type="ns1:CIMProperty">
      <name xsi:type="xsd:string">UsePwClass</name>
      <value xsi:type="xsd:string">>true</value>
    </item>
    <item xsi:type="ns1:CIMProperty">
      <name xsi:type="xsd:string">PwClassName</name>
      <value xsi:type="xsd:string">PW_1</value>
    </item>
  </properties>
</objectPath>
</objectPath>
<objectPath xsi:type="ns1:CIMObjectPath">
  <className xsi:type="xsd:string">EvcLink</className>
  <properties xsi:type="ns1:CIMPropertyList"
soapenc:arrayType="ns1:CIMProperty[]">
    <item xsi:type="ns1:CIMProperty">
      <name xsi:type="xsd:string">Npe</name>
      <value xsi:type="xsd:string">ems7606c</value>
    </item>
    <item xsi:type="ns1:CIMProperty">
      <name xsi:type="xsd:string">UniInftId</name>
      <value xsi:type="xsd:string">ATM6/0/0</value>
    </item>
    <item xsi:type="ns1:CIMProperty">
      <name xsi:type="xsd:string">Terminal</name>
      <value xsi:type="xsd:string">Z</value>
    </item>
  </properties>
<objectPath xsi:type="ns1:CIMObjectPath">
  <className xsi:type="xsd:string">EvcATMIMALinkAttrs</className>
  <properties xsi:type="ns1:CIMPropertyList"
soapenc:arrayType="ns1:CIMProperty[]">
    <item xsi:type="ns1:CIMProperty">
      <name xsi:type="xsd:string">AtmTransportMode</name>
      <value xsi:type="xsd:string">VP</value>

```



```

</item>
<item xsi:type="ns1:CIMProperty">
  <name xsi:type="xsd:string">PVPVPINumber</name>
  <value xsi:type="xsd:string">111</value>
</item>
<item xsi:type="ns1:CIMProperty">
  <name xsi:type="xsd:string">MaxCells</name>
  <value xsi:type="xsd:string">5</value>
</item>
<item xsi:type="ns1:CIMProperty">
  <name xsi:type="xsd:string">MCPTTimerToUse</name>
  <value xsi:type="xsd:string">3</value>
</item>
<item xsi:type="ns1:CIMProperty">
  <name xsi:type="xsd:string">UsePwClass</name>
  <value xsi:type="xsd:string">true</value>
</item>
<item xsi:type="ns1:CIMProperty">
  <name xsi:type="xsd:string">PwClassName</name>
  <value xsi:type="xsd:string">PW_2</value>
</item>
</properties>
</objectPath>
</objectPath>
</objectPath>
</objectPath>
</action>
</actions>
</ns1:performBatchOperation>
</soapenv:Body>
</soapenv:Envelope>

```

## Create ATM (PVP) Service Request with Pseudowire Redundancy enabled:

In this example, a ATM Pseudowire (PVP) service request is created with Pseudowire redundancy. To enable Pseudowire redundancy, set **UseBackPwClass** and **BackPwClassName** while creating the service request.

**UseBackPwClass** and **BackPwClassName** are highlighted with bold in this below example.

XML file in [Cisco Prime Provisioning API 6.8 Programmer Reference](#):

CreateATM\_IMA\_PVP\_SR\_PWRedundancy.xml

```

<?xml version="1.0" encoding="utf-8"?>
<soapenv:Envelope xmlns:soapenv="http://schemas.xmlsoap.org/soap/envelope/"
xmlns:soapenc="http://schemas.xmlsoap.org/soap/encoding/"
xmlns:xsd="http://www.w3.org/2001/XMLSchema"
xmlns:xsi="http://www.w3.org/2001/XMLSchema-instance"
xmlns:ns0="http://www.cisco.com/cim-cx/2.0" xmlns:ns1="urn:CIM">
  <soapenv:Header>
    <!-- WaitTimeout has a default set in system properties.-->
    <ns0:message id="87855" timestamp="2002-12-13T14:55:38.885Z"
      Wait="true" WaitTimeout="90" sessiontoken="p36bttjwy1" />
  </soapenv:Header>
  <soapenv:Body>
    <ns1:performBatchOperation>
      <actions xsi:type="ns1:CIMActionList"
        soapenc:arrayType="ns1:CIMAction[]">
        <action>
          <actionName xsi:type="xsd:string">createInstance</actionName>

```

```

<objectPath xsi:type="ns1:CIMObjectPath">
  <className xsi:type="xsd:string">ServiceOrder</className>
  <properties xsi:type="ns1:CIMPropertyList"
soapenc:arrayType="ns1:CIMProperty[]">
    <item xsi:type="ns1:CIMProperty">
      <name xsi:type="xsd:string">ServiceName</name>
      <value xsi:type="xsd:string">ATM_VP</value>
    </item>
    <item xsi:type="ns1:CIMProperty">
      <name xsi:type="xsd:string">CarrierId</name>
      <value xsi:type="xsd:string">322</value>
    </item>
    <item xsi:type="ns1:CIMProperty">
      <name xsi:type="xsd:string">DesiredDueDate</name>
      <value xsi:type="xsd:dateTime">2008-12-13T14:55:38.885Z</value>
    </item>
    <item xsi:type="ns1:CIMProperty">
      <name xsi:type="xsd:string">NumberOfRequests</name>
      <value xsi:type="xsd:string">1</value>
    </item>
  </properties>
</objectPath>
</action>
<action>
  <actionName xsi:type="xsd:string">createInstance</actionName>
  <objectPath xsi:type="ns1:CIMObjectPath">
    <className xsi:type="xsd:string">ServiceRequest</className>
    <properties xsi:type="ns1:CIMPropertyList"
soapenc:arrayType="ns1:CIMProperty[]">
      <item xsi:type="ns1:CIMProperty">
        <name xsi:type="xsd:string">RequestName</name>
        <value xsi:type="xsd:string">ATM_VP</value>
      </item>
      <item xsi:type="ns1:CIMProperty">
        <name xsi:type="xsd:string">Type</name>
        <value xsi:type="xsd:string">EvcIpran</value>
      </item>
    </properties>
  <objectPath xsi:type="ns1:CIMObjectPath">
    <className xsi:type="xsd:string">ServiceRequestDetails</className>
    <properties xsi:type="ns1:CIMPropertyList"
soapenc:arrayType="ns1:CIMProperty[]">
      <item xsi:type="ns1:CIMProperty">
        <name xsi:type="xsd:string">ServiceDefinition</name>
        <value xsi:type="xsd:string">ATM_VP</value>
        <qualifier xsi:type="xsd:string">
          <name xsi:type="xsd:string">ServiceDefinitionType</name>
          <value xsi:type="xsd:string">EvcIpran</value>
        </qualifier>
      </item>
      <item xsi:type="ns1:CIMProperty">
        <name xsi:type="xsd:string">AutopickVCID</name>
        <value xsi:type="xsd:string">>true</value>
      </item>
      <item xsi:type="ns1:CIMProperty">
        <name xsi:type="xsd:string">UseBackupVCID</name>
        <value xsi:type="xsd:string">>true</value>
      </item>
      <item xsi:type="ns1:CIMProperty">
        <name xsi:type="xsd:string">MCPTTimer1</name>
        <value xsi:type="xsd:string">505</value>
      </item>
      <item xsi:type="ns1:CIMProperty">
        <name xsi:type="xsd:string">MCPTTimer2</name>

```

```

        <value xsi:type="xsd:string">1005</value>
    </item>
    <item xsi:type="ns1:CIMProperty">
        <name xsi:type="xsd:string">MCPTTimer3</name>
        <value xsi:type="xsd:string">1505</value>
    </item>
</properties>
<objectPath xsi:type="ns1:CIMObjectPath">
    <className xsi:type="xsd:string">EvcLink</className>
    <properties xsi:type="ns1:CIMPropertyList"
    soapenc:arrayType="ns1:CIMProperty[]">
        <item xsi:type="ns1:CIMProperty">
            <name xsi:type="xsd:string">Npe</name>
            <value xsi:type="xsd:string">ems2941g</value>
        </item>
        <item xsi:type="ns1:CIMProperty">
            <name xsi:type="xsd:string">UniInftId</name>
            <value xsi:type="xsd:string">ATM0/IMA16</value>
        </item>
        <item xsi:type="ns1:CIMProperty">
            <name xsi:type="xsd:string">Terminal</name>
            <value xsi:type="xsd:string">A</value>
        </item>
    </properties>
<objectPath xsi:type="ns1:CIMObjectPath">
    <className xsi:type="xsd:string">EvcATMIMALinkAttrs</className>
    <properties xsi:type="ns1:CIMPropertyList"
    soapenc:arrayType="ns1:CIMProperty[]">
        <item xsi:type="ns1:CIMProperty">
            <name xsi:type="xsd:string">AtmTransportMode</name>
            <value xsi:type="xsd:string">VP</value>
        </item>
        <item xsi:type="ns1:CIMProperty">
            <name xsi:type="xsd:string">PVPVPINumber</name>
            <value xsi:type="xsd:string">12</value>
        </item>
        <item xsi:type="ns1:CIMProperty">
            <name xsi:type="xsd:string">MaxCells</name>
            <value xsi:type="xsd:string">6</value>
        </item>
        <item xsi:type="ns1:CIMProperty">
            <name xsi:type="xsd:string">MCPTTimerToUse</name>
            <value xsi:type="xsd:string">2</value>
        </item>
        <item xsi:type="ns1:CIMProperty">
            <name xsi:type="xsd:string">UsePwClass</name>
            <value xsi:type="xsd:string">>true</value>
        </item>
        <item xsi:type="ns1:CIMProperty">
            <name xsi:type="xsd:string">PwClassName</name>
            <value xsi:type="xsd:string">PW_1</value>
        </item>
        <item xsi:type="ns1:CIMProperty">
            <name xsi:type="xsd:string">UseBackPwClass</name>
            <value xsi:type="xsd:string">>true</value>
        </item>
        <item xsi:type="ns1:CIMProperty">
            <name xsi:type="xsd:string">BackPwClassName</name>
            <value xsi:type="xsd:string">PW_2</value>
        </item>
    </properties>
</objectPath>
</objectPath>
<objectPath xsi:type="ns1:CIMObjectPath">

```

```

<className xsi:type="xsd:string">EvcLink</className>
<properties xsi:type="ns1:CIMPropertyList"
soapenc:arrayType="ns1:CIMProperty[]">
  <item xsi:type="ns1:CIMProperty">
    <name xsi:type="xsd:string">Npe</name>
    <value xsi:type="xsd:string">ems7609f</value>
  </item>
  <item xsi:type="ns1:CIMProperty">
    <name xsi:type="xsd:string">UniInftId</name>
    <value xsi:type="xsd:string">ATM3/1/1</value>
  </item>
  <item xsi:type="ns1:CIMProperty">
    <name xsi:type="xsd:string">Terminal</name>
    <value xsi:type="xsd:string">Z</value>
  </item>
</properties>
<objectPath xsi:type="ns1:CIMObjectPath">
  <className xsi:type="xsd:string">EvcATMIMALinkAttrs</className>
  <properties xsi:type="ns1:CIMPropertyList"
soapenc:arrayType="ns1:CIMProperty[]">
    <item xsi:type="ns1:CIMProperty">
      <name xsi:type="xsd:string">AtmInterfaceEncapType</name>
      <value xsi:type="xsd:string">AAL5</value>
    </item>
    <item xsi:type="ns1:CIMProperty">
      <name xsi:type="xsd:string">AtmTransportMode</name>
      <value xsi:type="xsd:string">VP</value>
    </item>
    <item xsi:type="ns1:CIMProperty">
      <name xsi:type="xsd:string">PVPVPINumber</name>
      <value xsi:type="xsd:string">111</value>
    </item>
    <item xsi:type="ns1:CIMProperty">
      <name xsi:type="xsd:string">MaxCells</name>
      <value xsi:type="xsd:string">5</value>
    </item>
    <item xsi:type="ns1:CIMProperty">
      <name xsi:type="xsd:string">MCPTTimerToUse</name>
      <value xsi:type="xsd:string">2</value>
    </item>
    <item xsi:type="ns1:CIMProperty">
      <name xsi:type="xsd:string">UsePwClass</name>
      <value xsi:type="xsd:string">>true</value>
    </item>
    <item xsi:type="ns1:CIMProperty">
      <name xsi:type="xsd:string">PwClassName</name>
      <value xsi:type="xsd:string">PW_5</value>
    </item>
  </properties>
</objectPath>
</objectPath>
<!-- Third Link for Pseudowire Redundancy -->
<objectPath xsi:type="ns1:CIMObjectPath">
  <className xsi:type="xsd:string">EvcLink</className>
  <properties xsi:type="ns1:CIMPropertyList"
soapenc:arrayType="ns1:CIMProperty[]">
    <item xsi:type="ns1:CIMProperty">
      <name xsi:type="xsd:string">Npe</name>
      <value xsi:type="xsd:string">ems7606c</value>
    </item>
    <item xsi:type="ns1:CIMProperty">
      <name xsi:type="xsd:string">UniInftId</name>
      <value xsi:type="xsd:string">ATM6/0/0</value>
    </item>
  </properties>
</objectPath>

```

```

        <item xsi:type="ns1:CIMProperty">
          <name xsi:type="xsd:string">Terminal</name>
          <value xsi:type="xsd:string">Z-BackUp</value>
        </item>
      </properties>
    </objectPath>
  </objectPath>
</objectPath>
</action>
</actions>
</ns1:performBatchOperation>
</soapenv:Body>
</soapenv:Envelope>

```

## Create RAN Backhaul ATM Service Request With IOS XR

The following example shows a partial list of properties that needs to be specified to enable support for IOS XR devices. These attributes should be added under EvcLink (**L2VpnGrpName** and **AutoPickElineName**).

```

<objectPath xsi:type="ns1:CIMObjectPath">
  <className xsi:type="xsd:string"> EvcLink</className>

```

```

<properties xsi:type="ns1:CIMPropertyList"
  soapenc:arrayType="ns1:CIMProperty[]">
  <item xsi:type="ns1:CIMProperty">
    <name xsi:type="xsd:string">L2VpnGrpName</name>
    <value xsi:type="xsd:string">ISC</value>
  </item>

  <item xsi:type="ns1:CIMProperty">
    <name xsi:type="xsd:string">AutoPickElineName</name>
    <value xsi:type="xsd:string">>true</value>
    <qualifier xsi:type="ns1:CIMQualifier">
      <name xsi:type="xsd:string">editable</name>
      <value xsi:type="xsd:string">>true</value>
    </qualifier>
  </item>
</properties>
</objectPath>

```

## ATM Pseudowire End-to-End Provisioning Process

This section describes the process for using the API to provision ATM Pseudowire and includes the required operation, object definition (className), and parameter definitions.

### Process Summary

This ATM Pseudowire provisioning example uses the following processes:

1. Create device groups (optional).
2. Create devices.
3. Collect device configurations.
4. Create provider.
5. Create regions.
6. Declare devices as PEs.
7. Create customer.
8. Create VC ID pool.
9. Create ATM Pseudowire service definition (policy).
10. Create ATM Pseudowire service request.

### Detailed Process

This section describes the process for provisioning ATM Pseudowire using XML examples.

The complete list of XML examples for ATM Pseudowire is available here:

[Cisco Prime Provisioning API 6.8 Programmer Reference](#)



#### Note

For clarity, this provisioning process shows each step as a separate XML request. Many of these steps can be combined using **performBatchOperations**.

**Step 1** Create device groups (optional).

**Table 11-13** Create Device Group

Operation	className	Required Parameters
createInstance	DeviceGroup	Name

**XML Examples:**

- CreateDeviceGroup.xml



**Tip**

If you plan to create device groups, create the empty device groups before you create the devices. As you create each device, add the associated device group name as a key property in the create device XML request.

In the following example, the device group (CustDev) is added as a key property when creating the device **CiscoRouter**:

```
<ns1:createInstance>
  <objectPath xsi:type="ns1:CIMObjectPath">
    <className xsi:type="xsd:string">CiscoRouter</className>
    <properties xsi:type="ns1:CIMPropertyList"
soapenc:arrayType="ns1:CIMProperty[]">
      <item xsi:type="ns1:CIMProperty">
        <name xsi:type="xsd:string">DeviceGroup</name>
        <value xsi:type="xsd:string">CustDev</value>
      </item>
      <item xsi:type="ns1:CIMProperty">
        <name xsi:type="xsd:string">CfgUpDnldMech</name>
        <value xsi:type="xsd:string">DEFAULT</value>
      </item>
      <item xsi:type="ns1:CIMProperty">
        <name xsi:type="xsd:string">TransportMechanism</name>
        <value xsi:type="xsd:string">DEFAULT</value>
      </item>
      <item xsi:type="ns1:CIMProperty">
        <name xsi:type="xsd:string">Password</name>
        <value xsi:type="xsd:string">vpnsc</value>
      </item>
    </properties>
  </objectPath>
</ns1:createInstance>
```

**Step 2** Create devices.

Every network element that Prime Provisioning manages must be defined as a device in the system. An element is any device from which Prime Provisioning can collect configuration information.

**Table 11-14** Create Devices

Operation	className	Required Parameters
createInstance	<ul style="list-style-type: none"> <li>• CiscoRouter</li> <li>• CatOS</li> </ul>	One or more of the following: <ul style="list-style-type: none"> <li>• ManagementIPAddress</li> <li>• HostName</li> <li>• DomainName</li> </ul>

**XML Examples:**

- CreateCiscoRouter.xml
- CreateCat.xml

**Step 3** Collect device configurations.

A device configuration collection is a task. This task uploads the current configuration from the device to the Prime Provisioning database. The collection task is executed through a service request, and the service request is scheduled through a service order.

**Note**

The service request name must be unique for each NBI API.

**Table 11-15** *Collect Device Configurations*

Operation	className	Required Parameters
createInstance	ServiceOrder	<ul style="list-style-type: none"> <li>• ServiceName</li> <li>• NumberofRequests</li> <li>• ServiceRequest</li> </ul>
	ServiceRequest	<ul style="list-style-type: none"> <li>• RequestName</li> <li>• Type=Task</li> <li>• ServiceRequestDetails</li> </ul>
	ServiceRequestDetails	<ul style="list-style-type: none"> <li>• SubType=COLLECTION</li> <li>• Device (or DeviceGroup)</li> </ul> <p><b>Note</b> You must select at least one device or device group.</p> <ul style="list-style-type: none"> <li>• RetrieveVersion=true</li> <li>• RetrieveDeviceInterfaces=true</li> </ul>

**XML Examples:**

- CreateTaskServiceOrderCollection.xml

**Step 4** Create a provider.

The provider is the administrative domain of an ISP, with one BGP autonomous system (AS) number. The network owned by the provider is called the backbone network. If an ISP has two AS numbers, you must define it as two provider administrative domains.

**Table 11-16** *Create a Provider*

Operation	className	Required Parameters
createInstance	Provider	<ul style="list-style-type: none"> <li>• Name</li> <li>• AsNumber</li> </ul>

**XML Examples:**

CreateProvider.xml

**Step 5** Create regions.



Each provider can contain multiple regions.

**Table 11-17 Create Regions**

Operation	className	Required Parameters
createInstance	Region	<ul style="list-style-type: none"> <li>Name</li> <li>Provider</li> </ul>

**XML Examples:**

CreateRegion.xml

**Step 6** Declare devices as PEs.

The XML request that assigns a PE role to a device is also used to:

- Assign PE devices to Regions/Provider
- Specify interface information

**Table 11-18 Create PE Devices**

Operation	className	Required Parameters
createInstance	PE	<ul style="list-style-type: none"> <li>Provider</li> <li>Region</li> <li>Role= <ul style="list-style-type: none"> <li>N-PE</li> </ul> </li> <li>Device</li> <li>Interface</li> </ul>

**XML Examples:**

CreatePE.xml

**Step 7** Create a customer.

A customer is a requestor of VPN services. Each customer can contain multiple customer sites. Each site belongs to only one customer and can contain multiple CPEs.

**Table 11-19 Create Organization**

Operation	className	Required Parameters
createInstance	Organization	<ul style="list-style-type: none"> <li>Name</li> </ul>

**XML Examples:**

- CreateOrganization.xml

**Step 8** Create VC ID pool.

For a VPLS VPN, all PE-POP routers use the same VC ID to establish the virtual circuit (VC) across the provider core. The VC ID is also the VPN ID and is assigned from the VC ID pool. Prime Provisioning ensures that VC IDs are unique among VPLS VPNs.

**Note**

A VC ID pool is global (not associated with a provider or organization).

**Table 11-20 Create VC ID Pool**

Operation	className	Required Parameters
createInstance	VcIdPool	<ul style="list-style-type: none"> <li>Start</li> <li>Size</li> </ul>

**XML Examples:**

- CreateVcIdPool.xml

**Step 9** Create ATM Pseudowire service definition (policy).

A ATM Pseudowire service definition specifies the service subtype, device properties, and the attributes common to all attachment circuits.

**Table 11-21 Create a ATM Pseudowire Service Definition**

Operation	className	Required Parameters
createInstance	ServiceDefinition	<ul style="list-style-type: none"> <li>Name</li> <li>Type=EvcIpran</li> <li>Provider or Organization</li> </ul> <p><b>Note</b> If you do not specify a <b>Provider</b> or <b>Organization</b>, the service policy is global</p> <ul style="list-style-type: none"> <li>ServiceDefinitionDetails</li> </ul>
	ServiceDefinitionDetails	<ul style="list-style-type: none"> <li>SubType=Evc</li> <li>Parameters <ul style="list-style-type: none"> <li>AccessType = ATM</li> <li>TransportType = PSEUDOWIRE</li> <li>AtmTransportMode</li> <li>AutopickVCId</li> <li>EnablePWRedundancy</li> <li>UsePwClass</li> </ul> </li> </ul>

**XML Examples:**

- CreateATM\_IMA\_Policy.xml

**Step 10** Create ATM Pseudowire service request.

A ATM Pseudowire service request defines the service definition and assigns interfaces and attributes.

Table 11-22 Create a ATM Pseudowire Service Request

Operation	className	Required Parameters
createInstance	ServiceOrder	<ul style="list-style-type: none"> <li>• ServiceName</li> <li>• NumberOfRequests</li> <li>• Provider or Organization</li> </ul> <p><b>Note</b> If you do not specify a <b>Provider</b> or <b>Organization</b>, the service policy is global.</p> <ul style="list-style-type: none"> <li>• ServiceRequest</li> </ul>
	ServiceRequest	<ul style="list-style-type: none"> <li>• RequestName</li> <li>• Type=EvcIpran</li> <li>• ServiceRequestDetails</li> </ul>
	ServiceRequestDetails	<ul style="list-style-type: none"> <li>• ServiceDefinition <ul style="list-style-type: none"> <li>– ServiceDefinitionType=EvcIpran</li> </ul> </li> <li>• VCID</li> <li>• BackupVCID</li> <li>• MCPTTimer1</li> <li>• MCPTTimer2</li> <li>• MCPTTimer3</li> <li>• Npe</li> <li>• UniInftId</li> <li>• Terminal</li> <li>• AtmInterfaceEncapType</li> <li>• AtmTransportMode</li> <li>• AtmSubInterfaceNumber</li> <li>• PVPVPINumber</li> <li>• PVPVCINumber</li> <li>• MaxCells</li> <li>• MCPTTimerToUse</li> <li>• UsePwClass</li> <li>• PwClassName</li> <li>• UseBackPwClass - Only if PW Redundancy needs to be created</li> <li>• BackPwClassName - Only if PW Redundancy needs to be created</li> </ul>

**Tip**

Record the **LocatorId** value from the XML response for the service request. The Locator ID is required for subsequent service request tasks.

**XML Examples:**

- CreateATM\_IMA\_PVP\_SR\_PW.xml
- CreateATM\_IMA\_PVP\_SR\_PWRedundancy.xml (only if PW redundancy needs to be created for ATM IMA PVP Service)
- CreateATM\_IMA\_VCC\_SR\_PW.xml
- CreateATM\_IMA\_VCC\_SR\_PWRedundancy.xml (only if PW redundancy needs to be created for ATM IMA VCC Service)
- CreateIPRAN\_ATM\_SR\_IOS\_XR.xml

## Auditing Service Requests

A configuration audit occurs automatically each time you deploy a service request. During this configuration audit, Prime Provisioning verifies that all Cisco IOS commands are present and that they have the correct syntax. An audit also verifies that there were no errors during deployment by examining the commands configured by the service request on the target devices. If the device configuration does not match what is defined in the service request, the audit flags a warning and sets the service request to a *Failed Audit* or *Lost* state.

If you do not want the configuration audit to occur, change the value for the **Audit** parameter. The **Audit** parameter supports these values:

- **Audit**—This is the default. A successfully deployed service request is automatically audited unless this flag is changed.
- **NoAudit**—Do not perform a configuration audit when the service request is deployed.
- **ForceAudit**—Perform a configuration audit even if the service request deployment is not successful.

You can use the Audit parameter with a **Create**, **Modify**, or **Decommission** service request or a **Deployment** task. See the “[Service Decommission](#)” section on page 3-11 for more information. To perform a configuration audit as a separate task, see the “[Configuration Audit](#)” section on page 3-11.



# MPLS Transport Profile Provisioning

---

This chapter describes the provisioning support for MPLS Transport Profile (MPLS-TP) provided in Cisco Prime Provisioning.

The MPLS-TP API solution provides provisioning, updating, and deletion of MPLS-TP objects.

More specifically, the chapter describes MPLS-TP service concepts and the steps required to provision MPLS-TP services using the Prime Provisioning API. A provisioning example lists all steps from creating the inventory to deploying the service.

For information on MPLS-TP provisioning using the Prime Provisioning GUI, see the [Cisco Prime Provisioning 7.0 User Guide](#).

This chapter contains the following sections:

- [Prerequisites and Limitations, page 12-1](#)
- [MPLS-TP Service Definitions, page 12-1](#)
- [MPLS-TP Discovery, page 12-5](#)
- [MPLS-TP Service Requests, page 12-7](#)
- [Provisioning Example, page 12-20.](#)

## Prerequisites and Limitations

Prior to provisioning MPLS-TP on your network, it is assumed that you have completed the necessary preconfiguration steps. They are listed in the MPLS-TP chapter of the [Cisco Prime Provisioning 7.0 User Guide](#).

The current release of Prime Provisioning involves certain prerequisites for MPLS-TP, which are described in the [MPLS-TP Discovery, page 12-5](#).

Other prerequisites, including general system recommendations and installation requirements, are described in the [Cisco Prime Provisioning 7.0 Installation Guide](#).

## MPLS-TP Service Definitions

To provision MPLS-TP using the Prime Provisioning API, you need a MPLS-TP service definition and a MPLS-TP service request (SR). This section lists the supported service definitions, service orders, and policies and includes corresponding examples.

When you deploy a MPLS-TP service request using a service order, the attributes specified in the service definition are applied to the devices and interfaces listed in the service request.

## Supported MPLS-TP Features

Prime Provisioning supports the following MPLS-TP features:

- MPLS-TP Discovery Tasks
  - Full Discovery
  - MPLS Label Sync
- MPLS-TP Policies
  - Create MPLS-TP Policy
  - Modify MPLS-TP Policy
  - Delete MPLS-TP Policy
- MPLS-TP Service Requests
  - Create MPLS-TP Tunnel
  - Modify MPLS-TP Tunnel
  - Delete MPLS-TP Tunnel.

API XML examples for the above operations are contained in the [Cisco Prime Provisioning API 7.0 Programmer Reference](#).



### Note

It is possible to include or exclude mutipe nodes through the API when modifying an MPLS-TP service request. See example under [Service Request Examples, page 12-8](#).

## Policy Example

The following is an example of how to create an MPLS-TP policy with path protection. Path protection for the MPLS-TP Tunnel is enabled by setting the **protectedTpTunnel** variable to **TRUE** and setting the **diversityOption** to any of the three options from valueMap below, in this example **Node Diversity Desired**.

Example: CreateMplsTpPolicy.xml

```
<?xml version="1.0" encoding="UTF-8"?>
<soapenv:Envelope xmlns:soapenv="http://schemas.xmlsoap.org/soap/envelope/"
  xmlns:soapenc="http://schemas.xmlsoap.org/soap/encoding/"
  xmlns:xsd="http://www.w3.org/2001/XMLSchema"
  xmlns:xsi="http://www.w3.org/2001/XMLSchema-instance"
  xmlns:ns0="http://www.cisco.com/cim-cx/2.0"
  xmlns:ns1="urn:CIM">
  <soapenv:Header>
    <ns0:message id="1" sessiontoken="0AA9445A4E6A044ADD8E393BA254715B"
      Wait="false" WaitTimeout="300" />
  </soapenv:Header>
  <soapenv:Body>
    <ns1:createInstance>
      <objectPath xsi:type="ns1:CIMObjectPath">
        <className xsi:type="xsd:string">ServiceDefinition</className>
```

```

<properties xsi:type="ns1:CIMPropertyList"
  soapenc:arrayType="ns1:CIMProperty[]">
  <item xsi:type="ns1:CIMProperty">
    <name xsi:type="xsd:string">Type</name>
    <value xsi:type="xsd:string">Flexible</value>
  </item>
  <item xsi:type="ns1:CIMProperty">
    <name xsi:type="xsd:string">Name</name>
    <value xsi:type="xsd:string">TPPolicy-New3</value>
  </item>
</properties>
<objectPath xsi:type="ns1:CIMObjectPath">
  <className xsi:type="xsd:string">ServiceDefinitionDetails</className>
  <properties xsi:type="ns1:CIMPropertyList"
    soapenc:arrayType="ns1:CIMProperty[]">
    <item xsi:type="ns1:CIMProperty">
      <name xsi:type="xsd:string">PolicyData</name>
      <value xsi:type="xsd:string"><![CDATA[
<service serviceType="MPLS-TP" serviceName="MPLS-TP">
  <section useFor="SR" name="Service Information " required="true" >
    <field name="serviceType" title="Service Type" type="text" disabled="true"
required="false" editable="true" value="MPLS-TP"/>
    <field name="serviceDescription" title="Service Description" type="textarea"
required="false"/>
  </section>

  <section useFor="Policy" name="Policy Information " required="true" >
    <field name="policyName" title="Policy Name" type="text" required="true"/>
    <field name="policyDescription" title="Description" type="textarea"
required="false"/>
  </section>

  <section useFor="Policy-SR" name="Tunnel Characteristics" required="true" >
    <group>
      <field name="tunnelName" title="Source Name" type="text" required="false" value=""
editable="true">
        <validators>
          <validator type="regexp" expression=".*" errorMessage="Tunnel name can be
any number of characters"/>
        </validators>
      </field>
      <field name="dstTunnelName" title="Destination Name(If different)" type="text"
required="false" value="" editable="true">
        <validators>
          <validator type="regexp" expression=".*" errorMessage="Tunnel name can be
any number of characters"/>
        </validators>
      </field>
    </group>
    <group>
      <field name="tunnelDescription" title="Source Description" type="textarea"
required="false"/>
      <field name="dstTunnelDescription" title="Destination Description (If
different)" type="textarea" required="false"/>
    </group>
    <group>
      <field name="bandwidth" title="Transmit Bandwidth" type="integer"
required="false" style="width:120px" metricOptions="Kbps, [Mbps], Gbps"/>
      <field name="rxBandwidth" title="Recieve Bandwidth(If different)"
type="integer" required="false" style="width:120px" metricOptions="Kbps, [Mbps], Gbps"/>
    </group>
  </section>
</service>
]]></value>
    </item>
  </properties>
</objectPath>

```

```

        <field name="srcTunnelNumberAutoAllocate" title="Auto-Allocate Tunnel Number
At Source" type="boolean" required="false" value="true" visibility="Hidden"/>
        <field name="dstTunnelNumberAutoAllocate" title="Auto-Allocate Tunnel Number
At Destination" type="boolean" required="false" value="true" visibility="Hidden"/>
    </group>
    <field name="state" title="State" type="combo" required="false"
visibility="Hidden" value="Up">
        <valueMap>
            <value>Up</value>
            <value>Down</value>
        </valueMap>
    </field>
    <field name="protectedTpTunnel" title="Protection" type="boolean"
required="false" visibility="Hidden" value="true"/>
    <field name="diversityOption" title="Diversity Options" type="combo"
required="false" disabled="true" visibility="Hidden" value="Node Diversity Desired">
        <valueMap>
            <value>Node Diversity Desired</value>
            <value>Node Diversity Required</value>
            <value>Link Diversity Only</value>
        </valueMap>
    </field>
</section>

<section useFor="Policy-SR" name="Tunnel End-Points" required="true" >
    <field name="sourceDevice" title="Source Node" type="textpicker"
resource="devices" resourceToLoad="sourceBfdTemplate" required="true" editable="true" />
    <field name="sourceBfdTemplate" title="Source BFD" type="textpicker"
required="true"/>
    <field name="sourceBfdMinInterval" title="Source BFD min-interval (ms) (15 -
5000)" type="integer" required="false" visibility="Hidden"/>
    <field name="sourceBfdMinIntervalStandby" title="Source BFD min-interval Standby
(ms) (15 - 5000)" type="integer" required="false" visibility="Hidden"/>
    <field name="sourceBfdMultiplier" title="Source BFD Multiplier (2 - 10)"
type="integer" required="false" visibility="Hidden"/>
    <field name="sourceTunnelNumber" title="Source Tunnel Number" type="text"
required="false" visibility="Hidden" editable="true">
        <validators>
            <validator type="regexp" expression="\d*" errorMessage="Tunnel number must
be 0 - 65535"/>
        </validators>
    </field>
    <field name="sourceRouterId" title="Source Router ID" type="ip" required="false"
visibility="Hidden"/>
    <field name="sourceGlobalId" title="Source Global ID" type="integer"
required="false" visibility="Hidden"/>
    <field name="destinationDevice" title="Destination Node" type="textpicker"
resource="devices" resourceToLoad="destinationBfdTemplate" required="true"/>
    <field name="destinationBfdTemplate" title="Destination BFD" type="textpicker"
required="true"/>
    <field name="destinationBfdMinInterval" title="Destination BFD min-interval (ms)
(15 - 5000)" type="integer" required="false" visibility="Hidden"/>
    <field name="destinationBfdMinIntervalStandby" title="Destination BFD min-interval
Standby (ms) (15 - 5000)" type="integer" required="false" visibility="Hidden"/>
    <field name="destinationBfdMultiplier" title="Destination BFD Multiplier (2 - 10)"
type="integer" required="false" visibility="Hidden"/>
    <field name="destinationTunnelNumber" title="Destination Tunnel Number"
type="text" required="false" visibility="Hidden" editable="true">
        <validators>
            <validator type="regexp" expression="\d*" errorMessage="Tunnel number must
be 0 - 65535"/>
        </validators>
    </field>

```



```

        <field name="destinationRouterId" title="Destination Router ID" type="ip"
required="false" visibility="Hidden"/>
        <field name="destinationGlobalId" title="Destination Global ID" type="integer"
required="false" visibility="Hidden"/>
    </section>

    <section useFor="SR" name="Review Routing" required="true">
        <group id="pathOptionsGroup" cloneable="true">
            <field name="reqExOption" title="" type="combo" required="false"
value="Required NE/Link">
                <valueMap>
                    <value>Required NE/Link</value>
                    <value>Excluded NE/Link</value>
                </valueMap>
            </field>
            <field name="reqExElement" title="" type="textpicker"
resource="devicesAndTpLinks" width="400" required="true"/>
            <field name="pathType" title="" type="combo" required="false" value="Working
Path">
                <valueMap>
                    <value>Working Path</value>
                    <value>Protect Path</value>
                </valueMap>
            </field>
        </group>
    </section>
</service>

        ]]</value>
        </item>
        </properties>
    </objectPath>
</objectPath>
</ns1:createInstance>
</soapenv:Body>
</soapenv:Envelope>

```

#### Related APIs

- [ModifyMplsTpPolicy.xml](#)

## MPLS-TP Discovery

After completing the preconfiguration process, you can discover the MPLS-TP network for a particular MPLS-TP provider. This populates the repository with the network topology.

Prime Provisioning supports MPLS-TP discovery from both IOS and IOS-XR devices when deployed together with Prime Network (or) in the IP-NGN suite. Prime Provisioning should be 'paired' with Prime Network by setting the Prime Network gateway detail in the Prime Provisioning DCPL property **Inventory Import**.

Prime Provisioning in standalone mode (without Prime Network integration) supports CDP-based MPLS-TP discovery from IOS devices but this is deprecated.

As a prerequisite for running MPLS-TP discovery, all devices must be present and a Collect Config task must be run. For further information about MPLS-TP Discovery, see the [Cisco Prime Provisioning 7.0 User Guide](#).

## MPLS-TP Discovery Example

The following is an example of how to create an MPLS-TP Discovery task.

The relevant attributes that need to be set for this policy are highlighted in bold in the example. In this case, it is the attribute **Subtype**, which in the example is set to **TP\_DISCOVERY**.

If the item **labelSyncOnly** is set to **true**, only the label information gets discovered. In the example below, it is set to **false**, in which case Prime Provisioning performs a complete MPLS-TP discovery.

Example: CreateTaskServiceOrderTpDiscovery.xml

```
<?xml version="1.0" encoding="UTF-8"?>
<soapenv:Envelope
  xmlns:soapenv="http://schemas.xmlsoap.org/soap/envelope/"
  xmlns:soapenc="http://schemas.xmlsoap.org/soap/encoding/"
  xmlns:xsd="http://www.w3.org/2001/XMLSchema"
  xmlns:xsi="http://www.w3.org/2001/XMLSchema-instance"
  xmlns:ns0="http://www.cisco.com/cim-cx/2.0"
  xmlns:ns1="urn:CIM">
  <soapenv:Header>
    <!-- WaitTimeout has a default set in system properties.-->
    <ns0:message id="87855" timestamp="2002-12-13T14:55:38.885Z"
      Wait="false" WaitTimeout="60"
      sessiontoken="E8AF7A658C78F46BFF4E33E4E4DB1B78"/>
  </soapenv:Header>
  <soapenv:Body>
    <ns1:performBatchOperation>
      <actions xsi:type="ns1:CIMActionList"
        soapenc:arrayType="ns1:CIMAction[]">
        <action>
          <actionName xsi:type="xsd:string">createInstance</actionName>
          <objectPath xsi:type="ns1:CIMObjectPath">
            <className xsi:type="xsd:string">ServiceOrder</className>
            <properties xsi:type="ns1:CIMPropertyList"
              soapenc:arrayType="ns1:CIMProperty[]">
              <item xsi:type="ns1:CIMProperty">
                <name xsi:type="xsd:string">ServiceName</name>
                <value xsi:type="xsd:string">ServiceOrderForTpDiscovery</value>
              </item>
              <item xsi:type="ns1:CIMProperty">
                <name xsi:type="xsd:string">CarrierId</name>
                <value xsi:type="xsd:string">1</value>
              </item>
              <item xsi:type="ns1:CIMProperty">
                <name xsi:type="xsd:string">DesiredDueDate</name>
                <value xsi:type="xsd:dateTime">2002-12-13T14:55:38.885Z</value>
              </item>
              <item xsi:type="ns1:CIMProperty">
                <name xsi:type="xsd:string">NumberOfRequests</name>
                <value xsi:type="xsd:string">1</value>
              </item>
              <item xsi:type="ns1:CIMProperty">
                <name xsi:type="xsd:string">Organization</name>
                <value xsi:type="xsd:string">Customer1</value>
              </item>
            </properties>
          </objectPath>
        </action>
        <action>
          <actionName xsi:type="xsd:string">createInstance</actionName>
          <objectPath xsi:type="ns1:CIMObjectPath">
            <className xsi:type="xsd:string">ServiceRequest</className>
```

```

<properties xsi:type="ns1:CIMPropertyList"
  soapenc:arrayType="ns1:CIMProperty[]">
  <item xsi:type="ns1:CIMProperty">
    <name xsi:type="xsd:string">RequestName</name>
    <value xsi:type="xsd:string">TP-DISCOVERY-NBI</value>
  </item>
  <item xsi:type="ns1:CIMProperty">
    <name xsi:type="xsd:string">Type</name>
    <value xsi:type="xsd:string">Task</value>
  </item>
</properties>
<objectPath xsi:type="ns1:CIMObjectPath">
<className xsi:type="xsd:string">ServiceRequestDetails</className>
<properties xsi:type="ns1:CIMPropertyList"
  soapenc:arrayType="ns1:CIMProperty[]">
  <item xsi:type="ns1:CIMProperty">
    <name xsi:type="xsd:string">SubType</name>
    <value xsi:type="xsd:string">TP_DISCOVERY</value>
  </item>
  <item xsi:type="ns1:CIMProperty">
    <name xsi:type="xsd:string">Device</name>
    <value xsi:type="xsd:string">ngxp-agg-lv</value>
  </item>
  <item xsi:type="ns1:CIMProperty">
    <name xsi:type="xsd:string">labelSyncOnly</name>
    <value xsi:type="xsd:string">false</value>
  </item>
</properties>
</objectPath>
</objectPath>
</action>
</actions>
</ns1:performBatchOperation>
</soapenv:Body>
</soapenv:Envelope>

```

## MPLS-TP Service Requests

Before creating a service request, a service policy has to be defined. Use a predefined policy template as is or with modifications to create a service request, and deploy the service. For information on MPLS-TP policies, see the [Cisco Prime Provisioning 7.0 User Guide](#).

A MPLS-TP service request defines the service definition to use and applies the needed policy information.

When deploying a MPLS-TP service request using a service order, the attributes specified in the service definition are applied to the devices and interfaces defined in the service request.

This section includes the following:

- [Typical Sequence of Calls, page 12-8](#)
- [Service Request Examples, page 12-8](#)

## Typical Sequence of Calls

Once you have run Collect Config and MPLS-TP Discovery, the typical sequence of calls for MPLS-TP would be:

1. Associate devices with corresponding roles
2. Create MPLS-TP Policy (CreateMplsTpPolicy.xml )
3. View MPLS-TP Policy Response
4. Create Mpls MPLS-TP service request  
using either
  - CreateMplsTpTunnelServiceRequestWithProtection.xml—creates an MPLS-TP tunnel between tp-device1 and tp-device2 with both working and protect LSPs
 or
  - CreateMplsTpTunnelServiceRequestNoProtection.xml—creates an MPLS-TP tunnel with just a working LSP, no protect LSP
5. Create Mpls MPLS-TP service request Response
6. Deploy SR(Same XML as other service request types)
7. Modify MPLS-TP service request (ModifyMplsTpTunnelServiceRequest.xml).

## Service Request Examples

The following XML examples illustrate how you work with service requests for MPLS-TP APIs. They also demonstrate the kinds of properties (attributes) that need to be specified for each request.

This section contains the following examples:

- [Creating an MPLS-TP Service Request With Path Protection, page 12-8](#)
- [Modifying an MPLS-TP Service Request, page 12-11](#)
- [Modifying an MPLS-TP Protect Path Service Request, page 12-15](#)
- [Modifying an MPLS-TP Service Request with Include/Exclude Multiple Nodes, page 12-16](#)

### Creating an MPLS-TP Service Request With Path Protection

The following is an example of how to create an MPLS-TP service request with path protection. Protection path for TP Tunnel is enabled by setting the **protectedTpTunnel** variable to **TRUE** and selecting the **diversityOption** among any of the 3 options from valueMap below.

Example: CreateMplsTpTunnelServiceRequestWithProtection.xml

```
<?xml version="1.0" encoding="UTF-8"?>
<soapenv:Envelope xmlns:soapenv="http://schemas.xmlsoap.org/soap/envelope/"
  xmlns:soapenc="http://schemas.xmlsoap.org/soap/encoding/"
  xmlns:xsd="http://www.w3.org/2001/XMLSchema"
  xmlns:xsi="http://www.w3.org/2001/XMLSchema-instance"
  xmlns:ns0="http://www.cisco.com/cim-cx/2.0"
  xmlns:ns1="urn:CIM">
  <soapenv:Header>
    <ns0:message id="1" sessiontoken="E453ADAFF7319803C1E8E3C68E1850CD"
      Wait="false" WaitTimeout="300" />
  </soapenv:Header>
</soapenv:Envelope>
```

```

</soapenv:Header>
<soapenv:Body>
  <ns1:createInstance>
    <objectPath xsi:type="ns1:CIMObjectPath">
      <className xsi:type="xsd:string">ServiceRequest</className>
      <properties xsi:type="ns1:CIMPropertyList"
        soapenc:arrayType="ns1:CIMProperty[]">
        <item xsi:type="ns1:CIMProperty">
          <name xsi:type="xsd:string">Type</name>
          <value xsi:type="xsd:string">Flexible</value>
        </item>
        <item xsi:type="ns1:CIMProperty">
          <name xsi:type="xsd:string">RequestName</name>
          <value xsi:type="xsd:string">TP-3</value>
        </item>
      </properties>
    </objectPath xsi:type="ns1:CIMObjectPath">
      <className xsi:type="xsd:string">ServiceRequestDetails</className>
      <properties xsi:type="ns1:CIMPropertyList"
        soapenc:arrayType="ns1:CIMProperty[]">
        <item xsi:type="ns1:CIMProperty">
          <name xsi:type="xsd:string">ServiceDefinition</name>
          <value xsi:type="xsd:string">tp-policy</value>
        </item>
        <item xsi:type="ns1:CIMProperty">
          <name xsi:type="xsd:string">InstanceData</name>
          <value xsi:type="xsd:string"><![CDATA[
<service serviceType="MPLS-TP" serviceName="MPLS-TP">
  <section useFor="SR" name="Service Information " required="true" >
    <field name="serviceType" value="MPLS-TP" />
    <field name="serviceDescription" />
  </section>

  <section useFor="Policy" name="Policy Information " required="true" >
    <field name="policyName" title="Policy Name" type="text" required="true" />
    <field name="policyDescription" title="Description" type="textarea"
required="false" />
  </section>

  <section useFor="Policy-SR" name="Tunnel Characteristics" required="true" >
    <group>
      <field name="srcTunnelName" title="Source Name" type="text" required="false"
editable="true">
        <validators>
          <validator type="regex" expression=".*" errorMessage="Tunnel name can be
any number of characters" />
        </validators>
      </field>
      <field name="dstTunnelName" title="Destination Name(If different)" type="text"
required="false" editable="true">
        <validators>
          <validator type="regex" expression=".*" errorMessage="Tunnel name can be
any number of characters" />
        </validators>
      </field>
    </group>
    <group>
      <field name="srcTunnelDescription" title="Source Description" type="textarea"
required="false" />
      <field name="dstTunnelDescription" title="Destination Description(If
different)" type="textarea" required="false" />
    </group>
  </section>
</service>
]]></value>
        </item>
      </properties>
    </objectPath>
  </createInstance>
</soapenv:Body>

```

```

        <field name="bandwidth" title="Transmit Bandwidth" type="integer"
required="false" style="width:120px" metricOptions="Kbps, [Mbps], Gbps"/>
        <field name="rxBandwidth" title="Receive Bandwidth(If different)"
type="integer" required="false" style="width:120px" metricOptions="Kbps, [Mbps], Gbps"/>
    </group>

    <group>
        <field name="srcTunnelNumberAutoAllocate" title="Auto-Allocate Tunnel Number
At Source" type="boolean" required="false" value="true" visibility="Editable"/>
        <field name="dstTunnelNumberAutoAllocate" title="Auto-Allocate Tunnel Number
At Destination" type="boolean" required="false" value="true" visibility="Editable"/>
    </group>
    <field name="state" title="State" type="combo" required="false"
visibility="Editable" value="Up">
        <valueMap>
            <value>Up</value>
            <value>Down</value>
        </valueMap>
    </field>
    <field name="protectedTpTunnel" title="Protection" type="boolean"
required="false" visibility="Editable" value="true"/>
    <field name="diversityOption" title="Diversity Options" type="combo"
required="false" disabled="true" visibility="Editable" value="Node Diversity Desired">
        <valueMap>
            <value>Node Diversity Desired</value>
            <value>Node Diversity Required</value>
            <value>Link Diversity Only</value>
        </valueMap>
    </field>
</section>

<section useFor="Policy-SR" name="Tunnel End-Points" required="true" >
    <field name="sourceDevice" title="Source Node" type="textpicker"
resource="devices" resourceToLoad="sourceBfdTemplate" required="true" editable="true"
value="router-TP11"/>
    <field name="sourceBfdTemplate" title="Source BFD" type="textpicker"
required="true" value="BFDTemplate-SingleHopMilliSec-4"/>
    <field name="sourceBfdMinInterval" title="Source BFD min-interval (ms) (15 -
5000)" type="integer" required="false" visibility="Hidden"/>
    <field name="sourceBfdMinIntervalStandby" title="Source BFD min-interval Standby
(ms) (15 - 5000)" type="integer" required="false" visibility="Hidden"/>
    <field name="sourceBfdMultiplier" title="Source BFD Multiplier (2 - 10)"
type="integer" required="false" visibility="Hidden"/>
    <field name="sourceTunnelNumber" title="Source Tunnel Number" type="text"
required="false" visibility="Editable" editable="true">
        <validators>
            <validator type="regexp" expression="\d*" errorMessage="Tunnel number must
be 0 - 65535"/>
        </validators>
    </field>
    <field name="sourceRouterId" title="Source Router ID" type="ip" required="false"
visibility="Editable"/>
    <field name="sourceGlobalId" title="Source Global ID" type="integer"
required="false" visibility="Editable"/>
    <field name="destinationDevice" title="Destination Node" type="textpicker"
resource="devices" resourceToLoad="destinationBfdTemplate" required="true"
value="tp-device2/>
    <field name="destinationBfdTemplate" title="Destination BFD" type="textpicker"
required="true"/>
    <field name="destinationBfdMinInterval" title="Destination BFD min-interval (ms)
(15 - 5000)" type="integer" required="false" visibility="Hidden"/>
    <field name="destinationBfdMinIntervalStandby" title="Destination BFD min-interval
Standby (ms) (15 - 5000)" type="integer" required="false" visibility="Hidden"/>

```

```

        <field name="destinationBfdMultiplier" title="Destination BFD Multiplier (2 - 10)"
type="integer" required="false" visibility="Hidden"/>
        <field name="destinationTunnelNumber" title="Destination Tunnel Number"
type="text" required="false" visibility="Editable" editable="true">
            <validators>
                <validator type="regexp" expression="\d*" errorMessage="Tunnel number must
be 0 - 65535"/>
            </validators>
        </field>
        <field name="destinationRouterId" title="Destination Router ID" type="ip"
required="false" visibility="Editable"/>
        <field name="destinationGlobalId" title="Destination Global ID" type="integer"
required="false" visibility="Editable"/>
    </section>

    <section useFor="SR" name="Review Routing" required="true">
        <group id="pathOptionsGroup" cloneable="true">
            <field name="reqExOption" title="" type="combo" required="false"
value="Required NE/Link">
                <valueMap>
                    <value>Required NE/Link</value>
                    <value>Excluded NE/Link</value>
                </valueMap>
            </field>
            <field name="reqExElement" title="" type="textpicker"
resource="devicesAndTpLinks" width="400" required="true"/>
            <field name="pathType" title="" type="combo" required="false" value="Working
Path">
                <valueMap>
                    <value>Working Path</value>
                    <value>Protect Path</value>
                </valueMap>
            </field>
        </group>
    </section>
</service>]]</value>
        </item>
    </properties>
</objectPath>
</objectPath>
</ns1:createInstance>
</soapenv:Body>
</soapenv:Envelope>

```

## Modifying an MPLS-TP Service Request

The following is an example of how to modify an MPLS-TP service request. This is done by modifying the service data using the attribute **LocatorId**, which in the example is set to **194**.

Example: `ModifyMplsTpTunnelServiceRequest.xml`

```

<?xml version="1.0" encoding="UTF-8"?>
<soapenv:Envelope xmlns:soapenv="http://schemas.xmlsoap.org/soap/envelope/"
xmlns:soapenc="http://schemas.xmlsoap.org/soap/encoding/"
xmlns:xsd="http://www.w3.org/2001/XMLSchema"
xmlns:xsi="http://www.w3.org/2001/XMLSchema-instance"
xmlns:ns0="http://www.cisco.com/cim-cx/2.0"
xmlns:ns1="urn:CIM">
    <soapenv:Header>
        <ns0:message id="1" sessiontoken="E453ADAFF7319803C1E8E3C68E1850CD"
Wait="false" WaitTimeout="300" />
    </soapenv:Header>

```

```

</soapenv:Header>
<soapenv:Body>
  <ns1:modifyInstance>
    <objectPath subAction="modifyInstance" xsi:type="ns1:CIMObjectPath">
      <className xsi:type="xsd:string">ServiceRequest</className>

      <properties xsi:type="ns1:CIMPropertyList"
        soapenc:arrayType="ns1:CIMProperty[]">
        <item xsi:type="ns1:CIMProperty">
          <name xsi:type="xsd:string">Type</name>
          <value xsi:type="xsd:string">Flexible</value>
        </item>
        <item xsi:type="ns1:CIMProperty">
          <name xsi:type="xsd:string">RequestName</name>
          <value xsi:type="xsd:string">TP-3</value>
        </item>
      </properties>

      <objectPath subAction="modifyInstance" xsi:type="ns1:CIMObjectPath">
        <className xsi:type="xsd:string">ServiceRequestDetails</className>
      <keyProperties xsi:type="ns1:CIMKeyPropertyList"
        soapenc:arrayType="ns1:CIMKeyProperty[]">
        <item xsi:type="ns1:CIMProperty">
          <name xsi:type="xsd:string">LocatorId</name>
          <value xsi:type="xsd:string">194</value>
        </item>
      </keyProperties>
      <properties xsi:type="ns1:CIMPropertyList"
        soapenc:arrayType="ns1:CIMProperty[]">
        <item xsi:type="ns1:CIMProperty">
          <name xsi:type="xsd:string">ServiceDefinition</name>
          <value xsi:type="xsd:string">tp-policy</value>
        </item>
        <item xsi:type="ns1:CIMProperty">
          <name xsi:type="xsd:string">InstanceData</name>
          <value xsi:type="xsd:string"><<![CDATA[
<service serviceType="MPLS-TP" serviceName="MPLS-TP">
  <section useFor="SR" name="Service Information " required="true" >
    <field name="serviceType" title="Service Type" type="text" disabled="true"
required="false" editable="true" value="MPLS-TP"/>
    <field name="serviceDescription" title="Service Description" type="textarea"
required="false"/>
  </section>

  <section useFor="Policy" name="Policy Information " required="true" >
    <field name="policyName" title="Policy Name" type="text" required="true"/>
    <field name="policyDescription" title="Description" type="textarea"
required="false"/>
  </section>

  <section useFor="Policy-SR" name="Tunnel Characteristics" required="true" >
    <group>
      <field name="srcTunnelName" title="Source Name" type="text" required="false"
editable="true">
        <validators>
          <validator type="regexp" expression=".*" errorMessage="Tunnel name can be
any number of characters"/>
        </validators>
      </field>
      <field name="dstTunnelName" title="Destination Name(If different)" type="text"
required="false" editable="true">
        <validators>
          <validator type="regexp" expression=".*" errorMessage="Tunnel name can be
any number of characters"/>
        </validators>
      </field>
    </group>
  </section>
]]>>>

```



```

        </validators>
    </field>
</group>
<group>
    <field name="srcTunnelDescription" title="Source Description" type="textarea"
required="false"/>
    <field name="dstTunnelDescription" title="Destination Description(If
different)" type="textarea" required="false"/>
</group>
<group>
    <field name="bandwidth" title="Transmit Bandwidth" type="integer"
required="false" style="width:120px" metricOptions="Kbps,[Mbps],Gbps"/>
    <field name="rxBandwidth" title="Receive Bandwidth(If different)"
type="integer" required="false" style="width:120px" metricOptions="Kbps,[Mbps],Gbps"/>
</group>

<group>
    <field name="srcTunnelNumberAutoAllocate" title="Auto-Allocate Tunnel Number
At Source" type="boolean" required="false" value="true" visibility="Hidden"/>
    <field name="dstTunnelNumberAutoAllocate" title="Auto-Allocate Tunnel Number
At Destination" type="boolean" required="false" value="true" visibility="Hidden"/>
</group>
    <field name="state" title="State" type="combo" required="false"
visibility="Hidden" value="Up">
        <valueMap>
            <value>Up</value>
            <value>Down</value>
        </valueMap>
    </field>
    <field name="protectedTpTunnel" title="Protection" type="boolean"
required="false" visibility="Hidden" value="true"/>
    <field name="diversityOption" title="Diversity Options" type="combo"
required="false" disabled="true" visibility="Hidden" value="Node Diversity Desired">
        <valueMap>
            <value>Node Diversity Desired</value>
            <value>Node Diversity Required</value>
            <value>Link Diversity Only</value>
        </valueMap>
    </field>
</section>

<section useFor="Policy-SR" name="Tunnel End-Points" required="true" >
    <field name="sourceDevice" title="Source Node" type="textpicker"
resource="devices" resourceToLoad="sourceBfdTemplate" required="true" />
    <field name="sourceBfdTemplate" title="Source BFD" type="textpicker"
required="true"/>
    <field name="sourceBfdMinInterval" title="Source BFD min-interval (ms) (15 -
5000)" type="integer" required="false" visibility="Hidden"/>
    <field name="sourceBfdMinIntervalStandby" title="Source BFD min-interval Standby
(ms) (15 - 5000)" type="integer" required="false" visibility="Hidden"/>
    <field name="sourceBfdMultiplier" title="Source BFD Multiplier (2 - 10)"
type="integer" required="false" visibility="Hidden"/>
    <field name="sourceTunnelNumber" title="Source Tunnel Number" type="text"
required="false" visibility="Hidden" editable="true">
        <validators>
            <validator type="regexp" expression="\d*" errorMessage="Tunnel number must
be 0 - 65535"/>
        </validators>
    </field>
    <field name="sourceRouterId" title="Source Router ID" type="ip" required="false"
visibility="Hidden"/>
    <field name="sourceGlobalId" title="Source Global ID" type="integer"
required="false" visibility="Hidden"/>

```

```

        <field name="destinationDevice" title="Destination Node" type="textpicker"
resource="devices" resourceToLoad="destinationBfdTemplate" required="true"/>
        <field name="destinationBfdTemplate" title="Destination BFD" type="textpicker"
required="true"/>
        <field name="destinationBfdMinInterval" title="Destination BFD min-interval (ms)
(15 - 5000)" type="integer" required="false" visibility="Hidden"/>
        <field name="destinationBfdMinIntervalStandby" title="Destination BFD min-interval
Standby (ms) (15 - 5000)" type="integer" required="false" visibility="Hidden"/>
        <field name="destinationBfdMultiplier" title="Destination BFD Multiplier (2 - 10)"
type="integer" required="false" visibility="Hidden"/>
        <field name="destinationTunnelNumber" title="Destination Tunnel Number"
type="text" required="false" visibility="Hidden" editable="true">
            <validators>
                <validator type="regexp" expression="\d*" errorMessage="Tunnel number must
be 0 - 65535"/>
            </validators>
        </field>
        <field name="destinationRouterId" title="Destination Router ID" type="ip"
required="false" visibility="Hidden"/>
        <field name="destinationGlobalId" title="Destination Global ID" type="integer"
required="false" visibility="Hidden"/>
    </section>

    <section useFor="SR" name="Review Routing" required="true">
        <group id="pathOptionsGroup" cloneable="true">
            <field name="reqExOption" title="" type="combo" required="false"
value="Required NE/Link">
                <valueMap>
                    <value>Required NE/Link</value>
                    <value>Excluded NE/Link</value>
                </valueMap>
            </field>
            <field name="reqExElement" title="" type="textpicker"
resource="devicesAndTpLinks" width="400" required="true"/>
            <field name="pathType" title="" type="combo" required="false" value="Working
Path">
                <valueMap>
                    <value>Working Path</value>
                    <value>Protect Path</value>
                </valueMap>
            </field>
        </group>
    </section>
</service>

        ]]></value>
        </item>
    </properties>

</objectPath>

</objectPath>
</nsl:modifyInstance>
</soapenv:Body>
</soapenv:Envelope>

```

### Related APIs

- CreateMplsTpTunnelServiceRequestNoProtection.xml

- DecommisionMplsTpTunnelServiceRequest.xml

## Modifying an MPLS-TP Protect Path Service Request

In this example, an existing MPLS-TP protect path is modified without impacting the working path. The important attribute is **ModifyPath**, which needs to be set to **Protect**.

You can also do the opposite and modify the working path without impacting the protect path. In that case, the **ModifyPath** attribute needs to be set to **Working**. The **ModifyPath** attribute can also be set to **Both**.



### Note

The "ModifyPath" attribute is supported only when modifying MPLS-TP service requests, not when creating new MPLS-TP service requests.

### Example: ModifyMplsTpTunnelServiceRequest-ProtectPath.xml

```
<?xml version="1.0" encoding="UTF-8"?>
<soapenv:Envelope xmlns:soapenv="http://schemas.xmlsoap.org/soap/envelope/"
  xmlns:soapenc="http://schemas.xmlsoap.org/soap/encoding/"
  xmlns:xsd="http://www.w3.org/2001/XMLSchema"
  xmlns:xsi="http://www.w3.org/2001/XMLSchema-instance"
  xmlns:ns0="http://www.cisco.com/cim-cx/2.0"
  xmlns:ns1="urn:CIM">
  <soapenv:Header>
    <ns0:message id="1" sessiontoken="E453ADAFF7319803C1E8E3C68E1850CD"
      Wait="false" WaitTimeout="300" />
  </soapenv:Header>
  <soapenv:Body>
    <ns1:modifyInstance>
      <objectPath subAction="modifyInstance" xsi:type="ns1:CIMObjectPath">
        <className xsi:type="xsd:string">ServiceRequest</className>
        <properties xsi:type="ns1:CIMPropertyList"
          soapenc:arrayType="ns1:CIMProperty[]">
          <item xsi:type="ns1:CIMProperty">
            <name xsi:type="xsd:string">Type</name>
            <value xsi:type="xsd:string">Flexible</value>
          </item>
          <item xsi:type="ns1:CIMProperty">
            <name xsi:type="xsd:string">RequestName</name>
            <value xsi:type="xsd:string">TP-3</value>
          </item>
        </properties>
      <objectPath subAction="modifyInstance" xsi:type="ns1:CIMObjectPath">
        <className xsi:type="xsd:string">ServiceRequestDetails</className>
        <keyProperties xsi:type="ns1:CIMKeyPropertyList"
          soapenc:arrayType="ns1:CIMKeyProperty[]">
          <item xsi:type="ns1:CIMProperty">
            <name xsi:type="xsd:string">LocatorId</name>
            <value xsi:type="xsd:string">194</value>
          </item>
        </keyProperties>
        <properties xsi:type="ns1:CIMPropertyList"
          soapenc:arrayType="ns1:CIMProperty[]">
          <item xsi:type="ns1:CIMProperty">
            <name xsi:type="xsd:string">ServiceDefinition</name>
            <value xsi:type="xsd:string">tp-policy</value>
          </item>
          <item xsi:type="ns1:CIMProperty">
            <name xsi:type="xsd:string">ModifyPath</name>

```

```

        <value xsi:type="xsd:string">Protect</value>
      </item>
    ...
    ...
    ...
    ...
  </item>
</properties>
</objectPath>
</objectPath>
</ns1:modifyInstance>
</soapenv:Body>
</soapenv:Envelope>

```

## Modifying an MPLS-TP Service Request with Include/Exclude Multiple Nodes

In this example is shown how an existing MPLS-TP service request is modified to include or exclude multiple nodes.

The appropriate ID needs to be provided in the multiple group tags in the **Review Routing** section below (see XML example). The XML must have a unique ID in the group tag, for example pathOptionsGroup, pathOptionsGroup1, pathOptionsGroup2, etc. If you want to modify a few specific constraints amongst the ones originally provided, you need to provide the appropriate ID. For example, specify pathOptionsGroup to edit 1st constraint, pathOptionsGroup4 to edit 5th constraint and so on.

Make sure to set the **ModifyPath** attribute (**Working**, **Protect**, or **Both**).



### Note

The "ModifyPath" attribute is supported only when modifying MPLS-TP service requests, not when creating new MPLS-TP service requests.

### Example: ModifyMplsTpServiceRequestWithIncludeExcludeNodes.xml

```

<?xml version="1.0" encoding="UTF-8"?>
<soapenv:Envelope xmlns:soapenv="http://schemas.xmlsoap.org/soap/envelope/"
  xmlns:soapenc="http://schemas.xmlsoap.org/soap/encoding/"
  xmlns:xsd="http://www.w3.org/2001/XMLSchema"
  xmlns:xsi="http://www.w3.org/2001/XMLSchema-instance"
  xmlns:ns0="http://www.cisco.com/cim-cx/2.0"
  xmlns:ns1="urn:CIM">
  <soapenv:Header>
    <ns0:message id="1" sessiontoken="2359F8E3E9C2DCD79BB4354830704C78"
      Wait="false" WaitTimeout="300" />
  </soapenv:Header>
  <soapenv:Body>
    <ns1:modifyInstance>
      <objectPath xsi:type="ns1:CIMObjectPath">
        <className xsi:type="xsd:string">ServiceOrder</className>
        <properties xsi:type="ns1:CIMPropertyList"
          soapenc:arrayType="ns1:CIMProperty[]">
          <item xsi:type="ns1:CIMProperty">
            <name xsi:type="xsd:string">ServiceName</name>
            <value xsi:type="xsd:string">ServiceOrder253</value>
          </item>
          <item xsi:type="ns1:CIMProperty">
            <name xsi:type="xsd:string">CarrierId</name>
            <value xsi:type="xsd:string">322</value>
          </item>
          <item xsi:type="ns1:CIMProperty">

```

```

        <name xsi:type="xsd:string">DesiredDueDate</name>
        <value xsi:type="xsd:dateTime">2002-12-13T14:55:38.000Z</value>
    </item>
    <item xsi:type="ns1:CIMProperty">
        <name xsi:type="xsd:string">NumberOfRequests</name>
        <value xsi:type="xsd:string">1</value>
    </item>
</properties>
</objectPath>

<objectPath subAction="modifyInstance" xsi:type="ns1:CIMObjectPath">
    <className xsi:type="xsd:string">ServiceRequest</className>

    <properties xsi:type="ns1:CIMPropertyList"
        soapenc:arrayType="ns1:CIMProperty[]">
        <item xsi:type="ns1:CIMProperty">
            <name xsi:type="xsd:string">Type</name>
            <value xsi:type="xsd:string">Flexible</value>
        </item>
        <item xsi:type="ns1:CIMProperty">
            <name xsi:type="xsd:string">RequestName</name>
            <value xsi:type="xsd:string">TP-3</value>
        </item>
    </properties>

    <objectPath subAction="modifyInstance" xsi:type="ns1:CIMObjectPath">
        <className xsi:type="xsd:string">ServiceRequestDetails</className>
    <keyProperties xsi:type="ns1:CIMKeyPropertyList"
        soapenc:arrayType="ns1:CIMKeyProperty[]">
        <item xsi:type="ns1:CIMProperty">
            <name xsi:type="xsd:string">LocatorId</name>
            <value xsi:type="xsd:string">10</value>
        </item>
    </keyProperties>
    <properties xsi:type="ns1:CIMPropertyList"
        soapenc:arrayType="ns1:CIMProperty[]">
        <item xsi:type="ns1:CIMProperty">
            <name xsi:type="xsd:string">ServiceDefinition</name>
            <value xsi:type="xsd:string">TP_Policy</value>
        </item>
        <item xsi:type="ns1:CIMProperty">
            <name xsi:type="xsd:string">ModifyPath</name>
            <value xsi:type="xsd:string">Both</value>
        </item>
        <item xsi:type="ns1:CIMProperty">
            <name xsi:type="xsd:string">InstanceData</name>
            <value xsi:type="xsd:string"><![CDATA[
<service serviceType="MPLS-TP" serviceName="MPLS-TP">
    <section useFor="SR" name="Service Information " required="true" >
        <field name="serviceType" title="Service Type" type="text" disabled="true"
required="false" editable="true" value="MPLS-TP"/>
        <field name="serviceDescription" title="Service Description" type="textarea"
required="false" value="NBI excluding protect path"/>
    </section>

    <section useFor="Policy" name="Policy Information " required="true" >
        <field name="policyName" title="Policy Name" type="text" required="true"/>
        <field name="policyDescription" title="Description" type="textarea"
required="false"/>
    </section>

    <section useFor="Policy-SR" name="Tunnel Characteristics" required="true" >

```

```

    <group>
      <field name="srcTunnelName" title="Source Name" type="text" required="false"
editable="true">
        <validators>
          <validator type="regexp" expression=".*" errorMessage="Tunnel name can be
any number of characters"/>
        </validators>
      </field>
      <field name="dstTunnelName" title="Destination Name(If different)" type="text"
required="false" editable="true">
        <validators>
          <validator type="regexp" expression=".*" errorMessage="Tunnel name can be
any number of characters"/>
        </validators>
      </field>
    </group>
    <group>
      <field name="srcTunnelDescription" title="Source Description" type="textarea"
required="false"/>
      <field name="dstTunnelDescription" title="Destination Description(If
different)" type="textarea" required="false"/>
    </group>
    <group>
      <field name="bandwidth" title="Transmit Bandwidth" type="integer"
required="false" style="width:120px" metricOptions="Kbps,[Mbps],Gbps" metric="Mbps"
value="1"/>
      <field name="rxBandwidth" title="Receive Bandwidth(If different)"
type="integer" required="false" style="width:120px" metricOptions="Kbps,[Mbps],Gbps"
metric="Mbps" value="2"/>
    </group>

    <group>
      <field name="srcTunnelNumberAutoAllocate" title="Auto-Allocate Tunnel Number
At Source" type="boolean" required="false" value="true" visibility="Hidden"/>
      <field name="dstTunnelNumberAutoAllocate" title="Auto-Allocate Tunnel Number
At Destination" type="boolean" required="false" value="true" visibility="Hidden"/>
    </group>
    <field name="state" title="State" type="combo" required="false"
visibility="Hidden" value="Up">
      <valueMap>
        <value>Up</value>
        <value>Down</value>
      </valueMap>
    </field>
    <field name="protectedTpTunnel" title="Protection" type="boolean"
required="false" visibility="Hidden" value="true"/>
    <field name="diversityOption" title="Diversity Options" type="combo"
required="false" disabled="true" visibility="Hidden" value="Node Diversity Desired">
      <valueMap>
        <value>Node Diversity Desired</value>
        <value>Node Diversity Required</value>
        <value>Link Diversity Only</value>
      </valueMap>
    </field>
  </section>

  <section useFor="Policy-SR" name="Tunnel End-Points" required="true" >
    <field name="sourceDevice" title="Source Node" type="textpicker"
resource="devices" resourceToLoad="sourceBfdTemplate" required="true" editable="true"
value="router203"/>
    <field name="sourceBfdTemplate" title="Source BFD" type="textpicker"
required="true" value="bfd-tp-template"/>
    <field name="sourceBfdMinInterval" title="Source BFD min-interval (ms) (15 -
5000)" type="integer" required="false" visibility="Hidden" value=""/>

```

```

        <field name="sourceBfdMinIntervalStandby" title="Source BFD min-interval Standby
(ms) (15 - 5000)" type="integer" required="false" visibility="Hidden" value="" />
        <field name="sourceBfdMultiplier" title="Source BFD Multiplier (2 - 10)"
type="integer" required="false" visibility="Hidden" value="" />
        <field name="sourceTunnelNumber" title="Source Tunnel Number" type="text"
required="false" visibility="Hidden" editable="true">
        <validators>
            <validator type="regexp" expression="\d*" errorMessage="Tunnel number must
be 0 - 65535" />
        </validators>
    </field>
    <field name="sourceRouterId" title="Source Router ID" type="ip" required="false"
visibility="Hidden" />
    <field name="sourceGlobalId" title="Source Global ID" type="integer"
required="false" visibility="Hidden" />
    <field name="destinationDevice" title="Destination Node" type="textpicker"
resource="devices" resourceToLoad="destinationBfdTemplate" required="true"
value="router204" />
    <field name="destinationBfdTemplate" title="Destination BFD" type="textpicker"
required="true" value="bfd-tp-template" />
    <field name="destinationBfdMinInterval" title="Destination BFD min-interval (ms)
(15 - 5000)" type="integer" required="false" visibility="Hidden" />
    <field name="destinationBfdMinIntervalStandby" title="Destination BFD min-interval
Standby (ms) (15 - 5000)" type="integer" required="false" visibility="Hidden" />
    <field name="destinationBfdMultiplier" title="Destination BFD Multiplier (2 - 10)"
type="integer" required="false" visibility="Hidden" />
    <field name="destinationTunnelNumber" title="Destination Tunnel Number"
type="text" required="false" visibility="Hidden" editable="true">
    <validators>
        <validator type="regexp" expression="\d*" errorMessage="Tunnel number must
be 0 - 65535" />
    </validators>
</field>
    <field name="destinationRouterId" title="Destination Router ID" type="ip"
required="false" visibility="Hidden" />
    <field name="destinationGlobalId" title="Destination Global ID" type="integer"
required="false" visibility="Hidden" />
</section>

<section useFor="SR" name="Review Routing" required="true">

    <group id="pathOptionsGroup" cloneable="true">
        <field name="reqExOption" title="" type="combo" required="false"
value="Excluded NE/Link">
            <valueMap>
                <value>Required NE/Link</value>
                <value>Excluded NE/Link</value>
            </valueMap>
        </field>
        <field name="reqExElement" title="" type="textpicker"
resource="devicesAndTpLinks" width="400" required="true" value="router202: Ethernet1/0
(1000) &lt;===&gt; router203: Ethernet1/0 (301)" />
        <field name="pathType" title="" type="combo" required="false" value="Protect
Path">
            <valueMap>
                <value>Working Path</value>
                <value>Protect Path</value>
            </valueMap>
        </field>
    </group>

    <group id="pathOptionsGroup1" cloneable="true">
        <field name="reqExOption" title="" type="combo" required="false"
value="Required NE/Link">

```

```

        <valueMap>
          <value>Required NE/Link</value>
          <value>Excluded NE/Link</value>
        </valueMap>
      </field>
      <field name="reqExElement" title="" type="textpicker"
resource="devicesAndTpLinks" width="400" required="true" value="router203: Ethernet0/2
(501) &lt;===&gt; router204: Ethernet0/2 (5)"/>
        <field name="pathType" title="" type="combo" required="false" value="Protect
Path">
          <valueMap>
            <value>Working Path</value>
            <value>Protect Path</value>
          </valueMap>
        </field>
      </group>

    </section>
  </service>

    ]]></value>
  </item>
</properties>

</objectPath>

</objectPath>
</ns1:modifyInstance>
</soapenv:Body>
</soapenv:Envelope>

```

## Provisioning Example

This section describes the process for using the API to provision MPLS-TP, and includes the required operation, object definition (className), and parameter definitions.

This section contains the following:

- [Process Summary, page 12-20](#)
- [Provisioning Process, page 12-21](#)
- [Auditing Service Requests, page 12-24.](#)

## Process Summary

This MPLS-TP provisioning example documents the following process:

1. Create provider.
2. Create region for provider.
3. Run Collect Config.
4. Create and run MPLS-TP Discovery task.
5. Create service definition (policy).



6. Create tunnel service request.

## Provisioning Process

To provision MPLS-TP using Prime Provisioning APIs, a MPLS-TP service definition (policy) and a MPLS-TP service request are required.

This section describes the process for provisioning MPLS-TP using XML examples.

The complete package of XML examples for MPLS-TP is available here:

[Cisco Prime Provisioning API 7.0 Programmer Reference](#)



### Note

For clarity, this provisioning process shows each step as a separate XML request. Many of these steps can be combined using **performBatchOperations**.

### Step 1 Create a provider.

The provider is the administrative domain of an ISP, with one BGP autonomous system (AS) number. The network owned by the provider is called the backbone network. If an ISP has two AS numbers, you must define it as two provider administrative domains.

**Table 12-1 Create a Provider**

Operation	className	Required Parameters
createInstance	Provider	<ul style="list-style-type: none"> <li>• Name</li> <li>• AsNumber</li> </ul>

#### XML Examples:

ISCProviderCreateRequest.xml

### Step 2 Create regions.

Each provider can contain multiple regions.

**Table 12-2 Create a Region**

Operation	className	Required Parameters
createInstance	Region	<ul style="list-style-type: none"> <li>• Name</li> <li>• Provider</li> </ul>

#### XML Examples:

ISCDefaultRegionCreateRequest.xml

### Step 3 Run a Collect Config task.

A device configuration collection is a task. This task uploads the current configuration from the device to the Prime Provisioning database. The collection task is executed through a service request, and the service request is scheduled through a service order.



**Note** The service request name must be unique for each API.

**Table 12-3** *Collect Device Configurations*

Operation	className	Required Parameters
createInstance	ServiceOrder	<ul style="list-style-type: none"> <li>• ServiceName</li> <li>• NumberOfRequests</li> <li>• ServiceRequest</li> </ul>
	ServiceRequest	<ul style="list-style-type: none"> <li>• RequestName</li> <li>• Type=Task</li> <li>• ServiceRequestDetails</li> </ul>
	ServiceRequestDetails	<ul style="list-style-type: none"> <li>• SubType=COLLECTION</li> <li>• Device (or DeviceGroup)</li> </ul> <p><b>Note</b> You must select at least one device or device group.</p> <ul style="list-style-type: none"> <li>• RetrieveVersion=true</li> <li>• RetrieveDeviceInterfaces=true</li> </ul>

**XML Examples:**

- CreateTaskServiceOrderCollection.xml

**Step 4** Run an MPLS-TP Discovery task.

This discovers the MPLS-TP topology and resources and populates the repository.

**Table 12-4** Create an MPLS-TP Discovery Task

Operation	className	Required Parameters
createInstance	ServiceOrder	<ul style="list-style-type: none"> <li>• ServiceName</li> <li>• CarrierId</li> <li>• DesiredDueDate</li> <li>• NumberofRequests</li> <li>• Organization</li> </ul>
	ServiceRequest	<ul style="list-style-type: none"> <li>• RequestName</li> <li>• Type=Task</li> </ul>
	ServiceRequestDetails	<ul style="list-style-type: none"> <li>• SubType=TP_DISCOVERY</li> <li>• Device</li> <li>• labelSyncOnly</li> </ul>

**XML Examples:**

CreateTaskServiceOrderTpDiscovery.xml

**Step 5** Create service definition (policy).

Service definitions or policies are used to define common tunnel attributes.

**Table 12-5** Create a MPLS-TP Service Definition (Policy)

Operation	className	Required Parameters
createInstance	ServiceDefinition	<ul style="list-style-type: none"> <li>• Name</li> <li>• Type</li> <li>• Provider</li> </ul>
	ServiceDefinitionDetails	[For a complete list of parameters, see <a href="#">Policy Example, page 12-2</a> ]

**XML Examples:**

CreateMplsTpPolicy.xml

**Step 6** Create service request.

An MPLS-TP service request applies the service definition and assigns interfaces and attributes.

Table 12-6 Create an MPLS-TP Service Request

Operation	className	Required Parameters
createInstance	ServiceRequest	<ul style="list-style-type: none"> <li>RequestName=TP-3</li> <li>ServiceRequestDetails</li> </ul>
	ServiceRequestDetails	[For a complete list of parameters, see example <a href="#">Creating an MPLS-TP Service Request With Path Protection, page 12-8</a> ]

**Tip**

Record the **LocatorId** value from the XML response for the service request. The Locator ID is required for subsequent service request tasks.

**XML Example:**

CreateMplsTpTunnelServiceRequestWithProtection.xml

## Auditing Service Requests

There are currently two kinds of audit that can be applied to an MPLS-TP service request:

- [Config Audit, page 12-24](#)
- [Functional Audit, page 12-25](#)

### Config Audit

A configuration audit occurs automatically each time you deploy a service request. During this configuration audit, Prime Provisioning verifies that all Cisco IOS commands are present and that they have the correct syntax. An audit also verifies that there were no errors during deployment by examining the commands configured by the service request on the target devices. If the device configuration does not match what is defined in the service request, the audit flags a warning.

If you do not want the configuration audit to occur, change the value for the **Audit** parameter. The **Audit** parameter supports these values:

- **Audit**—This is the default. A successfully deployed service request is automatically audited unless this flag is changed.
- **NoAudit**—Do not perform a configuration audit when the service request is deployed.
- **ForceAudit**—Perform a configuration audit even if the service request deployment is not successful.

You can use the **Audit** parameter with a **Create**, **Modify**, or **Decommission** service request or a **Deployment** task. See the “[Service Decommission](#)” section on page 3-11 for more information. To perform a configuration audit as a separate task, see the “[Configuration Audit](#)” section on page 3-11.

## Functional Audit

In an MPLS-TP Functional Audit, information is retrieved from source and destination endpoints to provide tunnel audit information. A functional audit is then performed on service requests, which are not in one of the following states: Draft, Closed, Requested, Invalid, Failed Deploy.

The following is an example of how to create an MPLS-TP Functional Audit via the NBI.

The relevant attributes that need to be set for this service order is **RequestName**, **Type**, **SubType**, and **LocatorId**, which are highlighted with bold in the example below. In the example, they are set to **MplsTpFuncAudit-TASK**, **task**, **SubType**, and **13**.

Example: CreateTaskServiceOrderMplsTpFuncAudit.xml

```
<?xml version="1.0" encoding="UTF-8"?>
<soapenv:Envelope
  xmlns:soapenv="http://schemas.xmlsoap.org/soap/envelope/"
  xmlns:soapenc="http://schemas.xmlsoap.org/soap/encoding/"
  xmlns:xsd="http://www.w3.org/2001/XMLSchema"
  xmlns:xsi="http://www.w3.org/2001/XMLSchema-instance"
  xmlns:ns0="http://www.cisco.com/cim-cx/2.0"
  xmlns:ns1="urn:CIM">
  <soapenv:Header>
    <!-- WaitTimeout has a default set in system properties.-->
    <ns0:message id="87855" timestamp="2002-12-13T14:55:38.885Z"
      Wait="false" WaitTimeout="60"
      sessiontoken="26384AD0F199088FAA9F8989C4040DDA" />
  </soapenv:Header>
  <soapenv:Body>
    <ns1:performBatchOperation>
      <actions xsi:type="ns1:CIMActionList"
        soapenc:arrayType="ns1:CIMAction[]">
        <action>
          <actionName xsi:type="xsd:string">createInstance</actionName>
          <objectPath xsi:type="ns1:CIMObjectPath">
            <className xsi:type="xsd:string">ServiceOrder</className>
            <properties xsi:type="ns1:CIMPropertyList"
              soapenc:arrayType="ns1:CIMProperty[]">
              <item xsi:type="ns1:CIMProperty">
                <name xsi:type="xsd:string">ServiceName</name>
                <value xsi:type="xsd:string">ServiceOrder-MplsTpFuncAudit</value>
              </item>
              <item xsi:type="ns1:CIMProperty">
                <name xsi:type="xsd:string">CarrierId</name>
                <value xsi:type="xsd:string">234</value>
              </item>
              <item xsi:type="ns1:CIMProperty">
                <name xsi:type="xsd:string">DesiredDueDate</name>
                <value xsi:type="xsd:dateTime">2002-12-14T14:55:38.885Z</value>
              </item>
              <item xsi:type="ns1:CIMProperty">
                <name xsi:type="xsd:string">NumberOfRequests</name>
                <value xsi:type="xsd:string">1</value>
              </item>
            </properties>
          </objectPath>
        </action>
        <action>
          <actionName xsi:type="xsd:string">createInstance</actionName>
          <objectPath xsi:type="ns1:CIMObjectPath">
            <className xsi:type="xsd:string">ServiceRequest</className>
            <properties xsi:type="ns1:CIMPropertyList"
```

```

        soapenc:arrayType="ns1:CIMProperty[]">
<item xsi:type="ns1:CIMProperty">
  <name xsi:type="xsd:string">RequestName</name>
  <value xsi:type="xsd:string">MplsTpFuncAudit-TASK</value>
</item>
<item xsi:type="ns1:CIMProperty">
  <name xsi:type="xsd:string">Type</name>
  <value xsi:type="xsd:string">Task</value>
</item>
</properties>
<objectPath xsi:type="ns1:CIMObjectPath">
<className xsi:type="xsd:string">ServiceRequestDetails</className>
<properties xsi:type="ns1:CIMPropertyList"
  soapenc:arrayType="ns1:CIMProperty[]">
  <item xsi:type="ns1:CIMProperty">
    <name xsi:type="xsd:string">SubType</name>
    <value xsi:type="xsd:string">MPLS-TP.FUNCTIONAL_AUDIT</value> </item>
  <item xsi:type="ns1:CIMProperty">
    <name xsi:type="xsd:string">LocatorId</name>
    <value xsi:type="xsd:string">13</value>
  </item>
  </properties>
</objectPath>
</objectPath>
</action>
</actions>
</ns1:performBatchOperation>
</soapenv:Body>
</soapenv:Envelope>

```



## GUI to API Mapping

---

This appendix maps the GUI operations to the corresponding APIs.



Note

---

Support is not guaranteed for any mapping not listed.

---

## Service Inventory Tab

*Table A-1 Service Inventory Tab*

GUI Operation	Corresponding APIs
Inventory and Connection Manager	See the <a href="#">“Inventory and Connection Manager”</a> section on page A-2.

**Table A-1** *Service Inventory Tab (continued)*

GUI Operation	Corresponding APIs
Deployment Flow Manager	<ul style="list-style-type: none"> <li>• performBatchOperations</li> <li>• Create&lt;service type&gt;ServiceOrder (where &lt;service type&gt; =MPLS, VPLS, L2VPN)</li> </ul>
Device Console	<ul style="list-style-type: none"> <li>• Download Commands (see also Template Manager on the <a href="#">Service Design Tab</a>) <ul style="list-style-type: none"> <li>– CreateTemplateServiceOrderDownload</li> <li>– CreateTemplateServiceOrderDownloadTransient</li> </ul> </li> <li>• Download Template (see also Template Manager on the <a href="#">Service Design Tab</a>) <ul style="list-style-type: none"> <li>– CreateTemplateData, ModifyTemplateData</li> <li>– CreateTemplateDefn</li> </ul> Delete and View also supported. </li> <li>• Device Configuration Manager <ul style="list-style-type: none"> <li>– ViewConfiglet</li> <li>– ViewConfiguration</li> </ul> </li> <li>• Exec Commands <ul style="list-style-type: none"> <li>– CreateExecCommandServiceOrderDownload</li> </ul> </li> <li>• Reload <ul style="list-style-type: none"> <li>– CreateConfigServiceOrderDownload</li> </ul> </li> </ul>

## Inventory and Connection Manager

**Table A-2** *Inventory and Connection Manager Link*

GUI Operation	Corresponding APIs
Service Requests	Create<service type>ServiceOrder (where <service type> =MPLS, L2VPN, VPLS)  Delete, Modify, and View also supported. (see also Task Manager on the <a href="#">Monitoring Tab</a> )
Traffic Engineering Management	Not supported.
Inventory Manager	See individual inventory items.
Topology Tool	GUI only.



Table A-2 Inventory and Connection Manager Link (continued)

GUI Operation	Corresponding APIs
Devices	<ul style="list-style-type: none"> <li>• CreateCiscoRouter</li> <li>• CreateCatIOS</li> <li>• CreateCatOS               <ul style="list-style-type: none"> <li>– CreateVPNSM</li> </ul> </li> <li>• CreateIE2100</li> <li>• CreateTerminalServer</li> </ul> Delete, Modify, and View also supported.
Device Groups	CreateDeviceGroup Delete, Modify, and View also supported.
Customers	CreateOrganization Delete, Modify, and View also supported.
Providers	CreateProvider Delete, Modify, and View also supported.
Resource Pools	<ul style="list-style-type: none"> <li>• CreateRouteTarget</li> <li>• CreateRouteDistinguisher</li> <li>• CreateIPAddressPool</li> <li>• CreateMulticastAddrPool</li> <li>• CreateSiteOfOrigin</li> <li>• CreateVcIdPool</li> <li>• CreateVlanIdPool</li> </ul> Delete and View also supported.
CE Routing Communities	<ul style="list-style-type: none"> <li>• CreateCERC</li> <li>• CreateVPN_DefaultCerc</li> </ul> Delete, Modify, and View also supported.
VPNs	CreateVPN Delete, Modify, and View also supported.

**Table A-2** *Inventory and Connection Manager Link (continued)*

GUI Operation	Corresponding APIs
AAA Servers	<ul style="list-style-type: none"> <li>• CreateAAAServer</li> <li>• CreateAAAServerNTDomain</li> <li>• CreateAAAServerRADIUS</li> <li>• CreateAAAServerSDI</li> <li>• CreateAAAServerTACACS</li> </ul> Delete, Modify, and View also supported.
Named Physical Circuits	<ul style="list-style-type: none"> <li>• CreateNamedPhysicalCircuit</li> <li>• CreateNamedPhysicalCircuitRing</li> <li>• CreateNamedPhysicalCircuitRingExisting</li> </ul> Delete, Modify, and View also supported.

## Service Design Tab

**Table A-3** *Service Design Tab*

GUI Operation	Corresponding APIs
Policies	Create<service type>ServiceDefn (where <service type> =MPLS, L2VPN) Delete, Modify, and View also supported.
Templates	<ul style="list-style-type: none"> <li>• CreateTemplateData, ModifyTemplateData</li> <li>• CreateTemplateDefn</li> <li>• CreateTemplateServiceOrderDownload</li> <li>• CreateTemplateServiceOrderDownloadTransient</li> </ul> Delete and View also supported.
Protocols	Not supported.
Network Objects	CreateNetworkObject Delete, Modify, and View also supported.

# Monitoring Tab

**Table A-4**      *Monitoring Tab*

GUI Operation	Corresponding APIs
Task Manager	<ul style="list-style-type: none"> <li>• CreateTaskServiceOrderConfigAudit</li> <li>• CreateTaskServiceOrderCollection</li> <li>• CreateTaskServiceOrderDecommission</li> <li>• CreateTaskServiceOrderDeployment</li> <li>• CreateTaskServiceOrderMplsFuncAudit</li> </ul> Delete and View also supported.
Ping	CreateTaskServiceOrderMplsFuncAudit.xml (Ping is part of an MPLS functional audit.)
SLA	For SLA Probes: <ul style="list-style-type: none"> <li>• CreateSLAProbe, CreateSLAProbeServiceRequest</li> </ul> Delete, Modify and View also supported. For SLA Reports: <ul style="list-style-type: none"> <li>• execReport_SLAHttp, exexReport_SLAHttpCos</li> <li>• execReport_SLAJitter, execReport_SLAJitterCos</li> <li>• execReport_SLASummary, exectReport_SLASummaryCos</li> </ul>
TE Performance Report	Not supported.

# Administration Tab

**Table A-5**      *Administration Tab*

GUI Operation	Corresponding APIs
Security	GUI only.
Control Center	<ul style="list-style-type: none"> <li>• Hosts—Not supported.</li> <li>• Collection Zones <ul style="list-style-type: none"> <li>– CreateCollectionZone</li> </ul> Delete, Modify, and View also supported</li> <li>• Licensing—N/A</li> </ul>
Active Users	N/A
User Access Log	N/A
Manage TIBCO Rendezvous	N/A





## Implementing a Notification Server

---

This appendix describes how to modify the example servlet to customize for your own application, and contains the following sections:

- [Event Notification Overview, page B-1](#)
- [Running the Example Servlet, page B-3](#)
- [Customizing the Example Servlet, page B-5](#)
- [Events for Collection, page B-5](#)

### Event Notification Overview

Event notification allows an Prime Provisioning API user to collect events of interest from the Prime Provisioning system. The events of interest are triggered by changes to objects managed by Prime Provisioning. An event is registered and a notification is sent any time a database object is created, modified, or deleted, when a scheduled task begins or ends its execution, or when a watchdog event signals a change in execution status for any Prime Provisioning service.

The Prime Provisioning properties that manage the notification server are:

- `notification.clientEnabled`—Used to turn notification forwarding on and off.
- `notification.clientHost`—The machine running the event notification receiving program.
- `notification.clientPort`—The listener port to open on the receiving machine. This property is defined in the Tomcat `web.xml` file.
- `notification.clientMethod`—The method, or program, to contact on the receiving machine.
- `notification.clientRegFile`—Contains the events of interest to be forwarded.



Note

---

`clientHost`, `clientMethod`, and `clientPort` are used to construct a URL.

---

Figure B-1 illustrates the notification mechanisms implemented by Prime Provisioning.

Figure B-1 Event Notification Mechanisms

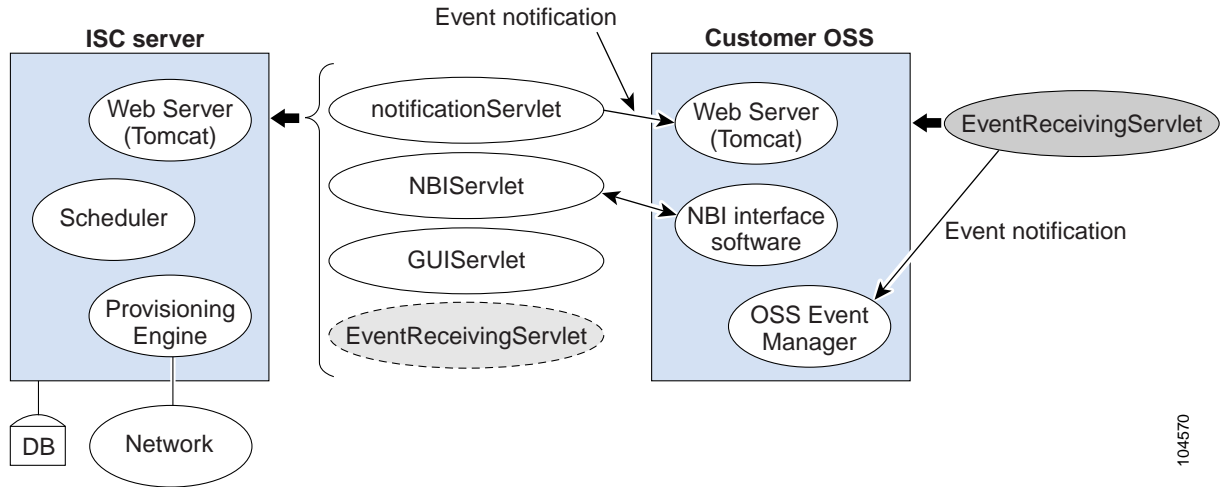

104570

The **EventReceivingServlet** can be customized and used for your own application.

The notification web.xml file (located in `$PRIMEF_HOME/resources/webserver/tomcat/webapps/notification/WEB-INF`) in Prime Provisioning identifies two servlets:

- notificationServlet
- eventListener (EventReceivingServlet program)

Use this file as a template for implementing a notification servlet.

In the following web.xml file, the **notificationServlet** section and **eventListener** section are indicated in **bold**.

```
<?xml version="1.0" encoding="ISO-8859-1"?>

<!DOCTYPE web-app
  PUBLIC "-//Sun Microsystems, Inc.//DTD Web Application 2.3//EN"
  "http://java.sun.com/dtd/web-app_2_3.dtd">
<web-app>
  <servlet>
    <servlet-name>notificationServlet</servlet-name>
    <display-name>Notification Servlet</display-name>
    <servlet-class>com.cisco.vpnsc.nbi.notification.NotificationServlet</servlet-class>
    <init-param>
      <param-name>log</param-name>
      <param-value>2</param-value>
    </init-param>
    <load-on-startup>2</load-on-startup>
  </servlet>
  <servlet>
    <servlet-name>eventListener</servlet-name>
    <display-name>Event Listener</display-name>
    <servlet-class>com.cisco.vpnsc.nbi.client.EventReceivingServlet</servlet-class>
    <init-param>
      <param-name>log</param-name>
      <param-value>2</param-value>
    </init-param>
  </servlet>
</web-app>
```

```

    <load-on-startup>2</load-on-startup>
  </servlet>

  <servlet-mapping>
    <servlet-name>eventListener</servlet-name>
    <url-pattern>/notification/servlet/eventListener</url-pattern>
  </servlet-mapping>
</web-app>

```

The Prime Provisioning installation contains an example servlet which can be activated to demonstrate the collection of notification events. The event notification receiving servlet (eventListener) calls a program com.cisco.vpnsnc.nbi.client.EventReceivingServlet. This program is included in the Prime Provisioning installation (\$PRIMEF\_HOME/resources/nbi/client/EventReceivingServlet.java) and shows a simple piece of code which receives an event and prints it to a log file.



Note

For more information on example clients, see [Appendix C, “Scripts”](#).

## Running the Example Servlet

Prime Provisioning includes an example event-notification client servlet. This servlet can be activated on a standard Prime Provisioning installation.

The example effectively creates a loopback scenerario whereby an Prime Provisioning event generates a SOAP/XML message that is sent back to the Prime Provisioning server's HTTP port. Upon arriving at the port (8030 is the default), the Tomcat server loads and executes the EventReceivingServlet client code.

You can observe the outbound event message and the inbound notification message by inspecting \$PRIMEF\_HOME/tmp/httpd\_out.0 and \$PRIMEF\_HOME/notification.0 respectively. If the event notification succeeds, you will see the SOAP/XML event notification at the bottom of the notification.0 file.

To run a demonstration of the example servlet:

- 
- Step 1** Add an event to the clientReg.txt file. This file is located \$PRIMEF\_HOME/resources/nbi/notification/clientReg.txt
- Step 2** Enable dynamic loading of servlets on the Prime Provisioning server with the following actions:
- A) edit \$PRIMEF\_HOME/resources/webserver/tomcat/conf/web.xml
  - B) Make sure the mapping for the invoker servlet-mapping is uncommented. The following is the XML text for the invoker servlet-mapping:
 

```

<!-- The mapping for the invoker servlet -->
<servlet-mapping>
  <servlet-name>invoker</servlet-name>
  <url-pattern>/servlet/*</url-pattern>
</servlet-mapping>

```
- For this example, add **com.cisco.vpnsnc.repository.devices.CiscoRouter.>** to specify events involving a CiscoRouter.
- Step 3** Change the property **notification.clientEnabled** to true. This file is located in \$PRIMEF\_HOME/etc/vpnsnc.properties.

From the GUI:

Go to **Administration->Control Center**.

Choose your host and click **Config**.

Locate the notification server and select the **clientEnabled** property. Set to **true** and click **Set Property**.

**Step 4** Restart Prime Provisioning.

**Step 5** Add a CiscoRouter device.

From the GUI:

Go to **Service Inventory > Inventory and Connection Manager > Devices**.

Click **Create** and select **Cisco IOS Device**.

Enter a hostname.

Click **Save**.

**Step 6** Go to \$PRIMEF\_HOME/tmp and cat the file httpd\_out.0. The XML at the end should look like the following example:

```
<?xml version="1.0" encoding="UTF-8"?>
<soapenv:Envelope xmlns:soapenv="http://schemas.xmlsoap.org/soap/envelope/"
xmlns:soapenc="http://schemas.xmlsoap.org/soap/encoding/"
xmlns:xsd="http://www.w3.org/2001/XMLSchema"
xmlns:xsi="http://www.w3.org/2001/XMLSchema-instance"
xmlns:ns0="http://www.cisco.com/cim-cx/2.0" xmlns:ns1="urn:CIM">
  <soapenv:Header>
    <ns0:message />
  </soapenv:Header>
  <soapenv:Body>
    <ns1:deliverEvent>
      <returns xsi:type="ns1:CIMReturnList" soapenc:arrayType="ns1:CIMReturn[]">
        <record>
          <objectPath xsi:type="ns1:CIMObjectPath">
            <className xsi:type="xsd:string">InstIndication</className>
            <properties xsi:type="ns1:CIMPropertyList"
soapenc:arrayType="ns1:CIMProperty[]">
              <item xsi:type="ns1:CIMProperty">
                <name xsi:type="xsd:string">IndicationType</name>
                <value xsi:type="xsd:string">create</value>
              </item>
              <item xsi:type="ns1:CIMProperty">
                <name xsi:type="xsd:string">IndicationTime</name>
                <value xsi:type="xsd:string">2003-12-03 13:15:26</value>
              </item>
              <item xsi:type="ns1:CIMProperty">
                <name xsi:type="xsd:string">InstClassName</name>
                <value xsi:type="xsd:string">CiscoRouter</value>
              </item>
              <item xsi:type="ns1:CIMProperty">
                <name xsi:type="xsd:string">InstName</name>
                <value xsi:type="xsd:string">xyz</value>
              </item>
              <item xsi:type="ns1:CIMProperty">
                <name xsi:type="xsd:string">LocatorId</name>
                <value xsi:type="xsd:string">40</value>
              </item>
            </properties>
          </objectPath>
        </record>
      </returns>
    </ns1:deliverEvent>
  </soapenv:Body>
</soapenv:Envelope>
```



```
</ns1:deliverEvent>
</soapenv:Body>
</soapenv:Envelope>
```

---

## Customizing the Example Servlet

Use the following procedure to implement a custom notification receiving servlet.

- 
- Step 1** Copy the web.xml file, located in \$PRIMEF\_HOME/resources/webserver/tomcat/webapps/notification/WEB-INF, to your own Tomcat structure.
- Step 2** Remove the notification servlet xml section. This section is specific to Prime Provisioning.
- Step 3** Change the eventListener program from **com.cisco.vpnsc.nbi.client.EventReceivingServlet** to your own program.
- Step 4** Specify the events to receive by editing the contents of the file \$PRIMEF\_HOME/resources/nbi/notification/clientReg.txt. The default contents of this file are:

```
com.cisco.vpnsc.repository.task.PersistentTask.>
com.cisco.vpnsc.repository.devices.PIX.>
```

This means that events involving **PIX** devices or **PersistentTask** will be forwarded to the EventListener servlet.

For example, add **com.cisco.vpnsc.repository.devices.CiscoRouter.>** to specify events involving a CiscoRouter.

See the “[Events for Collection](#)” section on page B-5 for a complete list of events that can be collected and forwarded.

- Step 5** Change the property **notification.clientEnabled** to true. This file is located in \$PRIMEF\_HOME/etc/vpnsc.properties.

From the GUI:

Go to **Administration >Control Center**.

Choose your host and click **Config**.

Locate the notification server and select the **clientEnabled** property. Set to **true** and click **Set Property**.

- Step 6** Restart Prime Provisioning.
- 

## Events for Collection

The following events can be collected for the Prime Provisioning notifications server:

- 'com.cisco.vpnsc.repository.task.Argument'
- 'com.cisco.vpnsc.repository.task.Action'
- 'com.cisco.vpnsc.repository.task.ActionDependency'

- 'com.cisco.vpnsc.repository.task.ActionTarget'
- 'com.cisco.vpnsc.repository.task.PersistentTask'
- 'com.cisco.vpnsc.repository.task.RuntimeAction'
- 'com.cisco.vpnsc.repository.task.RuntimeTask'
- 'com.cisco.vpnsc.repository.task.ScheduledTask'
- 'com.cisco.vpnsc.repository.devices.Device'
- 'com.cisco.vpnsc.repository.devices.CiscoDevice'
- 'com.cisco.vpnsc.repository.devices.CiscoRouter'
- 'com.cisco.vpnsc.repository.devices.PIX'
- 'com.cisco.vpnsc.repository.devices.TerminalServer'
- 'com.cisco.vpnsc.repository.devices.CatOs'
- 'com.cisco.vpnsc.repository.devices.NonCiscoDevice'
- 'com.cisco.vpnsc.repository.devices.IE2100'
- 'com.cisco.vpnsc.repository.devices.GenericDeviceInterface'
- 'com.cisco.vpnsc.repository.devices.CiscoDeviceInterface'
- 'com.cisco.vpnsc.repository.devices.NonCiscoDeviceInterface'
- 'com.cisco.vpnsc.repository.devices.PIXDeviceInterface'
- 'com.cisco.vpnsc.repository.devices.DeviceGroup'
- 'com.cisco.vpnsc.repository.devices.RepDev\_DevGp\_Mpng'
- 'com.cisco.vpnsc.repository.devices.CollectionZone'
- 'com.cisco.vpnsc.repository.devices.VPNSCHost'
- 'com.cisco.vpnsc.repository.devices.VPNSCHostProperties'
- 'com.cisco.vpnsc.repository.devices.VirtualCircuit'
- 'com.cisco.vpnsc.repository.devices.AtmVC'
- 'com.cisco.vpnsc.repository.device.FrameRelayVC'
- 'com.cisco.vpnsc.repository.devices.VlanVC'
- 'com.cisco.vpnsc.repository.devices.PEDevice'
- 'com.cisco.vpnsc.repository.devices.CPEDevice'
- 'com.cisco.vpnsc.repository.common.Customer'
- 'com.cisco.vpnsc.repository.common.Site'
- 'com.cisco.vpnsc.repository.common.LogicalDevice'
- 'com.cisco.vpnsc.repository.common.Cpe'
- 'com.cisco.vpnsc.repository.common.CustomerNetworkPrefix'
- 'com.cisco.vpnsc.repository.common.VPN'
- 'com.cisco.vpnsc.repository.common.Interface'
- 'com.cisco.vpnsc.repository.common.Vc'
- 'com.cisco.vpnsc.repository.common.PE'
- 'com.cisco.vpnsc.repository.common.Provider'

- 'com.cisco.vpnsc.repository.common.Region'
- 'com.cisco.vpnsc.repository.mpls.VRF'
- 'com.cisco.vpnsc.repository.common.GenericSR'
- 'com.cisco.vpnsc.repository.mlshare.AccessDomain'
- 'com.cisco.vpnsc.repository.common.AttributeValue'
- 'com.cisco.vpnsc.repository.common.ConfigletClob'
- 'com.cisco.vpnsc.repository.common.Configlet'
- 'com.cisco.vpnsc.repository.common.Policy'
- 'com.cisco.vpnsc.repository.common.SRAssociatedTemplate'
- 'com.cisco.vpnsc.repository.common.RepCableIpAddress'
- 'com.cisco.vpnsc.repository.common.RepSRReport'
- 'com.cisco.vpnsc.repository.common.SRHistoryReport'
- 'com.cisco.vpnsc.repository.common.StagedConfiglet'
- 'com.cisco.vpnsc.repository.common.StagedSR'
- 'com.cisco.vpnsc.repository.common.GenericSRToVpn'
- 'com.cisco.vpnsc.repository.mlshare.PhysicalLink'
- 'com.cisco.vpnsc.repository.mlshare.Ring'
- 'com.cisco.vpnsc.repository.mlshare.PhysicalLinkSeq'
- 'com.cisco.vpnsc.repository.mlshare.NamedPhysicalCircuit'
- 'com.cisco.vpnsc.repository.mlshare.MLSharePolicy'
- 'com.cisco.vpnsc.repository.mlshare.MIConnPolicy'
- 'com.cisco.vpnsc.repository.mlshare.LogicalLink'
- 'com.cisco.vpnsc.repository.mlshare.LogicalLinkSet'
- 'com.cisco.vpnsc.repository.mlshare.EndPoint'
- 'com.cisco.vpnsc.repository.mlshare.DevEndPoint'
- 'com.cisco.vpnsc.repository.mlshare.RepNotEditable'
- 'com.cisco.vpnsc.repository.mlshare.LinkTemplate'
- 'com.cisco.vpnsc.repository.mlshare.ReservedVlanPool'
- 'com.cisco.vpnsc.repository.mlshare.RingMembership'
- 'com.cisco.vpnsc.repository.mlshare.RingSeq'
- 'com.cisco.vpnsc.repository.mpls.MplsSR'
- 'com.cisco.vpnsc.repository.mpls.CERC'
- 'com.cisco.vpnsc.repository.mpls.CERCMembership'
- 'com.cisco.vpnsc.repository.mpls.VRFRole'
- 'com.cisco.vpnsc.repository.mpls.MplsVpnLink'
- 'com.cisco.vpnsc.repository.mpls.MplsLogicalLink'
- 'com.cisco.vpnsc.repository.mpls.MplsPolicyAttributeMap'
- 'com.cisco.vpnsc.repository.mpls.MplsPolicy'

- 'com.cisco.vpnsc.repository.mpls.MplsPolicyInterface'
- 'com.cisco.vpnsc.repository.mpls.MplsPolicyRoutingProtocol'
- 'com.cisco.vpnsc.repository.mpls.MplsPolicyOSPFRouting'
- 'com.cisco.vpnsc.repository.mpls.MplsPolicyBGPRouting'
- 'com.cisco.vpnsc.repository.mpls.MplsPolicyEIGRPRouting'
- 'com.cisco.vpnsc.repository.mpls.MplsPolicyIGRPRouting'
- 'com.cisco.vpnsc.repository.l2vpn.AC'
- 'com.cisco.vpnsc.repository.mpls.MplsPolicyISISRouting'
- 'com.cisco.vpnsc.repository.mpls.MplsPolicyRIPRouting'
- 'com.cisco.vpnsc.repository.mpls.MplsPolicyStaticRouting'
- 'com.cisco.vpnsc.repository.mpls.MplsPolicyNoneRouting'
- 'com.cisco.vpnsc.repository.mpls.MplsPolicyRedistributedRoutingProtocol'
- 'com.cisco.vpnsc.repository.mpls.MplsPolicyCercMembership'
- 'com.cisco.vpnsc.repository.mpls.RepStaticRoutes'
- 'com.cisco.vpnsc.repository.mpls.LinkAttrs'
- 'com.cisco.vpnsc.repository.mpls.LinkAttrsAttrMap'
- 'com.cisco.vpnsc.repository.mpls.LinkAttrsRedistributedRoutingProtocol'
- 'com.cisco.vpnsc.repository.mpls.LinkAttrsRoutingProtocol'
- 'com.cisco.vpnsc.repository.mpls.LinkAttrsOSPFRouting'
- 'com.cisco.vpnsc.repository.mpls.LinkAttrsBGPRouting'
- 'com.cisco.vpnsc.repository.mpls.LinkAttrsEIGRPRouting'
- 'com.cisco.vpnsc.repository.mpls.LinkAttrsIGRPRouting'
- 'com.cisco.vpnsc.repository.mpls.LinkAttrsISISRouting'
- 'com.cisco.vpnsc.repository.mpls.LinkAttrsRIPRouting'
- 'com.cisco.vpnsc.repository.mpls.LinkAttrsStaticRouting'
- 'com.cisco.vpnsc.repository.mpls.LinkAttrsNoneRouting'
- 'com.cisco.vpnsc.repository.mpls.RoutingProtocolAccessor'
- 'com.cisco.vpnsc.repository.mpls.LinkRoutingProtocolAccessor'
- 'com.cisco.vpnsc.repository.mpls.RepCableIpAddr'
- 'com.cisco.vpnsc.repository.mpls.RepOldTemplate'
- 'com.cisco.vpnsc.repository.mpls.MplsUniEtth'
- 'com.cisco.vpnsc.repository.mpls.LinkMulticastIPAddr'
- 'com.cisco.vpnsc.repository.l2vpn.L2VpnPolicyAttributeMap'
- 'com.cisco.vpnsc.repository.l2vpn.L2VpnPolicy'
- 'com.cisco.vpnsc.repository.l2vpn.L2VpnPolicyInterface'
- 'com.cisco.vpnsc.repository.l2vpn.EndToEndWireAttributeMap'
- 'com.cisco.vpnsc.repository.l2vpn.ACAttributeMap'
- 'com.cisco.vpnsc.repository.l2vpn.EndToEndWire'

- 'com.cisco.vpnsc.repository.l2vpn.EndToEndWireAttr'
- 'com.cisco.vpnsc.repository.l2vpn.ACAAttr'
- 'com.cisco.vpnsc.repository.l2vpn.L2VpnSR'
- 'com.cisco.vpnsc.repository.l2vpn.L2VpnLogicalLink'
- 'com.cisco.vpnsc.repository.l2vpn.UniInterface'
- 'com.cisco.vpnsc.repository.l2vpn.UniProtocolTunnel'
- 'com.cisco.vpnsc.repository.l2vpn.UniMacAccessList'
- 'com.cisco.vpnsc.repository.l2vpn.UniSecureMacAddress'
- 'com.cisco.vpnsc.repository.protocol.Protocol'
- 'com.cisco.vpnsc.repository.protocol.ProtocolBundle'
- 'com.cisco.vpnsc.repository.protocol.RepPro\_Bdl\_Mpng'
- 'com.cisco.vpnsc.nbi.vpnsc.PLHelper'
- 'com.cisco.vpnsc.repository.resourcePool.vpnscManaged.DataBlock'
- 'com.cisco.vpnsc.repository.resourcePool.vpnscManaged.AgeDataBlock'
- 'com.cisco.vpnsc.repository.resourcePool.vpnscManaged.RdAllocDataBlock'
- 'com.cisco.vpnsc.repository.resourcePool.vpnscManaged.RdAvailDataBlock'
- 'com.cisco.vpnsc.repository.resourcePool.vpnscManaged.RdAgeDataBlock'
- 'com.cisco.vpnsc.repository.resourcePool.vpnscManaged.RtAllocDataBlock'
- 'com.cisco.vpnsc.repository.resourcePool.vpnscManaged.RtAvailDataBlock'
- 'com.cisco.vpnsc.repository.resourcePool.vpnscManaged.RtAgeDataBlock'
- 'com.cisco.vpnsc.repository.resourcePool.vpnscManaged.SooAllocDataBlock'
- 'com.cisco.vpnsc.repository.resourcePool.vpnscManaged.SooAvailDataBlock'
- 'com.cisco.vpnsc.repository.resourcePool.vpnscManaged.SooAgeDataBlock'
- 'com.cisco.vpnsc.repository.resourcePool.vpnscManaged.RdNameSeed'
- 'com.cisco.vpnsc.repository.resourcePool.vpnscManaged.RtNameSeed'
- 'com.cisco.vpnsc.repository.resourcePool.vpnscManaged.SooNameSeed'
- 'com.cisco.vpnsc.repository.resourcePool.externallyManaged.PoolType'
- 'com.cisco.vpnsc.repository.resourcePool.vpnscManaged.IPDataBlock'
- 'com.cisco.vpnsc.repository.resourcePool.vpnscManaged.RdDataBlock'
- 'com.cisco.vpnsc.repository.resourcePool.vpnscManaged.RtDataBlock'
- 'com.cisco.vpnsc.repository.resourcePool.vpnscManaged.SooDataBlock'
- 'com.cisco.vpnsc.repository.resourcePool.vpnscManaged.VcIdDataBlock'
- 'com.cisco.vpnsc.repository.resourcePool.vpnscManaged.VlanDataBlock'
- 'com.cisco.vpnsc.repository.resourcePool.vpnscManaged.IPAllocDataBlock'
- 'com.cisco.vpnsc.repository.resourcePool.vpnscManaged.IPAvailDataBlock'
- 'com.cisco.vpnsc.repository.resourcePool.vpnscManaged.IPAgeDataBlock'
- 'com.cisco.vpnsc.repository.resourcePool.vpnscManaged.MCASTDataBlock'
- 'com.cisco.vpnsc.repository.resourcePool.vpnscManaged.MCASTAllocDataBlock'

- 'com.cisco.vpnsc.repository.resourcePool.vpnscManaged.MCASTAvailDataBlock'
- 'com.cisco.vpnsc.repository.resourcePool.vpnscManaged.MCASTAgeDataBlock'
- 'com.cisco.vpnsc.repository.resourcePool.vpnscManaged.VlanAllocDataBlock'
- 'com.cisco.vpnsc.repository.resourcePool.vpnscManaged.VlanAvailDataBlock'
- 'com.cisco.vpnsc.repository.resourcePool.vpnscManaged.VcIdAllocDataBlock'
- 'com.cisco.vpnsc.repository.resourcePool.vpnscManaged.VcIdAvailDataBlock'
- 'com.cisco.vpnsc.repository.collection.Data'
- 'com.cisco.vpnsc.repository.collection.DevOwner'
- 'com.cisco.vpnsc.repository.sla.SAAProbe'
- 'com.cisco.vpnsc.repository.sla.SAADNSProbe'
- 'com.cisco.vpnsc.repository.sla.SAAEchoProbe'
- 'com.cisco.vpnsc.repository.sla.SAAHTTPProbe'
- 'com.cisco.vpnsc.repository.sla.SAAJitterProbe'
- 'com.cisco.vpnsc.repository.sla.SAATCPCConnectProbe'
- 'com.cisco.vpnsc.repository.sla.SAAUDPEchoProbe'
- 'com.cisco.vpnsc.repository.sla.SAADHCProbe'
- 'com.cisco.vpnsc.repository.sla.SAAFTPProbe'
- 'com.cisco.vpnsc.repository.vpls.MacAddress'
- 'com.cisco.vpnsc.repository.vpls.VplsServiceAttributeMap'
- 'com.cisco.vpnsc.repository.vpls.VplsPolicyInterface'
- 'com.cisco.vpnsc.repository.vpls.VplsUniProtocolTunnel'
- 'com.cisco.vpnsc.repository.vpls.VplsUniInterface'
- 'com.cisco.vpnsc.repository.vpls.VplsPolicy'
- 'com.cisco.vpnsc.repository.vpls.VplsLinkAttributeMap'
- 'com.cisco.vpnsc.repository.vpls.VplsServiceAttributes'
- 'com.cisco.vpnsc.repository.vpls.VplsLink'
- 'com.cisco.vpnsc.repository.vpls.VplsSR'
- 'com.cisco.vpnsc.repository.common.HubGroup'
- 'com.cisco.vpnsc.repository.vpls.VplsLogicalLink'
- 'com.cisco.vpnsc.repository.common.MultipointHub'
- 'com.cisco.vpnsc.repository.deploymentflow.Service'
- 'com.cisco.vpnsc.repository.deploymentflow.DfProcess'
- 'com.cisco.vpnsc.repository.deploymentflow.Step'
- 'com.cisco.vpnsc.repository.deploymentflow.StepArg'
- 'com.cisco.vpnsc.repository.deploymentflow.NotifyUserId'
- 'com.cisco.vpnsc.repository.deploymentflow.GlobalData'
- 'com.cisco.vpnsc.repository.deploymentflow.StepData'
- 'com.cisco.vpnsc.repository.deploymentflow.DFProfileEntry'

- 'com.cisco.vpnsr.repository.ual.UALog'
- 'com.cisco.vpnsr.repository.ual.UALPolicy'
- 'com.cisco.vpnsr.repository.ual.ObjectLogEntry'
- 'com.cisco.vpnsr.repository.license.SoftwareLicense'
- 'com.cisco.insmbu.templatemgr.repository.TemplateGroup'
- 'com.cisco.insmbu.templatemgr.repository.Template'
- 'com.cisco.insmbu.templatemgr.repository.DataFile'
- 'com.cisco.insmbu.templatemgr.repository.Keyword'
- 'com.cisco.insmbu.templatemgr.repository.TemplateAssociationOnRole'
- 'com.cisco.insmbu.templatemgr.repository.BusinessClassAssociation'
- 'com.cisco.vpnsr.repository.nbi.ServiceOrder'
- 'com.cisco.vpnsr.repository.nbi.SOSRAssociation'







## Scripts

---

These UNIX shell scripts automate the input of XML requests to, and process the resulting output from, the Northbound Interface (NBI) Application Programmers Interface (API) of the Cisco Prime Provisioning network management application.

This appendix contains information about the following scripts:

- [changeMaxRoutes](#)
- [changepasswd](#)
- [changepw](#)
- [Fcollect](#)
- [collectConfig](#)
- [deletece](#)
- [deletesr](#)
- [deployallsr](#)
- [deployAllSR](#)
- [deploysr](#)
- [deleteSR](#)
- [deleteUnusedCpes](#)
- [downinterface](#)
- [getfile](#)
- [getpe](#)
- [getPEs](#)
- [modifyce](#)
- [purgeces](#)
- [purgeConfigs](#)
- [purgesrs](#)
- [removesr](#)
- [showces](#)
- [showsrr](#)
- [srdump](#)

- [srDump](#)
- [taskdump](#)
- [taskDump](#)
- [upinterface](#)
- [VrfPing](#)

## README File

The README file contains an example of a working script file and describes the required environment variables and parameters, and the location for optional files.

## Scripts Main directory

This section describes the scripts in the main directory. See the “[Script Subdirectories](#)” section on [page C-20](#) for more information about these optional files required by the UNIX shell scripts in the main scripts directory.



### Note

---

These scripts work with either the Sybase and Oracle database.

---

## env

The **env** file contains all of the environment or UNIX shell variable definitions required by all of the UNIX shell scripts in the main scripts directory. All existing UNIX shell scripts in this directory reference the **env** file. Any new scripts created must also include a reference to this file.

## changeMaxRoutes

This script changes the maximum allowed VPN routes for the service request links that belong to the specified VPN and Customer. It also downloads the **maxRoutes** value to the PE devices that belong to the service request links.

### Command Syntax

```
changeMaxRoutes [-v vpnName] [-c customerName] -m maxroutes
```

*Table C-1 changeMaxRoutes Command Options*

Option	Description
-v <i>vpnName</i>	VPN name. Optional parameter.
-c <i>customerName</i>	Customer name. Optional parameter.
-m <i>maxroutes</i>	The maximum number of VPN routes allowed in the device configuration. Required parameter.

**STDOUT**

```

State Success
OutputString
ilpe3.cisco.com|V1:test_vpn|change
ilpe3.cisco.com|V1:test_vpn|change
ilpe2.cisco.com|V2:test_vpn-s|change
ilpe2.cisco.com|V3:newvpn|nochange: Reason- since could not set maxroutes in repository

```

Where State is either *Success* or *Failure*. The OutputString is:

```
<pename>|<vrf name>|<change or nochange: Reason- >
```

**LOG**

The log information is stored in <Prime Provisioning log Location>/http.0.\* in XML format.

The information stored depends on the log level. Log levels range from **SEVERE** to **FINEST**, and are set using **Administration > Control Center > Hosts > Configuration > Logging > Default > Loglevel**.

## changepasswd

This script causes the Prime Provisioning application to change the password on a specified device.

**Command Syntax**

```
changepasswd -f inputfilename [-log logfile] | changepasswd -help
```

**STDOUT**

0 for success, 1 for failure

**Log Name**

The default log name is \$PRIMEF\_HOME/tmp/changepasswd.log.\$\$, where \$\$ is the process ID. An alternate log file name can be specified in the input parameters.

**Log Output Example**

```

-----
opening the repository
input: 3550_6-1|NbiRegion|test|test1|test2
rpmname: 3550_6-1
regionname: NbiRegion
newusername: test
newpassword: test1
newenpassword: test2
After constructTibrvMsg Password ID:: 43835
RPM 3550_6-1 Success
*****
input:

```

## changepw

This script causes the Prime Provisioning application to change the password on a specified device (single instance).

**Command Syntax**

```
changepw host password enablepassword authpassword encrpassword
```

Example:

```
changepw ilpe2 xyz abc qrs 123 asf
```

## Fcollect

This script collects device configurations on a supplied list of devices.

**Command Syntax**

```
collect device1 [device_list]
```

Example:

```
collect ensw2950-1 ensw2950-2
```

## collectConfig

Use this script to collect the device configuration for a specified device (**rpmName**). The device configuration is stored in the directory \$PRIMEF\_HOME/tmp in a file named after the device. You can list multiple device names (multiple **rpmName** parameters).

**Command Syntax**

```
collectConfig -r rpmName
```

**STDOUT**

0 for success, 1 for failure.

**File Name**

\$PRIMEF\_HOME/tmp/device, where *device* is the name of the device (for example, 3550\_6-1).

**File Output Example**

```
3550_6-1#term len 0
3550_6-1#show run
Building configuration...

Current configuration : 10676 bytes
!
version 12.1
no service pad
service timestamps debug uptime
service timestamps log uptime
no service password-encryption
!
hostname 3550_6-1
!
enable secret 5 $1$xHqv$.pVjEARIIvXrJ7tK1S0qa1
!
errdisable recovery cause 12ptguard
errdisable recovery interval 5000
```

```
ip subnet-zero
!
...
```

**Log Name**

\$PRIMEF\_HOME/tmp/collectConfig.log

**Log Output Example**

```
Mon Aug  2 14:13:36 PDT 2004:  collectConfig started
-----
collectConfig request created for device: 3550_6-1
-----

saving config for device 3550_6-1 in the directory /opt/vpnsc/iscadmin/tmp
```

## deletece

Deletes all CE devices in the repository that have no service requests associated with them.

**Command Syntax**

**deletece** [-p *pvc\_id*]

Optionally, you can specify a single CE device using the *pvc\_id* value with the -p script option flag.

**STDOUT**

```
Deleting unused CEs
c1234
The number of CEs deleted: 1
The number of Sites deleted: 0
To view the log file, please see /tmp/deletecefile
```

**Log Name**

\$PRIMEF\_HOME/tmp/deletecefile

**Log Output Example**

```
Deleting unused CEs
Start TIME = Mon Aug  2 15:24:36 PDT 2004
c1234
The number of CEs deleted: 1
The number of Sites deleted: 0
End TIME = Mon Aug  2 15:25:07 PDT 2004
```

## deletesr

This script performs the following actions:

- 1) Decommissions the specified list of service requests (SRs).
- 2) Runs a report on all specified SRs returning the jobId and status.
- 3) Runs a purge request for a closed SR.

**Command Syntax**

```
deletesr RJobId [SRJobId, ...]
```

Example:

```
deletesr 5,6,7
```

where 5, 6, and 7 are the SRJobIds.

## deleteSR

This script performs the following actions:

- Decommissions the list of service requests from the Prime Provisioning database. The service request is specified using the **SRJobId**.
- Produces an audit report for all specified service requests, returning the associated **JobId** and state for each one.
- Purges service requests in the *Closed* state.

The audit report can be disabled using the **-noaudit** option flag.

**Command Syntax**

```
deleteSR SRJobId [SRJobId, ...]
```

**STDOUT**

```
113      CLOSED - purging
Purge complete
```

## deleteUnusedCpes

This script performs the following actions:

1. Finds all CPEs that are not part of an MPLS SR.
2. Deletes these CPEs.
3. Deletes their corresponding target devices.
4. Deletes any sites that no longer have any CPEs.

**Note**

---

This script only checks for CPEs that are part of an MPLS SR. If any CPE is part of any other type of SR (L2VPN, for example), the script will fail.

---

**Command Syntax**

```
deleteUnusedCpes
```

## deployallsr

This script performs the following actions:

- Finds all the MPLS service requests that are in the *Requested* state.
- Deploys the above listed MPLS service requests to the Prime Provisioning-managed network.
- The SRs are deployed in batches of 100.

### Command Syntax

```
deployallsr [-outdir dir_name] [-log log_file_name]
```

### Log Name

```
$PRIMEF_HOME/tmp/deployallsr.log.1897_08_03_04_09_06_29
```

Where 1897 is the process ID, and the remaining numbers are the date and time. An alternate log file name can be specified in the input parameters.

### Log Output Example

```
SRs to be deployed...
146
Task deployment state: Completed
DateTime, SRJobID, State
2004-08-03 10:07:03, 146, CLOSED
```

## deployAllSR

This script deploys all MPLS SRs that are in the *Requested* state sequentially. It performs an audit by default unless the argument **-noaudit** is passed.

It performs the following actions:

1. Finds all MPLS SRs that are in the *Requested* state.
2. Deploys each of these SRs.

### Command Syntax

```
deployAllSR [-noaudit]
```

## deploysr

This script performs the following actions:

- Deploys all service requests listed in the input parameters, regardless of the state.
- Produces an audit report for all specified service requests, returning the associated **JobId** and state for each one.

### Command Syntax

```
deploysr SR_ID [-noaudit] [-force]
```

Table C-2 *deploysr Command Options*

Option	Description
SR ID	Service request ID.
<b>-noaudit</b>	An audit is performed by default unless the argument <b>-noaudit</b> is passed.
<b>-force</b>	The service request is deployed by default unless the argument <b>-force</b> is passed.

Example:

**deploysr 5**

where 5 is the SR ID.

#### STDOUT

None, unless there is an error. The following is an example of an error output:

```
The SR with ID: 1 does not exist in the Database!
```

## downinterface

Use this script to turn off or shut down a given network interface (**interfaceName**) on a given device (**rpmName**). This script logs into the listed RPM device and inserts the **shutdown** IOS command on the specified interface.

#### Command Syntax

```
downinterface -rpm rpmName [-user userName] -pw userPassword -enableuser enableUserName  
-enablepw enablePassword -interface interfaceName [-log logFilename]
```

Table C-3 *downinterface Command Options*

Command Option	Description
-rpm	Hostname (or IP address) of the RPM (PE device). Required parameter.
-user	Login username. This parameter is only required if both the username and password are required for login.
-pw	Login password. Required parameter.
-enableuser	Enable username. This parameter is only required if both the username and password are required to enter enable mode.
-enablepw	Enable password. Required parameter.
-interface	The complete interface name (for example, Switch1.1). Required parameter.
-log	Log filename. Optional parameter. If not specified, the file downinterface.log is created in the \$ECSP_HOME/tmp directory.



**STDOUT**

Non-zero exit code if there is an error.

## getfile

This script will get the latest config for a device from the repository.

**Command Syntax**

```
getfile {{-device device_name} [-dirname outputFileDirectory] {-outfile outputFileName}} | {-r deviceName}}
```

**Table C-4** *getfile Command Options*

Command Option	Description
<b>-device</b> <i>deviceName</i>	Mandatory. Name of device from which the config is to be collected.
<b>-dirname</b> <i>outputFileDirectory</i>	Name of the directory, where the output file is located. [default '/tmp']
<b>-outfile</b> <i>outputFileName</i>	Mandatory. Specify output file name.
<b>-r</b> <i>deviceName</i>	Use this option if only the device name is to be specified. This will use the default values <b>/tmp</b> for output file directory and <b>tmp</b> for output file name.

Example:

```
getfile -device ilpe2 -dirname /tmp/xyz -outfile outputfile
```

## getpe

This script provides a report for all PE device names and associated IP addresses contained in the Prime Provisioning database. The display is sent to the computer screen by default, or you can specify an output file, using the **-f filename** script option flag.

**Command Syntax**

```
getpe {-f filename | -help}
```

**STDOUT**

Creating getpe.txt in current directory

**File Name**

Default is getpe.txt (found in the directory where the script was executed). An alternate file name can be specified in the input parameters.

**File Output Example**

```
at1nga95r11-0038|null
```

```

stlsmo95r10-0063|null
stlsmo95r11-0064|null
washdc95r10-0068|null
washdc95r11-0069|null
atlnga95r12-0051|null
nycmny95r12-0057|null
okldca95r10-0059|null
okldca95r11-0060|null
cmbrma95r11-0084|null
dllstx95r13-0062|null
lsanca95r12-0054|null
okldca95r12-0061|null
clmboh95r10-0078|135.184.109.52
clmboh95r11-0079|null
atlnga95r10-0037|null
lsanca95r10-0035|10.20.21.136
lsanca95r11-0036|null
dllstx95r10-0033|null
dllstx95r11-0034|null
chcgil95r10-0039|135.184.14.155

```

## getPEs

This script will print all of the names of the PEs along with their management IP addresses.

### Command Syntax

**getPEs**

## modifyce

This script modifies the CE device names in the Prime Provisioning database. The **inputfilename** parameter is used to specify the CE device names to be changed.

For example, the following input file:

**1234 5678**

**4321 8765**

makes these modifications:

- The site named C1234 is changed to C5678
- The device named c1234 is changed to c5678
- The site named C4321 is changed to C8765
- The device named c4321 is changed to c8765

### Command Syntax

**modifyce -input filename [-log logFileName]**

To send the output to a log file, use the **-log** script option and specify a **logFileName**.

**STDOUT**

0 for success, 1 for failure.

**Log Name**

Default log name is \$PRIMEF\_HOME/tmp/modifyce.log.\$\$

Where \$\$ is the UNIX process id assigned to this script when it is run. An alternate log file name can be specified in the input parameters.

**Log Output Example**

```
*****
*
*

Tue Aug  3 09:19:19 PDT 2004
*****Detailed log messages for each of CE and it's Site name modification****
***
Success: Site with the name C1234 changed to C4321 and it's CE name changed from
c1234 to c4321
*****All the given CE names and it's Site name changed successfully!*****
*****
```

## purgeces

This script purges all closed SRs/CEs belonging to a VPN.

It performs the following actions:

1. Finds all closed SRs that are associated with the specified VPN.
2. Purges these SRs.
3. Deletes any CPEs and sites that are no longer used.

**Command Syntax**

```
purgeces [<VPN_NAME> | all]
```

**Table C-5** *purgeces* Command Options

Option	Description
VPN_NAME	Purges closed SRs/CEs belonging to VPN_NAME.
all	Purges all closed SRs/CEs.

Example:

```
purgeces vpn1
```

This purges all CE's belonging to vpn1.

## purgeConfigs

This script performs the following actions:

1. Runs a report to determine, which devices are candidates to have their configs removed.
2. Creates one or more collect config tasks. These task will perform collect config tasks on devices, which have exceeded the recommended number of stored configs.

### Command Syntax

**purgeConfigs [-t configThreshold]**

Example: `purgeConfigs -t 2`

## purgesrs

This script performs the following actions:

1. Finds all service requests in the Prime Provisioning database that are in the *Closed* state.
2. Purges or removes each of these service requests from the Prime Provisioning database.

If you specify a file and filename that contains a list of service request job IDs (**SRJobId**), only the service requests listed in the file are purged, and only if they are in the *Closed* state.

To purge service requests regardless of the state use the **-force** script option flag.

### Command Syntax

**purgesrs [-file <filename>] [-log <logFileName>] [-force]**

If no arguments are given, all service requests in the *Closed* state are purged.

**Table C-6** *purgesrs Command Options*

Option	Description
-file <filename>	The file containing the list of service requests to be purged.
-log <logFileName>	The log output file name.
-force	All service requests in <filename> are force purged

### Log Name

Specified on the command line.

### Log Output Example

```
SR with Id 140403 was purged
```

## removesr

Use this script to change a specified service request to the *Decommissioned* state. The service request remains in the Prime Provisioning database but is not deployed. Use the job ID (**SRJobId**) to specify the service request to decommission.

### Command Syntax

```
removesr SRJobId
```

### STDOUT

```
New SR created 140403
```

## showces

This script performs the following actions:

1. Shows all SRs/CEs belonging to a specified VPN.
2. Shows all SRs/CEs.

### Command Syntax

```
showces [-h | -n vpnName | -a]
```

(use only one option with this script)

**Table C-7** *showces Command Options*

Option	Description
<b>-h</b>	Prints help message.
<b>-n</b> <i>vpnName</i>	Prints SRs/CEs belonging to <vpn_name>
<b>-a</b>	Prints all SRs/CEs

Example:

```
showces -n vpn1
```

where *vpn1* is the name of the vpn. This command displays all the ces'es related to *vpn1*.

## showsr

This script performs the following actions:

- Finds all the MPLS service requests in the Prime Provisioning database which are not in the *Deployed*, *Functional*, or *Closed* state.
- Finds the VPNs associated with each MPLS service request.
- Finds the PE and CE devices associated with each MPLS service request.
- Displays this information in a table format.

When no arguments are specified, the output lists all service requests that are not in the *Deployed*, *Functional*, or *Closed* state.

### Command Syntax

```
showsr [-a] [last_N_sr] [sr_state]
```

```
showsr [-p pvc_id]
```

```
showsr [-v vpn_name]
```

**Table C-8** *showsr* Command Options

Option	Description
<b>-a</b>	Prints all service requests regardless of the state.
<i>last_N_sr</i>	Truncates the number of service requests reported, regardless of the state.
<i>sr_state</i>	Reports only service requests in a specified state. Valid [sr_state] values are: REQUESTED, PENDING, FAILED_DEPLOY, INVALID, DEPLOYED, BROKEN, FUNCTIONAL, LOST, CLOSED, FAILED_AUDIT and WAIT_DEPLOY.
<i>last_N_sr</i> [i>sr_state]	Prints the last (N) of service requests in a specified state. If last_N_sr = 0, all service requests in state [sr_state] are printed.
<b>-p</b> <i>pvc_id</i>	Reports only service requests with a specific device ID.
<b>-v</b> <i>vpn_name</i>	Reports only service requests with a specific VPN name.

### STDOUT

```
Job_ID SR_STATE PE_ROUTER CE_ROUTER VPN_ID CREATION_DATE_TIME
149 DEPLOYED dllstx95r10-0033 c1333698 V34 2004-1-27 15:56:18
```

## srdump

This script performs one of these actions:

- Returns information about all service requests in the Prime Provisioning database, which contain the network device specified by the *pvc\_id* parameter.
- Returns information about the service request designated by the *sr\_id*. The **-sr** script option is required when requesting *sr\_id*.

### Command Syntax

```
srdump pvc_id [-disable] [-configlet]
```

```
srdump -sr sr_id [-configlet]
```

Table C-9 *srdump* Command Options

Option	Description
<b>-sr</b>	Indicates that the required argument refers to a service request ID. If <b>-sr</b> is not specified, a PVC device name must be defined.
<i>sr_id</i>   <i>pvc_id</i>	The required identification number of the service request for this report. <ul style="list-style-type: none"> <li>• service request ID, <i>sr_id</i></li> <li>• PVC device name, <i>pvc_id</i></li> </ul>
<b>-disable</b>	Disables full reports. Only a brief report is displayed for each service request. Use this option to reduce the amount of data reported. This option is only available with the <i>pvc_id</i> argument.
<b>-configlet</b>	Prints the configlet for each service request.

**STDOUT**

```

CREATION_TIME          2004-1-27 16:12:30
MODIFICATION_TIME     2004-1-27 16:12:41
SR_ID                  147
OpType                 ADD
SR_STATE               DEPLOYED
CE_NAME                c1331520.customer
PE_NAME                nycmny95r11-0044.noc.att.com
BGP_AS                 65000
CE_ADDR                128.222.253.118/30
CE_ENCAP               FRAME_RELAY
CE_INTERFACE           Serial0.100
CE_DLCI/CE_VCD        777
CE_VCI                 -1
CE_VPI                 -1
NEIGHBOR_AS_OVERRIDE  false
PE_ADDR                128.222.253.117/30
PE_ENCAP               ATM
PE_INTERFACE           Switch1.216
PE_IF_SHUTDOWN         false
PE_VCD                 1
PE_VCI                 216
PE_VPI                 0
Vrf_Rd_Override_Enabled false
CERC                   any_to_any
IsHub                  true
HUB_RT                 13979:34
RD                     13979:34
VRF_NAME               34
PE_CE_PROTOCOL         BGP

```

Last State Change Comment: -1

```

-----
no rate-limit input access-group rate-limit 6 56000 16000 32000 conform-action transmit
exceed-action set-prec-transmit 1
exit
int Switch1.216
no rate-limit input access-group rate-limit 7 208000 40000 80000 conform-action transmit
exceed-action set-prec-transmit 4
exit

```

```

int Switch1.216
  no service-policy output COS_POLICY4:1
  pvc 0/216
  no service-policy output COS_POLICY4:1
exit
int Switch1.216 point-to-point
  ip accounting precedence input
  rate-limit input access-group rate-limit 8 8000 8000 8000 conform-action
set-prec-continue 0 exceed-action set-prec-continue 0
  rate-limit input access-group rate-limit 7 8000 8000 8000 conform-action transmit
exceed-action set-prec-transmit 4
  rate-limit input access-group rate-limit 6 8000 8000 8000 conform-action transmit
exceed-action set-prec-transmit 1
  pvc 0/216
  service-policy output COS_POLICY3:1
  tx-ring-limit 3
exit
ip vrf 34
  maximum routes 4500 75
router bgp 13979
address-family ipv4 vrf 34
  default-information originate
  maximum-paths eibgp 6
  neighbor 128.222.253.118 route-map set-CE-local-pref in
exit
-----

```

## srDump

This script performs the following actions:

### Command Syntax

```
srDump [-d] [-c] [-h] [-s] id
```

**Table C-10** *srDump* Command Options

Option	Description
<b>-d</b>	Disables full reports (only a brief report will be displayed for each service request).
<b>-c</b>	Prints the configlet for each service request.
<b>-h</b>	Displays the basic help.
<b>-s</b>	Indicates that the required argument, <id>, refers to a service request ID. If -s is not specified, it refers to a PVC device name.
<i>id</i>	The required identification number of the service request (with the -s option) or PVC device name for this report.



PVC ARGUMENT (CPE id)

Example: **srDump [-d] [-c] PVC\_Id**

1) Prints a list of SRs associated with a CPE

- If more than one SR is found, the following brief output is printed:

LocatorId  
State  
Organization

- If only one SR is found, the following detailed information is printed:

CreationTime  
ModificationTime  
LocatorId  
State  
Organization  
MvrfCe  
pe  
CE\_Intf\_Address  
CE\_DLCI  
CE\_Intf\_Encap  
CE\_Facing\_MVRFCE\_Intf\_Address  
CE\_VCD  
CE\_VCI  
CE\_VPI  
Vrf\_Rd\_Overwrite\_Enabled  
PE\_Intf\_Address  
PE\_DLCI  
PE\_Intf\_Encap  
PE\_Intf\_Shutdown  
PE\_Intf\_Address  
PE\_Facing\_MVRFCE\_Intf\_Address  
PE\_VCD  
PE\_VCI  
PE\_VPI  
Overridden\_Rd  
Overridden\_Vrf\_Name  
MVRFCE\_CE\_Routes\_To\_Site\_IP\_Address

2) Prints only a brief summary if the **-d** flag is used.

3) Prints the configlet also if the **-c** flag is used.

## SR ARGUMENT

Example: **srDump** [-d] [-c] [-s] *SR\_Id*

- 1) The **-s** flag is required to make the script treat the *id* variable as an SR ID.
  - 2) The **-c** flag also prints the configlet if the **-configlet** flag is used.
  - 3) Prints the detailed information of the SR (see above).
- (The **-d** flag will produce a less detailed output.)

## taskdump

This script provides information about service request tasks. Indicate the detail of the report by specifying either a:

- service request ID (*sr\_id*)
- task name (*task\_name*)

### Command Syntax

**taskdump -h** | *sr\_id* | *task\_name* [-verbose]

**Table C-11** *taskdump* Command Options

Option	Description
<b>-h</b>	Prints the help message.
<i>sr_id</i>	Obtain information about tasks associated with service request.
<i>task_name</i>	Obtain information about a specified task.
<b>-verbose</b>	Obtain detailed task information.

### STDOUT

```
Date: 2004-08-03T09:10:41 Level: INFO Message: Open repository succeeded
===== Creating ProvDrvSR succeeded for Job#140418SR#140423
    Date: 2004-08-03T09:11:07 Level: INFO Message: MPLS_VPN_Link[ 140413 ] Status [[
c2571924 ] Successful Deployment<br>[ dllstx95r10-0033 ] Successful Deployment<br>]
    Date: 2004-08-03T09:11:08 Level: INFO Message: Open repository succeeded
===== Creating ProvDrvSR succeeded for Job#140418SR#140423
bash-2.05b$ taskdump 140418
    Date: 2004-08-03T09:10:41 Level: INFO Message: Open repository succeeded
===== Creating ProvDrvSR succeeded for Job#140418SR#140423
    Date: 2004-08-03T09:11:07 Level: INFO Message: MPLS_VPN_Link[ 140413 ] Status [[
c2571924 ] Successful Deployment<br>[ dllstx95r10-0033 ] Successful Deployment<br>]
    Date: 2004-08-03T09:11:08 Level: INFO Message: Open repository succeeded
===== Creating ProvDrvSR succeeded for Job#140418SR#140423
```

## taskDump

This script provides information about service request tasks.

### Command Syntax

```
taskDump <[-A] [-I id] [-S] [-R]> [-r] [-a] [-f file_name] [-h]
```

(One or more of the first four options is required for this script.)

**Table C-12** *taskDump Command Options*

Option	Description
<b>-A</b>	Dump all persistent tasks.
<b>-I</b>	Dump specific persistent task name, requires <i>id</i>
<b>-S</b>	Dump the related scheduled tasks.
<b>-R</b>	Dump all active runtime tasks.
<b>-r</b>	Dump related runtime tasks.
<b>-a</b>	Dump persistent task actions.
<b>-f</b>	Create a configuration file, requires <i>file_name</i>
<b>-h</b>	Display the brief help utility.

## upinterface

Use this script to turn on (or turn up) a given network interface (**interfaceName**) on a given device (**rpmName**). This script logs into the specified RPM device and inserts the **no shutdown** IOS command on the specified interface.

### Command Syntax

```
upinterface -rpm rpmName [-user userName] -pw userPassword -enableuser enableUserName  
-enablepw enablePassword -interface interfaceName [-log logFileName]
```

**Table C-13** *upinterface Command Options*

Command Option	Description
<b>-rpm</b>	Hostname (or IP address) of the RPM (PE device). Required parameter.
<b>-user</b>	Login username. This parameter is only required if both the username and password are required for login.
<b>-pw</b>	Login password. Required parameter.
<b>-enableuser</b>	Enable username. This parameter is only required if both the username and password are required to enter enable mode.
<b>-enablepw</b>	Enable password. Required parameter.
<b>-interface</b>	The complete interface name (for example, Switch1.1). Required parameter.
<b>-log</b>	Log filename. Optional parameter. If not specified, the file upinterface.log is created in the \$ECSP_HOME/tmp directory.

**STDOUT**

Non-zero exit code if there is an error.

## VrfPing

VrfPing checks the connectivity between the PE and CE by executing the **traceroute vrf** and **ping atm** commands. If the **traceroute vrf** command succeeds, **VrfPing** returns with an exit status of 0. The **ping atm** command is executed only if the VCI value is specified with the **-vci** option and the **traceroute** command fails.

The exit states of VrfPing are:

- 0 - **traceroute** command successful.
- 1 - **traceroute** command failed. **ping atm** command successful (if vci was specified).
- 2 - **traceroute** command failed. **ping atm** command failed.

**Command Syntax**

```
VrfPing -pe pe_name -ce ce_name -vrf vrf_name -vci vci_value [-user user_name -pw user_passwd [-enuser enable_username -enpw enable_passwd [-log log_file_name]
```

*Table C-14 VrfPing Options*

Option	Description
<b>-pe</b>	Hostname (or IP address) of the PE device (RPM). Required parameter.
<b>-ce</b>	VPN interface address of the CE device. Required parameter.
<b>-vrf</b>	VRF name. Required parameter.
<b>-vci</b>	VCI value of the ATM subinterface.
<b>-user</b>	Login username. Required only if both username and password are required for login.
<b>-pw</b>	Login password. Required parameter.
<b>-enuser</b>	Enable username for PE. Required only if both username and password are required for login.
<b>-enpw</b>	Enable password for the PE device.
<b>-log</b>	Log file name. This parameter is optional. If not specified, the file vrfping.log is created in the \$ECSP_HOME/tmp directory.

**STDOUT**

Non-zero exit code if there is an error.

## Script Subdirectories

These subdirectories are located in the scripts main directory.

## util

This directory contains UNIX shell scripts that are used by the UNIX shell scripts in the main scripts directory. They perform utility functions which might be used by any of the UNIX shell scripts in the main directory. Users that create or modify scripts in the main directory have reference to these utility scripts, but they cannot be used directly or modified.

## xml

This directory contains input request XML template files. The main directory UNIX shell scripts read, copy, and modify the copied XML template file to generate inputs for the Prime Provisioning NBI. The files in this directory are not modified throughout the process.

## filters

This directory contains variables, used by the UNIX shell scripts in the main directory, to filter the responses generated by the Prime Provisioning NBI before the response data is formatted for output to the user. As you create or modify UNIX shell scripts in the main directory, you might need to modify or add new filter files to this directory.

## queries

This directory contains input request XML template files, similar to those in the `xml` subdirectory, but these files are in a different and more detailed format. The main directory UNIX shell scripts use the files in this directory in much the same way those in the `xml` directory are used. The resulting output from the NBI API are more detailed, and the scripts using the files of this directory can generate more detailed and formatted output to present to the user.





## Prime Provisioning XDE SDK

---

This appendix gives a brief overview of the Cisco Prime Provisioning XDE SDK (XDE SDK) and explains how to use it. The XDE SDK makes it possible to extend the Prime Provisioning feature set to customize it to meet your needs.

This appendix contains the following sections:

- [Introduction, page D-1](#)
- [System Recommendations, page D-1](#)
- [Installing and Setting Up the Prime Provisioning XDE SDK, page D-2](#)
- [Process Overview, page D-2](#)
- [Creating or Modifying Provisioning Logic, page D-3](#)
- [XDE SDK Functional Tests, page D-3](#)

### Introduction

The Prime Provisioning XDE SDK is an Eclipse-based plug-in that enables you to extend and test the existing provisioning functionality supplied in Prime Provisioning.

The XDE SDK provides a complete integrated development environment for

- building and viewing the provisioning logic
- building and viewing the device templates
- graphically debugging provisioning logic
- running and defining regression tests

### System Recommendations

General system requirements for running the XDE SDK are synonymous with those for Eclipse. See [eclipse.org](http://eclipse.org).

Specific requirements:

- Operation system support:
  - Windows
  - Linux

- OS X (Mac)
  - Memory requirements: 4 GB
  - Disc space: 1 GB
  - Java: Use the latest version of JRE or JDK
- Java information for Eclipse: <http://www.eclipse.org/downloads/moreinfo/jre.php>

## Installing and Setting Up the Prime Provisioning XDE SDK

To make the Prime Provisioning XDE SDK work as intended, the following steps are recommended in the installation process:

---

**Step 1** Set up your environment.

Before installing Eclipse, you need to make sure that your environment will support Eclipse and the XDE package. This includes:

- Checking the system recommendations: [System Recommendations, page D-1](#).
- Ensuring that a supported version of Java is installed. For this, use the latest version of JRE or JDK.

**Step 2** Install the latest Eclipse version.

Go to [eclipse.org/downloads/](http://eclipse.org/downloads/) and look for Eclipse for RCP and RAP developers. This page also contains a link to the Eclipse installation documentation.

Once you have Java and Eclipse installed, it is recommended that you ensure adequate memory is allocated to Eclipse (see [System Recommendations](#)).

You can do this by editing the **eclipse.ini** file

**<eclipse-install>/eclipse/eclipse.ini**

and changing the last two lines to:

```
-Xms512m
-Xmx1024m
```

**Step 3** Install the XDE SDK Eclipse plug-in.

**Step 4** Go to the Prime server:

**<isc-install>/resources/xde/packages/std**

and copy the provisioning logic files onto the server on which you are running Eclipse/XDE.

**Step 5** Import the provisioning logic files into the XDE SDK.

For information about how to import packages into the Eclipse SDK, go to

<http://www.eclipse.org/downloads/moreinfo/jre.php>

---

## Process Overview

The Prime Provisioning functionality has four main parts:



1. **Query phase:** The devices involved in the provisioning operation are queried for their current configuration. This determines what configuration is already provisioned on the network.  
XDE parses the device profiles and configurations into a set of XML files that can be processed by the provisioning logic.
2. **Logic phase:** The provisioning logic runs within XDE. XDE processes the existing device configurations and requested service design to create device configuration.  
The required device configuration templates are run to generate the actual device configuration.
3. **Provisioning phase:** XDE creates the minimal required set of commands to provision the service and pushes the configuration to the devices.
4. **Audit:** The configuration pushed to the devices are audited to make sure it has been applied correctly.

## Creating or Modifying Provisioning Logic

It is important to understand the difference between the two basic ways in which the provisioning logic can be changed. It will help you make informed choices, which can reduce risk of introducing errors in the logic.

The provisioning logic can be modified in the following two ways:

- Changing the existing provisioning logic
- Using an existing extension point (recommended)



Note

---

Cisco Prime Provisioning 6.8 does not support changing the existing provisioning logic.

---



Note

---

It's important to note that direct editing of the provisioning logic may cause Prime Provisioning to fail. This may also put the system into a state where upgrades can no longer be obtained for the product. If in doubt, please contact Cisco.

---

## Using Extension Points

Extension points are the recommended way to extend the provisioning system. Extension points allow the system to be extended without risking the existing functionality, and allowing new updates to be seamlessly installed.

## XDE SDK Functional Tests

The Prime Provisioning XDE SDK includes a range of standardized regression tests that can be used to test whether the new extension point logic has broken the existing provisioning logic.

New tests can also be written to exercise any new provisioning logic and to validate that it works correctly.

With the XDE Eclipse plug-in installed, navigate to the ProvTest package, which contains all the of the functional tests for provisioning. Use this to test what you have developed to make sure that no existing functionality has been broken. It currently contains some 1800 tests and additional tests can be added.



---

## A

- access domains [2-9](#)
  - defining [2-8](#)
  - introduction [2-8](#)
- API components [1-1](#)
  - API notifications server [1-8](#)
  - API server/servlet [1-8](#)
    - client [1-2](#)
    - HTTP/HTTPS server [1-3](#)
    - HTTP authentication/encryption [1-4](#)
    - HTTP response [1-3](#)
    - HTTP transport [1-3](#)
    - message security [1-8](#)
    - message validation/SOAP faults [1-7](#)
    - SOAP message envelope [1-5](#)
    - SOAP message header [1-5](#)
    - SOAP messages [1-5](#)
    - SOAP plug-in [1-4](#)
- API error messages [1-14](#)
- API notifications server [1-8](#)
- API operations [1-9](#)
- API requests
  - date/time format [3-15](#)
- API server/servlet [1-8](#)
- API status
  - checking from the API [2-1](#)
  - checking from the GUI [2-2](#)
  - overview [2-1](#)
- attributes
  - setting up optional attributes [4-8](#)
- audit
  - about configuration audit [3-11](#)

- certificate enrollment [3-10](#)
- L2VPN service requests [7-32](#)
- MPLS service requests [6-62](#)
- MPLS-TP service requests [12-24](#)
- performing configuration audits [2-12](#)
- TEM service requests [10-31](#)
- VPLS service requests [8-22](#)

authentication

- HTTP authentication/encryption [1-4](#)
- remote authentication [5-2](#)

---

## C

- canned reports [5-6](#)
- certificate enrollment audit [3-10](#)
- client [1-2](#)
  - setting up [5-2](#)
- collection
  - events [B-5](#)
  - operation [3-10](#)
  - SLA [3-13](#)
- common APIs
  - devices [3-2](#)
  - groupings [3-5](#)
  - introduction [3-1](#)
  - inventory [3-1](#)
  - resource pools [3-3](#)
  - session [3-7](#)
  - topology [3-4](#)
- computation ID
  - using in TEM [10-29](#)
- compute backup [10-29](#)
- configuration audit

- about [3-11](#)
- performing [2-12](#)

---

## D

- data file
  - creating data file from service request [4-11](#)
- date/time format in API requests [3-15](#)
- decommissioning
  - service [3-11](#)
- deployment
  - service deployment [3-12](#)
- device configurations
  - collecting [2-10, 6-58](#)
- device locking [5-22](#)
- dynamic instantiation of templates [4-3](#)

---

## E

- encryption
  - HTTP authentication/encryption [1-4](#)
- error logs [1-16](#)
- error messages [1-14](#)
- EVC
  - end-to-end provisioning process [9-139](#)
  - end-to-end wires [9-42](#)
  - MPLS core connectivity types [9-2](#)
  - policy examples [9-3, 11-4, 11-35](#)
  - policy types [9-2](#)
  - service definitions [9-1](#)
  - supported service definitions and service orders [9-2, 11-4, 11-34](#)
- EVC network diagrams
  - local connect [9-44](#)
  - pseudowire [9-42](#)
  - VPLS [9-43](#)
- EVC policies
  - Configuring an SVI/EVC Hybrid Scenario [9-24](#)
  - Create VPLS Policy [9-10](#)

- local connect policy [9-3, 9-5](#)
- Policy for specifying Service Instance Name for EVC Service Requests [9-28](#)
- pseudowire policy [9-4](#)
- VPLS policy [9-4](#)

### EVC policy examples

- Create Local Connect Policy with ATM/Ethernet internetworking [9-5](#)
- Create Pseudowire Policy with ATM/Ethernet Internetworking [9-10](#)

### EVC provisioning

- detailed process [9-140, 11-27, 11-54](#)
- end-to-end provisioning process [9-139](#)
- introduction [8-1, 9-1](#)
- prerequisites [9-139](#)
- process summary [9-139, 11-27, 11-54](#)

### EVC service request examples

- Configuring an SVI/EVC Hybrid Scenario Service Request [9-69](#)
- Create Access Ring with two NPEs [9-67](#)
- Create NPC [9-68](#)
- Creating a Local Connect Service Request for IOS-XR using Bridge Domain [9-77](#)
- Creating a Local Connect Service Request with ATM Ethernet [9-100](#)
- Creating a Pseudowire Service Request with ATM Ethernet [9-105](#)
- Creating a Pseudowire Service Request with P2P E-line Name [9-88](#)
- Creating a VPLS Service Request with IOS XR [9-124, 9-128](#)
- Local Connect Service Request [9-45, 11-9, 11-37](#)
- Modifying a EVC Service Request [9-60](#)
- Pseudowire Service Request [9-51](#)
- Specifying Service Instance Name for EVC Service Requests [9-74](#)
- VPLS Service Request [9-55](#)

### EVC service requests

- examples [9-44, 11-9, 11-37](#)
- introduction [9-41](#)
- overview [9-41](#)

### event notification

overview [B-1](#)

events

collection [B-5](#)

notification [B-1](#)

---

## F

functional audit [3-12](#)

---

## G

general purpose APIs [3-14](#)

getting started [2-1](#)

---

## H

HTTP

authentication/encryption [1-4](#)

response [1-3](#)

transport [1-3](#)

HTTP/HTTPS server [1-3](#)

---

## I

installation notes [2-1](#)

introduction to the ISC API [1-1](#)

inventory

creating [2-5](#)

---

## L

L2VPN

ATM policy [7-2](#)

ATM service request [7-11](#)

end-to-end wires [7-9](#)

ERS policy [7-5](#)

ERS service request [7-15](#)

policy examples [7-2](#)

service definitions [7-1](#)

service requests [7-9](#)

supported service definitions [7-2](#)

L2VPN provisioning

introduction [7-1](#)

prerequisites [7-21](#)

process summary [7-20](#)

provisioning process [7-22](#)

RBAC [7-21](#)

link template [4-18](#)

locator ID

using in MPLS-TP [12-24](#)

using in TEM [10-28](#)

locator IDs [1-14](#)

locking mechanism

device locking [5-22](#)

LOG [C-3](#)

logging in [2-3](#)

---

## M

message security [1-8](#)

message validation/SOAP faults [1-7](#)

monitoring

output for reports [5-10](#)

monitoring APIs [5-1](#)

MPLS

core connectivity types [9-2](#)

end-to-end provisioning process [6-53](#)

policy attributes [6-4](#)

schema diagram [6-2](#)

service definitions/policies [6-2](#)

service requests [6-11](#)

supported operations [6-3](#)

MPLS functional audit [3-12](#)

MPLS policy

creating [6-60](#)

MPLS provisioning

creating inventory [6-55](#)

detailed process and attributes [6-55](#)

introduction [6-1](#)

process summary [6-54](#)

#### MPLS service request

creating [6-60](#)

#### MPLS service request examples

Create BGP Max Prefix with Second VLAN ID and BGP DIO [6-22](#)

Create EIGRP Key Chain [6-28](#)

Create Independent Route Target [6-12](#)

Create OSPF Default Info Originate [6-34](#)

Create Static Route Configuration [6-18](#)

#### MPLS service requests [6-11](#)

#### MPLS-TP

policy examples [12-2](#)

supported features [12-2](#)

#### MPLS-TP Discovery [12-5](#)

#### MPLS-TP provisioning

example [12-20](#)

prerequisites and limitations [12-1](#)

process summary [12-20](#)

provisioning process [12-21](#)

#### MPLS-TP service requests

examples [12-8](#)

---

## N

#### negate templates

creating [4-8](#)

using [4-22](#)

#### non-Cisco devices

in TEM [10-2](#)

#### notifications

event notifications [5-1](#)

responses [5-3](#)

---

## O

#### optional attributes

setting up [4-8](#)

---

## P

#### planning tools

compute backup [10-29](#)

overview [10-29](#)

#### policies

creating service policy [2-11](#)

L2VPN policy examples [7-2](#)

#### prerequisites

for EVC provisioning [9-139](#)

for L2VPN provisioning [7-21](#)

for MPLS-TP provisioning [12-1](#)

for TEM provisioning [10-1](#)

for VPLS provisioning [8-11](#)

provisioning examples [4-12](#)

#### probes

SLA [5-13](#)

#### provider and customer relationship

customer [2-7](#)

defining [2-5](#)

provider [2-5](#)

region [2-7](#)

site [2-8](#)

#### provisioning examples

prerequisites [4-12](#)

process summary [4-12](#)

templates [4-12](#)

#### provisioning process

detailed [4-13](#)

---

## R

#### remote authentication [5-2](#)

#### reports

canned reports [5-6](#)

introduction [5-4](#)

- report definition filters [5-8](#)
  - report definitions [5-8](#)
  - SQL-based [5-4](#)
  - repository
    - populating [2-4](#)
  - resource pools
    - creating [6-57](#)
  - route aggregation
    - assigning [2-8](#)
- 
- ## S
- scripts
    - changeMaxRoutes [C-2](#)
    - changepasswd [C-3](#)
    - changepw [C-3](#)
    - collectConfig [C-4](#)
    - command syntax [C-2, C-3, C-4, C-5, C-6, C-7, C-8, C-9, C-10, C-11, C-12, C-13, C-14, C-16, C-18, C-19, C-20](#)
    - deletece [C-5](#)
    - deleteSR [C-6](#)
    - deletesr [C-5](#)
    - deleteUnusedCpes [C-6](#)
    - deployAllSR [C-7](#)
    - deployallsr [C-7](#)
    - deploysr [C-7](#)
    - downinterface [C-8](#)
    - env [C-2](#)
    - Fcollect [C-4](#)
    - file name [C-4, C-9](#)
    - File Output Example [C-4](#)
    - file output example [C-9](#)
    - filters [C-21](#)
    - getfile [C-9](#)
    - getpe [C-9](#)
    - getPEs [C-10](#)
    - LOG [C-3](#)
    - log name [C-3, C-5, C-7, C-11, C-12](#)
    - log output example [C-3, C-5, C-7, C-11, C-12](#)
    - Main directory [C-2](#)
    - modifyce [C-10](#)
    - purgeces [C-11](#)
    - purgeConfigs [C-12](#)
    - purgesrs [C-12](#)
    - queries [C-21](#)
    - removesr [C-13](#)
    - showces [C-13](#)
    - showsrs [C-13](#)
    - srDump [C-16](#)
    - srdump [C-14](#)
    - STDOUT [C-3, C-4, C-5, C-6, C-8, C-9, C-11, C-13, C-14, C-15, C-18, C-20](#)
    - subdirectories [C-20](#)
    - taskDump [C-18](#)
    - taskdump [C-18](#)
    - upinterface [C-19](#)
    - util [C-21](#)
    - VrfPing [C-20](#)
    - xml [C-21](#)
  - script subdirectories [C-20](#)
  - service decommissioning [3-11](#)
  - service definitions
    - introduction [1-14](#)
    - templates [4-5](#)
  - service deployment [3-12](#)
  - service model [1-11](#)
  - service orders
    - creating [2-11](#)
    - example [1-13](#)
    - introduction [1-12](#)
    - life cycle [1-12](#)
    - response [2-12](#)
    - templates [4-5](#)
  - service policy
    - creating [2-11](#)
  - service requests
    - auditing [6-62, 7-32, 8-22, 9-149, 10-31, 11-34, 11-60, 12-24](#)
    - creating [2-11](#)

- creating data file from service request [4-11](#)
  - EVC end-to-end wires [9-42](#)
  - EVC examples [9-44, 11-9, 11-37](#)
  - EVC service requests [9-41](#)
  - introduction [1-12](#)
  - L2VPN ATM service request [7-10](#)
  - L2VPN ERS service request [7-15](#)
  - L2VPN examples [7-10](#)
  - modifying [1-12, 4-23](#)
  - MPLS [6-11, 6-60](#)
  - MPLS-TP examples [12-8](#)
  - TEM [10-9](#)
  - TEM examples [10-10](#)
  - templates in service requests [4-18](#)
  - turning off templates [4-23](#)
  - VPLS [8-8](#)
  - servlet
    - API servlet [1-8](#)
    - customizing the example servlet [B-5](#)
    - running the example servlet [B-3](#)
  - SLA collection [3-13](#)
  - SLA probes
    - common probe parameters [5-16](#)
    - creating and deploying [5-13](#)
    - introduction [5-13](#)
    - types [5-17](#)
    - viewing [5-18](#)
  - SLA provisioning [5-12](#)
    - introduction [5-12](#)
    - process [5-12](#)
  - SLA reports [5-19](#)
  - SOAP
    - faults [1-7](#)
    - message body [1-6](#)
    - message envelope [1-5](#)
    - message header [1-5](#)
    - messages [1-5](#)
    - plug-in [1-4](#)
  - SQL-based reports [5-4](#)
  - SRAssociatedTemplate [4-19](#)
  - subtemplate
    - creating [4-9](#)
- 
- T
- task logs
    - viewing [5-24](#)
  - tasks
    - introduction [3-9](#)
    - viewing [3-9](#)
  - TE backup tunnel SR
    - create and deploy [10-18](#)
    - response [10-19](#)
  - TEM
    - compute backup [10-29](#)
    - non-Cisco devices and ISC TEM [10-2](#)
    - planning tools [10-29](#)
    - policy examples [10-4](#)
    - service definitions [10-2](#)
    - supported features [10-2](#)
    - using computation ID and locator ID [10-29](#)
  - TE managed primary tunnel SR
    - create and deploy [10-10](#)
    - create request [10-11](#)
    - create response [10-12](#)
    - receive computation response [10-13](#)
    - request performance computation status [10-12](#)
    - save and deploy request [10-15](#)
    - save and deploy response [10-17](#)
  - template examples
    - creating templates in policies (N-PE) [4-10](#)
    - creating templates in policies (U-PE) [4-10](#)
  - template node objects
    - data buffer object [4-20](#)
    - link template [4-18](#)
    - SRAssociatedTemplate [4-19](#)
    - using [4-18](#)
  - templates



- adding 4-6
  - basic template manager functions 4-4
  - creating in policies 4-10
  - data 4-2
  - definition 4-2
  - detailed provisioning process 4-13
  - dynamic instantiation 4-3
  - examples of template operations 4-6
  - introduction 4-1
  - operations 4-3, 4-6
  - policy-level functions 4-4
  - process summary 4-12
  - provisioning examples 4-12
  - removing configurations 4-22
  - service definitions 4-5
  - service-level template functions 4-4
  - service orders 4-5
  - subtypes 4-4
  - templates in a service request 4-18
  - transient 4-17
  - using 4-1
  - TEM provisioning
    - example 10-24
    - general limitations 10-1
    - introduction 10-1
    - prerequisites and limitations 10-1, 10-2
    - process summary 10-24
    - provisioning process 10-24
  - TEM service requests
    - examples 10-10
    - introduction 10-9
  - TE network discovery 10-7
  - TE policy
    - creating 10-4
    - deleting 10-6
    - viewing 10-6
  - TE topology example 10-9
  - TE traffic admission service request
    - create and deploy 10-19
    - create request 10-20
    - create response 10-21
    - save and deploy request 10-21
    - save and deploy response 10-22
  - TE unmanaged primary tunnel SR
    - create and deploy 10-17
  - topology
    - creating physical topology 2-9
  - Traffic Engineering Management, see TEM 10-1
  - transient templates 4-17
  - turning off templates
    - turning off for MPLS service requests 4-23
    - turning off for non-MPLS service types 4-24
- 
- V
- Virtual Private Networks 2-9
  - virtual private networks (VPNs) 2-8
  - VPLS
    - service definitions 8-2
    - service requests 8-8
  - VPLS provisioning
    - prerequisites 8-11
    - process summary 8-10
    - provisioning example 8-10
    - provisioning process 8-11
    - RBAC 8-11
  - VPNs 2-9
    - defining 2-8
- 
- W
- work flow 2-3
- 
- X
- XML examples
    - introduction 1-11

see under templates, MPLS, L2VPN, VPLS, EVC,  
TEM [1-11](#)

XML schema [1-10](#)