



Cisco Transport Planner DWDM Operations Guide

Software Release 9.4
February 2012

Americas Headquarters
Cisco Systems, Inc.
170 West Tasman Drive
San Jose, CA 95134-1706
USA
<http://www.cisco.com>
Tel: 408 526-4000
800 553-NETS (6387)
Fax: 408 527-0883

Text Part Number: OL-25606-01

THE SPECIFICATIONS AND INFORMATION REGARDING THE PRODUCTS IN THIS MANUAL ARE SUBJECT TO CHANGE WITHOUT NOTICE. ALL STATEMENTS, INFORMATION, AND RECOMMENDATIONS IN THIS MANUAL ARE BELIEVED TO BE ACCURATE BUT ARE PRESENTED WITHOUT WARRANTY OF ANY KIND, EXPRESS OR IMPLIED. USERS MUST TAKE FULL RESPONSIBILITY FOR THEIR APPLICATION OF ANY PRODUCTS.

THE SOFTWARE LICENSE AND LIMITED WARRANTY FOR THE ACCOMPANYING PRODUCT ARE SET FORTH IN THE INFORMATION PACKET THAT SHIPPED WITH THE PRODUCT AND ARE INCORPORATED HEREIN BY THIS REFERENCE. IF YOU ARE UNABLE TO LOCATE THE SOFTWARE LICENSE OR LIMITED WARRANTY, CONTACT YOUR CISCO REPRESENTATIVE FOR A COPY.

The Cisco implementation of TCP header compression is an adaptation of a program developed by the University of California, Berkeley (UCB) as part of UCB's public domain version of the UNIX operating system. All rights reserved. Copyright © 1981, Regents of the University of California.

NOTWITHSTANDING ANY OTHER WARRANTY HEREIN, ALL DOCUMENT FILES AND SOFTWARE OF THESE SUPPLIERS ARE PROVIDED "AS IS" WITH ALL FAULTS. CISCO AND THE ABOVE-NAMED SUPPLIERS DISCLAIM ALL WARRANTIES, EXPRESSED OR IMPLIED, INCLUDING, WITHOUT LIMITATION, THOSE OF MERCHANTABILITY, FITNESS FOR A PARTICULAR PURPOSE AND NONINFRINGEMENT OR ARISING FROM A COURSE OF DEALING, USAGE, OR TRADE PRACTICE.

IN NO EVENT SHALL CISCO OR ITS SUPPLIERS BE LIABLE FOR ANY INDIRECT, SPECIAL, CONSEQUENTIAL, OR INCIDENTAL DAMAGES, INCLUDING, WITHOUT LIMITATION, LOST PROFITS OR LOSS OR DAMAGE TO DATA ARISING OUT OF THE USE OR INABILITY TO USE THIS MANUAL, EVEN IF CISCO OR ITS SUPPLIERS HAVE BEEN ADVISED OF THE POSSIBILITY OF SUCH DAMAGES.

Cisco and the Cisco logo are trademarks or registered trademarks of Cisco and/or its affiliates in the U.S. and other countries. To view a list of Cisco trademarks, go to this URL: www.cisco.com/go/trademarks. Third-party trademarks mentioned are the property of their respective owners. The use of the word partner does not imply a partnership relationship between Cisco and any other company. (1110R)

Any Internet Protocol (IP) addresses and phone numbers used in this document are not intended to be actual addresses and phone numbers. Any examples, command display output, network topology diagrams, and other figures included in the document are shown for illustrative purposes only. Any use of actual IP addresses or phone numbers in illustrative content is unintentional and coincidental.

Cisco Transport Planner DWDM Operations Guide, Release 9.4
Copyright 2006-2012 Cisco Systems, Inc. All rights reserved.



CONTENTS

Preface xix

Revision History	xix
Document Objectives	xix
Audience	xix
Document Organization	xx
Related Documentation	xx
Document Conventions	xxi
Obtaining Optical Networking Information	xxii
Where to Find Safety and Warning Information	xxii
Cisco Optical Networking Product Documentation CD-ROM	xxii
Obtaining Documentation and Submitting a Service Request	xxii

CHAPTER 1

Introduction 1-1

1.1 Overview	1-1
1.1.1 Cisco Transport Planner, Release 9.4 Features	1-2
1.1.2 Network Design Process	1-3
1.1.2.1 Network Design Constraints	1-4
1.1.2.2 Platform Support	1-4
1.1.2.3 Topology Support	1-4
1.1.2.4 Protection Scheme Support	1-6
1.1.2.5 Service Support	1-8
1.1.3 Cisco Transport Planner Process Flow	1-10
1.1.4 Planning Traffic in Cisco Transport Planner	1-12
1.1.5 Cisco Transport Planner Traffic in the Project Explorer Pane	1-13
1.1.5.1 Point-to-Point Traffic Demands	1-14
1.1.5.2 P-Ring Traffic Demands	1-15
1.1.5.3 ROADM Traffic Demands	1-15
1.1.5.4 Aggregated Ethernet Demand	1-16
1.1.5.5 TDM Aggregated Demand	1-16
1.1.6 Auto, Forced, and Locked Parameters	1-17
1.2 Installing Cisco Transport Planner	1-17
1.3 Uninstalling Cisco Transport Planner	1-18
1.4 Launching the Cisco Transport Planner	1-19
1.4.1 Opening a Project	1-21

- 1.4.2 Loading and Unloading Networks 1-21
- 1.4.3 Saving a Project 1-22
- 1.4.4 Closing a Project 1-22
- 1.4.5 Deleting the CTP Cache 1-22
- 1.5 CTP Software Updates 1-23
 - 1.5.1 Check for Software Updates 1-23
 - 1.5.2 Discarding Software Updates 1-23
- 1.6 Setting Cisco Transport Planner Options 1-24
 - 1.6.1 Setting the Graphical Display 1-25
 - 1.6.2 Setting the Default Software Release 1-27
 - 1.6.3 Setting the Default Platform Values 1-28
 - 1.6.4 Setting the Default Project Values 1-37
 - 1.6.5 Defining Third-Party DWDM Interfaces 1-38
 - 1.6.6 Exporting User Options, Price Lists or Alien Definitions 1-43
 - 1.6.7 Importing User Options, Price Lists or Alien Definitions 1-43
 - 1.6.8 Importing Osmine Configuration File 1-44
 - 1.6.9 Resetting the Default Layout 1-44
 - 1.6.10 Adding User Profiles 1-44
 - 1.6.11 Understanding Sides Labeling 1-45
- 1.7 Understanding Hybrid Configuration 1-45
- 1.8 Understanding the Pay As You Grow Feature 1-46
 - 1.8.1 Unlock Pay As You Grow Bundles 1-47
 - 1.8.2 Forcing PAYG Bundles On a Card 1-47

CHAPTER 2

Creating and Analyzing Networks 2-1

- 2.1 Creating a Project 2-1
- 2.2 Adding Sites 2-10
- 2.3 Adding Fiber Spans 2-11
- 2.4 Creating an Optical Subnet 2-12
- 2.5 Adding Notes to a Project 2-14
- 2.6 Creating Traffic Subnet 2-15
- 2.7 Creating a Demand 2-16
 - 2.7.1 Manual Regeneration 2-16
 - 2.7.2 Understanding Omnidirectional Functionality 2-17
 - 2.7.2.1 Omnidirectional Demands 2-18
 - 2.7.3 Understanding Colorless Functionality 2-18
 - 2.7.3.1 Colorless Demands 2-19
 - 2.7.4 Understanding Colorless Omnidirectional Functionality 2-19

2.7.5	Creating a Point-to-Point Demand	2-19
2.7.6	Creating a Protected Ring Demand	2-22
2.7.7	Creating a ROADM Demand	2-25
2.7.8	Creating Ethernet Aggregated Demands	2-29
2.7.9	Creating TDM Aggregated Demands	2-36
2.7.10	Creating a Regeneration Site	2-42
2.7.10.1	Configurations for OTU2_XP	2-44
2.8	Viewing Circuits in a Network	2-49
2.9	Analyzing the Network	2-49
2.9.1	Viewing the Site Functional View	2-50
2.9.1.1	Changing the View	2-50
2.9.1.2	Alarm Information	2-51
2.9.1.3	Transponder and Muxponder Connections	2-51
2.10	Managing the Network Design	2-51
2.10.1	Creating a Copy of the Network	2-52
2.10.2	Creating a Copy of the Network in Design State	2-52
2.10.3	Creating a Network in the Install State	2-52
2.10.4	Creating an Upgrade Network	2-53
2.10.5	Unlocking Parameters in the Network Design	2-55
2.10.5.1	Forcing Manager	2-55
2.10.6	Creating a JPEG of the Network Design	2-58
2.10.7	Upgrading to CTP Software Release 9.4	2-58
2.11	Generating a BoM	2-59
2.11.1	Viewing BoM Report Totals	2-59
2.11.2	Generating a Network BoM	2-60
2.11.3	Generating a Site BoM	2-61
2.11.4	Generating a Spare Parts Report	2-63
2.11.5	Exporting a BoM	2-64
2.12	Managing the Price List	2-65
2.12.1	Creating a New Price List	2-65
2.12.2	Viewing a Price List	2-66
2.12.3	Loading and Unloading Price Lists	2-67
2.12.4	Updating a Price List from CCO	2-67
2.12.5	Copying a Price List	2-68
2.12.6	Deleting a Price List	2-68
2.12.7	Viewing Maintenance Contracts	2-69
2.13	Importing Designs Created in the Sherpa Tool	2-69
2.14	Bidirectional Communication with the Network Element	2-71

CHAPTER 3

Viewing Network Reports 3-1

- 3.1 Types of Reports 3-1
- 3.2 Viewing Reports 3-2
 - 3.2.1 Viewing the Summary Report 3-2
 - 3.2.2 Saving the NE Update File 3-3
 - 3.2.3 Viewing the Installation Parameters 3-4
 - 3.2.4 Viewing Internal Connections 3-7
 - 3.2.5 Viewing the Traffic Matrix Report 3-10
 - 3.2.6 Viewing the Layout of Single Site 3-16
 - 3.2.7 Exporting the Layout Report for Multiple Sites 3-19
 - 3.2.8 Viewing Power Consumption from the Layout Report 3-20
 - 3.2.9 Viewing the Link Availability Report 3-22
 - 3.2.10 Viewing Optical Results 3-24
 - 3.2.11 Viewing Wavelength Routing 3-28
 - 3.2.12 Viewing the Ethernet Aggregated Demand Report 3-32
 - 3.2.13 Viewing the TDM Aggregated Demand Report 3-33
 - 3.2.14 Viewing Any-to-Any Finalized Circuits 3-34
 - 3.2.15 Viewing Report Differences 3-35

CHAPTER 4

Editing a Project 4-1

- 4.1 Editing Project Parameters 4-1
- 4.2 Editing Network Parameters 4-1
- 4.3 Editing Site Parameters 4-2
- 4.4 Editing Side Labels 4-39
- 4.5 Editing Service Demand Association and Traffic Subnet 4-39
- 4.6 Creating a Maintenance Center 4-41
- 4.7 Editing a Point-to-Point Demand 4-41
- 4.8 Editing a P-Ring Demand 4-44
- 4.9 Editing a ROADM Demand 4-47
- 4.10 Editing an Ethernet Aggregated Demand 4-48
- 4.11 Editing a TDM Aggregated Demand 4-53
- 4.12 Add or Remove Sites from P-Ring, Ethernet Aggregated, and TDM Aggregated Demands 4-57
- 4.13 Add or Remove Multiple Optical Bypass Sites 4-58
- 4.14 Editing Fiber Span, Pair, and Fiber Parameters 4-58
- 4.15 Editing Fiber Spans, Fiber Pairs, and Fibers Using the Fibers Dialog Box 4-62
 - 4.15.1 Exporting the Fiber Spans, Fiber Pairs, and Fibers in a Network 4-65
- 4.16 Rack Rules 4-65

4.16.1	General Placement Rules	4-65
4.16.2	M2 and M6 Placement Rules	4-68
4.16.3	DCU Placement Rules	4-68
4.16.4	Fiber Storage Placement Rules	4-68
4.16.5	Air Ramp Placement Rules	4-68
4.16.6	Patch Panel Placement Rules	4-69
4.16.7	15216-MD-40-ODD/EVEN Unit Placement Rules	4-72
4.16.8	SMR Placement rules	4-73
4.16.9	Client Shelf Placement Rules	4-74
4.16.10	Y-Cable Placement Rules	4-75
4.17	Shelf Rules	4-76
4.17.1	General Shelf Placement Rules	4-76
4.17.1.1	Card Slots	4-76
4.17.1.2	Card Slot Constraints	4-78
4.17.2	Multishelf Placement Rules	4-78
4.17.2.1	Auto	4-79
4.17.2.2	Multishelf Integrated Switch	4-79
4.17.2.3	Multishelf External Switch	4-79
4.17.2.4	Shelf Management in Upgraded or Release-Upgraded Network	4-80
4.17.2.5	Multishelf Separate Shelves	4-80
4.17.2.6	Multishelf Separate Nodes	4-80
4.17.3	M2 and M6 Shelf Placement Rules	4-81
4.17.4	Alien Shelf Placement Rules	4-81
4.17.5	OTS Unit Placement Rules	4-82
4.17.5.1	Shelf Placement Rules	4-82
4.17.5.2	PSM Card Placement Rules	4-83
4.17.6	Cisco ONS 15216 FlexLayer Unit Placement Rules	4-83
4.17.7	Controller Cards Placement Rules	4-84
4.17.8	Client Cards Placement Rules	4-84
4.17.8.1	Node Placement Rules	4-84
4.17.8.2	Manual Regeneration Rules	4-85
4.17.8.3	OTU2_XP Card Placement Rules	4-85
4.17.8.4	AR-MXP and AR-XP Card Placement Rules	4-86
4.17.8.5	TXP/MXP and ITU Line Card Placement Rules	4-86
4.17.8.6	Transponder and Muxponder Card Placement Rules	4-87
4.17.9	Hybrid Site Layout Constraints	4-88
4.17.10	DCU - Layout Constraints	4-88
4.17.11	Multidegree Layout Rules	4-89
4.17.11.1	General OTS Units Placement Rules	4-89
4.17.11.2	OXC Multidegree Layout Rules	4-90

- 4.17.11.3 OIC Multidegree Layout Rules 4-91
- 4.18 Card Rules 4-91
 - 4.18.1 AR-MXP and AR-XP Card Constraints 4-91
 - 4.18.2 AR-MXP and AR-XP Card Operational Modes 4-92
 - 4.18.3 AR-MXP and AR-XP Card Client-Payloads 4-93
 - 4.18.4 AR-MXP and AR-MXP Card Mode–Port Restrictions 4-95
- 4.19 Adjusting Site Layout 4-97
 - 4.19.1 Constraints in Layout Adjustments in M2 and M6 Shelves 4-104
 - 4.19.2 Constraints in Layout Adjustments 4-104
 - 4.19.3 Adjusting the Shelf Layout 4-104
 - 4.19.4 Shelf Movement Rules 4-105
 - 4.19.5 Modifying Shelf Management Properties 4-106
 - 4.19.6 Card Movement Rules 4-106
- 4.20 Arranging Sites 4-107
- 4.21 Modifying Site Properties 4-111
- 4.22 Deleting Notes 4-119
- 4.23 Deleting Sites 4-119
 - 4.23.1 Fiber Joining Rules 4-120
- 4.24 Deleting a Traffic Demand 4-121
- 4.25 Deleting a Traffic Subnet 4-121
- 4.26 Deleting a Fiber Span 4-122
- 4.27 Deleting a Network 4-122

CHAPTER 5

Modeled Network Examples 5-1

- 5.1 Supported Cisco Transport Planner Topologies 5-1
 - 5.1.1 Linear Topologies 5-1
 - 5.1.1.1 Single-Span Topology 5-1
 - 5.1.1.2 Multispan Topology 5-2
 - 5.1.2 Ring Topology 5-2
 - 5.1.2.1 Closed Ring Topology 5-2
 - 5.1.2.2 Hubbed Ring Topology 5-3
 - 5.1.3 Mesh Topology 5-4

APPENDIX A

GUI Information and Shortcuts A-1

- A.1 Manage the Cisco Transport Planner Window A-1
 - A.1.1 Menu and Toolbar Options A-2
 - A.1.2 Cisco Transport Planner Panes A-6
 - A.1.2.1 Project Explorer Pane A-6

- A.1.2.2 Properties Pane **A-7**
- A.1.2.3 Analyzer Pane **A-8**
- A.1.2.4 Tasks Pane **A-9**
- A.1.3 Shortcuts **A-9**
- A.2 Site Icons **A-13**
- A.3 Demand Editor Icons **A-14**

APPENDIX B**Card Types B-1****APPENDIX C****System Messages C-1**

- C.1 Error Messages **C-1**
- C.2 Warning Messages **C-22**
- C.3 Information Messages **C-25**
- C.4 Traffic Mapping Troubleshooting **C-26**
 - C.4.1 Wavelength Exceeded **C-26**
 - C.4.2 Invalid Routing **C-27**
 - C.4.3 Cannot Find Alternate Route **C-27**
 - C.4.4 Cannot Route Service **C-27**
 - C.4.5 Overlapped Services Assigned to the Same Wavelength **C-28**
 - C.4.6 Protected Services Assigned to the Same Wavelength **C-29**
 - C.4.7 Cannot Route Service Because of Add/Drop Constraints **C-29**
 - C.4.8 Design Requires a ROADM or Full Mux/Demux Site **C-30**
- C.5 Amplifier Troubleshooting **C-31**
 - C.5.1 Incompatible DCUs (C-Band) **C-31**
 - C.5.2 MMU Does Not Have Correct Amplifier (L-Band) **C-32**
 - C.5.3 MMU Does Not Have Correct Amplifier (C-Band) **C-32**
 - C.5.4 Output Power or Tilt are Out of Range **C-33**
 - C.5.5 Invalid Fiber Values, Types, and Loss Values **C-33**
 - C.5.6 Attenuator Forcing Not Allowed **C-34**
 - C.5.7 Unavailable Add/Drop Channels **C-34**
 - C.5.8 Tilt Forced When No Tilt Design Is Selected **C-35**
 - C.5.9 Cannot Replace 32-DMX with 32DMX-O **C-36**
 - C.5.10 Preamplicifier Working in Invalid Mode **C-37**
 - C.5.11 Gain Too Low for an Amplifier **C-37**
 - C.5.12 Gain Too High for an Amplifier **C-38**
 - C.5.13 User Forcing Overridden **C-38**
 - C.5.14 Unsupported Configuration **C-39**
 - C.5.15 Channel Power Near the Fail Threshold **C-39**
 - C.5.16 Channel Power Below the Fail Threshold **C-40**

C.5.17 OSC Channel Power Below the Fail Threshold C-40

APPENDIX D

Third-Party DWDM Wavelength Interface Model D-1

Interface Operative Area D-1

Scale Factors D-4

Single-Interfering Cross-Talk Penalty Measurement D-5

Gaussian Cross-Talk Penalty Measurement D-6

APPENDIX E

Configuring CTP to Run on a Server E-1

APPENDIX F

Pay As You Grow Licensing F-1

F.1 Pay As You Grow F-1

F.1.1 PAYG Licenses F-1

F.2 PAYG for Client Cards F-2

INDEX



FIGURES

<i>Figure 1-1</i>	Y-cable protection	1-6
<i>Figure 1-2</i>	1+1 Protection	1-6
<i>Figure 1-3</i>	Fiber-switched Protection	1-7
<i>Figure 1-4</i>	PSM-OCH Protection	1-7
<i>Figure 1-5</i>	Cisco Transport Planner Process Flow	1-11
<i>Figure 1-6</i>	Project Explorer View	1-14
<i>Figure 1-7</i>	Point-to-Point Traffic Demand in the Project Explorer pane	1-14
<i>Figure 1-8</i>	P-Ring Traffic Demand in the Project Explorer pane	1-15
<i>Figure 1-9</i>	ROADM Traffic Demand in the Project Explorer pane	1-15
<i>Figure 1-10</i>	Aggregated Ethernet Demand in Project Explorer pane	1-16
<i>Figure 1-11</i>	TDM Aggregated Demand in Project Explorer pane	1-16
<i>Figure 1-12</i>	Locked Sites in the Project Explorer View	1-17
<i>Figure 1-13</i>	Cisco Transport Planner Start Page	1-20
<i>Figure 1-14</i>	Unloaded Network in the Project Explorer pane	1-21
<i>Figure 1-15</i>	Loaded Network in the Project Explorer pane	1-22
<i>Figure 1-16</i>	Duct Details Shown on the NtView Name Tab	1-26
<i>Figure 1-17</i>	Default CTP Software Release Window	1-28
<i>Figure 1-18</i>	AlienSoft Dialog Box, Default-OCH Tab	1-40
<i>Figure 1-19</i>	Interface Operative Area	1-42
<i>Figure 2-1</i>	Project Creation Wizard	2-2
<i>Figure 2-2</i>	Creating Optical Subnet	2-13
<i>Figure 2-3</i>	Create Optical Subnet Dialog Box	2-13
<i>Figure 2-4</i>	Traffic Subnet Builder Wizard	2-16
<i>Figure 2-5</i>	Point-to-Point Demand Between Two Sites	2-21
<i>Figure 2-6</i>	P-Ring Demand	2-24
<i>Figure 2-7</i>	Create ROADM Demand Dialog Box	2-25
<i>Figure 2-8</i>	ROADM Demand	2-27
<i>Figure 2-9</i>	EthernetAggr1 Demand Window, TrafficTab	2-31
<i>Figure 2-10</i>	New Request Window	2-32
<i>Figure 2-11</i>	Circuit Path View in a Ethernet Aggregated Demand	2-35

Figure 2-12	TDMAggr Demand Window	2-38
Figure 2-13	New Request Window	2-39
Figure 2-14	Circuit Path View in a TDM Aggregated Demand	2-41
Figure 2-15	Regeneration Editor	2-43
Figure 2-16	Dual Transponder Configuration	2-45
Figure 2-17	Dual Regenerator Configuration	2-46
Figure 2-18	Single-Regenerator Configuration	2-47
Figure 2-19	Protected-Transponder Configuration	2-47
Figure 2-20	Mixed-Mode Configuration	2-48
Figure 2-21	Unlocking Network in the Project Explorer Pane	2-55
Figure 2-22	Forcing Manager Dialog Box	2-56
Figure 2-23	Select Units to Force Dialog Box	2-57
Figure 2-24	Bill of Material Tab, Net View Subtab	2-60
Figure 2-25	Bill of Material Tab, Site View Subtab	2-62
Figure 2-26	Bill of Material Tab, Spare Subtab	2-63
Figure 2-27	Price Manager Dialog Box	2-65
Figure 3-1	Summary Tab	3-2
Figure 3-2	ANS View Subtab in the Installation Parameters Tab	3-5
Figure 3-3	Internal Connections Tab	3-8
Figure 3-4	Report Details for a Point-to-Point Demand	3-10
Figure 3-5	Report Details for a P-Ring Demand	3-10
Figure 3-6	Traffic Matrix Tab	3-11
Figure 3-7	Query Dialog	3-14
Figure 3-8	Layout Report (Rack View)	3-16
Figure 3-9	Layout Report (Shelf View)	3-17
Figure 3-10	Network Wide Layout Export Selection	3-19
Figure 3-11	Power Consumption	3-20
Figure 3-12	Link Availability Report	3-22
Figure 3-13	Optical Results Tab	3-24
Figure 3-14	Wavelength Routing Tab	3-28
Figure 3-15	Point-to -point Demand	3-29
Figure 3-16	Ethernet Aggregated Demand Tab	3-33
Figure 3-17	TDM Aggregated Demand Tab	3-34
Figure 3-18	Reports Diff Dialog Box	3-36
Figure 3-19	BoM Diff Report	3-37

Figure 3-20	Installation Parameters Diff Report	3-39
Figure 3-21	Internal Connections Diff Report	3-40
Figure 4-1	Site in the Project Explorer Pane	4-3
Figure 4-2	Analyzed Site in the Project Explorer Pane	4-3
Figure 4-3	PSM Terminal Optical Path Site in the Project Explorer Pane	4-4
Figure 4-4	PSM Terminal Multiple Section Site in Project Explorer Pane	4-5
Figure 4-5	Sites with Raman Amplifier	4-36
Figure 4-6	Edit Channel Plan—Traffic Subnet Builder	4-40
Figure 4-7	Select Subnet Dialog Box	4-41
Figure 4-8	Edit Point-to-Point Demand Dialog Box	4-42
Figure 4-9	Edit P-Ring Demand Dialog Box	4-44
Figure 4-10	Edit ROADM Demand Dialog Box	4-47
Figure 4-11	Ethernet Aggregated Demand Dialog Box	4-49
Figure 4-12	Edit Request Dialog Box for an Ethernet WDM Transport Channel	4-50
Figure 4-13	DWDM Channel View in an Ethernet Aggregated Demand	4-52
Figure 4-14	Edit Request in a TDM WDM Transport Channel	4-54
Figure 4-15	DWDM Channel View in a TDM Aggregated Demand	4-56
Figure 4-16	Fibers Dialog	4-62
Figure 4-17	Patch-Panel Placement for ETSI Without Node Protection	4-69
Figure 4-18	Patch-Panel Placement for ANSI and ETSI Without Node Protection	4-70
Figure 4-19	Patch-Panel Placement for ANSI and ETSI 3-N Degree	4-70
Figure 4-20	Patch-Panel Placement—Side Occupying More than One Shelf (ANSI)	4-71
Figure 4-21	Patch-Panel Placement—Side Occupying More than One Shelf (ETSI)	4-72
Figure 4-22	Client Shelf Placement-Node protection as Separated Shelves	4-74
Figure 4-23	Client Shelf Placement-Protection and Aggregated Demand	4-75
Figure 4-24	Selecting the Layout View	4-97
Figure 4-25	Details Dialog Box	4-98
Figure 4-26	Site Layout Before Adjustment	4-99
Figure 4-27	Site Layout After Adjustment	4-100
Figure 4-28	Ellipse Shape	4-107
Figure 4-29	Square Shape	4-108
Figure 4-30	Snake Shape	4-109
Figure 4-31	Double Ring Shape	4-110
Figure 4-32	Fit to Maximum Rectangle View Shape	4-111
Figure 4-33	Sites Edit Dialog	4-112

<i>Figure 4-34</i>	Add Sides Option	4-114
<i>Figure 4-35</i>	Side right-click options	4-115
<i>Figure 5-1</i>	Single-Span Topology Example	5-1
<i>Figure 5-2</i>	Multispan Topology Example	5-2
<i>Figure 5-3</i>	Closed Ring Topology Example	5-2
<i>Figure 5-4</i>	Hubbed Ring Topology Example	5-3
<i>Figure 5-5</i>	Mesh Ring Topology Example	5-4
<i>Figure A-1</i>	Cisco Transport Planner Window with Network Tree	A-1
<i>Figure D-1</i>	Interface Operative Area	D-2
<i>Figure D-2</i>	Interface Margin Application	D-3
<i>Figure D-3</i>	Q-Factor Curve	D-5
<i>Figure D-4</i>	Generation Block for Single-Interfering Cross-Talk Measurement	D-6
<i>Figure D-5</i>	Block Diagram for Crosstalk Measure	D-6
<i>Figure D-6</i>	Generation Block for Gaussian Cross-Talk Measurement	D-7
<i>Figure E-1</i>	Remote Desktop Connection Using Terminal Services	E-1
<i>Figure E-2</i>	VNC Environment	E-2



T A B L E S

<i>Table 1-1</i>	New Features in Cisco Transport Planner, Release 9.4	1-2
<i>Table 1-2</i>	Supported Combination for 40-Gbps Third-Party Interface	1-42
<i>Table 1-3</i>	Supported Combinations for 10-Gbps Third-Party Interface	1-42
<i>Table 1-4</i>	Supported Combinations for 2.5-Gbps Third-Party Interface	1-43
<i>Table 1-5</i>	Sides Labeling in Cisco Transport Planner	1-45
<i>Table 2-1</i>	Site Topology Restrictions	2-5
<i>Table 2-2</i>	Valid Ranges for Fiber Factor Values	2-9
<i>Table 2-3</i>	Notes Window	2-15
<i>Table 2-4</i>	BoM Net View Columns	2-60
<i>Table 2-5</i>	BoM Site View Columns	2-62
<i>Table 2-6</i>	BoM Spare Subtab Columns	2-64
<i>Table 2-7</i>	NE Update Wizard Options	2-74
<i>Table 3-1</i>	Report Availability	3-1
<i>Table 3-2</i>	Summary Tab Categories	3-3
<i>Table 3-3</i>	Installation Parameters Report ANS View Tab Columns	3-5
<i>Table 3-4</i>	Installation Parameters Report ANP View Tab	3-6
<i>Table 3-5</i>	Installation Parameters Report PP View Tab	3-6
<i>Table 3-6</i>	Internal Connections Tab Columns	3-9
<i>Table 3-7</i>	Traffic Matrix Tab Columns	3-12
<i>Table 3-8</i>	Query Dialog Fields	3-14
<i>Table 3-9</i>	Layout Table (Power Consumption) Columns	3-21
<i>Table 3-10</i>	Link Availability Tab Columns	3-22
<i>Table 3-11</i>	Query Dialog Fields	3-23
<i>Table 3-12</i>	Optical Results Tab Columns	3-24
<i>Table 3-13</i>	Query Dialog Fields	3-27
<i>Table 3-14</i>	Circuit Icons in a Routing Map	3-30
<i>Table 3-15</i>	Wavelength Routing Tab Columns	3-32
<i>Table 3-16</i>	A2A Finalized Circuits Tab Columns	3-35
<i>Table 3-17</i>	BoM Diff Report Columns	3-38
<i>Table 3-18</i>	Installation Parameters Diff Report Columns	3-39

Table 3-19	Internal Connections Tab Columns	3-41
Table 4-1	Site Design Rules for MSTP 15454 ONS Configuration	4-8
Table 4-2	Site Design Rules for HYBRID 15454 ONS Configuration (with FlexLayer Modules)	4-28
Table 4-3	Editable Fiber Properties	4-58
Table 4-4	Fibers Dialog Box Columns	4-62
Table 4-5	Operational modes supported by AR-MXP and AR-XP cards	4-92
Table 4-6	AR-MXP and AR-XP Card Supported Client-Payload Mapping—SONET/SDH, Ethernet, OTU1, and FC	4-93
Table 4-7	AR-MXP and AR-XP Card Supported Client-Payload Mapping—ISC and Video	4-94
Table 4-8	Card Mode–Port Mapping for AR-MXP Card	4-95
Table 4-9	Card Mode–Port Mapping for AR-XP Card	4-96
Table 4-10	Allowed Site Layout Movements	4-101
Table 4-11	Permitted Structure Modifications	4-118
Table 4-12	Site Modification Unlock Instances/Parameters	4-118
Table A-1	Menu and Toolbar Options	A-2
Table A-2	Project Explorer Toolbar Options	A-6
Table A-3	Properties Pane Toolbar Options	A-7
Table A-4	Analyzer Toolbar Options	A-8
Table A-5	Tasks Pane Toolbar Options	A-9
Table A-6	Shortcut Menu Actions	A-10
Table A-7	Site Icons	A-13
Table A-8	Demand Editor Icons	A-14
Table B-1	OC-192/STM-64 (9.953 Gbps)	B-1
Table B-2	OC-48/STM-16 (2.488 Gbps)	B-3
Table B-3	OTU1	B-5
Table B-4	OTU2	B-6
Table B-5	OTU2e	B-7
Table B-6	OTU3	B-7
Table B-7	OC-12/STM-4 (622 Mbps)	B-8
Table B-8	OC-3/STM-1 (155 Mbps)	B-9
Table B-9	OC-768/STM-256 (40 Gbps)	B-10
Table B-10	40Gigabit Ethernet Local Area Network ATM Physical Layer (40GE LAN PHY)	B-10
Table B-11	10Gigabit Ethernet Wide Area Network ATM Physical Layer (10GE WAN PHY) (9.953 Gbps)	B-11
Table B-12	10Gigabit Ethernet Local Area Network ATM Physical Layer (10GE LAN PHY)(10.3 Gbps)	B-12
Table B-13	10Gigabit Ethernet LAN-to-WAN	B-16
Table B-14	Gigabit Ethernet (1.25Gbps)	B-17

Table B-15	Fast Ethernet (100 Mbps)	B-19
Table B-16	Fiber Channel 10G (10.5 Gbps)	B-20
Table B-17	Fiber Channel 8G (8.5 Gbps)	B-22
Table B-18	Fiber Channel 4G (4.25 Gbps)	B-23
Table B-19	Fiber Channel 2G (2.125 Gbps)	B-24
Table B-20	Fiber Channel 1G (1.062 Gbps)	B-25
Table B-21	2 Gbps Fiber Connectivity (2.125 Gbps)	B-26
Table B-22	FICON-10G (10.5 Gbps)	B-28
Table B-23	FICON-4G (4.25 Gbps)	B-29
Table B-24	FICON-1G (1.062 Gbps)	B-30
Table B-25	Enterprise System Connection (ESCON) (200 Mbps)	B-31
Table B-26	ISC-3 Compatibility Mode (1.062 Gbps)	B-32
Table B-27	ISC-Peer 2R	B-33
Table B-28	ISC-3 Peer-1G (1.062 Gbps)	B-33
Table B-29	ISC-3 Peer-2G (2.125 Gbps)	B-33
Table B-30	Sysplex External Throughput Rate (8 Mbps)	B-34
Table B-31	Sysplex Control Link Oscillator (8 Mbps)	B-34
Table B-32	Serial Data Input (SDI)	B-34
Table B-33	Digital Video Broadcast-Asynchronous Serial Interface (DVB-ASI)	B-34
Table B-34	D1-Video (270 Mbps)	B-35
Table B-35	High Definition Television (HDTV) (1.48 Gbps)	B-35
Table B-36	DV-6000 (2.38 Gbps)	B-35
Table B-37	2R Any Rate	B-35
Table B-38	ONS 15530 2.5G ITU-T	B-35
Table B-39	SD-SDI (270 Mbps)	B-36
Table B-40	HD-SDI (1.485 Gbps)	B-36
Table B-41	3G-SDI (2.970 Gbps)	B-36
Table B-42	ONS 15530 10G ITU-T	B-36
Table B-43	E3/ T3/DS3 (100 Mbps)	B-37
Table B-44	Supported XFPs	B-37
Table C-1	Error Messages	C-1
Table C-2	Warning Messages	C-22
Table C-3	Information Messages	C-25
Table C-4	Wavelength Exceeded	C-26
Table C-5	Invalid Routing	C-27

<i>Table C-6</i>	Cannot Find Alternate Route	C-27
<i>Table C-7</i>	Cannot Route Service	C-28
<i>Table C-8</i>	Overlapped Services Assigned to the Same Wavelength	C-28
<i>Table C-9</i>	Protected Services Assigned to the Same Wavelength	C-29
<i>Table C-10</i>	Cannot Route Service Because of Add/Drop Constraints	C-29
<i>Table C-11</i>	Cannot Route Service Because of Add/Drop Constraints	C-30
<i>Table C-12</i>	Incompatible DCUs (C-Band)	C-31
<i>Table C-13</i>	MMU Does Not Have the Correct Amplifier (L-Band)	C-32
<i>Table C-14</i>	MMU Does Not Have the Correct Amplifier (C-Band)	C-32
<i>Table C-15</i>	Output Power or Tilt are Out of Range	C-33
<i>Table C-16</i>	Invalid Fiber Values, Types, and Loss Values	C-33
<i>Table C-17</i>	Attenuator Forcing Not Allowed	C-34
<i>Table C-18</i>	Unavailable Add/Drop Channels	C-34
<i>Table C-19</i>	Tilt Forced When No Tilt Design is Selected	C-35
<i>Table C-20</i>	Cannot Replace 32-DMX with 32DMX-0	C-36
<i>Table C-21</i>	Preamplifier Working in Invalid Mode	C-37
<i>Table C-22</i>	Gain Too Low for an Amplifier	C-37
<i>Table C-23</i>	Gain Too High for an Amplifier	C-38
<i>Table C-24</i>	User Forcing Overridden	C-38
<i>Table C-25</i>	Unsupported Configuration	C-39
<i>Table C-26</i>	Channel Power Near the Fail Threshold	C-39
<i>Table C-27</i>	Channel Power Below the Fail Threshold	C-40
<i>Table C-28</i>	OSC Channel Power Below the Fail Threshold	C-40
<i>Table F-1</i>	PAYG Licenses	F-1
<i>Table F-2</i>	PAYG for AR-MXP and AR-XP Cards	F-2



Preface

This section explains the objectives, intended audience, and organization of this publication and describes the conventions that convey instructions and other information.

This section provides the following information:

- [Revision History](#)
- [Document Objectives](#)
- [Audience](#)
- [Document Organization](#)
- [Related Documentation](#)
- [Document Conventions](#)
- [Obtaining Optical Networking Information](#)
- [Obtaining Documentation and Submitting a Service Request](#)

Revision History

This is the first release of this publication.

Document Objectives

The *Cisco Transport Planner DWDM Operations Guide* explains how to design networks using the Cisco Transport Planner design tool for the Cisco ONS 15454 SONET and SDH systems. It contains information about how to design an optical network. Use the *Cisco Transport Planner DWDM Operations Guide* in conjunction with the appropriate publications listed in the [Related Documentation](#) section.

Audience

This publication is intended for experienced network system engineers who are responsible for planning and ordering equipment for Cisco optical networking systems.

Document Organization

This *Cisco Transport Planner DWDM Operations Guide* is organized into the following chapters:

- [Chapter 1, “Introduction”](#) provides a list of features, an overview of the network design process, a description of the internal architecture, and the Cisco Transport Planner procedural flow.
- [Chapter 2, “Creating and Analyzing Networks”](#) provides instructions for using the Cisco Transport Planner tool to create a network design.
- [Chapter 3, “Viewing Network Reports”](#) provides instructions for generating reports and bills of materials.
- [Chapter 4, “Editing a Project”](#) provides instructions for adjusting and optimizing design components.
- [Chapter 5, “Modeled Network Examples”](#) provides examples of typical optical networks that you can model using Cisco Transport Planner.
- [Appendix A, “GUI Information and Shortcuts”](#) provides Cisco Transport Planner graphical user interface shortcuts.
- [Appendix B, “Card Types”](#) provides a list of card types that can be used to build a network, and the corresponding Cisco product identifier.
- [Appendix C, “System Messages”](#) provides a list of system errors.
- [Appendix D, “Third-Party DWDM Wavelength Interface Model”](#) provides reference information on third-party DWDM interface calculation.
- [Appendix E, “Configuring CTP to Run on a Server”](#) provides instructions to run CTP on a server.
- [Appendix F, “Pay As You Grow Licensing”](#) provides information about the composition of each PAYG bundle.

Related Documentation

Use this *Cisco Transport Planner DWDM Operations Guide* in conjunction with the following referenced Release 9.4 publications:

- *Cisco ONS 15454 DWDM Configuration Guide*
- *Cisco ONS 15454 DWDM Troubleshooting Guide*
- *Cisco ONS SONET TLI Command Guide*
- *Cisco ONS SDH TLI Command Guide*
- *Release Notes for Cisco Transport Planner*
- *Release Notes for Cisco ONS 15454, ONS 15454 M2, and ONS 15454 M6 DWDM*

Document Conventions

This publication uses the following conventions:

Convention	Application
boldface	Commands and keywords in body text.
<i>italic</i>	Command input that is supplied by the user.
[]	Keywords or arguments that appear within square brackets are optional.
{ x x x }	A choice of keywords (represented by x) appears in braces separated by vertical bars. The user must select one.
Ctrl	The control key. For example, where Ctrl + D is written, hold down the Control key while pressing the D key.
screen font	Examples of information displayed on the screen.
boldface screen font	Examples of information that the user must enter.
< >	Command parameters that must be replaced by module-specific codes.



Note

Means *reader take note*. Notes contain helpful suggestions or references to material not covered in the document.



Caution

Means *reader be careful*. In this situation, the user might do something that could result in equipment damage or loss of data.



Warning

IMPORTANT SAFETY INSTRUCTIONS

This warning symbol means danger. You are in a situation that could cause bodily injury. Before you work on any equipment, be aware of the hazards involved with electrical circuitry and be familiar with standard practices for preventing accidents. To see translations of the warnings that appear in this publication, refer to the translated safety warnings that accompanied this device.

Note: SAVE THESE INSTRUCTIONS

Note: This documentation is to be used in conjunction with the specific product installation guide that shipped with the product. Please refer to the Installation Guide, Configuration Guide, or other enclosed additional documentation for further details.

Obtaining Optical Networking Information

This section contains information that is specific to optical networking products. For information that pertains to all of Cisco, refer to the [Obtaining Documentation and Submitting a Service Request](#) section.

Where to Find Safety and Warning Information

For safety and warning information, refer to the *Cisco Optical Transport Products Safety and Compliance Information* document that accompanied the product. This publication describes the international agency compliance and safety information for the Cisco ONS 15454 system. It also includes translations of the safety warnings that appear in the ONS 15454 system documentation.

Cisco Optical Networking Product Documentation CD-ROM

Optical networking-related documentation, including Cisco ONS 15xxx product documentation, is available in a CD-ROM package that ships with your product. The Optical Networking Product Documentation CD-ROM is updated periodically and may be more current than printed documentation.

Obtaining Documentation and Submitting a Service Request

For information on obtaining documentation, submitting a service request, and gathering additional information, see the monthly *What's New in Cisco Product Documentation*, which also lists all new and revised Cisco technical documentation, at:

<http://www.cisco.com/en/US/docs/general/whatsnew/whatsnew.html>

Subscribe to the *What's New in Cisco Product Documentation* as a Really Simple Syndication (RSS) feed and set content to be delivered directly to your desktop using a reader application. The RSS feeds are a free service and Cisco currently supports RSS Version 2.0.



CHAPTER 1

Introduction



Note

Cisco MetroPlanner has been renamed to Cisco Transport Planner starting with release 8.5.



Note

In this guide, M2 chassis refers to the Cisco ONS 15454 M2 chassis, M6 chassis refers to the Cisco ONS 15454 M6 chassis, and M12 chassis refers to the Cisco ONS 15454 chassis.

Cisco Transport Planner (CTP) provides a way to model and test wavelength division multiplexing (WDM) optical networks in a graphical environment. The primary purpose of Cisco Transport Planner is to help sales engineers (SEs) design and validate networks of Cisco Optical Networking System (ONS) 15454 Multiservice Transport Platforms (MSTP). Using the CTP, an SE can create multiple instances of a network to modify different parameters in each instance for comparison. Cisco Transport Planner generates a shelf view of all the sites deployed in the optical network and provides a complete bill of materials (BoM) for the network and the differences between instances of a network.

This chapter describes how you use Cisco Transport Planner to design, analyze, and optimize new or existing Cisco optical networks and contains the following sections:

- [1.1 Overview, page 1-1](#)
- [1.2 Installing Cisco Transport Planner, page 1-17](#)
- [1.3 Uninstalling Cisco Transport Planner, page 1-18](#)
- [1.4 Launching the Cisco Transport Planner, page 1-19](#)
- [1.5 CTP Software Updates, page 1-23](#)
- [1.6 Setting Cisco Transport Planner Options, page 1-24](#)
- [1.8 Understanding the Pay As You Grow Feature, page 1-46](#)

1.1 Overview

This section describes the Cisco Transport Planner, Release 9.4 features, network design process, process flow, traffic planning, traffic services, and parameter states.

1.1.1 Cisco Transport Planner, Release 9.4 Features

Cisco Transport Planner software provides a simple tool set for designing optical networks with Cisco ONS 15454 MSTP products. You can enter all of the network parameters or minimal information, such as site distance, and Cisco Transport Planner will model the network you need to build and generate a detailed BOM with ordering information. Designing optical networks requires the verification of multiple constraints such as optical budget limitations and platform architectural restrictions. Single Cisco Transport Planner project can contain multiple copies of a network. This duplication allows you to change parameters in one network copy, then analyze and compare it with another network copy to determine the differences. The new features of Cisco Transport Planner, Release 9.4 are listed in [Table 1-1](#).

Table 1-1 *New Features in Cisco Transport Planner, Release 9.4*

Features	Description
100 G alien interfaces	Uses the wavelength assignment algorithm in CTP as the maximum separation rule for services using the 100 G alien interfaces.
Add or Remove Sites from P-Ring, Ethernet Aggregated, and TDM Aggregated Demands	Adds or removes sites from P-Ring, Ethernet Aggregated, and TDM Aggregated demands.
Any-to-any demand finalization	Finalizes the any-to-any demand when the network is in design-analyzed state. An A2A Finalized Circuits report is generated after the network is finalized and analyzed.
AR-MXP and AR-XP cards	<p>Aggregates a mix of client SAN service inputs (GE, FICON, ESCON, ISC3 and Fibre Channel), OC3/STM-1, OC12/STM-4, OC48/STM-16, Video (3G-SDI, SD-SDI, HD-SDI) into one 10 Gbps signal on the trunk side. The AR-MXP card supports a bandwidth of up to 10 Gbps and the AR-XP card, up to 20 Gbps.</p> <p>The AR-MXP and AR-XP cards have eight SFP and two XFP ports. The client and trunk ports are either SFP ports (2.5 Gbps) or XFP ports (10 Gbps).</p> <p>The AR-MXP or AR-XP cards can be installed in the Cisco ONS 15454, Cisco ONS 15454 M2, and Cisco ONS 15454 M6 systems. The FTA4 fan tray assembly has to be installed in the Cisco ONS 15454 system before installing the AR-MXP or AR-XP cards.</p> <p>The AR-MXP or AR-XP cards can be configured in High Rate and Low Rate modes. High Rate mode supports up to 80 channels with tunable XFPs and Low Rate mode supports up to 40 channels.</p> <p>The AR-MXP or AR-XP cards can be configured in multiple card modes. See Table 4-5 for card modes supported by AR-MXP and AR-XP cards.</p> <p>The SFPs and XFPs supported on AR-MXP and AR-XP cards are listed in Table B-44 on page B-37.</p>
Bi-directional communication with the network element	Imports node data from the network element, edits, analyzes the network, and exports node parameters to the network element.
Delete Cache (Tools menu)	Deletes CTP cache on restart.

Features	Description
Fiber Bragg dispersion compensation units (FDCU)	Supports creation of a low-latency network using FDCUs. The FDCUs are allowed only in 100 GHz optical subnets for point-to-point demands. The FDCUs cannot interoperate with standard DCUs. The FDCUs can be used for the following client interfaces: <ul style="list-style-type: none"> • OTU2_XP with ONS-XC-10G-C • High rate AR-XP and AR-MXP cards with ONS-XC-10G-C • TXP_MR_10EX_C • 40G DQPSK MXP
GUI enhancements	Enhancements made to the CTP interface: <ul style="list-style-type: none"> • Network details icon (in the network view)—This is used to hide or display duct information (duct name, EOL), amplifier forcing, and circuits of the network in the Network tab. • Wavelength usage information icon (in the network view)—This is used to hide or display the number of used and free wavelengths for every duct of the network in the Network tab. • Start Page—This is used to create a new project, open an existing project, or import node parameters of a network.
Multiple optical bypass sites	Specifies multiple sites where the channels for the current demand are optically dropped. Sites present between the source and destination sites along the path of this section are available to be added as optical bypass sites.
Omnidirectional support for 40-SMR2-C cards	Supports multidegree OXC sites of type SMR-2 with omnidirectional capability.
PAYG at card level	Uses of PAYG licenses per card to reduce the initial setup cost.
TCC Type	Chooses the TCC card type.
XFP in Restricted Equipment List	Places or moves the ONS-XC-10G-C and ONS-XC-10G-EP XFPs to the Restricted Equipment List.
Y-cable protection for LAN-WAN Conversion	Supports Y-cable protection type for LAN-WAN Conversion service type.

1.1.2 Network Design Process

To generate a network design, the SE enters the following parameters:

- The topology of the network—ring, linear, or meshed
- The type of equipment used at each site
- The distance separating the sites
- The type of fiber connecting the sites
- Service demands, including the service type, the protection type, and the number of channels between nodes
- The number of network sites

When the network parameters are entered, Cisco Transport Planner finds the best routing, defines the required add/drop filters, places optical amplifiers with dispersion compensation units (DCUs) or tunable dispersion compensation units (TDCU) to fit the user traffic demands at a minimum cost. The TDCU operates only over the C-band. Optimization is performed to meet the boundary conditions. The optimization includes attenuation and amplification.

Finally, Cisco Transport Planner generates a BOM, which includes the product codes, the quantities, and pricing information. In addition, it creates other reports, such as a shelf-level view of the configuration, which can be printed. This information helps the SE understand how the shelf is built and helps to avoid confusion and errors during the actual deployment. Within the BOM is the total network cost, which allows a quick comparison of various design options. The total network cost is the cost of the equipment for all of the sites in the designed network.

1.1.2.1 Network Design Constraints

Cisco Transport Planner searches for the best solution to a designed network using an optimization algorithm.

A network design must meet the optical budget and receiver overload criteria to operate efficiently. An analysis of the optical budget and receiver overload evaluates the strength of the signal traversing the ring. If a design solution satisfies the constraints, it is a valid design. The Cisco Transport Planner optimization algorithms generate multiple solutions and verifies the constraints against those solutions. If the constraints are satisfied, the solution with the lowest cost-to-utilization ratio is selected as the optimal solution.

If the network design solution fails to satisfy all the constraints, Cisco Transport Planner makes adjustments to parameters such as signal attenuation and amplification. Amplification is achieved using an erbium-doped fiber amplifier (EDFA). Attenuation is achieved using the variable optical attenuator (VOA) modules integrated into the platform. Cisco Transport Planner corrects the optical budget using an algorithm that includes automatic placement of EDFAs and VOA regulation.

For each internodal demand, Cisco Transport Planner performs an optical budget and receiver overload analysis and displays the results in various reports in the Graphical User Interface (GUI). If the network design algorithms are not able to provide a solution, then you can modify the input data (for example, by relaxing some user constraints) and run the analysis again.

1.1.2.2 Platform Support

Cisco Transport Planner Software R9.4 supports the Cisco ONS 15454 DWDM optical platform Software Releases 8.5, 9.0, 9.1, 9.2, 9.2.1, 9.3, and 9.4.

1.1.2.3 Topology Support

The Cisco Transport Planner supports the following network topologies:

- Linear (single-span or multispans)
- Ring (open or closed)
- Meshed

For more information on network topologies, see the [“5.1 Supported Cisco Transport Planner Topologies” section on page 5-1](#).

The Cisco Transport Planner enables you to design flexible networks with up to 150 site locations. A flexible network uses ROADM nodes to allow traffic modification or reconfiguration, or both as traffic requirements change.

In Cisco Transport Planner Software R9.4, the maximum number of locations where the optical service channel (OSC) is terminated is 40. The maximum number of add/drop locations supported is 40.

1.1.2.4 Protection Scheme Support

Cisco Transport Planner designs support the following protection schemes:

- Y-cable protected—In Y-cable protection, one transponder card is designated as active and the other as standby. The standby transponder card has the client-side laser turned off to avoid corrupting the signal transmitted back to the client. The active transponder monitors the signal from the trunk side and in the event of loss or signal failure, the system switches to the standby path. [Figure 1-1](#) shows an example of a Y-cable protected link.

Figure 1-1 Y-cable protection

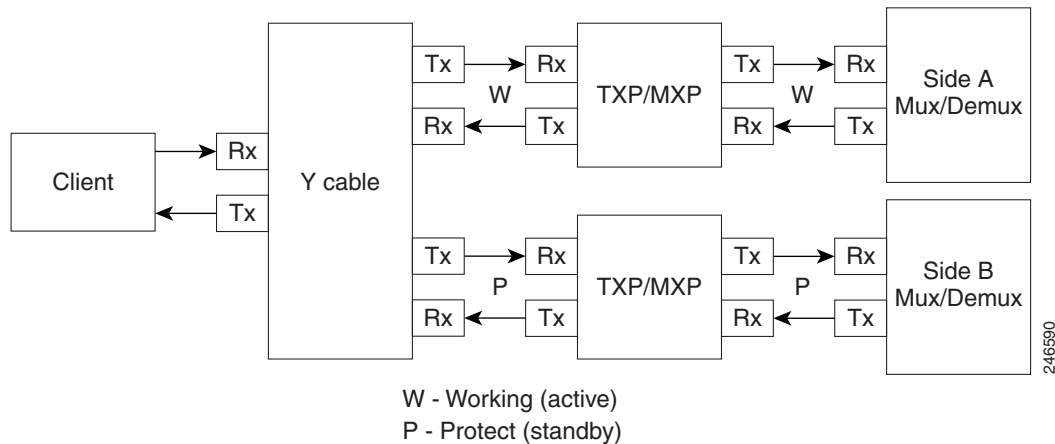

- Client-based 1+1—Two client signals are transmitted to separated line cards or transponder cards instead of using a Y-cable to split one client signal into two line cards or transponder cards. In client 1+1 protection, the failure and switchover is controlled by the client system. [Figure 1-2](#) shows an example of a 1+1 protected link.

Figure 1-2 1+1 Protection

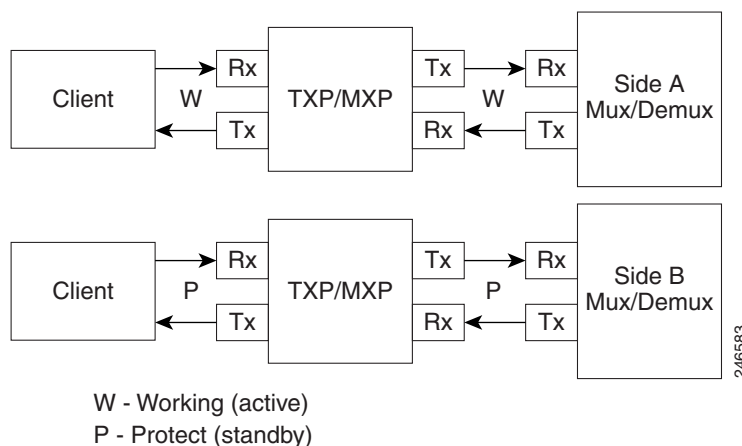

- Fiber-switched protection—The single client signal is injected into the client receive (Rx) port. It is then split into two separate signals on the two trunk transmit (Tx) ports. The two signals are transmitted over diverse paths. The far-end card chooses one of the two trunk Rx port signals and injects it into the Tx client port. [Figure 1-3](#) shows an example of a fiber-switched protected link.

Figure 1-3 Fiber-switched Protection

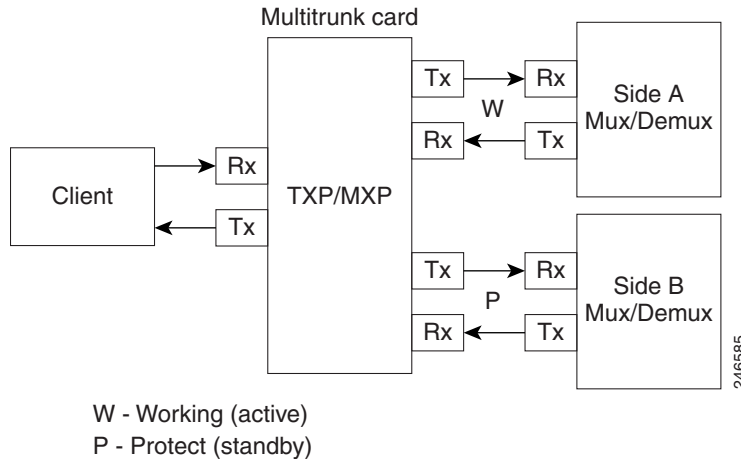

- PSM-OCH—Channel protection configuration provides protection at trunk level (like Fiber-Switched protection) for TXP/MXP that do not have dedicated Fiber-Switched cards. PSM splits the traffic originated by transponder trunk on working and protected TX ports. Working Tx (W-Tx) and protected TX (P-Tx) are connected to the add ports of Add-Drop stages adding the channel in two different directions. On the receiving direction PSM W-Rx and P-Rx are connected to the drop ports of Add-Drop stages receiving the channel from the two different directions. PSM switch selects a path among W-Rx and P-Rx ports so that only one direction at a time is connected to COM-RX ports and therefore to the TXP/MXP. [Figure 1-4](#) shows an example of a PSM-OCH protected link.

Figure 1-4 PSM-OCH Protection

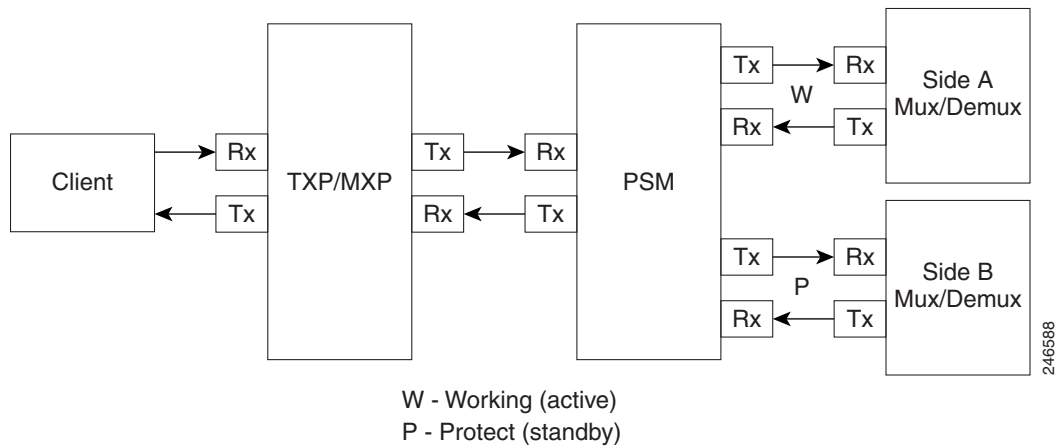

- Unprotected—Protection is not used.
- External card switch—Protection not used.

1.1.2.5 Service Support

Cisco Transport Planner can support any subset of the following services:

- Alien (third-party DWDM interface)
- Cisco ONS 15530 2.5 Gbps Aggregated
- ONS 15530 10 Gbps Aggregated
- ONS 15530 Multirate (MR) Transport
- ONS 15530 Data Multiplexer (MXP)
- 2R Any Rate
- 3G-SDI
- Gigabit Ethernet
- 10GE—10 Gigabit Ethernet (LAN and WAN)
- D1 Video
- DVB-ASI—Digital Video Broadcast-Asynchronous Serial Interface
- DV-6000
- DPSK—Different Phase Shift Keying
- ESCON—Enterprise System Connection
- Fast Ethernet
- Fiber Channel 1G
- Fiber Channel 2G
- Fiber Channel 4G
- Fiber Channel 8G
- Fiber Channel 10G
- FICON—Fiber Connection 1G
- FICON Express 2G
- FICON 4G
- FICON 8G
- FICON 10G
- E3 over FE
- T3 over FE
- DS3 over FE
- High Definition Television (HDTV)
- ISC-3 Peer (1G)
- ISC-3 Peer (1G with STP)
- ISC-3 Peer (2G)
- ISC-3 Peer (2G with STP)
- ISC-3 Peer (2R)
- ISC-3 Peer (2R)

- ISC-Compat (ISC-3 Compatibility mode)
- HD-SDI
- HDTV
- OC-3
- OC-12
- OC-48
- OC-192
- OC-768
- OTU2
- SD-SDI
- SDI—Serial Data Input
- STM-1
- STM-4
- STM-16
- STM-64
- STM-256
- 10GE WAN-Phy
- 10GE LANtoWAN
- OTU1
- OTU2
- OTU2e
- OTU3
- Sysplex CLO—control link oscillator
- Sysplex ETR—external throughput rate
- LAN-WAN Conversion

**Note**

The Sysplex CLO and Sysplex ETR services are supported only on the following topologies:

- Single span—Two terminal sites with 32MUX-O and 32DMX-O cards, 40MUX-O and 40DMX-O cards, 40WSS and 40DMX, or 32WSS and 32DMX or 32DMX-O cards installed and no intermediate sites in between.
- Point-to-Point—Two terminal sites with 32MUX-O and 32DMX-O cards, 40MUX-O and 40DMX-O cards, 40WSS and 40DMX, or 32WSS and 32DMX or 32DMX-O cards installed. Line amplifiers can be installed between the terminal sites, but intermediate (traffic terminating) sites cannot be installed.
- Two hubs—Two hub nodes in a ring with 32MUX-O, 32DMX-O, 32WSS, 40MUX-O, 40DMX, 40DMX-O, 40WSS, and 32DMX cards or 32DMX-O cards installed. Line amplifiers can be installed between the hubs.

Refer to the *Cisco ONS 15454 DWDM Reference Manual* for more information about the supported topologies for the ETR and CLO services.

1.1.3 Cisco Transport Planner Process Flow

The following stages are used to complete a network design. See [Figure 1-5](#) for the process flow.

1. Create a project using the Project Creation wizard.
2. Create a network using the Create Network wizard. The Create Network wizard adds sites and places the fiber spans between the sites. A span represents a pair of fibers.
3. Create a point-to-point, AggregatedEthernet, TDM Aggregated, protected ring (P-ring), and/or ROADM service demand.
4. Analyze the network design.
5. If you would like to force automatic tool choices, adjust the design and repeat the analysis until you have reached the desired configuration.
6. Create an Install copy of the network and update the parameters with real data from the field.
7. Analyze the Install network.
8. Create an upgrade copy of the network, as needed, to add forecasted channels.

Figure 1-5 Cisco Transport Planner Process Flow

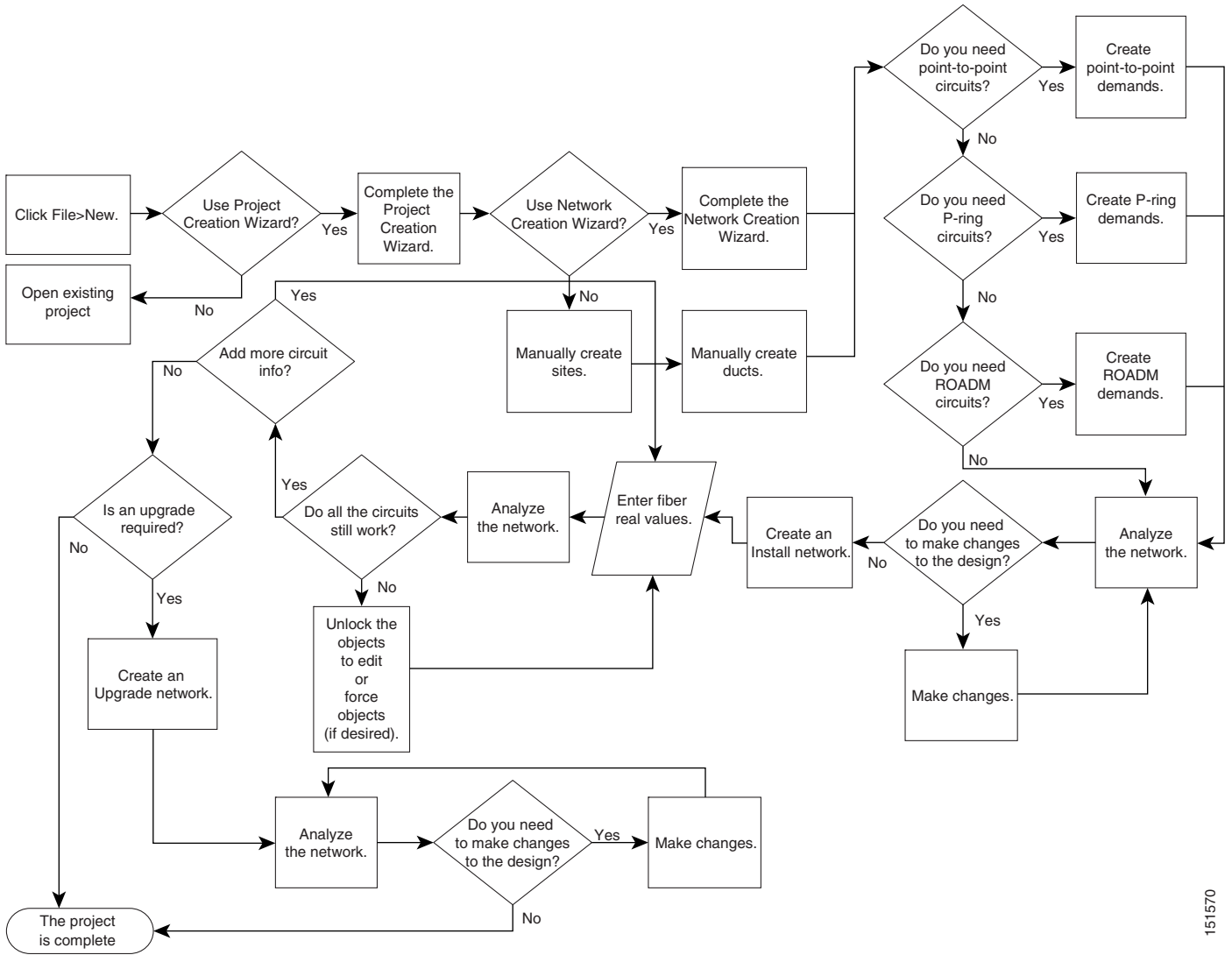

151570

1.1.4 Planning Traffic in Cisco Transport Planner

Traffic in Cisco Transport Planner is defined as an optical path for each pair of nodes requiring a service demand. An optical path is the combined channels between the two nodes. The following list gives definitions for some basic traffic items:

- **Circuit**—A single channel between a pair of source and destination nodes. In addition to the source and destination nodes and all the attributes that are common to the service containing the circuit, a circuit has the following attributes:
 - Present/forecast indication
 - Routing direction for unprotected service
 - ITU channel
 - Optical bypass indication
- **Demand**—A set of circuits with common characteristics, such as:
 - Service demand label
 - Number of existing circuits
 - Number of forecasted circuits
 - Client service type
 - Protection type
 - Optical bypass (number of channels and/or sites)
 - WDM interface type (TXT or ITU-LC)
 - WDM card type
 - Source client interface (SR, IR, or LR)
 - Destination client interface (SR, IR, or LR)
- **Traffic demand**—All traffic between the same set of nodes. Both L-band and C-band are supported. The following traffic demands are supported: P-ring, Fixed (point-to-point), and Any-to-any (ROADM).
 - In P-ring traffic demands, all the demands are used to support traffic topologies similar to bidirectional line switched rings (BLSRs) or multiplex section-shared protection rings (MS-SPRings). Each P-ring demand is between a pair of added/dropped nodes where BLSR-like (or MS-SPRing-like) traffic must exist. The number of circuits is the same for each demand, and is user-specified (from 1 to 40).
 - In fixed (point-to-point) traffic demands, the set of nodes is restricted to two sites. The number of circuits is user-specified (from 1 to 40).
 - In any-to-any (ROADM) traffic demands, a minimum of two nodes and a maximum of 40 ROADM nodes are supported. The any-to-any traffic demand allows each node to establish one or more circuits with the other nodes, either as a hub or meshed configuration. In a meshed configuration, each node defined in the set is connected to each of the nodes. This is the most common traffic type. In a hub configuration, the user-defined hub node is connected to each of the other nodes. ROADM circuits have the same protection types and services. The number of circuits is not user-specified and can vary from 0 to 40.



Note

In any-to-any (ROADM) traffic demand, the default routing strategy is Unprotected minimum hop count.

A ROADM demand can have multiple client service types and support multiple DWDM card interfaces for each client service type. A ROADM demand supports the following routing strategies:

- Protected (Default)—Each node pair in the traffic demand is connected using two connections.
- Unprotected optimum optical path—Each node pair is connected using one connection. The unprotected optimum optical path minimizes the number of required optical amplifiers, but also restricts the number of channels that can be deployed among the nodes of the traffic demand (maximum of 40 channels between each node pair) in the installed network.
- Unprotected minimum hop count—Each node pair in the traffic demand is connected by one connection. The unprotected minimum hop count maximizes the number of channels (for unprotected traffic types only) that can be deployed among the nodes of the traffic demand, but requires a higher number of optical amplifiers on the unprotected optimum optical path (maximum of 40 channels between each node pair) in the installed network.
- Unprotected subnet—Each node pair in the traffic demand is connected using one connection. You can manually force connections on only one branch of the ring. For unprotected subnets, you must manually select one starting node of the branch and the direction the ring must be traversed to define the subnet, starting from the initial site. The branch direction is specified by defining the outgoing side first, referred to as the starting node. This routing strategy option allows you to exclude some critical paths and (with ROADM traffic demands containing two sites) to force each ROADM connection clockwise or counterclockwise.

1.1.5 Cisco Transport Planner Traffic in the Project Explorer Pane

Cisco Transport Planner represents all of the user-defined traffic services as a tree view within the Project Explorer pane. The Project Explorer pane shows all of the open project information, including the networks, the network dependencies, sites, fibers, services, and so on. (Figure 1-6).

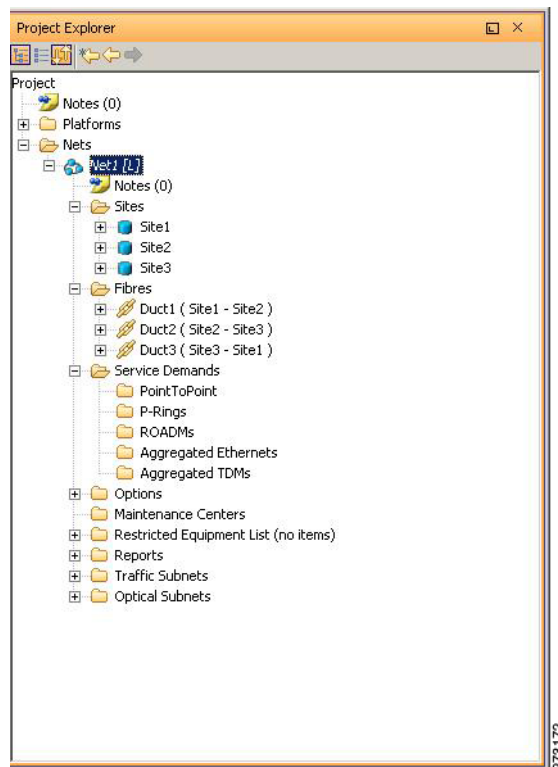
Figure 1-6 Project Explorer View

After you analyze a network design, the colors of tree view change according to the error/warning condition of the network design. The icons display as red if there are errors in the network design; orange if there are warnings but no errors; and green if there are no warnings or errors. The icon shows the color of the most severe condition. For more information about analyzing the network, see the “[2.9 Analyzing the Network](#)” section on page 2-49.

Right-clicking on certain items in the Project Explorer tree allows you to edit the parameters.

1.1.5.1 Point-to-Point Traffic Demands

Point-to-point traffic demands appear in the Service Demands > PointToPoint folder in the Project Explorer pane. Each point-to-point traffic demand is categorized by its source and destination site names. All of the point-to-point services between the two sites appear under the designated demand name (Figure 1-7).

Figure 1-7 Point-to-Point Traffic Demand in the Project Explorer pane

A point-to-point traffic demand includes the following information:

- Client service type
- Site# – Site# (source and destination site labels for this demand)

1.1.5.2 P-Ring Traffic Demands

Each protected ring (P-ring) traffic demand appears in the Project Explorer pane under the Service Demands > P-Rings folder. [Figure 1-8](#) shows an example of a P-ring traffic demand in the Project Explorer pane.

Figure 1-8 P-Ring Traffic Demand in the Project Explorer pane

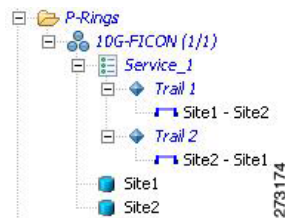

All the P-ring channels between each site pair are listed under each P-ring traffic demand. Each demand is labeled with the following information:

- P-ring number
- Client service type
- Site# – Site# (source and destination site labels for this demand)

1.1.5.3 ROADM Traffic Demands

Each ROADM traffic demand appears in the Project Explorer pane under the Service Demands > ROADMs folder. The ROADM folder contains each defined ROADM demand. You can define more demands for the same ROADM for the same set of nodes. [Figure 1-9](#) shows an example of a ROADM traffic demand.

Figure 1-9 ROADM Traffic Demand in the Project Explorer pane

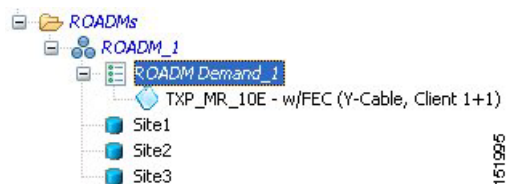

In the Project Explorer pane, each ROADM includes the ROADM demand name and a list of DWDM card types that support the client service types. Protection types appear in parentheses.

1.1.5.4 Aggregated Ethernet Demand

Each aggregated ethernet traffic demand appears in the Project Explorer pane under the Service Demands > Aggregated Ethernet folder. The Aggregated Ethernet folder contains each defined aggregated ethernet demand. Aggregated Ethernet demands are supported on ring and linear traffic subnets. [Figure 1-10](#) shows an example of an aggregated ethernet traffic demand.

Figure 1-10 Aggregated Ethernet Demand in Project Explorer pane

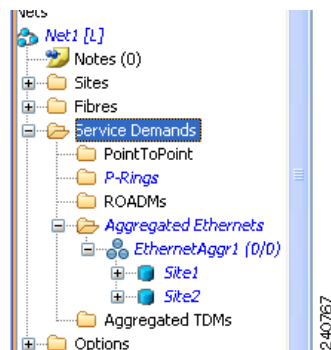

1.1.5.5 TDM Aggregated Demand

Each TDM aggregated demand appears in the Project Explorer pane under the Service Demands > Aggregated TDMs folder. [Figure 1-11](#) shows an example of a TDM aggregated traffic demand in the Project Explorer pane.

Figure 1-11 TDM Aggregated Demand in Project Explorer pane

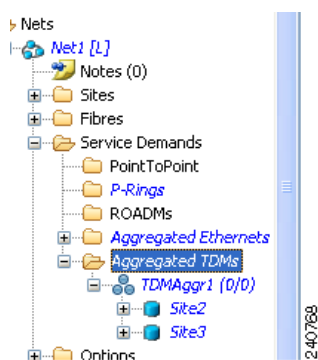

TDM aggregated demands are supported only on a ring traffic subnet.

1.1.6 Auto, Forced, and Locked Parameters

Parameters in CTP can be in one of three states:

- **Auto**— This parameter allows the highest degree of flexibility to CTP in designing a network. When you select Auto, CTP chooses the parameter value during network analysis.
- **Forced**—When you set a specific parameter value, other than Auto, CTP designs the network using these constraints. When a setting is forced, the item appears in blue italics in the Project Explorer pane.
- **Locked**—The state of a parameter after network analysis. The next time the analyzer is run, Cisco Transport Planner cannot change the value when it is in the Locked state. You can unlock an item using the Unlock command. For more information, see the [“2.10.5 Unlocking Parameters in the Network Design”](#) section on page 2-55 and [“2.10.5.1 Forcing Manager”](#) section on page 2-55. [Figure 1-12](#) shows an example of sites in a locked state.

Figure 1-12 Locked Sites in the Project Explorer View



Depending on the initial state, the network analyzer will:

- Move the parameter into the Locked state if the unit or parameter was set to Auto.
- Leave the parameter in the same state if the user forced a specific value for the unit or parameter.

1.2 Installing Cisco Transport Planner

Use the following procedure to install Cisco Transport Planner:

-
- Step 1** To download the installer, go to the Cisco software download site.
- Step 2** Navigate to the location where you want to save the CTP executable file to a local hard drive.
- Step 3** Click **Save**.
- Step 4** To start the installation of CTP:
- **Windows**—Navigate to the folder containing the CTP executable file and double-click it.
 - **Linux**—Assuming the CTP.bin file is accessible from the current shell path, navigate to the directory containing the CTP.bin file and enter:

```
% ./CTP.bin
```

The graphical CTP installation wizard is displayed.

- Step 5** Click **Next**. The license agreement is displayed.
- Step 6** To accept the license, select the I accept the terms of the License Agreement radio button.
- Step 7** Click **Next**.

Step 8 Specify the installation folder. On Windows XP, the default is C:\Program Files\Cisco\CTP-R9.4. To choose a different folder, click the **Choose...** button and browse to the required folder. To restore the default path, click the **Restore Default Folder** button.

Step 9 Click **Next**.

Step 10 Specify the shortcut folder by choosing any one of the following options:

- In a new Program Group—Specify a new folder. The default option is CTP-R9.4.
- In an existing Program Group—Select a folder from the list of existing folders.
- In the Start Menu
- On the Desktop
- In the Quick Launch Bar
- Other—Use this option to specify a commonly used folder.
- Don't create icons—Choose this option if you do not want to create a shortcut.



Note Check the Create Icons for All Users check box if you want to create shortcuts for all the users of a system.

Step 11 Click **Next**. The pre-installation summary is displayed.

Step 12 Review the pre-installation summary. If no changes are required, click **Install**; otherwise, click **Previous** to make modifications.

A progress bar displays the installation status. Click **Cancel** at any time to stop the installation.

When the installation process is complete, a screen indicates whether the installation succeeded or failed.

Step 13 Click **Done** to exit the installation wizard.

1.3 Uninstalling Cisco Transport Planner

Use the following procedure to uninstall Cisco Transport Planner:

Step 1 Click the Uninstall CTP icon available at the location selected in Step 10 of the [“1.2 Installing Cisco Transport Planner”](#) section on page 1-17.

The graphical Uninstall CTP wizard is displayed.

Step 2 Click **Uninstall**.

Step 3 A progress bar displays the uninstallation status. Click **Cancel** at any time to stop the uninstallation.

When the uninstallation process is complete, a screen displays the files that could not be uninstalled.

Step 4 Click **Done** to exit the uninstallation wizard.

1.4 Launching the Cisco Transport Planner

Before you start the Cisco Transport Planner (CTP), you need to save the user profiles provided by Cisco Systems to the profiles folder available at the installation location. Access to CTP features depends on the user profile you select when you start CTP. The default profile is Base Network Designer.

To launch the CTP, perform the following steps:

Step 1 Launch Cisco Transport Planner using any of the following options:

- Click the CTP icon in the Start > All Programs > CTP menu.
- Double-click the CTP icon in the quick launch bar.
- Double-click the CTP icon on the desktop.
- Browse to the installation folder and double-click the `ctp.jar` file.

CTP validates the installed Java version in the system. If the installed version is Java 1.6, the CTP login dialog box is displayed.



Note If Java 1.6 is unavailable, CTP displays the JVM Version Error dialog box that lists the incompatible Java versions. Install the required Java version from the <http://www.oracle.com/technetwork/java/index.html> website. Repeat [Step 1](#).

Step 2 From the Current selected profile drop-down list, select the user profile.

Step 3 Click **Continue** to open the Cisco Transport Planner.

The login profile type appears in the lower-right corner of the CTP window.

The Start Page is displayed (see [Figure 1-13](#)).

Figure 1-13 Cisco Transport Planner Start Page

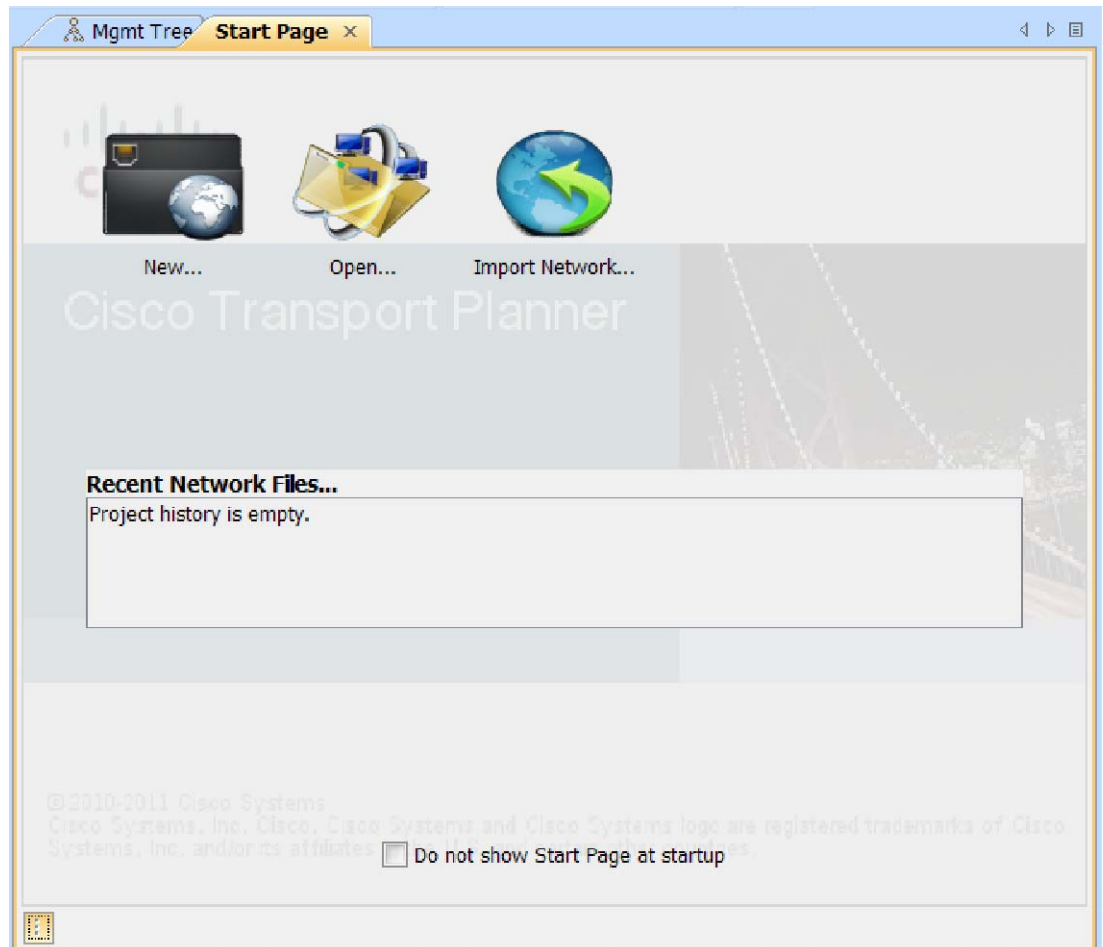

The Start Page provides the following options:

- **New**—Click to create a new project.
- **Open**—Click to open an existing project.
- **Import Network**—Click to import node parameters from a network.
- **Recent Network Files** area—Select an existing project to open it.

Selecting any of the above options opens a new tab.

- Step 4** Check the **Do not show Start Page at startup** checkbox to disable viewing the start page when Cisco Transport Planner is started.

Check **View Start Page** checkbox under Tools > Option > Graphic > Start Page to enable displaying the Start Page when launching the CTP.

1.4.1 Opening a Project

Use the following procedure to open an existing Cisco Transport Planner project. To create a new project, see [2.1 Creating a Project, page 2-1](#).

- Step 1** Click the project name under **Open** in the Tasks Pane. The project opens. If you do not see the project name listed, continue with [Step 2](#).
- Step 2** Click **Open** in the Start Page, click **Open** under Project in the Tasks Pane, or in the File menu.
- Step 3** In the Open Project dialog box, navigate to the desired folder and choose the project. Click **Open**. The Cisco Transport Planner project appears.



Note

You cannot open an existing CTP project in multiple CTP instances. The saved project (.MPZ file) is locked for the use of that CTP. If you try to open the project in another instance of CTP, an error message is displayed. The .MPZ project file is unlocked and released only after you close the Network.

1.4.2 Loading and Unloading Networks

Each network in a project requires memory. To save memory, when Cisco Transport Planner opens a project, all networks are in the Unloaded state. An unloaded network appears in the Project Explorer pane with a “U” next to the network identifier ([Figure 1-14](#)). To load an unloaded network, double-click on the network folder in the Project Explorer pane, or right-click the network and choose **Load** from the shortcut menu.

Figure 1-14 Unloaded Network in the Project Explorer pane

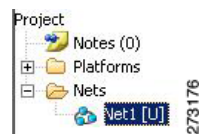

A loaded network appears in the Project Explorer pane with an “L” next to the network identifier ([Figure 1-15](#)). To unload a loaded network, right-click the network icon in the Project Explorer pane and choose **Unload** from the shortcut menu.



Note

When you load a network containing an alien interface that is not present in the parts database (DB), warning messages are displayed.

Figure 1-15 Loaded Network in the Project Explorer pane

1.4.3 Saving a Project

Use the following procedure to save a project:

-
- Step 1** Choose one of the following:
- To save an existing project with the same filename, choose **File > Save**. You have completed this procedure.
 - To save a new project, choose **File > Save** and go to [Step 2](#).
 - To save an existing project with a different filename, choose **File > Save As** and go to [Step 2](#).
- Step 2** In the Save Project dialog box, navigate to the desired folder and enter the filename. Click **Save**. Cisco Transport Planner saves projects as zipped files with the MPZ extension.
-

1.4.4 Closing a Project

Use the following procedure to close a Cisco Transport Planner project:

-
- Step 1** From the File menu, choose **Close**.
- Step 2** In the Save Project dialog box, click **Yes** to save or **No** to close without saving changes.
- Step 3** If you clicked Yes and have not previously saved the project, the Save Project dialog box appears. Enter the name of the project and click **Save**. The project closes.
- Step 4** To exit Cisco Transport Planner, choose **Exit** from the File menu.
-

1.4.5 Deleting the CTP Cache

To delete the CTP cache, perform the following steps:



Note CTP must be restarted to delete the CTP cache.

- Step 1** From the Tools menu, choose **Delete Cache**. An information message is displayed prompting you to restart CTP. If you do not want to restart CTP immediately, cache deletion is postponed to the next restart.

- Step 2** To close the project, choose **File > Close** after saving the changes.
- Step 3** To exit CTP, choose **File > Exit**.
- Step 4** Restart CTP. A message is displayed prompting you to continue with cache deletion.
- Step 5** Click **Yes** to delete the CTP cache or **No** to postpone cache deletion.
-

1.5 CTP Software Updates

Software updates for Cisco Transport Planner are routinely made available for installation. Installing the updates can rectify software errors and enhance software functionality. New updates can be installed from a local patch (.upz or .zip) file.

1.5.1 Check for Software Updates

You can check for software updates after CTP has started. Click **Check updates** in the Help menu. The Update CTP dialog box is displayed. In this dialog box, you can select either of the following options:

- Patch file—The updates are installed from a local .upz or .zip file. Click **Browse** to select the .upz or .zip file from your local folder. CTP checks all the updates available on the .upz or .zip file and displays only those that are new for the currently installed CTP version.



Note Do not unzip or extract the .upz or .zip patch file.

- Update server—CTP checks for online updates available on the server. The default server location is displayed in the corresponding edit box. You can type a different server location, if required. Click **Ok** to check for available updates on the server. Ensure that you have an internet connection.

Once the available updates are displayed, select those that need to be installed. Click **Apply** to install the updates or **Cancel** to continue using CTP without installing any updates. After the updates have been installed, you need to restart CTP for the updates to take effect.



Note Before restarting CTP, clear the CTP cache from your local system.

To view the patch information, click **About** in the Help menu. The About Cisco Transport Planner dialog box is displayed. Select the **Patch Info** tab to display the information about the currently installed patch.

1.5.2 Discarding Software Updates

The CTP can be rolled back to the previous working state if there are performance issues after installing the new updates. At the time of launching CTP, a prompt is displayed to press the “R” key to perform the roll back. If the software roll back does not complete successfully, an error message is displayed.

1.6 Setting Cisco Transport Planner Options

Cisco Transport Planner provides numerous options for customizing the tool and the design.

**Note**

The following procedures for setting options using the Tools menu apply to new projects during project creation. To change an existing (open) project, click the desired item in the Project Explorer pane Subnets folder and edit the parameter in the Properties pane.

1.6.1 Setting the Graphical Display

Use the following procedure to set the Cisco Transport Planner graphical display:

-
- Step 1** From the Tools menu, choose **Options**.
- Step 2** In the Options Explorer dialog box, right-click the Graphic folder and choose **Expand** from the shortcut menu.
- Step 3** Click **Chart Panel** and complete the following:
- In the Colors area, to change the colors of Border Paint, Background Paint, Line Paint, Plot Background Paint, and Plot Outline Paint, click the relevant fields in the Colors list, and click the drop-down arrow to display a color swatch popup window. Then, click the desired color.
 - In the Strokes area, to change the strokes of Border Stroke, Outline Stroke, and Default Line Stroke, click the relevant fields in the Strokes list, and click the drop-down arrow. Then click the desired stroke.
 - In the Font area, click the Font drop-down box to display a font popup window. Then select the desired Font, Size and Style.
 - In the Alfa area, enter numeric values for Background Alfa and Foreground Alfa.
 - In the Shapes area, click the Line Shape drop-down box. Then click the desired line shape.
 - In the Gridlines area, check the Range Gridlines and Domain Gridlines check boxes to view the gridlines for the same.
- Step 4** To change the color scheme for Cisco Transport Planner, click **Look & Feel** and choose the desired scheme from the drop-down list.
- Step 5** To enable displaying the Start Page when launching Cisco Transport Planner, check the **View Start Page** checkbox.
- Step 6** To change the appearance of the Project Explorer tree, click **Project Explorer** and complete the following tasks as needed:
- Overlapping—Check to reorder sites for a selected network.
 - Alarm Mode—Choose **Single** for an alarm icon to report only the condition of that item or choose **Cumulated** for an alarm icon to summarize the most critical alarm of the item and its children.
 - Bottom Right Icon—(Display only) Displays Locking to indicate that the lock icon appears at the bottom right of each locked item in the Project Explorer pane.
 - Top Right Icon—(Display only) Displays Alarm to indicate that the alarm icon appears at the top right of each alarmed item in the Project Explorer pane. The alarm icon will be green, yellow, orange, or red to indicate the alarm severity.
- Step 7** To change the NtView *Name* tab appearance, click **Network View** and complete the following tasks as needed:
- In the Site area, complete the following tasks:
 - Site Color—To set the default site color when no forcing is done, click the drop-down arrow to display a color swatch popup window. Click the desired color.
 - Site Selection Color, and Highlight Color—To change the site colors, click in the Color, Selection Color, and/or Highlight Color fields in the Site list. Click the drop-down arrow to display a color swatch popup window. Click the desired color.
 - Show Name—Check to display the site name on the NtView *Name* tab.

- Pass Through, OSC, Add/Drop, Hub, Gain equalizer, R-OADM, Line Amplifier, OXC, OIC, Background Amplified Color, Background Raman Amplified Span Color—To change the colors, click in the relevant fields in the Site list. Click the drop-down arrow to display a color swatch popup window. Click the desired color.
- Show Amplifiers—Check to display the amplifier icon for a site on the NtView *Name* tab.
- Show Raman Amplified Span—Check to display the Raman amplified span on the NtView *Name* tab.
- In the Fiber area, complete the following tasks, as needed.
 - True wave Reach Color, Dispersion Shifted Color, Metro Core Color, true wave, True Wave Plus Color, True Wave Minus Color, True wave Classic Color, Free Light Color, LS Color, Tera Light Color, E LEAF Color, TRUE WAVE RS Color, G 652 SMF Color, and Selection Color—To change the fiber color, click in the relevant fields in the Fiber list and then click the drop-down arrow.
 - Show Name—Check to display the fiber name on the NtView *Name* tab.
 - Show Length—Check to display the fiber length on the NtView *Name* tab.
 - Show total SOL Loss—Check to display start of life (SOL) loss on the NtView *Name* tab.
 - Show total EOL Loss—Check to display end of life (EOL) loss on the NtView *Name* tab.
 - Show CD C-band—Check to display C-band chromatic dispersion (CD) on the NtView *Name* tab.
 - Show CD L-band—Check to display L-band chromatic dispersion (CD) on the NtView *Name* tab.

The duct details displayed in the NtView *Name* tab is shown in [Figure 1-16](#).

Figure 1-16 Duct Details Shown on the NtView Name Tab

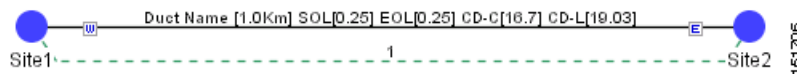

- To change the color of the traffic demands on the NtView *Name* tab, in the Point To Point, P-Ring, and Any To Any areas, click in the Color and Selection Color fields, and then click on the drop-down arrow to display a color swatch popup window. Click the desired color.

Step 8 To change the Network Mgmt Tree tab appearance, complete the following tasks as needed:

- In the Network area, click in the Color and Selection fields. Click the drop-down arrow to display a color swatch popup window. Click the desired color.
- In the Link area, complete the following tasks:
 - To change the link color, click the Color field in the Link list and then click the drop-down arrow. Choose the desired line width from the drop-down list.
 - To change the link appearance, click the Stroke field in the Link list and then click the drop-down arrow. Choose the desired line appearance from the drop-down list.

- Step 9** To change the layout appearance, click **Layout View** and complete the following tasks as needed:
- In the General area, click in the Background and Selection Color fields. Click the drop-down arrow to display a color swatch popup window. Click the desired color.
 - In the Any/Present View area, complete the following tasks:
 - To change the color for Foreground, Locked & Unlocked View, Locked Elements Background, and Locked Elements Foreground, click the relevant field and click the drop-down arrow to display a color swatch popup window. Click the desired color.
 - In the Alarmed View area, complete the following tasks:
 - To change the color for Unalarmed Elements Background, Unalarmed Elements Foreground, and Alarmed Elements, click the relevant field and click the drop-down arrow to display a color swatch popup window. Click the desired color.
- Step 10** Click **Ok**.
-

1.6.2 Setting the Default Software Release

Use the following procedure to set the default software release for CTP. This release will be used as the default software release when creating a project. See [2.1 Creating a Project, page 2-1](#).

- Step 1** From the Tools menu, choose Options.
- Step 2** In the Options Explorer dialog box click **General**.
- Step 3** In the column on the right, click the Default CTP Software Release option. A drop-down list appears.

Step 4 Click an option in the list to choose the desired software release. See [Figure 1-17](#).

Figure 1-17 Default CTP Software Release Window

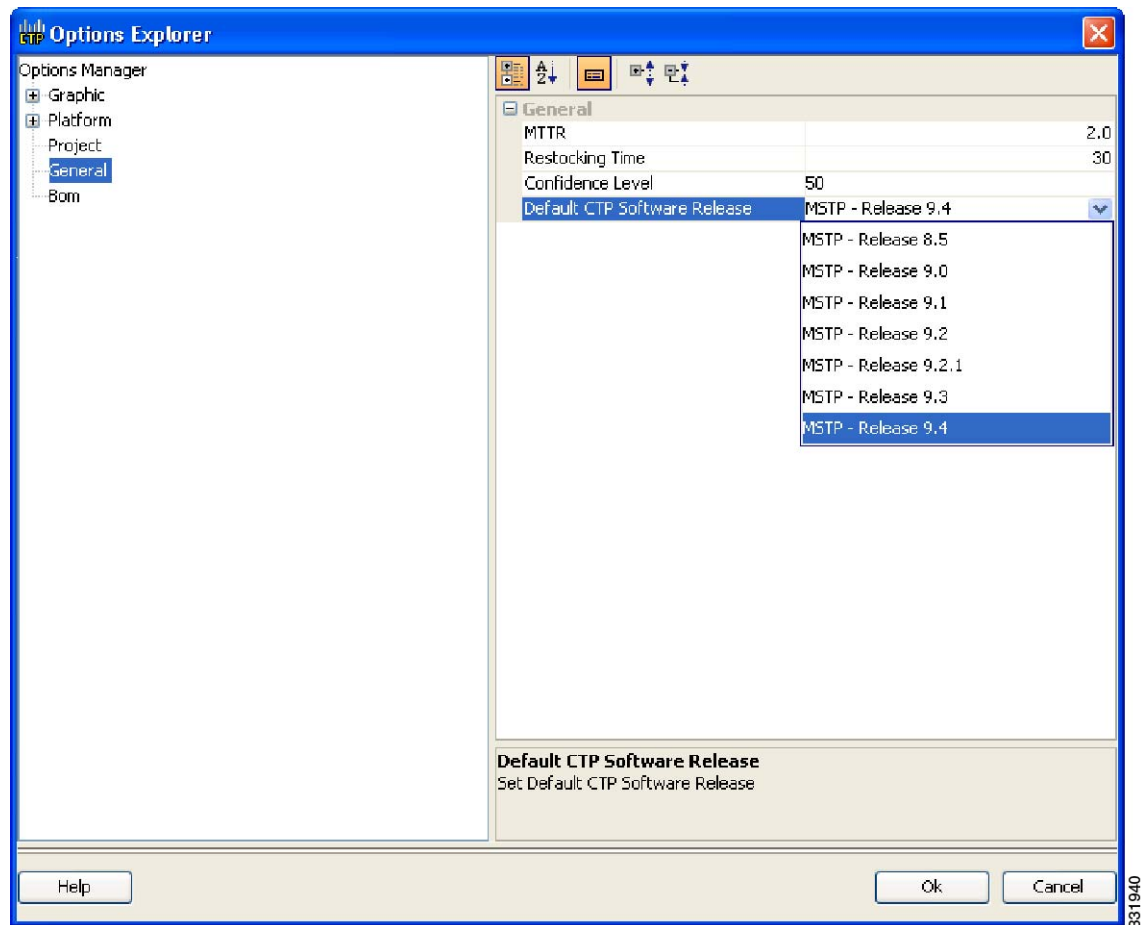

Step 5 Click **Ok**.

1.6.3 Setting the Default Platform Values

Use the following procedure to establish the default traffic mapping, dense wavelength division multiplexing (DWDM) design, and default layout settings for a particular platform and system release. The default settings will appear during project creation. All the options that you specify can be changed after project creation on a per-span basis.

-
- Step 1** From the Tools menu, choose **Options**.
 - Step 2** In the Options Explorer dialog box ([Figure 1-17](#)), right-click **Platform** and choose **Expand** from the shortcut menu.
 - Step 3** Click the desired **System Release** folder and complete the following tasks as needed:



Note

Default changes apply only to the specified system release.

For Software Releases 8.5, 9.0, 9.1, 9.2, 9.2.1, 9.3, and 9.4 choose the required settings:

- **Shelf Management**—The options available are Auto, Multi Shelf Integrated Switch, Multi Shelf External Switch, and Individual Shelf. These options allow you to specify the type of management to be used for the sites on the network.
Select **Auto** to set the default option of Multi Shelf Switch for all the nodes with more than one shelf. Select **Multi Shelf Integrated Switch** to configure all the Multiservice Transport Platform (MSTP) optical units (OADMs and amplifiers) in different shelves connected through a LAN. The LAN is implemented with switches plugged into the MSTP shelves.
Select **Multi Shelf External Switch** to configure all the MSTP optical units (OADMs and amplifiers) in different shelves connected through a LAN. The LAN is implemented with switches external to the MSTP shelves. For this option, two external Ethernet switch units (Cisco Catalyst 2950 and Cisco Catalyst 3650) are used to support the multishelf configuration. Cisco Catalyst 2950 supports 12 subtending shelves and Cisco Catalyst 3650 supports 24 subtending shelves. CTP supports a maximum of 30 shelves, including the node controller shelf, in a multishelf configuration.



Note When the Multi Shelf External Switch is forced, the multishelf external switch is placed in the layout irrespective of the node controller.



Note The Cisco ONS 15454 M6 (M6) chassis, when used as a node controller with the Multi Shelf External Switch, can support only two subtended shelves.

Select **Individual Shelf** to configure all the MSTP optical units (OADMs and amplifiers) in the same shelf.



Note Shelf management is disabled for HYBRID 15454 ONS configuration in Release 9.1 and later.



Note M6 chassis, when used as node controller, can support three subtended shelves, the subtended M6 chassis can subtend two more shelves.

- **Node Protection**—The options available are Same Shelf, Separated Shelves, and Node Split. Select **Same Shelf** to configure the optical units (amplifiers and OADM) on side A (CW direction) and side B (CCW direction) in the same shelf.



Note Node protection is disabled for HYBRID 15454 ONS configuration in Release 9.1 and later.

Select **Separated Shelves** to configure the optical units (amplifiers and OADM) on side A (CW direction) in one shelf and those on side B (CCW direction) in a second shelf.

- **C-band Rules**—Select the options from the drop-down list. The options appear in the following format: C 64 Chs 50 GHz (+2 dBm/Ch). The channels available are 80, 72, 64, 40, 32, 20, 16, and 8; the reference per channel power options available are -1 dBm, -2 dBm, 1 dBm, 2 dBm, 4 dBm, 5 dBm, 7 dBm and 8 dBm; and the spacing options available are 100 GHz and 50 GHz. You can use even wavelengths for 80, 72, and 64 channel design.

For HYBRID 15454 ONS configuration, the available options are 8, 16, 20, 32, and 40 channels.

- L-band Rules— Select the options from the drop-down list. The options appear in the following format: 32 Ch. 100 Ghz +5 dBm. The options available are: None, Expand, and channels available are 32; the reference per channel power options available are 2 dBm and 5 dBm; and the only spacing options available is 100 GHz.

Select **Expand** to indicate that the L-band rules are upgradable.



Note L-band is not applicable to HYBRID 15454 ONS configuration in Release 9.1 and later.

- Installation w/o CTP—Check this check box to install the network with default parameters. If you choose this option, CTP designs the network according to a set of predefined conditions, so that the selected node can be installed without the Cisco Transport Planner configuration files (thresholds and setpoints).
- Dithering Lower Limit—Enter a value that satisfies the following conditions:
 - Not lower than zero
 - Not higher than 32
 - Not higher than the dithering upper-limit value

The dithering value is the site identifier that CTP uses to adjust power on 80-WXC cards. Dithering value is provided only for sites with 40-WXC cards, that is, for sites with multidegree site structure and with the functionality “OXC” or “Auto”. This parameter is not displayed for non-OXC sites.

- Dithering Upper Limit—Enter a value that is not lower than zero and not higher than 32.
- Insulators—Check this check box to protect the Express Add/Drop (EAD) colorless ports of the 80-WXC-C cards configured as demux units.



Note The Cisco ONS 15216-FLD-2-ISO optical insulator is not supported in CTP Releases 9.3 and later releases.



Note Optical insulator connections are displayed only in the Patchcord Installation tab in the Internal Connections report.

- Structure—Choose the site structure from this drop-down list. If the network topology does not support the selected site structure, then the selection made in this drop-down list is ignored.
- MSM External Switch—Choose the multi shelf external switch type, from the drop-down list.
- Use Payg—Check this check box to enable the Pay As You Grow feature. For more information about the Pay As You Grow feature, see the [“1.8 Understanding the Pay As You Grow Feature” section on page 1-46](#).
- Service Level—Choose the service level, from the drop-down list.
- Service Level Num of Years—Choose the maintenance service level length (in years), from the drop-down list.
- Redundant Power—This drop-down list enables you to choose whether the redundant power supply is to be added.
- UTS AC Power Cables—Choose the type of cables to be used for the AC power supply, from the drop-down list. Cables are listed based on the country type.

- **Filler Card Type**—Choose the type of card to be placed in the empty slots of a chassis, from the drop-down list. The options available are:
 - **Blank**—CTP places only blank cards.
 - **UTS Filler**—CTP places blank cards in M12 chassis and Universal Transport System (UTS) filler cards in the M2 and M6 chassis. The two type of UTS filler cards placed by CTP are 15454-M-T-FILLER (in TNC and TSC card slots) and 15454-M-FILLER (in other slots).
- **Node Controller**—Choose a chassis to act as the node controller, from the drop-down list.
- **M6 Chassis in Use**—Enter an integer value for the number of M6 chassis to be used.
- **M12 Chassis in Use**—Enter an integer value for the number of M12 chassis to be used.
- **Redundant Controller Card**—This drop-down list enables you to choose whether to use a redundant controller card.
- **Side/Side cabling**—Choose the loss value between the west and east side of the site, from the drop-down list. It is useful in case of multi shelf node protection when the racks are not located close to each other.
- **Anti ASE**— The options available in the drop-down list are:
 - **Auto**—CTP decides if the site should be configured as anti-amplified spontaneous emissions (anti-ASE).
 - **Yes**—The site is configured such that all the express channels on the site are optically dropped and reinserted. In addition, all the patch cords between the West and East sections are removed.
 - **No**—The site is not configured as anti-ASE.

Step 4 Click the **Layout** folder and complete the following settings as required:

- **Osmine Compliant**—Check this check box to instruct CTP to ensure that all the sites placing transponder and line cards are compliant with OSMINE.
- **Hybrid Node**—Check this check box to instruct CTP to ensure that cross-connect, SDH, and SONET cards are not placed within the optical transport section (OTS) shelf.
- **Max Num of Shelves**—Specify the maximum number of shelves per rack. The maximum number of shelves you can specify is 4.
- **Fan Tray**—Select the type of fan tray to be placed within each node, from the drop-down list.
- **AIC**—Choose **Yes** from the drop-down list to instruct CTP to put the AIC card in slot 9 of the first shelf in each site.
- **Fiber Storage**—Choose **Yes** from the drop-down list to instruct CTP to put the fiber storage within the rack below the optical shelf.
- **Y-Cable**—The the Y-cable options from the drop-down list. The options available are:
 - **Auto**—Instructs CTP to set the default value for the Y-Cable option.
 - **1RU FlexLayer Shelf Assembly**—Instructs CTP to use the ONS 15216 Splitter/Combiner FlexLayer modules to implement the required Y-cable protections.
 - **2RU Y-Cable Panel**—Instructs CTP to use the new ADC Splitter/Combiner modules to implement the required Y-cable protections.
- **TXP/MXP/XP in OTS**—The options in the drop-down list enable you to choose whether to place client cards in OTS shelves.
- **Etsi Rack Width**—Choose the ETSI rack width from the drop-down list. The 19 inches option adds 15454E-19IEC-KIT for each ETSI shelf.

- **Rack Height in RU**—Enter an integer value for the rack height. The default option is Auto, which assigns 44 rack units (RU) for ANSI and 40 RUs for ETSI.
- **Alien Shelf Height**—Enter the height of the alien shelves in RU. If the alien shelf height is greater than the rack height, alien shelves will not be added to the site, and an error message will be displayed in the summary report.
- **Number of Alien Shelves**—Enter the number of alien shelves that are to be added to the site.
Number of alien shelves can vary based on the alien shelf height. Maximum number of alien shelves that can be added is 600, if the alien shelf height is 1 Rack Unit (RU) and there are no other shelves in the layout.
The maximum number of racks supported for a site is 15. If the addition of alien shelves require more than 15 racks, an error message will be displayed in the summary report and the layout is not built for the site.
- **Alien Shelf Name**—Enter the name of the alien shelves that are added to the site. This name will be displayed in the Layout reports.
- **Populate Shelves From Bottom**—Check this check box to instruct CTP to place the shelves in the rack starting from the bottom. This is useful in installing shelves in tall racks. For more information about the order in which CTP fills the rack, see the [“4.16.1 General Placement Rules” section on page 4-65](#).
- **Chassis Type**—Choose the type of chassis, from the drop-down list. The options available are Auto, M12 Chassis, M6 Chassis, and M2 Chassis. The default option is Auto, which selects combinations of the chassis in an optimized manner.
- **Power Supply**—Choose the type of power supply, from the drop-down list.
- **TCC Type (Release 9.4)**—Choose the type of TCC card, from the drop-down list. The options available are Auto, TCC2P, and TCC3. The default option is Auto, which selects the TCC3 card.



Note The M12 chassis with TCC2P cards, when used as the node controller cannot subtend M6 chassis.

- **DCC Shelves Management**—Check this check box to instruct CTP to reserve Slot 12 for equipping 15454-MR-L1 units to implement data communication channel (DCC) shelf management.
- **M12 Shelves**—Enter an integer value for the number of empty M12 shelves to be added to the node layout. CTP supports a maximum of 29 extra M12 shelves. The default option is Auto, which does not add any shelves.
- **M6 Shelves**—Enter an integer value for the number of empty M6 shelves to be added to the node layout. CTP supports a maximum of 29 extra M6 shelves. The default option is Auto, which does not add any shelves.
- **M2 Shelves**—Enter an integer value for the number of empty M2 shelves to be added to the node layout. The default option is Auto, which does not add any shelves.

The above values are applied to all the sites in the newly created network. The values can be modified for individual sites after the network creation.

Step 5 Click the **Restricted Equipment** folder. To restrict a unit, check the corresponding check box in the Restricted column for that unit.

To change the setting back to unrestricted, uncheck the check box. To apply restricted list changes to an open project, complete the following:

- a. Right-click the folder for the network that you want to update and choose **Expand** from the shortcut menu.
- b. Right-click the desired platform and release folder under RestrictedEqptListFolder in the Project Explorer pane and choose **Edit List** from the shortcut menu. The Restricted Equipment list for MSTP 454 DWDM [Release Number] dialog box appears.
- c. Click **Update**. The modified Restricted Equipment List is replaced with the global restricted equipment List.
- d. Click **OK** to close the dialog box.

Step 6 Click the **Fiber Options** folder and specify the fiber parameters as required:

- Span Label Tag—Enter the desired span label; the default label is Duct.
- Span Length—Enter the span length. The displayed unit of measure is retrieved from the Span Measurements Units field.
- EOL Ageing loss [dB]—Enter the EOL aging loss value. The EOL loss-per-span value is added at the end of life to each discrete fiber in the network (for example, to add an EOL margin for splicing).
- EOL Ageing Factor—Enter the number to use when factoring fiber aging. This factor is multiplied by the SOL total span loss without connectors.



Note Enter a value in either EOL Ageing Factor or EOL Ageing loss; you do not need to enter a value in both fields.

- Connector loss [dB]—Enter the concentrated loss at the end of the span.
- Length Based Loss—If checked, the fiber loss is determined by multiplying the Span Length by the Loss Factor. If this check box is unchecked, you must enter the total loss of the span.
- Tot SOL loss w/o conn [dB]—Enter the total start of life (SOL) link fiber loss value for each span, excluding the connector concentrated loss. This value is applicable only if the Length Based Loss check box is unchecked.
- DCN Extension (With Software R8.0 and later releases)—Check this check box to enable the default use of data connection network (DCN) extension on each span in the project. This setting implies that the OSC channel is not used to connect the two nodes. This default can be overridden on the network wizard pane.



Note

Use one of the following formulas to calculate the fiber loss at SOL:

$$\text{SOL} = \text{km} * \text{dB/km} + (2 * \text{connector loss})$$

$$\text{SOL} = \text{user entered loss} + (2 * \text{connector loss})$$

Use one of the following formulas to calculate the fiber loss at EOL:

$$\text{EOL} = \text{km} * \text{dB/km} * \text{EOL Aging Factor} + (2 * \text{connector loss}) + \text{EOL Aging Loss, or}$$

$$\text{EOL} = \text{user entered loss} * \text{EOL Aging Factor} + (2 * \text{connector loss}) + \text{EOL Aging Loss}$$

- Select the **Fiber Type** of each span of the network. You can specify a fiber type even if the fiber type is not supported for the design.
- PMD at Fiber—Enter the polarization mode dispersion (PMD) value. PMD is always entered in ps/nm/km.
- Loss—Enter the value of the SOL fiber loss per kilometer used to calculate the loss of each span in the network. The fiber loss factor is always entered in dB/km.

Step 7 Click the **Traffic Mapping** folder and complete the following tasks as needed.

- In the Fixed traffic area, choose the unprotected routing strategy from the drop-down list:
 - Auto— CTP automatically selects the minimum number of channels that can be deployed among the nodes of the traffic group.
 - Unprotected optimum optical path—Each node pair is connected using one connection. The unprotected optimum optical path minimizes the number of required optical amplifiers.
 - Unprotected minimum hop count—Each node pair in the traffic group is connected by one connection. The unprotected minimum hop count minimizes the number of channels (for unprotected traffic types only) that can be deployed among the nodes of the traffic group.
- In the General area, choose the algorithm and wavelength options.
 - Force Mesh Algorithm—For CTP Software Release 8.5, check this check box to force the mesh algorithm.
 - Allow Different Wavelengths—Check this check box to allow different wavelengths to be used for regeneration.
 - Coloring Priority Option—Check this check box to assign the wavelength from the left side of the available band, that is, from 1530 nm. If this option is unchecked, the wavelength is assigned from the right side of the available band, that is, from 1565 nm.
 - Flat Grid Filling Option—Check this check box to assign the wavelength in a flat grid, allocating each free wavelength without any guard band. If this option is unchecked, the wavelength is assigned according to the actual assignment rules.



Note Guard band is an unused part of the wavelength spectrum, for the purpose of preventing interference between the wavelength channels.

- Maximum Separation Option—Check this check box to assign the wavelengths for 40 G and 100 G CP-DQPSK service types from the first wavelength in the C-band (1530.3 nm) and for other service types from the last wavelength of the C-band (1561.8 nm) to overcome interference in demands where the wavelength selection is set to Auto.

Step 8 Click the **DWDM Design Rules** folder and complete the following tasks as needed:

- OSNR Alarm For Regeneration—Check this check box to define the optical signal-to-noise ratio (OSNR) alarm severity. When this limit is reached, CTP suggests a channel at an appropriate site on the network. After the network is designed and analyzed, in the Tasks pane (under Reports), click **Optical Results** to see if any site requires regeneration. The regeneration column will suggest the site where Regeneration is required.
- Run Quick Analysis—Check this check box to use a quick but less accurate algorithm to analyze the network in a short time. After the analysis, Cisco Transport Planner displays the following warning message: “Dcu design not optimized due to Run Quick Analysis option.”
- No-Tilt-Network-Design—Check this check box to force Cisco Transport Planner to operate the amplifiers inside the gain range where no tilt is generated and to determine the type and number of amplifiers in each site of the network accordingly. This option sets all the intermediary points of the network so that channels are always at the reference power level. The default value is Disabled.



Note Long spans (with insertion loss greater than 25 dB) might not be supportable.

- No In-line Bulk Attenuator Design—Check this check box to design the network without using any inline bulk attenuators. If the network cannot be designed without using external in-line attenuators, Cisco Transport Planner displays the following error message: “Unfeasible Network design. Site X should require usage of in-line attenuator. Leave unchecked to allow inline bulk attenuators.”
- No TXT/Line-Card Bulk Attenuator Design—Check this check box to design the network without using any external receive (Rx) bulk attenuators on transponder or line cards. If any of the clients require Rx bulk attenuators, then the related channel is shown with the working condition (flagged red, orange, or yellow). No Rx bulk attenuator will be shown in any of the reports (such as Optical Channel Results, Internal Connections, or BoM). Leave unchecked to allow bulk attenuators.
- Prevent Use of E-LEAF Dispersion Compensation Unit on E-LEAF Dispersion spans—Check this check box to prevent Cisco Transport Planner from using Extended -Large Effective area fiber (E-LEAF) dispersion compensation units (DCUs) on E-LEAF spans for the overall network. Leave unchecked if you want the algorithm to automatically optimize the usage of the E-LEAF DCUs.
- No DCU Design—Check this check box to avoid automatic placement of DCU units.
- Max Scalability Placement —Check this check box to scale up or expand the network made in your network design. You can add new sites and demands depending on your requirements, thus, CTC automatically creates the flexibility of the possible expansion of your network. It also checks to force the CTP to choose an EDFA/DCU placement that is best suited for future expansion of the designed network without any hardware changes.
- TDCU—From the drop-down list, select one of options to place the TDCU units (TDCU Coarse and TDCU Fine) in the network are:
 - Auto—Places the fixed DCU units in the network.
 - All Positions—Places the TDCU units wherever the fixed DCU units can be placed.
 - Never Place—Does not place the TDCU units in the network.
 - Selected Positions—Places the TDCU units in ROADM, WXC, and Dynamic Gain Equalizer (DGE) nodes.
- FDCU—From the drop-down list, select one of the options to place the FDCU units in the network.
 - Auto—Places standard DCUs in the network, automatically. The FDCU option can be set to “Always” at the network level for a specific network. FDCU units can also be forced on specific nodes in the network.
 - Always—Places the FDCU units in the network. The FDCU option for new networks is set to “Always”. Standard DCUs are placed if FDCU units are not available. Standard DCU units can also be forced on specific nodes in the network.
- Turbo Simplex—Check to achieve faster results by optimizing a subset of the total channels based on type and path rather than optimizing every channel. Unchecking this option can result in longer analysis times for large networks, especially with any-to-any ROADM traffic.
- Max Sc Value—Enables you to enter the maximum slope compensation value.
- Enable Connector Loss—Check this check box to apply the default connector loss values to the fiber. The applied value depends on the type of site where the fiber is connected:
- Pass through Connector Loss—Enter the connector loss value for a pass-through site.
- OXC Connector Loss—Enter the connector loss value for an OXC site.
- ROADM Connector Loss—Enter the connector loss value for a ROADM site.
- OSC Connector Loss—Enter the connector loss value for an OSC site.
- Line Amplifier Connector Loss—Enter the connector loss value for a line amplifier site.

**Note**

The Pass through Connector Loss, OXC Connector Loss, ROADM Connector Loss, OSC Connector Loss, and Line Amplifier Connector Loss properties are enabled only if the Enable Connector Loss check box is checked.

The values of these properties can also be specified in the Properties pane for the Options>DWDM Design Rules>System Release option in the Project Explorer pane and are applicable to the current network.

Step 9 Click **OK**.

1.6.4 Setting the Default Project Values

Use the following procedure to set the default project settings and repair time. These defaults will appear during project creation.

Step 1 From the Tools menu, choose **Options**.

Step 2 In the Options Explorer dialog box ([Figure 1-17 on page 1-28](#)), click **Project** and complete the following tasks to set the defaults that appear in the Project Creation wizard:

- Customer—Enter the default customer name (128-character maximum).
- Created by—Enter the default user name (128-character maximum).
- Measurement Units—Choose the default span length unit of measure from the drop-down list, either **Km** or **Miles**.
- Price List—Choose the default price list.
- Restricted Analysis—Check to use Restricted Analysis in the project.
- ANSI/ETSI—Choose either **ANSI** (American National Standards Institute) or **ETSI** (European Telecommunications Standards Institute) from the drop-down list.

Step 3 Click **General** and complete the following tasks:

- MTTR (hours)—Enter the mean time to repair (MTTR) for all sites in the network. This value will apply to every site in the network. If you change the MTTR value after creating sites, the new value will only apply to sites you create after the change.
- Restocking Time (days)—Enter the number of days required (including transportation time) to restock the units into the maintenance center.
- Confidence Level (%)—Choose the confidence level for finding the spare units in the maintenance center (50, 75, 95, or 99 percent).
- Default CTP Software Release—Choose a release to be set as the default CTP software release. This release will be used as the default release when creating a project. See [2.1 Creating a Project, page 2-1](#).

Step 4 Click **BoM** and complete the following:

- Use Bundles—(Multishelf configuration only) Check to use the Multishelf Management Integrated Kit bundle when generating the BoM instead of the single items. As a bundle, a common price is quoted, which is lesser than when the items are listed individually.
- Use Global Discount—Check to allow you to edit the discount box (Global Discount).

- Global Discount—Enter the global discount to be applied to the whole BoM.
- Use Client Payg—Check to include license for client cards. This option is available only for AR-MXP and AR-XP cards. This check box is selected by default.
- Include SW License(s)—This check box is checked by default. The software license for the release is shipped with the Cisco ONS 15454 chassis.
- Include Paper Documentation—Check to ship paper documentation separately with the product and listed in BoM.
- Include CD Documentation—Check to ship CD documentation separately with the product and listed in BoM.
- Hide BoM price/discount—Check to hide the BoM discount and the individual unit price. Only the final price is displayed.
- Service Level—Choose the service level from the drop-down list.
- Service Level Num of Years—Choose the maintenance service level length (in years) from the drop-down list.

Step 5 Click **OK**.

1.6.5 Defining Third-Party DWDM Interfaces

Cisco Transport Planner allows you to define a third-party DWDM interface to be used in project creation. After you define third-party DWDM interfaces, you can choose them when creating traffic demands. For more information on defining third-party interfaces, see [Appendix D, “Third-Party DWDM Wavelength Interface Model.”](#)



Note

If you create a network design with a third-party interface and need to share the design with other users, you must provide not only the saved network MPZ file but also the exported database file containing the third-party interface definition. To view this project, the other user first must import the database with the third-party interface values.

Use the following procedure to define a third-party DWDM interface:

Step 1 Click **Tools > DB Parts Mgmt.** The DB Parts Manager dialog box appears.



Note You cannot open the DB Parts Manager if a project is open or if you are using the Base Network Designer profile.

Step 2 Right-click **Platform Parts** and choose **Expand** from the shortcut menu.

Step 3 Right-click **Group** and choose **New Group** from the shortcut menu. The new group appears under Group and in each system release under parts DB.

Step 4 In the Group Editor dialog box, complete the following information:

- Name of group—Enter the name of the new database.
- Note—(Optional) Enter a description of the group.

Step 5 In the parts DB for the desired system release, click the group that you created.

- Step 6** In the Parts tab of the DB Parts Manager dialog box, right-click and choose **Client** and then **Alien** from the shortcut menu. A new row appears on the Parts tab for the client hardware.
- Step 7** Double-click the row to open the Alien dialog box.
- Step 8** In the General tab of the Alien dialog box, type the name of the card in the **Name** field and then enter the **Label** name.
- Step 9** Click the **Instance** tab and complete the following:
- **Ansi PID**—Enter the product identifier of the ANSI system, as needed. If you select BoM visible for this third-party interface with ANSI PID completed, the third-party interface is included in the BoM with the related product identifier.
 - **Etsi PID**—Enter the product identifier of the ETSI system, as needed. If you select BoM visible for this third-party interface with ETSI PID completed, the third-party interface is included in the BoM with the related product identifier.
 - **TAG**—(Display only) For internal use.
 - **SYS. NAME ANSI**—Not applicable for third-party interfaces.
 - **SYS. NAME ETSI**—Not applicable for third-party interfaces.
 - **WL START**—Choose the wavelength starting range that the third-party interface supports from the drop-down list.
 - **WL END**—Choose the wavelength ending range that the third-party interface supports from the drop-down list.
- Step 10** Click the **Physical Ports** tab and in the Label column, type a label for each port.
The CTC Ports and TL1 Ports tabs are not applicable for third-party interfaces.
- Step 11** Click **Ok**.
- Step 12** In the Parts tab of the DB Parts Manager dialog box, right-click and choose **Software** and then **Alien** from the shortcut menu. A new row appears on the Parts tab for the client software.
- Step 13** Double-click the row to open the AlienSoft dialog box.
- Step 14** In the General tab, complete the following:
- **Name**—Enter the name in the Name field.
 - **Related Item**—Choose the client card that you created in [Step 7](#) to [Step 11](#).
- Step 15** Click any of the following depending on the client card that you choose and proceed to [Step 16](#):
- **Default - OCh** tab ([Figure 1-18](#))
 - **DPSK-OCh** tab
 - **QPSK-OCh** tab

Figure 1-18 AlienSoft Dialog Box, Default-OCH Tab

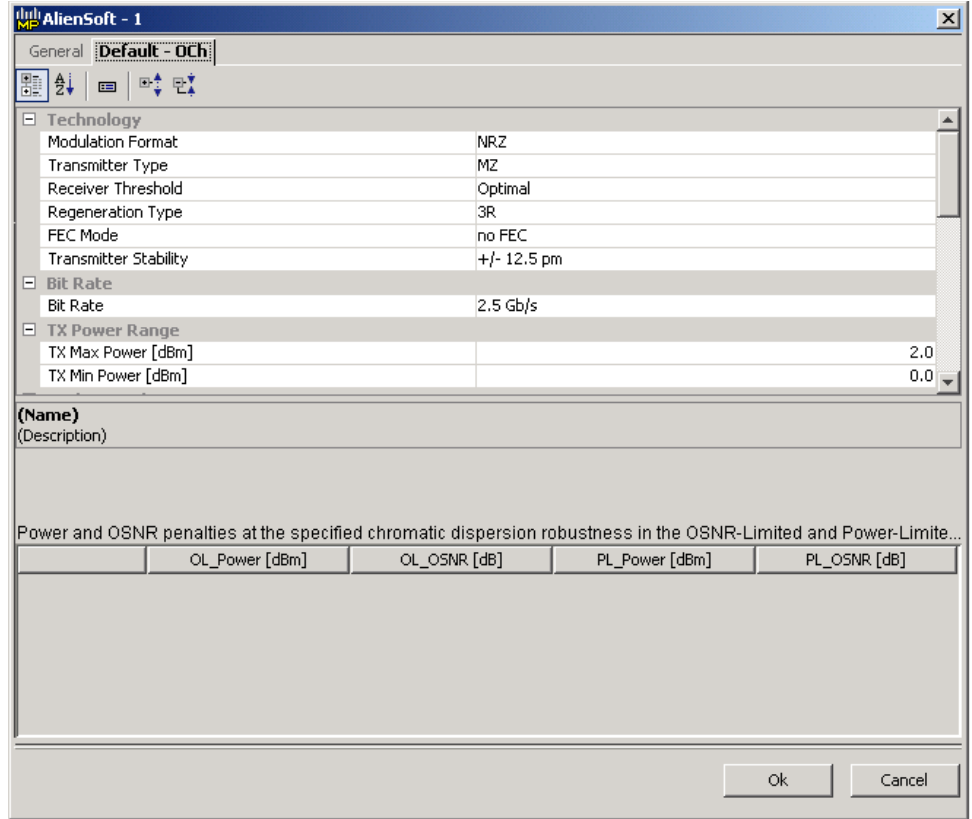

- Step 16** Complete the following (see Tables 1-2 through 1-4 for supported value combinations):
- In the Rules area, choose the C-band or L-band design rule from the Design Rule drop-down list.
 - In the Technology area, complete the following:
 - Modulation Format—Choose **NRZ** (Non Return to Zero) or **Duo Binary**.
 - Transmitter Type—Choose **MZ** (Mach Zehnder), **DML** (Direct Modulated Laser), or **EML** (Electro-absorption Modulated Laser).
 - Receiver Threshold—Choose **Optimal** (minimum BER) or **Average** (average received power).
For DPSK—Choose the Receiver Threshold as **Optimal**.
For QPSK—Choose the Receiver Threshold as **Average**.
 - Regeneration Type—Choose **3R** or **2R** regeneration mode.
 - FEC Mode—Choose **FEC** (Forward Error Correction), **no FEC**, or **E-FEC** (Enhanced FEC).
For DPSK or QPSK, set the FEC Mode to E-FEC.
 - Transmitter Stability—Choose the maximum wavelength error allowed (pm). The values are 12.5, 25, 50, or 100 pm.
 - Bit Rate—Choose the desired bit rate from the drop-down list. For DPSK or QPSK, choose the Bit Rate as 40 Gb/s.
 - In the TX Power Range area, complete the following:
 - TX Max Power—Enter the maximum power output level (dBm).
 - TX Min Power—Enter the minimum power output level (dBm).

- In the Back to Back Receiver Sensitivity area, complete the following as needed to define the working interface area for Back to Back. Back to Back is a configuration where the receiver is placed in front of the transmitter and no other equipment exists between the two. Back to Back is used to measure characteristics of the TX and RX pair. [Figure 1-19](#) shows the interface operative area.
 - Overload Power [ps/nm]—Enter the overload power level.
 - OL_Power [dBm]—Enter the minimum power level in the OSNR-limited range.
 - OL_OSNR [dB] on 0.5 nm RBW—Enter the minimum OSNR level in the OSNR-limited range (measured in 0.5 increments).
 - PL_Power [dBm]—Enter the minimum power level in the power-limited range.
 - PL_OSNR [dB] on 0.5 nm RBW—Enter the minimum power level in the OSNR-limited range (measured on 0.5 nm bandwidth).
- In the Chromatic Dispersion area, complete the following as needed:
 - Customize CD Robustness—Check to enable the CD Robustness field, as needed. Chromatic dispersion (CD) refers to the broadening of a light pulse after traveling a distance in the fiber.
 - CD Robustness [ps/(nm*km)]—If Customize CD Robustness is checked, choose the maximum positive dispersion, Dmax_pos [ps/(nm*km)], tolerable by the interface: 0 dB, 1 dB, 1.5 dB, 2 dB, or 3 dB.
- Customize Penalties—Check to enable the Gaussian cross-talk Penalties, Single-Interfering Cross-Talk Penalties, and Scale Q factors fields as needed.
- If Customize Penalties is checked, enter the values to determine the Gaussian cross-talk Penalties in the A_GXt and B_GXt fields, as needed. Gaussian cross talk refers to random power that interferes with a signal. The A_GXt and B_GXt values are the coefficients for the exponential curves that estimate P-penalty (PL), P-penalty (OL), OSNR-penalty (PL), and OSNR-penalty (OL) for Gaussian cross-talk levels in the OL and PL regions of the interface model with dispersion margins added (see [Figure 1-19](#)). The formula is $\text{Penalty (GXt)} = A_GXt * \exp(B_GXt * GXt)$.
- If Customize Penalties is checked, enter the values to determine the Single-Interfering Cross-Talk Penalties in the A_SIXt and B_SIXt fields, as needed. Single-interfering cross talk refers to interference caused by a single signal. The A_SIXt and B_SIXt values are the coefficients for the exponential curves that estimate P-penalty (PL), P-penalty (OL), OSNR-penalty (PL), and OSNR-penalty (OL) for single-interfering cross-talk in the OL and PL regions of the interface model with dispersion margins added (see [Figure 1-19](#)). The formula is $\text{Penalty (IXt)} = A_SIXt * \exp(B_SIXt * IXt)$.
- If Customize Penalties is checked, enter Scale Q values in the F-P(PL), F-P(OL), F-OSNR(PL), and F-OSNR(OL) fields, as needed. The scale factors measure how efficient a card is in recovering the signal distortion. The slope of the Q-factor curve versus OSNR or RX power determines how a BER increase could be recovered with an increase of OSNR, power, or both (depending in which OSNR/power working point the card is). In general, the scale factors are two values (one in OSNR and one in power) for each working point OL and PL of the interface model (see [Figure 1-19](#)). The the F-P(PL), F-P(OL), F-OSNR(PL), and F-OSNR(OL) values translate a Q-penalty (that is, a BER increase) into power and OSNR penalties. The formulas follow:
 - $\text{P-penalty(PL)} = \text{Q-penalty} * \text{F-P(PL)}$
 - $\text{P-penalty(OL)} = \text{Q-penalty} * \text{F-P(OL)}$
 - $\text{OSNR-penalty(PL)} = \text{Q-penalty} * \text{F-OSNR(PL)}$
 - $\text{OSNR-penalty(OL)} = \text{Q-penalty} * \text{F-OSNR(OL)}$

F-P(PL) and F-OSNR(PL) are evaluated in the PL working region, while F-P(OL) and F-OSNR(OL) are evaluated in the OL working region of the curve with the dispersion margins added.

Figure 1-19 Interface Operative Area

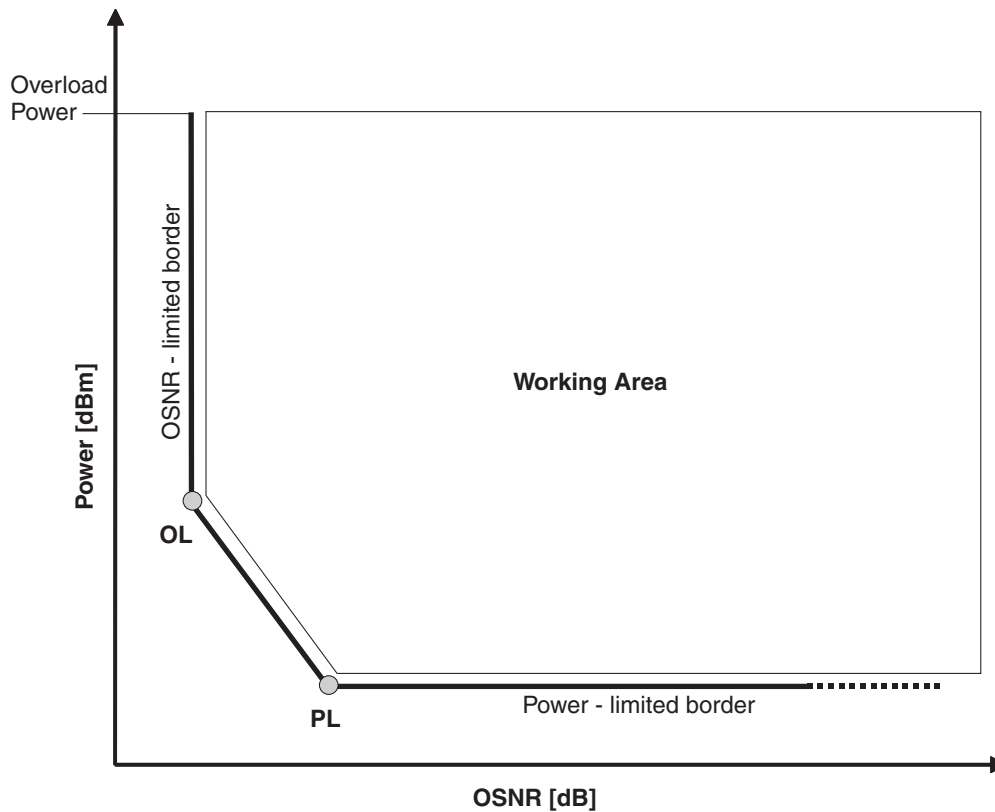

151731

Step 17 Click Ok.

Table 1-2 lists the supported combinations for 40-Gbps third party interfaces.

Table 1-2 Supported Combination for 40-Gbps Third-Party Interface

Modulation Format	TX Type	RX Threshold	FEC	TX Stability [pm]	Chromatic Dispersion Penalties [dBm]			
					P-penalty (OL)	OSNR-penalty (OL)	P-penalty (PL)	OSNR-penalty (PL)
Duo Binary	MZ	Optimal	E-FEC	± 12	0	1	0	1

Table 1-3 lists the supported combinations for 10-Gbps third party interfaces.

Table 1-3 Supported Combinations for 10-Gbps Third-Party Interface

Modulation Format	TX Type	RX Threshold	FEC	TX Stability [pm]	Chromatic Dispersion Penalties [dBm]			
					P-penalty (OL)	OSNR-penalty (OL)	P-penalty(PL)	OSNR-penalty (PL)
NRZ	MZ	Optimal	E-FEC	± 25	0	2	1	0
NRZ	MZ	Optimal	FEC	± 25	0	1.5	1	0
NRZ	MZ	Average	no FEC	± 25	2	0	2	0
NRZ	EML	Average	no FEC	± 100	0	3	3	0

Table 1-4 lists the supported combinations for 2.5-Gbps third party interfaces.

Table 1-4 Supported Combinations for 2.5-Gbps Third-Party Interface

Modulation Format	TX Type	RX Threshold	FEC	TX Stability [pm]	Chromatic Dispersion Penalties [dBm]			
					P-penalty (OL)	OSNR-penalty (OL)	P-penalty (PL)	OSNR-penalty (PL)
NRZ	DML	Average	FEC	± 25	0	2	2	0
NRZ	DML	Average	no FEC	± 25	0	2	2	0
NRZ	DML	Average	no FEC	± 25	3	0	3	0
NRZ	DML	Average	no FEC	± 25	3	3	3	3
NRZ	EML	Average	no FEC	± 25	0	2	2	0
NRZ	DML	Average	no FEC	± 100	0	3	3	0

1.6.6 Exporting User Options, Price Lists or Alien Definitions

Use the following procedure to export user options, price lists, maintenance contracts, and the parts database files. The export command creates a ZIP file that includes all of the created files.

-
- Step 1** From the Tools menu, choose **Export**. The Export dialog box appears.
- Step 2** In the Export dialog box, enter a file path and name in the file name field. To export to an existing file, click the ... button and navigate to the desired folder and file. Click **Select** to choose the file.
- Step 3** To select the items to export, complete the following as needed:
- User Option—Check to export the user options set using the Tools > Options command.
 - PartsDB—Check the desired platforms.
 - PriceDB—Check **All Price DB** to export all price lists, or expand All Price DB and check the individual price lists that you want to export.
- Step 4** Click **Ok**.
-

1.6.7 Importing User Options, Price Lists or Alien Definitions

Use the following procedure to import user options, price lists, maintenance contracts, and the parts database files. You can import a ZIP file of multiple exported items or an individual TXT file.

-
- Step 1** From the Tools menu, choose **Import**. The Import dialog box appears.
- Step 2** In the Import dialog box, click the ... button and navigate to the desired folder and file. Click **Select** to choose the file to import.
- Step 3** Click **load**.

- Step 4** If you selected a single TXT file, skip this step and go to [Step 5](#). If you selected a ZIP file with multiple exported options, complete the following as needed:
- User Option—Leave checked to import a file with the user options that were set with the Tools > Options command.
 - PartsDB—Leave checked to import the parts database for the desired platform.
 - PriceDB—Leave **All Price DB** checked to import all price lists, or uncheck and check the desired individual price lists.
- Step 5** Click **OK**.
- Step 6** In the confirmation dialog box, click **OK**.
-

1.6.8 Importing Osmine Configuration File

The Osmine configuration updates are provided in an Osmine configuration file. When a new Osmine configuration file is available, use this procedure to import it. The networks analyzed after the import operation will be OSMINE compliant as per the configurations provided in the Osmine configuration file.

- Step 1** From the Tools menu, choose **Osmine File Import**. The Select Osmine Config File dialog box is displayed.
- Step 2** Browse for the Osmine configuration file.
- Step 3** Click **Open**. The new configuration is loaded into CTP.
-

1.6.9 Resetting the Default Layout

Your graphical layout settings are saved when you exit Cisco Transport Planner. The next time that you launch Cisco Transport Planner, the layout appears as it did upon exiting. The default graphical layout includes items such as whether the panes are visible and/or docked.

To return to the Cisco Transport Planner default layout, choose **Default Layout** from the View menu. To restore the user modified layout, choose **My Default View** from the View menu.

1.6.10 Adding User Profiles

A user profile is a set of privileges used for running Cisco Transport Planner. Each profile offers different capabilities. Cisco Transport Planner is packaged with the Network Designer profile, but you can add other user profile types provided by Cisco. All the procedures in the *Cisco Transport Planner DWDM Operations Guide* are written for users with Network Designer access.

Use the following procedure to add a user profile to Cisco Transport Planner:

- Step 1** Close all open instances of Cisco Transport Planner.
- Step 2** Identify the folder where Cisco Transport Planner is installed on your computer, see the [“1.4 Launching the Cisco Transport Planner”](#) section on page 1-19.

- Step 3** Create a profile folder; if profile folder already exists, go to [Step 4](#).
- Step 4** Copy the profile JAR file provided by Cisco Systems into the profile folder.
- Step 5** Launch Cisco Transport Planner. For more information, see the “[1.4 Launching the Cisco Transport Planner](#)” section on page 1-19. The new profile will appear in the **Current Selected Profile** drop-down list.

1.6.11 Understanding Sides Labeling

In Cisco Transport Planner Software R8.5 and later, the label for each supported site structure is different from the labels that have been used in the previous releases. [Table 1-5](#) summarizes the labeling format in Cisco Transport Planner.

Table 1-5 Sides Labeling in Cisco Transport Planner

Sites	Labeling in Previous Releases	Default labeling in Cisco Transport Planner Software R8.5 and later
Terminal/Terminal+	Only one side is created and labeled, T.	Label A is used for the existing side.
Line/Line+	Two sides are created and are labeled, West and East.	Labels A and B are used for the existing sides.
Multidegree with PP-MESH-4	—	Labels A, B, C, and D are used for the existing sides.
Multidegree with PP-MESH-8	—	Labels A, B, C, D, E, F, G, and H are used for the existing sides.
PSM Line	—	Labels Aw and Ap are used for the existing sides, where w stands for working and p stands for protection.
PSM Section	—	Labels Aw and Ap are used for the existing sides, where w stands for working and p stands for protection.



Note

The default labels applied to the sides can be edited. For more information about editing side labels, see the “[4.4 Editing Side Labels](#)” section on page 4-39.

1.7 Understanding Hybrid Configuration

Typically a node has ONS 15454 MSTP configuration with add/drop units like 40-MUX-C/40-DMX-C, ROADM units and so on. However, the node configuration can also have ONS 15454 amplifiers along with ONS 15216 FlexLayer add/drop units like FLB-2s, FLA-8s, and FLD-4s, and is known as Hybrid 15454 ONS configuration. A network design can have up to 80 channels in a typical MSTP configuration; however, in a Hybrid configuration the number of channels is restricted to 40. In a Hybrid configuration, the Data Connection Network (DCN) manages the traffic instead of Optical Service Channel (OSC). Hybrid nodes are add/drop nodes with express traffic and are comparatively less expensive than MSTP nodes.

1.8 Understanding the Pay As You Grow Feature

The Pay As You Grow (PAYG) feature enables you to implement a cost effective solution when the wavelength requirements are comparatively less than the maximum capacity of the network. Instead of purchasing a standard card that is configured to work on maximum supported wavelengths, you can purchase a PAYG license that comprises of license restricted cards and a base license. The license restricted cards support only a number of wavelengths for which the licenses are installed on the card. The base license supports only 10 wavelengths. Therefore, a license restricted card having only the base license will support only ten wavelengths even if its maximum capacity is to support 40 wavelengths. The cost of the PAYG license is less than the cost of the standard card. For more information about the PAYG licenses, see the [Appendix F, “Pay As You Grow Licensing”](#).

When there is a need of more than ten wavelengths, additional licenses can be purchased to support the increased demand. Each new license supports ten additional wavelengths. Therefore, the PAYG functionality significantly reduces the initial setup cost and enables the purchase of additional wavelength capacity on a need basis.

During the analysis of the network, the CTP algorithm decides on whether to use a standard card or a PAYG license depending on the lower implementation cost.

The cards and units that support a PAYG bundle are:

- 40-SMR1-C
- 40-SMR2-C
- 80-WXC-C
- 15216-MD-40-ODD

The PAYG licensing is applied to each side of every site. The license depends on the cards placed on that side and the wavelengths that are added, dropped, or expressed. The PAYG licensing is not dependent on site, type, or functionality.

The applied PAYG bundle is displayed in the Bill of Material of the site. To view it, right-click the site in the Project Explorer pane and select the Bill of Material option from the shortcut menu.

The PAYG bundle to which a card is associated is displayed in the card property. To view it, select the card in the Project Explorer pane; the PAYG bundle name is displayed for the Payg Bundle property in the Properties pane.

1.8.1 Unlock Pay As You Grow Bundles

When a license restricted card is associated with a PAYG bundle, the association is maintained for future analysis. Therefore, if the network is analyzed with increased wavelength demands, CTP adds additional licenses even though using a standard card is cost effective.

During a network upgrade, the association of the license restricted card with the PAYG bundle is not modified unless the Unlock Pay As You Grow Bundle option is selected. Right-click the site either in the Project Explorer pane or in the NtView *Name* tab, and select the Unlock Pay As You Grow Bundles option from the shortcut menu. On selecting the Unlock Pay As You Grow Bundle option all the PAYG bundle information from a previous analysis are deleted and are recalculated when the network is analyzed again.



Note

The Unlock Pay As You Grow Bundle option is enabled only in the Upgrade or Install mode.

1.8.2 Forcing PAYG Bundles On a Card

The Developer and Optical Designer profile users can decide whether to associate a card with the PAYG bundle or not. Select the card in the Project Explorer pane; the Force Payg drop-down list is displayed in the Properties pane. The options available are:

- Auto—The PAYG bundle or the standard card is used based on cost effectiveness.
- Yes—The card is always associated with the PAYG bundle even if using the PAYG bundle is not the most cost effective solution.
- No—The card is never associated with a PAYG bundle even if using the PAYG bundle is a more cost effective solution.



Note

The Force Payg drop-down list is enabled only in the Upgrade and Install modes, when the card is in the locked state.



CHAPTER 2

Creating and Analyzing Networks

A project consists of a single network or multiple networks that you analyze and compare. In a project, you can have multiple copies of a single network with the same customer input data, but use different options in each to investigate multiple solutions.

2.1 Creating a Project

Use the following procedure to create a single network in a project. A new network is in the Design state. For more information about the different network states, see the [“2.10 Managing the Network Design” section on page 2-51](#).



Note

All options that the Project Creation wizard sets can be changed as needed, except Measurement Units and ANSI/ETSI.

- Step 1** From the File menu, choose **New** or click **New** in the Start Page. The Project Creation wizard appears (Figure 2-1).

Figure 2-1 Project Creation Wizard

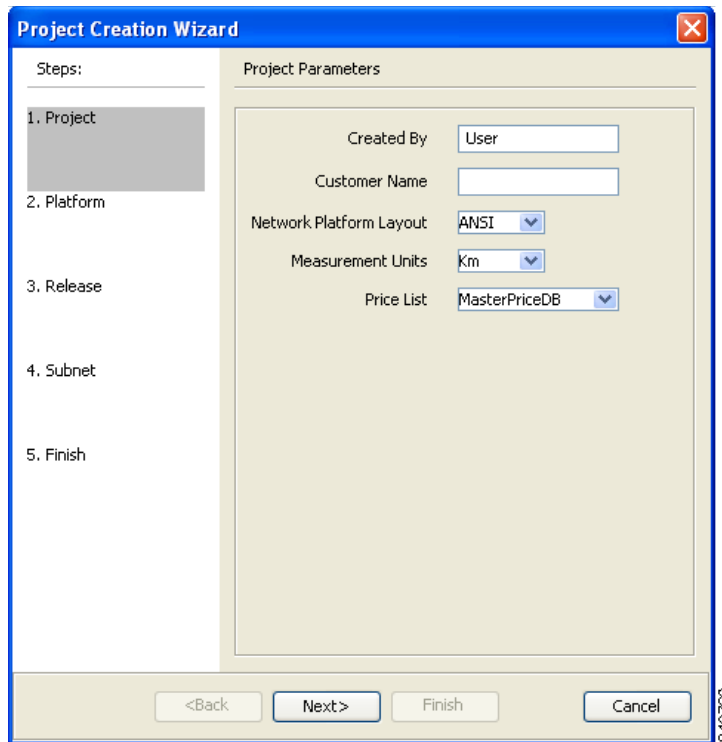

- Step 2** In the Project Parameters area complete the following:
- **Created By**—Enter a user name. You can enter a maximum of 128 character.
 - **Customer Name**—Enter the name of the customer requiring this network design. You can enter a maximum of 128 character.
 - **Network Platform Layout**—Choose **ANSI** (the North American standard) or **ETSI** (the international standard) from the drop-down list to indicate the platform type. ANSI networks will not allow you to define SDH (ETSI) service demands. ETSI networks will not allow you to define SONET (ANSI) service demands.
 - **Span Measurement Units**—Choose **Km** (kilometers) or **Miles** from the drop-down list to set the unit of measure used for span length.
 - **Price List**—Choose a price list from the drop-down list.
- Step 3** Click **Next**.
The Choose Platform area appears.
- Step 4** In the Choose Platform area, check the desired platform and click **Next**.
The Choose Release area appears.
- Step 5** In the Choose Release area, check the desired software release for the network design and click **Next**.
The Subnet Options area appears.
To set a default software release see “[1.6.2 Setting the Default Software Release](#)” section on page 1-27.

- Step 6** In the Subnet Options area, complete the following:
- Traffic Mapping Algorithm Release 9.4—Check to select the ONS 15454 Software R9.4 version of the interface and the wavelength routing optimization algorithm to be used in the network design. Software R9.4 is backward compatible: it allows you to manage Software Releases 8.5, 9.0, 9.1, 9.2, 9.2.1, and 9.3 and load 7.0 and 8.0.
 - Design Rules Release 9.4—Check to select DWDM Design Rules Release 9.4.
 - Layout Release 9.4—Check to define the ONS 15454 Software R9.4 version of the algorithm used to generate the layout of each site within the subnetwork. Software R9.4 is backward compatible: it allows you to manage Software Releases 8.5, 9.0, 9.1, 9.2, 9.2.1, and 9.3 and load 7.0 and 8.0.
 - Bundle Licensing Release 9.4—Check this check box to select the PAYG bundle licensing for Release 9.4. For more information about the Pay As You Grow (PAYG) feature, see the [“1.8 Understanding the Pay As You Grow Feature”](#) section on page 1-46.
- Step 7** Click **Next**.
- Step 8** Complete one of the following:
- To run the Network Creation wizard, check the **Run the Network Wizard Now** check box and click **Finish**. Continue with [Step 9](#).
 - To create an empty project to add sites and fibers manually, un-check the **Run the Network Wizard Now** check box and click **Finish**. Project Creation wizard creates the project and an empty network and subnetwork where you can manually add sites and fibers. Skip the remaining steps in this procedure. To add sites manually, see the [“2.2 Adding Sites”](#) section on page 2-10.
- Step 9** In the Topology area of the Network Creation wizard, choose one of the following options from the Network-Topology drop-down list:
- Ring—Supports both MSTP 15454 ONS and HYBRID 15454 ONS configurations.
-  **Note** In HYBRID 15454 ONS configuration, at least one node must be hub for the ring topology.
- Linear—Supports both MSTP 15454 ONS and HYBRID 15454 ONS configurations.
 - PSM Line—Supports only MSTP 15454 ONS configuration.
 - PSM Section—Supports only MSTP 15454 ONS configuration.
- Step 10** To instruct Cisco Transport Planner to automatically create a traffic subnet associated with the created network, check the Create Traffic Subnet check box. Cisco Transport Planner creates (in addition to the Traffic_ALL) an additional traffic subnet (Traffic_Ring or Traffic_Linear) depending on the topology value you specify in the Network Creation wizard.
- Step 11** Click **Next**.
The Configuration page appears.
- Step 12** Choose one of the following options from the node type drop-down list:
- MSTP 15454 ONS—To create an MSTP 15454 configuration.
 - HYBRID 15454 ONS—To create a 15216 FlexLayer Hybrid configuration.
- 15216 FlexLayer Hybrid configuration cannot be mixed with the 15454 MSTP configuration. However, a network can have two clusters one being MSTP and the other 15216 hybrid, without any connection between the two.

**Note**

For PSM Line and PSM Section topologies, the only possible configuration is MSTP 15454 ONS and the node type drop-down list is disabled.

- Step 13** Enter the number of sites in the fields displayed depending on the network topology selected in [Step 9](#). The following options are available:

Network topology	Fields to be entered...	Maximum, Minimum, and Default Number of Sites
Ring or Linear	Number of Sites	Maximum: 150 Minimum: 2 Default: 3
PSM Line	<ul style="list-style-type: none"> Intermediate Sites on Working path Intermediate Sites on Protected path 	Both for working and protected paths: Maximum: 74 Minimum: 0 Default: 0
PSM Section	<ul style="list-style-type: none"> Intermediate Sites on Working path Intermediate Sites on Protected path 	Both for working and protected paths: Maximum: 74 Minimum: 0 Default: 0

The maximum number of locations where the optical service channel (OSC) can be terminated in a network is 150. The maximum number of add/drop locations (equipped with WSS, WXC, multiplexer/demultiplexer, or OADM cards) traversed by an optical circuit is by default limited to 40. However, this maximum limit can be customized to 150.

- Step 14** On the Site Name and Topology area, choose the topology for each site from the drop-down list. For multi-degree sites, choose the number of sides from the drop-down list or see [2.2 Adding Sites, page 2-10](#). Available Site Topology options are:

Structure	Supported Configurations	Description
Line	<ul style="list-style-type: none"> MSTP 15454 ONS HYBRID 15454 ONS 	Site with two sides facing two fiber spans. The default site value for ring topology is Line.
Terminal	<ul style="list-style-type: none"> MSTP 15454 ONS HYBRID 15454 ONS 	Site with one side facing one fiber span.
Line+	MSTP 15454 ONS	Site with two sides facing two fiber spans that can provide multidegree expansion capability through an MMU unit.

Structure	Supported Configurations	Description
Terminal+	MSTP 15454 ONS	Site with one side facing one fiber span that can provide multidegree expansion capability through an MMU unit. Terminal+ is not allowed for ring network or linear network topology intermediate sites.
Multi-degree	MSTP 15454 ONS	Sites have two or more sides and face two or more fiber spans. The default is two and you can choose up to eight sides for a site.
PSM Terminal - Optical Path Protection	MSTP 15454 ONS	Provides protection for terminal sites at line level through an optical protection switching module (PSM). In this configuration, the PSM is directly connected to the fibers after the amplification stage.
PSM Terminal - Multiplex Section Protection	MSTP 15454 ONS	Provides protection for terminal sites at multiplex level through an optical protection switching module (PSM). In this configuration the PSM is equipped between the mux/demux stage and the amplification stage.

The site topology options displayed depend upon the restrictions listed in the following table. See [Table 2-1](#).

Table 2-1 Site Topology Restrictions

If the Network Topology is...	then...
Ring	You cannot choose the following options: <ul style="list-style-type: none"> • Terminal • Terminal+ • PSM Terminal - Optical Path Protection • PSM Terminal - Multiplex Section Protection
Linear	You cannot choose the following options: <ul style="list-style-type: none"> • Terminal for the intermediate sites • Terminal+ for the intermediate sites • PSM Terminal - Optical Path Protection • PSM Terminal - Multiplex Section Protection
PSM Line	You cannot set any topology for the sites. CTP automatically sets the site topology as follows: <ul style="list-style-type: none"> • PSM Terminal - Optical Path Protection for the two PSM sites • Line for the intermediate sites
PSM Section	You cannot set any topology for the sites. CTP automatically sets the site topology as follows: <ul style="list-style-type: none"> • PSM Terminal - Optical Path Protection for the two PSM sites • Line for the intermediate sites

Step 15 Click **Next**

The Options area appears.

Step 16 The Options area allows you to define C-band and L-band rules for the network design. In the Options area complete the following:

- C-band rules—The C-band options appear in the following format: 80Ch. 50 GHz +1dBm. The channels available are 80, 72, 64, 40, 32, 20, 16, or 8; the reference per channel power options available are -1 dBm, +1 dBm, 2 dBm, -2 dBm, +4 dBm, 5 dBm, 7 dBm and 8 dBm; and the spacing options available are 100 GHz or 50 GHz. You can use even wavelengths for the following channel designs:
 - 80 (40 even wavelengths + 40 odd wavelengths)
 - 72 (40 even wavelengths + 32 odd wavelengths)
 - 64 (32 even wavelengths + 32 odd wavelengths)



Note L-band Expand is also supported in the 50 GHz even wavelengths design.



Note For the HYBRID 15454 ONS configuration, 32 channels is the default value. The channels available are 8, 16, 20, 32, and 40.

- L-band Rules— The L-band options appear in the following format: 32 Ch. 100 Ghz +5dBm. The options available are: None, Expand, and channels available are 32; the reference per channel power available are 2 dBm and 5 dBm; and, the spacing options available is 100 GHz.



Note L-band is not applicable for the HYBRID 15454 ONS configuration.



Note If you use a Line+ or Multidegree site, you must select design rules based on 100 GHz channel spacing, and in the case of Line+, you must also select 32-channel rules. If these conditions are not met, Cisco Transport Planner will provide an error message when you attempt to analyze the network. See [Table 4-1](#) and [Table 4-2](#) for additional details on site design rules.

Step 17 Click **Next**

The Site Management area appears.

Step 18 In the Site Management area, complete the following.

- Shelf Management—Choose one of the shelf management configurations:
 - Auto—External switch is placed if node controller is M12. If M6 is the node controller, the external switch is placed only if it is required.
 - Multi Shelf Integrated Switch—All the Multi Service Transport Platform (MSTP) optical cards (optical add/drop multiplexers [OADMs] and amplifiers) reside in different shelves connected by a LAN. The LAN is implemented with switches connected to the MSTP shelves. For this option, the Multi Shelf Integrated Switch Cards (MS-ISC) are used to support the multishelf configuration.
 - Multi Shelf External Switch—All the MSTP optical cards (OADMs and amplifiers) reside in different shelves connected by a LAN. The LAN is implemented with switches external to the MSTP shelves (Cisco Catalyst 2950). For this option, two external Ethernet switch units

(Cisco Catalyst 2950 and Cisco Catalyst 3650) are used to support the multishelf configuration. The Cisco Catalyst 2950 supports 12 subtending shelves and Cisco Catalyst 3650 supports 24 subtending shelves. CTP supports a maximum of 30 shelves, including the node controller shelf, in a multishelf configuration.



Note When the Multi Shelf External Switch is forced, the Multi Shelf External switch is placed in the layout irrespective of the node controller.



Note The M6 chassis, when used as node controller, can support three subtended shelves. The subtended M6 chassis can subtend two more shelves.

- Individual Shelf—All the MSTP optical cards (OADMs and amplifiers) reside in the same shelf. For this option, the multishelf management is not supported; every shelf is managed as an independent shelf.



Note Shelf Management is disabled for HYBRID 15454 ONS configuration.



Note If you select the Shelf Management type as Multi Shelf Integrated Switch or Multi Shelf External Switch, you can modify the MSM Shelf ID for Multi Shelf Management Configuration. To modify the MSM Shelf ID, refer [“3.2.6 Viewing the Layout of Single Site” section on page 3-16](#).

- Node Protection—Choose **Same Shelf** (single shelf configurations) or **Separated Shelves** (multishelf configurations). Same Shelf configuration places all the OADM/ROADM units in a single shelf, and does not provide any protection at the shelf level in the node. Separated Shelves places OADM/ROADM units (west-facing and east-facing) in separate shelves in the node and it is selectable only if Multishelf management is selected. You can also set node protection for a multidegree node.



Note Node protection is disabled for HYBRID 15454 ONS configuration with an auto-selected value of Same Shelf.

- Hybrid Site Config—Check to create all the nodes configured as hybrid MSTP/Multi Service Provisioning Platform (MSPP) nodes. Hybrid Node is only available if you chose Individual Shelf as the Shelf Management type.
- OSMINE Compliant—Check this option to place the DWDM units in the shelves according to Operations Systems Modifications for Integration of Network Elements (OSMINE) placement rules.
- DCC Chain—Check to put a TXP(P)_MR_2.5G card in slot 12 on each shelf of each site to use DCC.
- Max Shelves per Rack—Choose the maximum number (from 1 to 4) of ANSI or ETSI shelves (equipping optical cards or TXP/MXP cards) that can be placed in each rack in the site when generating the layout of the site.
- Installation w/o CTP—Check this box to design a network that does not require the setup of configuration files (thresholds and setpoints). Installation without Cisco Transport Planner is also known as automatic node turn up. When this feature is enabled, the software in the node will configure

itself with parameters; XML configuration files are not required to configure the node. When this option is selected at the end of EDFA and DCU placement, Cisco Transport Planner will analyze the resulting network and verify that in each node, where the option installation w/o Cisco Transport Planner is enabled, has:

- A preamplifier in each direction.
- All amplifiers working in gain control mode.
- A flat node output spectrum, that is, the resulting channel tilt at the exit of the node is 0.
- A feasible set point forced during simulation.
- Use Payg—Check this check box to enable the Pay As You Grow feature on all the sites created in the current network. For more information about the Pay As You Grow feature, see the [“1.8 Understanding the Pay As You Grow Feature” section on page 1-46](#).

Step 19 Click **Next**.

The Span Parameters area appears.

Step 20 In the Span Parameters area, complete the following.

- Span Label Tag—Enter the desired span label.
- Span Fiber Type—Choose the fiber type for each span in the network.
- Span Length—Enter the span length. The displayed unit of measure is retrieved from the Span Measurements Units field.
- EOL Ageing Factor—Enter the number to use when factoring fiber aging. This factor is multiplied by the SOL total span loss without connectors.
- EOL Ageing loss [dB]—Enter the EOL aging loss value. The EOL loss-per-span value is added at the end of life to each discrete fiber in the network (for example, to add an EOL margin for splicing).



Note Enter a value in either EOL Ageing Factor or EOL Ageing loss; you do not need to enter a value in both fields. Use one of the following formulas to calculate the fiber loss at SOL:

$$\text{SOL} = \text{km} * \text{dB/km} + (2 * \text{connector loss})$$

$$\text{SOL} = \text{user entered loss} + (2 * \text{connector loss})$$

Use one of the following formulas to calculate the fiber loss at EOL:

$$\text{EOL} = \text{km} * \text{dB/km} * \text{EOL Aging Factor} + (2 * \text{connector loss}) + \text{EOL Aging Loss}$$

$$\text{EOL} = \text{user entered loss} * \text{EOL Aging Factor} + (2 * \text{connector loss}) + \text{EOL Aging Loss}$$

- Connector loss [dB]—Enter the concentrated loss at the end of the span.
- CD factor [ps/mn/km]—Enter the fiber chromatic dispersion (CD) factor. The default value is dependent on the selected fiber type. Any value that you enter in this field is lost whenever you change the fiber type. Chromatic dispersion is always entered in ps/nm/km. Fiber chromatic dispersion is defined for the middle of the wavelength band. C-band is defined at 1545.3 nm and L-band is defined at 1590.4 nm.
- PMD factor [ps/sqrt(km)]—Enter the polarization mode dispersion (PMD) factor. The default value is dependent on the selected fiber type. Any value that you enter in this field is lost whenever you change the fiber type. PMD is always entered per kilometer.
- Length Based Loss—If this check box is checked, the fiber loss is determined by multiplying the Span Length with the Loss Factor. If this check box is unchecked, you must enter the total span loss value for the Tot SOL Loss w/o Connectors property.
- Loss factor [dB/km]—Enter the value of the SOL fiber loss per kilometer that is used to calculate the loss of each span in the network. The fiber loss factor is always entered in dB/km.

- Tot SOL Loss w/o Connectors—Enter the start of life fiber loss value for each span, excluding the connector concentrated loss.
This property is disabled if the Length Based Loss check box is checked.
- DCN extension—Check this check box to use DCN extensions on each of the spans in the network. This implies that the OSC channel is not used to connect the two nodes. All nodes facing a span with the DCN Extension option enabled require a ITU-T G.709 generic communications channel (GCC) access that must be provided by the customer.



Note For HYBRID 15454 ONS configuration, this option is disabled by default.

- OSC Frame Type—Choose the OSC frame type. The options available are Auto, OC3 Frame, GE Frame, and FE Frame. The default option is Auto.



Note

- CTP does not allow connecting different types of frames through a pass-through site.
- CTP does not allow removing a node if different frame types are used in the node.

Step 21 Click **Finish**. CTP checks the validity of the fiber factor values. If the fiber factor values are within the valid range (Table 2-2), CTP creates a visual representation of the network. If the values are out of range, CTP issues a warning, asking you to confirm the input values.



Note

All options set by the Network Creation wizard can be changed as needed per site and per span.

Table 2-2 Valid Ranges for Fiber Factor Values

Fiber Type	Parameter	Min. Error Value	Min. Warning Value	Default Value	Max. Warning Value	Max. Error Value	Unit
ITU-T G.652-SMF	Loss factor	0	0.2	—	0.4	10	dB/km
	Chromatic dispersion factor at 1545.3 nm (C-band)	0	16.2	16.7	17.1	30	ps/nm/km
	Chromatic dispersion factor at 1590.4 nm (L-band)	0	18.53	19.03	19.43	30	ps/nm/km
	PMD factor	0	0.0	0.1	0.5	10	ps/(√km)
ITU-T G.655-E-LEAF	Loss factor	0	0.2	—	0.4	10	dB/km
	Chromatic dispersion factor at 1545.3 nm	0	3.4	3.80	4.2	10	ps/nm/km
	PMD factor	0	0	0.1	0.5	10	ps/(√km)

Table 2-2 Valid Ranges for Fiber Factor Values (continued)

Fiber Type	Parameter	Min. Error Value	Min. Warning Value	Default Value	Max. Warning Value	Max. Error Value	Unit
ITU-T G.655-True Wave	Loss factor	0	0.2	—	0.4	10	dB/km
	Chromatic dispersion factor at 1545.3 nm	0	3.8	4.19	4.6	10	ps/nm/km
	PMD factor	0	0	0.1	0.5	10	ps/(√km)
ITU-T G.652-DS (Dispersion shifted)	Loss factor	0	0.2	—	0.4	10	dB/km
	Chromatic dispersion factor at 1590.4 nm (L-band)	0	2.43	2.83	3.23	30	ps/nm/km
	PMD factor	0	0	0.1	0.5	10	ps/(√km)

2.2 Adding Sites

Use the following procedure to add new sites to an existing network. A site is a customer premise equipment (CPE) where any equipment can be co-located in a rack within a building. The Cisco Transport Planner supports up to 150 sites in a network. The number of racks and nodes in a site is independent of the number of sites in the network. The maximum number of locations where the OSC can be terminated in a network is 40. When the number of locations where the OSC is terminated exceeds the maximum supported value, the tool completes the design, but in the summary report an alarm is reported to indicate this situation. The maximum number of add/drop locations in a network is 40. The maximum number of add/drop locations (equipped with WSS, WXC, multiplexer/demultiplexer, or OADM) traversed by an optical circuit is limited to 40.



Note

Every new site added to a design is automatically configured as Multi-Shelf Integrated Switch with Same Shelf protection. To change this, you can edit the site properties after adding it to the network design. See the “4.3 Editing Site Parameters” section on page 4-2.

-
- Step 1** Right-click the network folder in the Project Explorer pane and choose **Expand** from the shortcut menu.
- Step 2** Right-click the Sites folder and choose **New Site** from the shortcut menu. The Site Creation wizard appears. As an alternative, if sites already exist in the network design and you have the NtView *Name* tab open, click the **Create a new site** icon in the toolbar. For more information about the Cisco Transport Planner icons, see [Appendix A, “GUI Information and Shortcuts.”](#)
- Step 3** Choose the type of node from the Node Type drop-down list. The options available are:
- MSTP 15454 ONS
 - HYBRID 15454 ONS

- Step 4** Choose the type of interface from the Select line or terminal site drop-down list. The options available are:
- **Line**—Two pairs of fibers are terminated at the node.
 - **Terminal**—A single pair of fibers is terminated at the node.
 - **Line+**—Two pairs of fibers are terminated at the node but the number of fibers can be increased. An MMU card (topology upgrade) must be installed.
 - **Terminal+**—A single pair of fibers is terminated at the node but the number of fibers can be increased. An MMU card (topology upgrade) must be installed.
 - **Multi-degree**—Nodes have two or more sides and face two or more fiber spans.
 - **PSM Terminal - Optical Path Protection**—Provides protection for terminal sites at Line level through an optical protection switching module (PSM). In this configuration, the PSM is directly connected to the fibers after the amplification stage.
 - **PSM Terminal- Multiplex Section Protection**—Provides protection for terminal sites at multiple levels through an optical protection switching module (PSM). In this configuration the PSM is equipped between the mux/demux stage and the amplification stage.



Note In the HYBRID 15454 ONS configuration, the supported interface types are line and terminal.

- Step 5** If you chose multi-degree in [Step 4](#), choose the number of sides from the No of Sides drop-down list. The default option is two.
- Step 6** Click **Finish**.
-

2.3 Adding Fiber Spans

Use the following procedure to manually add fiber spans between sites. A fiber span consists of a pair of fibers (one transmit and one receive) between two sites. A span is represented by a fiber duct in the *NetViewName* tab. Within a fiber duct, more than one fiber pair can exist.



Note The number of fiber spans that each site can support is defined in the site properties. See the [“2.2 Adding Sites”](#) section on page 2-10 or the [“4.3 Editing Site Parameters”](#) section on page 4-2.

- Step 1** In the *NtView Name* tab, click the Create a new duct icon in the toolbar. For more information about the Cisco Transport Planner icons, see [Appendix A, “GUI Information and Shortcuts.”](#)
- Step 2** Click one of the sites that you want to connect with a fiber span. This site becomes the source site for later network analysis output.
- Step 3** Click the destination site. This becomes the destination site for later network analysis output. For the first span, the source site is set as A and the destination site is set as B. Cisco Transport Planner automatically adjusts East and West for additional spans.
HYBRID 15454 ONS configuration cannot be connected to the 15454 MSTP configuration. However, a network can have two clusters one being MSTP and the other 15216 hybrid, without any connection between the two.

The New Duct dialog box appears.



Note To connect any two sites using a duct, both the source and destination sites must have at least one unconnected side.

Step 4 Choose the Connection Type:

- Line
- Remote Add/Drop

A Remote Add/Drop duct can be created only between a terminal site and the Remote Add/Drop side of any non-terminal site.

The remote terminal site to which the remote add/drop side is connected, must fulfill the following site functionality, type and equipment constraints in addition to the rules in [Table 4-1](#) and [Table 4-2](#):

- Site functionality must be Auto or Add/Drop.
- Site type must be Auto or Mux/Demux.
- Add/Drop units can be 40-MUX-C/40-DMX-C, 15216-MD-40-ODD or 15216-MD-40-EVEN.

For more information see [4.21 Modifying Site Properties, page 4-111](#).

Step 5 Choose the side(s) of the source and destination site to connect.

If you chose **Line** in [Step 4](#), only the line sides are displayed here. If you chose **Remote Add/Drop**, the line side is displayed for the terminal site, while the combo-box of the other site lists the site's unconnected Remote Add/Drop ports.

2.4 Creating an Optical Subnet

An optical subnet is a collection of spans with certain associated, defined, common properties. You can define distinct optical subnets on the same network and can also set a list of associated properties on each of them.

The following properties are supported in an optical subnet:

- C-band Rules—Allows you to define rules for the C-band channels, the maximum per channel power, and the channel spacing for the design.
- L-band Rules—Allows you to define, for the L-band channels, the maximum per channel power, and the channel spacing for the design.

When you create a new project (see [2.1 Creating a Project, page 2-1](#)), Cisco Transport Planner automatically creates an optical subnet associated to the network. At least one optical subnet (even if empty) must exist for each network in a project.

You can create an optical subnet using the Project Options (default) Optical Subnet property (Design Rules) values. To do this:

- Step 1** Select the **Optical Subnet** folder in the Project Explorer pane. The Optical Subnet Pane appears in the Task Pane on the right side of the screen (Figure 2-2).

Figure 2-2 Creating Optical Subnet

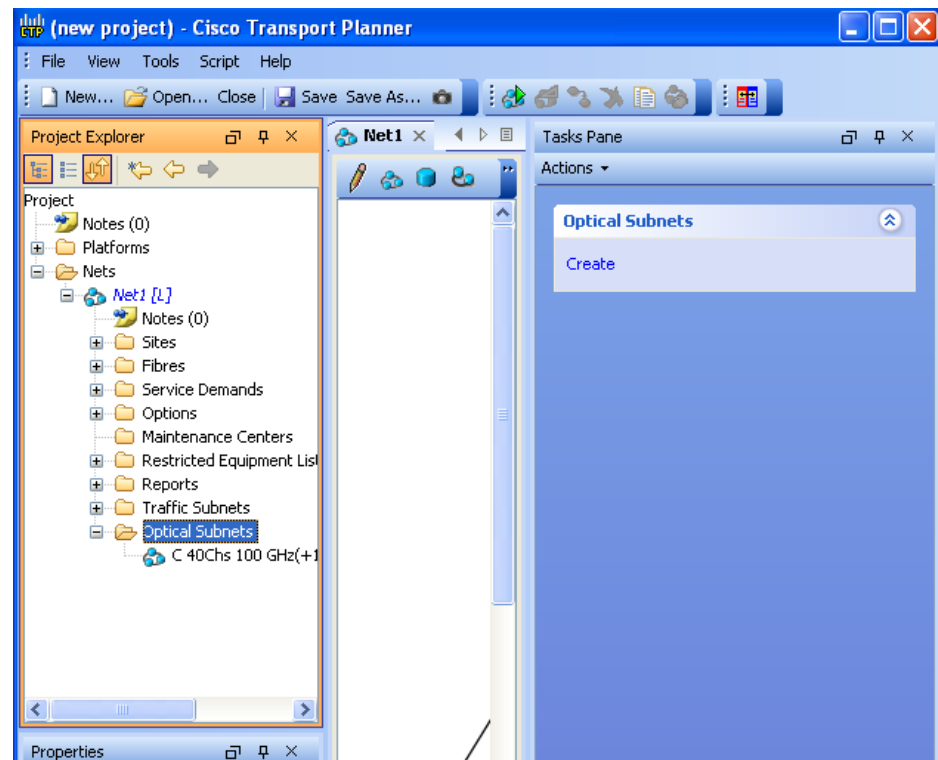

- Step 2** Click **Create**. The **Create Optical Subnet** dialog box appears (Figure 2-3). Alternatively, right-click the **Optical Subnets** folder and select **Create**. The default name, which is a combination of the user-created C-band and L-band rules, and the wizard-created default C-band and L-band rules are displayed.

Figure 2-3 Create Optical Subnet Dialog Box

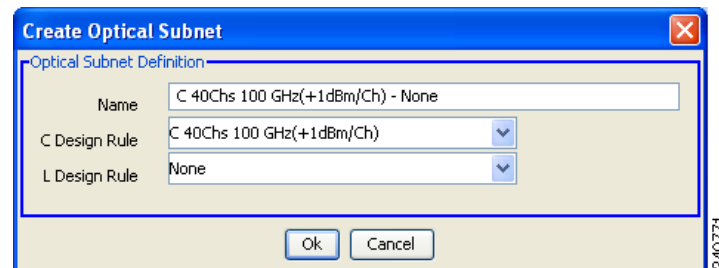

- Step 3** Select C-band and L-band design rules from the C Design Rule and L Design Rule drop-down lists for the new optical subnet that you want to create.
- Step 4** Click **OK**. A new optical subnet with the design properties you selected is created and placed in project explorer under the Optical Subnets folder.

**Note**

You cannot create more than one optical subnet with the same properties values and each span must be part of only one optical subnet.

Cisco Transport Planner allows you to do the add or remove spans, edit designs rules, define an optical subnet as current, and to delete an optical network. To do these, select the optical subnet you want to change under Optical Subnets in the Project Explorer pane. In the Tasks Pane, choose the following:

- Add/Remove Spans—Adds or removes the spans that are included in a given optical subnet.
- Edit Design Rule—Modifies the property value of the design rule of a new or existing optical subnet.
- Set as Current—CTP automatically defines the optical subnet with the greatest number of spans.
- Delete—Deletes the optical subnets in the Tasks Pane.

**Note**

When you delete an optical subnet, all the spans contained in the deleted optical subnet are placed within the current optical subnet. In case the current optical subnet is deleted, all their spans will be automatically placed within the optical subnet with the greatest number of spans. When the current optical subnet is removed, the tool automatically defines as current the optical subnet with the greatest number of contained spans.

2.5 Adding Notes to a Project

Use the following procedure to add a note to any item in the Project Explorer pane. Each network has a Notes folder in the Project Explorer pane. After you have created a note, it appears in the Notes folder for that particular network.

-
- Step 1** Right-click the desired item in the Project Explorer pane and choose **Edit Note** from the shortcut menu.
- Step 2** In the Edit Note creation box, enter the desired text.
- Step 3** To close the Edit Note creation box and to save the note, click the **X** in the upper right corner of the window.

- Step 4** To view notes, double-click the **Notes** folder. The Notes window appears. [Table 2-3](#) lists the columns in the Notes window.

Table 2-3 Notes Window

Column	Description
Header	Displays the note text. To view the entire note, click the plus (+) sign next to the header to expand the text.
Action	Click Go to open the item in the Project Explorer pane where the note was created.
Source	Displays the location of the note, for example, ProjectManager.Nets.Net2.Sites.Site2.W.

- Step 5** To close the Notes window, click the **X** in the upper right corner of the window.

2.6 Creating Traffic Subnet

- Step 1** In the Project Explorer pane, scroll down to Traffic Subnets. Right-click Traffic Subnets, and select **Create**.

The Traffic Subnet Creation wizard appears.

- Step 2** Select the Topology for the subnet from the drop-down list (**Ring**, **Linear**, and **Mesh**), then click **Next**.



Note If Ring or Linear topology is selected for the subnet, the spans in the subnet must be adjacent and also ordered.

- Step 3** Click **Press** to build new subnet. The Traffic Subnet Builder Wizard appears ([Figure 2-4](#)).

- Step 4** Select the ducts that should be a part of the subnet from the list displayed on the left handside, and click **OK**. This takes you back to the Traffic Subnet Creation Wizard.

- Step 5** Click **Finish** to complete the creation of the traffic subnet. The created subnet appears under Traffic Subnets in the Project Explorer pane.

Figure 2-4 Traffic Subnet Builder Wizard

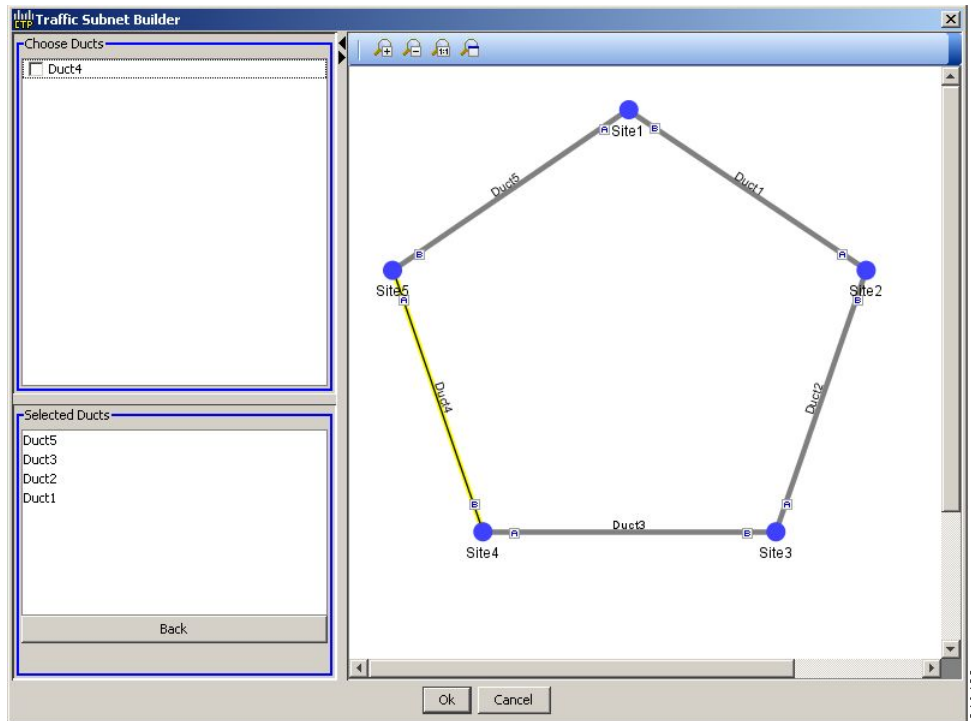

2.7 Creating a Demand

Cisco Transport Planner provides five types of service demands:

- Point-to-point
- Protected ring (P-ring)
- ROADM
- Ethernet aggregated
- TDM aggregated

You can also create regeneration sites while creating a service demand.

2.7.1 Manual Regeneration

In optical networks, as the fiber length increases, a loss in the signal ratio and power could occur due to attenuation and dispersion. A regenerator is required to recreate the weak and distorted optical signals through reamplification, regeneration, and retiming processes. The regenerators remove noise and distortion, convert the optical signal to an electrical signal, and then convert the signals back to optical signals (O-E-O conversion).

Cisco Transport Planner supports the creation of regeneration sites in the network. Regeneration is supported for the following demands:

- Point-to-point
- P-ring
- Ethernet Aggregated
- TDM Aggregated

The demand is displayed in the following manner:

Demand > Service > Trail > Section

- “Service” is the circuit through which traffic flows between nodes.
- “Trail” is the network section joining two traffic nodes. By default, a trail has only one section. The trail can be split in different regeneration sections.
- “Section” is a contiguous subset of the span.

A new section is added whenever a regeneration site is created. The sections can have different wavelengths based on availability. Regeneration can be performed using any two cards back-to-back (OTU2_XP, TXP, or MXP) or with a dedicated regenerator card.

2.7.2 Understanding Omnidirectional Functionality

The omnidirectional functionality on a side enables you to connect the side to a local multiplexer and demultiplexer that can add or drop traffic to or from any of the node directions. Omnidirectional traffic can be added or dropped only on the omnidirectional side.

Omnidirectional sides are different from standard add/drop sides in the following ways:

- Omnidirectional sides are internal sides that cannot be connected through fibers or ducts.
- Amplifiers on omnidirectional sides are placed between the 80-WXC-C card (bidirectional mode) and the Add/Drop (Mux/Demux) units.
- Raman amplification is excluded on omnidirectional sides, as the amplification depends on the Raman Amplified option on a duct.

Multi-degree sites that use the OXC functionality and are equipped with the following equipment can support omnidirectional sides:

- 40-WXC-C/MESH-PP-4
- 40-WXC-C/MESH-PP-8
- 80-WXC-C/MESH-PP-4
- 80-WXC-C/MESH-PP-8
- Flexible (nodes equipped with 80-WXC-C and 40-WXC-C equipment)
- 40-SMR2-C

Multi-degree OXC sites equipped with 40-WXC-C or 40-SMR2-C units can support both omnidirectional sides and the Omnidir Entry Point options. However, both options cannot be used on the same side.

For more information see the [“Modifying Site Properties”](#) section on page 111.

2.7.2.1 Omnidirectional Demands

In all service demands (except ROADM demands), the value of the omnidirectional property is independent for each section or trail of a service.

You can perform operations at the trail level. The following are some examples:

- Terminate a working trail on the omnidirectional stage, and connect the protected trail to a standard add/drop stage.
- Terminate a trail on a line side and regenerate the trail in an intermediate omnidirectional side.
- Force both working and protected trails (or consecutive trails in the case of a P-Ring demand) to terminate on the same omnidirectional side. By default, traffic from all demands (except ROADM demands) terminates on two different omnidirectional sides.

The omnidirectional property is available for the source and destination of each section of a service trail. A section terminating on an omnidirectional side can be routed in all possible directions. If multiple omnidirectional sides are available for a site, you can force the section to terminate on a specific side.

2.7.3 Understanding Colorless Functionality

The colorless property enables tuning of channel wavelengths without changing the optical interface of the port. A colorless side is connected to two 80-WXC-C cards configured as a multiplexer and demultiplexer.

A colorless stage is available at the local add/drop stage on line, terminal, or multi-degree sites. In line and terminal sites, you can implement colorless sides using the following configurations:

- Line or terminal ROADM site with 80-WXC-C cards



Note For line sites, you must have 80-WXC-C cards on both sides even when only one of the ports is forced as colorless.

- Line or terminal sites equipped with 40-SMR1-C
- Line or terminal sites equipped with 40-SMR2-C

In multi-degree sites you can implement colorless sides through a node having OXC functionality and are equipped with the following:

- 40-WXC-C/MESH-PP-4
- 40-WXC-C/MESH-PP-8
- 80-WXC-C/MESH-PP-4
- 80-WXC-C/MESH-PP-8
- 40-SMR2-C

2.7.3.1 Colorless Demands

In all service demands (except ROADM) the colorless property is available separately for each trail and section of a service demand.

For example, in a P-ring demand you can terminate one trail on a colorless mux/demux stage and connect the other trail to a standard (colored) mux/demux stage.

Colorless sections must be associated to an 80-WXC-C colorless port and can be terminated on sides having colorless add/drop ports to achieve full wavelength tuning capability on fixed physical ports.

2.7.4 Understanding Colorless Omnidirectional Functionality

A colorless and omnidirectional side is connected to a multiplexer (80-WXC-C card) and demultiplexer (80-WXC-C card) that can add or drop traffic to or from any of the node directions. You can define an omnidirectional colorless side by adding one or more colorless ports to an omnidirectional side.

In all service demands (except ROADM), you can configure colorless termination points as omnidirectional, to achieve full routing capability for all possible wavelengths.



Note

In a 50GHz design, an omnidirectional demand can be dropped only on a colorless omnidirectional side.

2.7.5 Creating a Point-to-Point Demand

Use the following procedure to add a point-to-point traffic demand:

-
- Step 1** In the NtView *Name* tab, click the **Create new Point-to-Point demand** icon in the toolbar. For more information about the Cisco Transport Planner icons, see [Appendix A, “GUI Information and Shortcuts.”](#)
- Step 2** Click the source site of the demand.
- Step 3** Click the destination site of the demand. The Point to Point Demand Creation wizard appears.
- Step 4** From the drop-down list, select **Traffic Subnet ALL** or any of the previously created traffic subnets to which this service demand should be part of, and proceed to [Step 5](#). If you wish to create a new traffic subnet see [“2.6 Creating Traffic Subnet” section on page 2-15](#).
- Step 5** Click **Next**.
- Step 6** On the General Parameters page, complete the following:
- **Label**—Enter the name of the demand.
 - **Source**—(Display only) Displays the source site name.
 - **Destination**—(Display only) Displays the destination site name.
 - **Service Type**—Choose the service type from the drop-down list. For a list of services, see the [“1.1.2.5 Service Support” section on page 1-8](#).
 - **Present # ch**—Enter the number of channels to be created. The Forecast # ch field automatically updates with the number entered in this field.
 - **Forecast # ch**—Enter the number of channels to be installed at a later date. This value includes the Present # ch value. For example, if you entered 4 in the Present # ch value and want to add two channels in the future, enter 6.

- Step 7** Click **Next**. The Platform Parameters page appears.
- Step 8** On the Platform Parameters page, complete the following in the Platform area:
- Protection—Choose the protection type from the drop-down list: **Client 1+1**, **Y-Cable**, **Fiber Switched**, **Unprotected**, or **PSM-OCH**. For more information on protection types, see the [“1.1.2.4 Protection Scheme Support” section on page 1-6](#).
 - Path—(Unprotected only) Choose the routing type from the drop-down list:
 - **Auto**—Allows the highest degree of flexibility in routing the channels. Cisco Transport Planner routes the channels with the lowest possible cost, given the other constraints.
 - **A**—Select this for a Terminal or a Terminal+ site.
 - **A or B**—Select either of these for a Line or a Line+ site.
 - **A, B, C, or D**—Select either of these for a Multidegree site if four ducts are connected.
 - **A, B, C, D, E, F, G, or H**—Select either of these for a Multidegree site if eight ducts are connected.
 - **Aw or Ap**—Select either of these for a PSM Terminal - Optical Path Protection or PSM Terminal - Multiplex Section Protection site.
 - Optical Bypass—(Unprotected only) Choose the site where the channels for the current demand will be optically bypassed. A channel in optical bypass is dropped on one side of the node and added on the other side of the same node to allow the future use of that node as an add/drop location.
 - Colorless— Choose an option from the colorless drop-down list. For more information on colorless property see [“2.7.3 Understanding Colorless Functionality” section on page 2-18](#).
 - **Auto**—(Default) Disables colorless functionality on the demand.
 - **Yes**—Enables colorless functionality on the demand.
 - **No**—Disables colorless functionality on the demand.
 - Omni-directional— Choose an option from the Omni-directional drop-down list. For more information on omnidirectional property see [“2.7.2 Understanding Omnidirectional Functionality” section on page 2-17](#).
 - **Auto**—(Default) Dynamically enables omnidirectional functionality on a colorless demand, when the colorless demand needs to be dropped on an omnidirectional side with colorless ports, due to lack of any other colorless port on the side.
 - **Yes**—Enables omnidirectional functionality on the demand.
 - **No**—Disables omnidirectional functionality on the demand.
- Step 9** In the Platform Parameters page, complete the following fields in the Interface/Card Type area. The options available are based on the service type selected in [Step 6](#).
- Transponder—Click to expand, then check the Card Type check box to select the card at the end sites of the service channels.
- If you have selected the Service Type as LAN-WAN Conversion in [Step 6](#), when you expand Transponder, select any one of the following OTU2-XP LAN-WAN modes and then proceed to step [Step 10](#):
- OTU2-XP- Mixed Mode—Select the card type as OTU2-XP Mixed Mode if the Protection type is either Unprotected, Client 1+1, or PSM-OCH.
 - OTU2-XP- Txp Mode—Select the card type as OTU2-XP Txp Mode if the Protection type is either Unprotected, Client 1+1, or PSM-OCH.

- OTU2-XP- Splitter Mode—Select the card type as OTU2-XP Splitter Mode if the Protection type is Fiber-Switched.



Note Y-cable protection is not supported on the LAN to WAN interface (ports 1 and 3)

- Line Card—Click to expand, then check the Card Type check box to select the card at the end sites of the service channels.
- Alien Card—Appears only if you created a third-party interface as described in the “1.6.5 Defining Third-Party DWDM Interfaces” section on page 1-38. Click to expand, and then check the card type check box to select the card at the end sites of the service channels.
- Pluggable Card—Click to expand, then check the card type check box to select the card at the end sites of the service channels.

Step 10 In the Client Interface area, define the client interface type for the source (SR, ZR, ER, or LR) and destination (EW, SW, or LW) from the Source and Destination drop-down list. This option is available for transponder and muxponder interfaces that have pluggable client interfaces that depend on the selected service type and card type.



Note In the LAN-WAN conversion mode, CTP automatically selects the Source and Destination client interface type if you have not selected the Source and Destination client interface type.

Step 11 Click **Finish**. The Demand Editor dialog box appears listing the present and forecast channels.

The demand appears in the NtView *name* tab and in the Project Explorer pane in the Service Demands > Point To Point folders. A demand is a solid line when selected and a dotted line when not selected. The line has a number above it that indicates the number of channels that are present. Figure 2-5 shows a selected point-to-point demand with five channels between sites 1 and 2.

Figure 2-5 Point-to-Point Demand Between Two Sites

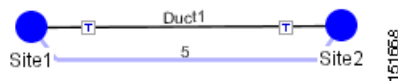

Step 12 To add a new service, click the **Add new service** icon in the toolbar. A new row appears. Complete the parameters for the new channel.

Step 13 To delete an existing channel, select the row and click the **Delete service** icon in the toolbar.

Step 14 To set path constraints, click the **Path Constraints Editor** icon in the toolbar and complete the following as required:

- Output Node Interface—Choose from the drop-down list, the side through which the demand must be routed.
- Exclude Sites—Choose the sites that must be excluded from the demand route.
- Exclude Ducts—Choose the ducts that must be excluded from the demand route.

Click **OK** to save the changes and **Cancel** to close the dialog box without saving the changes.

Step 15 This icon is available only at the trail level of the service demand.

- Step 16** To add a regeneration site, click the **Regeneration...** icon in the toolbar. The Regeneration editor appears. The regeneration site can be created only at the trail level. For more information, see the “[2.7.10 Creating a Regeneration Site](#)” section on page 2-42.
- Step 17** Click **OK** to save the changes to the channels and close the Demand editor dialog box, or **Cancel** to close the dialog box without saving the changes.



Note To make changes to the demand parameters, see the “[4.7 Editing a Point-to-Point Demand](#)” section on page 4-41, or click **Cancel** to close the Demand Editor dialog box.



Note For each network, Cisco Transport Planner automatically creates a default subnet that exactly matches the overall network topology. This cannot be deleted.

2.7.6 Creating a Protected Ring Demand

Use the following procedure to create a P-ring traffic demand.

- Step 1** Create a ring network using either the procedures in [2.1 Creating a Project, page 2-1](#) or by manually placing sites into a ring configuration.
- Step 2** In the Native Net# tab, click the **Create new P-Ring demand** icon in the toolbar. The P-Ring Creation wizard appears. For more information about the Cisco Transport Planner icons, see [Appendix A, “GUI Information and Shortcuts.”](#)
- Step 3** For each network, the tool automatically creates, a default subnet that exactly matches the overall network topology. This cannot be deleted. From the drop-down list, select any previously created traffic subnet with a ring topology that this circuit should be part of and proceed to [Step 4](#). If you wish to create a new traffic subnet see [2.6 Creating Traffic Subnet, page 2-15](#).
- Step 4** On the General Parameters page, complete the following:
- Label—Enter the name of the demand.
 - Service Type—Choose the service type from the drop-down list. For a list of services, see the “[1.1.2.5 Service Support](#)” section on page 1-8.
 - Present # ch—Enter the number of channels to be created. The Forecast # ch field automatically updates with the number entered in this field.
 - Forecast # ch—Enter the number of channels to be installed at a later date. This value includes the Present # ch value. For example, if you entered 4 in the Present # ch value and want to add two channels in the future, enter 6.
- Step 5** Click **Next**.
- Step 6** On the Sites Selection page, in the Protection Sites area, press **Ctrl** and click the sites that you want to add to the P-ring. A P-ring requires at least two sites. Click the right arrow button. To remove a site added to the list, click the site and click the left arrow button.
- In the Optical Bypass area, press **Ctrl** and click the sites that you want to add to the P-ring. Click the right arrow button. To remove a site added to the list, click the site and click the left arrow button.
- Step 7** Click **Next**. The WDM Client Selection page appears.

- Step 8** On the WDM Client Selection page, enter the following Platform Parameters:
- Colorless— Choose an option from the colorless drop-down list. For more information on colorless property see [“2.7.3 Understanding Colorless Functionality” section on page 2-18](#).
 - **Auto**—(Default) Disables colorless functionality on the demand.
 - **Yes**—Enables colorless functionality on the demand.
 - **No**—Disables colorless functionality on the demand.
 - Omni-directional— Choose an option from the Omni-directional drop-down list. For more information on omnidirectional property see [“2.7.2 Understanding Omnidirectional Functionality” section on page 2-17](#).
 - **Auto**—(Default) Dynamically enables omnidirectional functionality on a colorless demand, when the colorless demand needs to be dropped on an omnidirectional side with colorless ports, due to lack of any other colorless port on the side.
 - **Yes**—Enables omnidirectional functionality on the demand.
 - **No**—Disables omnidirectional functionality on the demand.

- Step 9** Complete the following in the Interface/Card Type area. The options available are based on the service type selected in [Step 4](#).
- Transponder—Click to expand, then check the Card Type check box to select the card at the end sites of the service channels.

If you have selected the Service Type as LAN-WAN Conversion in [Step 4](#), when you expand Transponder, select any one of the following OTU2-XP LAN-WAN modes:

- OTU2-XP- Mixed Mode—Select the card type as OTU2-XP Mixed Mode if the Protection type is either Unprotected, Client 1+1, or PSM-OCH.
- OTU2-XP- Txp Mode—Select the card type as OTU2-XP Txp Mode if the Protection type is either Unprotected, Client 1+1, or PSM-OCH.
- OTU2-XP- Splitter Mode—Select the card type as OTU2-XP Splitter Mode if the Protection type is Fiber-Switched.
- Line Card—Click to expand, then check the card type check box to select the card at the end sites of the service channels.
- Alien Card—Appears only if you created a third-party interface as described in the [“1.6.5 Defining Third-Party DWDM Interfaces” section on page 1-38](#). Click to expand, and then check the card type check box to select the card at the end sites of the service channels.
- Pluggable Card—Click to expand, then check the card type check box to select the card at the end sites of the service channels.

In the Client Interface area, define the client interface type for the source (SR, ZR, ER, or LR) and destination (EW, SW, or LW) from the Source and Destination drop-down list. This option is available for transponder and muxponder interfaces that have pluggable client interfaces that depend on the selected service type and card type.



Note In the LAN-WAN Conversion mode, CTP automatically selects the Source and Destination client interface type if you have not selected the Source and Destination client interface type.

Step 10 Click **Finish**. The Demand Editor dialog box appears.

The demand appears in the NtView *name* tab and in the Project Explorer pane in the Service Demands > P-Rings folders. A demand is a solid line when selected and a dotted line when not selected. The line has a number above it that indicates the number of channels present. Figure 2-6 shows a selected one-channel P-ring between sites 1, 2, 3, and 5 with an optical bypass of site 4.

Step 11 To add a new service, click the **Add new service** icon in the toolbar. A new row appears. Complete the parameters for the new channel.

Step 12 To delete an existing channel, select the row and click the **Delete service** icon in the toolbar.

Step 13 To add a regeneration site, click the **Regeneration...** icon in the toolbar. The Regeneration editor appears. The regeneration site can be created only at the trail level. For more information, see the “2.7.10 Creating a Regeneration Site” section on page 2-42.

Step 14 Click **OK** to save the changes to the channels and close the Demand Editor dialog box, or **Cancel** to close the dialog box without saving the changes.



Note

To make changes to the demand parameters, see the “4.8 Editing a P-Ring Demand” section on page 4-44, or click **Cancel** to close the Demand Editor dialog box.

Figure 2-6 P-Ring Demand

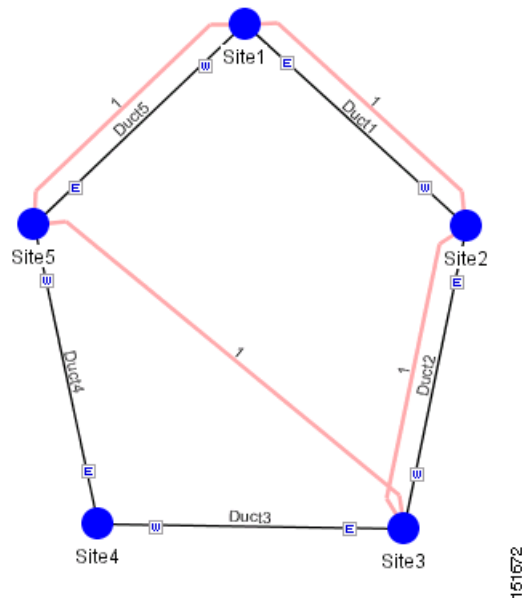

2.7.7 Creating a ROADM Demand

Use the following procedure to create ROADM traffic groups and demands:

- Step 1** In the Project Explorer pane, under Nets, right-click the **ROADM** folder and choose **New ROADM Group**. The ROADM Group Creation wizard appears.
- Step 2** Select the desired traffic subnet from the Traffic Subnet field. You can create a new traffic subnet if desired using the “[2.6 Creating Traffic Subnet](#)” section on page 2-15.
- Step 3** Enter the ROADM traffic group name in the Group Name field.
- Step 4** Check the desired sites.
- Step 5** Click **Finish**. The new ROADM traffic group appears under the ROADM folder in the Project Explorer pane.
- Step 6** Right-click the new ROADM traffic group and choose **Create new ROADM demand** from the shortcut menu. The Create ROADM Demand dialog box appears ([Figure 2-7](#)).

Figure 2-7 Create ROADM Demand Dialog Box

Service Types	Yes/No	Client Interface	Y-Cable	I+I	Fiber Switched	Supported
<input checked="" type="checkbox"/> 10G-FICON	<input type="checkbox"/>	40G CP-DQPSK TXP - w/FEC	<input type="checkbox"/>	<input type="checkbox"/>	<input type="checkbox"/>	
<input type="checkbox"/> 10GE LAN PHY	<input type="checkbox"/>	40G CP-DQPSK TXP - w/EFEC	<input type="checkbox"/>	<input type="checkbox"/>	<input type="checkbox"/>	
<input type="checkbox"/> 10GE WAN PHY	<input type="checkbox"/>	40G CP-DQPSK MXP - w/EFEC	<input type="checkbox"/>	<input type="checkbox"/>	<input type="checkbox"/>	10G-FICON
<input type="checkbox"/> 1G-FICON	<input type="checkbox"/>	40G CP-DQPSK MXP - w/FEC	<input type="checkbox"/>	<input type="checkbox"/>	<input type="checkbox"/>	10G-FICON
<input type="checkbox"/> 2G-FICON	<input type="checkbox"/>	40G CP-DQPSK ME TXP - w/FEC	<input type="checkbox"/>	<input type="checkbox"/>	<input type="checkbox"/>	
<input type="checkbox"/> 2R Any Rate	<input type="checkbox"/>	40G CP-DQPSK ME TXP - w/EFEC	<input type="checkbox"/>	<input type="checkbox"/>	<input type="checkbox"/>	
<input type="checkbox"/> 40GE LAN PHY	<input type="checkbox"/>	40G CP-DQPSK ME TXP - w/EFEC	<input type="checkbox"/>	<input type="checkbox"/>	<input type="checkbox"/>	
<input type="checkbox"/> 4G-FICON	<input type="checkbox"/>	40G CP-DQPSK ME MXP - w/EFEC	<input type="checkbox"/>	<input type="checkbox"/>	<input type="checkbox"/>	10G-FICON
<input type="checkbox"/> 5G InfiniBand	<input type="checkbox"/>	40G CP-DQPSK ME MXP - w/FEC	<input type="checkbox"/>	<input type="checkbox"/>	<input type="checkbox"/>	10G-FICON
<input type="checkbox"/> 8G-FICON	<input type="checkbox"/>	0N5-XG-10G-EP - w/FEC	<input type="checkbox"/>	<input type="checkbox"/>	<input type="checkbox"/>	
<input type="checkbox"/> D1 Video	<input type="checkbox"/>	0N5-XG-10G-EP - w/EFEC	<input type="checkbox"/>	<input type="checkbox"/>	<input type="checkbox"/>	
<input type="checkbox"/> DV-6000	<input type="checkbox"/>	0N5-XG-10G-EP - w/o FEC	<input type="checkbox"/>	<input type="checkbox"/>	<input type="checkbox"/>	
<input type="checkbox"/> DVB ASI	<input type="checkbox"/>	40G DQPSK TXP - w/FEC	<input type="checkbox"/>	<input type="checkbox"/>	<input type="checkbox"/>	
<input type="checkbox"/> E3/T3/DS3 Over FE	<input type="checkbox"/>		<input type="checkbox"/>	<input type="checkbox"/>	<input type="checkbox"/>	
<input type="checkbox"/> ESCON	<input type="checkbox"/>		<input type="checkbox"/>	<input type="checkbox"/>	<input type="checkbox"/>	

- Step 7** (Optional) If you copied properties of an existing ROADM demand, click Use Template to use the properties of the copied ROADM demand.
- Step 8** Enter a name for the demand in the Demand Name field.
- Step 9** Select a traffic pattern type (Hub, Meshed, or Ring) from the Traffic Type drop-down list:
 - Hub—If you select Hub, select the originating site from the First Site drop-down list.
 - Meshed—If you select Meshed, go to [Step 10](#).
 - Ring—If you select Ring, select **Routing Strategy** as either **Unprotected Minimum Hop**, **Unprotected Optimum Path**, or **Unprotected Subnet**, and proceed to [Step 11](#)



Note

Refer to the “[1.1.5.3 ROADM Traffic Demands](#)” section on page 1-15 for more information on the connectivity choices.

- Step 10** Select a routing strategy from the **Routing Strategy** drop-down list: **Protected**, **Unprotected Minimum Hop**, **Unprotected Optimum Path**, or **Unprotected Subnet**. If you chose Unprotected Subnet, continue with the next step; otherwise proceed to [Step 12](#).
- Step 11** If you chose Unprotected Subnet, choose the starting site and the direction the ring must be traversed from the drop-down lists.
- Step 12** In the Service Types list, check the boxes for one or more client service types for the ROADM demand. The client interfaces that support each service type appear in the table to the right of the Service Types list.
- Step 13** Check the OmniDirection check box to enable the omnidirectional property for the ROADM demand.

**Note**

- The omnidirectional property is applied to the unprotected ROADM demand only when all the sites in the ROADM group have a minimum of one omnidirectional side with two colorless ports on each side.
- The omnidirectional property is applied to the protected ROADM demand only when all the sites in the ROADM group has minimum two omnidirectional sides with two colorless ports on each side.
- When the ROADM demand is finalized, CTP shows the omnidirectional property as Yes irrespective of the source or destination.

- Step 14** Check the Colorless check box to enable the colorless property for the ROADM demand.

**Note**

- The colorless property is applied to the unprotected ROADM demand only when one line side with one colorless port is available in each site.
- The colorless property is applied to the protected ROADM demand only when two line sides with one colorless port are available in each site.
- If there are no colorless ports on the line side but available on the omnidirectional side, CTP displays an error message.
- When the ROADM demand is finalized, CTP shows the colorless property as Yes irrespective of the source or destination.

- Step 15** To further define the client interfaces, complete the following options for each client interface listed in the table. Check boxes in gray are not available for selection.

- Yes/No—Check to select this card to implement the service type.
- Client Interface—(Display only) Displays the card type for the selected service type.
- Y Protected—Check to select Y-cable protection if the connectivity type is Protected.
- 1+1 Protected—Check to select 1+1 protection if the connectivity type is Protected.
- Fiber Switched—Check to select fiber-switching protection if the connectivity type is Protected.
- Supported Service—(Display only) Displays the service types supported for the card.

You can select more than one client interface to support the same service type. By default, Cisco Transport Planner checks the best client interface to support each service.

Step 16 Click **OK** to create the demand. [Figure 2-8](#) shows an example of ROADM Demand.

Figure 2-8 ROADM Demand

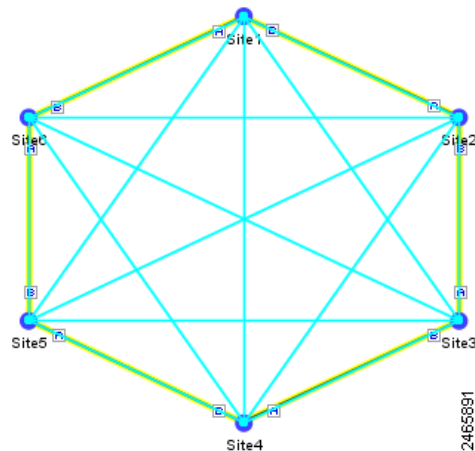

Step 17 Copy ROADM demand properties. The following properties are copied:

- Traffic Type
- Routing Strategy
- Service Types
- OmniDirection
- Colorless
- DWDM Card Interface table (Yes/No, Client Interface, and Protection Type columns)

These properties can be used as a template while creating a new ROADM demand or editing an existing one. To copy the properties, select the ROADM demand, right-click, and choose the Copy Properties option. When the ROADM demand properties are copied, the Use Template button is enabled in the Create ROADM Demand and Edit ROADM Demand dialog boxes.



Note

- The Copy Properties option is not available when you log out of the CTP session.
- ROADM demand properties copied from Release 8.5 and later can be used in an upgraded network up to Release 9.4.
- ROADM demand properties copied in the later releases (for example, Release 9.4) is not available in the earlier releases (for example, Release 9.1).

Step 18 Analyse the network.

Click the Analyze Network icon in the toolbar.

Step 19 Finalize the Any-to-Any demand. Perform one of the following:

- To finalize Any-to-Any demand in design-analyzed state, complete [Step 20](#).
- To finalize Any-to-Any demand in upgrade state, complete [Step 21](#).

- Step 20** To finalize Any-to-Any demand in design-analyzed state, complete the following steps:
- a. Click the **Finalize Any-to-Any traffic** icon in the network view toolbar or right-click the ROADM group in the Project Explorer and choose the **Finalize Connectivity** option. The Finalize Any-to-Any Traffic window appears.
 - b. Click **Please select a Site or Click here** in the left pane to select the required connectivity (for example, Site1 - Site2). Click **OK**.
 - c. Select a card listed under the ROADM demand and click the **Finalize** button. The ROADM Finalize Connectivity wizard appears.
 - d. On the General Parameters page, complete the following:
 - Label—Enter the name of the demand.
 - Service Type—Choose the service type from the drop-down list. For a list of services, see the [“1.1.2.5 Service Support”](#) section on page 1-8.
 - Present # ch—Enter the number of channels to be created. The Forecast # ch field automatically updates with the number entered in this field.
 - Forecast # ch—Enter the number of channels to be installed at a later date. This value includes the Present # ch value.
 - e. In the Platform area of the Platform Parameters page, choose the protection type from the drop-down list: **Y-Cable Protected**, or **Client 1+1**. For more information on protection types, see the [“1.1.2.4 Protection Scheme Support”](#) section on page 1-6.
 - f. In the 454DWDM area, complete the following:
 - Transponder—Click to expand, then check the card check box to select the card at the end sites of the service channels.
 - g. In the Client Interface area, define the client interface type (SR, IR, or LR) for the source and destination from the Source and Destination drop-down lists. This option is available for transponder and muxponder interfaces that have pluggable client interfaces, which depend on the selected service type and card type.
 - h. Click **Finish**. The Demand Editor dialog box appears listing the present and forecast channels.
 - i. To add a new service, click the **Add new service** icon in the toolbar. A new row appears. Complete the parameters for the new channel.
 - j. To delete an existing channel, select the row and click the **Delete service** icon in the toolbar.
 - k. To add a regeneration site, click the **Regeneration...** icon in the toolbar. The Regeneration editor appears. The regeneration site can be created only at the trail level. For more information, see the [“2.7.10 Creating a Regeneration Site”](#) section on page 2-42.
 - l. Click **OK** to save the changes to the channels and close the Demand Editor dialog box, or **Cancel** to close the dialog box without saving the changes.
 - m. Click **Close** to exit the Finalize Any-to-Any Traffic window.
 - n. Analyse the network again. The A2A Finalization Report appears.
 - o. Click **OK** to complete the finalisation.



Note When the network state is changed, demands that were finalized before the change in the network state are deleted.

- Step 21** To finalize Any-to-Any demand in upgrade state, complete the following steps:
- Upgrade the analysed network.
 - In the upgraded network, go to the card listed under the ROADM demand, select the required connectivity (for example, Site1 - Site2), right-click and select the Finalize connectivity option. The ROADM Finalize Connectivity wizard appears.
 - Perform Steps 20d through 20l.
 - Analyse the upgraded network again.
The demands that were finalized appear in the reports.
- Step 22** To edit any Any-to-Any finalized demand, complete the following steps:
- Click the Mgmt Tree tab and right-click the analyzed network.
 - Choose **A2A Finalized Circuits** from the drop-down list. The A2A Finalized Circuits tab appears.
 - Select any Any-to-Any Finalized demand and click **Edit** on the toolbar or double-click the demand in The A2A Finalized Circuits tab. CTP prompts to unlock the network. Choose **Yes** to open the demand editor. The network is set to Any-to-Any Finalization mode on unlocking the demand. Modify as required and click **OK** to close the demand editor.

**Note**

- CTP does not allow the card type to be edited in Any-to-Any Finalized demand.
- When multiple demands are selected in the A2A Finalized Circuits tab, the Edit option is disabled.

Step 23 Finalize the demand again for the changes to be reflected in the A2A Finalized Circuits report.

Step 24 To delete any Any-to-Any finalized demand, complete the following steps:

- Click the Mgmt Tree tab and right-click the analyzed network.
- Choose **A2A Finalized Circuits** from the drop-down list. The A2A Finalized Circuits tab appears.
- Select any Any-to-Any Finalized demand and click **Delete** on toolbar in The A2A Finalized Circuits tab. CTP prompts to confirm deletion. Choose **Yes** to delete the selected demand.

**Note**

When multiple demands are selected in the A2A Finalized Circuits tab, the Delete option is disabled.

2.7.8 Creating Ethernet Aggregated Demands

An Ethernet aggregated demand is a collection of low-rate Gigabit Ethernet/10Gigabit Ethernet services that can be aggregated on a single 10-Gbps wavelength division multiplexing (WDM) trunk. This demand is supported only by the GE_XP, 10GE_XP, GE_EXP, and 10GE_EXP cards when configured as an L2-Switch.

The Ethernet Aggregation Creation wizard allows you to:

- Create one WDM transport channel at a time over a predefined traffic subnet.
- Specify the wavelength to be used for the channel, and define a list of locations with add/drop VLAN circuit capability.

- Create a set of desired VLAN circuits on this WDM transport channel.
- The check functionality generates a report showing for each section of the subnet where the WDM transport channel is over allocated and then perform corrective action when required.
- The clone functionality creates an identical copy of the current WDM transport channel with the same add/drop sites and WDM channel configuration parameters. You can then start filling this channel with the desired circuits.

Use the following procedure to create Ethernet aggregated demands:

-
- Step 1** In the NtView *name* tab, click the **Create new Aggregated Ethernet demand** icon in the toolbar. For more information about Cisco Transport Planner icons, see [Appendix A, “GUI Information and Shortcuts.”](#) The EthernetAggr Creation wizard appears.
- Step 2** Choose the desired traffic subnet from the Traffic Subnet drop-down list. You can create a new traffic subnet if desired (see [2.6 Creating Traffic Subnet, page 2-15](#)).
- Step 3** Click **Next**. The General Parameters page appears.
- Step 4** In the General Parameters pane, enter values in the following fields:
- **Label**—Enter the name of the demand. The default value is EthernetAggr1.
 - **Present/Forecast**—Check this box if this demand will be needed in the future; uncheck this box if this demand is needed now. This parameter drives the list of pluggable port modules to be equipped on the card and will affect BoM reports.
 - **Colorless**— Choose an option from the colorless drop-down list. For more information on colorless property see [“2.7.3 Understanding Colorless Functionality” section on page 2-18](#).
 - **Auto**—(Default) Disables colorless functionality on the demand.
 - **Yes**—Enables colorless functionality on the demand.
 - **No**—Disables colorless functionality on the demand.
 - **Omni-directional**—Choose an option from the Omni-directional drop-down list. For more information on omnidirectional property see [“2.7.2 Understanding Omnidirectional Functionality” section on page 2-17](#).
 - **Auto**—(Default) Dynamically enables omnidirectional functionality on a colorless demand, when the colorless demand needs to be dropped on an omnidirectional side with colorless ports, due to lack of any other colorless port on the side.
 - **Yes**—Enables omnidirectional functionality on the demand.
 - **No**—Disables omnidirectional functionality on the demand.
- Step 5** Click **Next**.
- Step 6** In the Sites selection pane, complete the following tasks:
- In the Protection Sites area, press **Ctrl** and click the sites that you want to add to the Ethernet aggregated demand. An Ethernet aggregated demand requires at least two sites. Click the right arrow button. To remove a site added to the list, click the site and click the left arrow button.
 - In the Optical Bypass area, press **Ctrl** and click the sites that you want to add to the Ethernet aggregated demand. Click the right arrow button. To remove a site added to the list, click the site and click the left arrow button. If the Present/Forecast check box is checked, you cannot select Optical Bypass sites. A channel in optical bypass is dropped on one side of the node and added on the other side of the same node to allow the future use of that node as an add/drop location.

- Step 7** In the Node Configuration selection pane, enter values for the following options:
- DWDM Trunk—Select the DWDM trunk type. You can specify the kind of WDM trunk interface for the card in each add/drop site. Allowed values are:
 - Auto
 - w/EFEC
 - w/FEC
 - w/o FEC
 - Wavelength—Select the WDM transport channel wavelength. This option allows you to force the current WDM transport channel wavelength. Wavelengths are listed based on the selected band. Allowed values are:
 - Auto—Allows CTP to assign a wavelength to the channel with the lowest possible cost, given the other set of constraints.
 - C band-32 ch.odd
 - L band- 32 ch.odd
 - C band- 40 ch
 - C band- 64 ch
 - C band-72 ch
 - C band- 80 ch
 - New CFG—Choose the desired card type for each of the protected sites.
- Step 8** Click **Finish**. The *name* Demand window appears (Figure 2-9).

Figure 2-9 EthernetAggr1 Demand Window, TrafficTab

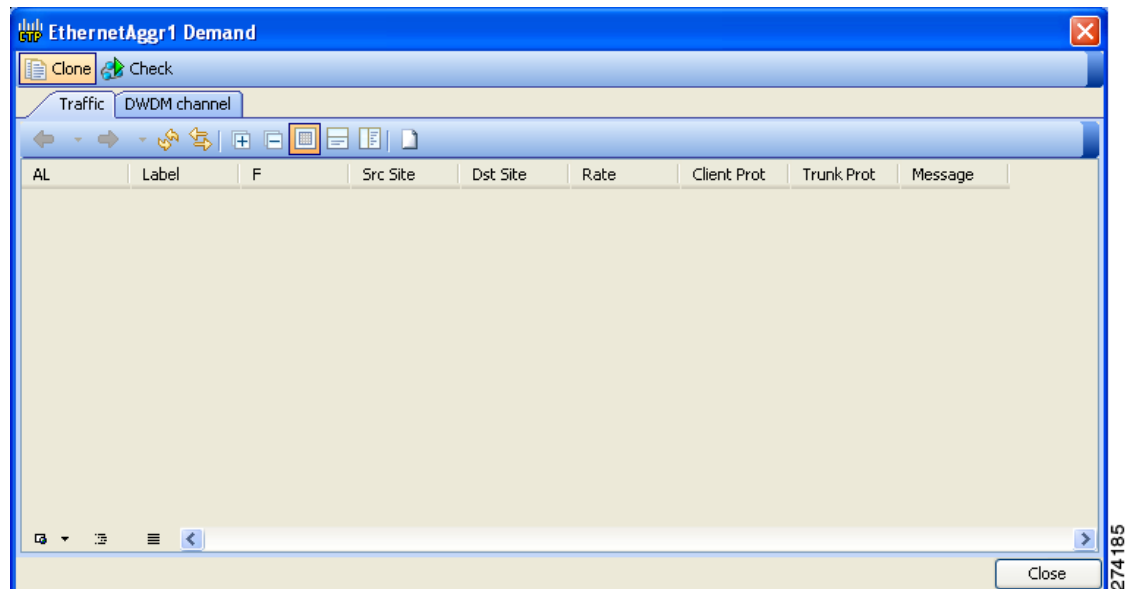

- Step 9** Click Close.

Step 10 To add a circuit, right-click the Ethernet Demand in the Project Explorer pane and choose **New point to point request**. The New Request window appears (Figure 2-10).

Figure 2-10 New Request Window

Step 11 The New Request window contains four areas of information: Quantity, General, Src, and Dest.

Quantity Area

Quantity—Enter the number of circuits to be created.

General Area

- Label—Enter the label for the circuit. By default, VLAN_Circuit_x is used.
- Trunk Protection—Enter the trunk protection type. Allowed values are:
 - Unprotected
 - Protected
- P/F—Select Forecast if this demand will be needed in the future. Select Present if this demand is needed now. This parameter drives the list of pluggable port modules to be equipped on the card and affects BoM reports.

- Path Forcing—This option allows you to force the circuit routing on the traffic subnet associated with this demand. Allowed values are:
 - Auto—(Default) Causes the tool to automatically define the trunk path.
 - Side *x*—Represents the label of the side on the Src site where the circuit is routed.
- Client Protection—Allowed values are:
 - Unprotected
 - Client 1+1
- Circuit rate—Displays the allowed circuit rates.

Src Area

- Site—Select the source site. Allowed values include the list of sites added in the WDM traffic channel.
- SFP lambda—Select the desired SFP/XFP for this port or set it to Auto to allow the tool to select an appropriate value.
- Card—Select the Card. Allowed values are Auto, 10GE-XP, 10GE-EXP, GE-XP, and GE-EXP. Auto allows the tool to select an appropriate card type based on other constraints.

The Src area contains Working and Protected subareas.

Working sub-area

- Port CIR—Select the Committed Information Rate (CIR), with 1 being the highest and 0.1 being the lowest.
- Port Rate-Reach—Select the desired PPM for this port, or set it to Auto to allow the tool to select an appropriate value.
- Port Num—Select the port number. Allowed values are Auto, 1, and 2. Auto allows the tool to select an appropriate port number based on other constraints.

Protected sub-area

These fields are enabled only if client protection is enabled in the Client Protection field.

- Port CIR—Select the CIR, with 1 being the highest and 0.1 being the lowest.
- Port Rate-Reach—Select the desired PPM for this port, or set it to Auto to allow the tool to select an appropriate value.
- Port Num—Select the port number. Allowed values are Auto, 1, and 2. Auto allows the tool to select an appropriate port number based on other constraints.

Dest Area

- Site—Select the destination site. Allowed values include the list of sites added in the WDM traffic channel.
- SFP lambda—Select the desired SFP/XFP for this port or set it to Auto to allow the tool to select an appropriate value.
- Card—Select the card. Allowed values are Auto, 10GE-XP, 10GE-EXP, GE-XP, and GE-EXP. Auto allows the tool to select an appropriate card type based on other constraints.

The Dest area contains Working and Protected subareas.

Working sub-area

- Port CIR—Select the CIR, with 1 being the highest and 0.1 being the lowest.
- Port Rate-Reach—Select the desired PPM for this port, or set it to Auto to allow the tool to select an appropriate value.
- Port Num—Select the port number. Allowed values are Auto, and 1 to 20. Auto allows the tool to select an appropriate port number based on other constraints.

Protected sub-area

These fields are enabled only if the client protection is enabled in the Client Protection field.

- Port CIR—Select the CIR, with 1 being the max and 0.1 being the lowest.
- Port Rate-Reach—Select the desired PPM for this port, or set it to Auto to allow the tool to select an appropriate value.
- Port Num—Select the port number. Allowed values Auto, 1, to 20. Auto allows the tool to select an appropriate port number based on other constraints.

Step 12 Click **OK**.

Step 13 The **Traffic** tab displays the following details about the circuit:

- AL—Displays the alarm (if any) for the circuit.
- Label—Displays the name of the circuit.
- F—If checked, it is a forecast circuit. If unchecked, it is a present circuit.
- Src Site—Displays the source site.
- Dst Site—Displays the destination site.
- Rate—Displays the circuit rate/bandwidth.
- Client Prot—Displays the client protection scheme.
- Trunk Prot—Displays the trunk protection scheme.
- Message—Displays a message related to the circuit.

Step 14 If you want to clone this demand, click the **Clone** button in the left corner of the screen. A new demand, which is a copy of this demand, is created and appears in the Project Explorer pane.

Step 15 Click the **Check** tab in the left corner of the window to generate a report showing the circuit path in the WDM traffic channel and to check any over-allocation of bandwidth (Figure 2-11). The **Report** tab displays, in a row, each of the sites on the subnet, and each span in between.

Figure 2-11 Circuit Path View in a Ethernet Aggregated Demand

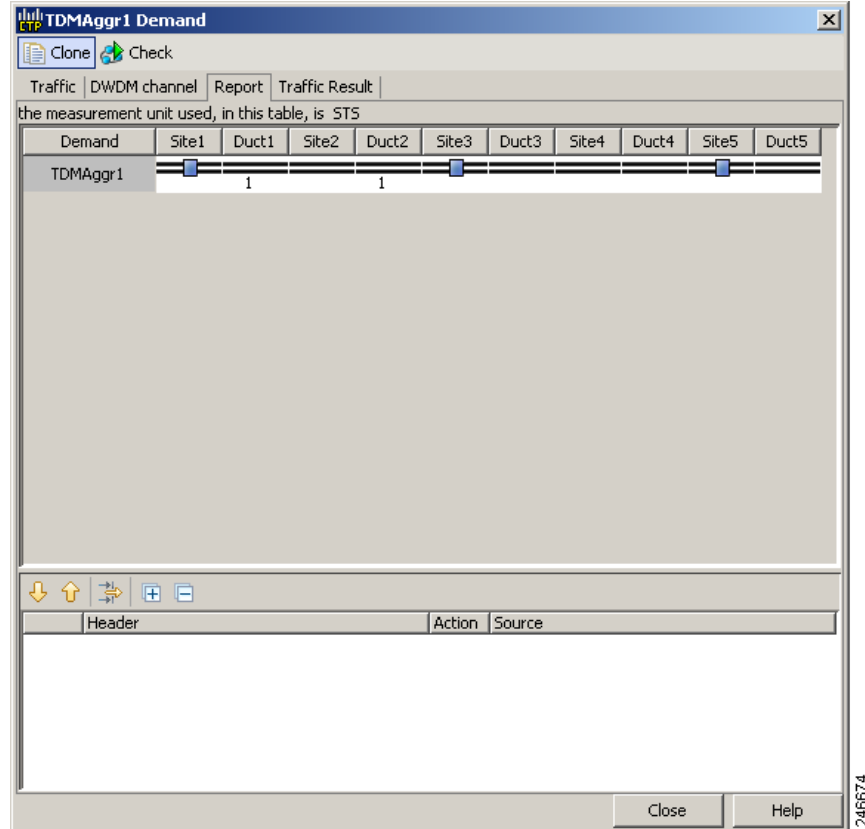

Step 16 The **Traffic Result** tab displays the following:

- Label—Displays the name of the circuit.
- F—If checked, it is a forecast circuit. If unchecked, it is a present circuit.
- Src Site—Displays the source site.
- Dst Site—Displays the destination site.
- Trunk Protection—Displays the trunk protection scheme.
- Path Forcing—Displays the output Node interface. If no client or trunk protection is used, displays NA.
- Client Protection—Displays the client protection scheme.
- Circuit Rate—Displays the circuit rate/bandwidth.
- Src Wrk Port Num—Displays the source working port number.
- Src Prt Port Num—Displays the source protect port number.
- Dst Wrk Port Num—Displays the destination working port number.
- Dst Prt Port Num—Displays the destination protect port number.
- Src Wrk Port CIR—Displays the source working port CIR. The highest is 1 and 0 the lowest.
- Src Prt Port CIR—Displays the source protect port CIR. The highest is 1 and 0 the lowest.
- Dst Wrk Port CIR—Displays the destination working port CIR. The highest is 1 and 0 the lowest.

- Dst Prt Port CIR—Displays the destination protect port CIR. The highest is 1 and 0 the lowest.
- Src Wrk Port Rate-Reach—Displays the PPM for the source working port. For example, Rack 1.Shelf 1. Slot 5.
- Src Prt Port Rate-Reach—Displays the PPM for the source protect port. For example, Rack 1.Shelf 1. Slot 4.
- Dst Wrk Port Rate-Reach—Displays the PPM for the destination working port.
- Dst Prt Port Rate-Reach—Displays the PPM for the destination protect port.
- Src Card—Displays the source card.
- Dst Card—Displays the destination card.
- Working Src Card Rack-Shelf-Slot—Displays the rack, shelf, and slot position of the working source card.
- Working Dst Card Rack-Shelf-Slot—Displays the rack, shelf, and slot position of the working destination card.
- Protecting Src Card Rack-Shelf-Slot—Displays the rack, shelf, and slot position of the protect source card.
- Protecting Dst Card Rack-Shelf-Slot—Displays the rack, shelf, and slot position of the protect source card.
- Alarm—Displays the alarm status.

Step 17 To add a regeneration site, click the **Regeneration...** icon in the toolbar of the DWDM channel tab. The Regeneration Editor appears. The regeneration site can be created only at the trail level. For more information, see the “[2.7.10 Creating a Regeneration Site](#)” section on page 2-42.

Step 18 Click **Close**. To edit circuits, see the “[4.10 Editing an Ethernet Aggregated Demand](#)” section on page 4-48.

2.7.9 Creating TDM Aggregated Demands

A TDM aggregated demand is a collection of low-rate SONET and Gigabit Ethernet services that is aggregated on a single 10-G WDM trunk. The TDM aggregated demand is a specific service demand that is carried only by the ADM-10G card.

The TDM Aggr Creation wizard allows you to:

- Create one WDM transport channel at a time over a predefined traffic subnet
- Specify the wavelength to be used for the channel, and define a list of locations with add/drop STS circuit capability.
- Create a set of STS circuits on this WDM transport channel to pass traffic.
- The check functionality generates a report showing, for each section of the subnet, where the WDM transport channel is over allocated and then perform, when required, the corrective action.

The total amount of bandwidth used by all the defined circuits in each section of the WDM transport channel cannot exceed the maximum channel capacity of STS-192c. Sections exceeding the maximum capacity are colored red in the report. Demands that fail the check are flagged as invalid demands and the Analyzer stops.

The clone functionality allows you to create an empty copy of the current WDM transport channel, with the same add/drop sites and WDM channel configuration parameters. You can then start filling this channel with the desired circuits.

Use the following procedure to create TDM aggregated demands:

-
- Step 1** In the NtView *name* tab, click the Create new TDM Aggregated demand icon in the toolbar. For more information about CTP icons, see [Appendix A, “GUI Information and Shortcuts.”](#) The TDMAggr wizard appears.
- Step 2** Select the desired traffic subnet from the Traffic Subnet drop-down list. You can create a new traffic subnet if desired using (see [2.6 Creating Traffic Subnet, page 2-15](#)).
- Step 3** Click **Next**. The General Parameters page appears.
- Step 4** In the General Parameters pane, complete the following tasks:
- **Label**—Enter the name of the demand. The default value is TDMAggr1.
 - **Present/Forecast**—Check this box if this demand will be needed in the future; uncheck this box if this demand is needed now. This parameter drives the list of pluggable port modules to be equipped on the card and will affect BoM reports.
 - **Colorless**— Choose an option from the colorless drop-down list. For more information on colorless property see [“2.7.3 Understanding Colorless Functionality” section on page 2-18](#).
 - **Auto**—(Default) Disables colorless functionality on the demand.
 - **Yes**—Enables colorless functionality on the demand.
 - **No**—Disables colorless functionality on the demand.
 - **Omni-directional**— Choose an option from the Omni-directional drop-down list. For more information on omnidirectional property see [“2.7.2 Understanding Omnidirectional Functionality” section on page 2-17](#).
 - **Auto**—(Default) Dynamically enables omnidirectional functionality on a colorless demand, when the colorless demand needs to be dropped on an omnidirectional side with colorless ports, due to lack of any other colorless port on the side.
 - **Yes**—Enables omnidirectional functionality on the demand.
 - **No**—Disables omnidirectional functionality on the demand.
- Step 5** Click **Next**.
- Step 6** In Sites selection pane, complete the following tasks:
- In the Protection Sites area, press **Ctrl** and click the sites that you want to add to the TDM aggregated demand. A TDM aggregated demand requires at least two sites. Click the right arrow button. To remove a site added to the list, click the site and click the left arrow button.
 - In the Optical Bypass area, press **Ctrl** and click the sites that you want to add to TDM aggregated demand. Click the right arrow button. To remove a site added to the list, click the site and click the left arrow button. If the Present/Forecast check box is checked, you cannot select Optical Bypass sites. A channel in optical bypass is dropped on one side of the node and added on the other side of the same node to allow the future use of that node as an add/drop location.

- Step 7** In the Node Configuration selection pane, complete the following tasks:
- DWDM Trunk—Select the DWDM trunk type to specify the kind of WDM trunk interface for the card in each allowed add/drop site. Allowed values are:
 - Auto
 - w/EFEC
 - w/FEC
 - w/o FEC
 - Wavelength—Allows you to force the current WDM transport channel wavelength. Allowed values are:
 - Auto—Allows CTP to assign a wavelength to the channel with the lowest possible cost, given the other set of constraints.
 - C band-32 ch.odd
 - L band- 32 ch.odd
 - C band- 40 ch
 - C band- 64 ch
 - C band- 72 ch
 - C band- 80 ch
- Step 8** Click **Finish**. The *name* Demand window appears (Figure 2-12).

Figure 2-12 TDMAggr Demand Window

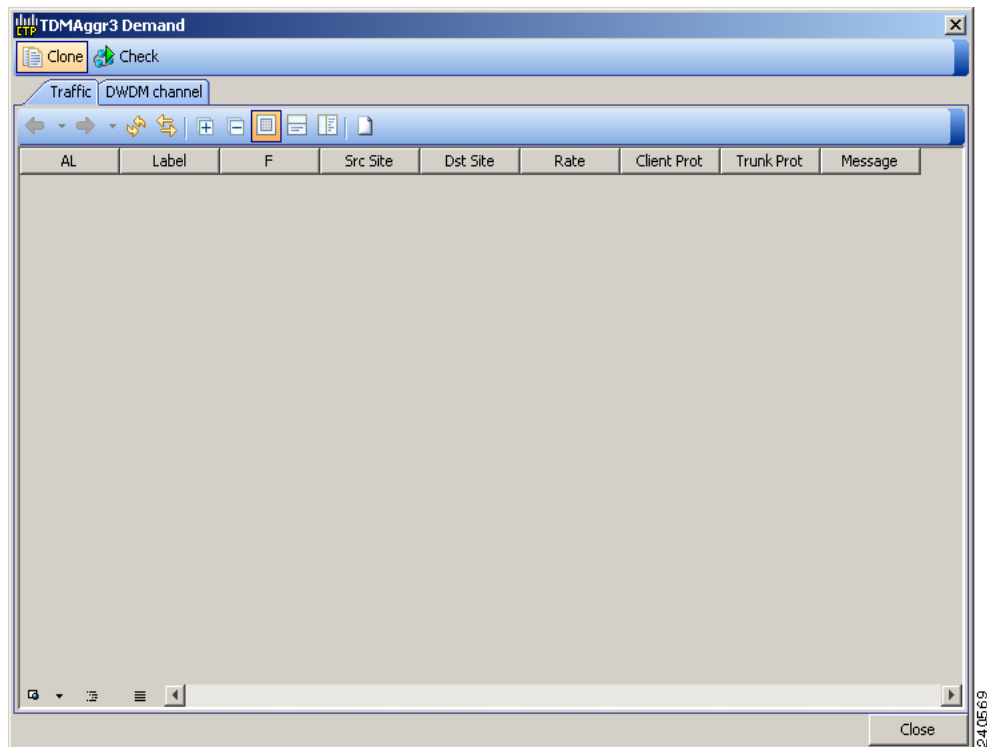

- Step 9** Click Close.

- Step 10** To add a circuit, right-click the Ethernet Demand in the Project Explorer pane and choose **New point to point request**. The New Request window appears (Figure 2-13).

Figure 2-13 New Request Window

- Step 11** The New Request window contains four areas of information: Quantity, General, Src, and Dest.

Quantity Area

Quantity—Enter the number of circuits to be created.

General Area

- Label—Enter the label for the circuit. By default, VLAN_Circuit_x is used.
- Trunk Protection—Enter the trunk protection type. Allowed values are:
 - Unprotected
 - UPSR
- P/F—Select Forecast if this demand will be needed in the future. Select Present if this demand is needed now. This parameter drives the list of pluggable port modules to be equipped on the card and affects BoM reports.

- Path Forcing—This option allows you to force the circuit routing on the traffic subnet associated with this demand. Allowed values are:
 - Auto—(Default) Causes the tool to automatically define the trunk path.
 - Side *x*—Represents the label of the side on the Src site where the circuit is routed.
- Client Protection—Allowed values are:
 - Unprotected
 - 1+1 APS
- Circuit rate—Displays the allowed circuit rates.

Src Area

- Site—Select the source site. Allowed values include the list of sites added in the WDM traffic channel.
- SFP lambda—Select the desired SFP/XFP for this port or set it to Auto to allow the tool to select an appropriate value.
- Card—Select the Card. Allowed values are Auto and ADM-*x*. Auto allows the tool to select an appropriate card type based on other constraints.

The Src area contains Working and Protected sub-areas.

Working sub area

- Port Num—Select the port number. The allowed values are Auto, and from 1 to 17. Selecting Auto allows the tool to select an appropriate port number based on other constraints.

In addition to ports 1 to 16, port 17 also acts like a client port in TDM aggregated demands. Following are the guidelines to use port 17:

- Port 17 must be selected only when the ADM-10G card is used in a single-card configuration.
 - Port 17 supports the circuit rates VC4-64C/STS-192C. It also supports the circuit rates from STS1/VC4 to STS-48c/VC4-16c or a combination of them.
 - For circuit rates VC4-64C/STS-192C with the port number as Auto, port 17 automatically becomes the source and the destination port. Port 17 will not be selected for any other circuit rate unless the user specifically forces the port.
 - Port 17 supports UPSR Client Protection on ANSI platform and SNCP client protection on ETSI platform, except for the circuit rates VC4-64C/STS-192C.
- Port Rate-Reach—Select the desired PPM for this port or set it to Auto to allow the tool to select an appropriate value.

Protected sub area

The following fields are available only if client protection is enabled:

- Port Num—Select the port number. The allowed values are Auto, and from 1 to 17. Selecting Auto allows the tool to select an appropriate port number based on other constraints.

You can force port 17 as protected source or destination port for Client UPSR/SNCP protection with circuit rates less than VC4-64/STS-192c.

- Port Rate-Reach—Select the desired PPM for this port or set it to Auto to allow the tool to select an appropriate value.

Dest Area

- Site—Select the destination site. Allowed values include the list of sites added in the WDM traffic channel.
- SFP lambda—Select the desired SFP/XFP for this port or set it to Auto to allow the tool to select an appropriate value.
- Card—Select the card. Allowed values are Auto and ADM-x. Auto allows the tool to select an appropriate card type based on other constraints.

The Dest area contains Working and Protected sub areas.

Working sub area

- Port Num—Select the port number. The allowed values are Auto, and from 1 to 17. Selecting Auto allows the tool to select an appropriate port number based on other constraints.

In addition to ports 1 to 16, port 17 also acts like a client port in TDM aggregated demands. The guidelines to use the port are the same as given in the [Working sub area](#) for source ports.

- Port Rate-Reach—Select the desired PPM for this port, or set it to Auto to allow the tool to select an appropriate value.

Protected sub-area

- Port Num—Select the port number. Allowed values are Auto and 1 to 16. Auto allows the tool to select an appropriate port number based on other constraints.
- Port Rate-Reach—Select the desired PPM for this port, or set it to Auto to allow the tool to select an appropriate value.

Step 12 Click **OK**.

Step 13 If you want to clone this demand, click the **Clone** button in the left corner of the screen. A new demand, which is a copy of this demand, is created and appears in the Project Explorer pane.

Step 14 Click the **Check** tab on the left corner of the window to generate a report showing the circuit path in the WDM traffic channel and to check any over-allocation of bandwidth ([Figure 2-14](#)). The report shows, in a row, each of the sites on the subnet, and each span in between.

Figure 2-14 Circuit Path View in a TDM Aggregated Demand

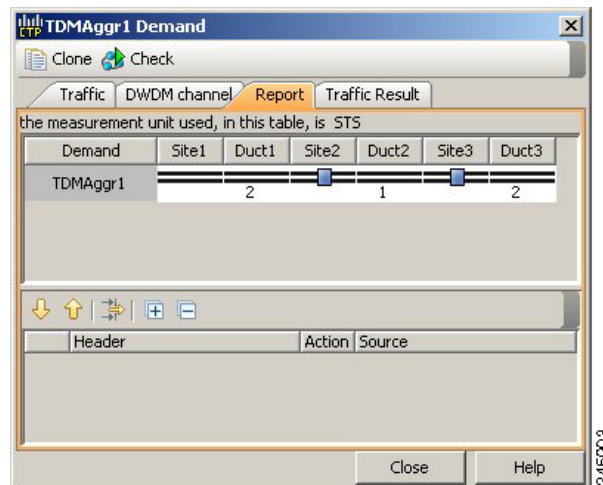

245903

- Step 15** To add a regeneration site, click the **Regeneration...** icon in the toolbar of the DWDM channel tab. The Regeneration Editor appears. The regeneration site can be created only at the trail level. For more information, see the “[2.7.10 Creating a Regeneration Site](#)” section on page 2-42.
- Step 16** Click **Close**. To edit circuits, see the “[4.11 Editing a TDM Aggregated Demand](#)” section on page 4-53.
-

2.7.10 Creating a Regeneration Site

A regeneration site is required when the optical communications link has to span long distances. The optical signal has to be regenerated when the optical signal-to-noise ratio (OSNR) goes beyond a critical limit. After a network is analyzed, the Optical Results highlights if any site requires regeneration. For more information about optical results, see the “[3.2.10 Viewing Optical Results](#)” section on page 3-24.

Use the following procedure to create a regeneration site in the network.

**Note**

A regeneration site cannot be a site with the functionality as OLA, OSC, pass-through, or hub.

**Note**

The **Regeneration...** icon is active only when you select a trail in the Demand Editor.

- Step 1** In the Demand Editor, click the **Regeneration...** icon in the toolbar. The Regeneration Editor appears, [Figure 2-15](#). For more information about Cisco Transport Planner icons, see [Appendix A, “GUI Information and Shortcuts”](#).

Figure 2-15 Regeneration Editor

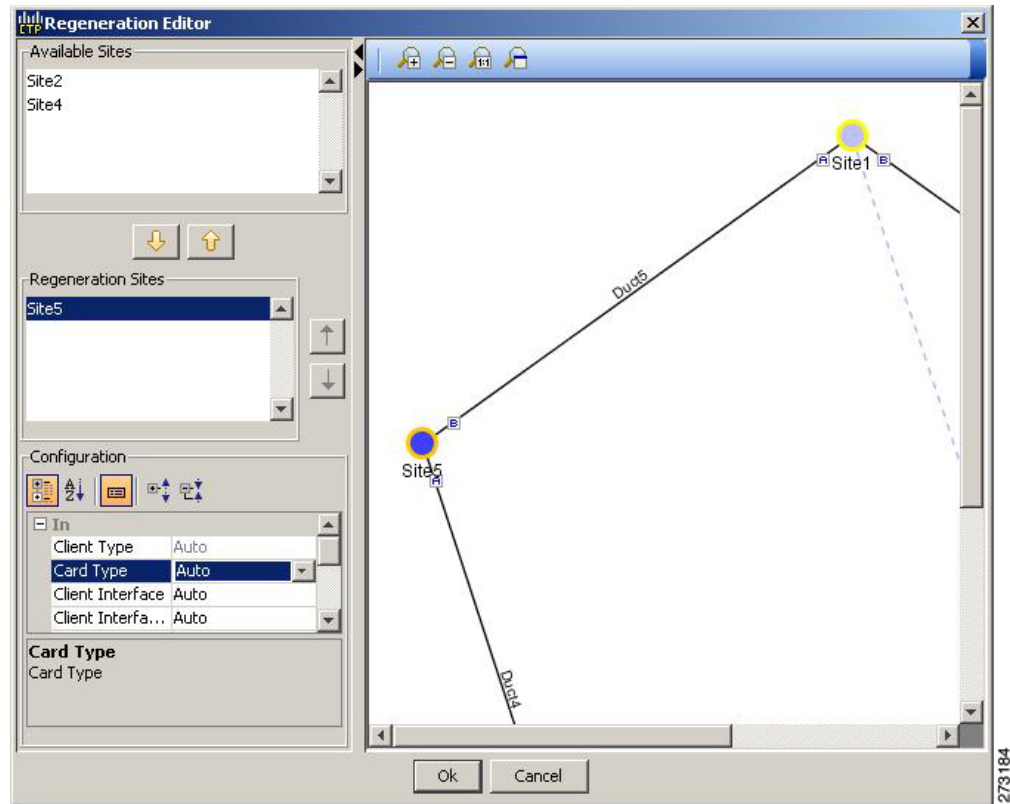

- Step 2** In the Available Sites area, choose the site and click the down arrow icon. To remove a site added to the Regeneration Sites list, choose the site and click the up arrow icon.



Note When adding more than one regeneration site to the path, ensure the regeneration sites are added in the correct sequence to avoid unfeasible routing. For example, if you create a point-to-point demand from site1 (source) to site 3 (destination), the sites available in the path are site 4 and site 5. Site 5 must be selected first, followed by site 4, because site 5 is closer to site 1.

- Step 3** To sort the regeneration sites in the list, use the up and down arrow icons located on the left.

- Step 4** If you chose a source or destination card for a regeneration site, choose the card type for the site from the drop-down list. The regeneration cards that are compatible with the source and destination cards are displayed in the interface.



Note The OTU2_XP card has four modes. For more information on these modes, refer to the [“2.7.10.1 Configurations for OTU2_XP”](#) section on page 2-44.

- Step 5** Colorless— Choose an option from the drop-down list. Colorless traffic demands are terminated at colorless add/drop ports, so that, these demands can be tuned in all possible wavelengths without changing the optical interface of the port.



Note These values apply only to the selected trail.

- Auto—(Default) Disables colorless functionality on the demand.
- Yes—Enables colorless functionality on the demand.
- No—Disables colorless functionality on the demand.

Step 6 Omnidir Src Side, Omnidir Dest Side— Choose an option to enable omnidirectional functionality on a source or destination side. An omnidirectional side allows routing of the added and dropped traffic in all the possible directions associated to Line sides.

- Auto—(Default) Disables omnidirectional functionality on the sides.
- Yes—Enables omnidirectional functionality on the sides.
- No—Disables omnidirectional functionality on the sides.

Step 7 Click **OK**.



Note

To allow different wavelengths to be used for regeneration, choose the Allow different wavelengths option in the Properties pane in Net > Options > Traffic Mapping > System Release 9.4.

2.7.10.1 Configurations for OTU2_XP

The OTU2_XP card operates in six different configurations as shown in the following table:

Configuration	Card listed as	Port 1	Port 2	Port 3	Port 4
Dual Transponder (2 x 10G transponder)	OTU2-XP-Txp mode	Client port 1	Client port 2	Trunk port 1	Trunk port 2
Dual Regenerator (2 x 10G standard regenerator with enhanced FEC [E-FEC] only on one port)	OTU2-XP-Regen mode	Trunk port 1	Trunk port 2	Trunk port 1	Trunk port 2
Single Regenerator (1 x 10G E-FEC regenerator with E-FEC on two ports))	OTU2-XP-Single Regen mode	Not used	Not used	Trunk port	Trunk port

Configuration	Card listed as	Port 1	Port 2	Port 3	Port 4
10 GE LAN Phy to WAN Phy	OTU2-XP-Txp mode Mixed mode Splitter mode	Client port	Client port in transponder or trunk port in regenerator configuration	Trunk port Note In a Multi trunk card, the LAN port is always on Port1, and not on port 2.	Trunk port in transponder or regenerator configuration.
Protected Transponder (1 x 10G splitter protected transponder)	OTU2-XP-Splitter mode	Client port	Not used	Trunk port (working)	Trunk port (protect)
Mixed Mode (1 x 10G transponder and 1 x 10G standard regenerator)	OTU2-XP-Mixed mode	Client port	Trunk port 4 without FEC or with FEC	Trunk port 1 without FEC or with FEC or E-FEC	Trunk port 2 without FEC or with FEC or E-FEC

2.7.10.1.1 Dual Transponder (OTU2-XP-Txp)

You can configure the OTU2_XP card as a dual transponder (Figure 2-16). When configured as a dual transponder (OTU2-XP-Txp), the card supports two completely independent bidirectional 10-Gbps services. Port 1 and Port 2 support traffic from or to port 3 and port 4, respectively. Both paths are completely independent and can support different services. G.709 wrapping or unwrapping and FEC correction capability can be independently activated on each path.

Figure 2-16 Dual Transponder Configuration

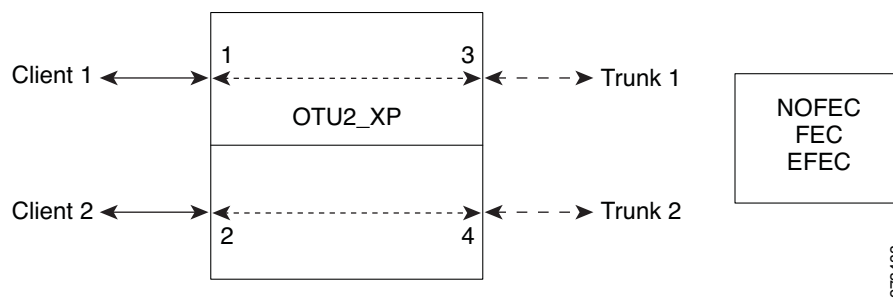

You can assign one the following service types as the client:

- OC-192/STM64
- 10GE WAN-PHY
- 10GE LAN-PHY
- 10G-FC
- LAN-WAN Conversion

You can set one of the following trunk modes on both trunks for any of the service types:

- No FEC
- FEC
- E-FEC

2.7.10.1.2 Dual Regenerator (OTU2-XP-Regen)

You can configure the OTU2_XP card as a dual regenerator (Figure 2-17). When configured as a dual regenerator (OTU2-XP-Regen), the unit regenerates two completely independent bidirectional 10-Gbps signal paths (similar to the OTU2-XP-Txp configuration). In this configuration, all four ports support DWDM XFPs. You can also independently set G.709 framing and FEC capability for all four ports. You can enable E-FEC encoding only on ports 3 and 4.

Figure 2-17 Dual Regenerator Configuration

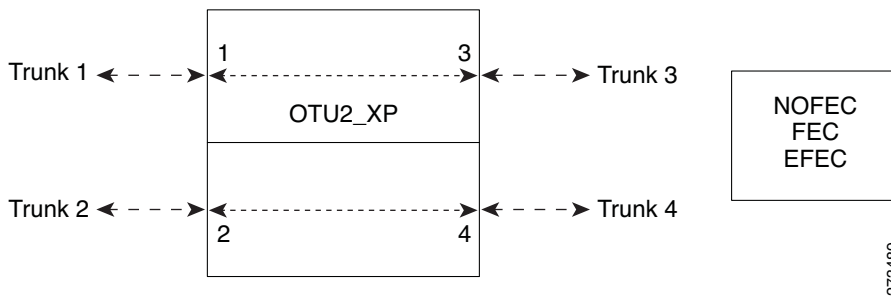

You can use the following combinations of trunk modes according to the framing of the service to be regenerated:

- OC-192/STM-64 service type:
 - Trunk ports 1 and 2: No FEC
 - Trunk ports 3 and 4: No FEC
- OTU-2 service type:
 - Trunk ports 1 and 2: FEC
 - Trunk ports 3 and 4: FEC
 - or
 - Trunk ports 1 and 2: E-FEC
 - Trunk ports 3 and 4: FEC

2.7.10.1.3 Single Regenerator (OTU2-XP- Single Regen)

You can configure the OTU2_XP card as a single regenerator (Figure 2-18). When configured as a single regenerator (OTU2-XP- Single Regen), the card regenerates only one bidirectional 10-Gbps signal path. The ports 3 and 4 support DWDM XFPs and G.709 framing as well as E-FEC.

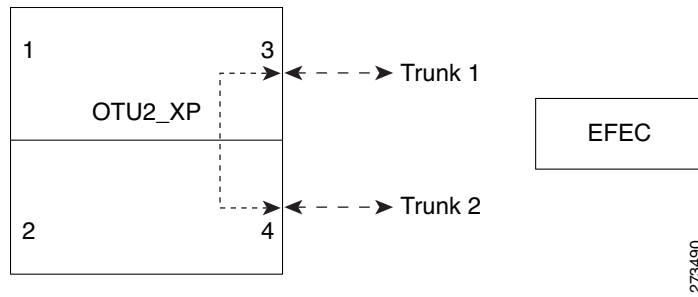
Figure 2-18 Single-Regenerator Configuration

2.7.10.1.4 Protected Transponder (OTU2-XP- Splitter)

You can configure the OTU2_XP card as a protected transponder (Figure 2-19). When configured as a protected transponder (OTU2-XP- Splitter), the card implements the fiber-switched protection. In this configuration, the client service on port 1 is transmitted to ports 3 and 4 and then on to both trunks. Only one signal received from the two trunks on ports 3 and 4 is transmitted to port 1 (the signal from the other port is only monitored). After detecting a failure on one trunk, the unit automatically switches on the other port, which restores the signal on port 1. In protected-transponder configurations, port 2 is always disabled.

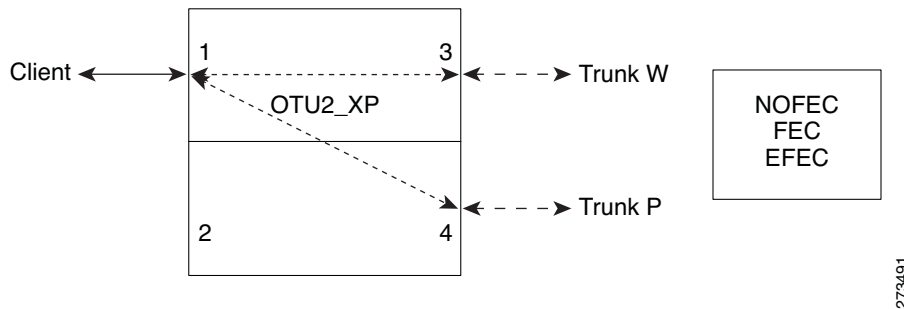
Figure 2-19 Protected-Transponder Configuration

You can set one of the following service type for the client port:

- OC-192/STM64
- 10GE WAN-PHY
- 10GE LAN-PHY
- 10G-FC
- LAN-WAN Conversion

You can set one of the following trunk modes on both trunks for any of the service types:

- No FEC
- FEC
- E-FEC

2.7.10.1.5 Mixed Mode (OTU2-XP- Mixed)

You can configure the OTU2_XP card in mixed mode (Figure 2-20). When configured in mixed mode (OTU2-XP- Mixed), the card is a regenerator on one set of the ports and a transponder on the other set. The two sets are completely independent and can be configured to transmit or regenerate different services. You can independently set G.709 framing and FEC capability on each trunk port, but ports 1 and 2 cannot have E-FEC encoding.

Figure 2-20 Mixed-Mode Configuration

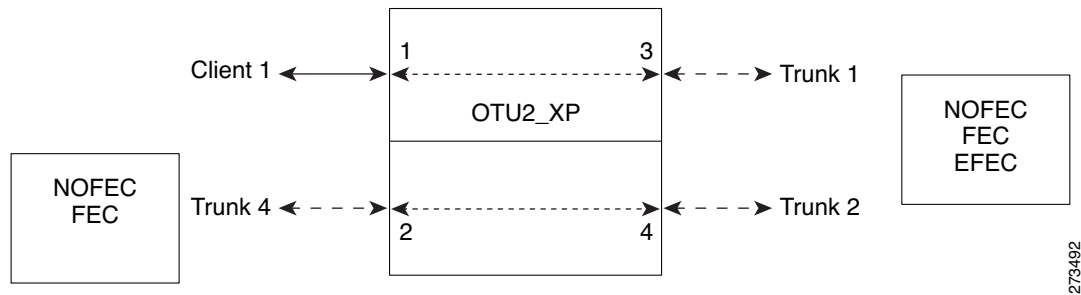

You can swap the configuration of the two sets, that is, ports 1 to 3 set as the regenerator and ports 2 and 4 as the transponder.

You can set one of the following service types for the client port:

- OC-192/STM64
- 10GE WAN-PHY
- 10GE LAN-PHY
- 10G-FC
- OTU2
- LAN-WAN Conversion

You can set one of the following trunk modes on all the trunks for all service types:

- No FEC (all)
- FEC (all)
- E-FEC (only to ports 3 and 4)

CTP does not automatically select mixed mode for OTU2_XP cards. You need to select mixed mode for an OTU2_XP card to force it.



Note

The FI and FC demands are not supported on port 2 as a source when the LAN-WAN traffic is fed as a source on port 1.

For further information on the OTU2_XP card, refer to the *Cisco ONS 15454 DWDM Configuration Guide, Release 9.4*.

2.8 Viewing Circuits in a Network

You can view all the circuits that have been created in any of the Service Demands folders in the **Traffic** tab of the **Net1** tab.

The following columns are displayed:

- SA—Indicates the system alarms that affect the circuit. This indication is available only after the network is analysed.
- AL— Indicates the optical alarms that affect the circuit. This indication is available only after the network is analysed.
- F—Indicates if the demand will be needed in the future.
- Demand —Displays the name of the demand.
- Group—Displays the demand group to which the circuit belongs.
- Label —Displays the label of the circuit.
- TMSubnet—Displays the name of the traffic subnet in which the circuit is defined.
- SrvType— Displays the service type value.
- Sites—Lists the add/drop site.
- Card/TrunkType—Displays the card type and trunk type.
- Protection type— Displays the protection type of the demand.
- Wavelength —Displays the assigned wavelength.

You can edit the circuits for any demand by double-clicking the circuit or by choosing the circuit and clicking the **Edit** button in the toolbar.

Use any one of the following options to group and order the circuits:

- Type\Demand\Group— The circuits are first grouped and ordered by demand name. Each set of circuits with the same demand name is then ordered by the group name.
- SrvType\Type\group—The circuits are first grouped and ordered by service type. Each set of circuits with the same service type is then ordered by the group name.

**Note**

You can also select a set of fields in a particular order in the Group by dialog box to build a grouping rule to be applied to the table.

2.9 Analyzing the Network

After you have created the desired sites, fiber spans, and service demands, you must analyze the network to determine network performance. The network must be in the Design, Install, or Upgrade state before you can analyze it. Cisco Transport Planner automatically optimizes the design and summarizes the optical transmission performance. If there are problems with the design, Cisco Transport Planner lists the problems and descriptions in the Analyzer Messages pane.

Use the following procedure to analyze the network:

-
- Step 1** Click the **Mgmt Tree** tab, and click the network that you want to analyze.
- Step 2** Click the Analyze Network icon in the toolbar. For more information about the Cisco Transport Planner icons, see [Appendix A, “GUI Information and Shortcuts.”](#) As an alternative, click **Analyze** in the Tasks Pane.
- The Cisco Transport Planner analysis status bar indicates when the network analysis is complete.
- Step 3** If any problems occur during the analysis, click the **Analyzer** tab to view the results on the Analyzer Messages pane. The Summary report appears. See the “[3.2.1 Viewing the Summary Report](#)” section on [page 3-2](#) for more information. Warning and error messages help you identify problems with your current design. For a list of all system messages, see [Appendix C, “System Messages.”](#)
- Step 4** If necessary, resolve the problems listed in the Summary report. After you resolve the problems in the network, you can analyze the network again.



Note

You can return a Design-Analyzed network to the design state to make further changes by clicking the network icon in the Mgmt Tree and clicking **Design** in the Tasks Pane.

2.9.1 Viewing the Site Functional View

The Site Functional View displays a graphical view of the circuit connections, optical power, alarms, and signal loss of a selected site. After you have created the desired sites, fiber spans, and service demands, and analyzed the network, you can now view the Site Functional View. All the cards in each side are grouped together.

You can view the site functional view in either of the following ways:

- Right-click on the Site in the Project Explorer pane and select **Open Site Functional View**.
- In the Network view, right-click on the Site and select **Open Site Functional View**.
- Select the Site in the Network view and click **Open Site Functional View** in the **Tasks Pane**.

The Site Functional View of a selected site is displayed in a new tab. Double-click a side to see the details of that side. To return to the normal view, right-click on the side and click **Close Node**.

2.9.1.1 Changing the View

You can change the view of the graphical display to view the layout information in detail. Right-click on the sides of the image (grey area outside the image) to change the view.

You can select the following:

- Fit to View—Fits the side view into the available display space.
- Zoom In—Magnifies the view of the graphical display.
- Zoom Out—Shrinks the view of the graphical display

2.9.1.2 Alarm Information

Within the side display, an alarm box is shown that gives the alarm count for the Critical (CR), Major (MJ), and Minor (MN) alarms that affect that side. The alarm associated with the card is indicated to reflect the severity of the alarm (red, orange, and yellow).

2.9.1.3 Transponder and Muxponder Connections

All the transponder and muxponder cards with the patchcords are grouped together. To open and view the transponder and muxponder connections, right-click the patch panel and select **Open Patch Panel**.

2.10 Managing the Network Design

After creating and analyzing a network design, you must prepare the design for installation at a customer site. After a network has been installed, you can reanalyze to correct any problems.

Network designs have several possible states:

- **Design**—The initial state for any new network design. You can add, delete, or change any aspect of the network design. In the Design state, no locks exist. After analyzing a design, you can put it back into the Design state to modify it by choosing Design in the Tasks Pane.
- **Design-Analyzed**—The state of the network design after you run the network analyzer. All reports are available and updated. You cannot change any aspect of the network design. You can modify the BoM, such as changing global discounts and spare parts. You can return to the Design state after analyzing the network by choosing Design in the Tasks Pane.
- **Copy**—A copy of a network. You can create a copy of a network in any state. A copy is useful for testing different design options. You can copy a network before or after analyzing it. A copied network inherits the set of project options defined in the original network. For more information, see the [“2.10.1 Creating a Copy of the Network” section on page 2-52](#).
- **Install**—A network is initially designed with theoretical fiber values (such as loss, length, etc.). When a network is installed in the field, you can move the network into the Install state so that you can enter and check the real fiber parameter values. You can create an Install network from a network in the Design-Analyzed or Upgrade-Analyzed state. A network in the Install state inherits the set of project options defined in the analyzed network. All sites in an Install network are locked. You cannot modify any aspect of the network design except the span parameters and (on unlocked sites) amplifiers. You can, however, modify the BoM. All routed circuits are fixed, and cannot be changed while in this state. For more information, see the [“2.10.3 Creating a Network in the Install State” section on page 2-52](#).
- **Install-Analyzed**—The state of the Install network design after you run the network analyzer. All reports are available and updated. Cisco Transport Planner locks all sites, spans, demands, and equipment when a network is in the Install-Analyzed state.

- **Upgrade**—During network design, you define a number of the channels to be implemented at the present time and a number of channels to be implemented in the future (forecast). After installing the network, you might decide to implement the forecast circuits. To do this, you create an Upgrade network and then select the forecast or traffic demand services that you want to implement. You can create an Upgrade network from a network in the Design-Analyzed or Install-Analyzed state. You can unlock specified parameters to alter the design to include forecasted channels and traffic demands. A network in the Upgrade state inherits the set of project options defined in the analyzed network. For more information, see the [“2.10.4 Creating an Upgrade Network” section on page 2-53](#).
- **Upgrade-Analyzed**—The state of the Upgrade network design after you run the network analyzer. All reports are available and updated. Cisco Transport Planner locks all sites, spans, demands, and equipment when a network is in the Upgrade state.

To complete the procedures in this section, you must have a project open and the network(s) loaded. See the [“1.4.1 Opening a Project” section on page 1-21](#) and the [“1.4.2 Loading and Unloading Networks” section on page 1-21](#).

2.10.1 Creating a Copy of the Network

To create a copy of a network in any state, right-click the network and choose **Copy** from the shortcut menu. A new copy appears in the Network Mgmt Tree tab.

2.10.2 Creating a Copy of the Network in Design State

To create a copy of a network in the design state, right-click the network and choose the **Upgrade to Design** option from the shortcut menu or click **Copy & Go back to Design Mode** on the toolbar. A new copy appears in the Network Mgmt Tree tab. This copy retains all the forcing options and removes the reports, BoM, and output data.

The **Upgrade to Design** and **Copy & Go back to Design Mode** options are available only for networks in “Upgrade” or “Upgrade Analyzed” state from Release 8.5 and later.

2.10.3 Creating a Network in the Install State

Use the following procedure to create a network in the Install state:

-
- Step 1** If the network is not analyzed, complete the [“2.9 Analyzing the Network” section on page 2-49](#).
 - Step 2** Click the **Mgmt Tree** tab.
 - Step 3** Right-click the network and choose **Install** from the shortcut menu. A new network appears in the Mgmt Tree in the Install state. All results from the analyzed network are imported into the Install network and are placed in the Locked mode.
 - Step 4** Make the necessary changes to the Install network. You can edit the following fiber parameters: fiber loss value, fiber CD, fiber PMD, and fiber length. See the [“4.14 Editing Fiber Span, Pair, and Fiber Parameters” section on page 4-58](#). Cisco Transport Planner also allows you to unlock site parameters for modification. To change site parameters, see the [“4.3 Editing Site Parameters” section on page 4-2](#).

Step 5 In the Mgmt Tree view, click the **Analyze Network** icon in the toolbar. For more information about the Cisco Transport Planner icons, see [Appendix A, “GUI Information and Shortcuts.”](#) The Transport Planner Analyzer status window appears to indicate the progress. As an alternative, click **Analyze** in the Tasks Pane. The Cisco Transport Planner analysis status bar indicates when the network analysis is complete. The network now appears in the Install-Analyzed state.



Note If you have changed parameters that are inconsistent with the present network layout (for example, if you set an output tilt value that the amplifier cannot reach), during network analysis an error message on the Analyzer Messages pane identifies which parameter is causing the problem. Warning and error messages help you identify problems with your current design. For a list of all system messages, see [Appendix C, “System Messages.”](#)

Step 6 When you have analyzed the network and are satisfied with the results, import the new generated installation parameters to each site of the network. For more information, see the [“3.2.2 Saving the NE Update File”](#) section on page 3-3.

2.10.4 Creating an Upgrade Network

Use the following procedure to put a network in the Upgrade state:

Step 1 If the network is not analyzed, complete [Analyzing the Network, page 49](#).

Step 2 Click the **Mgmt Tree** tab.

Step 3 Right-click the analyzed network and choose **Upgrade** from the shortcut menu. A new Upgrade network appears in the Mgmt Tree tab. All results from the analyzed network are imported into the Upgrade network.

Step 4 Make the necessary changes to the Upgrade network. For more information, see the [Editing Fiber Span, Pair, and Fiber Parameters, page 58](#) and the [“4.3 Editing Site Parameters”](#) section on page 4-2.

Step 5 In the Mgmt Tree view, click the **Analyze Network** icon in the toolbar. For more information about Cisco Transport Planner icons, see [Appendix A, “GUI Information and Shortcuts.”](#) The Transport Planner Analyzer status window appears to indicate the progress. As an alternative, click **Analyze** in the Tasks pane in any view. The Cisco Transport Planner analysis status bar indicates when the network analysis is complete. The network now appears in the Upgrade-Analyzed state.



Note If you have changed parameters that are inconsistent with the present network layout (for example, if you set an output tilt value that the amplifier cannot reach), during network analysis an error message on the Analyzer Messages pane identifies which parameter is causing the problem. Warning and error messages can help you identify problems with your current design. For a list of all system messages, see [Appendix C, “System Messages.”](#)

In an Upgrade network, you can perform the following tasks:

- Modify the fiber span properties (such as length, dispersion, PMD coefficient, excess losses, and aging).
- Add or delete traffic

- Convert forecasted traffic to present traffic
- Finalize ROADM traffic to present traffic
- Modify the type of a node
- Force the presence or the absence of a card or a module (this includes amplifiers, OSC modules, OADM cards, and DCU modules)

In an Upgrade network, you can force certain installation parameters:

- Amplifier per-channel output power setpoint
- Amplifier output tilt setpoint
- OADM card aggregate output power setpoint
- Full multiplexer/demultiplexer or ROADM output power setpoint



Note If a network is analyzed in the Upgrade state when the cards are in the unlocked state, CTP replaces any existing TCC2P card with a TCC3 card in the M12 shelf.

You cannot change the following parameters when in Upgrade state:

- Node input channel fail threshold
- Node OSC channel fail threshold
- Preamplifier input power threshold
- OADM card aggregate input power setpoint
- Full muxponder/demuxponder or ROADM input power setpoint
- Channel drop power

When upgrading a network that has a point-to-point demand, you can:

- Move Future circuits to become Present. This move can be done without unlocking the circuit.
- Add new, present, or future point-to-point services to the existing demand.
- Delete any present or future channel originally defined in the baseline network.
- Change any unlocked point-to-point circuit or unlocked point-to-point service demand parameter.

When upgrading a network that has an any-to-any demand, you can:

- Move any of the Any-to-Any (future) services to become Present. This move can be done without unlocking the circuit.
- Create a new Any-to-Any demand on an already existing Any-to-Any group.
- Create a new Any-to-Any group.
- Delete an existing Any-to-Any demand from an Any-to-Any group.
- Delete an Any-to-Any group with all of its Any-to-Any demands.



Note Any-to-Any services that have been moved to Present will be represented as Point-to-Point services.

2.10.5 Unlocking Parameters in the Network Design

The Locked state occurs when no value is set for a parameter and Auto option is selected. During network analysis, Cisco Transport Planner assigns a value for each parameter set with Auto and puts them in the Locked state. The Locked state indicates that the next time the network is analyzed, the analyzer cannot change the value. Locking a site forces the presence or absence of all preamplifiers, boosters, add/drop filters, TDCU, and DCU units that the site/network requires as a result of running the analyzer previously.

Locked elements are indicated by a closed padlock icon in the Project Explorer pane. For more information on the Auto, forced, and locked states, see the “1.1.6 Auto, Forced, and Locked Parameters” section on page 1-17.

Figure 2-21 Unlocking Network in the Project Explorer Pane

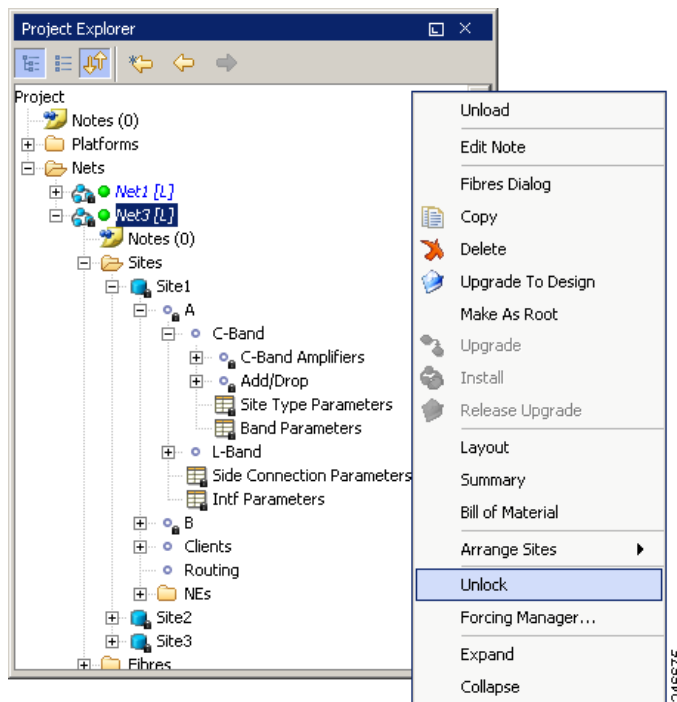

To unlock network components, right-click the desired element in Upgrade or Install mode in the Project Explorer pane and choose **Unlock** from the shortcut menu (Figure 2-21). You can unlock at the network level or the site level or the element level. Unlocking items at higher level unlocks all elements under that level.

2.10.5.1 Forcing Manager

Forcing Manager enables you to unlock multiple interfaces connected to various ducts and sites. This helps you unlock a group of sites and ducts based on individual units such as amplifiers, DCUs, add/drop units, band parameters, and node layout.

For example, you can unlock all the amplifiers, TDCUs, and DCUs of all the sites in the network in one go, with the help of Forcing Manager.

Use the following procedure to unlock multiple units in different sites/ducts:

- Step 1** Right-click the network folder in the Project Explorer pane and choose Forcing Manager from the shortcut menu. The Forcing Manager dialog appears (Figure 2-22).

To create a network in design mode, see 2.10.2 [Creating a Copy of the Network in Design State](#).

To create an upgrade network, see 2.10.4 [Creating an Upgrade Network](#).

Forcing Manger can be used in both the design mode and the upgrade mode.

- Step 2** Choose any one of the following options from the left pane of the Forcing Manager dialog:

- Sites—When a site is selected, all the interfaces under that site will be selected.
- Ducts—When a duct is selected, both the interfaces associated with the duct are selected.

The list of sites and ducts available for selection is displayed in the left pane. If you choose the option sites, the list of ducts are disabled. When you choose ducts, the list of sites are disabled.

Figure 2-22 Forcing Manager Dialog Box

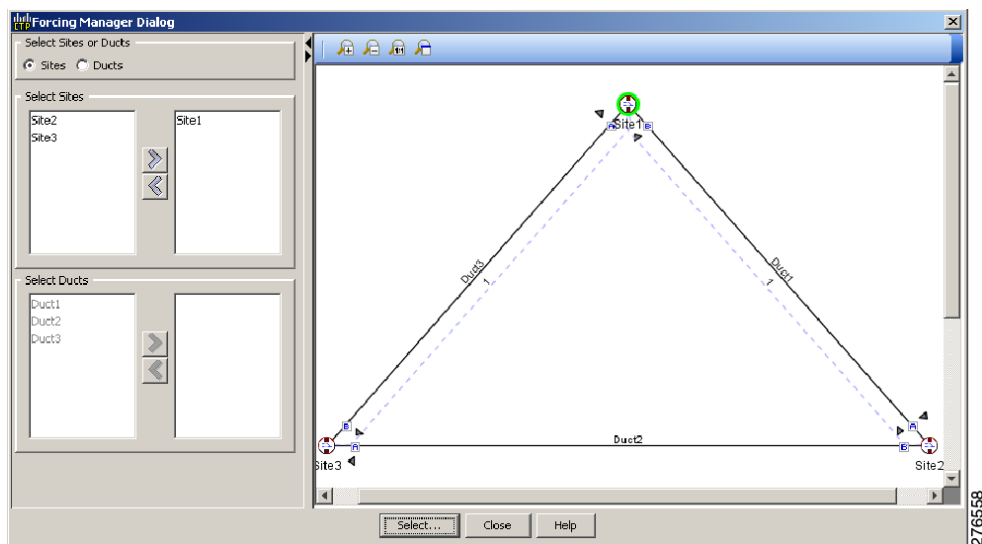

- Step 3** Choose the required sites/ducts that need to be unlocked.

The network layout is displayed in the right pane of the Forcing Manager dialog. The chosen sites/ducts are highlighted in a different color.

- Step 4** Click **Select** to select the individual units from the site/duct.

- Step 5** Click **Close** to close the Forcing Manager dialog.

- Step 6** Click **Help** to display the Help content for CTP.

- Step 7** Clicking **Select** to open the Select Units to Force dialog box.

Figure 2-23 Select Units to Force Dialog Box

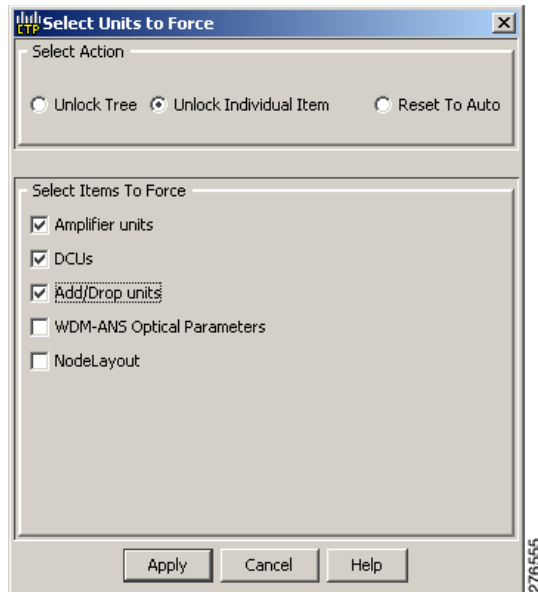

- Step 8** Select any one of the following options from the **Select Units to Force** dialog box (Figure 2-23):
- **Unlock Tree**—Unlocks all the units from the selected sites/ducts.
 - **Unlock Individual Item**—From the chosen sites/ducts, you can unlock one or more of the following items:
 - **Amplifier units**—Unlocking an amplifier will unlock the DCUs in a particular interface.
 - **TDCU**—Can be unlocked without unlocking amplifiers.
 - **DCUs**—Can be unlocked without unlocking amplifiers.
 - **Add/Drop units**
 - **WDM-ANS Optical Parameters**
 - **NodeLayout**—Unlocking a node unlocks all its children. This option is not available for ducts, as it is a site parameter.
 - **Reset to Auto**—Choose one or more of the following items to reset the values:
 - **Amplifier units**
 - **DCUs**
 - **Add/Drop units**
- Step 9** Click **Apply** to apply the changes to the network.
- Step 10** Click **Cancel** to cancel the changes and close the dialog box.
- Step 11** Click **Help** to display the Help content for CTP.
- Step 12** Click **OK** to close the Forcing Manager Dialog box.

2.10.6 Creating a JPEG of the Network Design

Use the following procedure to create a snapshot of your network design in JPEG format:

-
- Step 1** Click the **NtView Name** tab.
 - Step 2** Complete the “[4.20 Arranging Sites](#)” section on page 4-107 as necessary so that the sites in the network appear in the tab in the desired arrangement.
 - Step 3** Click the Save network view image icon in the toolbar.
 - Step 4** In the Save network view image dialog box, navigate to the desired directory.
 - Step 5** Enter the file name in the File Name field and click **Save**.
-

2.10.7 Upgrading to CTP Software Release 9.4

Use the following procedures to upgrade a release to CTP Software Release 9.4:



Note

- CTP Release 9.4 supports upgrading CTP Software Release 7.0 and later.
 - You can upgrade a software release only to its next highest supported release. For example, Release 7.0 can be upgraded to Release 8.0 but not to Release 8.5.
-

-
- Step 1** From the File menu, click **Open** to load the saved CTP project (Release 7.0 and later).
 - Step 2** Right-click on the network loaded in the Project Explorer pane and choose **Release Upgrade**. CTP automatically creates a copy of the initially loaded network and updates the system release to the next highest release. The newly created copy is moved into the Upgrade administrative state.
 - Step 3** Repeat [Step 2](#) until the release is upgraded to Release 9.4.



Note

The tool allows you to manually enter the details of a deployed network even if the Cisco Transport Planner design file is not available. You can perform a release upgrade only on a network that has been analyzed.



Note

If a network is analyzed in the Release Upgrade state when the cards are in the unlocked state, CTP replaces any existing TCC2P card with a TCC3 card in the M12 shelf.

2.11 Generating a BoM

You can generate a BoM when a network is in the Install or Upgrade state, or after you have successfully analyzed your network design. The price database selected during project creation is used to generate the BoM.

To complete the procedures in this section, you must have a project open and the network(s) loaded. See the “1.4.1 Opening a Project” section on page 1-21 and the “1.4.2 Loading and Unloading Networks” section on page 1-21.

2.11.1 Viewing BoM Report Totals

Use the following procedure to view the BoM report totals:

-
- Step 1** Click the **Mgmt Tree** tab and click the network.
- Step 2** In the Tasks Pane, click **Bill of Material**. The Bill of Material tab appears. As an alternative, you can access this report by choosing **Bill of Materials** from the Reports folder in the Project Explorer pane. The upper section of the BoM tab (in the Net view, Site view, and Spare subtabs) displays the following information:
- **BoM total discounted**—Displays the price for the overall network (without spare parts) for each item in the BoM. If Use global discount is checked, the total includes the discount from the Global discount percentage field.
 - **Spare total discounted**—Displays the price for all of the recommended spare parts in all of the maintenance centers for the overall network. It is the sum of each spare item using the discounted price. The total appears after you check the Spare Part Report check box.
 - **BoM + Spare total discounted**—Displays the sum of the BoM total discounted price and spare total discounted price.
 - **Price List**—Displays the name of the price list database selected for the project.
 - **Price List last update**—Displays the date that the selected price list was last updated.
 - **Currency**—Displays the value of the currency used for each of the price values as specified within the selected price list database.
- Step 3** To use the Multishelf Management Integrated Kit bundle when generating the BoM instead of the single items, check **Use MSM bundle**.
- Step 4** Check **Use Spare Parts** to include the spare parts in the report totals.
-  **Note** You can check the Use Spare Parts check box only if the network is in Design mode.
-
- Step 5** The Global discount percentage field shows the percentage from the Global Discount Percentage option in the Default Project Options window. To change the global discount for the entire network, check **Use global discount** and enter a new global discount in the form of a percentage in the **Global discount percentage** field. The global discount is applied to all components in the BoM and will overwrite any discount specified in the Global Price List.
-

2.11.2 Generating a Network BoM

Use the following procedure to generate a BoM for the network:

- Step 1** Click the **Mgmt Tree** tab and click the network.
- Step 2** In the Tasks Pane, click **Bill of Material**. The Bill of Material tab (see [Figure 2-24](#)) appears. The Net View subtab is selected by default. Items that are not found appear in yellow in the BOM.

Figure 2-24 Bill of Material Tab, Net View Subtab

The screenshot shows the 'Net view' subtab of the Bill of Material report. The table contains the following data:

Product ID	Description	Quan...	Unit price	Unit Disco...	Total price	Dis
15454-EAP-MF	Ethernet Adapater Panel Mechanical Frame	2	400.00	0.0 %	800.00	
15454-AIR-RAMP=	ONS 15454 Air Ramp / Baffle for the ANSI Cha...	2	120.00	0.0 %	240.00	
15454-FBR-STRG=	Fiber Storage Shelf	2	800.00	0.0 %	1,600.00	
15454-FTA3-T	Shelf Fan Tray Assembly, ANSI, 15454, HPCFM, ...	2	500.00	0.0 %	1,000.00	
15454-SA-HD	15454 SA HD NEB53 ANSI w/ RCA and Ship Kit	2	2,000.00	0.0 %	4,000.00	
15454-EAP	Ethernet Adapater Panel	4	550.00	0.0 %	2,200.00	
15454-BLANK=	Empty slot Filler Panel	18	225.00	0.0 %	4,050.00	
15454-MS-ISC-100T	MultiShelf Management Integrated Switch Card	4	10,000.00	0.0 %	40,000.00	
15454-TCC2P-K9	Timing Communications Control Two Plus, 1-Temp	4	3,000.00	0.0 %	12,000.00	
15454-R7.0.05WK9	Rel. 7.0.0 Feature Pkg., CD, Right To Use Lice...	2	1,995.00	0.0 %	3,990.00	
SF15454-R7.0.0K9	Rel. 7.0.0 SW, Pre-loaded on TCC	4	0.00	0.0 %	0.00	
15454-OSC-CSM=	ONS 15454 Combiner and Separator with OSC ...	4	6,500.00	0.0 %	26,000.00	
15454-AD-1C-58.1=	ONS 15454 OADM - 1 Chn - 100GHz - 1558.17	2	9,500.00	0.0 %	19,000.00	
15454-10E-L1-C=	15454 10G Multi-Rate Transponder- EFEC- Full ...	2	50,000.00	0.0 %	100,000.00	
ONS-XC-10G-S1	XFP - OC192/STM64/10GFE - 1310 SR - SMLC	2	4,800.00	0.0 %	9,600.00	

[Table 2-4](#) describes the Net view subtab columns. See the “[2.11.1 Viewing BoM Report Totals](#)” section on [page 2-59](#) for a description of the data, check boxes, and fields at the top of the window.

Table 2-4 BoM Net View Columns

Column Label	Description
Product ID	Displays the ordering code used to order the BoM from Cisco.
Description	Displays a description of the product.
Quantity	Displays the number of specific products in the BoM.
Unit price	Displays the price for each unit. If the price does not appear, Invalid will display. This occurs when the price list reports “NaN” (Not a Number) for the item because the price list has never been updated. Invalid items appear in the list in red. Items that have not been updated from CCO appear in yellow.

Table 2-4 *BoM Net View Columns (continued)*

Column Label	Description
Unit Discount	Displays the per-unit discount amount that you assigned in the Global Discount Percentage field. If you leave the field blank, the field displays the default value from the Price List database.
Total price	Displays the total price of the products before applying the discount.
Discounted Total Price	Displays the total price of the products after applying the discount.
Site #	Displays the number of products to be assigned to a particular site. The number of Site columns is the same as the number of sites in the network.

Step 3 To close the Bill of Material report, click the **X** in the upper right corner of the Bill of Material tab.

2.11.3 Generating a Site BoM

A site BoM lists all of the hardware and software parts required for the system to work as designed at a given site. Use the following procedure to generate a BoM for a site:

-
- Step 1** Click the **NtView Name** tab and click the site.
- Step 2** In the Tasks Pane, click **Bill of Material**. The Site view subtab is selected by default (Figure 2-25). Items that do not appear in the price list appear in red.

Figure 2-25 Bill of Material Tab, Site View Subtab

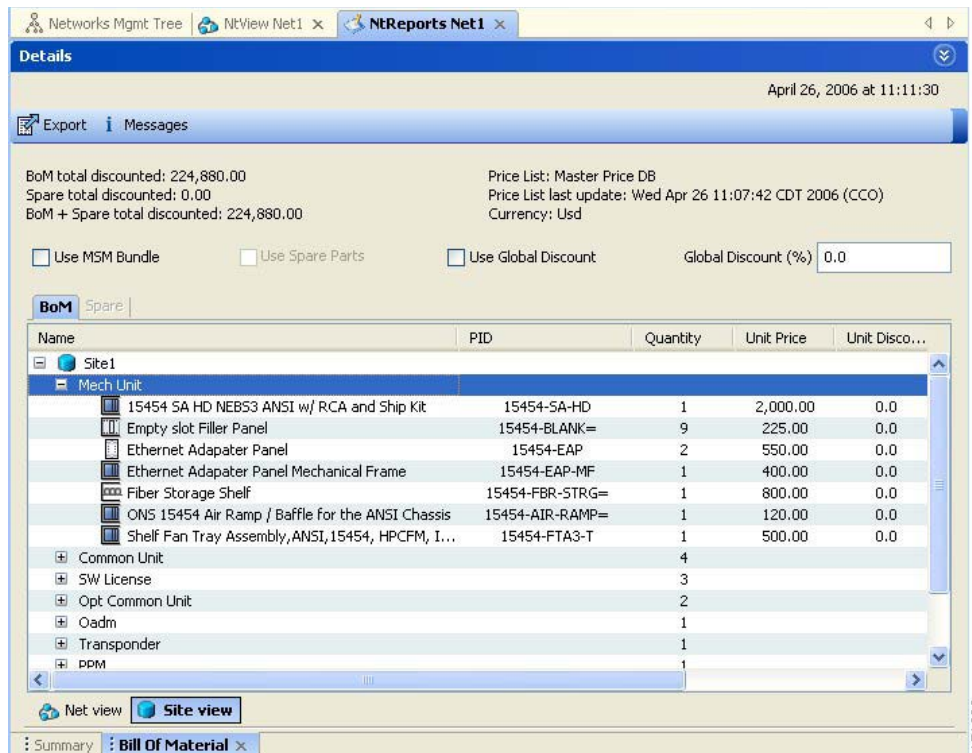

Table 2-5 describes the Site view subtab columns. See the “2.11.1 Viewing BoM Report Totals” section on page 2-59 for a description of the data, check boxes, and fields at the top of the window.

Table 2-5 BoM Site View Columns

Column Label	Description
Name	Displays the site name. Click the plus (+) sign to expand the site and display the categories. Click the plus (+) sign to expand each category to view the items in the BoM.
Product ID	Displays the ordering code used to order the BoM from Cisco.
Quantity	Displays the number of that specific item in the BoM.
Unit price	Displays the price for each unit. If the price does not appear, Invalid will display. This occurs when the price list reports “NaN” (Not a Number) for the item because the price list has never been updated. Invalid items appear in the list in red. Items that have not been updated from CCO appear in yellow.
Unit Discount	Displays the per-unit discount amount that you assigned in the Global Discount Percentage field. If you leave the field blank, the field displays the default value from the Price List database.
Total Price	Displays the total price of the products before applying the discount.
Discounted Total Price	Displays the total price of the products after applying the discount.

Step 3 To close the Bill of Material report, click the **X** in the upper-right corner of the Bill of Material tab.

2.11.4 Generating a Spare Parts Report

After you generate the BoM, use the following procedure to determine the spare parts required by the network. If the network is in the Upgrade state, the report includes the parts required to support the implemented services and the new additional present services. To generate a spare parts report, you must associate a site with a maintenance center before network analysis. For more information, see the “4.3 Editing Site Parameters” section on page 4-2.

Step 1 Click the **Mgmt Tree** tab and click the network.

Step 2 In the Tasks Pane, click **Bill of Material**. Click the **Spare** subtab (Figure 2-26).

Figure 2-26 Bill of Material Tab, Spare Subtab

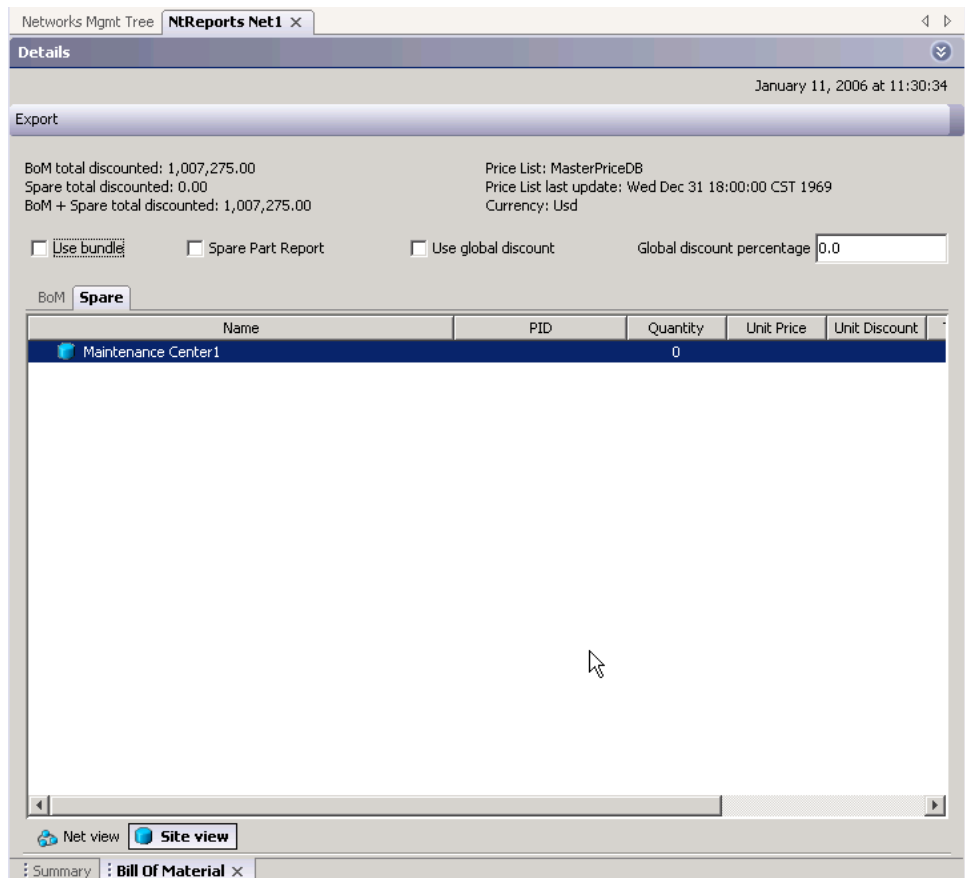

Table 2-6 describes the Spare subtab columns. See the “2.11.1 Viewing BoM Report Totals” section on page 2-59 for a description of the data, check boxes, and fields at the top of the window.

Table 2-6 BoM Spare Subtab Columns

Column Label	Description
Name	Displays the name of the item at the site. Right-click the maintenance center and choose Expand All from the shortcut menu to view all spare parts.
Product ID	Displays the ordering code used to order the BoM from Cisco.
Quantity	Displays the number of specific items in the BoM.
Unit price	Displays the price for each unit. If the price does not appear, Invalid will display. This occurs when the price list reports “NaN” (Not a Number) for the item because the price list has never been updated. Invalid items appear in the list in red. Items that have not been updated from CCO appear in yellow.
Unit Discount	Displays the per-unit discount amount that you assigned in the Global Discount Percentage field. If you leave the field blank, the field displays the default value from the Price List database.
Total Price	Displays the total price of the parts before applying the discount.
Discounted Total Price	Displays the total price of the parts after applying the discount.

Step 3 To close the Bill of Material report, click the **X** in the upper right corner of the Bill of Material tab.

2.11.5 Exporting a BoM

Use the following procedure to export the BoM to an external file in XML, Excel spreadsheet, HTML, or text format:

-
- Step 1** Click the **Mgmt Tree** tab and click the network.
 - Step 2** In the Tasks Pane, click **Bill of Material**. The Bill of Material tab appears.
 - Step 3** Click **Export**. The BoM export dialog box appears.
 - Step 4** In the BoM export dialog box, type the name of the file, choose the file type (**.xls** and **.html**) from the drop-down list, and navigate to the desired folder. Click **Save**.
-

2.12 Managing the Price List

A price list is defined for each project and is used to generate a BoM. Cisco Transport Planner can manage multiple price lists. You can even change a project price list after a project has been established. The Master Price list is the Global Price List in US dollars. You can download new price lists from Cisco Connection Online (CCO).

Only the selected price value is saved with a project; the actual price database is not saved with the project. When opening a saved project (for example, a project received from another designer), the associated price database might not be available. If this is the case, Cisco Transport Planner notifies you that the Master Price list will be used.

To save memory, Cisco Transport Planner automatically loads only the price list selected for the current project.

2.12.1 Creating a New Price List

Use the following procedure to download a price list from CCO. You can download price lists from CCO if no projects are currently open.

- Step 1** If a project is open, close the project. See the “1.4.4 Closing a Project” section on page 1-22.
- Step 2** From the Tools menu, choose **Price List Mgmt.** The Price Manager dialog box appears (Figure 2-27).

Figure 2-27 Price Manager Dialog Box

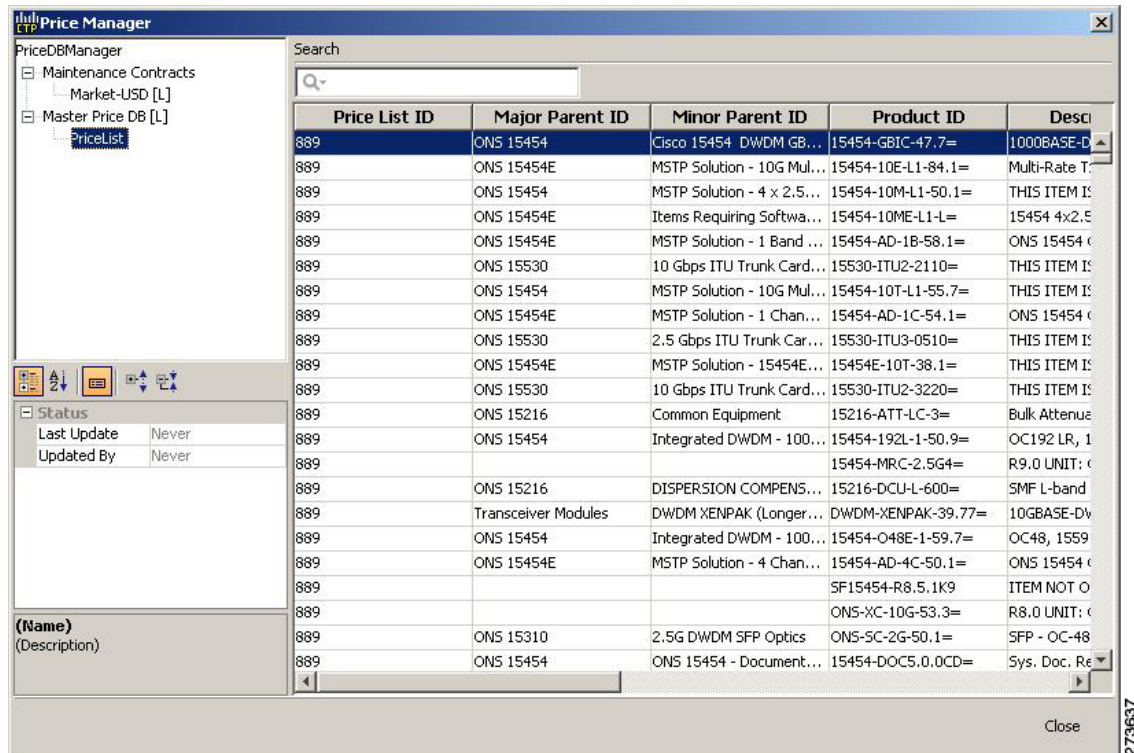

273637

- Step 3** In the Price Manager dialog box, right click **PriceDBManager** and choose **New Price DB** from the shortcut menu.
- Step 4** In the Create a New Price DB dialog box, enter the price list name.
- Step 5** From the drop-down list, choose the desired CCO price list.
- Step 6** Click **OK**.
- Step 7** Click **OK** to update from CCO.
- Step 8** In the CCO User Name/Password dialog box, type your user name and password, and click **OK**. Cisco Transport Planner downloads the CCO price list.
- Step 9** When the update is complete, click **OK** to close the confirmation dialog box. The new price list appears in the PriceDBManager tree.
- Step 10** Click **Close** to close the Price Manager dialog box.
-

2.12.2 Viewing a Price List

Use the following procedure to view and filter a price list:

- Step 1** From the Tools menu, choose **Price List Mgmt**. The Price Manager dialog box appears ([Figure 2-27 on page 2-65](#)).
- The PriceDB Manager tree lists all of the created price lists. To save memory, Cisco Transport Planner automatically loads only the price list selected for the current project (unless the user requests otherwise). An L indicates that the price list is loaded in memory and is available. A U indicates that a price list is currently not loaded in memory and is not available.
- Step 2** To load or unload a price list, right-click a price list and choose **Load** or **Unload** from the shortcut menu.
- Step 3** Click **PriceList** under the desired price list identifier in the PriceDBManager tree. The list displays in the right pane of the Price Manager dialog box. The properties of the price list appear in the bottom left corner of the Price Manager dialog box:
- Last update—Indicates the date of the last download from CCO for this price list. If Never appears, this indicates that the user created a price list without downloading from CCO.
 - Updated by—Identifies the way in which the price list was updated.

The price list displays the following columns:

- Price List ID—For internal use.
- Major Parent ID—Lists the platform.
- Minor Parent ID—Lists the equipment type.
- Product ID—Identifies the ordering code for the specific unit.
- Description—Provides detail about the item.
- Service Category—For future use.
- List Price—Indicates the price of the item. If NaN (Not a Number) appears in the field, the list has not been updated.
- Major ID—For internal use.
- Minor ID— For internal use.

- Update Status—Identifies how the last update was made to an item:
 - None—Indicates that the price list has never been updated.
 - local_file—Indicates that the price list has been updated from a local file.
 - cco—Indicates that the price list has been updated from CCO.
 - user—Indicates that the price list has been manually updated by the user who directly edited the price list. The user can modify the Discount field.
 - Discount—If a discount applies, identifies the discount percentage. To modify this field, enter the new percentage.
- Step 4** To search for a specific item in a price list, type the desired item in the Search field at the top of the list. As you type, Cisco Transport Planner filters the list items to match your search entry. To choose Search options, click the Search Tool icon to the left of the Search field and choose one of the following:
- Column name—Searches only the specified column for the search string. The All option searches all columns.
 - Case sensitive—Matches the case of the search string.
 - Case insensitive—Disregards the case of the search string.
 - Match from start—Searches only for the search string if it appears at the beginning of column text.
 - Match any where—Searches for the search string if it appears anywhere in the price list.
- Step 5** To sort the items in the price list, click on a column to sort by that column.
- Step 6** Click **Close** to close the Price Manager dialog box.
-

2.12.3 Loading and Unloading Price Lists

To save memory, Cisco Transport Planner automatically loads only the price list selected for the current project. An “L” by a price list in the Price Manager dialog box indicates that the price list is loaded; a “U” in the Price Manager dialog box indicates that the price list is not loaded. Use the following procedure to load or unload price lists in Cisco Transport Planner:

- Step 1** From the Tools menu, choose **Price List Mgmt**. The Price Manager dialog box appears ([Figure 2-27 on page 2-65](#)).
- Step 2** Right-click the price list and choose **Load** or **Unload** from the shortcut menu.
-

2.12.4 Updating a Price List from CCO

Use the following procedure to update a specified price list from CCO or from a local file. You can also update all price lists, even the lists that are not currently loaded. You can update a price lists from CCO if no projects are currently open.

- Step 1** If a project is open, close the project. See the “[1.4.4 Closing a Project](#)” section on [page 1-22](#).
- Step 2** From the Tools menu, choose **Price List Mgmt**. The Price Manager dialog box appears ([Figure 2-27 on page 2-65](#)).

- Step 3** Right-click the desired price list identifier in the PriceDBManager tree and choose **Expand** from the shortcut menu.
 - Step 4** Right-click the desired price list in the expanded tree and choose **UpdateFromCCO** from the shortcut menu.
 - Step 5** In the Update from CCO dialog box, choose **Update single price list** to download data for the specified list or **Update all price lists** to download the latest data for all price lists.
 - Step 6** In the CCO User Name/Password dialog box, type your user name and password and click **OK**. Cisco Transport Planner downloads the price list.
 - Step 7** When the update is complete, click **OK** to close the confirmation dialog box.
 - Step 8** Click **Close** to close the Price Manager dialog box.
-

2.12.5 Copying a Price List

Use the following procedure to create a new price list by copying from an existing one. The new price list will have all of the attributes and values of the original price list (such as Updated By, Last Update, unit price, discounts, and so on). You can copy a price list if no projects are currently open.

- Step 1** If a project is open, close the project. See the [“1.4.4 Closing a Project” section on page 1-22](#).
 - Step 2** From the Tools menu, choose **Price List Mgmt**. The Price Manager dialog box appears ([Figure 2-27 on page 2-65](#)).
 - Step 3** Right-click the desired price list in the PriceDBManager tree and choose **Copy** from the shortcut menu.
 - Step 4** Enter the name for the new price list and click **Ok**. The new price list appears in the PriceDBManager tree.
 - Step 5** Click **Close** to close the Price Manager dialog box.
-

2.12.6 Deleting a Price List

Use the following procedure to delete a price list. You cannot delete the Master Price List or a price list that is in use by a project. You can delete a price list if no projects are currently open.

- Step 1** If a project is open, close the project. See the [“1.4.4 Closing a Project” section on page 1-22](#).
 - Step 2** From the Tools menu, choose **Price List Mgmt**. The Price Manager dialog box appears ([Figure 2-27 on page 2-65](#)).
 - Step 3** Right-click the desired price list in the PriceDBManager tree and choose **Delete** from the shortcut menu.
 - Step 4** Click **Close** to close the Price Manager dialog box.
-

2.12.7 Viewing Maintenance Contracts

Use the following procedure to view maintenance contracts:

-
- Step 1** From the Tools menu, choose **Price List Mgmt.** The Price Manager dialog box appears ([Figure 2-27 on page 2-65](#)).
 - Step 2** Right-click **Maintenance Contracts** and choose **Expand** from the shortcut menu.
 - Step 3** Click **ContractsList**. The Contract PID column lists the service contract identifiers for the hardware and software parts used by Cisco Transport Planner. The Contract Category column describes the service programs.
 - Step 4** Click **MapPidsContracts**. The PID column lists the product identifiers. The Contracts column lists the service contract identifier.
 - Step 5** Click **Close** to close the Price Manager dialog box.
-

2.13 Importing Designs Created in the Sherpa Tool

The Sherpa tool is used to create Layer 2 network designs using Cisco Carrier Packet Transport (CPT) system. These network designs can be saved as XML files and imported into CTP. Use the following procedure to import designs created in the Sherpa tool.

-
- Step 1** From the Tools menu, choose **Import From Sherpa**. The Sherpa file import wizard is displayed.
 - Step 2** In the Import XML area:
 - Click the **Browse** button to browse for the Sherpa generated XML file. Select the XML file and click **Open**. The file path is displayed in the Import field.
 - Select one of the following radio buttons to define the import mode:
 - Custom—The Sherpa network is manually mapped to an existing CTP network that is in the Design or Upgrade mode.
 - Green Field—Sherpa design is imported into a new network in a new CTP project. Ensure that there is no project currently open in CTP, as two projects cannot be simultaneously open.
 - Step 3** Click **Next**.
 - Step 4** In the Project/Network Options area, these radio buttons are available under two categories—Project and Network:
 - The following radio buttons define project creation:
 - Use existing CTP project—The Sherpa design is imported into an existing CTP project, which is currently open. This option is unavailable if Green Field is selected as the import mode.
 - Create a new project—The Sherpa design is imported into a new CTP project. This option is unavailable if Custom is selected as the import mode.

- The following radio buttons define network creation:
 - Use existing network—The sites in the Sherpa design are imported into an existing network, which can be selected in the adjacent drop-down list. This option is unavailable if Green Field is selected as the import mode.
 - Create a new Network—The sites in the Sherpa design are imported into a new network. This option is unavailable if Custom is selected as the import mode.

Step 5 To complete importing the Sherpa file, do one of the following:

- If you have selected the Green Field option, click **Finish**. The Sherpa design is imported into CTP. The sites, ducts, and demands are created in CTP with the same parameters as defined in the Sherpa design.
- If you have selected the Custom option, click **Next** to choose the settings to map the Sherpa elements to CTP elements.

You can map sites, fibers, and demands. The elements present in the Sherpa project are displayed as a tree structure on the left side of the Sherpa file import wizard.

Step 6 In the Sherpa - CTP Site Mappings area:

- Check the check box corresponding to the Sherpa site that needs to be mapped to a CTP site. By default, all the check boxes are selected.
- Click the cell in the CTP Match column. The list of available sites in the CTP network are displayed as a drop-down list. You can select:
 - Create New—A new site is created in CTP with the same name as that of the Sherpa site.
 - Site name—The Sherpa site is mapped to the selected CTP site. If there is any conflict between the fibers at the Sherpa site and the fibers at the CTP site being mapped, those fibers in the Sherpa Project tree structure are displayed in red. The conflict is resolved once the fibers are correctly mapped, as described in step 8.

Step 7 Click **Next**.

Step 8 In the Sherpa - CTP Fiber Mappings area:

- Check the check box corresponding to the Sherpa fiber that needs to be mapped to a CTP fiber. By default, all the check boxes are selected.
- Click the cell in the CTP Match column. The list of available ducts in the CTP network are displayed as a drop-down list. You can select:
 - Create New—A new duct is created in CTP with the same name as that of the Sherpa duct.
 - Duct name—The Sherpa duct is mapped to the selected CTP duct.

Step 9 Click on a duct in the Fibers Imported From Sherpa column. In the Fiber Property Chooser area, check the check box to retain either the Sherpa value or the CTP value for the duct parameters. No parameters are displayed in the Fiber Property Chooser area if the CTP match for the duct is set as Create New.

Step 10 Click **Next**.

- Step 11** In the Sherpa - CTP Demand Mappings area:
- Check the check box corresponding to the Sherpa demand that needs to be mapped to a CTP demand. By default, all the check boxes are selected.
 - Click the cell in the CTP Match column. The list of available demands in the CTP network are displayed as a drop-down list. You can select:
 - Create New—A new demand is created in CTP with the same name as that of the Sherpa demand. This is the only option available when the Sherpa design is being imported for the first time.
 - Demand name—The Sherpa demand is mapped to the selected CTP demand. This option is available only when the Sherpa design is reimported into the same CTP project.
- Step 12** Click the cell in the Circuits Imported From Sherpa column. In the Demand Property Chooser area, check the check box to retain either the Sherpa value or the CTP value for the demand parameters. No parameters are displayed in the Demand Property Chooser area if the CTP match for the demand is set as Create New.
- Step 13** Click **Finish**. The Sherpa design is imported into CTP. All the imported Sherpa elements are now converted as standard CTP elements.

**Note**

The sites, fibers, and demands in the Sherpa Project tree structure are displayed in blue if the elements they are being mapped to are in the locked state in CTP. This can occur while importing a Sherpa design into a CTP network that is in the upgrade or release upgrade state. In case of locked fibers, and demands, a message window is displayed after clicking Next in the Fibre Options page or Finish in the Demand Options page, respectively. Click **Yes** to unlock the elements.

However, the sites do not get unlocked during the import process. If the analysis generates any error due to the sites being locked, you have to unlock the sites manually.

**Note**

The CPT cards like fabric card, line card, and CPT 50 panel are not included in CTP reports and layouts. However, CTP supports the two CPT trunk pluggables—ONS-XC-10G-C and ONS-XC-10G-EPxx.x. These pluggables are visible in Optical Results, Traffic Matrix, and Internal Connections reports.

2.14 Bidirectional Communication with the Network Element

CTP communicates with the network element to import and export node parameters of the network. Use the following procedure to import a network from the node, analyze the network, and export the network to the node element.

- Step 1** From the CTP File menu choose **Import Network** or click **Import Network** in the Start Page. The Node Login dialog box appears.
- Step 2** In the Node Login dialog box, complete the following:
- Node IP—Enter the IP address of the Cisco Transport Controller (CTC) node.
 - Username—Enter the CTC username.
 - Password—Enter the CTC password.

- Step 3** Click **Ok**. The CTC window opens. The CTP window becomes inactive.
- Step 4** (Optional) Perform node provisioning as required in the CTC window.
- Step 5** In the network view, click **Circuits > Circuits** tabs. Verify that all the circuits are in the DISCOVERED state in Status column.
- Step 6** From the Tools menu in the CTC window, choose **Export XML** to export the node data to CTP. The Export Network Information into XML window appears listing all the nodes that are discovered.



Note The **Export XML** option is available only when CTC is launched through CTP.

- Step 7** Select the nodes to be exported into XML and click **OK**. The Export Successful dialog box appears when all the node data is exported.
- Step 8** Click **OK**.
- Step 9** (Optional) Repeat Steps 4 through 8 to make additional provisioning to the network.
- Step 10** Close the CTC window.
- a. From the File menu choose **Exit** option.
 - b. Click **Yes** to confirm exit.

The CTC window closes, the CTP window becomes active, and Import Network wizard appears. This may take about 1 minute depending on the system configuration.

- Step 11** In the Project/Network Options area, these radio buttons are available under two categories—Project and Network:
- The following radio buttons define project creation:
 - Use existing CTP project—This imports the node data from CTC into an existing CTP project. This option is disabled.
 - Create a new project—This imports the node data from CTC into a new CTP project.
 - The following radio buttons define network creation:
 - Use existing network—This imports the sites from the CTC node into an existing network. This option is disabled.
 - Create a new Network—This imports the sites from the CTC node into a new network.

- Step 12** Click **Next** to choose the settings to map the node elements to CTP elements.
- Step 13** In the Site Options area, check the check box corresponding to the site that needs to be mapped to a CTP site. By default, all the check boxes are selected.



Note CTP does not support omnidirectional and colorless sites or cascading 80-WXC-C cards.

- Step 14** Click **Next**.
- Step 15** In the Node - CTP Fibre Mappings area, check the check box corresponding to the fiber that needs to be mapped to a CTP fiber. By default, all the check boxes are selected.
- Step 16** Click on a duct in the Fibre Imported From Node column. In the Fiber Property Chooser area, for fibre type, select the fiber type from the drop-down list in the Node column.
- Step 17** Click **Next**.
- Step 18** In the Node - CTP Demand Mappings area, check the check box corresponding to the demand that needs to be mapped to a CTP demand. By default, all the check boxes are selected.



Note CTP supports importing Point-to-Point demands only.

- Step 19** Click **Finish**. The Importing Complete dialog box appears when the node properties are imported into CTP.
- Step 20** Click **Yes**. All the imported node elements are now converted as standard CTP elements. The Log Viewer displays the import log. This log file is saved in the CTP cache directory.
- The network is imported in the design mode.
- Step 21** (Optional) Make changes to the network in CTP as required.
- Step 22** Analyze the network for the imported node data to be applied. Perform the “Analyzing the Network” task described in “[2.9 Analyzing the Network](#)” section on page 2-49. After the network is analyzed, CTP provides an option to export CTP NE Update Configuration file to the node.
- Step 23** To export NE Update Configuration file to the node, right-click on any node in the analyzed network and choose **Provision Node**. The Node Login window appears.
- Step 24** In the Node Login window, complete the following:
- Username—Enter the CTC username.
 - Password—Enter the CTC password.



Note The Node IP field is prepopulated with the node IP address.

- Step 25** Click **Ok**. The CTC window opens with the node setup selection window for the selected node. The CTP window becomes inactive.
- Step 26** In the node setup selection window for the selected node, choose the node to be provisioned. Click **OK**.
- Step 27** On the Node Setup for *node name* page, choose one or more of the following:
- Node/Shelves Layout—Choose to preprovision the slots when no DWDM cards are installed. The slots are preprovisioned in each shelf in CTC for the cards defined in the network plan. (Errors will occur if cards are installed or the slots are preprovisioned). Preprovisioning the slots before the physical cards are installed ensures that card installers place the cards in the correct slots. Preprovisioning the slots is also useful if you want to set up the network prior to card installation. The node layout also preprovisions the chassis and passive units.
 - Passive Units—Choose to preprovisions the passive units.
 - Card Parameters—Check this check box to provision the following parameters, if the cards are installed.
 - TXP, MXP, GE_XP, 10GE_XP, GE_XPE, 10GE_XPE, ADM-10G, and OTU2_XP cards—Provisions the OTN and FEC parameters.
 - OPT-AMP-L, OPT-AMP-17-C, OPT-AMP-C, GE_XP, 10GE_XP, GE_XPE, and 10GE_XPE cards—Provisions the card mode.
 - Pluggable Port Modules—Check this check box to allow the provisioning of PPMs on TXP, MXP, GE_XP, 10GE_XP, GE_XPE, 10GE_XPE, ADM-10G, and OTU2_XP cards, including PPM payloads.
 - Internal Patchcords—Check this check box to allow creation of internal patchcords among cards provisioned in the node.
 - Optical Sides—Check this check box to allow the provisioning of optical sides.

- ANS Parameters—Check this check box to install the ANS parameters. ANS parameters provision the values required for the node to function within the specified network design. ANS parameters include span losses, optical power, optics thresholds, amplifier working mode, gain, tilt, and so on.
- Select All—Check this check box to select all the options.
- Skip Interactive Mode—Check this check box to enable CTC to provision all the chosen setup components automatically without displaying the results after each step.
- Save Installation Files (XML and log) On Node—Check this check box to enable CTC to save the XML and log files on the node.

Step 28 Click **OK**. The NE Update wizard appears. If you chose **Skip Interactive Mode** in [Step 27](#), continue with [Step 29](#). If not, the wizard page that appears depends on the options chosen in [Step 27](#). [Table 2-7](#) describes the NE Update wizard options..

Table 2-7 NE Update Wizard Options

NE Update Function	Action
Node/Shelves Layout	<p>View the cards and slots on the left side of the page and verify that they are the same as the layout in the Cisco Transport Planner Shelf Layout. If the cards and slots match, click Apply. If not, click Cancel and contact your next level of support to verify that you have the correct node setup file. If the site has a multishelf configuration, click Next and repeat this step for each shelf at the site.</p> <p>CTC preprovisions the slots. (This might take a few seconds.) The results appear in the Log window. Slots that are successfully provisioned display an “Applied” status. A “Slot not empty” status appears if slots cannot be provisioned because a card is physically installed or the slot is already provisioned. If this occurs, complete the following steps. Otherwise, continue with the next NE Update function.</p> <ol style="list-style-type: none"> 1. Click Cancel, then click Yes in the confirmation dialog box. The slot preprovisioning does not revert when you click Cancel. 2. If a physical card is installed, remove it from the shelf. 3. Perform one of the following steps: <ul style="list-style-type: none"> – Delete all the preprovisioned slots. – Delete the slot where the Slot Not Empty error occurred. Provision the slot manually, then repeat Steps 27 and 28 making sure to uncheck the Provision Node Layout option in Step 27. <p>Note When you preprovision a slot, the card is purple in the CTC shelf graphic and “NP” (not present) appears on the card. After the physical card is installed, the card changes to white and “NP” is removed from the CTC shelf graphic.</p>
Passive Units Layout	<ol style="list-style-type: none"> 1. Review the passive unit settings. 2. Click Apply. 3. Click Next.
Pluggable Port Modules	<ol style="list-style-type: none"> 1. Review the PPM settings for each TXP, MXP, GE_XP, 10GE_XP, GE_XPE, 10GE_XPE, and OTU2_XP card. 2. Click Apply. 3. Click Next.

Table 2-7 NE Update Wizard Options

NE Update Function	Action
Card Parameters	<ol style="list-style-type: none"> 1. Review the OTN, FEC, and card mode settings for each TXP, MXP, GE_XP, 10GE_XP, GE_XPE, 10GE_XPE, and OTU2_XP card. 2. Click Apply. 3. Click Next.
Internal Patchcords	<ol style="list-style-type: none"> 1. Review the internal patchcords. 2. Click Apply. 3. Click Next.
Optical Sides	<ol style="list-style-type: none"> 1. Review the optical side assignments. 2. Click Apply. 3. Click Next.
ANS Parameters	<ol style="list-style-type: none"> 1. Review the ANS parameters on the left half of the page. 2. Click Apply. The log file displays the results. At the end, a Done status will appear. If a parameter could not be applied, a Setting Refused status appears. If this occurs, contact your next level of support.
Select All	If checked, selects all the options.
Skip Interactive Mode	If checked, CTC provisions all the chosen setup components automatically without displaying the results after each step.
Save Installation Files (XML and log) On Node	If checked, CTC saves the XML and log files on the node.

Step 29 Click **Finish**, then click **OK** in the Wizard Complete confirmation dialog box. The confirmation box indicates whether importing the NE Update Configuration file to the node was completed successfully.



Note Common control cards are not provisioned by CTP.



CHAPTER 3

Viewing Network Reports

3.1 Types of Reports

Cisco Transport Planner provides the reports listed in [Table 3-1](#). Report availability depends on whether a network has been analyzed or whether it is in the Install or Upgrade state. Reports are also available by site. See [Table 3-1](#) for report availability details.

Table 3-1 Report Availability

Report	Network Availability	Site Availability
NE Update	Analyzed	—
Installation Parameters	Analyzed	Analyzed
Traffic Matrix	Analyzed	Analyzed
Layout	Install, Upgrade, and Analyzed	Install, Upgrade, and Analyzed
Link Availability	Analyzed	Analyzed
Internal Connections	Analyzed	—
Optical Results	Analyzed	Analyzed
Wavelength Routing	Analyzed	—
Summary	Install, Upgrade, and Analyzed	Install, Upgrade, and Analyzed
Bill of Material	Install, Upgrade, and Analyzed	Install, Upgrade, and Analyzed
Ethernet Aggregated Demand	Analyzed	—
TDM Aggregated Demand	Analyzed	—
Any-to-Any Finalized Circuits	Analyzed	Analyzed

For more information on the Bill of Materials report, see the [“2.11 Generating a BoM”](#) section on [page 2-59](#). In addition, you can compare the following reports using the Reports Diff tool: Bill of Material, Internal Connections, and Installation Parameters.

To complete the procedures in this section, you must have a project open and the network(s) loaded. See the [“1.4.1 Opening a Project”](#) section on [page 1-21](#) and the [“1.4.2 Loading and Unloading Networks”](#) section on [page 1-21](#).

3.2 Viewing Reports

The following procedures use the Tasks Pane to access reports. You can also access reports by clicking the desired report in the Reports folder in the Project Explorer pane.

3.2.1 Viewing the Summary Report

The Summary report summarizes design information, optical results, design cost, and analyzer messages. You can view it before or after you analyze a network. It automatically appears when you analyze a network. Use the following procedure to view the report at another time:

- Step 1** Complete one of the following:
- To view the Summary report for a network, click the **Mgmt Tree** tab and click the network.
 - To view the Summary report for a site, click the **NtView Name** tab and click the site.
- Step 2** In the Tasks Pane, click **Summary**. The Summary tab appears (Figure 3-1).

Figure 3-1 Summary Tab

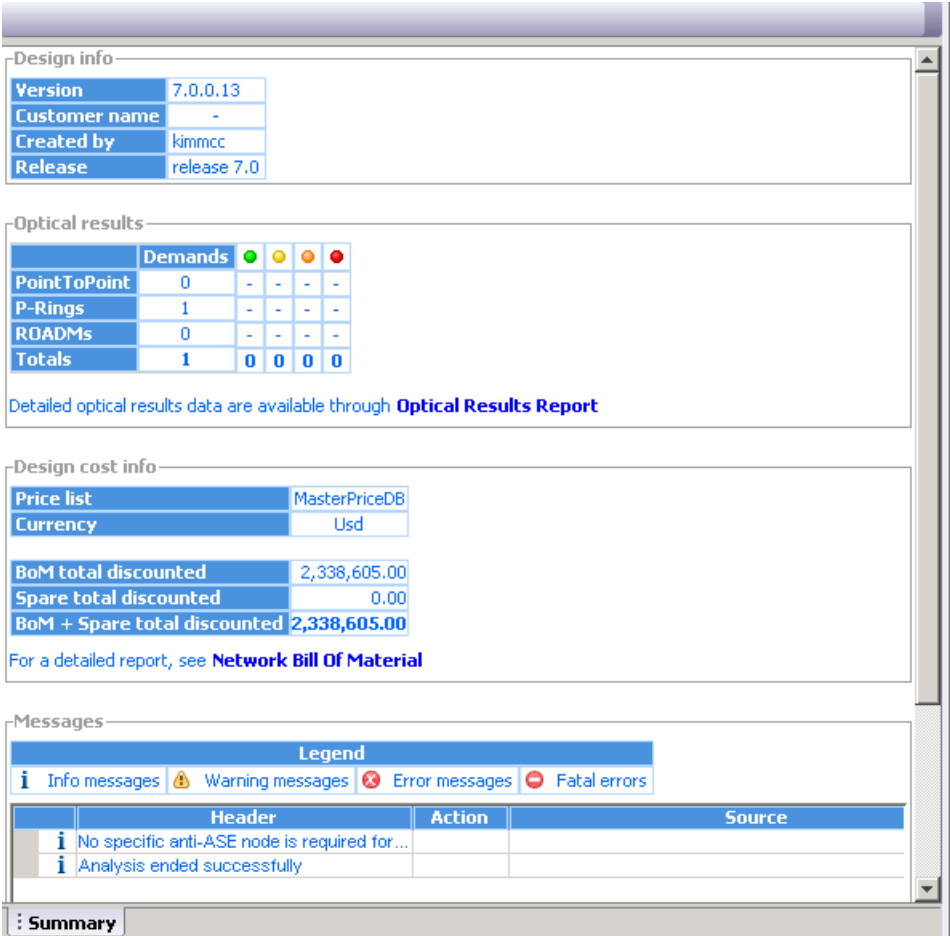

151699

Table 3-2 lists the categories in the Summary tab and their descriptions.

Table 3-2 Summary Tab Categories

Category	Description
Design info	Displays the following information: <ul style="list-style-type: none"> Version—Displays the Cisco Transport Planner software release version. Customer name—Displays the name of the customer requiring this network design. Created By—Displays the user login name. Release—Displays the Cisco Transport Planner software release number.
Optical results	Indicates how many demands are included in the network, and identifies the number and severity of alarms for each demand.
Design cost info	Displays the following information: <ul style="list-style-type: none"> Price list—Displays the price list used. Currency—Displays the currency selected for the price list. BoM total discounted—Displays the total price of the products (excluding spare parts) in the network with the discount applied. Spare total discounted—Displays the total price of the spare parts in the network with the discount applied. BoM + Spare total discounted—Displays the total price of the products (including spare parts) in the network with the discount applied.
Messages	Displays any analyzer messages that occurred as a result of network analysis. Warning and error messages will help you identify problems with your current design. For a list of all system messages, see Appendix C, “System Messages.”

3.2.2 Saving the NE Update File

After Cisco Transport Planner completes network analysis, you can create a configuration file. If the Optical Networking System (ONS) Software Release is 7.0 or later, a single XML file is created including all the automatic node setup (ANS) parameters for all the sites in the network. This file can be directly imported to a site using the NE Update feature in Cisco Transport Controller (CTC). CTC uses this file to preprovision a node.

Each file is named as NeUpdate.xml by default. The list of reported installation parameters depend on the system release selected for the designed network. You generally save this file after you analyze an installed network.

Use the following procedure to save the NE Update file:

-
- Step 1** Click the **Mgmt Tree** tab and click the analyzed network.
 - Step 2** In the Tasks Pane, click **NE Update**. The Network Element Update File dialog box appears.

- Step 3** This step is applicable only if you have selected MSTP Release 7.0, else go to [Step 4](#). Check the **Include wavelength parameters** check box to include trunk wavelength preprovisioning in the NE Update XML file. Do not check this check box if the network where you are importing the NE Update file is using ONS Software R7.0. If this option is checked, trunk wavelength is preprovisioned in CTC for all the TXP and MXP units required to support present traffic demands.



Note During project creation, selecting MSTP- Release 7.0 allows you to create projects for system releases R7.0 and 7.0.x. However, when importing the NE Update file on a node using system release R7.0., the node cannot read the NE Update XML file if Include wavelength parameters is checked.

- Step 4** To save the file in a different directory than the Destination Folder, click **Change** and navigate to the desired directory. Click **Save**.
- Step 5** Click **Finish**.
- Step 6** Click **Cancel** to close the window without saving a configuration setup file.

3.2.3 Viewing the Installation Parameters

The Installation Parameters reports shows the values to be set (provisioned) at installation time on each site in the network. These parameters are grouped under the network elements (NE) that are created after network analysis. These parameters are exported when you save the NE Update file and are used to automatically provision a node using CTC.

The NE Update file provides details of the parameters used to provision the passive units. The passive units are individually identified using the unit ID. The unit ID starts from 1 and gets incremented with the list of passive units present in that particular NE.

Passive units are optical devices that the controller card cannot manage and that are not configurable using software. The passive units that are provisioned in the ANP are:

- DCU units
- 15216-MD-40-ODD
- 15216-MD-40-EVEN
- PP-MESH-4/PP-MESH-8
- 15454-PP-4-SMR patch panel



Note CTP lists the passive units in Release 9.1 and later.

Use the following procedure to view the installation parameters after a network has been analyzed:

- Step 1** Complete one of the following:
- To view the Installation Parameters report for a network, click the **Mgmt Tree** tab and click the network.
 - To view the Installation Parameters report for a site, click the **NtView Name** tab and click the site.

Step 2 In the Tasks Pane, click **Installation Parameters**. The Installation Parameters tab appears (Figure 3-2). The ANS view subtab appears by default. This tab displays the Automatic Node Setup information.

Figure 3-2 ANS View Subtab in the Installation Parameters Tab

Name	Side	Posi...	Unit	Port #	Port ID	Port Label	Parameter	Value	Measurement Unit	Manual Set
Site1										
NE - 1										
A Rack...			OPT-AMP C	2	LINE-2-1-TX	COM TX	NetworkType	Metro-Core	string	No
A Rack...			OPT-AMP C	2	LINE-2-1-TX	COM TX	dwdm:Rx::Amplifier:...	1.0	dBm	No
A Rack...			OPT-AMP C	6	LINE-2-3-TX	LINE TX	dwdm:Rx::Amplifier:Tilt	-0.0	dB	No
A Rack...			OPT-AMP C	1	LINE-2-1-RX	COM RX	Control Gain	string	No	No
A Rack...			OSC + Combiner/S...	4	LINE-1-2-RX	LINE RX	dwdm:Rx::Threshold:...	-24.0	dBm	No
A Rack...			OSC + Combiner/S...	4	LINE-1-2-RX	LINE RX	dwdm:Rx::MinExpecte...	0.0	dB	No
A Rack...			OSC + Combiner/S...	4	LINE-1-2-RX	LINE RX	dwdm:Rx::MaxExpecte...	0.8	dB	No
A Rack...			OSC + Combiner/S...	4	LINE-1-2-RX	LINE RX	dwdm:Rx::Threshold:...	-5.0	dBm	No
A Rack...			OSC + Combiner/S...	4	LINE-1-2-RX	LINE RX	dwdm:Rx::Threshold:...	-7.4	dBm	No
A Rack...			OSC + Combiner/S...	4	LINE-1-2-RX	LINE RX	dwdm:Tx::Power:OS...	-6.5	dBm	No
A Rack...			40 WSS C	83	LINE-3-2-TX	COM TX	dwdm:Tx::Power:Ad...	-4.2	dBm	No
A Rack...			40 WSS C	84	LINE-3-2-RX	COM RX	dwdm:Rx::Power:Ad...	1.0	dBm	No
A Rack...			40 DMX C	1	CHAN-5-1-TX	N/A	dwdm:Rx::A::Power:...	-15.1	dBm	No
A Rack...			40 DMX C	2	CHAN-5-2-TX	N/A	dwdm:Rx::A::Power:...	-15.1	dBm	No
A Rack...			40 DMX C	3	CHAN-5-3-TX	N/A	dwdm:Rx::A::Power:...	-15.1	dBm	No
A Rack...			40 DMX C	4	CHAN-5-4-TX	N/A	dwdm:Rx::A::Power:...	-15.1	dBm	No
A Rack...			40 DMX C	5	CHAN-5-5-TX	N/A	dwdm:Rx::A::Power:...	-15.1	dBm	No
A Rack...			40 DMX C	6	CHAN-5-6-TX	N/A	dwdm:Rx::A::Power:...	-15.1	dBm	No
A Rack...			40 DMX C	7	CHAN-5-7-TX	N/A	dwdm:Rx::A::Power:...	-15.1	dBm	No
A Rack...			40 DMX C	8	CHAN-5-8-TX	N/A	dwdm:Rx::A::Power:...	-15.1	dBm	No
A Rack...			40 DMX C	9	CHAN-5-9-TX	N/A	dwdm:Rx::A::Power:...	-15.1	dBm	No
A Rack...			40 DMX C	10	CHAN-5-10-TX	N/A	dwdm:Rx::A::Power:...	-15.1	dBm	No
A Rack...			40 DMX C	11	CHAN-5-11-TX	N/A	dwdm:Rx::A::Power:...	-15.1	dBm	No
A Rack...			40 DMX C	12	CHAN-5-12-TX	N/A	dwdm:Rx::A::Power:...	-15.1	dBm	No



Note

If a particular side does not have any demand and does not have traffic passing through that side, the ANS parameters related to that side will not be displayed in the Installation Parameters report. The NE Update XML file (in ANS tab) does not display any parameters of that side. When a side has a fiber connected, but has no demand passing through it, then the summary report displays an error stating that the installation parameters for that particular side cannot be generated. For additional information on the summary report refer to “3.2.1 Viewing the Summary Report” section on page 3-2. The warning and error messages help you identify problems with your current design. For a list of all system messages, see Appendix C, “System Messages.”

Table 3-3 describes the columns on the ANS view tab of the Installation Parameters report.

Table 3-3 Installation Parameters Report ANS View Tab Columns

Column	Description
Name	Displays the name of the site.
Side	Displays the node interface.
Position	Displays the rack, shelf number (MSM Shelf ID), and slot position of the card where the patchcord originates.
Unit	Displays the name of the card.
Port #	Displays the port number where the patchcord originates.
Port ID	Displays the port ID.
Port Label	Displays the name of the port.
Parameter	Displays the name of the parameter to be set, such as RX Power Low.

Table 3-3 *Installation Parameters Report ANS View Tab Columns (continued)*

Column	Description
Value	Displays the name of the value to be set.
Measurement Unit	Displays the measurement unit for the related installation parameter value, such as dBm.
Manual Set	Indicates with a Yes or No which parameters must be manually set using the CTC interface. This column only applies to alarms. It does not apply to threshold crossing alerts (TCAs).

- Step 3** Click the **ANP view** tab to view the Automatic Node Provisioning information. [Table 3-4](#) describes the columns on the ANP view tab of the Installation Parameters report.

Table 3-4 *Installation Parameters Report ANP View Tab*

Category	Description
Name	Displays the name of the site.
Unit ID	Displays the unit (slot number) of the passive units in the shelf. Note The unit ID is not displayed for the active units.
Shelf ID	Displays the shelf identifier. Note The Shelf ID displays the MSM shelf ID for an MSM configuration.
Rack number	Displays the rack number.
Rack position	Identifies the rack position in the shelf.
Slot position	Identifies the slot position in the shelf for the card.
Equipment type	Displays the card type. Note The Equipment type lists the Fine TDCU (F TDCU) or Coarse TDCU (C TDCU) units, with the corresponding slot position.
Description	Displays the details of the card type.

- Step 4** Click the **PP view** tab to view the Provisioning Parameters information. [Table 3-5](#) describes the columns on the PP view tab of the Installation Parameters report.

Table 3-5 *Installation Parameters Report PP View Tab*

Column	Description
Name	Displays the name of the site.
Unit ID	Displays the unit of the provisioning parameter.
Shelf ID	Displays the shelf identifier.
Slot position	Displays the slot number for the card with the PPM.
Port position	Displays the port number.
Ppm position	Displays the PPM location on the card.

Table 3-5 *Installation Parameters Report PP View Tab (continued)*

Column	Description
Parameter	Displays the name of the PPM. Note The TDCU compensation parameter and the corresponding wavelength value is displayed.
Value	Displays the installation parameter value. Note The TDCU wavelength value is displayed.

Step 5 To close the Installation Parameters report, click the **X** on the top right of the Installation Parameters tab.

3.2.4 Viewing Internal Connections

Use the following procedure to view the network internal connections after a network has been analyzed.

Use this procedure to view patchcord connections related to optical amplifiers, optical filter units, connections with client interface units, transponders, line cards, pluggables, Multi-Shelf Management (MSM), and passive inventory units.

Step 1 Click the **Mgmt Tree** tab, and click the analyzed network.

Step 2 In the Tasks Pane, click **Internal Connections**. The Internal Connections tab appears ([Figure 3-3](#)).

Figure 3-3 Internal Connections Tab

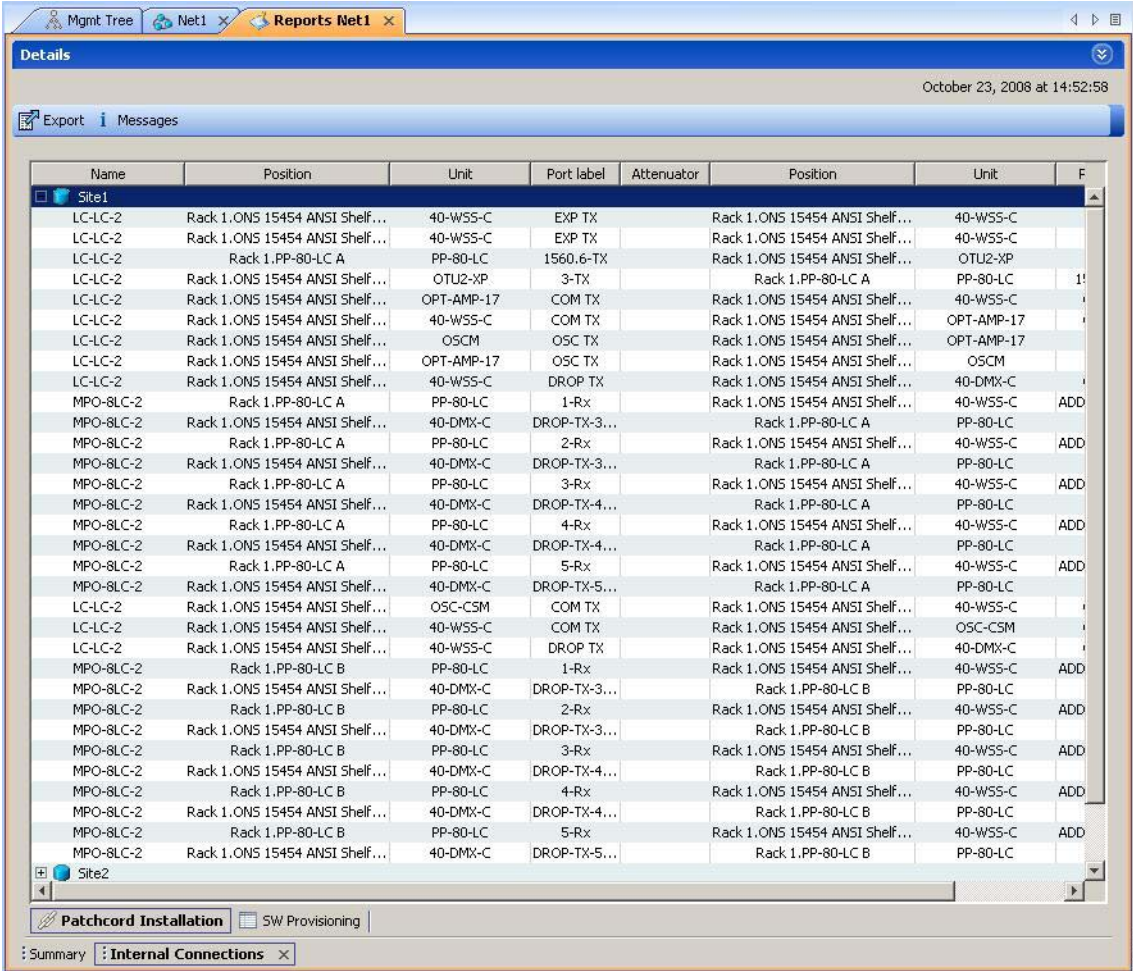

Step 3 The Internal Connections tab has the following three options:

- Patchcord Installation—To view all the patchcord connections that the installer has to mechanically cable within the site between the different ports of the cards.
- SW Provisioning—To view the patchcord representation on the local CTC interface. This subtab contains all the connections to be manually set or removed with respect to the default connections that are automatically generated by the software running on the node. This view has the following sections:
 - To Be Manually Set—These patchcord connection are manually set by using the CTC local craft.
 - Automatically Set—These patchcord connections are set automatically on the site by the system software.
 - To Be Removed—These patchcord connections are automatically set on the node and must be manually removed by using the CTC.
- MSM Connections—To view patchcord connections related to multi-shelf management and passive inventory.

Step 4 Click Patchcord Installation, SW Provisioning or MSM Connections.

Table 3-6 lists the columns in the Internal Connections Details window and their descriptions. Click a column to sort the table information by that column.

Table 3-6 Internal Connections Tab Columns

Column Name	Description
Name	Displays the name of the site. On the SW provisioning view subtab, this column indicates whether the connection should be manually set using the CTC interface or removed. In the MSM Connections tab this column indicates the name of the cable used in the connection.
Unit Type-1	(MSM Connections subtab only) Displays the source unit. The source unit can be MS 100T card, Shelf Ethernet switch or an M6 chassis.
Position-1	Displays the rack, shelf, and slot position of the card from which the patchcord originates. In the MSM Connections subtab, this displays the position of the source unit.
Unit-1	Displays the name of the card.
Port Num	(SW provisioning view subtab only) Displays the port number where the patchcord terminates.
Port ID-1	(SW provisioning view subtab only) Displays the port ID.
Id-1	(MSM Connections subtab only) Displays the source unit ID.
Port label-1	Displays the name of the port. In the MSM Connections subtab this displays the name of the port from which the cable is connected.
W/P	Displays whether the port is a working or a protected port.
Attenuator	When indicated, this is the product ID of the bulk attenuator to be equipped on this connection. It also reports when an internal attenuator must be placed between the DC-TX and DC-RX ports on the preamplifier (when no DCU is equipped).
Unit Type-2	(MSM Connections subtab only) Displays the destination unit. The destination unit can be MS 100T card, Shelf Ethernet switch or an M6 chassis.
Position-2	Displays the rack, shelf, and slot position of the card where the patchcord terminates. In the MSM Connections subtab, this displays the position of the destination unit.
Unit-2	Displays the name of the card.
Port Num	(SW provisioning view subtab only) Displays the port number where the patchcord terminates.
Port ID-2	(SW provisioning view subtab only) Displays the port ID.
Id-2	(MSM Connections subtab only) Displays the destination unit ID.
Port Label-2	Displays the name of the port. In the MSM Connections subtab this displays the name of the port to which the cable is connected.
P/F	Displays whether the connection relates to a present or forecast circuit.

Step 5 To export the information to an external file, click **Export**. In the Internal connections export dialog box, type the name of the file and navigate to the desired folder. Click **Save**.

Step 6 To close the Internal Connections tab, click the **X** in the upper right corner of the tab.

3.2.5 Viewing the Traffic Matrix Report

The Traffic Matrix report displays the point-to-point, P-ring, ROADM, and aggregated demand channel data in the form of service, Och-CC, trail, and section information (see [Figure 3-4](#) and [Figure 3-5](#)). The Och-CC row displays the circuit details from the source client card to the destination client card and does not include the regeneration points, if any.

Figure 3-4 Report Details for a Point-to-Point Demand

Unprotected				1+1/Y-Cable				Fiber-Switched			
Service				Service				Service			
+	Och-CC			+	Och-CC-W			+	Och-CC-W		
	+	Trail			+	Trail			+	Trail-W	
		+	Section			+	Section			+	Section
				+	Och-CC-P				+	Trail-P	
					+	Trail				+	Section
						+	Section				

273906

Figure 3-5 Report Details for a P-Ring Demand

P-Ring			
Service			
	Och-CC		
	+	Trail	
		+	Section 1
		+	Section 2
	+	Trail	
		+	Section
	+	Trail	
		+	Section

273907

Use the following procedure to view the traffic matrix report:

- Step 1** Complete one of the following tasks:
- To view the Traffic Matrix report for a network, click the **Mgmt Tree** tab and click the network.
 - To view the Traffic Matrix report for a site, click the **NtView name** tab and click the site.
- Step 2** In the Tasks Pane under Reports, click **Traffic Matrix**. The Traffic Matrix tab appears (see Figure 3-6). A default query opens.

Figure 3-6 Traffic Matrix Tab

Demand	Section	Src Site	Src Position	Src Card	Src Cle...	Src ClientPPM	Src Tru...	Src trunk PPM	Src Card Opt
Site1 - Site3									
Service_1									
OCH-CC		Site1	Rack 1.ONS 15454 ANSI Sh...	OTU2-XP	1-TX	ONS-XC-10G-51			MixedMode
Trail		Site1	Rack 1.ONS 15454 ANSI Sh...	OTU2-XP	1-TX	ONS-XC-10G-51	3-TX	XFP1	MixedMode
Section_1		Site1	Rack 1.ONS 15454 ANSI Sh...	OTU2-XP	1-TX	ONS-XC-10G-51	3-TX	XFP1	MixedMode
Section_2		Site5	Rack 1.ONS 15454 ANSI Sh...	OTU2-XP	NA	NA	1-TX	XFP1	RegenMode
Section_2		Site5	Rack 1.ONS 15454 ANSI Sh...	OTU2-XP	NA	NA	3-TX	XFP1	RegenMode
Section_2		Site3	Rack 1.ONS 15454 ANSI Sh...	OTU2-XP	1-TX	ONS-XC-10G-51	3-TX	XFP1	TxpMode



Note

To add a column to the report, right-click a column and choose the column name from the shortcut menu. The column names with checks in the shortcut menu appear on the report. To remove a column, right-click and choose the column (checked) from the shortcut menu.

Table 3-7 Traffic Matrix Tab Columns

Column Label	Description
Demand	Categorizes each demand type (Point-to-Point, P-ring, and ROADM). Each demand is further categorized into service, trails, and sections. Click the plus (+) sign by a demand type to expand and show the optical channels.
Section	Displays the sections under every service.
Src Site	Displays the site name for the optical channel source.
Src Position	Displays the rack, shelf ID, and slot identifiers for the source of the optical channel. The format of the field is <i>Rack.Shelf.Slot</i> .
Src Card	Displays the unit name for the optical channel source.
Src Client Port	Displays the port for the source of the optical channel; for example, 1-RX.
Src Client PPM	Displays the pluggable port modules for the source port; for example ONS-XC-10G-S1.
Src Trunk Port	Displays the trunk port for the source of the optical channel; for example, DWDM-TX.
Src Trunk PPM	Displays the pluggable port module for the trunk port.
Src Card OpMode	Displays the source card operating mode; for example, for the OTU2_XP card, the mode is TxpMode or RegenMode.
Src T/C OpMode	Displays the trunk or client operating mode.
A/D Src Position	Displays the rack, shelf, and slot identifiers for the source of the add/drop channel. The format of the field is <i>Rack.Shelf.Slot</i> .
A/D Src Unit	Displays the unit name for the add/drop channel source
A/D Src Port	Displays the port for the source of the add/drop channel
Src Colorless	Displays if the section is colorless capable at the source side.
Src Omni-dir	Displays the label of the omnidirectional side that the section uses from the source side of the demand. If the section does not use any omnidirectional side from the source side, then it displays None.
Dst Site	Displays the site name for the optical channel destination.
Dst Position	Displays the rack, shelf ID, and slot identifiers for the destination of the optical channel. The format of the field is <i>Rack.Shelf.Slot</i> .
Dst Card	Displays the unit name for the optical channel destination.
Dst Client Port	Displays the port for the destination of the optical channel; for example, 1-TX.
Dst Client PPM	Displays the pluggable port modules for the destination port.
Dst Trunk Port	Displays the trunk port for the source of the optical channel; for example, DWDM-TX.
Dst Trunk PPM	Displays the pluggable port module for the trunk port.
Dst Card OpMode	Displays the source card operating mode; for example, for the OTU-XP card, the mode is TxpMode or RegenMode.
Dst T/C OpMode	Displays the trunk or client operating mode.
A/D Dst Position	Displays the rack, shelf, and slot identifiers for the destination of the add/drop channel. The format of the field is <i>Rack.Shelf.Slot</i> .

Table 3-7 Traffic Matrix Tab Columns (continued)

Column Label	Description
A/D Dst Unit	Displays the unit name for the add/drop channel source.
A/D Dst Port	Displays the port for the destination of the add/drop channel.
Dst Colorless	Displays if the section is colorless capable at the destination side.
Dst Omni-dir	Displays the label of the omnidirectional side that the section uses from the destination side of the demand. If the section does not use any omnidirectional side from the destination side, then it displays None.
Cl. Serv. Type	Displays the client service type of the demand; for example, OC-48.
Opt Bypass	Identifies where the optical channel is dropped and reinserted when it is not terminated on a TXP or MXP card (optical bypass). If “none” appears in the Op Bypass column, no optical bypass is defined for the optical channel.
Protection Type	Displays the protection type of the demand; for example, P-ring or Y-cable.
Wavelength (Wavelength No.)	Displays the wavelength value of the optical channel. Also, displays the serial number of the wavelength in the wavelength band. The alphabet “e” besides the wavelength serial number represents that it is an “even” wavelength in the C-band.
Latency	Displays the latency time for the current OCH-CC circuit. This value includes all the latency components for the OCH-CC circuit, including fiber and DWDM units on the path.

Step 3 To create a new query, click **New Query** to open the Query Dialog box (see [Figure 3-7](#)). The Query Dialog box allows you to filter the optical results using a variety of parameters and templates.

Figure 3-7 Query Dialog

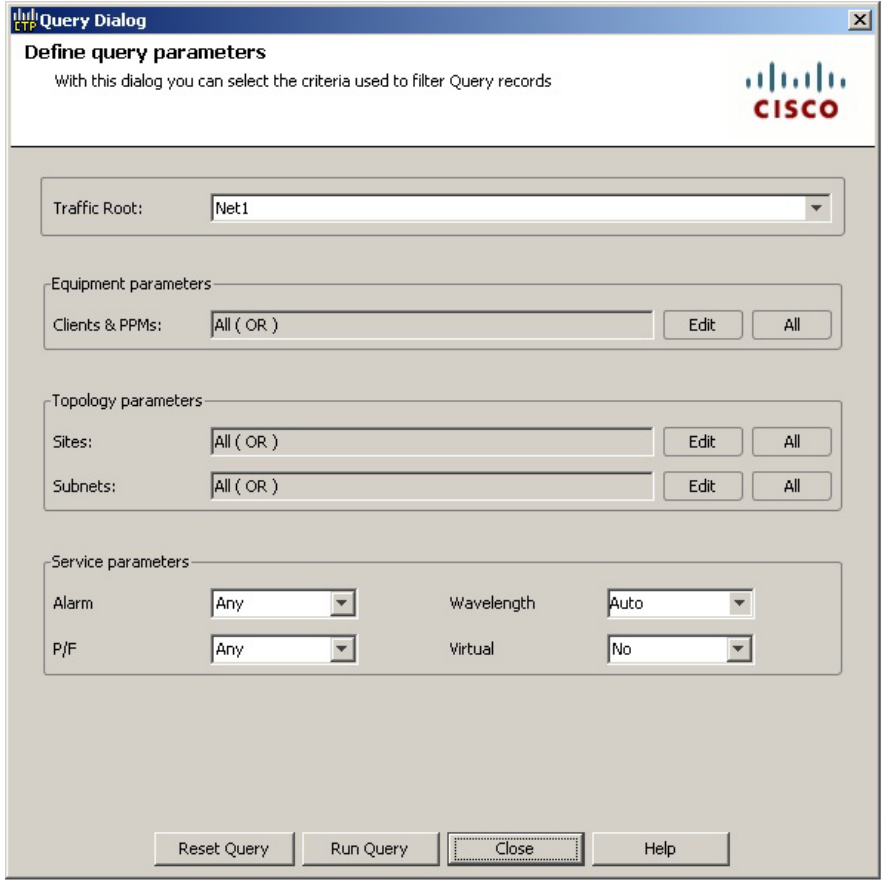

Step 4 To perform a query using individual parameters, select the desired parameters from the drop-down lists in the Query Definition area. The selected parameters appear in the Query Preview area at the bottom of the screen. [Table 3-8](#) describes the fields in the Query Dialog box.

Table 3-8 Query Dialog Fields

Field Label	Description
Traffic Root	Allows you to filter the report to include only the data for the selected level. You can query up to the service level.
Clients & PPMs	Allows you to filter the report to include the data for the selected cards or PPM.
Sites	Allows you to filter the report to include only the results of incoming and outgoing services to or from a specific site.
Subnets	Allows you to filter the report to include only the results of services in the selected subnet.
Wavelength	Allows you to filter the report to include only services using the specified wavelength.

273187

Table 3-8 Query Dialog Fields (continued)

Field Label	Description
Alarm	Allows you to filter the report to include only services flagged with a green, yellow, orange, or red indicator.
P/F	Allows you to filter the report to include only present services, only forecast services, or both.
Virtual	Allows you to filter the report to include or exclude virtual channels in the Optical Results table.

Step 5 Complete one of the following tasks, as needed:

- Click **Run Query**. The window closes, and the query results appear in the Traffic Matrix tab (see [Figure 3-6](#)). The parameters of the query appear in the horizontal area just below the button bar.
- Click **Reset Query** to clear your selections in the Query Dialog box.
- Click **Close** to close the window without running a query.

Step 6 To close the Traffic Matrix report, click the **X** in the upper right corner of the tab.

3.2.6 Viewing the Layout of Single Site

Use the following procedure to view a graphical representation of the layout for a single site in an analyzed network. Additionally, you can also modify the MSM Shelf ID for Multi Shelf Management Configuration.

- Step 1** In the Project Explorer pane, click the **NtView Name** tab and click the desired site.
- Step 2** In the Tasks Pane, click **Layout**. The Layout tab appears, as shown in Figure 3-8. To change sites, choose the desired site from the drop-down list.

Figure 3-8 Layout Report (Rack View)

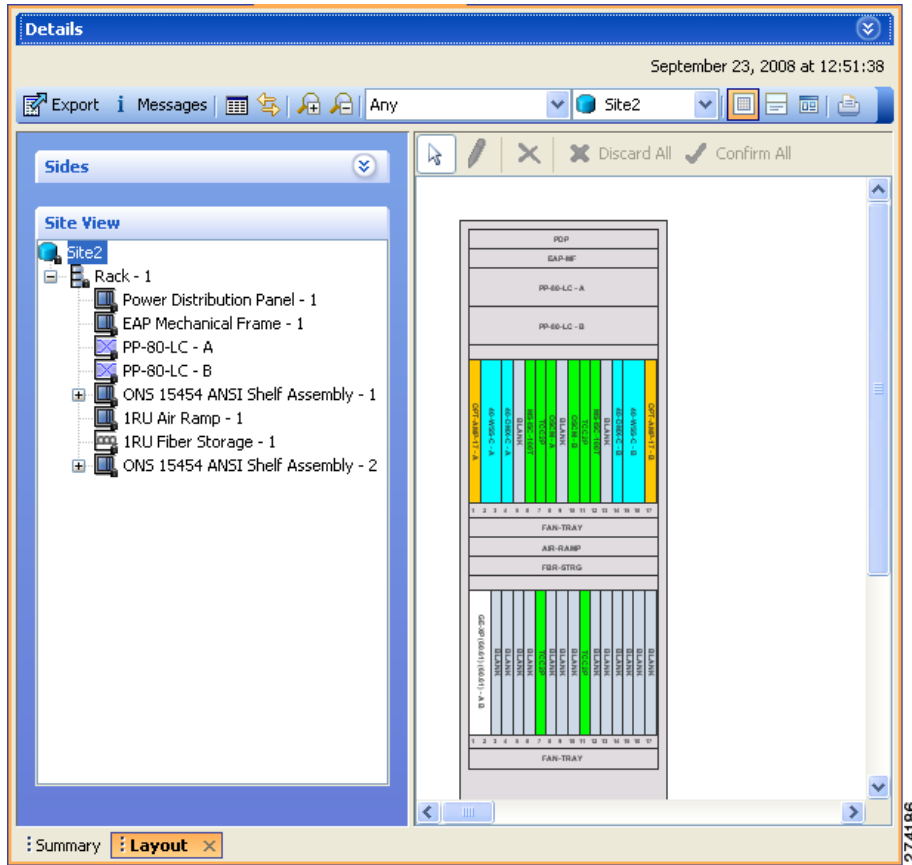

- Step 3** From the **Site** drop-down list, double-click the site in the network to display in the layout report.
- Step 4** In the tree view on the left of the tab, right-click a rack and choose **Expand** to view a list of all shelves and cards in the rack.



Note Alien shelves are displayed only in the layout reports.

- Step 5** To modify the ANSI/ETSI MSM Shelf ID Configuration, do the following:
 - a. Double-click the shelf assembly. The Details dialog box appears.
 - b. Update the MSM Shelf ID and click **Enter**.



Note The valid range of the shelf ID is from 1 to 8 for Multi Shelf Integrated Switch, 1 to 12 for Multi Shelf External Switch, and 1 to 30 for Multi Shelf Integrated with M6 chassis.

c. Close the Details dialog box.

The MSM shelf ID is updated in the Layout report, Traffic Matrix report, Installation parameters report, and the NE Update file.



Note For the MSM Shelf ID to be updated across all the reports, ensure you close and reopen all the reports.



Note You can modify the MSM Shelf ID if you have selected the Shelf Management Type as either Multi Shelf Integrated Switch or Multi Shelf External Switch.

Step 6 Click the desired rack or shelf to view it in the layout graphic. [Figure 3-9](#) displays the shelf view.

Figure 3-9 Layout Report (Shelf View)

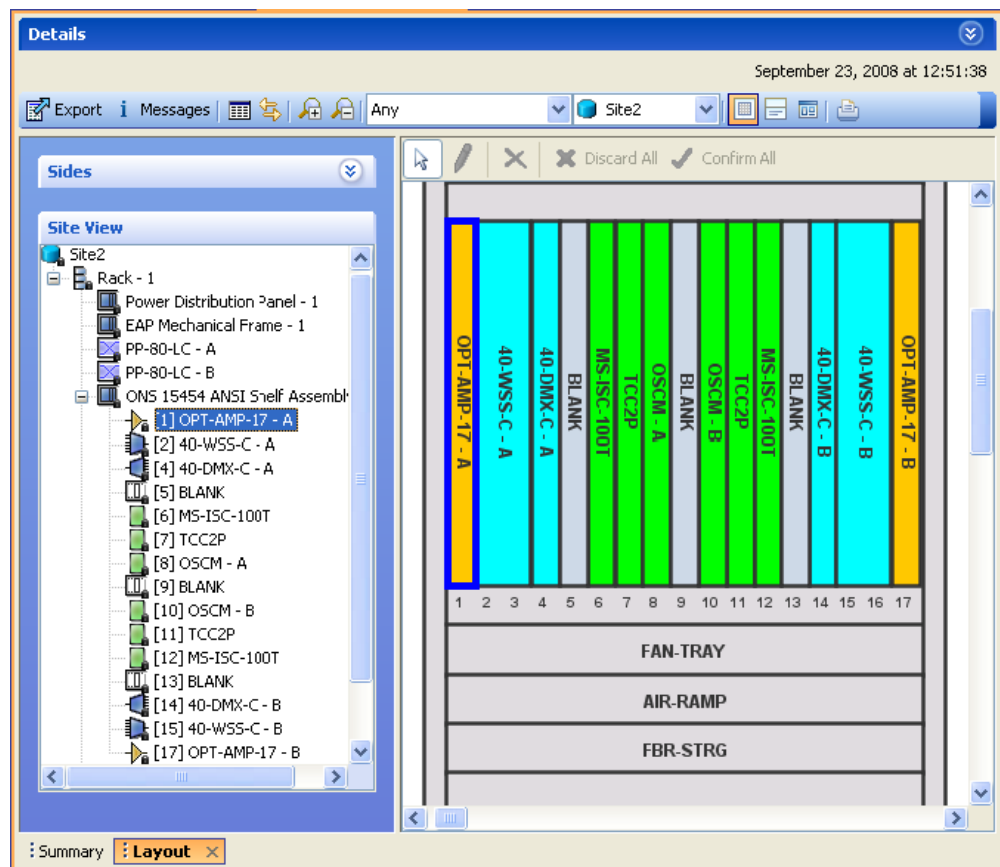

274187

Step 7 To view details about a card, double-click the card. The Details dialog box opens with client information:

- Product ID—Displays the product ID of the card.
- Service Category—Future use.
- Description—Provides a brief description of the card functionality.
- Price—Lists the price for the card based on the price list selected during project creation.
- ITU Channel—Identifies the ITU channel wavelength for the card.

For transponder and muxponder cards, click the **Ports** subtab in the Details dialog box to view which pluggable port modules are to be used for each TXP/MXP unit:

- Type—Displays the type of pluggable port module.
- P/F—P refers to pluggable port modules that support the present client demand, while F refers to pluggable port modules that support the future client demand.
- PID—Displays the pluggable port module product ID.
- Wavelength—Displays the wavelength value.
- Rate—Displays the capacity of the port at the node. It is equal to or greater than the sum of the size of the circuits assigned to the port.
- Reach—Displays the reach value.
- Service1—Lists all the client services assigned to the particular port.

Step 8 Click **Close** to close the Details dialog box.

Step 9 To filter the layout display, choose one of the following from the drop-down list:

- All—Displays all cards for both the present and forecast traffic demand.
- Present—Displays cards for only the present traffic demand.
- Locked & Unlocked—Highlights the locked and unlocked cards in the layout.
- Alarmed—Highlights the alarmed cards in the layout.

Step 10 After network analysis, all items are in locked mode. To unlock cards so that Cisco Transport Planner can rearrange the layout to optimize slot usage during network analysis, right-click locked card in the rack tree and choose **Unlock**.



Note You can unlock only on Upgrade networks in the Design state.

Step 11 To export the graphical representation of the layout in JPEG format, click **Export**. In the Layout export dialog box, type the name of the file and navigate to the desired folder. Click **Save**. If you want to export the layout report for multiple sites, see [“3.2.7 Exporting the Layout Report for Multiple Sites”](#).

Step 12 To zoom the layout graphic in or out, click the Zoom In and Zoom Out icons. For more information about the Cisco Transport Planner icons, see [Appendix A, “GUI Information and Shortcuts.”](#)

Step 13 To close the Layout report, click the **X** in the upper right corner of the tab.

3.2.7 Exporting the Layout Report for Multiple Sites

Use the following procedure to export the layout report of multiple sites in an analyzed network:

- Step 1** In the Project Explorer pane, navigate to the Reports folder and click **Layout**. In the Details window, click the **Network Wide Layout Export** button.

The Network Wide Layout Export Selection dialog box opens. (Figure 3-10).

Figure 3-10 Network Wide Layout Export Selection

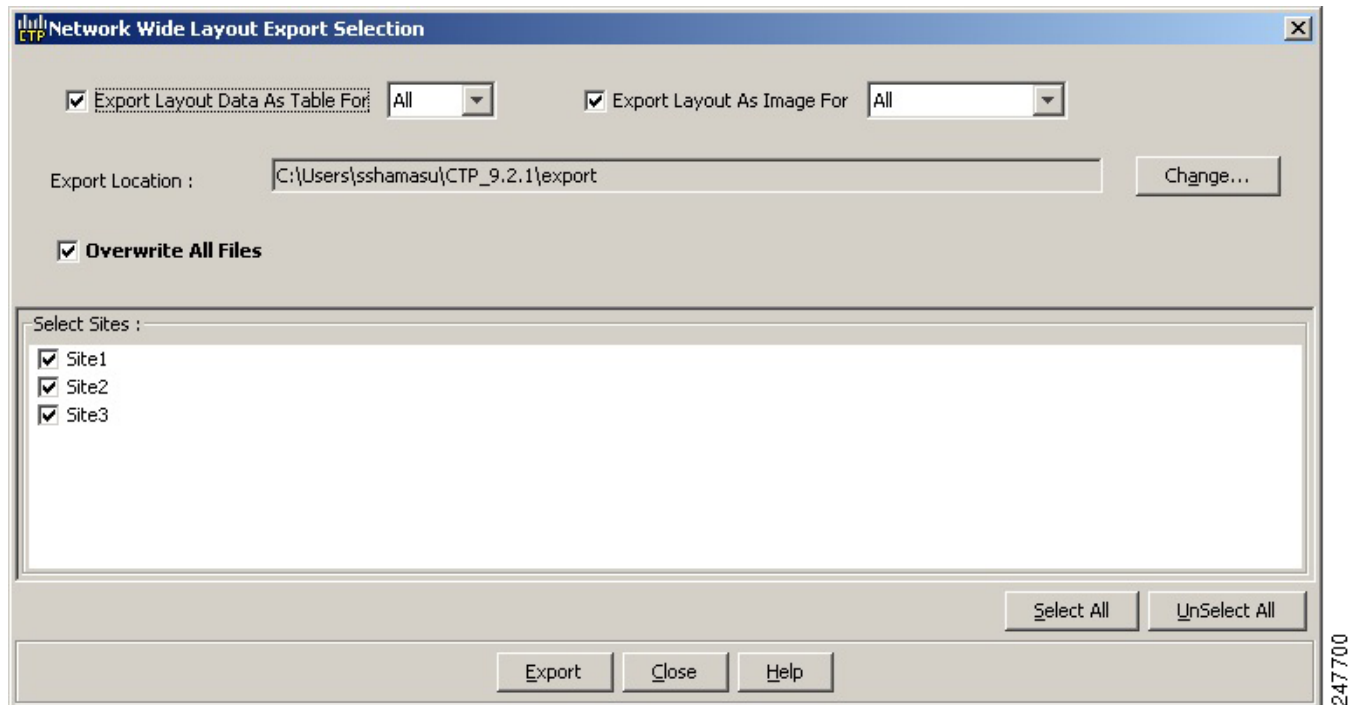

- Step 2** In the Network Wide Layout Export Selection window, complete the following:
- Export Layout Data As Table For — Select to export the layout report of the selected sites in .xls format. Select the options from the drop-down list:
 - All—Exports the layout report of the present and forecasted equipments of a site.
 - Present— Exports the layout report of the equipments present in a site.
 The .xls file lists the following information:
 - The different cards used and slots where the cards are placed.
 - Maximum and average power consumption of the equipment.
 - Unit weights of the equipment.
 - Export Layout As Images For—Select to export the layout report of the selected sites in JPEG format. The .jpg file provides a graphical representation of the site layout. Select the options from the drop-down list:
 - All—Exports the layout report of the present and forecasted equipments of a site.
 - Present—Exports the layout of the equipments present in a site.

- Locked and Unlocked—Exports the layout of the equipments (in JPEG format) that are locked and/or unlocked in a site. Additionally, the layout report provides links of the cards or shelves movement.
- Alarmed — Exports the report of the equipments that has alarms.
- Export Location—Specify the filename and the desired folder to save the export data.
- Overwrite All Files— Overwrites the existing exported reports.
- Select Sites— Select the sites to fetch the report.

Step 3 Click **Export**. The Network Wide Layout Summary window opens.

The summary page displays the location where the exported files are available for the selected sites.



Note

The layout report of the sites are saved as separate files (.jpg and .xls) with the site label as the file name.

3.2.8 Viewing Power Consumption from the Layout Report

Use the following procedure to view the power consumption for each unit of equipment in a site. Power consumption is available in report form from the Layout report.

- Step 1** Click the *NtView Name* tab and click the desired site.
- Step 2** In the Tasks Pane, click **Layout**. The Layout tab appears (Figure 3-8 on page 3-16). To change sites, choose the desired site from the drop-down list.
- Step 3** Click the View layout as table icon in the report tool bar. The Layout Table report appears (Figure 3-11).

Figure 3-11 Power Consumption

Name	Position	Description	Max power consumption (W)
Rack	Rack - 1		181.00
Power Distribution Panel	Shelf - 1		0.00
EAP Mechanical Frame	Shelf - 1	Ethernet Adapter Panel Mechanical Frame	0.00
ONS 15454 ANSI Shelf	Shelf - 1	15454 SA HD NEB53 ANSI w/ RCA and Ship Kit	181.00
OSC-CSM	Slot 1	ONS 15454 Combiner and Separator with OSC Module	27.00
AD-1C	Slot 2	ONS 15454 OADM - 1 Chn - 100GHz - 1558.17	25.00
TXP_MR_10E_y	Slot 3	15454 10G Multi-Rate Transponder- EFEC- Full C-Band Tunable	42.00
Blank	Slot 4	Empty slot Filler Panel	0.00
Blank	Slot 5	Empty slot Filler Panel	0.00
MS-ISC-100T	Slot 6	MultiShelf Management Integrated Switch Card	0.00
TCC2P	Slot 7	Timing Communications Control Two Plus, I-Temp	30.00
Blank	Slot 8	Empty slot Filler Panel	0.00
Blank	Slot 9	Empty slot Filler Panel	0.00
Blank	Slot 10	Empty slot Filler Panel	0.00
TCC2P	Slot 11	Timing Communications Control Two Plus, I-Temp	30.00
MS-ISC-100T	Slot 12	MultiShelf Management Integrated Switch Card	0.00
Blank	Slot 13	Empty slot Filler Panel	0.00
Blank	Slot 14	Empty slot Filler Panel	0.00
Blank	Slot 15	Empty slot Filler Panel	0.00
Blank	Slot 16	Empty slot Filler Panel	0.00
OSC-CSM	Slot 17	ONS 15454 Combiner and Separator with OSC Module	27.00
IRU Air Ramp	Shelf - 1	ONS 15454 Air Ramp / Baffle for the ANSI Chassis	0.00
IRU Ether Straps	Shelf - 1	Ether Straps Shelf	0.00

Table 3-9 describes the information in the columns of the Layout Table report.

Table 3-9 *Layout Table (Power Consumption) Columns*

Column Label	Description
Name	Lists the equipment at the site.
Position	Identifies the rack, shelf, or slot location for applicable units of equipment.
Description	Describes each equipment type.
Max Power Consumption (W)	Displays the maximum power consumption for each unit of equipment. Note For transponder/muxponder cards with pluggable port modules, the maximum power consumption shown is for the board fully equipped with the maximum number of pluggable port modules.
Average Power Consumption (W)	Displays the average power consumption for applicable units of equipment. Note For transponder/muxponder cards with pluggable port modules, the average power consumption shown is for the board fully equipped with the maximum number of pluggable port modules.
Unit Weights (kg/lb)	Displays the weight of all the units of a site in kilograms in a ETSI network and in pounds in an ANSI network.

- Step 4** To export power consumption data, click **Export**. The Layout table export dialog box appears. Enter the name of the file and navigate to the desired folder. Click **Save**.
- Step 5** Click **Close** to close the Layout Table report.

3.2.9 Viewing the Link Availability Report

Cisco Transport Planner determines link availability based on unit failure rate and time to repair. Use the following procedure to view the Link Availability report:

- Step 1** Complete one of the following:
 - To view the Link Availability report for a network, click the **Mgmt Tree** tab and click the network.
 - To view the Link Availability report for a site, click the **NetView Name** tab and click the site.
- Step 2** In the Tasks Pane, click **Link Availability**. The Link Availability tab appears (Figure 3-12).

Figure 3-12 Link Availability Report

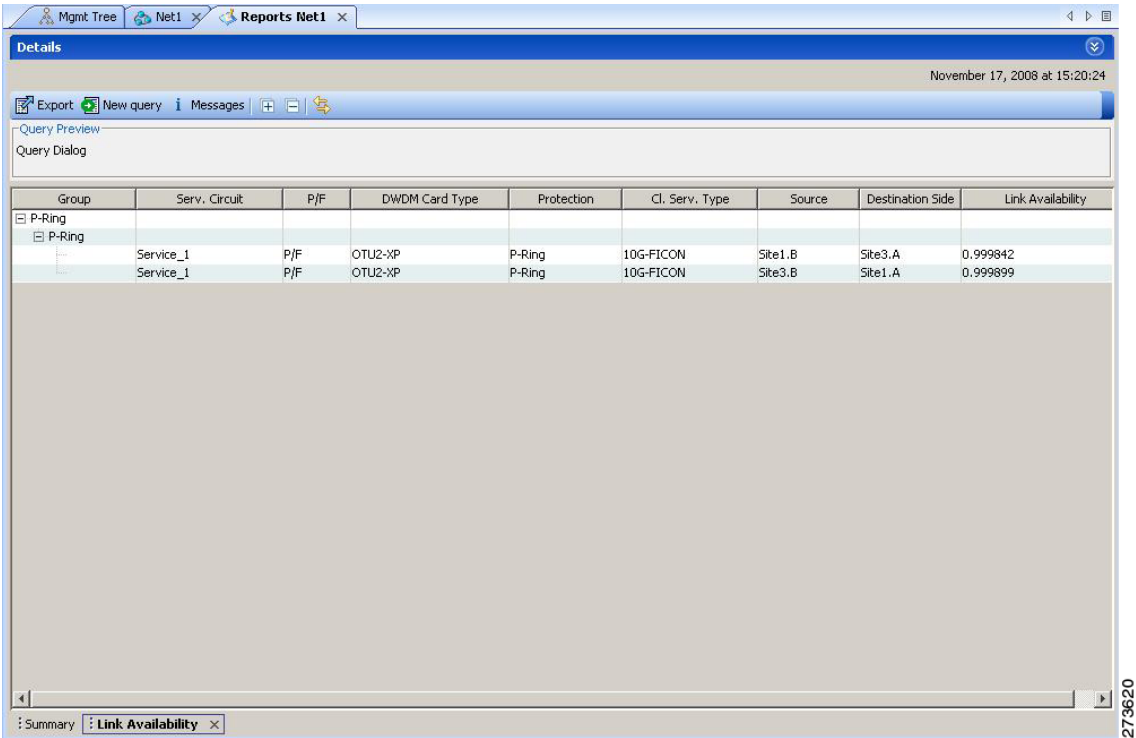

Each row in the tab shows the performance of one optical path. Table 3-10 describes the information in the columns.

Table 3-10 Link Availability Tab Columns

Column Label	Description
Group	Categorizes each demand type (Point-to-Point, P-ring, and ROADM). Click the plus (+) sign by a demand type to expand and show the optical channels.
Serv. Circuit	Displays the optical channel label; for example, Site1-Site2.
P/F	Identifies whether the channel is present and forecast (P/F) or forecast (F).
DWDM Card Type	Identifies the type of transponder or line card used for the optical channel.
Protection	Displays the protection type of the demand; for example, P-ring or Y-cable.

Table 3-10 Link Availability Tab Columns (continued)

Column Label	Description
Cl. Serv. Type	Displays the client service type of the demand; for example, OC-48.
Source	Displays the site name for the optical channel source.
Destination	Displays the site name for the optical channel destination.
Link Availability (% Complete)	Displays the link availability percentage. Link availability is calculated based on the failure rate and time to repair.

Step 3 Click **New Query** to open the Query Dialog (Figure 3-7 on page 3-14). The Query Dialog allows you to filter the link availability using a variety of parameters.

Step 4 To perform a query using individual parameters, select the desired parameters from the drop-down lists in the Query Definition area. The selected parameters appear in the Query Preview area at the bottom of the screen. Table 3-11 describes the fields in the Query Dialog.

Table 3-11 Query Dialog Fields

Field Label	Description
Traffic Root	Allows you to filter the report to include only the data for the selected level. You can query up to the service level.
Clients & PPMs	Allows you to filter the report to include the data for the selected cards or PPM.
Sites	Allows you to filter the report to include only the results of incoming and outgoing services to or from a specific site.
Subnets	Allows you to filter the report to include only the results of services in the selected subnet.
Wavelength	Allows you to filter the report to include only services using the specified wavelength.
Alarm	Allows you to filter the report to include only services flagged with a green, yellow, orange, or red indicator.
P/F	Allows you to filter the report to include only present services, only forecast services, or both.
Virtual	Allows you to filter the report to include or exclude virtual channels in the Optical Results table.

Step 5 Choose one of the following, as needed:

- Click **Run Query**. The window closes, and the query results appear in the Link Availability tab. The parameters of the query appear in the horizontal area just below the button bar.
- Click **Reset Query** to clear your selections in the Query Dialog.
- Click **Close** to close the window without running a query.

Step 6 To close the Link Availability report, click the **X** in the upper right corner of the tab.

3.2.10 Viewing Optical Results

Use the following procedure to view the optical results of the network that you created and analyzed:

- Step 1** Complete one of the following:
 - To view the Optical Results report for a network, click the **Mgmt Tree** tab and click **Optical Results** under Reports in the Project Explorer pane.
 - To view the Optical Results report for a site, click the **NtView Name** tab and right click on the site and select **Optical Results** in the drop down menu.
- Step 2** In the Tasks Pane, click **Optical Results**. The Optical Results tab appears (Figure 3-13).

Figure 3-13 Optical Results Tab

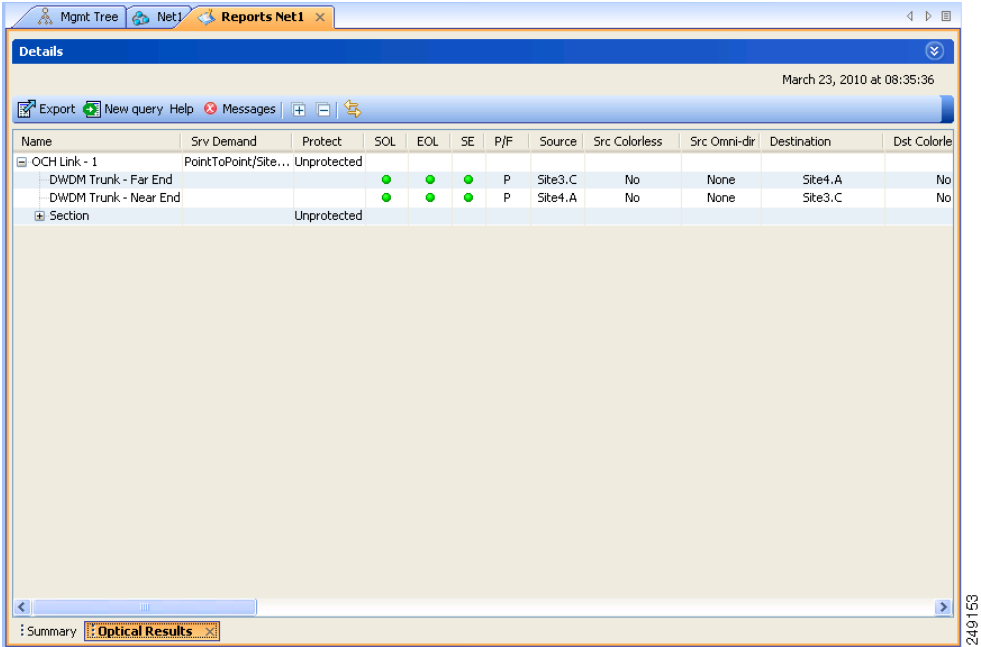

Each row in the tab shows the performance of one optical path. Table 3-12 describes the information in the columns.

Table 3-12 Optical Results Tab Columns

Column Label	Description
Name	Displays the identification number automatically given to each path in the order that the channels were entered into the design.
Srv Demand	Identifies the demand group for the optical channel.
Protect	Displays the protection type of the channel. For a protected channel, both paths are shown. The path leaving the east side of the source is shown first.

Table 3-12 *Optical Results Tab Columns (continued)*

Column Label	Description
SOL	Displays the results summary of the analysis run with Start of Life fiber loss values. The indicator shows the optical performance for the each direction of the bidirectional OCH Trail. Green indicates success, yellow indicates success with a marginal failure risk (between 0 and 16 percent), orange indicates that the channel has a higher risk of failure (between 16 and 50 percent), and red indicates failure.
EOL	Displays the results summary of the analysis run with End of Life fiber loss values. The indicator shows the optical performance for the each direction of the bidirectional Optical Channel Trail (OCH Trail). The indicator shows the optical performance for the path at the end of the fiber's life. Green indicates success, yellow indicates success with a marginal failure risk (between 0 and 16 percent), orange indicates that the channel has a higher risk of failure (between 16 and 50 percent), and red indicates failure.
SE	Indicates a system-related error exists that may impact the analysis of the design. If the indicator is red, review the messages reported at the end of the analysis or determine which units or sites are having a problem.
Regeneration	Displays the status of the single channel nonlinear effect (NLE) alarm check. Green indicates check passed. Yellow indicates marginal NLE; orange indicates consistent NLE, and Red indicates failure.
Single-channel NLE Status	Displays the status of the single channel NLE alarm check. Green indicates check passed. Yellow indicates marginal NLE; orange indicates consistent NLE, and red indicates failure.
Multi-channel NLE Status	Displays the status of the multiple channel NLE alarm check. Green indicates check passed. Yellow indicates marginal NLE; orange indicates consistent NLE, and red indicates failure.
Wavelength	Displays the assigned wavelength of the optical path.
Wavelength (Wavelength No.)	Displays the wavelength value of the optical channel. Also, displays the serial number of the wavelength in the wavelength band. The alphabet "e" besides the wavelength serial number represents that it is an "even" wavelength in the C-band.
P/F	Displays the present/forecast services indication.
Source	Displays the name of the source site and side; for example, Site 1-E.
Src Colorless	Displays if the section is colorless capable at the source side.
Src Omni-dir	Displays the label of the omnidirectional side that the section uses from the source side of the demand. If the section does not use any omnidirectional side from the source side, then it displays None.
Destination	Displays the name of the destination site and side; for example, Site 1-E.
Dst Colorless	Displays if the section is colorless capable at the destination side.
Dst Omni-dir	Displays the label of the omnidirectional side that the section uses from the destination side of the demand. If the section does not use any omnidirectional side from the destination side, then it displays None.
Span (km)	Displays the total span length (source -> destination) for this path in kilometers.

Table 3-12 *Optical Results Tab Columns (continued)*

Column Label	Description
Src Tx Type	Displays the type of DWDM unit or pluggable port module used at the source of the specific OCH Trail.
Dst Tx Type	Displays the type of DWDM unit or pluggable port module used at the destination of the specific OCH Trail.
BER target	Displays the bit error rate (BER) target for this channel based on the capability of the channel's optical interface. It is 1.0E-15 for the interfaces using forward error correction (FEC) and 1.0E-12 for interfaces without FEC.
SOL OSNR (dB)	Displays the start of life average OSNR value at the receiver. OSNR refers to the selected resolution bandwidth (RBW) bandwidth.
EOL OSNR (dB)	Displays the end of life average OSNR value at the receiver. OSNR refers to the selected RBW bandwidth.
SOL OSNR Margin (dB)	Displays the SOL OSNR margin calculation, which is the difference between the OSNR value at a certain power of the working point of the receiver client and the working area boundary.
EOL OSNR Margin (dB)	Displays the EOL OSNR margin calculation, which is the difference between the OSNR value at a certain power of the working point of the receiver client and the working area boundary.
SOL RX (dBm)	Displays the SOL received average power at the destination site in dBm.
EOL RX (dBm)	Displays the EOL received average power at the destination site in dBm.
SOL Power margin (dB)	Displays the SOL power budget margin at the receiver in decibels. It is defined as the offset between the receiver working point and the BER curve with margin. A positive value indicates no power problems.
EOL Power margin (dB)	Displays the EOL power budget margin at the receiver in decibels. It is defined as the offset between the receiver working point and the BER curve with margin. A positive value indicates no power problems.
SOL Overload (dB)	Displays the SOL overload margin at the receiver in decibels. A positive value indicates no overload problems.
EOL Overload (dB)	Displays the EOL overload margin at the receiver in decibels. A positive value indicates no overload problems.
Residual CD [ps/nm]	Displays the total dispersion value of the circuit. This total is the difference between the sum of CD robustness of the source and destination transponders, and the sum of fiber dispersion and dispersion compensation due to DCU units in the circuit.
RX atten	Displays the attenuation at the input of the receiver.
TX atten	Displays the attenuation at the output of the receiver.
PMD (ps)	Displays the calculated total PMD for each circuit. This total includes all the PMD components for the OCH Trail, including fiber and DWDM units on the path. If the overall PMD for the link overcomes the maximum allowed, the PMD value is colored red. The maximum allowed value depends on the client interface. For these special cases, the network must be manually resolved by contacting a Cisco optical sales engineer.

Table 3-12 *Optical Results Tab Columns (continued)*

Column Label	Description
Min GB[GHz]	Displays the minimum Guard Band (GB) requirement between channels on the 40G CP-DQPSK MXP and 40G CP-DQPSK ME MXP cards and other transponders in a mixed Any-to-Any connectivity.
Filtering Penalty	Displays the value of the penalties caused by the different filter types (OADM, ROADM, and arrayed waveguide grating [AWG]).

Step 3 Click **New Query** to open the Query Dialog (Figure 3-7 on page 3-14). The Query Dialog allows you to filter the optical results using a variety of parameters.

Step 4 To perform a query using individual parameters, select the desired parameters from the drop-down lists in the Query Definition area. The selected parameters appear in the Query Preview area at the bottom of the screen. Table 3-13 describes the fields in the Query Dialog.

Table 3-13 *Query Dialog Fields*

Field Label	Description
Traffic Root	Allows you to filter the report to include only the data for the selected level. You can query upto the service level.
Clients & PPMs	Allows you to filter the report to include the data for the selected cards or PPM
Sites	Allows you to filter the report to include only the results of incoming/outgoing services to or from a specific site.
Subnets	Allows you to filter the report to include only the results of services in the selected subnet.
Wavelength	Allows you to filter the report to include only services using the specified wavelength.
Alarm	Allows you to filter the report to include only services flagged with a green, yellow, orange, or red indicator.
P/F	Allows you to filter the report to include only present services, only forecast services, or both.
Virtual	Allows you to filter the report to include or exclude virtual channels in the Optical Results Table.

Step 5 Choose one of the following tasks, as needed:

- Click **Run Query**. The window closes, and the query results appear in the Optical Results tab. The parameters of the query appear in the horizontal area just below the button bar.
- Click **Reset Query** to clear your selections in the Query Dialog.
- Click **Close** to close the window without running a query.

Step 6 To close the Optical Results report, click the **X** in the upper-right corner of the tab.

3.2.11 Viewing Wavelength Routing

Use the following procedure to view the wavelength routing map for the network that was analyzed:

- Step 1** Click the **Networks Mgmt Tree** tab, and click the analyzed network.
- Step 2** In the Tasks Pane, click **Wavelength Routing**. The Wavelength Routing tab appears (Figure 3-14). Each wavelength supported by the platform is represented by a row.



Note ROADM (Any-to-Any) demands are not shown in this report.

Figure 3-14 Wavelength Routing Tab

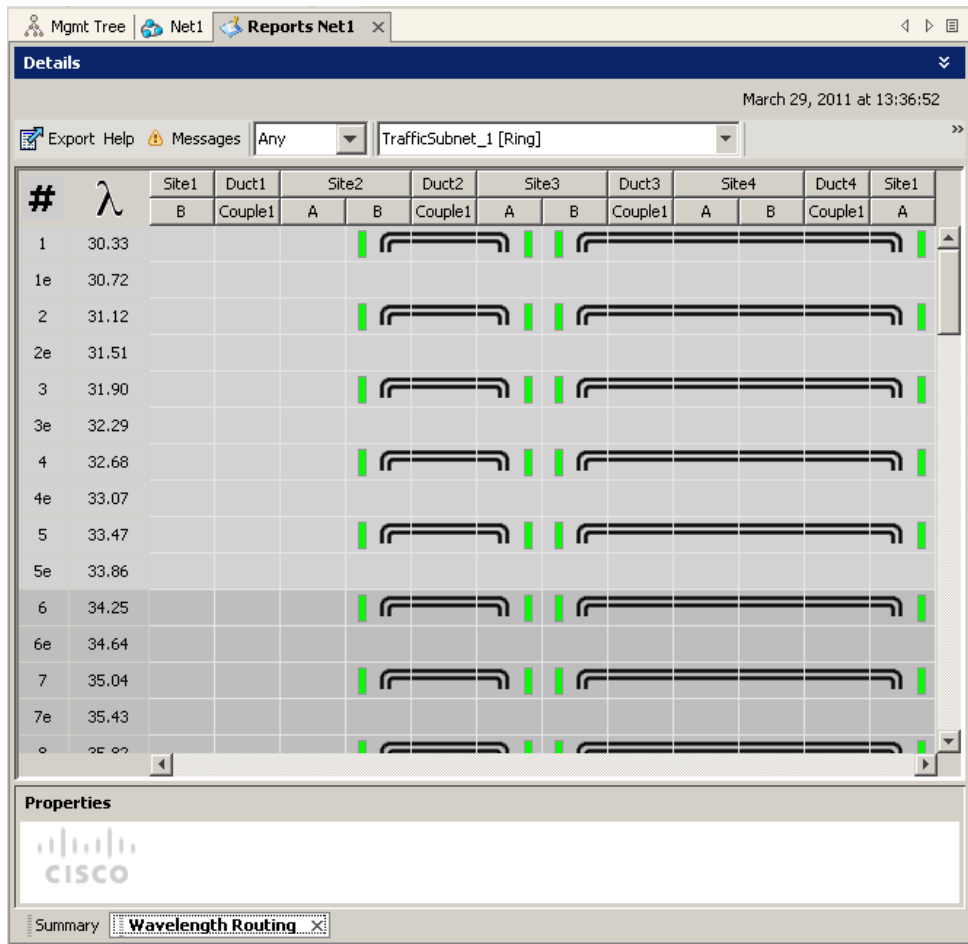

- Step 3** Choose one of the following from the Messages drop-down list:
 - **Any** (to view both forecast and present routing)
When you select Any, forecast demands are shown with a grey background.
 - **Present** (to view only the present routing)
 - **Forecast** (to view only the forecast routing).

Step 4 To view the routing map for a particular linear or ring subnet, expand the Traffic subnet ALL option in the traffic subnet drop-down list and choose the subnet.



Note In addition to the existing subnets, a linear subnet is created for every demand. Choosing a linear subnet from the Traffic Subnet ALL option displays the routing map for that particular demand only. You cannot view the routing maps for all the demands across subnets at the same time. You can view the routing map for any of the point-to-point demands by selecting it from the drop-down list.



Note The two ends of the circuit are indicated by the add/drop source and destination sites. See [Table 3-14](#).

Figure 3-15 Point-to-point Demand

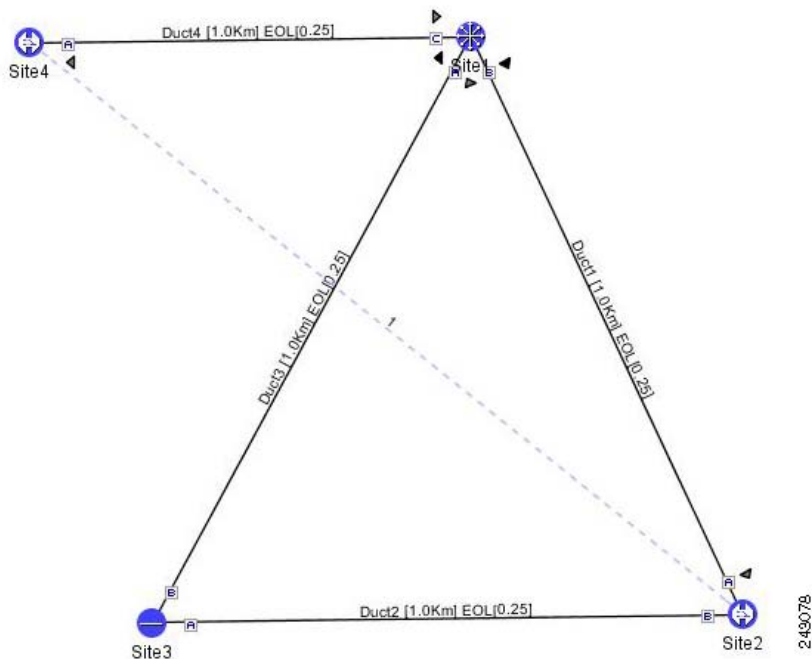

Table 3-14 lists and explains the circuit icons present in the routing map

Table 3-14 Circuit Icons in a Routing Map











Component	Description
	Indicates channel a add/drop source or destination site.
	Indicates channel a add/drop source or destination site.
	Indicates an express site.
	Indicates alarms.
	Indicates the side of the site through which the demand exits the subnet. For example, in Figure 3-15 a point-to-point demand is created from site 2 to site 4. The demand exits the subnet at site 1 on side C. To view the complete circuit, select the linear subnet from the traffic subnet drop-down list.
	Indicates the regeneration site.
	Indicates an omnidirectional side.
	Indicates the omnidirectional side of a regeneration site where the demand terminates.
	Indicates an omnidirectional demand.
	Indicates a colorless demand.

Table 3-14 *Circuit Icons in a Routing Map*



Component	Description
	Indicates a colorless omnidirectional demand.
	Indicates an optical bypass site.

Table 3-15 describes the columns in the Wavelength routing tab.

Table 3-15 Wavelength Routing Tab Columns

Column Label	Description
#	Displays the serial number of the wavelength in the wavelength band. The alphabet “e” besides the wavelength serial number represents that it is an “even” wavelength in the C-band.
λ	Lists the wavelengths supported by the platform.
Site #	Represents a site in the network. The colors in the Site columns indicate for each side of the site the SOL/EOL channel status. <ul style="list-style-type: none"> • Green indicates success. • Yellow indicates success with a marginal failure risk (between 0 and 16 percent). • Orange indicates that the channel has a higher risk of failure (between 16 and 50 percent) • Red indicates failure.
Duct #	Represents a duct in the network.
A	Represents a Terminal or a Terminal+ site.
A and B	Represents a Line or Line+ site.
A, B, C, and D	Represents a multidegree site with PP-MESH-4.
A, B, C, D, E, F, G, and H	Represents a multidegree site with PP-MESH-8.
Couple	Represents a pair of fibers at a site.



Note Tool tips are available on this report. Move the cursor over a Site column for circuit information, card name, and product ID. Move the cursor over a Duct/Couple column for loss, length, and fiber type.

- Step 5** To export the graphical representation of the layout in JPEG format, click **Export**. In the Wavelength Routing export dialog box, type the name of the file and navigate to the desired folder. Click **Save**.
- Step 6** To close the Wavelength Routing report, click the **X** in the upper-right corner of the window.

3.2.12 Viewing the Ethernet Aggregated Demand Report

Use the following procedure to view the Ethernet Aggregated Demand report:

- Step 1** Click the Mgmt Tree tab and right-click the analyzed network.
- Step 2** Choose Ethernet Aggregated Demand from the drop-down list.
- The Ethernet Aggregated Demand Report tab appears (Figure 3-16).

Figure 3-16 Ethernet Aggregated Demand Tab

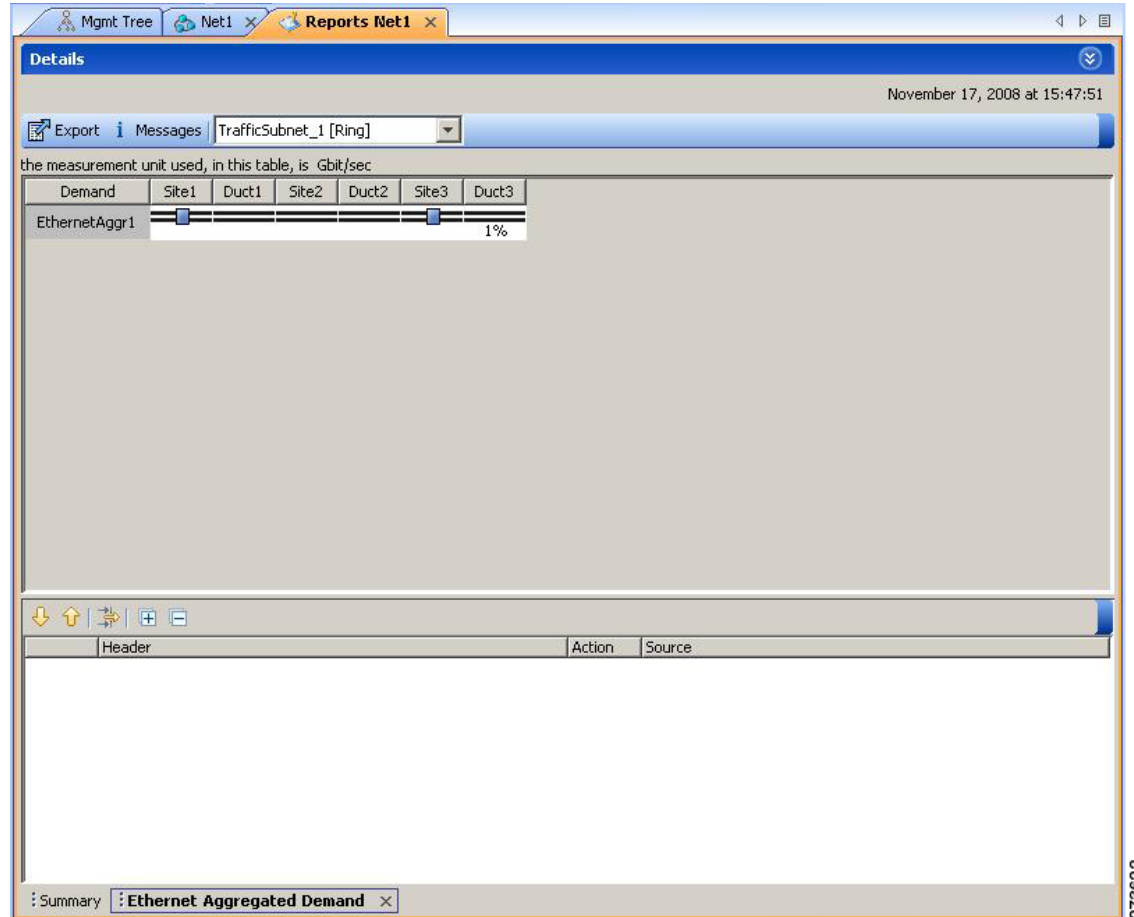

273622

3.2.13 Viewing the TDM Aggregated Demand Report

Use the following procedure to view the TDM Aggregated Demand report:

-
- Step 1** Click the Mgmt Tree tab and right-click the analyzed network.
 - Step 2** Choose TDM Aggregated Demand from the drop-down list.
The TDM Aggregated Demand Report tab appears (Figure 3-17).

Figure 3-17 TDM Aggregated Demand Tab

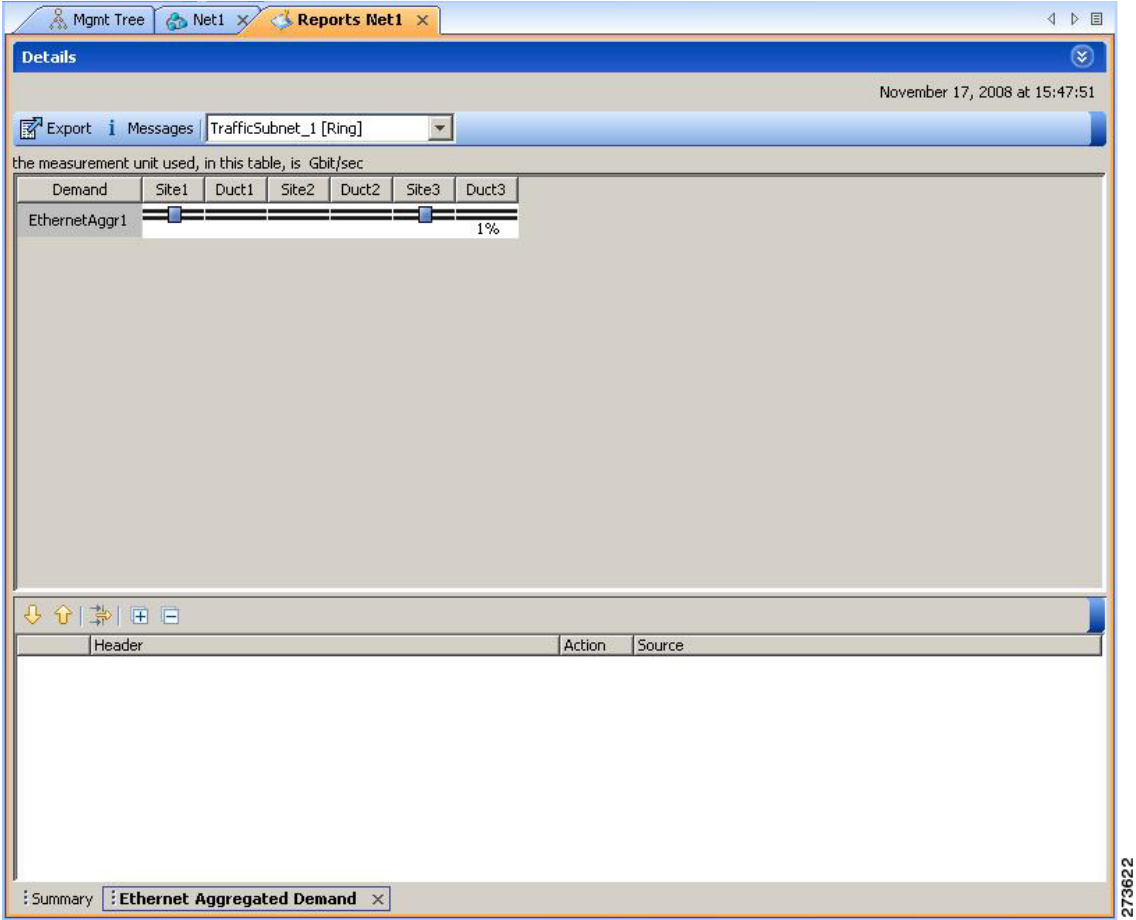

3.2.14 Viewing Any-to-Any Finalized Circuits

To view the Any-to-Any (A2A) Finalized Circuits report:

- Step 1** Click the Mgmt Tree tab and right-click the analyzed network.
- Step 2** Choose A2A Finalized Circuits from the drop-down list.

The A2A Finalized Circuits tab appears.

The A2A Finalized Circuits tab allows to edit or delete any Any-to-Any finalized ROADM demand (see [“2.7.7 Creating a ROADM Demand”](#) task on page 2-25).

Table 3-16 describes the columns in the A2A Finalized Circuits tab.

Table 3-16 A2A Finalized Circuits Tab Columns

Column Label	Description
Name	Displays the name of the site.
Wavelength	Displays the wavelength value of the optical channel. Also, displays the serial number of the wavelength in the wavelength band. The alphabet “e” besides the wavelength serial number represents that it is an “even” wavelength in the C-band.
From Loc	Displays the site and side where the demand originates.
To Loc	Displays the site and side where the demand terminates.
Signal Rate	Displays the signal rate.
Equipment	Displays the card type.
Notes	Allows to add notes or comments.
Finalized On	Displays the date when the demand was finalized.

3.2.15 Viewing Report Differences

You can compare the BoM, Internal Connections, and Installation Parameters reports for two networks. This is useful to see the differences between a baseline network and an Install or Upgrade network.

- The BoM Diff report lists the units that were added and/or removed from the BoM.
- The Internal Connection Diff report lists changed connections. If at least one of the two endpoints of an internal connection is different, Cisco Transport Planner reports that the internal connection has changed. The report shows all internal connections that were present in the baseline network but are not present in the final network, and all internal connections not present in the baseline network but present in the final network.
- The Installation Parameters Diff report lists changed parameters between the baseline network and the final network.

Use the following procedure to compare networks:

- Step 1** Click the Reports Diff icon. For more information about Cisco Transport Planner icons, see [Appendix A, “GUI Information and Shortcuts.”](#) The Reports Diff dialog box appears. [Figure 3-18](#) shows the Reports Diff dialog box as it appears when at least two analyzed networks exist in a project.

Figure 3-18 Reports Diff Dialog Box

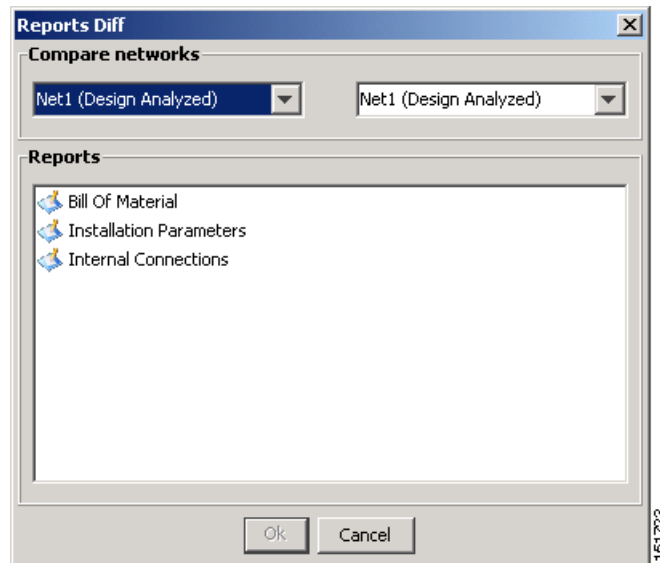

- Step 2** In the Compare networks area, choose the baseline network from the drop-down list on the left. Choose the network to compare from the drop-down list on the right.
- Step 3** Click the report you would like to view. If you chose one non-analyzed network, you can view only the Bill of Material differences report.
- Bill of Material—([Figure 3-19 on page 3-37](#)) For a description of the columns, see [Table 3-17 on page 3-38](#).
 - Installation Parameters—([Figure 3-20 on page 3-39](#)) For a description of the columns, see [Table 3-18 on page 3-39](#).
 - Internal Connections—([Figure 3-21 on page 3-40](#)) For a description of the columns, see [Table 3-19 on page 3-41](#).
- Step 4** Click **OK**.
- [Figure 3-19](#) shows the BoM Diff report.

Figure 3-19 BoM Diff Report

The screenshot shows the 'BoM Diff Report Net1-Net6' window in MetroPlanner. It displays summary information for two networks and a detailed table of components.

Name	PID	Quantity	Unit Price	Total Price	Disc
ONS 15454 OADM - 1 Chn - 100GHz - 1558.17	15454-AD-1C-58.1	1	20,000.00	20,000.00	20,000.00
ONS 15454 OADM - 2 Chs - 100GHz - 1554.13 - 1554.94	15454-AD-2C-54.1	1	30,000.00	30,000.00	30,000.00
ONS 15454 OADM - 4 Chs - 100GHz - 58.17-58.98-59.79-60.61	15454-AD-4C-58.1	1	40,000.00	40,000.00	40,000.00
Transponder	=	5		157,000.00	157,000.00
PPM	=	5		15,695.00	15,695.00
Mech Unit	≠	22/18		11,715.00/7,845.00	11,715.00
Common Unit	≠	6/4		38,000.00/29,000.00	38,000.00
SW License	≠	6/3		7,980.00/3,990.00	7,980.00
Opt Common Unit	=	2		18,000.00	18,000.00
Amplifier	=				
ONS 15454 Optical Pre-Amplifier Module	15454-OPT-PRE	1	22,000.00	22,000.00	22,000.00

The upper section of the BoM Diff Report tab displays the following information for each network:

- **BoM total discounted**—Displays the price for the overall network (without spare parts) for each item in the BoM. If Use global discount is checked, the total includes the discount from the Global discount percentage field.
- **Spare total discounted**—Displays the price for all of the recommended spare parts in all of the maintenance centers for the overall network. It is the sum of each spare item using the discounted price. The total appears after you check the Spare Part Report check box.
- **BoM + Spare total discounted**—Displays the sum of the BoM total discounted price and spare total discounted price.
- **Price List**—Displays the name of the price list database selected for the project.
- **Currency**—Displays the value of the currency used for each of the price values as specified within the selected price list database.

Table 3-17 describes the information in the BoM Diff report columns. Click a column to sort the table information by that column.

Table 3-17 BoM Diff Report Columns

Column Label	Description
Name	Displays the name of the site and equipment.
Difference Summary (not labeled)	Indicates a difference exists between the two network BoMs: = (equal sign)—Indicates that no difference exists between the two networks. ≠ (not equal sign)—Indicates that the item is present on both networks, but the number per network is different. 1—Indicates that this item is present in the first network but not in the second network. 2—Indicates that this item is present in the second network but not in the first network.
PID	Displays the ID string of the product. To view a PID, click on the plus (+) sign by the equipment name to expand it.
Quantity	Displays the number of specific products in the BoM. If the networks have a different quantity, Cisco Transport Planner displays both numbers in red in the following format: <i>first-network-quantity/second-network-quantity.</i>
Unit Price	Displays the price for each unit. To view a unit price, click on the plus (+) sign by the equipment name to expand it.
Total Price	Displays the total price of the products before applying the discount. If the networks have a different quantity, Cisco Transport Planner displays both numbers in red in the following format: <i>first-network-total-price/second-network-total-price.</i>
Discounted Total Price	Displays the total price of the products after applying the discount. If the networks have a different quantity, Cisco Transport Planner displays both numbers in red in the following format: <i>first-network-discounted-total-price/second-network-discounted-total-price.</i>

Figure 3-20 shows the Installation Parameters Diff report.

Figure 3-20 Installation Parameters Diff Report

Name	Position	Unit	Port label	Attenuator	Position	Unit	Port label	P/F
LC-LC-2	= Rack 1.ONS 15454 ANSI Shelf...	OSC-CSM	COM TX		Rack 1.ONS 15454 ANSI Shelf...	OPT-PRE	COM RX	P
MPO-8LC-2	= Rack 1.ONS 15454 ANSI Shelf...	40-DMX-C	DROP-TX-3...		Rack 1.PP-80-LC A	PP-80-LC	1-Tx	P
MPO-8LC-2	= Rack 1.ONS 15454 ANSI Shelf...	40-DMX-C	DROP-TX-3...		Rack 1.PP-80-LC A	PP-80-LC	2-Tx	P
MPO-8LC-2	= Rack 1.ONS 15454 ANSI Shelf...	40-DMX-C	DROP-TX-4...		Rack 1.PP-80-LC A	PP-80-LC	3-Tx	P
MPO-8LC-2	= Rack 1.ONS 15454 ANSI Shelf...	40-DMX-C	DROP-TX-4...		Rack 1.PP-80-LC A	PP-80-LC	4-Tx	P
MPO-8LC-2	= Rack 1.ONS 15454 ANSI Shelf...	40-DMX-C	DROP-TX-5...		Rack 1.PP-80-LC A	PP-80-LC	5-Tx	P
LC-LC-2	= Rack 1.ONS 15454 ANSI Shelf...	40-WXC	COM TX		Rack 1.ONS 15454 ANSI Shelf...	OSC-CSM	COM RX	P
LC-LC-2	= Rack 1.ONS 15454 ANSI Shelf...	40-WXC	EXP TX		Rack 1.PP4 0	PP-MESH-4	COM RX - C	P
LC-LC-2	= Rack 1.ONS 15454 ANSI Shelf...	OPT-PRE	COM TX		Rack 1.ONS 15454 ANSI Shelf...	40-WXC	COM RX	P
ATT-4dB	= Rack 1.ONS 15454 ANSI Shelf...	OPT-PRE	DC TX		Rack 1.ONS 15454 ANSI Shelf...	OPT-PRE	DC RX	P
LC-LC-2	= Rack 1.ONS 15454 ANSI Shelf...	OSC-CSM	COM TX		Rack 1.ONS 15454 ANSI Shelf...	OPT-PRE	COM RX	P
LC-LC-2	= Rack 1.ONS 15454 ANSI Shelf...	OPT-PRE	COM TX		Rack 1.ONS 15454 ANSI Shelf...	40-WXC	COM RX	P
ATT-4dB	= Rack 1.ONS 15454 ANSI Shelf...	OPT-PRE	DC TX		Rack 1.ONS 15454 ANSI Shelf...	OPT-PRE	DC RX	P
LC-LC-2	= Rack 1.ONS 15454 ANSI Shelf...	40-WXC	COM TX		Rack 1.ONS 15454 ANSI Shelf...	OSC-CSM	COM RX	P
LC-LC-2	= Rack 1.ONS 15454 ANSI Shelf...	40-WXC	DROP TX		Rack 1.ONS 15454 ANSI Shelf...	40-DMX-C	COM RX	P
LC-LC-2	= Rack 1.ONS 15454 ANSI Shelf...	40-WXC	EXP TX		Rack 1.PP4 0	PP-MESH-4	COM RX - A	P
LC-LC-2	= Rack 1.ONS 15454 ANSI Shelf...	40-MUX-C	COM TX		Rack 1.ONS 15454 ANSI Shelf...	40-WXC	ADD RX	P
LC-LC-2	= Rack 1.ONS 15454 ANSI Shelf...	OSC-CSM	COM TX		Rack 1.ONS 15454 ANSI Shelf...	OPT-PRE	COM RX	P
LC-LC-2	= Rack 1.ONS 15454 ANSI Shelf...	ADM-10G	ILK1-TX		Rack 1.ONS 15454 ANSI Shelf...	ADM-10G	ILK1-RX	P
LC-LC-5	= Rack 1.ONS 15454 ANSI Shelf...	ADM-10G	TRK1-TX		Rack 1.PP-80-LC A	PP-80-LC	1558.9-RX	P
LC-LC-2	= Rack 1.ONS 15454 ANSI Shelf...	ADM-10G	TRK2/ILK2-TX		Rack 1.ONS 15454 ANSI Shelf...	ADM-10G	TRK2/ILK2-RX	P
LC-LC-5	= Rack 1.ONS 15454 ANSI Shelf...	10GE-XP	DWDM-A-TX		Rack 1.PP-80-LC A	PP-80-LC	1559.7-RX	P
LC-LC-2	= Rack 1.ONS 15454 ANSI Shelf...	10GE-XP	DWDM-B-TX		Rack 1.PP-80-LC B	PP-80-LC	1559.7-RX	P
LC-LC-2	= Rack 1.ONS 15454 ANSI Shelf...	ADM-10G	ILK1-TX		Rack 1.ONS 15454 ANSI Shelf...	ADM-10G	ILK1-RX	P
LC-LC-2	= Rack 1.ONS 15454 ANSI Shelf...	ADM-10G	TRK1-TX		Rack 1.PP-80-LC B	PP-80-LC	1558.9-RX	P

Table 3-18 describes the columns in the Installation Parameters Diff report. Click a column to sort the table information by that column.

Differences between networks appear in red and in the following format:
baseline-network-value/final-network-value.

Table 3-18 Installation Parameters Diff Report Columns

Category	Description
Name	Displays the name of the site.
(Diff Summary)	Indicates a difference exists between the two network BoMs: = (equal sign)—Indicates that no difference exists between the two networks. ≠ (crossed-out equal sign)—Indicates that the item is present on both networks, but the number per network is different. 1—Indicates that this item is present in the first network but not in the second network. 2—Indicates that this item is present in the second network but not in the first network.
Side	Displays the node interface: T (terminal), E (east), or W (west).
Position	Displays the rack, shelf, and slot position of the card from which the patchcord originates.

Table 3-18 Installation Parameters Diff Report Columns (continued)

Category	Description
Unit	Displays the name of the card.
Port #	Displays the port number from which the patchcord originates.
Port ID	Displays the port ID.
Port Label	Displays the name of the port.
Parameter	Displays the name of the parameter to be set, such as RX Power Low.
Value	Displays the name of the value to be set.
Measurement Unit	Displays the measurement unit for the related installation parameter value, such as dBm.
Manual Set	Indicates with a Yes or No which parameters must be manually set using the CTC interface.

Figure 3-3 shows the Internal Connections Diff report.

Figure 3-21 Internal Connections Diff Report

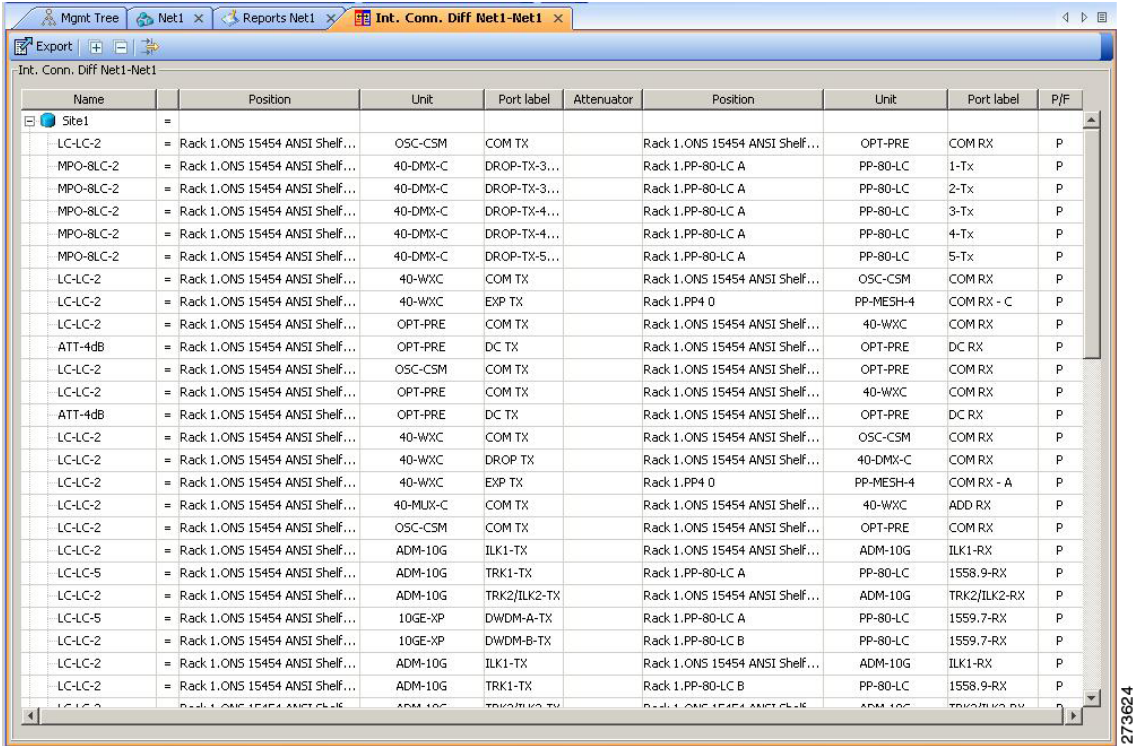

273624

Table 3-19 lists the columns in the Internal Connections Diff report and their descriptions. Click a column to sort the table information by that column.

Differences between networks appear in red and in the following format: *baseline network value/final network value*.

Table 3-19 Internal Connections Tab Columns

Column Name	Description
Name	Displays the name of the site. On the SW provisioning view subtab, this column indicates whether the connection should be manually set using the CTC interface or removed.
Difference Summary (not labeled)	Indicates a difference exists between the two network BoMs: = (equal sign)—Indicates that no difference exists between the two networks. ≠ (not equal sign)—Indicates that the item is present on both networks, but the number per network is different. 1—Indicates that this item is present in the first network but not in the second network. 2—Indicates that this item is present in the second network but not in the first network.
Position	Displays the rack, shelf, and slot position of the card from which the patchcord originates.
Unit	Displays the name of the card.
Port label	Displays the name of the port.
Attenuator	When indicated, this is the product ID of the bulk attenuator to be equipped on this connection. It also reports when an internal attenuator must be placed between the DC-TX and DC-RX ports on the preamplifier (when no DCU is equipped).
Position	Displays the rack, shelf, and slot position of the card where the patchcord terminates.
Unit	Displays the name of the card.
Port Label	Displays the name of the port.
P/F	Displays whether the connection relates to a present (P/F) or forecast (F) circuit.



CHAPTER 4

Editing a Project

CTP allows you to edit the a project either before or after network analysis. Error messages that occur during network analysis often cannot be resolved until you edit one or more network components.

To complete the procedures in this section, you must have a project open and the network(s) loaded. See the [“1.4.1 Opening a Project”](#) section on page 1-21 and the [“1.4.2 Loading and Unloading Networks”](#) section on page 1-21.

4.1 Editing Project Parameters

Use the following procedure to edit project parameters:

-
- Step 1** Click **Project** in the Project Explorer pane.
- Step 2** In the Properties pane, complete the following tasks as needed:
- **Customer**—Enter the name of the customer (128-character maximum) requiring this network design.
 - **Created by**—Enter the user name (128-character maximum).
 - **Units**—Displays the span measurement unit: Km (kilometers) or Miles.
 - **Price List**—Choose the price database from the drop-down list.
 - **Layout**—Displays ANSI (the North American standard) or ETSI (the international standard) to indicate the platform type. ANSI networks do not allow you to define SDH (ETSI) service demands. ETSI networks do not allow you to define SONET (ANSI) service demands.
-

4.2 Editing Network Parameters

Use the following procedure to edit network parameters:

-
- Step 1** Click a network in the Project Explorer pane or Mgmt Tree.
- Step 2** In the Properties pane, complete the following tasks as needed:
- **Name**—Enter the network name (128-character maximum).
 - **Position**—Enter the object location in pixels.

- Created by—Enter the user name (128-character maximum).
- Status—Displays the state of the network (Design, Design-Analyzed, Install, and so on).
- Measurement Units—Choose Km or Miles from the drop-down list. Any change made to the measurement unit at the network level will change the measurement unit of all the ducts within that network. For additional information on changing the measurement units of an individual duct, see [4.14 Editing Fiber Span, Pair, and Fiber Parameters, page 4-58](#)
- Use Bundles—Check to use the Multishelf Management Integrated Kit bundle when generating the BoM instead of the single items.
- Use Spare Parts—Check to determine the spare parts required by the network. If the network is in the Upgrade state, the parts required to support the implemented services and the newly added present services are included. To generate a spare parts report, you must associate the sites in a network with a maintenance center before network analysis.
- Use Global Discount—Check to use the global discount for the entire network. The global discount is applied to all components in the BoM.
- Global Discount—Enter a new global discount in the form of a percentage.
- Use Client Payg—Check to include license for client cards. This option is available only for AR-MXP and AR-XP cards. This check box is selected by default.
- Service Level—Choose the service level (contract) identifier from the drop-down list.
- Service Length—Choose the maintenance service level length (in years) from the drop-down list.
- Include SW Licenses—Check to include software licenses in the BoM.
- Include Paper Documentation—Check to include paper documentation in the BoM.
- Include CD Documentation—Check to include CD documentation in the BoM.
- Hide Bom/price discount—Check to hide the global discount in the Unit Price column of the BoM.
- Dimension—Enter the network size in pixels.
- Background color—Click to choose a color for the network background.
- Background image—Displays the JPEG or GIF filename used as a background, if any. To choose a JPEG or GIF file as a background graphic for the network, click the down arrow and navigate to the desired directory.

4.3 Editing Site Parameters

Editing the site parameters allows you to make changes to the current site configuration. A site folder in the Project Explorer pane displays the interface node information. Each site contains an NE folder in which network elements (NEs) are placed. The NEs are created after the network analysis.

The following configurations result in more than one NE creation:

- Individual shelf with OIC site functionality: One NE for each side.
- Individual shelf: One NE for each shelf.
- Multishelf with line card: One NE and one NE for each line card shelf.

Modifications in the site structure, functionality, and type also modify the number of NEs created.

Figure 4-1 shows a site in the Project Explorer pane before network analysis. Figure 4-2 shows a site in the Project Explorer pane after network analysis.

Figure 4-1 Site in the Project Explorer Pane

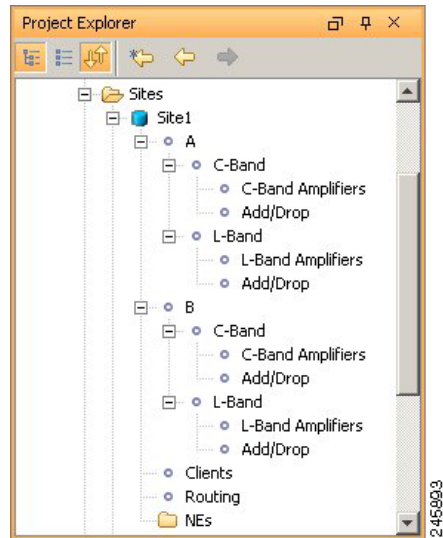
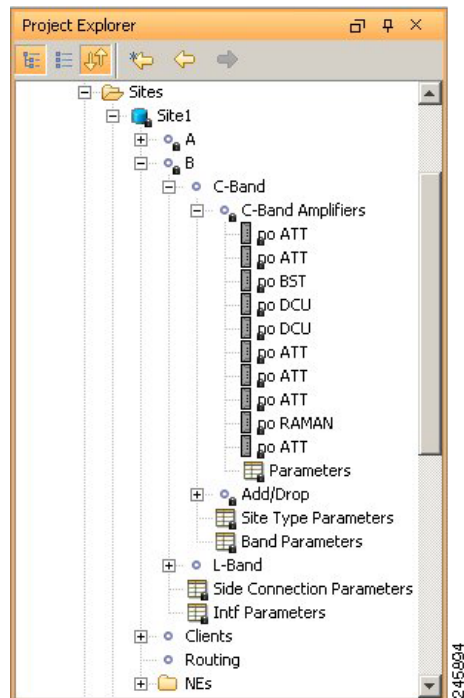

Figure 4-2 Analyzed Site in the Project Explorer Pane



A site folder for an analyzed network design also contains the following items, many of which you can edit:

- A and B—For a Line or Line+ site, two interface nodes appear in the Project Explorer pane under the Site folder, labeled A and B. For a Terminal or Terminal+ site, only one interface node (A) appears.
- A(w) and A(p)—For a PSM Terminal Optical Path site or a PSM Terminal Multiple Section site, two interface sides appear in the Project Explorer pane under the Site folder, labeled A(w) and A(p). A(w) represents the working path and A(p) represents the protection path. For a PSM Terminal Optical Path site, the following options are available under the supported bands for the two interfaces. See [Figure 4-3](#).
 - For A(w): Amplifiers, add/drop, and DWDM protection
 - For A(p): DWDM protection

For a PSM Terminal Multiple Section site, the following options are available under the supported bands for the two interfaces. See [Figure 4-4](#).

- For A(w): Amplifiers, add/drop, and DWDM protection
- For A(p): Amplifiers and DWDM protection

Figure 4-3 PSM Terminal Optical Path Site in the Project Explorer Pane

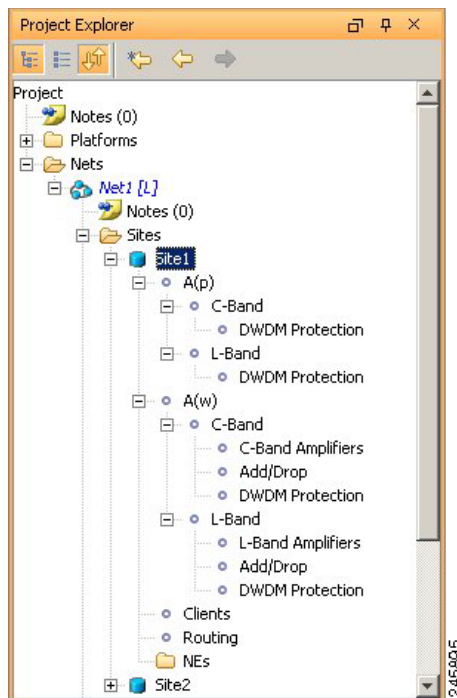
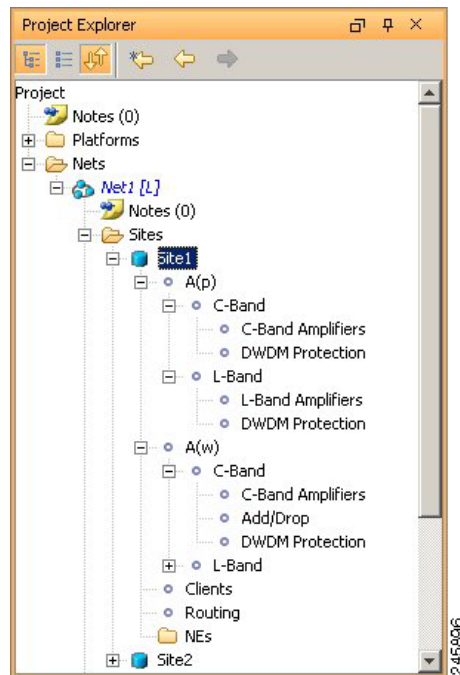

Figure 4-4 PSM Terminal Multiple Section Site in Project Explorer Pane



- C-Band or L-Band—Displays the supported band for the sides.
- Amplifiers—Lists the amplifiers and all related cards for each band and for each side.
- Add/Drop—Displays all of the add/drop and related cards for the band and side.
- Site Type Parameters—When selected, shows the site functionality and type in the Properties pane.
- Band Parameters—When selected, shows the output power in the Properties pane.
- Client—Lists the client cards.

Use the following procedure to edit site parameters. To delete a site, see the [“4.23 Deleting Sites”](#) section on page 4-119.

-
- Step 1** In the Project Explorer pane, right-click the network folder and choose **Expand** from the shortcut menu.
- Step 2** Click the desired Site folder. The site parameters appear in the Properties pane.
- Step 3** Complete the following tasks to modify the site parameters in the Properties pane, as needed:
- Name—Enter the site name.
 - Position—Enter the site pixel position; for example, an entry of 0,0 positions the Site icon in the upper-left corner of the NtView *Name* tab.
 - MTTR (hours)—Enter the mean time to repair (MTTR) for all sites in the network. This value applies to every site in the network. If you change the MTTR value after creating sites, the new value will only apply to sites you create after the change.
 - Maintenance Center—Choose the name of the maintenance center from the drop-down list. To create a maintenance center, see the [“4.6 Creating a Maintenance Center”](#) section on page 4-41.
 - IP Address—Enter the IP address of the node.
 - Shelf Management—Choose one of the shelf configuration types from the drop-down list:

- Auto—Sets the default option of the Multi Shelf Switch for all the nodes with more than one shelf.
- Multi Shelf Integrated Switch—All the MSTP optical cards (OADMs and amplifiers) reside in different shelves connected on a LAN. The LAN is implemented with switches connected to the MSTP shelves. For this option, Multi-Shelf Integrated Switch Cards (MS-ISC) are used to support the multishelf configuration.
- Multi Shelf External Switch—All the MSTP optical cards (OADMs and amplifiers) reside in different shelves connected by a LAN. The LAN is implemented with switches external to the MSTP shelves (Cisco Catalyst 2950). For this option, two external Ethernet switch units (Cisco Catalyst 2950 and Cisco Catalyst 3650) are used to support the multishelf configuration. The Cisco Catalyst 2950 supports 12 subtending shelves and Cisco Catalyst 3650 supports 24 subtending shelves. CTP supports a maximum of 30 shelves, including the node controller shelf, in a multishelf configuration.



Note The M6 chassis, when used as node controller, can support three subtended shelves. The subtended M6 chassis can subtend two more shelves.



Note If you select the Shelf Management Type as Multi Shelf Integrated Switch or Multi Shelf External Switch, you can modify the MSM Shelf ID for multi shelf management configuration. To modify the MSM Shelf ID, refer [“3.2.6 Viewing the Layout of Single Site” section on page 3-16](#).

- Individual Shelf—All the MSTP optical cards (OADMs and amplifiers) reside in the same shelf. For this option, multishelf management is not supported; every shelf is managed as an independent shelf.



Note Shelf management is disabled for HYBRID 15454 ONS configuration.



Note If you chose Individual Shelf as the Shelf Management type, n Network Elements (NEs) will be created where n is the number of shelves. If you chose Multishelf as the Shelf Management type, all subtended shelves will belong to a single NE. The network elements are created after network analysis.

- Node Protection—Choose the node protection type from the drop-down list: Same Shelf or Separated Shelves.



Note Node protection is disabled for HYBRID 15454 ONS configuration.

- DCC Shelves Management—When checked, indicates that a TXP(P)_MR_2.5G card is in slot 12 on each shelf at each site.
- Installation w/o CTP—When checked indicates that the network is installed with the default parameters, so that the selected node can be installed without the Cisco Transport Planner configuration files (thresholds and setpoints).
- Node Type—(Release 9.1 and later releases) Displays the configuration type of the site. This value cannot be edited after site creation.

- **MSM External Switch**—Enables you to choose the Multi Shelf External Switch type. The options are Auto, Cat 2950, and Cat 3650. The default option is Auto.
- **Insulators**—If checked, protects the Express Add/Drop (EAD) colorless ports of the 80-WXC-C cards configured as demux units.



Note The Cisco ONS 15216-FLD-2-ISO optical insulator is not supported in CTP Release 9.3 and later.



Note Optical insulator connections are displayed only in the Patchcord Installation tab in the Internal Connections report.

- **Service Level**—Choose the service level from the drop-down list.
- **Service Level Num of Years**—Choose the maintenance service level (in years) from the drop-down list.
- **Use Payg**—Check this check box to enable the Pay As You Grow (PAYG) feature on the site. For more information about the Pay As You Grow feature, see the [“1.8 Understanding the Pay As You Grow Feature” section on page 1-46](#).
- **Osmine Compliant**—When checked, indicates that the transponder/muxponder cards are placed in the shelves according to OSMINE placement rules.
- **Hybrid Node**—When checked, indicates that all the nodes are configured as hybrid MSTP/MSPP nodes.
- **Max Num of Shelves**—Choose the maximum number (from 1 to 4) of ANSI or ETSI shelves (that equip optical cards or transponder/muxponder cards) that can be placed in each rack in the site when generating the site layout.
- **Chassis Type**—Allows you to choose the chassis type. The options available are Auto, M12 Chassis, M6 Chassis, and M2 Chassis. The default option is Auto.



Note M2 chassis does not support MSM configuration.

The following section lists chassis selection rules for MSM with M2, M6, and M12 chassis (hybrid configuration):

- M2 chassis is not selected for MSM configuration.
- M6 chassis is forced when OSC Frame type is forced to GE.
- The layout is not built and an error message is displayed for the following conditions:
 - When the chassis type is forced as M12 (for Site1), M2 (for Site 2), and M12 (for Site 3).
 - When the chassis type is forced as M12 and when OSC pluggables are forced.
- M2 or M6 is not selected when the chassis type is selected as Auto. [Table 4-1](#) summarizes the chassis selection rules when the chassis type is Auto. [Table 4-2](#) summarizes the chassis selection rules when the FlexLayer modules are used.

Table 4-1 Site Design Rules for MSTP 15454 ONS Configuration

Structure	Functionality	Type	Card Options	C-band 100 GHz				C-band 50 GHz			L-b and 100 GHz	Shelf Option ¹		
				32/16 Chs	8 Chs	40 Chs	20 Chs	64 Chs	72 Chs	80 Chs	32 Chs	M12	M6	M2
Line	Pass Through	—	—	Yes	Yes	Yes	Yes	Yes	Yes	Yes	Yes	—	—	—
	Line amplifier	Line	Inline AT1	Yes	Yes	Yes	Yes	Yes	Yes	Yes	Yes	Yes	Yes	Yes
		Glass Through	—	Yes	Yes	Yes	Yes	Yes	Yes	Yes	Yes	Yes	Yes	Yes
	OSC Site	—	—	Yes	Yes	Yes	Yes	Yes	Yes	Yes	Yes	Yes	Yes	Yes
	Add/Drop	OADM ²	List of AD-xC units INLINE ATT1	Yes	Yes	Yes	Yes	No	No	No	No	Yes	Yes	Yes
			FLD-4 Units	Yes	Yes	Yes	Yes	No	No	No	No	Yes	Yes	Yes
		Mux/Demux	Add: 32-MUX-O Drop: 32-DMX-O	Yes	Yes	No	Yes	No	No	No	No	Yes	No	No
	Hub	Mux/Demux	Add: 32-MUX-O Drop: 32-DMX-O	Yes	Yes	No	Yes	No	No	No	No	Yes	No	No
			Add: 40-MUX-C Drop: 40-DMX-C	Yes	Yes	Yes	Yes	No	No	No	No	Yes	Yes	No
			15216-MD-40-ODD (MD-ID-50) ³	Yes	No	Yes	Yes	Yes	Yes	Yes	No	Yes	Yes	Yes
15216-MD-40-EVEN			No	No	No	No	Yes	Yes	Yes	No	Yes	Yes	Yes	

Table 4-1 Site Design Rules for MSTP 15454 ONS Configuration (continued)

Structure	Functionality	Type	Card Options	C-band 100 GHz				C-band 50 GHz			L-b and 100 GHz	Shelf Option ¹			
				32/16 Chs	8 Chs	40 Chs	20 Chs	64 Chs	72 Chs	80 Chs		32 Chs	M12	M6	M2
				Line	Hub	WSS	Add: 32-WSS-C Drop: 32-DMX-O	Yes	Yes	No	Yes	No	No	No	No
			Add: 32-WSS-C Drop: 32-DMX-C	Yes	Yes	No	Yes	Yes	Yes	Yes	No	No	Yes	Yes	No
			Add: 40-WSS-C Drop: 40-DMX-C	Yes	Yes	Yes	Yes	No	No	No	No	No	Yes	Yes	No
			Add: 40-WSS-CE Drop: 40-DMX-CE	No	No	No	No	Yes	Yes	Yes	No	No	Yes	No	No
		40-SMR1-C	15216- MD-40-ODD	Yes	Yes	Yes	Yes	No	No	No	No	No	Yes	Yes	Yes
			FLD-4 Units	Yes	Yes	Yes	Yes	No	No	No	No	No	Yes	Yes	Yes
			Add: 32-WSS-C Drop: 32-DMX-C	Yes	Yes	No	Yes	No	No	No	No	No	Yes	No	No
			Add: 40-MUX-C Drop: 40-DMX-C	Yes	Yes	Yes	Yes	No	No	No	No	No	Yes	Yes	No
			Add: 40-WSS-C Drop: 40-DMX-C	Yes	Yes	Yes	Yes	No	No	No	No	No	Yes	No	No

Table 4-1 Site Design Rules for MSTP 15454 ONS Configuration (continued)

Structure	Functionality	Type	Card Options	C-band 100 GHz				C-band 50 GHz				L-b and 100 GHz	Shelf Option ¹		
				32/16 Chs	8 Chs	40 Chs	20 Chs	64 Chs	72 Chs	80 Chs	32 Chs		M12	M6	M2
Line	Hub	40-SMR2-C	15216- MD-40-ODD	Yes	Yes	Yes	Yes	No	No	No	No	Yes	Yes	Yes	
			FLD-4 Units	Yes	Yes	Yes	Yes	No	No	No	No	Yes	Yes	Yes	
			Add: 32-WSS-C Drop: 32-DMX-C	Yes	Yes	No	Yes	No	No	No	No	Yes	No	No	
			Add: 40-MUX-C Drop: 40-DMX-C	Yes	Yes	Yes	Yes	No	No	No	No	Yes	Yes	No	
			Add: 40-WSS-C Drop: 40-DMX-C	Yes	Yes	Yes	Yes	No	No	No	No	Yes	No	No	
			80-WXC-C	Yes	No	Yes	Yes	Yes	Yes	Yes	No	Yes	Yes	No	
		FLD-4 Units	Yes	No	Yes	Yes	No	No	No	No	Yes	Yes	Yes		
		15216- MD-40- EVEN	No	No	No	No	Yes	Yes	Yes	No	Yes	Yes	No		
		Add: 40-MUX-C Drop: 40-DMX-C	Yes	No	Yes	Yes	No	No	No	No	Yes	Yes	No		
		Add: 32-WSS-C Drop: 32-DMX-C	Yes	No	No	Yes	Yes	Yes	No	No	Yes	No	No		
		Add: 40-WSS-C Drop: 40-DMX-C	Yes	No	Yes	Yes	Yes	Yes	Yes	No	Yes	No	No		
		Add: 40-WSS-CE Drop: 40-DMX-CE (15216-ID-50)	No	No	No	No	Yes	Yes	Yes	No	Yes	No	No		

Table 4-1 Site Design Rules for MSTP 15454 ONS Configuration (continued)

Structure	Functionality	Type	Card Options	C-band 100 GHz				C-band 50 GHz				L-b and 100 GHz	Shelf Option ¹		
				32/16 Chs	8 Chs	40 Chs	20 Chs	64 Chs	72 Chs	80 Chs	32 Chs		M12	M6	M2
				Line	Hub	80-WXC-C- MUX/DMX	15216- MD-40-ODD	Yes	No	Yes	Yes	Yes	Yes	Yes	No
			FLD-4 Units	Yes	No	Yes	Yes	No	No	No	No	No	Yes	Yes	Yes
			15216- MD-40- EVEN	No	No	No	No	Yes	Yes	Yes	No	Yes	Yes	No	
			Add: 40-MUX-C Drop: 40-DMX-C	Yes	No	Yes	Yes	No	No	No	No	Yes	Yes	No	
			Add: 32-WSS-C Drop: 32-DMX-C	Yes	No	No	Yes	Yes	Yes	No	No	Yes	No	No	
			Add: 40-WSS-C Drop: 40-DMX-C	Yes	No	Yes	Yes	Yes	Yes	Yes	No	Yes	No	No	
			Add: 40-WSS-CE Drop: 40-DMX-CE	No	No	No	No	Yes	Yes	Yes	No	Yes	No	No	
	Gain Equalizer	WSS	Add: 32-WSS-C	Yes	No	No	Yes	Yes	Yes	No	Yes	Yes	No	No	
40-WSS-C			Yes	No	Yes	Yes	Yes	Yes	Yes	No	Yes	Yes	No		
Add: 40-WSS-CE			No	No	No	No	Yes	Yes	Yes	No	Yes	No	No		
40-SMR1-C		None	Yes	Yes	Yes	Yes	No	No	No	No	Yes	Yes	Yes		
40-SMR2-C		None	Yes	Yes	Yes	Yes	No	No	No	No	Yes	Yes	Yes		
80-WXC-C		None	Yes	No	Yes	Yes	Yes	Yes	Yes	No	Yes	Yes	No		

Table 4-1 Site Design Rules for MSTP 15454 ONS Configuration (continued)

Structure	Functionality	Type	Card Options	C-band 100 GHz				C-band 50 GHz			L-b and 100 GHz	Shelf Option ¹		
				32/16 Chs	8 Chs	40 Chs	20 Chs	64 Chs	72 Chs	80 Chs		32 Chs	M12	M6
Line	R-OADM	WSS	Add: 32-WSS-C Drop: 32-DMX-O	Yes	No	No	Yes	Yes	No	No	No	Yes	No	No
			Add: 32-WSS-C Drop: 32-DMX-C	Yes	No	No	Yes	Yes	Yes	No	Yes	Yes	No	No
			Add: 40-WSS-C Drop: 40-DMX-C	Yes	No	Yes	Yes	Yes	Yes	Yes	No	Yes	Yes	No
			Add: 40-WSS-CE Drop: 40-DMX-CE	No	No	No	No	Yes	Yes	Yes	No	Yes	No	No
		40-SMR1-C	15216-MD-40-ODD	Yes	Yes	Yes	Yes	No	No	No	No	Yes	Yes	Yes
			FLD-4 Units	Yes	No	Yes	Yes	No	No	No	No	Yes	Yes	Yes
			Add: 32-WSS-C Drop: 32-DMX-C	Yes	Yes	No	Yes	No	No	No	No	Yes	No	No
			Add: 40-MUX-C Drop: 40-DMX-C	Yes	Yes	Yes	Yes	No	No	No	No	Yes	Yes	No
			Add: 40-WSS-C Drop: 40-DMX-C	Yes	Yes	Yes	Yes	No	No	No	No	Yes	No	No

Table 4-1 Site Design Rules for MSTP 15454 ONS Configuration (continued)

Structure	Functionality	Type	Card Options	C-band 100 GHz				C-band 50 GHz			L-b and 100 GHz	Shelf Option ¹			
				32/16 Chs	8 Chs	40 Chs	20 Chs	64 Chs	72 Chs	80 Chs		32 Chs	M12	M6	M2
				Line	R-OADM	40-SMR2-C	15216- MD-40-ODD	Yes	Yes	Yes	Yes	No	No	No	No
			FLD-4 Units	Yes	No	Yes	Yes	No	No	No	No	No	Yes	Yes	Yes
			Add: 32-WSS-C Drop: 32-DMX-C	Yes	Yes	No	Yes	No	No	No	No	No	Yes	No	No
			Add: 40-MUX-C Drop: 40-DMX-C	Yes	Yes	Yes	Yes	No	No	No	No	No	Yes	Yes	No
			Add: 40-WSS-C Drop: 40-DMX-C	Yes	Yes	Yes	Yes	No	No	No	No	No	Yes	No	No
		80-WXC-C	15216- MD-40-ODD (MD-ID-50) ³	Yes	No	Yes	Yes	Yes	Yes	Yes	No	No	Yes	Yes	No
			FLD-4 Units	Yes	No	Yes	Yes	No	No	No	No	No	Yes	Yes	Yes
			15216- MD-40- EVEN	No	No	No	No	Yes	Yes	Yes	No	No	Yes	Yes	No
			Add: 40-MUX-C Drop: 40-DMX-C	Yes	No	Yes	Yes	No	No	No	No	No	Yes	Yes	No
			Add: 32-WSS-C Drop: 32-DMX-C	Yes	No	Yes	Yes	Yes	Yes	Yes	No	No	Yes	No	No
			Add: 40-WSS-C Drop: 40-DMX-C	Yes	No	Yes	Yes	Yes	Yes	Yes	No	No	Yes	No	No
			Add: 40-WSS-CE Drop: 40-DMX-CE (15216-ID-50)	No	No	No	No	Yes	Yes	Yes	No	No	Yes	No	No

Table 4-1 Site Design Rules for MSTP 15454 ONS Configuration (continued)

Structure	Functionality	Type	Card Options	C-band 100 GHz				C-band 50 GHz				L-b and 100 GHz	Shelf Option ¹		
				32/16 Chs	8 Chs	40 Chs	20 Chs	64 Chs	72 Chs	80 Chs	32 Chs		M12	M6	M2
Line	R-OADM	80-WXC-C MUX/DMX	15216-MD-40-ODD	Yes	No	Yes	Yes	Yes	Yes	Yes	No	Yes	Yes	No	
			FLD-4 Units	Yes	No	Yes	Yes	No	No	No	No	Yes	Yes	Yes	
			15216-MD-40-EVEN	No	No	No	No	Yes	Yes	Yes	No	Yes	Yes	No	
			Add: 40-MUX-C Drop: 40-DMX-C	Yes	No	Yes	Yes	No	No	No	No	Yes	Yes	No	
			Add: 32-WSS-C Drop: 32-DMX-C	Yes	No	Yes	Yes	Yes	Yes	Yes	No	Yes	No	No	
			Add: 40-WSS-C Drop: 40-DMX-C	Yes	No	Yes	Yes	Yes	Yes	Yes	No	Yes	No	No	
			Add: 40-WSS-CE Drop: 40-DMX-CE	No	No	No	No	Yes	Yes	Yes	No	Yes	No	No	
Line+ (includes MMU)	Hub	WSS	Add: 32-WSS-C Drop: 32DMX-O	Yes	No	Yes	Yes	No	No	No	No	Yes	No	No	
			Add: 32-WSS-C Drop: 32-DMX-C	Yes	No	Yes	Yes	No	No	No	Yes	Yes	No	No	
	ROADM	WSS	Add: 32-WSS-C Drop: 32DMX-O	Yes	No	Yes	Yes	No	No	No	No	Yes	No	No	
			Add: 32-WSS-C Drop: 32-DMX-C	Yes	No	Yes	Yes	No	No	No	Yes	Yes	No	No	

Table 4-1 Site Design Rules for MSTP 15454 ONS Configuration (continued)

Structure	Functionality	Type	Card Options	C-band 100 GHz				C-band 50 GHz				L-b and 100 GHz	Shelf Option ¹		
				32/16 Chs	8 Chs	40 Chs	20 Chs	64 Chs	72 Chs	80 Chs	32 Chs		M12	M6	M2
				Terminal	Add/Drop	AD-xC	OADM cards	Yes	Yes	Yes	Yes	No	No	No	No
			FLD-4 Units	Yes	Yes	Yes	Yes	No	No	No	No	Yes	Yes	Yes	
		Mux/Demux	Add: 32MUX-O	Yes	Yes	No	Yes	No	No	No	No	Yes	No	No	
			Drop: 32DMX-O												
			Add: 40-MUX-C	Yes	Yes	Yes	Yes	No	No	No	No	Yes	Yes	No	
			Drop: 40-DMX-C												
			15216- MD-40-ODD (MD-ID-50) ³	Yes	Yes	Yes	Yes	Yes	Yes	Yes	Yes	Yes	Yes	Yes	
			15216- MD-40- EVEN	No	No	No	No	Yes	Yes	Yes	Yes	Yes	Yes	Yes	
	R-OADM	WSS	Add: 32-WSS-C	Yes	Yes	No	Yes	No	No	No	No	Yes	No	No	
			Drop: 32-DMX-O												
			Add: 32-WSS-C	Yes	Yes	No	Yes	Yes	Yes	No	Yes	Yes	No	No	
			Drop: 32-DMX-C												
			Add: 40-WSS-C	Yes	Yes	Yes	Yes	Yes	Yes	Yes	No	Yes	Yes	No	
			Drop: 40-DMX-C												
			Add: 40-WSS-CE	No	No	No	No	Yes	Yes	Yes	No	Yes	No	No	
			Drop: 40-DMX-CE												

Table 4-1 Site Design Rules for MSTP 15454 ONS Configuration (continued)

Structure	Functionality	Type	Card Options	C-band 100 GHz				C-band 50 GHz				L-b and 100 GHz	Shelf Option ¹		
				32/16 Chs	8 Chs	40 Chs	20 Chs	64 Chs	72 Chs	80 Chs	32 Chs		M12	M6	M2
Terminal	R-OADM	40-SMR1-C	15216-MD-40-ODD	Yes	Yes	Yes	Yes	No	No	No	No	Yes	Yes	Yes	
			FLD-4 Units	Yes	Yes	Yes	Yes	No	No	No	No	Yes	Yes	Yes	
			Add: 40-MUX-C Drop: 40-DMX-C	Yes	Yes	Yes	Yes	No	No	No	No	Yes	Yes	No	
			Add: 40-WSS-C Drop: 40-DMX-C	Yes	Yes	Yes	Yes	No	No	No	No	Yes	No	No	
			Add: 32-WSS-C Drop: 32-DMX-C	Yes	Yes	No	Yes	No	No	No	No	Yes	No	No	
		40-SMR2-C	15216-MD-40-ODD	Yes	Yes	Yes	Yes	No	No	No	No	Yes	Yes	Yes	
			FLD-4 Units	Yes	Yes	Yes	Yes	No	No	No	No	Yes	Yes	Yes	
			Add: 40-MUX-C Drop: 40-DMX-C	Yes	Yes	Yes	Yes	No	No	No	No	Yes	Yes	No	
			Add: 32-WSS-C Drop: 32-DMX-C	Yes	Yes	No	Yes	No	No	No	No	Yes	No	No	
			Add: 40-WSS-C Drop: 40-DMX-C	Yes	Yes	Yes	Yes	No	No	No	No	Yes	No	No	

Table 4-1 Site Design Rules for MSTP 15454 ONS Configuration (continued)

Structure	Functionality	Type	Card Options	C-band 100 GHz				C-band 50 GHz				L-b and 100 GHz	Shelf Option ¹		
				32/16 Chs	8 Chs	40 Chs	20 Chs	64 Chs	72 Chs	80 Chs	32 Chs		M12	M6	M2
				Terminal	R-OADM	80-WXC-C	15216- MD-40-ODD (MD-ID-50) ³	Yes	No	Yes	Yes	Yes	Yes	Yes	No
			15216- MD-40- EVEN	No	No	No	No	Yes	Yes	Yes	No	Yes	Yes	No	
			FLD-4 Units	Yes	No	Yes	Yes	No	No	No	No	Yes	Yes	Yes	
			Add: 40-MUX-C Drop: 40-DMX-C	Yes	No	Yes	Yes	No	No	No	No	Yes	Yes	No	
			Add: 32-WSS-C Drop: 32-DMX-C	Yes	No	Yes	Yes	Yes	Yes	Yes	No	Yes	No	No	
			Add: 40-WSS-C Drop: 40-DMX-C	Yes	No	Yes	Yes	Yes	Yes	Yes	No	Yes	No	No	
			Add: 40-WSS-CE Drop: 40-DMX-CE (15216-ID-50)	No	No	No	No	Yes	Yes	Yes	No	Yes	No	No	
		80-WXC-C MUX/DMX	15216- MD-40-ODD	Yes	No	Yes	Yes	Yes	Yes	Yes	No	Yes	Yes	No	
			15216- MD-40- EVEN	No	No	No	No	Yes	Yes	Yes	No	Yes	Yes	No	
			FLD-4 Units	Yes	Yes	Yes	Yes	No	No	No	No	Yes	Yes	Yes	
			Add: 40-MUX-C Drop: 40-DMX-C	Yes	No	Yes	Yes	No	No	No	No	Yes	Yes	No	
			Add: 32-WSS-C Drop: 32-DMX-C	Yes	No	Yes	Yes	Yes	Yes	Yes	No	Yes	No	No	

Table 4-1 Site Design Rules for MSTP 15454 ONS Configuration (continued)

Structure	Functionality	Type	Card Options	C-band 100 GHz				C-band 50 GHz				L-b and 100 GHz	Shelf Option ¹		
				32/16 Chs	8 Chs	40 Chs	20 Chs	64 Chs	72 Chs	80 Chs	32 Chs		M12	M6	M2
Terminal	R-OADM	80-WXC-C MUX/DMX	Add: 40-WSS-C Drop: 40-DMX-C	Yes	No	Yes	Yes	Yes	Yes	Yes	No	Yes	No	No	
			Add: 40-WSS-CE Drop: 40-DMX-CE	No	No	No	No	Yes	Yes	Yes	No	Yes	No	No	
Terminal+ (includes MMU)	R-OADM	WSS	Add: 32-WSS-C Drop: 32DMX-O	Yes	No	Yes	Yes	No	No	No	No	Yes	No	No	
			Add: 32-WSS-C Drop: 32-DMX-C	Yes	No	Yes	Yes	No	No	No	Yes	Yes	No	No	
Multi- Degree	OXC ⁴	40 WXC-C/ PP- MESH-4 ⁵	Add: 32-WSS-C Drop: 32-DMX-C	Yes	No	Yes	Yes	No	No	No	No	Yes	No	No	
			Add: 40-MUX-C Drop: 40-DMX-C	Yes	No	Yes	Yes	No	No	No	No	Yes	Yes	No	
			Add: 40-WSS-C Drop: 40-DMX-C	Yes	No	Yes	Yes	No	No	No	No	Yes	No	No	
			Add: 80-WXC-C MUX Drop: 80-WXC-C DMX	Yes	No	Yes	Yes	No	No	No	No	Yes	No	No	

Table 4-1 Site Design Rules for MSTP 15454 ONS Configuration (continued)

Structure	Functionality	Type	Card Options	C-band 100 GHz				C-band 50 GHz			L-b and 100 GHz	Shelf Option ¹		
				32/16 Chs	8 Chs	40 Chs	20 Chs	64 Chs	72 Chs	80 Chs		32 Chs	M12	M6
				Multi-Degree	OXC ⁴	80-WXC-C/ PP-MESH-4 ⁵	15216- MD-40-ODD (MD-ID-50) ³	Yes	No	Yes	Yes	Yes	Yes	Yes
			15216- MD-40- EVEN	No	No	No	No	Yes	Yes	Yes	No	Yes	Yes	No
			FLD-4 Units	Yes	No	Yes	Yes	No	No	No	No	Yes	Yes	Yes
			Add: 40-MUX-C Drop: 40-DMX-C	Yes	No	Yes	Yes	No	No	No	No	Yes	Yes	No
			Add: 32-WSS-C Drop: 32-DMX-C	Yes	No	Yes	Yes	Yes	Yes	Yes	No	Yes	No	No
			Add: 40-WSS-C Drop: 40-DMX-C	Yes	No	Yes	Yes	Yes	Yes	Yes	No	Yes	No	No
			Add: 40-WSS-CE Drop: 40-DMX-CE (15216-ID-50)	No	No	No	No	Yes	Yes	Yes	No	Yes	No	No
			Add: 80-WXC-C MUX Drop: 80-WXC-C DMX	Yes	No	Yes	Yes	Yes	Yes	Yes	No	Yes	No	No

Table 4-1 Site Design Rules for MSTP 15454 ONS Configuration (continued)

Structure	Functionality	Type	Card Options	C-band 100 GHz				C-band 50 GHz				L-b and 100 GHz	Shelf Option ¹		
				32/16 Chs	8 Chs	40 Chs	20 Chs	64 Chs	72 Chs	80 Chs	32 Chs		M12	M6	M2
Multi-Degree	OXC ⁴	40 WXC/ PP- MESH-8 ⁵	Add: 32-WSS-C Drop: 32-DMX-C	Yes	No	Yes	Yes	No	No	No	No	Yes	No	No	
			Add: 40-MUX-C Drop: 40-DMX-C	Yes	No	Yes	Yes	No	No	No	No	Yes	Yes	No	
			Add: 40-WSS-C Drop: 40-DMX-C	Yes	No	Yes	Yes	No	No	No	No	Yes	No	No	
			Add: 80-WXC-C MUX Drop: 80-WXC-C DMX	Yes	No	Yes	Yes	No	No	No	No	Yes	No	No	
		80-WXC-C/ PP-MESH-8 ⁵	15216- MD-40-ODD (MD-ID-50) ³	Yes	No	Yes	Yes	Yes	Yes	Yes	No	Yes	Yes	No	
			15216- MD-40- EVEN	No	No	No	No	Yes	Yes	Yes	No	Yes	Yes	No	
			FLD-4 Units	Yes	No	Yes	Yes	No	No	No	No	Yes	Yes	Yes	
			Add: 40-MUX-C Drop: 40-DMX-C	Yes	No	Yes	Yes	No	No	No	No	Yes	Yes	No	
			Add: 32-WSS-C Drop: 32-DMX-C	Yes	No	Yes	Yes	Yes	Yes	Yes	No	Yes	No	No	

Table 4-1 Site Design Rules for MSTP 15454 ONS Configuration (continued)

Structure	Functionality	Type	Card Options	C-band 100 GHz				C-band 50 GHz			L-b and 100 GHz	Shelf Option ¹		
				32/16 Chs	8 Chs	40 Chs	20 Chs	64 Chs	72 Chs	80 Chs		32 Chs	M12	M6
				Multi-Degree	OXC ⁴	80-WXC-C/ PP-MESH-8 ⁵	Add: 40-WSS-C Drop: 40-DMX-C	Yes	No	Yes	Yes	Yes	Yes	Yes
			Add: 40-WSS-CE Drop: 40-DMX-CE (15216-ID-50)	No	No	No	No	Yes	Yes	Yes	No	Yes	No	No
			Add: 80-WXC-C MUX Drop: 80-WXC-C DMX	Yes	No	Yes	Yes	Yes	Yes	Yes	No	Yes	No	No
		40-SMR2-C/ PP-4-SMR	15216- MD-40-ODD	Yes	No	Yes	Yes	No	No	No	No	Yes	Yes	No
			FLD-4 Units	Yes	No	Yes	Yes	No	No	No	No	Yes	Yes	Yes
			Add: 40-MUX-C Drop: 40-DMX-C	Yes	No	Yes	Yes	No	No	No	No	Yes	Yes	No
			Add: 32-WSS-C Drop: 32-DMX-C	Yes	No	Yes	Yes	No	No	No	No	Yes	No	No
			Add: 40-WSS-C Drop: 40-DMX-C	Yes	No	Yes	Yes	No	No	No	No	Yes	No	No
			Add: 80-WXC-C MUX Drop: 80-WXC-C DMX	Yes	No	Yes	Yes	No	No	No	No	Yes	No	No
		Flexible ⁶	—	Yes	No	Yes	Yes	No	No	No	No	Yes	Yes	No

Table 4-1 Site Design Rules for MSTP 15454 ONS Configuration (continued)

Structure	Functionality	Type	Card Options	C-band 100 GHz				C-band 50 GHz				L-b and 100 GHz	Shelf Option ¹		
				32/16 Chs	8 Chs	40 Chs	20 Chs	64 Chs	72 Chs	80 Chs	32 Chs		M12	M6	M2
Multi-Degree	OIC	WSS	Add: 32-WSS-C Drop: 32-DMX-C	Yes	No	No	Yes	Yes	Yes	No	No	Yes	No	No	
			Add: 32-WSS-C Drop: 32-DMX-O	Yes	No	No	Yes	Yes	Yes	No	No	Yes	No	No	
			Add: 40-WSS-E Drop: 40-DMX-E	Yes	No	Yes	Yes	Yes	Yes	Yes	No	Yes	Yes	No	
			Add: 40-WSS-CE Drop: 40-DMX-CE	No	No	No	No	Yes	Yes	Yes	No	Yes	No	No	
		80-WXC-C MUX/DMX	15216- MD-40-ODD	Yes	No	Yes	Yes	Yes	Yes	Yes	No	Yes	Yes	No	
			15216- MD-40- EVEN	No	No	No	No	Yes	Yes	Yes	No	Yes	Yes	No	
			FLD-4 Units	Yes	No	Yes	Yes	No	No	No	No	Yes	Yes	Yes	
			Add: 40-MUX-C Drop: 40-DMX-C	Yes	No	Yes	Yes	No	No	No	No	Yes	Yes	No	
			Add: 32-WSS-C Drop: 32-DMX-C	Yes	No	Yes	Yes	Yes	Yes	Yes	No	Yes	No	No	
			Add: 40-WSS-C Drop: 40-DMX-C	Yes	No	Yes	Yes	Yes	Yes	Yes	No	Yes	No	No	
			Add: 40-WSS-CE Drop: 40-DMX-CE	No	No	No	No	Yes	Yes	Yes	No	Yes	No	No	

Table 4-1 Site Design Rules for MSTP 15454 ONS Configuration (continued)

Structure	Functionality	Type	Card Options	C-band 100 GHz				C-band 50 GHz				L-b and 100 GHz	Shelf Option ¹		
				32/16 Chs	8 Chs	40 Chs	20 Chs	64 Chs	72 Chs	80 Chs	32 Chs		M12	M6	M2
				PSM Terminal- Multiple Section Protection	Add/Drop	AD-xC	OADM cards	Yes	Yes	Yes	Yes	No	No	No	No
FLD-4 Units	Yes	Yes	Yes				Yes	No	No	No	No	Yes	Yes	Yes	
Mux/Demux	Add: 40-MUX-C	Yes	Yes			Yes	Yes	No	No	No	No	Yes	No	No	
	Drop: 40-DMX-C														
	15216- MD-40-ODD (MD-ID-50) ³	Yes	Yes			Yes	Yes	Yes	Yes	Yes	Yes	Yes	Yes	Yes	
15216- MD-40- EVEN	No	No	No		No	Yes	Yes	Yes	Yes	Yes	Yes	Yes			
ROADM	WSS	Add: 32-WSS-C	Yes		Yes	No	Yes	Yes	Yes	No	No	Yes	No	No	
		Drop: 32-DMX-C													
		Add: 40-WSS-C	Yes		Yes	Yes	Yes	Yes	Yes	Yes	No	Yes	No	No	
		Drop: 40-DMX-C													
	Add: 40-WSS-CE	No	No		No	No	Yes	Yes	Yes	No	Yes	No	No		
	Drop: 40-DMX-CE														
	80-WXC-C	15216- MD-40-ODD (MD-ID-50) ³	Yes		No	Yes	Yes	Yes	Yes	Yes	No	Yes	Yes	No	
		15216- MD-40- EVEN	No	No	No	No	Yes	Yes	Yes	No	Yes	Yes	No		
FLD-4 Units		Yes	No	Yes	Yes	No	No	No	No	Yes	Yes	Yes			
Add: 32-WSS-C Drop: 32-DMX-C		Yes	No	Yes	Yes	Yes	Yes	Yes	No	Yes	No	No			

Table 4-1 Site Design Rules for MSTP 15454 ONS Configuration (continued)

Structure	Functionality	Type	Card Options	C-band 100 GHz				C-band 50 GHz				L-b and 100 GHz	Shelf Option ¹		
				32/16 Chs	8 Chs	40 Chs	20 Chs	64 Chs	72 Chs	80 Chs	32 Chs		M12	M6	M2
PSM Terminal-Optical Path Protection	ROADM	80-WXC-C	Add: 40-WSS-C Drop: 40-DMX-C	Yes	No	Yes	Yes	Yes	Yes	Yes	No	Yes	No	No	
			Add: 40-WSS-CE Drop: 40-DMX-CE (15216-ID-50)	No	No	No	No	Yes	Yes	Yes	No	Yes	No	No	
	80-WXC-C MUX/DMX	15216-MD-40-ODD	Yes	No	Yes	Yes	Yes	Yes	Yes	No	Yes	No	No		
		15216-MD-40-EVEN	No	No	No	No	Yes	Yes	Yes	No	Yes	No	No		
		FLD-4 Units	Yes	No	Yes	Yes	No	No	No	No	Yes	Yes	Yes		
		Add: 40-MUX-C Drop: 40-DMX-C	Yes	No	Yes	Yes	No	No	No	No	Yes	Yes	No		
		Add: 32-WSS-C Drop: 32-DMX-C	Yes	No	Yes	Yes	Yes	Yes	Yes	No	Yes	No	No		
		Add: 40-WSS-C Drop: 40-DMX-C	Yes	No	Yes	Yes	Yes	Yes	Yes	No	Yes	No	No		
		Add: 40-WSS-CE Drop: 40-DMX-CE (15216-ID-50)	No	No	No	No	Yes	Yes	Yes	No	Yes	No	No		

Table 4-1 Site Design Rules for MSTP 15454 ONS Configuration (continued)

Structure	Functionality	Type	Card Options	C-band 100 GHz				C-band 50 GHz				L-b and 100 GHz	Shelf Option ¹		
				32/16 Chs	8 Chs	40 Chs	20 Chs	64 Chs	72 Chs	80 Chs	32 Chs		M12	M6	M2
				PSM Terminal- Optical Path Protection	Add/Drop	AD-xC	OADM cards	Yes	Yes	Yes	Yes	No	No	No	No
FLD-4 Units	Yes	Yes	Yes				Yes	No	No	No	No	Yes	Yes	Yes	
Mux/Demux	Add: 40-MUX-C	Yes	Yes			Yes	Yes	No	No	No	No	Yes	Yes	No	
	Drop: 40-DMX-C														
	15216- MD-40-ODD (MD-ID-50) ³	Yes	Yes			Yes	Yes	Yes	Yes	Yes	Yes	Yes	Yes	Yes	
15216- MD-40- EVEN	No	No	No		No	Yes	Yes	Yes	Yes	Yes	Yes	Yes			
ROADM	WSS	Add: 32-WSS-C Drop: 32-DMX-C			Yes	Yes	No	Yes	Yes	Yes	No	No	Yes	No	No
			Add: 40-WSS-C Drop: 40-DMX-C		Yes	Yes	Yes	Yes	Yes	Yes	Yes	No	Yes	No	No
		Add: 40-WSS-CE Drop: 40-DMX-CE	No		No	No	Yes	Yes	Yes	Yes	No	Yes	No	No	
		40-SMR1-C	15216- MD-40-ODD		Yes	No	Yes	Yes	No	No	No	No	Yes	Yes	Yes
			FLD-4 Units	Yes	No	Yes	Yes	No	No	No	No	Yes	Yes	Yes	
			Add: 32-WSS-C Drop: 32-DMX-C	Yes	No	No	Yes	No	No	No	No	Yes	No	No	
	Add: 40-MUX-C Drop: 40-DMX-C		Yes	No	Yes	Yes	No	No	No	No	Yes	Yes	No		
	Add: 40-WSS-C Drop: 40-DMX-C	Yes	No	Yes	Yes	No	No	No	No	Yes	No	No			

Table 4-1 Site Design Rules for MSTP 15454 ONS Configuration (continued)

Structure	Functionality	Type	Card Options	C-band 100 GHz				C-band 50 GHz				L-b and 100 GHz	Shelf Option ¹		
				32/16 Chs	8 Chs	40 Chs	20 Chs	64 Chs	72 Chs	80 Chs	32 Chs		M12	M6	M2
PSM Terminal-Optical Path Protection	ROADM	40-SMR2-C	15216-MD-40-ODD	Yes	No	Yes	Yes	No	No	No	No	Yes	Yes	Yes	
			FLD-4 Units	Yes	No	Yes	Yes	No	No	No	No	Yes	Yes	Yes	
			Add: 32-WSS-C Drop: 32-DMX-C	Yes	No	No	Yes	No	No	No	No	Yes	No	No	
			Add: 40-MUX-C Drop: 40-DMX-C	Yes	No	Yes	Yes	No	No	No	No	Yes	Yes	No	
			Add: 40-WSS-C Drop: 40-DMX-C	Yes	No	Yes	Yes	No	No	No	No	Yes	No	No	
			80-WXC-C	15216-MD-40-ODD (MD-ID-50) ³	Yes	No	Yes	Yes	Yes	Yes	Yes	No	Yes	Yes	No
		15216-MD-40-EVEN	No	No	No	No	Yes	Yes	Yes	No	Yes	Yes	No		
		FLD-4 Units	Yes	No	Yes	Yes	No	No	No	No	Yes	Yes	Yes		
		Add: 32-WSS-C Drop: 32-DMX-C	Yes	No	Yes	Yes	Yes	Yes	Yes	No	Yes	No	No		
		Add: 40-WSS-C Drop: 40-DMX-C	Yes	No	Yes	Yes	Yes	Yes	Yes	No	Yes	No	No		
		Add: 40-WSS-CE Drop: 40-DMX-CE (15216-ID-50)	No	No	No	No	Yes	Yes	Yes	No	Yes	No	No		

Table 4-1 Site Design Rules for MSTP 15454 ONS Configuration (continued)

Structure	Functionality	Type	Card Options	C-band 100 GHz			C-band 50 GHz			L-b and 100 GHz	Shelf Option ¹			
				32/16 Chs	8 Chs	40 Chs	20 Chs	64 Chs	72 Chs		80 Chs	32 Chs	M12	M6
				PSM Terminal-Optical Path Protection	ROADM	80-WXC-C MUX/DMX	15216-MD-40-ODD	Yes	No	Yes	Yes	Yes	Yes	Yes
15216-MD-40-EVEN	No	No	No				No	Yes	Yes	Yes	No	Yes	No	No
FLD-4 Units	Yes	No	Yes				Yes	No	No	No	No	Yes	Yes	Yes
Add: 40-MUX-C Drop: 40-DMX-C	Yes	No	Yes				Yes	No	No	No	No	Yes	Yes	No
Add: 32-WSS-C Drop: 32-DMX-C	Yes	No	Yes				Yes	Yes	Yes	Yes	No	Yes	No	No
Add: 40-WSS-C Drop: 40-DMX-C	Yes	No	Yes				Yes	Yes	Yes	Yes	No	Yes	No	No
Add: 40-WSS-CE Drop: 40-DMX-CE (15216-ID-50)	No	No	No				No	Yes	Yes	Yes	No	Yes	No	No

1. “Yes” indicates that the configuration is supported in the specific shelf and CTP selects the most convenient layout according to the number of units and user settings. “No” indicates that the configuration is not supported on the specific shelf.
2. Available only if explicitly configured by the user.
3. The 15216-MD-ID-50 unit is placed by default in the 15216-MD-40-ODD unit. However, it can also be placed in the 15216-MD-40-EVEN unit if the design starts from the even grid.
4. One or multiple sides can be selected as omnidirectional entry points.
5. One or multiple sides can be selected as omnidirectional or colorless side or both.
6. When the Flexible type is selected, the 40-WXC-C or 80-WXC-C card can be set on different sides.

Table 4-2 Site Design Rules for HYBRID 15454 ONS Configuration (with FlexLayer Modules)

Structure	Functionality	Type	Card Options	C-band 100 GHz				Shelf Option ¹		
				32/16 Chs	8 Chs	40 Chs	20 Chs	M12	M6	M2
Line	Pass Through	N/A	N/A	Yes	Yes	Yes	Yes	Yes	Yes	Yes
	OLA	Line amplifier	FLA and FLB modules	Yes	Yes	Yes	Yes	Yes	Yes	Yes
		Glass Through	N/A	Yes	Yes	Yes	Yes	Yes	Yes	Yes
	OSC-Site	N/A	N/A	Yes	Yes	Yes	Yes	Yes	Yes	Yes
	Add/Drop	OADM	FLA, FLB, and FLD-4 ² modules	Yes	Yes	Yes	Yes	Yes	Yes	Yes
		Mux/Demux	SC-4B + FLA-8	Yes	No	No	Yes	Yes	Yes	Yes
			MD-40-ODD	Yes	No	Yes	Yes	Yes	Yes	Yes
	Hub	OADM	FLA, FLB, and FLD-4 ² modules	Yes	Yes	Yes	Yes	Yes	Yes	Yes
		Mux/Demux	SC-4B + FLA-8	Yes	No	No	Yes	Yes	Yes	Yes
MD-40-ODD			Yes	No	Yes	Yes	Yes	Yes	Yes	
Terminal	Add/Drop	OADM	FLA and FLB modules	Yes	Yes	Yes	Yes	Yes	Yes	Yes
		Mux/Demux	SC-4B + FLA-8	Yes	No	No	Yes	Yes	Yes	Yes
			MD-40-ODD	Yes	No	Yes	Yes	Yes	Yes	Yes

1. “Yes” indicates that the configuration is supported in the specific shelf and CTP selects the most convenient layout according to the number of units and user settings. “No” indicates that the configuration is not supported on the specific shelf.

2. FLA and FLB modules cannot be forced in a site with FLD-4 modules.

- Power Supply—(Release 9.2 and later releases) Allows you to choose the type of power supply. The options available are Auto, AC Power, and DC Power. The default option is Auto.
- Filler Card Type—Choose the type of card to be placed in the empty slots of a chassis. The options are:
 - Blank—CTP enables placement of only blank cards.
 - UTS Filler—CTP enables placement of blank cards in M12 chassis and Universal Transport System (UTS) filler cards in the M2 and M6 chassis. The two type of UTS filler cards placed by CTP are 15454-M-T-FILLER (in TNC and TSC card slots) and 15454-M-FILLER (in other slots).
- Populate Shelves From Bottom—Check this check box to instruct Cisco Transport Planner to place the shelves in the rack from the bottom. This is useful in installing shelves in tall racks. For more information about the order in which CTP fills the rack, see the “4.16.1 General Placement Rules” section on page 4-65.
- Redundant Power—(Release 9.2 and later releases, M6 chassis only) Enables you to choose the redundant power supply to be added. The options available are Auto, Yes, and No. The Default option is Yes.

- UTS AC Power Cables—(Release 9.2 and later releases) Enables you to choose the type of cables to be added for the AC power supply. The cables are listed based on the country type. The default option is EU.
- Redundant Controller Card—(Release 9.2 and later releases, M6 chassis only) Enables you to choose the redundant controller card. The options available are Auto, Yes, and No. The default option is Yes.



Note M6 chassis without a redundant controller card is not supported in the MSM configuration.

- M6 Shelves—(Release 9.2 and later releases) Enter an integer value for the number of empty shelves to be added to the node layout. CTP supports a maximum of 29 extra M6 shelves. The Auto option does not add any shelves.
- M12 Shelves—(Release 9.2 and later releases) Enter an integer value for the number of empty shelves to be added to the node layout. CTP supports a maximum of 29 extra M12 shelves. The Auto option does not add any shelves.
- Node Controller—Enables you to choose a chassis as a node controller. The options available are Auto, M12 Chassis, and M6 Chassis. The default option is Auto.
- TCC Type (Release 9.4)—Choose the type of TCC card, from the drop-down list. The options available are Auto, TCC2P, and TCC3. The default option is Auto, which selects the TCC3 card.



Note The M12 chassis with TCC2P cards, when used as the node controller cannot subtend M6 chassis.

- Functionality—Displays the site functionality. To edit this field, double-click the site in the network view. The Edit dialog box appears. Choose the site functionality from the drop-down list. [Table 4-1](#) and [Table 4-2](#) summarizes the site design rules. The site icon changes depending on the functionality. For a description of the site icons, see [Appendix A, “GUI Information and Shortcuts.”](#)



Note You can choose only the following options for the functionality parameter of intermediate sites (on both the working and protected sides) in a PSM Line or PSM Section network topology:
PSM Section: Pass Through or Line amplifier
PSM Line: Pass Through

- Auto—Allows the highest degree of flexibility in creating the network. Cisco Transport Planner generates a design for the site with the lowest possible cost given the other constraints.
- Pass Through—Indicates that no equipment will be located at this site.
- Line amplifier—Prevents any add/drop traffic at this site.
- OSC site—Indicates that site is designated for network communication, providing the possibility to access the OSC for management of the MSTP network. By default, no amplifiers are included in this site. However, if Cisco Transport Planner determines that an amplifier is required in the network, it can automatically place it at this location. Cisco Transport Planner allows you to set (force) preamplifier and booster amplifiers for each direction on a OSC site node.
- Add/Drop—Indicates that this site has add/drop capability. Only point-to-point and P-ring circuits can be added/dropped at this site.

- Hub—Indicates that this site is equipped with filters for adding and dropping all the channels (on both West and East sides). All express paths are open in hub configurations.



Note In HYBRID 15454 ONS configuration at least one node must be of the HUB functionality for the ring topology.

- Gain equalizer—Indicates that this site uses WSS cards to control the generated tilt and extend unregenerated distances. The site is realized as an ROADM site without demultiplexer cards.
- R-OADM—Indicates that this site supports Any-to-Any and also Fixed (point-to-point and P-ring) traffic types.
- OXC—Indicates that this site uses OXC (optical cross connect) cards to control the generated tilt and extend unregenerated distances. This site is realized as an ROADM site without demultiplexer cards.
- OIC—Indicates that this site uses OIC (optical inter connect) cards to control the generated tilt and extend unregenerated distances. This site is realized as an ROADM site without demultiplexer cards.



Note This functionality is available only for multidegree sites. Also, if you choose the structure of a site as multidegree and functionality as OXC, the Shelf Management option that you select should either be Integrated or External. Otherwise, the application displays an error message when analyzed.

- Type—Displays the site type. To edit this field, double-click the site in the network view. The Edit dialog box appears. Choose the site type from the drop-down list (see [Table 4-1](#)):
 - Auto—Allows the highest degree of flexibility in creating the network. Cisco Transport Planner generates a design for the site with the lowest possible cost given the other set of constraints.
 - Glass Through—Indicates a low-priority amplification site.
 - Line—Indicates a high-priority amplification site.
 - OADM—Indicates that it is a site with add/drop channels using discrete channel filters.
The OADM units available for the MSTP 15454 ONS configuration are 1Ch, 2Ch, 4Ch, 1-band, 4-band, and FLD-4.
The OADM units available for the Hybrid 15454 ONS configuration are FLB-2, FLA-8, and FLD-4.



Note

- Avoid using all FLA-2 or FLA-8 units because it can lead to a total loss of signal in the system. If there is an overlap of selected wavelengths between FLA-2 and FLA-8 units, CTP displays an error message. If you use more than six 6 FLA 2 units, then the insertion loss is about 18 dB.
- FLA-8 and FLB-2 modules cannot be forced in a site having FLD-4 modules.
- OADM units cannot be forced along with the FLD-4 units in MSTP 15454 ONS configuration.

- WSS—Indicates that it is a site equipped with 32DMX or 32DMX-O. This option allows you to force the use of specific ROADM units.

- Mux/Demux—Indicates that this is a full multiplexer/demultiplexer (FMD) site that adds and drops all channels on both sides using the 32MUX-O and 32DMX-O cards. Optical bypass is allowed.
 - 80-WXC-C—Indicates that the site supports mesh and multi-ring topologies for 50 GHz networks.
 - 80-WXC-C Mux/Dmx—Indicates that this is a full multiplexer/demultiplexer (FMD) site that adds and drops all channels on both sides using the 80-WXC-C card in mux/demux mode.
 - 40-WXC-C w/PP-MESH-4—(Multidegree OXC sites only) Indicates the mesh type that is provided for sites with 80-WXC-C cards. If this type is selected, the site can support up to 4 degrees, independent of the number of fibers connected to the site.
 - 40-WXC-C w/PP-MESH-8—(Multidegree OXC sites only) Indicates the mesh type that is provided for sites with 80-WXC-C cards units. If this type is selected, the site can support up to 8 degrees, independent of the number of fibers connected to the site
 - 80-WXC-C w/PP-MESH-4—(Multidegree OXC sites only) Indicates the mesh type that is provided for sites with 80-WXC-C cards. A site with this type can support up to 4 degrees, independent of the number of fibers connected to the site.
 - 80-WXC-C w/PP-MESH-8—(Multidegree OXC sites only) Indicates the mesh type that is provided for sites with 80-WXC-C cards. A site with this type can support up to 8 degrees, independent of the number of fibers connected to the site.
 - WSS/DMX—Multidegree OIC sites only.
 - Flexible—Indicates that the site can support different equipment on each side. Valid for multi-degree OXC sites equipping 40-WXC-C or 80-WXC-C units at the different sides.
 - SMR-1—Single module ROADM-1 for line and terminal sites. It integrates preamplifier, OSC splitter/combiner, and a 2x1 wavelength cross connect. SMR-1 will be the default configuration for design rules with 40, 32, 20, 16 channels and for Line ROADM, Line Hub, and Terminal ROADM sites. SMR-1 configuration is selected only if the forced amplifier is compatible with it. For the same design rule, if SMR-1 is restricted, then SMR-2 will be the default configuration.
 - SMR-2—Single module ROADM-2 for line, terminal, and multidegree sites. It integrates preamplifier, booster, OSC splitter/combiner, and a 4x1 wavelength cross-connect. SMR-2 will be the default configuration for multidegree sites with less than 5 sides. SMR-2 uses a new 15454 PP-4-SMR Patch Panel that is different from the one that the earlier WXC card used. SMR-2 is not selected for multidegree sites with omnidirectional entry point.
- For both the SMR cards:**
- Cisco ONS 15216-MD-40-ODD units are automatically picked up as add/drop units for the SMR configuration. You can also force other mux/demux units like 32-WSS/32-DMX, or 40-WSS/40-DMX, or 40-MUX/40-DMX. To force these units, you should select the required site type and functionality.
 - You can place the SMR units in the Restricted Equipment list.
 - If 15216-MD-40-ODD is restricted, SMR with 40 mux/demux configuration will be the default site type.
- Anti ASE—Choose **Yes** to configure the site so that all the express channels on the site are optically dropped and reinserted. In addition, all the patch cords between the West and East sections are removed. Choose **Auto** to allow Cisco Transport Planner to decide if the site should be configured as anti-amplified spontaneous emissions (anti-ASE). See [Table 4-1](#) and [Table 4-2](#) for a summary of the site design rules. Anti-ASE is disabled for HYBRID 15454 ONS configuration.

Step 4 Click any side under a site to check the Omnidir Entry Point option. Check this option to mark the side as omnidirectional. This option is available only for multi-degree sides using OXC functionality and equipped with 40-SMR2-C or 40-WXC-C. Traffic cannot be added or dropped at the marked side and OSC units are not allowed. A side with Omnidir Entry Point option enabled can be connected only to a terminal site. Traffic from the terminal site is directed towards a side not having the omnidirectional property. You cannot create a service demand between the terminal site connected to the OXC through the omnidirectional side. Traffic directed to the OXC site is terminated on the sides without the omnidirectional property.

Step 5 To modify amplifier parameters, click **C-Band Amplifiers** or **L-Band Amplifiers** in the Project Explorer pane for the desired site interface. Choosing a value other than Auto will force a setting on the unit. For more information, see the “[1.1.6 Auto, Forced, and Locked Parameters](#)” section on page 1-17.

a. In From Fiber area of the Properties pane, complete the following as needed:

- PRE—Choose the preamplifier from the drop-down list (**Auto**, **None**, **OPT-EDFA-17** [C-band], **OPT-EDFA-24** [C-band], **OPT-AMP-C** [C-band], **OPT-AMP-17** [C-band], **OPT-BSTE** [C-band] **OPT-PRE** [C-band], **OPT-BST** [C-band], or **OPT-AMP-L** [L-band]).



Note The OPT-EDFA-17 and OPT-EDFA-24 amplifiers do not support DCU modules.



Note The OPT-AMP-C and OPT-PRE amplifiers support FDCU modules.



Note If Raman amplification is enabled, the amplifier in the From Fiber area can be OPT-EDFA-17, OPT-EDFA-24, OPT-AMP-C, OPT-AMP-17, OPT-BST, or OPT-BST-E.

- DCU 1/2—Choose the DCU from the drop-down lists.
- Output power—Enter the output power.
- Tilt—Enter the desired tilt value.
- TDCU—Choose the TDCU type from the **TDCU units forcing** dialog box. You can force any of the following TDCU types:
 - Auto—CTP automatically places the fixed DCU units in the network.
 - AUTO-Fixed—CTP automatically places the fixed DCU units.
 - AUTO-TDCU—CTP automatically places the TDCU units
 - T-DCU Fine— Choose the TDCU Type as T-DCU Fine and the compensation value from the Compensation drop-down list. CTP places the T-DCU Fine unit in the network. If you choose the compensation value as Auto, CTP chooses the optimum compensation value.
 - T-DCU Coarse—Choose the TDCU Type as T-DCU Coarse and the compensation value from the Compensation drop-down list. CTP places the T-DCU Coarse unit in the network. If you choose the compensation value as Auto, CTP chooses the optimum compensation value.



Note Forcing the TDCU at the site-level overrides the design rules that is set at the network-level. The TDCU type that is set at the site-level overrides the placement rules set at the network-level, except for the **Auto** option. The **Auto** option places the TDCU based on the value that is set at the network-level.

**Note**

The TDCU units forcing dialog box can be launched from the TDCU Forcing Property when you select **C-Band Amplifiers** in the Project Explorer pane.

**Note**

You can edit the TDCU unit only when DCU 1 and DCU 2 is set to Auto, and you can edit DCU 1 and DCU 2 only when the TDCU unit is set to Auto.

- FDCU—Choose the FDCU unit from the drop-down list. The options are Auto, None, 15216-FBGDCU-165, 15216-FBGDCU-331, 15216-FBGDCU-496, 15216-FBGDCU-661, 15216-FBGDCU-826, 15216-FBGDCU-992, 15216-FBGDCU-1157, 15216-FBGDCU-1322, 15216-FBGDCU-1653, 15216-FBGDCU-1983. The Auto option places a FDCU unit only if the value of the FDCU field is set to “Always” at the network level.

**Note**

The FDCU field is enabled only if the amplifier selected in the Pre field is OPT-AMP-C or OPT-PRE, in the From fiber area.

- Attenuator In—Choose from the drop-down list the attenuator to be placed before the preamplifier position.
- Attenuator Out—Choose from the drop-down list the attenuator to be placed after the preamplifier position.

While analyzing a network created in a CTP version earlier than Release 9.2.1, the Attenuator Out property inherits the value assigned to the Attenuator property in the Line/OADM area of the Add/Drop properties. Also, the lock applied to the Attenuator property is retained on the Attenuator Out property. The Attenuator property in the Line/OADM area of the Add/Drop properties is not available in CTP Release 9.4.

**Note**

The Attenuator In and Attenuator Out drop-down lists are enabled only when a preamplifier is selected in the PRE drop-down list in the From Fiber area.

b. In the To Fiber area of the Properties pane, complete the following tasks as needed:

- BST—Choose the desired booster from the drop-down list (**Auto**, **None**, **OPT-EDFA-17** [C-band], **OPT-EDFA-24** [C-band], **OPT-AMP-C** [C-band], **OPT-AMP-17** [C-band], **OPT-BSTE** [C-band] **OPT-PRE** [C-band], **OPT-BST** [C-band], **OPT-AMP-L** [L-band], or **OPT-BST-L** [L-band]).

**Note**

The OPT-EDFA-17 and OPT-EDFA-24 amplifiers do not support DCU modules.

**Note**

If Raman amplification is enabled, the amplifier in the To Fiber area can be OPT-EDFA-17, OPT-EDFA-24, OPT-AMP-C, OPT-BST, or OPT-BST-E.

- DCU 1/2—Choose the DCUs from the drop-down lists.
- Output power—Enter the output power.
- Tilt—Enter the tilt value.

- TDCU—Select the TDCU Type from the **TDCU units forcing** dialog box. You can force any of the following TDCU types:
 - Auto—CTP automatically places the fixed DCU units in the network.
 - AUTO-Fixed—CTP automatically places the fixed DCU units.
 - AUTO-TDCU—CTP automatically places the TDCU units.
 - T-DCU Fine— Select the TDCU Type as T-DCU Fine and choose the compensation value from the Compensation drop-down list. The CTP places the T-DCU Fine unit in the network. If you select the compensation value as Auto, CTP chooses the optimum compensation value.
 - T-DCU Coarse—Select the TDCU Type as T-DCU Coarse and choose the compensation value from the Compensation drop-down list. The CTP places the T-DCU Coarse unit in the network. If you select the compensation value as Auto, CTP chooses the optimum compensation value.

**Note**

Forcing the TDCU at the site-level overrides the design rules that is set at the network level. The TDCU type that is set at the site-level overrides the placement rules set at the network level, except for the **Auto** option. The **Auto** option places the TDCU based on the value that is set at the network-level.

**Note**

You can edit the TDCU unit only when DCU1 and DCU2 is set to Auto, and you can edit DCU1 and DCU2 only when the TDCU unit is set to Auto.

- FDCU—Choose the FDCU unit from the drop-down list. The options are Auto, None, 15216-FBGDCU-165, 15216-FBGDCU-331, 15216-FBGDCU-496, 15216-FBGDCU-661, 15216-FBGDCU-826, 15216-FBGDCU-992, 15216-FBGDCU-1157, 15216-FBGDCU-1322, 15216-FBGDCU-1653, 15216-FBGDCU-1983. The Auto option places a FDCU unit only if the value of the FDCU field is set to “Always” at the network level.

**Note**

This field is enabled only if the amplifier selected in the Bst field is OPT-AMP-C in the To Fiber area.

- Attenuator In—Choose from the drop-down list the attenuator to be placed before the post amplifier position.
- Attenuator Out—Choose from the drop-down list the attenuator to be placed after the post amplifier position.

**Note**

The Attenuator In and Attenuator Out properties are enabled only when a booster is selected in the BST drop-down list in the To Fiber area.

- c. In the Properties pane, General area, choose the OSC from the drop-down list (**OSC-CSM** or **OSCM**).
- d. In the Properties pane, Raman Amplification area, complete the following tasks as needed:

**Note**

Options in the Raman Amplification area are enabled for a side only if the fiber span connected to it is Raman amplified. For information about enabling Raman amplification on a fiber span, see the [“4.14 Editing Fiber Span, Pair, and Fiber Parameters”](#) section on page 4-58.

- RAMAN—Choose the Raman amplifier from the drop-down list. The options available are Auto, RAMAN-CTP, RAMAN-CTP-COP, OPT-RAMP-CE, or OPT-RAMP-C.

These rules are applicable to RAMAN-CTP and RAMAN-COP configurations:

- On selecting the RAMAN-CTP option, CTP places the 15454-M-RAMAN-CTP unit.
- On selecting the RAMAN-COP-CTP option, CTP places both the 15454-M-RAMAN-CTP and 15454-M-RAMAN-COP units. The 15454-M-RAMAN-COP unit cannot be placed as standalone.
- The 15454-M-RAMAN-CTP and 15454-M-RAMAN-COP units are placed only in M2 or M6 chassis and cannot be used without post-amplifiers.
- The DCN extension has to be enabled on the Raman amplified span.
- On selecting the RAMAN-CTP or RAMAN-CTP-COP option, the DCU1, DCU2, and TDCU parameters in the Raman Amplification area are disabled.
- The Raman amplified span must have the same configuration at both ends, that is, either RAMAN-CTP or RAMAN-COP-CTP.
- If the node on which RAMAN-CTP or RAMAN-CTP-COP has been configured is not a terminal or hub, then it should have the gain equalization capability. Therefore, such a node must be equipped with either 40-SMR1-C, 40-SMR2-C, 40-WXC-C, 80-WXC-C, 32MUX-O, 32DMX-0, or any WSS unit.
- The RAMAN-CTP link can traverse up to two consecutive Raman amplified spans; whereas, the RAMAN-CTP-COP link can traverse only one Raman amplified span. However, the Raman amplified span can have intermediate pass-through nodes.
- The traffic traversing the RAMAN-CTP-COP configured span must be dropped at the sides where the Raman amplified span terminates.
- If the RAMAN-CTP option is selected in the Restricted Equipment list, the RAMAN-COP option is selected implicitly.

**Note**

A Raman amplifier must not be placed on a pass-through site. For example, in [Figure 4-5](#), Site 1 is a pass-through site. The algorithm treats the span between Site 3 and Site 1 and the span between Site 1 and Site 2 as one span, and places the Raman amplifier on the external sites (Site 2 and Site 3) on the ends of the span.

Figure 4-5 Sites with Raman Amplifier

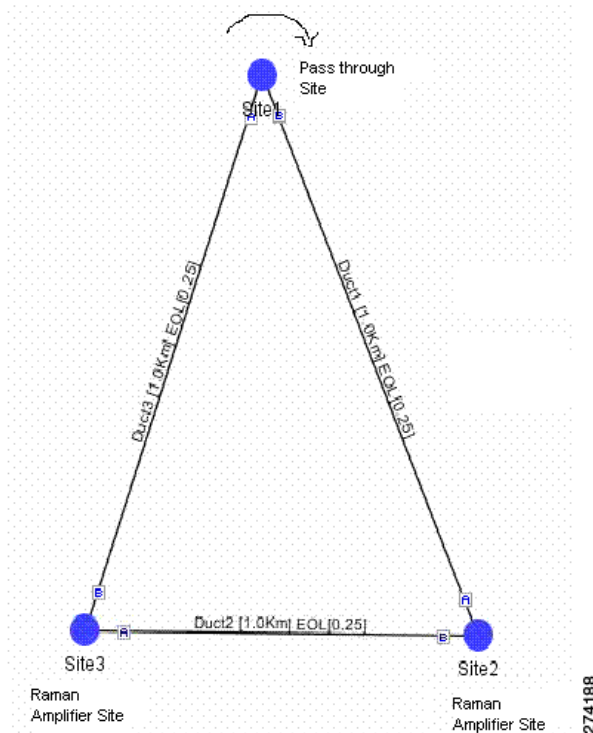

- DCU1—Choose the DCU from the drop-down list.
- DCU2—Choose the DCU from the drop-down list.
- Gain—Enter the gain value.
- Tilt—Enter the tilt value.
- TDCU—Select the TDCU Type from the **TDCU units forcing** dialog box. You can force any of the following TDCU types:
 - Auto—CTP automatically places the fixed DCU units in the network.
 - AUTO-Fixed—CTP automatically places the fixed DCU units.
 - AUTO-TDCU—CTP automatically places the TDCU units
 - T-DCU Fine— Select the TDCU Type as T-DCU Fine and choose the compensation value from the Compensation drop-down list. The CTP places the T-DCU Fine unit in the network. If you select the compensation value as Auto, CTP chooses the optimum compensation value.
 - T-DCU Coarse—Select the TDCU Type as T-DCU Coarse and choose the compensation value from the Compensation drop-down list. The CTP places the T-DCU Coarse unit in the network. If you select the compensation value as Auto, CTP chooses the optimum compensation value.

**Note**

Forcing the TDCU at the site-level overrides the design rules that is set at the network-level. The TDCU type that is set at the site-level overrides the placement rules set at the network-level, except for the **Auto** option. The **Auto** option places the TDCU based on the value that is set at the network-level.



Note You can edit the TDCU unit only when the Raman Amplified option is selected in the fiber couple.



Note You can edit the TDCU unit only when DCU1 and DCU2 is set to Auto, and you can edit DCU1 and DCU2 only when the TDCU unit is set to Auto.

- FDCU—Choose the FDCU unit from the drop-down list. The options are Auto, None, 15216-FBGDCU-165, 15216-FBGDCU-331, 15216-FBGDCU-496, 15216-FBGDCU-661, 15216-FBGDCU-826, 15216-FBGDCU-992, 15216-FBGDCU-1157, 15216-FBGDCU-1322, 15216-FBGDCU-1653, 15216-FBGDCU-1983. The Auto option places a FDCU unit only if the value of the FDCU field is set to “Always” at the network level.



Note The OPT-RAMP-C and OPT-RAMP-CE cards support FDCU units.

- No post-amplifier—Check this check box to configure the Raman amplifier without having a post amplifier on the other side of the site. This configuration is useful in networks with special fibers where the power of channels entering the fiber is very low.

The No post-amplifier check box is enabled only when the site structure is set to Line with the functionality as Line Amplifier and the type as Line.

When the No post-amplifier check box is checked, the DCU1, DCU2, and TDCU parameters in the Raman Amplification area are disabled.

- In fiber output power—Specify the value of the maximum power allowed to enter the fiber at the other side of the node.

You can edit the In fiber output power only when the No post-amplifier check box is checked.



Note In the Upgrade or Install mode, the No post-amplifier and the In fiber output properties are enabled only when the amplifier node is unlocked. For more information about unlocking site parameters, see the [“2.10.5 Unlocking Parameters in the Network Design” section on page 2-55](#).

Step 6 To add Alien Shelves to the network, choose the required site from the project explorer.

In the properties pane, complete the following:

- Alien Shelf Name—Enter the name of the alien shelves to be added to the site. This name is displayed in the layout reports.
- Number of Alien Shelves—Enter the number of alien shelves to be added to the site.

Number of alien shelves can vary based on the alien shelf height. The maximum number of alien shelves that can be added is 645, if the alien shelf height is 1RU (rack height being 44 rack units) and there are no other shelves in the layout.

The maximum number of racks supported for a site is 15. If the addition of alien shelves require more than 15 racks, an error message is displayed in the summary report and the layout is not built for the site.

- Alien Shelf Height—Enter the height of the alien shelves in rack units (RU). If the alien shelf height is greater than the rack height, alien shelves are not added to the site. An error message is displayed for the same in the summary report.

Alien shelves are displayed only in the Layout report and are not listed in any other report. Alien shelves are not be added to the BoM.

Step 7 To modify patch panel settings, in the Project Explorer pane, click Add/Drop for the site interface. In the Properties pane, choose the desired values.



Note For SMR, if the patch panel forced is different from SMR PP MESH 4, then WSS is the site type instead of SMR.

Step 8 To modify OADM parameters, click Add/Drop in the Project Explorer pane for the desired site interface. In the Properties pane, complete the following tasks as needed:

- OADM Forcing—Choose OADM or FLD units from the drop-down list.



Note The FLD-4 units must be equipped as local add/drop units connected to the cross-connect card (SMR/WXC card) when they are forced on non-OADM site types.

- In the Odd Grid Units and Even Grid Units areas, complete the following tasks as needed:
 - Patch Panel—Choose the patch panel from this drop-down list.
 - Demux—Choose the demultiplexer from this drop-down list.
 - Mux—Choose the multiplexer from this drop-down list.

If you select the 15216-MD-40-ODD or 15216-MD-40-EVEN unit as the multiplexer, the demultiplexer is automatically forced to 15216-MD-40-ODD or 15216-MD-40-EVEN unit respectively, and vice-versa. The patch panel settings become uneditable if you choose the 15216-MD-40-ODD or 15216-MD-40-EVEN unit as the mux/demux.



Note In a HYBRID 15454 ONS network when FLA-8 is selected as Mux, then the Demux is automatically selected.

4.4 Editing Side Labels

By default, CTP alphabetically names the sides with labels A through H. You can rename the sides as per requirement with any alphabet between A through H. Swapping of side labels is also possible. Use this procedure to edit side labels.

Note

In this guide, all references are to the default side labels A and B.

Note

Sides of a PSM Terminal site and the sides having remote add/drop ports cannot be renamed.

- Step 1** In the Project Explorer, right-click the side label and choose **Edit** from the shortcut menu. The Side Edit Dialog box is displayed. The left column, Side Name to be edited, displays the side names of all the sides present at the site. The right column, Names: Options, is used to enter a new name for the side.
- Step 2** Click the cell in the Name: Options column and select a new name from the drop-down list.
- Step 3** Repeat Step 2 for the other sides as required. Ensure that there is no duplication of side labels.
- Step 4** Click **OK** to apply the new side labels. CTP will now display the new side labels at all interfaces where side names are displayed. For example, in the Project Explorer, various reports, and the network view.

Note

Layout rules are applied to the sides as per the new labels, unless the layout of the side is locked.

4.5 Editing Service Demand Association and Traffic Subnet

Use this procedure to change the association of a service demand from one traffic subnet to another. You can change the association if the destination subnetwork satisfies all of the add/drop requirements of the service demand.

You can edit a traffic subnet only in the Design mode; in Install and Upgrade mode, this feature is not supported.

- Step 1** In the Project Explorer pane, right-click **Traffic Subnets** and choose **View Demand Relationship** from the shortcut menu. The Select Subnet dialog box appears (see [Figure 4-7](#)).
- a. Expand the Traffic Subnet folder to view the service demands associated with it.
 - b. Click the **Move to Subnet** row to see the list of destination traffic subnets where this service demand can be moved to. The list will only contain those Traffic Subnets that can satisfy the add/drop needs of this service demand.

**Note**

Cisco Transport Planner will check to see if each user-forced demand can be met at the destination traffic subnet. In case the check fails, a message shall be displayed asking the user to confirm if this operation should be continued. Click Yes to continue. All the unfeasible properties within each demands will be reset to the default value.

- c. Select the desired destination traffic subnet and click **OK**.

Step 2 (Optional) To edit the wavelength set associated to a traffic subnet, right-click **Traffic Subnets** in the Project Explorer pane and choose **Edit Channel Plan**. The Traffic Subnet Builder dialog box appears (see [Figure 4-6](#)).

- a. Click the **Channel Rules** drop-down list to view the available channel rules.
- b. Select the desired channel rule and click **Apply**.
- c. Check the check box for the required wavelength in the Selection column to associate the wavelength to the traffic subnet. Uncheck the wavelength in the Selection column to remove the wavelength from the traffic subnet.
- d. Click **Save** to save the wavelength association for the selected channel rule.
- e. Click **OK** to apply the wavelength association to the traffic subnet.

Figure 4-6 Edit Channel Plan—Traffic Subnet Builder

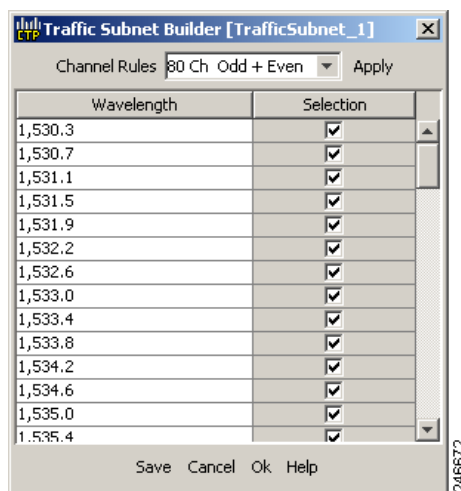

Step 3 To edit a defined traffic subnet, right-click **Traffic Subnets** in the Project Explorer pane and choose **Edit**. The Traffic Subnet Builder dialog box shown in [Figure 4-7](#) appears.

- a. From the Selected Ducts area, click the ducts you want to include the new the new traffic subnet and click **OK**. The selected ducts are added in the Choose Ducts area.
- b. Click **OK**. The properties of the original traffic subnet are updated with the selected options.

**Note**

Later, when analyzing the network, if the tool discovers that the order of the add/drop sites in the destination traffic subnet has been modified, the analyzer will mark these traffic demands as invalid and will not proceed with the analysis.

Figure 4-7 Select Subnet Dialog Box

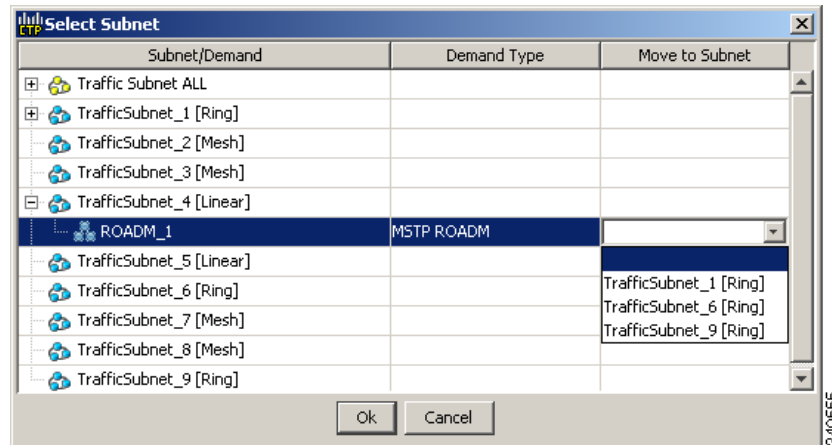

4.6 Creating a Maintenance Center

Use the following procedure to add maintenance centers that will supply your network with spare parts in the event of a failure. This feature helps your customer determine the quantity of spares that should be purchased, depending on the number of maintenance centers and their availability. Maintenance centers appear in the Maintenance Center folder under a site in the Project Explorer pane.

-
- Step 1** In the Project Explorer pane, right-click the network folder and choose **Expand** from the shortcut menu.
- Step 2** Scroll down the Project Explorer pane, right-click the **Maintenance Center** folder, and choose **New Maintenance Center** from the shortcut menu.
- Step 3** Highlight the new maintenance center in the Project Explorer pane.
- Step 4** In the Properties pane, complete the following as needed:
- Confidence Level—Choose the percentage that represents the required confidence level for finding needed spare parts in the maintenance center: **50**, **75**, **95**, or **99** percent.
 - Restocking time (days)—Enter the time (including transportation) required to restock the part in the maintenance center.
- Step 5** To associate a maintenance center with a site, see the “[4.3 Editing Site Parameters](#)” section on page 4-2.
-

4.7 Editing a Point-to-Point Demand

Use the following procedure to edit a point-to-point demand:

-
- Step 1** In the Project Explorer pane, right-click the network folder and choose **Expand** from the shortcut menu. In the Project Explorer pane, right-click the point-to-point demand and choose **Edit** from the shortcut menu. The Demand Editor appears (see [Figure 4-8](#)). The table lists the details of the demand as Demand > Service > Trail > Section.

**Note**

You can alternatively edit the point-to-point demand from the Network View. Right-click on the demand and click Edit to open the Demand Editor dialog box and edit the demand properties in the Properties pane.

The service can contain more than one trail based on the protection type. For more information about the Cisco Transport Planner icons, see [Appendix A, “GUI Information and Shortcuts.”](#)

Figure 4-8 Edit Point-to-Point Demand Dialog Box

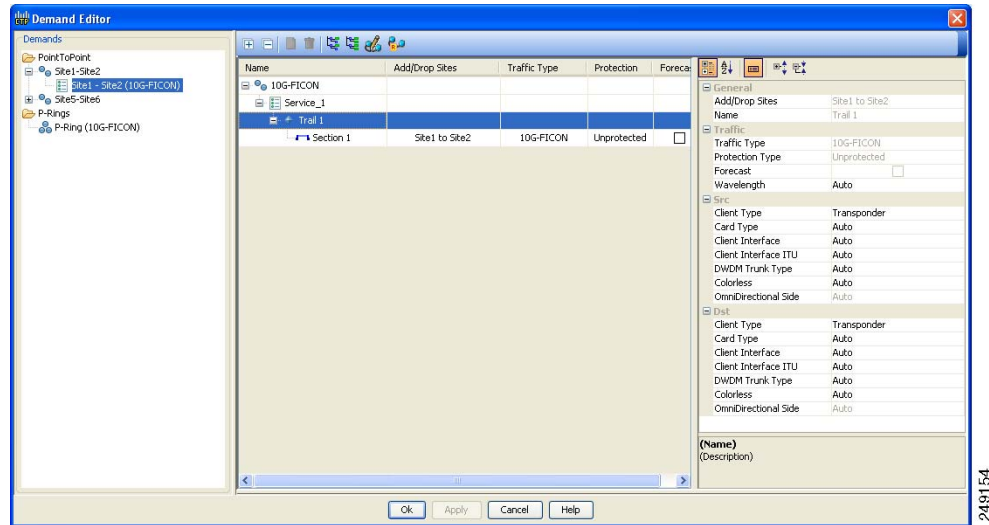

Step 2 At the demand level, you can edit the following properties in the Properties pane:

- Name—Edit the name of the demand.
- Traffic Type—Choose the desired traffic type from the drop-down list. The possible values are 10G-FICON, 8G-FICON, 10GE LAN PHY, 10GE WAN PHY, 15530 10 Gbps Aggregated, 15530 2.5 Gbps Aggregated, 15530 Data MXP, 15530 MR Transport, 1G-FICON, 2G-FICON, 2R-Any Rate, 3G-SDI, D1 Video, DV-6000, DVB ASI, ESCON, Fast Ethernet 100 Mbps, Fiber Channel, Fiber Channel 10G, Fiber Channel 2G, Fiber Channel 4G, Fiber Channel 8G, Gigabit Ethernet, SD-HDI, HD-SDI, HDTV, ISC-Compat, ISC-Peer-1G, ISC-Peer-1G with STP, ISC-Peer-2G, ISC-Peer-2G with STP, ISC-Peer-2R, OTU1, OTU2, OTU2e, OTU3, SDI, Sysplex CLO, Sysplex ETR. The OC-12, OC-192, OC-3, OC-48 and OC-768 traffic types are specific to ANSI networks. STM1, STM16, STM256, STM4 and STM64 traffic types are specific to ETSI networks.
- Protection—Choose the desired protection type from the drop-down list. The possible values are Client1+1, Fiber-Switched, Y-Cable, PSM-OCH, and Unprotected.

Step 3 At the service level, you can edit the following properties in the Properties pane:

- Forecast—Changes a present section to a forecast section.
- Wavelength—Forces a particular channel wavelength.
 - Auto—Allows the tool to assign a wavelength to the channel with the lowest possible cost, given the other set of constraints.
 - Allowed wavelength bands—**C band-32 ch.odd, L band- 32 ch.odd, C band- 40 ch., C band - 72 ch., or C band- 80 ch.** Wavelengths are listed based on the selected band.

Step 4 At the trail level, you can edit the following properties in the Properties pane:

- Wavelength—Forces a particular channel wavelength.
 - Auto—Allows the tool to assign wavelength to the channel with the lowest possible cost, given the other set of constraints.
 - Allowed wavelength bands—**C band-32 ch.odd, L band- 32 ch.odd, C band- 40 ch., C band- 64 ch., C band - 72 ch., or C band- 80 ch.** Wavelengths are listed based on the selected band.
- You can edit the following properties for the source and destination sites:
 - Client Type
 - Card Type
 - Client Interface
 - Client Interface ITU
 - DWDM Trunk Type
 - Colorless
 - OmniDirectional Side

The options available are based on the service and card type selected.



Note You can force different card types for the source and destination sites.

Step 5 At the section level, you can edit the following properties in the properties pane:

- Optical Bypass—Specifies the sites from the drop-down list where the channels for the current demand will be optically dropped. Sites present between the source and destination sites along the path of this section are available as options.
- Wavelength—Forces a particular channel wavelength.
 - Auto—Allows the tool to assign wavelength to the channel with the lowest possible cost, given the other set of constraints.
 - Allowed wavelength bands—**C band-32 ch.odd, L band- 32 ch.odd, C band- 40 ch., C band - 72 ch., or C band- 80 ch.** Wavelengths are listed based on the selected band.
- You can edit the following properties for the source and destination sites:
 - Client Type
 - Card Type
 - Client Interface
 - Client Interface ITU
 - DWDM Trunk Type
 - Colorless
 - OmniDirectional Side

The options available are based on the service and card type selected.



Note You can force different card types for the source and destination sites.

- Step 6** To add a new service, click the **Add new service** icon in the toolbar. A new row appears.
- Step 7** To delete an existing channel, select the row and click the **Delete service** icon in the toolbar.
- Step 8** To edit path constraints, click the **Path Constraints Editor** icon in the toolbar. See [“Creating a Point-to-Point Demand”](#) section on page 19.
- Step 9** To add a regeneration site, click the **Regeneration...** icon in the toolbar. The Regeneration editor appears. The regeneration site can be created only at the trail level. For more information, see the [“2.7.10 Creating a Regeneration Site”](#) section on page 2-42

**Note**

When siblings of the same type (service, trail, or section) are chosen, the Properties pane displays the properties that are common. The properties that are different are marked with an asterisk.

- Step 10** Click **OK** to save the changes to the channels and close the Demand Editor dialog box, or **Cancel** to close the dialog box without saving the changes.

4.8 Editing a P-Ring Demand

Use the following procedure to change the distribution of services in a P-ring service demand:

- Step 1** In the Project Explorer pane, right-click the network folder and choose **Expand** from the shortcut menu. In the Project Explorer pane, right-click the P-ring demand and choose **Edit** from the shortcut menu. The Demand Editor appears (see [Figure 4-9](#)). The table lists the details of the demand as Demand > Service > Trail > Section.
- For more information about the Cisco Transport Planner icons, see [Appendix A, “GUI Information and Shortcuts.”](#)

Figure 4-9 Edit P-Ring Demand Dialog Box

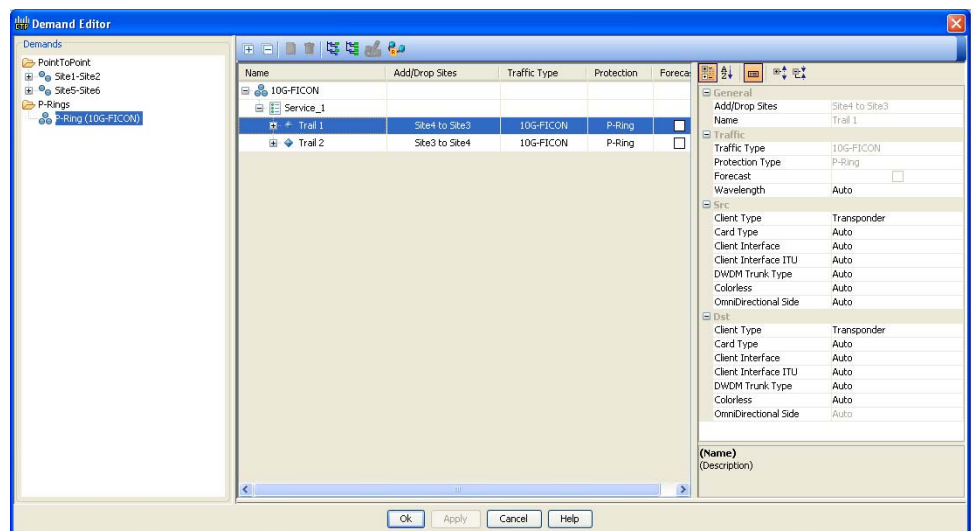

248155

- Step 2** At the demand level, you can edit the following properties in the properties pane:
- Name—Edit the name of the demand.
 - Traffic Type—Choose the desired traffic type from the drop-down list. The possible values are 10G-FICON, 10GE LAN PHY, 10GE WAN PHY, 15530 10 Gbps Aggregated, 15530 2.5 Gbps Aggregated, 15530 Data MXP, 15530 MR Transport, 1G-FICON, 2G-FICON, 2R-Any Rate, D1 Video, DV-6000, DVB ASI, ESCON, Fast Ethernet 100 Mbps, Fiber Channel, Fiber Channel 10G, Fiber Channel 2G, Fiber Channel 4G, Gigabit Ethernet, HDTV, ISC-Compat, ISC-Peer-1G, ISC-Peer-2G, ISC-Peer-2R, OC-12, OC-192, OC-3, OC-48, OC-768, SDI, Sysplex CLO, and Sysplex ETR.
- Step 3** At the service level, you can edit the following properties in the Properties pane:
- Forecast—Changes a present section to a forecast section.
 - Wavelength—Forces a particular channel wavelength.
 - Auto—Allows the tool to assign wavelength to the channel with the lowest possible cost, given the other set of constraints.
 - Allowed wavelength bands—**C band-32 ch.odd, L band- 32 ch.odd, C band- 40 ch., C band - 72 ch., or C band- 80 ch.** Wavelengths are listed based on the selected band.
- Step 4** At the trail level, you can edit the following properties in the Properties pane:
- Wavelength—Forces a particular channel wavelength.
 - Auto—Allows the tool to assign wavelength to the channel with the lowest possible cost, given the other set of constraints.
 - Allowed wavelength bands—**C band-32 ch.odd, L band- 32 ch.odd, C band- 40 ch., C band- 64 ch., C band - 72 ch., or C band- 80 ch.** Wavelengths are listed based on the selected band.
 - You can edit the following properties for the source and destination sites:
 - Client Type
 - Card Type
 - Client Interface
 - Client Interface ITU
 - DWDM Trunk Type
 - Colorless
 - OmniDirectional Side

The options available are based on the service and card type selected.



Note You can force different card types for the source and destination sites.

- Step 5** At the section level, you can edit the following properties in the Properties pane:
- **Optical Bypass**—Specifies the sites from the drop-down list where the channels for the current demand will be optically dropped. Sites present between the source and destination sites along the path of this section are available as options.
 - **Wavelength**—Forces a particular channel wavelength.
 - **Auto**—Allows the tool to assign wavelength to the channel with the lowest possible cost, given the other set of constraints.
 - **Allowed wavelength bands**—**C band-32 ch.odd, L band- 32 ch.odd, C band- 40 ch., C band - 72 ch., or C band- 80 ch.** Wavelengths are listed based on the selected band.
 - You can edit the following properties for the source and destination sites:
 - Client Type
 - Card Type
 - Client Interface
 - Client Interface ITU
 - DWDM Trunk Type
 - Colorless
 - OmniDirectional Side

The options available are based on the service and card type selected.



Note You can force different card types for the source and destination sites.

- Step 6** To add a new service, click the **Add new service** icon in the toolbar. A new row appears.
- Step 7** To delete an existing service from the P-ring, choose the row and click the **Delete service** icon in the toolbar.
- Step 8** To add a regeneration site, click the **Regeneration...** icon in the toolbar. The Regeneration Editor appears. The regeneration site can be created only at the trail level. For more information, see the [“2.7.10 Creating a Regeneration Site” section on page 2-42.](#)



Note When siblings of the same type (service, trail, or section) are chosen, the Properties pane displays the properties that are common. The properties that are different are marked with an asterisk.

- Step 9** Click **OK** to save the changes to the channels and close the Edit P-Ring Demand dialog box, or **Cancel** to close the dialog box without saving the changes.
-

4.9 Editing a ROADM Demand

Use the following procedure to change the distribution of services in a ROADM service demand:

- Step 1** In the Project Explorer pane, right-click the network folder and choose **Expand** from the shortcut menu.
- Step 2** Right-click ROADM demand and choose **Edit** from the shortcut menu. The Edit ROADM Demand dialog box appears (see [Figure 4-10](#)).

Figure 4-10 Edit ROADM Demand Dialog Box

- Step 3** (Optional) If you copied properties of an existing ROADM demand, click Use Template to use the properties of the copied ROADM demand.
- Step 4** Select a traffic pattern type from the Traffic Type drop-down list:
- Hub — If selected, the First Site drop-down list becomes available.
 - Meshed—If selected, go to [Step 6](#).
 - Ring—If selected, choose the Connectivity type as either Unprotected Minimum Hop, Unprotected Optimum Path, or Unprotected Subnet, and proceed to [Step 7](#).



Note Refer to the “[1.1.5.3 ROADM Traffic Demands](#)” section on page 1-15 for more information about the connectivity type choices.

- Step 5** For Hub traffic types, select the originating site from the First Site drop-down list.
- Step 6** Select a connectivity type from the Connectivity type drop-down list. The choices are Protected, Unprotected Minimum Hop, Unprotected Optimum Path, and Unprotected Subnet.
- Step 7** In the Service types pane, check the check boxes for one or more client service types for the ROADM demand. The client interfaces that support each service type appear in the right pane.
- Step 8** Check the OmniDirection check box to enable the omnidirectional property for the ROADM demand.

**Note**

- The omnidirectional property is applied to the unprotected ROADM demand only when all the sites in the ROADM group have a minimum of one omnidirectional side with two colorless ports on each side.
- The omnidirectional property is applied to the protected ROADM demand only when all the sites in the ROADM group has minimum two omnidirectional sides with two colorless ports on each side.
- When the ROADM demand is finalized, CTP shows the omnidirectional property as Yes irrespective of the source or destination.

Step 9 Check the Colorless check box to enable the colorless property for the ROADM demand.

**Note**

- The colorless property is applied to the unprotected ROADM demand only when one line side with one colorless port is available in each site.
- The colorless property is applied to the protected ROADM demand only when two line sides with one colorless port are available in each site.
- If there are no colorless ports on the line side but available on the omnidirectional side, CTP displays an error message.
- When the ROADM demand is finalized, CTP shows the colorless property as Yes irrespective of the source or destination.

Step 10 To further refine the client interfaces, complete the following options for each row in the right pane. Check boxes in gray are not available for the client interface selection.

- Yes/No—Check to select this card to implement the service type.
- Client Interface—Displays the card type for the selected service type.
- Y-Cable—Check to select Y-cable protection if the connectivity type is Protected.
- 1+1 Protected—Check to select 1+1 protection if the connectivity type is Protected.
- Fiber Switched—Check to select fiber-switching protection if the connectivity type is Protected.
- Supported Service—Displays the service types supported for the card.

You can select more than one client interface to support the same service type. By default, Cisco Transport Planner checks the best client interface to support each service.

Step 11 Click **OK** to save the changes to the demand.

4.10 Editing an Ethernet Aggregated Demand

Use the following procedure to edit Ethernet aggregated demands.

Step 1 In the Project Explorer pane, right-click the network folder and choose **Expand** from the shortcut menu.

Step 2 In the Project Explorer pane, right-click the Ethernet aggregated demand and choose **Edit demand** from the shortcut menu. The Ethernet Aggregated Demand dialog box appears ([Figure 4-11](#)).

Figure 4-11 Ethernet Aggregated Demand Dialog Box

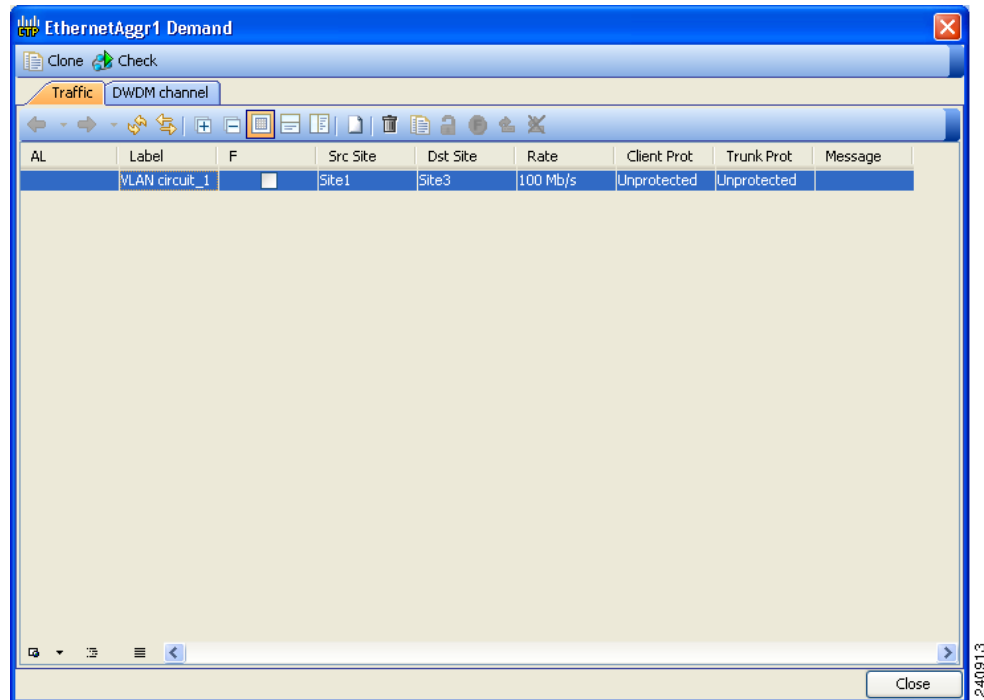

- Step 3** If a circuit already exists, to make a copy of it, right-click the circuit and click **Copy Circuit**. A new circuit appears as a WDM traffic channel with the same parameters as the original circuit.
- Step 4** To delete a circuit, right-click the circuit and click **Delete Circuit**.

- Step 5** To modify the parameters of an existing circuit, double-click the circuit. The Edit Request dialog box appears (see [Figure 4-12](#)).

Figure 4-12 Edit Request Dialog Box for an Ethernet WDM Transport Channel

- Step 6** The Edit request dialog box contains three areas of information: General, Src, and Dest.

General Area

- Label—Enter the label for the circuit. By default, VLAN_Circuit_x is used.
- Trunk Protection—Select the trunk protection type. Allowed values are:
 - Unprotected
 - Protected
- P/F—Choose Forecast if this demand will be needed in the future. Choose Present if this demand is needed now. This parameter drives the list of pluggable port modules to be equipped on the card and affects BoM reports.
- Path Forcing—Allows you to force the circuit routing on the traffic subnet associated with this demand. Allowed values are:
 - Auto—(Default) Causes the tool to automatically define the trunk path.
 - Side x—Represents the label of the side on the Src site where the circuit is routed.
- Client Protection—Choose the client protection type. Allowed values are:
 - Unprotected
 - Client 1+1
- Circuit Rate—Choose the circuit rates.

Src Area

- Site—Select the source site. Allowed values include the list of sites added in the WDM traffic channel.
- SFP lambda—Select the desired SFP/XFP for this port or set it to Auto to allow the tool to select an appropriate value.
- Card—Select the card. Allowed values are Auto, 10GE-XP, 10GE-EXP, GE-XP, and GE-EXP. Auto allows the tool to select an appropriate card type based on other constraints.

The Src area contains Working and Protected sub areas.

Working sub area

- Port CIR—Select the CIR, with 1 being the highest and 0.1 being the lowest.
- Port Rate-Reach—Select the desired PPM for this port, or set it to Auto to allow the tool to select an appropriate value.
- Port Num—Select the port number. Allowed values are Auto, 1, and 2. Auto allows the tool to select an appropriate port number based on other constraints.

Protected sub area

These fields are enabled only if client protection is enabled in the Client Protection field.

- Port CIR—Select the CIR, with 1 being the highest and 0.1 being the lowest.
- Port Rate-Reach—Select the desired PPM for this port, or set it to Auto to allow the tool to select an appropriate value.
- Port Num—Select the port number. Allowed values are Auto, 1, and 2. Auto allows the tool to select an appropriate port number based on other constraints.

Dest Area

- Site—Select the destination site. Allowed values include the list of sites added in the WDM traffic channel.
- SFP lambda—Select the desired SFP/XFP for this port or set it to Auto to allow the tool to select an appropriate value.
- Card—Select the card. Allowed values are Auto, 10GE-XP, 10GE-EXP, GE-XP, and GE-EXP. Auto allows the tool to select an appropriate card type based on other constraints.

The Dest area contains Working and Protected sub areas.

Working sub area

- Port CIR—Select the CIR, with 1 being the highest and 0.1 being the lowest.
- Port Rate-Reach—Select the desired PPM for this port, or set it to Auto to allow the tool to select an appropriate value.
- Port Num—Select the port number. Allowed values are Auto, 1 to 20. Auto allows the tool to select an appropriate port number based on other constraints.

Protected sub area

These fields are enabled only if client protection is enabled in the Client Protection field.

- Port CIR—Select the CIR, with 1 being the highest and 0.1 being the lowest.
- Port Rate-Reach—Select the desired PPM for this port, or set it to Auto to allow the tool to select an appropriate value.
- Port Num—Select the port number. Allowed values are Auto, and 1 to 20. Auto allows the tool to select an appropriate port number based on other constraints.

- Step 7** Click **OK**.
- Step 8** Click **Check** on the left corner of the window to generate a report showing the circuit path in the WDM traffic channel and to check any over-allocation of bandwidth. The report shows, in a row, each of the sites on the subnet, and each span in between.
- Step 9** To edit the demand, click the **DWDM channel** tab.
See [Figure 4-13](#).

The table lists the details of the demand as Demand > Service > Trail > Section.

For more information about the Cisco Transport Planner icons, see [Appendix A, “GUI Information and Shortcuts.”](#)

Figure 4-13 DWDM Channel View in an Ethernet Aggregated Demand

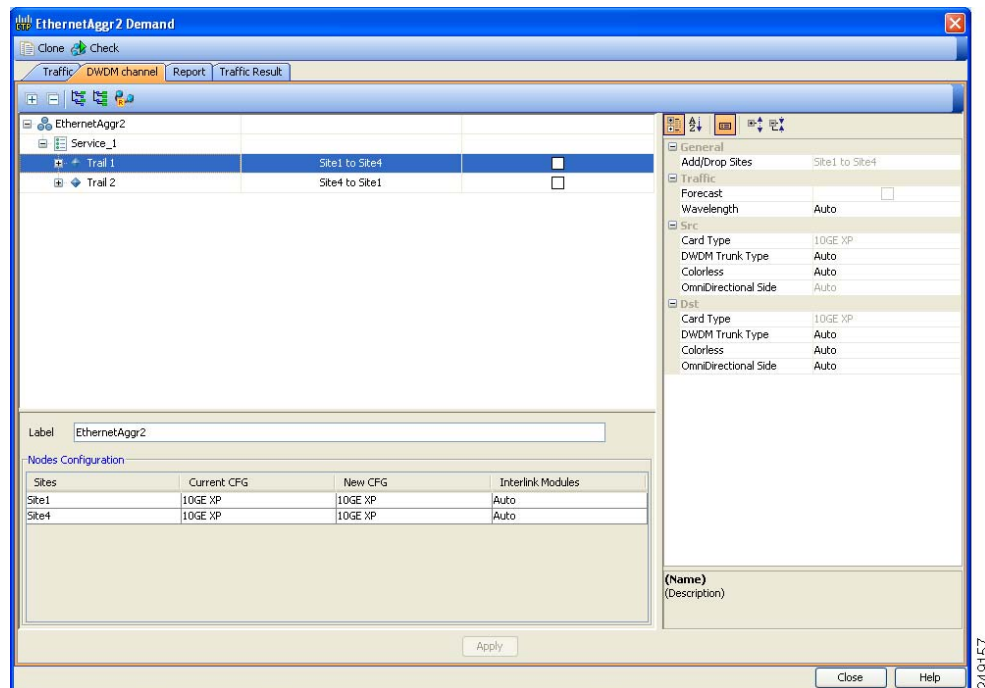

- Step 10** At the service level, you can edit the following properties in the Properties pane:
- Forecast—Changes a present section to a forecast section.
 - Wavelength—Forces a particular channel wavelength.
 - Auto—Allows the tool to assign wavelength to the channel with the lowest possible cost, given the other set of constraints.
 - Allowed wavelength bands—**C band-32 ch.odd, L band- 32 ch.odd, C band- 40 ch., C band - 72 ch., or C band- 80 ch.** Wavelengths are listed based on the selected band.
- Step 11** At the trail level, you can edit the following properties in the Properties pane:
- Wavelength—Forces a particular channel wavelength.
 - You can edit the following property for the source and destination sites:
 - DWDM Trunk Type
 - Colorless

- OmniDirectional Side

Step 12 At the section level, you can edit the following properties in the Properties pane:

- Optical Bypass—Specifies the sites from the drop-down list where the channels for the current demand will be optically dropped. Sites present between the source and destination sites along the path of this section are available as options.
- Wavelength—Forces a particular channel wavelength.
- You can edit the following property for the source and destination sites:
 - DWDM Trunk Type
 - Colorless
 - OmniDirectional Side

Step 13 To add a regeneration site, click the **Regeneration...** icon in the toolbar of the DWDM channel tab. The Regeneration Editor appears. The regeneration site can be created only at the trail level. For more information, see the [“2.7.10 Creating a Regeneration Site” section on page 2-42](#)



Note When siblings of the same type (service, trail, or section) are chosen, the Properties pane displays the properties that are common. The properties that are different are marked with an asterisk.

Step 14 Click **Apply** to save the changes to the channels and click **Close**.

4.11 Editing a TDM Aggregated Demand

Use the following procedure to edit a TDM aggregated demand:

-
- Step 1** In the Project Explorer pane, right-click the network folder and choose **Expand** from the shortcut menu.
- Step 2** In the Project Explorer pane, right-click the TDM aggregated demand and choose **Edit demand** from the shortcut menu. The TDM Aggregated Demand dialog box appears ([Figure 2-12](#)).
- Step 3** To make a copy of the circuit, right-click the circuit and click **Copy Circuit**. A new circuit appears under WDM Traffic channel with the same parameters as the original circuit.
- Step 4** To delete a circuit, right-click the circuit and click **Delete Circuit**.
- Step 5** To modify the parameters of an existing circuit, double-click the circuit. The **Edit request** dialog box appears (see [Figure 4-14](#)).

Figure 4-14 Edit Request in a TDM WDM Transport Channel

The screenshot shows the 'Edit request' dialog box with the following fields and values:

- General:**
 - Label: Circuit_1
 - Trunk Protection: Unprotected
 - P/F: Present
 - Path Forcing: Auto
 - Client Protection: Unprotected
 - Circuit Rate: STS1
- Src:**
 - Site: Site1
 - SFP lambda: Auto
 - Card: Auto
 - Working:
 - Port Num: Auto
 - Port Rate-Reach: Auto
 - Protected:
 - Port Num: Auto
 - Port Rate-Reach: Auto
- Dest:**
 - Site: Site4
 - SFP lambda: Auto
 - Card: Auto
 - Working:
 - Port Num: Auto
 - Port Rate-Reach: Auto
 - Protected:
 - Port Num: Auto
 - Port Rate-Reach: Auto

Buttons: OK, Cancel

Step 6 The Edit request window contains three area of information: General, Src, and Dest.

General Area

- Label—Enter the label for the circuit. By default, VLAN_Circuit_x is used.
- Trunk Protection—Enter the trunk protection type. Allowed values are:
 - Unprotected
 - UPSR
- P/F—Select Forecast if this demand will be needed in the future. Select Present if this demand is needed now. This option drives the list of pluggable port modules to be equipped on the card and affects BoM reports.
- Path Forcing—This option allows you to force the circuit routing on the traffic subnet associated with this demand. The following values are supported:
 - Auto—(Default) Causes the tool to automatically define the trunk path.
 - Side *x*—Represents the label of the side on the Src site where the circuit is routed.
- Client Protection—Allowed values are:
 - Unprotected
 - 1+1 APS
- Circuit rate—Displays the allowed circuit rates.

Src Area

- Site—Select the source site. Allowed values include the list of sites added in the WDM traffic channel.
- SFP lambda—Select the desired SFP/XFP for this port or set it to Auto to allow the tool to select an appropriate value.
- Card—Select the card. Allowed values are Auto and ADM-*x*. Auto allows the tool to select an appropriate card type based on other constraints.

The Src area contains Working and Protected sub areas.

Working sub area

- Port Num—Select the port number. Allowed values are Auto and 1 to 16. Auto allows the tool to select an appropriate port number based on other constraints.
- Port Rate-Reach—Select the desired PPM for this port, or set it to Auto to allow the tool to select an appropriate value.

Protected sub area

These fields are enabled only if client protection is enabled in the Client Protection field.

- Port Num—Select the port number. Allowed values are Auto and 1 to 16. Auto allows the tool to select an appropriate port number based on other constraints.
- Port Rate-Reach—Select the desired PPM for this port, or set it to Auto to allow the tool to select an appropriate value.

Dest Area

- Site—Select the destination site. Allowed values include the list of sites added in the WDM traffic channel.
- SFP lambda—Select the desired SFP/XFP for this port or set it to Auto to allow the tool to select an appropriate value.
- Card—Select the card. Allowed values are Auto and ADM-*x*. Auto allows the tool to select an appropriate card type based on other constraints.

The Dest area contains Working and Protected sub areas.

Working sub area

- Port Num—Select the port number. Allowed values are Auto and 1 to 16. Auto allows the tool to select an appropriate port number based on other constraints.
- Port Rate-Reach—Select the desired PPM for this port, or set it to Auto to allow the tool to select an appropriate value.

Protected sub area

- Port Num—Select the port number. Allowed values are Auto and 1 to 16. Auto allows the tool to select an appropriate port number based on other constraints.
- Port Rate-Reach—Select the desired PPM for this port, or set it to Auto to allow the tool to select an appropriate value.

Step 7 Click **OK**.

Step 8 Click the **Check** tab in the left corner of the window to generate a report showing the circuit path in the WDM traffic channel and to check any over allocation of bandwidth. The report shows, in a row, each of the sites on the subnet, and each span in between.

Step 9 To edit the demand, click the **DWDM channel** tab.
See [Figure 4-15](#).

The table lists the details of the demand as Demand > Service > Trail > Section.

For more information about the CTP icons, see [Appendix A, “GUI Information and Shortcuts.”](#)

Figure 4-15 DWDM Channel View in a TDM Aggregated Demand

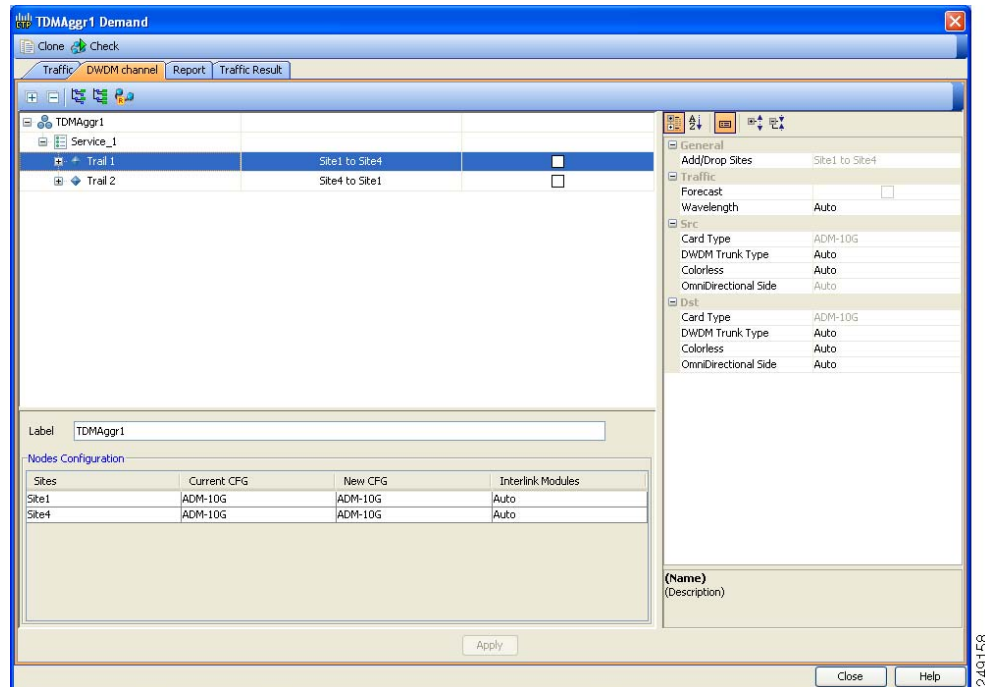

Step 10 At the service level, you can edit the following properties in the Properties pane:

- Forecast—Changes a present section to a forecast section.
- Wavelength—Forces a particular channel wavelength.
 - Auto—Allows the tool to assign wavelength to the channel with the lowest possible cost, given the other set of constraints.
 - Allowed wavelength bands—**C band-32 ch.odd, L band- 32 ch.odd, C band- 40 ch., C band - 72 ch., or C band- 80 ch.** Wavelengths are listed based on the selected band.

Step 11 At the trail level, you can edit the following properties in the Properties pane:

- Wavelength—Forces a particular channel wavelength.
- You can edit the following property for the source and destination sites:
 - DWDM Trunk Type
 - Colorless
 - OmniDirectional Side

Step 12 At the section level, you can edit the following properties in the Properties pane:

- Optical Bypass—Specifies the sites from the drop-down list where the channels for the current demand will be optically dropped. Sites present between the source and destination sites along the path of this section are available as options.

- Wavelength—Forces a particular channel wavelength.
- You can edit the following property for the source and destination sites:
 - DWDM Trunk Type
 - Colorless
 - OmniDirectional Side

Step 13 To add a regeneration site, click the **Regeneration...** icon in the toolbar of the DWDM channel tab. The Regeneration Editor appears. The regeneration site can be created only at the trail level. For more information, see the “[2.7.10 Creating a Regeneration Site](#)” section on page 2-42.

**Note**

When siblings of the same type (service, trail, or section) are chosen, the Properties pane displays the properties that are common. The properties that are different are marked with an asterisk.

Step 14 Click **Apply** to save the changes to the channels and click **Close**.

4.12 Add or Remove Sites from P-Ring, Ethernet Aggregated, and TDM Aggregated Demands

To add or remove sites from P-Ring, Ethernet Aggregated, and TDM Aggregated demands:

-
- Step 1** In the Project Explorer pane, right-click the network folder, and choose **Expand** from the shortcut menu. Perform the following.
- For P-Ring demand—In the Project Explorer pane, right-click the P-Ring demand and choose **Add/Remove Site** from the shortcut menu. The Add/Remove Sites dialog box listing all the sites in the network appears.
 - For Ethernet Aggregated and TDM Aggregated demands—In the Project Explorer pane, right-click the Ethernet Aggregated or TDM Aggregated demand and choose **Add/Remove Site** from the shortcut menu. The Add/Remove Sites dialog box listing all the sites in the network appears.
- Step 2** To add sites to the demand, select the sites in the Site Inclusion/Exclusion Panel and click the right arrow. Sites can be added only when the demand is in Unlock¹ state. When a site is added to the demand, new trails are created to accommodate the new sites. The existing circuits in the demand are not affected.
- Step 3** To remove sites from the demand, select the sites in the Site Inclusion/Exclusion Panel and click the left arrow. Sites can be removed only when the demand is in Unlock¹ state. When a site is removed, all the associated circuits originating or terminating from that site are also removed.
- Step 4** Click **OK** to confirm adding or removing sites from P-Ring, Ethernet Aggregated, and TDM Aggregated demands. The updated site details are displayed in the Demand Editor window.
-

1. To Unlock a demand, right-click the demand and choose **Unlock** from the shortcut menu.

4.13 Add or Remove Multiple Optical Bypass Sites

The Optical Bypass Editor allows to specify multiple sites where the channels for the current demand are optically dropped. To add or remove multiple optical bypass sites:

-
- Step 1** Create a Point-to-Point, P-Ring, Ethernet Aggregated, or TDM Aggregated demand. To create a Point-to-Point, P-Ring, Ethernet Aggregated, or TDM Aggregated demand, see [2.7 Creating a Demand](#), page 2-16.
- Step 2** Right-click the network folder and choose **Expand** from the shortcut menu.
- In the Project Explorer pane, right-click the demand and choose **Edit** from the shortcut menu. The Demand Editor window appears. The Demand Editor window lists the details of the demand as Demand > Service > Trail > Section.



Note You can alternatively edit the demand from the network view. Right-click on the demand and click **Edit** to open the Demand Editor window.

- Step 3** Select the section in the demand. Click **Optical Bypass** in the toolbar. The Optical Bypass Editor window appears.
- Step 4** To add a site as optical bypass site, go to [Step 5](#). To delete an optical bypass site, go to [Step 6](#).
- Step 5** To add an optical bypass site, select a site in the Available Sites pane in the Optical Bypass Editor. Click the down arrow to move the selected site to the Optical Bypass Sites pane. Sites present between the source and destination sites along the path of this section can be added as optical bypass sites. To add optical bypass site to the network in Upgrade or Release Upgrade state, unlock the demand and site to be added.
- Step 6** To delete an optical bypass site, select a site in the Optical Bypass Sites pane in the Optical Bypass Editor. Click the up arrow to move the selected site to Available Sites pane. When an optical bypass site is removed from the network, all the associated add/drop card are removed only when the site is in unlocked state.
- Step 7** Click **OK** to confirm adding or deleting optical bypass site.
- Step 8** Click **OK** to save the changes to the channels and close the Demand Editor dialog box.
-

4.14 Editing Fiber Span, Pair, and Fiber Parameters

Using the Properties pane you can manage a fiber span, a fiber pair, and individual fibers. A fiber pair consists of two different fibers (clockwise and counter-clockwise). [Table 4-3](#) lists the properties that you can modify for a fiber span, fiber pair, or fiber.

Table 4-3 Editable Fiber Properties

Property	Fiber Span	Fiber Pair	Fiber
Name	Yes	Yes	No
Connection Type	No	No	No
EOL Ageing Loss	Yes	No	No

Table 4-3 *Editable Fiber Properties (continued)*

Property	Fiber Span	Fiber Pair	Fiber
EOL Ageing Factor	Yes	No	No
Measurement Units	Yes	No	No
Fiber Type	Yes	Yes	No
Span Length	Yes	Yes	Yes
FDP In and FDP Out	No	No	Yes
Length Based Loss	Yes	Yes	No
Connector Loss (per site)	Yes	Yes	Yes
Tot SOL Loss w/o Connectors	Yes	Yes	No
CD C-Band and CD L-Band	Yes	Yes	No
Loss	Yes	Yes	Yes
PMD at Fiber	Yes	Yes	Yes
Raman Amplified	Yes	Yes	No
Attenuation at Lambda One	Yes	Yes	No
Attenuation at Lambda Two	Yes	Yes	No

Use the following procedure to edit a fiber span, fiber pair, and fiber parameters:

-
- Step 1** In the Project Explorer pane, right-click the **Fiber** folder and choose **Expand** from the shortcut menu.
- Step 2** In the Project Explorer pane, click one of the following. The options available for editing in the Properties pane change depending on your selection.
- To edit a fiber span, click the duct identifier.
 - To edit a fiber pair, click the fiber pair identifier.
 - To edit an individual fiber, click the fiber identifier.
- Step 3** In the Properties pane, edit the following parameters, as necessary. See [Table 4-3](#) for the properties that you can change for a fiber span, fiber pair, or individual fiber.
- Name—Enter the desired name for the fiber span, pair, or fiber.
 - Connection Type—Displays the type of connection between the sites that the fiber span connects.
 - EOL Ageing Loss—Enter the EOL aging loss value. The EOL loss per span value is added at the end of life to each discrete fiber in the network (for example, to add an EOL margin for splicing). If you set the ageing factor, you do not need to set the ageing loss.
 - EOL Ageing Factor—Enter the number to factor fiber aging. This factor is multiplied by the SOL total span loss without connectors. If you set the ageing loss, you do not need to set the ageing factor.
 - Measurement Units—Choose the measurement unit (Km or Miles) for a fiber span (duct) from the drop-down list. You can set the measurement unit only for the duct, but not for the fiber pair (couple) or fiber.
 - Fiber Type—Choose the type of fiber for each span in the network.
 - Span Length—Enter the span length. The displayed unit of measurement is retrieved from the Span Length field.

- FDP In—Enter the fiber distribution panel (FDP) connector information where the fiber is connected at the receiving end.
- FDP Out—Enter the fiber distribution panel (FDP) connector information where the fiber is connected at the transmitting end.
- Length Based Loss—If this check box is checked, the fiber loss is determined by multiplying the Span Length with the Loss Factor. If this check box is unchecked, enter the total span loss value in the Tot SOL Loss w/o Connectors property.
- Connector loss [x]—Enter the concentrated connector loss at the end of the span terminating at the source site.
- Connector loss [y]—Enter the concentrated connector loss at the end of the span terminating at the destination site.



Note By default, the Connector Loss property uses the value as specified in the DWDM Design Rules. You can override the default value by typing a new value. For more information about the DWDM Design Rules, see [“1.6.3 Setting the Default Platform Values” section on page 1-28.](#)

- Tot SOL Loss w/o Connectors—Enter the start of life fiber loss value for each span, excluding the connector concentrated loss.
This property is disabled if the Length Based Loss check box is checked.
- CD C-Band and CD L-Band—Enter the fiber CD factor. The default value is dependent on the selected fiber type. Any value that you enter is lost whenever you change the fiber type. Chromatic dispersion is always entered in ps/nm/km. Fiber chromatic dispersion is defined for the middle of the wavelength band. C-band is defined at 1545.3 nm and L-band is defined at 1590.4 nm.
- Loss—Enter the value of the SOL fiber loss per kilometer used to calculate the loss of each span in the network. The fiber loss factor is always entered in dB/km.
- PMD at Fiber—The default value is dependent on the selected fiber type. You can type a new PMD value. Any entered value is lost whenever you change the fiber type and its default value is applied. PMD is always entered in ps/nm/km.
If the PMD values entered for the individual fibers in a fiber couple are different from each other, then no PMD value is displayed for the fiber span (Duct) and the fiber pair (Couple) properties.
- Raman Amplified—Check this option to enable Raman amplification. It allows placement of Raman amplifiers on both end-points of the span. When this option is checked, the Raman amplification properties of the C-band amplifier are enabled.



Note You can choose adjacent spans as Raman amplified and choose a site between these spans as a pass-through site. The algorithm treats the adjacent spans as one span and places the Raman amplifier on the external sites on the ends of the span. The Raman amplified span is indicated by two red dots.

- Attenuation at Lambda One—Enter the attenuation value for the first Raman signal. The default value is Auto, which allows the tool to select an appropriate value.
- Attenuation at Lambda Two—Enter the attenuation value for the second Raman signal. The default value is Auto, which allows the tool to select an appropriate value.

Step 4 As needed, view the following totals for a fiber span, fiber pair, or individual fiber on the Properties pane:

- Loss BOL—(Display only) Displays the total loss beginning of life (BOL) calculation.



Note BOL is also referred to as SOL.

- Loss EOL—(Display only) Displays the total loss EOL calculation.
 - CD—(Display only) Displays the total chromatic dispersion.
 - PMD—(Display only) Displays the total polarization mode dispersion.
-

4.15 Editing Fiber Spans, Fiber Pairs, and Fibers Using the Fibers Dialog Box

The Fibers Dialog lists all fiber spans, fiber pairs, and fibers in the network. Use the following procedure to view and edit fiber parameters in the Fibers Dialog box appears.

- Step 1** In the Project Explorer pane, right-click the **Fibers** folder in the desired network and choose **Fibers Dialog** from the shortcut menu. The Fibers Dialog appears (Figure 4-16).

Figure 4-16 Fibers Dialog

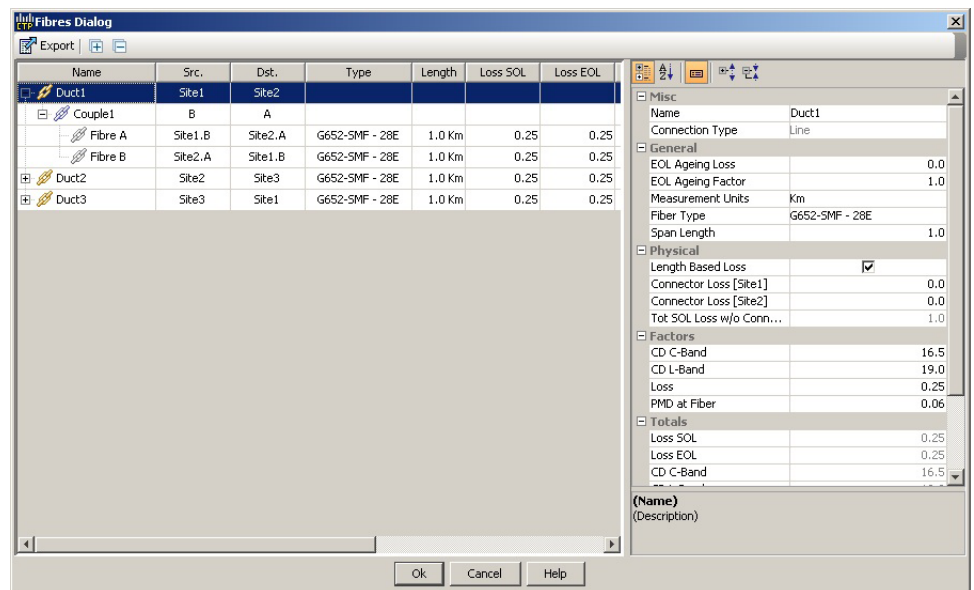

Table 4-4 describes the Fiber Dialog box columns.

Table 4-4 Fibers Dialog Box Columns

Column	Description
Name	Displays the name of the fiber span (Duct), pair (Couple), or fiber. Click the plus (+) sign by a Duct name to expand the list and show the Couple names. Click the plus (+) sign by a Couple name to expand the list and show the individual fiber names.
Src.	Displays the name of the source site or interface for the fiber span, fiber pair, or fiber.
Dst.	Displays the name of the destination site or interface for the fiber span, fiber pair, or fiber.
Type	Displays the type of fiber for each span in the network.
Length	Displays the span length. The displayed unit of measurement is retrieved from the Span Length field.
Loss SOL	Displays the total loss SOL calculation.
Loss EOL	Displays the total loss EOL calculation.

Table 4-4 *Fibers Dialog Box Columns (continued)*

Column	Description
CD C-Band	Displays the total chromatic dispersion for the C-band.
CD L-Band	Displays the total chromatic dispersion for the L-band.
PMD	Displays the total polarization mode dispersion (PMD).
QD C-Band	Displays the secondary order dispersion for C-band.
QD L-Band	Displays the secondary order dispersion for L-band.
RD	Displays the random dispersion value.

Step 2 To edit a fiber span, fiber pair, or fiber, select it in the Fibers Dialog. The Properties pane in the right area of the Fibers Dialog displays the properties for the selected item.

Step 3 In the Properties pane, edit the following parameters, as necessary. See [Table 4-3](#) for the properties that you can change for a fiber span, fiber pair, or individual fiber.

- Name—Enter the desired name for the fiber span, pair, or fiber.
- EOL Ageing loss—Enter the EOL aging loss value. The EOL loss per span value is added at the end of life to each discrete fiber in the network (for example, to add an EOL margin for splicing). If you set the ageing factor, you do not need to set the ageing loss.
- EOL Ageing factor—Enter the number to factor fiber aging. This factor is multiplied by the SOL total span loss without connectors. If you set the ageing loss, you do not need to set the ageing factor.
- Measurement Units— You can view the span length and the measurement unit of each fiber span (Duct), fiber pair (Couple), and fiber. You cannot change the measurement unit of the fiber span and pair (Couple). To change the measurement unit of the fiber span and pair, edit the measurement unit of the corresponding duct.
- Fiber Type—Choose the type of fiber for each span in the network.
- OSC Frame Type—Choose the OSC frame type. The options available are Auto, OC3 Frame, GE Frame, and FE Frame. The default option at is Auto.
- Span Length—Enter the span length. The displayed unit of measurement is retrieved from the Span Length field.
- FDP In—Enter the fiber distribution panel (FDP) connector information where the fiber is connected at the receiving end.
- FDP Out—Enter the fiber distribution panel (FDP) connector information where the fiber is connected at the transmitting end.
- Length Based Loss—If this check box is checked, the fiber loss is determined by multiplying the Span Length with the Loss Factor. If this check box is unchecked, enter the total span loss value in the Tot SOL Loss w/o Connectors property.
- Connector loss [x]—Enter the concentrated connector loss at the end of the span terminating at the source site.
- Connector loss [y]—Enter the concentrated connector loss at the end of the span terminating at the destination site.

**Note**

By default, the Connector Loss property takes the value as specified in the DWDM Design Rules. Any entered value will overwrite the default value. For more information about the DWDM Design Rules, see [“1.6.3 Setting the Default Platform Values” section on page 1-28](#).

- **Tot SOL Loss w/o Connectors**—Enter the start of life link fiber loss for each span, without the connector concentrated loss. The total SOL loss without connectors is equal to the loss factor multiplied by the length.
This property is disabled if the Length Based Loss check box is selected.
- **CD C-Band and CD L-Band**—Enter the fiber CD factor. The default value is dependent on the selected fiber type. Any value that you enter is lost whenever you change the fiber type. Chromatic dispersion is always entered in ps/nm/km. Fiber chromatic dispersion is defined for the middle of the wavelength band. C band is defined at 1545.3 nm. L band is defined at 1590.4 nm.
- **Loss**—Enter the value of the SOL fiber loss per kilometer used to calculate the loss of each span in the network. The fiber loss factor is always entered in dB/km.
- **PMD at Fiber**—The default value is dependent on the selected fiber type. You can type a new PMD value. Any entered value is lost whenever you change the fiber type and its default value is applied. PMD is always entered in ps/nm/km.
If the PMD values entered for the individual fibers in a fiber couple are different from each other, then no PMD value is displayed for the fiber span (Duct) and the fiber pair (Couple) properties.
- **Raman Amplified**—Check this option to enable Raman amplification. It allows placement of Raman amplifiers on both end-points of the span. When this option is checked, the Raman amplification properties of the C-band amplifier are enabled.



Note You can select adjacent spans as Raman Amplified and select a site between these spans as a pass-through site. The algorithm treats the adjacent spans as one span and places the Raman amplifier on the external sites on the ends of the span.

- **Attenuation at Lambda One**—Enter the attenuation value for the first Raman signal. The default value is Auto, which allows the tool to select an appropriate value.
- **Attenuation at Lambda Two**—Enter the attenuation value for the second Raman signal. The default value is Auto, which allows the tool to select an appropriate value.

CTP updates the Fibers Dialog box with the new values.

Step 4 As needed, view the following totals for a fiber span, fiber pair, or individual fiber on the Properties pane:

- **Loss BOL**—(Display only) Displays the total loss BOL calculation.



Note BOL is also referred to as SOL.

- **Loss EOL**—(Display only) Displays the total loss EOL calculation.
- **CD**—(Display only) Displays the total chromatic dispersion.
- **PMD**—(Display only) Displays the total polarization mode dispersion.

Step 5 Click **OK**.

4.15.1 Exporting the Fiber Spans, Fiber Pairs, and Fibers in a Network

Use the following procedure to export all fiber spans, fiber pairs, and single fibers in a network to a .xls format:

-
- Step 1** In the Project Explorer pane, right-click the **Fibers** folder in the desired network and choose **Fibers Dialog** from the shortcut menu. The Fibers Dialog box appears (Figure 4-16).
- Step 2** Click **Export**. The Fibers Export dialog box appears.
- Step 3** Navigate to the desired directory, type the XLS filename, and click **Save**.
-

4.16 Rack Rules

This section describes the following rules:

- [4.16.1 General Placement Rules](#)
- [4.16.2 M2 and M6 Placement Rules](#)
- [4.16.3 DCU Placement Rules](#)
- [4.16.4 Fiber Storage Placement Rules](#)
- [4.16.5 Air Ramp Placement Rules](#)
- [4.16.6 Patch Panel Placement Rules](#)
- [4.16.7 15216-MD-40-ODD/EVEN Unit Placement Rules](#)
- [4.16.8 SMR Placement rules](#)
- [4.16.9 Client Shelf Placement Rules](#)
- [4.16.10 Y-Cable Placement Rules](#)

4.16.1 General Placement Rules

The following general rules apply to rack filling:

- CTP provisions the shelves in the rack from the top in the following order:
 1. PDP
 2. Ethernet switch shelf
 3. EAP shelf (fan out)
 4. Y-cable shelves (FlexLayer or Y-cable FMT)
 5. Band Combiner/Interleaver-deinterleaver FlexLayer shelf
 6. DCU shelves
 7. Patch-panel L shelves (PP-64-LC and FMT-32-Ch)
 8. 15216 40-Channel Mux/Demux unit
 9. Air ramp (only for ETSI M12 shelves)
 10. MSTP optical shelves

11. Air ramp (only for ANSI and ETSI M12 shelves)
 12. Fiber storage shelf
 13. Patch-panel shelves (for ETSI)
 14. PP-MESH-4/PP-MESH-8
 15. Transponder shelves (Present)
 16. Line card shelves (Present)
 17. Transponder shelves (Forecast)
 18. Line card shelves (Forecast)
- If the Populate Shelves From Bottom check box is checked in the Layout area of Site properties, CTP provisions the shelves of the rack from the bottom. The shelves are arranged in the rack from top to bottom in the following order:
 1. PDP
 2. Line card shelves (Forecast)
 3. Transponder shelves (Forecast)
 4. Line card shelves (Present)
 5. Transponder shelves (Present)
 6. PP-MESH-4/PP-MESH-8
 7. Patch-panel shelves (for ETSI)
 8. Air ramp (only for ETSI M12 shelves)
 9. MSTP optical shelves
 10. Air ramp (only for ANSI/ETSI M12 shelves)
 11. Fiber storage shelf
 12. 15216 40-Channel Mux/Demux unit
 13. DCU shelves
 14. Patch-panel L shelves (PP-64-LC and FMT-32-Ch)
 15. Band Combiner/Interleaver-deinterleaver FlexLayer shelf
 16. Y-cable shelves (FlexLayer or Y-cable FMT)
 17. EAP shelf (fan out)
 18. Ethernet switch shelf
 - External switch shelf can be placed anywhere in any rack.
 - The shelves from the DCU to the fiber storage unit are related to the optical shelf and must be used for every optical shelf.
 - You cannot force the TDCU units in both Raman and post amplifier positions.
 - The Power Distribution Panel (PDP) is always at the top of each rack and it is assumed to be a part of the rack.
 - CTP places the MSTP optical shelf in the first available (layout unlocked) shelf position, starting from the first rack of the site or from the first rack of each side (for sites with site protection).

- CTP places as many shelves as possible within a rack, taking into account the height of the racks and the height of each shelf as shown in the following table:

Height	Rack/Shelf
2000 mm	<ul style="list-style-type: none"> • ANSI rack • ETSI rack
44.75 mm (1 RU for ANSI)	<ul style="list-style-type: none"> • DCU (ANSI) shelf • 15454-PP-64-LC PATCH-PANEL (ANSI) shelf (4.7/5.0 patch panel) • 15216-MD-40-ODD • Fiber storage (ANSI) shelf • PDP (ANSI) shelf • Air ramp (ANSI) shelf • FlexLayer shelf • Ethernet switch • Ethernet Adapter Panel (EAP) shelf (fan out)
89.50 mm (2 RU for ANSI)	<ul style="list-style-type: none"> • 15454-PP2-64-LC PATCH-PANEL (ANSI) shelf • 15454-YCBL-LC (ANSI) shelf • 15454-80 LC-PC-II (PATCH-PANEL ANSI) • PP-MESH-4 (MESH PATCH-PANEL ANSI) • PP-MESH-8 (MESH PATCH-PANEL ANSI)
50 mm (1 RU for ETSI)	<ul style="list-style-type: none"> • DCU (ETSI) shelf • 15454-PP-64-LC PATCH-PANEL (ETSI) shelf (4.7/5.0 patch panel) • 15216-MD-40-ODD • Fiber storage (ETSI) shelf • PDP (ETSI) shelf • Air ramp (ETSI) shelf • FlexLayer shelf • Ethernet switch • Ethernet Adapter Panel (EAP) shelf (fan out)
100 mm (2 RU for ETSI)	<ul style="list-style-type: none"> • 15454-PP2-64-LC PATCH-PANEL (ETSI) shelf • 15454-YCBL-LC (ETSI) shelf • 15454-80 LC-PC-II (PATCH-PANEL ETSI) • PP-MESH-4 (MESH PATCH-PANEL ETSI) • PP-MESH-8 (MESH PATCH-PANEL ETSI)
407 mm	Card chassis ANSI (MSTP and transponder) shelf
617 mm	Card chassis ETSI (MSTP and transponder) shelf

Height	Rack/Shelf
254 mm (6 RU)	M6 shelf
89.50 mm (2 RU)	M2 shelf

4.16.2 M2 and M6 Placement Rules

The following rules apply to M2 and M6 chassis placement:

- CTP places one M6 chassis on top of another M6 chassis without any air ramp.
- CTP does not allow an M2 chassis in an MSM configuration. If you force an M2 chassis in an MSM configuration, an error message is displayed.

4.16.3 DCU Placement Rules

The following rules apply to DCU placement:

- CTP places the DCU shelves and DCU units on top of each MSTP optical shelf connected to the entering fiber of the span (or spans) to be compensated.
- If no room is available within the recommended space (for example, during an upgrade), then CTP places the DCU shelves and units in any of the other racks, starting preferably in the same rack as the MSTP optical shelf.
- CTP computes the DCU patchcord length with respect to the preamplifier position, using the same rules as the ones defined for TXP/MXP units.

4.16.4 Fiber Storage Placement Rules

The following rules apply to fiber storage placement:

- If the fiber storage option is flagged as ON/AUTO, CTP places one fiber storage shelf below each MSTP optical shelf.
- If MSTP optical shelves are in different racks, CTP places a fiber storage shelf in each rack with an MSTP optical shelf.

4.16.5 Air Ramp Placement Rules

The following rules apply to air ramp placement:

- An ANSI shelf must always have another ANSI shelf, an air ramp, or an empty space at the bottom of it.
- An ETSI shelf must always have one air ramp on top of it and one air ramp or an empty space at the bottom of it.
- Air ramp is not required on top of the ETSI shelf if the ETSI shelf is placed directly below the PDP in the rack.

CTP automatically adjusts the air ramp placement when changes occur in the layout options.

4.16.6 Patch Panel Placement Rules

The following rules apply to patch panel placement:

- If you choose 15454-PP-64-LC, 15454-PP2-64-LC, or 15454-80-LC-PP-II patch panel, CTP deploys one patch panel for each side in the site.

For example:

- For a C-band /Odd channel terminal equipped with 32-Mux/Demux units: one patch panel shelf
- For a C-band /Odd channel full-OADM: two patch-panel shelves.

CTP places the two patch panel shelves together in the same rack when site protection is disabled and places them in two separate racks when site protection is enabled.

- CTP places the patch panel shelves together on top of the OTS main shelf (under the DCU).
- If the length of the MPO does not allow the patch panels to be together on top of the OTS main shelf (under the DCU shelves), then CTP places the patch panel shelves according to the following rules:
 - ETSI (without node protection)

If the OTS units in both sides can be hosted within one shelf, then the layout is as shown in [Figure 4-17](#).

Figure 4-17 Patch-Panel Placement for ETSI Without Node Protection

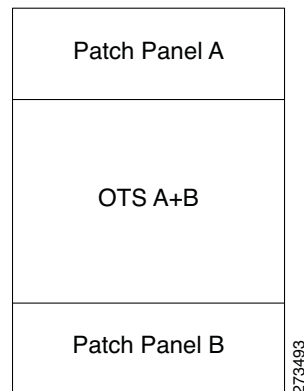

- ANSI and ETSI (without node protection)

If the OTS units on both sides cannot be hosted within one shelf, then the layout is as shown in [Figure 4-18](#).

Figure 4-18 Patch-Panel Placement for ANSI and ETSI Without Node Protection

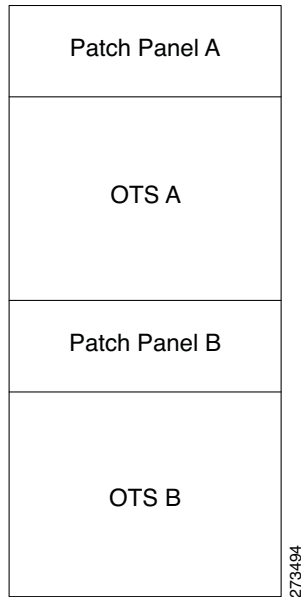

- ANSI and ETSI 3-N degree

For ANSI and ETSI 3-N degree, the layout is as shown in [Figure 4-19](#).

Figure 4-19 Patch-Panel Placement for ANSI and ETSI 3-N Degree

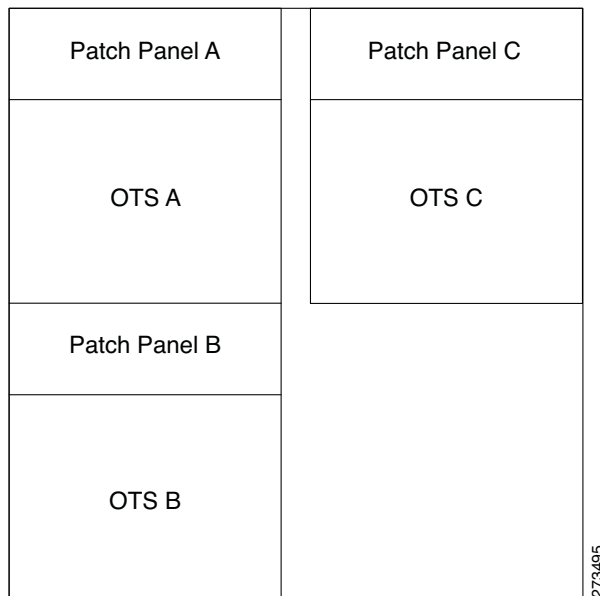

- Side occupying more than one shelf—ANSI

For a side occupying more than one shelf (ANSI), the layout is as shown in [Figure 4-20](#).

Figure 4-20 Patch-Panel Placement—Side Occupying More than One Shelf (ANSI)

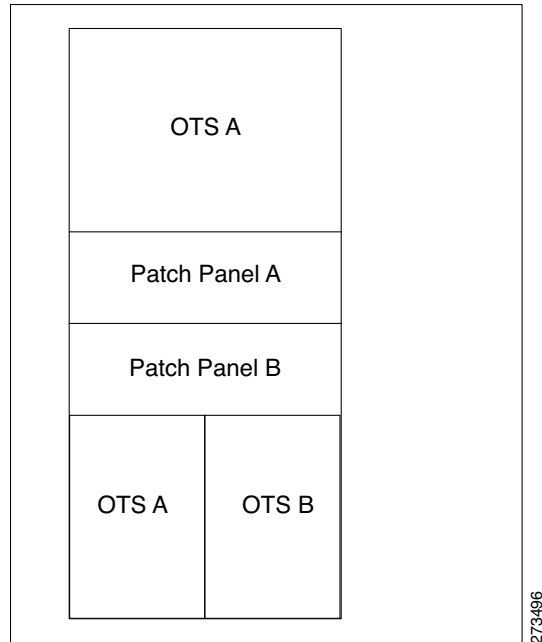

- Side occupying more than one shelf—ETSI

For a side occupying more than one shelf (ETSI), the layout is as shown in [Figure 4-21](#).

Figure 4-21 Patch-Panel Placement—Side Occupying More than One Shelf (ETSI)

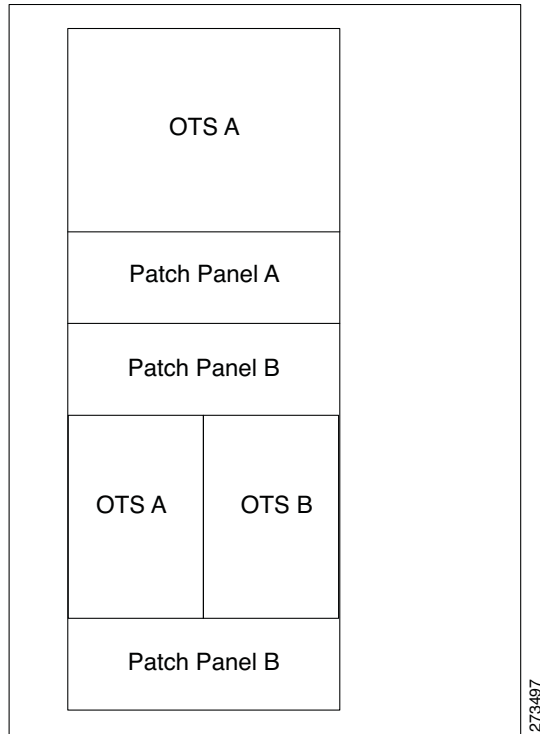

- If the OTS optical units cannot fit in one MSTP optical shelf, then CTP hosts the cards that are connected to the patch panel through MPO cables in the same shelf and places the patch-panel shelf on top of it.

4.16.7 15216-MD-40-ODD/EVEN Unit Placement Rules

The following rules apply to 15216 40-Channel Mux/Demux unit:

- CTP occupies the shelves in the rack from the top, adding the 15216-MD-40-ODD unit as close as possible to the shelf that contains the SMR cards.



Note The SMR card refers to both the 40-SMR1-C and 40-SMR2-C cards.

- CTP automatically selects the 15216-MD-40-ODD as add/drop units for SMR1 and SMR2 card configurations.
- If a rack can accommodate the SMR card but cannot accommodate the 15216-MD-40-ODD unit, then CTP adds a new rack and shelf to accommodate both the SMR card and the 15216-MD-40-ODD unit. CTP ensures that the SMR card and the 15216-MD-40-ODD unit are always placed in the same rack.

- You can move the 15216-MD-40-ODD unit to other shelves, however, a warning message is displayed suggesting that you place the 15216-MD-40-ODD unit as close as possible to the shelf that contains the SMR cards.
- You can manually force the 15216-MD-40-ODD unit with the 15216 FlexLayer Modules (15216 FLB-2, FLA-8, FLD-4, FLD-9, CS-4).
- If you try to manually force the 15216-MD-40-ODD unit into non-SMR site types, an error message is displayed.
- The interleaver-deinterleaver in the 15216-MD-40-ODD unit is not visible in the layout.
- To achieve network optimization, CTP applies the following placement rules based on the maximum channel requirements as defined by the optical subnet design rule. For more information about optical subnet design, see the [“2.4 Creating an Optical Subnet”](#) section on page 2-12.
 - If the maximum channel count is less than or equal to 40, a 15216-MD-40-ODD unit is placed.
 - If the maximum channel count is greater than 40:
 - The traffic has only odd wavelengths, 15216-MD-40-ODD and MD-ID-50 units are placed.
 - The traffic has only even wavelengths, 15216-MD-40-EVEN and MD-ID-50 units are placed.
 - The traffic has both odd and even wavelengths, 15216-MD-40-ODD, 15216-MD-40-EVEN, and MD-ID-50 units are placed.

These placement rules are also applicable to the traffic being dropped at omnidirectional sides. For more information on omnidirectional functionality, see the [“2.7.2 Understanding Omnidirectional Functionality”](#) section on page 2-17.

**Note**

By default, the 15216-MD-40-ODD and 15216-MD-40-EVEN units are used when colored omnidirectional sides are configured with the 80-WXC-C card; whereas the 40-MUX-C and 40-DMX-C cards are used by default to configure colored omnidirectional sides with the 40-WXC-C card.

4.16.8 SMR Placement rules

Following are the placement rules for SMR:

**Note**

SMR refers to both SMR-1 and SMR-2 cards.

- If 15216 40-channel mux/demux units are associated with SMR, they must be placed in the same rack.
- The patch panel used for SMR-2 (SMR PP MESH 4) must be placed above the shelf where the SMR is placed.
- Forced OTS cards (like AMP, BST) are placed first, followed by SMR.
- For a line site, SMR of the first side must be placed left in the shelf and that of the next side must be placed right.
- In the upgrade scenario, if 15216 40-channel mux/demux units are associated with SMR, they must be placed in the same rack, even if there are free slots in the existing shelves. Movement of SMR card to another shelf or rack displays a warning message.

4.16.9 Client Shelf Placement Rules

The following rules apply to client shelf placement:

- Node protection as same shelf:
CTP places the client shelves from the first rack in an optimized manner.
- Node protection as separated shelves:
CTP places the client shelves, with unprotected or 1+1 protected cards, with their respective OTS racks. See [Figure 4-22](#).

Figure 4-22 Client Shelf Placement-Node protection as Separated Shelves

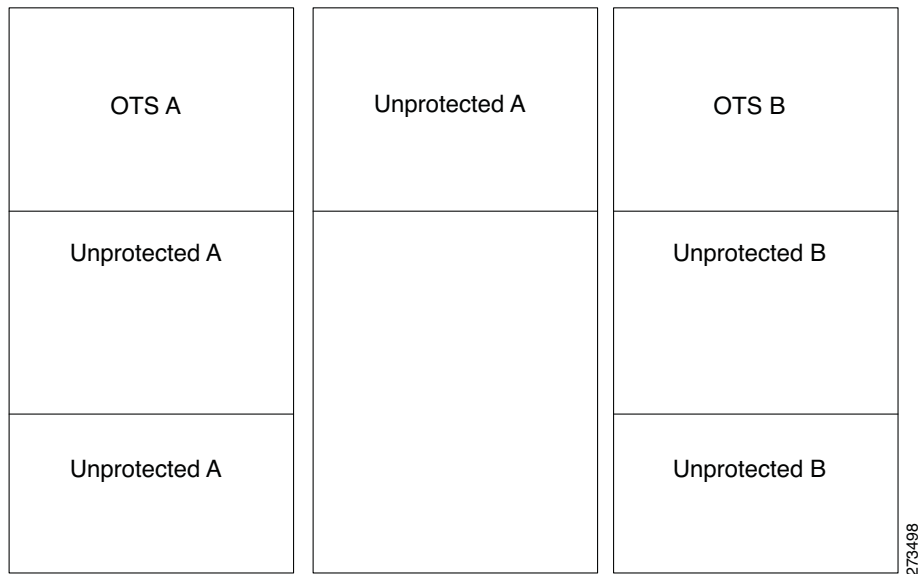

- CTP places the client shelves, filled with protection and aggregated demands, from the first rack in an optimized manner. CTP places these shelves after placing the unprotected or 1+1 protected shelves. CTP places the remaining client shelves, after filling the last OTS side rack, in new racks placed after the last OTS side rack. See [Figure 4-23](#).

Figure 4-23 Client Shelf Placement-Protection and Aggregated Demand

OTS A	Unprotected A	OTS B	Y-Cable
Unprotected A	Y-Cable	Unprotected B	Aggregated Demands
Unprotected A	Aggregated Demands	Unprotected B	

273489

4.16.10 Y-Cable Placement Rules

The following rules apply to Y-cable placement:

- CTP numbers each Y-cable protection module within the Y-cable protection shelf with progressive numbers (1 to n).
- The required number of Y-cable protection modules depends on the number of client ports (on transponders and muxponders) implementing the Y-cable protection within the racks in the site.
- Each Y-cable protection module can only connect transponders within the same rack.
- The shelf containing the Y-cable protection modules can be partially full.
- CTP uses single-mode or multimode Y-cable protection modules depending on the client interface on the transponder implementing the Y-cable protection.
- If a rack cannot physically hold all the Y-cable protection modules required to manage the Y-cable protected transponders, then CTP moves one client shelf (for example, the bottom shelf) to the next rack. If the moved shelf contains Y-cable protected transponders, then CTP moves the related Y-cable protection modules together.
- CTP shifts the shelf if (as mentioned in the previous item) no space is available within the rack to hold the shelves and the Y-cable protection modules required to support both present and future traffic demands.
- A Y-cable protection FlexLayer module (supporting two different Y-cable protection groups) in a rack could be partially unused even if additional shelves equipped with transponders are deployed in a rack that follows in the site.

4.17 Shelf Rules

This section includes the following rules:

- [4.17.1 General Shelf Placement Rules](#)
- [4.17.2 Multishelf Placement Rules](#)
- [4.17.3 M2 and M6 Shelf Placement Rules](#)
- [4.17.4 Alien Shelf Placement Rules](#)
- [4.17.5 OTS Unit Placement Rules](#)
- [4.17.6 Cisco ONS 15216 FlexLayer Unit Placement Rules](#)
- [4.17.7 Controller Cards Placement Rules](#)
- [4.17.8 Client Cards Placement Rules](#)
- [4.17.9 Hybrid Site Layout Constraints](#)
- [4.17.10 DCU - Layout Constraints](#)
- [4.17.11 Multidegree Layout Rules](#)

4.17.1 General Shelf Placement Rules

The following subsections list the general rules for and constraints on card slot placement.

4.17.1.1 Card Slots

Each unit represented in the layout includes the slot occupancy provided in the following lists for one-slot and two-slot units.

- One-slot units:
 - Blank
 - AIC
 - TCC3 or TCC2P
 - T-DCU Fine
 - T-DCU Coarse
 - OSCM, OSC-CSM
 - AD-1C, AD-2C, AD-4C
 - AD-1B, AD-4B
 - 4MD
 - OPT-PRE, OPT-BST, OPT-BST-L, OPT-BST-E
 - AMP-17-C
 - AMP-C
 - 32-DMX
 - 40-DMX-C
 - 40-DMX-E

- 40-MUX-C
- MMU
- PSM
- All the line cards
- All TXP and MXP units
- 10GE-XP
- OTU2-XP
- MS-ISC-100T
- TSC
- TNC
- OPT-EDFA-17
- OPT-EDFA-24
- AR-MXP
- AR-XP
- Two-slot units:
 - 32MUX-O
 - 32DMX-O
 - 32-WSS
 - 40-WXC
 - 80-WXC-C
 - 40-WSS-C
 - 40-WSS-E
 - OPT-AMP-L
 - OPT-RAMP-C
 - OPT-RAMP-CE
 - ADM-10G, GE-XP
 - 40G CP-DQPSK MXP
 - 40G CP-DQPSK ME MXP
 - 40G CP-DQPSK TXP
 - 40G CP-DQPSK ME TXP
- FlexLayer module
 - C/L Band Combiner
- 15216 modules
 - FLB-2
 - FLA-8
 - FLD-4
 - FLD-9
 - SC-4B

- DCU module
 - A DCU module takes half of the DCU shelf space.

4.17.1.2 Card Slot Constraints

- CTP places TCC units in slots 7 or 11. The Generated layout always places both working and standby TCC unit on each shelf.
- CTP places AIC units in slot 9.
- CTP places OSCM units only in slots 8 or 10.
- CTP places MS-ISC-100T units in slots 6 and 12
- CTP places 2.5G and 10G line cards only in slots 5, 6, 12, and 13.
- CTP places TSC or TNC cards in slots 1 and 8 in M6 chassis.
- CTP places TSC or TNC card in slot 1 in M2 chassis.
- CTP replaces the OSCM card with a TNC card when an OSCM card is selected and the chassis type is forced as M2 or M6 (if M2 or M6 chassis placement will make the layout optimized, unless forced).
- CTP places TSC cards as controller cards for the additional M2 or M6 chassis.
- For OSMINE compliance, the CTP does not place any card (if there is no booster placed by algorithm for that side) in slot 2 or in slot 16. CTP places a blank faceplate in slot 2 and 16. If the OTS side contains booster card, it is placed in slot 2 or slot 16.
- CTP places the T-DCU units in slots 1 to 6 and 12 to 17.
- CTP places the RAMAN-CTP and RAMAN-COP units as a pair in either of the adjacent slots 2 and 3, 4 and 5, or 6 and 7 in the M6 chassis.



Note

CTP allows a double slot card movement when the destination has a blank faceplate followed with a single slot card or the destination is a single slot card followed by a blank card.

4.17.2 Multishelf Placement Rules

- Multishelf site aggregate some of shelves that do not hold XC units.
- CTP creates the layout even if the MSTP equipment (for example, OTS and TXP/MXP units, but not ITU line cards) in a site is to be deployed on more than the available number of MSTP shelves. In this case CTP generates the error message, “Generated layout exceeded the maximum number of shelves in a multishelf site”.
- The MSTP and MSPP (line card) shelves can be placed on the same rack even if MSPP shelves cannot be part of the multishelf management.
- By default, CTP designates the OTS optical shelf in rack number 1 as the Node Controller (NC).
- The software running on the node assigns a shelf number when a subtended shelf is registered to the NC. You can assign any of the available numbers in the allowed range [1 to 8]. The numbers do not have to be consecutive.
- The maximum number of shelves in a multishelf configuration are:
 - 8 when using a multishelf integrated switch

- 12 when using a multishelf external switch

The following subsections list the placement rules for different types of multishelf configurations.

4.17.2.1 Auto

When the Shelf Management parameter is set to Auto:

- If the node controller is an M6, external switch is placed when:
Total number of shelves $> (2 * M6) + 1$
where
 $M6 = \text{Number of Cisco ONS 15454 M6 shelves}$
The number of external switches placed depend on the number of shelves exceeding the value $(2 * M6) + 1$.
- If the node controller is an M12, external switch is placed by default.
CTP adds additional external switches when:
Total number of shelves $> (\text{total number of shelves subtended by the first switch}) + (M6 * 2)$

4.17.2.2 Multishelf Integrated Switch

When the Shelf Management parameter is set to Multi Shelf Integrated:

- The LAN architecture of different MSTP shelves is implemented using the Cisco ONS 15454 MS-ISC-100T cards.
- To cope with TCC redundancy and to guarantee multishelf LAN reliability, the Cisco ONS 15454 MS-ISC-100T cards are redundant (connected to both the active and standby TCC units).
- CTP places both the Cisco ONS 15454 MS-ISC-100T cards in the node controller shelf.
- CTP places the Cisco ONS 15454 MS-ISC-100T cards in slots 6 and 12.
- If the node controller is an M6:
 - CTP does not place an external switch.
 - Total shelves that can be subtended $= (M6 * 2) + 1$.
- If the node controller is an M12:
 - CTP does not place an external switch.
 - CTP places Cisco ONS 15454 MS-ISC-100T card on the node controller chassis.
 - Total shelves that can be subtended $= (M6 * 2) + 8$.

4.17.2.3 Multishelf External Switch

When the Shelf Management parameter is set to Multi Shelf External:

- The LAN architecture of different MSTP shelves is implemented using Catalyst 2950G-24-EI-DC units.
- To cope with TCC redundancy and to guarantee multishelf LAN reliability, Catalyst 2950G-24-EI-DC units are redundant (connected to both the active and standby TCC units).
- CTP places both Catalyst 2950G-24-EI-DC units on the same rack of the Node Controller (NC) shelf.

- If the node controller is an M6:
 - The Multi Shelf External Switch is placed in the layout irrespective of the node controller.
 - Additional external switches are placed when
Total number of shelves > (total number of shelves subtended by the first switch) + (M6 * 2)
- If the node controller is an M12:
 - External switch is placed by default.
 - Additional external switches are placed when
Total number of shelves > (total number of shelves subtended by the first switch) + (M6 * 2)

4.17.2.4 Shelf Management in Upgraded or Release-Upgraded Network

The following rules apply for Shelf Management on upgraded or release-upgraded network with layout in locked state:

- When the Shelf Management configuration type is Auto:
 - If the M12 chassis is the node controller and the MS-ISC card is placed in the layout—On upgrading the network if the layout cannot accommodate all the subtended shelves added, then the Multi Shelf External Switch (Cisco Catalyst 3650) is placed in the layout.
 - If M6 chassis is the node controller and there is no Multi Shelf External Switch placed—On upgrading the network if the number of the M6 chassis cannot support all the shelves, then the Multi Shelf External Switch is placed in the layout.
- When the Shelf Management configuration type is Multi Shelf Integrated:
 - If M12 chassis is the node controller and the MS-ISC cards are placed in the layout—On upgrading the network if the layout cannot accommodate all the subtended shelves, then CTP displays an error message.
 - If M6 chassis is the node controller—On upgrading the network if the M6 chassis cannot support all the subtended shelves, then CTP displays an error message.
- When the Shelf Management configuration type is Multi Shelf External Switch:
 - If the Cisco Catalyst 2950 is placed in the base network—On upgrading the network if the Cisco Catalyst 2950 cannot subtend all the shelves, then the Cisco Catalyst 3650 is placed in addition to the Cisco Catalyst 2950 in the layout.

4.17.2.5 Multishelf Separate Shelves

CTP orders the racks by first placing all the units facing one side and then all the other units facing the other side.

4.17.2.6 Multishelf Separate Nodes

- If the site functionality is not ROADM or OADM, CTP displays the following warning message at the end of the network analysis:

“Separate nodes are allowed on ROADM/OADM sites only and cannot be applied to Site 'x’”
- If the site functionality is ROADM or OADM, CTP orders the rack by first placing all the units facing one side and then all the other units facing the other side.

- For OIC nodes with multishelf configuration, all the sides are placed in the layout in an optimized manner (like OXC). The entire site is considered as one Network Element. Two MSISC cards or two CAT switches are used in this configuration.
- For OIC node with individual shelf configuration, each degree is considered as one Network Element and each side is placed in separate racks and shelves. MSISC cards or CAT switches are not used in this configuration.

4.17.3 M2 and M6 Shelf Placement Rules

- CTP places OSC-CSM card in an M6 shelf when the M6 shelf is used as an OSC regenerator site.
- CTP chooses the following:
 - TNC card as the node controller for an M6 shelf
 - TNC card for OTS shelves
 - TSC card if OSC card is not required
 - TSC card for all the client shelves
 - TSC card for sites with DCN extension
 - TSC card as the node controller if OSC-CSM card is required
- CTP does not support a combination of TSC and TNC cards in an M6 shelf
- CTP does not support the following cards on an M6 shelf:
 - AIC
 - AIC-I
 - OSCM
 - ISC



Note CTP does not allow the use of M2 chassis in an MSM configuration.

4.17.4 Alien Shelf Placement Rules

Following are the placement rules for alien shelves:

- Alien shelves are added to the rack after all the other shelves are added.
They are added to the first available rack with free space equal to or greater than the alien shelf height.
- All the alien shelves in a site must have the same height and name.
- Different sites can have different alien shelf height and name.
- Height of the alien shelf should be less than that of the rack height.
- Number of alien shelves can vary based on the alien shelf height. Maximum number of alien shelves that can be added is 600, if the alien shelf height is 1 Rack Unit (RU) and there are no other shelves.
- Product-IDs are not assigned to the alien shelves.
- Alien shelves are not be added to the BoM.

4.17.5 OTS Unit Placement Rules

This section includes the following topics:

- [4.17.5.1 Shelf Placement Rules](#)
- [4.17.5.2 PSM Card Placement Rules](#)

4.17.5.1 Shelf Placement Rules

The following subsections provide the placement rules for the different types of shelf configurations.

- CTP places the sides in alphabetical order in the shelves. This order is broken only for the purpose of optimisation.

For example, if sides A and C takes exactly half the shelf and B takes more than half, then the A and B sides do not go in the same shelf. CTP places A and C in the same shelf for the purpose of optimization and places B in the next shelf.

- CTP places the optical units within the OTS optical shelves by following the optical signal flow. However, for OSMINE designs, CTP places the MMU unit last to keep 32-WSS/Mux units adjacent to 32-Demux units.

For example: Booster or OSC-CSM->Preamplifier->WXC->WSS or Mux ->Demux or A/D filters

To optimize slot occupancy, this order can be changed (for example, Demux before WSS when a single slot is free in the left side).

- If the OPT-RAMP-C or the OPT-RAMP-CE unit is present, it must fill the outer slots (1 to 2 or 16 to 17).
- CTP places the TDC units (TDCU- FC and TDCU-CC) in slots 1 to 6 and 12 to 17.

Individual Shelf

- All OTS optical units (except for TXP/MXP or line card) reside in one shelf.
- CTP places TXP/MXP (or ITU line card depending on the hybrid parameter setting) units in the free slots in the OTS optical shelf.
- If all the OTS units cannot be placed within the OTS shelf, then CTP generates the following error message:

“Layout not feasible for {0} Individual Shelf configuration - No room in the optical shelf to host all the OTS units”.

Individual Shelf and Multishelf (Same Shelf)

- CTP places the optical units facing side A on the left side of the shelf and the optical units facing side B on the right side of the shelf.
- If one side of the shelf is full but more units (for example, add/drop filters) need to be placed within the shelf, then CTP uses the empty slots on the other side.

Individual Shelf and Multishelf (Both Same Shelf and Separate Shelves)

- For line sites, CTP places the OSC unit, the preamplifier, and the booster units facing side A on the left side of the shelf and places the OSC unit, the preamplifier, and the booster units facing side B on the right side of the shelf.

The same placement applies for multidegree sites if both A and B units fit into one shelf (a half shelf for A and a half shelf for B).

- If a side requires more than a half shelf, CTP places the units from left to right.

Multishelf Same Shelf

- CTP places all the OTS optical units apart from a 4MD unit in a single OTS optical shelf.
- CTP places the additional 4MD unit that could not be placed within the first shelf in the second shelf.

Multishelf Separate Shelves

- CTP places all MSTP units facing one side and all MSTP units facing other side in separate racks.
- CTP places all optical units facing one side in a single OTS optical shelf.
- For terminal and line sites, CTP places units facing one side from left to right and the units facing the other side from right to left
- Shelf numbers are assigned in the following order:
 - Increasing number to all OTS shelves, from the first side to the last side.
 - Increasing number to all client shelves, from the first side to the last side.

4.17.5.2 PSM Card Placement Rules

- With OCH protection, CTP places PSM cards anywhere in the service slots but preferably next to the related TXP/MXP unit.
- With line protection, CTP places PSM cards before any other card in the slots 1 or 17.
- With section protection, CTP places PSM card next to the PRE.

4.17.6 Cisco ONS 15216 FlexLayer Unit Placement Rules

These are the Cisco ONS 15216 FlexLayer unit placement rules:

- CTP places the FLB-2, FLA-8, FLD-4, FLD-9, and Cisco ONS 15216-MD-40-ODD units in FlexLayer shelves.
- The FLD-4 units are placed on the rack along with the other units specific to that side.
- The FLA-2 and FLA-8 add/drop units are placed next to each other.
- The Cisco ONS 15216 shelf accommodates four cards. The cards cannot be moved within the shelf or across the shelves.
- CTP places the FLD-4 units in all the four slots in the sequence—Top-Left, Bottom-Left, Top-Right, and Bottom-Right.
- CTP does not place the FLD-4 units automatically. The FLD-4 units have to be forced by configuring the OADM Forcing property on each side of the node.
- CTP places FLD-9 optical insulators in the two 1 RU slots, starting first with the left slots and then the right slots.

- If the Cisco ONS 15216-MD-40-ODD unit is used, CTP places the Cisco ONS 15216 shelf near the Cisco ONS 15216-MD-40-ODD shelf.
- If the EAD colorless ports of the 80-WXC-C cards are configured as demux units and protected by optical insulators, CTP places the FlexLayer shelf as close to the 80-WXC-C demux units, immediately after any required air ramp.

4.17.7 Controller Cards Placement Rules

These are the controller card placement rules for an M12 shelf.

- By default, CTP places TCC3 controller cards when an unlocked network is analyzed.
- If a locked network is analyzed, any existing TCC2P card is not replaced with a TCC3 card.
- TCC3 cards are placed in any new M12 chassis being added in a locked network. No changes are made to the existing M12 chassis with TCC2P controller card.

4.17.8 Client Cards Placement Rules

This section consists of the following topics:

- [4.17.8.1 Node Placement Rules](#)
- [4.17.8.2 Manual Regeneration Rules](#)
- [4.17.8.3 OTU2_XP Card Placement Rules](#)
- [4.17.8.4 AR-MXP and AR-XP Card Placement Rules](#)
- [4.17.8.5 TXP/MXP and ITU Line Card Placement Rules](#)
- [4.17.8.6 Transponder and Muxponder Card Placement Rules](#)

4.17.8.1 Node Placement Rules

The following subsections provide the placement rules for different types of node configurations.

Non-Multidegree Node

CTP places the side A card in the left half of the shelf and the side B card in the right half of the shelf.

Multidegree Node

CTP places the client cards from the available space in the left half of the shelf and then in the right half of the shelf.

Node Protection as Same Shelf

CTP places the client cards from the first available shelf in an optimized manner.

Node Protection as Separate Shelves:

CTP places the unprotected and 1+1 protected client cards in respective OTS racks. CTP places all the unprotected and 1+1 protected client cards before placing the next OTS side cards.

CTP places the protection and aggregated cards after placing all the OTS, unprotected, and 1+1 protection cards. The protection and aggregated cards do not follow any specific placement rule. So CTP places them in the available space in the OTS shelf, then in existing client shelves (unprotected and 1+1 shelves), and then in new client shelves.

4.17.8.2 Manual Regeneration Rules

The following subsection provide the placement rules for manual regeneration.

- CTP places a pair of back-to-back transponders in the same shelf whenever possible. However, CTP does not add an additional shelf so that the transponder/muxponder pair of units can be in the same shelf.
- With node protection as separate shelves, the two cards can be placed in their respective OTS side racks, but if free space is available in the other side of the OTS rack, the cards are placed there first before a new shelf is created.

4.17.8.3 OTU2_XP Card Placement Rules

The following subsection provide the placement rules for OTU2_XP card.

Transponder Mode

- If the card is used in transponder mode and if both trunk have the same side, then CTP places the card in the same side of the OTS rack.
- If the trunks have two different sides, then CTP places the card in any available space in an optimized manner.

Regen Mode

With separate shelves, the trunks are connected to two different sides, so they will always be placed in available space in an optimized manner.

Mixed Mode

For cards that have TXP and Regen mode in two different trunks, CTP follows the rules for the mode with the more-specific rules and places the cards in an optimized manner.

Splitter

Because this feature is the same as fiber switched, CTP follows the rules for fiber-switched cards placed in any available space in an optimized manner.

Y-cable

The existing Y-cable client card placement rules are followed. The pair is placed in the same shelf.

4.17.8.4 AR-MXP and AR-XP Card Placement Rules

The following subsections provide the placement rules for AR-MXP and AR-XP cards.

TXP_MR, TXPP_MR, MXP_MR, MXPP_MR, MXP_DME, MXPP_DME, MXP-4x2.5-10G, and MXPP-4x2.5-10G Card Modes

- If the card is used in transponder mode and if both trunks have the same side, then CTP places the card in the same side of the OTS rack.
- If the trunks have two different sides, then CTP places the card in any available space in an optimized manner.
- If the trunks have only one side, CTP places the card where the side is assigned.

RGN_10G Mode

With separate shelves, the trunks are connected to two different sides, so they are placed in any available space in an optimized manner.

Splitter

Because this feature is the same as fiber-switched, CTP follows the rules for fiber-switched cards placed in any available space in an optimized manner.

Y-cable

The existing Y-cable client card placement rules are followed. The pair is placed in the same shelf.

4.17.8.5 TXP/MXP and ITU Line Card Placement Rules

The following subsection provide the placement rules for TXP/MXP and ITU line cards.

- CTP places the TXP/MXP unit (or ITU line card for a hybrid site) by first filling the empty slots in the OTS optical shelves and then the slots in the following shelves.
- The site-protection option affects placement rules for both MSTP and MSPP units (line cards) even if MSPP shelves are not managed by the system in the multi-shelf site.
- If an MXP unit supports both protected and unprotected channels, CTP applies the rules for protected MXP channel.
- CTP places TXP/MXP units that implement fiber-switched protection in any rack in order to minimize the number of shelves.
- CTP places each of the transponders included in a fiber-switched protection site on either the left or right shelf side in order to fill the empty slots.
- By default, CTP uses side A to place Y-cable client interfaces within shelves in the racks. If the rack using side B is filled but can host n additional shelves, and an additional side A rack hosting only Y-cable client units has been added, then if the number of these client unit shelves is $\leq n$ these shelves are moved to the side B rack.
- CTP places the MSPP line cards in M12 chassis irrespective of the chassis type selected.
- With multishelf node protection, all the units facing a different side are placed in different racks (even with multidegree nodes) with the exception of units (TXP/MXP) that need to be placed in the same shelf to support required functionality (for example, Y-cable protection units or 1+1 line cards).

TXP/Line Card Placement (OSMINE Noncompliant)

- Y-cable Protection

TXP/MXP units that are part of a Y-cable protection sites are placed within the same shelf, but the unit facing side A is preferably placed on the left side of the shelf (slots 1 to 6) the unit facing side B is preferably placed on the right side of the shelf (slots 12 to 17).
- Individual Shelf and Multishelf Side A and B Same Shelf
 - 1+1 Client Protection:

CTP places TXP/MXP units or line cards that are part of a 1+1 client protection within the same shelf, but the unit facing side A is placed on the left side of the shelf (slots 1 to 6) and the unit facing side B is placed on the right side of the shelf (slots 12 to 17).
 - Unprotected Transponder or Line Card.

CTP places TXP/MXP units and line cards related to side A traffic in the left side of the shelf (slots 1 to 6) and the transponders and line cards related to side B traffic in the right side of the shelf (slots 12 to 17). If side A and side B have a different number of added or dropped channels, then CTP places the remaining client boards (transponder or line card) to fill remaining available slots even if they are not on the preferred side of the shelf.
- Multishelf Side A and Side B Separate Shelves
 - 1+1 Client Protection:
 - TXP/MXP

For TXP/MXP units that are part of a 1+1 client protection site, CTP places the client unit facing side A in the shelf of the unit facing side A and the client unit facing side B in the shelf of the units facing side B.
 - Line Card

For line cards that are part of a 1+1 client protection site, CTP places both units in the same shelf (the switch is done by XC). The unit facing side A is on the left side of the shelf (slots 1 to 6) the unit facing side B is on the right side of the shelf (slots 12 to 17).
 - Unprotected Transponder or Line Cards

CTP places TXP/MXP units and line cards facing side A in the shelf of the appropriate rack as defined in the previous bullet item, but fills all the slots of the shelf.

TXP/Line Card Placement (OSMINE Compliant)

- 1+1, Y-cable Protected Transponder or Line Card

CTP places each transponder or line card that is involved in a Client 1+1 or Y-cable protection group in adjacent slots. In a protection group, CTP places the TXP/MXP facing side A in the left slot and the TXP/MXP facing side B in the right slot.
- Unprotected Transponder or Line Card

CTP places TXP/MXP units or line card facing side A in the shelf of the appropriate rack as defined in the previous bullet item, but fills all the slots of the shelf.

4.17.8.6 Transponder and Muxponder Card Placement Rules

- In an ADM single-card configuration with node protection as same shelf, CTP places the card in an optimized manner. CTP looks for space in all OTS shelves, then in the existing client shelves, and then creates a new shelf if needed.

- In an ADM single-card configuration with node protection as separate shelves, if the trunks use same side (for example, A,A), then CTP places the card in the respective OTS side rack. If the trunks use different sides (A,B), CTP places the card in any shelf or rack in an optimized manner.

4.17.9 Hybrid Site Layout Constraints

- For a site flagged as a Hybrid node configuration, CTP does not place either the XC or SONET/SDH units and displays the following message:

“The generated BOM does not include SONET/SDH units.”

- For a site with an individual shelf and flagged as a Hybrid Node configuration, when the resulting site type does not allow placing all the (OTS optical) units within the OTS shelf, then CTP displays the following error message:

“Hybrid layout not feasible for <SiteX> - Resulting NE Site Type configuration xxxx (e.g. AUTO [A/D])”

- CTP does not place an ADM-10G card in a shelf with a line card even when Hybrid Site configuration is enabled.

4.17.10 DCU - Layout Constraints

- For multishelf site protection configurations, each DCU shelf containing DCU modules that compensates for the chromatic dispersion of fiber entering in one side is placed in the same rack of the MSTP optical shelf as the one holding units facing on that side.

For example, CTP places the side A DCU shelf and side A DCU units in the same rack as the one holding the MSTP optical shelf with units facing side A.

- For configurations with an individual shelf or no site protection, the CTP places the DCU shelves in the same rack as the one holding the MSTP optical shelf.
- CTP places the DCU units within the shelf as follows:

- In general, the DCU faces side A on the left side of the DCU shelf and the DCU faces side B on the right side of the DCU shelf.
- If two DCU units are required on one side and no DCU units are required on the other side, then CTP places both units within the same DCU shelf.

The following examples are for various DCU shelf configuration:

Example 1: DCU side A | DCU side B

Example 2: DCU side A | DCU side A

Example 3:

Upper shelf: DCU side A | Empty

Lower shelf: DCU side A | DCU side B

- DCUs for side A are placed from top to bottom, from left to right.
- DCUs for side B are placed from top to bottom, from left to right.

4.17.11 Multidegree Layout Rules

This section consists of the following topics:

- [4.17.11.1 General OTS Units Placement Rules](#)
- [4.17.11.2 OXC Multidegree Layout Rules](#)
- [4.17.11.3 OIC Multidegree Layout Rules](#)

4.17.11.1 General OTS Units Placement Rules

The following subsections provide placement rules for different types of unit configurations.

- Each “half shelf” gets a different default side ID if side B holds a card that can be part of the side object (a card connected to the span).
- The software running on the node (the patch-cord manager) moves shelf by shelf from shelf ID = 1 to shelf ID = 8 and from slots 1 to 6 to slots 12 to 17 (even on the right side of the shelf the order is always left to right). For each half shelf, each time the software finds a unit that is part of a side object, it automatically assigns a side ID to all the units within that half shelf (starting from side A and incrementing each ID).
- The side ID is not incremented if the patch-cord manager finds an empty half shelf or an half shelf that does not hold a card that can be part of the side object.
- The side ID is not maintained when moving cards from one shelf to another.
- If the patch-cord manager finds a user-defined (or NE update-defined) side ID, it uses the assigned label for that side. The next side encountered is labeled as user side ID +1.
- For multidegree nodes without node protection, the layout algorithm fills each half shelf with units starting from the outside to the inside of the shelf.

OTS unit placement (without node protection)

- For each side, the layout algorithm starts placing all the OTS units of one side within the first free half-shelf. If no free half shelf is found, then a new shelf is added to the layout.
- If the OTS unit of one side cannot be hosted within a half shelf, then the following cases are possible:
 - If the second half of the same shelf is empty, then the remaining units of current side are placed within the second half shelf.
 - If the second half of the shelf is not available, then this half shelf is unused for holding OTS units of this side, and all the OTS units of this side are moved to a new empty shelf. Empty half shelves can be filled with remaining OTS units of first side that can be placed within an half shelf.
- OTS units of different sides cannot be placed within the same half shelf. If half shelf is only partially filled with OTS cards, then the remaining slots are filled with client cards (transponders).

OTS unit placement (with node protection)

With node protection, a different shelf or rack must be used for each side of the unit.

Client unit placement

- If an OTS shelf or half shelf has empty slots, the layout algorithm starts filling the empty slots with client cards of that side.

- For a multishelf site without node protection, if no other client card of the OTS side is placed (due to some additional constraint such as OSMINE) within this shelf, then any other client card of any other side is placed in the empty slot.

Y-cable protected unit placement (same shelf and separated shelves):

Client pairs are deployed (both in the same shelf) using the following criteria:

- A and B sides (A left, B right)
- A and C sides (A left, C right)
- B and C sides (B left, C right)
- B and D sides (B left, D right)

The goal is to optimize shelf occupancy, so available slots in existing shelves are used first, then new shelves are created if needed.

1+1 protected unit placement

- Same shelf:

Client pairs are deployed (both in the same shelf) using the following criteria:

- A and B sides (A left, B right)
- A and C sides (A left, C right)
- B and C sides (B left, C right)
- B and D sides (B left, D right)

The goal is to optimize shelf occupancy, so available slots in existing shelves are used first, then new shelves are created if needed.

- Separate shelves:

Each client is deployed in a rack related to its own side.

The goal is to optimize shelf occupancy, so available slots in existing shelves are used first, then new shelves are created if needed.

DCU unit placement

- In a multidegree node site, CTP places the DCU units for a side within the same rack that contains the OTS unit shelf for that side.
- In an unlocked rack layout, CTP places the DCU shelves in a rack with each one above the related OTS shelf.
- In an unlocked rack layout, CTP places the DCU units to use the optimal number of DCU shelves.
- CTP places the DCU units for each side starting from the first free slot in the existing DCU shelf, and then adding a new DCU shelf when no space is available.

4.17.11.2 OXC Multidegree Layout Rules

- OXC multidegree sites are supported with multishelf only.
- The following message appears if an OXC multidegree site with single shelf is selected: “Multi Shelf management is required for OXC MultiDegree Site site name”

4.17.11.3 OIC Multidegree Layout Rules

From Release 9.1 onwards, for OIC nodes with multishelf configuration, all the sides are placed in the layout in an optimized manner (like OXC). The entire site is considered as one Network Element. Two MSISC cards or two CAT switches are used in this configuration.

For OIC node with individual shelf configuration, each degree is considered as one Network Element and each side is placed in separate racks and shelves. MSISC cards or CAT switches are not used in this configuration.

4.18 Card Rules

This section includes the following rules:

- [4.18.1 AR-MXP and AR-XP Card Constraints](#)
- [4.18.2 AR-MXP and AR-XP Card Operational Modes](#)
- [4.18.3 AR-MXP and AR-XP Card Client-Payloads](#)

4.18.1 AR-MXP and AR-XP Card Constraints

This section lists AR-MXP and AR-XP card constraints.

- AR-MXP and AR-XP cards are supported only in Point-to-Point, P-Ring, and ROADM demands.
- AR-MXP and AR-XP cards do not interoperate with the following cards:
 - MXP-MR-10DME
 - MXPP-MR-10DME
 - MXP_MR_2.5G
 - MXPP_MR_2.5G
 - TXPP_MR_2.5G
 - GE_XP card
 - 10GE_XP card
 - ADM-10G card
- AR-XP card supports a maximum bandwidth of 20 Gbps.
- AR-MXP card supports a maximum bandwidth of 10 Gbps.
- In the AR-MXP card, if any of the SFP ports are aggregated to any of the XFP port, the other XFP port cannot be used.
- AR-MXP card supports a maximum of four OTU1 trunk ports or one OTU2 trunk port.
- AR-MXP card does not support MXP-VAD-10G (High Rate) operation mode.

4.18.2 AR-MXP and AR-XP Card Operational Modes

Table 4-5 provides a list of operational modes supported by AR-MXP and AR-XP cards.

Table 4-5 Operational modes supported by AR-MXP and AR-XP cards

Card Mode	Rate	AR-XP	AR-MXP
TXP_MR (Unprotected Transponder)	High Rate	Yes	Yes
	Low Rate	Yes	Yes
TXPP_MR (Protected Transponder)	Low Rate	Yes	Yes
MXP_DME (Unprotected Data Muxponder)	High Rate	Yes	Yes
MXPP_DME (Protected Data Muxponder)	High Rate	No	Yes
	Low Rate	No	No
MXP_MR (Unprotected Multi-Rate Muxponder)	High Rate	Yes	Yes
	Low Rate	Yes	Yes
MXPP_MR (Protected Multi-Rate Muxponder)	High Rate	No	Yes
	Low Rate	Yes	Yes
MXP-4x2.5-10G (OC48/OTU1 Unprotected Muxponder)	High Rate	Yes	Yes
MXPP-4x2.5-10G (OC48/OTU1 Protected Muxponder)	High Rate	No	Yes
RGN_10G (OTU2 Regenerator)	High Rate	Yes	Yes
RGN_2.5G (OTU1 Regenerator)	Low Rate	Yes	Yes
MXP-VDC-10G (Video Muxponder)	High Rate	No	Yes

4.18.3 AR-MXP and AR-XP Card Client-Payloads

Table 4-6 provides client-payload mapping supported by AR-MXP and AR-XP cards.

Table 4-6 AR-MXP and AR-XP Card Supported Client-Payload Mapping—SONET/SDH, Ethernet, OTU1, and FC

Card Mode	Rate	SONET/SDH			Ethernet			OTU1	FC				
		OC3/ STM1	OC12/ STM4	OC48/ STM16	FE	GE	10GE/ OTU2	OTU1	FICON1G/ FC1G	FICON2G/ FC2G	FICON4G/ FC4G	FICON8G/ FC8G	ESCO N
TXP_MR	LOW	Yes	Yes	Yes	Yes	Yes	No	No	Yes	Yes	Yes	No	Yes
	HIGH	No	No	No	No	No	No	No	No	No	No	Yes	No
TXPP_MR	LOW	Yes	Yes	Yes	Yes	Yes	No	No	Yes	Yes	Yes	No	Yes
	HIGH	No	No	No	No	No	No	No	No	No	No	No	No
MXP_DME	HIGH	No	No	No	No	Yes	No	No	Yes	Yes	Yes	No	No
MXPP_DME	HIGH	No	No	No	No	Yes	No	No	Yes	Yes	Yes	No	No
MXP_MR	LOW	Yes	Yes	No	Yes	Yes	No	No	Yes	No	No	No	Yes
	HIGH	Yes	Yes	Yes	Yes	Yes	No	Yes	Yes	Yes	Yes	No	Yes
MXPP-MR	LOW	Yes	Yes	No	Yes	Yes	No	No	Yes	No	No	No	Yes
	HIGH	Yes	Yes	Yes	Yes	Yes	No	Yes	Yes	Yes	Yes	No	Yes
MXP-4x2.5-10G	HIGH	No	No	Yes	No	No	No	Yes	No	No	No	No	No
MXPP-4x2.5-10G	HIGH	No	No	Yes	No	No	No	Yes	No	No	No	No	No
MXP-VD-10G	HIGH	No	No	No	No	No	No	No	No	No	No	No	No
RGN_10G	HIGH	No	No	No	No	No	Yes	No	No	No	No	No	No
RGN_2.5G	LOW	No	No	No	No	No	No	Yes	No	No	No	No	No

Table 4-7 AR-MXP and AR-XP Card Supported Client-Payload Mapping—ISC and Video

Card Mode	Rate	ISC			Video		
		ISC-1	ISC3_S TP_1G	ISC3_S TP_2G	SD-SDI	HD-SDI	3G-SDI
TXP_MR	LOW	No	Yes	Yes	No	No	No
	HIGH	No	No	No	No	No	No
TXPP_MR	LOW	No	Yes	Yes	No	No	No
	HIGH	No	No	No	No	No	No
MXP_DME	HIGH	No	No	No	No	No	No
MXPP_DME	HIGH	No	No	No	No	No	No
MXP_MR	LOW	No	No	No	No	No	No
	HIGH	No	No	No	Yes	Yes	No
MXPP-MR	LOW	No	No	No	No	No	No
	HIGH	No	No	No	Yes	Yes	No
MXP-4x2.5-10G	HIGH	No	No	No	No	No	No
MXPP-4x2.5-10G	HIGH	No	No	No	No	No	No
MXP-VD-10G	HIGH	No	No	No	No	No	Yes
RGN_10G	HIGH	No	No	No	No	No	No
RGN_2.5G	LOW	No	No	No	No	No	No

4.18.4 AR-MXP and AR-MXP Card Mode–Port Restrictions

Table 4-8 lists card mode–port restrictions for the AR-MXP card.

Table 4-8 Card Mode–Port Mapping for AR-MXP Card

AR-MXP Configurations			Operational Mode Instance – 1		Operational Mode Instance – 2		Operational Mode Instance – 3		Operational Mode Instance – 4	
Operational Mode	Rate	Client : Trunk Mapping	Client Port(s)	Trunk Port(s)	Client Port(s)	Trunk Port(s)	Client Port(s)	Trunk Port(s)	Client Port(s)	Trunk Port(s)
TXP-MR	LOW	1 : 1	4	8	3	7	2 ¹	6 ¹	1 ¹	5 ¹
	HIGH	1 : 1	9	10	—	—	—	—	—	—
TXPP-MR	LOW	1 : 2	1	5,6	2 ¹	7,8 ¹	—	—	—	—
	HIGH	NIL	—	—	—	—	—	—	—	—
MXP-DME	HIGH	4 : 1	1 to 4	9	5 to 8	10	—	—	—	—
		8 : 1	1 to 8	9	—	—	—	—	—	—
MXP-MR	LOW	N : 2 (N=2,3,4,5,6,7)	D ²	5 or 6	D ²	7 or 8	—	—	—	—
	HIGH	N : 1 (N=2,3,4,5,6,7 or 8)	D ²	9	—	—	—	—	—	—
MXPP-MR	LOW	N : 2 (N=2,3,4,5,6)	D ²	5,6	D ²	7,8	—	—	—	—
	HIGH	N : 2 (N=2,3,4,5,6,7,8)	D ²	9,10	—	—	—	—	—	—
MXP-4x2.5-10G	HIGH	4 : 1	1 to 4-> or 5 to 8->	9 or 10	—	—	—	—	—	—
MXPP-4x2.5-10G	HIGH	4 : 2	1 to 4-> or 5 to 8->	9,10	—	—	—	—	—	—
MXP-VAD-10G	HIGH	3 : 1	1 to 3	9	—	—	—	—	—	—
RGN-10G	HIGH	1 : 1	9	10	—	—	—	—	—	—
RGN-2.5G	LOW	1 : 1	4	8	3	7	2 ¹	6 ¹	1 ¹	5 ¹

1. Not supported if the adjacent AR-MXP cards use OTU1 as client ports.
2. D = dynamic mapping of client ports.

Table 4-9 lists card mode–port restrictions for the AR-XP card.

Table 4-9 Card Mode–Port Mapping for AR-XP Card

AR-XP Configurations			Operational Mode Instance – 1		Operational Mode Instance – 2		Operational Mode Instance – 3		Operational Mode Instance – 4	
Card Mode	Rate	Client : Trunk Mapping	Client Port(s)	Trunk Port(s)	Client Port(s)	Trunk Port(s)	Client Port(s)	Trunk Port(s)	Client Port(s)	Trunk Port(s)
TXP-MR	LOW	1 : 1	4	8	3	7	2	6	1	5
	HIGH	1 : 1	9	10	—	—	—	—	—	—
TXPP-MR	LOW	1 : 2	1	5,6	2	7,8	—	—	—	—
	HIGH	NIL	—	—	—	—	—	—	—	—
MXP-DME	HIGH	4 : 1	1 to 4	9	5 to 8	10	—	—	—	—
		8 : 1	1 to 8	9	—	—	—	—	—	—
MXPP-DME	HIGH	8 : 2	1 to 8	9,10	—	—	—	—	—	—
MXP-MR	LOW	N : 2 (N=2 to 7)	D ¹	5 or 6	D ¹	7 or 8	—	—	—	—
	HIGH	N : 1 (N=2 to 8)	D ¹	9	D ¹	10	—	—	—	—
MXPP-MR	LOW	N : 2 (N=2 to 6)	D ¹	5,6	D ¹	7,8	—	—	—	—
	HIGH	N : 2 (N=2 to 8)	D ¹	9,10	—	—	—	—	—	—
MXP-4x2.5-10G	HIGH	4 : 1	1 to 4	9	5 to 8	10	—	—	—	—
MXPP-4x2.5-10G	HIGH	4 : 2	1 to 4 or 5 to 8	9,10	—	—	—	—	—	—
MXP-VAD-10G	HIGH	3 : 1	1 to 3	9	—	—	—	—	—	—
RGN-10G	HIGH	1 : 1	9	10	—	—	—	—	—	—
RGN-2.5G	LOW	1 : 1	4	8	3	7	2	6	1	5

1. D = dynamic mapping of client ports.

4.19 Adjusting Site Layout

Site layout adjustment is a feature that allows you to move a selected card from its current slot to another slot in the chassis. This feature helps you customize the site layout based on your requirements. You can move both present and forecast cards. Cisco Transport Planner will automatically change the card position values and cable lengths in the Traffic Matrix report, Aggregated TDM /Ethernet report, Internal Connection report, and BoM report. You can view the modified reports by reopening the report. Shelf movement is possible for the following:

- All PP-Mesh, Patch Panel, Alien shelf, and DCU shelves.
- DCU cards
- EAP, Air Ramp, Fan Tray, Flex Shelf, and External Switch.

Site layout adjustments can only be done on a network that has been analyzed and is in any administrative state (Design, Upgrade, or Installation). Site layout adjustment can also be done on a release-upgraded network that has been analyzed.

Use the following procedure to move a card to a new position:

- Step 1** Right-click the site for which you want to move the cards in the rack and choose **Layout** (see [Figure 4-24](#)). The Details dialog box appears (see [Figure 4-25](#)).

Figure 4-24 Selecting the Layout View

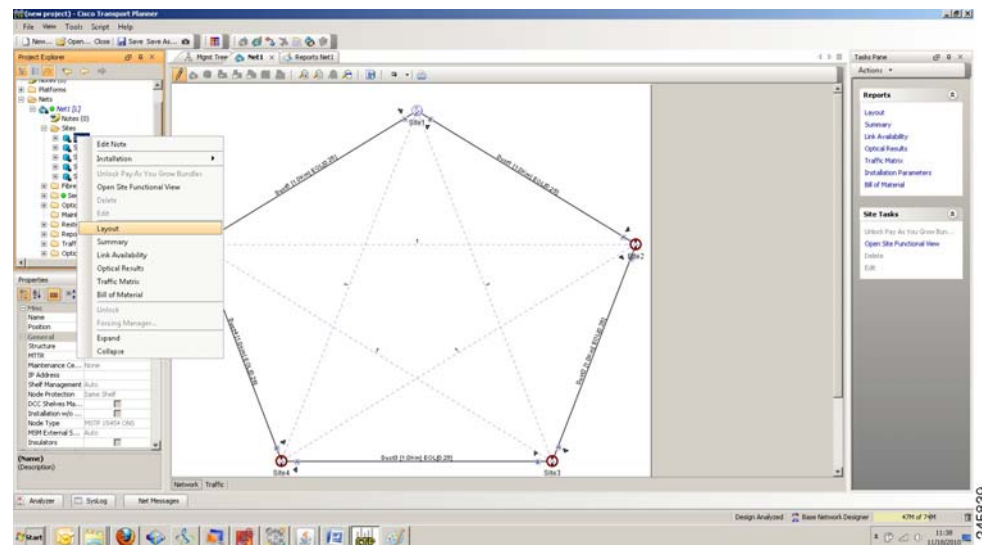
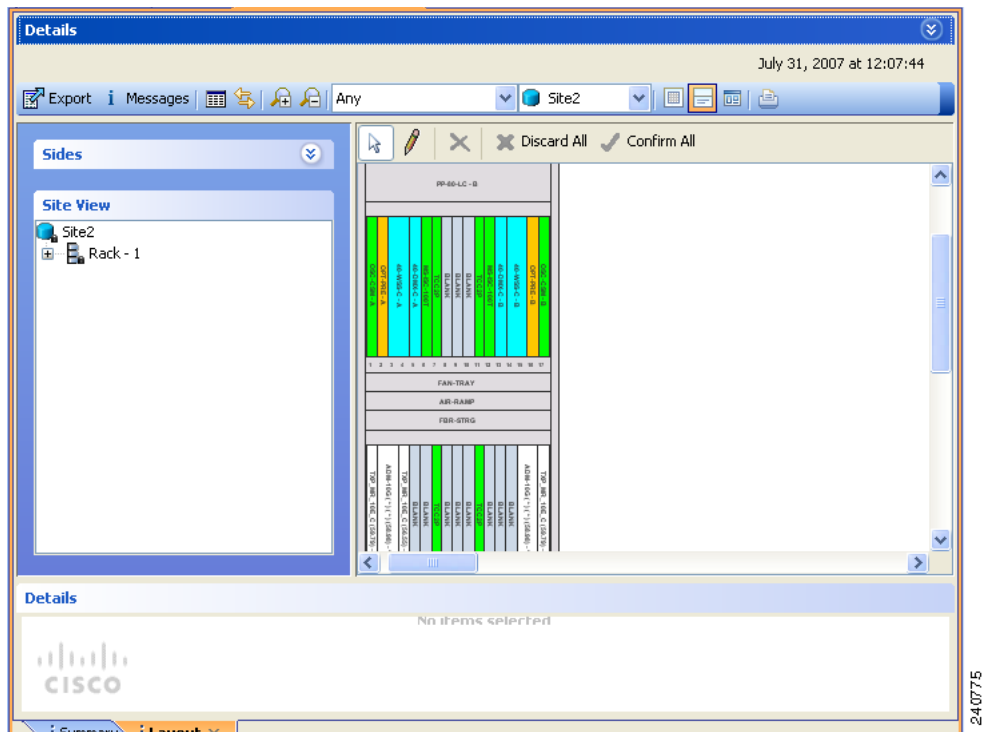

Figure 4-25 Details Dialog Box



Step 2 Choose the **Locked & Unlocked** mode from the drop-down list for the layout.

Step 3 Choose **Draw Mode** and then click the card and move it to the desired slot in the shelf (see [Figure 4-26](#)).

Figure 4-26 Site Layout Before Adjustment

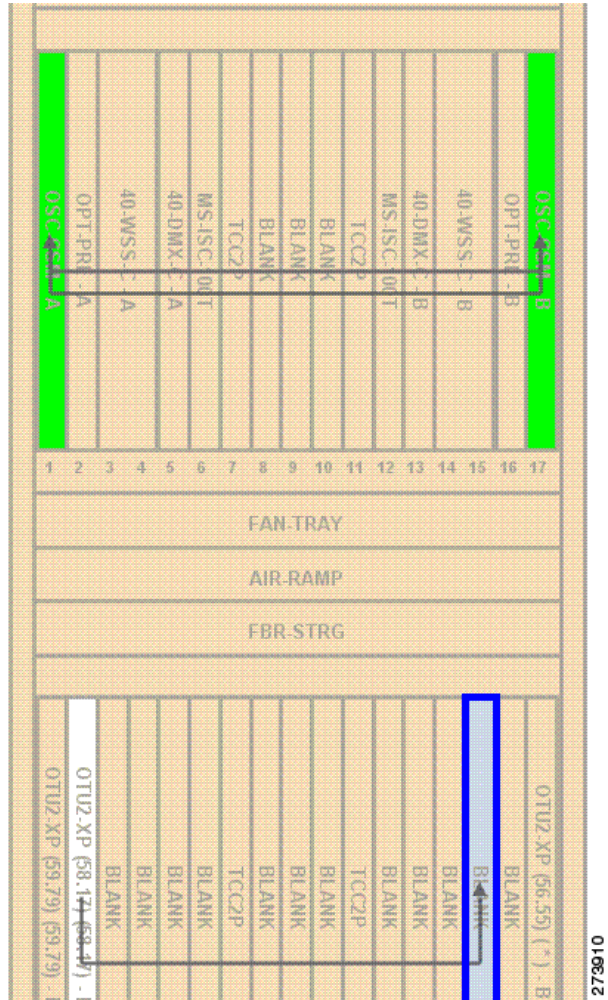

- Step 4** Click **Confirm All** to confirm the changes made. When you confirm all site adjustments, Cisco Transport Planner automatically unlocks both the source and destination slot positions (see [Figure 4-27](#)).

Figure 4-27 Site Layout After Adjustment

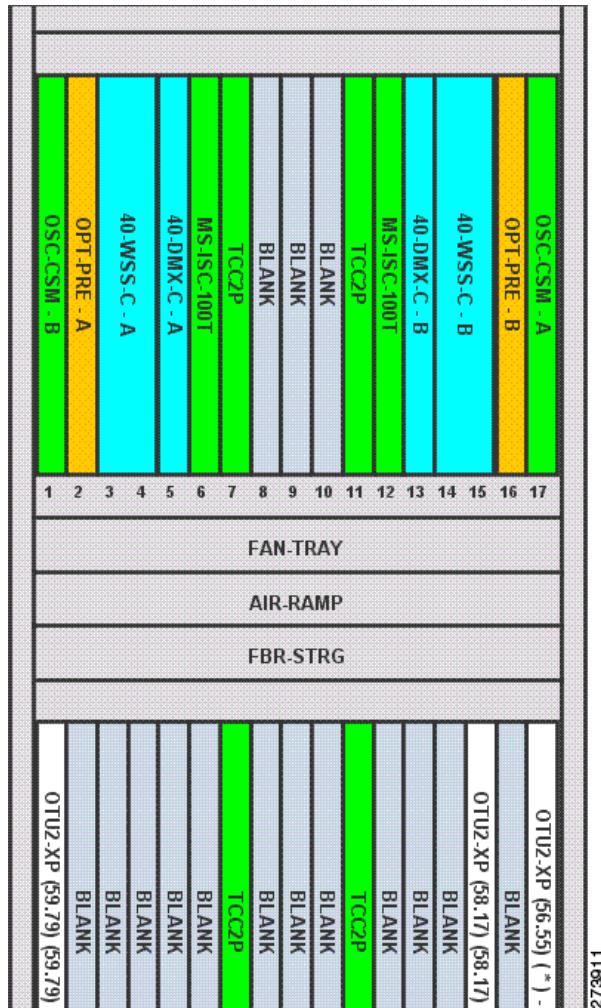

Note

The destination slot position must be within an existing shelf on the existing rack. A destination slot can be any empty slot or any other slot containing a client/OTS card. It cannot be a slot you have already defined as the destination for another position change (in the current layout adjustment session).



Note

A double slot card can be moved if the destination has one slot card and blank card.

Table 4-10 lists the allowed site layout adjustments.

The following constraints are applicable to card layout adjustment:

- When the network is moved to design mode, all the reports are deleted. When you analyze the network again, the reports are regenerated with the cards placed in their default positions. To avoid this default placement upgrade the network, add the services, and then analyze the network so that the cards are retained in the same position. In some cases, you may need to unlock the site.
- Only OSCM cards can be moved to slots 8 or 10.
- MS-ISC, Blank, TCC, and AIC cards cannot be moved. Cards cannot be moved to slots 6 or 12 if MS-ISC cards are present in those slots.
- DCU cards can move only to empty locations in another DCU shelf. You can also swap a DCU card with another DCU card in another location. You cannot create new shelves to accommodate a DCU card.
- In DCC shelf management, TXP-MR-2.5G or TXPP-MR-2.5G cards in slot 12 cannot be moved.
- The other constraints are included in Table 4-10.

Table 4-10 Allowed Site Layout Movements

From/To	OTS	Unprotected/Fiber-switched TXP-MXP	Unprotected/Fiber-switched LC	1+1 Protected TXP-MXP	1+1 Protected LC	Y-cable Protected TXP	Y-cable Protected MXP/Multi-trunk	Y-cable and 1+1 Protection in Same Card	1+1 Protected Multi-trunk	PSM Line / Section	PSM-0 CH
OTS	Yes ¹	Yes	No	Yes	No	No	No	No	Yes	Yes	Yes
Unprotected/Fiber-switched TXP-MXP	Yes	Yes	No	Yes for same-shelf protection; Yes for separated-shelves protection	No	No	No	No	Yes for same-shelf protection; Yes for separated-shelves protection	Yes	Yes
Unprotected/Fiber-switched LC	No	No	Yes	No	No for different shelves; Yes for same shelf	No	No	No	No	No	No

Table 4-10 Allowed Site Layout Movements

From/To	OTS	Unprotected/Fiber-switched TXP-MXP	Unprotected/Fiber-switched LC	1+1 Protected TXP-MXP	1+1 Protected LC	Y-cable Protected TXP	Y-cable Protected MXP/Multi-trunk	Y-cable and 1+1 Protection in Same Card	1+1 Protected Multi-trunk	PSM Line / Section	PSM-0 CH
1+1 Protected TXP-MXP	Yes	Yes	No	Yes for same-shelf protection; Yes for separated-shelves protection	No	No	No	No	Yes for same-shelf protection; Yes for separated-shelves protection	No	Yes for same-shelf protection; Yes for separated-shelves protection
1+1 Protected LC	No	No	Yes	No	Yes	No	No	No	No	No	No
Y-cable Protected TXP	Yes	Yes	No	Yes for same-shelf protection; Yes for separated-shelves protection	No	Yes	Yes	No	Yes for same-shelf protection; Yes for separated-shelves protection	No	Yes
Y-cable Protected MXP/Multi-trunk	Yes	Yes	No	Yes for same-shelf protection; Yes for separated-shelves protection	No	No	No	No	Yes for same-shelf protection; Yes for separated-shelves protection	No	Yes

Table 4-10 Allowed Site Layout Movements

From/To	OTS	Unprotected/Fiber-switched TXP-MXP	Unprotected/Fiber-switched LC	1+1 Protected TXP-MXP	1+1 Protected LC	Y-cable Protected TXP	Y-cable Protected MXP/Multi-trunk	Y-cable and 1+1 Protection in Same Card	1+1 Protected Multi-trunk	PSM Line / Section	PSM-OCH
Y- Cable and 1+1 Protection on Same Card	Yes	Yes	No	Yes for same-shelf protection; Yes for separated-shelves protection	No	No	No	No	No	No	No
1+1 Protected Multi-trunk	Yes	Yes	No	Yes for same-shelf protection; Yes for separated-shelves protection	No	No	No	No	Yes for same-shelf protection; Yes for separated-shelves protection	No	Yes for same-shelf protection; Yes for separated-shelves protection
PSM Line/Section	Yes	Yes	No	No	No	No	No	No	No	No	No
PSM-OCH	Yes	Yes	No	Yes for same-shelf protection; Yes for separated-shelves protection	No	No	No	No	Yes for same-shelf protection; Yes for separated-shelves protection	No	No

- For all site movements marked as **Yes**, Cisco Transport Planner creates a reverse link. For example, when a Y-cable protected TXP is moved to an OTS card, a reverse link (that is, a link between the OTS card and the Y-cable protected TXP) is created automatically.

4.19.1 Constraints in Layout Adjustments in M2 and M6 Shelves

The following constraints are applicable to card layout adjustment in an M2 or M6 shelf:

- Card movement is allowed between the following chassis:
 - 15454 ONS chassis to M6 and vice-versa
 - M6 chassis to M2 chassis and vice-versa
 - M6 chassis to M6 chassis
 - M2 chassis to M2 chassis
- TNC or TSC card movements are not allowed.
- The movement for the following cards from ONS 15454 chassis to M2 or M6 chassis is not allowed:
 - OSCM
 - AIC
 - ISC

4.19.2 Constraints in Layout Adjustments

For any other kind of forced position, Cisco Transport Planner will not prevent you from forcing any destination position even if it does not match some of the layout recommended constraints (for example, OSMINE or TXP/MXP 1+1 Client protection).

You need to ensure that the following conditions are met when doing layout adjustments:

- Site layout adjustments can only be done on a network that has been analyzed and is in any administrative state (Design, Upgrade, or Installation).
- A pair of TXP/MXP cards that are part of a Y-cable protection group must stay within the same shelf.
- A pair of ADM-10G cards that are part of the same ADM peer group must stay within the same shelf.
- A pair of line cards that are part of a protection group must stay within the same shelf.
- A pair of line cards in a site that are part of a P-ring circuit must stay within the same shelf.
- You should not perform more than five movements before clicking the **ConfirmAll** button.
- Manual layout adjustment is not supported for FLD-4 units.

4.19.3 Adjusting the Shelf Layout

You can adjust the shelf layout using the “Move” option. To adjust the shelf layout do the following:

-
- Step 1** Right-click the site for which you want to move the shelves in the rack and choose **Layout**.
- Step 2** Right-click on the shelf and select **Move**. The **Shelf Movement** dialog box opens.
- Step 3** In the Shelf Movement dialog box select the following:
- **Source Rack**— Specifies the selected shelf rack. You cannot edit this field.
 - **Destination Rack**— Select the destination rack ID to move the shelf to the selected rack.
 - **From RU**— Displays the shelf number of the selected shelf. You cannot edit this field.

- **To RU**—Select the exact rack unit position to move the shelf.
- **Swap**— Check the check box to swap the source and destination shelves that are of the same rack unit size.



Note If you do not select the Swap option, then you can move any shelf to any rack or within the rack, if an empty slot is available.

Step 4 Click **OK**. Cisco Transport Planner will automatically change the shelf position values and cable lengths in the Traffic Matrix report, Aggregated TDM /Ethernet report, Internal Connection report, and BoM report.



Note To move a passive shelf, right-click on the passive shelf and follow [Step 2](#) to [Step 4](#) of the shelf movement.

4.19.4 Shelf Movement Rules

The following constraints are applicable to shelf movement adjustments:

- You can move any shelf to any rack or a shelf within a rack if the slot position is blank.
- You can do site adjustments in only one site before confirming the changes.
- Only one shelf movement can be performed at a time.
- The maximum number of 15 racks can be created.
- Shelf movement is not possible for PDP shelf.
- You can move the Y-cable protection module shelf within the rack in the available space.
- Passive shelves can be moved within the same rack or across the racks.
- After every shelf movement, the Layout is analyzed to modify the BOM, based on the cables that are connected.
- Cisco Transport Planner will automatically update the layout with the new shelf position values and cable lengths in the Traffic Matrix report, Aggregated TDM /Ethernet report, Internal Connection report, and BoM report.
- Air ramp and fiber storage associated with the ANSI/ETSI shelf will be automatically moved with the 15454 ONS shelf movement.
- The shelf movement is not allowed if there is no space to accommodate the air ramp and fiber storage associated with the shelf.
- M6 and 15454 ONS shelves can be moved in the same rack or across racks.
- When the source and destination chassis are of different RUs, move the source chassis below the destination chassis if the space is available. Interchanging the chassis are not allowed.

4.19.5 Modifying Shelf Management Properties

CTP enables you to modify the Shelf Management configuration type when the layout is in Locked state.

- When the Shelf Management configuration type is changed from Multi Shelf Integrated Switch to Multi Shelf External Switch, CTP:
 - Places the Multi Shelf External Switch at the end of the rack. If space is not available, a new rack is created.
 - Adds the Multi Shelf External Switch to the BoM, and the MS-ISC card is removed from the BoM if the node controller is M12 chassis.
 - Network analysis is not blocked.
- When the Shelf Management configuration type is changed from Multi Shelf External Switch to Multi Shelf Integrated Switch, CTP prompts to unlock the layout.
- When the Shelf Management configuration type is changed from Auto to Multi Shelf External Switch, Multi Shelf Integrated Switch, or Individual Shelf, CTP prompts to unlock the layout.

4.19.6 Card Movement Rules

The following constraints are applicable to card movements:

- AR-MXP card follows the existing MXP card movement rules.
- AR-XP card follows the existing TXP card movement rules.
- AR-MXP and AR-XP cards are allowed to move to the Cisco ONS 15454 shelf only when the Cisco ONS 15454 shelf has a FTA4 fan tray assembly.
- AR-MXP and AR-XP cards are allowed to move to M2 or M6 shelf from Cisco ONS 15454 shelf and vice-versa. If any protection is configured, then the existing protection rules are applied.
- AR-MXP and AR-XP cards are allowed to move to M2 shelf from M6 shelf and vice-versa. If any protection is configured, then the existing protection rules are applied.

4.20 Arranging Sites

Sites can be arranged into four different configurations. Use the following procedure to arrange the sites into a configuration or to move all of the sites so that they appear in the Cisco Transport Planner window:

- Step 1** Click the **NtView Name** tab.
- Step 2** Click the Arrange Sites drop-down list, and choose one of the following:



Note All shapes are approximations.

- Fit to visible rectangle view—Zooms to display all sites in the NtView Name tab.
- Arrange to an ellipse—Rearranges all sites in an ellipse form (Figure 4-28).

Figure 4-28 Ellipse Shape

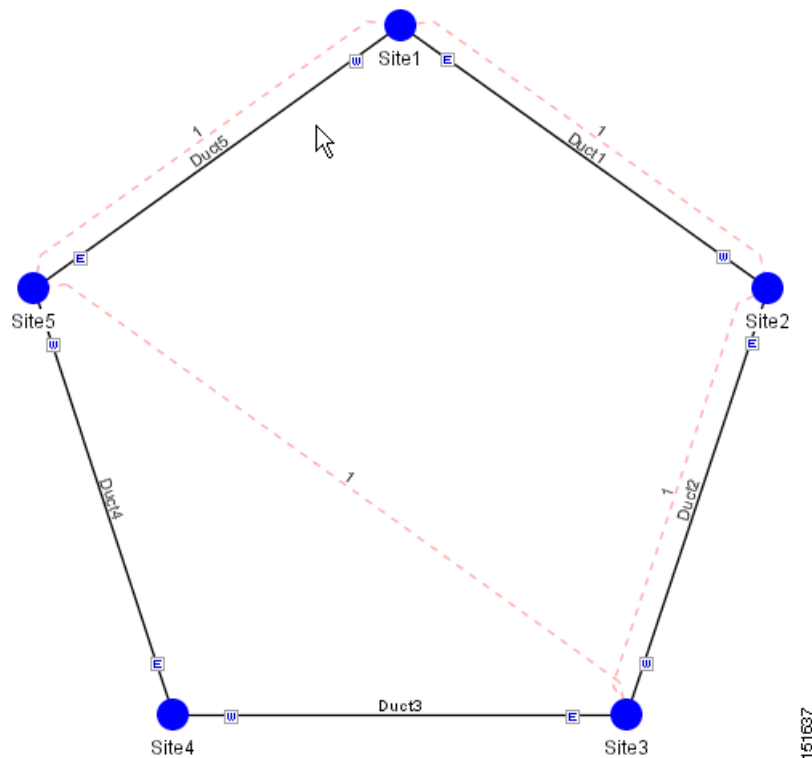

151637

- Arrange to a square—Rearranges all sites in a square form so that the sites appear clockwise around the square (Figure 4-29). To complete a full square, this arrangement requires at least four sites.

Figure 4-29 Square Shape

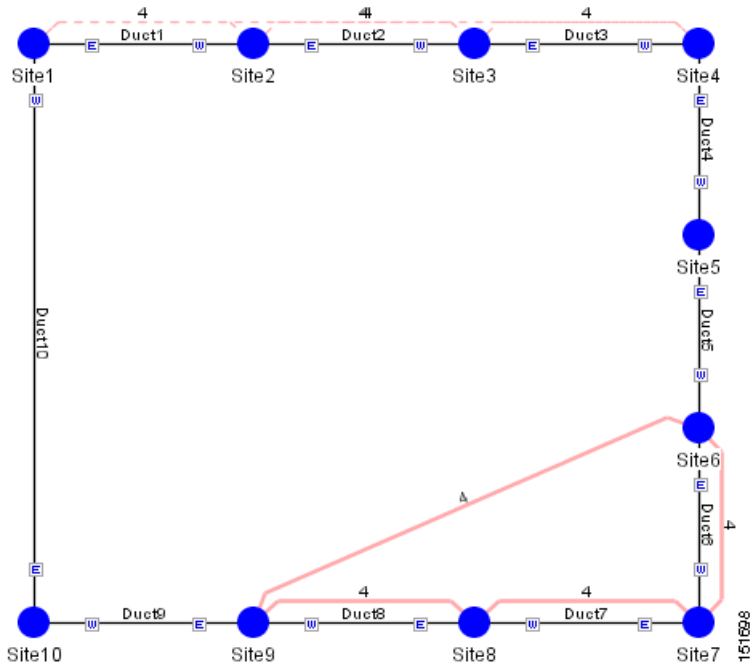

- Arrange to a snake—Rearranges all sites so that they cross the NtView *Name* tab from right to left and then left to right in a serpentine, linear format (Figure 4-30).

Figure 4-30 Snake Shape

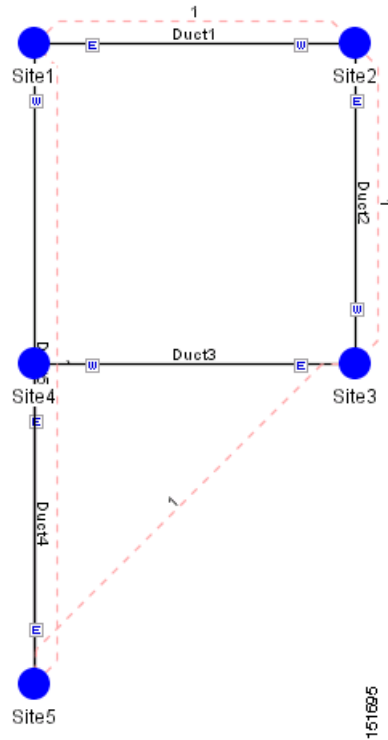

- Arrange to a double ring—Rearranges the sites into a dual ring format (Figure 4-31).

Figure 4-31 Double Ring Shape

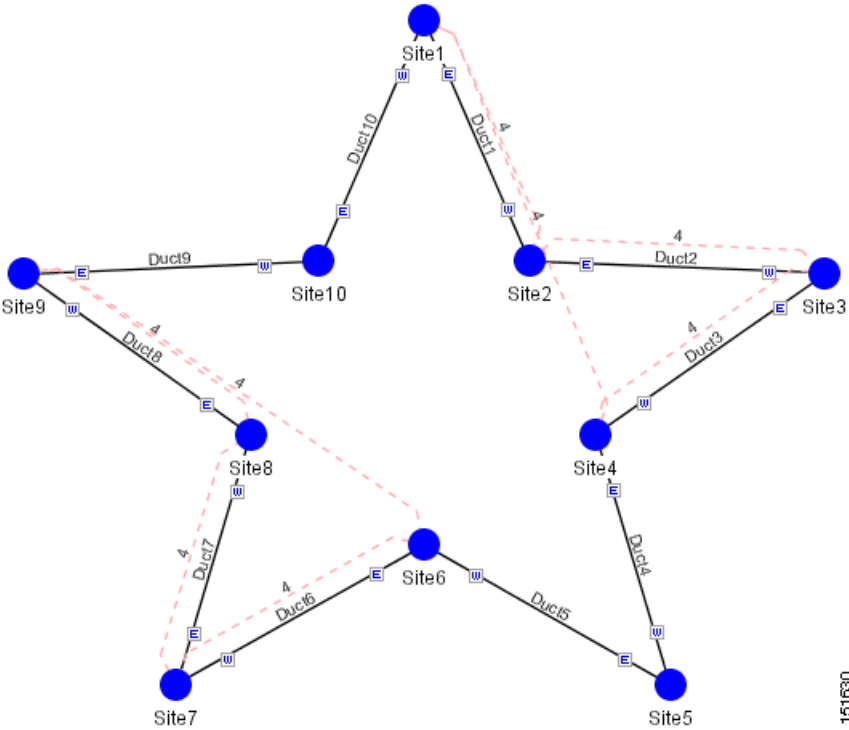

151630

- Arrange to Fit to Maximum Rectangle View—Arranges sites in proportion, using all network map area (Figure 4-32).

Figure 4-32 *Fit to Maximum Rectangle View Shape*

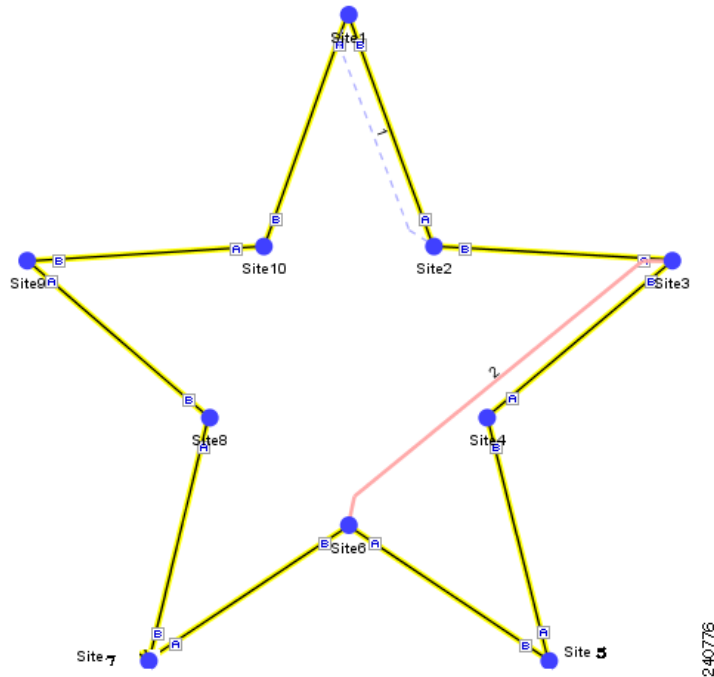

4.21 Modifying Site Properties

You can edit a site after you have created it using the Network Creation Wizard. To create a site, see the “2.1 Creating a Project” section on page 2-1. The following properties of a site can be modified:

- Site Structure
- Site Functionality
- Site Type
- Number of Sides

To edit the properties of a site:

-
- Step 1** In the Project Explorer pane, click the Sites folder. The list of sites included in the network appears.
- Step 2** Complete any one of the following:
- In Project Explorer pane, right-click the site you want to modify and select **Edit**.
 - In NtView, double-click the site icon.
 - In NtView, right-click the site icon and select Edit.

The **Site Edit** dialog box appears (Figure 4-33).

Figure 4-33 Sites Edit Dialog

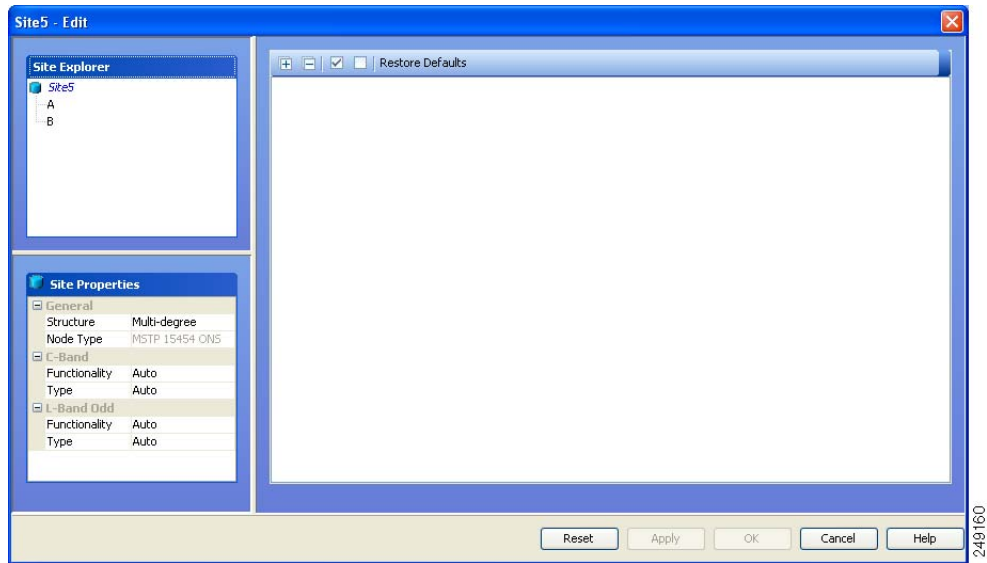

- Choose the **Structure** type from the drop-down list in the **Site Properties** pane:

Structure	Supported Configurations	Description	Possible Structure Edits
Line	<ul style="list-style-type: none"> • MSTP 15454 ONS • HYBRID 15454 ONS 	Two pairs of fibers are terminated at the node.	Can be changed to Line+ site. Note Line+site structure edit is applicable only on MSTP 15454 ONS
Terminal	<ul style="list-style-type: none"> • MSTP 15454 ONS • HYBRID 15454 ONS 	A single pair of fiber is terminated at the node.	Can be changed to a Terminal+ site.
Line+	<ul style="list-style-type: none"> • MSTP 15454 ONS 	Two pairs of fibers are terminated at the node, but the number of fibers can be increased when an MMU card (topology upgrade) is installed. This node is ready to scale to become a multidegree node after MMUs are installed in this node.	Can be changed to a Line site.

Structure	Supported Configurations	Description	Possible Structure Edits
Terminal+	MSTP 15454 ONS	A single pair of fiber is terminated at the node, but the number of fibers can be increased if an MMU card (topology upgrade) is installed. This node is ready to scale to become a multidegree node after MMUs are installed in this node.	Can be changed to a Terminal site.
Multi-degree	MSTP 15454 ONS	Nodes have more than two sides and face more than two fiber spans.	



Note You cannot edit the site structure parameter of PSM sites. For PSM sites with add/drop functionality, mux/demux is the supported site type. For PSM Line sites ROADM functionality, 40-SMR1-C, 40-SMR2-C, and WSS are the supported site types. For PSM section sites with ROADM functionality, WSS is the only supported site type.

To change any other structure (such as changing Line to Terminal), you must delete and reinsert the site.

- Choose the **C-Band** and **L-Band** parameters from the drop-down list. See [Table 4-1](#) and [Table 4-2](#) for additional details on Site Design rules.



Note L-band is not applicable to HYBRID 15454 ONS configuration.

- Right-click the site, click **Add Side**, and choose **Line** or **Omni-Directional** to add a line or omnidirectional side to a site ([Figure 4-34](#)). The new side gets listed under the site in the Site Explorer pane. If the site added is omnidirectional, the Omnidirectional Side property of the side is set to **Yes**. You can add a side to a site only if the site does not already have the maximum number of allowed sides provisioned for it. Click **Apply** after adding each side for the change to take effect.

Figure 4-34 Add Sides Option

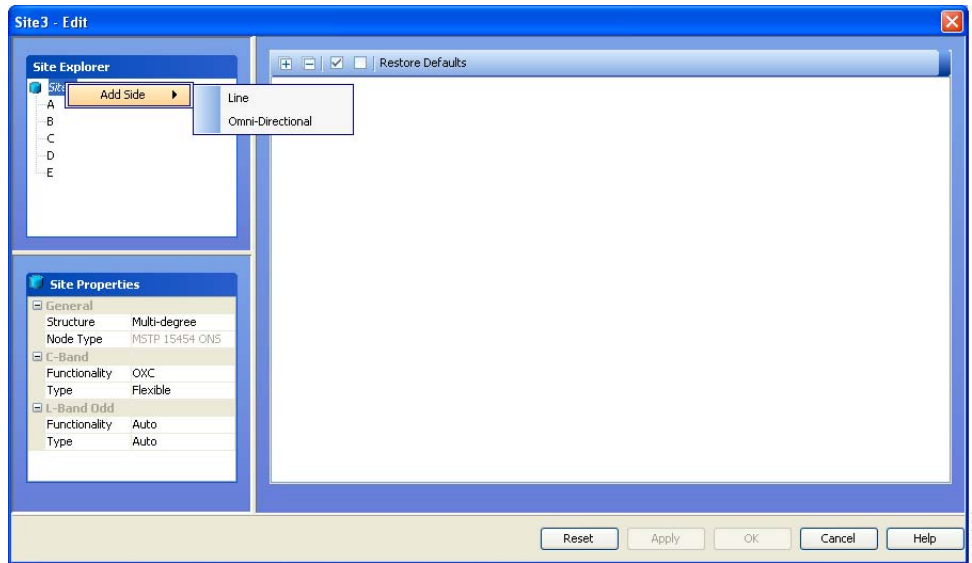

- Step 3** Click a side to view and modify properties associated with it in the Side Properties pane:
- Label—Displays the label of the side.
 - OmniDir Entry Point—Displays the value of the OmniDir Entry Point option.
 - Colorless Ports—Displays the number of colorless ports on the side.
 - Remote Spur—Displays the number of remote spurs associated with the side.
 - Omnidirectional Side—Displays the value of the omnidirectional property for the side.
 - Side Type—Displays the type of the side. This property can be edited for multi-degree sites with OXC functionality and type as flexible.
- Step 4** Right-click a side and select any of the following options to modify the properties of a side. Click **Apply** after selecting each option for the change to take effect.

Figure 4-35 Side right-click options

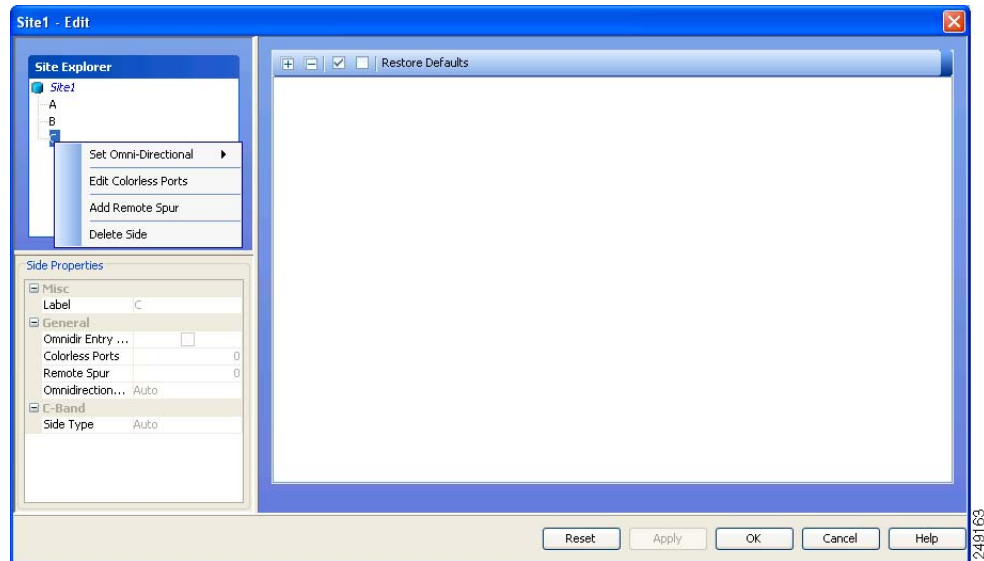

- **Set Omni-Directional**—Allows you to set the omnidirectional property of the side. The available values are Auto, Yes, and No. The default option is Auto. The Auto option allows CTP to dynamically enable omnidirectional functionality on a side in the following ways:
 - If there are no free sides (free sides are those sides not connected by ducts) available on a site, and the site has less than eight provisioned sides, CTP automatically creates an omnidirectional side.
 - If one or more free sides are available, CTP automatically makes one of the free sides omnidirectional.

The Yes option indicates that omnidirectional demands can be dropped on the side and the No option indicates that omnidirectional demands cannot be dropped on the side.

For information on supported site structure and functionality for omnidirectional sides, see [“2.7.2 Understanding Omnidirectional Functionality” section on page 2-17.](#)

- Edit Colorless Ports—Allows you to add or edit colorless ports in the Colorless Ports dialog. The maximum number of colorless ports allowed per side, varies according to the site functionality and type as defined in the following table:

Functionality	Type	Colorless ports (50 GHz)	Colorless ports (100 GHz)
ROADM	80-WXC-C (mux/demux)	72	72
ROADM / Hub / Terminal	40-SMR1-C	9	9
	40-SMR2-C	9	9
Hub / Terminal	80-WXC-C (mux/demux)	80	80
OIC	80-WXC-C (mux/demux)	72 if 2 sides are connected to ducts. 63 if 3 sides are connected to ducts. 54 if 4 sides are connected to ducts. 45 if 5 sides are connected to ducts. 36 if 6 sides are connected to ducts. 27 if 7 sides are connected to ducts. 18 if 8 sides are connected to ducts.	72 if 2 sides are connected to ducts. 63 if 3 sides are connected to ducts. 54 if 4 sides are connected to ducts. 45 if 5 sides are connected to ducts. 36 if 6 sides are connected to ducts. 27 if 7 sides are connected to ducts. 18 if 8 sides are connected to ducts.
OXC	80-WXC-C	9	9
	40-SMR2-C	9	9
	Flexible	9	9

**Note**

For OXC nodes with 80-WXC-C, 40-SMRC-2 or Flexible configurations, the maximum number of colorless ports allowed also indicates the maximum number of demands (colored and colorless) that can be added to the side. Forcing the maximum number of colorless ports on a side prevents any colored demand from being added to the side.

For example, if you force nine colorless ports on a side of an OXC node with 80-WXC-C card, then a colored demand cannot be dropped on the side. However, if you force only seven colorless ports, the remaining two ports can be utilized for dropping two colored demands.

- Add Remote Spur—Allows you to add a remote add/drop port to the side and increments the Remote Add/Drop Port property of the side by one. You can add only one remote add/drop port to a side. For sites with 80-WXC-C card (mux/demux mode), the number of remote add/drop ports allowed varies depending on the number of available Express Add/Drop (EAD) ports on the side.

To add or remove remote add/drop ports, the network must be in Design or Upgrade mode, and the sites must have a defined structure, functionality, and type as described in the following table.

Structure	Functionality	Type	Equipment
Line	ROADM / Hub	40-SMR1-C	40-SMR1-C
		40-SMR2-C	40-SMR2-C
		80-WXC-C	80-WXC-C (bidirectional)
		80-WXC-C (mux/demux)	80-WXC-C (mux/demux)
Terminal Note Terminal sites must not have amplifiers or DCUs connected to them while connecting to a remote add/drop port. A terminal site with a remote add/drop port cannot be upgraded to any other site structure.	ROADM	40-SMR1-C	40-SMR1-C
		40-SMR2-C	40-SMR2-C
		80-WXC-C (mux/demux)	80-WXC-C (mux/demux)
Multi-degree	OXC	80-WXC-C w/ MESH-PP-4	80-WXC-C
		80-WXC w/ MESH-PP-8	80-WXC-C
		Flexible	80-WXC-C (bidirectional) or 40-WXC-C
		40-SMR2-C + 15454-PP-4-SMR	40-SMR2-C
	OIC	80-WXC-C (mux/demux)	80-WXC-C (mux/demux)

**Note**

- You cannot add remote spurs to sites with functionality or type set to Auto, or to sites with protection type set to PSM Line or PSM Section.
- Amplifiers and DCUs are not supported on any sides of a remote spur.
- If a remote terminal has active units, DCN extension must be implemented on the spur link.
- Remote spurs are not supported for colorless sites with OXC functionality, or equipped with 40-SMR1-C or 40-SMR2-C.

You can define local add/drop units at a side where a remote add/drop port is present, only if the local add/drop units are connected to an 80-WXC-C card configured as mux/demux.

To delete a remote spur, delete the side associated with it; this reduces the Remote Add/Drop Port property of the side by one. You cannot delete a side with a remote add/drop port if the port is connected to a remote network terminal.

- **Delete Side**—Allows you to delete the selected side. If you delete an omnidirectional side or a colorless side, any locked service referencing the side is unlocked.

- Step 5** Click **Apply**. The selected changes are applied to the site.
- Step 6** Click **OK** to save the changes and exit the **Edit** dialog box.

**Note**

When you modify a site, Cisco Transport Planner does not allow you to decrease the number of node sites. For example, it would not be possible to change a Line site to a Line+ or Multi-Degree site but, a Multi-Degree site can be changed to a Line site.

Table 4-11 shows the structure modifications that you can make using Cisco Transport Planner.

Table 4-11 Permitted Structure Modifications

Starting Structure	Ending Structure
Terminal or Terminal+	Line, Line+, Multi-Degree
Line or Line+	Multi-Degree

When you modify the properties of a site, Cisco Transport Planner checks the compatibility between the original site properties and the new configurations that you make on each site. It also checks for consistency in the add/drop section and/or in the amplifier/DCU section and displays a warning message in case of inconsistency. Cisco Transport Planner then unlocks the related instances and/or parameters for you to make modifications. If the units were forced, Cisco Transport Planner removes the forcing to perform the required modifications.

If the starting instances/parameters are consistent, even if not optimal for the ending configuration, Cisco Transport Planner will warn the user about possible sub-optimization, but the related unit/parameter will be kept Locked (with its Layout property).

While upgrading a site equipped with 80-WXC-C, 80-WXC-C Mux/Demux, or 80-WXC-C with MESH-PP-4/8, CTP unlocks the entire site. This is not applicable for flexible site types.

For Multi-Degree sites with OXC functionality, if you upgrade the type of the site to Flexible, CTP unlocks the entire site. For Multi-degree sites with OXC functionality and flexible type, if you change the configuration of a side (from 40-WXC-C to 80-WXC-C, or vice versa), CTP unlocks only the parameters of the changed side.

Site modifications that require unlocking of some instances/parameters are provided in Table 4-12.

Table 4-12 Site Modification Unlock Instances/Parameters

Starting Configuration	Ending Configuration	Mandatory Unlock	Suggested Unlock
Line, PT	Line, OLA	All amplifiers/DCU section	-
Line, OSC-site	Line, OLA	All amplifiers cards.	-
Line, OLA	Line, A/D	None.	All amplifier cards
Line, OLA	Line, ROADM	None.	All amplifier cards
Line, A/D, OADM-xc	Line, ROADM	All OADM-xc cards.	All amplifier cards
Line, HUB, WSS	Line, ROADM	None.	All amplifier cards
Term, ROADM, WSS	Line, ROADM, WSS	None.	All amplifier cards

Table 4-12 Site Modification Unlock Instances/Parameters

Starting Configuration	Ending Configuration	Mandatory Unlock	Suggested Unlock
Term, ROADM, WSS	Multi-degree, WSS	32-DMX-O (if present)	All amplifier cards
Line, ROADM, WSS	Multi-degree, WXC, PP-MESH-4	32-DMX-O (if present)	WSS cards, 40-MUX-C is the default; all amplifier cards
Line, ROADM, WSS	Multi-degree, WXC, PP-MESH-8	32-DMX-O (if present), AMP-17 cards (if present)	WSS units (40-MUX-C is the default), all amplifier cards

4.22 Deleting Notes

Use the following procedure to delete a note from any item in the Project Explorer pane:

-
- Step 1** Double-click the **Notes** folder.
 - Step 2** In the Notes window, click **Go** in the Action column for the note that you want to delete. The item is highlighted in the Project Explorer pane.
 - Step 3** Right-click the item in the Project Explorer pane and choose **Delete Note** from the shortcut menu.
-

4.23 Deleting Sites

Use the following procedure to delete sites from a network. You can delete a site if the site is in the Unlocked state and does not have a traffic demand set up on it. You can delete sites from a network in the Design state only.

-
- Step 1** Verify that the site is in the Unlocked state in the Project Explorer pane. For more information, see the [“2.10.5 Unlocking Parameters in the Network Design” section on page 2-55](#).
 - Step 2** Delete traffic demands on the site. For more information, see the [“4.24 Deleting a Traffic Demand” section on page 4-121](#).
 - Step 3** In the NtView *Name* tab, click the Site icon and click **Delete** from the Tasks Pane. You can also right-click on the Site icon and click **Delete** from the shortcut menu. For more information about the Cisco Transport Planner icons, see [Appendix A, “GUI Information and Shortcuts.”](#)
 - Step 4** For a Line or Line+ site, a confirmation dialog box is displayed. Click **No** to delete the fiber spans along with the site. Click **Yes** to delete the site and replace the two fiber spans connected to it with a single fiber span that directly connects the adjacent sites. The new fiber span is created as per the rules in the [“4.23.1 Fiber Joining Rules” section on page 4-120](#).
-

4.23.1 Fiber Joining Rules

When deleting a Line or Line+ site, the sites adjacent to the deleted site can be directly connected with a new fiber span that inherits properties from the old fiber spans. The new fiber span can be created when these conditions are fulfilled.

- No traffic is added, dropped, or bypassed at the deleted site.
- No remote Add/Drop site is connected to the deleted site.
- The following fiber properties must be the same for both the fibers that are connected to the site to be deleted.
 - Fiber Type
 - Connection Type
 - Length Based Loss
 - DCN Extension
 - OSC Frame Type
 - Optical Subnet Design Rules (both for C-band and L-band)
 - Raman Amplification
 - Measurement Units

If the above conditions are not fulfilled, the fibers cannot be joined. You have to delete the site along with the fibers connected to it.

Following property values are inherited from the old fiber spans as per the specified rules.

- Properties acquired by the fiber span (Duct):
 - EOL Ageing Loss = The value that is greater in the two fibers
 - EOL Ageing Factor = The value that is greater in the two fibers
- Properties acquired by the fiber pair (Couple):
 - $CD\ C\text{-band and } CD\ L\text{-band} = (CD1 * L1 + CD2 * L2) / (L1 + L2)$

where

CD1 = Chromatic dispersion of the first fiber

CD2 = Chromatic dispersion of the second fiber

L1 = Length of the first fiber

L2 = Length of the second fiber

- $PMD = \text{SQRT}[(P1^2 * L1 + P2^2 * L2) / (L1 + L2)]$

where

SQRT = Square root

P1 = PMD of the first fiber

P2 = PMD of the second fiber

L1 = Length of the first fiber

L2 = Length of the second fiber

- QD C-band and QD L-band = The value that is greater in the two fibers

- RD Factor = The value that is greater in the two fibers
- Properties acquired by the fiber:
 - Span Length = Cumulative length of the old fiber spans
 - Loss factor = $[(LF1 \times L1) + (LF2 \times L2)] / (L1 + L2)$

where

LF1 = Loss factor of the first fiber

LF2 = Loss factor of the second fiber

L1 = Length of the first fiber

L2 = Length of the second fiber

- Connector Loss = The value of the corresponding site

4.24 Deleting a Traffic Demand

A traffic demand must be in the Unlocked state before you can delete it. Use the following procedure to delete a traffic demand:

-
- Step 1** In the Project Explorer pane, right-click the network folder and choose **Expand** from the shortcut menu.
 - Step 2** Verify that the demand is in the Unlocked state. For more information, see the [“2.10.5 Unlocking Parameters in the Network Design” section on page 2-55](#).
 - Step 3** Right-click the demand that you want to delete in the Project Explorer pane and choose **Delete** from the shortcut menu. As an alternative, you can click **Delete** in the Tasks Pane.
-

4.25 Deleting a Traffic Subnet

Use the following procedure to delete a created traffic subnet. The Traffic Subnet ALL cannot be deleted.

-
- Step 1** In the Project Explorer pane, click the **Net > Traffic Subnets** folder to expand it.
 - Step 2** Right-click the traffic subnet to be deleted and select **Delete** to delete the subnet.
 - Step 3** If the traffic subnet being deleted is associated with demands, a dialog box will appear listing all the demands associated with this subnet. These associations will be removed and the demands will be moved to the Traffic Subnet ALL demand. Upon confirmation, the traffic subnet will be deleted.



Note Demands moved under **Traffic Subnet All** will be marked invalid and the network will not be analyzed, until the user associates the demands with either a Ring or Linear subnet.

4.26 Deleting a Fiber Span

Use the following procedure to delete a fiber span from the network design:

-
- Step 1** In the Project Explorer pane, right-click the network folder and choose **Expand** from the shortcut menu.
 - Step 2** In the Project Explorer pane, right-click the duct that you want to delete and choose **Delete** from the shortcut menu. As an alternative, you can click **Delete** in the Tasks Pane.
 - Step 3** Click **Yes** to confirm the fiber deletion.
-

4.27 Deleting a Network

To delete a network from a project, in the Network Mgmt Tree tab click the network and choose **Delete** from the Tasks Pane. You cannot delete a network if it is the only network in a project.



CHAPTER 5

Modeled Network Examples

This chapter provides examples of typical optical networks you can model using the Cisco Transport Planner.

This chapter contains the following section:

[5.1 Supported Cisco Transport Planner Topologies, page 5-1](#)

5.1 Supported Cisco Transport Planner Topologies

The Cisco Transport Planner supports the following topologies:

- Linear ([5.1.1.1 Single-Span Topology](#) or [5.1.1.2 Multispan Topology](#))
- Ring ([5.1.2.2 Hubbed Ring Topology](#) or [5.1.2.1 Closed Ring Topology](#))
- [5.1.3 Mesh Topology](#)

An example of each topology is given in this chapter.

5.1.1 Linear Topologies

In a linear topology, the nodes are arranged in a line and are connected to two other adjacent nodes. However, the first and last node are not connected. There are two types of linear topologies, single-span and multispan.

5.1.1.1 Single-Span Topology

[Figure 5-1](#) shows an example of a single-span topology. This topology is characterized by a single span link. It can support only two terminal sites (full terminal or flexible channel-count terminal) without any intermediate line amplifier or optical add/drop multiplexing (OADM) sites.

Figure 5-1 *Single-Span Topology Example*

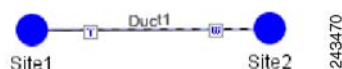

5.1.1.2 Multispan Topology

Figure 5-2 shows an example of a multispan topology. This configuration is characterized by the presence of two terminal sites (full terminal or flexible channel-count terminal) with intermediate OADM or line amplifier nodes. In a multispan configuration, specific wavelengths are terminated at different points in the span and only unprotected traffic can be provisioned.

Figure 5-2 Multispan Topology Example



5.1.2 Ring Topology

In a ring topology, each node is connected to exactly two other nodes, forming a circular configuration. It requires at least three nodes to form a ring. There are two types of ring topologies—closed ring and hubbed ring.

5.1.2.1 Closed Ring Topology

Figure 5-3 shows an example of a closed ring configuration. Here the traffic flows in a circular manner across the network.

Figure 5-3 Closed Ring Topology Example

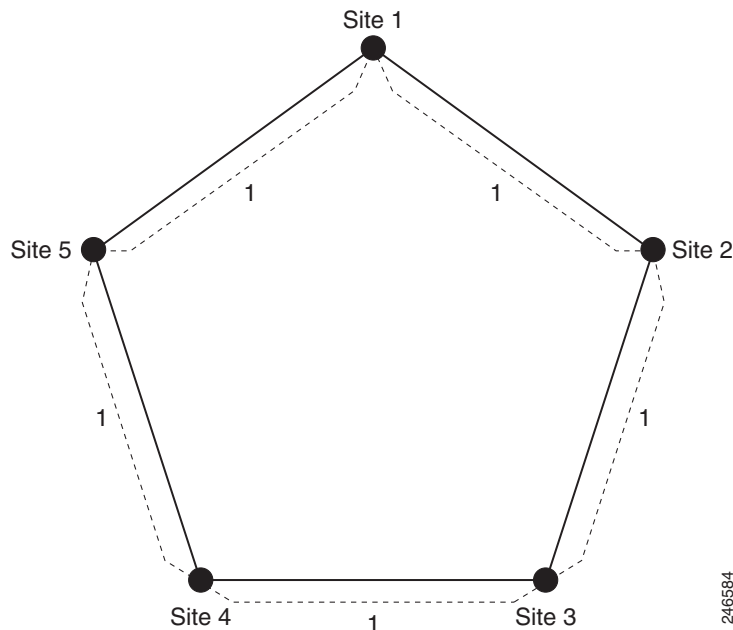

5.1.2.2 Hubbed Ring Topology

Figure 5-4 shows an example of a hubbed ring topology, also known as an open ring. In this configuration, at least one of the sites must be a hub site, where all channels are terminated. At the hub site, no traffic is expressed from one side to another, hence forming a break in the ring.

Figure 5-4 Hubbed Ring Topology Example

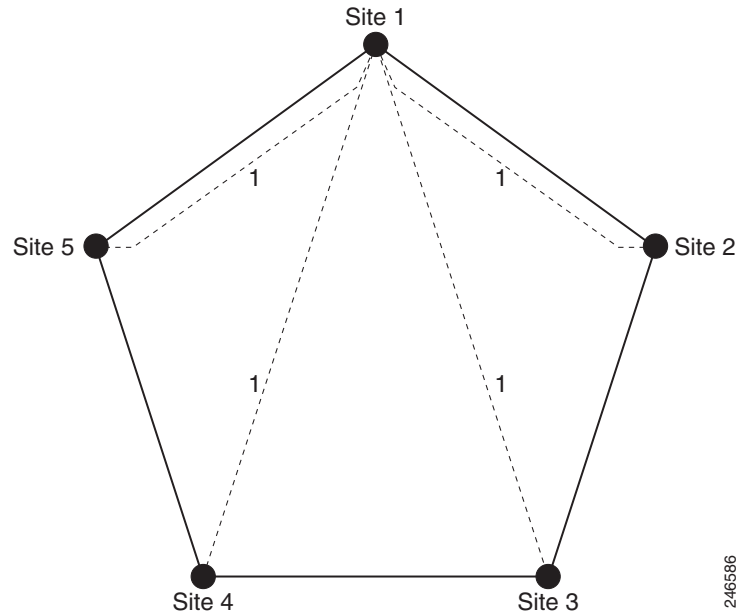

246586

5.1.3 Mesh Topology

Figure 5-5 shows an example of a mesh topology where each node is connected to one or more nodes. This configuration provides maximum redundancy to the network.

Figure 5-5 Mesh Ring Topology Example

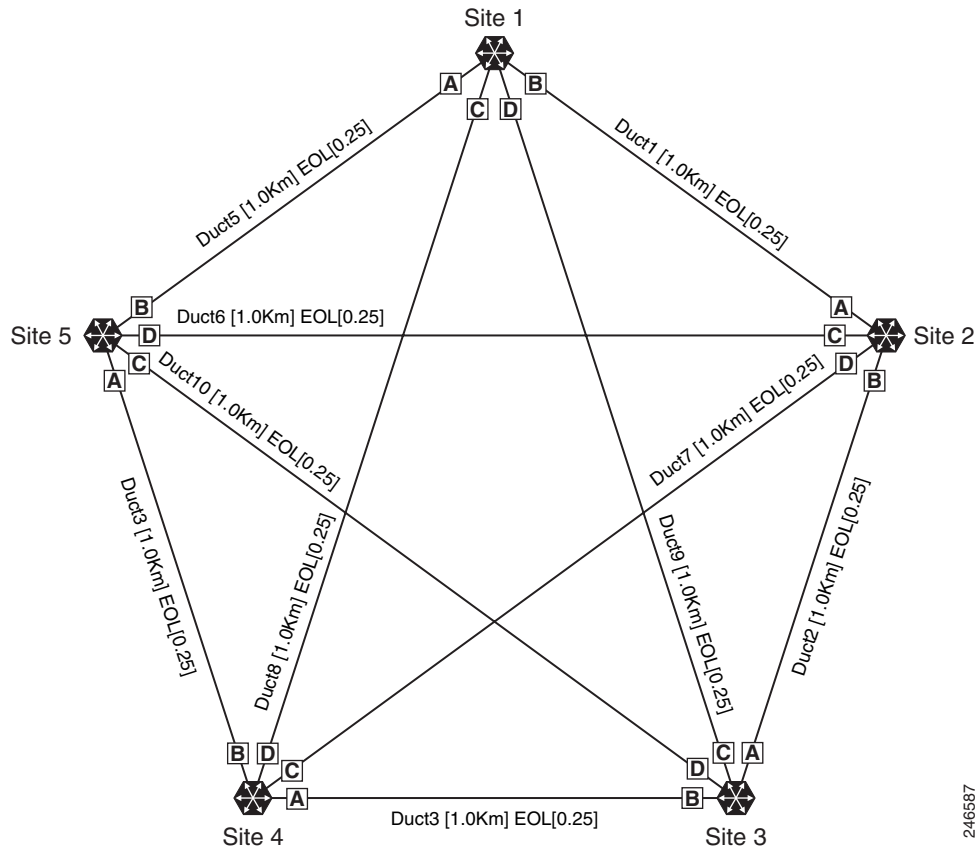

246587



APPENDIX **A**

GUI Information and Shortcuts

This appendix describes the Cisco Transport Planner views, menus, tools, and shortcuts options. For more information about Cisco Transport Planner, refer to [Chapter 1, “Introduction.”](#)

A.1 Manage the Cisco Transport Planner Window

The Cisco Transport Planner window provides a menu bar, toolbar, a Project Explorer pane, a Properties pane, an Analyzer pane, and a Task Pane to allow you to manage a network design ([Figure A-1](#)). The Mgmt Tree tab displays the networks that you have created for a project. The NtVw Net# tab displays the sites for a network (identified by the Net# on the tab).

Figure A-1 Cisco Transport Planner Window with Network Tree

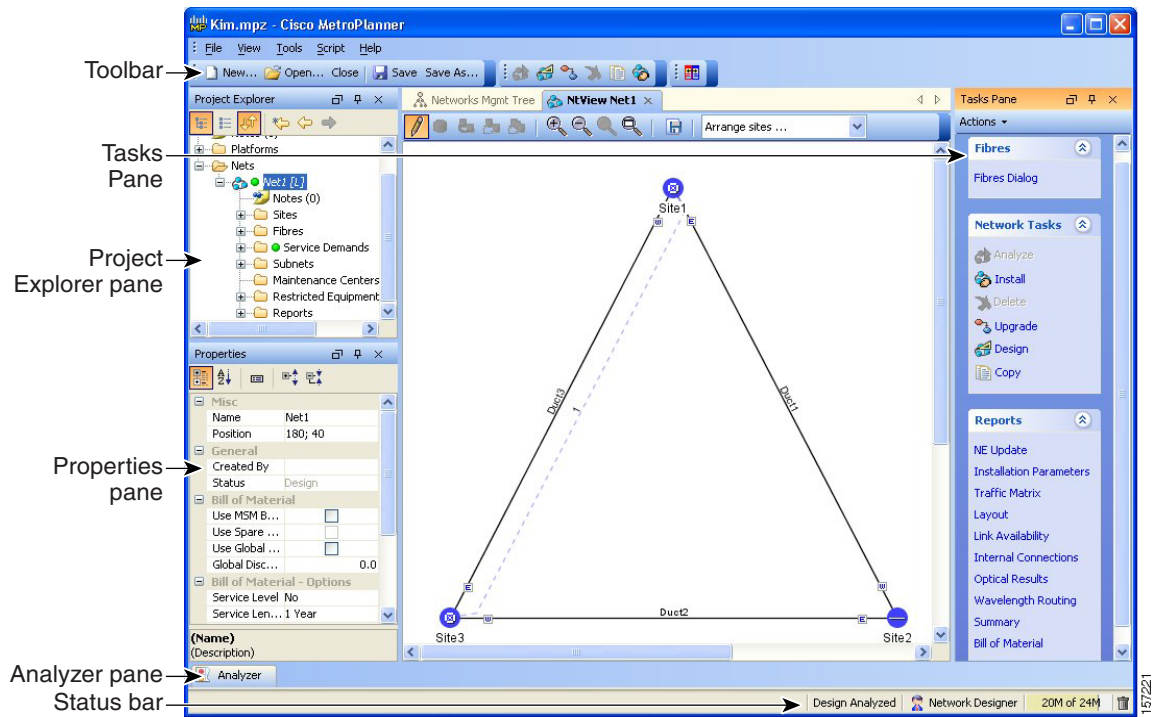

A.1.1 Menu and Toolbar Options

The Cisco Transport Planner window menu bar and toolbar provide primary Cisco Transport Planner functions. [Table A-1](#) shows the actions that are available from the menu and toolbar.

Table A-1 *Menu and Toolbar Options*





Menu	Menu Option	Toolbar	Description
File	New		Creates a new Cisco Transport Planner project. See the “2.1 Creating a Project” section on page 2-1.
	Open		Opens an existing Cisco Transport Planner project. See the “1.4.1 Opening a Project” section on page 1-21.
	Import Network		Imports node parameters from a network.
	Close		Closes the current project without closing the Cisco Transport Planner session. If you have not saved the current project, Cisco Transport Planner will prompt you to save before closing. See the “1.4.4 Closing a Project” section on page 1-22.
	Save		Saves the current project. See the “1.4.4 Closing a Project” section on page 1-22.
	Save As		Allows you to save the current project with a new file name. See the “1.4.3 Saving a Project” section on page 1-22.
	Clear History	—	Clears the file history from Cisco Transport Planner. Cisco Transport Planner maintains a list of the last ten open projects in the File menu.
	Exit	—	Exits the Cisco Transport Planner software.

Table A-1 Menu and Toolbar Options (continued)

Menu	Menu Option	Toolbar	Description
View	My Default Layout	—	Changes the Cisco Transport Planner display to the user default layout. Cisco Transport Planner allows you to define the default value for Platform Options, Project Options, and General Options. The defined value are used as default for each new created project. See the “1.6 Setting Cisco Transport Planner Options” section on page 1-24.
	Default Layout	—	Returns the Cisco Transport Planner display to the system default layout.
	Tasks Pane	—	Displays the commands available for the selected entity (network, site, duct, etc.).
	Project Explorer	—	Displays the Project Explorer pane, which includes folders for project notes, networks, sites, fibers, traffic demand groups, subnets, maintenance centers, restricted equipment list, and reports. Clicking the plus (+) sign by each folder expands the folder. Clicking the minus (–) sign by each folder hides the folder. contents. You can also right-click a folder and choose Expand from the shortcut menu to show folder contents. The default location of the Project Explorer pane is the upper left section of the Cisco Transport Planner window.
	Properties	—	Displays the Properties pane, which shows parameter settings for the selected entity in the Project Explorer pane, Mgmt Tree tab, or NtVw Net# tab. The default location of the Properties pane is the lower left section of the Cisco Transport Planner window.
	Analyzer Messages	—	Displays the Analyzer Messages pane at the bottom of the Cisco Transport Planner window. The Analyzer Messages pane displays any error messages that occur during network analysis.
	A2A Finalized Circuits	—	Displays Any-to-Any Finalization report at the bottom of the Cisco Transport Planner window. The Any-to-Any Finalization report pane displays the demands that are finalized in the network.

Table A-1 Menu and Toolbar Options (continued)

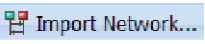
Menu	Menu Option	Toolbar	Description
Tools	Options	—	Opens the Options Explorer dialog box, where you can change the user default settings. See the “ 1.6 Setting Cisco Transport Planner Options ” section on page 1-24.
	DB Parts Mgmt	—	Opens the PartsTreePanel dialog box, where you can view the list of available parts for each release. See the “ 1.6.4 Setting the Default Project Values ” section on page 1-37.
	Price List Mgmt	—	Opens the Price Manager dialog box, where you can view maintenance contracts and add price databases. See the “ 2.12 Managing the Price List ” section on page 2-65.
	Export	—	Opens the Export dialog box, which allows you to export user options, price lists, maintenance contracts, and parts database files. See the “ 1.6.6 Exporting User Options, Price Lists or Alien Definitions ” section on page 1-43.
	Import	—	Opens the Import dialog box, which allows you to import user options, price lists, maintenance contracts, and parts database files. See the “ 1.6.7 Importing User Options, Price Lists or Alien Definitions ” section on page 1-43.
	Import from Sherpa	—	Opens the Import dialog box, which allows you to import Layer 2 network designs using the Cisco Carrier Packet Transport system.
	Delete Cache	—	Deletes the CTP cache on restart.
Help	Manual	—	Opens the Cisco Transport Planner online help.
	Tips Of The Day	—	Opens the Tip of the Day dialog box, which provides helpful hints about using Cisco Transport Planner. Click the Next button to view the next tip and the Back button to view a previous tip. Check Show Tips on Startup to display the Tip of the Day dialog box when you launch Cisco Transport Planner.
	About	—	Displays Cisco Transport Planner version information.

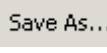
Network Toolbar





—	Create a new site		Opens the Site Creation wizard when you click this icon and then click in the Cisco Transport Planner window. See the “ 2.2 Adding Sites ” section on page 2-10.
—	Create a new duct		Allows you to create a new duct between sites. See the “ 2.3 Adding Fiber Spans ” section on page 2-11.
—	Create a new P2P demand		Opens the Point to Point Demand Creation wizard when you click this icon and then click two sites. See the “ 2.7.5 Creating a Point-to-Point Demand ” section on page 2-19.
—	Create a new P-ring demand		Opens the P-Ring Creation wizard. See the “ 2.7.6 Creating a Protected Ring Demand ” section on page 2-22.
—	Finalize Any-to-Any traffic		Opens Finalize Any-to-Any Traffic window.

Table A-1 Menu and Toolbar Options (continued)

















Menu	Menu Option	Toolbar	Description
—	Toggle the filter for Any-to-Any finalized traffic		Displays the Any-to-Any demands that are finalized in the network.
—	Create a new TDM Aggregated demand		Opens a TDM creation wizard. See the 2.7.9 Creating TDM Aggregated Demands, page 2-36
—	Create a new Ethernet Aggregated demand		Opens a Ethernet creation wizard. See the 2.7.8 Creating Ethernet Aggregated Demands, page 2-29
—	Network Details		Hides or displays duct information (duct name, EOL), amplifier forcing, and circuits on the network map in the Network tab.
—	Wavelength usage information		Hides or displays the number of used and free wavelengths for every duct on the network map in the Network tab.
—	Zoom in		Zooms in on the NtVw Net# tab.
—	Zoom out		Zoom out from the NtVw Net# tab.
—	Normal viewing		Returns the NtVw Net# tab to normal viewing (1:1).
—	Fit to window		Resizes the view so that all sites fit inside the NtVw Net# tab window.
—	Save network view image		Saves a JPEG of the network design. See the “2.10.6 Creating a JPEG of the Network Design” section on page 2-58.
—	Analyze Network		Analyzes the selected network. See the “2.9 Analyzing the Network” section on page 2-49.
—	Enter design mode		Puts the selected Design-Analyzed network back into the design mode for further changes. See the “2.9 Analyzing the Network” section on page 2-49.
—	Put current network in upgrade mode		Creates a copy of the selected Design-Analyzed network in the Upgrade state. See the “2.10.4 Creating an Upgrade Network” section on page 2-53.

Table A-1 Menu and Toolbar Options (continued)

Menu	Menu Option	Toolbar	Description
—	Delete current network		Deletes the selected network. See the “ 4.27 Deleting a Network ” section on page 4-122.
—	Copy current network		Copies the selected network. See the “ 2.10.1 Creating a Copy of the Network ” section on page 2-52.
—	Put current network in install mode		Creates a copy of the selected Design-Analyzed network in the Install state. See the “ 2.10.3 Creating a Network in the Install State ” section on page 2-52.
—	Copy & Go back to Design Mode		Copies the selected network in the Design state. See the “ 2.10.2 Creating a Copy of the Network in Design State ” section on page 2-52.
—	Reports Diff		Opens the Reports Diff dialog box, which allows you to create a report that shows the differences between networks.
—	Run the Garbage Collector		Deletes unloaded networks from memory.

A.1.2 Cisco Transport Planner Panes

Cisco Transport Planner provides four panes that help you manage a network design: Project Explorer, Properties, Analysis, and Tasks Pane.

A.1.2.1 Project Explorer Pane

The Project Explorer pane provides a management tree for the entire project. Each network appears as a folder that contains the sites, fibers, traffic groups, subnets, maintenance centers, restricted equipment lists, and reports for that network. If you have made changes to a network design, that network folder and the changed item folder appear in blue italics in the pane.

By default, the Project Explorer pane is located in the upper-left section of the Cisco Transport Planner window. [Table A-2](#) shows the actions that are available from the Project Explorer toolbar.

Table A-2 Project Explorer Toolbar Options











Toolbar	Description
	Displays the Project Explorer as a single pane.
	Displays the Project Explorer as split panes. The upper pane contains the main project tree; the lower pane shows only the folders for the network that is selected in the upper pane.

Table A-2 Project Explorer Toolbar Options (continued)

Toolbar	Description
	Auto scrolls to the selected object in the Project Explorer tree. For example, if you click on a site in the NtView Net# tab but it is not in view in the Project Explorer tree, Cisco Transport Planner will automatically scroll the Project Explorer pane until the selected site is in view.
	Moves backward through the list of previously selected items in the Project Explorer pane.
	Moves forward through the list of previously selected items in the Project Explorer pane.
	Moves (undocks) the Project Explorer pane from the default location in the upper left corner so that you can move it around your desktop area as an individual window.
	Moves the Project Explorer pane back to the default location.
	Hides the Project Explorer pane. To view again, move the mouse over the Prop tab that appears in the upper left corner of the Cisco Transport Planner window.
	When in hidden mode, reopens the Project Explorer pane in the default location.
	Closes the Project Explorer pane. To reopen, choose Project Explorer from the View menu.

A.1.2.2 Properties Pane

The Properties pane shows all of the parameters set for a selected item (either in the Project Explorer pane, the Network Mgmt Tree tab, or the NtVw Net# tab). Many items are editable in the Properties pane. By default, the Properties pane is located in the lower-left section of the Cisco Transport Planner window.

Table A-3 shows the actions that are available from the Properties Pane toolbar.

Table A-3 Properties Pane Toolbar Options











Toolbar	Description
	Categorizes the properties by type.
	Organizes the properties in alphabetical order.
	Shows or hides the description area at the bottom of the Properties pane.

Table A-3 *Properties Pane Toolbar Options (continued)*

Toolbar	Description
	Expands the property categories (if collapsed).
	Collapses the property categories (if expanded).
	Moves (undocks) the Properties pane from the default location in the lower left corner so that you can move it around your desktop area as an individual window.
	Moves the Properties pane back to the default location.
	Hides the Property pane. To view again, move the mouse over the Prop tab that appears in the upper left corner of the Cisco Transport Planner window.
	When in hidden mode, reopens the Properties pane so that it appears in the default location.
	Closes the Properties Pane. To reopen, choose Properties from the View menu.

A.1.2.3 Analyzer Pane

The Analyzer tab at the bottom of the Cisco Transport Planner window appears after you have analyzed a network design. Clicking the Analyzer tab opens the Analyzer pane. [Table A-5](#) shows the actions that are available from the Analyzer pane.

Table A-4 *Analyzer Toolbar Options*











Toolbar	Description
	Moves down through the Analyzer messages.
	Moves up through the Analyzer messages.
	Opens the Apply Filters dialog box, which allows you to filter the messages to show or hide Exceptions, Errors, Warnings, and/or Info.
	Expands the Analyzer message categories (if collapsed).
	Collapses the Analyzer message categories (if expanded).





Table A-4 Analyzer Toolbar Options (continued)

Toolbar	Description
	Moves (undocks) the Analyzer pane from the default location in the lower left corner so that you can move it around your desktop area as an individual window.
	Moves the Analyzer pane back to the default location.
	Hides the Analyzer pane. To view again, move the mouse over the Analyzer tab that appears in the bottom of the Cisco Transport Planner window.
	Opens the Analyzer pane so that it remains open in the bottom section of the Cisco Transport Planner window.
	Closes the Analyzer pane. To reopen, choose Analyzer messages from the View menu.

A.1.2.4 Tasks Pane

The Tasks Pane lists the available commands and reports for a selected item. The commands change based on the selected item. For example, a selected site will have different commands available than a selected fiber span. By default, the Tasks Pane is located in the upper right section of the Cisco Transport Planner window. [Table A-5](#) shows the actions that are available from the Tasks Pane toolbar.

Table A-5 Tasks Pane Toolbar Options

Toolbar	Description
	Moves (undocks) the Tasks Pane from the default location in the lower left corner so that you can move it around your desktop area as an individual window.
	Moves the Tasks Pane back to the default location.
	Hides the Tasks Pane. To view again, move the mouse over the Tasks tab that appears in the upper right corner of the Cisco Transport Planner window.
	When in hidden mode, reopens the Tasks Pane so that it appears in the default location.
	Closes the Tasks Pane. To reopen, choose Tasks Pane from the View menu.

A.1.3 Shortcuts

Cisco Transport Planner provides the following mouse shortcuts:

- Double-clicking a network icon in the Network Mgmt Tree tab opens the NtVw Net# tab, which shows the sites for that network.

- Right-clicking a report table column displays a shortcut menu that allows you to view or hide the columns in a report.
- Right-clicking an item in the Network Mgmt Tree tab or NtVw Net# tabs opens a shortcut menu that allows you to choose actions to perform on the selected item. The shortcut menu options differ based on the item selected and the network state. (Many commands are not available until a network is analyzed.) [Table A-6](#) lists the shortcut menu actions that are available for each item.

Table A-6 **Shortcut Menu Actions**

Toolbar	Description
Networks in the following states: Design, Install, and Upgrade	<ul style="list-style-type: none"> • Unload/Load—Unloads or loads the network. See the “1.4.2 Loading and Unloading Networks” section on page 1-21. • Edit Note—Allows you to create a note for the network. See the “2.5 Adding Notes to a Project” section on page 2-14.
Networks in the following states: Design, Install, and Upgrade	<ul style="list-style-type: none"> • Delete—Removes the network from the project. See the “4.27 Deleting a Network” section on page 4-122. • Copy—Creates a copy of the network. See the “2.10.1 Creating a Copy of the Network” section on page 2-52. • Upgrade to Design—Copies the selected network in the Design state. See the “2.10.2 Creating a Copy of the Network in Design State” section on page 2-52. • Arrange Sites—Allows you to rearrange sites in the Cisco Transport Planner window. See the “4.20 Arranging Sites” section on page 4-107. • Forcing Manager—Unlocks individual units in multiple sites/ducts. See “2.10.5.1 Forcing Manager” section on page 2-55.

Table A-6 *Shortcut Menu Actions (continued)*

Toolbar	Description
Analyzed networks	<ul style="list-style-type: none"> • Unload/Load—Unloads or loads the network. See the “1.4.2 Loading and Unloading Networks” section on page 1-21. • Edit Note—Allows you to create a note for that item. See the “2.5 Adding Notes to a Project” section on page 2-14. • Install—Creates a copy of the network in the Install state. See the “2.10.3 Creating a Network in the Install State” section on page 2-52. • Open Site Functional View—Opens the site functional view. See the 2.9.1 Viewing the Site Functional View, page 2-50. • Delete—Removes the network from the project. See the “4.27 Deleting a Network” section on page 4-122. • Upgrade—Creates a copy of the network in the Upgrade state. See the “2.10.4 Creating an Upgrade Network” section on page 2-53. • Copy—Creates a copy of the network. See the “2.10.1 Creating a Copy of the Network” section on page 2-52. • Layout—Opens the Layout tab. See the “3.2.6 Viewing the Layout of Single Site” section on page 3-16. • Internal Connections—Opens the Internal Connections tab. See the “3.2.4 Viewing Internal Connections” section on page 3-7. • Optical Results—Opens the Optical Results tab. See the “3.2.10 Viewing Optical Results” section on page 3-24. • Wavelength Routing—Opens the Wavelength Routing tab. See the “3.2.11 Viewing Wavelength Routing” section on page 3-28. • Bill of Material—Opens the Bill of Materials tab. See the “2.11.2 Generating a Network BoM” section on page 2-60.
Analyzed networks	<ul style="list-style-type: none"> • Installation—Opens a submenu with the following options: <ul style="list-style-type: none"> – NE Update—Creates a configuration file for each site in the network. See the “3.2.2 Saving the NE Update File” section on page 3-3. – Installation Parameters—Opens the Installation Parameters tab. See the “3.2.3 Viewing the Installation Parameters” section on page 3-4. <p>Arrange Sites—Allows you to rearrange sites in the Cisco Transport Planner window. See the “4.20 Arranging Sites” section on page 4-107</p>

Table A-6 Shortcut Menu Actions (continued)

Toolbar	Description
Sites	<ul style="list-style-type: none"> • Edit—Allows you to edit the demand. See the “4.7 Editing a Point-to-Point Demand” section on page 4-41, “4.8 Editing a P-Ring Demand” section on page 4-44, or “4.9 Editing a ROADM Demand” section on page 4-47. • Edit Note—Allows you to create a note for that item. See the “2.5 Adding Notes to a Project” section on page 2-14. • Unlock—Unlocks the site. See the “2.10.5 Unlocking Parameters in the Network Design” section on page 2-55. • Delete—Removes the site from the project. See the “4.23 Deleting Sites” section on page 4-119. <p>If the network is analyzed, the following actions are also available:</p> <ul style="list-style-type: none"> • Layout—Opens the Layout tab. See the “3.2.6 Viewing the Layout of Single Site” section on page 3-16. • Internal Connections—Opens the Internal Connections tab. See the “3.2.4 Viewing Internal Connections” section on page 3-7. • Optical Results—Opens the Optical Results tab. See the “3.2.10 Viewing Optical Results” section on page 3-24. • Wavelength Routing—Opens the Wavelength Routing tab. See the “3.2.11 Viewing Wavelength Routing” section on page 3-28. • Bill of Material—Opens the Bill of Materials tab. See the “2.11.2 Generating a Network BoM” section on page 2-60. • Installation—Opens a submenu with the following options: <ul style="list-style-type: none"> – NE Update—Creates a configuration file for each site in the network. See the “3.2.2 Saving the NE Update File” section on page 3-3. – Installation Parameters—Opens the Installation Parameters tab. See the “3.2.3 Viewing the Installation Parameters” section on page 3-4. • Provision Node—Exports the NE Update Configuration file to the node. Opens the Node Login window. See the “2.14 Bidirectional Communication with the Network Element” section on page 2-71. • Unlock Pay As You Grow Bundles—Recalculates the PAYG bundles for the site when the network is analyzed. See the “1.8.1 Unlock Pay As You Grow Bundles” section on page 1-47.
Sites	<ul style="list-style-type: none"> • Open Site Functional View—Opens the site functional view. See the 2.9.1 Viewing the Site Functional View, page 2-50. • Unlock—Unlocks the site. See the “2.10.5 Unlocking Parameters in the Network Design” section on page 2-55. • Forcing Manager—Unlocks individual units in multiple sites/ducts. See “2.10.5.1 Forcing Manager” section on page 2-55.

Table A-6 *Shortcut Menu Actions (continued)*

Toolbar	Description
Fiber spans	<ul style="list-style-type: none"> Edit Note—Allows you to create a note for that item. See the “2.5 Adding Notes to a Project” section on page 2-14. <p>If the network is analyzed, the Unlock command is also available. See the “2.10.5 Unlocking Parameters in the Network Design” section on page 2-55.</p>
Traffic demands	<ul style="list-style-type: none"> Edit Note—Allows you to create a note for that item. See the “2.5 Adding Notes to a Project” section on page 2-14. Edit—Allows you to edit the demand. See the “4.7 Editing a Point-to-Point Demand” section on page 4-41, “4.8 Editing a P-Ring Demand” section on page 4-44, or “4.9 Editing a ROADM Demand” section on page 4-47. Delete—Removes the demand from the project. See the “4.24 Deleting a Traffic Demand” section on page 4-121. Add/Remove Site—Allows to add or remove sites from P-Ring, Ethernet Aggregated, and TDM Aggregated demands. <p>If the network is analyzed, the Unlock command is also available. See the “2.10.5 Unlocking Parameters in the Network Design” section on page 2-55.</p>

A.2 Site Icons

A site icon indicates the functionality of site. [Table A-7](#) lists the site icons.

Table A-7 *Site Icons*











Site Name	Site Icon	Description
Add/Drop		Indicates that this site has add/drop capability. Only point-to-point and P-ring circuits can be added/dropped at this site.
Gain equalizer		Indicates that this site uses wavelength selective switch cards to control the generated tilt and extend unregenerated distances. The site is realized as an ROADM site without demultiplexer cards.
Hub		Indicates that this site is equipped with filters for adding and dropping all the channels (on both West and East sides). All express paths are open in hub configurations.
Line amplifier		Indicates that any add/drop traffic is prevented at this site.

Table A-7 Site Icons

Site Name	Site Icon	Description
OSC site		Indicates that site is designated for network communication, providing the possibility to access the optical service channel (OSC) for management of the MultiService Transport platform (MSTP) network. By default, no amplifiers are included in this site. However, if Cisco Transport Planner determines that an amplifier is required in the network, it can automatically place it at this location. Cisco Transport Planner allows you to set (force) preamplifier and booster amplifiers for each direction on a OSC Site node.
Pass Through		Indicates that no equipment will be located at this site.
R-OADM		Indicates that this site supports Any-to-Any and also Fixed (point-to-point and P-ring) traffic types.
PSM		Indicates a PSM site with Aw representing the working path and Ap representing the protected path.
Terminal		Indicates a terminal site.
OXC		Indicates a multi degree OXC site.
OIC		Indicates a multi degree OIC site

A.3 Demand Editor Icons

Table A-8 Demand Editor Icons









Icons	Description
	Expands the services of a demand (if collapsed).
	Collapses the services of a demand (if expanded).

Table A-8 Demand Editor Icons

Icons	Description
	Creates a new service.
	Deletes an existing service.
	Selects siblings at the same level.
	Selects all siblings of the same type.
	Opens the path constraints editor.
	Opens the regeneration editor.
	Opens Optical Bypass editor.



APPENDIX **B**

Card Types

This appendix provides a list of interface and card types supported in Cisco Transport Planner, as well as the corresponding Cisco product ID (Tables B-1 to B-43).



Note

The card names in this appendix designated with “_C” or “_L” appear in Cisco Transport Planner with a “_y” designation before network analysis. The “_y” designation indicates that Cisco Transport Planner will use either a C- or L-band card, depending on the band selected during project creation.

Table B-1 OC-192/STM-64 (9.953 Gbps)

Interface Type	Card Type	Protection Type	Product ID
Line Card	10G_XR without FEC	Client 1+1 Y-Cable PSM-OCH	15454-10G-XR=
Transponder	TXP_MR_10E_C and TXP_MR_10E_L with EFEC ¹	Client 1+1 Y-Cable PSM-OCH	15454-10E-L1-C= (C band) 15454-10E-L1-L= (L band)
Transponder	TXP_MR_10E_C and TXP_MR_10E_L with FEC ²	Client 1+1 Y-Cable PSM-OCH	15454-10E-L1-C= (C band) 15454-10E-L1-L= (L band)
Transponder	TXP_MR_10E_C and TXP_MR_10E_L without FEC	Client 1+1 Y-Cable PSM-OCH	15454-10E-L1-C= (C band) 15454-10E-L1-L= (L band)
Transponder	TXP_MR_10E with EFEC	Client 1+1 Y-Cable PSM-OCH	15454-10E-L1-xx.y= (C band) 15454-10E-L1-xx.y= (L band)
Transponder	TXP_MR_10E with FEC	Client 1+1 Y-Cable PSM-OCH	15454-10E-L1-xx.y= (C band) 15454-10E-L1-xx.y= (L band)

Table B-1 OC-192/STM-64 (9.953 Gbps) (continued)

Interface Type	Card Type	Protection Type	Product ID
Transponder	TXP_MR_10E without FEC	Client 1+1	15454-10E-L1-xx.y= (C band)
		Y-Cable	15454-10E-L1-xx.y= (L band)
		PSM-OCH	
Transponder	TXP_MR_10G with FEC	Client 1+1	15454-10T-L1-xx.y=
		Y-Cable	
Transponder	TXP_MR_10G without FEC	Client 1+1	15454-10T-L1-xx.y=
		Y-Cable	
Line Card	OC-192 LR STM-64 LR	Client 1+1	15454-192L-1-xx.y= (ANSI) 15454E-64L-xx.y= (ETSI)
Transponder	OTU-2_XP with EFEC	Y-Cable	15454-OTU2-XP=
		Client 1+1	
		PSM-OCH	
		Fiber-Switched	
Transponder	OTU-2_XP with FEC	Y-Cable	15454-OTU2-XP=
		Client 1+1	
		PSM-OCH	
		Fiber-Switched	
Transponder	OTU-2_XP without FEC	Y-Cable	15454-OTU2-XP=
		Client 1+1	
		PSM-OCH	
		Fiber-Switched	
Transponder	TXP_MR_10EX_C with EFEC and FEC	Client 1+1	15454-10EX-L1-C=
		Y-Cable	
		PSM OCH	
Transponder	40G DQPSK MXP with FEC	Client 1+1	15454-40G-MXP-C=
		Y-Cable	
		PSM OCH	
Transponder	40G DQPSK MXP with EFEC	Client 1+1	15454-40G-MXP-C=
		Y-Cable	
		PSM OCH	
Transponder	40G CP-DQPSK MXP with FEC	Client 1+1	15454-40G-CP-DQPSK-MXP-C=
		Y-Cable	
		PSM OCH	

Table B-1 OC-192/STM-64 (9.953 Gbps) (continued)

Interface Type	Card Type	Protection Type	Product ID
Transponder	40G CP-DQPSK MXP with EFEC	Client 1+1 Y-Cable PSM OCH	15454-40G-CP-DQPSK-MXP-C=
Transponder	40G CP-DQPSK ME MXP with FEC	Client 1+1 Y-Cable PSM OCH	15454-40G-CP-DQPSK-ME-MXP-C=
Transponder	40G CP-DQPSK ME MXP with EFEC	Client 1+1 Y-Cable PSM OCH	15454-40G-CP-DQPSK-ME-MXP-C=

1. Enhanced forward error correction.
2. Forward error correction.

Table B-2 OC-48/STM-16 (2.488 Gbps)

Interface Type	Card Type	Protection Type	Product ID
Transponder	TXP_MR_2.5G TXPP_MR_2.5G with FEC	Client 1+1 Y-Cable Fiber-Switched	15454-MR-L1-xx.y= (Unprot) 15454-MRP-L1-xx.y= (Prot)
Transponder	TXP_MR_2.5G TXPP_MR_2.5G without FEC	Client 1+1 Y-Cable Fiber-Switched	15454-MR-L1-xx.y= (Unprot) 15454-MRP-L1-xx.y= (Prot)
Transponder	MXP_2.5_10E_C and MXP_2.5_10E_L with EFEC	Client 1+1 Y-Cable	15454-10ME-L1-C= (C band) 15454-10ME-L1-L= (L band)
Transponder	MXP_2.5_10E_C and MXP_2.5_10E_L with FEC	Client 1+1 Y-Cable	15454-10ME-L1-C= (C band) 15454-10ME-L1-L= (L band)
Transponder	MXP_2.5_10EX_C with EFEC	Client 1+1 Y-Cable	15454-10EX-L1-C=
Transponder	MXP_2.5_10EX_C with FEC	Client 1+1 Y-Cable	15454-10EX-L1-C=
Transponder	MXP_2.5_10E with EFEC	Client 1+1 Y-Cable	15454-10ME-xx.y=
Transponder	MXP_2.5_10ET with FEC	Client 1+1 Y-Cable	15454-10ME-xx.y=
Transponder	MXP_2.5_10G with FEC	Client 1+1 Y-Cable	15454-10M-L1-xx.y=

Table B-2 OC-48/STM-16 (2.488 Gbps) (continued)

Transponder	MXP_2.5_10G without FEC	Client 1+1 Y-Cable	15454-10M-L1-xx.y=
Transponder	MXP_2.5G_10E with FEC	Client 1+1 Y-Cable	15454-10ME-L1-xx.y=
Transponder	MXP_2.5G_10E without FEC	Client 1+1 Y-Cable	15454-10ME-L1-xx.y=
Transponder	MXP_2.5G_10E_y with FEC	Client 1+1 Y-Cable	15454-10ME-L1-xx.y=
Transponder	MXP_2.5G_10E_y without FEC	Client 1+1 Y-Cable	15454-10ME-L1-xx.y=
Line Card	OC48ELR / SMT-16ELR	Client 1+1	15454-O48E-1-xx.y (ANSI) 15454E-EL16HSxxyy= (ETSI)
Line Card	MRC-I-12	Client 1+1	15454E-MRC-I-12=
PL	DWDM ITU-T SFP	Client 1+1	ONS-SC-4G=
Transponder	ADM-10G with EFEC	Client 1+1	15454-ADM-10G=
Transponder	ADM-10G with FEC	Client 1+1	15454-ADM-10G=
Transponder	ADM-10G without FEC	Client 1+1	15454-ADM-10G=
Transponder	MXP_2.5G_10EX_C with EFEC and FEC	Client 1+1 Y-Cable PSM OCH	15454-10MEX-L1-C=
Muxponder	AR-MXP with EFEC, FEC, NOFEC	Y-Cable Client 1+1 PCM OCH	AR-MXP - MXP-MR (HR)
Muxponder	AR-MXP with EFEC, FEC, NOFEC	Y-Cable Client 1+1 PCM OCH	AR-MXP - MXP-2.5G-10G (HR)
Muxponder	AR-XP with EFEC, FEC, NOFEC	Y-Cable Client 1+1 PCM OCH Fiber-Switched	AR-XP - MXP-2.5G-10G (HR) AR-XP - MXPP-2.5G-10G (HR)
Muxponder	AR-XP with EFEC, FEC, NOFEC	Y-Cable Client 1+1 PCM OCH Fiber-Switched	AR-XP - MXP-MR (HR) AR-XP - MXPP-MR (HR)

Table B-2 OC-48/STM-16 (2.488 Gbps) (continued)

Transponder	AR-MXP with FEC, NOFEC	Client 1+1 Y-Cable PSM OCH Fiber-Switched	AR-MXP - TXP-MR (LR) AR-MXP - TXPP-MR (LR)
Transponder	AR-MXP with FEC, NOFEC	Client 1+1 Y-Cable PSM OCH Fiber-Switched	AR-XP - TXP-MR (LR) AR-XP - TXPP-MR (LR)

Table B-3 OTU1

Interface Type	Card Type	Protection Type	Product ID
Muxponder	AR-MXP with EFEC, FEC, NOFEC	Client 1+1 Y-Cable PSM OCH	AR-MXP - MXP-2.5G-10G (HR)
Muxponder	AR-MXP with EFEC, FEC, NOFEC	Client 1+1 Y-Cable PSM OCH	AR-MXP - MXP-MR (HR)
Muxponder	AR-XP with EFEC, FEC, NOFEC	Client 1+1 Y-Cable PSM OCH Fiber-Switched	AR-XP - MXP-MR (HR) AR-XP - MXPP-MR (HR)
Muxponder	AR-XP with EFEC, FEC, NOFEC	Client 1+1 Y-Cable PSM OCH Fiber-Switched	AR-XP - MXP-2.5G-10G (HR) AR-XP - MXPP-2.5G-10G (HR)
Transponder	AR-MXP with FEC, NOFEC	Client 1+1 Y-Cable PSM OCH Fiber-Switched	AR-MXP - TXP-MR (LR) AR-MXP - TXPP-MR (LR)
Transponder	AR-XP with FEC, NOFEC	Client 1+1 Y-Cable PSM OCH Fiber-Switched	AR-XP - TXP-MR (LR) AR-XP - TXPP-MR (LR)

Table B-4 OTU2

Interface Type	Card Type	Protection Type	Product ID
Transponder	OTU-2_XP with EFEC	Y-Cable Client 1+1 PSM-OCH Fiber-Switched	15454-OTU2-XP=
Transponder	OTU-2_XP with FEC	Y-Cable Client 1+1 PSM-OCH Fiber-Switched	15454-OTU2-XP=
Transponder	OTU-2_XP without FEC	Y-Cable Client 1+1 PSM-OCH Fiber-Switched	15454-OTU2-XP=
Transponder	40G DQPSK MXP with FEC	Client 1+1 Y-Cable PSM OCH	15454-40G-MXP-C=
Transponder	40G DQPSK MXP with EFEC	Client 1+1 Y-Cable PSM OCH	15454-40G-MXP-C=
Transponder	40G CP-DQPSK MXP with FEC	Client 1+1 Y-Cable PSM OCH	15454-40G-CP-DQPSK-MXP-C=
Transponder	40G CP-DQPSK MXP with EFEC	Client 1+1 Y-Cable PSM OCH	15454-40G-CP-DQPSK-MXP-C=
Transponder	40G CP-DQPSK ME MXP with FEC	Client 1+1 Y-Cable PSM OCH	15454-40G-CP-DQPSK-ME-MXP-C=
Transponder	40G CP-DQPSK ME MXP with EFEC	Client 1+1 Y-Cable PSM OCH	15454-40G-CP-DQPSK-ME-MXP-C=

Table B-5 OTU2e

Interface Type	Card Type	Protection Type	Product ID
Transponder	40G DQPSK MXP with FEC	Client 1+1 Y-Cable PSM OCH	15454-40G-MXP-C=
Transponder	40G DQPSK MXP with EFEC	Client 1+1 Y-Cable PSM OCH	15454-40G-MXP-C=
Transponder	40G CP-DQPSK MXP with FEC	Client 1+1 Y-Cable PSM OCH	15454-40G-CP-DQPSK-MXP-C=
Transponder	40G CP-DQPSK MXP with EFEC	Client 1+1 Y-Cable PSM OCH	15454-40G-CP-DQPSK-MXP-C=
Transponder	40G CP-DQPSK ME MXP with FEC	Client 1+1 Y-Cable PSM OCH	15454-40G-CP-DQPSK-ME-MXP-C=
Transponder	40G CP-DQPSK ME MXP with EFEC	Client 1+1 Y-Cable PSM OCH	15454-40G-CP-DQPSK-ME-MXP-C=

Table B-6 OTU3

Interface Type	Card Type	Protection Type	Product ID
Transponder	40G CP-DQPSK TXP with FEC	Client 1+1 Y-Cable PSM OCH	15454-40G-CP-DQPSK-TXP-C=
Transponder	40G CP-DQPSK TXP with EFEC	Client 1+1 Y-Cable PSM OCH	15454-40G-CP-DQPSK-TXP-C=
Transponder	40G CP-DQPSK ME TXP with FEC	Client 1+1 Y-Cable PSM OCH	15454-40G-CP-DQPSK-ME-TXP-C=
Transponder	40G CP-DQPSK ME TXP with EFEC	Client 1+1 Y-Cable PSM OCH	15454-40G-CP-DQPSK-ME-TXP-C=

Table B-7 OC-12/STM-4 (622 Mbps)

Interface Type	Card Type	Protection Type	Product ID
Transponder	TXP_MR_2.5G TXPP_MR_2.5G with FEC	Client 1+1	15454-MR-L1-xx.y= (Unprot)
		Y-Cable	15454-MRP-L1-xx.y= (Prot)
		Fiber-Switched	
Transponder	TXP_MR_2.5G TXPP_MR_2.5G without FEC	Client 1+1	15454-MR-L1-xx.y= (Unprot)
		Y-Cable	15454-MRP-L1-xx.y= (Prot)
		Fiber-Switched	
Transponder	ADM-10G with EFEC	Client 1+1	15454-ADM-10G=
Transponder	ADM-10G with FEC	Client 1+1	15454-ADM-10G=
Transponder	ADM-10G without FEC	Client 1+1	15454-ADM-10G=
Muxponder	AR-MXP with EFEC, FEC, NOFEC	Client 1+1	AR-MXP - MXP-MR (HR)
		Y-Cable	
		PCM OCH	
Muxponder	AR-MXP with FEC, NOFEC	Client 1+1	AR-MXP - MXP-MR (LR)
		Y-Cable	AR-MXP - MXPP-MR (LR)
		PCM OCH	
		Fiber-Switched	
Muxponder	AR-XP with EFEC, FEC, NOFEC	Client 1+1	AR-XP - MXP-MR (HR)
		Y-Cable	AR-XP - MXPP-MR (HR)
		PCM OCH	
		Fiber-Switched	
Muxponder	AR-XP with FEC, NOFEC	Client 1+1	AR-XP - MXP-MR (LR)
		Y-Cable	AR-XP - MXPP-MR (LR)
		PCM OCH	
		Fiber-Switched	
Transponder	AR-MXP with FEC, NOFEC	Client 1+1	AR-MXP - TXP-MR (LR)
		Y-Cable	AR-MXP - TXPP-MR (LR)
		PSM OCH	
		Fiber-Switched	
Transponder	AR-XP with FEC, NOFEC	Client 1+1	AR-XP - TXP-MR (LR)
		Y-Cable	AR-XP - TXPP-MR (LR)
		PSM OCH	
		Fiber-Switched	

Table B-8 OC-3/STM-1 (155 Mbps)

Interface Type	Card Type	Protection Type	Product ID
Transponder	TXP_MR_2.5G TXPP_MR_2.5G with FEC	Client 1+1	15454-MR-L1-xx.y= (Unprot)
		Y-Cable	15454-MRP-L1-xx.y= (Prot)
		Fiber-Switched	
Transponder	TXP_MR_2.5G TXPP_MR_2.5G without FEC	Client 1+1	15454-MR-L1-xx.y= (Unprot)
		Y-Cable	15454-MRP-L1-xx.y= (Prot)
		Fiber-Switched	
Transponder	ADM-10G with EFEC	Client 1+1	15454-ADM-10G=
Transponder	ADM-10G with FEC	Client 1+1	15454-ADM-10G=
Transponder	ADM-10G without FEC	Client 1+1	15454-ADM-10G=
Muxponder	AR-MXP with EFEC, FEC, NOFEC	Client 1+1 Y-Cable PCM OCH	AR-MXP - MXP-MR (HR)
Muxponder	AR-MXP with FEC, NOFEC	Client 1+1 Y-Cable PCM OCH Fiber-Switched	AR-MXP - MXP-MR (LR) AR-MXP - MXPP-MR (LR)
Muxponder	AR-XP with EFEC, FEC, NOFEC	Client 1+1 Y-Cable PCM OCH Fiber-Switched	AR-XP - MXP-MR (HR) AR-XP - MXPP-MR (HR)
Muxponder	AR-XP with FEC, NOFEC	Client 1+1 Y-Cable PCM OCH Fiber-Switched	AR-XP - MXP-MR (LR) AR-XP - MXPP-MR (LR)
Transponder	AR-MXP with FEC, NOFEC	Client 1+1	AR-MXP - TXP-MR (LR)
		Y-Cable	AR-MXP - TXPP-MR (LR)
		PSM OCH Fiber-Switched	
Transponder	AR-XP with FEC, NOFEC	Client 1+1	AR-XP - TXP-MR (LR)
		Y-Cable	AR-XP - TXPP-MR (LR)
		PSM OCH Fiber-Switched	

Table B-9 OC-768/STM-256 (40 Gbps)

Interface Type	Card Type	Protection Type	Product ID
Line Card	CRS-1 40G DPSK ITU-T LC	Client 1+1 PSM-OCH	1OC768-DPSK/C=
Line Card	CRS-1 40G ITU-T LC	Client 1+1 PSM-OCH	1OC768-ITU/C
Transponder	40G DWDM ITU-T TXP	Client 1+1 PSM-OCH	40G-DWDM-ITU-T-TXP-C
Transponder	40G CP-DQPSK TXP with FEC	Client 1+1 Y-Cable PSM OCH	15454-40G-CP-DQPSK-TXP-C=
Transponder	40G CP-DQPSK TXP with EFEC	Client 1+1 Y-Cable PSM OCH	15454-40G-CP-DQPSK-TXP-C=
Transponder	40G CP-DQPSK ME TXP with FEC	Client 1+1 Y-Cable PSM OCH	15454-40G-CP-DQPSK-ME-TXP-C=
Transponder	40G CP-DQPSK ME TXP with EFEC	Client 1+1 Y-Cable PSM OCH	15454-40G-CP-DQPSK-ME-TXP-C=

Table B-10 40Gigabit Ethernet Local Area Network ATM Physical Layer (40GE LAN PHY)

Interface Type	Card Type	Protection Type	Product ID
Transponder	40G CP-DQPSK TXP with FEC	Client 1+1 Y-Cable PSM OCH	15454-40G-CP-DQPSK-TXP-C=
Transponder	40G CP-DQPSK TXP with EFEC	Client 1+1 Y-Cable PSM OCH	15454-40G-CP-DQPSK-TXP-C=
Transponder	40G CP-DQPSK ME TXP with FEC	Client 1+1 Y-Cable PSM OCH	15454-40G-CP-DQPSK-ME-TXP-C=
Transponder	40G CP-DQPSK ME TXP with EFEC	Client 1+1 Y-Cable PSM OCH	15454-40G-CP-DQPSK-ME-TXP-C=

Table B-11 10Gigabit Ethernet Wide Area Network ATM Physical Layer (10GE WAN PHY) (9.953 Gbps)

Interface Type	Card Type	Protection Type	Product ID
Transponder	TXP_MR_10E_C and TXP_MR_10E_L with EFEC	Client 1+1	15454-10E-L1-C= (C band)
		Y-Cable	15454-10E-L1-L= (L band)
		PSM-OCH	
Transponder	TXP_MR_10E_C and TXP_MR_10E_L with FEC	Client 1+1	15454-10E-L1-C= (C band)
		Y-Cable	15454-10E-L1-L= (L band)
		PSM-OCH	
Transponder	TXP_MR_10E_C and TXP_MR_10E_L without FEC	Client 1+1	15454-10E-L1-C= (C band)
		Y-Cable	15454-10E-L1-L= (L band)
		PSM-OCH	
Transponder	TXP_MR_10E with EFEC	Client 1+1	15454-10E-L1-C= (C band)
		Y-Cable	15454-10E-L1-L= (L band)
		PSM-OCH	
Transponder	TXP_MR_10E with FEC	Client 1+1	15454-10E-L1-C= (C band)
		Y-Cable	15454-10E-L1-L= (L band)
		PSM-OCH	
Transponder	TXP_MR_10E without FEC	Client 1+1	15454-10E-L1-C= (C band)
		Y-Cable	15454-10E-L1-L= (L band)
		PSM-OCH	
Transponder	TXP_MR_10G with FEC	Client 1+1	15454-10T-L1-xx.y=
		Y-Cable	
Transponder	TXP_MR_10G without FEC	Client 1+1	15454-10T-L1-xx.y=
		Y-Cable	
Transponder	OTU-2_XP with EFEC	Y-Cable	15454-OTU2-XP=
		Client 1+1	
		PSM-OCH	
		Fiber-Switched	
Transponder	OTU-2_XP with FEC	Y-Cable	15454-OTU2-XP=
		Client 1+1	
		PSM-OCH	
		Fiber-Switched	
Transponder	OTU-2_XP without FEC	Y-Cable	15454-OTU2-XP=
		Client 1+1	
		PSM-OCH	
		Fiber-Switched	

Table B-11 10Gigabit Ethernet Wide Area Network ATM Physical Layer (10GE WAN PHY) (9.953 Gbps) (continued)

Interface Type	Card Type	Protection Type	Product ID
Transponder	TXP_MR_10EX_C with EFEC and FEC	Client 1+1 Y-Cable PSM OCH	15454-10EX-L1-C=
Transponder	40G DQPSK MXP with FEC	Client 1+1 Y-Cable PSM OCH	15454-40G-MXP-C=
Transponder	40G DQPSK MXP with EFEC	Client 1+1 Y-Cable PSM OCH	15454-40G-MXP-C=
Transponder	40G CP-DQPSK MXP with FEC	Client 1+1 Y-Cable PSM OCH	15454-40G-CP-DQPSK-MXP-C=
Transponder	40G CP-DQPSK MXP with EFEC	Client 1+1 Y-Cable PSM OCH	15454-40G-CP-DQPSK-MXP-C=
Transponder	40G CP-DQPSK ME MXP with FEC	Client 1+1 Y-Cable PSM OCH	15454-40G-CP-DQPSK-ME-MXP-C=
Transponder	40G CP-DQPSK ME MXP with EFEC	Client 1+1 Y-Cable PSM OCH	15454-40G-CP-DQPSK-ME-MXP-C=

Table B-12 10Gigabit Ethernet Local Area Network ATM Physical Layer (10GE LAN PHY)(10.3 Gbps)

Interface Type	Card Type	Protection Type	Product ID
Transponder	TXP_MR_10E_C and TXP_MR_10E_L with EFEC	Client 1+1 Y-Cable PSM-OCH	15454-10E-L1-C= (C band) 15454-10E-L1-L= (L band)
Transponder	TXP_MR_10E_C and TXP_MR_10E_L with FEC	Client 1+1 Y-Cable PSM-OCH	15454-10E-L1-C= (C band) 15454-10E-L1-L= (L band)
Transponder	TXP_MR_10E_C and TXP_MR_10E_L without FEC	Client 1+1 Y-Cable PSM-OCH	15454-10E-L1-C= (C band) 15454-10E-L1-L= (L band)

Table B-12 10Gigabit Ethernet Local Area Network ATM Physical Layer (10GE LAN PHY)(10.3 Gbps) (continued)

Interface Type	Card Type	Protection Type	Product ID
Transponder	TXP_MR_10E with EFEC	Client 1+1	15454-10E-L1-C= (C band)
		Y-Cable PSM-OCH	15454-10E-L1-L= (L band)
Transponder	TXP_MR_10E with FEC	Client 1+1	15454-10E-L1-C= (C band)
		Y-Cable PSM-OCH	15454-10E-L1-L= (L band)
Transponder	TXP_MR_10E without FEC	Client 1+1	15454-10E-L1-C= (C band)
		Y-Cable PSM-OCH	15454-10E-L1-L= (L band)
Transponder	TXP_MR_10E_y with EFEC	Client 1+1 Y-Cable PSM-OCH	15454-10E-L1-L= (L band)
Transponder	TXP_MR_10E_y with FEC	Client 1+1 Y-Cable PSM-OCH	15454-10E-L1-L= (L band)
Transponder	TXP_MR_10E_y without FEC	Client 1+1 Y-Cable PSM-OCH	15454-10E-L1-L= (L band)
Transponder	10GE_XP with EFEC	Client 1+1	15454-10GE-XP = (Unprot)
		Y-Cable	15454-10GE-XP = (Prot)
Transponder	10GE_XP with FEC	Client 1+1	15454-10GE-XP = (Unprot)
		Y-Cable	15454-10GE-XP = (Prot)
Transponder	10GE_XP without FEC	Client 1+1	15454-10GE-XP = (Unprot)
		Y-Cable	15454-10GE-XP = (Prot)
Transponder	10GE_XPE with EFEC	Client 1+1 Y-Cable	15454-10GE-XPE=
Transponder	10GE_XPE with FEC	Client 1+1 Y-Cable	15454-10GE-XPE=
Transponder	10GE_XPE without FEC	Client 1+1 Y-Cable	15454-10GE-XPE=
Transponder	OTU-2_XP with EFEC	Y-Cable Client 1+1 PSM-OCH Fiber-Switched	15454-OTU2-XP=

Table B-12 10Gigabit Ethernet Local Area Network ATM Physical Layer (10GE LAN PHY)(10.3 Gbps) (continued)

Interface Type	Card Type	Protection Type	Product ID
Transponder	OTU-2_XP with FEC	Y-Cable Client 1+1 PSM-OCH Fiber-Switched	15454-OTU2-XP=
Transponder	OTU-2_XP without FEC	Y-Cable Client 1+1 PSM-OCH Fiber-Switched	15454-OTU2-XP=
Transponder	10GE_EXP with EFEC	Y-Cable Client 1+1	15454-10GE-XPE=
Transponder	10GE_EXP with FEC	Y-Cable Client 1+1	15454-10GE-XPE=
Transponder	10GE_EXP without FEC	Y-Cable Client 1+1	15454-10GE-XPE=
Transponder	TXP_MR_10EX_C with EFEC	Client 1+1 Y-Cable PSM OCH	15454-10EX-L1-C=
Transponder	TXP_MR_10EX_C with FEC	Client 1+1 Y-Cable PSM OCH	15454-10EX-L1-C=
Line Card	4-10GE-ITU with EFEC	Client 1+1 PSM OCH	4-10GE-ITU/C=
Line Card	4-10GE-ITU with FEC	Client 1+1 PSM OCH	4-10GE-ITU/C=
Line Card	4-10GE-ITU without FEC	Client 1+1 PSM OCH	4-10GE-ITU/C=
Line Card	10GE-ITU with EFEC	Client 1+1 PSM OCH	10GE-ITU/C=
Line Card	10GE-ITU with FEC	Client 1+1 PSM OCH	10GE-ITU/C=
Line Card	10GE-ITU without FEC	Client 1+1 PSM OCH	10GE-ITU/C=
Line Card	DWDM XENPAK without FEC	Client 1+1 PSM OCH	DWDM-XENPAK-xx.yy=

Table B-12 10Gigabit Ethernet Local Area Network ATM Physical Layer (10GE LAN PHY)(10.3 Gbps) (continued)

Interface Type	Card Type	Protection Type	Product ID
PL	DWDM XFP on Cat with EFEC	Client 1+1 PSM OCH	DWDM-XFP-xx.yy=
PL	DWDM XFP on Cat with FEC	Client 1+1 PSM OCH	DWDM-XFP-xx.yy=
PL	DWDM XFP on Cat without FEC	Client 1+1 PSM OCH	DWDM-XFP-xx.yy=
PL	DWDM X2 without FEC	Client 1+1 PSM OCH	DWDM-X2-xx.yy=
Transponder	40G DQPSK MXP with FEC	Client 1+1 Y-Cable PSM OCH	15454-40G-MXP-C=
Transponder	40G DQPSK MXP with EFEC	Client 1+1 Y-Cable PSM OCH	15454-40G-MXP-C=
Transponder	40G CP-DQPSK MXP with FEC	Client 1+1 Y-Cable PSM OCH	15454-40G-CP-DQPSK-MXP-C=
Transponder	40G CP-DQPSK MXP with EFEC	Client 1+1 Y-Cable PSM OCH	15454-40G-CP-DQPSK-MXP-C=
Transponder	40G CP-DQPSK ME MXP with FEC	Client 1+1 Y-Cable PSM OCH	15454-40G-CP-DQPSK-ME-MXP-C=
Transponder	40G CP-DQPSK ME MXP with EFEC	Client 1+1 Y-Cable PSM OCH	15454-40G-CP-DQPSK-ME-MXP-C=

Table B-13 10Gigabit Ethernet LAN-to-WAN

Interface Type	Card Type	Protection Type	Product ID
Transponder	40G DQPSK MXP with FEC	Client 1+1 Y-Cable PSM OCH	15454-40G-MXP-C=
Transponder	40G DQPSK MXP with EFEC	Client 1+1 Y-Cable PSM OCH	15454-40G-MXP-C=
Transponder	40G CP-DQPSK MXP with FEC	Client 1+1 Y-Cable PSM OCH	15454-40G-CP-DQPSK-MXP-C=
Transponder	40G CP-DQPSK MXP with EFEC	Client 1+1 Y-Cable PSM OCH	15454-40G-CP-DQPSK-MXP-C=
Transponder	40G CP-DQPSK ME MXP with FEC	Client 1+1 Y-Cable PSM OCH	15454-40G-CP-DQPSK-ME-MXP-C=
Transponder	40G CP-DQPSK ME MXP with EFEC	Client 1+1 Y-Cable PSM OCH	15454-40G-CP-DQPSK-ME-MXP-C=
Transponder	OTU-2_XP with EFEC	Client 1+1 Y-Cable PSM OCH Fiber-Switched	15454-OTU2-XP=
Transponder	OTU-2_XP with FEC	Client 1+1 Y-Cable PSM OCH Fiber-Switched	15454-OTU2-XP=
Transponder	OTU-2_XP with out EFEC	Client 1+1 Y-Cable PSM OCH Fiber-Switched	15454-OTU2-XP=

Table B-14 Gigabit Ethernet (1.25Gbps)

Interface Type	Card Type	Protection Type	Product ID
Transponder	MXP_MR_10DME with EFEC	Client 1+1 Y-Cable	15454-10DME-C= (C band) 15454-10DME-L= (L band)
Transponder	MXP_MR_10DME with FEC	Client 1+1 Y-Cable	15454-10DME-C= (C band) 15454-10DME-L= (L band)
Transponder	MXP_MR_10DME without FEC	Client 1+1 Y-Cable	15454-10DME-C= (C band) 15454-10DME-L= (L band)
Transponder	TXP_MR_2.5G TXPP_MR_2.5G with FEC	Client 1+1 Y-Cable Fiber-Switched	15454-MR-L1-xx.y= (Unprot) 15454-MRP-L1-xx.y= (Prot)
Transponder	TXP_MR_2.5G TXPP_MR_2.5G without FEC	Client 1+1 Y-Cable Fiber-Switched	15454-MR-L1-xx.y= (Unprot) 15454-MRP-L1-xx.y= (Prot)
Pluggable	GE DWDM GBIC	Client 1+1	15454-GBIC-xx.y=
Transponder	GE_XP with EFEC	Client 1+1 Y-Cable PSM OCH	15454-GE-XP = (Unprot) 15454-GE-XP = (Prot)
Transponder	GE_XP with FEC	Client 1+1 Y-Cable PSM OCH	15454-GE-XP = (Unprot) 15454-GE-XP = (Prot)
Transponder	GE_XP without FEC	Client 1+1 Y-Cable PSM OCH	15454-GE-XP = (Unprot) 15454-GE-XP = (Prot)
Transponder	GE_XPE with EFEC	Client 1+1 Y-Cable PSM OCH	15454-GE-XPE=
Transponder	GE_XPE with FEC	Client 1+1 Y-Cable PSM OCH	15454-GE-XPE=
Transponder	GE_XPE without FEC	Client 1+1 Y-Cable PSM OCH	15454-GE-XPE=
Transponder	ADM-10G with EFEC	Client 1+1	15454-ADM-10G=
Transponder	ADM-10G with FEC	Client 1+1	15454-ADM-10G=
Transponder	ADM-10G without FEC	Client 1+1	15454-ADM-10G=

Table B-14 Gigabit Ethernet (1.25Gbps) (continued)

Interface Type	Card Type	Protection Type	Product ID
Transponder	10GE_EXP with EFEC	Y-Cable Client 1+1	15454-10GE-XPE=
Transponder	10GE_EXP with FEC	Y-Cable Client 1+1	15454-10GE-XPE=
Transponder	10GE_EXP without FEC	Y-Cable Client 1+1	15454-10GE-XPE=
Transponder	GE_EXP with EFEC	Y-Cable Client 1+1 PSM-OCH	15454-GE-XPE=
Transponder	GE_EXP with FEC	Y-Cable Client 1+1 PSM-OCH	15454-GE-XPE=
Transponder	GE_EXP without FEC	Y-Cable Client 1+1 PSM-OCH	15454-GE-XPE=
Transponder	MXP_MR_10DMEX_C with EFEC	Y-Cable Client 1+1 PSM-OCH	15454-10DMEX-C=
Transponder	MXP_MR_10DMEX_C with FEC	Y-Cable Client 1+1 PSM-OCH	15454-10DMEX-C=
Transponder	MXP_MR_10DMEX_C without FEC	Y-Cable Client 1+1 PSM-OCH	15454-10DMEX-C=
PL	DWDM GBIC without FEC	Client 1+1	15454-GBIC-xx.y=
PL	DWDM ITU-T SFP without FEC	Client 1+1 PSM-OCH	ONS-SC-4G=
Muxponder	AR-MXP with EFEC, FEC, NOFEC	Client 1+1 Y-Cable PCM OCH	AR-MXP - MXP-MR (HR)
Muxponder	AR-MXP with EFEC, FEC, NOFEC	Client 1+1 Y-Cable PCM OCH	AR-MXP - MXP-DME (HR)

Table B-14 Gigabit Ethernet (1.25Gbps) (continued)

Interface Type	Card Type	Protection Type	Product ID
Muxponder	AR-MXP with FEC, NOFEC	Client 1+1 Y-Cable PCM OCH Fiber-Switched	AR-MXP - MXP-MR (LR) AR-MXP - MXPP-MR (LR)
Muxponder	AR-XP with EFEC, FEC, NOFEC	Client 1+1 Y-Cable PCM OCH Fiber-Switched	AR-XP - MXP-MR (HR) AR-XP - MXPP-MR (HR)
Muxponder	AR-XP with EFEC, FEC, NOFEC	Client 1+1 Y-Cable PCM OCH Fiber-Switched	AR-XP - MXP-DME (HR) AR-XP - MXPP-DME (HR)
Muxponder	AR-XP with FEC, NOFEC	Client 1+1 Y-Cable PCM OCH Fiber-Switched	AR-XP - MXP-MR (LR) AR-XP - MXPP-MR (LR)
Transponder	AR-MXP with FEC, NOFEC	Client 1+1 Y-Cable PSM OCH Fiber-Switched	AR-MXP - TXP-MR (LR) AR-MXP - TXPP-MR (LR)
Transponder	AR-XP with FEC, NOFEC	Client 1+1 Y-Cable PSM OCH Fiber-Switched	AR-XP - TXP-MR (LR) AR-XP - TXPP-MR (LR)

Table B-15 Fast Ethernet (100 Mbps)

Interface Type	Card Type	Protection Type	Product ID
Transponder	TXP_MR_2.5G	Client 1+1	15454-MR-L1-xx.y= (Unprot)
	TXPP_MR_2.5G 2R	Y-Cable Fiber-Switched	15454-MRP-L1-xx.y= (Prot)
Muxponder	AR-MXP with EFEC, FEC, NOFEC	Client 1+1 Y-Cable PCM OCH	AR-MXP - MXP-MR (HR)

Table B-15 Fast Ethernet (100 Mbps) (continued)

Interface Type	Card Type	Protection Type	Product ID
Muxponder	AR-MXP with FEC, NOFEC	Client 1+1 Y-Cable PCM OCH Fiber-Switched	AR-MXP - MXP-MR (LR) AR-MXP - MXPP-MR (LR)
Muxponder	AR-XP with EFEC, FEC, NOFEC	Client 1+1 Y-Cable PCM OCH Fiber-Switched	AR-XP - MXP-MR (HR) AR-XP - MXPP-MR (HR)
Muxponder	AR-XP with FEC, NOFEC	Client 1+1 Y-Cable PCM OCH Fiber-Switched	AR-XP - MXP-MR (LR) AR-XP - MXPP-MR (LR)
Transponder	AR-MXP with FEC, NOFEC	Client 1+1 Y-Cable PSM OCH Fiber-Switched	AR-MXP - TXP-MR (LR) AR-MXP - TXPP-MR (LR)
Transponder	AR-XP with FEC, NOFEC	Client 1+1 Y-Cable PSM OCH Fiber-Switched	AR-XP - TXP-MR (LR) AR-XP - TXPP-MR (LR)

Table B-16 Fiber Channel 10G (10.5 Gbps)

Interface Type	Card Type	Protection Type	Product ID
Transponder	TXP_MR_10E_C and TXP_MR_10E_L with EFEC	Client 1+1 Y-Cable PSM-OCH	15454-10E-L1-C= (C band) 15454-10E-L1-L= (L band)
Transponder	TXP_MR_10E_C and TXP_MR_10E_L with FEC	Client 1+1 Y-Cable PSM-OCH	15454-10E-L1-C= (C band) 15454-10E-L1-L= (L band)
Transponder	TXP_MR_10E_C and TXP_MR_10E_L without FEC	Client 1+1 Y-Cable PSM-OCH	15454-10E-L1-C= (C band) 15454-10E-L1-L= (L band)
Transponder	TXP_MR_10E with EFEC	Client 1+1 Y-Cable PSM-OCH	15454-10E-L1-C= (C band) 15454-10E-L1-L= (L band)

Table B-16 *Fiber Channel 10G (10.5 Gbps) (continued)*

Interface Type	Card Type	Protection Type	Product ID
Transponder	TXP_MR_10E with FEC	Client 1+1 Y-Cable PSM-OCH	15454-10E-L1-C= (C band) 15454-10E-L1-L= (L band)
Transponder	TXP_MR_10E without FEC	Client 1+1 Y-Cable PSM-OCH	15454-10E-L1-C= (C band) 15454-10E-L1-L= (L band)
Transponder	TXP_MR_10E TXP_MR_10E_y	Client 1+1 Y-Cable PSM-OCH	15454-10E-L1-C= (C band) 15454-10E-L1-L= (L band)
Transponder	OTU-2_XP with EFEC	Y-Cable Client 1+1 PSM-OCH Fiber-Switched	15454-OTU2-XP=
Transponder	OTU-2_XP with FEC	Y-Cable Client 1+1 PSM-OCH Fiber-Switched	15454-OTU2-XP=
Transponder	OTU-2_XP without FEC	Y-Cable Client 1+1 PSM-OCH Fiber-Switched	15454-OTU2-XP=
Transponder	TXP_MR_10EX_C with EFEC and FEC	Client 1+1 Y-Cable PSM OCH	15454-10EX-L1-C=
Transponder	40G DQPSK MXP with FEC	Client 1+1 Y-Cable PSM OCH	15454-40G-MXP-C=
Transponder	40G DQPSK MXP with EFEC	Client 1+1 Y-Cable PSM OCH	15454-40G-MXP-C=
Transponder	40G CP-DQPSK MXP with FEC	Client 1+1 Y-Cable PSM OCH	15454-40G-CP-DQPSK-MXP-C=

Table B-16 *Fiber Channel 10G (10.5 Gbps) (continued)*

Interface Type	Card Type	Protection Type	Product ID
Transponder	40G CP-DQPSK MXP with EFEC	Client 1+1 Y-Cable PSM OCH	15454-40G-CP-DQPSK-MXP-C=
Transponder	40G CP-DQPSK ME MXP with FEC	Client 1+1 Y-Cable PSM OCH	15454-40G-CP-DQPSK-ME-MXP-C=
Transponder	40G CP-DQPSK ME MXP with EFEC	Client 1+1 Y-Cable PSM OCH	15454-40G-CP-DQPSK-ME-MXP-C=

Table B-17 *Fiber Channel 8G (8.5 Gbps)*

Interface Type	Card Type	Protection Type	Product ID
Transponder	40G DQPSK MXP with FEC	Client 1+1 Y-Cable PSM OCH	15454-40G-MXP-C=
Transponder	40G DQPSK MXP with EFEC	Client 1+1 Y-Cable PSM OCH	15454-40G-MXP-C=
Transponder	40G CP-DQPSK MXP with FEC	Client 1+1 Y-Cable PSM OCH	15454-40G-CP-DQPSK-MXP-C=
Transponder	40G CP-DQPSK MXP with EFEC	Client 1+1 Y-Cable PSM OCH	15454-40G-CP-DQPSK-MXP-C=
Transponder	40G CP-DQPSK ME MXP with FEC	Client 1+1 Y-Cable PSM OCH	15454-40G-CP-DQPSK-ME-MXP-C=
Transponder	40G CP-DQPSK ME MXP with EFEC	Client 1+1 Y-Cable PSM OCH	15454-40G-CP-DQPSK-ME-MXP-C=

Table B-17 *Fiber Channel 8G (8.5 Gbps) (continued)*

Interface Type	Card Type	Protection Type	Product ID
Transponder	AR-MXP with EFEC, FEC, NOFEC	Client 1+1 Y-Cable PSM OCH	AR-MXP - TXP-MR (HR)
Transponder	AR-XP with EFEC, FEC, NOFEC	Client 1+1 Y-Cable PSM OCH	AR-XP - TXP-MR (HR)

Table B-18 *Fiber Channel 4G (4.25 Gbps)*

Interface Type	Card Type	Protection Type	Product ID
Transponder	MXP_MR_10DME with EFEC	Client 1+1 Y-Cable	15454-10DME-C= (C band) 15454-10DME-L= (L band)
Transponder	MXP_MR_10DME with FEC	Client 1+1 Y-Cable	15454-10DME-C= (C band) 15454-10DME-L= (L band)
Transponder	MXP_MR_10DME without FEC	Client 1+1 Y-Cable	15454-10DME-C= (C band) 15454-10DME-L= (L band)
Transponder	MXP_MR_10DMEX_C with FEC	Y-Cable Client 1+1 PSM-OCH	15454-10DMEX-C=
Muxponder	AR-MXP with EFEC, FEC, NOFEC	Client 1+1 Y-Cable PSM OCH	AR-MXP - MXP-MR (HR)
Muxponder	AR-MXP with EFEC, FEC, NOFEC	Client 1+1 Y-Cable PSM OCH	AR-MXP - MXP-DME (HR)
Muxponder	AR-XP with EFEC, FEC, NOFEC	Client 1+1 Y-Cable PSM OCH Fiber-Switched	AR-XP - MXP-MR (HR) AR-XP - MXPP-MR (HR)
Muxponder	AR-XP with EFEC, FEC, NOFEC	Client 1+1 Y-Cable PSM OCH Fiber-Switched	AR-XP - MXP-DME (HR) AR-XP - MXPP-DME (HR)

Table B-18 Fiber Channel 4G (4.25 Gbps) (continued)

Interface Type	Card Type	Protection Type	Product ID
Transponder	AR-MXP with NOFEC	Client 1+1 Y-Cable PSM OCH Fiber-Switched	AR-MXP - TXP-MR (LR) AR-MXP - TXPP-MR (LR)
Transponder	AR-XP with NOFEC	Client 1+1 Y-Cable PSM OCH Fiber-Switched	AR-XP - TXP-MR (LR) AR-XP - TXPP-MR (LR)

Table B-19 Fiber Channel 2G (2.125 Gbps)

Interface Type	Card Type	Protection Type	Product ID
Transponder	MXP_MR_10DMEX_C with FEC	Y-Cable Client 1+1 PSM-OCH	15454-10DMEX-C=
Transponder	MXP_MR_10DMEX_C without FEC	Y-Cable Client 1+1 PSM-OCH	15454-10DMEX-C=
PL	DWDM ITU-T SFP without FEC	Client 1+1 PSM-OCH	ONS-SC-4G=
Muxponder	AR-MXP with EFEC, FEC, NOFEC	Client 1+1 Y-Cable PSM OCH	AR-MXP - MXP-MR (HR)
Muxponder	AR-MXP with EFEC, FEC, NOFEC	Client 1+1 Y-Cable PSM OCH	AR-MXP - MXP-DME (HR)
Muxponder	AR-XP with EFEC, FEC, NOFEC	Client 1+1 Y-Cable PSM OCH Fiber-Switched	AR-XP - MXP-MR (HR) AR-XP - MXPP-MR (HR)
Muxponder	AR-XP with EFEC, FEC, NOFEC	Client 1+1 Y-Cable PSM OCH Fiber-Switched	AR-XP - MXP-DME (HR) AR-XP - MXPP-DME (HR)

Table B-19 Fiber Channel 2G (2.125 Gbps) (continued)

Interface Type	Card Type	Protection Type	Product ID
Transponder	AR-MXP with FEC, NOFEC	Client 1+1 Y-Cable PSM OCH Fiber-Switched	AR-MXP - TXP-MR (LR) AR-MXP - TXPP-MR (LR)
Transponder	AR-XP with FEC, NOFEC	Client 1+1 Y-Cable PSM OCH Fiber-Switched	AR-XP - TXP-MR (LR) AR-XP - TXPP-MR (LR)

Table B-20 Fiber Channel 1G (1.062 Gbps)

Interface Type	Card Type	Protection Type	Product ID
Transponder	MXP_MR_10DME with EFEC	Client 1+1 Y-Cable	15454-10DME-C= (C band) 15454-10DME-L= (L band)
Transponder	MXP_MR_10DME with FEC	Client 1+1 Y-Cable	15454-10DME-C= (C band) 15454-10DME-L= (L band)
Transponder	MXP_MR_10DME without FEC	Client 1+1 Y-Cable	15454-10DME-C= (C band) 15454-10DME-L= (L band)
Transponder	TXP_MR_2.5G TXPP_MR_2.5G with FEC	Client 1+1 Y-Cable Fiber-Switched	15454-MR-L1-xx.y= (Unprot) 15454-MRP-L1-xx.y= (Prot)
Transponder	TXP_MR_2.5G TXPP_MR_2.5G without FEC	Client 1+1 Y-Cable Fiber-Switched	15454-MR-L1-xx.y= (Unprot) 15454-MRP-L1-xx.y= (Prot)
Transponder	MXP_MR_10DMEX_C with EFEC	Y-Cable Client 1+1 PSM-OCH	15454-10DMEX-C=
Transponder	MXP_MR_10DMEX_C with FEC	Y-Cable Client 1+1 PSM-OCH	15454-10DMEX-C=
Transponder	MXP_MR_10DMEX_C without FEC	Y-Cable Client 1+1 PSM-OCH	15454-10DMEX-C=
PL	DWDM ITU-T SFP without FEC	Client 1+1 PSM-OCH	ONS-SC-4G=

Table B-20 *Fiber Channel 1G (1.062 Gbps) (continued)*

Interface Type	Card Type	Protection Type	Product ID
Muxponder	AR-MXP with EFEC, FEC, NOFEC	Client 1+1 Y-Cable PSM OCH	AR-MXP - MXP-MR (HR)
Muxponder	AR-MXP with EFEC, FEC, NOFEC	Client 1+1 Y-Cable PSM OCH	AR-MXP - MXP-DME (HR)
Muxponder	AR-MXP with FEC, NOFEC	Client 1+1 Y-Cable PSM OCH Fiber-Switched	AR-MXP - MXP-MR (LR) AR-MXP - MXPP-MR (LR)
Muxponder	AR-XP with EFEC, FEC, NOFEC	Client 1+1 Y-Cable PSM OCH Fiber-Switched	AR-XP - MXP-MR (HR) AR-XP - MXPP-MR (HR)
Muxponder	AR-XP with EFEC, FEC, NOFEC	Client 1+1 Y-Cable PSM OCH Fiber-Switched	AR-XP - MXP-DME (HR) AR-XP - MXPP-DME (HR)
Muxponder	AR-XP with FEC, NOFEC	Client 1+1 Y-Cable PSM OCH Fiber-Switched	AR-XP - MXP-MR (LR) AR-XP - MXPP-MR (LR)
Transponder	AR-MXP with FEC, NOFEC	Client 1+1 Y-Cable PSM OCH Fiber-Switched	AR-MXP - TXP-MR (LR) AR-MXP - TXPP-MR (LR)
Transponder	AR-XP with FEC, NOFEC	Client 1+1 Y-Cable PSM OCH Fiber-Switched	AR-XP - TXP-MR (LR) AR-XP - TXPP-MR (LR)

Table B-21 *2 Gbps Fiber Connectivity (2.125 Gbps)*

Interface Type	Card Type	Protection Type	Product ID
Transponder	MXP_MR_10DME with EFEC	Client 1+1 Y-Cable	15454-10DME-C= (C band) 15454-10DME-L= (L band)

Table B-21 2 Gbps Fiber Connectivity (2.125 Gbps) (continued)

Transponder	MXP_MR_10DME with FEC	Client 1+1 Y-Cable	15454-10DME-C= (C band) 15454-10DME-L= (L band)
Transponder	MXP_MR_10DME without FEC	Client 1+1 Y-Cable	15454-10DME-C= (C band) 15454-10DME-L= (L band)
Transponder	TXP_MR_2.5G TXPP_MR_2.5G with FEC	Client 1+1 Y-Cable Fiber-Switched	15454-MR-L1-xx.y= (Unprot) 15454-MRP-L1-xx.y= (Prot)
Transponder	TXP_MR_2.5G TXPP_MR_2.5G without FEC	Client 1+1 Y-Cable Fiber-Switched	15454-MR-L1-xx.y= (Unprot) 15454-MRP-L1-xx.y= (Prot)
Transponder	MXP_MR_10DMEX_C with EFEC	Y-Cable Client 1+1 PSM-OCH	15454-10DMEX-C=
Transponder	MXP_MR_10DMEX_C with FEC	Y-Cable Client 1+1 PSM-OCH	15454-10DMEX-C=
Transponder	MXP_MR_10DMEX_C without FEC	Y-Cable Client 1+1 PSM-OCH	15454-10DMEX-C=
PL	DWDM ITU-T SFP without FEC	Client 1+1 PSM-OCH	ONS-SC-4G=
Muxponder	AR-MXP with EFEC, FEC, NOFEC	Client 1+1 Y-Cable PSM OCH	AR-MXP - MXP-MR (HR)
Muxponder	AR-MXP with EFEC, FEC, NOFEC	Client 1+1 Y-Cable PSM OCH	AR-MXP - MXP-DME (HR)
Muxponder	AR-XP with EFEC, FEC, NOFEC	Client 1+1 Y-Cable PSM OCH Fiber-Switched	AR-XP - MXP-MR (HR) AR-XP - MXPP-MR (HR)
Muxponder	AR-XP with EFEC, FEC, NOFEC	Client 1+1 Y-Cable PSM OCH Fiber-Switched	AR-XP - MXP-DME (HR) AR-XP - MXPP-DME (HR)

Table B-21 2 Gbps Fiber Connectivity (2.125 Gbps) (continued)

Transponder	AR-MXP with FEC, NOFEC	Client 1+1 Y-Cable PSM OCH Fiber-Switched	AR-MXP - TXP-MR (LR) AR-MXP - TXPP-MR (LR)
Transponder	AR-XP with FEC, NOFEC	Client 1+1 Y-Cable PSM OCH Fiber-Switched	AR-XP - TXP-MR (LR) AR-XP - TXPP-MR (LR)

Table B-22 FICON-10G (10.5 Gbps)

Interface Type	Card Type	Protection Type	Product ID
Transponder	OTU-2_XP with EFEC	Y-Cable Client 1+1 PSM-OCH Fiber-Switched	15454-OTU2-XP=
Transponder	OTU-2_XP with FEC	Y-Cable Client 1+1 PSM-OCH Fiber-Switched	15454-OTU2-XP=
Transponder	OTU-2_XP without FEC	Y-Cable Client 1+1 PSM-OCH Fiber-Switched	15454-OTU2-XP=
Transponder	TXP_MR_10E_y with EFEC	Y-Cable Client 1+1 PSM-OCH	15454-10E-L1-L= (L band)
Transponder	TXP_MR_10E_y with FEC	Y-Cable Client 1+1 PSM-OCH	15454-10E-L1-L= (L band)
Transponder	TXP_MR_10E_y without FEC	Y-Cable Client 1+1 PSM-OCH	15454-10E-L1-L= (L band)
Transponder	TXP_MR_10EX_C with EFEC and FEC	Client 1+1 Y-Cable PSM OCH	15454-10EX-L1-C=

Table B-22 FICON-10G (10.5 Gbps) (continued)

Interface Type	Card Type	Protection Type	Product ID
Transponder	TXP_MR_10E with EFEC	Client 1+1 Y-Cable PSM-OCH	15454-10E-L1-xx.y= (C band) 15454-10E-L1-xx.y= (L band)
Transponder	TXP_MR_10E with FEC	Client 1+1 Y-Cable PSM-OCH	15454-10E-L1-xx.y= (C band) 15454-10E-L1-xx.y= (L band)
Transponder	TXP_MR_10E without FEC	Client 1+1 Y-Cable PSM-OCH	15454-10E-L1-xx.y= (C band) 15454-10E-L1-xx.y= (L band)
Transponder	40G DQPSK MXP with FEC	Client 1+1 Y-Cable PSM OCH	15454-40G-MXP-C=
Transponder	40G DQPSK MXP with EFEC	Client 1+1 Y-Cable PSM OCH	15454-40G-MXP-C=

Table B-23 FICON-4G (4.25 Gbps)

Interface Type	Card Type	Protection Type	Product ID
Transponder	MXP_MR_10DME with EFEC	Client 1+1 Y-Cable	15454-10DME-C= (C band) 15454-10DME-L= (L band)
Muxponder	AR-MXP with EFEC, FEC, NOFEC	Client 1+1 Y-Cable PSM OCH	AR-MXP - MXP-MR (HR)
Muxponder	AR-MXP with EFEC, FEC, NOFEC	Client 1+1 Y-Cable PSM OCH	AR-MXP - MXP-DME (HR)
Muxponder	AR-XP with EFEC, FEC, NOFEC	Client 1+1 Y-Cable PSM OCH Fiber-Switched	AR-XP - MXP-MR (HR) AR-XP - MXPP-MR (HR)
Muxponder	AR-XP with EFEC, FEC, NOFEC	Client 1+1 Y-Cable PSM OCH Fiber-Switched	AR-XP - MXP-DME (HR) AR-XP - MXPP-DME (HR)

Table B-23 FICON-4G (4.25 Gbps) (continued)

Interface Type	Card Type	Protection Type	Product ID
Transponder	AR-MXP with NOFEC	Client 1+1 Y-Cable PSM OCH Fiber-Switched	AR-MXP - TXP-MR (LR) AR-MXP - TXPP-MR (LR)
Transponder	AR-XP with NOFEC	Client 1+1 Y-Cable PSM OCH Fiber-Switched	AR-XP - TXP-MR (LR) AR-XP - TXPP-MR (LR)

Table B-24 FICON-1G (1.062 Gbps)

Interface Type	Card Type	Protection Type	Product ID
Transponder	MXP_MR_10DME with FEC	Client 1+1 Y-Cable	15454-10DME-C= (C band) 15454-10DME-L= (L band)
Transponder	MXP_MR_10DME without FEC	Client 1+1 Y-Cable	15454-10DME-C= (C band) 15454-10DME-L= (L band)
Transponder	MXP_MR_10DMEX_C with EFEC	Y-Cable Client 1+1 PSM-OCH	15454-10DMEX-C=
Transponder	MXP_MR_10DMEX with FEC	Y-Cable Client 1+1 PSM-OCH	15454-10DMEX-C=
Transponder	MXP_MR_10DMEX_C without FEC	Y-Cable Client 1+1 PSM-OCH	15454-10DMEX-C=
PL	DWDM ITU-T SFP without FEC	Client 1+1 PSM-OCH	ONS-SC-4G=
Muxponder	AR-MXP with EFEC, FEC, NOFEC	Client 1+1 Y-Cable PSM OCH	AR-MXP - MXP-MR (HR)
Muxponder	AR-MXP with EFEC, FEC, NOFEC	Client 1+1 Y-Cable PSM OCH	AR-MXP - MXP-DME (HR)

Table B-24 FICON-1G (1.062 Gbps) (continued)

Interface Type	Card Type	Protection Type	Product ID
Muxponder	AR-MXP with FEC, NOFEC	Client 1+1 Y-Cable PSM OCH Fiber-Switched	AR-MXP - MXP-MR (LR) AR-MXP - MXPP-MR (LR)
Muxponder	AR-XP with EFEC, FEC, NOFEC	Client 1+1 Y-Cable PSM OCH Fiber-Switched	AR-XP - MXP-MR (HR) AR-XP - MXPP-MR (HR)
Muxponder	AR-XP with EFEC, FEC, NOFEC	Client 1+1 Y-Cable PSM OCH Fiber-Switched	AR-XP - MXP-DME (HR) AR-XP - MXPP-DME (HR)
Muxponder	AR-XP with FEC, NOFEC	Client 1+1 Y-Cable PSM OCH Fiber-Switched	AR-XP - MXP-MR (LR) AR-XP - MXPP-MR (LR)
Transponder	AR-MXP with FEC, NOFEC	Client 1+1 Y-Cable PSM OCH Fiber-Switched	AR-MXP - TXP-MR (LR) AR-MXP - TXPP-MR (LR)
Transponder	AR-XP with FEC, NOFEC	Client 1+1 Y-Cable PSM OCH Fiber-Switched	AR-XP - TXP-MR (LR) AR-XP - TXPP-MR (LR)

Table B-25 Enterprise System Connection (ESCON) (200 Mbps)

Interface Type	Card Type	Protection Type	Product ID
Transponder	TXP_MR_2.5G TXPP_MR_2.5G 2R	Client 1+1 Y-Cable Fiber-Switched	15454-MR-L1-xx.y= (Unprot) 15454-MRP-L1-xx.y= (Prot)
Muxponder	AR-MXP with EFEC, FEC, NOFEC	Client 1+1 Y-Cable PCM OCH	AR-MXP - MXP-MR (HR)

Table B-25 Enterprise System Connection (ESCON) (200 Mbps) (continued)

Muxponder	AR-MXP with FEC, NOFEC	Client 1+1 Y-Cable PCM OCH Fiber-Switched	AR-MXP - MXP-MR (LR) AR-MXP - MXPP-MR (LR)
Muxponder	AR-XP with EFEC, FEC, NOFEC	Client 1+1 Y-Cable PCM OCH Fiber-Switched	AR-XP - MXP-MR (HR) AR-XP - MXPP-MR (HR)
Muxponder	AR-XP with FEC, NOFEC	Client 1+1 Y-Cable PCM OCH Fiber-Switched	AR-XP - MXP-MR (LR) AR-XP - MXPP-MR (LR)
Transponder	AR-MXP with FEC, NOFEC	Client 1+1 Y-Cable PSM OCH Fiber-Switched	AR-MXP - TXP-MR (LR) AR-MXP - TXPP-MR (LR)
Transponder	AR-XP with FEC, NOFEC	Client 1+1 Y-Cable PSM OCH Fiber-Switched	AR-XP - TXP-MR (LR) AR-XP - TXPP-MR (LR)

Table B-26 ISC-3 Compatibility Mode (1.062 Gbps)

Interface Type	Card Type	Protection Type	Product ID
Transponder	TXP_MR_2.5G without FEC	Client 1+1	15454-MR-L1-xx.y= (Unprot) 15454-MRP-L1-xx.y= (Prot)
Transponder	MXP_MR_10DME with EFEC	Client 1+1	15454-10DME-C= (C band) 15454-10DME-L= (L band)
Transponder	MXP_MR_10DME with FEC	Client 1+1	15454-10DME-C= (C band) 15454-10DME-L= (L band)
Transponder	MXP_MR_10DME without FEC	Client 1+1	15454-10DME-C= (C band) 15454-10DME-L= (L band)
Transponder	MXP_MR_10DMEX	Y-Cable Client 1+1 PSM-OCH	15454-10DMEX-C=

Table B-26 *ISC-3 Compatibility Mode (1.062 Gbps) (continued)*

Interface Type	Card Type	Protection Type	Product ID
Transponder	AR-MXP with FEC, NOFEC	Client 1+1 Y-Cable PSM OCH Fiber-Switched	AR-MXP - TXP-MR (LR) AR-MXP - TXPP-MR (LR)
Transponder	AR-XP with FEC, NOFEC	Client 1+1 Y-Cable PSM OCH Fiber-Switched	AR-XP - TXP-MR (LR) AR-XP - TXPP-MR (LR)

Table B-27 *ISC-Peer 2R*

Interface Type	Card Type	Protection Type	Product ID
Transponder	TXP_MR_2.5G 2R	Client 1+1	15454-MR-L1-xx.y= (Unprot) 15454-MRP-L1-xx.y= (Prot)

Table B-28 *ISC-3 Peer-1G (1.062 Gbps)*

Interface Type	Card Type	Protection Type	Product ID
Transponder	MXP_MR_10DME with EFEC	Client 1+1 PSM-OCH	15454-10DME-C= (C band) 15454-10DME-L= (L band)
Transponder	MXP_MR_10DME with FEC	Client 1+1 PSM-OCH	15454-10DME-C= (C band) 15454-10DME-L= (L band)
Transponder	MXP_MR_10DME without FEC	Client 1+1 PSM-OCH	15454-10DME-C= (C band) 15454-10DME-L= (L band)
Transponder	MXP_MR_10DMEX_C with EFEC and FEC	Client 1+1 PSM-OCH	15454-10DMEX-C=

Table B-29 *ISC-3 Peer-2G (2.125 Gbps)*

Interface Type	Card Type	Protection Type	Product ID
Transponder	MXP_MR_10DME with EFEC	Client 1+1 PSM-OCH	15454-10DME-C= (C band) 15454-10DME-L= (L band)
Transponder	MXP_MR_10DME with FEC	Client 1+1 PSM-OCH	15454-10DME-C= (C band) 15454-10DME-L= (L band)
Transponder	MXP_MR_10DME without FEC	Client 1+1 PSM-OCH	15454-10DME-C= (C band) 15454-10DME-L= (L band)

Table B-29 *ISC-3 Peer-2G (2.125 Gbps) (continued)*

Transponder	MXP_MR_10DMEX_C with EFEC and FEC	Client 1+1 PSM-OCH	15454-10DMEX-C=
Transponder	AR-MXP with FEC, NOFEC	Client 1+1 Y-Cable PSM OCH Fiber-Switched	AR-MXP - TXP-MR (LR) AR-MXP - TXPP-MR (LR)
Transponder	AR-XP with FEC, NOFEC	Client 1+1 Y-Cable PSM OCH Fiber-Switched	AR-XP - TXP-MR (LR) AR-XP - TXPP-MR (LR)

Table B-30 *Sysplex External Throughput Rate (8 Mbps)*

Interface Type	Card Type	Protection Type	Product ID
Transponder	TXP_MR_2.5G 2R	Client 1+1	15454-MR-L1-xx.y= (Unprot) 15454-MRP-L1-xx.y= (Prot)

Table B-31 *Sysplex Control Link Oscillator (8 Mbps)*

Interface Type	Card Type	Protection Type	Product ID
Transponder	TXP_MR_2.5G 2R	Client 1+1	15454-MR-L1-xx.y= (Unprot) 15454-MRP-L1-xx.y= (Prot)

Table B-32 *Serial Data Input (SDI)*

Interface Type	Card Type	Protection Type	Product ID
Transponder	TXP_MR_2.5G	Client 1+1	15454-MR-L1-xx.y= (Unprot)
	TXPP_MR_2.5G 2R	Y-Cable Fiber-Switched	15454-MRP-L1-xx.y= (Prot)

Table B-33 *Digital Video Broadcast-Asynchronous Serial Interface (DVB-ASI)*

Interface Type	Card Type	Protection Type	Product ID
Transponder	TXP_MR_2.5G	Client 1+1	15454-MR-L1-xx.y= (Unprot)
	TXPP_MR_2.5G 2R	Y-Cable Fiber-Switched	15454-MRP-L1-xx.y= (Prot)

Table B-34 D1-Video (270 Mbps)

Interface Type	Card Type	Protection Type	Product ID
Transponder	TXP_MR_2.5G TXPP_MR_2.5G 2R	Client 1+1	15454-MR-L1-xx.y= (Unprot)
		Y-Cable	15454-MRP-L1-xx.y= (Prot)
		Fiber-Switched	

Table B-35 High Definition Television (HDTV) (1.48 Gbps)

Interface Type	Card Type	Protection Type	Product ID
Transponder	TXP_MR_2.5G TXPP_MR_2.5G 2R	Client 1+1	15454-MR-L1-xx.y= (Unprot)
		Y-Cable	15454-MRP-L1-xx.y= (Prot)
		Fiber-Switched	

Table B-36 DV-6000 (2.38 Gbps)

Interface Type	Card Type	Protection Type	Product ID
Transponder	TXP_MR_2.5G TXPP_MR_2.5G 2R	Client 1+1	15454-MR-L1-xx.y= (Unprot)
		Y-Cable	15454-MRP-L1-xx.y= (Prot)
		Fiber-Switched	

Table B-37 2R Any Rate

Interface Type	Card Type	Protection Type	Product ID
Transponder	TXP_MR_2.5G TXPP_MR_2.5G 2R	Client 1+1	15454-MR-L1-xx.y= (Unprot)
		Y-Cable	15454-MRP-L1-xx.y= (Prot)
		Fiber-Switched	

Table B-38 ONS 15530 2.5G ITU-T

Interface Type	Card Type	Protection Type	Product ID
TXP	MR MM TXP	Client 1+1	15530-TSP1-xx21 (MM Unprot)
	MR SM TXP	Fiber-Switched	15530-TSP1-xx22 (SM Unprot)
	MR MM TXP with splitter		15530-TSP1-xx11 (MM Prot)
	MR SM TXP with splitter		15530-TSP1-xx12 (SM Prot)
LC	2.5-Gbps Aggregation	Client 1+1	15530-ITU3-xx20 (Unprot)
	2.5-Gbps Aggregation with splitter	Fiber-Switched	15530-ITU3-xx10 (Prot)

Table B-39 SD-SDI (270 Mbps)

Interface Type	Card Type	Protection Type	Product ID
Muxponder	AR-MXP with EFEC, FEC, NOFEC	Client 1+1 Y-Cable PSM OCH	AR-MXP - MXP-MR (HR)
Muxponder	AR-XP with EFEC, FEC, NOFEC	Client 1+1 Y-Cable PSM OCH Fiber-Switched	AR-XP - MXP-MR (HR) AR-XP - MXPP-MR (HR)

Table B-40 HD-SDI (1.485 Gbps)

Interface Type	Card Type	Protection Type	Product ID
Muxponder	AR-MXP with EFEC, FEC, NOFEC	Client 1+1 Y-Cable PSM OCH	AR-MXP - MXP-MR (HR)
Muxponder	AR-XP with EFEC, FEC, NOFEC	Client 1+1 Y-Cable PSM OCH Fiber-Switched	AR-XP - MXP-MR (HR) AR-XP - MXPP-MR (HR)

Table B-41 3G-SDI (2.970 Gbps)

Interface Type	Card Type	Protection Type	Product ID
Muxponder	AR-XP with EFEC, FEC, NOFEC	Client 1+1 Y-Cable PSM OCH	AR-XP - MXP-VAD-10G (HR)

Table B-42 ONS 15530 10G ITU-T

Interface Type	Card Type	Protection Type	Product ID
LC	10-Gbps Aggregation	Client 1+1	15530-ITU2-xx20 (Unprot)
	10-Gbps Aggregation with splitter	Fiber-Switched	15530-ITU2-xx10 (Prot)
MXP	Data Muxponder	Client 1+1	15530-MSMP-xx22 (Unprot)
	Data Muxponder with splitter	Fiber-Switched	15530-MSMP-xx12 (Prot)

Table B-43 E3/ T3/DS3 (100 Mbps)

Interface Type	Card Type	Protection Type	Product ID
Muxponder	GE_XPE with EFEC	Client 1+1 PSM-OCH	15454-GE-XPE=
Muxponder	GE_XPE without EFEC	Client 1+1 PSM-OCH	15454-GE-XPE=
Muxponder	GE_XPE with FEC	Client 1+1 PSM-OCH	15454-GE-XPE=

Table B-44 Supported XFPs

Card	XFPs Supported	Default XFP
ADM-10G	<ul style="list-style-type: none"> ONS-XC-10G ONS-XC-10G-C ONS-XC-10G-EP30.3= through ONS-XC-10G-EP61.4= 	ONS-XC-10G-C
10GE-XP	<ul style="list-style-type: none"> ONS-XC-10G ONS-XC-10G-C ONS-XC-10G-EP30.3= through ONS-XC-10G-EP61.4= 	ONS-XC-10G-C
10GE-XPE	<ul style="list-style-type: none"> ONS-XC-10G ONS-XC-10G-C ONS-XC-10G-EP30.3= through ONS-XC-10G-EP61.4= 	ONS-XC-10G-C
OTU-2_XP	<ul style="list-style-type: none"> ONS-XC-10G ONS-XC-10G-C ONS-XC-10G-EP30.3= through ONS-XC-10G-EP61.4= 	ONS-XC-10G-C
10G-XR	<ul style="list-style-type: none"> ONS-XC-10G ONS-XC-10G-C 	ONS-XC-10G-C
GE-XP	<ul style="list-style-type: none"> ONS-XC-10G ONS-XC-10G-C ONS-XC-10G-EP30.3= through ONS-XC-10G-EP61.4= 	ONS-XC-10G-C
GE-XPE	<ul style="list-style-type: none"> ONS-XC-10G ONS-XC-10G-C ONS-XC-10G-EP30.3= through ONS-XC-10G-EP61.4= 	ONS-XC-10G-C

Table B-44 Supported XFPs (continued)

GE-XP	<ul style="list-style-type: none"> • ONS-SC-EOP1 • ONS-XC-10G-EP30.3= through ONS-XC-10G-EP61.4= 	ONS-SC-EOP1
40G DQPSK MXP	<ul style="list-style-type: none"> • ONS-XC-10G-1470 through ONS-XC-10G-1610 • ONS-XC-10G-S1 • ONS-XC-10G-I2 • ONS-XC-10G-L2 • ONS-XC-10G-C • ONS-XC-8G-SM • ONS-XC-8G-MM • ONS-XC-10G-SR-MM • ONS-XC-10G-EP30.3= through ONS-XC-10G-EP61.4= 	ONS-XC-10G-C
40G CP-DQPSK MXP	<ul style="list-style-type: none"> • ONS-XC-10G-1470 through ONS-XC-10G-1610 • ONS-XC-10G-S1 • ONS-XC-10G-I2 • ONS-XC-10G-L2 • ONS-XC-10G-C • ONS-XC-8G-SM • ONS-XC-8G-MM • ONS-XC-10G-SR-MM • ONS-XC-10G-EP30.3= through ONS-XC-10G-EP61.4= 	ONS-XC-10G-C
40G CP-DQPSK ME MXP	<ul style="list-style-type: none"> • ONS-XC-10G-1470 through ONS-XC-10G-1610 • ONS-XC-10G-S1 • ONS-XC-10G-I2 • ONS-XC-10G-L2 • ONS-XC-10G-C • ONS-XC-8G-SM • ONS-XC-8G-MM • ONS-XC-10G-SR-MM • ONS-XC-10G-EP30.3= through ONS-XC-10G-EP61.4= 	ONS-XC-10G-C

Table B-44 Supported XFPs (continued)

AR-MXP AR-XP	<ul style="list-style-type: none"> • ONS-XC-10G-C • ONS-XC-10G-S1 • ONS-XC-10G-I2 • ONS-XC-10G-L2 • ONS-XC-8G-SM • ONS-XC-8G-MM • ONS-XC-10G-EP30.3 through ONS-XC-10G-EP61.4 • ONS-SE-200-MM • ONS-SI-155-SR-MM • ONS-SI-622-SR-MM • ONS-SC-2G-xx.x • ONS-SC-2G-xxxx= • ONS-SE-4G-MM • ONS-SE-4G-SM • ONS-SE-100BX10U • ONS-SE-100BX10D • ONS-SE-GE-BXU • ONS-SE-GE-BXD • ONS-SE-ZE-EL • ONS-SI-100-FX • ONS-SI-100-LX10 • ONS-SI-GE-LX • ONS-SI-GE-SX • ONS-SI-GE-ZX 	ONS-XC-10G-C
-----------------	--	--------------

Table B-44 Supported XFPs (continued)

AR-MXP AR-XP	<ul style="list-style-type: none"> • ONS-SI-155-I1 • ONS-SI-155-L2 • ONS-SI-622-I1 • ONS-SI-622-L1 • ONS-SI-622-L2 • ONS-SC-4G-xx.x • ONS-SI-2G-L1 • ONS-SI-2G-L2 • ONS-SI-2G-S1 • ONS-SE-Z1 • ONSSI-155-L1 • ONS-SE-155-xxxx • ONS-SC-155-EL • ONS-SC-4G-xx.x • ONS-SC-HD3GV-TX • ONS-SC-HD3GV-RX 	—
-----------------	--	---



System Messages

This appendix lists the system messages for Cisco Transport Planner. They are classified as:

- [C.1 Error Messages](#)
- [C.2 Warning Messages](#)
- [C.3 Information Messages](#)



Note

In the System Messages, Cisco Transport Planner will replace {n} with a Site name, an Unit name, an Optical design rule, or a Number as applicable.

C.1 Error Messages

Error Messages for Cisco Transport Planner are listed in [Table C-1](#):

Table C-1 Error Messages

Message Type	Error Message
Traffic mapping	50 GHz scalability is supported only with {0} design rules.
Traffic mapping	Verify if in Add/Drop sites, OADM units are forced and compatible with the traffic.
Traffic mapping	No available wavelength due to units forced on optical bypass site {0}
Traffic mapping	Verify if in the optical bypass interfaces there are wavelengths compatible units
Traffic mapping	The network is broken: please connect all the sites together.
Traffic mapping	The traffic model is empty: please add at least one service request.
Traffic mapping	Number of add/drop nodes exceeded the maximum ({0}) allowed in the network.
Traffic mapping	ONS15454 DWDM platform supports up to {0} non-pass-through sites.
Traffic mapping	Line+ sites can't support DMX-O units due to layout constraints.
Traffic mapping	Line+ sites can't support Individual Shelf with DCC chain option due to layout constraints.
Traffic mapping	DWDM pluggable {0} is restricted by the user.

Table C-1 Error Messages (continued)

Message Type	Error Message
Traffic mapping	Any to Any traffic is not supported by {0} rules.
Traffic mapping	Can't find a valid path between site {0} and site {1} due to ROADM demand strategy
Traffic mapping	Any to Any traffic requires ROADM units but ROADM is not allowed by restricted equipment list.
Traffic mapping	Can't place ROADM units in site {0} to support Any to Any traffic.
Traffic mapping	ROADM configuration is not allowed by restricted equipment list.
Traffic mapping	Mux Demux configuration is not allowed by restricted equipment list.
Traffic mapping	Only ROADM configuration is allowed with selected design rules.
Traffic mapping	ROADM is not allowed by the selected design rules.
Traffic mapping	ROADM-O is not allowed with L band.
Traffic mapping	Line+ or Terminal+ site topologies are not allowed by selected design rules.
Traffic mapping	Line+ or Terminal+ site topologies require ROADM units but ROADM is not allowed by restricted equipment list.
Traffic mapping	OADM unit {0} defined in {1} is not allowed by restricted equipment list.
Traffic mapping	Can't find a valid aggregating client.
Traffic mapping	Can't find a valid client.
Traffic mapping	Client {0} can't be tuned on wavelength {1}.
Traffic mapping	Forced wavelength {0} is outside selected band.
Traffic mapping	Forced client {0} can't be tuned on selected band.
Traffic mapping	Interface Type {0} is not supported by the selected Design Rules.
Traffic mapping	Add/Drop not available in site {0}.
Traffic mapping	Maximum wavelength re-usage reached for ITU channel {0}.
Traffic mapping	All solutions exceed {0} wavelengths. See the “C.4.1 Wavelength Exceeded” section on page C-26.
Traffic mapping	The anti ASE option is available only in sites with add/drop capability.
Traffic mapping	More than one anti ASE site was selected.
Traffic mapping	Protected services are not allowed with linear networks.
Traffic mapping	In a network with hub nodes protected services are allowed only between hub sites.
Traffic mapping	Invalid routing (out of network boundary). See the “C.4.2 Invalid Routing” section on page C-27.
Traffic mapping	Can't route service with optical bypass in {0}.
Traffic mapping	Can't find alternate route due to multiple HUB nodes along the path. See the “C.4.3 Cannot Find Alternate Route” section on page C-27.
Traffic mapping	Can't route service through HUB node {0}. See the “C.4.4 Cannot Route Service” section on page C-27.

Table C-1 Error Messages (continued)

Message Type	Error Message
Traffic mapping	Overlapped services assigned to the same wavelength. See the “C.4.5 Overlapped Services Assigned to the Same Wavelength” section on page C-28.
Traffic mapping	Protected services assigned to the same wavelength. See the “C.4.6 Protected Services Assigned to the Same Wavelength” section on page C-29.
Traffic mapping	Can't route service due to add drop equipment constraints. See the “C.4.7 Cannot Route Service Because of Add/Drop Constraints” section on page C-29.
Traffic mapping	Design requires forcing a site as ROADM or Full Mux/Demux but no valid site was found.
Traffic mapping	Design requires forcing site as ROADM or Full Mux/Demux: remove equipment constraints.
Traffic mapping	Path constraints prevent routing of {0}
Traffic mapping	Traffic subnet constraints prevent routing of {0}
Traffic mapping	In a linear network, terminal sites must have structure Terminal
Traffic mapping	Wavelength {0} may require additional ASE filtering
Traffic mapping	50 GHz scalability is supported only with {0} design rules
Traffic mapping	The Network is broken: please connect all the sites together
Traffic mapping	The traffic model is empty: please add at least one service request
Traffic mapping	Number of add/drop nodes exceeded the maximum ({0}) allowed in the network
Traffic mapping	ONS15454 DWDM platform supports up to {0} non-pass-through sites
Traffic mapping	Line+ sites can't support DMX-O units due to layout constraints
Traffic mapping	Line+ sites can't support Individual Shelf with DCC chain option due to layout constraints
Traffic mapping	Client {0} is not available in the equipment list
Traffic mapping	Any to Any traffic is not supported by {0} rules
Traffic mapping	Any to Any traffic requires ROADM units but ROADM is not allowed by restricted equipment list
Traffic mapping	Can't place ROADM units in site {0} to support Any to Any traffic
Traffic mapping	ROADM configuration is not allowed by restricted equipment list
Traffic mapping	WXC configuration is not allowed by restricted equipment list
Traffic mapping	Mux Demux configuration is not allowed by restricted equipment list
Traffic mapping	Only ROADM configuration is allowed with selected design rules
Traffic mapping	Multidegree structure in site {0} is not allowed with selected design rules
Traffic mapping	ROADM is not allowed by the selected design rules
Traffic mapping	ROADM-O is not allowed with L band
Traffic mapping	Line+ or Terminal+ site topologies are not allowed by selected design rules

Table C-1 Error Messages (continued)

Message Type	Error Message
Traffic mapping	Line+ or Terminal+ site topologies require ROADMs but ROADMs are not allowed by restricted equipment list
Traffic mapping	OADM unit {0} defined in {1} is not allowed by restricted equipment list
Traffic mapping	In mesh network user must force OADM units for site configured as OADM
Traffic mapping	Can't find a valid aggregating client
Traffic mapping	Can't find a valid client
Traffic mapping	Can't find a valid XFP
Traffic mapping	Client {0} can't be tuned on wavelength {1}
Traffic mapping	Forced wavelength {0} is outside selected band
Traffic mapping	Forced client {0} can't be tuned on selected band
Traffic mapping	Interface Type {0} is not supported by the selected Design Rules
Traffic mapping	Add/Drop not available in site {0}
Traffic mapping	Maximum wavelength re-usage reached for ITU channel {0}
Traffic mapping	All solutions exceed {0} wavelengths
Traffic mapping	The anti ASE option is available only in sites with add/drop capability
Traffic mapping	More than one anti ASE site was selected
Traffic mapping	No specific anti-ASE node is required for this traffic matrix requirement
Traffic mapping	Protected services are not allowed with linear networks
Traffic mapping	In a network with hub nodes protected services are allowed only between hub sites
Traffic mapping	Invalid routing (out of network boundary)
Traffic mapping	Can't route service with optical bypass in {0}
Traffic mapping	Can't find alternate route due to HUB nodes along the path
Traffic mapping	Can't route service through HUB node {0}
Traffic mapping	Overlapped services assigned to the same wavelength
Traffic mapping	Routing for some of the services cannot be completed with the given constraints. Please use the link aside for details about the problem.
Traffic mapping	Protected services assigned to the same wavelength
Traffic mapping	Can't route service due to add drop equipment constraints
Traffic mapping	Design requires forcing a site as ROADMs or Full Mux/Demux but no valid site was found
Traffic mapping	Design requires forcing site as ROADMs or Full Mux/Demux: remove equipment constraints
Traffic mapping	PP4 is not allowed in site {0} (fiber interfaces are limited to A,B,C and D)
Traffic mapping	No valid path from {0} to {1}
Traffic mapping	No valid path from {0} to {1}, bypass in {2}
Traffic mapping	Wavelength forced outside of selected band for {0}

Table C-1 Error Messages (continued)

Message Type	Error Message
Traffic mapping	Client {0} can't be tuned at {1}
Traffic mapping	Invalid functionality option for structure {0} in site {1}
Traffic mapping	Invalid mux - demux configuration in site {0}
Traffic mapping	Invalid mux - demux combination on two sides of site {0}
Traffic mapping	Unit options are not compatible with design rule {0} in site {1}
Traffic mapping	Unit options are not compatible with design rules in site {0}
Traffic mapping	Unit {0} is not available in Restricted Equipment List
Traffic mapping	Mesh topology not supported yet
Traffic mapping	Network Cluster {0} requires mesh algorithm
Traffic mapping	Unconnected site {0}
Traffic mapping	Incompatible port {0} assignment in site {1}
Traffic mapping	No valid SFP was found for port {0} in site {1}
Traffic mapping	Only one GE-STS24 can be assigned to port {0} in site {1}
Traffic mapping	Incompatible rate/reach options circuit {0}
Traffic mapping	Incompatible rate/reach options for port {0} in site {1}
Traffic mapping	Incompatible CIR settings for port {0} in site {1}
Traffic mapping	Can't find a valid SFP for port {0} in site {1}
Traffic mapping	Port {0} in site {1} is not available
Traffic mapping	Exceeded rate for port {0} in site {1}
Traffic mapping	Can't provision circuit {0}
Traffic mapping	Maximum frame rate exceeded in section {0} - {1}
Traffic mapping	Maximum frame rate exceeded in node {0}
Traffic mapping	Protected circuits are not allowed in a linear traffic subnet
Traffic mapping	Invalid routing {0}
Traffic mapping	Client protection is not allowed if all nodes are single card configuration
Traffic mapping	Trunk protection with no client protection is not allowed if at least one node is double card configuration
Traffic mapping	Client protection with no trunk protection is not allowed
Traffic mapping	Errors were found on {0}: please run the checker and fix all problems
Traffic mapping	Client and trunk protections are not allowed at the same time on port {0} in site {1}
Traffic mapping	50 GHz scalability is not supported with Ethernet or TDM aggregated demands
Traffic mapping	Cards required for {0} demand are not available in the equipment list
Traffic mapping	Impossible to find two independent paths for protected service
Traffic mapping	Structure {0} is not supported for design rule {1}
Traffic mapping	No available wavelength found due to traffic constraints

Table C-1 Error Messages (continued)

Message Type	Error Message
Traffic mapping	Too many add/drop nodes ({0} > {1}) in cluster {2}
Traffic mapping	Too many nodes ({0} > {1}) in cluster {2}
Traffic mapping	Too many ROADM nodes ({0} > {1}) in group {2}
Traffic mapping	Demand {0} defined on traffic subnet {1} is in an invalid status
Traffic mapping	Demand {0} is crossing different sites clusters
Traffic mapping	PP4 forced on site {0} can handle at most 4 sides
Traffic mapping	{0} in Any to Any demand doesn't support 50 GHz scalability
Traffic mapping	Regeneration not available
Traffic mapping	Alien traffic type cannot be regenerated
Traffic mapping	Regeneration not allowed
Traffic mapping	Regeneration not allowed for PSM-OCH protected demands
Traffic mapping	Cards forced in the trails of PRing are not compatible
Traffic mapping	L Band Option not allowed with PSM topology
Traffic mapping	32MUX-O/32-DMX-O cards are not allowed for PSM configuration
Traffic mapping	Optical ByPass not allowed with PSM Config
Traffic mapping	Regeneration not allowed with PSM Config
Traffic mapping	Only LINE site topology is allowed between PSM config
Traffic mapping	Only OLA and Passthrough sites allowed between PSM config
Traffic mapping	Only Passthrough sites allowed between PSM Config
Traffic mapping	Terminal or Terminal Plus configurations are not allowed for PSM Och protection
Traffic mapping	Is not allowed to insert circuit from site {0} to site {1} because is tagged as Omnidirectional Entry Point configuration
Traffic mapping	Is not allowed to insert Any to Any Group contains site {0} and site {1} because is tagged as Omnidirectional Entry Point configuration
Traffic mapping	No Interoperable group found for the card selection. Please check if its a valid card selection
Traffic mapping	All the trails of the P-Ring should have same card
Traffic mapping	Restricted Equipment forced by user tm.client_restricted2.details = Client {0} is not available in the equipment list
Traffic mapping	Incompatible source and destination
Traffic mapping	Forced source and destination cards are not compatible
Traffic mapping	Demand cannot be regenerated
Traffic mapping	Conflicting trunk mode
Traffic mapping	Unfeasible trunk mode forcing by the user
Traffic mapping	Cannot force different cards for protection {0} in demand {1}
Traffic mapping	Trunk pluggable not found. The pluggable(s) may be restricted by the user.

Table C-1 Error Messages (continued)

Message Type	Error Message
Traffic mapping	No trunk pluggable found for the user forced card
Traffic mapping	Unfeasible card mode forcing by user
Traffic mapping	OTU2 XP can have both in/out going trunks in EFEC only in Enhanced Regen Mode
Traffic mapping	No suitable card found
Traffic mapping	Unable to find a compatible card for source or destination
Traffic mapping	Alien traffic type cannot be regenerated
Traffic mapping	User must force OADM units for sites configured as OADM.
Traffic mapping	Mux-Demux should not be forced for site ({0}) as it is not supported by the site type.
Traffic mapping	For hybrid 216 {0} only FLA8 and MD-40 Mux/Demux is allowed.
Traffic mapping	The express loss in the site {0} is High. Please reduce the number of FLAs.
Traffic mapping	The add/drop loss in the site {0} is High. Please reduce the number of FLAs.
Traffic mapping	We cannot mix hybrid 15216 sites with non-hybrid pure MSTP site {0}.
Traffic mapping	We must have atleast one Hub site in a Ring Topology.
Traffic mapping	ROADM demands are not allowed with 15216 hybrid network.
Traffic mapping	L-Band optical subnet rule is not supported in 15216 network.
Traffic mapping	Multiple optical subnets are not supported in single 15216 cluster.
Traffic mapping	A 15216 network is capable only till C Band odd 40ch. Please remove any higher capacity selected {0}.
Traffic mapping	We cannot force FLA8 {0} in a 40 ch optical subnet.
Traffic mapping	Site type Mux/Demux not allowed for {0} in 8 ch optical subnet.
Traffic mapping	Optical by pass at {0} is not allowed with 15216 Network.
Traffic mapping	PSM Line or Section protection at {0} is not allowed with 15216 network.
Traffic mapping	There is an overlap in the Route involving {0}. This may be due to the order of regeneration selected.
Traffic mapping	Trunk protection with no client protection is not allowed for selected traffic type.
Traffic mapping	ROADM demand is not supported for PSM Line, PSM Section topology.
Traffic mapping	Optical Bypass is not allowed in a non Add Drop Site {0}.
Traffic mapping	SMR Multidegree site {0} cannot have an omni-direction entry interface.
Traffic mapping	SMR Multidegree is not allowed in site {0} (fiber interfaces are limited to A,B,C and D)
Traffic mapping	PP-Mesh-4-SMR is restricted. SMR Multidegree is not possible in site {0}
Traffic mapping	SMR-1 is restricted. Site {0} type cannot be SMR-1
Traffic mapping	SMR-2 is restricted. Site {0} type cannot be SMR-2
Traffic mapping	Incorrect Client Interface forcing for LAN-WAN Conversion traffic.

Table C-1 Error Messages (continued)

Message Type	Error Message
Traffic mapping	Incompatible Client Interface forcing.
Traffic mapping	Y-Cable protection is not allowed with electrical SFP.
Traffic mapping	Incompatible trunk Interface forcing
Traffic mapping	10G-XR support w/o FEC trunk interface only.
Traffic Mapping	Cannot Route demand! Didn't find any colorless ports free.
Traffic Mapping	A demand Added or Dropped to a Remote Add/Drop Site cannot be Colorless.
Traffic Mapping	This demand is conflicting with the Wavelength {0} with some other new demand.Please unlock the demand and re-analyze.
Traffic Mapping	50Ghz design is not allowed for site {0} with Remote Add/Drop.
Traffic Mapping	Invalid Structure for {0}. Only Multidegree Site can be OmniDirectional.
Traffic Mapping	Cannot Route demand! Didn't find any colorless ports free.
Traffic Mapping	Cannot Route demand! Didn't find any valid OmniDirectional Side.
Traffic Mapping	OmniDirectional Sides not possible for this protected demand in {0}. Atleast two sides needs to be available.
Traffic Mapping	Cannot Route demand! Didn't find any OmniDirectional Side for {0}.
Traffic Mapping	OmniDirectional Side not possible in {0}. No Free side left.
Traffic Mapping	Optical ByPass is not allowed for OmniDirectional or(and) Colorless Demand.
Traffic Mapping	No Colorless Ports found in {1}. Please force the {0} as OmniDirectional or force any Line Side in the site with Colorless Ports.
Traffic Mapping	Atleast one colorless port must be forced for demand {0} at {1}.
Traffic Mapping	Incompatible configuration with SMR. Please unlock {0}.
Traffic Mapping	Unit {0} is not available in equipment list.
Traffic Mapping	Demand {0} defined on traffic subnet {1} is in an invalid status.
Traffic Mapping	Hybrid layout option is not supported for SMR site types.
Traffic Mapping	Raman Amplification is not supported with SMR site types.
Traffic Mapping	Side/Side Cabling option should be Auto for SMR2 type in site {0}.
Traffic Mapping	Omni-directional interface is not allowed for site type {0}.
Traffic Mapping	Omni-directional interface is not allowed for site functionality {0}.
Traffic Mapping	Invalid mux-demux forcing.
Traffic Mapping	Colorless ports not allowed for site type {0}.
Traffic Mapping	{0} has only {1} Layer-I Colorless Ports against the needed {2} ports.Please update the forcings.
Traffic Mapping	{0} has only {1} Colorless ports available.Layer-II units are not allowed for non-omnidirectional OXC/SMR interface.
Traffic Mapping	Site Connected to Remote Spur Duct should be of functionality Add/Drop and type Mux-Demux.

Table C-1 Error Messages (continued)

Message Type	Error Message
Traffic Mapping	Selected functionality or type does not support Remote Add/Drop Port on it.
Traffic Mapping	Mux-Demux should not be forced on side ({0}) which is not connected to any duct and not forced as omnidirectional.
Traffic Mapping	Mux-Demux cards cannot be forced on {0} ,Since second layer cascade is not allowed on {1} site.
Traffic Mapping	Forcing of mux/demux is not allowed on {0},since all available add/drop ports has been remotize'd.
Traffic Mapping	Forced Site type does not allow to remotize more than {0} add/drop ports.
Traffic mapping	Preamplifier setting on {0} is not compatible with M2 chassis type setted on this site.
Traffic mapping	Booster amplifier setting on {0} is not compatible with M2 chassis type setted on this site.
Traffic mapping	In {0}, OSC-CSM forcing is not compatible with OSC frame type selected.
Traffic mapping	[SiteName1], [SiteName 2] Do not have colorless ports.
Traffic mapping	[SiteName1], [SiteName 2] Do Do not have 2 Omni Interfaces.
Traffic mapping	[SiteName1], [SiteName 2] Do Do not have 1 Omni Interface.
Traffic mapping	[SiteName1], [SiteName 2] are not Multi Degree.
Traffic mapping	[SiteName1], [SiteName 2] do not have 2 Omni Interfaces with at least 1 colorless port each.
Traffic mapping	[SiteName1], [SiteName 2] do not have Omni Interfaces with at least 2 colorless ports each.
Traffic mapping	Site is not LINE or LINE plus.
Traffic mapping	Chromatic dispersion of the two fibers are not same.
Traffic mapping	Chromatic dispersion-L of the two fibers are not same.
Traffic mapping	Subnet rules (C Band) of the two fibers are not same.
Traffic mapping	Subnet rules (L Band) of the two fibers are not same.
Traffic mapping	DCN extension rule of the two fibers are not same.
Traffic mapping	OSC Framing rule of the two fibers are not same.
Traffic mapping	Fiber type of the two fibers are not same.
Traffic mapping	Connection type of the two fibers are not same.
Traffic mapping	C-Band option of the two fibers are not same.
Traffic mapping	Site has a remote add-drop node connected to it.
Traffic mapping	Absolute length loss of the two fibers are not same.
Traffic mapping	Raman amp option of the two fibers are not same.
Traffic mapping	Measurement unit (e.g. k.m., miles etc.) of the two fibers are not same.
Traffic mapping	Cannot Merge Ducts [Duct1] and [Duct 2].
Traffic mapping	Do you want the ducts connected to be merged Click Yes if you want to Merge or else No to delete the Ducts Apply Changes.

Table C-1 Error Messages (continued)

Message Type	Error Message
Traffic mapping	Can only Merge Fibers for Line or Line Plus site [SiteName] is [topology].
Traffic mapping	No free colorless port is available in {0} for {1} ROADM demand
Traffic mapping	Invalid Mux-DeMux and OADM Forcing {0}
Traffic mapping	Site Connected to Remote Spur Duct should be of functionality Add/Drop and type Mux-Demux (OR) OADM with FLD Units Forced.
Traffic mapping	OADM units forced after unlocking the Node Add/Drop Mux/De-Mux, Unlock the service demands which are adding or dropping for site {0} interface {1}
Traffic mapping	Either OADM units changed to FLD or FLD units changed to oadm cards, Unlock the service demands which are adding or dropping for site {0} interface {1}
Traffic mapping	Any-to-Any traffic is not supported with fixed OADM cards.
Traffic mapping	Site {0} is forced with non FLD4 Units. Multiple Optical ByPass is allowed only with FLD4 units.
Traffic mapping	Incompatible Client sfp forcing.
Network design analysis	Preamplifier setting on {0} is not compatible with M2 chassis type setted on this site.
Network design analysis	Booster amplifier setting on {0} is not compatible with M2 chassis type setted on this site.
Network design analysis	In {0}, OSC-CSM forcing is not compatible with OSC frame type selected.
Network design analysis	Node {0} is attached to SMR-2 site {1} through an interface tagged as Omnidirectional Entry Point and therefore no amplifier can be forced.
Network design analysis	{0} is configured as a Remote Add/Drop side and therefore no amplifier can be forced.
Network design analysis	Link {0}-{1} is a remote spur and therefore no amplifier can be forced.
Network design analysis	Link {0}-{1} is a remote spur and therefore Raman amplification is not supported.
Network design analysis	Link {0}-{1} is a remote spur and therefore DCN must be enabled.
Network design analysis	Interface {0} is configured as Omnidirectional and therefore amplifiers cannot be forced as None.
Network design analysis	Interface {0} is configured as Omnidirectional and therefore the OSC unit is not allowed.
Network design analysis	In {0} is impossible to find an OSC unit that supports selected OSC frame type and site constraints.
Network design analysis	Raman amplification is not supported on duct {0}, connecting two hybrid sites.
Network design analysis	Some circuit exceeded the maximum number of allowed amplified spans. Please contact Custom Design team for validating the design.
Network design analysis	Service type {0} does not allow DCU on its optical path. Please force related DCU positions to NONE.
Network creation	Omni-directional side {0} - {1} is not used by any Service Demand.

Table C-1 Error Messages (continued)

Message Type	Error Message
Network creation	Installation parameters for this side cannot be generated; please take corrective actions before loading ANS file to this node.
Network creation	Service type {0} does not allow DCU on its optical path. Please force related DCU positions to NONE.
Amplifier Placement	Automatic Node Turn-Up: In {0}, 32 channels cards are not supported in WXC site.
Amplifier Placement	Automatic Node Turn-Up: In {0}, different design rules for different spans are not supported
Amplifier Placement	Automatic Node Turn-Up: In {0}, Line+ node does not support the selected design rule
Amplifier Placement	Automatic Node Turn-Up: In {0}, multidegree node does not support the selected design rule.
Amplifier Placement	Automatic Node Turn-Up: In {0}, only WXC functionality is supported
Amplifier Placement	Automatic Node Turn-Up: In {0}, 40-MUX-C or 40-DMX-C is not supported.
Amplifier Placement	In {0}, required {1} is in restricted equipment list
Amplifier Placement	In {0}, cannot force a demux if it is not supported by site type.
Amplifier Placement	In {0}, cannot force a mux if it is not supported by site type.
Amplifier Placement	In {0}, cannot force an in-line attenuator if it is not supported by site type.
Amplifier Placement	In {0}, cannot force an in-line attenuator because of presence of OADMs in the other side.
Amplifier Placement	Node {0} is set as Pass-through and therefore no hardware or setpoint can be forced
Amplifier Placement	Node {0} faces a raman amplified span, forcing not feasible
Amplifier Placement	Forcing of Raman on {0} is not compatible with the amplifier forcing done in Node {1}. Please correct the forcings done.
Amplifier Placement	Selection of OPT-BST or OPT-BST-E units as pre-amplifier is allowed only if Raman is used on {0}. Please correct the forcings done.
Amplifier Placement	Raman Amplifier configuration for {0} is not allowed by restricted equipment list
Amplifier Placement	Raman post amp forcing is not allowed for {0}
Amplifier Placement	In {0}, OSC card cannot be set to "none"
Amplifier Placement	In {0}, cannot force OSCM card in hybrid node
Amplifier Placement	In {0}, cannot force output power or tilt setpoint without the related amplifier forced.
Amplifier Placement	Invalid forcing in amplifier node of {0} because of Pass-through site forcing.
Amplifier Placement	In {0}, cannot force unplaced OSC card in a non Pass-through site.
Amplifier Placement	In {0}, cannot force OSCM without an amplifier forced.
Amplifier Placement	Cannot force input attenuator in {0} without the related amplifier forced.

Table C-1 Error Messages (continued)

Message Type	Error Message
Amplifier Placement	Cannot force DCUs in {0} without forcing an amplifier that supports them.
Amplifier Placement	Incompatible types for DCU couple in {0}.
Amplifier Placement	Incompatible dispersion modules in {0}
Amplifier Placement	In {0}, output power is out of limits of amplifier selected.
Amplifier Placement	In {0}, amplifier tilt is out of allowed range.
Amplifier Placement	Couple between {1} and {2} has an invalid value in {0}
Amplifier Placement	Couple between {0} and {1} is of invalid type
Amplifier Placement	Fiber between {1} and {2} has an invalid value in {0}
Amplifier Placement	Fiber between {0} and {1} has SOL total loss greater than EOL total loss.
Amplifier Placement	Span {0} is forced as Raman but no traffic is present
Amplifier Placement	In {0} interfaces selected for add channels cannot be equalized with 40-MUX-C.
Amplifier Placement	Try selecting fewer or more similar interface types, and/or do not use the 40-MUX-C card
Amplifier Placement	Can't respect forcing on {0} attenuator (on channel {1}) in {2} {3} {4}. No A/D ports are available
Amplifier Placement	Tilt forced on {0} in {1} {2} {3} when no-tilt design option is selected
Amplifier Placement	DMX-O is suggested as drop unit in {0} instead of the forced DMX.
Amplifier Placement	DMX might cause problems during channels provisioning and or in case of equipment failures.
Amplifier Placement	Fail low channel threshold cannot be set in {0} {1} {2}; please allow placement of booster amplifier.
Amplifier Placement	In {0}, {1} is working with a gain of {2} dB: this value is below its minimum allowed gain.
Amplifier Placement	In {0}, {1} in EOL condition will be working with a gain of {2} dB: this value is below its minimum allowed gain.
Amplifier Placement	In {0}, {1} is working with a gain of {2} dB: this value exceeds its maximum allowed gain.
Amplifier Placement	In {0}, {1} in EOL condition will be working with a gain of {2} dB: this value exceeds its maximum allowed gain.
Amplifier Placement	Site {0} cannot be installed without Cisco Transport Planner configuration file.
Amplifier Placement	Unsupported configuration due to excessive number of amplifiers (max {0} per directions).
Amplifier Placement	Unsupported configuration due to excessive number of OSC regen sites (max {0}).
Amplifier Placement	In {0}, channel power is near the fail low threshold.
Amplifier Placement	In {0}, minimum channel power is below the fail low threshold.
Amplifier Placement	In {0}, OSC channel power is below the fail low threshold.

Table C-1 Error Messages (continued)

Message Type	Error Message
Amplifier Placement	Network cannot be installed as one or more OSC links are unfeasible.
Amplifier Placement	If possible, try selecting DCN extension option on the longest spans.
Amplifier Placement	Try to unfreeze amplifier or DCUs in site {0}, interface {1}, {2} position.
Amplifier Placement	Transmission error. Please contact custom design.
Amplifier Placement	Transmission error on channel {0}. Please contact custom design.
Amplifier Placement	Excessive ROADM crossTalk penalty on channel {0}. Try to lower the output power of the preamplifier in the ROADM site in which the failed channels are added.
Amplifier Placement	Excessive filtering penalty on channel {0}. Please contact custom design
Amplifier Placement	Filtering problem on channel {0}. Please contact custom design
Amplifier Placement	Excessive PMD on channel {0}. Please contact custom design.
Amplifier Placement	Excessive SC on channel {0}. Please contact custom design.
Amplifier Placement	In site {0} the Pass Through forcing and DCN Extension option are incompatible
Amplifier Placement	In {0}, DCN Extension option have to be set on both fiber couples facing a Pass-Through node
Amplifier Placement	Automatic Node Turn-Up: node {0} mandatory requires preamplifiers (otherwise this node must be set as Pass-Through).
Amplifier Placement	Automatic Node Turn-Up: In {0}, amplifier output power cannot be forced.
Amplifier Placement	Automatic Node Turn-Up: In {0}, Fiber Switch protection scheme is not supported.
Amplifier Placement	Automatic Node Turn-Up: In {0}, only “32 Chs +5 dbm/Ch” and “40 Chs +4 dbm/Ch” design rules are supported.
Amplifier Placement	Automatic Node Turn-Up: In {0}, only “32 Chs +5 dbm/Ch” design rule is supported.
Amplifier Placement	Automatic Node Turn-Up: In {0}, C + L band upgradeability is not supported.
Amplifier Placement	Automatic Node Turn-Up: In {0}, OADM output power cannot be forced.
Amplifier Placement	Automatic Node Turn-Up: node {0} cannot be set as OADM full mux/demux.
Dithering Generation	Lower Dithering limit ({0}) cannot be less than {1}
Dithering Generation	Upper Dithering limit ({0}) cannot be greater than {1}
Dithering Generation	Lower Dithering limit ({0}) cannot exceed Upper Limit ({1})
Dithering Generation	Site {0} Dithering value cannot be less than Lower Dithering limit {1}
Dithering Generation	Site {0} Dithering value cannot be greater than Upper Dithering limit {1}
Dithering Generation	Sites {0} and {1} cannot have the same Dithering value
Dithering Generation	Number of available Dithering values {0} cannot be less than number of MultiDegree sites {1}
Dithering Generation	Cannot find available Dithering value for site {0}

Table C-1 Error Messages (continued)

Message Type	Error Message
Dithering Generation	Cannot force Dithering value different from 0 in site {0}
Layout	MSTP shelves number in site {0} exceeds maximum MultiShelf configuration ({1})
Layout	No linecards placed in Hybrid site {0} optical shelf
Layout	Release 4.7/5.0 does not support MultiShelf
Layout	No PRE/BST card present with OSCM in site {0}
Layout	Layout not feasible for {0} Individual Shelf configuration - No room in the optical shelf to host all the OTS units
Layout	No space for DCU: unlock Site {0} layout
Layout	Hybrid Layout in Site {0} is allowed with Individual Shelf only
Layout	Node protection is not allowed in Terminal Site {0}
Layout	DCC Chain in Site {0} is allowed with Individual Shelf only
Layout	Node protection in Site {0} is not allowed with Individual Shelf
Layout	Cable DB part not identified in Site {0}
Layout	Site {0} layout must be unlocked to allow Patch Panel/DCU insertion
Layout	Layout in site {0} cannot be built due an internal error. Other reports for the same site may be wrong or incomplete. Please contact support.
Layout	{0} site layout must be unlocked to apply modified properties
Layout	A/D cards configuration in site {0} is not allowed: please select "Multi Shelf External Switch" or force 32-DMX card
Layout	Units equipped in site {0} shelf {1} need FTA4. Please replace current fan tray before equipping the units into the shelf
Layout	Only card Layout position can be changed (Site {0})
Layout	Card in Rack {0} - Shelf {1} - Slot {2} cannot be moved to Rack {3} - Shelf {4} - Slot {5} (Site {6})
Layout	Just one move is allowed for Card in Rack {0} - Shelf {1} - Slot {2} (Site {3})
Layout	Cards in Rack {0} - Shelf {1} - Slot {2} and Rack {3} - Shelf {4} - Slot {5} (Site {6}) belong to a YCable Protection Group and must be moved to the same destination shelf
Layout	Multidegree topology in site {0} is not supported with Individual Shelf configuration
Layout	Y cable protection with GE XP / 10GEXP / GE EXP / 10GE EXP traffic demand in site {0} is not supported with Osmine Configuration
Layout	Y cable protection with GE XP / 10GEXP traffic demand in site {0} is not supported with Osmine Configuration
Layout	Network not managed by Osmine: Site {0} with WXC and WSS is not admitted.
Layout	Layout not feasible for {0} M2 Shelf cannot go in MSM Configuration.
Layout	Layout not feasible for {0},M2 chassis is in Restricted List and is forced.

Table C-1 Error Messages (continued)

Message Type	Error Message
Layout	Layout not feasible for {0},M6 chassis is in Restricted List and is forced.
Layout	Layout not feasible for {0},M12 chassis is in Restricted List and is forced.
Layout	Layout not feasible M12 chassis and M6 Chassis are in Restricted List.
Layout	In Site: {0} and Side: {1} with the current configuration, M6 chassis has been forced, either due to Chassis type forcing of GE frame forcing, whereas M12 chassis is the suggested option.
Layout	Layout not feasible for Site: {0} and Side: {1},M6 is not supported for the site configuration and M12 Chassis is in Restricted Equipment List.
Layout	Extra M2 Shelf cannot go in MSM Configuration for site {0}, hence ignoring additional M2 chassis.
Layout	MSM External Configuration for site {0} and M6 Forced, M6 Chassis has integrated MSM capability.
Layout	OSC frame type is forced to GE for site {0} and Interface {1}, Power is not sufficient with the available GE Module.
Layout	Layout not feasible for {0},Single Controller card doesn't support MSM.
Layout	The forced {0} is not compatible with the {1} forced for the {2}.
Layout	M2 Chassis cannot have more than one neighbour with ONS 15454 chassis forced.
Layout	When M2 chassis is forced, all the connected ducts with only one exception, should have couples forced with valid OSC Frames.
Layout	Layout not feasible for {0} with the selected Shelf.
Layout	The frame forcings across {0} are not compatible because the site is a passthrough site. The current values will be ignored and best defaults would be chosen.
Layout	The OSC frame forcing in the couples connecting the PSM Line {0} need to be same.
Layout	The {0} is a OSC regen site hence the connected couples should not have GE frame type forced.
Layout	The {0} has OSC-CSM forced which is not compatible with GE frame forcing on the couple in {1}.
Layout	The {0} has WSS card with DMX and M2 forced which is not compatible. Analysis not feasible.
Layout	MSTP shelves number in site {0} exceeds maximum MultiShelf configuration ({1}).
Layout	Racks in site {0} exceeds maximum number of supported Racks({1}). Layout is not built for the site.
Layout	No linecards placed in Hybrid site {0} optical shelf.
Layout	Release 4.7/5.0 does not support MultiShelf.
Layout	No PRE/BST card present with OSCM in site {0}.
Layout	Layout not feasible for {0} Individual Shelf configuration - No room in the optical shelf to host all the OTS units.

Table C-1 Error Messages (continued)

Message Type	Error Message
Layout	No space for DCU: unlock Site {0} layout.
Layout	Hybrid Layout in Site {0} is allowed with Individual Shelf only.
Layout	Node protection is not allowed in Terminal Site {0}.
Layout	Node protection is not allowed in PSM Line/Section Site {0}.
Layout	DCC Chain in Site {0} is allowed with Individual Shelf only.
Layout	Node protection in Site {0} is not allowed with Individual Shelf.
Layout	Node protection in Site {0} is not allowed without ADD/DROP.
Layout	Cable DB part not identified in Site {0}.
Layout	Site {0} layout must be unlocked to allow Patch Panel/DCU insertion.
Layout	Layout in site {0} cannot be built due an internal error. Other reports for the same site may be wrong or incomplete. Please contact support.
Layout	{0} site layout must be unlocked to apply modified properties.
Layout	A/D cards configuration in site {0} is not allowed: please select "Multi Shelf External Switch" or force 32-DMX card.
Layout	Units equipped in site {0} shelf {1} need FTA4. Please replace current fan tray before equipping the units into the shelf.
Layout	Only card Layout position can be changed (Site {0}).
Layout	Card in Rack {0} - Shelf {1} - Slot {2} cannot be moved to Rack {3} - Shelf {4} - Slot {5} (Site {6}).
Layout	Multidegree topology in site {0} is not supported with Individual Shelf configuration.
Layout	Invalid Alien Shelf Height for site {0}, Alien Shelves Could not be added.
Layout	Alien Shelf Height is more than Rack Height for site {0}, Alien Shelves Could not be added.
Layout	Unit in the Rack {0} - Shelf {1} - Slot {2} for site {3} requires FAN TRAY 4.
Layout	SMR2 in Separate Shelf is not Feasible for Site {0} due to cable unavailable with appropriate length.
Layout	Layout not feasible for {0} M2 Shelf cannot go in MSM Configuration.
Layout	The interface {0} has Raman CTP forced with M12 chassis. This is not compatible.
Layout	The interface {0} has Raman CTP, which needs high power cables to connect, Only cables of length 2m are bundled with the card.
Layout	Raman-CTP or Raman-COP cards forced with M12 chassis in the interface {0} is not a supported configuration.
Layout	Raman-CTP or Raman-COP cards forced with M2 chassis in the interface {0} is not a supported configuration.
Layout	Raman-CTP or Raman-COP cards placed in {0} because M6 chassis is restricted.

Table C-1 Error Messages (continued)

Message Type	Error Message
Layout	Raman-CTP or Raman-COP cards placed in M12 chassis in the interface {0} is not a supported configuration.
	The Site {0} has TCC 2p as node controller. So it cannot subtend M6/M2 Shelves.
Amplifier algorithm	In {0}, can't force a demux if it is not supported by site type.
Amplifier algorithm	In {0}, can't force an inline attenuator if it is not supported by site type.
Amplifier algorithm	In {0}, can't force an inline attenuator because of presence of OADMs in the other side.
Amplifier algorithm	Invalid forcing in amplifier node of {0} because of Pass-through site forcing.
Amplifier algorithm	In {0}, can't force unplaced OSC card in a non Pass-through site.
Amplifier algorithm	In {0}, can't force OSCM without an amplifier forced.
Amplifier algorithm	Can't force power output or tilt in {0} without the related amplifier forced.
Amplifier algorithm	Cannot force input attenuator in {1} without the related amplifier forced.
Amplifier algorithm	Can't force DCUs in {0} without forcing an amplifier that supports them. See the “C.5.1 Incompatible DCUs (C-Band)” section on page C-31.
Amplifier algorithm	Incompatible types for DCU couple in {0}. See the “C.5.1 Incompatible DCUs (C-Band)” section on page C-31.
Amplifier algorithm	Incompatible dispersion modules in {0}. See the “C.5.1 Incompatible DCUs (C-Band)” section on page C-31.
Amplifier algorithm	In {0}, MMU presence requires OPT-AMP-L forcing in bst and pre position. See the “C.5.2 MMU Does Not Have Correct Amplifier (L-Band)” section on page C-32.
Amplifier algorithm	In {0}, MMU presence requires OPT-PRE and OPT-BST-E forcing. See the “C.5.3 MMU Does Not Have Correct Amplifier (C-Band)” section on page C-32.
Amplifier algorithm	In {0}, output power setting is not supported by the amplifier. See the “C.5.4 Output Power or Tilt are Out of Range” section on page C-33.
Amplifier algorithm	In {0}, amplifier tilt is out of limits. See the “C.5.4 Output Power or Tilt are Out of Range” section on page C-33.
Amplifier algorithm	Couple between {1} and {2} has an invalid value in {0}. See the “C.5.5 Invalid Fiber Values, Types, and Loss Values” section on page C-33.
Amplifier algorithm	Couple between {0} and {1} is of invalid type. See the “C.5.5 Invalid Fiber Values, Types, and Loss Values” section on page C-33.
Amplifier algorithm	Fiber between {1} and {2} has an invalid value in {0}. See the “C.5.5 Invalid Fiber Values, Types, and Loss Values” section on page C-33.
Amplifier algorithm	Fiber between {0} and {1} has SOL total loss greater than EOL total loss. See the “C.5.5 Invalid Fiber Values, Types, and Loss Values” section on page C-33.

Table C-1 Error Messages (continued)

Message Type	Error Message
Amplifier algorithm	A {0} attenuator (on channel {1}) in {2} {3} {4} was present, but A/D ports on this channel are no longer available. See the “C.5.7 Unavailable Add/Drop Channels” section on page C-34.
Amplifier algorithm	Tilt forced on {0} in {1} {2} {3} when no-tilt design option is selected. See the “C.5.8 Tilt Forced When No Tilt Design Is Selected” section on page C-35.
Amplifier algorithm	Can't change DMX with DMX-O as needed in {1} because user forcing. See the “C.5.9 Cannot Replace 32-DMX with 32DMX-O” section on page C-36.
Amplifier algorithm	Low threshold on channels power in {0} {1} {2} because passive user forcing on OPT-BST position.
Amplifier algorithm	In {0}, {1} is working in an invalid mode. See the “C.5.10 Preamplifier Working in Invalid Mode” section on page C-37.
Amplifier algorithm	In {0}, {1} is working with a gain of {2} dBm: this is too low. See the “C.5.11 Gain Too Low for an Amplifier” section on page C-37.
Amplifier algorithm	In {0}, {1} will be work (in EOL condition) with a gain of {2} dBm: this is too low. See the “C.5.11 Gain Too Low for an Amplifier” section on page C-37.
Amplifier algorithm	In {0}, {1} is working with a gain of {2} dBm: this is too high. See the “C.5.12 Gain Too High for an Amplifier” section on page C-38.
Amplifier algorithm	In {0}, {1} will be work (in EOL condition) with a gain of {2} dBm: this is too high. See the “C.5.12 Gain Too High for an Amplifier” section on page C-38.
Amplifier algorithm	In {0}, {1} cannot respect user forcing. See the “C.5.13 User Forcing Overridden” section on page C-38.
Amplifier algorithm	In {0}, {1} cannot respect user forcing due to {2}. See the “C.5.13 User Forcing Overridden” section on page C-38.
Amplifier algorithm	Unsupported configuration due to excessive number of amplifiers (max {0} per directions). See the “C.5.14 Unsupported Configuration” section on page C-39.
Amplifier algorithm	Unsupported configuration due to excessive number of OSC regen sites (max {0}). See the “C.5.14 Unsupported Configuration” section on page C-39.
Amplifier algorithm	In {0}, channel power is near the fail threshold. See the “C.5.15 Channel Power Near the Fail Threshold” section on page C-39.
Amplifier algorithm	In {0}, channel power is below the fail threshold. See the “C.5.16 Channel Power Below the Fail Threshold” section on page C-40.
Amplifier algorithm	In {0}, OSC channel power is near the fail threshold. See the “C.5.15 Channel Power Near the Fail Threshold” section on page C-39.
Amplifier algorithm	In {0}, OSC channel power is below the fail threshold. See the “C.5.17 OSC Channel Power Below the Fail Threshold” section on page C-40.

Table C-1 Error Messages (continued)

Message Type	Error Message
Amplifier algorithm	Network unfeasible due to OSC channel. See the “C.5.17 OSC Channel Power Below the Fail Threshold” section on page C-40.
Amplifier algorithm	Try to unfreeze amplifier or dcus in site {0}, interface {1}, {2} position
Amplifier algorithm	Transmission error. Please contact custom design.
Amplifier algorithm	Transmission error on channel {0}. Please contact custom design.
Amplifier algorithm	Excessive ROADM crossTalk penalty on channel {0}. Try to lower the output power of the preamplifier in the Roadm site in which the failed channels are added.
Amplifier algorithm	Excessive filtering penalty on channel {0}. Please contact custom design.
Amplifier algorithm	Filtering problem on channel {0}. Please contact custom design.
Amplifier algorithm	One or more demands present unexpected results at the end of the analysis. Refer to channels errored on system.
Amplifier algorithm	Excessive PMD on channel {0}. Please contact custom design.
Amplifier algorithm	Node {0} is set as Pass-Through and therefore no hardware or setpoint can be forced
Amplifier algorithm	Forcing of tilt in {0} is not allowed in case of Raman amplified span
Amplifier algorithm	Forcing of Raman ({0}) is not allowed in PSM Topology. Please correct the forcings done.
Amplifier algorithm	In {0} Raman embedded amplifier has dispersion modules with MAL greater then supported
Amplifier algorithm	In {0} Raman post amplifier has total dispersion modules with MAL greater then supported
Amplifier algorithm	Network analysis must be validated. Please contact custom design.
Amplifier algorithm	In network with PSM-Line protection and different fiber types, DCU placement must be validated.
Amplifier algorithm	Site {0} connected to duct with DCN extension property enabled must have functionality Add/Drop.
Amplifier algorithm	Couple under duct {0} must have DCN extension property disabled
Amplifier algorithm	In site {0} between fibers DCN extension, no OSC and no Booster are allowed
Amplifier algorithm	In Add/Drop site {0}, OSC cannot be forced since the facing fiber has DCN extension enabled
Amplifier algorithm	In Add/Drop site {0} facing a fiber with DCN extension enabled, Booster cannot be forced as None
Amplifier algorithm	The DCN path from {0} to {1} contains too many Line Amplifier sites
Amplifier algorithm	In interfaces tagged as Omnidirectional Entry Point is not allowed set Mux or Demux
Amplifier algorithm	In interfaces tagged as Omnidirectional Entry Point a Terminal site must be connected

Table C-1 Error Messages (continued)

Message Type	Error Message
Amplifier algorithm	Node {0} refers to an interface tagged as Omnidirectional Entry Point and therefore no amplifier can be forced
Amplifier algorithm	Node {0} refers to an interface tagged as Omnidirectional Entry Point and therefore no OSC card can be forced
Amplifier algorithm	Raman Amplifier module is required in node {0}. Unlock it
Amplifier algorithm	Forcing of amplifier in {0} is not allowed in case of Raman amplified span.
Amplifier algorithm	Node {0} faces a raman amplified span, only OPT-BST unit can be forced.
Amplifier algorithm	Span {0} must be configured as Raman to allow Raman amplifier {1} in node {2}.
Amplifier algorithm	Forcing of Raman on {0} is not compatible with the amplifier forcing done in Node {1}. Please correct the forcings done.
Amplifier algorithm	Selection of OPT-BST or OPT-BST-E units as pre-amplifier is allowed only if Raman is used on {0}. Please correct the forcings done.
Amplifier algorithm	Raman Amplifier configuration for {0} is not allowed by restricted equipment list.
Amplifier algorithm	Raman post amp forcing is not allowed for {0}
Amplifier algorithm	Node {0} faces a raman amplified span, only OPT-BST unit can be forced.
Amplifier algorithm	Span {0} must be configured as Raman to allow Raman amplifier {1} in node {2}.
Amplifier algorithm	Forcing of Raman on {0} is not compatible with the amplifier forcing done in Node {1}. Please correct the forcings done.
Amplifier algorithm	Selection of OPT-BST or OPT-BST-E units as pre-amplifier is allowed only if Raman is used on {0}. Please correct the forcings done.
Amplifier algorithm	Raman Amplifier configuration for {0} is not allowed by restricted equipment list.
Amplifier algorithm	Raman post amp forcing is not allowed for {0}
Amplifier algorithm	Span {0} is forced as Raman but no traffic is present.
Amplifier algorithm	In {0} is not allowed forcing a booster or setting DCN extension enabled.
Amplifier algorithm	In Add/Drop site {0} facing a fiber with DCN extension enable, OSC cannot be forced
Amplifier algorithm	Site {0} is facing spans with different optical design rules: an Add/Drop functionality is required.
Amplifier algorithm	{0} is an hybrid 15454 MSTP site : selection of OPT-BST or OPT-BST-E units as pre-amplifiers is not allowed.
Amplifier algorithm	Span is too short for Raman amplification. If possible, lower the output power setpoint of the booster.
Amplifier algorithm	Raman optical amplifiers are not available in L Band.
Amplifier algorithm	In {0} is not allowed forcing a pre-amplifier or setting DCN extension enabled.
Amplifier algorithm	In {0}, cannot force OSCM card without an amplifier or SMR forced.

Table C-1 Error Messages (continued)

Message Type	Error Message
Amplifier algorithm	Forcing of T-DCU on both {0} is not allowed. Please remove T-DCU forcing either from {1}.
Amplifier algorithm	{0} - side {1} is connected to a span not used by any Service Demand.
Amplifier algorithm	In multidegree site {0} configured as SMR2 type with Individual Shelf, only first two sides can have OSC-CSM unit forcing.
Amplifier algorithm	{0} has OSC functionality : side {1} can't face a fiber with DCN extension enabled.
Amplifier algorithm	Raman amplification is not supported on duct {0}, connecting two hybrid sites.
Amplifier algorithm	Some circuit exceeded the maximum number of allowed amplified spans. Please contact Custom Design team for validating the design.
Amplifier algorithm	In {0} the amplifier {1} doesn't support DCU modules: please unlock or reset to Auto any related DCU.
Amplifier algorithm	In {0}, DFB power fail is near the minimum allowed threshold.
Amplifier algorithm	In {0}, DFB power fail is below the minimum allowed threshold.
Amplifier algorithm	Duct {0} is connecting two hybrid sites: Raman amplification is not supported.
Amplifier algorithm	Some circuit exceeded the maximum number of allowed amplified spans. Please contact Custom Design team for validation of the design.
Amplifier algorithm	The Raman amplifier at {0} is not compatible with the Raman amplifier at the other end of the line
Amplifier algorithm	The Raman amplifier at {0} requires an equalization unit (e.g. SMR, WSS or WXC)
Amplifier algorithm	The Raman amplifier at {0} requires DCN extension on the facing fiber
Amplifier algorithm	Some circuits are traversing {0} RAMAN-CTP amplified spans (max {1} allowed)
Amplifier algorithm	Some circuits are traversing {0} RAMAN-COP + RAMAN-CTP amplified spans (max {1} allowed)
Amplifier algorithm	Duct {0} is a Raman amplified span using RAMAN-COP: all circuits must be terminated in {1} and {2}
Amplifier algorithm	RAMAN-COP is not supported on {0} fiber (duct {1})
Layout messages	MSTP shelves number in site {0} exceeds maximum MultiShelf configuration (12).
Layout messages	No linecards placed in Hybrid site {0} optical shelf.
Layout messages	Release 4.7/5.0 does not support MultiShelf.
Layout messages	No PRE/BST card present with OSCM in site {0}.
Layout messages	Layout not feasible for {0} Individual Shelf configuration - No room in the optical shelf to host all the OTS units.
Layout messages	No space for DCU: unlock Site {0} layout.
Layout messages	Hybrid Layout in Site {0} is allowed with Individual Shelf only.

Table C-1 Error Messages (continued)

Message Type	Error Message
Layout messages	Node protection is not allowed in Terminal Site {0}.
Layout messages	DCC Chain in Site {0} is allowed with Individual Shelf only.
Layout messages	Node protection in Site {0} is not allowed with Individual Shelf.
Layout messages	Cable DB part not identified in Site {0}.
Layout messages	Site {0} layout must be unlocked to allow Patch Panel/DCU insertion.
Layout messages	Layout in site {0} cannot be built due an internal error. Other reports for the same site may be wrong or incomplete. Please contact support.
Layout messages	Y cable protection with GE XP / 10GEXP traffic demand in site {0} is not supported with Osmine Configuration
Layout messages	Network not managed by Osmine: Site {0} with WXC and WSS is not admitted.
Layout messages	Invalid Alien Shelf Height for site {0} , Alien Shelves Could not be added.
Layout messages	Alien Shelf Height is more than Rack Height for site {0} , Alien Shelves Could not be added.
Layout messages	SMR with Raman Amplification is Not Supported on Side {0} for Site {1}.
Layout messages	SMR2 in Separate Shelf is not Feasible for Site {0} due to cable unavailable with appropriate length.
Generic	Error deleting site- generic, cannot be classified.
Generic	At least one optical bypass point is defined in this site. The site can not be deleted until the optical bypass is removed.
DCU placement	Fiber Bragg DCU on {0} is incompatible with the client card.
DCU placement	Fiber Bragg DCU on {0} is incompatible with the trunk pluggable.
DCU placement	50Ghz spacing is not allowed for {0} with Fiber-Bragg DCU.
DCU placement	Fiber Bragg is not supported for 50Ghz channel spacing.
DCU placement	FBGDCU option is set to Always at the project level and channel spacing is 50 Ghz for {0}.
DCU placement	DCU cannot be forced for {0} along with Fiber-Bragg DCU.

C.2 Warning Messages

Warning Messages for Cisco Transport Planner are listed in [Table C-2](#):

Table C-2 Warning Messages

Message Type	Warning Message
Traffic mapping	Wavelength {0} may require additional ASE filtering.
Traffic mapping	In {0}, add/drop input power must be modified from {2} to {1}.
Network creation	In {0}, minimum channel power for port {1} of {2} is below the fail low threshold.

Table C-2 Warning Messages

Message Type	Warning Message
Network creation	In {0}, minimum channel power for port {1} of {2} is near the fail low threshold.
Amplifier algorithm	Can't respect forcing on {0} attenuator (on channel {1}) in {2} {3} {4}. No A/D ports are available. See the “C.5.6 Attenuator Forcing Not Allowed” section on page C-34.
Amplifier algorithm	In {0}, minimum channel power is near the fail low threshold
Amplifier algorithm	Dcu design not optimized due to “Run Quick Analysis” option
Amplifier algorithm	In {0}, 32-DMX might have problem as drop unit. If supported by node type try 32-DMX-O.
Amplifier algorithm	32-DMX might cause problems during channels provisioning and/or in case of equipment failure.
Amplifier algorithm	In {0}, 40-DMX might have problem as drop unit.
Amplifier algorithm	40-DMX might cause problems during channels provisioning and/or in case of equipment failure.
Amplifier algorithm	PSM switching threshold on port {0}-RX {1} is close to minimum channel power
Amplifier algorithm	PSM switching on port {0}-RX {1} might not be completely reliable
Amplifier algorithm	PSM switching on port {0}-RX is based on EDFA safety shutdown procedure and might be longer than 50 ms
Amplifier algorithm	PSM unit might not correctly switch on port {0}-RX in case of fiber cut
Amplifier algorithm	OPT-RAMP-C on {0} side is facing a span with an excessive loss.
Amplifier algorithm	OPT-RAMP-CE on {0} side is facing a span with an excessive loss.
Amplifier algorithm	Forcing of T-DCU on {0} in L-Band network is not allowed. Please check the TDCU forcing in Options Explorer.
Amplifier Placement	In {0}, MMU mandatory requires OPT-PRE and OPT-BST-E. Please remove any other amplifier type forcing
Amplifier Placement	In {0} an external DCN access must be provided for DCN functionality
Amplifier Placement	In {0}, OSC channel power is near the fail low threshold.
Amplifier Placement	A {0} attenuator (on channel {1}) in {2} {3} {4} was present, but A/D ports on this channel are longer available
Amplifier Placement	In {0}, control mode of {3} amplifier must be modified from {2} to {1}
Amplifier Placement	Output tilt is forced on {0} in {1} {2} {3} but no-tilt design option is selected
Amplifier Placement	In {0}, MMU mandatory requires OPT-AMP-L in booster and pre position. Please remove any other amplifier type forcing
Amplifier Placement	In {0}, bypass power must be modified from {2} to {1}
Amplifier Placement	In {0}, drop power must be modified from {2} to {1}
Amplifier Placement	In {0}, RX amplifier power fail threshold must be modified from {2} to {1}
Amplifier Placement	In {0}, TX amplifier power fail threshold must be modified from {2} to {1}
Amplifier Placement	In {0}, channel LOS threshold must be modified from {2} to {1}.

Table C-2 Warning Messages

Message Type	Warning Message
Amplifier Placement	In {0}, OSC LOS threshold must be modified from {2} to {1}
Amplifier Placement	In {0}, minimum expected span loss must be modified from {2} to {1}
Amplifier Placement	In {0}, maximum expected span loss must be modified from {2} to {1}
Amplifier Placement	In {0}, OSC TX power must be modified from {2} to {1}
Amplifier Placement	In {0}, band drop power at {3} must be modified from {2} to {1}
Amplifier Placement	In {0}, channel drop power at {3} must be modified from {2} to {1}
Amplifier Placement	In {0}, 32-DMX might have problem as drop unit. If supported by node type try 32-DMX-O
Amplifier Placement	32-DMX might cause problems during channels provisioning and/or in case of equipment failure
Amplifier Placement	In {0}, 40-DMX might have problem as drop unit
Amplifier Placement	40-DMX might cause problems during channels provisioning and/or in case of equipment failure
Amplifier Placement	In {0}, {1} is working in power control mode.
Amplifier Placement	In case of fiber cut or equipment failure, channels survivability might not be guaranteed
Amplifier Placement	In {0}, {1} cannot respect user forcing. See C.5.13 User Forcing Overridden , page C-38.
Amplifier Placement	The forced setpoint/item has been overwritten by CTP with a feasible value.
Amplifier Placement	In {0}, {1} cannot respect user forcing due to {2}
Amplifier Placement	The forced setpoint/item has been overwritten by CTP with a feasible value.
Amplifier Placement	Between nodes {0} and {1}, {2} gain equalizer node(s) is (are) suggested for an optimal design
Amplifier Placement	Excessively long chains of OLA nodes (>{0}) might cause problems in LOS detection at receivers in case of channels failure.
Amplifier Placement	In {0}, 32-DMX-O is suggested as drop unit in instead of the forced 32-DMX.
Amplifier Placement	32-DMX might cause problems during channels provisioning and/or in case of equipment failure.
Amplifier Placement	Osmine configuration in site {0} is not supported with L-Band
Amplifier Placement	Hybrid Site Config in a Single-Shelf configuration is only supported for an OADM Site Type
Layout	Osmine configuration in site {0} is not supported with L-Band
Layout	Hybrid Site Config in a Single-Shelf configuration is only supported for an OADM Site Type
Layout	Unit in the Rack {0} - Shelf {1} - Slot {2} for site {3} requires FAN TRAY 4.
Layout	Extra M6 Shelf cannot be added for site {0}, M6 chassis is Restricted.
Layout	Extra M12 Shelf cannot be added for site {0}, M12 chassis is Restricted.

Table C-2 *Warning Messages*

Message Type	Warning Message
Layout	M6 Chassis with integrated MSM capability, is forced in {0} with MSM External Switch. This adds extra to BOM.
Layout	Requested number of extra shelves could not be added due to MSM configuration restrictions. Please check the layout for details.
Layout	TNC pluggable {0} forced with ONS 15454 chassis in {1}, hence ignoring pluggable forcing.
Layout	The chassis type set to M6 due to the forcing of OSC Pluggables at {0}.
Layout	Auto Option for Shelf Management is assigned Single Shelf Configuration by the algorithm as Site {0} is a non add drop site.
Layout	Layout for Site {0} is unlocked to add Fiber Storage.
Layout	Osmine configuration in site {0} is not supported with L-Band.
Layout	Network not managed by Osmine: Site {0} with WXC and WSS is not admitted.
Layout	Hybrid Site Config in a Single-Shelf configuration is only supported for an OADM Site Type.
Generic	Traffic associated to this subnet will be unlocked.
Generic	If traffic subnet will be deleted, this traffic will be unlocked and if it requires a specific traffic subnet topology, it will not be editable until it will associated to another traffic subnet.
Generic	This traffic cannot be edited. It needs to be associated to a valid traffic subnet.
DCU placement	Fiber Bragg DCU is forced on {0} with traffic generating out of it expressing through non-OLA/PT site {1}.

C.3 Information Messages

Information Messages for Cisco Transport Planner are listed in [Table C-3](#):

Table C-3 *Information Messages*

Message Type	Information Message
Traffic Mapping	No specific anti-ASE node is required for this traffic matrix requirement
Layout	Layout for Site {0} is unlocked to add Fiber Storage
Layout	The generated BOM does not include SONET/SDH units(OC192LR and OC48ELR will be included if applicable).
Layout	Just one move is allowed for Card in Rack {0} - Shelf {1} - Slot {2} (Site {3}).
Layout	Cards in Rack {0} - Shelf {1} - Slot {2} and Rack {3} - Shelf {4} - Slot {5} (Site {6}) belong to a YCable Protection Group and must be moved to the same destination shelf.

Table C-3 Information Messages

Message Type	Information Message
Layout	Y cable protection with GE XP / 10GEXP traffic demand in site {0} is not supported with Osmine Configuration.
Layout	Y cable protection with GE XP / 10GEXP / GE EXP / 10GE EXP traffic demand in site {0} is not supported with Osmine Configuration.
Layout	The generated BOM does not include SONET/SDH units(OC192LR and OC48ELR will be included if applicable).
Amplifier algorithm	In {0}, the attenuator {1} is placed between fiber interface and port {2} of {3}.
Amplifier algorithm	This attenuator is present both in BOM and Project Explorer but not in internal connections.

C.4 Traffic Mapping Troubleshooting

The following procedures help you resolve traffic mapping problems with the network design.

C.4.1 Wavelength Exceeded

Symptom Cisco Transport Planner warns you that all network analysis solutions exceed the wavelengths.

[Table C-4](#) describes the potential causes of the symptom and the solution.

Table C-4 Wavelength Exceeded

Possible Problem	Solution
A span in the ring must carry more than 32 wavelengths to implement the traffic demands.	Remove the forced path routing on unprotected channels: <ol style="list-style-type: none"> 1. In the Project Explorer pane under the Service Demands folder, right-click the appropriate demand and choose Edit from the shortcut menu. 2. In the Path column, choose Auto from the drop-down list. 3. Reanalyze the network.
A span in the ring must carry more than 16/8 wavelengths.	Change the traffic mapping design rules under the related subnet and choose an option that allows a greater number of channels: <ol style="list-style-type: none"> 1. In the Project Explorer pane under the Subnets folder, expand Traffic Mapping and click System Release. 2. In the Properties pane, choose the new rules option from the C-Band Rules or L-Band Rules drop-down list. 3. Reanalyze the network.

C.4.2 Invalid Routing

Symptom Cisco Transport Planner warns you of invalid routing (out of network boundary).

[Table C-5](#) describes the potential causes of the symptom and the solution.

Table C-5 *Invalid Routing*

Possible Problem	Solution
In a linear network, the direction of each service demand is restricted by the topology but the user applied an unfeasible direction forcing.	Remove the forced path routing: <ol style="list-style-type: none"> 1. In the Project Explorer pane under the Service Demands folder, right-click the appropriate demand and choose Edit from the shortcut menu. 2. In the Path column of the Edit <demand> dialog box, choose Auto from the drop-down list. 3. Reanalyze the network.

C.4.3 Cannot Find Alternate Route

Symptom Cisco Transport Planner warns you that it cannot find an alternate route due to multiple hub nodes along the path.

[Table C-6](#) describes the potential causes of the symptom and the solution.

Table C-6 *Cannot Find Alternate Route*

Possible Problem	Solution
Because a hub node does not allow express channels, if multiple hub nodes are present, not all point-to-point connections are possible.	Remove the hub functionality constraints: <ol style="list-style-type: none"> 1. In the Project Explorer pane under the Sites folder, click C-Band or L-Band for the appropriate site. 2. In the Properties pane, choose Auto from the Functionality drop-down list. 3. Reanalyze the network.

C.4.4 Cannot Route Service

Symptom Cisco Transport Planner warns you that it cannot route service through a hub node.

[Table C-7](#) describes the potential causes of the symptom and the solution.

Table C-7 *Cannot Route Service*

Possible Problem	Solution
Since a hub node does not allow express channels, not all service routes are possible.	<p>Remove the path routing forcing or the hub functionality constraints.</p> <p>To remove the path routing forcing:</p> <ol style="list-style-type: none"> 1. In the Project Explorer pane under the Service Demands folder, right-click the appropriate demand and choose Edit from the shortcut menu. 2. In the Path column of the Edit <demand> dialog box, choose Auto from the drop-down list. 3. Reanalyze the network. <p>To remove the hub functionality constraints:</p> <ol style="list-style-type: none"> 1. In the Project Explorer pane under the Sites folder, click C-Band or L-Band for the appropriate site. 2. In the Properties pane, choose Auto from the Functionality drop-down list. 3. Reanalyze the network.

C.4.5 Overlapped Services Assigned to the Same Wavelength

Symptom Cisco Transport Planner warns you that overlapped services are assigned to the same wavelength.

[Table C-8](#) describes the potential causes of the symptom and the solution.

Table C-8 *Overlapped Services Assigned to the Same Wavelength*

Possible Problem	Solution
Some unprotected channels with assigned wavelengths and directions overlap along the ring.	<p>Remove path routing forcing and/or wavelengths on the specific channels.</p> <p>To remove the path routing forcing:</p> <ol style="list-style-type: none"> 1. In the Project Explorer pane under the Service Demands folder, right-click the appropriate demand and choose Edit from the shortcut menu. 2. In the Path column of the Edit <demand> dialog box, choose Auto from the drop-down list. 3. Reanalyze the network. <p>To remove the wavelength forcing:</p> <ol style="list-style-type: none"> 1. In the Project Explorer pane under the Service Demands folder, right-click the appropriate demand and choose Edit from the shortcut menu. 2. In the Wavelength column of the Edit <demand> dialog box, choose Auto from the drop-down list. 3. Reanalyze the network.

C.4.6 Protected Services Assigned to the Same Wavelength

Symptom Cisco Transport Planner warns you that protected services are assigned to the same wavelength.

[Table C-9](#) describes the potential causes of the symptom and the solution.

Table C-9 *Protected Services Assigned to the Same Wavelength*

Possible Problem	Solution
In ring networks, each protected/P-ring request allocates one wavelength. If more than one protected service is forced on the same wavelength and aggregation is not possible, the network is not feasible.	Remove forced wavelengths on the specific channels: <ol style="list-style-type: none"> 1. In the Project Explorer pane under the Service Demands folder, right-click the appropriate demand and choose Edit from the shortcut menu. 2. In the Wavelength column of the Edit <demand> dialog box, choose Auto from the drop-down list. 3. Reanalyze the network.

C.4.7 Cannot Route Service Because of Add/Drop Constraints

Symptom Cisco Transport Planner warns you that it cannot route service because of add/drop equipment constraints.

[Table C-10](#) describes the potential causes of the symptom and the solution.

Table C-10 *Cannot Route Service Because of Add/Drop Constraints*

Possible Problem	Solution
Add/drop equipment forcing might prevent express channels in a node, which makes unfeasible some channel routes.	Remove add/drop equipment constraints. <ol style="list-style-type: none"> 1. In the Project Explorer pane under the Sites folder, click C-Band or L-Band for the appropriate site. 2. In the Properties pane, choose Auto from the Functionality drop-down list. 3. Reanalyze the network.

C.4.8 Design Requires a ROADM or Full Mux/Demux Site

Symptom Cisco Transport Planner warns you that the design requires a ROADM or full multiplexer/demultiplexer site, but no valid site was found.

Table C-11 describes the potential causes of the symptom and the solution.

Table C-11 *Cannot Route Service Because of Add/Drop Constraints*

Possible Problem	Solution
The traffic mapping algorithm might not be able to find a valid solution that respects both the user forcing and the system specifications (in terms of maximum site losses and layout constraints). In such cases, the only possible countermeasure for the algorithm is to upgrade one node to a full capacity node (ROADM or full Mux/Demux). If no valid node is found due to user forcing or equipment locking, the process stops and the network is unfeasible.	<p>Remove any forcing/locking that prevents at least one node from being upgraded to ROADM or full multiplexer/demultiplexer. Conditions that prevent upgrading a node to ROADM or full multiplexer/demultiplexer are:</p> <ul style="list-style-type: none"> • Site functionality is forced to Add/Drop and site type is forced to OADM • During an upgrade procedure, OADM equipment is locked if the site <p>To change site functionality and type forcing:</p> <ol style="list-style-type: none"> 1. In the Project Explorer pane under the Sites folder, click C-Band or L-Band for the appropriate site. 2. In the Properties pane, choose Auto from the Functionality drop-down list. 3. Choose Auto from the Type drop-down list. 4. Reanalyze the network. <p>To unlock OADM equipment:</p> <ol style="list-style-type: none"> 1. In the Project Explorer pane under the Sites folder, click Add/Drop under the appropriate site. 2. In the Properties pane, choose Auto from the OADM Forcing drop-down list. 3. Reanalyze the network.

C.5 Amplifier Troubleshooting

The following procedures help you resolve amplifier-related problems with the network design.

C.5.1 Incompatible DCUs (C-Band)

Symptom Cisco Transport Planner warns you that DCUs are incompatible.

[Table C-12](#) describes the potential causes of the symptom and the solution.

Table C-12 *Incompatible DCUs (C-Band)*

Possible Problem	Solution
If the DCUs in the same site are both SMF slope compensating, the cumulative negative dispersion should not be over 1600 ps/nm.	Remove or change one of the forced DCUs: <ol style="list-style-type: none"> 1. In the Project Explorer pane, click C-Band Amplifiers. 2. In the Properties pane, choose the desired DCU from the DCU1 and/or DCU2 drop-down lists. 3. Reanalyze the network.
If the DCUs in the same site belong to different types, only the following DCU combinations are allowed: DCU-E-200 and DCU-100, or DCU-E-350, and DCU-100.	
Two E-LEAF slope compensating DCUs are not allowed at the same site.	

C.5.2 MMU Does Not Have Correct Amplifier (L-Band)

Symptom Cisco Transport Planner warns you that an L-band node with an MMU requires that the OPT-AMP-L card is forced as the preamplifier (PRE) and booster amplifier (BST).

Table C-13 describes the potential causes of the symptom and the solution.

Table C-13 *MMU Does Not Have the Correct Amplifier (L-Band)*

Possible Problem	Solution
In L-band, a node with an MMU installed has amplifier forcing other than two OPT-AMP-L amplifier units, one as PRE and one as BST.	Remove any amplifier forcing in the node: <ol style="list-style-type: none"> 1. In the Project Explorer pane under the Sites folder, click L-Band Amplifiers for the appropriate site. 2. In the Properties pane, choose Auto from the PRE and BST drop-down lists. 3. Reanalyze the network.

C.5.3 MMU Does Not Have Correct Amplifier (C-Band)

Symptom Cisco Transport Planner warns you that a C-band node with an MMU requires both a preamplifier (OPT-PRE) and a booster (OPT-BST).

Table C-14 describes the potential causes of the symptom and the solution.

Table C-14 *MMU Does Not Have the Correct Amplifier (C-Band)*

Possible Problem	Solution
In C-band, a node with an MMU installed requires both OPT-PRE and OPT-BST.	Remove any amplifier forcing in the node: <ol style="list-style-type: none"> 1. In the Project Explorer pane under the Sites folder, click C-Band Amplifiers for the appropriate site. 2. In the Properties pane, choose Auto from the PRE and BST drop-down lists. 3. Reanalyze the network.

C.5.4 Output Power or Tilt are Out of Range

Symptom Cisco Transport Planner warns you that the output power or tilt are out of range for the amplifier selected.

[Table C-15](#) describes the potential causes of the symptom and the solution.

Table C-15 Output Power or Tilt are Out of Range

Possible Problem	Solution
The output power or tilt forced by the user is not within the allowed range based on the algorithm selected and the type of amplifier selected.	Remove or change the forced value: <ol style="list-style-type: none"> 1. In the Project Explorer pane under the Sites folder, click C-Band Amplifiers or L-Band Amplifiers for the appropriate site. 2. In the Properties pane, choose Auto from the Tilt drop-down list in the From Fiber and To Fiber areas. If you force a value, the tilt value limits are -3.0 to +3.0. 3. Reanalyze the network.

C.5.5 Invalid Fiber Values, Types, and Loss Values

Symptom Cisco Transport Planner warns you of one of the following:

- Fiber pairs are of invalid types or values
- Fibers have a start of life (SOL) total loss greater than an end of life (EOL) total loss

[Table C-16](#) describes the potential causes of the symptom and the solution.

Table C-16 Invalid Fiber Values, Types, and Loss Values

Possible Problem	Solution
An attenuator is forced in a site where there is no place to connect.	Remove the attenuator forcing or verify that the attenuator is inserted on the correct side and wavelength: <ol style="list-style-type: none"> 1. In the Project Explorer pane under the Sites folder, click C-Band Amplifiers or L-Band Amplifiers for the appropriate site. 2. In the Properties pane, complete one of the following: <ul style="list-style-type: none"> • Choose Auto from the Attenuator drop-down list in the From Fiber area to remove the forcing. • Verify that the attenuator is inserted on the correct side and wavelength. If not, revise accordingly. 3. Reanalyze the network.

C.5.6 Attenuator Forcing Not Allowed

Symptom Cisco Transport Planner warns you that attenuator forcing on channels is not allowed; no add/drop ports are available.

Table C-17 describes the potential causes of the symptom and the solution.

Table C-17 Attenuator Forcing Not Allowed

Possible Problem	Solution
Cisco Transport Planner has an attenuator forced in a site where there is no place to connect.	<p>Remove the attenuator forcing or verify that the attenuator is inserted on the correct side and wavelength:</p> <ol style="list-style-type: none"> In the Project Explorer pane under the Sites folder, click C-Band Amplifiers or L-Band Amplifiers for the appropriate site. In the Properties pane, complete one of the following: <ul style="list-style-type: none"> Choose Auto from the Attenuator drop-down list for the appropriate amplifier. Verify that the attenuator is inserted on the correct side and wavelength. If not, revise accordingly. Reanalyze the network.

C.5.7 Unavailable Add/Drop Channels

Symptom Cisco Transport Planner warns you that an attenuator was present, but add/drop channels are no longer available.

Table C-18 describes the potential causes of the symptom and the solution.

Table C-18 Unavailable Add/Drop Channels

Possible Problem	Solution
After a network upgrade, a client was removed but the add/drop attenuator is still forced.	<p>Unlock the add/drop attenuator:</p> <ol style="list-style-type: none"> In the Project Explorer pane under the Sites folder, click Client for the appropriate site. In the Properties pane, choose Auto from the drop-down list for the appropriate Rx and Tx attenuator. Reanalyze the network.

C.5.8 Tilt Forced When No Tilt Design Is Selected

Symptom Cisco Transport Planner warns you that tilt is forced for an amplifier although No Tilt Design was selected for the network.

Table C-19 describes the potential causes of the symptom and the solution.

Table C-19 *Tilt Forced When No Tilt Design is Selected*

Possible Problem	Solution
<p>The user forced one or more amplifier tilt setting, but the No Tilt Design option is also selected.</p> <p>Note To view that No Tilt Design is selected in the Project Explorer, click the appropriate system release under DWDM Design Rules settings in the Subnets folder.</p>	<p>Remove forced tilt for the amplifier:</p> <ol style="list-style-type: none"> 1. In the Project Explorer pane under the Sites folder, click C-Band Amplifiers or L-Band Amplifiers for the appropriate site. 2. In the Properties pane, choose Auto from the Tilt drop-down list for the appropriate amplifier. 3. Reanalyze the network.

C.5.9 Cannot Replace 32-DMX with 32DMX-O

Symptom Cisco Transport Planner warns you that 32-DMX cannot be replaced with 32DMX-O as needed because of user forcing.

Table C-20 describes the potential causes of the symptom and the solution.

Table C-20 *Cannot Replace 32-DMX with 32DMX-O*

Possible Problem	Solution
Cisco Transport Planner attempts to use the 32DMX-O card but the 32-DMX card is forced by the user. This could cause an overload of alarms or, if no channel is alarmed, problems during network installation.	<p>If channels dropped at the site are alarmed, allow the use of add/drop attenuators:</p> <ol style="list-style-type: none"> 1. In the Project Explorer pane under the Subnets folder, expand DWDM Design Rules and click System Release. 2. In the Properties pane, uncheck No TXT/Line-Card RX Bulk Attenuator Design. 3. Reanalyze the network. <p>If no channel is alarmed, remove the 32-DMX forcing:</p> <ol style="list-style-type: none"> 1. In the Project Explorer pane under the Sites folder, click Add/Drop for the appropriate site. 2. In the Properties pane, choose Auto from the Demux drop-down list. 3. Reanalyze the network.

C.5.10 Pre-amplifier Working in Invalid Mode

Symptom Cisco Transport Planner warns you that a pre-amplifier is working in an invalid mode.

[Table C-21](#) describes the potential causes of the symptom and the solution.

Table C-21 Pre-amplifier Working in Invalid Mode

Possible Problem	Solution
A pre-amplifier is working in power control mode. Based on the traffic matrix, channel survivability might not be guaranteed if the fiber is cut or the equipment fails.	<p>If the booster amplifier preceding the pre-amplifier is forced as None by the user, remove the None forcing on the booster amplifier:</p> <ol style="list-style-type: none"> 1. In the Project Explorer pane under the Sites folder, click C-Band Amplifiers or L-Band Amplifiers for the appropriate site. 2. In the Properties pane, choose Auto from the Tilt drop-down list for the From Fiber (BST) amplifier. 3. Reanalyze the network. <p>If the span preceding the pre-amplifier is within the 27 to 30 dB range, use a higher powered C- or L-band rules algorithm (such as, 32 Chs + 5 dBm/ch):</p> <ol style="list-style-type: none"> 1. In the Project Explorer pane under the Subnets folder, expand Traffic Mapping and click System Release. 2. In the Properties pane, choose the new rules option from the C-Band Rules or L-Band Rules drop-down list. 3. Reanalyze the network. <p>If span is greater than 30 dB, the error is unavoidable.</p>

C.5.11 Gain Too Low for an Amplifier

Symptom Cisco Transport Planner warns you that an amplifier is working with a gain that is too low.

[Table C-22](#) describes the potential causes of the symptom and the solution.

Table C-22 Gain Too Low for an Amplifier

Possible Problem	Solution
An amplifier is working with a gain lower than its minimum capabilities. This could be caused by a span that is too short or by compensation problems (L-band only) coupled with the “Use in-line attenuator” option not selected.	<p>If attenuators are forced or inline attenuators were disabled, remove the forcing on the attenuators:</p> <ol style="list-style-type: none"> 1. In the Project Explorer pane under the Sites folder, click Add/Drop for the appropriate site. 2. In the Properties pane, choose Auto from the Attenuator drop-down list. 3. Reanalyze the network.

C.5.12 Gain Too High for an Amplifier

Symptom Cisco Transport Planner warns you that an amplifier is working with a gain that is too high. [Table C-23](#) describes the potential causes of the symptom and the solution.

Table C-23 *Gain Too High for an Amplifier*

Possible Problem	Solution
An amplifier is working with a gain that is greater than its physical capabilities.	Remove the forcing on the attenuators: <ol style="list-style-type: none"> 1. In the Project Explorer pane under the Sites folder, click Add/Drop for the appropriate site. 2. In the Properties pane, choose Auto from the Attenuator drop-down list. 3. Reanalyze the network.

C.5.13 User Forcing Overridden

Symptom Cisco Transport Planner warns you that user forcing will not be allowed.



Note

This is a warning and does not prevent the network from being fully functional. The message is displayed in situations where a forcing configured by the user cannot be respected due to physical constraints since the problem may appear only after several calculation steps. The algorithm notifies the user and ignores the setting to avoid interrupting the analysis.

[Table C-24](#) describes the potential causes of the symptom and the solution.

Table C-24 *User Forcing Overridden*

Possible Problem	Solution
If the warning appears during a network upgrade, this means the installation parameters must be updated because the upgrade is traffic affecting. This warning could also appear after importing a Cisco MetroPlanner 2.5.x network with all output as forcings.	For a network upgrade, unlock the site with the warning. For a 2.5.x import, if you cannot update the installation parameters, open the design in Cisco MetroPlanner 2.5.x.

**Note**

In the upgrade mode, Cisco Transport Planner remembers all the parameters from last analysis and not from its parent network. A warning with respect to the installation parameters is displayed only when there is a difference between the new values and the values from previous analysis. For example: Create a network design and analyse it. Upgrade the network design and modify some spans. Analyse the upgraded network. A warning message is displayed since some of the installation parameters have changed. Re-analyse the network with making modifications. The warning is no longer displayed since none of the installation parameters have changed. You can create a diff report to identify all the modified installation parameters, see “[3.2.15 Viewing Report Differences](#)” section on page 3-35.

C.5.14 Unsupported Configuration

Symptom Cisco Transport Planner warns you that the configuration is unsupported because of an excessive number of amplifiers or OSC regeneration sites.

[Table C-25](#) describes the potential causes of the symptom and the solution.

Table C-25 *Unsupported Configuration*

Possible Problem	Solution
The system is working over its specifications.	Revise the design and reanalyze.

C.5.15 Channel Power Near the Fail Threshold

Symptom Cisco Transport Planner warns you that the channel power is near the fail threshold.

[Table C-26](#) describes the potential causes of the symptom and the solution.

Table C-26 *Channel Power Near the Fail Threshold*

Possible Problem	Solution
Some thresholds are set to the minimum value allowed; this could lead to some false alarms during network life.	Remove the forcing: <ol style="list-style-type: none"> 1. In the Project Explorer pane under the Sites folder, click C-Band Amplifiers or L-Band Amplifiers for the appropriate site. 2. In the Properties pane, choose Auto from the PRE and BST drop-down lists. 3. Reanalyze the network.

C.5.16 Channel Power Below the Fail Threshold

Symptom Cisco Transport Planner warns you that the channel power is below the fail threshold.

[Table C-27](#) describes the potential causes of the symptom and the solution.

Table C-27 Channel Power Below the Fail Threshold

Possible Problem	Solution
The channel power received by the site is too low, and the fail threshold cannot be set.	Remove the forcing: <ol style="list-style-type: none"> 1. In the Project Explorer pane under the Sites folder, click C-Band Amplifiers or L-Band Amplifiers for the appropriate site. 2. In the Properties pane, choose Auto from the PRE and BST drop-down lists. 3. Reanalyze the network.

C.5.17 OSC Channel Power Below the Fail Threshold

Symptom Cisco Transport Planner warns you that the OSC channel power is below the fail threshold and that the network is not feasible.

[Table C-28](#) describes the potential causes of the symptom and the solution.

Table C-28 OSC Channel Power Below the Fail Threshold

Possible Problem	Solution
The OSC channel is not working.	Remove the forcing: <ol style="list-style-type: none"> 1. In the Project Explorer pane under the Sites folder, click C-Band Amplifiers or L-Band Amplifiers for the appropriate site. 2. In the Properties pane, choose Auto from the OSC drop-down list. 3. Reanalyze the network. If the span where the OSC fails is longer than 37 dB, the error is unavoidable.



APPENDIX **D**

Third-Party DWDM Wavelength Interface Model

Cisco Transport Planner allows you to define a third-party dense wavelength division multiplexing interface to be used in project creation. After you define third-party DWDM interfaces, you can choose them when creating traffic demands. This appendix provides background information for calculating third-party client wavelength interfaces.

Interface Operative Area

In the Cisco Transport Planner interface model, the operative area of an interface is defined on a two-dimensional Cartesian plane where the x-axis is the optical signal-to-noise ratio (OSNR) value (dB) and y-axis is the receiver (Rx) power value (dBm). Three lines border the operative area. These lines are an approximation of the ISO-Bit Error Rate (BER) curve corresponding to the maximum BER tolerable by the interface:

- On the original ISO-BER curve there are two points, OL and PL, that define the two main borders: OSNR limited (OL) and power limited (PL).
- The upper boundary of the OSNR-limited border is the interface power overload; this is also the upper limit to the working area. Physical constraints limit this value to 35 to 40 dB.

Figure D-1 shows the working area in an interface.

Figure D-1 Interface Operative Area

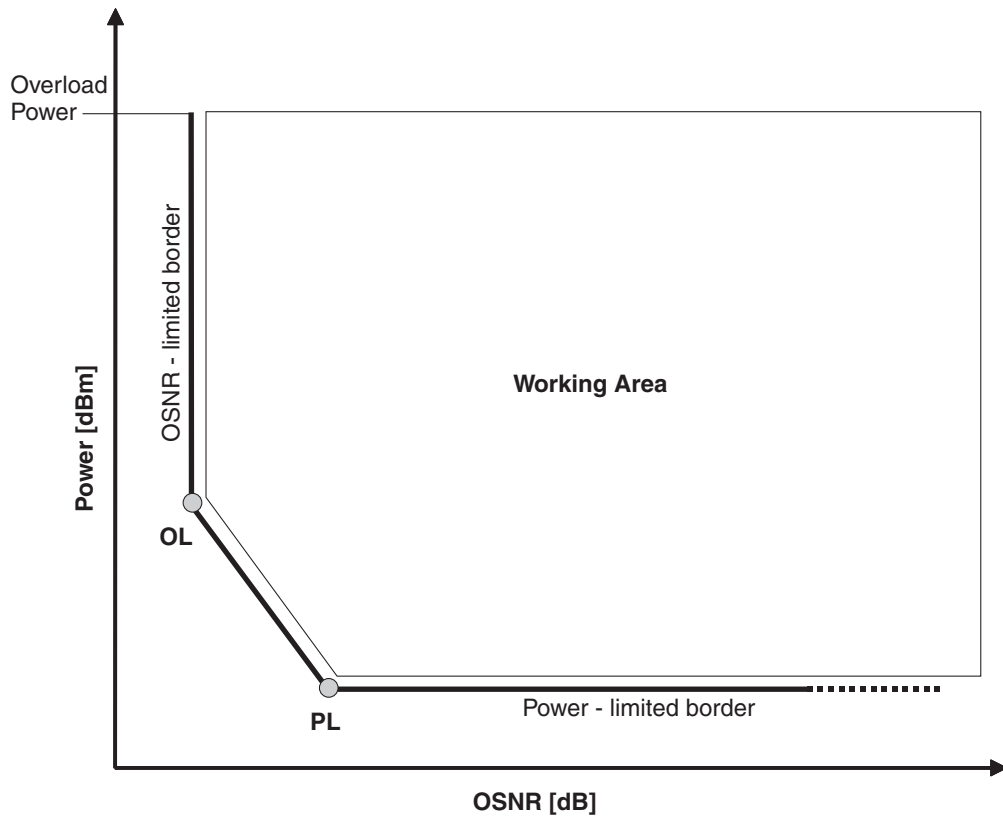

151731

Signal impairments reduce the operative area of the interface. Because of signal distortion, higher OSNR and/or power on the Rx are required to get the same BER. When the power and OSNR margins are increased, OL and PL identify a new working area (Figure D-2).

Figure D-2 Interface Margin Application

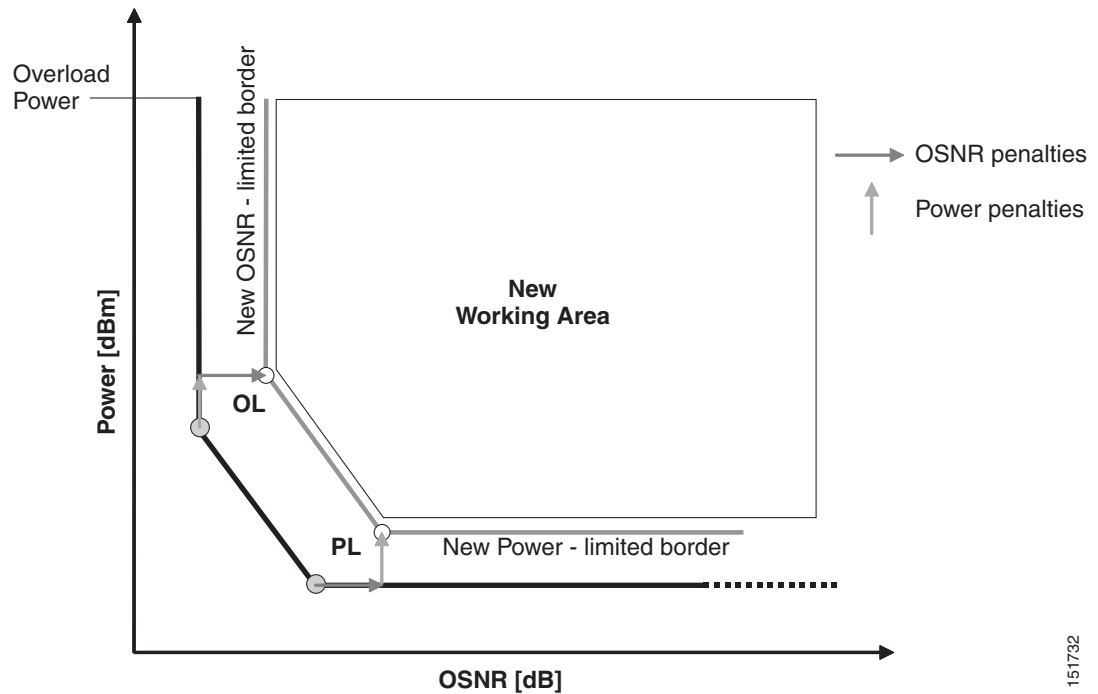

To define a third-party client interface, you enter parameters in Cisco Transport Planner that build the working area and model its robustness to signal impairments such as dispersion, single interfering, Gaussian cross talk (Xt), etc. The input parameters follow:

- Transmitter characteristics:
 - Modulation format— Non Return to Zero (NRZ) or Duo Binary
 - Transmitter type—Mach Zehnder (MZ), Direct Modulated Laser (DML), or Electro-absorption Modulated Laser (EML)
 - Receiver threshold—Optimal (minimum BER) or Average (average received power)
 - Regeneration type—3R or 2R regeneration mode
 - Forward Error Correction (FEC) mode—FEC, Enhanced FEC (E-FEC), or none
 - Transmitter stability—The maximum wavelength error allowed (pm)
- Bit rate
- Power range—Transmit (Tx) maximum and minimum power output levels (dBm)
- Back-to-back receiver sensitivity—A configuration in which the receiver is placed in front of the transmitter with no other equipment between the two. Back to back is used to measure Tx and Rx pairs.
 - Overload power (dBm)
 - OL_power (dBm)—The minimum power level in the OSNR-limited range

151732

- OL_OSNR (dB)—The minimum OSNR level in the OSNR-limited range (measured on 0.5 nm bandwidth)
- PL_power (dBm)—The minimum power level in the power-limited range
- PL_OSNR (dB)—The minimum power level in the OSNL-limited range (measured in .5 nm increments)
- Chromatic dispersion (CD)—The broadening of a light pulse after traveling a distance in the fiber. You can set the CD robustness [ps/nm], which is the maximum positive dispersion tolerable by the interface.
- Scale value—Calculates how efficient a card is in recovering the signal distortion. For more information, see the “Scale Factors” section on page D-4.
- Single-interfering cross-talk penalties—Calculates interference caused by a single signal. For more information, see the “Single-Interfering Cross-Talk Penalty Measurement” section on page D-5.
- Gaussian cross-talk penalties—Calculates random power that interferes with a signal. For more information, see the “Gaussian Cross-Talk Penalty Measurement” section on page D-6.

Transmitter characteristics, bit rate, and back-to-back sensitivity parameters are required to create a third-party interface; the other parameters are optional. Cisco Transport Planner checks your input to determine if the third-party interface could be modeled on a card type already present in the software. If the interface is not supported, Transport Planner displays an error message. For the procedure to define third-party interfaces, see “1.6.5 Defining Third-Party DWDM Interfaces” section on page 1-38.

Scale Factors

The slope of the Q-factor (BER error function) curve versus OSNR or Rx power determines how a BER increase could be recovered with an increase of OSNR, power, or both depending in which OSNR/power working point the card is. In general, the scale factors are two values (one in OSNR and one in power) for each working point (OL and PL) of the interface model. If one is zero, it means that for that working point the BER is not sensitive to an increase. At least one factor must be different from zero.

The scale factors reflect the optical signal after it has passed through the maximum dispersion it can tolerate, because when the signal is more distorted the slope is higher and the factors are applied on impairments other than dispersion. As a result, the slope should be calculated at the OSNR and power of the OL and PL points with the dispersion margins added. Q-factor variation is 2 dB.

F-P(PL), F-P(OL), F-OSNR(PL), and F-OSNR(OL) values entered in Cisco Transport Planner translate a Q-penalty (that is, a BER increase) into power and OSNR penalties. F-P(PL) and F-OSNR(PL) are evaluated in the PL working region, while F-P(OL) and F-OSNR(OL) are evaluated in the OL working region of the curve with the dispersion margins added.

The formulas follow:

- $P\text{-penalty}(PL) = Q\text{-penalty} * F\text{-P}(PL)$
- $P\text{-penalty}(OL) = Q\text{-penalty} * F\text{-P}(OL)$
- $OSNR\text{-penalty}(PL) = Q\text{-penalty} * F\text{-OSNR}(PL)$
- $OSNR\text{-penalty}(OL) = Q\text{-penalty} * F\text{-OSNR}(OL)$

Figure D-3 illustrates the increase in OSNR corresponding to a variation of the Q-factor equal to 2 dB.

Figure D-3 Q-Factor Curve

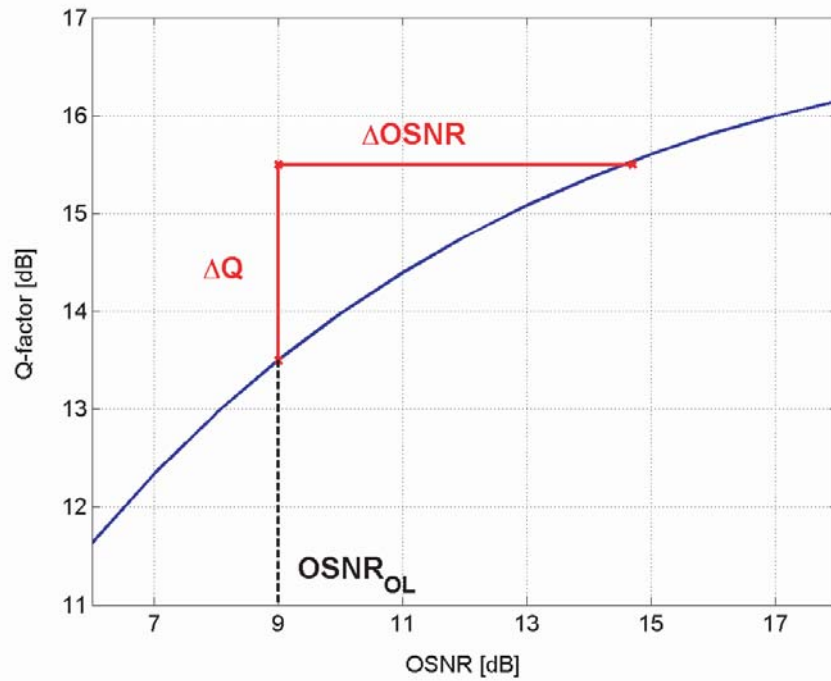

151980

Single-Interfering Cross-Talk Penalty Measurement

The single interfering cross-talk (Xt) measurement is shown in Figure D-4. The signal is split into two parts and recombined after one part has passed through attenuation, polarization scrambling, and linear transmission. The cross-talk calculation is the ratio between the two recombined signals. The attenuation allows different levels of cross-talk. The polarization scrambling measures the worst case of reciprocal polarization between the signal and its attenuated replica and the fiber to avoid phase coherence between signal and replica.

Because the penalty depends on the OSNR and power level, the measurement is calculated in the two working points OL and PL with the dispersion margin added. Consequently, a fiber with the maximum dispersion the interface can tolerate is placed between the transmitter and the splitter, as shown in Figure D-5. Transmission into the fiber should be linear (with channel power less than -10 dBm).

To calculate single-interfering cross-talk, you can input the coefficients for the exponential curves that estimate P-penalty(PL), P-penalty(OL), OSNR-penalty(PL), and OSNR-penalty(OL) for in the OL and PL regions of the interface model with dispersion margins added. The formula is $\text{Penalty}(\text{IXt}) = A_{\text{SIXt}} * \exp(B_{\text{SIXt}} * \text{IXt})$.

Figure D-4 Generation Block for Single-Interfering Cross-Talk Measurement

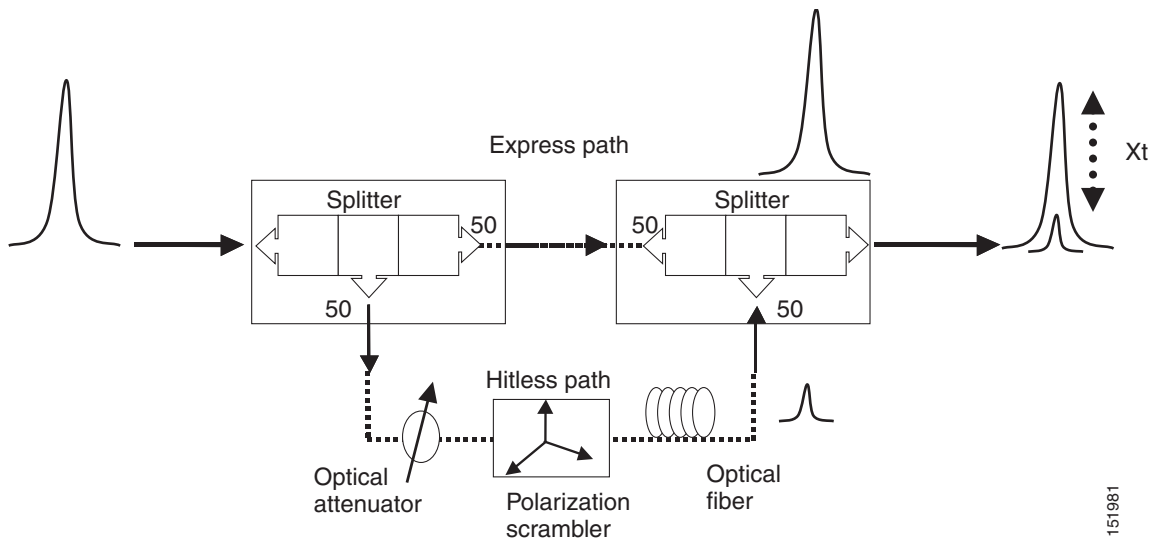
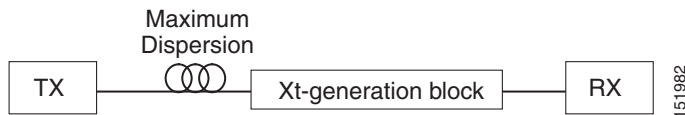

Figure D-5 Block Diagram for Crosstalk Measure



Gaussian Cross-Talk Penalty Measurement

Cross-talk with Gaussian statistics can be simulated by recombining a high number of interfering signals. The interfering branch shown in Figure D-4 set up has to be replicated in order to obtain more interfering signals, as shown in Figure D-6. The signal is split into N parts and each part but one passes through an attenuator (from A_1 to A_N in Figure D-6), a polarization scrambler, and a spool of fiber. Ten interfering signals are enough to guarantee a good approximation of the Gaussian statistics. In case of the single interfering cross-talk, the penalty depends on the working point, OSNR/power, in which the card is working. The measurement should be done in the OL and PL with dispersion margin added with the maximum dispersion tolerable by the card, as shown in the block diagram of Figure D-5.

To calculate Gaussian cross-talk levels, you can enter the coefficients for the exponential curves that estimate P-penalty(PL), P-penalty(OL), OSNR-penalty(PL), and OSNR-penalty(OL) in the OL and PL regions of the interface model with dispersion margins added. The formula is $\text{Penalty}(\text{GXt}) = A_{\text{GXt}} * \exp(B_{\text{GXt}} * \text{GXt})$.

Figure D-6 Generation Block for Gaussian Cross-Talk Measurement

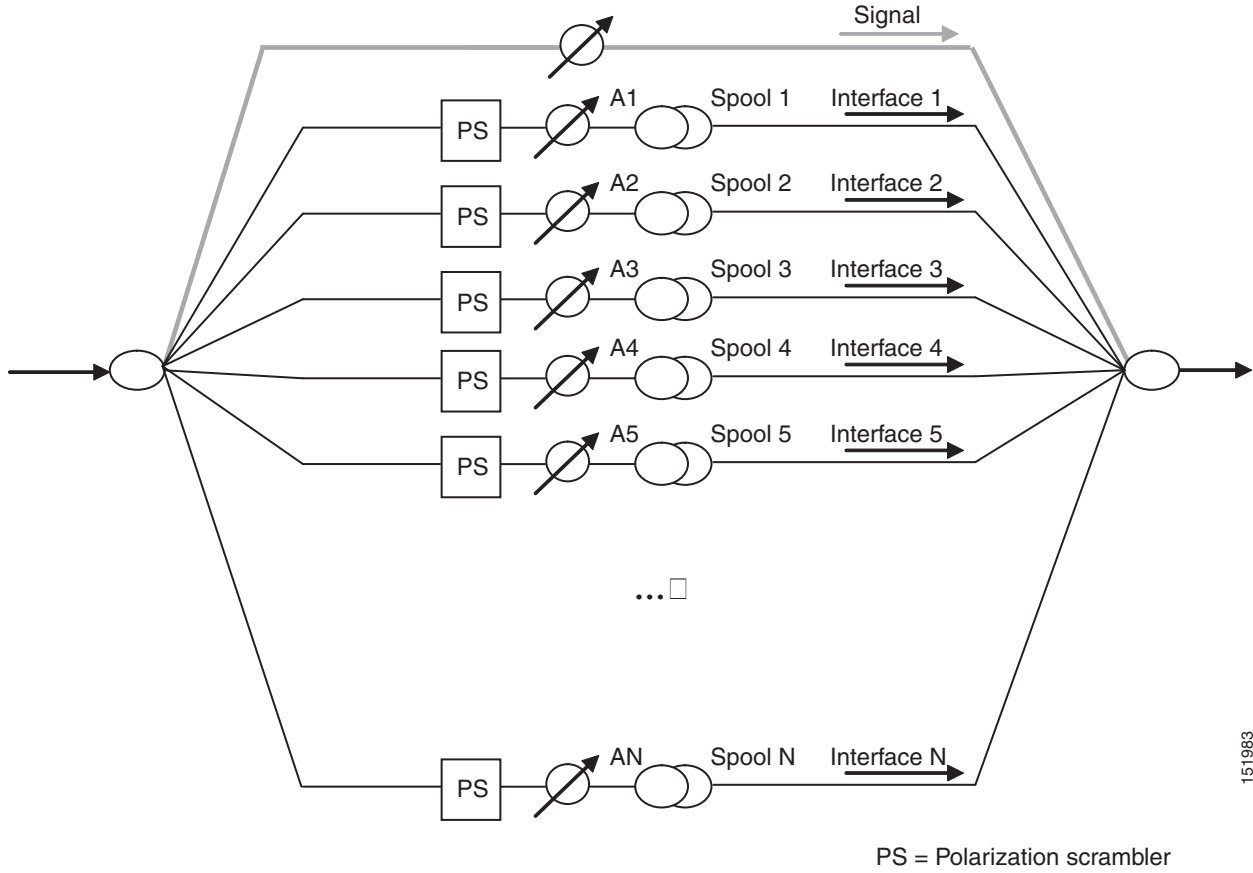

151983



APPENDIX **E**

Configuring CTP to Run on a Server

Analysis of complex networks are CPU intensive and often time consuming. Cisco Transport Planner can be deployed on a server so that network analysis is carried out on the server. CTP launch and operation are supported by the following remote application software:

- Windows Server with Terminal Services
- VNC

Terminal Services, available in Windows Server, makes it possible to run CTP on the terminal server but have it controlled from the user desktop, thus behaving like a local application. See [Figure E-1](#).

For more information about Windows Terminal Server, refer to the following URL:

<http://download.microsoft.com/download/2/8/1/281f4d94-ee89-4b21-9f9e-9accef44a743/TerminalServerOverview.doc>

Figure E-1 Remote Desktop Connection Using Terminal Services

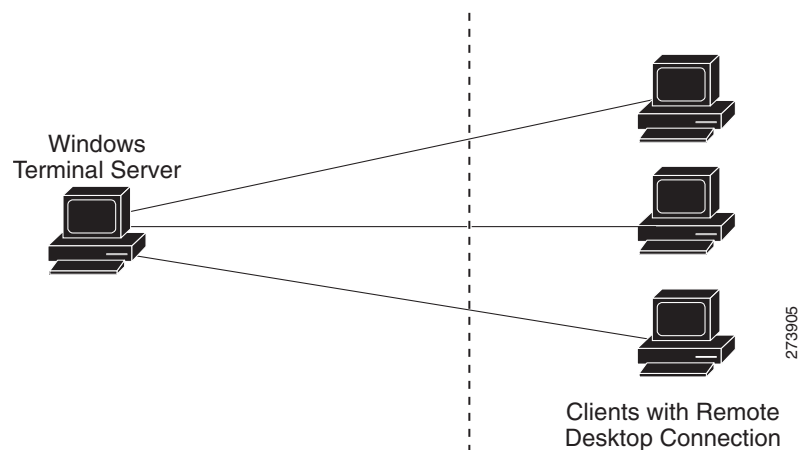

To use VNC, an instance of the VNC server must be installed on the server and the VNC viewer must be installed on the user desktop. To download VNC, go to <http://www.realvnc.com/>. See Figure E-2.

Figure E-2 VNC Environment

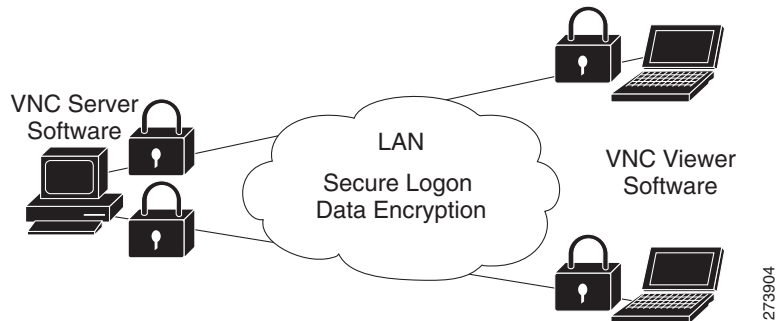

The server must be configured by the administrator so that all users have their own home directory on the server. The connection to the server is secure and can be established using a username and password. An instance of Cisco Transport Planner is installed in each user home directory. Users can deploy their Cisco Transport Planner profiles in their own server home directory. The profile settings are saved in the server home directory for every user.

The user can work on the server and save the design files in a directory in the home directory or in a public directory. An FTP client can be used to download or upload design files to the server from the desktop.

GoodSync can be used for file synchronization. For more information about GoodSync, go to <http://www.goodsync.com>.



APPENDIX **F**

Pay As You Grow Licensing

The Pay As You Grow (PAYG) licensing enables you to implement a cost effective solution when the wavelength requirements are comparatively less than the maximum capacity of the network. For more information about the Pay As You Grow feature, see the “[1.8 Understanding the Pay As You Grow Feature](#)” section on page 1-46.

F.1 Pay As You Grow

On enabling the Pay As You Grow licensing, the CTP algorithm decides on whether to use a PAYG instead of a standard capacity card based on the lower implementation cost. [Table F-1](#) lists PAYG licenses.

F.1.1 PAYG Licenses

Each PAYG license consists of cards or units, and a base license as listed in [Table F-1](#).

Table F-1 **PAYG Licenses**

PAYG Licenses	Description
15454-SMR1-LIC	License restricted to the 40-SMR1-C card.
15454-SMR2-LIC	License restricted to the 40-SMR2-C card.
15216-MD-ODD-LIC	License restricted to the Cisco ONS 15216 MD-40-ODD unit.
15454-WXC-LIC	License restricted to the 80-WXC-C card.
15454-LIC-CH-10	Capacity Expansion—License for ten additional add/drop or express channels.

F.2 PAYG for Client Cards

Table F-2 lists PAYG licenses for AR-MXP and AR-XP cards.

Table F-2 **PAYG for AR-MXP and AR-XP Cards**

PAYG Licenses	Description
15454-AR-MXP-LIC=	ONS 15454 Any-Rate Muxponder—Software license, upgradeable.
15454-AR-XP-LIC=	ONS 15454 Any-Rate Xponder—Software license, upgradeable.
15454-LIC-TXP-8G=	ONS 15454 Any-Rate Muxponder—8G FC TXP software license.
15454-LIC-MXP-4x2.5=	ONS 15454 Any-Rate Muxponder—4xOC48 or 4xSTM16 software license.
15454-LIC-10G-DM=	ONS 15454 Any-Rate Muxponder—Data Muxponder software license.
15454-LIC-MXP-AR=	ONS 15454 Any-Rate Muxponder—Any Rate Muxponder software license.
15454-LIC-REG-10G=	ONS 15454 Any-Rate Muxponder—10GE over OTN Regen software license.



INDEX

Numerics

- 15216 FlexLayer Hybrid
 - configuration [2-3](#)
- 80-WXC
 - site design rules (table) [4-19](#)
- 80-WXC-C card [4-31](#)

A

- A2A Finalized Circuit report
 - viewing [3-34](#)
- adding
 - fiber spans [2-11](#)
 - notes [2-14](#)
 - Remote Spur [4-116](#)
 - sites [2-10](#)
 - user profiles [1-44](#)
- adding sides
 - multi-degree site [2-4, 2-11](#)
- alien interface
 - defining [1-38](#)
 - Gaussian cross-talk [D-6](#)
 - scale factors [D-4](#)
 - single-interfering cross-talk [D-5](#)
 - working area [D-1](#)
- alien shelf placement rules [4-81](#)
- amplifier
 - OPT-EDFA-17 [4-32, 4-33](#)
 - OPT-EDFA-24 [4-32, 4-33](#)
- Analyzer pane, description [A-8](#)
- analyzing a network design [2-49](#)
- any-to-any, description [1-12](#)

- arranging sites [4-107](#)

B

- BOM report
 - exporting [2-64](#)
 - network [2-60](#)
 - site [2-61](#)
 - spare part [2-63](#)
 - totals [2-59](#)

C

- card descriptions [B-1](#)
- card movement rules [4-106](#)
- card placement rules [4-84](#)
- card rules [4-91](#)
- card slot constraints [4-78](#)
- changing network state
 - install [2-52](#)
 - upgrade [2-53](#)
- channel rules
 - traffic subnet [4-40](#)
- chassis
 - M12 [1-1](#)
 - M2 [1-1](#)
 - M6 [1-1](#)
- chassis placement rules [4-68](#)
- chassis selection rules [4-7](#)
- circuit, description [1-12](#)
- Cisco TransportPlanner
 - GUI description [A-1](#)
- client-based 1+1 protection, description [1-6](#)

client service support [1-8](#)
 closing a project [1-22](#)
 colorless demand [2-19](#)
 colorless omnidirectional [2-19](#)
 colorless property [2-18, 4-116](#)
 enable [2-26, 4-48](#)
 color scheme [1-25](#)
 copy, description [2-51](#)
 copying price lists [2-68](#)
 copy network and go back to design mode [2-52](#)
 Copy Properties [2-27](#)
 Copy ROADM demand properties [2-27](#)
 creating
 Ethernet aggregated demand [2-29](#)
 maintenance center [4-41](#)
 network copy [2-52](#)
 network design JPEG [2-58](#)
 optical subnet [2-12](#)
 point-to-point demands [2-19](#)
 price lists [2-65](#)
 P-ring demands [2-22](#)
 ROADM demands [2-25](#)
 TDM aggregated demand [2-36](#)
 traffic subnet [2-15](#)

CTP cache

 deleting [1-22](#)

D

database file
 importing [1-43](#)

default layout, resetting [1-44](#)

defining a third-party interface [1-38](#)

deleting
 fiber spans [4-122](#)
 network [4-122](#)
 networks [4-122](#)
 notes [4-119](#)
 price lists [2-68](#)

 sites [4-119](#)
 traffic subnet [4-121](#)

demand
 add site [4-57](#)
 add sites [4-57](#)
 mapping [2-72](#)
 remove site [4-57](#)
 remove sites [4-57](#)

demand, description [1-12](#)

Design-Analyzed state, description [2-51](#)

design state, description [2-51](#)

double ring site arrangement [4-110](#)

E

EDFA amplifiers [4-32, 4-33](#)

edit channel plan
 traffic subnet [4-40](#)

editing
 Ethernet aggregated demand [4-48](#)
 fiber spans [4-58, 4-62](#)
 network parameters [4-1](#)
 point-to-point demand [4-41](#)
 P-ring demand [4-44](#)
 project parameters [4-1](#)
 ROADM demand [4-47](#)
 service demand [4-39](#)
 side label [4-39](#)
 sides, sides
 editing [4-114](#)
 sites [4-2](#)
 sites, sites
 editing [4-113](#)
 TDM aggregated demand [4-53](#)

ellipse site arrangement [4-107](#)

Ethernet aggregated demand
 creating [2-29](#)
 editing [4-48](#)

Ethernet Aggregated Demand report [3-32](#)

export
 network [2-71, 2-72](#)
 xml to CTP [2-72](#)

exporting
 BOM [2-64](#)
 fiber spans [4-65](#)

Export XML [2-72](#)

F

FDCU [1-36, 4-33, 4-34, 4-37](#)

fiber
 mapping [2-72](#)

fiber spans
 adding a span [2-11](#)
 deleting [4-122](#)
 editing [4-58, 4-62](#)
 exporting [4-65](#)

fiber-switched protection, description [1-7](#)

Filler card [4-28](#)

FLD-4 units [4-38](#)

Flexible Site Type [4-31](#)

FlexLayer placement rules [4-83](#)

G

Gaussian cross-talk [D-6](#)

graphical display, setting [1-25](#)

guard band [1-35](#)

H

hybrid configuration [1-45](#)

I

import
 network [2-71, 2-72](#)

xml to node [2-73](#)

importing
 database files [1-43](#)
 Osmine configuration file [1-44](#)
 Sherpa design [2-69](#)

Install-Analyzed state, description [2-51](#)

Installation Parameters report [3-4](#)

Installing CTP [1-17](#)
 Linux [1-17](#)
 Windows [1-17](#)

Install state, description [2-51](#)

interface operative area [D-1](#)

Internal Connections report [3-7](#)

J

JPEG, network design [2-58](#)

L

layout adjustments
 constraints [4-104](#)
 M2 [4-104](#)

layout report [3-16](#)

layout rules
 DCU [4-88](#)
 hybrid site [4-88](#)
 multidegree [4-89](#)
 OIC multidegree nodes [4-91](#)
 OTS units [4-89](#)
 OXC multidegree sites [4-90](#)

linear topologies [5-1](#)

linear topology [5-2](#)

Link Availability report [3-22](#)

loading
 network [1-21](#)
 price lists [2-67](#)

locked state [2-55](#)

M

M2 and M6 shelf placement rules [4-81](#)

maintenance

contracts [2-69](#)

creating a maintenance center [4-41](#)

Manual Regeneration [1-3](#)

creating [2-42](#)

map

demand [2-72](#)

fiber [2-72](#)

node elements [2-72](#)

site [2-72](#)

Maximum Rectangle View [4-111](#)

menu bar and toolbar description [A-2](#)

meshed topology [5-4](#)

mouse shortcuts [A-9](#)

MSM External Switch [4-7](#)

multi-degree site

adding sides [2-4](#)

multishelf placement rules [4-78](#)

N

network

BOM [2-60](#)

deleting [4-122](#)

editing [4-1](#)

export [2-71, 2-72](#)

import [2-71, 2-72](#)

loading [1-21](#)

unloading [1-21](#)

network analysis

server [E-1](#)

Network Creation wizard [2-3](#)

network design

analyzing [2-49](#)

constraints [1-4](#)

creating a copy [2-52](#)

creating a JPEG [2-58](#)

process flow [1-10](#)

process overview [1-3](#)

putting a network in the Install state [2-52](#)

putting a network in the upgrade state [2-53](#)

state descriptions [2-51](#)

supported client services [1-8](#)

supported platforms [1-4](#)

supported protection schemes [1-6](#)

supported topologies [1-4](#)

unlocking [2-55](#)

Network Mgmt Tree tab

changing the appearance [1-26](#)

Network Wide Layout Export [3-19](#)

Network Wide Layout Export Selection

Export layout as image [3-19](#)

Export layout data as table [3-19](#)

Export location [3-20](#)

Network Wide Layout summary [3-20](#)

Overwrite all files [3-20](#)

NE Update file, saving [3-3](#)

node

setup from CTP [2-73](#)

node controller [4-29](#)

node elements

mapping [2-72](#)

node parameters

export [2-71](#)

import [2-71](#)

node provisioning [2-73](#)

node setup [2-73](#)

notes

adding [2-14](#)

deleting [4-119](#)

NtVw Net# tab

changing the appearance [1-25](#)

showing duct details [1-26](#)

O

OADM Forcing [4-38](#)
 omnidirectional demand [2-18](#)
 omnidirectional functionality [2-17](#)
 omnidirectional property [4-115](#)
 enable [2-26, 4-47](#)
 omnidirectional entry point [4-32, 4-114](#)
 OPT-EDFA-17 amplifier [4-32, 4-33](#)
 OPT-EDFA-24 amplifier [4-32, 4-33](#)
 optical bypass
 add site [4-58](#)
 editor [4-58](#)
 remove site [4-58](#)
 optical bypass sites [4-58](#)
 optical insulators [1-31, 4-7](#)
 Optical Results report [3-24](#)
 optical subnet
 creating [2-12](#)
 OSC frame type [2-9, 4-63](#)
 FE Frame [2-9, 4-63](#)
 GE Frame [2-9, 4-63](#)
 OC3 Frame [2-9, 4-63](#)
 Osmine configuration file
 importing [1-44](#)
 OSNR alarm
 regenerating [1-35](#)
 OTU2_XP
 Dual Regenerator [2-44](#)
 Dual Transponder [2-44, 2-45](#)
 Mixed Mode [2-45](#)
 Protected Transponder [2-45](#)
 Single Regenerator [2-44](#)

P

panes [A-6](#)
 Pay As You Grow [1-46](#)
 bundles [F-1](#)

 overview [1-46](#)
 Pay As You Grow,PAYG [F-1](#)
 PAYG
 licensing
 client cards [F-2](#)
 PAYG,PAYG
 understanding [1-46](#)
 PAYG. *See* Pay As You Grow
 PAYG license,licensing
 PAYG,PAYG
 licensing [1-46](#)
 penalty [D-6](#)
 placement rules
 15216 40-Channel Mux/Demux units [4-72](#)
 air ramp [4-68](#)
 alien shelves [4-81](#)
 AR_MXP card [4-86](#)
 AR_XP card [4-86](#)
 card slots [4-76](#)
 client shelf [4-74](#)
 controller card [4-84](#)
 DCU [4-68](#)
 external switch [4-66](#)
 M12 as node controller [4-79, 4-80](#)
 M6 as node controller [4-79, 4-80](#)
 fiber storage [4-68](#)
 FlexLayer unit [4-83](#)
 general [4-65](#)
 ITU line card [4-86](#)
 M2 [4-68, 4-81](#)
 M6 [4-68, 4-81](#)
 manual regeneration [4-85](#)
 multishelf [4-78](#)
 multishelf separate nodes [4-80](#)
 multishelf separate shelves [4-80](#)
 MXP card [4-86](#)
 node [4-84](#)
 one-slot card [4-76](#)
 OTS unit [4-82](#)

- OTS units [4-89](#)
 - OTU2_XP card [4-85](#)
 - patch panel [4-69](#)
 - PSM card [4-83](#)
 - rack [4-65](#)
 - shelf [4-76](#)
 - SMR card [4-73](#)
 - two-slot card [4-76](#)
 - TXP card [4-86](#)
 - Y-cable [4-75](#)
 - platform
 - setting default values [1-28](#)
 - support [1-4](#)
 - point-to-point demand
 - creating [2-19](#)
 - deleting [4-121](#)
 - description [1-12](#)
 - editing [4-41](#)
 - viewing in Project Explorer [1-14](#)
 - populate shelves
 - from bottom [4-66](#)
 - from top [4-65](#)
 - power consumption [3-20](#)
 - PP-MESH [3-32](#)
 - price lists
 - copying [2-68](#)
 - creating [2-65](#)
 - deleting [2-68](#)
 - loading or unloading [2-67](#)
 - updating [2-67](#)
 - viewing [2-66](#)
 - viewing contracts [2-69](#)
 - P-ring demand
 - creating [2-22](#)
 - deleting [4-121](#)
 - description [1-12](#)
 - editing [4-44](#)
 - viewing in Project Explorer [1-15](#)
 - process flow [1-10](#)
 - project
 - adding notes [2-14](#)
 - closing [1-22](#)
 - deleting notes [4-119](#)
 - editing parameters [4-1](#)
 - saving [1-22](#)
 - setting default values [1-37](#)
 - Project Creation wizard [2-2](#)
 - Project Explorer
 - changing the appearance [1-25](#)
 - description [A-6](#)
 - loaded network [1-22](#)
 - unloaded network [1-21](#)
 - view [1-14](#)
 - Properties pane, description [A-7](#)
 - protection support [1-6](#)
 - Provision Node [2-73](#)
-
- ## R
- Raman amplification [4-32, 4-33, 4-64](#)
 - RAMAN-CTP [4-35](#)
 - RAMAN-CTP-COP [4-35](#)
 - regenerating
 - OSNR alarm [1-35](#)
 - Remote Spur [4-114](#)
 - adding [4-116](#)
 - duct creation [2-12](#)
 - reports
 - BOM totals [2-59](#)
 - Installation Parameters [3-4](#)
 - Internal Connections [3-7](#)
 - layout [3-16](#)
 - Layout Table (power consumption) [3-20](#)
 - Link Availability [3-22](#)
 - network BOM [2-60](#)
 - Optical Results [3-24](#)
 - site BOM [2-61](#)
 - spare part BOM [2-63](#)

- Summary [3-2](#)
- Traffic Matrix [3-10](#)
- Wavelength Routing [3-28](#)
- resetting the default layout [1-44](#)
- restricted equipment list, updating [1-33](#)
- ring topology [5-2](#)
- ROADM demand
 - creating [2-25](#)
 - deleting [4-121](#)
 - description [1-12](#)
 - editing [4-47](#)
 - routing strategies [1-13](#)
 - viewing in Project Explorer [1-15](#)
- rules, C-band [1-30](#)
- Run Quick Analysis [1-35](#)

S

- saving
 - NE Update file [3-3](#)
 - project [1-22](#)
- scale factors [D-4](#)
- service demand
 - editing [4-39](#)
- setting
 - graphical display [1-25](#)
 - platform default values [1-28](#)
 - project default values [1-37](#)
- setup
 - node from CTP [2-73](#)
- shelf adjustments [4-105](#)
- shelf layout, adjusting [4-104](#)
- Shelf Management [1-30, 2-6, 4-5](#)
 - Auto [1-30, 2-6, 4-6](#)
 - Locked state [4-106](#)
 - modify [4-106](#)
 - Multi Shelf External Switch [1-30, 2-6, 4-6](#)
 - Multi Shelf Integrated Switch [1-30, 2-6, 4-6](#)
 - rules [4-79](#)
 - release-upgraded network [4-80](#)
 - upgraded network [4-80](#)
- Shelf Movement [4-104](#)
 - Destination rack [4-104](#)
 - From rack unit [4-104](#)
 - Source rack [4-104](#)
 - Swap [4-105](#)
 - To rack unit [4-105](#)
- shelf movement rules [4-105](#)
- shelf placement rules [4-76](#)
- shelf rules [4-76](#)
- shelves placement
 - bottom-up approach [4-66](#)
 - top-down approach [4-65](#)
- Sherpa file
 - importing [2-69](#)
- shortcuts [A-9](#)
- side label
 - editing [4-39](#)
- Sides Label [1-45](#)
- single-interfering cross-talk [D-5](#)
- single-span topology [5-1](#)
- site
 - add [4-57](#)
 - add to demand [4-57](#)
 - mapping [2-72](#)
 - network elements [4-2](#)
 - remove [4-57](#)
 - remove from demand [4-57](#)
- Site Functional View [2-50](#)
 - Alarms [2-51](#)
 - Changing the view
 - Zoom In [2-50](#)
 - Zoom Out [2-50](#)
 - Open Site Functional View [2-50](#)
 - Transponder and Muxponder connections [2-51](#)
 - Zoom Out [2-50](#)
- site layout, adjusting [4-97](#)
- site properties, modify [4-111](#)

sites

- add [4-57](#)
- adding a site [2-10](#)
- add to demand [4-57](#)
- arranging [4-107](#)
- BOM [2-61](#)
- creating a maintenance center [4-41](#)
- deleting [4-119](#)
- deleting a site [4-119](#)
- editing [4-2](#)
- optical bypass
 - add [4-58](#)
 - remove [4-58](#)
 - remove [4-57](#)
 - remove from demand [4-57](#)
- snake site arrangement [4-109](#)
- snapshot, network design [2-58](#)
- software updates [1-23](#)
- spare part BOM [2-63](#)
- spare parts suppliers [4-41](#)
- square site arrangement [4-108](#)
- Summary report [3-2](#)

T

tasks pane

- description [A-9](#)

TCC type [1-33, 4-29](#)

TDM aggregated demand

- creating [2-36](#)
- editing [4-53](#)

TDM Aggregated Demand report

- Viewing [3-33](#)

Terminal Services [E-1](#)

third-party interface

- defining [1-38](#)
- Gaussian cross-talk [D-6](#)
- scale factors [D-4](#)

single-interfering cross-talk [D-5](#)working area [D-1](#)topologies [5-1](#)

- linear [5-1, 5-2](#)
- meshed [5-4](#)
- ring [5-2](#)
- single-span [5-1](#)

topology support [1-4](#)

traffic

- viewing [1-13](#)

traffic groups

- description [1-12](#)
- point-to-point [1-14](#)
- P-ring [1-15](#)
- ROADM [1-15](#)

Traffic Matrix report [3-10](#)

traffic subnet

- channel rules [4-40](#)
- creating [2-15](#)
- deleting [4-121](#)
- edit channel plan [4-40](#)

UUninstalling CTP [1-18](#)

unloading

- network [1-21](#)
- price lists [2-67](#)

unlocking network components [2-55](#)unprotected minimum hop count, description [1-13](#)unprotected optimum optical path, description [1-13](#)unprotected subnet, description [1-13](#)

update

- software [1-23](#)

updating

- price lists [2-67](#)
- restricted equipment list [1-33](#)

Upgrade-Analyzed state, description [2-52](#)upgrade network to design mode [2-52](#)

Upgrade state, description [2-52](#)
user profiles, adding [1-44](#)
Use Template [2-27, 4-47](#)

V

viewing

 maintenance contracts [2-69](#)
 price lists [2-66](#)
 traffic [1-13](#)

VNC [E-1](#)

W

Wavelength Routing report [3-28](#)

Wavelength Selection

 Coloring Priority [1-35](#)
 Flat Grid Filling [1-35](#)
 Maximum Separation [1-35](#)

X

xml

 export to CTP [2-72](#)
 import to node [2-73](#)

Y

Y-cable protection, description [1-6](#)

